

**Backward diodes are great** for the detection of microwaves—if the mount is right. A stripline mount, designed with a probe, solves the major problems of

this diode: the variation of the output with temperature and with the position of the diode in the waveguide. The examination of the design starts on page 44.

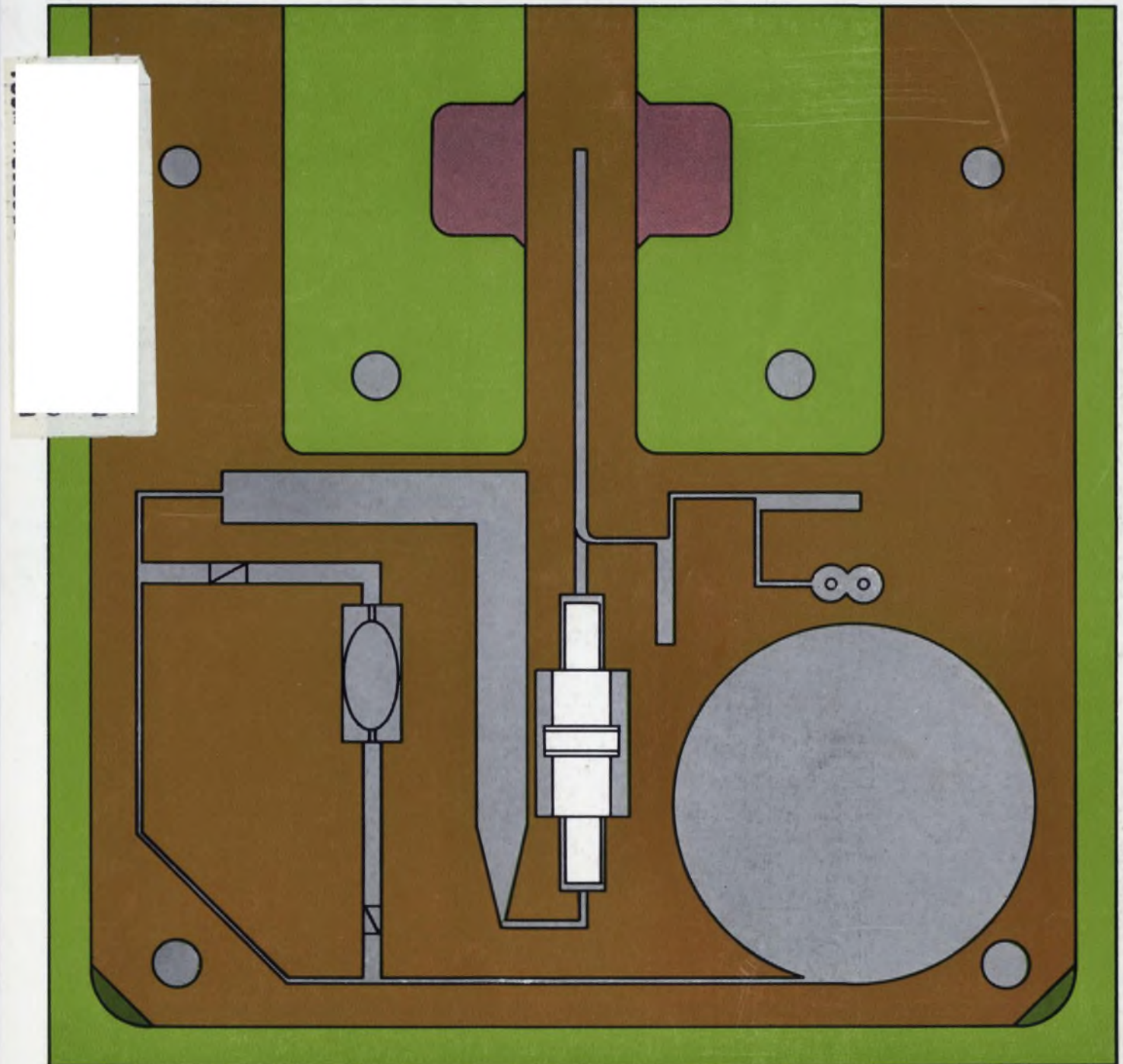



**HI-FI**



Transistor output; matches any PP transistor to 4, 8, 16  $\Omega$  speaker. Primary 48, 36, 12  $\Omega$  C.T.; 20  $\rightarrow$  to 20 KC; 40 watts.

**MINIATURE MIL TYPE**



Metal case hermetically sealed to MIL-T-27B. Gold Dumet leads spaced on 0.1 radius, for printed circuit application.

**CHOPPER**



Magnetic shielded plus electrostatic shield for voltage isolation of 2x10<sup>6</sup>. Primary 200K C.T. to within 0.1%. Secondary 50K.

**HIGH POWERED AUDIO**



Low distortion 2.5 KW output transformer, PP 450 TH's 18,500 ohms C.T. to 24/6 ohms, 20 KV hipot. 520 lbs.

**CATHODE FOLLOWER OUTPUT**



Provides equal voltages to 5 loads. Primary inductance maintained to 5% with 20% change in DC unbalance and 30% change in AC voltages.

**"SPECIAL" CUSTOM BUILT AUDIO TRANSFORMERS TO YOUR SPECIFICATIONS**

**HI-FREQUENCY CARRIER TO MIL-T-27B**



Electrostatically shielded, humbucking, +30 dbm level. Within .5 db 250 cycles to 110 KC. 600/135:600 centertapped to .1% tolerance.

**HYBRID TRANSFORMER**



Two transformers each 600  $\Omega$  primary, 40K  $\Omega$  C.T. secondary 250 cycles to 5 KC within 1/4 db, 40 db isolation over band.

**MICROMODULE**



Life tested per micromodule specs: no failures. 10K  $\Omega$  C.T. to 10K  $\Omega$ , 100 mw from 400  $\rightarrow$  to 20KC.

**SUBMINIATURE MOLDED TRANSFORMER**



Grade 3 with printed circuit leads for transistor application. 150  $\Omega$  to 150  $\Omega$  at 10 dbm level. Size 1/2 x 1/2 x 1/2"; weight 5 grams.

**BOLOMETER TRANSFORMER**



Primary 10 ohms, secondary 530K ohms, 230:1 ratio, response from 1/2 cycle to 25 cycles. 120 db magnetic shielding, plus full electrostatic shielding.

**ULTRA-MINIATURE**



Electrostatically & magnetically shielded output transformer 1/4 D. x 1/4" H. Pri. 15K CT, Sec. 8K CT; max. level 50 mw; audio range response. To MIL-T-27B, grade 4.

Exceptional quality and reliability is provided in all UTC designs. Over 30 years of engineering knowledge and experience substantiated by extensive field performance assure the highest quality and most reliable components in the industry. Complete environmental testing facilities are incorporated to prove out new designs. Full analysis and evaluation of materials are conducted in UTC's Material and Chemical Laboratories. Rigid quality control measures coordinated with exhaustive statistical findings and latest production procedures results in the industry's highest degree of reliability. Range covered in Audio Transformers is from 0.1 cycles to 400 MC . . . microwatts to 50 KW.

**MILITARY AND COMMERCIAL TYPES FOR EVERY PHASE OF THE ELECTRONICS ART**

- POWER TRANSFORMERS
- AUDIO TRANSFORMERS
- INDUCTORS
- PULSE TRANSFORMERS
- ELECTRIC WAVE FILTERS
- LUMPED CONSTANT DELAY LINES
- HIGH Q COILS
- MAGNETIC AMPLIFIERS
- SATURABLE REACTORS
- REFERENCE UNITS

Write for catalog of over 1,300 UTC TOP QUALITY STOCK ITEMS IMMEDIATELY AVAILABLE from your local distributor.



**UNITED TRANSFORMER CORP.**  
150 VARICK STREET, NEW YORK 13, N. Y.

PACIFIC MFG. DIVISION: 3630 EASTHAM DRIVE, CULVER CITY, CALIF.  
EXPORT DIVISION: 13 EAST 40th STREET, NEW YORK 16, N. Y. CABLE: "ARLAB"

ON READER-SERVICE CARD CIRCLE 243

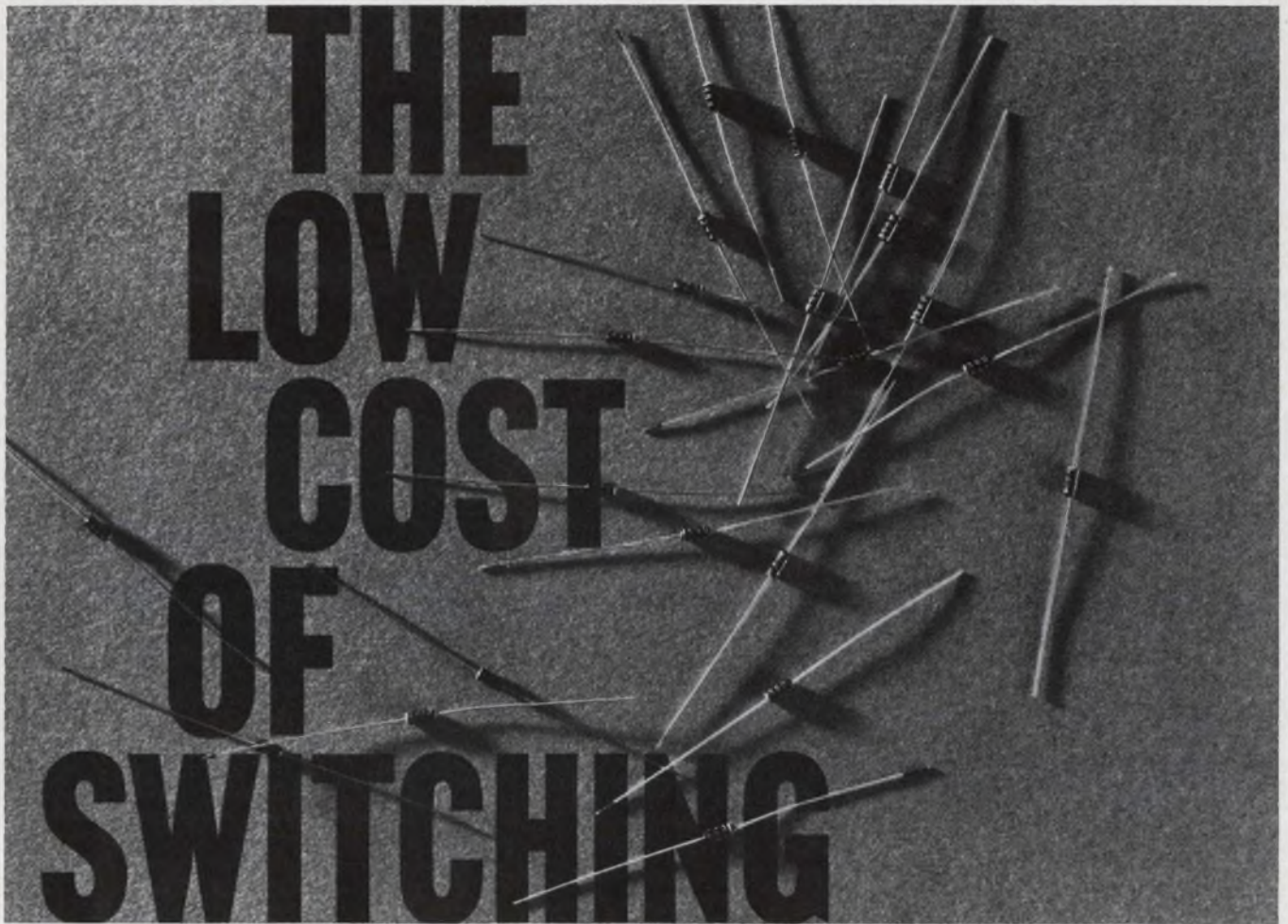

**...new value  
from new pricing  
on hot carrier diodes  
from hpa**

Ultra-fast switching with hp associates 2900 Hot Carrier Diode is now more economical than ever. New production techniques and experience have reduced the cost of these popular devices, and the savings is passed on to you.

The performance characteristics and pricing listed in the chart make the hpa 2900 ideally suited for use in TV tuners, commercial communications limiters, detectors and mixers, and multiplexing in signal processing.

Contact your Hewlett-Packard field engineer for complete data.

TYPICAL SPECIFICATIONS, hpa 2900		
<b>Forward Current</b> $I_{F1}$	<b>Breakdown Voltage</b> $BV_R$	
20 ma min. @ $V_F = 1.0$ v 1.0 ma min. @ $V_F = 0.4$ v	10 v @ $I_R = 10$ $\mu$ a	
<b>Leakage Current</b> $I_R$	<b>Lifetime</b> $\tau$	<b>Price</b>
100 na @ $V_R = -5.0$ v	100 ps	1 to 99, \$3.00 100 to 999, \$2.25

*Data subject to change without notice. Prices f. o. b. factory.*



**hp associates** 620 PAGE MILL ROAD,  
PALO ALTO, CALIF. 94304, (415) 321-8510  
An Affiliate of Hewlett-Packard



No, it's not the start of a price war. We're simply demonstrating that our new solid-state Model 616A frequency meter costs about half the price of any other comparably performing instrument now available. But, since the 616A is so versatile, who needs two of them anyway? This clever little instrument, with all silicon semiconductor insides, gives you direct frequency measurement through the entire 225 Mc telemetry band, and as high as 12 gigacycles with one plug-in. That's because we cunningly built in the prescaler. But Hewlett-Packard and Beckman didn't. There's a plug-in to a counter, and the total cost is twice that of our 616A. Then they sell you a second

plug-in to measure above 400 Mc. Speaking of plug-ins... the 616A comes well equipped! Slip in a frequency converter or other special CMC frequency extender plug-ins, and your frequency measurements can soar to 1,000 Mc, 3,000 Mc, and even a phenomenal 12 gigacycles! Or, with our time interval plug-ins, measure time from .1  $\mu$ sec. to 1 sec., or 1  $\mu$ sec. to 10 sec. Not only is the Model 616A half the price, but notice, it's half-rack size too! One reason is because, like others in the 600-Series, it features



an advanced "mother board" technique. Lost are excess size, weight, and components; gained are new shape, reliability, and ease-of-maintenance. Button it up with its front cover and this rugged 28-pound wizard goes right out in the field. All this for just \$2,185. Interested? Then send now for the complete specs. And, if you're new at comparing our specs to high-powered H-P and big, bad B, you can earn a glorious Crusading Engineers' medal which reveals to everyone that you had the guts to look at somebody else for a change. It's also a great conversation opener for sweet young things you want to dazzle at your next T. G. I. F. party!

12973 Bradley · San Fernando, California · Phone (213) 367-2161 · TWX 213-764-5993

COMPUTER MEASUREMENTS COMPANY IS A LEADING DESIGNER AND MANUFACTURER OF ELECTRONIC INSTRUMENTATION TO COUNT, MEASURE, AND CONTROL.

ON READER-SERVICE CARD CIRCLE 3

---

## NEWS

- 13 News report
- 17 **ESSA: Technical and meteorological success**  
Operational success of the ESSA II satellite has contributed both to aerospace electronics and to world-wide meteorology.
- 21 **Medical electronics fights heart disease**  
New devices and techniques coming out of the medical-electronics laboratory promise to reduce heart fatalities.
- 23 Microwave power race subsiding
- 25 Devices bury their heads in sand
- 31 Washington Report
- 35 Letters
- 41 **Editorial: Craftsmanship is the mark of the professional engineer.**
- 

## TECHNOLOGY

- 44 **Forward with backward diodes:** The vast improvements expected from these diodes can be realized with a new stripline mount.
- 52 **Predict common-emitter performance** before you build. Use these graphs to determine its step response as an amplifier or switch.
- 58 **Will a switch fail** after several hundred operations? The Poisson statistics in graphical form find the answer speedily.
- 62 **Need a small power inverter?** This compact poly-phase inverter design uses digital technique and integrated circuits.
- 66 **Widen multivibrator ranges** by separating the timing and bias. A constant-current source permits timing ranges up to 200 to 1.
- 72 **Combine reverse agc with diodes** for wide-range gain control, high agc loop gain and low receiver current in AM command receivers.
- 76 **Tackle those tough decisions** with this step-by-step attack. It will help boost your decision-making score and avoid fumbles.
- 87 Ideas for Design
- 

## PRODUCTS

- 98 **Test Equipment:** Memory tester uses 5 MHz IC logic
- 106 **Systems:** Sweep oscillator covers 0.25 to 40 GHz
- 112 Components
- 125 Power Equipment
- 126 Microwaves
- 128 Production Equipment
- 129 Semiconductors
- 132 Microelectronics
- 

## Departments

- 134 New Literature
- 138 Design aids
- 139 Application Notes
- 142 Advertisers' Index
- 144 Designer's Datebook
-



» 1958 «  
BOURNS TRIMPOT®  
MODEL 200

**GOOD**  
**\$3.60**



» 1966 «  
BOURNS TRIMPOT®  
MODEL 200

**BETTER**  
**\$3.60**

The quality goes up, the price stays down.  
Better value is part of

# BOURNS TOTAL VALUE

In 1958, when you paid \$3.60 (100-piece price) for a TRIMPOT® Model 200 potentiometer, you got the best buy of the day. Today, for the same price, you get an even better buy.

Power rating of Model 200 is now 100% higher. In addition, Model 200 now meets the steady-state humidity requirements of MIL-STD-202B, Method 103. Materials, too, are better. In 1959, when copper-plated printed-circuit pins were the industry standard, Bourns switched to gold-plated grade-A nickel pins. The results: better weldability, better solderability, better reliability. (Three years later, MIL-STD-1276 required this change of all printed-circuit components.)

Bourns products undergo this kind of upgrading constantly. Rather than wait for imposed standards to dictate improvements, Bourns sets higher standards with products that anticipate tomorrow's needs. Obviously, this philosophy puts quality above cost; however, through stringent production efficiency programs, Bourns keeps prices down.

Ever-rising quality—at competitive prices—is part of Bourns Total Value. It's one of the many reasons more adjustment potentiometers throughout the world bear the Bourns label than any other. It's one sound reason for *you* to investigate Bourns products, too.

THIS IS BOURNS TOTAL VALUE / Always your best value in potentiometers

## EXCLUSIVE RELIABILITY PROGRAM

The Bourns Reliability Assurance Program is the only one of its kind in the potentiometer industry. Its primary goal is reliability! It frequently requalifies all standard models to insure conformance with published specifications. It also makes available free test data, saving you the time and expense of quality verification. Conducted in *addition* to quality control, it makes Bourns potentiometers the most thoroughly inspected and tested units available.

## SUPERIOR QUALITY CONTROL

One-fifth of all Bourns employees work in quality control or reliability monitoring. This is one of the highest personnel ratios of QC employees and inspectors in the electronics industry. In addition, all standard Bourns products undergo extensive in-process and 100% final inspection. These facts help account for the company's return rate of only 0.2% (2 units returned of each 1000 shipped!), one of the lowest on record.

## MOST ADVANCED PRODUCTS

As the pioneer in adjustment potentiometers, Bourns has set the standards for an entire industry—in new products, in product improvements, in materials, in processes. Innovations such as the RESISTON® carbon and PALIRIUM® film

elements and the virtually indestructible SILVERWELD® termination demonstrate that Bourns is constantly pushing the standards higher.

## LARGEST SELECTION

Bourns offers the world's largest selection of potentiometers and an extensive line of precision potentiometers, relays and micro-components. This single-source capability means less shopping around, avoidance of costly specials.

## BEST AVAILABILITY

The factory maintains a constant reserve of more than 500,000 units. In addition, more than sixty distributors across the nation carry complete stocks of Bourns adjustment potentiometers. Whatever you need in potentiometers, you can depend on Bourns for an off-the-shelf answer.

## OUTSTANDING APPLICATIONS HELP

Bourns maintains a staff of ten professional Application Engineers whose sole job is to give you technical assistance. Each of these specialists serves a specific geographic area. All are extremely able and anxious to help you cut time, corners and costs.

## LONGEST EXPERIENCE, RELIABILITY

Bourns—originator of the TRIMPOT® lead-screw-actuated potentiometer—has

been making adjustment potentiometers longer than any other manufacturer. Bourns products have the longest reliability record, too, having performed successfully in every major U.S. missile and space program. And the record continues: in today's world-wide markets, far more adjustment potentiometers bear the Bourns label than any other.

## COMPETITIVE PRICES

Depth of product line and high production efficiency allow Bourns to meet or beat the prices of competitors—despite its heavy extra expenditure for product reliability. Furthermore, Bourns "holds the line" on prices while continually upgrading its products. In those cases where a Bourns unit is slightly more expensive, you can be sure that the small extra cost means considerable extra value. It is a firm Bourns policy *never* to compromise quality for price.



BOURNS, INC., RIVERSIDE, CALIFORNIA

Manufacturing Facilities  
RIVERSIDE, CALIFORNIA; AMES, IOWA;  
TORONTO, CANADA

Subsidiaries  
TORONTO, CANADA; ZUG, SWITZERLAND;  
THE HAGUE, NETHERLANDS

TRIMPOT is a registered trademark of Bourns, Inc.

©1966, BOURNS, Inc.

TRIMPOT® AND PRECISION POTENTIOMETERS—RELAYS—MICROCOMPONENTS: TRANSFORMERS, INDUCTORS, RESISTORS AND CAPACITORS

ON READER-SERVICE CARD CIRCLE 212

*Will this new  
General Purpose P&B relay make  
our best seller obsolete?*

**Never!**

*Never?*

*Well,  
maybe!*

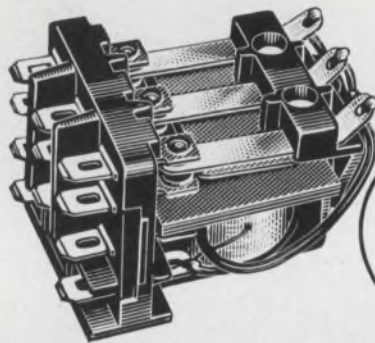

Our new KU relay is quite exceptional. For many relay users, it will be more convenient, more versatile, easier to install and replace . . . and cost substantially less money. Here's why.

**MODERN, COST SAVING TERMINALS**

Quick-connect terminals mean faster installation on your production line . . . easier replacement in the field. Standard models have .187" terminals, but .205" may be ordered. All terminals are punched for those who prefer solder connections. Barriers molded into the sturdy front meet U/L and CSA requirements.



**TRUE 10 AMP NYLON SOCKET**

A nylon socket—rated for carrying 10-amperes—can be supplied to make the KU a handy plug-in relay. Covered (KUP) relays, incidentally, cost



dramatically less than similar relays having octal-type plugs.

You may specify five- or ten-ampere KU relays. Longer movable arms and a unique method of staking the stationary contacts to the header contribute to the improved reliability and longer life of this new series.

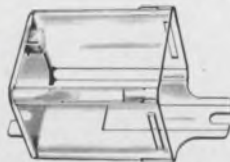

**WIDE CHOICE OF FEATURES**

Two styles of heat and shock resistant polycarbonate dust covers are available. One, with slotted flanges, provides a quick, convenient method for mounting the relay directly to a chassis. A handy push-button which operates the movable contacts can also be supplied for manually checking circuits. KUP relays are

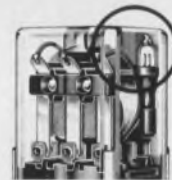
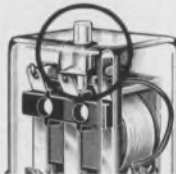

available with a neon lamp wired in parallel with their coils to indicate that power is reaching the relays.

Longer life, improved reliability, exceptional versatility and, in the case of covered relays, substantially lower costs are all part of the KU Series. Interested? Call your P&B sales representative today, or get in touch with us direct.

**KU SERIES SPECIFICATIONS**

**GENERAL:**

**Description:** 5 or 10 amperes General Purpose Relay.

**Expected Life:** 10,000,000 cycles, Mech.

**Breakdown Voltage:** 1,500V rms 60 Hz between all elements; 500V rms 60 Hz between open contacts.

**CONTACTS:**

**Arrangements:** Up to 3 Form C.

**Rating:** 5 or 10 amps @ 28V DC or 115V AC resistive.

**COILS:**

**Voltage:** DC to 110V; AC to 230V 60 Hz.

**Power:** DC 1.2 W; AC 1 and 2 poles 2.0 VA; AC 3 poles 2.7 VA.

**Resistance:** 16,500 ohms max.

**MOUNTING:**

(open relay) 6/32" mtg. stud, 7/32" locating tab on 7/16" centers. Socket available.

STANDARD P&B RELAYS ARE AVAILABLE AT LEADING ELECTRONIC PARTS DISTRIBUTORS



**POTTER & BRUMFIELD**

Division of American Machine & Foundry Company, Princeton, Indiana

Export: AMF International, 261 Madison Avenue, New York, N. Y.

Speed Inquiry to Advertiser via Collect Night Letter  
ON READER-SERVICE CARD CIRCLE 4



# ?

**Should you buy Signetics  
new SP600 series dual in-line plug-in packages  
just because they're low-priced**



**No, there are better reasons.  
They contain multi-function DTL circuits, for one.**

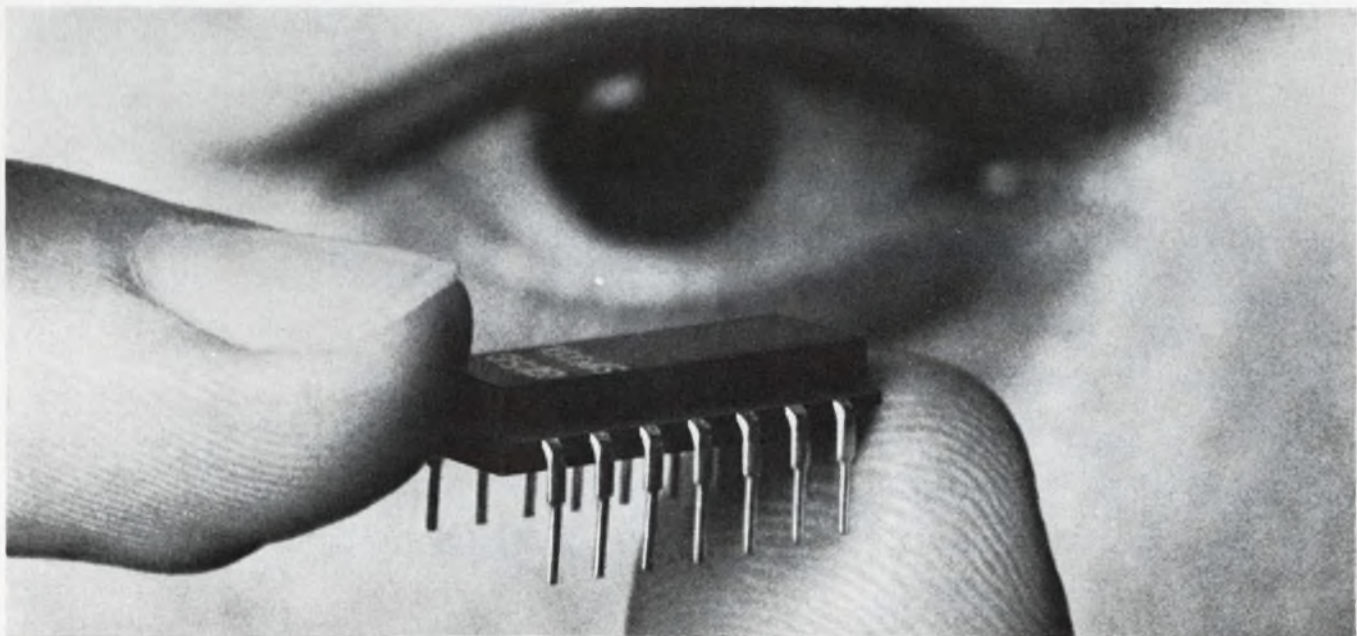

For another, the SP600 package is monolithic. A solid epoxy block encapsulates both the circuit chip and the leads connecting it to the external plug-in pins. Result: mechanical ruggedness and built-in vapor barrier protection for the circuit. The new SP600 series package has been tested and stressed to levels far in excess of those required by MIL-S-19500D and MIL-STD-750, even though it is intended for

commercial applications. Handling and insertion ease are guaranteed by 100 mil center-to-center pin spacing and 300 mils between rows conforming to widely accepted circuit board drill patterns. Mechanical or hand insertion and high-volume flow soldering techniques can be used on all Signetics SP600 series circuits. For the other umpteen reasons, write for your free copy of our SP600A brochure.

## **SIGNETICS INTEGRATED CIRCUITS**

A subsidiary of Corning Glass Works,  
811 East Arques Avenue, Sunnyvale, California  
Tel.: (408) 739-7700 TWX: (910) 737-9965



Signetics SP600 series includes a J-K flip-flop, three multiple DTL gate packages (dual, triple and quadruple NAND/NOR), a quadruple gate-input expander, and a dual DTL line driver/buffer element.

ON READER-SERVICE CARD CIRCLE 5

# GLASS-K

New CORNING® GLASS-K Capacitor gives you 100,000 pf in this case size

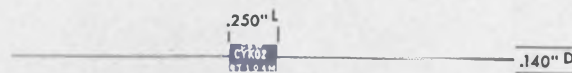

with performance stability and reliability that no conventional CK-type can match

# SS-K

Compare these unretouched photomicrographs of cross-sections of three CK-type capacitors:

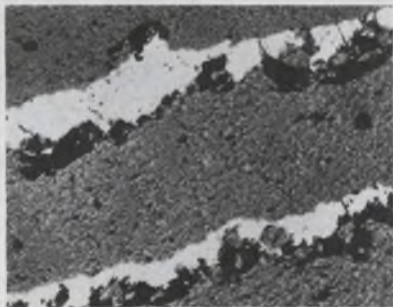

Dielectric of a conventional CK ceramic

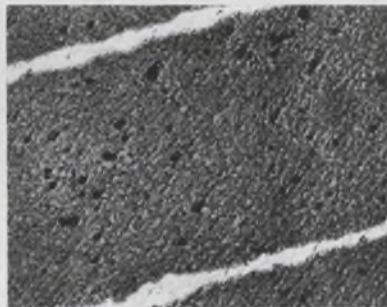

Dielectric of a second make of conventional CK ceramic

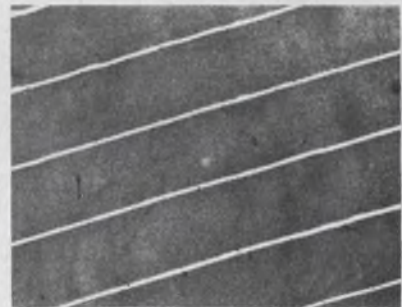

Dielectric of CORNING GLASS-K Capacitor

No holes in the Glass-K dielectric means greater uniformity—so we can make thinner dielectric layers, put more pf in a smaller case size.

No holes in the Glass-K dielectric—so naturally the Glass-K gives you more stable performance . . . less change because of environmental fluctuation.

No holes in the Glass-K means uniformity in the dielectric—which means greater performance predictability.

No holes in the Glass-K means greater dielectric density and less chance for failure—so naturally, it gives you more reliability.

That's the reason you get all these good characteristics in the Glass-K:

- $\Delta C$  in life as tight as 2%
- IR greater than 10,000 megohms
- D.F. of 2.5% maximum
- pf ranges from 1000 to 51,000 in just .250" x .100", from 21,000 to 100,000 in just .250" x .140"

As you can see, now there is a material difference in CK-type capacitors. Yet Glass-K prices are competitive.

Send for complete data today to Corning Glass Works, 3911 Electronics Drive, Raleigh, N.C.

**CORNING**  
ELECTRONICS

Speed Inquiry to Advertiser via Collect Night Letter  
ON READER-SERVICE CARD CIRCLE 6

# All from Sprague!

## ENERGY-STORAGE CAPACITORS for every type of discharge application

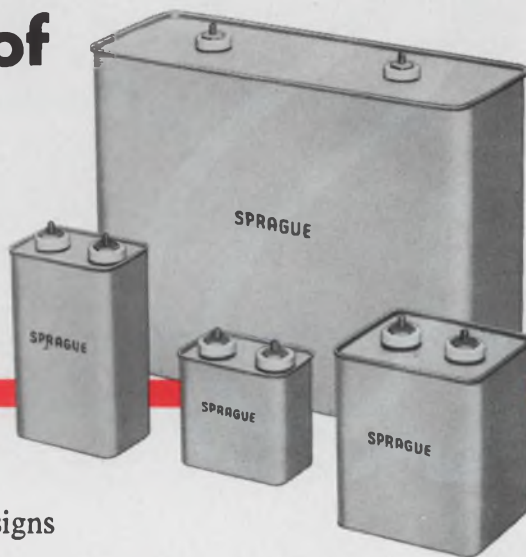

A pioneer in high voltage capacitors, Sprague has a broader line of designs for energy-storage applications than any other capacitor manufacturer. If your project involves lasers, masers, electronic photoflash, time-control circuits, exploding wire, thermonuclear fusion research, magnetization of permanent magnets, medical equipment, or similar discharge applications, Sprague can provide a capacitor to meet your specific needs.

### **Light, Moderate, or Heavy Duty Capacitors**

Available types range from small, light-weight units for aerospace applications such as satellites, missiles, etc., to heavy-duty capacitors for high-current/high-frequency oscillatory discharges.

### **Broad Range of Electrical Ratings**

Voltages from 2 kilovolts to 24 kilovolts. Energy ratings up to 6700 joules. Self-inductance as low as .0025 microhenry.



### **Energy-Storage Electrolytic Capacitors**

A selected line of cylindrical electrolytics for industrial applications requiring maximum capacitance in minimum space.

### **Paper, Metallized Paper, and Paper/Film Designs**

Metallized capacitors intended for light-weight, space-saving applications . . . one-half the size, one-third the weight of conventional capacitors. Other available designs include castor oil impregnation for extremely long life (assuring a high number of discharges), and non-flammable synthetic askarel impregnation for applications where non-combustibility is a prerequisite.

For complete information or application engineering assistance on Sprague Energy-Storage Capacitors, write to Field Engineering Department, Sprague Electric Company, 347 Marshall St., North Adams, Mass. 01248.

## SPRAGUE COMPONENTS

CAPACITORS  
TRANSISTORS  
RESISTORS  
INTEGRATED CIRCUITS  
THIN-FILM MICROCIRCUITS

PULSE TRANSFORMERS  
INTERFERENCE FILTERS  
PULSE-FORMING NETWORKS  
TOROIDAL INDUCTORS  
ELECTRIC WAVE FILTERS

CERAMIC-BASE PRINTED NETWORKS  
PACKAGED COMPONENT ASSEMBLIES  
BOBBIN and TAPE WOUND MAGNETIC CORES  
SILICON RECTIFIER GATE CONTROLS  
FUNCTIONAL DIGITAL CIRCUITS

**SPRAGUE**<sup>®</sup>  
THE MARK OF RELIABILITY

'Sprague' and '®' are registered trademarks of the Sprague Electric Co.

ON READER-SERVICE CARD CIRCLE 7

# ED News

Weather satellites please engineers and weathermen PAGE 17

Medical electronics wages war against heart disease PAGE 21

Microwave power race slackening PAGE 23

Pile of sand used for temperature calibration PAGE 25

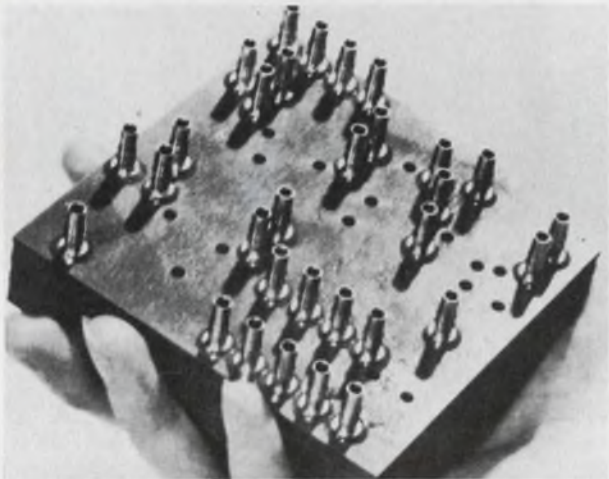

The situation is "fluid" . . . 24



Computer analyzes electrocardiograms . . . 21

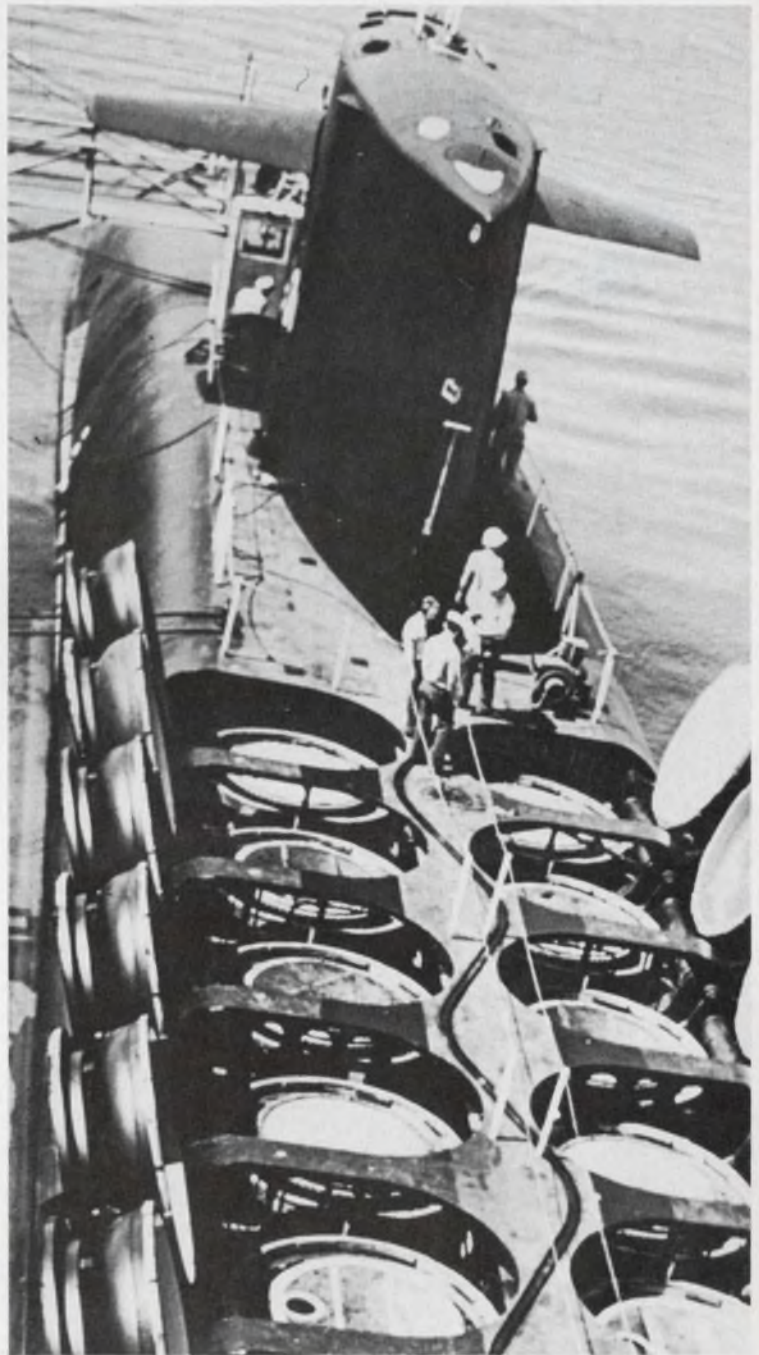

New missiles for Polaris subs . . . 26

# New from Sprague!

*This Resistor has 5 Times the Resistance of a Conventional Metal-Film Resistor of Equal Size!*

*This Resistor is 21 Times Smaller than a Conventional Metal-Film Resistor with Equal Resistance Value!*

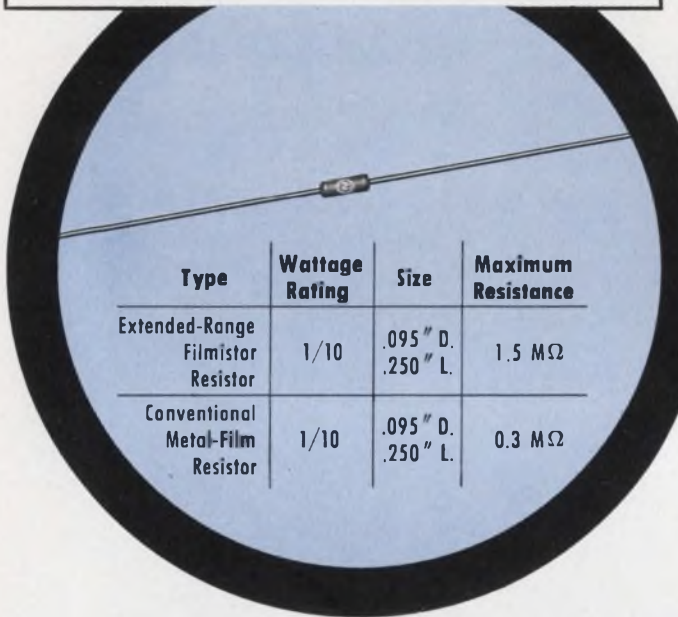

Type	Wattage Rating	Size	Maximum Resistance
Extended-Range Filmistor Resistor	1/10	.095" D. .250" L.	1.5 MΩ
Conventional Metal-Film Resistor	1/10	.095" D. .250" L.	0.3 MΩ

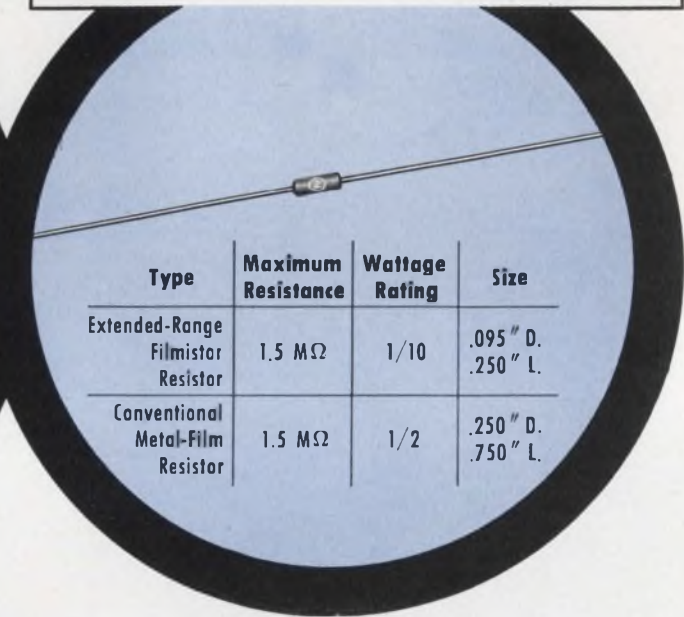

Type	Maximum Resistance	Wattage Rating	Size
Extended-Range Filmistor Resistor	1.5 MΩ	1/10	.095" D. .250" L.
Conventional Metal-Film Resistor	1.5 MΩ	1/2	.250" D. .750" L.

## Both Resistors are one and the same...they're Sprague's new **EXTENDED-RANGE FILMISTOR® METAL-FILM RESISTORS**

**Substantial saving of space in all wattage ratings—1/20, 1/10, 1/8, 1/4, 1/2, and 1 watt—with absolutely NO SACRIFICE IN STABILITY!**

New manufacturing techniques at Sprague Electric have made possible a major breakthrough in resistance limits for metal-film resistors. Extended-Range Filmistor Resistors now offer, in addition to accuracy . . . stability . . . reliability . . . extended resistance values in size reductions which were previously unobtainable. Size and weight advantages of Filmistor Resistors now make them the ideal selection for applications in high-impedance circuits, field-effect

transistor circuits, etc., where space is at a premium. Many designs which previously had to settle for the higher temperature coefficients of carbon-film resistors in order to obtain required resistance values can now utilize the low and controlled temperature coefficients of Filmistor Metal-Film Resistors.

Other key features are  $\pm 1\%$  standard resistance tolerance, low inherent noise level, negligible voltage coefficient of resistance, and tough molded case for protection against mechanical damage and humidity.

*For complete technical data, write for Engineering Bulletin 7025C to Technical Literature Service, Sprague Electric Company, 347 Marshall Street, North Adams, Massachusetts 01248.*

### SPRAGUE COMPONENTS

RESISTORS	PULSE TRANSFORMERS	CERAMIC-BASE PRINTED NETWORKS
CAPACITORS	INTERFERENCE FILTERS	PACKAGED COMPONENT ASSEMBLIES
TRANSISTORS	PULSE-FORMING NETWORKS	BOBBIN and TAPE WOUND MAGNETIC CORES
THIN-FILM MICROCIRCUITS	TOROIDAL INDUCTORS	SILICON RECTIFIER GATE CONTROLS
INTEGRATED MICROCIRCUITS	ELECTRIC WAVE FILTERS	FUNCTIONAL DIGITAL CIRCUITS



Sprague® and ® are registered trademarks of the Sprague Electric Co.

Galileo had setbacks too.

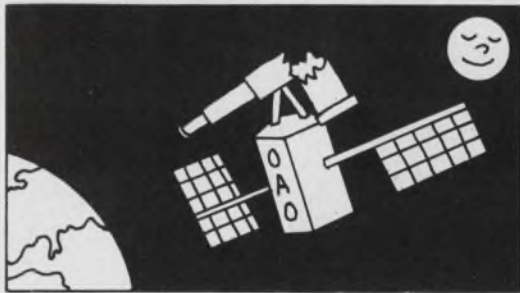

### Astronomers disappointed by space fizzle

Many in scientific circles still have long faces over the disappointing power failure in the first Orbiting Astronomical Observatory (OAO-1). The heaviest and electronically most complex of our unmanned space vehicles, the OAO-1 was expected to provide astronomers with their first prolonged look at the universe from an extraterrestrial vantage point.

After several delays on the launch pad the OAO was finally orbited successfully, and astronomers put down their telescopes and waited in anticipation. But soon the battery portion of the power system began to falter, and eventually the \$50 million satellite went silent. As one scientist put it, "it's like giving a child a toy and then not letting him play with it."

OAO-1 was the first of four such orbiting observatories to be launched by NASA. Astronomers will now have to wait for number two. No date, however, will be set for the second OAO until NASA is satisfied that it has pinpointed the cause of the malfunction in the OAO-1.

### Gas industry looks to fuel cells

While the electric utility industry trumpets the desirability of "all-electric living," the gas industry is quietly investigating its own version of one-utility service. But in this case the one utility is gas.

The trump card that the gas industry eventually hopes to play is the air-and-natural-gas fuel cell. Similar in operation to the hydrogen-oxygen fuel cells used in manned space satellites, these cells use air and natural gas for fuel. This would eliminate the cost and handling problems of pure hydrogen and oxygen.

What is reported to be the largest air-and-natural-gas fuel cell built to date has recently been operated successfully by Pratt & Whitney Aircraft. The 4000-watt unit was developed for Columbia Gas Systems, Inc., and will be used by the company in its fuel-cell R&D program. Initially, tests are to be conducted with the cell powering a 1-ton window air conditioner, a 3-ton gas-fired central air

# News Report

conditioner and a central gas-fired furnace. Later the equipment will be moved into the home of a Columbia employee for further tests.

### New date for TV picture-tube regulation

The Federal Trade Commission has extended the effective date of its regulation covering acceptable ways of specifying TV picture-tube sizes (ED 6, March 15, 1966, p. 13). The regulation will now become effective January 1, 1967, instead of July 1, 1966, as originally set. According to the FTC, the extension has been allowed because of the financial burdens that TV manufacturers would encounter in order to meet the original date.

The FTC has also stated that it will not object to manufacturers' rounding off the new size designations to the nearest inch, since it believes this will not adversely affect the public interest. Still up in the air is the question of which of the allowable methods for specifying picture size the TV industry will eventually adopt. Most manufacturers are still studying the question on a which-way-do-I-lose-the-least basis. Best guess is that the picture diagonal—measured on a flat plane—will be selected by most, even though this will cut one or two inches from the majority of familiar tubes.

### Computers help produce star catalog

By using advanced computer techniques, workers at the Smithsonian Astrophysical Observatory have expanded what was originally planned as an aid to satellite tracking into the most comprehensive star catalog ever published. The 250,000 stars listed in the new catalog were scattered through more than 50 separate catalogs and atlases, many of which employed different formats and reference systems. Computers were first used to correlate the diverse data, and then to update the star information and positions. The updating was necessary because all stars have an actual motion in space with respect to Earth. Although this motion is exceedingly small, it must nevertheless be taken into account if the data are to be usable for satellite tracking. (over)

The final data were enough to fill 2600 pages. To solve the problem of reproducing this material without errors, a Stromberg Carlson 4020 computer was used to set the type electronically. Twelve magnetic tapes, each containing star data for a particular section of the sky and instructions on how to display the data, were prepared and fed into the computer.

The 4020 computer contains a character matrix and a cathode-ray tube. A light beam scans the matrix, which contains the images of numerical and alphabetical characters. According to the magnetic-tape instructions, the light beam picks the appropriate letter or number image and displays it in its proper place on the face of the cathode-ray tube. In this way, an entire page of data is almost instantly displayed on the tube. A camera inside the computer enlarges the display to actual-page size and records it as a positive film image. The processing of each page takes one and one-half seconds.

Photographs produced by the computer are used to make plates which are then used for printing. The system thus transfers data from magnetic tape to printed page entirely free of any introduced human error.

## Japanese receiving tubes on the way out?

Last year 43 million Japanese receiving tubes were imported into the U.S. But if a U.S. Customs Court decision is upheld, the Japanese tubes may be priced right out of the American market.

In a pilot case the Customs Court has ruled that the import duty on such tubes be based on the Japanese distributors' price, rather than on the factory price as in the past. The result would be to double or treble the import duty, and this would all but eliminate the Japanese tubes' price advantage over U.S. tubes.

## 26,000 Mil. Specs. going on film

Everyone involved in defense work has at one time or another wrestled with the problem of finding, filing and updating Military Specifications. But the problem of the average company is minuscule when compared with that of the Johnson Research Co. of Farmingdale, N. Y. Part of Johnson's business is to provide subscribing firms

with updated lists of Mil. Specs. This necessitates Johnson's filing and constantly handling the entire array of over 26,000 Mil. Specs.

As the storage problem threatens to get out of hand at any moment, Johnson has arranged to have the entire file microfilmed by the Thomas Publishing Co. The specs. will be put on microfiche, which are 4- x 6-inch translucent, plastic cards. As many as 72 full-size pages can be placed on each card, so the file will be reduced to fit into a shoe box. At present they take up a whole bookcase 18 feet long and 8 feet high.

## Holography claims are exaggerated

Home color movies and television with holography? These are irresponsible claims, protests Dr. Dennis Gabor of the University of London, who is known as the father of holography.

According to Dr. Gabor, "those who talk about a billion-dollar industry within a short time are misleading the public and the investors. First of all, a laser beam is needed. Having a laser in a home is out of the question. Secondly, the bandwidth requirements far exceed our capabilities today—by about  $30 \times 30^3$ . Last, but not least, a transparency that works in real time is essential, and we simply do not have such a device." It is not likely that these problems will be solved by the next year, muses Dr. Gabor.

---

FETs and integrated circuits have been added to Motorola Semiconductor's HEP program of consumer-oriented electronics for the hobbyist, experimenter and professional. According to a company spokesman, Motorola is the first semiconductor manufacturer to include these relatively sophisticated devices in a program directed at the consumer market.

The most massive nuclear particle yet found has been uncovered by the 13.5-Bev Synchrotron at the Argonne National Laboratory. The new particle, known as N-3245, is about three and one-half times as massive as the proton. It has a lifetime somewhat longer than  $10^{-22}$  seconds, which is more than that of any of its family of nuclear particles.

Congressman Weston E. Vivian (D-Mich.) will be the keynote speaker at the American University's Institute on Systems Science to be held in Wash., D. C., May 9 through 12. Congressman Vivian is the only engineering PHD in the 89th Congress.



# An Allen-Bradley announcement of importance to motor designers

The new MO6-C ferrite magnet having 30% higher intrinsic coercive force

■ The new Allen-Bradley MO6-C ceramic permanent magnets provide at least 30% increase in the highest previously available intrinsic coercive force—obtainable with A-B's MO5-C material. This advance is achieved with the same high residual flux density.

Designers of permanent magnet motors have a choice of these advantages—30% higher resistance to demagnetization, or 30% increase in motor output, or 30% increase in cold temperature protection. In fact, where the higher coercive force is not required, the designer can give himself a 30% reduction in magnet size.

This new Allen-Bradley MO6-C material opens the door to such motor designs where permanent magnets heretofore were not practical, namely for motors used in many portable tools and appliances. Like with the MO5-C material, these new MO6-C magnets are radially oriented, and are available in virtually all sizes and shapes currently being produced in segments for motors from 3/4" diameter to 10 hp. While MO5-C magnets will continue to satisfy most needs, MO6-C enables designers to satisfy more exacting motor design requirements because of its unusually high intrinsic coercive force.

Allen-Bradley application engineers will be pleased to help you obtain maximum economy in your motor design through optimizing magnet performance. Please let us hear from you. Allen-Bradley Co., 1344 S. Second Street, Milwaukee, Wis. 53204. In Canada: Allen-Bradley Canada Limited. Export Office: 630 Third Ave., New York, N.Y., U.S.A. 10017.

## TYPE MO6-C CERAMIC PERMANENT MAGNETS

### Typical Characteristics

—stated values have been determined at 25°C.

Property	Unit	Nominal Value
Residual Induction ( $B_r$ )	Gauss	3300
Coercive Force ( $H_c$ )	Oersteds	2800
Intrinsic Coercive Force ( $H_{ci}$ )	Oersteds	3100
Peak Energy Product ( $B_d H_d$ max)	Gauss-Oersteds	$2.5 \times 10^6$
Reversible Permeability	—	1.09
Curie Temperature	+°C	450
Temperature Coefficient of Flux Density at $B_r$	%/°C	-0.20
Specific Gravity	—	4.9
Weight per Cu. In.	Lbs.	0.177

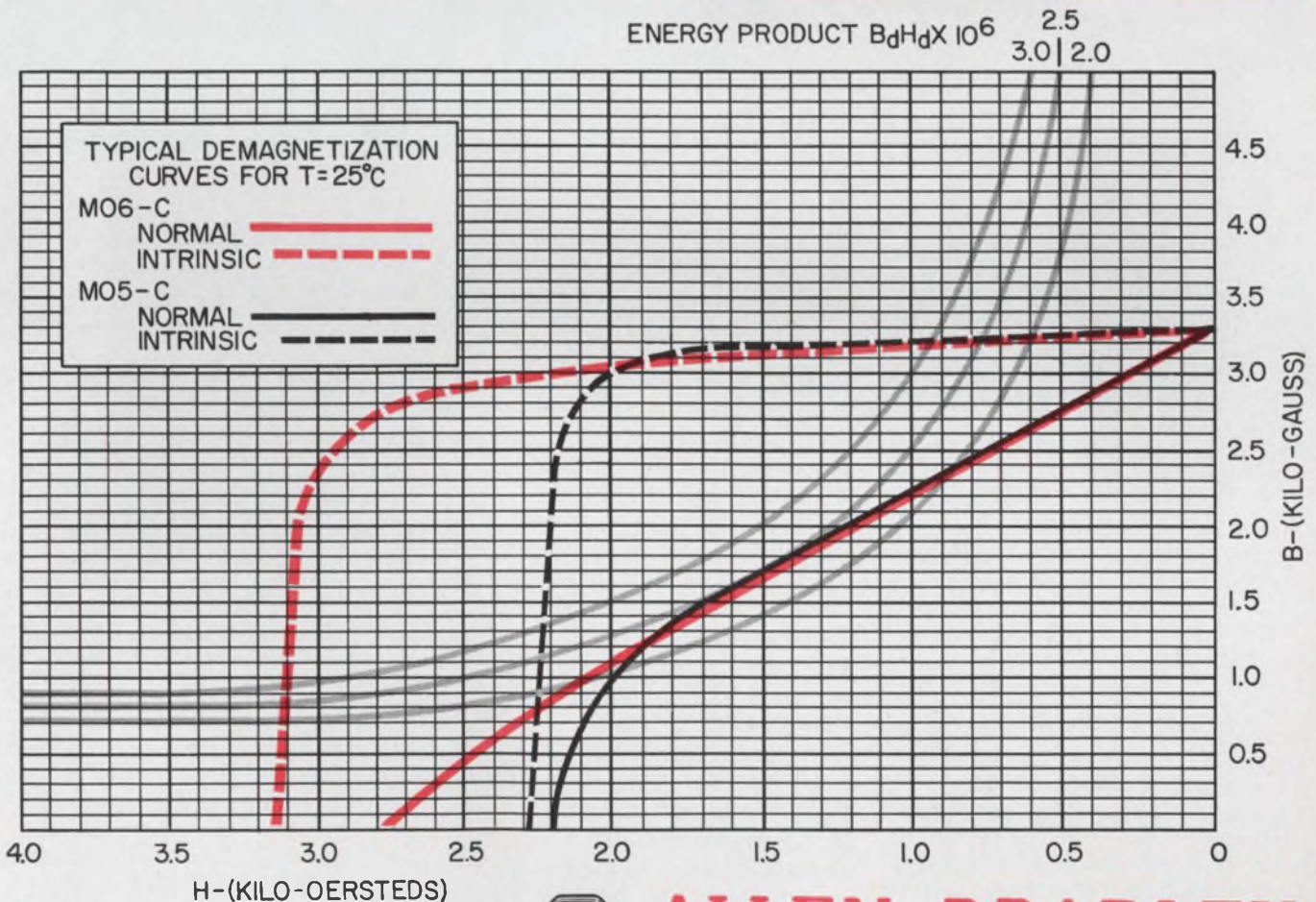

366-3B



# ALLEN-BRADLEY

QUALITY MOTOR CONTROL  
 QUALITY ELECTRONIC COMPONENTS

ON READER-SERVICE CARD CIRCLE 9

# MODEL CW-1 BOXCAR INTEGRATOR



The Model CW-1 Boxcar Integrator is a gated signal averaging device useful for the recovery of either complete repetitive waveforms or incremental portions thereof from noise. The input to the Boxcar Integrator is sampled by a variable width, variable delay gate which can be fixed at any point on, or slowly scanned across, the repetitive waveform. The sampled portion of the input waveform is averaged by a variable time constant integrator, displayed on the panel meter, and made available for external recording or other use. Because the mean value of random noise is zero, the output of the integrator will asymptotically approach the average value of that portion of the input waveform being sampled at any moment, with a corresponding suppression of the accompanying noise. The Model CW-1 may be used in such widely varied applications as pulsed nuclear resonance, laser excitation decay, and biological evoked response experiments. In general, this instrument should be of value in any application where noise interferes with the recovery of repetitive waveforms.

## SPECIFICATIONS

### SIGNAL CHANNEL —

**Input Sensitivity:**  $\pm 2$  volt to  $\pm 10$  volts in 1, 2, 5, sequence for  $\pm 10$  volts output.

**Dynamic Range:** Will accept inputs 15 times full scale requirement without overloading.

**Integration Time Constants:** 100 microseconds to 100 seconds in 1, 3, 10 sequence.

**Holding Time:** At least  $10^6$  times integration time constant for 10% F.S. change in output, up to  $10^5$  sec.

**Output:** (a)  $\frac{1}{2}$ % Panel Meter,  $\pm 10$  volts.

(b)  $\pm 10$  volts provided at front panel at an impedance of 1 K.

(c) Recorder Output — suitable for most galvanometric and servo recorders.

### GATE TIMING CIRCUITS —

**Operating Modes:** (a) Ext. Trigger

(b) Ext. Gate

(c) Recurrent: Time Base triggered automatically and repetitively.

(d) Continuous: Gate on continuously.

**Time Base Widths:** 10 microseconds to 1 second in 1, 2, 5 sequence.

**Gate Pulse Width:** Continuously adjustable from 1 microsecond to .11 second.

**Delay:** (a) Manual adjustment from 0% to 100% of Time Base Width.

(b) Automatic scanning from 0% to that % of Time Base Width selected by setting the Manual Delay Dial.

**Automatic Delay Scan Periods:** 1, 2, 5, 10, 20, 50, and 100 minutes.

### GENERAL —

**Power Requirements:** 105-125 volts or 210-250 volts; 50-60 Hz; approximately 15 watts.

**Size:** 19"W x 5"H x 14"D.

**Price:** \$1,950.00. Export prices approximately 5 per cent higher (except Canada). Request Bulletin No. 127.

ON READER-SERVICE CARD CIRCLE 10

**PAR PRINCETON**  
APPLIED RESEARCH CORP.  
Dept. E  
Box 565, Princeton, N. J., Tel. (609) 799-1222

# Weather satellites go operational

**Meteorologists learn much from ESSA II weather satellite, but aerospace electronics has benefited too.**

Neil Sclater  
Technical Editor

The launching of the ESSA II weather satellite on Feb. 28, 1966, has ushered in a new era in world-wide weather forecasting. Apart from its meteorological implications, ESSA II also represents a giant step forward in aerospace electronic systems and their design. Each passing week of successful operation makes these contributions more apparent. Two of the most noteworthy are:

- An evaluation of the effectiveness of "cross-strapping," which is a technique involving multi-component redundancy within systems.
- An example of how the application of "design margin" principles can result in high operational reliability.

## Cross-strapping is incorporated

Experience with earlier un-

manned space systems indicated the need for the cross-strapping, or multiple redundancy, of subsystems which could be controlled from the ground. Without cross-strapping, loss of a single subsystem can cause loss of the entire system, even though all its other components are operating satisfactorily. But with cross-strapping, any component of one system can be interchanged with the same component of the redundant system.

In the ESSA II, cross-strapping is used between two complete on-board camera systems. This component-sharing between the two systems is controlled by ground stations, which receive continuous telemetry signals from the satellite indicating the operational condition of the system components. Should a component fail in the "on" system, a signal is sent to the satellite causing the redundant component to be switched into use. A combination of

relay and solid-state circuitry controls the actual switching operation in the satellite.

## Design margin proves effective

In an unmanned satellite as complex as ESSA II, mere redundancy of sub-systems is insufficient to secure the required reliability. Solar cells, transistors and other items within subsystem circuitry must also be made redundant to some extent. The problem, though, is how to arrive at an optimum level of redundancy without encumbering the satellite with excessive weight.

The designers of ESSA II applied the techniques of design margin to this problem. They gathered extensive statistical, experimental and operational data on part and component failure, and then based their design for part redundancy on an analysis of this data. What made their design margin analysis particularly meaningful was the actual flight data which had been gained from previous TIROS satellites. Thanks to TIROS IX, this was

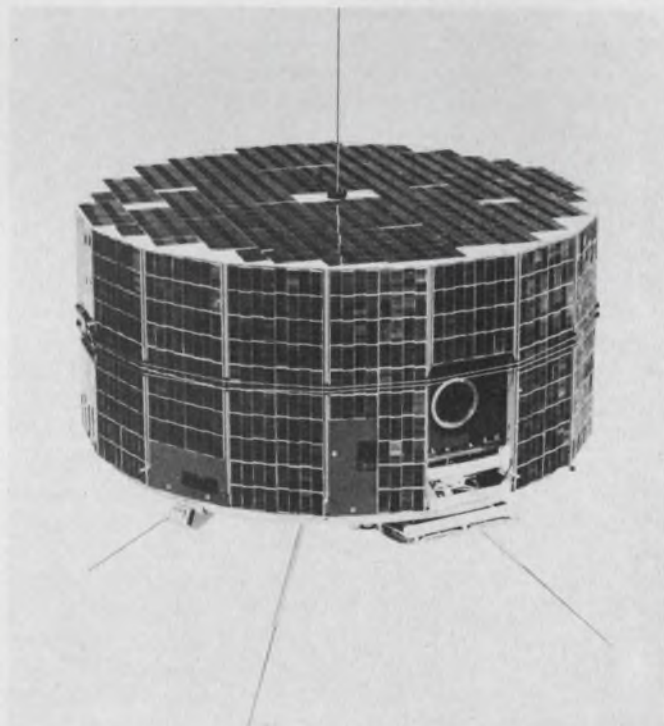
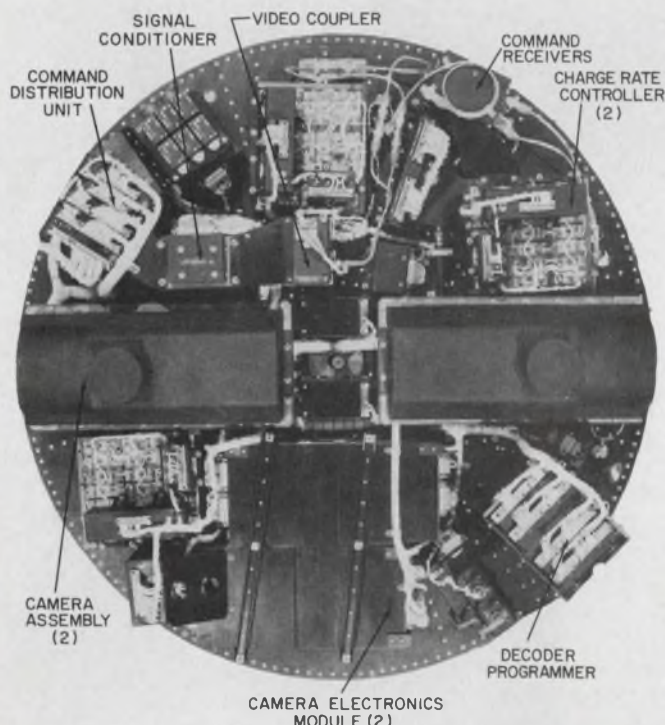

ESSA II is the latest of the TIROS-class weather satellites. Its two cameras are mounted 180 degrees apart on the outer rim. Electronic circuitry is arranged around the baseplate (shown at left). Numbers in parenthesis indicate redundancy.

(ESSA, *continued*)

especially true in the area of radiation effects.

### TIROS IX's improper orbit

TIROS IX was something of a mishap in the weather satellite program, but from an engineering standpoint it was a happy accident. When it was launched, TIROS IX was hurled into an improper orbit by a defective final booster. Although not designed to withstand the damaging effects of space radiation, its improper orbit took TIROS IX well into the Van Allen radiation belt. This inadvertent "worst case" provided engineers with the first tangible evidence of the effects of long-term deterioration on an "unhardened" space vehicle.

The radiation intensity to which TIROS IX was subjected was 50 to 75 times greater than had been planned. Damage to the solar cells exposed directly to the radiation has been extensive, but ample reserve cells still operate the electronics and keep the batteries charged.

Because of TIROS IX, engineers knew where to begin when the time came to build ESSA II, which was to operate within the Van Allen belt. Extensive experimental irradiation programs had been carried out on the ground, but now essential design margin information was available to substantiate findings.

According to TIROS-ESSA project manager Abraham Schanpf of RCA Astro-Electronics Div., Hightstown, N. J., the configuration of the TIROS/ESSA satellites is far from perfect from a radiation standpoint. The ideal would be a spherical shape. Nevertheless, the aluminum shielding (about 1/8 inch thick) over critical electronic packages and the use of heavy equipment as "shadowing" mass has proven successful. The fact that 425 integrated circuits are now working effectively on ESSA II attests to the efficiency of anti-radiation precautions and component layout. Although ESSA II is the first weather satellite to use integrated circuits, later satellites will use them more extensively.

### Global system now operational

Now that ESSA II has been put

successfully in orbit, the TIROS Operational Satellite (TOS) system is fully functional. Financed by the Environmental Science Services Administration (ESSA) of the U.S. Department of Agriculture, the system aims to provide complete, uninterrupted photocoverage of the Earth's cloud cover on a daily basis.

The TOS system consists of ESSA I, launched Feb. 3, 1966, and ESSA II. Each of these operational satellites plays a separate but complementary role in the over-all system.

ESSA I takes pictures of cloud cover over the entire Earth and stores them for read-out by Command and Data Acquisition Stations near Fairbanks, Alas., and Wallops Island, Va. These pictures are retransmitted to the Environmental Satellite Center at Suitland, Md., where they are processed to provide world-wide cloud-cover maps. When combined with other collected meteorological data, these global maps are extremely useful for long-range weather forecasting.

ESSA II also takes pictures of cloud cover over the entire Earth. However, its basic purpose is to provide short-range weather forecasting data on a local or regional basis. It does this by doing away with ESSA I's storage feature and transmitting the pictures back to Earth almost immediately after they are taken. This allows any relatively modest receiving station to receive the pictures and use them for local forecasting. Real-time transmission is accomplished by retention of the picture on a photo-sensitive layer on the face of the camera vidicon tube during the transmission period, which lasts about 200 seconds.

The future of the TOS system requires that two satellites be operational at all times. One, like ESSA I, will be for long-range forecasting, and will transmit its stored pictures only when requested by certain, suitably equipped ground stations. The second will be for local forecasting and will transmit its pictures at once like ESSA II. Eight substitute ESSA satellites are now "waiting on the bench." One of these, TOS/AVCD, incorporates the "request" feature and will be launched when pictures from ESSA I fall below acceptable quality. It will be dubbed ESSA III only

when it is launched successfully.

### Wheel configuration is used

The present operational TOS system was preceded by nine research and development spacecraft, designated TIROS I through IX. TIROS I through VIII had their cameras mounted in the base of their drum-shaped configuration, and were spin-stabilized in orbits inclined either 48 or 59 degrees to the equator. TIROS IX as well as ESSA I and II have the same shape, but orbit the Earth in a cart-wheel configuration. Effectively this means that they roll along in orbit on their sides, much like wheels.

The two cameras on ESSA I and II and TIROS IX are mounted 180 degrees apart on the outer rim of the satellite. As the satellite rolls along in its orbit, each camera

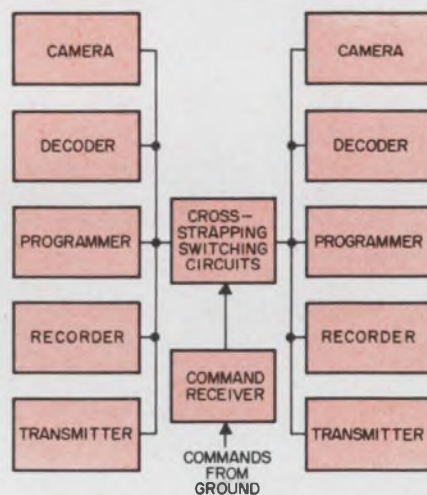

**Cross-strapping**, under control of ground commands, is used in ESSA II. This allows components to be switched between redundant systems. During normal operation components of the camera systems are regularly switched to balance their use.

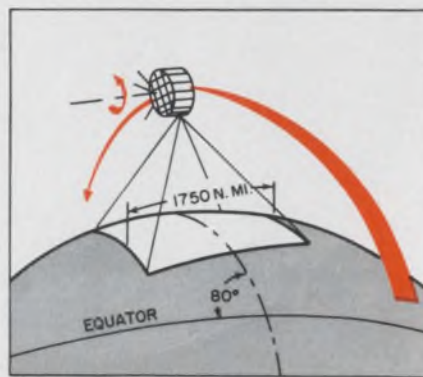

ESSA II's orbital altitude of 750 nautical miles results in each TV picture covering an area approximately 1750 miles square.

# OUR CUSTOMERS HAVE NEVER SEEN THE LIGHT

and the day they do will be the day we lose business

Rolling metals to uniform standards is a specialty. Rolling metals for ultra-thin gauge foils for photo etching, shims, strain gauges, honeycomb structures, capacitors, etc; and rolling them virtually free of pin holes is a dedication.

We, at Arnold Engineering have the dedication and capability of precision rolling more than fifty-five metals. We've already rolled alloys and metals as soft as copper to a "thinness" of 0.000069"—alloys as hard as

Type 302 stainless and Elgiloy to 0.0002" and less. All of our mills, slitters and centerless grinding facilities are housed in a separate air conditioned filtered and pressurized clean room to minimize foreign particles which could cause pin holes in finished work. With dual source, non-contacting beta-ray gauges, we have held tolerances totalling 0.000017" on a week's run of .0011 ga. When you're ready to roll, give us the nod. We would like to show you how we can keep you in the dark.



**ARNOLD**

SPECIALISTS in MAGNETIC MATERIALS

THE ARNOLD ENGINEERING COMPANY, Main Office, MARENGO, ILL.  
BRANCH OFFICES and REPRESENTATIVES in PRINCIPAL CITIES

Speed Inquiry to Advertiser via Collect Night Letter  
ON READER-SERVICE CARD CIRCLE 11

**New from Sprague!**

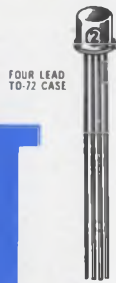

# LOW COST DUET<sup>★</sup> 3N123 DUAL-EMITTER CHOPPER TRANSISTORS



**CHECK THESE FEATURES!**

$BV_{EEO} > 25 \text{ VOLTS}$

$|V_o| < 250 \mu\text{V}$

$|\Delta V_o / T_A| < 2.3 \mu\text{V per } ^\circ\text{C}$

$f_T > 6 \text{ mc}$

## HIGH VOLTAGE! RELIABLE PLANAR CONSTRUCTION!

Sprague offers more dual-emitter transistor types than any other source!

TYPE No.	$BV_{EEO}$ (volts)	$V_o$ ( $\mu\text{V}$ )	TYPE No.	$BV_{EEO}$ (volts)	$V_o$ ( $\mu\text{V}$ )	TYPE No.	$BV_{EEO}$ (volts)	$V_o$ ( $\mu\text{V}$ )	TYPE No.	$BV_{EEO}$ (volts)	$V_o$ ( $\mu\text{V}$ )	TYPE No.	$BV_{EEO}$ (volts)	$V_o$ ( $\mu\text{V}$ )
3N90	30	50	3N95	50	200	3N104	20	50	3N109	50	150	3N116	12	200
3N91	30	100	3N100	10	50	3N105	15	250	3N110	30	30	3N117	20	50
3N92	30	200	3N101	30	50	3N106	30	250	3N111	30	150	3N118	20	100
3N93	50	50	3N102	40	50	3N107	50	250	3N114	12	50	3N119	20	200
3N94	50	100	3N103	50	50	3N108	50	30	3N115	12	100	3N123	25	250

\*Trademark

For complete information, write to Technical Literature Service,  
Sprague Electric Co., 347 Marshall St., North Adams, Mass. 01248

**SPRAGUE COMPONENTS**

TRANSISTORS  
CAPACITORS  
RESISTORS  
THIN-FILM MICROCIRCUITS  
INTEGRATED CIRCUITS  
INTERFERENCE FILTERS

PACKAGED COMPONENT ASSEMBLIES  
FUNCTIONAL DIGITAL CIRCUITS  
MAGNETIC COMPONENTS  
PULSE TRANSFORMERS  
CERAMIC-BASE PRINTED NETWORKS  
PULSE-FORMING NETWORKS



Sprague and the logo are registered trademarks of the Sprague Electric Co.

NEWS

(ESSA, continued)

points toward the Earth in turn. Horizon-sensing equipment in the satellite controls the cameras so that each takes pictures only when it faces the Earth.

ESSA I and II are in near-polar, circular orbits. Their combinations of altitude and orbital inclination make their orbits sun-synchronous.

**Technical summary of ESSA II**

Spacecraft	Cylindrical, 18-sided polygon, 22 inches high and 42 inches in diameter, weighing 290 pounds.
Mission Objectives	Add automatic picture transmission capability to the TIROS operational satellite system. Provide daily coverage of local weather systems for weather stations around the world equipped with APT receivers.
Launch Vehicle	Three-stage, thrust-augmented improved Delta.
Orbital Elements: Inclination	Near-polar and sun-synchronous; 78.6 degrees retrograde to the Equator.
Period Orbit	113.5 minutes. Circular, approximately 865 statute (750 nautical) miles high.
Velocity	Approximately 16,300 miles per hour.
Cameras	Two 1-inch automatic picture transmission vidicons which take more than 140 two-thousand-statute-mile-square pictures daily with a resolution of about two miles at picture center.
Power System	9,100 solar cells which convert sun energy to electrical energy to keep 63 nickel-cadmium batteries charged.
Tracking	Fifteen stations of the worldwide space tracking and data acquisition network (STADAN) operated by the Goddard Space Flight Center.

(continued on p 28)

# Medical electronics fights heart disease

**New techniques coming out of the medical-electronic laboratory promise to reduce heart fatalities.**

**Frank Egan**  
News Editor

Three new diagnostic aids developed by medical-electronic researchers have joined the fight against the nation's No. 1 killer—heart disease.

The aids are designed to reveal heart abnormalities early, while there is still hope for surgical and other assistance. Medical men say that early detection might have reduced significantly last year's 700,000 American heart fatalities.

The new electronic aids make different approaches to diagnosis. One detects just one of the specific conditions that can lead to heart failure—pericardial effusion. The second can pinpoint a variety of abnormal conditions. And the third employs a computer to analyze electrocardiograms.

## Ultrasonics spots fluid

The pericardial effusion detector uses an ultrasonic technique developed at the University of Rochester School of Medicine and Dentistry, N. Y. Pericardial effusion is evidenced by the presence of fluid around the heart.

Previously, the most reliable means of tracing it were either to puncture the membrane around the

heart or to circulate through the blood stream some material opaque to X-rays which would make the heart show up in a radiograph. Both these procedures take considerable time and trouble.

The new technique requires only that an ultrasonic transducer be placed against the patient's chest. Some of the sound waves generated are reflected back to the transducer by structures inside the patient's body. Fluid around the heart has a different density from that of the surrounding tissue, and this affects the intensity of the echo returned to the transducer.

An oscilloscope is used to display the returned signal. It produces one pattern for a patient with a healthy heart and a completely different pattern if there is pericardial effusion.

The ultrasonic technique was developed by Dr. Arthur J. Moss, assistant professor of medicine, and Fred Bruhn, a fourth-year medical student.

## Instrument hears defects

The new instrument for detecting a variety of heart abnormalities is the PhonoCardioScan, now being marketed by Beckman Instruments,

Inc. Developed by the Humetrics Division of Thiokol Chemical Corp. for rapid detection of abnormal heart sounds, the PhonoCardioScan is an electronic instrument about the size of an attache case. It comes with two electrodes and a microphone, which are attached to the patient. The sound of the patient's heart beat is converted into an electrical signal which is then compared in the device with an electrical analog of a normal heart's sound. The result of this comparison is presented visually in digital form.

The digital output of the PhonoCardioScan indicates whether the heart under examination is normal, or whether its beat indicates irregularities. A significant feature of the unit is that the examiner does not have to interpret the test results. He merely records the digital output on cards that are supplied with the unit, and then sends them elsewhere for medical interpretation. This, together with the fact that it requires only two to three minutes for an examination, make the PhonoCardioScan ideal for use as a mass screening aid.

The instrument is currently being tested on 10,000 Chicago school children in a program sponsored jointly by the U.S. Public Health Service, the Illinois Department of Public Health and the Chi-



**PhonoCardioScan listens to the heart** through an electrical network that distinguishes between normal and abnormal sounds.



**Electrocardiograms are recorded and then analyzed** by an IBM computer.

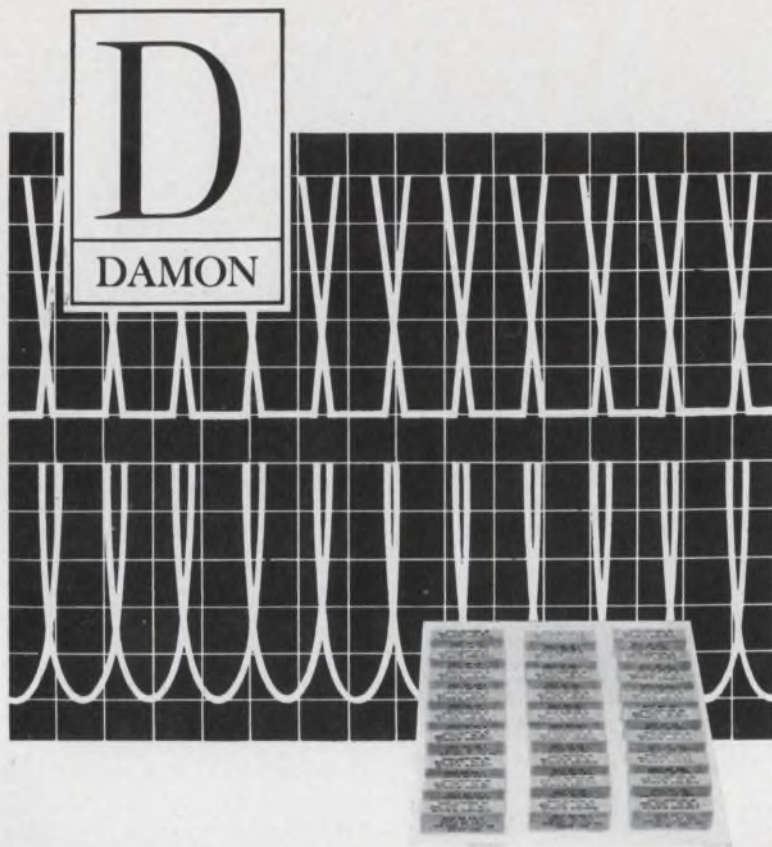

# Contiguous Comb Crystal Filters

## Multi-Channel Real-Time Signal Detection with Single Channel Driving Power

Contiguous Comb Crystal Filters (Damon's name for a unique new design) permit direct operation of large numbers of adjacent frequency channels from a single low power driver. As there are no padding or isolation losses, drive power requirements are no greater for multi-channel operation than for single channel. Miniaturized Contiguous Comb Crystal Filters with reduced active driving circuitry are now being used in airborne and ground-based Doppler radar systems where small size and high reliability are essential. A wide range of filters is available with Chebyshev, Butterworth or Gaussian characteristics for CW Doppler, FM Doppler, or Pulse Doppler Systems.

Write for Data on Contiguous Comb Crystal Filters

**DAMON ENGINEERING, INC.**

240 HIGHLAND AVENUE, NEEDHAM HEIGHTS 94, MASS.

(617) 449-0800

Speed Inquiry to Advertiser via Collect Night Letter  
ON READER-SERVICE CARD CIRCLE 13

## NEWS

(medical, continued)  
cago Heart Association.

### Computer analysis on trial

That old stand-by for detecting heart abnormalities—the electrocardiogram—is used in conjunction with a computer in a development recently announced by IBM. The computer is used to analyze electrocardiograms rapidly and with an accuracy that compares favorably with that of the best electrocardiographers. According to Dr. Jacob I. Hirsch of the New York University School of Medicine, this technique “will certainly excel where large volumes of electrocardiograms tax the endurance of the human interpreter.” The experimental system has been used on more than 300 patients at Mt. Sinai Hospital in N. Y.

Electrocardiogram signals from a patient are registered on a strip-chart recorder and on a magnetic tape unit, both contained in a special console that can be wheeled to the patient's bed. The strip-chart recorder provides a visual display for immediate interpretation by a physician, if desired. The record on magnetic tape is for transmission to the computer.

To transmit the magnetic-tape data to the computer, a technician places the patient's telephone receiver in a cradle on the console and dials the computer center. He then presses the record button on the console to start transmission.

At the computer center the data is processed by an IBM 1401 data-processing system and a special analog-to-digital converter. The converter includes pre-processing circuits that search out points of interest in the electrocardiogram waveform and convert only these into digital form for processing.

According to Dr. R. E. Bonner of IBM's Advanced Systems Development Div., pre-processing simplifies analysis by reducing the data handled by a factor of 10.

Besides printing out its analysis for the physician, the computer records 200 measurements per patient in its disk storage unit along with the patient's identification. If another ECG comes in later for the same patient, the computer searches its file and compares the two waveforms for differences. ■ ■



## Microwave race for power slackening

The race to push up the continuous-wave microwave power limit is "probably drawing to a close", according to the vice-president of research of Varian Associates, Palo Alto, Calif.

The researcher, Dr. Theodore Moreno, told a technical seminar at the recent New York IEEE Convention that in the last 15 years power advances had occurred at the rate of about 2 dB a year. Future advances, he said, would undoubtedly occur at a greatly reduced rate. The high cost of increasing power, he explained during a summary of significant developments in high-power linear-beam tubes, is not justified in view of current and expected microwave power needs. Dr. Moreno indicated, however, that significant advances could still be expected in tube quality.

### Peak reached last year

The peak in cw power development, according to Dr. Moreno, was the generation last year of more than 500 kW at X-band (roughly 8 GHz). This feat was performed by a group at Eitel-McCullough, a subsidiary of Varian, with a hybrid tube known as an extended interaction klystron—a cross between a klystron and a traveling-wave tube which combines the best characteristics of both.

Dr. Moreno acknowledged that it was technically feasible to go on increasing power output. But even radio astronomy research, which now has the highest demands for microwave cw power, will demand only several hundred kilowatts of power—well within the limits of existing technology.

There have been many important milestones in the power race in recent years, and some have resulted in important improvements in quality. The 20-kW klystrons of five years ago, Dr. Moreno stated, have vastly improved. Late versions include five motor-tuned cavities which are normally stagger-tuned to achieve stability and far wider bandwidth than had been previously obtained. Electronic bandwidth increased by a factor of nearly three. At the 1-dB level 30 MHz



## Field-proven hp 204B, 208A Oscillators

Low-noise test signals, 5 Hz (cps) to 560 kHz (kc)  
Battery operated, portable, solid-state  
Floating output, isolated from ground and chassis  
Logarithmic frequency dial, accurate to  $\pm 3\%$   
Stability  $> 5$  parts in  $10^4$   
600-ohm output impedance  
Flat frequency response, within  $\pm 3\%$

### Use it for:

The 204B as an economical, portable wide-range oscillator, lab supply of low-noise signals

The 208A's especially useful for monitored, accurately attenuator-controlled output requirements

Here are two oscillators offering special value for a wide range of applications. The 208A (monitor meter calibrated in volts, \$525) and 208A Option 01 (monitor meter calibrated in dbm, \$535) are broadly useful in communications, field, lab and production applications where calibrated output attenuation is desirable. The 204B is ideal for general uses in the lab, on the production line and in the field... a bargain at only \$315.

A demonstration of these measuring tools is available from your Hewlett-Packard field engineer, or you can write for complete information to Hewlett-Packard, Palo Alto, California 94304, Tel. (415) 326-7000; Europe: 54 Route des Acacias, Geneva.

Data subject to change without notice.  
Prices f.o.b. factory.

HEWLETT  PACKARD  
An extra measure of quality

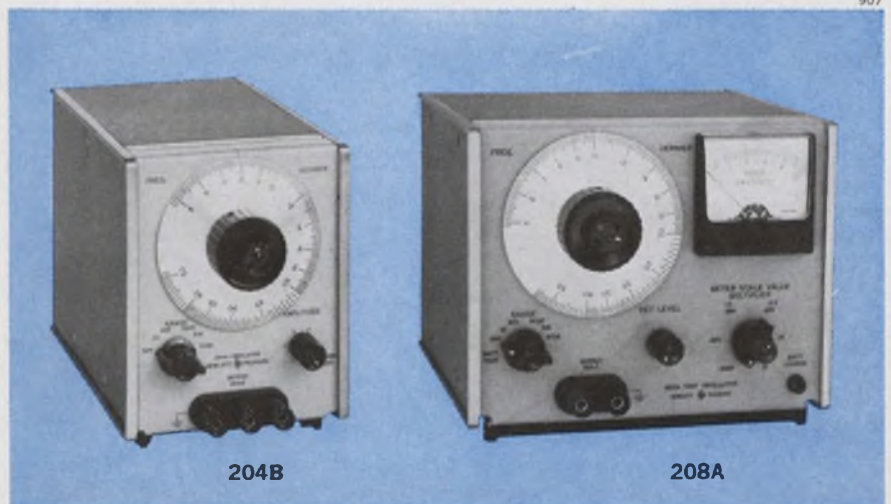

ON READER-SERVICE CARD CIRCLE 14

(power race, continued)

bandwidth was obtained with an efficiency of about 35%, he reported.

Its wider-electronic bandwidth gives the traveling-wave tube certain advantages over the klystron, Dr. Moreno said. While the klystron's bandwidth is sufficient for most satellite applications, it has to be mechanically retuned to change transmitter channels. The modern TWT, on the other hand, can be switched without this retuning. But the inherent efficiency of the TWT is generally less than that of the klystron, the researcher said, noting that figures of 25% are typical. Even after such considerations as intermodulation distortion, am-to-pm conversion ratios and noise figures, neither type ever has a clear-cut advantage over the other.

#### Hybrid developed

Designers are discovering, Dr. Moreno said, that the advantages of both tubes can be combined. The extended interaction klystron, the present power record-holder, is just such a compromise. A high-powered device, it employs a disc-loaded waveguide as a slow-wave interaction circuit in place of the more conventional klystron TE entrant cavities. Double-slot coupling exists between adjacent structures. The hybrid tube produces power at an efficiency of 35% with a gain of 41 dB.

The hybridization of klystrons and TWTs, Dr. Moreno added, has led to development of a high-performance amplifier suitable for advanced radar systems. ■ ■

## Fluids control milling machines

Fluid devices have replaced standard electrical control units on 16-twist-drill milling machines operated by the Brown & Sharpe Manufacturing Co. The machines are being rebuilt for the firm's twist-drill-manufacturing plant in Detroit.

Relay controls and solenoid-operated valves previously controlled a program of speeds and directions of bar stock into each machine's cut-

## WHY 9 CUTS?

Because it takes 9 different crystal cuts to cover the frequency spectrum. Hughes makes quartz crystal units in all 9 cuts, from 1kc to over 150 mc!

There's another reason for making 9 cuts. Usually any one frequency can be handled by several different cuts, but some cuts display better frequency tolerance with temperature than others. Hughes has the capability to provide the cut needed over any operating temperature range for minimum frequency drift.

Whether you need custom or MIL spec units in prototype or production quantities, why not call on Hughes' broad experience and engineering depth for all your crystal requirements. For specific information call or write Hughes Electronic Devices, Newport Beach, Calif.

Leader in Frequency Control Devices



**HUGHES**

HUGHES AIRCRAFT COMPANY  
ELECTRONIC DEVICES  
NEWPORT BEACH, CALIFORNIA

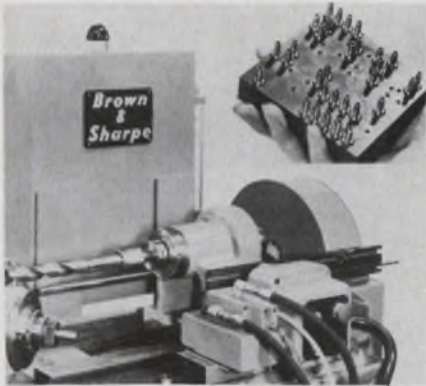

Fluid control unit (shown in insert) controls program of twist-drill milling machine.

ting head. The program is now controlled more reliably, according to the company, by pneumatic-piloted valves and fluidic circuits integrated in monolithic packages by the Fluidic Products Department of Corning Glass Works. ■ ■

## Devices bury their heads in sand

A column of sand acts like a liquid in a unique temperature-calibration system. Instruments and devices under test are imbedded in a heat-controlled sand medium for calibration, or heat-reaction testing. The sand, referred to as a "fluidized bed," takes on the properties of the liquids or salts used in more conventional calorimetry systems.

The designers, Procedyne Corp., New Brunswick, N. J., report the system can record temperatures from  $-58$  to  $+1000^{\circ}\text{F}$ . The insulat-

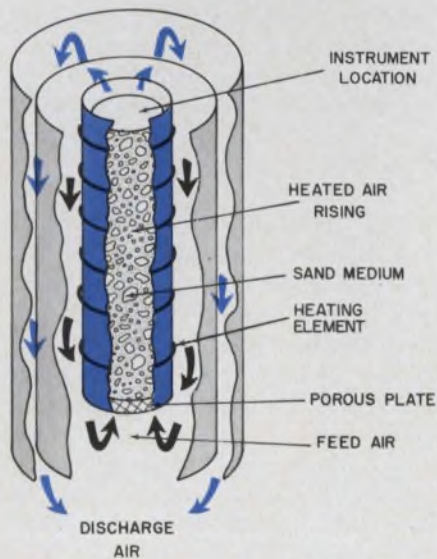

Heat controlled sand medium is used for temperature calibration.

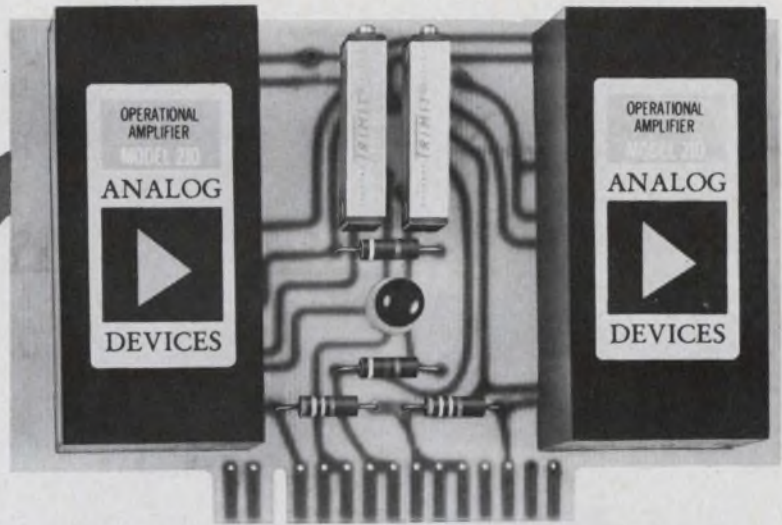

**Drift of only  $1\mu\text{V}/^{\circ}\text{C}$  and  $2\text{pa}/^{\circ}\text{C}$**   
at a price you can afford

**\$157**

## Chopper Stabilized Operational Amplifier

For little more than the cost of a differential op amp you can reach right down into microvolt signals with orders-of-magnitude better stability and accuracy. Model 210 mounts right onto your P-C card, provides 100 volt/ $\mu\text{sec}$  slewing-rate, only  $3\mu\text{V}$  peak-to-peak noise

### SPECIFICATIONS (Model 210)

DC Gain	Max Drift	Noise DC-2cps	Bandwidth	Slewing Rate	Max Offset	Output Rating	OEM Price
160 db	$1\mu\text{V}/^{\circ}\text{C}$ $2\text{pa}/^{\circ}\text{C}$	$3\mu\text{V}$ peak-peak	20 Mc	100 V/ $\mu\text{Sec}$	$50\mu\text{V}$ 50 pa	$\pm 10\text{V}$ @ 20 ma	\$128 (100 lot)

Isn't that a spec-and-a-half for only \$157? Well there's more yet. This new 3 cubic-inch op amp has built-in chopper-drive, plus an internal 0.2  $\mu\text{sec}$  fast overload recovery network. Output is shortproof too.

No more AC chopper-excitation voltages, no more plug-and-socket interconnections, no long wires to suck up noise on their way to the summing junction, no problem of finding P-C card "floor-space" for an external overload recovery circuit. In many applications, the 50  $\mu\text{V}$  & 50 pa offsets even let you

eliminate the external balance potentiometer.

This is an excellent amplifier for such applications as precision integrators, low-level DC amplifiers, fast A-D and D-A converters, accurate pulse amplifiers, and many precision circuits in high-speed analog computers.

**DRIFT  $0.2\mu\text{V}/^{\circ}\text{C}$**  — If you need even more exotic performance, our Model 203 has  $0.2\mu\text{V}/^{\circ}\text{C}$  &  $0.5\text{pa}/^{\circ}\text{C}$  drift in the same miniature P-C mounting package. (Price \$215)

**APPLICATION MANUAL**—Write for free manual giving valuable op amp theory and application aids. We'll also send you data on our 16 other op amp models.



**ANALOG DEVICES, INC.**

221 Fifth Street, Cambridge, Mass.  
Phone 617/491-1650

ON READER-SERVICE CARD CIRCLE 16

(sand, continued)

ing qualities of the sand permit the use of exposed test leads. In addition the personnel hazards caused by the use of boiling or flammable liquids or corrosive salts are eliminated.

The heart of the system is the calibration cell (see simplified diagram). Essentially a heat exchanger, the cell is made up of annular chambers for air circulation and a coaxially mounted sand column.

Preheated air is directed into the annulus containing the heating element. After it is bubbled up through the medium, the air is removed by way of one of the outer jackets.

New incoming air is preheated while the discharge air is cooled. This exchange action explains the cell's isothermal characteristic; very low sustaining heat is required and practically no temperature gradients exist across the cell.

A closed-loop arrangement including a thermocouple, temperature indicator and proportional band controller regulates the heating element. Accuracy greater than 1/2% of full scale is claimed. ■ ■

## Navy developing Poseidon missile

The guidance package for the new Poseidon missile will be designed, developed and produced for the Navy's Special Projects Office by the same industry-university team that supplies the guidance for the Polaris missile system. Responsible for designing the new system will be the Instrumentation Laboratory of M.I.T. Both General Electric Co. and Raytheon Co. will provide industrial support.

Although the Poseidon guidance system reportedly will be more than twice as accurate as that of the most advanced Polaris (the A-3), it will be only slightly larger in size and weight. This will be accomplished by the use of integrated circuits and high-density packaging techniques.

Poseidon was originally announced by President Johnson in his January 1965 defense message to Congress. When deployed on U.S. missile-carrying submarines, the President said, Poseidon's increased

# What do you mean... "or equal?"

## Robinson MET-L-FLEX mounts have no equal...!

Only Met-L-Flex mounts are completely impervious to the elements—extreme high or low temperatures, oils, chemicals, fuels, whatever—our mounts will withstand them all!

Met-L-Flex mounts are **all metal**—they incorporate a resilient cushioning material of fabricated, knitted stainless steel wire. It isolates your product from vibration and shock, and we're the only ones that have it!

Perhaps your product doesn't require a mount this great? Fine, we also have a **complete line** of elastomeric mounts to meet any vibration or shock problem... so whether you're mounting electronic gear, little "black boxes," heavy machinery, or complete computer systems, we have the mount to solve the problem.



Met-L-Flex unit isolator for Airborne, Vehicular and Industrial applications.

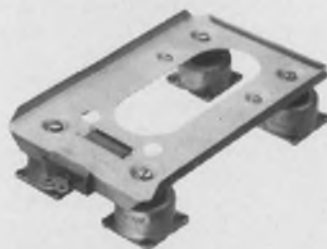

High Frequency engineered mounting systems for missile applications.

# VibraShock

ROBINSON TECHNICAL PRODUCTS, INC.  
3310 Vanowen Street, Burbank, California 91504  
(213) 849-7181 TWX 910-498-2217

ON READER-SERVICE CARD CIRCLE 17

# GO ... 20 Hz to 1 GHz

## Kay 1500 Sweep & Marker Generator



### TYPICAL PLUG-INS

Model	Center Freq.	Sweep Width
P-141	20 Hz-200 KHz	20 Hz-20 KHz
P-142	35 Hz-600 KHz	20 Hz-20 KHz
P-130	100 Hz-2 MHz	200 Hz-2 MHz
P-152	10 KHz-20 MHz	10 KHz-20 MHz
P-855	2-32 MHz	5 Hz-800 KHz
P-856	10-120 MHz	10 Hz-1 MHz
P-860	2-220 MHz	10 KHz-30 MHz
P-867	220-470 MHz	20 KHz-30 MHz
PI-123	100-1000 MHz ANY SINGLE OCTAVE	5 KHz-Octave
<b>Freq. Marker</b>		
PM-7631	6 Pulse & Ext.	
PM-7632	6 Pulse & Ext.	
PM-932	30 Pulse	
PM-861	6 Harmonic and CW Osc.	

### ■ VOLTAGE CONTROLLED OSCILLATORS

#### ■ MARKERS

Pulse  
RF Turn-off  
Harmonic  
CW Birdie

#### ■ SWEEP

0.2 to 60 cps  
Log and Linear  
External Input  
Manual Control

The basic rack contains a variable, sawtooth sweep generator, a fast-acting AGC, frequency-marker control and output circuits, RF output circuits with precision attenuators, a calibrated output meter, an accurate RF detector, and carefully regulated power supplies.

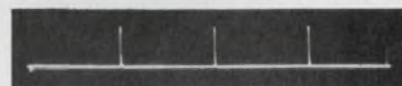

Pulse-Type Markers



Harmonic (or Comb) Birdie Markers

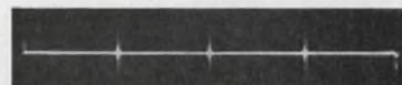

Single-Freq. Type Birdie Markers



Detected Turn-Off Markers

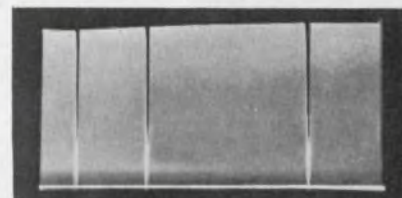

Undetected Turn-Off Markers

# KAY ELECTRIC COMPANY

Pine Brook, N. J. 07058 • (201) 227-2000 • TWX: 710-734-4347

April 26, 1966

ON READER-SERVICE CARD CIRCLE 18

MEPCO introduces ...

# S.M.A.C.

Simultaneous Mass Attachment of Components

for the mass-production of  
**FILM HYBRID MICROCIRCUITS**

It's new from MEPCO . . . the major key to Mepco's breakthrough in the art of mass-producing film hybrid microcircuits.

Ask about S.M.A.C. today.

Find out what it can mean to your present and future production schedules.



## MEPCO, INC.

COLUMBIA ROAD, MORRISTOWN, NEW JERSEY  
07960 (201) 539-2000

ON READER-SERVICE CARD CIRCLE 19

## NEWS

(Poseidon, continued)

accuracy and striking power "will permit its use effectively against a broader range of possible targets and give added insurance of penetration of enemy defenses." ■ ■



Nuclear submarines that now carry the Polaris A-3 missile will accommodate the Poseidon after modification of their missile tubes.

(continued from p 20)

This means that the orbital plane revolves about the Earth's polar axis at the same velocity as that at which the Earth rotates about the Sun. The primary advantage of such an orbit is that solar illumination on the portions of the Earth directly beneath the satellite remains essentially constant on each orbit. This ensures that each TV picture has essentially the same scene-brightness.

When the satellites are on the night side of the Earth their cameras are automatically shut down. On the day side of the Earth they each take a sufficient number of pictures per orbit to cover the entire Earth with some overlap. ESSA I can store over 48 pictures on its tape recorders for later transmission upon command. Stations receiving ESSA II can acquire two or three pictures per orbit on each of one to three orbits. The nearer a station is to the poles, the more frequently the satellite is in range. ■ ■

Twice as accurate  
as any potentiometer  
in its price class

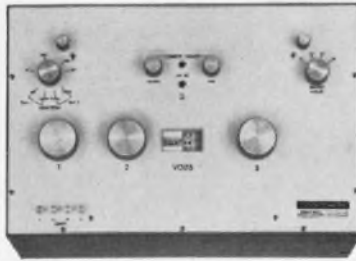

Half the price  
of any potentiometer  
in its accuracy class

# Here's the biggest news in potentiometers in 10 years!

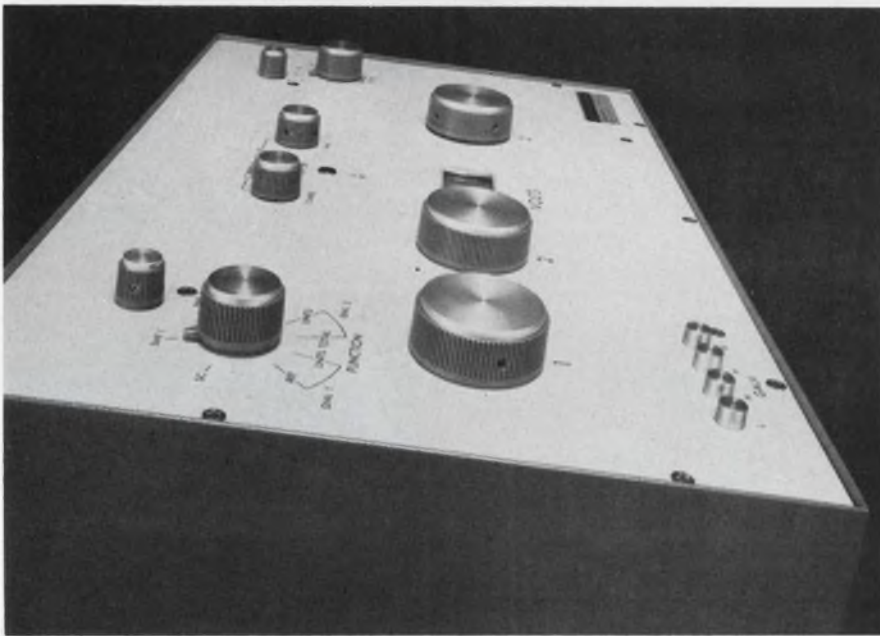

It's the all-new Model 2784 Laboratory Potentiometer from Honeywell! We invite you to check specs and prices on all other pots—you'll find that only instruments costing three to four times as much offer the features built into the new 2784. Features such as:

**Extremely High Accuracy** — .002% at the one volt range. Most other pots in the 2784's price range are .01% accurate.

**Wide Range** — From 0 to 11.110 volts, with a resolution of 5 ppm. The 2784 is the first extended range pot from a major manufacturer.

And, its range is direct—no voltage dividers are used.

**Versatile**—Low temperature coefficient design lets you use the 2784 as a laboratory potentiometer or a production calibration instrument.

**Completely Self-Checking**—Another first for instruments in this price range.

**Total Double Guarding**—The 2784 is the first potentiometer in any price class to offer guarding of all measuring system devices.

**Smooth Performance**—Because it uses a non-convoluted slide wire,

you get infinite resolution on the wire . . . not the bumpy, discontinuous measurements produced by a convoluted slide wire.

**Low Thermal EMF's**—Less than .1 microvolt; residual EMF's are well within the 2784's limits of resolution.

In addition, the new Model 2784 offers recessed terminals; automatic decimal point location; single window in-line readout; printed circuitry; very low temperature coefficient; main dial standardizing; correctable auxiliary output, and dual EMF input.

Call your nearby Honeywell representative or mail this coupon today for complete technical specifications on the new Honeywell Model 2784 Laboratory Potentiometer.

**Carl Boyer**  
Honeywell, Denver Division  
Mail Station 414  
Denver, Colorado 80217

Please send literature on the Model 2784 Potentiometer to:

Name \_\_\_\_\_

Company \_\_\_\_\_

Address \_\_\_\_\_

City \_\_\_\_\_ State \_\_\_\_\_ Zip \_\_\_\_\_

**DATA HANDLING SYSTEMS**  
**Honeywell**

**■ AT LAST—  
AN ALL-PURPOSE LINE OF  
LOW-CURRENT RECTIFIERS**

Call off the search if you've been trying to track down a truly all-purpose 1.5-amp rectifier. Here's a new glass-encapsulated, general purpose device you can use almost anywhere. We call it the A14, and it's rated up to 800 volts PRV.

Try it out in your TV and radio power supplies, power logic circuits, free-wheeling rectifiers, battery chargers or communication equipments. You'll find they're great, too, for arc suppression and general purpose power supplies.

Every rectifier in the all-new line is transient-voltage protected . . . will dissipate voltage transients to 1000 watts in the reverse direction without

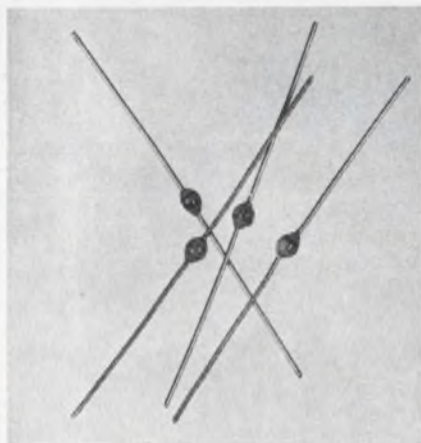

ACTUAL SIZE G-E 1.5-amp rectifiers

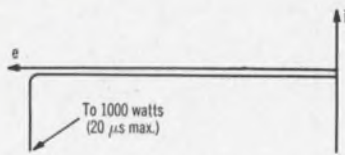

Voltage transients up to 1000 watts are instantly absorbed.

damage. Each device is hermetically sealed to keep harmful moisture out. Each features dual heatsink design for maximum heat dissipation under both surge and continuous duty. And all are available at competitive prices.

Want more details? Circle Number 811 on the magazine Reader's Service Card.

**Trigger Happy?**

We are, if variety and breadth are what you're seeking in negative-resistance trigger device lines. G.E. offers no fewer than four major lines to choose from: unijunction transistors, characterized by their very stable trigger points; silicon unidirectional switches, character-

ized by fixed, stable breakover voltage (6 to 10-volt range); silicon bilateral switches, bilateral versions of the SUS; and G-E DIACs, the ideal devices for low cost TRIAC triggering on 120/240-volt a-c lines. Circle Number 813 to learn more about any or all of them.

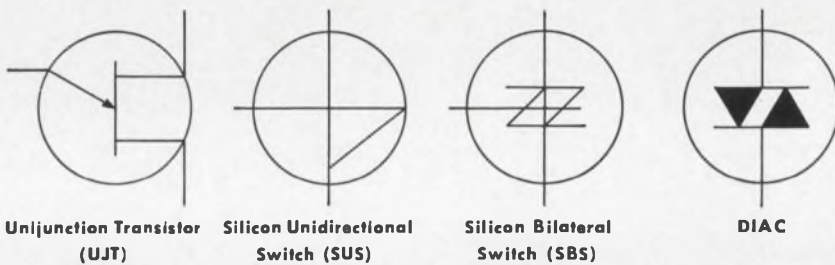

**■ BREADBOARDING  
THE EASY WAY**

Why re-invent a power control circuit that may already have been designed, built and stocked for you? Try these G-E standard TRIAC assemblies first:

- S100A1-4 Basic Variable Voltage Circuits
- S100B1-4 Extended Range Variable Voltage Circuits
- S100C1-4 Extended Range Variable Voltage Circuits (RFI Suppressed)
- S100D1-4 Combination Variable Voltage Circuits and Static Switches (RFI Suppressed)
- S100E1-4 Blower Motor Speed Controls with Set Low Speed (RFI Suppressed)
- S100F1-4 Basic Variable Voltage Controls (RFI Suppressed)
- S100G1-4 Static Switches

Each standard assembly is two inches wide, one inch high and three inches long complete with electrically isolated heatsink. Each is available both direct from G.E. and from your authorized G-E distributor. Try 'em. Or ask for more facts by circling Number 812. Ask about our specialty assemblies, too.

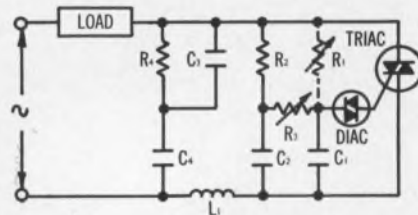

S100C1-4 Extended Range Variable Voltage Assembly with RFI Suppression

More information on all G-E semiconductor products can be obtained by calling your G-E engineer/salesman or distributor. Or write to Section 220-30, General Electric Company, Schenectady, N. Y. In Canada: Canadian General Electric, 189 Dufferin St., Toronto, Ont. Export: Electronic Component Sales, IGE Export Division, 159 Madison Ave., New York, N. Y.





### Electronics helps in crime control

The Justice Department once again is the latest Federal agency to offer new marketing opportunities to the electronic industry. The Department is holding \$7 million to be granted to cities this year for R&D aimed at improving law enforcement. It will be used mainly for development and evaluation of computer files of criminals' habits and physical appearances, closed-circuit-TV police line-ups, and data transmission including high-speed systems for circulating particulars of stolen property.

The grants will be made only to those cities which are developing systems that will key in with those of most other cities in the nation. Systems tailored to meet the specific needs of one city alone will not qualify for assistance, according to Courtney Evans, head of the Department's Office of Law Enforcement Assistance.

Recently it was revealed that the Department's Federal Bureau of Investigation is seeking 35 electronic firms' help in developing ways to transmit fingerprint information over the national crime data computer network that is presently being set up (ED 8, Apr. 12, 1966, p. 32). The FBI is now deciding on which large population area to run a mass test of its new computer system in. The system will contain arrest records filed for a number of years by some 13,000 agencies. The region to be selected will have to have a most comprehensive range of criminal activity, for the test must bring out every conceivable problem that may be encountered in operating a nationwide crime computer system.

### Navy readies for future H-bomb losses

The "Missing H-bomb of Palomares" has apparently taught the Navy a lesson. It will be better prepared the next time—and officials see no reason why there may not be a next time.

The Navy is understood to have turned for help to a private operations research firm, which is said to be looking at H-bomb-recovery problems and the associated problem of radioactive-waste disposal.

# Washington Report

S. DAVID PURSGLOVE,  
WASHINGTON EDITOR

Hopefully, says a Navy official, the company will come up with practical suggestions on the shape of an organization to cope with recovery, the types of temporary buildings needed in a recovery area and the requirements for instruments, equipment and supplies.

### Electronics remains the key to the oceans

Electronics is the key to profitable utilization of the sea. This statement is hackneyed, but never before has it been reaffirmed by a body representative of such a broad spectrum of government and industry interest as that which has just issued a report. The National Security Industrial Association and the Interagency Committee on Oceanography set up a joint panel on exploitation of the Continental Shelves. The panel has now completed a five-month study of five industries concerned and the recommendations in its report have important implications for the electronic industry and designers. The panel points out that inadequate prediction of weather and sea conditions "has been responsible for inefficiency in operation, as well as serious loss of life and equipment." It adds flatly that a major preoccupation of the offshore petroleum industry is "with finding an effective means of killing hurricanes in their early stages and improved services in environmental prediction."

It urges that additional weather stations be established to make records in the mixed layers of the ocean and atmosphere; that more efficient use be made of data furnished by existing weather stations; and that some steps be taken toward achievement of weather modification. The panel also recommended more accurate, reliable and economical all-weather navigation systems, and better information-storage and -retrieval systems for oceanic data. Finally, it called for development of better oceanographic instruments. Toward this latter end, it suggested that a National Oceanographic Instrumentation Center be set up to standardize and calibrate instruments, develop standards and specifications, and consult on instrument development.

# Washington Report

CONTINUED

The five industries involved in Continental-shelf exploitation that were examined were the petroleum, mining, chemical, fishing and maritime.

## "Air buses" will rely on electronics

Vertical take-off and landing (VTOL) "air buses" for use in the Northeast Corridor will depend heavily on electronic navigation, signal and landing-aid systems that have yet to be developed, according to National Aeronautics and Space Agency officials. The Commerce Department has given its support to a proposal by M.I.T. that VTOL aircraft be employed to provide regular commuter services between the heavily populated areas on the eastern seaboard between Washington, D.C., and Boston.

The much discussed M.I.T. proposal, which has met with wide approval, was funded by the Department—an office that is largely concerned with high-speed ground transportation. But it is NASA that has carried out the pioneering civilian work on VTOL aircraft.

For more than a year NASA officials have indicated that one major obstacle to the imminent use of VTOLs for city-center-to-city-center transportation is the lack of tried and proven signaling and landing-aid systems that would permit "air buses" to be truly all-weather operational. NASA's position has been that there is little merit in developing an air commuter network that would be out of service a great part of the time because of bad weather.

The Commerce Department's latest nod toward VTOLs is expected to lead to a better-funded push for the needed electronics.

## Study urges "diversify now"

Government officials have been privately urging the electronic industry to study with an open mind a recent report by the Denver Research Institute on the need for the industry to diversify now (ED 8, Apr. 12, 1966, p. 13). The Electronic Industries Association and the Aerospace Industries Association have both been perusing the report and are expected shortly to adopt official public positions. Officials of the Associations, however, have already admitted the validity of the reasoning behind the report's conclusions, even if they are unsure whether they will publicly support its plea for diversification.

Now is the time for electronic firms that rely heavily on military contracts to diversify into non-war areas despite thriving business that they may be doing as a result of the Vietnam war was the main conclusion of the report. Although the Institute's study was undertaken for the Arms Control and Disarmament Agency, it is Defense Department officials who have been among the report's staunchest advocates. Once burned by the near disappearance of an aircraft industry that had depended too heavily on war contracts, the Pentagon is anxious to see the electronic industry spread into other than war areas so that it may remain vital and vigorous and readily available whenever it might be needed in a hurry for military tasks.

The Institute believed this was the time to start diversification because many electronics and military oriented firms have ample cash rolling in from the Vietnam build-up. Pentagon officials agree. Said one: "You people ought to take some of these profits and plow them into new fields so you'll be around the next time we need you." He agreed that military business for electronic and aerospace firms was erratic and could very likely slump again in a few years. But he added that the Defense Department was reluctant to have any push for diversification result in shortages of military material.

## Punctuality—keynote to new rail age

The need for new electronic systems to ensure reliable control over the high-speed trains envisioned for the near future was clearly pointed up by a railroader about to embark on a commuter service venture. The Richmond, Fredericksburg & Potomac Railroad is considering joining the Federal demonstration projects by supplying commuter service from Northern Virginia suburbs into Washington, D.C. Because the commuter self-propelled cars would have to be sandwiched into a busy freight schedule, John J. Neubauer, Jr., administrative assistant to the president of RF&P, said schedules would almost have to be split second. "If a commuter got to the station at 8:04," said Neubauer, "he probably would have missed the 8:03."

## Government defines competition

New guidelines established by the Bureau of the Budget spell out in detail the policies to be followed in defining Federal competition with private industry. In general, the Government will provide goods and services for its own use only if the cost of so doing is at least ten percent less than that of obtaining them from private sources.

**ENVIRONMENTAL PROOF**  
is what we call it . . .



**Stackpole Rotary Switches**  
**Specially Designed to Guard Against**  
**EXPOSURE—CONTACT CONTAMINATION—PRODUCTION DAMAGE**

**COMPETITIVELY PRICED**—This completely enclosed, rugged switch costs no more than the open clip type.

**SAMPLES IN 3 DAYS**—to your exact specifications. Send your drawing and prove it to yourself.

**ORDERS IN 2 TO 3 WEEKS**—On-time delivery of uniform, high quality production quantities to meet your schedule.

**SEND YOUR DRAWING FOR A QUOTATION AND SAMPLE.** Take advantage of Stackpole quality, price and service. For additional information and technical data write: Electro-Mechanical Products Division, Stackpole Carbon Company, St. Marys, Pennsylvania 15857. Phone: 814-834-1521. TWX: 510-693-4511.



**STACKPOLE**  
ELECTRO-MECHANICAL  
PRODUCTS DIVISION



## Your Breathing Troubles: Understand Them, Face Them, Treat Them

**Y**OU have trouble with your breathing: unusual shortness of breath, persistent coughing, too much phlegm—or a combination. Is it serious? It might be.

You know it's not "just a cold." Your trouble has been going on for a long time, or coming and going over months, perhaps years. You are only noticing it now—and wondering. Or perhaps you've been aware of it for a while. But you put it down to "too much smoking" or "just run down" or "getting out of condition." Now you think there might be more to it than that.

Yes, there might.

### What Happens?

Your lungs are a complicated system of air sacs with connecting tubes, large and small. Their job is taking in fresh air and forcing out stale air. Trouble comes when the flow of air in and out of the lungs is impaired. Then trouble shows itself in breathlessness, coughing or other such symptoms.

Your air flow may be impeded by one or more of several possibilities. A doctor can usually tell which factors are involved in a particular case. When they consider the overall picture, the general name given to this trouble by medical experts is "chronic airway disease." By this they mean breathing trouble that involves impaired air flow, the cause for which must be found for each patient. It may not be easy.

Having looked into the situation of the patient before him, the doctor may give his trouble a specific name, too, depending on the cause and other features. Asthma, chronic bronchitis, em-

physema—these are the three most important of several ailments that come under "chronic airway disease."

### Three Ailments

... *Asthma* is the collection of breathing troubles that result from an allergy to some normally harmless substance.

... *Chronic bronchitis* means long-lasting trouble in the lung tubes that shows itself in coughing, too much phlegm, and breathlessness.

... *Emphysema* may show itself in the same way—especially by breathlessness—but it has the added feature that some of the small sacs (air spaces) deep in the lungs are damaged.

These three (and certain other ailments) are lumped together under one heading because they so often overlap. Also, they look and feel much alike.

### What Causes?

... *Asthma* can be explained, in a general way: You're allergic to some substance, like ragweed pollen or horse dander. But finding the substance (or substances) that are guilty in your particular case may be difficult.

... *Chronic bronchitis*? Maybe it's caused by repeated colds, too much smoking, air pollution, or other things that do damage in the lungs—or by a combination of several or all such things.

... In *emphysema*, with the over-stretched air sacs and destroyed air sac walls that are its outstanding feature, the cause is less clear. But the doctors have strong suspicions about infections, cigarette smoking and air pollution.

Most important for you, the doctors have ways of meeting the challenges

of the various causes of chronic breathing trouble and of the very real and known troubles they cause.

If you (or someone in your family) has chronic airway disease, you can be helped. Your doctor has available both advice and medical procedures of several kinds. He has ways to help you breathe better, to combat infection if it is present, and to avoid those things that aggravate your symptoms.

### What Should You Do?

If you have breathing troubles, you cannot decide for yourself what is causing them. *Let your doctor decide.* If you turn out to have chronic airway disease, particularly emphysema, you want to know how you can be helped. *Your doctor can tell you.*

Write for the free booklet, "Your Breathing Troubles: Understand Them, Face Them, Treat Them," paid for by Christmas Seals. Use the coupon. Paste it to a postcard.

NTA  
GPO, Box 2400  
New York, N.Y. 10001

Send me the free booklet, "Your Breathing Troubles: Understand Them, Face Them; Treat Them"

Name \_\_\_\_\_

Address \_\_\_\_\_

City \_\_\_\_\_

State \_\_\_\_\_

Zip Code \_\_\_\_\_

Emphysema-Bronchitis  
National TB Association 

# It's Time To Renew Your Free Subscription To **Electronic Design**

Complete the renewal form when you receive it. Return it immediately to insure uninterrupted service.

In the year ahead ELECTRONIC DESIGN will be the magazine that keeps pace with your fast-moving field. Look to ED for these special issues—Signal Generators, Designing for Automation, a Semiconductor Directory; plus special in-depth coverage of the Wescon and IEEE shows, and more. All in addition to the most abundant, most comprehensive coverage of the news, products, and technology which are of importance to you.

Drop your renewal in the mail today and keep ELECTRONIC DESIGN coming to your desk for the next year.

## **29** issues in **66**

If you are not now a subscriber and would like to receive your own copy each month circle Reader Service Number 800.

**Announcing  
Westinghouse CYW6...  
The Only Glass-Type  
Capacitor  
with 'feet'  
(and no 'pants') →**

THEY PUT YOU A STEP AHEAD FOR  
FASTER, MORE RELIABLE SOLDERING  
AND BOARD CLEANING

Satisfy military glass capacitor requirements at low cost with Westinghouse's new CYW6. Every capacitor is tested to MIL-C-11272.

CYW6's construction is unique. Its capacitor plates are molded in glass for ultimate stability. Its case is injection-molded from a low-loss, high-temperature glass-filled silicone material. The result is precision. Flash or "pants" never form on the leads. And case dimensions are exact.

CYW6's exclusive "feet" space the capacitor body above the circuit board for more reliable soldering and efficient board cleaning. No other capacitor gives you this combination of outstanding electrical performance plus features for low-cost, reliable circuit production.

CALL YOUR WESTINGHOUSE DISTRIBUTOR — Or for detailed technical data, write G. Blackman, Marketing Manager, Westinghouse Capacitor Department, P. O. Box 868, Pittsburgh, Pa. 15230.

CYW6 CHARACTERISTICS: • Capacitance range 1 through 560 pf. • 300 volts, DCW at  $-55^{\circ}$  to  $+125^{\circ}$ C. No derating required. Dissipation factor less than .001 at  $25^{\circ}$ C and 1 KC. • Capacitance drift less than 0.1% per decade of frequency. J-09303

You can be sure  
if it's Westinghouse



# Letters

## Analog-IC suggestions

Sir:

I would like to call two important points to the attention of R. J. Widlar and J. N. Giles in reference to their article "Avoid Over-Integration . . .," which appeared in the Feb. 1, 1966 issue of *ELECTRONIC DESIGN*.

My first comment is on the sine-wave oscillator with stable gain. Gain stability is, of course, one of the important requirements in an oscillator design. But frequency stability is also important. Normally gain stability in nearly-sinusoidal oscillators does not lead to frequency stability. To achieve frequency stability, we must use either crystals or non-minimum phase-shift networks in the positive feedback path. Non-minimum phase-shift networks can be realized by using RC networks (notch filters).

The second point I would like to make concerns Eq. 9. This expression can be derived by writing the continuity equation in the base region with the proper boundaries. It can be shown that this expression holds only when  $V_{CB} \rightarrow 0$ . Also, since  $Q_1$  and  $Q_2$  in Fig. 3 do not operate under the same conditions ( $Q_2$  acts as a diode), the proportionality constants in Eq. 9 for  $Q_1$  and  $Q_2$  are not the same. Thus Eq. 10 must be used with utmost care. I hope this note will stimulate more thoughts and discussions.

Vasil Uzunoglu

Scientific Consultant  
ARINC Research Corp.  
Annapolis, Md.

## The author replies

Sir:

I agree wholeheartedly with Mr. Uzunoglu that non-minimum phase-shift networks make an oscillator less sensitive to variations in components other than the frequency-determining elements. However, operational-amplifier techniques can minimize these variations to the point where the frequency stability is dominated more by the stability of the RC elements than by the characteristics of the amplifier. When this is the case, it does not

make much sense to go to non-minimum phase-shift networks, since they are similarly affected by changes in the RF elements.

The emitter-base voltage of a transistor is affected by collector-base voltage. This sensitivity is reflected in Eq. 9 as a change in the unspecified proportionality constant, which means that the equation still holds for any constant emitter-base voltage. Even so, the change in the emitter-base voltage with the collector-base voltage is quite small. At a fixed collector current, it is described by  $h_{rb}$ , which is about  $10^{-4}$  for practically all transistors.

In both the logarithmic amplifier and the multiplier, the transistors are matched and operated at essentially equal collector-base voltages (in fact,  $V_{CB} = 0$  for the log amp). Hence the error caused by the non-zero collector-base voltage will be about 0.1 mV, which can be neglected. This is demonstrated mathematically by the fact that the proportionality constant in Eq. 9 does not show up in Eq. 10.

As Mr. Uzunoglu mentioned, the fact that  $Q_2$  (Fig. 3) is connected as a diode does introduce an error. The error arises because Eq. 12 also includes the value of base current ( $I_{B2}$ ) flowing through  $R_b$ . With a dc current gain of 50, this decreases the emitter-base voltage of  $Q_2$  by 0.5 mV below its expected value. Since this is small by comparison with the initial offset voltage of the transistor pair, it can also be neglected. The important point is that  $Q_2$  is operating at a constant current, so this error does not alter the logarithmic characteristic generated by  $Q_1$ .

Robert Widlar

Section Manager  
Linear Microcircuits  
Fairchild Semiconductor  
Mountain View, Calif.

**Mho: yes  
siemens: no**

Sir:

It is heartening to read Mr. Howard Cook's protest (ED 4, February 15, p. 42) against the substitution

**Come  
to where  
the  
"Action"  
is on...**



**BOURNS**

**EASTERN  
RADIO CORP.**

312 CLIFTON AVENUE  
CLIFTON, NEW JERSEY 07015

**N.J. 201-471-6600  
N.Y. 212-244-8930**

(DIRECT N.Y. LINE)

# World's largest selection of adjustment potentiometers

## BOURNS TRIMPOT® POTENTIOMETERS

**More engineers specify Bourns TRIMPOT Potentiometers because:**

**TRIMPOT Potentiometer line is complete:**

Bourns offers you the largest selection of adjustment potentiometers... 33 standard models—4 terminal types—3 mounting styles.

**TRIMPOT Potentiometers are small:**

Space-saving size and choice of shapes permit the installation of up to 17 units (and sometimes even more) in one square inch of panel area.

**TRIMPOT Potentiometers are accurate:**

Screw-driver adjustment gives as much as 9000° of rotation... you can make and repeat the finest adjustments.

**TRIMPOT Potentiometers are stable:**

Adjustment shaft is self-locking... settings are virtually immune to acceleration, vibration and shock.

**TRIMPOT Potentiometers are fully tested:**

All units are 100% inspected before shipment and are checked by Bourns' exclusive Reliability Assurance Program to assure you of reliable performance.

**TRIMPOT Potentiometers are proven:**

They are backed by over 17 years of engineering know-how and have been specified and used in more military, industrial or commercial equipment than any other leadscrew potentiometer in the world!

REMEMBER—IF IT'S TRIMPOT, IT'S BOURNS

### Only Bourns TRIMPOT Potentiometers Give You All Of These Outstanding Features

**SPRING**—Carriage spring provides positive no-slip performance during rotation plus a reliable idling feature at mechanical limits of travel.

**LEADSCREW**—Stainless steel leadscrew is corrosion-resistant.

**O-RING**—Silicone rubber O-ring seals potentiometer against humidity, withstands high temperature.

**SHAFT HEAD**—Stainless steel with machined slot for screw-driver adjustment. Meets military salt spray requirements.

**WIPER**—Gold-plated wiper carriage and precious-metal wiper for low noise. Carriage and wiper are welded together.

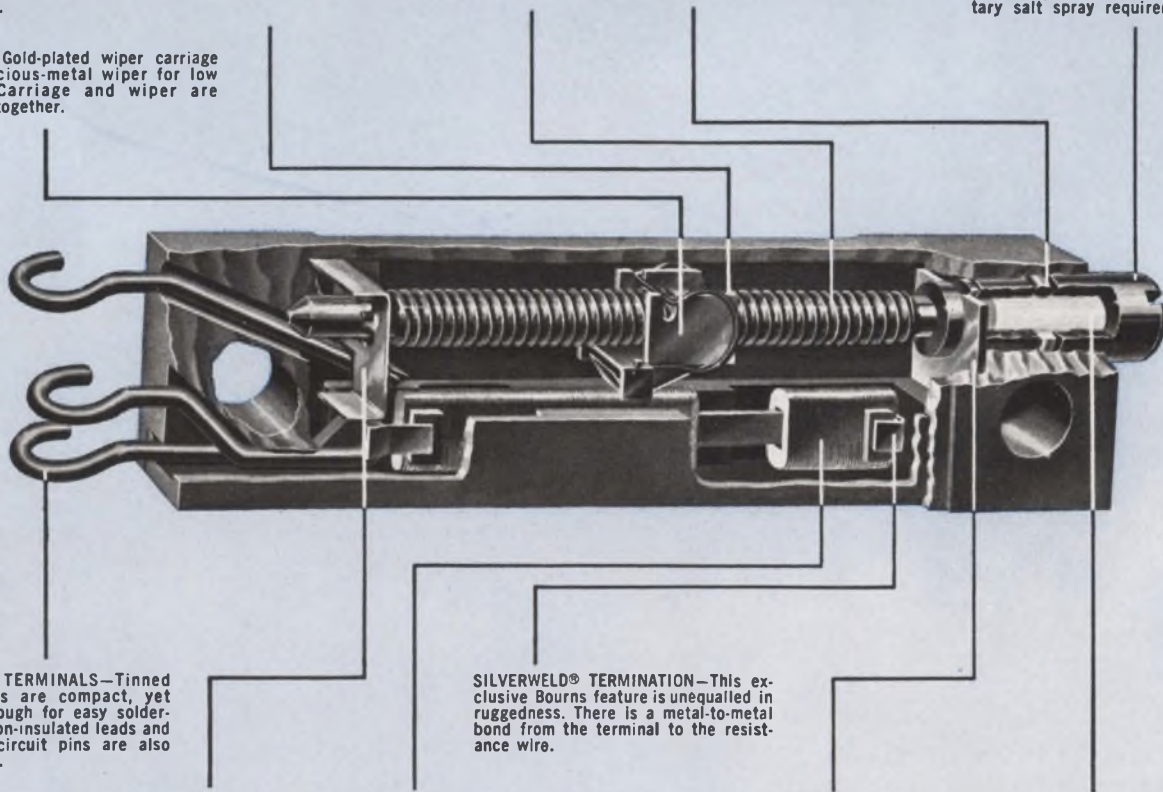

**SOLDER TERMINALS**—Tinned terminals are compact, yet large enough for easy soldering. Teflon-insulated leads and printed circuit pins are also available.

**SILVERWELD® TERMINATION**—This exclusive Bourns feature is unequalled in ruggedness. There is a metal-to-metal bond from the terminal to the resistance wire.

**PICK-OFF**—Precious-metal, positive-contact pick-off assures wiper continuity.

**ELEMENT**—Special ceramic element card for maximum reliability is precision wound with low-temperature-coefficient resistance wire.

**SHAFT RETAINER**—Shaft is locked in place for top performance under extreme shock, vibration and acceleration.

**SHAFT INSULATOR**—High-dielectric-strength, ceramic insulator isolates shaft head from internal circuits.

This cutaway of Model 224 shows the typical high quality to be found in all Bourns TRIMPOT potentiometers, although some features may vary from model to model.



# ...longest record of reliability

## TRIMPOT® POTENTIOMETERS—UNSEALED



General-Purpose Wirewound Model 200. Max. temp. 105°C / L, S, P terminals / 0.50 watt at 70°C / 10 ohms to 100K.



General-Purpose RESISTON® Carbon Element Model 215. Max. temp. 125°C / L, S, P terminals / 0.25 watt at 50°C / 20K to 1 Meg.



High-Temperature Wirewound Model 260. Max. temp. 175°C / L, S, P terminals / 1.0 watt at 70°C / 10 ohms to 100K.

## TRIMPOT POTENTIOMETERS— HUMIDITY PROOF



General-Purpose RESISTON Carbon Element Model 235. Max. temp. 135°C / L, S, P terminals / 0.25 watt at 50°C / 20K to 1 Meg.



General-Purpose Wirewound Model 236. Max. temp. 135°C / L, S, P terminals / 0.8 watt at 70°C / 10 ohms to 100K.



Micro-Miniature High-Temperature Wirewound Model 3000. Max. temp. 175°C / P terminals / 0.5 watt at 70°C / 50 ohms to 20K.



Micro-Miniature High-Temperature RESISTON Carbon Element Model 3001. Max. temp. 150°C / P terminals / 0.20 watt at 70°C / 20K to 1 Meg.



Sub-Miniature High-Temperature Wirewound Model 220. Max. temp. 175°C / L, W terminals / 1.0 watt at 70°C / 10 ohms to 30K / Mil-Spec style RT10 and meets MIL-R-27208A.



High-Temperature Wirewound Model 224. Max. temp. 175°C / L, S, P terminals / 1.0 watt at 70°C / 10 ohms to 100K / Mil-Spec style RT12 and meets MIL-R-27208A.



Ultra-Reliable High-Temperature Wirewound Model 224-500. Max. temp. 150°C / L, P terminals / 0.5 watt at 70°C / 100 ohms to 20K. Performance and reliability statistically verified to customer.



High-Temperature, High-Resistance RESISTON Carbon Element Model 3051. Max. temp. 150°C / L, S, P terminals / 0.25 watt at 50°C / 20K to 1 Meg / Mil-Spec style RJ11 and meets MIL-22097B.



High-Temperature High-Resistance PALIRIUM® Film Element Model 3052. Max. temp. 175°C / L, P terminals / 1.0 watt at 70°C / 10K to 1 Meg.



High-Temperature, Low-Resistance PALIRIUM Element Model 3053. Max. temp. 175°C / L, P terminals / 0.5 watt at 70°C / 2 ohms to 100 ohms.



High-Temperature Wirewound Model 3010. Max. temp. 175°C / L, P terminals / 1.0 watt at 70°C / 10 ohms to 100K / Mil-Spec style RT11 and meets MIL-R-27208A.



High-Temperature RESISTON Carbon Element Model 3011. Max. temp. 150°C / L, P terminals / 0.25 watt at 50°C / 20K to 1 Meg / Mil-Spec style RJ11 and meets MIL-R-22097B.



High-Temperature High-Resistance PALIRIUM Element Model 3012. Max. temp. 175°C / L, P terminals / 1.0 watt at 70°C / 10K to 1 Meg.



3/4" Square Wirewound Model 3280. Max. temp. 175°C / L, P, W terminals / 1.0 watt at 70°C / 10 ohms to 50K.



3/4" Square RESISTON Carbon Element Model 3281. Max. temp. 150°C / L, P, W terminals / 0.5 watt at 50°C / 20K to 1 Meg.



3/4" Square, High-Temperature Wirewound Model 3250. Max. temp. 175°C / L, P, W terminals / 1.0 watt at 70°C / 10 ohms to 50K / Mil-Spec style RT22 and meets MIL-27208A.



3/4" Square High-Temperature RESISTON Carbon Element Model 3251. Max. temp. 150°C / L, P, W terminals / 0.50 watt at 50°C / 20K to 1 Meg / Mil-Spec style RJ22 and meets MIL-R-22097B.

## BOURNS® SINGLE-TURN POTENTIOMETERS



3/16" Diameter Micro-Miniature High-Temperature Humidity-Proof Wirewound Model 3300. Max. temp. 175°C / P, S terminals / 0.5 watt at 70°C / 50 ohms to 20K.

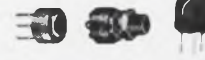

3/16" Diameter Micro-Miniature High-Temperature Humidity-Proof RESISTON Carbon Element Model 3301. Max. temp. 150°C / P, S terminals / 0.25 watt at 70°C / 10K to 1 Meg.



Sub-Miniature Wirewound Model 3367. Max. temp. 105°C / P, S terminals / 0.5 watt at 70°C / 10 ohms to 20K / meets steady-state humidity.



Sub-Miniature RESISTON Carbon Element Model 3368. Max. temp. 105°C / P, S terminals / 0.25 watt at 50°C / 20K to 1 Meg / meets steady-state humidity.

## LOW-COST COMMERCIAL POTENTIOMETERS



Wirewound TRIMIT® Potentiometers Models 271, 273, 275. Max. temp. 85°C / L, S, P terminals / 0.5 watt at 25°C / 50 ohms to 20K.

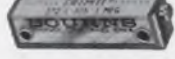

RESISTALOY® Carbon Element TRIMIT Models 272, 274, 276. Max. temp. 85°C / L, S, P terminals / 0.2 watt at 25°C / 20K to 1 Meg.

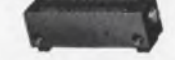

Wirewound E-Z-TRIM® Potentiometer Model 3067. Max. temp. 85°C / S, P terminals / 0.5 watt at 25°C / 100 ohms to 20K / Priced under \$1 in production quantities.



Carbon Element E-Z-TRIM Potentiometer Model 3068. Max. temp. 85°C / S, P terminals / 0.2 watt at 25°C / 20K to 1 Meg.

## SPECIAL-PURPOSE POTENTIOMETERS



High-Power (2 watts) High-Temperature Wirewound Model 207. Max. temp. 175°C / L terminals / 2 watts at 50°C / 100 ohms to 100K. As Rheostat Model 208, available 100K to 200K.



High-Power (5 watts) Humidity-Proof Wirewound Model 3020. Max. temp. 200°C / L terminals / 5.0 watts at 25°C / 100 ohms to 50K.



Dual-Element Wirewound TWIN-POT® Potentiometer Model 209. Max. temp. 135°C / L terminals / 0.50 watt (each element) at 70°C / 10 ohms to 50K.



15 watts, High-Temperature Wirewound Model 3030. Max. temp. 265°C / L terminals / 15 watts at 25°C / 10 ohms to 10K.



Radiation-Resistant, High-Temperature Wirewound Model 3040. Max. temp. 350°C / W terminals / 5.0 watts at 70°C / 500 ohms to 20K.

## PANEL-MOUNTED POTENTIOMETERS



Most models are available with panel mounting. Unique design permits quick factory assembly to "on-the-shelf" units. In addition, mounting screws, brackets and clip brackets are available to meet almost any mounting requirement.

## KEY TO TERMINAL TYPES

L=Insulated stranded leads  
S=Solder lugs (includes panel-mounting bushing on Models 3367S, 3368S, 3300S and 3301S only)  
P=Printed-circuit pins  
W=Uninsulated wires (edge-mounting 3250, 3251, 3280 and 3281).

Write TODAY for detailed specifications on any model in the large BOURNS® Potentiometer and TRIMPOT® Potentiometer line AND a list of factory representatives.

Remember—  
Don't MIL-SPECulate...  
SPECify Bourns.

TRIMPOT is a registered trademark of Bourns, Inc.



BOURNS, INC., TRIMPOT DIVISION  
1200 COLUMBIA AVE., RIVERSIDE, CALIF.  
PHONE 954-1700 • TWX: 714-692 9592  
CABLE: BOURNSINC.

MANUFACTURER: TRIMPOT® & PRECISION POTENTIOMETERS, RELAYS; TRANSDUCERS FOR PRESSURE, POSITION, ACCELERATION. PLANTS: RIVERSIDE, CALIFORNIA; AMES, IOWA; TORONTO, CANADA

Speed Inquiry to Advertiser via Collect Night Letter  
ON READER-SERVICE CARD CIRCLE 22

**Come  
to where  
the  
"Action"  
is on...**



**BOURNS**

**EASTERN  
RADIO CORP.**

312 CLIFTON AVENUE  
CLIFTON, NEW JERSEY 07015

**N.J. 201-471-6600**

**N.Y. 212-244-8930**

(DIRECT N.Y. LINE)

ON READER-SERVICE CARD CIRCLE 23

**LETTERS**

of the siemens for the mho. It is high time such a protest was made, for the siemens is a miserable choice for a unit. Who was Siemens, anyway; what did he do? I have not yet found anyone who knows, and this suggests strongly that Siemens does not belong in the company of Faraday, Henry and Ohm. Mr. Cook is also right to point out the impropriety of using a name which is already the name of a company.

There ought to be some way in which the scientific and engineering community can kill this before it is too late. If we had acted quickly and decisively, we could probably have avoided having the hertz thrust upon us. There must be some means available for lodging a formal protest and putting a stop to the siemens.

Thomas W. Parsons  
Cardion Electronics, Inc.  
Woodbury, L.I., N. Y.

**Absolute values needed for standard measures**

David Bean seems to have missed his own point in his letter in the March 1 issue, "Down With Standards That are Earthbound." What he wants is not a less arbitrary and more universal system of units. Any system is arbitrary, even his, and is universal only to the extent that it is adopted. What he is really after is an absolute definition of that system.

In this respect his point is well taken. One could hardly measure the second against its standard, tropical year 1900. That standard in itself is lost forever.

We should instead define the metric units in terms of absolute standards. The meter is already defined in terms of the orange-red spectral line of Krypton 86. The kilogram could be defined as  $5.9790 \times 10^{26}$  times the rest mass of the proton.

The time when the world is finally approaching a uniform system of units is hardly an opportune moment to start changing to a new system unnecessarily.

Dennis W. Baker  
U.S. Navy Marine Engineering  
Laboratory  
Annapolis, Md.

**Accuracy is our policy**

The author of "Build a toneburst generator for \$50" in ED 4, Feb. 15, 1966, points out two errors.

On p. 104, the second sentence of the second paragraph should read: "If an oscilloscope can be requisitioned to measure the cycling function . . . ."

On p. 105, a line was omitted from the lower left portion of the schematic (shown in color below):

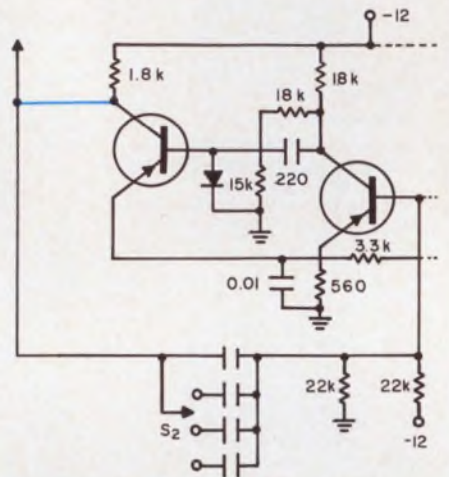

Page U146 of the Mar. 15 issue incorrectly shows Heath's dc scope as General Resistance's volt/ratio meter and GR's meter as Heath's scope.

The caption for the thin-film solar cell photograph on page U70 of the March 15 issue erroneously implied that the cells shown were being developed by RCA. Although RCA is doing work on such cells, the photograph shows thin-film solar cells now under development at the Electronic Research Division of Clevite Corp.

Several errors appeared in the artwork for the article "Try Capacitance Transducers," starting on page 188 of the March 15 issue. First, Figures 7 and 8 were reversed. The illustration appearing with the caption for 7 was actually 8, and vice versa.

In addition, the dimension R on Figure 3j should be the radius to the outside plate, instead of the inner plate as shown.

Finally, in the equation for Figure 3k, the dielectric constant  $\epsilon$  should appear in the numerator.

# Let SOLA custom-build your "tough spec" power supplies...

- HI-VOLTAGE TRANSISTORIZED POWER SUPPLIES
- LOW-VOLTAGE TRANSISTORIZED POWER SUPPLIES
- HI-VOLTAGE FERRORESONANT POWER SUPPLIES
- CVDC POWER SUPPLIES
- INVERTERS - CONVERTERS

No specs are too tough for SOLA design engineers. Proof? SOLA has custom-designed power supplies for the most sophisticated applications. Electron probe microanalysis equipment, nucleonic liquid gages for supersonic aircraft, precipitators, CRT devices, for instance.

The SOLA power supply used in liquid gages, for example, contains 120 parts, four etched circuit boards, yet measures only 1.86" in diameter, and .9" high. What's more, it provides regulation of  $\pm 0.25\%$  for all conditions of line, load, and temperature. It operates in a temperature range of  $-55^{\circ}\text{C}$  to  $72^{\circ}\text{C}$ , at thirty times the pull of gravity.

This is one of the many "tough spec" custom power supplies SOLA has engineered over the years. Whatever your requirements might be . . . extreme temperatures, tight regulation, low ripple, compactness, stability . . . remember, SOLA can custom-build your power supplies in OEM quantities. And at a price that's realistic.

Try us. We haven't been stumped yet. Send us your specifications, or a description of the end result required.

Write Sola Electric, Division of Sola Basic Industries, 1717 Busse Road, Elk Grove Village, Illinois 60007. Or call (312) 439-2800.

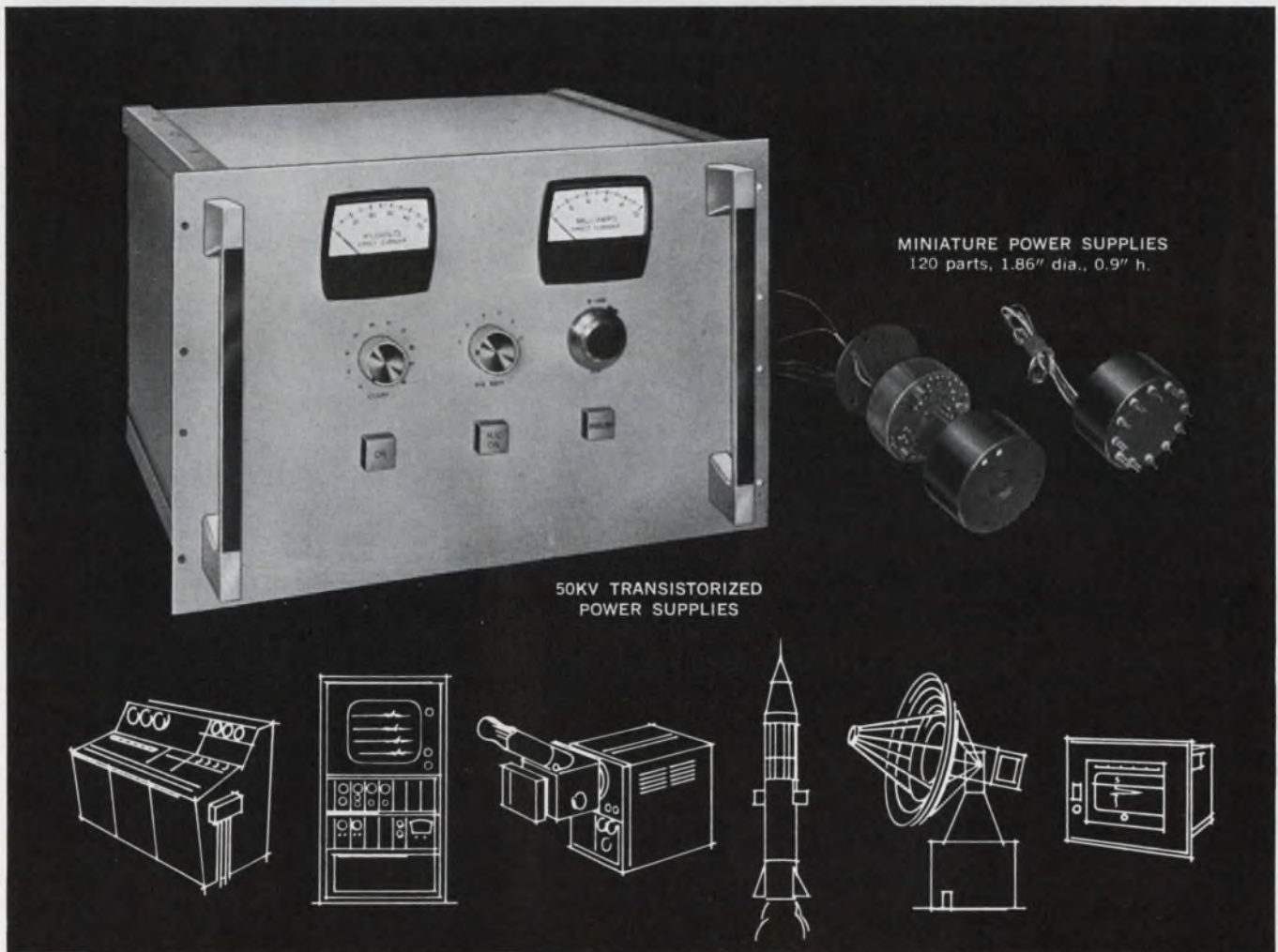

MINIATURE POWER SUPPLIES  
120 parts, 1.86" dia., 0.9" h.

50KV TRANSISTORIZED  
POWER SUPPLIES

**SOLA ELECTRIC** **SB**  
DIVISION OF SOLA BASIC INDUSTRIES

Speed Inquiry to Advertiser via Collect Night Letter  
ON READER-SERVICE CARD CIRCLE 24



**TRW CAPACITORS...  
IN SPACE-SAVING  
SHAPES**

**The 601 PE... a particular shape for a particular need.**

Design with Mylar reliability in the size and shape of a disc! The slim, compact type 601 PE is tailored for printed circuits in military or industrial applications.

In all you will find more than 200 design variations of reliable TRW Capacitors. Round or oval cross-sections. Axial

or radial leads. Dipped, tape-wrapped, or metal enclosed cases. Essentially all these constructions are available in film-foil, in metalized Mylar\* and polycarbonate dielectric.

In a tight spot? There's a TRW Capacitor to help you. Contact TRW Capacitors, Box 1000, Ogallala, Nebraska.

\*Du Pont Trademark

**TRW CAPACITORS**

ON READER-SERVICE CARD CIRCLE 25

**Co-Publishers**

James S. Mulholland, Jr.  
Robert E. Ahrens Dorf

**Editorial Director**

Edward E. Grazda

**Editor**

Howard Bierman

**Managing Editor**

Robert C. Haavind

**Technical Editors**

Joseph J. Casazza  
Rene Colen  
Maria Dekany  
Richard Harnar  
Mark B. Leeds  
Neil Sclater

**News Editors**

Frank Egan  
Roger K. Field

**West Coast Editors**

Ralph Dobriner  
Peer Fossen

**Copy Editor**

Peter Beales

**New Products Editor**

David Sorgan

**Washington Editor**

S. David Pursglove

**Editorial Production**

Dollie S. Viebig  
Anne T. Lombardi

**Art Director**

Clifford M. Gardiner

**Art Assistant**

William Kelly

**Technical Illustrators**

Lewis D. Hill  
Leonard P. Levenson  
Cheh Nam Low

**Production Manager**

Thomas V. Sedita

**Asst. Production Manager**

Helen De Polo

**Production Assistants**

Carl Merkin  
Bernard Wolinsky

**Circulation Manager**

Nancy L. Merritt

**Reader Service**

Diane Pellechi



## Craftsmanship: the mark of the professional engineer

The old-time concept of the craftsman is gradually fading from the scene. The reasons for his decline are manifold—the machine age, the rise of the unions, the sharing of responsibility for a task among many rather than its being given to one worker—all have contributed. And yet, we still need craftsmen.

We do not necessarily mean of the genius of Cellini, da Vinci or Michelangelo, although they will always be welcome. Rather, we mean the ordinary kind of craftsman who spent five or seven years as an apprentice, and then through diligence and energy earned the right to be considered a full-fledged printer, or shoemaker, or whatever. Just learning a certain amount of information was not enough. The true craftsman had to be resourceful and creative. He had to master the tools of his trade and be able, when necessary, to invent tools of his own to further his art.

The sort of ingenuity he sometimes needed can be seen firsthand in museums which display the handtools of old. We happened last year on a whaling museum where many such treasures of the past are kept. It was incredible to see with what few simple tools the whalers fashioned huge, leak-proof whale-oil barrels, sturdy wooden ships, or delicate scrimshaw figures made from whales' teeth and bones.

What pride these men must have taken in their work! What difficulties they must have overcome to produce such fine results with such clumsy implements!

On today's production lines how often does one see this pride in workmanship? Despite such incentives as Zero Defects programs and cash rewards for excellence, the worker who really loves his work and will give his all to achieve something a little better is rare. And as like as not, his fellow workers will gibe at him for wasting so much time and effort to do a good job.

How many engineers are themselves true craftsmen? What percentage becomes so skilled at the craft that it can grapple with all the intricacies of making a complex system operate properly? Faced with new engineering problems, how many of them can evolve at least some approach to a solution?

Few companies today demand that their engineers pass the kind of apprenticeship that the craftsmen of yore had to undergo. Nowadays each engineer must, in large part, take it upon himself to deepen his understanding and ability by accepting challenging assignments. But without this extra effort he will never arrive at the grasp of his profession or the degree of expertise which was the hallmark of the old-time craftsman.

ROBERT HAAVIND

## Guaranteed Stability

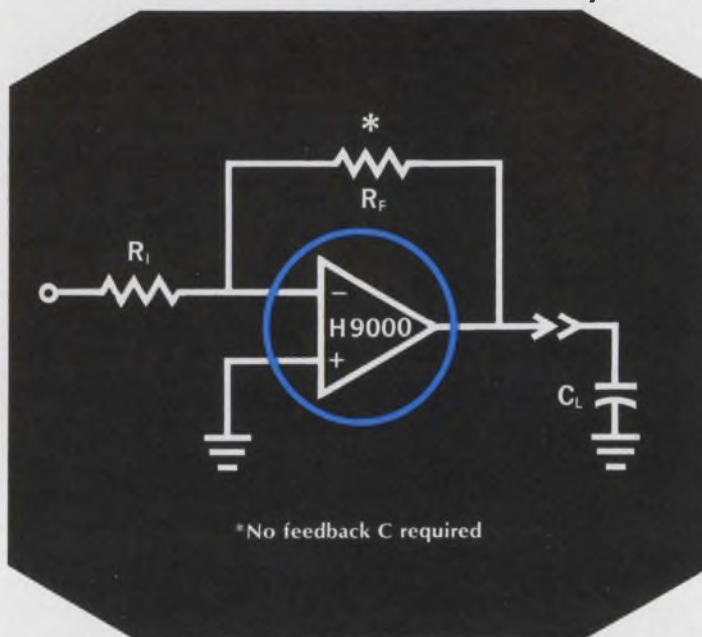

### Gain-Bandwidth Product > 150 MHz

A *stable* 150 MHz Gain-Bandwidth Product Operational Amplifier can now be obtained due to recent advances in dielectric isolation. This new unit, designed for industrial and military requirements, utilizes hermetically sealed UCE transistors and MIL-grade passive components throughout. Other typical specifications of the H9000 are listed below:

GAIN	VOLTAGE DRIFT	CURRENT DRIFT	UNITY BANDWIDTH	SLEW RATE	OUTPUT
100 db	2 $\mu$ V/ $^{\circ}$ C	0.2nA/ $^{\circ}$ C	20MHz	30V/ $\mu$ sec	$\pm$ 10V@ $\pm$ 30mA

The H9000 Amplifier is priced at \$99.00 in small quantities. Order from your UNION CARBIDE ELECTRONICS distributor today.

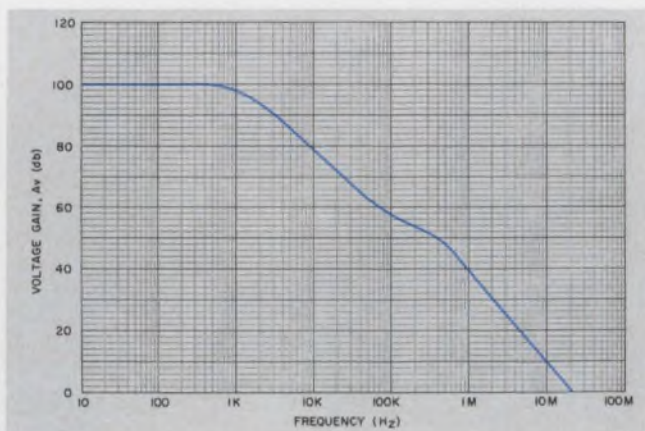

**UNION  
CARBIDE**  
ELECTRONICS

UNION CARBIDE CORPORATION 365 Middlefield Road, Mountain View, California 94041 TWX: 415-969-9166; Telephone: (415) 961-3300

Speed Inquiry to Advertiser via Collect Night Letter  
ON READER-SERVICE CARD CIRCLE 26

# ED Technology

Backward diodes push ahead as microwave detectors PAGE 44

Predict common-emitter performance graphically PAGE 52

ICs shrink poly-phase power inverter PAGE 62

Use constant-current to increase multivibrator range PAGE 66

Make the right decision! PAGE 76

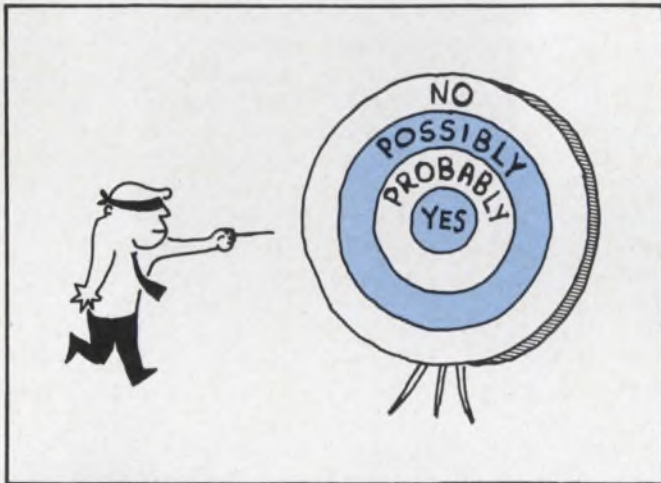

Decisions, decisions, decisions . . . p 76

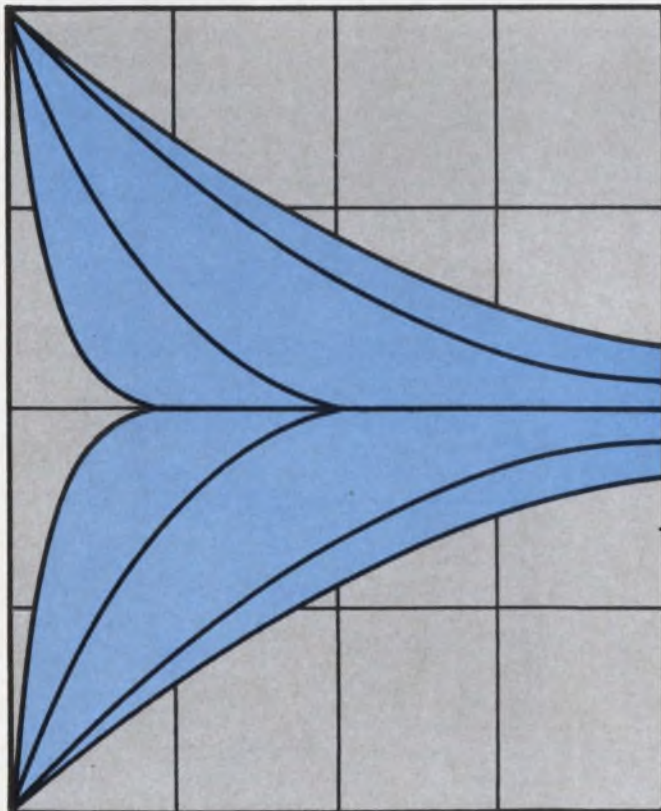

Get a line on common-emitters . . . p 52

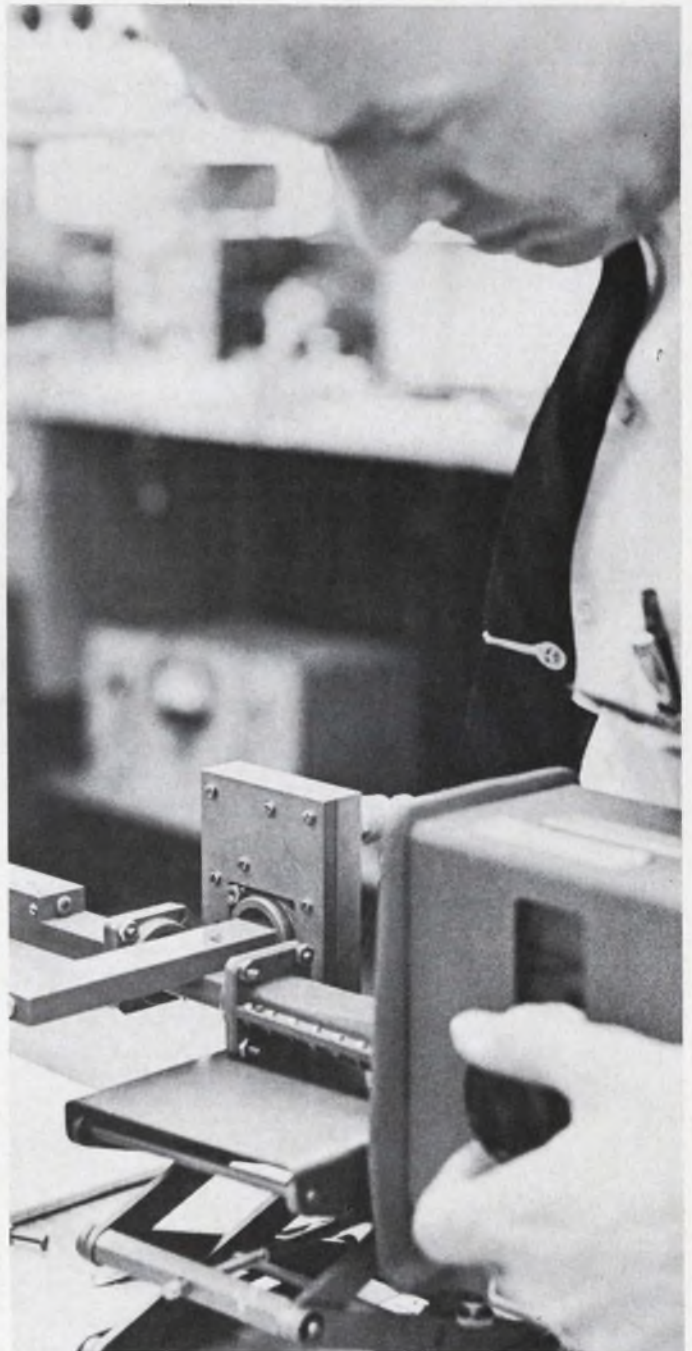

Going forward with the backward diode . . . p 44

# Forward with backward diodes: the vast improvements expected from these diodes in detectors can now be realized with a new stripline mount.

The backward diode appears to have all the qualifications for a great low-level microwave detector.<sup>1</sup> Its temperature coefficient,  $T_i$ , is better by several magnitudes than that of conventional diodes. However, its puzzling reaction to temperature changes and its unpredictable behavior in waveguide mounts have discouraged many designers.

Stripline techniques help to solve both of these problems.

A newly designed stripline mount that uses a probe detector should make the backward diode more popular with microwave design engineers. The mount's greatest assets are as follows:

- Its package is extremely rugged and mechanically stable. Components are not easily broken or displaced by vibration and shock.

- It eliminates the critical need to position the diode precisely—a problem with conventional mounts.

- The tuned probe offers good matching. The microwave transmission path can be changed during the initial breadboarding stage.

- The dielectric (irradiated polyethylene) substrate damps out rapid changes in the ambient temperature and increases the diode's temperature stability.

Some of the backward diode's troublesome design problems can be traced to its inherent properties, and some are the result of the way the diode has been used in circuits. Let's explore both of these areas and see why the stripline mount eliminates most of the trouble.

## Backward diode resembles zener

The backward diode is a highly doped, alloyed-junction diode that operates on the principle of quantum-mechanical tunnelling. It is actually a special case of the Esaki tunnel diode,<sup>2,3,4</sup> with the pn junction doped just slightly into degeneracy.

For small forward bias, the primary currents are conventional diffusion and drift currents.

For reverse bias, the energy bands overlap and a large reverse current flows. This current is due to the tunneling of electrons and is nearly independent of temperature.

---

Clarence E. Bowen, member, technical staff, Bell Telephone Laboratories, Greensboro, N. C.

The diode is essentially a zener at the origin. If this point is accepted, then the static I-V curve (Fig. 1) makes it immediately obvious that the diode's RF impedance is unusually low, its current sensitivity unusually high, and it is also clear that it is a low-level device. (The curve shows values for Philco's L4154 diode. Slight changes may be expected with other diodes.)

The name "backward diode" derives from the fact that the easy flow of current takes place in the negative rather than the positive region of the characteristic curve. If the n region is considered to be the anode and the p region to be the cathode, then biasing may be applied as if it were a conventional diode. Indeed, looking at Fig. 1 upside down, we see that the shape is similar to that of a conventional I-V curve, with the breakdown occurring at 0.5 volt in the reverse direction.

There is a slight negative resistance region, as shown, with a peak voltage of approximately 50 mV and a peak current of approximately 60  $\mu$ A. Note from Fig. 1 that there is an optimum amplitude range of impressed ac voltages to be detected. If the voltage swing is too large, leakage currents become excessive, and if the voltage swing is too small, the current sensitivity falls off.

At microwave frequencies, this simple picture is complicated by the shunting effect of the junction capacitance (Fig. 2).

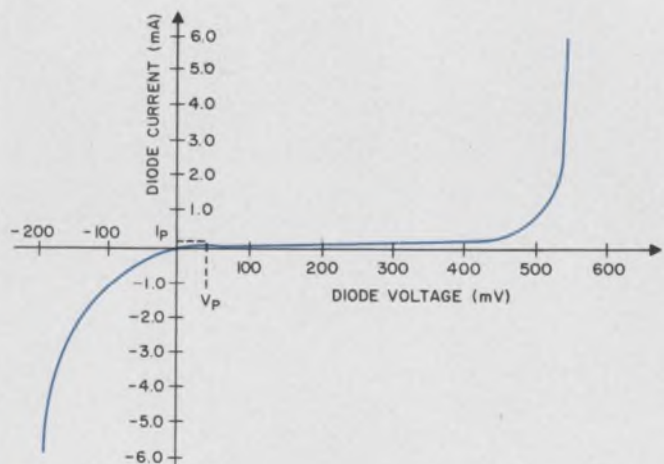

1. Typical I-V curve for backward diodes is very similar to that of a point-contact diode, when turned upside down. Therefore the backward diode may be used as if the n region were the anode and the p region were the cathode.



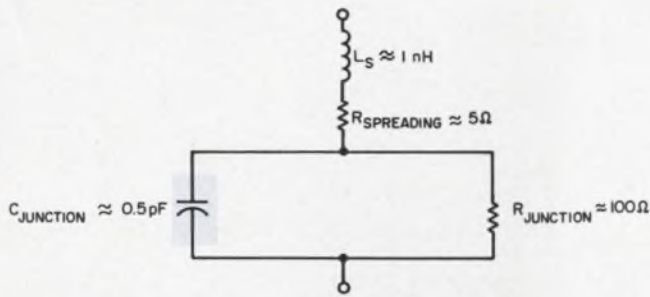

2. Equivalent circuit of a backward diode does not include the case capacitance that usually shunts the entire device. The typical values are for a Philco L4154 diode.  $L_s$  is the whisker and packaging inductance.

In most applications the backward diode has a temperature coefficient,  $T_c$ , that is vastly superior to that of crystal detector diodes. However, there are many problems in getting a stable temperature coefficient. It is possible to obtain positive coefficients, negative coefficients and coefficients that change sign at some critical temperature. These changes can affect the output radically.

### Capacitance plays havoc with output

Especially at high frequencies (X-band), the temperature dependence of the diode's capacitance becomes the critical problem. The capacitance increases with the temperature. At frequencies below X-band, the effects of a temperature-sensitive capacitance become less pronounced and begin to be overwhelmed by the other temperature-varying mechanisms.

As the capacitance increases with temperature, at least three things can happen:

1. The diode's impedance match can improve or degrade, resulting in more or less reflected power, depending on the nature of the original match.
2. The capacitance shunts more current around the rectifying junction and reduces the rectified output voltage. For a capacitance of 0.5 pF or so, this is a noticeable effect in X-band.
3. If the swept frequency output voltage is not flat, as suggested in Fig. 3, the changed reactance can shift the entire response curve up in frequency. Notice that in Fig. 3 some frequencies see a positive and some frequencies see a negative  $T_c$ .

The Smith Chart (Fig. 4) shows the changes in impedance as the temperature of the waveguide mount is raised by about 40°F. The over-all impedance was reduced from  $Z_{cold}$  to  $Z_{hot} \approx 0.9 Z_{cold}$ , while the input vswr improved from 4.25 to 3.60. It was established that only the diode was responsible for these changes.

The improved vswr implies an increase in output voltages— $V_{hot} \approx 1.08 V_{cold}$ , since the detected output voltage should change linearly with the absorbed power level. However, for this diode, this is not quite so. The increase in absorbed power is offset by the increased shunting effect of  $Z_{hot}$ , and the output voltage actually decreases to  $V_{hot} \approx 0.98 V_{cold}$ . This surprising result has been verified under varying combinations of diodes, mounts and operating conditions.

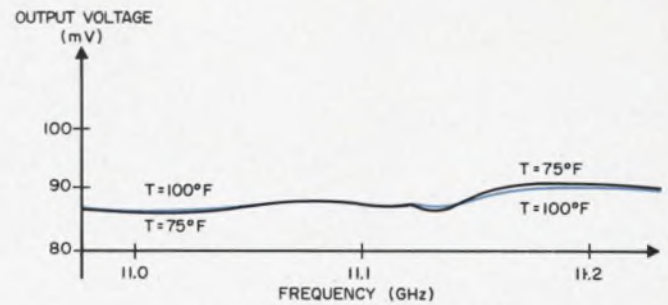

3. The changes in the diode's capacitance with temperature are sufficient to change the output voltage. This variation is more apparent at X-band and above, where the reactance of the capacitance is less than 100 ohms.

The conclusion is that the vswr improves while the rectified output voltage can actually decrease with temperature.

### Diode position is critical in guide mount

The unpredictable performance of backward diodes in waveguide mounts can be attributed to the fact that it is nearly impossible to insert the diode into the same place each time. Even the slightest variations in the position of the diode changes the impedance match toward the diode.

The large-signal impedance of the diode can be thought of as a resistance, whose value is a time-weighted average of the inverse slope at each point on the characteristic curve. The curve is traversed by an alternating voltage. Since the dc load resistor determines the operating region of the characteristic curve and the shape of the curve itself is a function of temperature, the RF impedance becomes a function of load resistor, power level and temperature.

Therefore, if the total impedance match can be changed considerably by the diode's position, a given change in  $R_L$  or temperature will improve or degrade the match, as shown in Figs. 3 and 4. This effect can change a positive temperature coefficient to a negative one with a mere change in the diode's axial position.

It becomes apparent that the quality of detection is limited as much by the detector mount as by the diode.

### Probe mount tunes out mismatch

Detection with a probe in a stripline mount solves the matching problem and keeps the diode in a fixed position. A diode shunting a waveguide appears as an inductive post to RF, and its reactance depends on the shape of the package. Since the equivalent circuit of a long thin probe changes from a shunting inductance to a capacitance as the probe is shortened, there is a critical length for which the reactive mismatch is essentially tuned out. Of course, the dc path through the diode to ground must be re-established, but this is easily accomplished with a low-pass filter. The configuration of the detector mount is shown in Fig. 5. Fig. 6 shows the representative return loss obtained from such a stripline detector mount,

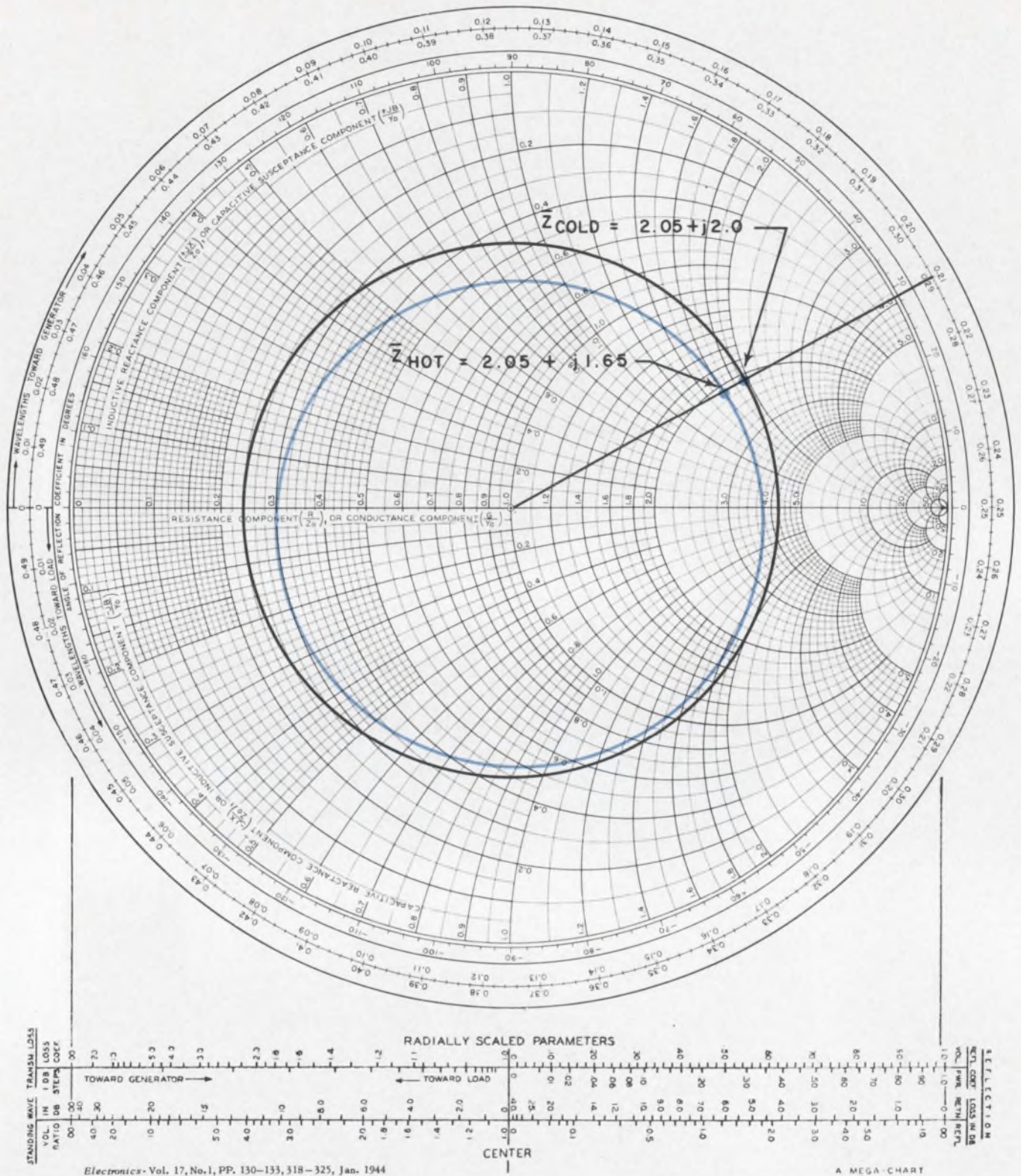

Electronics - Vol. 17, No. 1, PP. 130-133, 318-325, Jan. 1944

A MEGA-CHART

4. The decrease of the diode's impedance with temperature improves the vswr of the detector. However, this

improvement does not result in an increased output. The increased shunting effect of  $Z_{hot}$  decreases the output.

with a tuned probe, over a band of 200 MHz. Some of the stripline mounts have an input vswr of 1.5, with an average of about 1.7 which is much better than the required vswr of 2.5 for satisfactory performance.<sup>1</sup> Also, the stripline detector mount permits the interchange of diodes without appreciably changing the impedance match.

following the diode. This film, 100 ohms/square, is lossy to RF but could not affect the dc. It absorbs the RF components that remain after detection and therefore reduces the leakage problem. A metex gasket is used around the edges of the metal backing plates, to insure against leakage caused by higher-order transmission modes. (Striplines are intended to utilize only TEM mode propaga-

A resistive film is placed on the circuit path

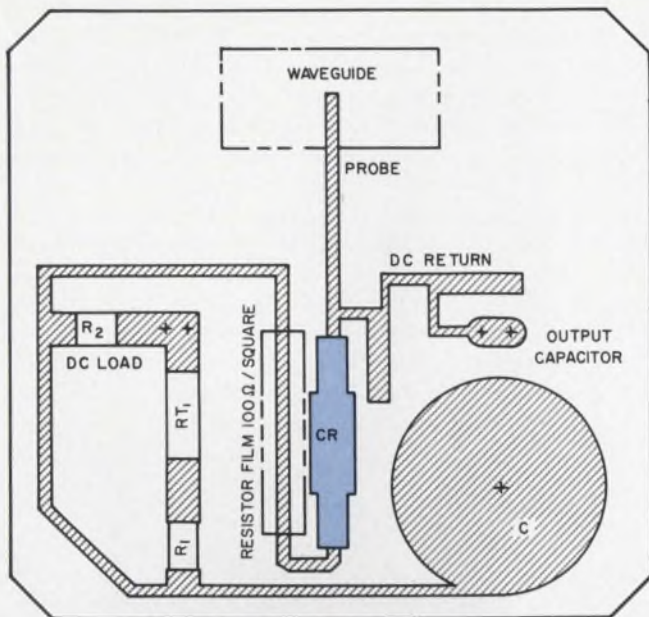

5. Stripline detector mount eliminates the critical mounting problems of the diode encountered in waveguide mounts. This mount, when combined with a tuned probe, makes the backward diode a high-quality detector.  $RT_1$ , a temperature-sensitive resistor, is usually not needed.

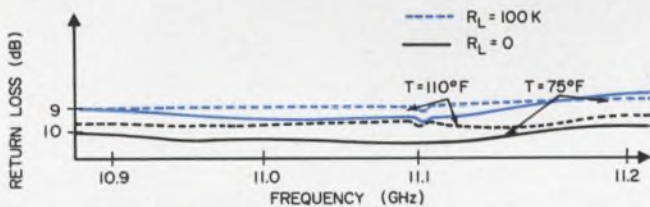

6. Return loss of the stripline mount remains fairly constant over a 200 MHz band that centers around 11.1 GHz. A matched load (solid black line) reduces the return loss by about 1 dB. The increase in temperature also reduces the return loss.

tion, but occasionally higher-order modes exist, yielding larger fringing fields with increased possibility of RF leakage). The precautions reduce the leakage below detectable levels.

The probe extends into the waveguide aperture, as shown, and acts as a small antenna. It is well known that a probe of this type in a waveguide behaves like a tuned circuit—long stubs look inductive and short ones, capacitive. A length can be found experimentally that simulates resonance and tunes out its reactive mismatch. The impedance of the transmission line leading up to the diode is 70 ohms.

The dc return is through a stripline low-pass filter. It provides the necessary dc continuity through the diode to ground, but its impedance is high enough toward the RF signal, so it is not seen by the RF.

The dc level is set at the diode. The resistive film is placed over the circuit path to attenuate the remaining RF components. It has been found that without the film enough RF is reflected back from the dc load to upset the input vswr. The dramatic effect of not using enough film is shown in Fig. 7.

The next component in line is  $R_2$  in Fig. 5, a

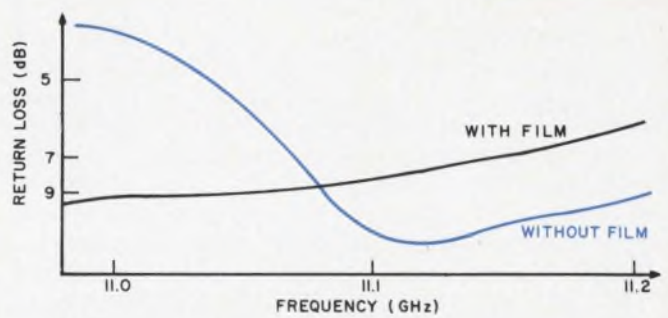

7. Resistive film over the dc path has a critical effect on the amount of reflected RF energy and therefore on the vswr of the mount. Measurements again were taken in a 200 MHz band around 11.1 GHz.

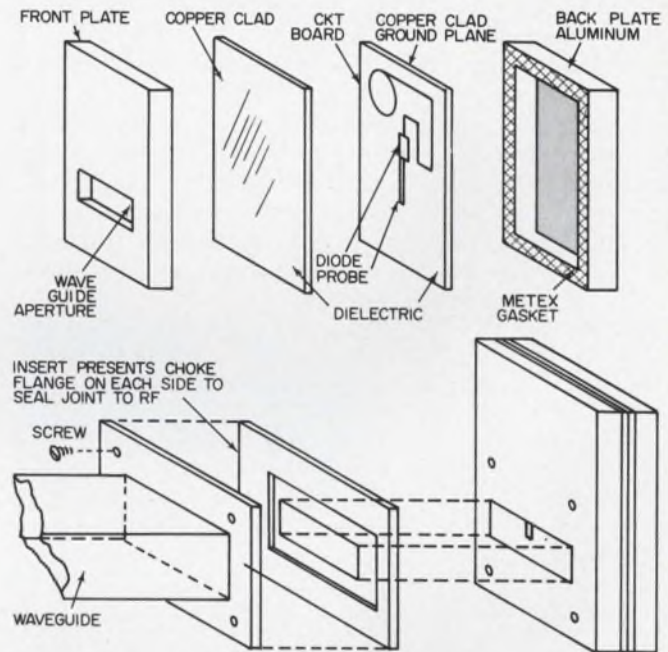

8. A sketch of the mount shows how it is constructed and how it fits on the waveguide flange.

stripline resistor to ground. (The symbols ++ indicate eyelets that make a metallic contact with the ground plane.)

The output capacitor maintains the dc level and shorts out any remaining RF. A large copper area makes a simple parallel plate capacitor with the ground planes. A bellows makes contact with the center of the capacitor and conducts the output level to the center conductor of a type-N coaxial connector.

Fig. 8 indicates how the mount is constructed and how it fits on the waveguide flange.

The X-band detector with this mount is stable within 0.05 dB with age and with temperature variations of  $\pm 3^\circ\text{C}$ . It has a vswr of 1.7, negligible RF leakage and operates from  $-35$  dBm to 0 dBm (Fig. 9). The differential sensitivity is typically around 20 mV/dB at 0 dBm. The temperature coefficient is about  $3 \times 10^{-4}$  parts/ $^\circ\text{C}$  at  $-4$  dBm.

#### Other factors to consider

Among the other important considerations affecting the backward diode as a detector, the following should also be included:

▪ **Power level**—The backward diode is usually operated at levels below 0 dBm. Its high current sensitivity makes it especially useful for lower levels. When the power becomes too high, this current sensitivity decreases rapidly, as the rectified output voltage saturates at a value somewhat less than 0.3 V. There is an optimum power level that, when exceeded, causes the temperature coefficient to increase as current sensitivity decreases.

▪ **Load resistor**—The dc load resistor partly determines the optimum power level, by developing an output voltage that reverse-biases the diode. Generally the dc load should be kept as small as possible without sacrificing too much differential sensitivity. Approximately 100 ohms is a recommended choice.

▪ **Impedance match**—Broadband applications would require terminations with a matched load rather than a quarter-wave short. Vswr resonances in the vicinity of the operating frequency can seriously affect the over-all temperature coefficient.

The maximum allowable power level for a given diode-mount combination may be determined with Fig. 10. This figure also helps in the selection of

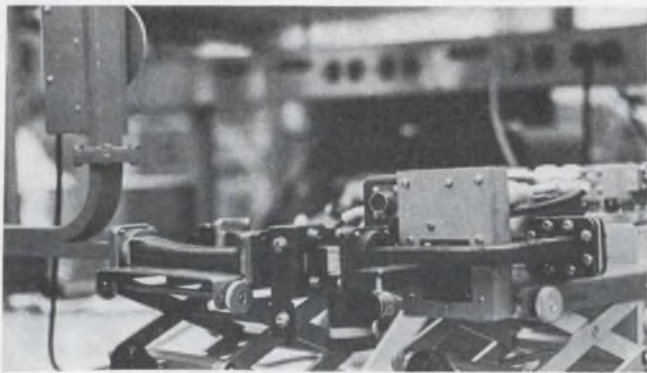

9. A laboratory bench model of the backward diode detector is mounted in a leveler.

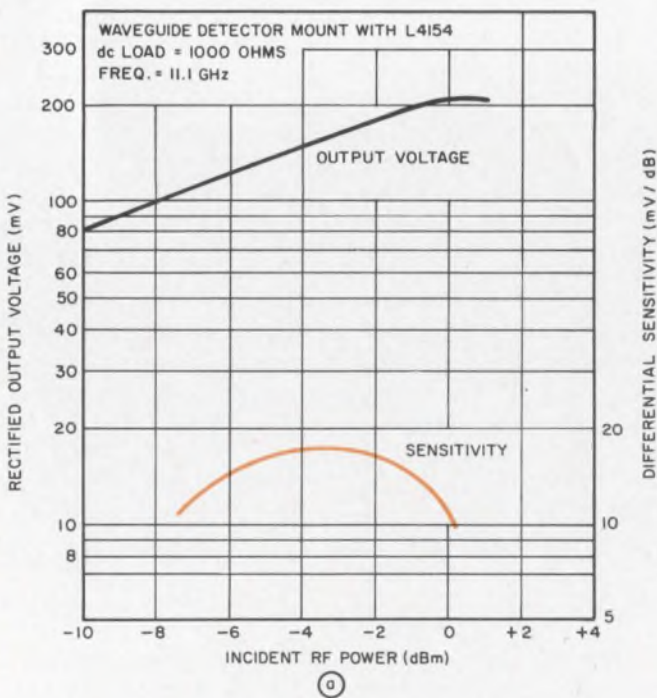

an optimum load resistor for a given power level.

An important design point is that the detector's *differential sensitivity* (the change in rectified output voltage with respect to a change in incident RF power) is generally a more useful parameter than the level of output detected voltage.

The static, or low-frequency, I-V curves cannot be used directly to determine the maximum allowable voltage swing and the other parameters at microwave frequencies. For example, at X band, an incidental voltage wave does not see the impedance suggested by the I-V curve; it sees the impedance shunted by a capacitive reactance of less than 100  $\Omega$  for the L4154.

A logical choice of load resistor and power level, therefore, would be a combination that caused operation to be in the vicinity of maximum differential sensitivity, but always on the low-power side of the peak. It is important to realize that a small load resistor, with a low output voltage, does not necessarily imply a low sensitivity to changes in RF power.

It should be noted that for a smaller load resistor, the reduced output voltage allows a higher operating power level before saturating the detector.

Higher power levels increase the negative tendency of the temperature coefficient, because of the temperature-sensitive diffusion current (see Fig. 11). Here the output voltage is swept over a 200-MHz band. The temperature coefficient with a 300- $\Omega$  load resistor is clearly lower than that with a 5000- $\Omega$  load. The detector is shown in Fig. 12.

Designers should watch out for another phenomenon. The large majority of backward diodes tested have shown predictable and well-behaved qualities. Several, however, exhibited anomalies that are not well understood. The phenomenon is interpreted as a gross instability in the diode's I-V

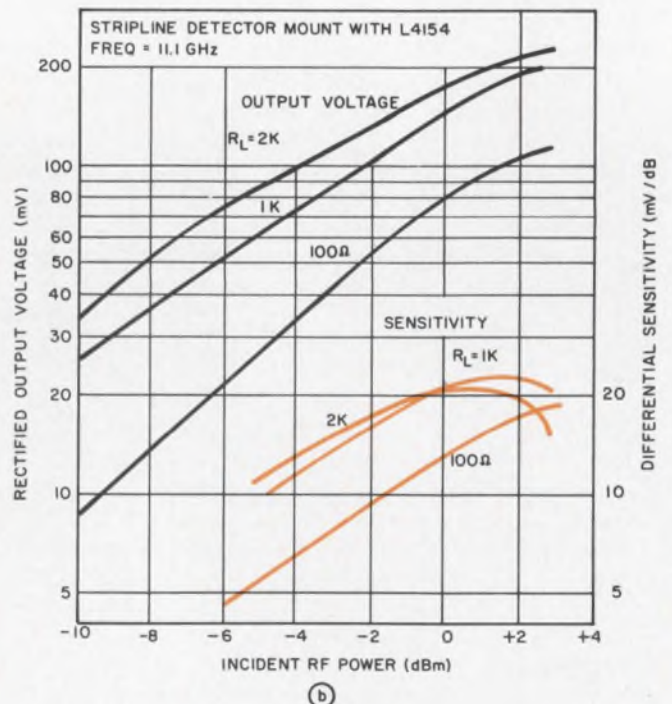

10. The maximum allowable power level may be found with these graphs for waveguide (a), and stripline mounts (b).

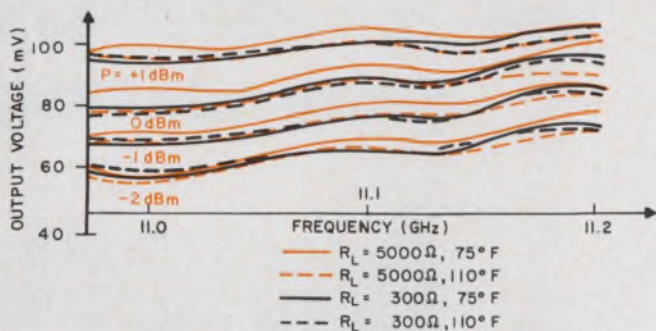

11. The detected output voltage changes with the load resistor (solid lines) and with temperature (dashed lines). Higher power levels increase the negative effect of  $T_c$ .

characteristic that occurs at a given temperature. Under testing two L2517 diodes have been loaded resistively with 100 ohms and driven by a sinusoidal 20 kHz voltage. The current response of a normal stabilized diode showed no significant change, as the temperature was raised from  $26^\circ\text{C}$  to  $71.5^\circ\text{C}$ . The other diode showed the beginnings of a double trace with approximately equal intensities (see Fig. 13). Evidently the diode characteristic is switching between two different, but well-defined, states and is spending roughly half its time in each state.

The result of this effect is to produce a different average current and, thus, a measurably changed rectified output voltage when the diode becomes unstable. (The present version of the L2517, used with a properly designed detector mount, is reported to be free of this anomalous behavior.) Fig. 14 represents the rectified output voltages of an unstable L4154 diode with a 330-ohm resistive load and an incident signal at X-band. It is a plot of output voltage, at various power levels, as the detector mount is slowly and uniformly heated. The length of time in either state ranges from 15 seconds to three minutes. It has also been noted that the changes are not instantaneous, but take perhaps 10 seconds to complete.

The temperature at which the instability occurs remains the same under varying conditions of power level, load resistor and detector mount. It is therefore felt that the tendency of a given diode to be stable or unstable is inherent in the diode itself rather than in its operating conditions.

This kind of temperature instability is unusual. However, apparently the effects are exaggerated when there is a poor impedance match to the detector mount. ■ ■

#### References:

1. C. A. Burrus Jr., "Backward Diodes for Low-Level Millimeter-Wave Detection," *I.E.E.E. Transactions on Microwave Theory and Techniques*, September 1963, pp 357-362.
2. T. H. Oxley, "Backward Diodes as Mixers at Microwave Frequencies," *Journal of Electronics and Control*, Volume 17, July 1964, pp 1-17.
3. Lloyd P. Hunter, *Handbook of Semiconductor Electronics*, McGraw-Hill Book Company, Inc., 1962, Sections 3.8, 11.10.
4. Roy H. Mattson, *Basic Junction Devices and Circuits*, John Wiley and Sons, 1963, pp 432-436.
5. "Power Monitor and Detector Characteristics of Microwave Associates—Diodes," *Micronotes*, Volume 2, Number 7, January 1965.

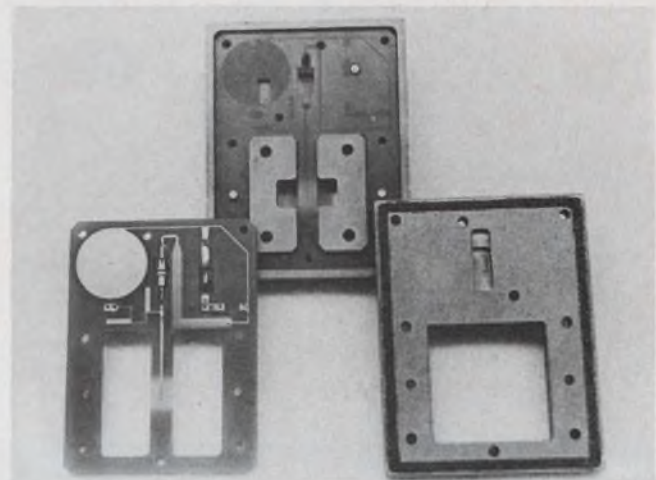

12. Circuit board and front and back plates of the detector show compactness of the detector.

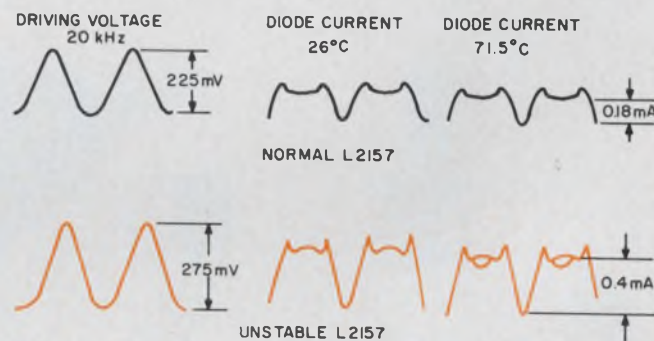

13. Gross temperature instability may occur in some backward diode. It appears as a double trace in the output current that changes the average current.

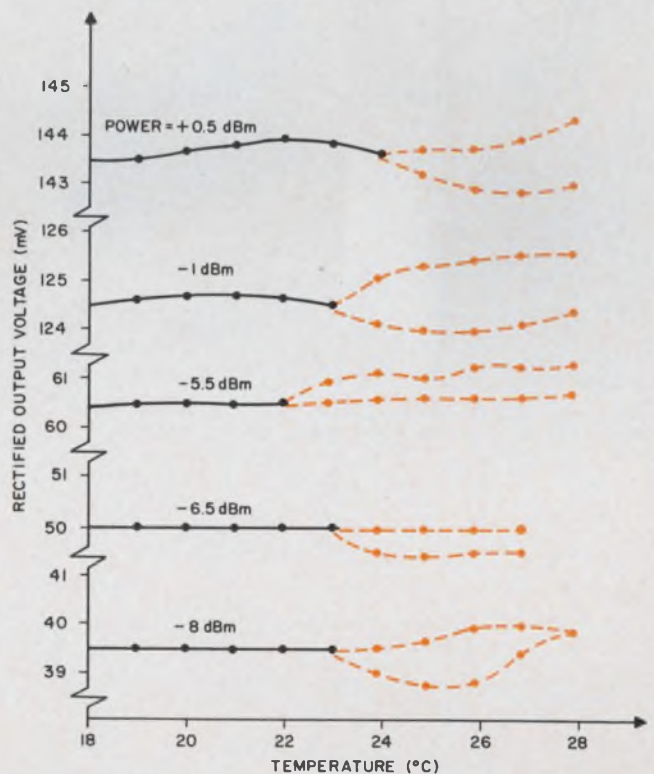

14. The rectified output voltage of an L4154 in X-band clearly shows the effects of temperature instability at varying power levels. The diode apparently switches between two states.



# Now-you can design using economy

Now — in economy plastic packages — integrated circuits, silicon and germanium bipolar transistors, FET's, unijunctions, power transistors, and silicon rectifiers . . . all from TI.

Now you can reduce the cost of entire electronic systems while retaining top performance. Many new additions to TI's already broad line of plastic-encapsulated semiconductors now make it possible for you to design high-performance circuits, like the variable timing control shown at the right, using low-cost, plastic-encapsulated TI semiconductors exclusively. Your rapidly expanding choices at TI now include:

### New plastic-encapsulated unijunction features 20-times lower leakage at less than $\frac{1}{3}$ the price

TI's new TIS43 plastic-encapsulated unijunction transistor — industry's first — now adds increased savings to the inherent economy of simplified UJT circuitry. Made possible by combining TI's proven planar UJT technology with advanced SILECT plastic packaging techniques, this new transistor offers 20 times lower leakage than the best conventional silicon-alloy TO-18 unijunctions currently selling at more than three times the price.

Extremely low leakage (10 nA max, 0.1 nA typical at 25°C) makes the TIS43 ideal for precision timing circuits. Low leakage also permits the use of smaller, less expensive capacitors. This economy, combined with low initial price and the reduced component count possible with unijunction circuitry, permits important cost savings in a wide range of applications.

Vibration and shock resistance have been increased threefold over alloy UJT's through use of the more rugged planar construction (shown in figure 3) and a solid, one-piece plastic package. The TIS43 will withstand over 60,000 G constant acceleration, making it ideal for use in military fuzes and heavy-duty industrial applications.

Principal electrical characteristics are:  $I_{EO} = 10$  nA max at 25°C;  $\eta = 0.55$  min, 0.82 max;  $r_{bb} = 4.0$  k $\Omega$  min, 9.1 k $\Omega$  max;  $V_{OB1} = 3.0$  V min. (Similar characteristics are available in a metal TO-18 package — designated 2N3980.)

Applications include oscillators, voltage- and current-sensing circuits, multivibrators, waveform generators, and astable and bistable circuits. The TIS43 is also ideal for an economical triggering device for SCR's. Circle 181 on the Reader Service card for data sheet.

### New plastic package for TI integrated circuits

This new plug-in economy package has 14 pins on 100-mil centers with rows 300 mils apart. The package is designed for economical flow-soldering techniques and is adaptable to high-speed automatic or manual insertion. Most of TI's more than 150 integrated circuit types are available in this new package.

### Three new series of SILECT silicon bipolar amplifiers

For low-noise, low-level applications, the PNP 2N4058-62 offers 1.7 dB typical noise figure and an  $h_{FE}$  of 200 typical at  $I_c = 1$  mA. These units are complements to the 2N3707-11 NPN series. Circle 182 on Reader Service card for data sheet.

For FM RF and IF applications, the NPN

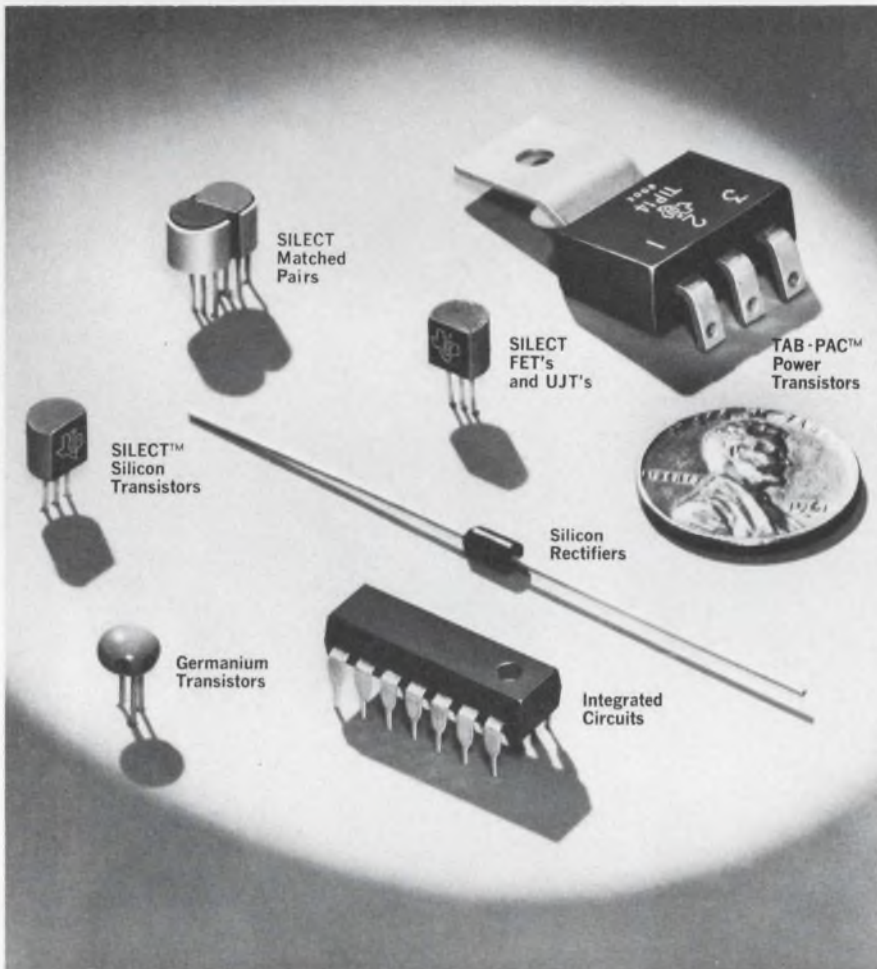

Figure 1. Industry's broadest selection of economy semiconductors helps reduce cost, improve performance of industrial and consumer equipments.

*TI cannot assume any responsibility for any circuits shown or represent that they are free from patent infringement.*

# complete electronic systems semiconductors from TI

2N4254-55 Series provides low feedback capacitance ( $C_{ch} = 0.65 \text{ pF max}$ ) for high, stable gain without neutralization and low noise (2.8 dB typical at 100 MHz). High power gain (26 dB typical MAG at 100 MHz) makes possible high performance from low-cost circuits. Circle 183 on Reader Service card for data sheet.

For auto radio RF and IF applications, the PNP TIS37-38 is interchangeable with many popular germanium drift-field transistors, providing higher temperature capability at no added cost. Noise figure of the TIS37-38 is 3 dB typical at 1 MHz, 75 ohms. Circle 184 on Reader Service card for data sheet.

## Twelve new SILECT silicon bipolar switching transistors

Twelve new economy devices cover a broad range of popular metal-case types. (JEDEC 2N nearest equivalents are indicated in parentheses): TIS51(3011), TIS47(2368), TIS48(2369), TIS49(2369A), TIS50(2894), TIS53(3639), TIS54(3640), TIS44(706), TIS45(708), TIS46(914), TIS52(3014), TIS55(3646). Write for specific data sheets.

## Two new SILECT N-channel field-effect transistors

Here is industry's first plastic FET chopper. The new TIXS42 features a low  $r_{ds(on)}$  of 70 ohms max and low  $I_C$  of 5 nA max at 25°C. It is well suited to high-speed commutators, relay contact replacement, and analog-digital converters. Circle 185 on Reader Service card for data sheet.

For VHF TV, FM radio and communications equipment, the new TIS34 combines low feedback capacitance ( $C_{rss} < 2 \text{ pF}$ ) and high transconductance ( $|Y_{fs}| = 3500 - 6500 \text{ } \mu\text{mhos}$ ), permitting the design of high-gain un-neutralized VHF circuits (grounded-gate connection). Other features include high  $y_{fs}/C_{iss}$  ratio (high-frequency figure-of-merit), and low cross-modulation. Circle 186 on Reader Service card for data sheet.

## New plastic-encapsulated germanium planar transistors

Two new additions to TI's plastic-encapsulated germanium planar line cover a broad range of AM-FM-TV high-frequency applications.

The TIXM10, for RF amplifier and mixer applications, provides an  $h_{fe}$  of 16 dB min, 22 dB max at 100 MHz,  $r_{11}C_c$  of 6 pF max, and a noise figure of 4 dB max at 200 MHz. The TIXM11, for oscillator and IF amplifier applications, features  $h_{fe}$  of 29 dB min, 39 dB max at 10 MHz, 30-50 dB at 455 kHz, and 14 dB at 100 MHz. Circle 187 on Reader Service card for data sheets.

## New plastic-encapsulated silicon rectifiers

These new compact, low-cost axial-lead silicon rectifiers help you reduce cost of industrial and consumer equipment. The 1N4001-07 rectifiers are rated at 1 amp, 50 to 1000 volts. They are smaller (0.200" long by 0.100" dia) and less costly than glass, top hat, and flangeless rectifiers. Features include high surge current capability (30 amps single cycle surge), low forward voltage drop ( $V_F = 1.1 \text{ V at 1 amp}$ ), excellent moisture resistance, and an isolated package that requires no insulating sleeve. Circle 188 on Reader Service card for data sheet.

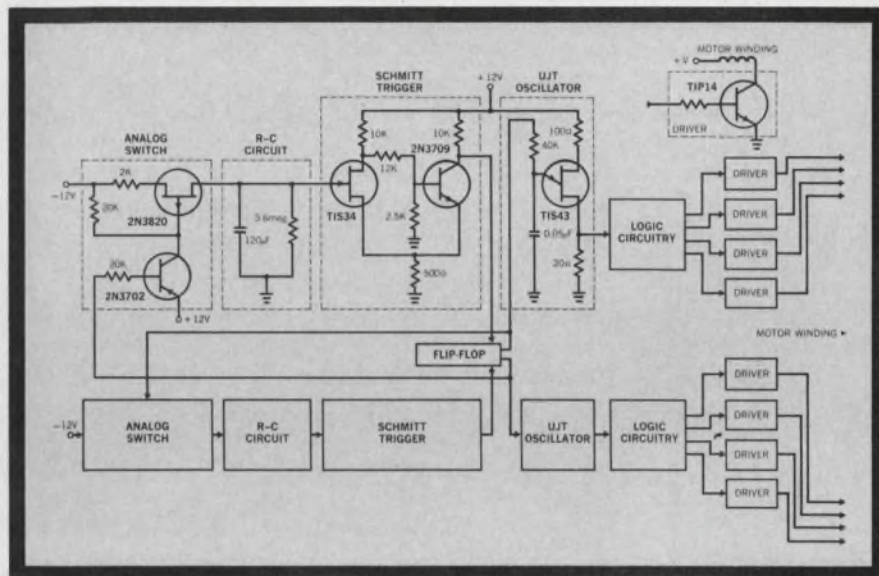

Figure 2. This variable timing control illustrates use of a variety of economy plastic-packaged TI semiconductors — bipolar transistors, unijunctions, FETs, and Tab-Pac™ silicon power transistors.

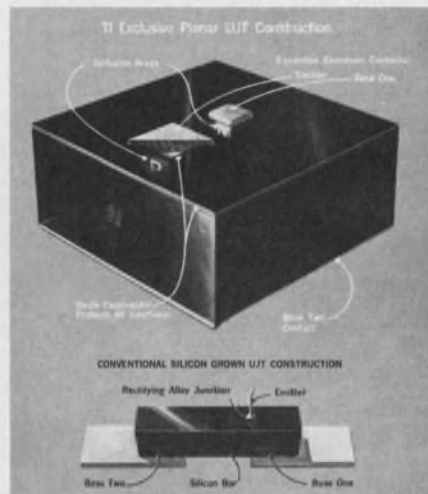

Figure 3. TI's exclusive planar UJT gives lower leakage and greater reliability than conventional silicon alloy UJT's.

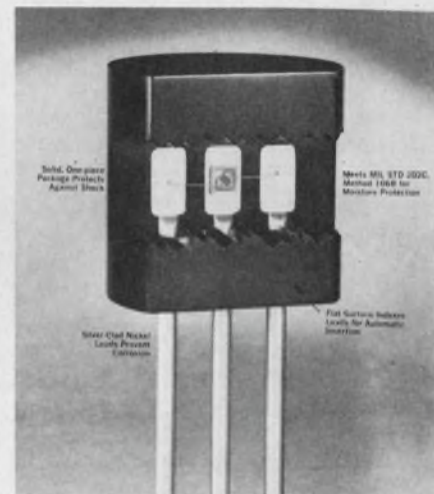

Figure 4. Model illustrates simple, rugged construction of SILECT (SILicon EConomy Transistor) package. Rapidly expanding, mechanized production assures volume availability.



**TEXAS INSTRUMENTS**  
INCORPORATED  
13500 N. CENTRAL EXPRESSWAY  
P. O. BOX 5012 • DALLAS 22, TEXAS

SEMICONDUCTOR PLANTS IN BEDFORD, ENGLAND • NICE, FRANCE • DALLAS, TEXAS

# Predict common-emitter performance

before you build. Use these graphs to determine quickly and accurately its step response as an amplifier.

Examine any modern amplifying or switching system—and chances are you'll find at least one common-emitter stage in it. Now, thanks to a master-graph technique, the performance of these popular circuits can be predicted—well in advance of their design.

These easy-to-use charts quickly present a complete picture of the circuit's response to the very basic step-function input. They provide accurate visual information on rise time, bandwidth, slope, time delay, overshoot and other key performance criteria.

In using the graphs, the engineer needs only a knowledge of transistor and circuit parameters. The design technique itself is free of complex, time-consuming calculations and other laborious steps. It is based upon a combination of the  $T$ -equivalent and the Giacoletto simplified circuit versions, as used in common-emitter analysis. It marries the comprehensiveness of the former technique with the ease of the latter, and it contains none of the disadvantages associated with either.

## Survey master chart for response

For this design technique, the step response of the common-emitter is used to generate a plot (family) of response curves. Master charts are thus formed and then used repeatedly to describe the desired response of a particular case.

The master graphs are directly applicable to single-ended common emitter circuits in amplifier design, and they can be extended to switching circuits through piece-by-piece linearization.

The engineer usually begins his task with vendor specifications and design information on how to load the circuit. These data allow him to solve for the time constants required by the graphic method. With these constants, and the aid of the master graphs, he then determines the desired output waveshape. Visual inspection of this waveshape, in turn, reveals rise time, slope at various waveform points, delay from the start of the input pulse to any convenient point of the output, and the in-phase overshoot. If bandwidth is required, it can be derived from the rise time through well-known bandwidth/rise time relationships.

A typical common-emitter circuit driving an RC load and its associated  $T$ -equivalent are shown in Fig. 1. The  $T$ -equivalent model provides a compre-

hensive representation of the true transistor, but the calculating steps leading to its solution are often prohibitively time consuming.<sup>1,2</sup> Even for a simple case, such as the linear transistor inverter, the combination of loop and node equations requires the laborious calculation of third-order equations for  $V_{out}$  in terms of a step input.

The Giacoletto model (Fig. 2) is a simplified equivalent circuit that eases the paperwork, but it gives a poorer representation of circuit performance.<sup>3</sup> While this solution yields acceptable answers for delay and rise time, it fails to reflect the in-phase overshoot that characterizes the step response. The model's forte is the separation of the input and output loops; this facilitates the solution of the input and output time constants.

## Models combined for complete analysis

The Giacoletto analysis provides the basic equations for the present graphic technique. However, the well-known, in-phase overshoot, which is maintained in the truer,  $T$ -equivalent model, is restored in the graphic analysis by incorporating a simple corrective term.

In accordance with Fig. 2, Eqs. 1 and 2 are written in the Laplace form that describes the relationship between input and output loops. Thus,

$$V_{out} = -\frac{\alpha_o}{r_e} (V' Z_L), \quad (1)$$

$$V' = -\frac{V_{in}}{s} \left( \frac{Z_e}{Z_e + r_b} \right), \quad (2)$$

where  $Z_L$  is the parallel combination of  $R_L$  and  $C_L$  and  $Z_e$  is the parallel combination of  $C_{eq}$  and  $r_e$  ( $1 - \alpha_o$ .) Note that  $C_{eq} = C_d + C_c [1 + (\alpha_o R_L / r_e)]$



**Tracing the key waveshapes.** Circuit-designer Hilsenrath observes the step response of his common-emitter. By using a set of master response curves, he was able to predict performance before he built the network.



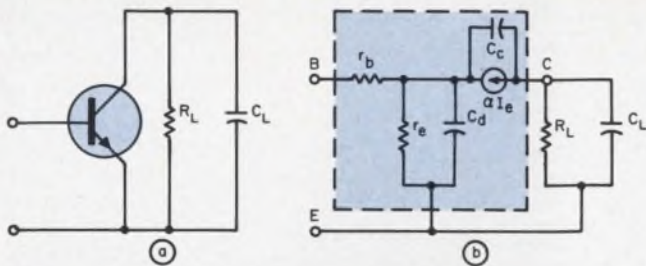

1. In a typical common-emitter circuit (a), RC loads must be driven. The step response for this application is the basis for deriving a set of master response graphs. Solutions for the T-equivalent (b) of the transistor often entail complex cubic equations.

and  $\alpha_o = \alpha(1 + j\omega/\omega_a)$ , where  $\omega_a$  is the cutoff frequency of the collector generator. The resistance of the source ( $R_s$ ) is lumped with (added to) the base resistance  $r_b$ .

It follows that the normalized output voltage, as a function of time, is

$$V_{out,(norm)} = -\frac{1}{(\tau_2 - \tau_1)} [\tau_2(1 - e^{-t/\tau_2}) - \tau_1(1 - e^{-t/\tau_1})], \quad (3)$$

where  $\tau_1$  is the input loop time constant  $= r_e r_b C_{eq} / [r_e + r_b(1 - \alpha_o)]$  and  $\tau_2$  is the output loop time constant  $= R_L C_L$ . Equation 3, which eliminates unnecessary reference to the output amplitude, is in a convenient form for development of a normalized plot.

### Accounting for rise and fall times

Equation 3 will not give explicit solutions for rise and fall times, because of the transcendental nature of the expression. The desired information is obtained indirectly by finding the 10% and 90% points of the output waveshape. These points can be easily located by constructing families of curves of the two exponential expressions  $-\tau_2(1 - e^{-t/\tau_2})$  and  $\tau_1(1 - e^{-t/\tau_1})$ . These curves (Fig. 3), represent a relevant set of parameters and RC load values.

Once the graph has been drawn, the appropriate pair of curves for given values of  $\tau_2$  and  $\tau_1$  can be interpolated from the families of curves and added graphically, to produce the output voltage curve for the particular case under investigation. Inspection of this curve yields the 10% and



**Master common-emitter response!** Author Hilsenrath shows a colleague how to extend the design technique beyond the realm of simple, small-signal, common-emitter stages, by adding appropriate RC networks.

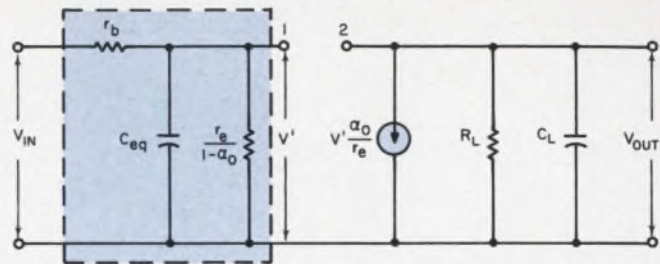

2. The Giacometto model is a simplified version of the common-emitter's equivalent circuit. Quadratic equations are used to solve for its response, but the representation is not as complete as the T-equivalent's. A combination of two models gives the best results.

90% points from which delay and rise time can then be determined visually. Since the term  $1/(\tau_2 - \tau_1)$  is only a multiplier, it has no effect on the waveshape.

The curve obtained from Fig. 3 does not reflect the in-phase overshoot component of the output voltage. An approximate expression for this component can be found and plotted for the subsequent addition of this characteristic (as a correction term) to the output voltage curve.

With  $V'$  calculated, as in Eq. 2,  $C_c$  can be reconnected where it actually belongs—that is, from node 1 to node 2, as shown in Fig. 4. Consider  $V'$  as a source with a low output impedance, compared with the combined impedance of  $C_c$  and  $Z_L$ . Then let the generator  $V' \alpha_o / r_e$  go to zero and calculate  $V_{overshoot}$  for a step input. Therefore,

$$V_{overshoot} \cong \frac{V_{in}}{s} \left( \frac{Z_e}{Z_e + r_b} \right) \left( \frac{Z_L}{Z_L + Z_{cc}} \right), \quad (4)$$

where  $Z_{cc} = 1/sC_c$ . The solution, normalized to the same scale factor as Eq. 3, yields:

$$V_{overshoot(norm)} = \frac{r_e C_c}{\alpha_o (t_2 - \tau_1)} [e^{-t/\tau_2} - e^{-t/\tau_1}] \quad (5)$$

The exponentials  $e^{-t/\tau_2}$  and  $-e^{-t/\tau_1}$  may be plotted separately and then added graphically to provide the in-phase overshoot curve (Fig. 5).

### Making the method more universal

The master graphs can be applied to any common-emitter circuit capable of responding within the range of the indicated time scales and constants. The range, as given, covers any typical medium-speed, common-emitter circuit (a response time of 5 ns or more). The graphs can be extended to slower circuits, by simply multiplying all time scales and constants by one or several orders of magnitude—that is, by 10, 100, 1000, etc. The transistor model described here is not for very-high-frequency applications (such as those involving transistors that respond within 1.0 ns). At these frequencies the model becomes very complex, and the mathematics do not reduce to a form that permits a simple graphic interpretation to be made.

The graphic method was developed specifically for the small-signal, common-emitter circuit. The analysis holds, however, when an RC network, consisting of  $R_E$  and  $C_E$ , is inserted between the emit-

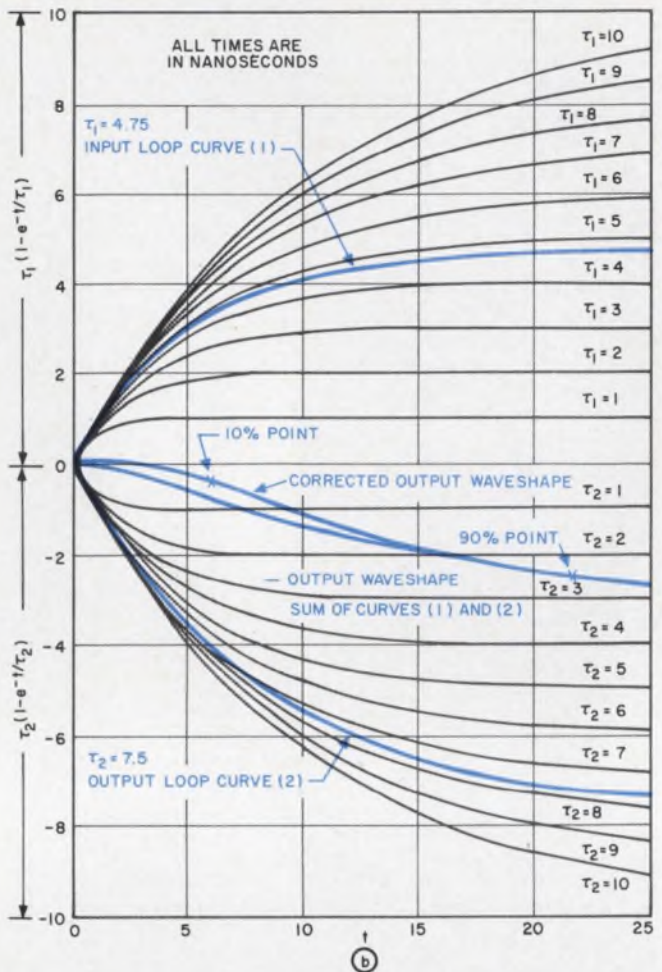
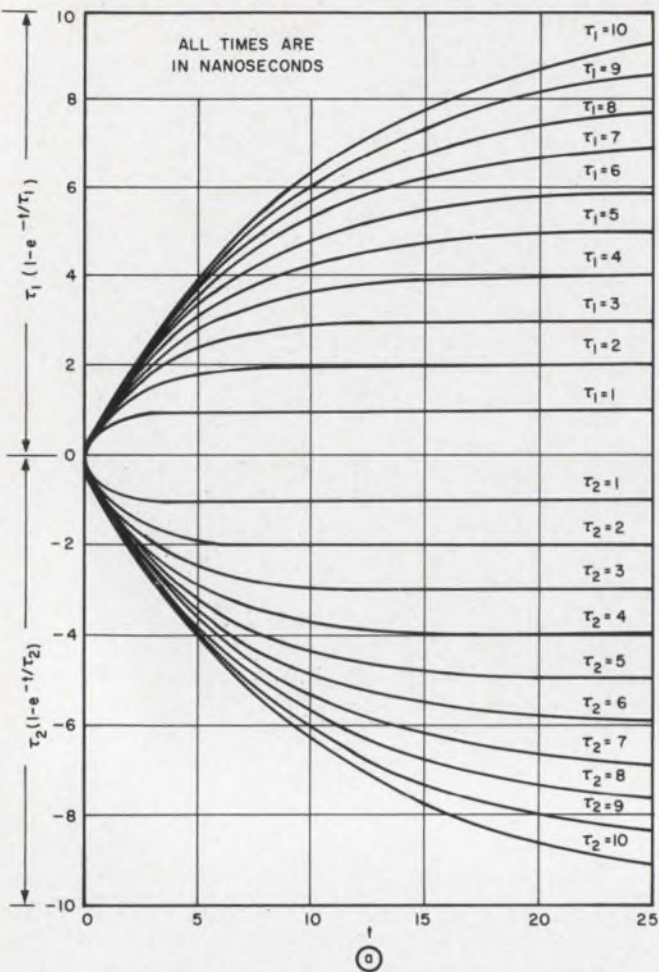

3. A family of curves representing a relevant set of transistor parameters and RC load values may be constructed. The graph is then used to predict circuit response. Part

ter and the circuit common. This is done to achieve dc stability and a high-frequency bypass, and it is valid if the network meets the condition  $R_E C_E = r_e C_d$ . Under this condition there is no current flowing from node 3 to node 4, and the connection between these nodes can be eliminated. This application is depicted in Fig. 6.

The total impedance in the emitter leg of the model, as shown in Fig. 1b, now becomes  $r_e'$ , and the diffusion capacitance becomes  $C_d'$ , where

$$r_e' = r_e + R_E \quad (6)$$

$$C_d' = \frac{C_E C_d}{C_E + C_d} \quad (7)$$

$$C_{eq}' = C_d' + C_c \left( 1 + \frac{\alpha_o R_L}{r_e} \right) \quad (8)$$

The analysis then proceeds with the time-constant  $\tau_1$  calculated with  $r_e'$  and  $C_{eq}'$ . With this simple modification, the validity of the analysis is thereby extended to another important category—handling signals in Class A operation. Additional extension of the method is achieved through a piece-by-piece linearization that permits application of the technique to the large-signal mode. Observe that the graphic technique described here is limited to the step response, which is the least complicated ap-

“a” is a plot of the exponential portions—here the  $\tau_1$  curves refer to the input loop and the  $\tau_2$  curves refer to the output loop. The combined waveforms appear in (b).

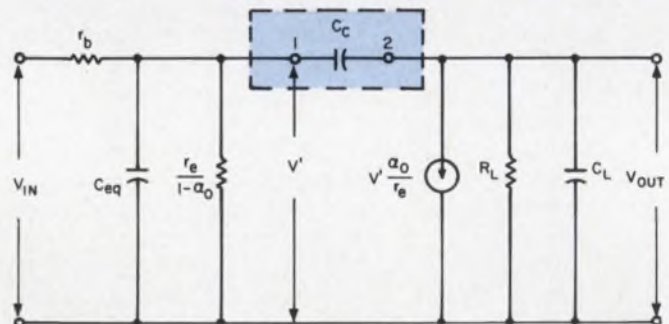

4. The in-phase-overshoot portion of the response must be accounted for. This is done by adding capacitor  $C_c$  between nodes 1 and 2 in the Giacoletto model (compare with Fig. 2).

proach to the analysis of speed response. The mathematics developed for this technique, however, can serve as a guideline to developing similar graphic methods for input functions other than the step and for circuits other than the common-emitter.

#### Practice makes near-perfect prediction

The simplicity of applying the graphic method is readily illustrated through a typical design problem in which an RC network is in the circuit. In this case, performance can be predicted from

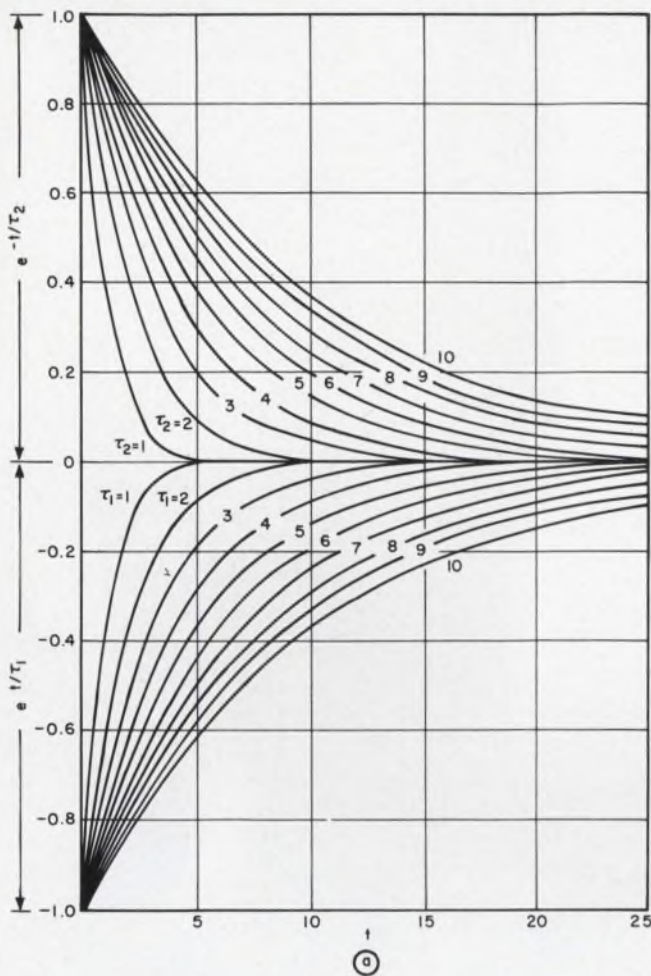

5. This graph permits interpolation of the in-phase overshoot to be made (a). To the plot of the exponential portions of the normalized overshoot voltage, we graphic-

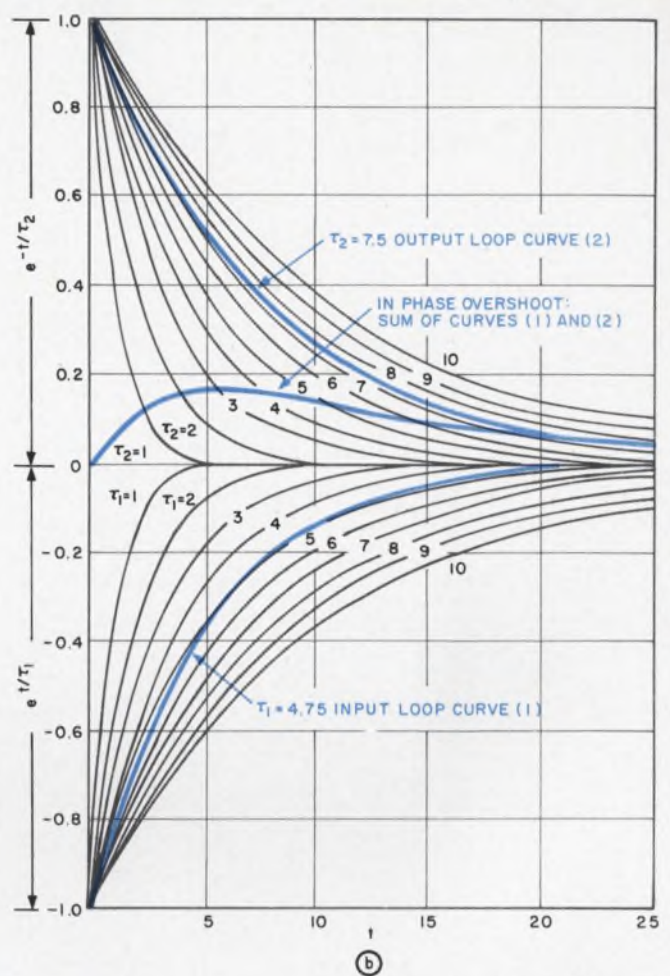

ally add the input and output loop curves to obtain the complete response (b). The graph is applicable to common-emitter circuits.

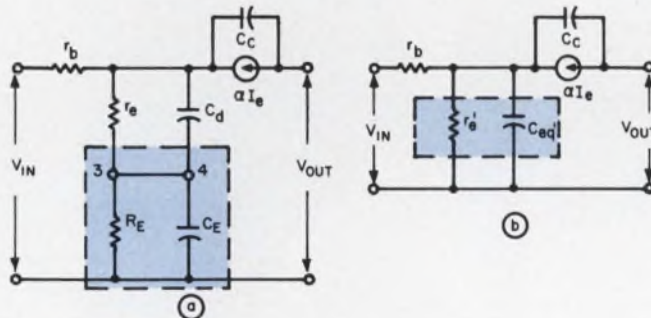

6. The design technique may be extended into another realm of Class A operation, by adding an appropriate RC network between nodes 3 and 4 (a). Because  $R_E C_E = r_e C_d$ , a simpler equivalent circuit (b) results.

the following set of parameters:

$r_b = 50 \Omega$	$C_c = 17 \text{ pF}$
$r_e = 26 \Omega$	$R_E = 100 \Omega$
$\alpha_o = 0.99$	$C_E = 15.3 \text{ pF}$
$\omega_o = 2\pi 100 \text{ MHz}$	$R_L = 500 \Omega$
$C_d = 1/r_e \omega_o = 61.5 \text{ pF}$	$C_L = 15 \text{ pF}$

With this information alone, the designer determines the required response data by serially following these steps:

1. Calculate  $\tau_1$  and  $\tau_2$ , according to the explanatory material after Eq. 3. For the values given,

$\tau_1 = 4.75 \text{ ns}$ , and  $\tau_2 = 7.50 \text{ ns}$ .

2. Using the  $\tau_1$  and  $\tau_2$  values, draw two interpolated curves as shown by the heavy lines in Fig. 3.

3. Add graphically the magnitude of the two interpolated curves to obtain the output waveshape shown in Fig. 3.

4. Use the values of  $\tau_1$  and  $\tau_2$  to draw the two interpolated curves for the exponentials of  $V_{overshoot}$  (Eq. 5). These curves are exhibited in Fig. 5.

5. Add graphically the magnitude of the two exponential curves to obtain the in-phase overshoot, as shown in Fig. 5.

6. Correct the scale factor by the constant multiplier  $C_c(R_E + r_e)/\alpha_o$ , to adjust the curve to the scale of Fig. 3. Here the multiplier is 2.17 ns.

7. Add the adjusted overshoot curve to the uncorrected output waveshape, shown in Fig. 3, to produce the corrected waveshape. For the case under discussion, it can be seen that the 10% point of the corrected waveshape occurs at 6.0 ns, and the 90% point occurs at 21.5 ns. ■ ■

#### References:

1. Amplifier Circuit Theory, M. M. McWhorter and J. M. Pettit, McGraw-Hill, New York 1961, p. 32.
2. Transistor Electronics, D. DeWitt and A. L. Rossoff, McGraw-Hill New York, 1957, p. 112.
3. Transistors and Active Circuits, J. G. Linvill and J. F. Gibbons, McGraw-Hill, New York, 1961, p. 140.

17...

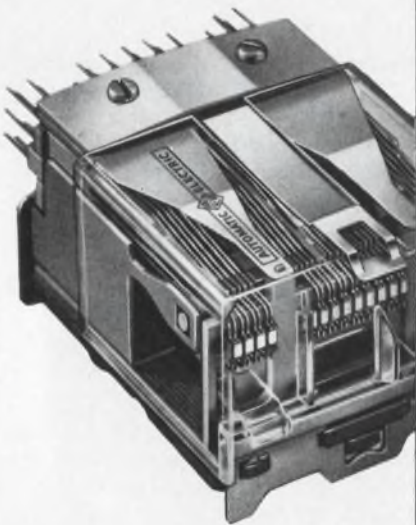

34...

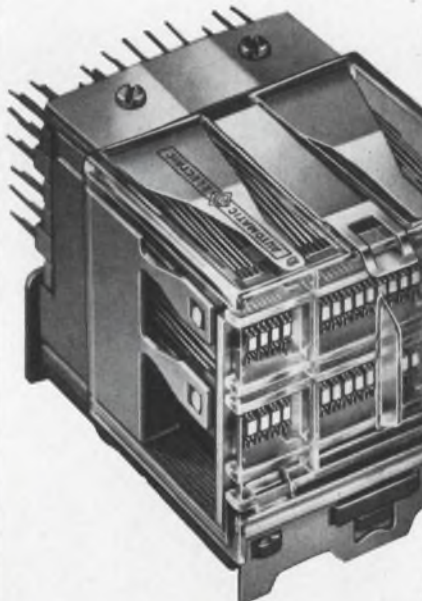

51...shift  
or latch!

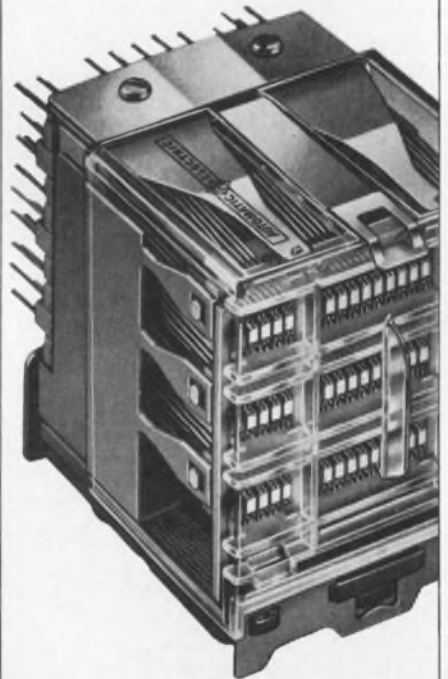

Assuring the simultaneous transfer of circuits in a multiple-relay group is one of the trickier problems faced by electrical and electronic engineers. AE's happy solution is the WQA Relay—the first industrial-control component specifically designed for uniform transfer of up to 51 circuits.

The modular construction of the WQA permits one, two or three rows of contact forms, each with a capacity for 17 circuit transfers. Unique, compact design saves valuable mounting space, replacing 4 or more "general-purpose" relays. Remarkably sensitive, even the largest pile-up requires less than 6 watts input. Continuing tests show a life expectancy of over 800 million operations without readjustment.

If you use latching relays, investigate the new WRM. It has

all WQA features plus a special one of its own. When pulsed on one winding, remanent magnetism keeps the WRM relay latched without power consumption until it is restored by a second pulse to its release winding.

. . .

For full information, ask for Circular 1957. Write the Director, Control Equipment Sales, Automatic Electric, Northlake, Illinois 60164.

**AUTOMATIC ELECTRIC**  
SUBSIDIARY OF  
GENERAL TELEPHONE & ELECTRONICS **GTE**

ON READER-SERVICE CARD CIRCLE 27

# why "grope" for answers when you can see them

Model SPA-3a (200 cps to 15 mc)  
 Model SPA-3/25a (1 kc to 25 mc)  
 Federal Stock No. 6625-967-0425  
 Manual Scan Control now standard  
 5 mc sweep width now available



## SEE YOUR SPECTRUM

(up to 5 mc scan widths)  
 200 cps to 25 mc

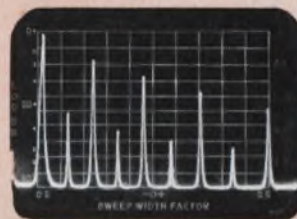

Harmonic analysis of distorted sine wave. 40 db log amplitude scale used.

**Panoramic** swept band SPA-3/25a displays and measures level vs. frequency of signals on an easily interpreted calibrated 5" CRT read-out. Sweep widths adjust from 0 to 3 mc. Extensively field-proven for ruggedness, ease of use, and reliability. The evidence: hundreds now in use for instant visual analysis of virtually all types of signals—CW, modulated signals, pulses, and noise and other random waveforms.

**Typical applications include:** telephone carrier system monitoring and malfunction analysis . . . modulation measurements . . . noise spectrum density analysis . . . broadband search and monitoring . . . telemetry subcarrier frequency analysis . . . frequency response tracing of filters (with Companion Sweep Generator G-6) . . . distortion measurements . . . laboratory use.

For 200 cps-15 mc, Model SPA-3a offers most of the features of the SPA-3/25a at still lower cost. The SPA-3a now has a highly stabilized 0-100 kc sweep width range recommended for narrow band testing. A wide selection of accessories further extends the usefulness of these electronic workhorses. Other widely used *Pan-*

*oramic* Spectrum Analyzers are available for 1/2 cps to 73 gc/s coverage. All instruments are tested and certified to meet MIL-Q-9858 specs.

### Advantages of the SPA-3/25a:

- Fully calibrated and self-checking with precise ( $\pm 0.02\%$ ) frequency markers every 50 kc.
- High sensitivity, 25  $\mu\text{v}$  full scale, 2  $\mu\text{v}$  readable. Uniform response within  $\pm 1/2$  db. Precise attenuators, 0 to 95 db.
- Exceptional frequency resolution separates signals 200 cps apart on reduced sweep widths, IF bandwidth range 200 cps to 20 kc provides optimum selectivity for all types of tests.
- Three calibrated level scales, linear, 40 db log, and power.
- Adjustable scan rate 1-60 cps synchronized or free-running for best visual presentation.
- Smoothing filter simplifies noise analysis by presenting single line level vs frequency plots.
- Use-engineered for reliability and for simplicity and convenience of operation. Semi-skilled personnel readily operate the SPA-3/25a in many applications.

Ask about the  
**NEW TA-2!**

Fully portable  
 Modularized  
 Solid state  
 Battery operated  
 20 cps to 27.5 mc



WRITE FOR BULLETIN AND DEMONSTRATION. START "LOOKING" FOR TROUBLE THE FAST, EASY WAY!



## THE SINGER COMPANY METRICS DIVISION

915 PEMBROKE ST., BRIDGEPORT, CONNECTICUT  
 PHONE (203) 366-3201 • TWX 710-453-3483

Design and production of PANORAMIC • SENSITIVE RESEARCH • EMPIRE • GERTSCH instruments for measurement

# Will a switch fail after several hundred operations?

The Poisson statistics in graphical form find the answer without mathematical calculations.

This graphical presentation of Poisson statistics offers an easy way for engineers to study the probability of events in a series. They allow the rapid calculation of asymmetry, flatness, standard deviation, distribution and frequency. The number of trials, successful events (malfunctions) and the single-unit probability are interrelated with these parameters.

The probability of frequency of failure (success) will be denoted as (PPFF) $N$ . If you want to know the chances of success (or failure) happening exactly  $N$  times, the graph in Fig. 1 will provide the answer. This graph determines the frequency of occurrence once the standard deviation and the number of successes (or failures) are known.

The probability that the number of successes or failures will be between zero and  $N$  is denoted as (PPDF) $N$ , the Poisson probability of the distribution of failure. The nomograph for this is in Fig. 2. It really determines the distribution of the selected type of events below and above  $N$ . If the value of (PPDF) $N$  is known, then either the number of successes (or failures) or the standard deviation may be determined from this graph.

The probability of the number of events occurring above  $N$  is represented by  $1 - (\text{PPDF})N$ . This function predicts the location and frequency of single events and groupings in a series.

The standard-deviation nomograph (Fig. 3) allows a graphical calculation of the standard deviation from the number of trials,  $10^n$ , and the probability of an event occurring in a single trial,  $P$ . The standard deviation may be interpreted as an indication of the shape of the Poisson curve. The Kurtosis value,  $\beta$ , may be read directly from the standard deviation on this graph. This value is an indication of the flatness of the curve, which may be referred to as a normal curve value of three.

The skewness value, or asymmetry, is provided by Fig. 4, from a knowledge of the standard deviation. This value may be compared with a skewness value of zero for a normal curve.

## Example:

If a piece of electronic equipment had flown 399 missions with three failures, what would the chances be of a failure on the four-hundredth mission if the equipment had a 0.99 reliability for

each mission?

**First:** The standard deviation  $\sigma$  is determined from the graph in Fig. 3. Enter 400 on the right line, as  $4(10^2)$ , and 0.01 on the centerline as  $1(10^{-2})$ . The standard deviation is read at left as 2. Note that this is *not* the error.

**Second:** The standard deviation of 2, and the number of events (the fourth failure) are entered on the (PPFF) $N$  nomograph (Fig. 1) as follows:

(a) The value of the standard deviation, 2, is entered on  $\sigma$ .  $N$  as 4 is entered on the adjacent slant line. These points are aligned to intersect the right index line with a reference point (line  $a$ ).

(b)  $N$  is selected as 4 on the right line. This is aligned with the previously established reference point to intersect a new reference point on the left index line (line  $b$ ).

(c) The standard deviation of 2 is entered on  $\sigma$ , immediately to the right of the left index. This is aligned with the new reference point to intersect the answer at left as 0.2 (line  $c$ ).

Thus the probability of a malfunction on this mission is 0.2%.

In this example, the Kurtosis value is 3.25 and the asymmetry is 0.5, which indicate the shape of the curve. From Fig. 2, the (PPDF) $N$  value is 0.635 and the distribution above  $N$  is 0.365.

Thus all the parameters are established without mathematical calculation and with an accuracy that is acceptable for most applications.

Although the graphs are suitable for most applications, the following equations may be used:

$$(\text{PPFF}) N = e^{-\sigma} (mP) N/N! \quad (1)$$

$$(\text{PPDF}) N = \int_0^N (\text{PPFF}) N \quad (2)$$

These equations will provide optimum values. ■ ■

### Abbreviations and symbols

- $N$  = number of events (successes or failures)
- $P$  = probability of an event happening on a single trial
- (PPFF) $N$  = probability that an event happens exactly  $N$  times
- (PPDF) $N$  = Poisson probability that the number of events occurring will be between zero and  $N$
- $\alpha$  = asymmetry of the distribution curve
- $\beta$  = flatness of the distribution curve, called Kurtosis
- $\sigma$  = standard deviation, indicates the shape of the distribution curve.

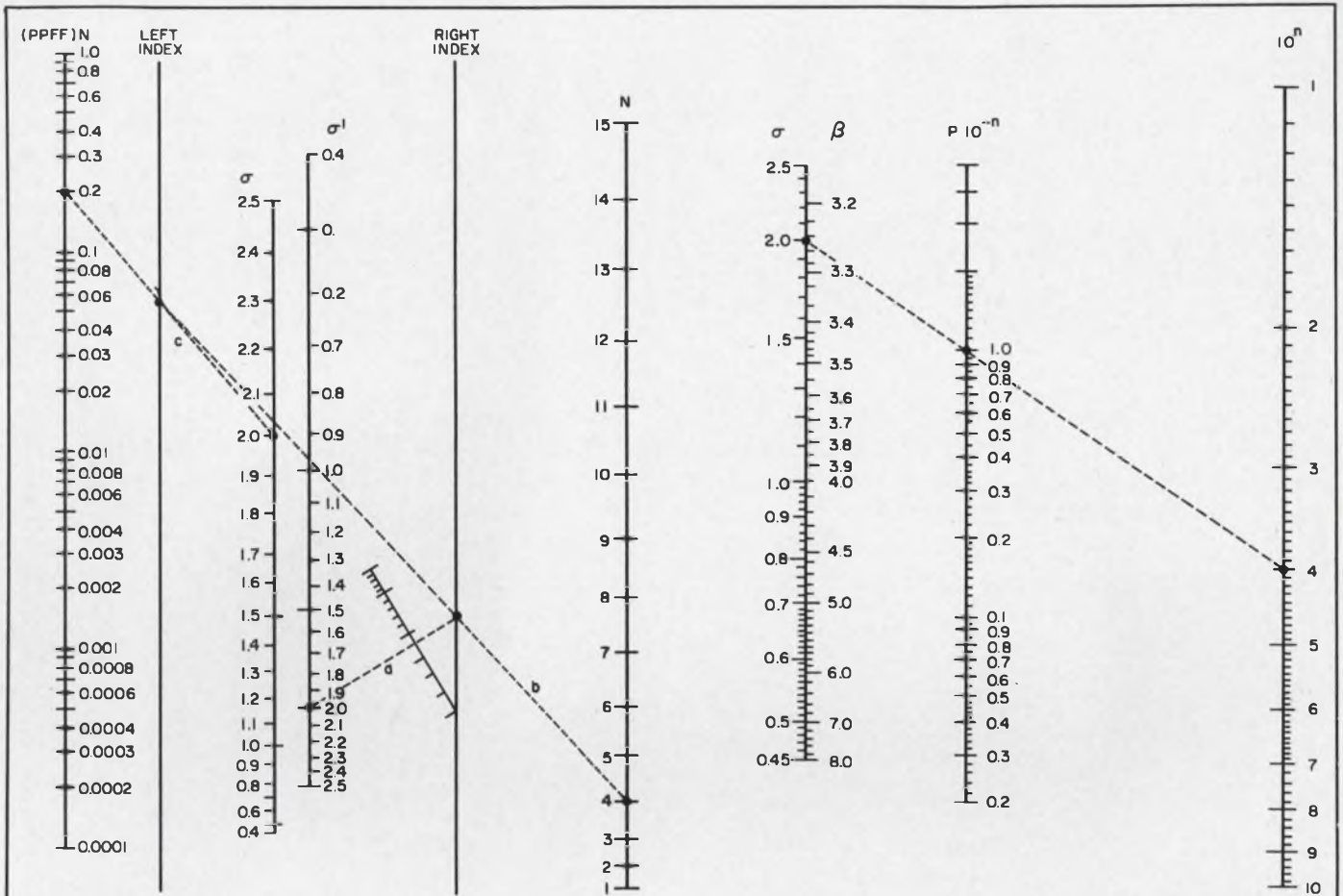

1. The probability of success or failure can be found from this graph—that is, the chances that an event will happen exactly  $N$  times.

3. The standard deviation,  $\sigma$ , can be calculated graphically from the number of trials and from the probability that an event will occur in a single trial.

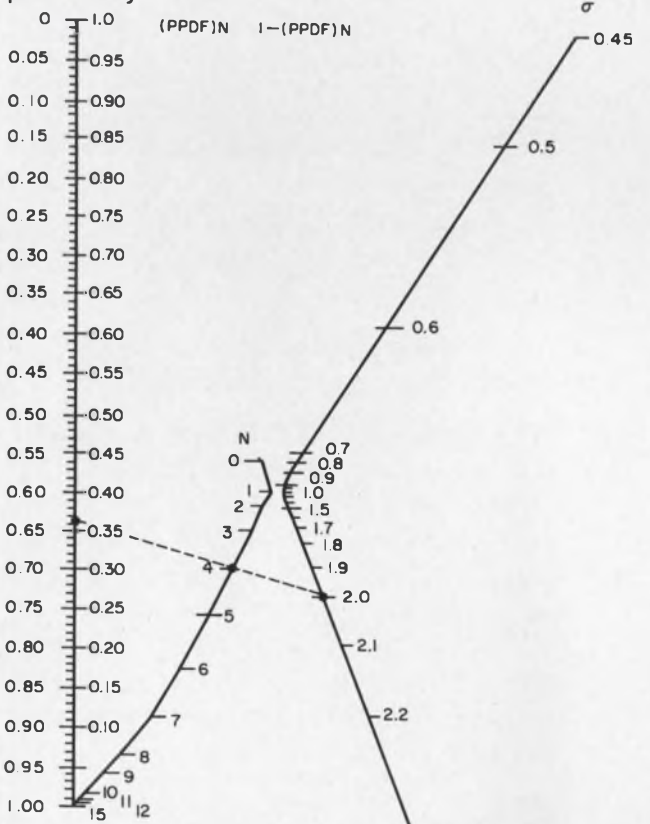

2. The Poisson probability that the number of events occurring will be between zero and  $N$  is  $(PPDF)N$ . The probability that it will be greater than  $N$  is  $1 - (PPDF)N$ .

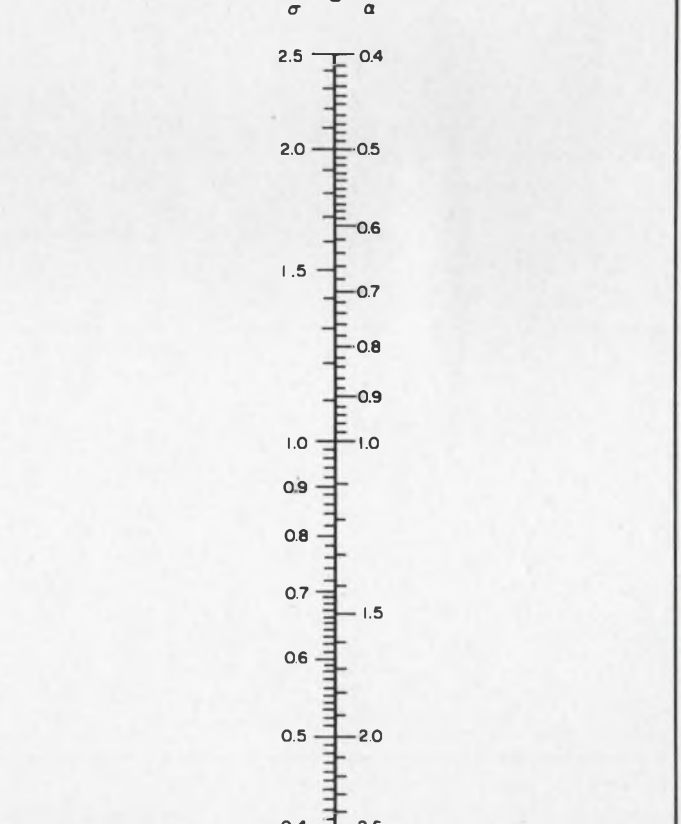

4. The relationship between the standard deviation and the asymmetry, or skewness ( $\alpha$ ), of the Poisson curve is straightforward.

# 0.0004 seconds

**A breakthrough  
in torque  
response**

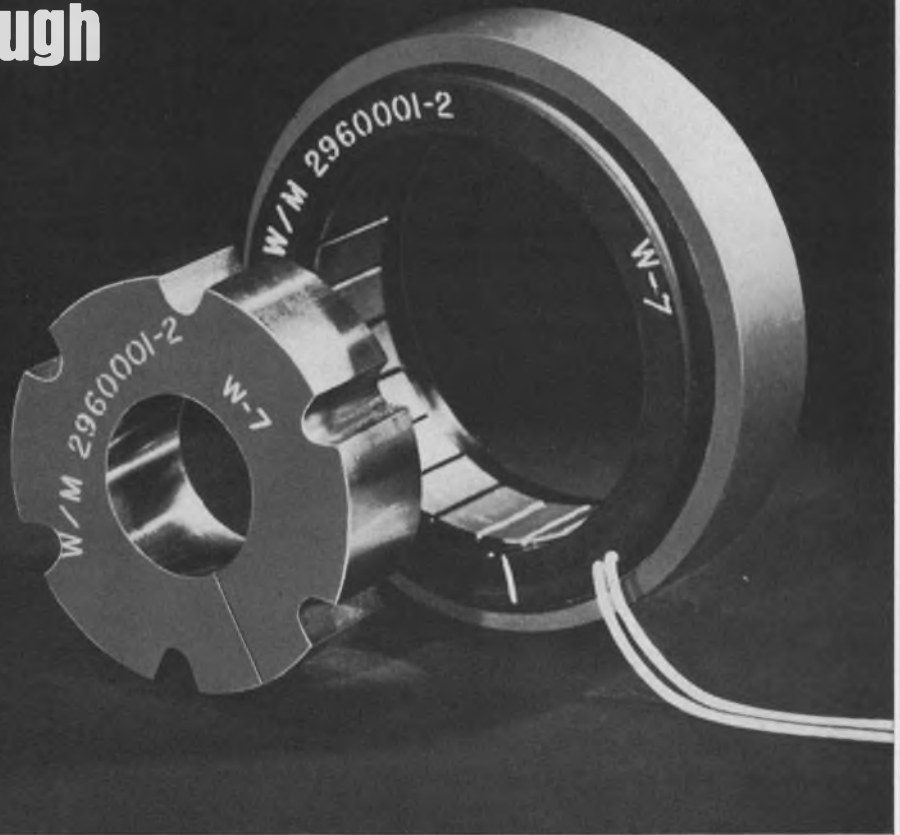

*Torque motors with a response of four hundred millionths of a second are now a reality. And this breakthrough is only one of several benefits offered you in a new line of torquers by Wright Division of Sperry Rand.*

## Reliability

No contacts. No brushes. No commutation bars. Simplified winding. Permanent magnet.

## Better Performance

Direct Drive. No friction. No ripple torque.

## What does a Wright torque motor do?

It holds, clamps, stabilizes, drives, opens, closes, cracks, shuts, pushes, picks up, moves, rotates, nulls, controls, actuates.

Design engineers are invited to write or telephone for details. Comparison will show you that on applications where incremental rotation is needed, this new Wright concept in torquers offers substantial advantages.

SIZE	O.D.	Watts at Peak Torque	Design					
			2 Pole 180°		4 Pole 90°		6 Pole 60°	
			Peak Torque Oz.-In.	Electrical Time Constant L/R (Secs.)	Peak Torque Oz.-In.	Electrical Time Constant L/R (Secs.)	Peak Torque Oz.-In.	Electrical Time Constant L/R (Secs.)
10C	.9650	9.5	6.5	.0004	—	—	—	—
14C	1.3400	19	12	.0007	24	.0004	—	—
18C	1.8000	35	23	.0013	46	.0007	—	—
23C	2.3000	60	40	.0022	80	.0011	—	—
27C	2.6093	71	47	.0026	94	.0013	140	.0007
40C	4.000	180	100	.0055	200	.0028	300	.0019
50C	5.000	183	120	.007	240	.004	360	.0025
70C	7.000	377	250	.015	500	.0075	750	.005
100C	10.000	545	360	.020	720	.010	—	—

**WRIGHT**   
Division of Sperry Rand Corporation

Durham, North Carolina ■ Telephone 919-682-8161 ■ TWX 919-682-8931

ON READER-SERVICE CARD CIRCLE 28



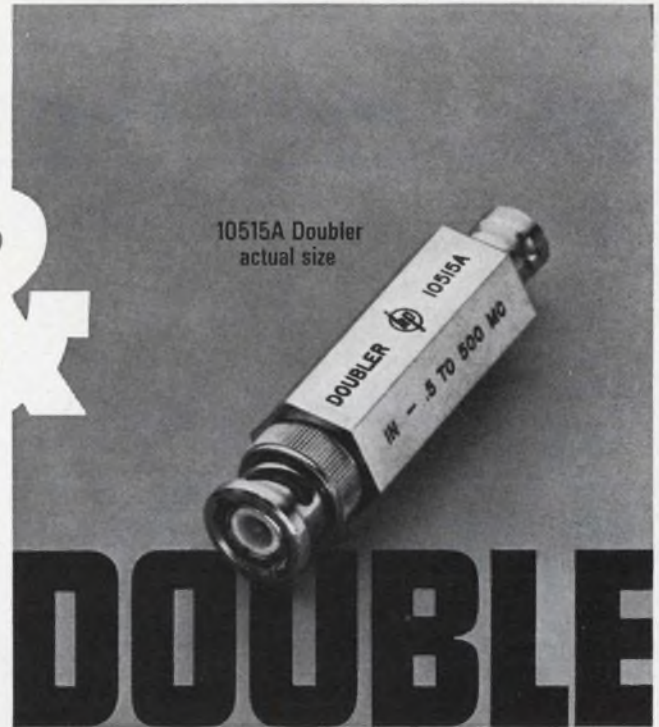

## NEW

### hp DOUBLE-BALANCED MIXER

- Broadband application, 200 kHz-500 MHz (to dc on one port)
- Low noise (7 db max. noise figure to 50 MHz, 9 db max to 500 MHz)
- Superior balance for minimum feed-through from any of three ports
- Broadband for versatile application, yet has the high performance of limited special-purpose devices

Use the Hewlett-Packard 10514A Mixer in designing receivers, wave analyzers, single-sideband systems (no balance adjustment necessary); as a pulse modulator; phase detector for evaluating short-term stability of signal sources; for spectrum analysis outside the analyzer's normal frequency range; to measure spurious response of signal sources; as a current-controlled attenuator for smooth electronic level control; balanced modulator; phase detector; frequency doubler; spectrum or comb generator.

Specially selected hot carrier diodes and special transformer design permit this unique performance, flat frequency response (typically  $\pm 0.2$  db 0.5 to 50 MHz,  $\pm 1.5$  db overall), low intermodulation products,  $\pm 1$  nsec rise and fall times as a pulse modulator. Each unit is completely tested with highly specialized equipment not duplicated in most laboratories. \$250.

## NEW

### hp FREQUENCY DOUBLER

- Broadband (0.5-500 MHz input, 1-1000 MHz output) yet meets or beats the performance of narrowband units
- Flat response, low conversion loss, excellent harmonic suppression.

Use the Hewlett-Packard 10515A Doubler to double the range of signal sources without appreciably degrading performance; use it as a broadband ac-dc converter for detecting low-level AM. \$120.

Both devices offer new performance capabilities with less design and test work for you than required by previous measurement tools. They're rugged and have been type tested over a wide environmental range. Data sheets will give you an idea of what they will do for you. Use the phone to get information from your Hewlett-Packard field engineer, or write for complete information: Hewlett-Packard, Palo Alto, Calif. 94304, Tel. (415) 326-7000; Europe: 54 Route des Acacias, Geneva.

*Data subject to change without notice. Prices f.o.b. factory.*

HEWLETT  PACKARD  
An extra measure of quality

# Need a small power inverter?

This compact poly-phase inverter design uses digital technique and integrated circuits.

To put an efficient power inverter into a small package can offer a real challenge to designers of portable electronic equipment.

Such an inverter is used to convert dc to poly-phase ac to drive such things as servo tuning systems and cooling motors. The advantages of a digital approach to inverter design include the possibility of using integrated circuits. This can reduce cost and weight and improve reliability.

A block diagram of a three-phase power inverter is shown in Fig. 1. The frequency of the astable oscillator used to drive the counter is equal to the product of twice the number of phases and the desired output frequency. For example, to build a 400-Hz, three-phase power inverter, the oscillator frequency would be 2400 Hz ( $2 \times 3\phi \times 400$  Hz).

The counter, a digital frequency divider, provides properly phased switching voltages to the power transistors, which drive the output transformer. Known as a Johnson or a Tarczy-Hornoch modulo-n counter, it is basically a shift register. The output is fed back into the input to achieve a counting operation. The output from each stage of the counter is a square wave at the output frequency. Each successive output is delayed in phase by one full cycle divided by the number of the division. In a divide-by-six counter, each successive output would be delayed by 60 degrees.

Although Johnson counters can be constructed of discrete components, they are best built with the integrated-circuit flip-flops and gates that are commercially available. This makes for an extremely small power inverter.

Using this technique, a three-phase, 400-Hz, 115-volt power inverter was developed to drive a blower motor. The inverter operates from a 28-volt dc power source. The internal multivibrator operates at 2400 Hz, and the Johnson counter is used to divide this frequency by six. The counter consists of three IC flip-flops (SN 511A) and one IC combination gate and phase inverter (SN 514A). The devices, manufactured by Texas Instruments, are mounted on the printed-circuit board, shown in Fig. 2.

Good decoupling is achieved by using the emitter-follower outputs of the integrated circuits. Each output from the counter drives an intermediate transistor switch, which in turn drives a two-transistor power switch. These power transistors switch the dc input across each of the primary legs of a three-phase power transformer.

The power transistors are operated in a push-

pull arrangement by using a bifilar winding on the primaries of the transformer. An interphase transformer is used to develop a quasi-square waveform, Fig. 3. This lowers the harmonic distortion of the output voltage to less than 30 per cent. Thus, better saturation of the power transistors is possible and a cleaner output waveform results.

The operating characteristics of the inverter are given in the accompanying table, and a complete circuit diagram is shown in Fig. 4. This inverter was designed to operate a 125-watt fan motor.

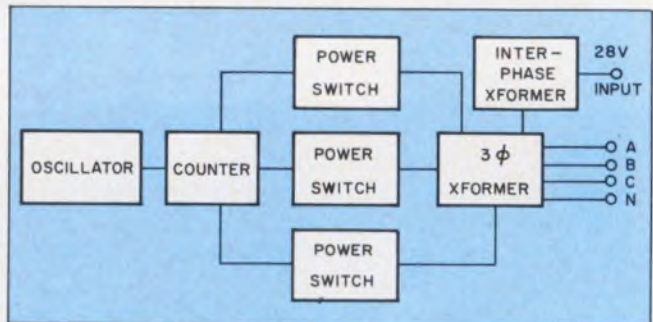

1. Three-phase inverter uses four IC packages and 15 transistors. The power-switch block includes two transistor switches in parallel.

## Inverter characteristics

	Three-phase inverter	Two-phase inverter
<b>Input</b>		
Operating voltage:	18-29 Vdc	18-29 Vdc
Automatic turn-off:	> 33 V	> 33 V
Maximum voltage:	80 V for 500 $\mu$ s	80 V for 500 $\mu$ s
Power (resistive load):	250 W	65 W
<b>Output</b>		
Voltage (@ 28 V input):	115/200 Vac, Y-connection, 3- $\phi$	115 Vac, 2- $\phi$
Frequency (-5%, +15%):	400 Hz	400 Hz
Power:	200 W	40 W
Overload (5 s):	200%	100%
Temperature range:	-55 to 85°C	-55 to 85°C
Size:	60 in. <sup>3</sup>	18 in. <sup>3</sup>
Weight:	3.25 lbs	1.5 lbs

A two-phase, 400-Hz power inverter was also developed to operate a small blower motor and a servo system. This inverter consists of an astable multivibrator oscillator that operates at 1600 Hz, a Johnson counter that uses two flip-flops, and a power switch that delivers 15 watts of square wave power for each phase. Its operating characteristics, too, are given in the accompanying table.

The servo and blower motors could have been powered by a single-phase inverter, with the use of a phase-shifting capacitor. However, temperature requirements would have called for extremely large, heavy and expensive components. All three of these factors were greatly reduced by using the integrated-circuit packages and the two-phase system. ■ ■

**Bibliography:**

- Olsson, Bengt G. "Solid-State Inverters Suppress Harmonics." *Electronic Design*. Sept. 28, 1964.
- Perlin, Allen I. "Designing Shift Counters." *Computer Design*. Dec., 1964.
- Rachwalski, Alfons Z. "Quasi-Square Waveform Drive High Efficiency Static Inverter." *Electronic Design*. Sept. 13, 1963.
- Rhoades, W. T. "Ultra-High-Speed Counters." *Electronic Design*. Sept. 28, 1964.
- Sorensen, Albert A. "Design Techniques for Static Inverters." *Electrical Manufacturing*. Jan./Feb., 1960.
- "Ten-State Johnson Counters." Series 51 Semiconductor Networks, Application Report. Texas Instruments, Inc.
- Vergez, Paul. "Getting Maximum Efficiency in DC/AC Converters." *Electronic Design*. April 26, 1963.

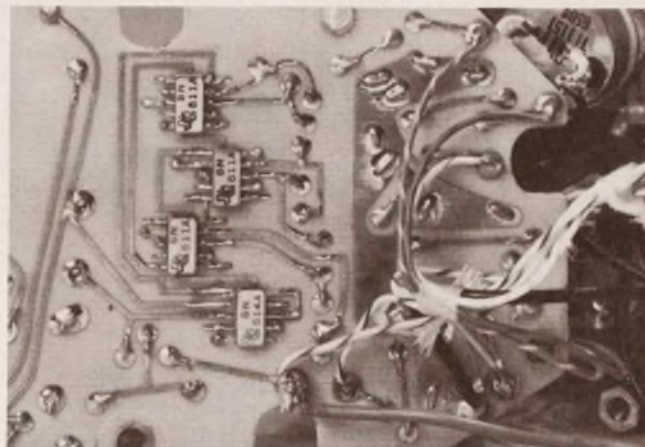

2. The integrated circuits are soldered to the printed-circuit board. Their flat shape simplifies the mechanical packaging problem.

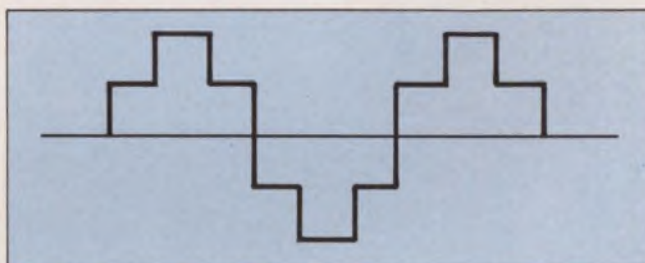

3. Quasi-square waveform of the output line-to-line voltage greatly reduces the harmonic content of the signal.

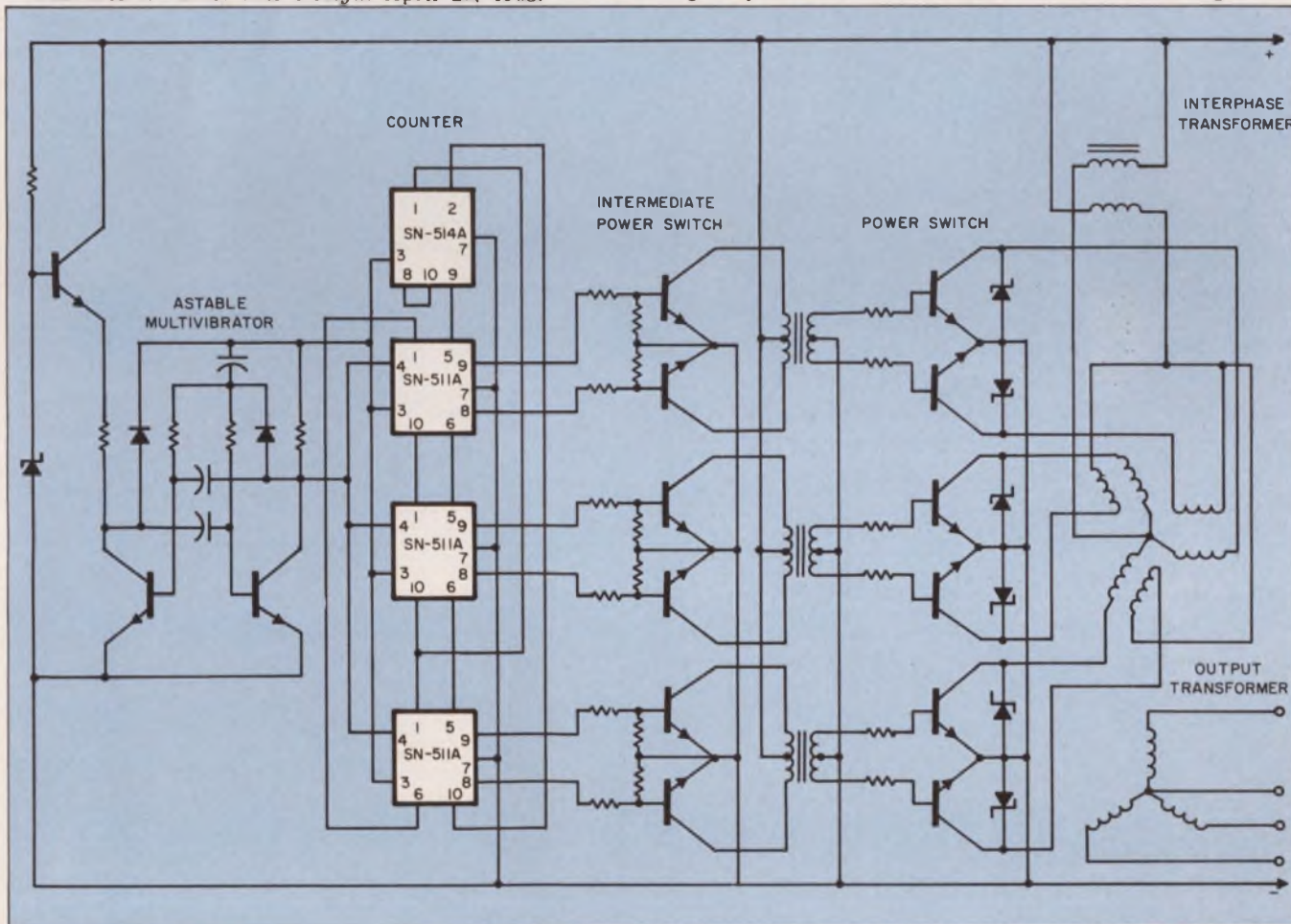

4. Over-all schematic of the three-phase inverter. The final volume of the inverter package is only 60 cubic inches.

WANT TO SAVE MONEY BY  
 USING **GUDEBROD**  
 LACING TAPE? . . .



**YOU DO IT HERE!**

Harness tying may be a relatively minor operation. But it also can be a major cost drain. Lacing tape is one of the smallest costs in the harnessing operation but with Gudebrod Tape you can save dollars in making harnesses. Knots tie easier, workers say they almost tie themselves, knots stay tied, the harness workers can go right on with the harnessing without having to go back for re-tightening. Workers like to use Gudebrod Tape. You cut harnessing time—you have fewer rejects. All of this works for you in saving money on cable harnesses—that's why it pays to specify Gudebrod Lacing Tape, the original flat braided tape. Prove these statements in your own harnessing department—give Gudebrod Tape a comparative test.



**GUDEBROD  
 CABLE-LACER**

**—ANOTHER MONEY SAVER**

The first hand tool specifically engineered for continuous wire harnessing. Handle holds bobbin, feeds tape as needed, grips tape for knotting. Speeds, eases harnessing. Has paid for itself in a day in many plants.

**CABLE LACING INFORMATION:**

When you need help on knots, on spacing, on the type of tape to use—Gudebrod is your one best source for information. We have over 200 different lacing tapes in stock, for temperatures up to 1500° F. or down to -100° F., burn proof

tapes, tapes that do not outgas in vacuum, color coded tapes, cut lengths, tapes of nylon, Dacron\*, Teflon\*, spun glass, silica fiber. Ask for a copy of our Product Data Book.

\*Du Pont Registered Trade Mark

Area Code 215, WA 2-1122



**GUDEBROD BROS. SILK CO., INC.**

FOUNDED IN 1870

*Electronics Division*

12 SOUTH 12th STREET, PHILADELPHIA, PENNSYLVANIA 19107

ON READER-SERVICE CARD CIRCLE 30

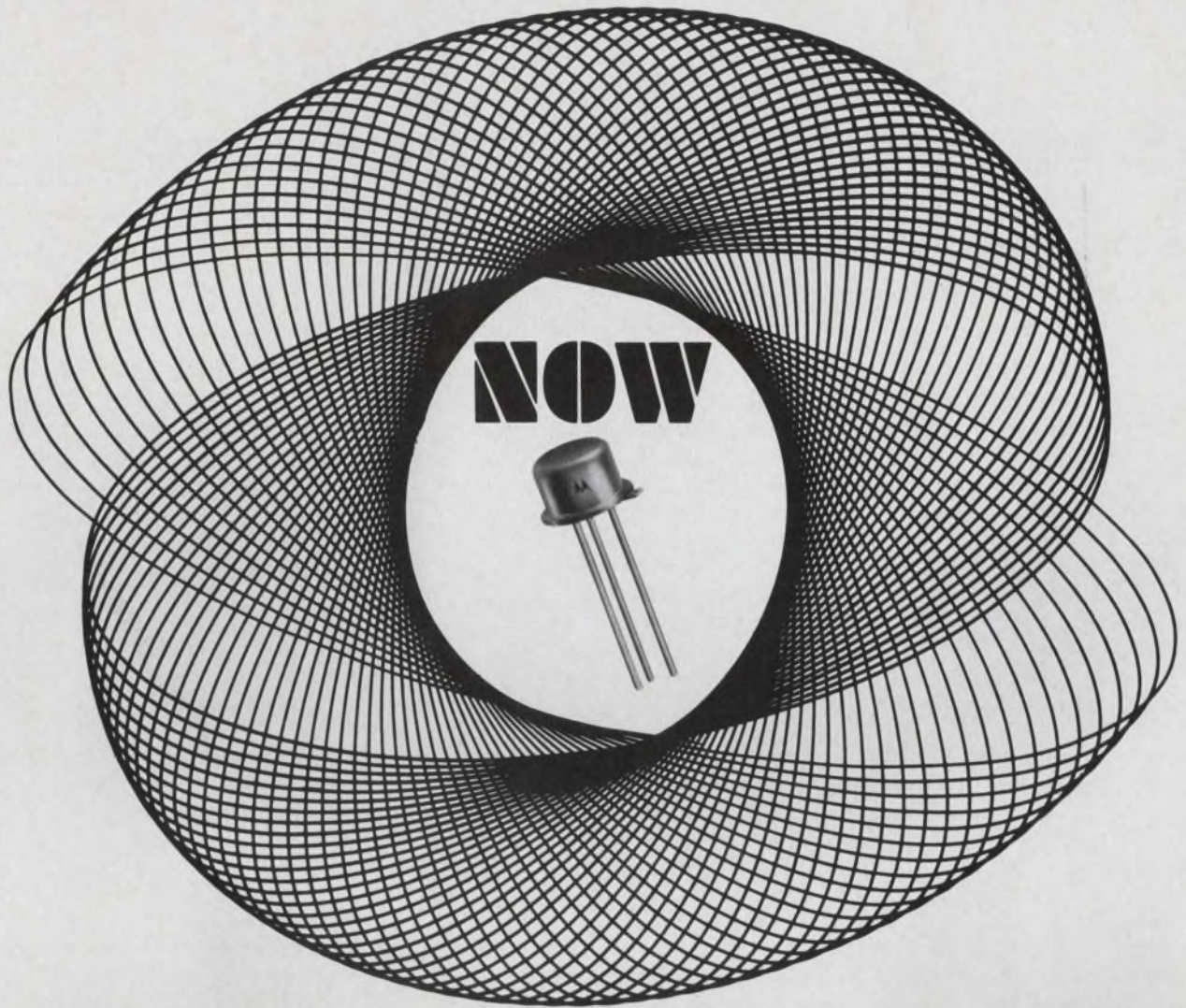

## a new era for current-mode switching... with Motorola's 1800 MHz 2N3960 NPN Silicon Annular\* Transistor

### TYPICAL SWITCHING TIMES

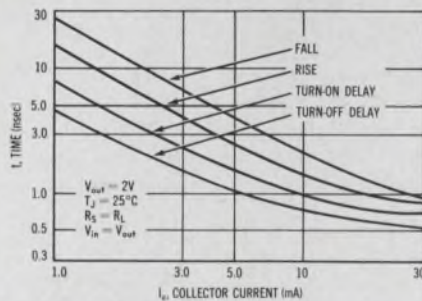

### LIMIT CURVES AVAILABLE IN DESIGNERS' DATA SHEET

You'll find a full complement of limit curves on each device in a special Motorola Designers Data Sheet. Thus, you can readily explore their use in your circuits using "worst case" design techniques. Both devices are in stock in TO-18 packages. TO GET STARTED, send for your copy of the Data Sheet. Simply write Technical Information Center, Motorola Semiconductor Products Inc., Box 955, Phoenix, Arizona 85001.

A new magnitude of switching speed for non-saturated, digital systems applications is here — ready for your immediate prototype designs... with typical  $f_T$  performance of 1800 MHz!

Previously, frequency response has been limited to a range of about 1200 MHz before encountering a self-limiting trade-off with breakdown voltage. Now, Motorola's newly developed "narrow-base profile" process technique makes possible a micro-thin base thickness (on the order of 0.1 micron) and a new high level of frequency response ( $f_T$ ).

And, because the 2N3960 uses Motorola's patented annular device structure, this frequency response is offered to you at no sacrifice in breakdown voltages. You've come to expect this with all annular built devices.

As a result, both 2N3960 and its sister device, 2N3959, are able to satisfy, as never before, the three key requirements for highest speed in current-mode designs — high  $f_T$ , low capacitances, and low base-spreading resistance.

Guaranteed minimum  $f_T$  values are 1300 MHz for 2N3959 and 1600 MHz for 2N3960 at 10 mA. Both are also specified at 5 and 30 mA collector currents.

### Other high-performance characteristics...

Output Capacitance ( $C_{obo}$ ) ( $V_{ce} = 4$ Vdc, $I_e = 0$ , $f = 100$ Kc)	2.5 pF max.
Input Capacitance ( $-C_{ibo}$ ) ( $V_{be} = 0.5$ Vdc, $I_c = 0$ , $f = 100$ Kc)	2.5 pF max.
Collector-Base Time Constant ( $\tau_b, C_c$ ) ( $I_c = 10$ mA, $V_{ce} = 10$ V)	25 psec max.
2N3959	40 psec max.
Collector-Base Breakdown Voltage ( $BV_{cbo}$ ) ( $I_c = 10$ $\mu$ Adc, $I_e = 0$ )	20 Vdc min.
Collector-Emitter Breakdown Voltage ( $BV_{ceo}$ ) ( $I_c = 10$ mA, $I_e = 0$ )	12 Vdc min.

\*Annular semiconductors patented by Motorola Inc.



**MOTOROLA**  
Semiconductors

Speed Inquiry to Advertiser via Collect Night Letter  
ON READER-SERVICE CARD CIRCLE 31

# Widen multivibrator ranges by separating the timing and biasing. A constant-current source permits timing ranges up to 200 to 1.

The timing ranges of multivibrators can be increased to as much as 200 to 1 by adding circuitry which essentially separates the requirements of bias and timing.

This technique has been applied to monostable, complementary and astable multis, none of which need be limited to the 20 to 1 timing ranges usually obtained. Thus, the variation on the monostable multis discussed here is 1 to 200  $\mu$ s; on the astable multis, the frequency may be varied from 25 kHz to 5 MHz.

## The monostable multi

Let's first see how the bias and timing requirements are related in a monostable multi, Fig. 1. The timing here depends on capacitor  $C_1$  and a variable resistor, shown as  $R_2$  and a potentiometer  $P_1$ . (It's much more economical to vary the timing with a pot instead of a variable capacitor.)

Changing resistor  $P_1$  and  $R_2$  changes the amount of base current into  $Q_2$ . The base current variation that can be tolerated depends on the current gain of the transistor. Generally this is, in a worst case, about 20. With the timing capacitor fixed, a bias resistor variation no greater than 20 times in the worst case may be allowed. If the resistor is too small, there is too much base current, causing storage problems. If it is too large, the transistor will barely turn on.

Ideally what we'd want is to feed a constant base current into  $Q_2$  that would be turned off during the timing cycle and turned back on at the cycle's end. Then the resistor normally used for both biasing and timing,  $R_2$  and  $P_1$ , could be used for timing only. The resistor's minimum value is picked so as not to exceed the maximum base current of  $Q_2$ .

Such a switchable base drive is implemented with the four-terminal, current-source network shown in the box in Fig. 1. It works like this:

With  $Q_1$  normally off and  $Q_2$  normally on, the base of  $Q_3$  sits at about 12 volts.  $Q_3$  is forward biased to provide a current of 1 mA to the base of  $Q_2$ . A negative-going input pulse cuts off  $Q_2$ , which turns  $Q_1$  on. With  $Q_1$  saturated,  $Q_3$  is backbiased.

At the end of the timing cycle,  $Q_2$  begins to turn on, turning  $Q_1$  off, which turns on  $Q_3$ . This rapidly saturates  $Q_2$  and ends the cycle.

The design of the four-terminal network proceeds as follows:

$$I_{C3} = \frac{V_{CC}}{h_{fe3} R_3} \quad (1)$$

$$I_{B3} = \frac{I_{C3}}{h_{fe3}} \quad (2)$$

The current through  $R_8$  and  $R_9$  is designed to be five times  $I_{B3}$ .

$$I_{R8, R9} = 5 I_{B3} \quad (3)$$

$$V_{B3} = \frac{V_{CC} R_9}{R_8 + R_9} = a V_{CC} \quad (4)$$

where  $V_{B3}$  is the voltage at the base of  $Q_3$  and  $a = R_9 / (R_8 + R_9)$ .  $V_{B3}$  is picked so as not to exceed the base emitter breakdown of  $Q_3$  when  $Q_1$  is on. Therefore,

$$R_8 = \frac{V_{CC} - V_{B3}}{5 I_{B3}} \quad \text{and} \quad R_9 = \frac{V_{B3}}{5 I_{B3}}$$

With  $Q_1$  turned off and  $Q_3$  maintaining  $Q_2$  on:

$$I_{E3} = \frac{V_{CC} - V_{B3} - V_{BE3}}{R_1 + R_7} \quad (5)$$

$$R_7 = \frac{V_{CC} - V_{B3} - V_{BE3} - I_{E3} R_1}{I_{E3}} \quad (6)$$

$C_3$  is a speed-up capacitor which overdrives the base of  $Q_2$  during turn on:

$$C_3 = \frac{Q}{V_{CC} - V_{B3} - V_{BE3}} \quad (7)$$

where  $Q$  is the charge stored in  $Q_2$  at the specified collector current of  $Q_2$ .

Two advantages are gained by adding this biasing circuit. First, of course, the timing range is greatly increased. This is due mainly to the fact that instead of  $R_2$  and  $P_1$  saturating  $Q_2$  to end the cycle, they now have to provide only enough current to drive  $Q_2$  into the active region. Positive feedback through  $Q_1$  and  $Q_3$  provide the regeneration to end the cycle rapidly.

Also, the turn-on time of  $Q_2$  is now independent of the fall time at the base of  $Q_2$ . In a standard monostable multi there has to be an optimum ratio between  $C_1$  and  $C_2$  for long time durations to optimize the turn-on of  $Q_2$ . This optimum ratio limits the frequency of operation, since  $C_2$  must be rather large. The positive feedback in the modified circuit allows  $C_2$  to be small—it can be a non-electrolytic capacitor—and therefore it does not limit the frequency.

Adding yet another current source to the mo-

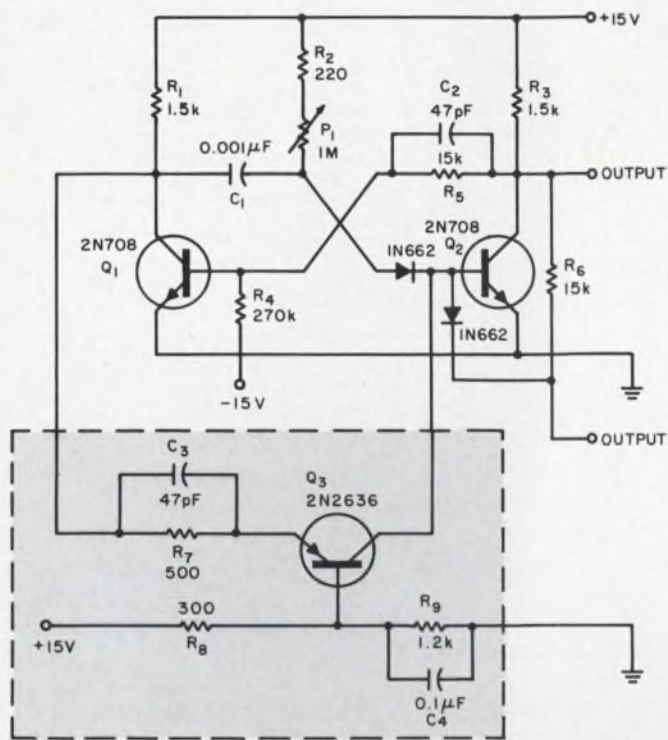

1. Monostable multi adjusts its timing by varying potentiometer  $P_1$ . But this also affects biasing. Adding the bias circuit allows the resistor combination of  $R_2$  and  $P_1$  to be used for timing only. Range goes from 1 to 200  $\mu$ s.

nostable multi, Fig. 2, separates the bias and timing functions still more. Pulse width is much more stable because the timing capacitor discharge is linear;  $Q_3$  is a constant-current source.

In the first multi, the total current flowing into the base of  $Q_2$  is the combination of the current through  $P_1$  and  $R_2$  and the bias current provided by  $Q_3$ . With  $P_1$  shorted out, considerable current flows into the base of  $Q_2$  at the end of the timing cycle. This drives  $Q_2$  deep into storage, limiting the operating speed.

However, the modified circuit of Fig. 2 cuts off the  $Q_5$  timing current at the end of the timing cycle, or as soon as  $Q_1$  turns off. The storage time involved in the turn-off of  $Q_5$  is due to the turning off of  $Q_6$ , introducing overdrive current into the base of  $Q_5$ . This is constant no matter what the timing current is. In addition, the storage time introduced by  $Q_6$  when turning on  $Q_5$  is no more than 10 ns with the transistors shown. The operation of the circuit of Fig. 2 is as follows:

$Q_5$  is normally on,  $Q_1$  and  $Q_3$  are off.  $Q_6$  is forward-biased and provides therefore a steady base current to  $Q_5$ . A positive pulse coming in through  $C_5$  cuts off  $Q_5$  and turns  $Q_1$  and  $Q_3$  on. This positive step is transmitted through  $C_1$ , which was charged to approximately -15 volts and maintains  $Q_5$  off during the one-shot timing cycle.

$C_1$  charges through constant-current source  $Q_3$  at a rate determined by the setting of  $P_1$  and the voltage across it, approximately 5.7 volts. When the voltage at the collector of  $Q_3$  has reached -1 volt,  $Q_5$  starts turning on,  $Q_1$  begins to turn off.  $Q_6$  also starts conducting, turning  $Q_5$  on harder. This cycle of events is regenerative so that  $Q_5$  rapidly

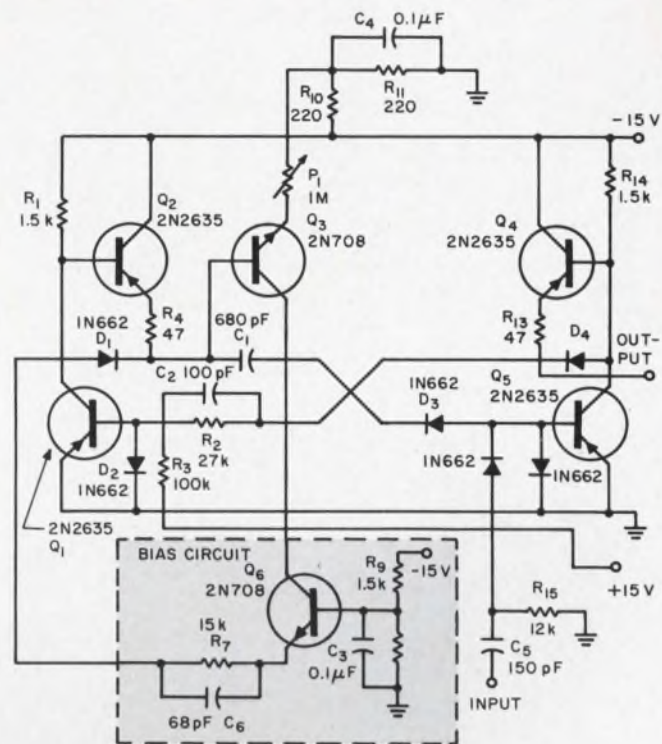

2. More linear operation is possible by adding still another current source and separating the bias and timing functions even more sharply. Pulse width is more stable because of linear timing capacitor discharge.

saturates and cuts off  $Q_1$ , which cuts off  $Q_3$ .

The circuit effectively separates the charging current through  $C_1$ , which varies the timing of the one shot, from the bias current turning on  $Q_5$ , which should be constant. The current through  $Q_3$  has to be sufficient to set  $Q_5$  into the active region and start the regenerative action.

Timing current through the capacitor is  $V_{CC}/2P_1$ . The period is:

$$T = \frac{\Delta E \cdot C_1}{I} \quad \text{or} \quad T = \frac{2\Delta E \cdot P_1 \cdot C_1}{V_{CC}}$$

where  $E$  is the voltage  $C_1$  is charged to initially. Since  $C_1$  is charged to  $V_{CC}$ , the period may be rewritten as  $T = 2P_1 \cdot C_1$ .

### The complementary monostable

Before explaining the application of this technique to the complementary monostable, let's discuss the multi's operation, since it is not as well known as the ordinary monostable. In the circuit of Fig. 3,  $Q_1$  and  $Q_2$  are normally on.  $C_1$  is charged essentially to the supply voltage,  $V_{CC}$ , with the polarity as shown in the figure. A negative trigger through  $C_3$  and  $D_4$  turns  $Q_1$  off. The positive step through  $C_1$  turns off  $Q_2$ .  $C_1$  now discharges through  $R_1$  and  $R_3$  until the base-emitter junction of  $Q_2$  becomes forward biased.  $Q_2$  turning on turns  $Q_1$  on and ends the timing period.

The timing equation may be derived as follows: During the stable state  $C_1$  is charged to  $V_{CC} = V_{D1} - V_{BE2} - V_{CS1}$ . When  $Q_1$  turns off, the instan-

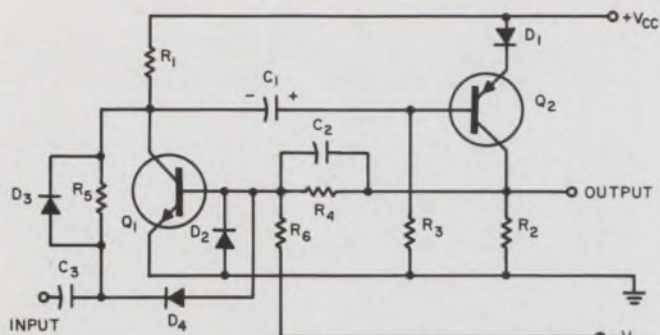

3. In a complementary monostable multivibrator both  $Q_1$  and  $Q_2$  are normally on.

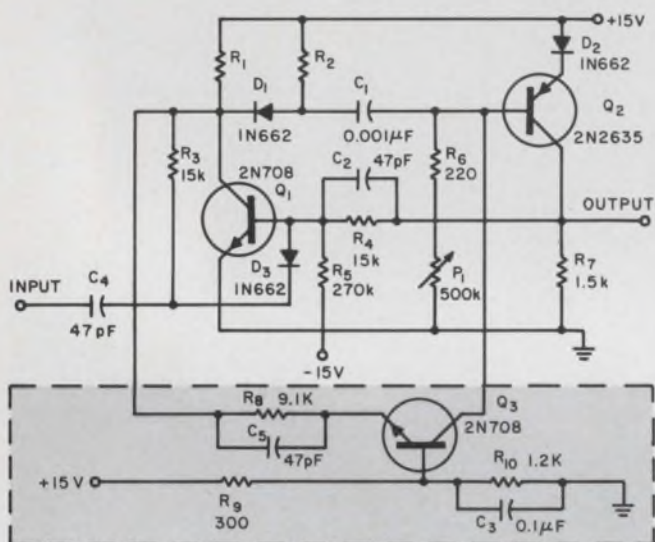

4. Wide-range technique can also be applied to the complementary monostable multi.

taneous voltage at the base of  $Q_2$  becomes  $V_{CC} = V_{D1} - V_{BE2} - V_{CS1} + V_{CC} R_3 / (R_1 + R_3)$ . As soon as the voltage at the base of  $Q_2$  decays to  $V_{CC} - V_{D1} - V_{BE2}$ ,  $Q_2$  turns on and ends the cycle. The voltage at the base of  $Q_2$  as a function of time is:

$$E_{B2} = (V_{CC} - V_{D1} - V_{BE2} - V_{CS1} + aV_{CC})e^{-t/R_1 C} \quad (8)$$

where  $R_1 = R_1 + R_3$  and  $a = R_3 / (R_1 + R_3)$ .

The pulse width may be solved for by substituting  $E_{B2} = V_{CC} - V_{D1} - V_{BE2}$  into Eq. 8.

$$T = R_1 C \ln \left( \frac{V_{CC} - V_{D1} - V_{BE2} - V_{CS1} + aV_{CC}}{V_{CC} - V_{D1} - V_{BE2}} \right) \quad (9)$$

If the diode drops are neglected and  $a$  is close to 1, the time delay becomes  $0.69 R_1 C$ , which is the same as the timing of the standard monostable. At the end of the cycle,  $C_1$  recharges through the saturated impedances of  $D_1$ ,  $Q_2$  and  $Q_1$ . The duty cycle of the circuit approaches 95% making it very useful as a pulse stretcher and frequency divider at high frequencies. The rise and fall times at the collectors of  $Q_1$  and  $Q_2$  are essentially limited by the inherent speed of the transistors.

The wide-range technique may be applied to the complementary monostable multi, Fig. 4. The timing of the circuit is dependent on  $C_1$ ,  $R_2$ ,  $R_6$ , and  $P_1$ . Again,  $R_6$  and  $P_1$  have the dual function of timing and biasing.  $Q_1$  and  $Q_2$  are normally on.  $Q_3$  is forward biased and provides a constant 1 mA

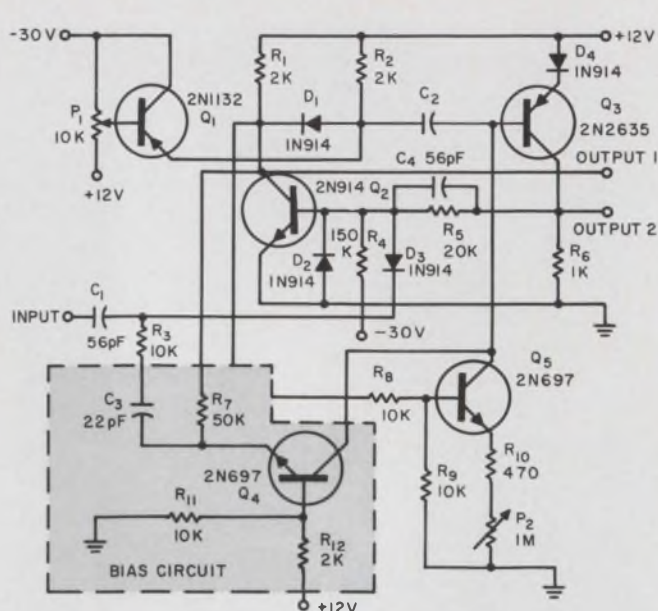

5. Linear complementary monostable multi results from still another current source.

to the base of  $Q_2$ . A negative trigger through  $D_3$  turns off  $Q_1$ . The positive step transmitted through  $C_1$  turns off  $Q_2$ .  $Q_1$  turning off back-biases  $Q_3$  which turns off.

As soon as  $Q_2$  enters the active region a regenerative cycle is started.  $Q_1$  starts turning on, which turns on  $Q_3$  and saturates  $Q_2$ , thus ending the cycle.  $D_1$  in the circuit decouples the collector of  $Q_1$  from  $C_1$ , as the resistance of  $P_1$  drops, so as to be able to keep  $Q_3$  cut off during the timing cycle. With  $D_1$  and  $R_2$  out of the circuit and  $C_1$  connected directly to the collector of  $Q_1$ , at the instant of turning off,  $C_1$  is a short circuit.

If the combination of  $R_6$ ,  $P_1$  and  $R_1$  is such as to make the swing at the collector less than the 13 volts necessary to keep  $Q_3$  cut off, the operation of the circuit will be impeded. The complementary monostable in Fig. 4, is superior to the ordinary monostable of Fig. 1 because of the fast recovery of  $C_1$  through the saturated impedances of  $Q_1$  and  $Q_2$ . The ordinary monostable recovers through a resistor.

The design of the network is similar to that of the standard monostable.

$$V_{B3} = aV_{CC} \quad (10)$$

where  $V_{B3}$  is the base voltage of  $Q_3$  and  $a = R_{10} / (R_9 + R_{10})$ .

The current through  $R_9$  and  $R_{10}$  should be five times  $I_{B3}$ .

$$I_{R9}, R_{10} = 5 I_{B3} \quad (11)$$

Therefore:

$$R_9 = \frac{V_{CC} - V_{B3}}{5 I_{B3}} \quad (12)$$

where  $V_{CC}$  is the positive supply voltage.

$$R_{10} = \frac{V_{B3}}{5 I_{B3}} \quad (13)$$

$V_{B3}$  should not exceed the base emitter breakdown of  $Q_3$ . The collector current of  $Q_3$  should



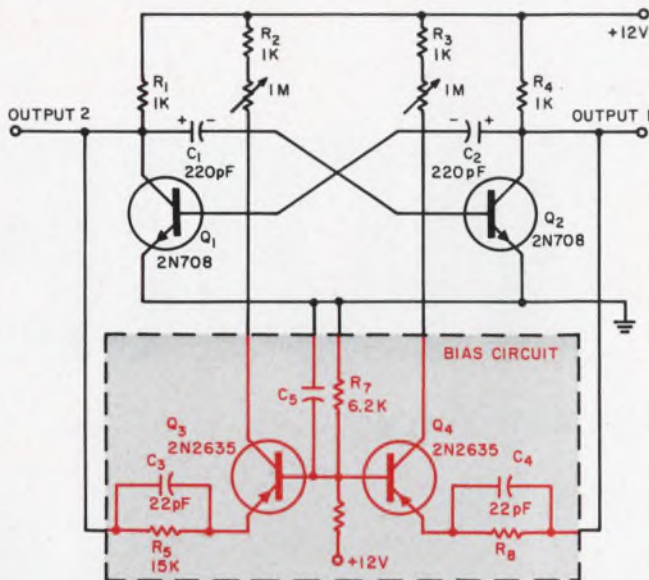

6. Wide-range astable multi uses two transistors for constant biasing.

be able to turn on  $Q_2$  in the worst case.

$$I_{c3} = \frac{V_{cc}}{h_{fe2} R_7} \quad (14)$$

$Q_3$  supplies current to turn  $Q_2$  on when  $Q_1$  is on, therefore,

$$R_8 = \frac{(V_{B3} - V_{BE3}) h_{fe2} R_7}{V_{cc}} \quad (15)$$

Just as in the linear monostable, Fig. 2, a more linear operation may be obtained by adding another current source to the wide-range complementary monostable, Fig. 5.

The bias current at the end of the timing cycle in the wide-range circuit, Fig. 4, is composed of the current through  $P_1$  and the biasing current introduced by  $Q_3$ . Too much storage is introduced as  $P_1$  gets shorted out.

In the circuit of Fig. 5, the timing current provided by  $Q_5$  is turned off at the end of the cycle.  $Q_4$  then rapidly turns on  $Q_3$ , introducing very little storage time. The period of this circuit is

$$T = \Delta V \cdot P_2 \cdot C / \alpha \cdot V_{cc},$$

where  $\Delta V$  is the step transmitted through  $C_2$  to the base of  $Q_3$  when  $Q_2$  turns off. This step is the voltage at the base of  $Q_1$  and also is the portion of  $V_{cc}$ —in this case -30 volts—across  $P_2$  and  $R_{10}$  when  $Q_2$  turns off.

In Fig. 5,  $Q_2$ ,  $Q_3$  and  $Q_4$  are normally on,  $Q_5$  is off. A negative trigger to the base of  $Q_2$  turns off  $Q_2$ ,  $Q_3$  and  $Q_4$ .

With  $Q_2$  off,  $Q_5$  is forward-biased. A constant current discharges  $C_2$  towards ground. As soon as  $Q_3$  enters the active region, the collector of  $Q_2$  starts dropping towards ground.  $Q_1$  starts turning on, saturating  $Q_3$  to end the timing cycle.

With  $Q_2$  saturated,  $Q_5$  turns off. Besides the wide range variation afforded by  $Q_4$ , clamping the collector of  $Q_2$  to a variable voltage also permits wide timing variations as well as pulse width modulation.

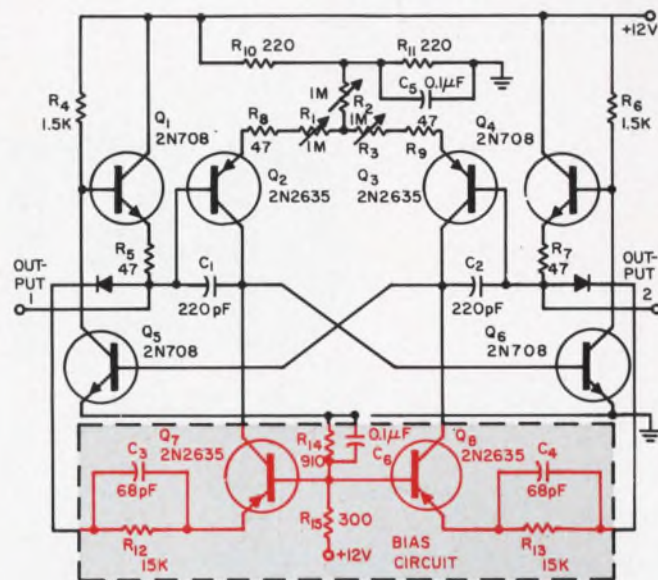

7. Linear improvement in the wide-range astable multi is achieved by adding four more transistors.

### Wide-range astable multivibrator

Extremely wide-range operation may be achieved by using the technique in the astable multivibrator, Fig. 6. Here, two transistors are used for constant biasing. Operation is as follows:

With  $C_1$  charged as shown in Fig. 6,  $Q_1$  turning on back-biases  $Q_2$  and  $Q_3$  which are therefore cut off.  $Q_2$  cut off turns  $Q_1$  on, thereby introducing a constant current into the base of  $Q_1$  and maintaining it turned on. When the potential at the base of  $Q_2$  reaches +0.7 volts,  $Q_2$  turns on, turning off  $Q_1$  and  $Q_3$ .  $Q_1$  turns  $Q_3$  on and the cycle is repeated.

The design of the constant-current source is identical to that of the standard monostable. The frequency may be varied by either  $P_1$  or  $P_2$ , the asymmetry being varied correspondingly. Wide range is easily attained by insuring a constant drive to  $Q_1$  and  $Q_2$  at the appropriate times. The period of the modified astable multivibrator is

$$T = 0.69 (R_1 C_1 + R_2 C_2)$$

Considerable improvement may be achieved by adding four more transistors to the wide-range astable multivibrator, Fig. 7. The sequence of operation is as follows:

$Q_5$  turning off turns  $Q_7$  on and cuts off  $Q_2$ .  $Q_6$  turning on cuts off  $Q_4$  and turns on  $Q_3$ .  $C_1$  charges through the low output impedance of  $Q_1$  to the supply voltage, +12 volts.  $C_2$ , which has been charged to +12 volts, causes the base of  $Q_5$  to go negative by -12 volts as soon as  $Q_6$  turns on.  $C_2$  then charges linearly through constant-current source  $Q_3$ .

When the voltage at the base of  $Q_5$  reaches +0.7 volt,  $Q_5$  turns on and the cycle is reversed. With  $R_1$  and  $R_2$  shorted, the frequency may be controlled symmetrically by  $R_2$ . With  $R_2$  shorted, the symmetry may be varied by either  $R_1$  or  $R_3$ . The function of  $Q_1$  and  $Q_4$  is to recharge the timing capacitors through a low output impedance, thus permitting widely asymmetrical operation. ■ ■

# GET MORE

*from the new hp dual-beam scope!*

Only with the hp 132A do you get this combination of performance features:

- **Two completely independent beams that let you:**  
display signals at different sweep speeds  
make simultaneous x-y and y-t plots
- **Two 100  $\mu\text{v}/\text{cm}$  vertical amplifiers offering:**  
common mode rejection of 40,000:1  
constant 500 kc bandwidth 1 mv/cm to 20 v/cm - 200 kc at 100  $\mu\text{v}/\text{cm}$   
shock mounted nuvistor input stages for stable displays
- **Recorder outputs from each vertical amplifier**
- **3.5 kv aluminized, internal-graticule crt - for bright traces with no parallax error**

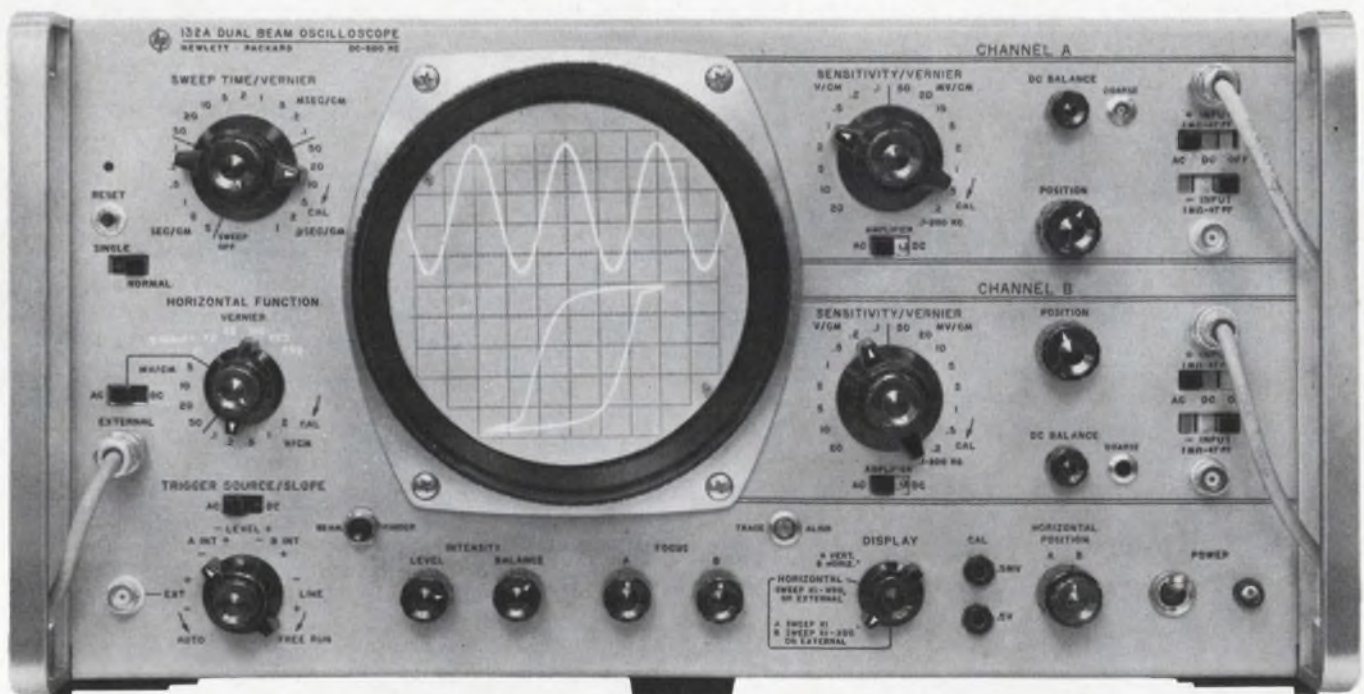

# LOOK AT WHAT YOU CAN DO WITH THE NEW hp 132A:

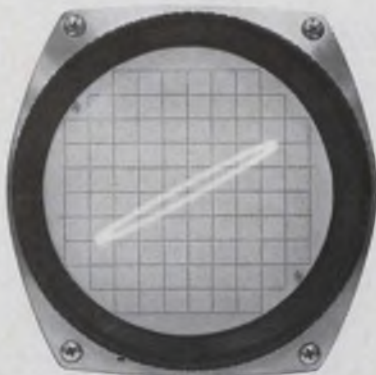

## Make x-y plots with 100 $\mu\text{v}/\text{cm}$ sensitivity!

To get x-y plots of low-level signals, such as transducer outputs, just plot Channel A against Channel B. No need for external preamps with the 100  $\mu\text{v}/\text{cm}$  sensitivity of both channels. Phase shift between the two vertical amplifiers is less than  $2^\circ$  for frequencies up to 50 kc.

bases and a unique arrangement that takes the place of a costly sweep delay generator for most applications.

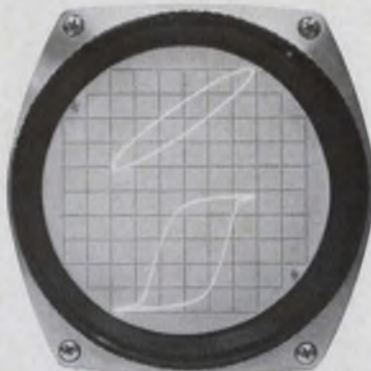

## Plot two signals against a common third!

Plot both vertical amplifiers against a common 5  $\text{mv}/\text{cm}$  300 kc horizontal amplifier. Measure phase shift in two parts of your circuit at one time or compare phase shift of a test circuit with the standard. Relative phase shift between vertical and horizontal amplifiers is within  $2^\circ$  for frequencies to 10 kc, insuring accurate measurements.

amplifiers offer 100  $\mu\text{v}/\text{cm}$  sensitivity and constant 500 kc bandwidth from 1  $\text{mv}/\text{cm}$  to 20  $\text{v}/\text{cm}$ . And bandwidth is 200 kc at the most sensitive range. Because bandwidth is constant over a wide range of sensitivities, displays remain the same as the range switch is changed. Nuistor input amplifiers mounted in a common shock mounted heat sink assure steady displays even in the presence of vibration and shock; 40,000:1 common mode rejection, too. Thus, you get accurate displays of differential signals. Each vertical amplifier provides outputs for driving a recorder or other external equipment.

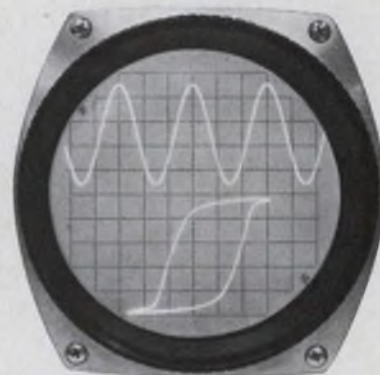

## Make simultaneous x-y and time plots!

Here's an exclusive feature that lets you monitor phase shift in a circuit while simultaneously measuring another signal against time. Just use Channel B and the horizontal amplifier for the x-y plot, while displaying the signal vs. time on Channel A. Ideal for servo and audio work, it lets you do many tasks that previously required two scopes. Added to the advantages inherent in the unique 132A design is the scope's low price of just \$1275. Compare 132A performance with that of any other comparable scope. You'll see how much more you get from the new Hewlett-Packard instrument. For complete data or a demonstration, call your hp field engineer, or write for complete information: Hewlett-Packard, Palo Alto, California 94305, Tel. (415) 326-7000; Europe: 54 Route des Acacias, Geneva.



## Observe an entire signal plus a magnified portion simultaneously!

You can simultaneously see fast and slow signal changes with a unique feature on the 132A that lets you magnify the Channel B sweep while leaving the Channel A sweep unmagnified. Thus, for example, in amplifier tests, you can apply the output to both scope inputs and simultaneously observe overall pulse response and the response to the leading edge in detail. The horizontal position control lets you observe any part of the unmagnified waveform . . . and you can identify that part by an intensified area (the magnified area) on Channel A. Essentially, you have the equivalent of two time

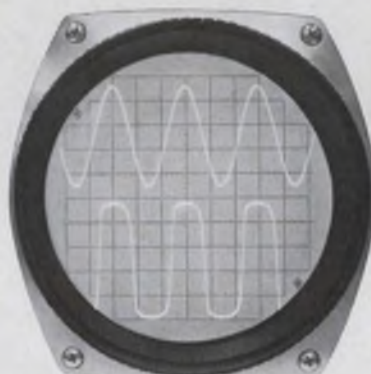

## Measure two signals vs. time — simultaneously!

Measure gain, delay time, pulse response. For comparing two signals at the same sweep time, the 132A is a regular dual-beam scope. No need for preamplifiers for displaying small signals . . . both vertical

 Price f. o. b. factory.  
**HEWLETT hp PACKARD**  
 An extra measure of quality

9845

ON READER-SERVICE CARD CIRCLE 32

## Combine reverse agc and diodes for wide-range gain control in AM command receivers. The design yields low receiver current and high agc loop gain.

An AM command receiver that incorporates an agc scheme requires no agc amplification. It covers a 42-kHz bandwidth centered at 150 MHz.

Designed by RS Electronics of Sunnyvale, Calif., for use in the stratosphere, the receiver had to maintain a stable over-all gain between  $-65^{\circ}\text{C}$  and  $+72^{\circ}\text{C}$ . Current drain had to be kept low.

Several methods of gain control were investigated. Forward agc would have provided a good control range but at the expense of too much collector current. Reverse agc had the disadvantage of poor signal overloading characteristics.

Primarily to keep the over-all receiver current low, the company decided to use a combination of reverse agc and diodes (Fig. 1). Semiconductor diodes, acting as variable conductance elements in series and in parallel with the signal path, are quite effective as a gain control.

However, the over-all receiver was designed to minimize the demands on the agc. Open loop gain was made stable to  $\pm 3$  dB over the temperature range, with common-base transistor stages used extensively.

The diode current was offset by the decreased current in the reverse agc stages. The over-all effect was an almost constant receiver current drain, less than 3 dB audio output change and less than 10% distortion at 90% AM, with signal strength varying between  $4\ \mu\text{V}$  and 10 mV.

In the circuit of Fig. 1, assume a voltage condition where  $\text{CR}_{201}$  is not conducting. The series current flow of  $Q_{201}$  and  $Q_{202}$  is essentially through the ground return provided by  $\text{CR}_{202}$  and  $R_{202}$ . Under this condition the two transistors are operating at their normal current and full gain.

Assume now that the voltage on the agc bus increases in a positive direction. At the onset of forward conduction through  $\text{CR}_{201}$ , three significant changes take place. First, the forward conduction of  $\text{CR}_{201}$  increases the shunt conductance across the IF signal path, thus reducing the over-all gain.

Second, the forward current of  $\text{CR}_{201}$ , now flowing through  $R_{202}$ , decreases the current through  $Q_{201}$  and  $Q_{202}$ , further reducing the

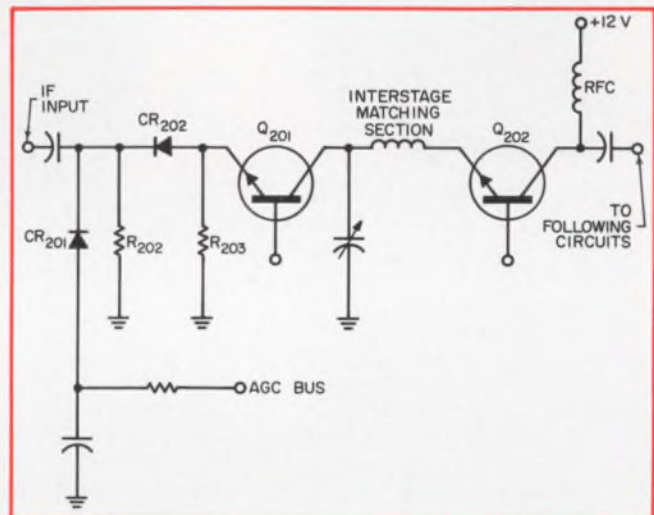

1. Basic agc circuit uses combination of reverse agc and diodes in series and parallel with the signal path.

gain by the reverse agc characteristics of the transistors.

Third, the accompanying decrease in forward current through  $\text{CR}_{202}$  further reduces the gain, by reduced forward conductance of this diode, which is in series with the IF signal path.  $R_{203}$  serves the purpose of maintaining a minimum current through  $Q_{201}$  and  $Q_{202}$  to prevent distortion.

The combination of diodes and reverse agc provides wide-range gain control for small changes in agc bus voltage. The agc loop gain is inherently high, and no amplification is needed. The agc voltage is derived directly from the AM detector through the agc emitter follower  $Q_{207}$  (Fig. 2).

The normal output level of the receiver is set by the AM detector's dc reference level, which is determined by the voltage divider  $R_{217}$ ,  $\text{CR}_{204}$  and  $R_{218}$ .  $\text{CR}_{204}$ , in addition to providing forward bias to the detector diode, offers temperature compensation to maintain a constant range.

The agc function on the front end board is the same as that on the IF board, except it is applied to a single transistor instead of a series-connected pair.

There is some difference, however, at the input stage (Fig. 3). The primary function of gain

R. W. Mongeon, Product Manager and J. Isabeau, Engineering Manager, RS Electronics Corp., Sunnyvale, Calif.

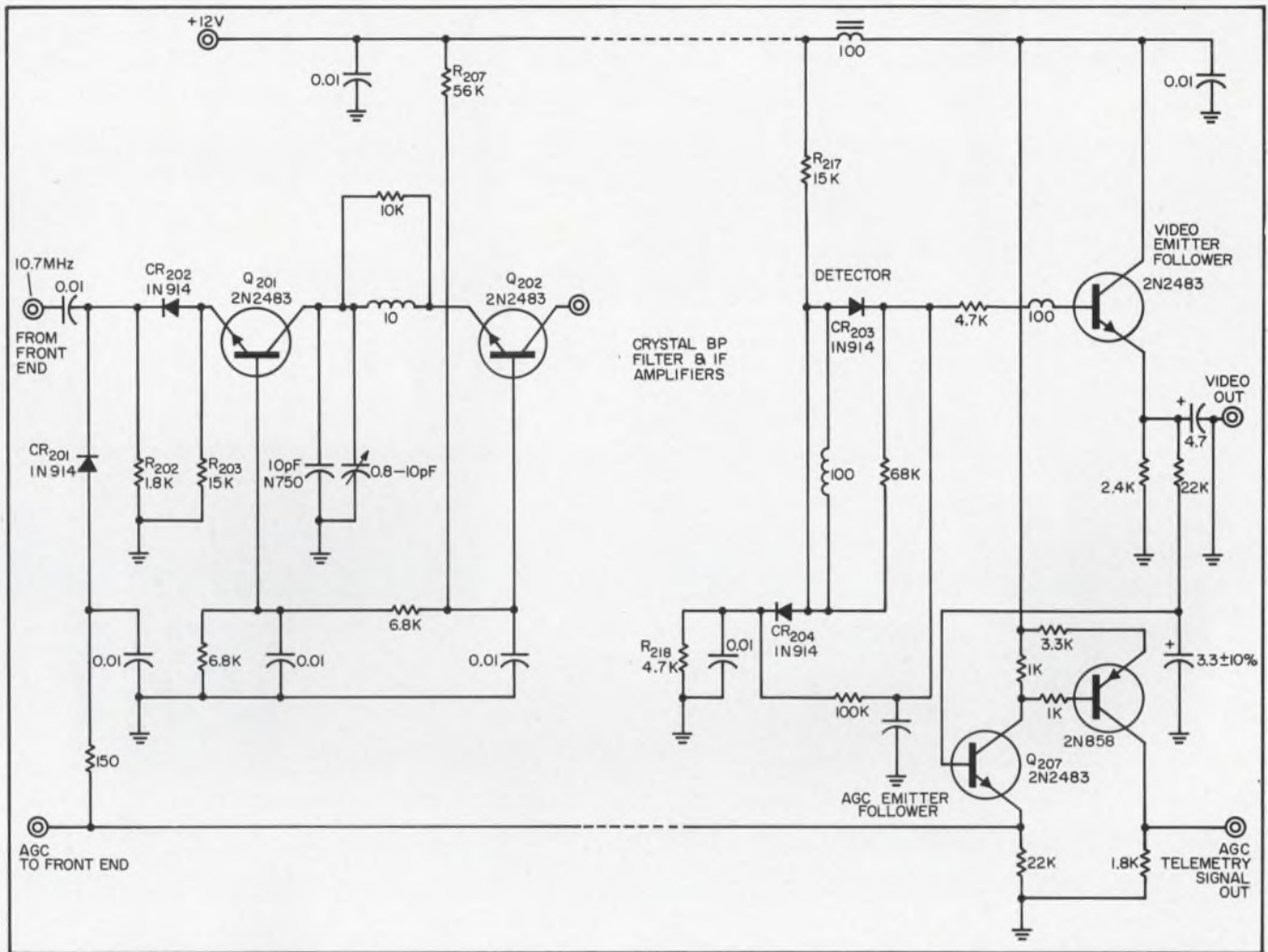

2. Agc voltage is derived directly from the AM detector through the agc emitter follower  $Q_{207}$ .

control is provided by  $CR_{101}$ , which shunts the collector signal circuit. Forward current through  $CR_{101}$  must also pass through  $R_{103}$ .

In doing so this current in  $R_{103}$  decreases the emitter current of  $Q_{101}$  and decreases the gain by the reverse agc characteristics of  $Q_{101}$ . In addition the current through  $CR_{104}$  also decreases, as does its forward conductance. This results in an increase in emitter degeneration and a consequent further decrease in first-stage gain.

Over-all specifications for the Model 4787 command receiver include:

frequency	142 to 158 MHz
frequency stability	$\pm 0.005\%$
input impedance	50 ohms
IF bandwidth	42 kHz min at -6 dB 100 kHz max at -60 dB
sensitivity	$4 \mu V$ max for 20 dB
(50% AM)	(S+N)/N ratio
power input	180 mW at $+12 \pm 0.5$ Vdc
size	32 in. <sup>3</sup>
weight	2.5 lbs

Other circuit features of note are the use of a single conversion, with a crystal filter, to obtain the 42-kHz bandwidth at 150 MHz; crystal local oscillator at 160.7 MHz, without multiplication, and a high-level detector that provides good linearity without an audio amplifier. ■ ■

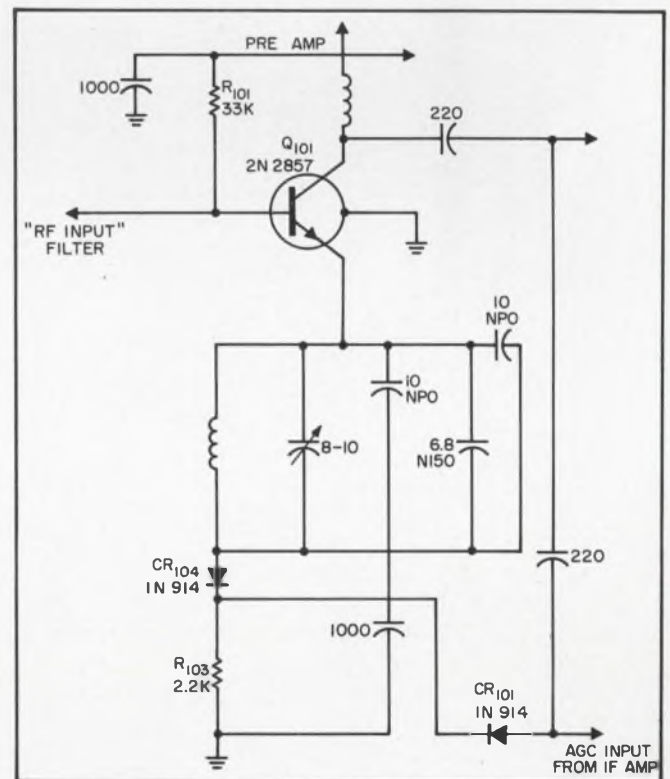

3. Input stage agc is applied at  $Q_{101}$  through  $CR_{101}$ , shunting the collector signal circuit, and  $R_{103}$ .

# INTEGRATED LOGIC MODULES

*Lowest Prices in the Industry\**

- 30 FAN-OUT, ALL SOURCES
- UP TO 4V NOISE REJECTION
- DC TO 5 MC
- 0 TO 70°C

**We have never  
Delivered Late**



NEW logic and circuit techniques, thoroughly tested for 9 months, have resulted in a minimum fan-out of 30 from all sources, 25% lower prices, and REALISTIC noise immunity from 0.9V to 4V. Delivery from stock. Send for complete and ACCURATE data.

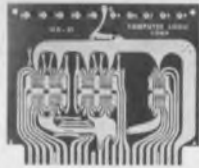
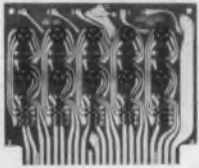

Phone: 213 451-9754

**COMPUTER LOGIC CORP.**



\*\$11.20 per JK Flip-Flop Unit Load Concept

1528 20th Street • Santa Monica, California

**A COMPLETE FAMILY OF COMPATIBLE TRUE BLUE LOGIC MODULES**

ON READER-SERVICE CARD CIRCLE 33

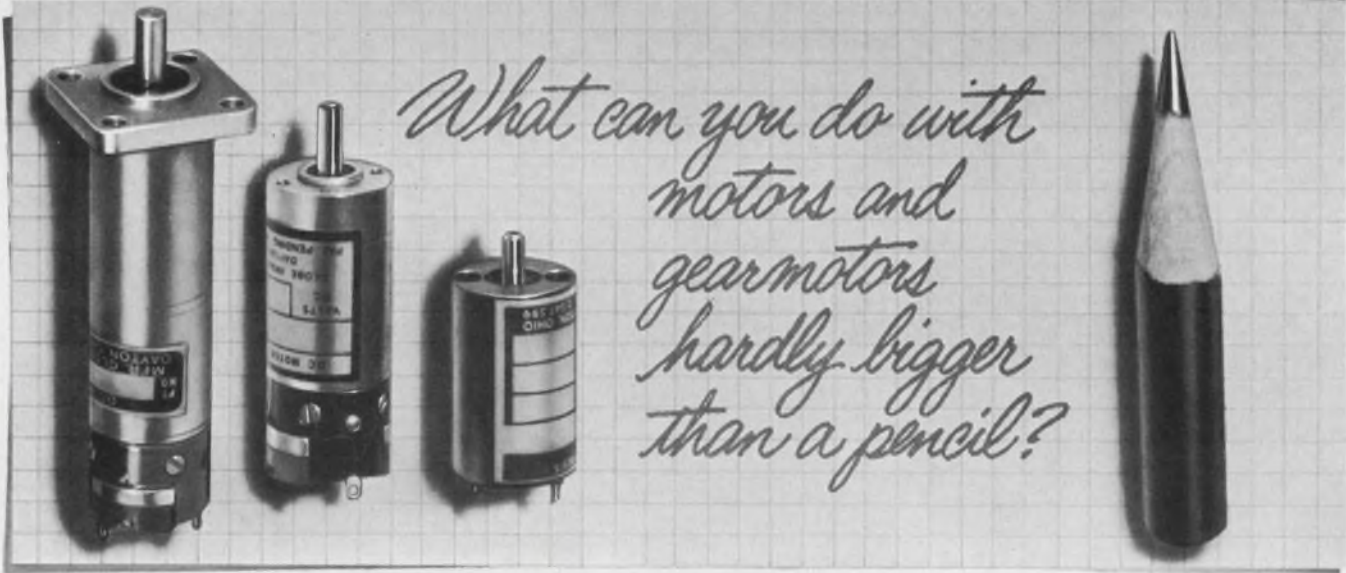

You can figure on designing more compact products. As a matter of fact Globe has developed 2 new MIL spec motors—one for a.c. called Type CC, and one for d.c. named VT. Both motors are only  $\frac{5}{8}$ " in diameter, weigh  $1\frac{1}{2}$  ounces. Type VT uses a system of planetary gearing that multiplies torque up to 50 oz. in.

Choices for designers are fantastic; we have 83 standard gear ratios. Type VT can be wound for any voltage up to 50 v.d.c., and we can furnish them with speed governors. Type CC is a hysteresis synchronous motor. And if you need a smaller or larger power unit, come to the can-do manufacturer. Request Bn. 58.

**TYPE VT**—Produces .0025 HP in the 8,000 to 17,000 rpm range. Size:  $\frac{5}{8}$ " x  $1\frac{3}{8}$ " long. 1.48 oz. To 50 v.d.c. Planetary gearing in 83 ratios.

**TYPE CC**—Produces .07 oz. in. max. sync. torque. Size:  $\frac{5}{8}$ " x  $1\frac{3}{8}$ " long. 1.5 oz. 26 v.a.c. (115 v.a.c. with series capacitor), 2 or 4 poles, 400 cycles.

**GLOBE**

Visit our Booth 1323 Design Show

Globe Industries, Inc., 2275 Stanley Avenue  
Dayton, Ohio 45404, U.S.A., Tel.: 513 222-3741

ON READER-SERVICE CARD CIRCLE 34

# Our group.

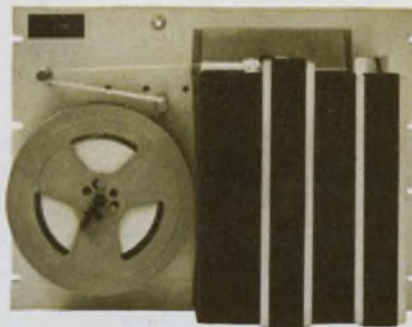

A family of three perforators is just right when it satisfies about 99 percent of the applications. And these Tally perforators do.

Easily the best known perforator on the market today is the wonderfully reliable Tally 420 which operates at 60 characters per second. Some of our customers have operated this perforator up to 500 million cycles without overhaul.

Fastest perforator in the family is the Tally P-150, which, as you might guess, operates at 150 characters per second. Rounding out the line is our popular 120 character per second perforator, the P-120.

The Tally P-120 and P-150 offer a remarkable degree of sophistication. With the parity option they catch their own mistakes while working at maximum speed. Here's how it works. Parity contacts in the perforating mechanism allow

integration during a punching cycle and before the tape is advanced to the next character. If an incorrect parity code is sensed, (1) tape advance is inhibited, (2) the code in error is overpunched with an all-hole delete code, (3) tape is advanced and the same character punched again. Clean accurate tapes are a virtual certainty.

All Tally perforators accept paper, plastic, or foil tapes. They feature asynchronous operation so that punch commands can be accepted at any time interval up to maximum speed. Tally perforators handle 5 through 8 channels on any standard tape up to 1 inch without modification. Tally perforators have high quality die blocks and precision honed punch pins individually fitted for long life punching. All models offer integral reeling. All Tally perforators are available in 50/60 Hz, 115/230 vac models.

Options include bit echo verification, remote backup, end of

tape, low tape, tape motion sensors, and teletypesetter configuration.

*Write for more wisdom.* Complete data on each and every member of the Tally group of perforated tape equipment is yours for the asking. For your information please address K. Crawford, Tally Corporation, 1310 Mercer Street, Seattle, Washington 98109. Phone: (206) MA 4-0760. TWX: (910) 444-2039. In the U.K. and Europe, address H. Ulijohn, Tally Europe, Ltd., Radnor House, 1272 London Road, London, S.W. 16, England. Phone POLlards 9199.

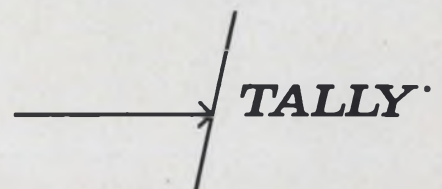

Speed Inquiry to Advertiser via Collect Night Letter  
ON READER-SERVICE CARD CIRCLE 35

## Tackle those tough decisions with this step-by-step attack. It will help you boost your decision-making score and avoid fumbles.

Can decision-making be learned or effectively improved? Or does it take a special kind of innate talent?

The answer to both questions is yes.

Making a sound decision requires native intelligence. But, more important, the technique involved in making decisions can be learned—and once learned, it can be improved with hard work. Engineers have a head start, because of their training and experience in problem solving.

The busy engineer is constantly expected to make important design or specification decisions. These may involve large sums of money, people's safety, or a company's reputation for engineering competence. With the pressures of business, there isn't always time to seek a place of solitude and reflect on the best solution. Often a quick decision, based on intuition and experience, may be the only—and sometimes the best—alternative. But if you take orderly and logical steps to arrive at a decision, you are more likely to reach a sound one.

There are six characteristics that every capable decision-maker has. Listed in no special order, they are:

- **Analytical ability**—Calls for skill in reducing a complex problem to various elements and identifying truly relevant facts. Includes the capacity for anticipating results following the decision.

- **Ideation ability**—A fancy name for the ability to gather pertinent concepts and facts under a large total picture.

- **Intuitive judgement**—The ability to predict outcomes with reasonable accuracy. Acting on an educated "hunch" is important, if all the facts are not available or if fast action is needed.

- **Courage to act**—Call it "guts," because that best describes what's needed to proceed in view of uncertainties, frustrations, conflicting opinions or opposition.

- **Open-mindedness**—Keeping mental doors open to new avenues or being flexible enough to change direction. What's called for is the ability to sense subtle distinctions or contradictions in available information.

- **Creativity**—The capacity to think of original approaches to solve problems.

With these on your side, there's a step-by-step

way to analyze any tough problem and arrive at a decision. If you practice the procedures consciously, they will soon become automatic and comparatively effortless. Here they are:

### 1. Determine the problem.

State the broad problem or goal simply. Then reduce complex factors to individual problems or situations, for more manageable handling. Pose significant questions: What's really wrong? What causes it? What are the obstacles?

Remember that decision-making isn't only confined to solving problems. Sensing an opportunity to improve a product or a procedure will require you to follow a similar path before you reach your goal.

### 2. Gather the facts.

If you define your objectives clearly or make a precise statement of your goal, the kind of facts you will need for a sound decision will be apparent. At the same time you'll be able to establish how much time to devote to the search. The more important the decision, the more time that should be allotted for fact-finding, obviously. Bring all the pertinent knowledge, experience and facts you can to bear on the matter.

Here's where investigation, originality and hard work pay dividends. The kind of questions you ask and whom you ask may sometimes seem to have little relationship to the problem under study. But if you're a creative and adventuresome individual, who's not shy about ruffling a few feathers if necessary, you'll dig for all the relevant background on the problem.

Get advice from experts if you can. If it's to be a group decision, have each person contribute knowledge from his own area of competence. Gather facts by your own accurate observations, but be impartial and unemotional. Be sure not to discard those facts that may be opposed to your pet point of view.

### 3. Analyze alternate solutions

At this point various alternatives appear as solutions.

Each has to be weighed logically for its relative importance. A mathematical analysis or construction of a prototype may be helpful. Identify those factors over which you have little or no control.

Reserve critical judgment on a final decision until you are ready to make it.

### 4. Select an alternative and make the decision.

The more the alternatives, the more the need

---

E. A. Michals, Public Relations Manager, Pyle-National Company, Chicago, Ill.



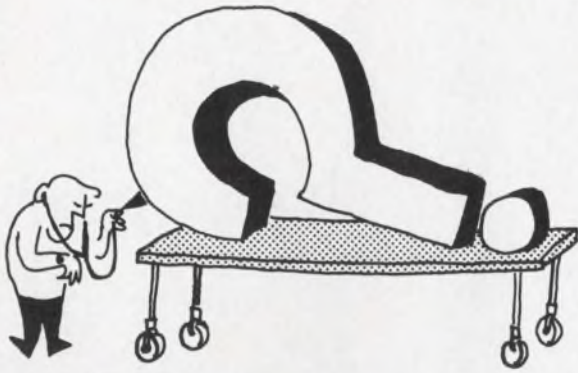

An accurate diagnosis of the problem is critical, if a successful decision is to be reached. Even simple decisions may involve more factors than are immediately apparent.

for proper evaluation of each alternative. You may have to balance several factors that have no common denominator. Resist making a decision if a change in important information is imminent, or if any important data are incomplete or shown to be unreliable. Avoid, however, needless procrastination, because you'll probably never have all the facts on a particular matter.

Incidentally, deciding to do nothing about a problem for the time being is also making a decision—but often a bad one.

More than one good decision may exist. Is one a little better than the others? There is no substitute for your own commonsense, or even for listening to the "right" advice. The man with more experience in the area under scrutiny, or the one with keener insight, may hold the key to the solution.

#### 5. Put the decision into action.

Top managers are decisive; so—immediately after making the decision, at any rate—stick to your guns, regardless of doubts. Sometimes it may be advisable to test a decision on a small scale, so that adjustments can be made for uncertainties. The probability of success or failure can then be estimated at minimum risk.

If your decision proves to be wrong, admit it (at least to yourself) and change it if you can. Learn from your failures; they will serve as good experience in similar situations. Learn also from your successes; they may be particularly adaptable to new situations in the future.

#### How an engineer might use the method

Now let's examine a situation where you, as an engineer, might have to make a decision, and let's see how you can put the step-by-step method to work.

Suppose your company is developing a microwave communications system for use by a manufacturer. It will connect his outlying branches with a headquarters. You've been made responsible for selecting the transmission equipment to do the job.

First, *determine the problem*. In this case you'll want to know what type of communication is required (voice, data or maybe video for visual

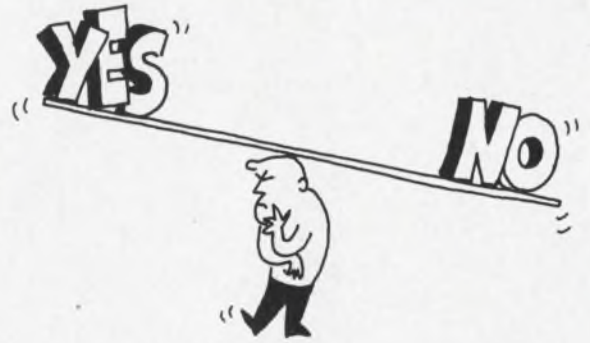

**Weigh the alternatives** logically. Once you've determined their relative importance, you will be well on your way to reaching a sound decision.

monitoring), so that bandwidth can be established. Next, you'll need to know how much transmitter power and receiver sensitivity will be required for good communications. You may find that your company's "off-the-shelf" gear doesn't have the channel capacity or power to do the job. Now you're faced with the problem of either modifying existing equipment or designing new units.

*Gather the facts*. Does the customer really need all those channels? Talk to him and find out just exactly what he needs, and where he might change his requirements.

Study the geographical characteristics of transmission paths to determine the number of repeater stations required. How much reliability is needed? What failure reporting features are required? What kind of maintenance facilities does the customer have available?

Armed with the facts, start *analyzing alternative solutions*. Designing new units may be cheaper than modifying existing equipment, because the new equipment might have a broader long-term market. On the other hand, modified units might be put into service faster. Should transmitter power be raised, or receiver sensitivity improved? Or should higher-gain antennas be used? Will equipment improvements reduce the number of repeaters required? Once you've studied all the alternatives, you're ready to take the final step.

Now select the best alternatives and *make your decisions*. If you've followed the preceding steps faithfully, you should come up with a good decision.

#### Don't get careless

With practice, you'll find that following a logical procedure becomes second nature. When you reach this point, look out! This is the time when almost everyone starts to become careless and begins sliding over some significant step and/or information. Overconfidence resulting from a string of success is an ever-present danger that you'll have to continually guard against. No matter how finely you've honed your decision-making technique, never lose sight of the logical procedure involved. ■ ■

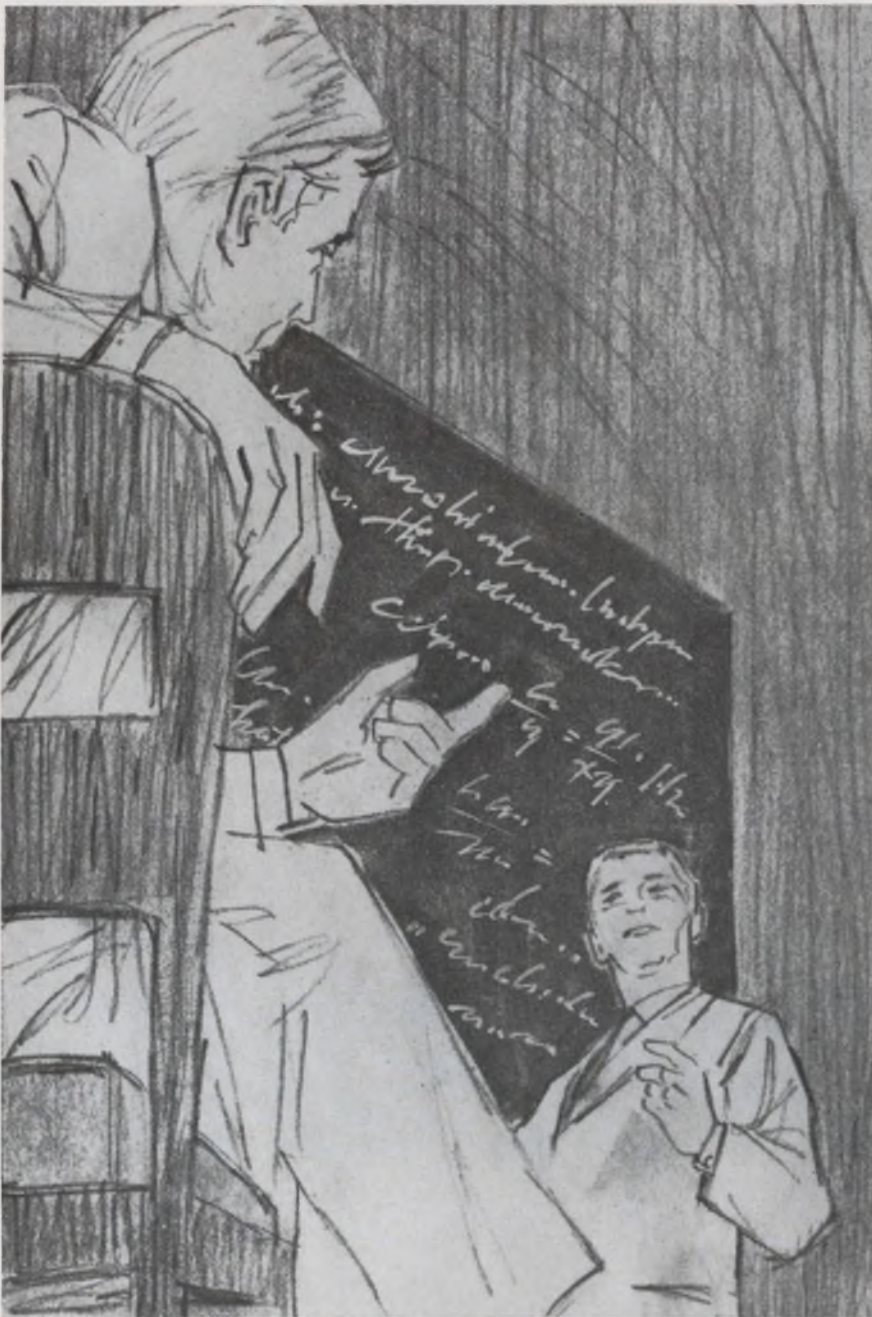

# Looking for a New Job?

- Fill out one application . . .
- Check off the companies that interest you . . .
- We do the rest

Contacting the job market takes only ten minutes with ELECTRONIC DESIGN's Career Inquiry Service. To put Career Inquiry Service to work for you, fill in the attached resume. Study the employment opportunity ads in this section. Then circle the numbers at the bottom of the form that correspond to the numbers of the ads that interest you.

ELECTRONIC DESIGN will be your secretary, type neat duplicates of your application and send them to any number of companies you select—the same day the resume is received.

Career Inquiry Service is a fast, efficient way to present your job qualifications to companies recruiting engineering personnel—as confidentially and discreetly as you would in person. This service is the first of its kind in the electronic field, and one that engineers have used effectively since its inception in 1959.

We take the following precautions to ensure that your application receives complete, confidential protection:

- All forms are delivered unopened to one reliable specialist at ELECTRONIC DESIGN.
- Your form is kept confidential and is processed only by this specialist.
- The "circle number" portion of the form is detached before the application is sent to an employer, so that no company will know how many numbers you circled.
- All original applications are placed in confidential files at ELECTRONIC DESIGN and after a reasonable lapse of time they are destroyed.

## **EXPERIENCE: *is yours being used?***

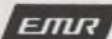
HAVE YOU CONSIDERED EMR AS A CAREER EMPLOYER? YOU SHOULD! EXPERIENCED ENGINEERS WITH EXCEPTIONAL ABILITY AND IMAGINATION ARE INVITED TO EXPLORE THESE OPPORTUNITIES: RELIABILITY, QUALITY CONTROL, MECHANICAL, LOGIC DESIGN, PRODUCT DEVELOPMENT, RF, CIRCUIT DESIGN, ELECTRONIC SYSTEMS, APPLICATIONS, ELECTRONIC PACKAGING. SEND RESUME TO J. B. APPLIEDORN, PROFESSIONAL STAFFING, BOX 3041, SARASOTA, FLORIDA. *ELECTRO-MECHANICAL RESEARCH, INC.* 

ON CAREER-INQUIRY FORM CIRCLE 901

**ELECTRONIC DESIGN CAREER INQUIRY SERVICE**

USE BEFORE JUNE 7, 1966

April 26, 1966

After completing, staple, fold and mail career form to ELECTRONIC DESIGN, 850 Third Avenue, New York, N. Y. Our Reader Service Department will forward copies to the companies you select below.

(Please print with a soft pencil or type.)

Name \_\_\_\_\_ Telephone \_\_\_\_\_

Home Address \_\_\_\_\_ City \_\_\_\_\_ Zone \_\_\_\_\_ State \_\_\_\_\_

Date of Birth \_\_\_\_\_ Place of Birth \_\_\_\_\_ Citizenship \_\_\_\_\_

Position Desired \_\_\_\_\_

**Educational History**

College	Dates	Degree	Major	Honors

Recent Special Training \_\_\_\_\_

**Employment History**

Company	City and State	Dates	Title	Engineering Specialty

Outstanding Engineering and Administrative Experience \_\_\_\_\_

Professional Societies \_\_\_\_\_

Published Articles \_\_\_\_\_

Minimum Salary Requirements (Optional) \_\_\_\_\_

Use section below instead of Reader Service Card. Do not write personal data below this line. This section will be detached before processing.

Circle Career Inquiry numbers of companies that interest you

- 900 901 902 903 904 905 906 907 908 909 910 911 912 913 914 915 916 917 918 919 920 921 922 923 924  
 925 926 927 928 929 930 931 932 933 934 935 936 937 938 939 940 941 942 943 944 945 946 947 948 949

# Reliability Engineers

Lockheed engineers are developing some of the most important vehicle systems in the country. There are major modifications underway on Polaris. And, the new fleet ballistic missile, Poseidon, is now in its early stages. Other systems include unique land vehicles and deep submersibles. Reliability engineers are needed in these areas and many more. We invite you to investigate the following:

**BSEE or BSME—Reliability design review:**  
Experienced with small electrical components and semiconductors. Prepare procurement, test and design specifications.

**BSEE—Reliability analysis:**  
Experienced in circuit design and analysis. Perform detailed reliability analyses of complex electronic parts and circuits and recommend improvements in design reliability.

**BSEE—Reliability test engineering:**  
Prepare test procedures for electrical and electronic packages and coordinate procedures with test laboratories, conduct proofing of test procedures & equipment.

**BSME—Reliability and inspection:**  
Perform mechanical and structural reliability analyses. Provide for inspection planning and review prints to determine inspection attributes. Experience in metallurgy and NDT helpful.

**Non-destructive testing:**  
Background in electronics and applied physics plus knowledge of instrumentation related to the use of X-rays, sound waves, electrical fields and optics.  
Write Mr. K. R. Kiddoo, Professional Placement Manager, Lockheed Missiles & Space Company, P.O. Box 504, Sunnyvale, California. An equal opportunity employer.

**LOCKHEED**  
**MISSILES & SPACE COMPANY**  
A GROUP DIVISION OF LOCKHEED AIRCRAFT CORPORATION

ON CAREER-INQUIRY FORM CIRCLE 902

Fold here, staple and Mail.

FIRST CLASS  
Permit No. 725  
New York, N. Y.

**BUSINESS REPLY MAIL**

No Postage Stamp Necessary if Mailed in the United States

POSTAGE WILL BE PAID BY

**ELECTRONIC DESIGN**

**READER SERVICE**  
850 THIRD AVENUE  
NEW YORK, NEW YORK 10022

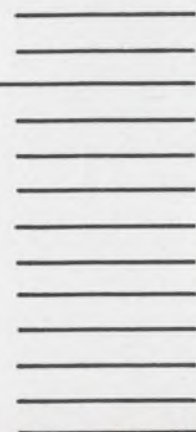

# Electronic Engineers:

## Instant Careers

A vast array of assignments has opened at Boeing's Commercial Airplane and Supersonic Transport divisions in Seattle. Partly because unprecedented jetliner sales have created the largest backlog in the history of commercial aviation. And because the next generation of jets is on drawing boards and in the wind tunnels. Also because of the new \$250 million facilities expansion in the Seattle area.

If your present spot is static, the challenge and advancement opportunities of new Boeing programs will warrant your immediate investigation. And be well worth your while.

Life in the great Pacific Northwest is living at its finest. The Seattle area is famous for a climate so mild you can golf, fish or boat (both fresh and salt water) year-round. It's but an hour's drive from sea-level to ski-level.

There's more. Seattle's Opera House, Repertory Theater, Pacific Science Center (next to the Space Needle on the World's Fair grounds) and Symphony have gained national acclaim. Seattle-area schools, too, are ranked among the finest.



Typical assignments include: electrical/electronic design, electrical/electronic development, electro-optical systems, flight test instrumentation, navigation & guidance systems, radar technology, operations research analysis, systems research analysis, mathematical statistics and research, analog & hybrid flight simulation, and programming & systems analysis incorporating commercial, manufacturing support, and engineering and scientific applications.

Salaries are competitively commensurate with your experience and education. ON CAREER-INQUIRY FORM CIRCLE 903

educational background. Moving and travel allowances are paid to newly hired personnel. Boeing is an equal opportunity employer.

Please telephone (collect) or send a resume to the Boeing Employment Office nearest you:

**Chicago:** (312) 726-8955, 120 South LaSalle St., Dept. CCO, Chicago, Ill. 60603. **Phoenix:** (602) 264-1238, Suite 1012, The Del Webb Bldg., Dept. CCO, Rosenzweig Center, Phoenix, Ariz. 85012. **Minneapolis:** (612) 338-5896, 404 Roanoke Bldg., 109 South 7th St., Dept. CCO, Minneapolis, Minn. 55402. **San Francisco:** (415) 434-0438, Suite 304, 16 California Street, Dept. CCO, San Francisco, Calif. 94111. **Houston:** (713) RI 8-0305, Houston Siteman Bldg., Holcumbe & Fannin Blvds., Dept. CCO, Houston, Tex. 77025. **Detroit:** (313) 962-5850, Suite 1157, The Guardian Bldg., 500 Griswold St., Dept. CCO, Detroit, Mich. 48226. **New York:** (212) 697-8838, Suite 1604, Dept. CCO, 535 5th Ave., New York City, N.Y. 10017. **Seattle:** (206) 237-4659, Mr Thomas Sheppard, Commercial Airplane Division, P.O. Box 707-CCO, Renton, Wash. 98055.

Join the  
world leader in  
jet transportation

**BOEING**

COMMERCIAL AIRPLANE DIVISION  
SUPERSONIC TRANSPORT DIVISION

# INFRARED ENGINEERS AND SCIENTISTS:

Can you contribute to the development of products like these?

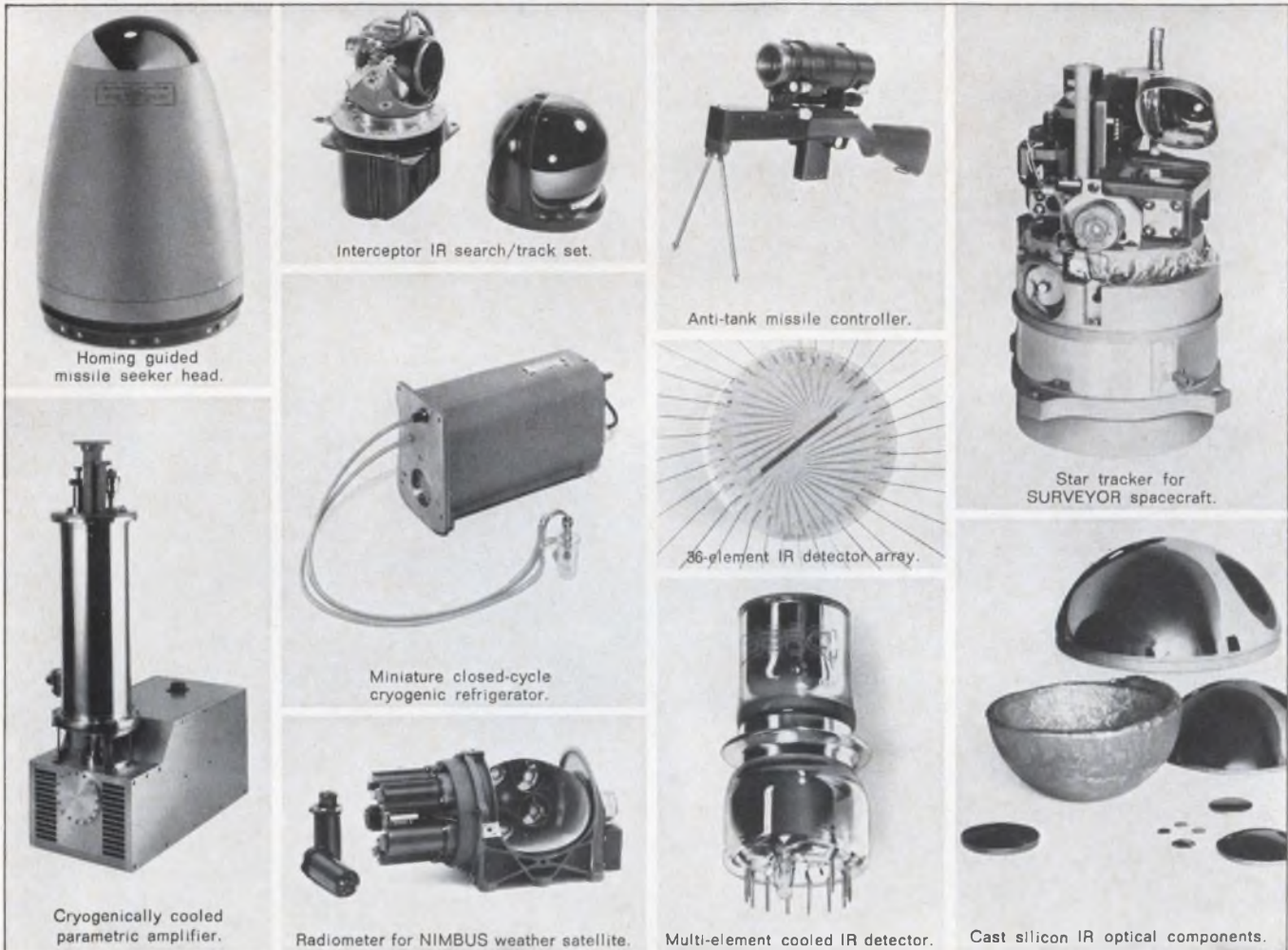

Rapid growth of Hughes infrared activities in the Aerospace Divisions and the Santa Barbara Research Center has created many responsible positions for qualified engineers and scientists in all phases of IR systems development from conception through production engineering.

Immediately available assignments include openings in such diverse technologies as optical design, semiconductor physics, cryogenics, mechanical engineering, precision electro-mech-

anisms, electronic circuit design, servo systems... and many other areas.

Current Hughes IR contracts include advanced systems for: space exploration, weather satellites, anti-ballistic missile defense, night reconnaissance, aircraft and space vehicle defense, and tactical weapon guidance and fire control.

Professional experience, an accredited degree and U.S. citizenship required.

For immediate consideration, please air-mail your resume to:

**Mr. Robert A. Martin**  
**Head of Employment**  
**Hughes Aerospace Divisions**  
**11940 W. Jefferson Blvd.**  
**Culver City 6, , California**

**HUGHES**  
 HUGHES AIRCRAFT COMPANY  
 AEROSPACE DIVISIONS

An equal opportunity employer

# Why Lockheed is for Engineers who work with speed.

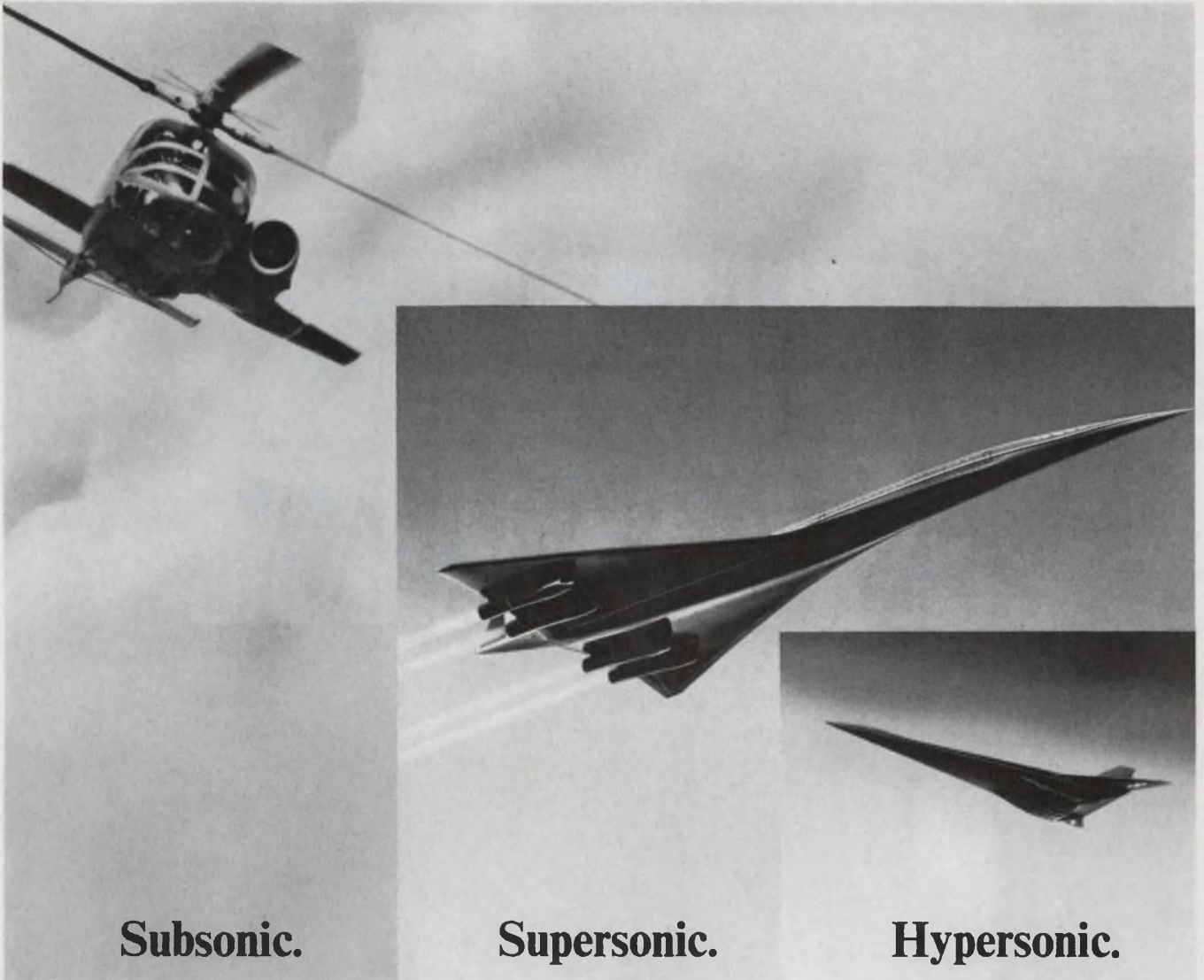

**Subsonic.**

**Supersonic.**

**Hypersonic.**

There are no speed limits on progress in developmental aviation at Lockheed. An unusually diverse range of advanced programs is offered in three speed regimes—hypersonic, supersonic, subsonic. A diversity that is unmatched elsewhere in the aerospace industry today.

Working towards the day when high priority passengers and cargo will travel at speeds many times faster than sound, Lockheed is using the SCRAMJET approach in manned hypersonic test and cruise vehicles.

In the supersonic speed regime, Lockheed is designing an exceptionally advanced airplane with capabili-

ties far superior to any craft in the skies today. At the same time, other remarkable aircraft, for Mach 3 flight, are in development. In commercial aviation, Lockheed is working on America's SST Program, a major and growing endeavor. Other supersonic programs include extremely advanced versions of Lockheed's famed F-104 Starfighter.

A revolutionary composite rotary-wing craft, able to stop, fold, or start blades in forward flight, is one of Lockheed's most promising subsonic endeavors. Also, work on the Army's Advanced Aerial Fire Support System—AAFSS—goes rapidly ahead.

In addition, mass short-haul travel between major cities is another focal point of Lockheed's expanding subsonic STOL and V/STOL research and development programs.

A large number of significant positions are open for engineers and scientists on these and other sub, super, and hypersonic programs. For information, write: Mr. E. W. Des Lauriers, Professional Placement Manager, Dept. 1304, 2402 North Hollywood Way, Burbank, California. Lockheed is an equal opportunity employer.

**LOCKHEED-CALIFORNIA COMPANY**  
A DIVISION OF LOCKHEED AIRCRAFT CORPORATION

ON CAREER-INQUIRY FORM CIRCLE 904

# GENUS NOVUM

Literally translated from the Latin the headline means a "new breed." Literally speaking, that's the most honest way to describe today's Manufacturing Engineer at IBM Kingston. It's here we manufacture a product line ranging from Precision Display Systems to High-Current Power Supplies; Miniature Ferrite Memories to Large-Scale Time-Sharing Systems.

To accomplish this successfully the requirement is for a "new breed" of Manufacturing Engineers; individuals who can create new techniques, innovate new procedures and work in previously unexplored areas. Individuals who can move across

such diverse disciplines as chemical milling, linear programming, electron beam welding, automatic circuit testing, automated assembly, computer control of manufacturing processes and dozens of others.

If you believe your training and abilities fit you to make important personal contributions to totally new manufacturing systems, we suggest you contact us immediately. There's lots of room to move your career forward because we anticipate introducing twice as many technological changes in the next 5 years as we have in the last 15.

Immediate openings are currently available to individuals possessing

degrees and/or equivalent experience in these areas:

- Systems Planning
- Programming
- Automation Engineering
- Process Control
- Process Engineering
- Plastics Engineering
- Chemical Engineering
- Printed Circuit Engineering
- Mechanism Design
- Metallurgy
- Test Equipment Engineering
- Logic Design
- Circuit Design
- Package Design
- Tool Design

Direct your inquiries in complete confidence to: Mr. C. E. Nelson, Dept. 555R4, IBM Corporation, Neighborhood Road, Kingston, N. Y.

An Equal Opportunity Employer (M/F)

## IBM®

ON CAREER-INQUIRY FORM CIRCLE 905



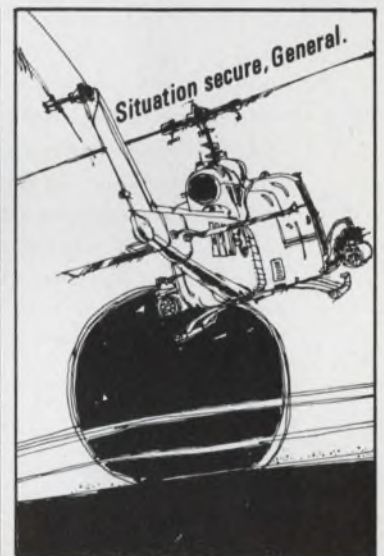
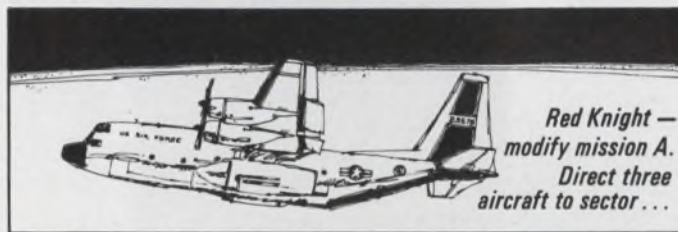
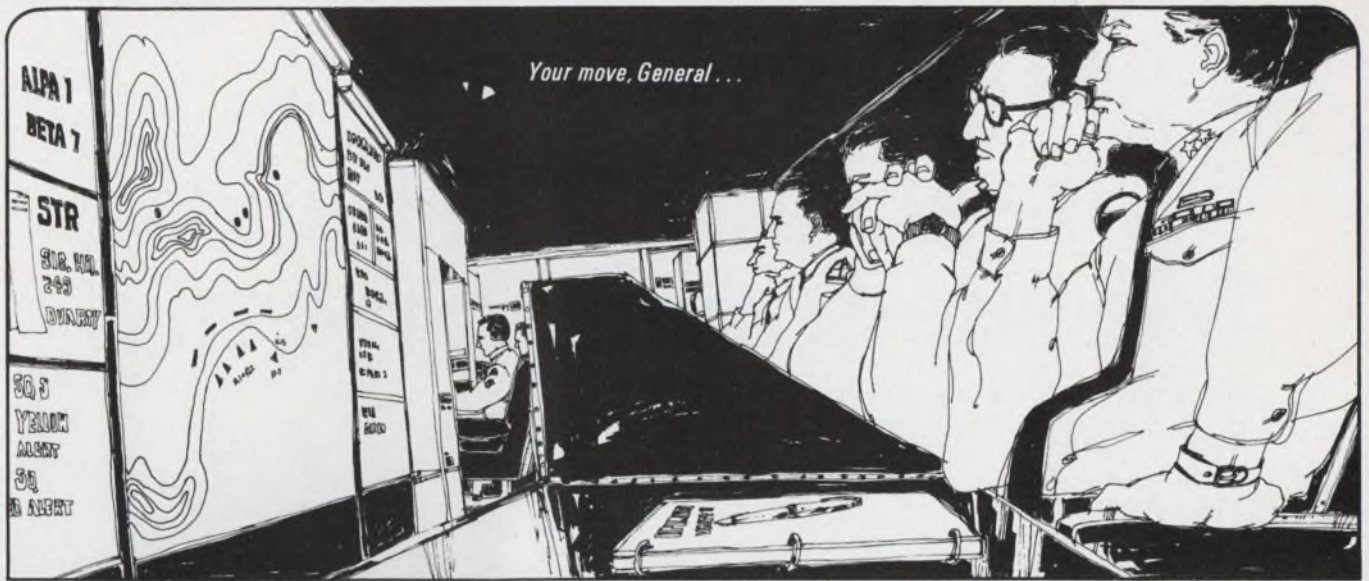

## **YOUR MOVE, TO COMMAND A BETTER FUTURE**

To command land, sea and air forces in a combat area, commanders must know the exact battlefield situation and have instant communications with all forces. LTV Electro-systems designed and produced the Airborne Battlefield Command and Control Center (ABC<sup>3</sup>) in just 98 days, providing a self-contained war room, operable either in the air or on the ground, to produce a "see for yourself" command environment.

The prototype used sensor aircraft and television, SLR (side looking radar), infrared and photographic devices to reconstruct and display reconnaissance information in near real time, plus HF, VHF and UHF communication links. After testing this system in combat zones, the Air Force ordered

follow-on versions, challenging LTV Electro-systems engineers to increase the crew capacity and communications capability.

To command the best in your future, be prepared with full information about LTV Electro-systems and its quick reaction engineering. The ABC<sup>3</sup> is only one facet of the engineering challenge. There's also big work involving big projects in space/air/ground electromagnetic reconnaissance and surveillance systems; command and control systems; high-power radar and radio; nuclear detection and surveillance equipment; information processing and display systems; super power equipment; VLF transmitters; commercial radio transmitters; guidance systems; antennas; electronic warfare systems; satellite tracking systems... and more.

These vital programs offer exceptional personal and professional opportunities to engineers in the following disciplines: **RF SYSTEMS / RF CIRCUIT DESIGN / DIGITAL CIRCUITS DESIGN / DIGITAL SYSTEMS ANALYSIS / WEAPON SYSTEMS ANALYSIS / GUIDANCE SYSTEMS / RADAR SYSTEMS / ANTENNA SYSTEMS DESIGN / ELECTRO-MECHANICAL PACKAGING / MECHANICAL SYSTEMS / ELECTRO-OPTICS / SCIENTIFIC PROGRAMMING**... plus others.

For complete information about a career with LTV Electro-systems, Inc., write: Professional Placement, P. O. Box 6118, Dallas, Texas 75222. LTV is an equal opportunity employer.

**LTV**  
**ELECTROSYSTEMS, INC.**

A SUBSIDIARY OF LING-TEMCO-VOUGHT INC

ON CAREER-INQUIRY FORM CIRCLE 906

# Electronic Engineers: Move ahead with Douglas Missile & Space Systems Division

If you are looking for growth potential and the opportunity to work with some of the best professionals in your field, come to Douglas. Challenging opportunities await you in Electronic Engineering if you are:

**INSTRUMENTATION ENGINEERS** — You will analyze measurement requirements for transducer characteristics, determine selection of transducers and formulation of detailed procurement and testing specifications. Positions require BS/MS EE or Physics degree.

**INERTIAL INSTRUMENTS ENGINEERS** — You will assist in the development, evaluation, and testing of gyroscopes and accelerometers for missile reference and autopilot systems. Mechanical or Electrical Engineer with BS or advanced degree and 3 to 6 years experience in inertial instruments.

**CIRCUIT DESIGN ENGINEERS** — You will perform detailed circuit design and analysis primarily in the analog circuit design area, including AC and DC amplifiers, regulators, inverters, and demodulators. BS in EE, MS in EE desirable, and minimum of 3 years experience in circuit design.

**TELEMETRY SYSTEMS ENGINEERS** — Your responsibilities will include system engineering and design of on-board PCM telemetry systems. You will determine requirements on the system to allow sizing and format selection, and determine multiplexing techniques and define interface requirements with other vehicle systems. Requires BS/MS EE or Physics degree.

**DIGITAL TIMING SYSTEM DESIGNERS** — Your responsibilities will include the determination of requirements for the system design of an airborne central timing system and

programmer to be used for control of vehicle subsystems. Positions require BS/MS EE or Physics degree.

**RECORDING SYSTEMS DESIGNERS** — You will determine requirements for system design of airborne recording systems, voice through video, and airborne search and control systems. Analog and digital recording systems experience desired with BS/MS EE or Physics degree.

**ELECTRO MAGNETIC COMPATIBILITY ENGINEERS** — You must be familiar with EMC specifications, experienced in practical circuit and large system design, and possess mathematical analysis capability in EMC. BSEE degree with 3 to 5 years experience required.

**PACKAGING DESIGN** — Your experience should include design of large electronic assemblies containing complex electronic circuitry, such as used for missile control systems, employing the latest in multi-layer printed circuit board technology. Openings are for Senior Engineers with BS in EE, ME, or Physics and four years experience in electronics packaging design of missile airborne equipment.

Please send your resume and salary history in confidence to Mr. E. K. MacDonald, Douglas Missile & Space Systems Division, 2720 Ocean Park Blvd., Santa Monica, California.

You gain by going to

## DOUGLAS

MISSILE & SPACE SYSTEMS DIVISION

An equal opportunity employer, males and females may apply.

# Oscillator-multivibrator combo forms super-regenerative detector

Two standard circuits can be combined in a reflex arrangement to produce a new type of detector. This system offers lower distortion, higher reliability and less total power consumption than conventional types of super-regenerative detectors.

By combining a bi-stable multivibrator (Fig. 1a) with an RF oscillator (Fig. 1b), we develop the reflex circuit (Fig. 2a). The multivibrator action causes the RF oscillations to be switched OFF and ON at a rate of approximately 20 kHz (thus the term digital). The actual point at which the RF oscillations begin (conduction of current in the collector of  $Q_2$ ) is determined by the sum of the multivibrator waveform and voltage present in the RF tank circuit. Signals present on the antenna are coupled to the transistor emitter through the RF feedback circuit.

Referring to Fig. 2b, we see that the amplitude-modulated signal (A) will be summed with the linear ramp of the switching waveform (B) in transistor  $Q_2$ . When the combined levels (A + B) exceed the switching threshold, the collector changes state, and the subsequent pulse-width variation ( $\Delta P$ ) occurs at the received signal

modulation rate.

A Twin-T filter coupled to the collector of either  $Q_1$  or  $Q_2$  will allow the detected modulation to pass to an audio amplifier and reject the switching-frequency component. The detector output level is low; however, the linear switching ramp insures low-distortion performance. A standard quartz crystal can be used to control the RF frequency of the detector and simultaneously im-

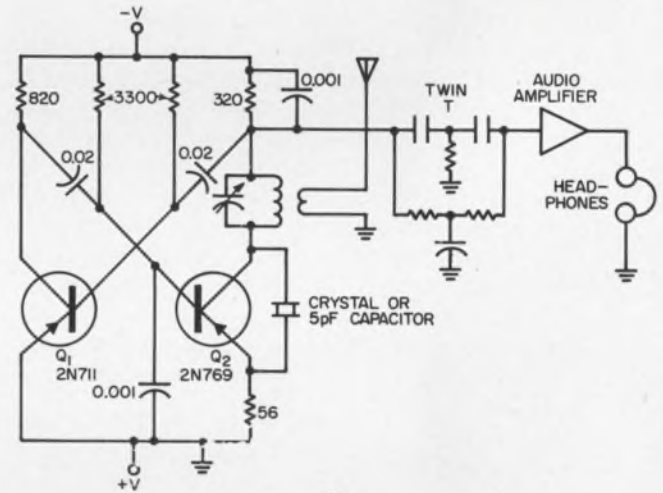

(a)

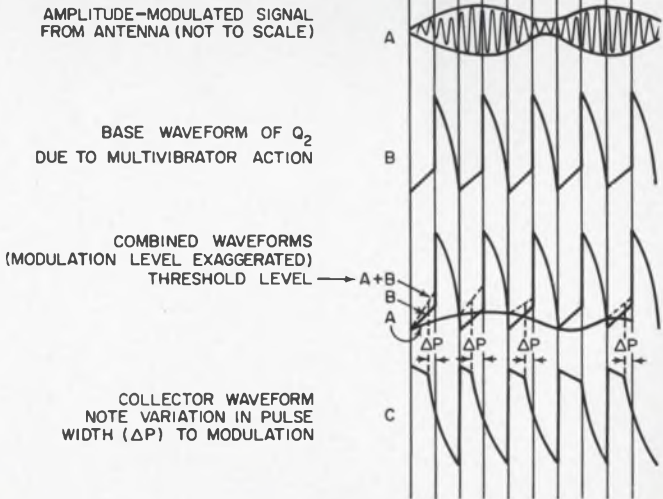

(b)

**IDEAS FOR DESIGN:** Submit your Idea for Design describing a new or important circuit or design technique, the clever use of a new component, or a cost-saving design tip to our Ideas for Design editor. If your idea is published, you will receive \$20 and become eligible for an additional \$30 (awarded for the Best of Issue Idea) and the grand prize of \$1000 for the Idea of the Year.

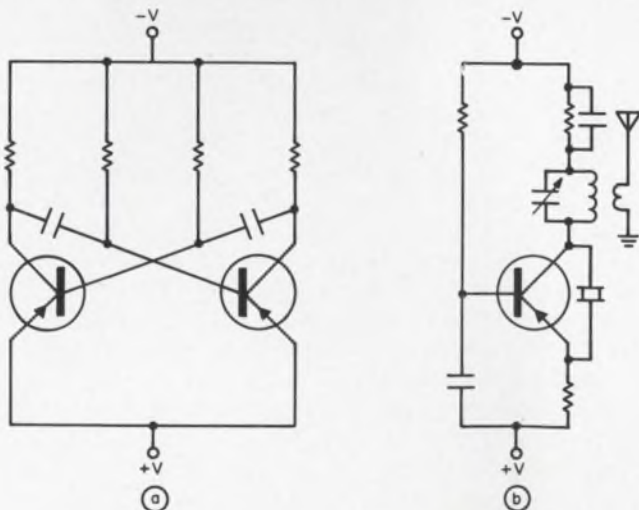

1. Combination of bi-stable multivibrator (a) and RF oscillator (b) results in a super-regenerative, reflex-action detector. Low distortion and high reliability accrue.

2. Digital reflex quenching circuit forms full receiver (a). Multivibrator switches RF oscillator ON and OFF at a digital rate. System exhibits low distortion, high reliability and little power consumption. Key waveforms appear in (b).

prove circuit *Q* to provide crystal filter action.

The component values shown may be used in an operational configuration. Microcircuit techniques may alternatively be employed for size reduction. A hearing-aid type of amplifier, coupled to the detector, will form a complete receiver, with excellent sensitivity and selectivity characteristics and low power-consumption needs. The detector shown uses less than 1/4 mW power from a 0.5-volt source. This makes the unit attractive for military field-helmet receivers or similar applications, where a small monitor receiver is required.

*R. T. (Ted) Hart, Systems Project Engineer, Collins Radio Co., Dallas, Tex.*

VOTE FOR 110

## Simple transition detector has unipolar outputs

Only one transistor stage is required to make a simple circuit that produces a positive output pulse on both the leading and lagging edges of an input pulse. The circuit can be employed as a transition detector or in timing and control applications.

The key to this system lies in the RLC network in the transistor's base circuit (see schematic "a"). With the input at ground, *Q* is OFF and the output will be at -10 volts. When the input is negative, *R* and *L* provide a dc path that clamps the base to ground; therefore the output is restored to the -10-volt level. During the leading or

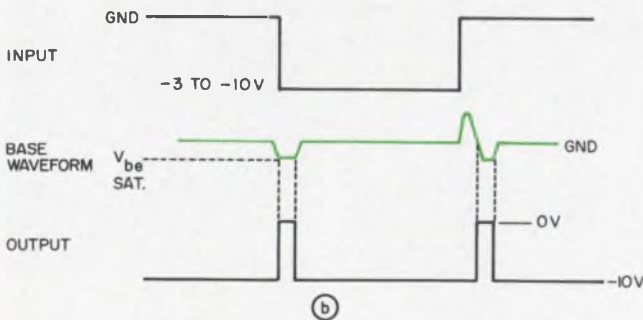
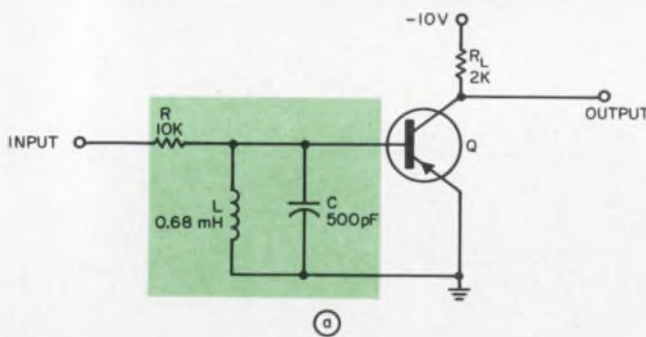

**Transition detector is formed** by a one-stage RLC circuit (a). A positive output appears each time the base is driven negative (b). These pulses appear only at the leading and trailing edges of the input pulse.

lagging edge of the input waveform, the RLC circuit will resonate, producing a positive-and-negative-going waveform at the base of *Q*. The negative portion of this signal will drive *Q* into saturation, causing the output to switch to ground. The result is a positive output pulse for every transition of the input waveform.

Analysis of the unloaded RLC circuit shows that the voltage developed across the inductor will be an underdamped oscillation for a step-function input, provided that  $4RC > L/R$ . With the base *Q* connected to the output of the RLC circuit, only one negative oscillation occurs. This is because the low input impedance of *Q* (as it is driven into saturation) shunts the tuned circuit. Thus the base waveform makes brief excursions into both sides of ground (see schematic "b").

With the component values shown, a 10-volt output pulse is produced for every transition of an input square wave that exceeds three volts in amplitude. The output pulse resulting from positive input rises is slightly delayed, because the base goes positive before going negative for positive input transitions.

*Richard J. Bouchard, Electronic Engineer, Sanders Associates, Inc., Nashua, N. H.*

VOTE FOR 111

## Deflection amplifier shows high efficiency, linearity

Now that high-voltage transistors are available, a specified vertical-deflection power can be easily obtained with little battery power. In this design large, wide-tolerance electrolytic capacitors are not needed.

Earlier deflection amplifiers, using low-voltage rated bipolars, were operated typically at high currents. Inefficiency was ascribed mostly to the resulting high  $I^2R$  losses. The new circuit (Fig. 1) delivers 0.5 A peak-to-peak of 60 Hz sawtooth current to a 27-mH vertical-deflection yoke. It also provides 90 degrees CRT deflection with a 10-kV acceleration potential. Total input power is slightly over 3 watts. Linearity is adjustable to two percent or better.

With a 150-volt supply, the trapezoidal waveform at the DTS-423 transistor collector (Fig. 2a) is 350 volts peak-to-peak, much as with vacuum tubes. In fact, a vacuum-tube transformer was used to transform collector impedance down by 8-to-1, to match the yoke impedance. (Note that the Stancor VO-100 is connected as an auto-transformer and must be modified to permit grounding of the output winding.)

Feedback is employed in the sawtooth voltage generator and in the output amplifier to improve linearity. No vertical-hold control is necessary, because synchronization is absolute. The UJT bases are interchanged to obtain a lower stand-off ratio. This has no effect upon normal operation but it allows the emitter to fire at a lower voltage

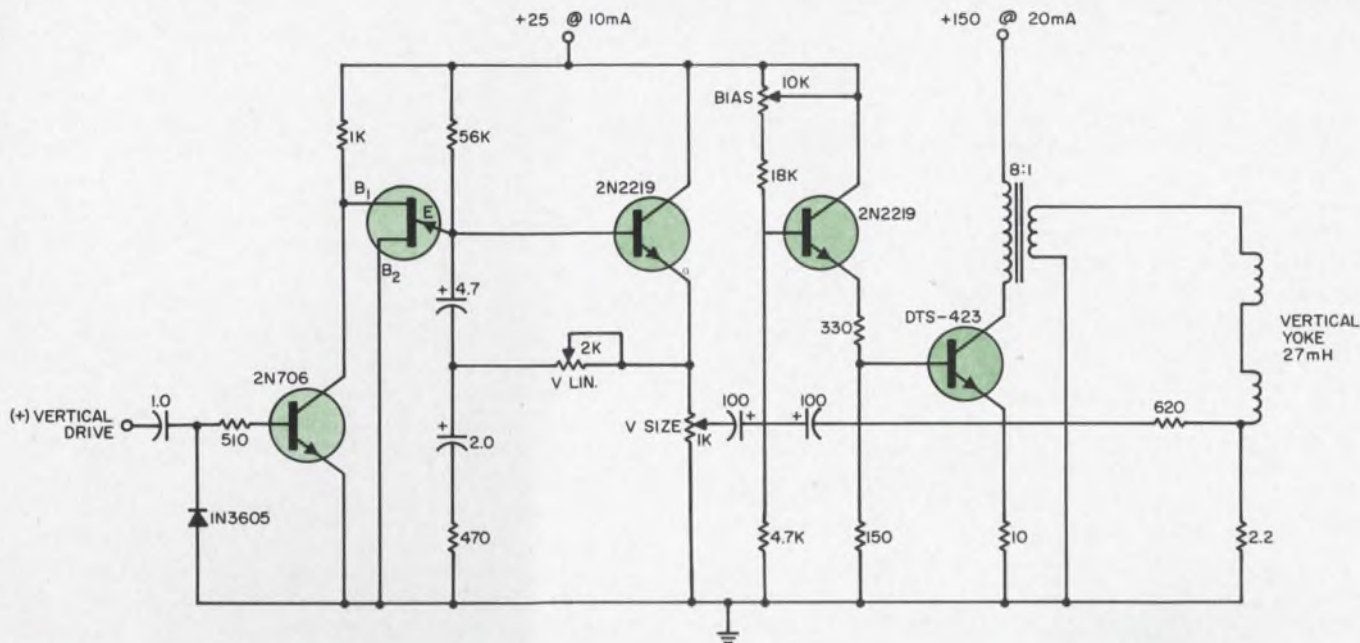

1. Efficiency and linearity result when high-voltage transistors and a UJT are used in this deflection amplifier.

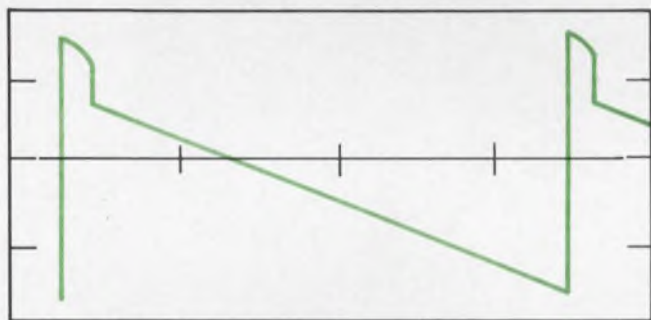

(a)

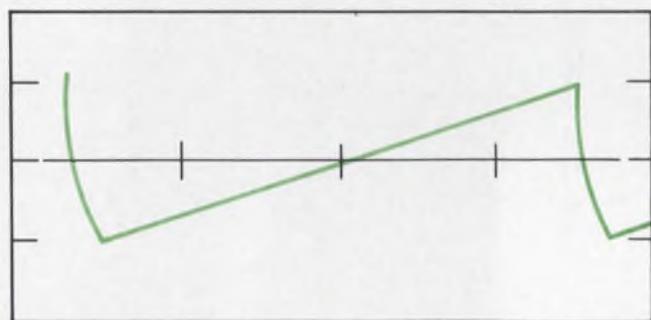

(b)

2. The output amplifier collector voltage (a) is 350 volts peak-to-peak. Here the horizontal scale is 5.0 ms/div and the vertical 100 V/div. Linearity of the yoke current (b) is due to feedback. Vertical scale here is 0.25 A/div; horizontal, 5 ms/div.

when free-running. If the higher stand-off ratio connection were used, the free-running frequency would be about 15 Hz and the resulting waveform greatly distorted. The 10-k $\Omega$  bias control is set for minimum DTS-423 collector current without clipping (Fig. 2b).

Howard Stearns, Principal Engineer, Fairchild Hiller Corp., Rockville, Md. VOTE FOR 112

## Crowbar circuits protects expensive IC components

A simple, inexpensive crowbar circuit can be used to protect an entire bank of integrated circuits (ICs) against over-voltage conditions and short-duration transients.

As many as 30 ICs, operating off a single supply, could be destroyed if their supply voltage were to rise above the maximum rating of the devices. Because of their low-heat capacity and relatively small internal resistances, even a short-duration transient can cause extensive damage.

The crowbar is connected between the supply and the IC load (see schematic). Normally, the SCR is non-conducting. Its anode is at the same potential as the input to the series regulator. Diode  $CR_1$  is back-biased. The current-limiter stage protects power supply components against output shorts.

When the output voltage exceeds the breakdown voltage of  $CR_2$ , the SCR fires and clamps the output at +2 volts. A large current flows through  $R_1$  and the SCR, thus blowing the fuse and shutting off all power to the supply and the ICs. The SCR will reset automatically, if the fault has been

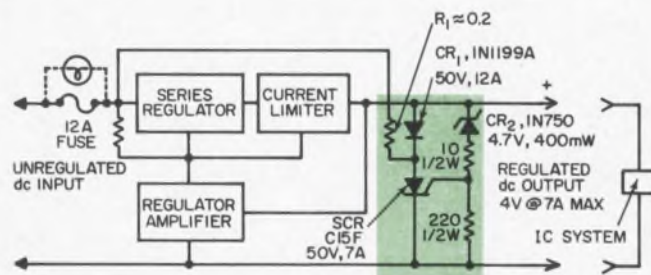

Simple crowbar circuit provides fast shut-off of power supply so that over-voltage transients do not damage integrated circuits.

removed, when the fuse is replaced. By placing a lamp across the fuse, a visual fault indication will be available. The supply must then be shut off to reset the SCR.

The crowbar will operate whether the overvoltage is due to a failure in the regulator or to a short from the output line to a higher voltage line in the system. Since the Zener cannot provide a starting pulse, the SCR must have a good gate-sensitivity characteristic. Although direct Zener-diode firing of SCR's is not recommended for repetitive operations, this method is adequate for the one-shot application discussed here.

*Richard A. Karlin, Vice-President, Linear-Alpha, Inc., Evanston, Ill.* VOTE FOR 113

## Switch-bridge provides versatile load control

A switch-bridge, easily built with four transistor stages, is used to drive an ungrounded load ( $R_L$ ) with a relative positive or negative current, or no current at all. Control is firmly established,

with the direction of the drive source to the load independently varied.

To accomplish this (see schematic), a pair of gates are closed, or all gates are closed. For example, if pair A is closed, current flows from X to Y in the load. Similarly if pair B is closed, current flows from Y to X in the load. Closing both pairs produces a small unbalance current, due to transistor  $V_{ce}$  variations.

Turn-on of A or B is accomplished by driving the corresponding DH-036 pulse transformer. The transformer response determines the frequency range over which the switch-bridge is operational. The turn-on waveform should encompass the generator waveform; otherwise pulse splitting will occur.

The circuit, when driven from a high-impedance generator, acts as a current switch. Setting  $r_g \gg R_{sat}$  by using low-leakage transistors, and driving from a fixed  $E_g$ , we get an accurate bi-directional current switch.

In one variation a number of switch-bridges may be placed in series, each with an independent turn-on control. In this way a system capability is generated.

*Harry Metz, Development Engineer, IT&T Federal Labs, Nutley, N. J.* VOTE FOR 114

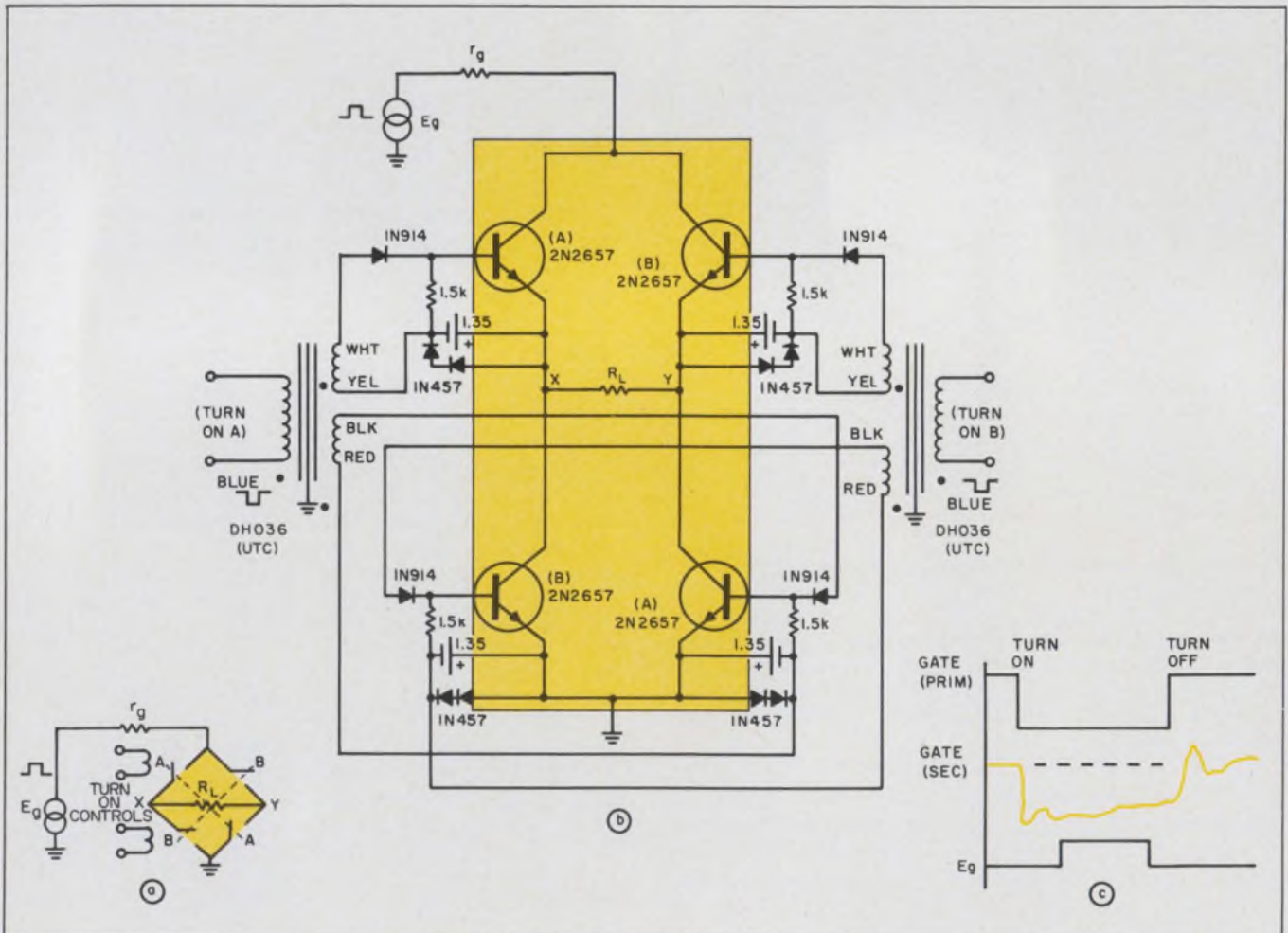

Switch-bridge controls direction of load drive (a). Complete circuit (b) is used with ungrounded loads as a bi-directional

current switch. Waveforms (c) show generator pulse must be narrower than gate, to avoid pulse splitting.

Schjel-Flex\*

... new twist  
in circuitry

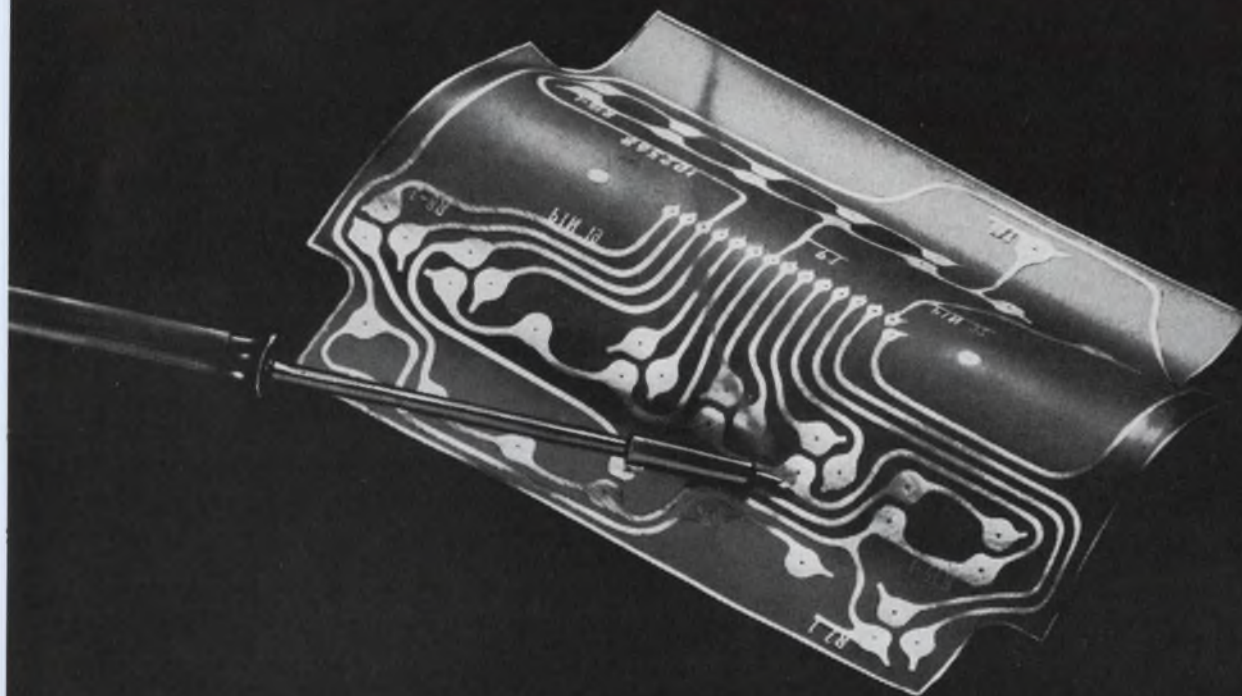

Schjel-Flex Kapton† circuit for Astronautics, Inc., Milwaukee, Wisconsin.

## New Schjel-Flex\* Kapton circuit beats heat

Of course you wouldn't lay a hot soldering iron on a flexible printed circuit. But if someone *should*, this one wouldn't be a production reject. It takes the heat because the base is Kapton, laminated to copper with a proprietary Schjeldahl adhesive system that approximates the characteristics of the polyimide film.

We've made hundreds of thousands of Schjel-Flex circuits. Most often, we use our polyester laminate, GT-5500 Schjel-Clad.\* With polyester's excellent physical, electrical and chemical properties, the circuits are right for most applications. But sometimes extreme processes or service temperature requirements exceed polyester's limits. That's why we've developed the Kapton laminate. It retains poly-

ester properties at much greater temperature extremes.

For example, at room temperature, a Schjel-Flex Kapton circuit has tensile strength of about 25,000 psi. At 260°C, it's 14,000 to 15,000 psi. Typical cut-through temperature, using a weighted probe on heated film, is 435°C. Room temperature dielectric strength is 7,000 volts/mil; 4,000 volts/mil at 260°C. The Kapton base is non-flammable, infusible and unaffected by known organic solvents.

There are other high temperature circuits. But ours is the first to use an adhesive system — instead of fusion-bonding copper to Teflon† or a Teflon-Kapton combination. The adhesive doesn't permit conductor "swimming"

during processing. Tolerances of  $\pm 0.1\%$  can be achieved.

Schjel-Flex circuits offer the design freedom of materials you can bend, twist and flex. At the same time, they give you the precision and assembly ease of printed circuit boards. Yet with all their desirable qualities, our continuous roll production keeps unit costs low.

We'd like to help find a Schjel-Flex answer to your circuit problem — whether you want to make or buy. Our list of standard Schjel-Clad laminates will soon include the Kapton-base material (designated GT-7500). We're already making circuits of it. Don't let pronunciation stop you. Say "Shell-Doll."

\*Trademark, G. T. Schjeldahl Company

†Du Pont trademark



**Schjeldahl** / ELECTRICAL  
PRODUCTS  
DIVISION

G. T. SCHJELDAHL COMPANY • NORTHFIELD, MINNESOTA 55057 • PHONE 507-645-5633

## Have power-handling problems kept you from full use of IC's in your design?

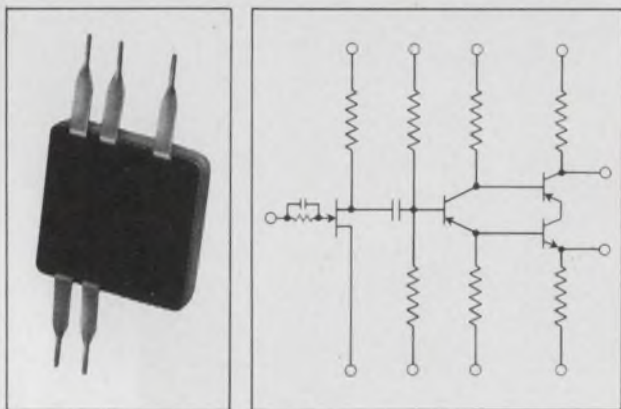

### Look how our hybrid circuitry can help:

Let's say you'd like to give your design all the advantages of integrated circuitry — miniaturization, reliability, cost reduction. But your power requirements seem too high for efficient use of monolithic circuits.

This is where we come in.

We've been developing a wide range of hybrid circuitry techniques to extend the usefulness of integrated circuits, and to complement monolithic circuits. For example, we've designed circuits (see illustration above) dissipating up to 20 watts and passing up to 6 amps. And we're pushing up this power-handling ability in the near future. It makes sense — there is, of course, no fundamental limit to the ability of hybrid circuitry to handle large amounts of power.

Other problem areas also yield to the hybrid approach: circuits requiring signal or supply voltages up to 300V have been designed and built. Two-dimensional circuitry and small size make higher speeds possible. Low initial tooling charges make hybrid circuits economically feasible for small-quantity runs or prototype production. Packaging concepts at Philco run the gamut from low-cost conformal coated circuits for consumer use . . . to epoxy encapsulated circuits for industrial use . . . to highest-reliability devices sealed in TO-5 or flat pack for military or space uses.

A call to your local representative or to George Meadows, Spring City, Pa. (215-948-8400), will bring further information — and an invitation to submit discrete circuit plans for a quick quote on hybridization costs!

#### SOLID-STATE PRODUCTS OPERATION

## PHILCO

A SUBSIDIARY OF *Ford Motor Company*  
 LANSDALE DIVISION - SPRING CITY, PA.  
 In Canada, Don Mills Road, Don Mills, Ontario, Canada

ON READER-SERVICE CARD CIRCLE 36

#### IDEAS FOR DESIGN

## Antenna-beam offset improves radar resolution

The slope of the main lobe of a high-gain antenna pattern is greatest in the vicinity of the first null. This characteristic can be used to obtain improved resolution, by simply shifting the antenna pattern to one side on transmission and to the opposite side on reception.

A non-reciprocal ferrite device can be used to control the beam shift. Note that this improvement is obtained with some sacrifice in power.

To illustrate this concept, consider the pattern of a uniformly illuminated circular aperture. Assume that the diameter of the antenna is 40 wavelengths. The relative two-way patterns of the antenna for three different beam offsets appear in the accompanying diagram. For an offset of 0.2

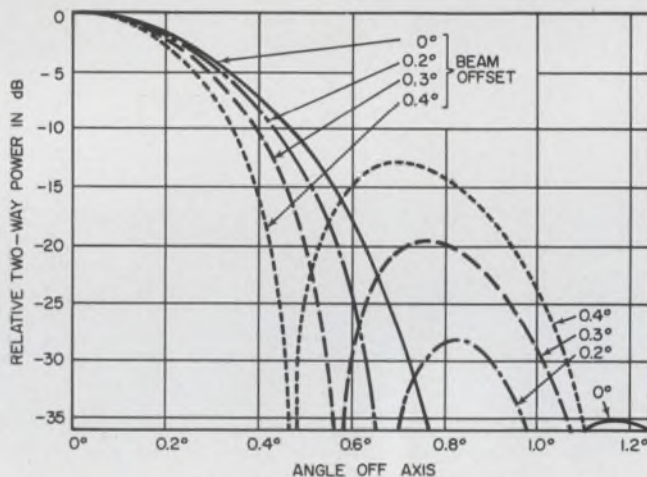

Radar resolution is improved if the beam is shifted to different sides during transmission and reception. This benefit is accompanied by a loss in power efficiency.

degree, the two-way power loss is 1.69 dB. For a 0.3-degree offset, the loss is 3.92 dB. And with an offset of 0.4 degree, the loss is 7.16 dB. Observe that the apparent narrowing of the beamwidth also results in greatly increased sidelobes.

L. A. Zurcher, R. J. Gunderman and H. F. Mathis, Senior Technical Specialists, North American Aviation, Inc., Columbus, Ohio.

VOTE FOR 115

## Circuit converts generator into monopulser unit

It is often necessary to obtain a single positive or negative output voltage pulse from a signal generator which is not equipped for single-pulse operation. This can easily be achieved by a two-stage complementary network and a relay.

In effect, the circuit functions as a single-pulse cutoff unit. It avoids the costly, time-consuming



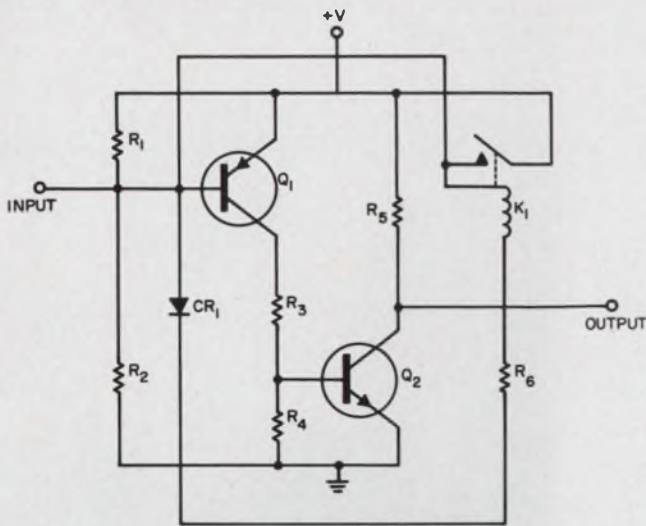

Single pulse cutoff circuit is formed by two-stage complementary network and relay. It converts a signal generator into a monopulser unit.

process of internal modification of the generator. Such a circuit for use with negative voltage pulses is shown in the schematic. Transistors  $Q_1$  and  $Q_2$  are non-conducting in the absence of a pulse. The first negative pulse on the base of  $Q_1$  causes both transistors to conduct. The feedback loop consisting of  $R_6$  and  $CR_1$  clamps both transistors ON.

This provides a permanent low-impedance path for relay  $K_1$ . When the trailing edge of the negative pulse reaches the base of  $Q_1$ , pull-in voltage is supplied to  $K_1$ . The relay then locks itself on and clamps the input voltage to positive.

*Fred W. Kear, Design Engineer, Sparton Southwest, Inc., Albuquerque, N. M.*

VOTE FOR 116

## Bootstrap action yields high $Z_{in}$ wideband amplifier

An input impedance of about 35 k $\Omega$  in a stable, wideband amplifier is achieved by the bootstrap action of a feedback capacitor. The circuit also shows good temperature stability.

The input of the amplifier (see schematic) is ac-coupled via the 1.1- $\mu$ F input capacitor. Polarity of the input capacitor is chosen according to application. The first base is biased at approximately two volts.

Bandpass of the amplifier is approximately 40 Hz to 40 MHz using 2N2369 transistors ( $Q_1$ ,  $Q_2$ ,  $Q_3$ ) and a 2N2894 for  $Q_4$ .  $CR_1$  and  $CR_2$  are low-conductance silicon diodes. The low-frequency response may be extended by increasing the value of the 1.1- $\mu$ F and 3- $\mu$ F capacitors.

Different values of gain and bandwidth may be attained by varying the values of  $R_1$  and  $C_1$ . For example, a 60-dB amplifier will show a bandwidth

**PERFECTION**  
**THE GOAL—**  
**PRECISION**  
**THE RESULT**  
*Specify*  
**MELPAR**  
**Frequency**  
**Standards**

**Timing**  
**Systems**

**Tuning**  
**Forks**

- RUGGED
- RELIABLE
- COMPACT



Fork Standard

Actual Size:  
1-29/32 x 1-15/32 x 0.4



Tuning Fork

Actual Size:  
0.757 x 7/8



Crystal Standard

Actual Size:  
1-19/32 x 1-19/32 x 3-3/8

**SELECTED BY GOVERNMENT AND INDUSTRY FOR WIDE-RANGING APPLICATIONS:**

**FOR TIME BASE:**

- Real Time
- Interval Time
- Teletype Communications

**FOR FREQUENCY REFERENCE:**

- Servo Speed Controls
- Inverters
- SSB Communications

**FOR TONE GENERATION:**

- Selective Signaling
- ASW
- Mobile Communications

**SIZE AND PERFORMANCE TO MEET ANY REQUIREMENT**

**FREQUENCIES:** 1 CPS to 1 MCPS

**ACCURACIES:** 0.1 to 0.0005%

**TEMPERATURE RANGES:** -55°C to +125°C

If you have a special frequency generation problem or would like more detailed technical data and list of representatives nationwide, please write or phone:

SPECIAL PRODUCTS DEPT.

**MELPAR INC**

A SUBSIDIARY OF WESTINGHOUSE AIR BRAKE COMPANY

7728 ARLINGTON BLVD. • FALLS CHURCH, VA. • (703) 534-6000

ON READER-SERVICE CARD CIRCLE 37

# NEW! MINIATURE TOGGLE SWITCH

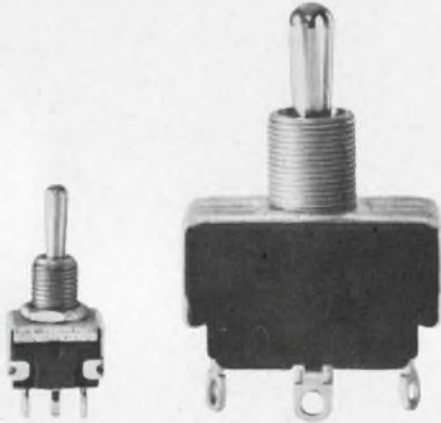

New miniature switch (left), standard model (right), both actual size.

- Same capability, durability, reliability as larger standard toggle switches
- Single or double pole, double throw types
- Momentary or maintained action
- Rated 5 amps, 125 VAC and 28 VDC

Patterned after Cutler-Hammer's military toggle switches used in space exploration, this new version actually exceeds commercial miniature switch specifications for single or double pole, double throw types.

**SMALL SIZE OPENS UP NEW APPLICATIONS.** Extra large (.07-inch diameter) terminal holes can accept three #22 wires. It can also accept large wires. Result: cooler operation and less contact resistance. Contact erosion is minimized, contact life extended.

**UP TO 50% LONGER LIFE** made possible by massive current-carrying parts. This design advantage also offers exceptionally high current-carrying capacity. For instance, initial contact resistance is only .01 ohms maximum.

**NO RIVETED JOINTS.** They've been completely eliminated in contacts and terminals to prevent heat rise, poor circuit and accelerated switch deterioration resulting from imperfect or loose joints. At the rated load, electrical life surpasses 50,000 operations. Mechanical life exceeds 100,000 cycles. Cutler-Hammer, Inc. Milwaukee, Wisconsin 53201.

For more information circle no. 208

What's new? Ask . . .

**CUTLER-HAMMER**



## IDEAS FOR DESIGN

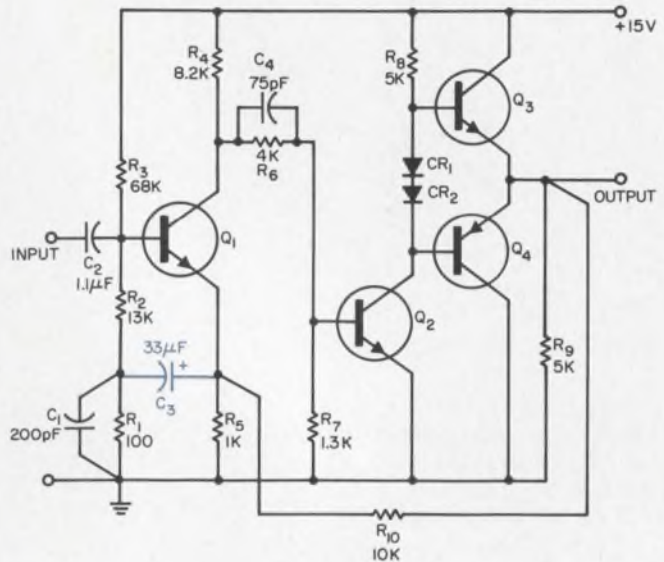

Bootstrap action of feedback capacitor  $C_3$  yields an input impedance of 35 k $\Omega$  in this 40-dB, 40-MHz-bandwidth amplifier.

about 3 MHz; a 20-dB amplifier, a 75-MHz bandwidth.

Dc stability of the output operating point is attained through a compensating system which takes advantage of base-to-emitter voltage changes at temperature extremes. Note that the  $Q_1$  current is equal to the current in  $R_4$  minus the current in  $R_6$ . At  $-55^\circ\text{C}$ ,  $V_{BE2}$  increases by 25% to 30%, causing  $R_6$  to draw more current away from  $R_4$  and thereby decrease  $Q_1$ 's current. At the same time,  $V_{BE1}$  increases, causing a drop in the  $Q_1$  emitter voltage. The resulting decrease in  $R_5$  current is fully compensated for by the decrease in  $Q_1$  current, and the output dc voltage therefore remains constant. A similar but opposite analysis holds for high-temperature operation.

Output impedance of the amplifier is 10 ohms, as provided by the emitter-follower output transistors. If the  $Q_2$  collector is connected directly to the  $Q_3$  base, the network comprising  $CR_1$ ,  $CR_2$ , and  $Q_1$  may be eliminated, sacrificing the capacity to drive large ac-coupled loads.

*William J. Travis, Design Engineer, Sprague Electric Co., North Adams, Mass.*

VOTE FOR 117

## Variable pulse limiter uses few components

Only one transistor stage and a Zener diode are needed for a stable, precise pulse limiter. The limiter, moreover, has a continuously variable output capacity.

This circuit (see schematic) was designed to

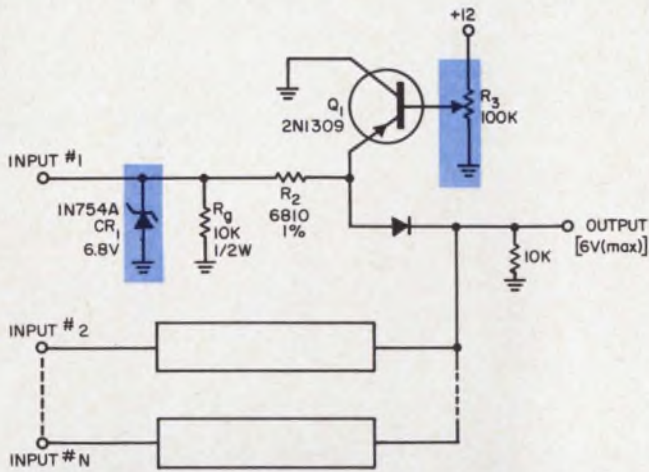

Few components are required in the variable-output, high-stability, precision pulse limiter. Zener diode  $CR_1$  serves as a coarse limiter, and  $R_1$  is the output level set.

convert input pulses of from 8 to 16 volts in amplitude into a continuously variable output-pulse train of from 0 to 6 volts' amplitude. The output, once set, will vary only 0.001 volt or less.

Because of the circuit's extremely low current-drain, there is virtually no limit to the number that may be placed in parallel. It works equally well with negative pulses when an npn transistor and a negative bias supply are substituted for a pnp transistor and a positive supply. It can also operate with positive and negative pulses simultaneously, through the use of both transistor types together. Its operation is straightforward.

The 10-k $\Omega$  resistor is a ground return for an isolation diode at the input (not shown). The input Zener diode,  $CR_1$ , has a Zener breakdown voltage that is approximately one volt above the maximum desired output. It thus acts as a coarse limiter. The 6.9-k $\Omega$  series load is a high-precision resistor.

The 10-k $\Omega$  potentiometer in the base of  $Q_1$  is set to yield the desired output. When the input pulse is less than, or equal to, the desired output,  $Q_1$  is cutoff. When the input pulse exceeds the desired output level,  $Q_1$  acts as a short-circuit to the unwanted portion of the pulse, thus serving as the limiter.

*Louis J. Brocato, Professional Engineer, Baltimore, Md.*

VOTE FOR 118

**IFD Winner for Jan. 18, 1966**

**Charles Alvine, Project Engineer, University of California at Los Angeles, Los Angeles, Calif.**

His idea "Tristable multivibrator forms 3-phase generator" has been voted the \$50.00 Most Valuable of Issue Award.

**Cast Your Vote for the Best Idea in this Issue.**



*Johanson*

## 4700 Series MICRO-MINIATURE Highest Q Variable Air Capacitors

New Johanson 4700 Series variable air capacitors provide, in micro miniature size, the high Q important in demanding aerospace applications. In addition their ultra-rugged construction assures highest reliability in the most critical environments.

Available in printed circuit, turret and threaded terminal types.

### SPECIFICATIONS

Size: .145 diameter, 1/2" length

Q @ 100 MC, >5000

Q @ 250 MC, >2000

Capacity Range: 0.35 pF to 3.5 pF

Working Voltage: 250 VDC (test voltage, 500 VDC)

Insulation Resistance: > 10<sup>6</sup> Megohms

Temp. Range: -55°C to 125°C

Temp. Coefficient: 50±50 ppm/°C

Write today for full data.

*Johanson* **MANUFACTURING CORPORATION**

400 Rockaway Valley Road, Boonton, N. J. 07005 (201) 334-2676

ELECTRONIC ACCURACY THROUGH MECHANICAL PRECISION.

ON READER-SERVICE CARD CIRCLE 38

RCA 2N4068  
(actual size)



NEW RCA NPN SILICON TRANSISTOR FOR CRITICAL INDUSTRIAL APPLICATIONS: Wide-band amplifiers—Distributed amplifiers—Video amplifiers in TV cameras, camera chains, monitors, oscilloscopes—Video marker generators—Relay drivers—NIXIE<sup>®</sup>, neon-indicator and electro-luminescent-indicator driver circuits—Direct on-off control circuits... much more

<sup>®</sup>Registered Trade Mark: Burroughs Corporation

# $BV_{CEO} = 150\text{ V min.}$

# $C_{cb} = 3.5\text{ pF max.}$

# $f_T = 50\text{ Mc/s min.}$

## PLUS

- Low Leakage Current— $I_{CBO} = 50\text{ nA max at } V_{CB} = 120\text{ V}$  • High Gain— $h_{FE} = 30\text{ min at } I_C = 30\text{ ma, } V_{CE} = 10\text{ V}$  • Low Saturation Voltages— $V_{CE}(\text{sat}) = 1\text{ V typ, } V_{BE}(\text{sat}) = 0.68\text{ V typ, at } I_C = 30\text{ mA, } I_B = 1\text{ mA}$  • High Current Capability— $200\text{ mA max.}$  • High Power Dissipation— $0.5\text{ watts free air at } 25^\circ\text{C}_{TFA}$  • Wide Temperature Range—operates from  $-65^\circ\text{C}$  to  $+175^\circ\text{C}$
- Hermetically Sealed Metal Case

# PRICE 95¢\*

RCA 2N4069 is the same as RCA 2N4068, except for an integral heat sink to provide twice the dissipation capability (1W). **99¢\***



\*In quantities of 1,000 and up

As Wide-band amplifiers the 2N4068 and 2N4069 easily cover bandwidths to 4.5 Mc/s and higher; as general purpose amplifiers, they operate up to 100 Mc/s. The very high  $BV_{CEO}$ , the low collector-to-base feedback capacitance, the low leakage and saturation voltages give assurance of top performance in critical applications. The RCA 2N4068 and 2N4069 also feature exceptionally linear transfer characteristic and high-temperature capability compared with germanium and plastic-encapsulated silicon devices.

**Available through your RCA distributor**



For delivery information, and for your copy of RCA Technical Bulletin 2N4068-2N4069 (which has all pertinent performance curves, applications data and electrical and mechanical specifications), call your local RCA Field Office; or write: RCA Commercial Engineering, Section EG-4.4, Harrison, N. J.



RCA Electronic Components and Devices

**The Most Trusted Name in Electronics**

# ED Products

Memory tester uses 5 MHz IC logic PAGE 98

Sweep oscillator covers 0.25 to 40 GHz PAGE 106

Tri-axial accelerometer in 0.3 in.<sup>3</sup> package PAGE 114

Dual-frequency antenna has common feed PAGE 126



System sweeps 0.25 to 40 GHz 106

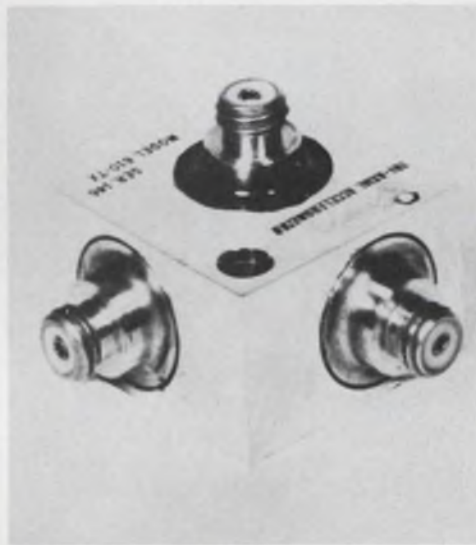

Simultaneous tri-axial measurement 114

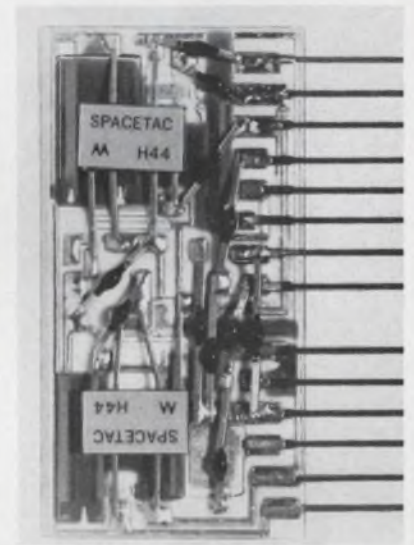

Flip-flop draws 150  $\mu$ W 126



IC logic shrinks memory tester 98

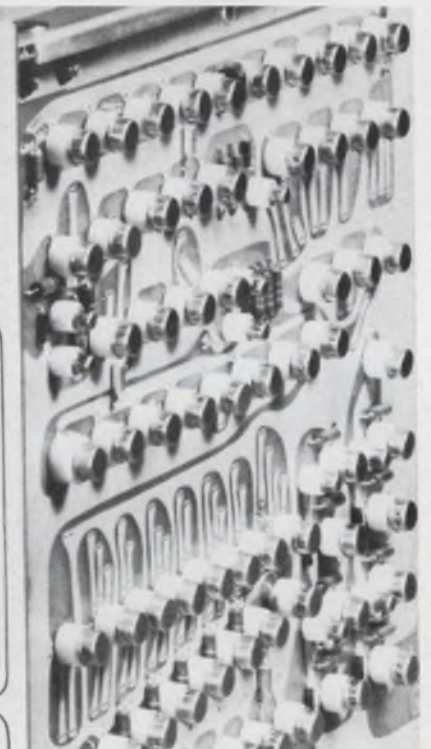

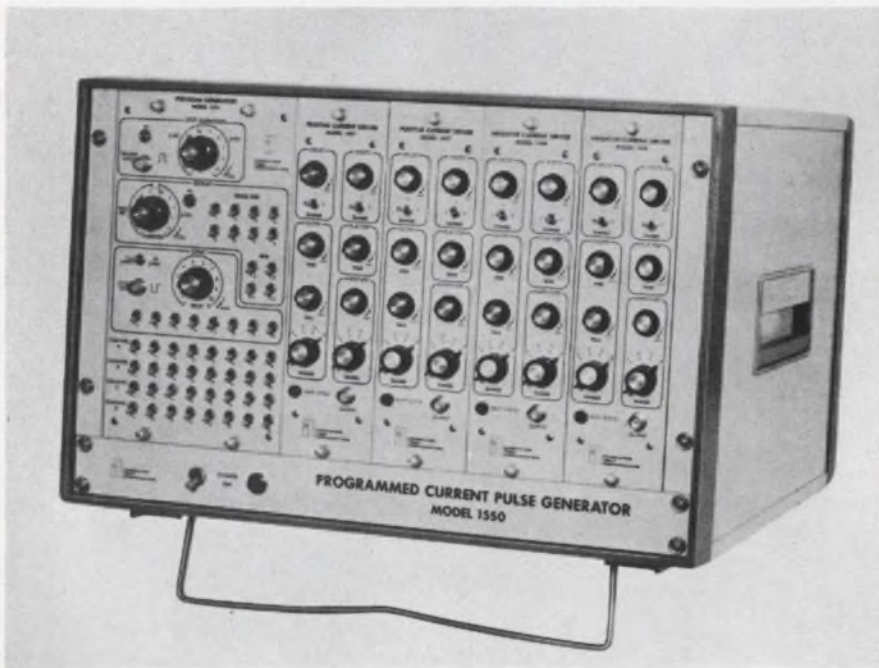

## Memory tester with IC logic has rise times to 20 ns

A programmed current pulse generator tests ferrite memory cores, plated wire memories, planar thin films, multi-apertured devices and other high-speed memory devices. The model 1550 memory tester is completely contained in a 19-3/4- x 21-5/8- x 13-in. package, which incorporates 5 MHz integrated circuit logic, solid-state current drivers and power supplies. The use of integrated circuit logic permits the high pulse programming rates. Increased reliability, inherent in the minimal use of discrete components and solder joints, is claimed. Current drivers are the manufacturer's models 1457 (positive) and 1458 (negative) which are characterized by a

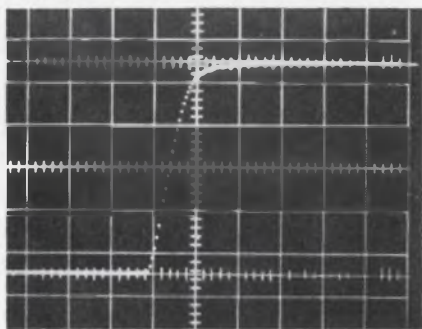

Pulse slope may be varied from 20 ns to 2  $\mu$ s. Maximum rise-time is shown on an abscissa of 10 ns/cm. Ordinate is scaled at 160 mA/cm.

highly linear 20 ns rise time capability.

The program generator in the 1550 provides an eight-step pulse sequence with 5 MHz internal clock that can be set up in any desired pattern by a series of toggle switches at each of the four output channels. The period between successive steps in the program can be continuously varied by a front panel control from 0.2  $\mu$ s to 0.5 ms. The program can also be advanced through successive steps from an external source. A step/repeat feature of the program generator permits either single steps or odd-even pairs of steps to be repeated within the over-all test pattern. The repeat interval can be varied internally over a range of 0.2  $\mu$ s to 2 ms or controlled externally for longer intervals.

Sync pulses are available at any one of the eight program steps by selecting appropriate toggle switches. This makes it possible to observe the desired output steps on a scope, or to analyze the response of the driver load after the application of the pulse program. The sync pulse can be delayed for periods up to 10  $\mu$ s from the start of the program step.

The output stages of the 1550

use positive and negative current drivers with highly linear rise and fall times that are independently adjustable to 20 ns. Current pulse amplitude can be varied from 50 mA to 1 A. Rise and fall time remain unaffected by adjustments in pulse amplitude, which helps to reduce test set-up time. An output voltage rating of 50 V and a 60 pF output capacitance make the drivers especially suited to driving inductive loads with high back voltages. The drivers can withstand a 50 V back emf without damage. Current pulse width and pulse delay are both independently variable up to 10  $\mu$ s.

A protective circuit built into the drivers prevents overload damage to the output stages by automatically shutting the unit off when the duty cycle reaches the 25% point. This is indicated to the operator by a front panel light. Once the overload is removed, the driver automatically resets itself. Input is standard 115 Vac, 50 to 60 Hz. Integral ventilating equipment consists of a blower and air-filter.

P&A: \$8450; 30 to 60 days. Computer Test Corp., 12 Fellowship Rd., Cherry Hill, N. J. Phone: (609) 665-5250.

Circle No. 250

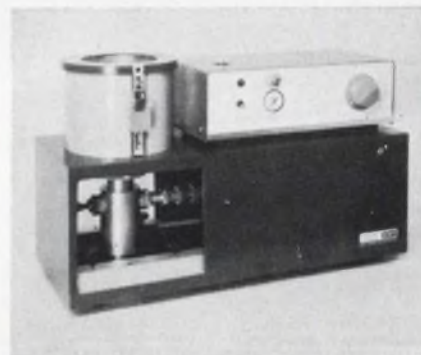

## Microphone calibrator

Model 901D variable frequency microphone calibrator can be used as a standard reference for sound pressure calibration. The calibrator generates precise low frequency sound pressures at high levels, within  $\pm 0.2$  dB. Interchangeable drive modules can provide sound levels from 110 dB to 170 dB in 10-dB steps. Range covered is 3 Hz to 200 Hz.

Bolt, Beranek & Newman Inc., 50 Moulton St., Cambridge, Mass. Phone: (617) 491-1850.

Circle No. 251

# Let's talk facts about trimmer capacitor reliability

**Only JFD gives you these design advantages... in the industry's  
broadest product line—over 500 standard models**

**Widest choice of drive mechanisms—**  
All seven are engineered for  
greatest tuning linearity without reversals  
and for the ultimate in repeatability.  
Anti-backlash designs exceed  
Mil-C-14409B requirements.

**Versatile choice of six  
dielectric materials to satisfy the  
most varied design parameters.**

**Matched metalizing—Exclusive  
JFD metalizing processes form a  
homogeneous bond between dielectric and  
metal parts. There are no air gaps to widen  
tolerances and distort actual capacitances.**

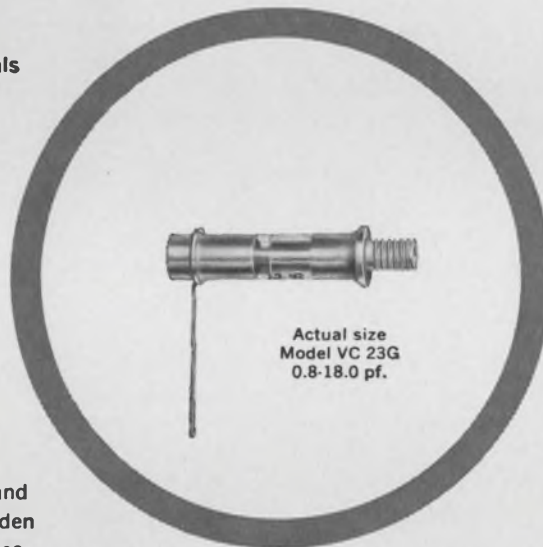

**Industry's most comprehensive  
and advanced construction  
variations assure you the degree of  
reliability your application requires.**

**High level shock and  
vibration resistance—A plateau of  
90 g's is common . . . by far the  
industry's highest. This is insured by  
continuous monitoring in JFD's  
shock and vibration laboratories.**

**High reliability of each individual  
unit is assured through the industry's  
most exacting quality control program.**

**That's why more JFD trimmer capaci-  
tors meet or exceed Mil-C-14409B than  
all other makes combined. JFD trimmer**

**capacitors have been specified in the  
Apollo, Gemini, Minuteman and L. E. M.  
programs where high reliability is a must.**

SEND FOR JFD CATALOG C-66

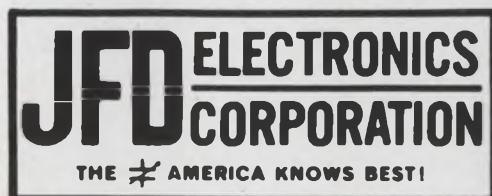

Components Division  
JFD ELECTRONICS CORPORATION, 15th Ave. at 62nd St., Brooklyn, N. Y. 11219  
Tel: 212 DE 1-1000  
JFD NORTHEASTERN, Ruth Drive, P. O. Box 228, Marlboro, Mass. 07152  
JFD NEW YORK-NORTHERN, Damiano Pl., P. O. Box 96, New Hartford, N. Y. 13503  
JFD MID-ATLANTIC, P. O. Box 5055, Philadelphia, Pa. 19111  
JFD MID-ATLANTIC-MARYLAND, P. O. Box 7676, Baltimore, Md. 21207  
JFD MIDWESTERN, 6330 W. Hermione St., Chicago, Ill. 60646  
JFD MIDWESTERN-OHIO, P. O. Box 8086, Cincinnati, Ohio 45208  
JFD WESTERN, 9 Morlan Place, Arcadia, California 91006  
JFD ISRAEL LTD., Industrial Area B, Bldg. 23, Azor, Israel  
JFD ELECTRONICS, EUROPE S A, 7 Rue de Rocroy, Paris, 10, France

Precision Piston Trimmer Capacitors ■ Metalized Inductors ■ LC Tuners ■ Ceramic Fixed and Variable Capacitors ■ Fixed and Variable Distributed and Lumped Constant Delay Lines  
Speed Inquiry to Advertiser via Collect Night Letter

ON READER-SERVICE CARD CIRCLE 39

## Converter

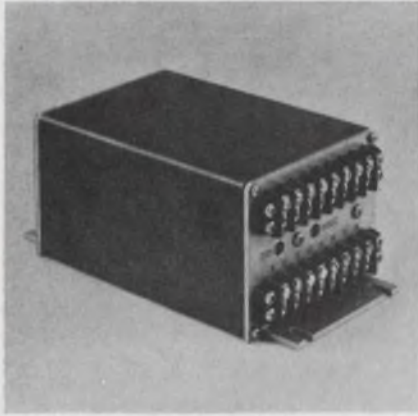

The PI-600 frequency-to-dc converter provides regulated V and I outputs over a 250- to 3000-Hz input range. Full-scale outputs of 0 to 5 V, 1 to 5 mA or 4 to 20 mA are selected by terminal strip jumpers. Input is transformer coupled and accepts sine wave, square wave or pulses. Sensitivity is 0.01 Vrms and accuracy is  $\pm 0.05\%$ .

P&A: \$350; 3 to 4 wks. Anadex Instruments Inc., 7833 Haskell Ave., Van Nuys, Calif. Phone: (213) 781-6811.

Circle No. 252

## In-line wattmeter



The type IW3-5E wattmeter features a nearly flat frequency response from 30 kHz to 2.0 MHz. Designed for use in 50  $\Omega$  unbalanced systems, it can be supplied with type N or uhf female interchangeable connectors. Standard instruments provide power ranges of 10, 25, 100 watts full scale. The meter is available in standard 19-in. rack versions.

Bayly Engineering Ltd., 120 Hunt St., Ajax, Ontario, Canada. Phone: (416) 942-1020.

Circle No. 253

## Automatic PC tester

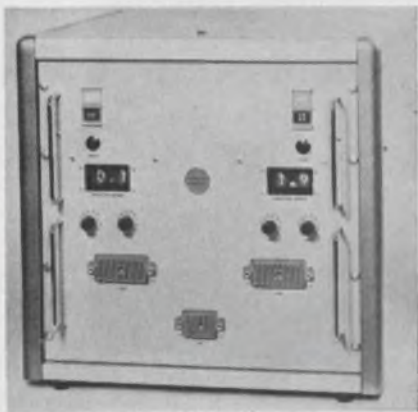

The model QC 400 automatic printed circuit tester offers go/no-go analysis of compact printed assemblies. Continuity resistance, shorts and open circuit tests are performed at five per second.

Points are cross-checked to avoid multipath errors and numerical readouts display pin numbers of faults.

P&A: \$2500; 2 wks. Automation Dynamics Corp., Industrial Pkwy., Northvale, N. J. Phone: (201) 768-9200.

Circle No. 254

## Null detector

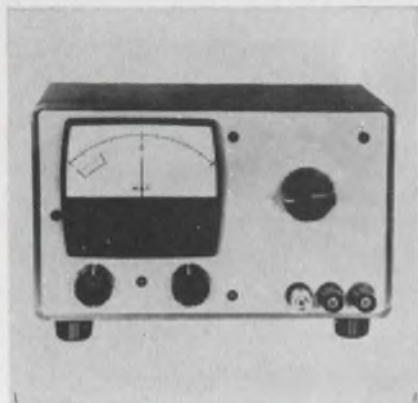

The model 810, zero-centered, polarity-sensing null detector provides a usable sensitivity of 1  $\mu$ V. Input filtering provides more than 70-dB ac pickup rejection. A guarded battery power supply eliminates common mode coupling. Input impedance is 1 Meg and power consumption is less than 30 mW. Zero offset control balances out up to 100  $\mu$ V.

P&A: \$295; 10 days. Electro Scientific Industries Inc., 13900 N.W. Science Park Dr., Portland, Ore. Phone: (503) 646-4141.

Circle No. 263



## Servo analyzer

A transfer function analyzer with analog and digital outputs provides an automatic method for determining lf characteristics of any 3- or 4-terminal network. The "Servodyne" accepts a test signal and compares phase and amplitude with the sinusoid it generates. Forcing function amplitude is preset with  $\pm 2\%$  accuracy from 10 mV to 10 V peak while frequency is adjustable from 0.1 to 99 Hz. Ratio of drive-to-test signal amplitude is measured with  $\pm 0.5$ -dB accuracy over a 60-dB range. Phase is measured over  $\pm 180^\circ$  with  $\pm 1.5^\circ$  accuracy.

Canoga Electronics Corp., 1805 Colorado Ave., Santa Monica, Calif. Phone: (213) 451-1341.

Circle No. 256

## Pulse amplifier

As a pulse modulator for RF amplifiers, or a power supply for pulsed beacon magnetrons, TWTs or klystrons, the model 604 pulse amplifier offers adjustable rise times of 25 to 100 ns to 1500 V and 15 to 100 ns to 500 V. Operating from 115 Vac, the amplifier accepts 10 V inputs from any generator and amplifies it up to 1500 V at 6 A.

Output pulse width is variable from 50 ns to dc. Rep rates are single-shot to 1 MHz. Internal floating deck construction permits ground-based output of either polarity. Overshoot is less than 5%, line regulation is 1% for 10% change and load regulation 1% for no load to full load.

Price: \$2900. Cober Electronics Inc., 7 Gleason Ave., Stamford, Conn. Phone: (203) 327-0003.

Circle No. 257





### Capacitance tester

A dual-range capacitance tester provides in-line digital readout of capacitance, dissipation factor, equivalent series resistance and dc leakage current over 120 Hz or 1 kHz. Capacitance is measured to  $\pm 0.25\%$  full scale accuracy, dissipation factor to  $\pm 0.2\%$  and resistance to  $\pm 2\%$ . With an internal 0 to 100 Vdc bias supply, dc leakage current is measured to  $\pm 1\%$ .

P&A: \$4500; stock to 30 days. Micro Instrument Co., 13100 Crenshaw Blvd., Gardena, Calif. Phone: (213) 323-2700.

Circle No. 258

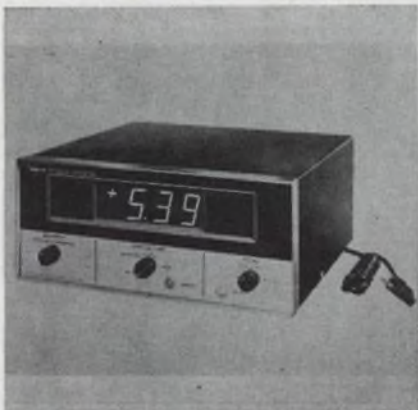

### Digital voltmeter

The model 111 dc DVM finds applications in production testing, incoming inspection and quality control. Accuracy of 0.1% is claimed for the 0.001- to 999-V range. The 3-digit segmental display is said to be readable from 20 ft even with high background light.

Printer output and ac capabilities are available as options.

Price: \$500. Simpson Electric Co., 5200 W. Kinzie St., Chicago. Phone: (312) 379-1121.

Circle No. 259

## Ballantine High Voltage AC/DC Calibrator Model 421A

Price: \$650

Portable  
 0-111 V dc  
 0-1110 V ac  
 400 or 1000 Hz,  
 RMS or Peak-to-Peak  
 May be used with  
 Optional Error  
 Computer



**NEW,  
 Improved!**  
**Accurately Calibrates to 0.15%  
 Vm's, 'Scopes, Recorders...**  
*(and other ac and dc voltage-sensing devices)*

Ballantine's new Model 421A is an accurate source of dc or ac voltage that can be set precisely to any value desired up to 111 volts on dc or up to 1110 volts on ac. It's small, rugged, portable . . . enabling you to check with ease a wide range of instruments without loss of down time. You'll find it useful, too, as an accurate, stable source for measurements of gain or loss, and as a stable source for bridges or strain gauges.

The selected voltage is indicated digitally to four significant figures on each of six decade ranges. The voltage indicated may be dc, or it may be ac at 400 Hz or 1000 Hz, RMS or Peak-to-Peak.

Note, for example, the settings in the photo — 42.35 volts RMS at 1000 Hz output. And with an accuracy that you can be sure is better than 0.15%. The receptacle on the lower right of the instrument is for high voltage outputs from 100 volts to 1110 volts at 400 Hz, RMS or Peak-to-Peak.

In addition to its greater voltage range on ac, the Model 421A has a lower source impedance on ac than the Model 421 it replaces. It also features a connection for an optional Model 2421 Error Computer that enables you to read calibration errors directly in percentages, speeding up your calibrations considerably.

Line voltage effects on the instrument are negligible. A  $\pm 10\%$  line voltage change, for instance, causes less than a 0.05% change in output voltage.

Write for brochure giving many more details



— Since 1932 —  
**BALLANTINE LABORATORIES INC.**

Boonton, New Jersey

CHECK WITH BALLANTINE FIRST FOR DC AND AC ELECTRONIC VOLTMETERS/AMMETERS/OHMETERS, REGARDLESS OF YOUR REQUIREMENTS. WE HAVE A LARGE LINE, WITH ADDITIONS EACH YEAR. ALSO AC/DC LINEAR CONVERTERS, AC/DC CALIBRATORS, WIDE BAND AMPLIFIERS, DIRECT-READING CAPACITANCE METERS, AND A LINE OF LABORATORY VOLTAGE STANDARDS FOR 0 TO 1,000 MHZ

Speed Inquiry to Advertiser via Collect Night Letter

ON READER-SERVICE CARD CIRCLE 40

## TEST EQUIPMENT

### Kilovoltmeters



Three triple-range ac/dc kilovoltmeters in ranges of 0-5/10/25 kV, 0-10/25/50 kV and 0-25/50/100 kV ac/dc are available. Measuring 5-1/2-in. wide, 7-in. high, and 3-in. deep, the portable voltmeters weigh 2 lbs. Meter accuracy is stated as  $\pm 2\%$  dc or  $\pm 3\%$  ac full scale and maximum circuit loading is claimed to be less than  $100 \mu\text{a}$ .

P&A: \$160 to \$225; stock. Peschel Instruments Inc., Rte. 216, Patterson, N. Y. Phone: (914) 878-3251.

Circle No. 260

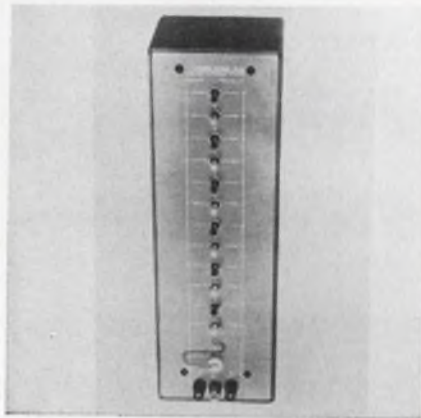

### Transfer standard

These standards transfer measurements from a 10-k $\Omega$  resistance standard to values up to 110 Megs. The instrument consists of 11 wire-wound resistors which can be switched in series, parallel or series/parallel. Models are offered with 100-k $\Omega$ , 1-Meg and 10-Meg sections. Accuracy is  $\pm 15$  ppm for 10 Megs and  $\pm 10$  ppm otherwise.

P&A: \$400 to \$775; stock to 30 days. Electro Scientific Industries, 13900 N. W. Science Park Dr., Portland, Ore. Phone: (503) 646-4141.

Circle No. 264

### Frequency converters



Series ATA frequency converters are stable sources of 400 Hz power operating from 50 to 70 Hz lines. Frequency stability, waveform purity and low dynamic impedance are reported. Output power is 100 to 1000 VA. Voltage regulation, from no load to full load, is 0.5%. Line regulation is  $\pm 0.5\%$  from 105 to 125 V.

P&A: \$620 to \$2300; stock. Del Electronics Corp., 521 Homestead Ave., Mount Vernon, N. Y. Phone: (914) 699-2000.

Circle No. 261

### Synchro bridge

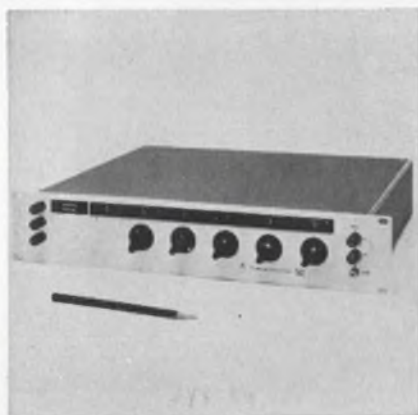

This synchro bridge measures electrical angular data of 3-wire synchros to 2 s of arc. As a null detector with a phase angle voltmeter, it can measure all commercially available synchro transmitters. Null meter deviation is used for interpolation of angular error. The instrument has a resolution of  $0.0001^\circ$ .

P&A: \$1000; 30 to 60 days. Electric North Atlantic Industries, 200 Terminal Dr., Plainview, N. Y. Phone: (516) 681-8600.

Circle No. 262



### Resistivity bridge

Semiconductor materials can be checked on the production line with a semi-automatic portable direct-reading resistivity bridge.

A 10-turn helical pot with a scale length of 100 divisions covers from 0.01 to 1000  $\Omega\text{-cm}$  with  $\pm 5\%$  accuracy. A high-precision probe is optional. The 10-lb unit is battery powered.

Price: \$545. J. A. Radley Research Institute, Elgar Rd., Reading, Berks., England. Phone: Re-82428.

Circle No. 265

### Multimeter



With more than 54 ranges, this solid-state multimeter covers dc and ac voltage and current, RF to 1.5 GHz and  $2 \Omega$  to 20 Megs center scale. Both Vac and dc have 11 ranges covering 12 mV to 1200 V full scale. Dc accuracy is  $\pm 2\%$  with 10 Meg/V input resistance. RF accuracy is  $\pm 0.5$  dB to 500 MHz. The meter is powered by 3D cell batteries.

Price: \$795. Edwin Industries Corp., 5858 E. Molloy Rd., Syracuse, N. Y. Phone: (315) 454-4407.

Circle No. 255



## New microelectronic package for semiconductors permits mechanized production of hybrid integrated circuits

From the very first days of microelectronics, designers and manufacturers of hybrid film circuits have sought a semiconductor package truly suited for the new technology.

The ideal package would be of microminiature dimensions; it should be capable of mounting on the substrate by mass production, jiggling techniques; capable of being completely characterized for both AC and DC measurements and readily pre-selected (for noise, gain, etc.,) for critical applications.

LIDS (leadless inverted devices) developed by Amperex fulfill all of these requirements... and more.

As a start, Amperex is offering two high-performance silicon planar epitaxial transistor families in the new Amperex LIDS: high-speed switches similar to the 2N2369 and low-noise, high gain amplifiers similar to the 2N930. Dual-diodes will

be available next, followed by the entire Amperex line of small signal RF, AF and switching types.

The Amperex LID is an all-ceramic package that is smaller (0.075" x 0.045" x 0.032") and less costly than any existing metal package. Its smaller size permits the manufacturer to reduce costs by reducing the substrate size.

Having no external wiring expensive wire-bonding machinery and the skilled labor to operate it are no longer needed; handling is simpler, breakage is eliminated and production yields of the integrated circuits will be higher.

For complete protection before, during and after assembly, the transistor chip is coated with epoxy after it is mounted in the LID.

In place of delicate, external wire leads, LIDS have four contact legs that are an integral part of the ceramic package. Their surfaces are coated with metallized solderable gold. This construction permits the LIDS to be positioned on the substrate by automatic jigs, without the need for micro-optics for orientation.

Any number of LIDS can be mounted simultaneously for true mass production volume and cost savings. LIDS are bonded to the substrate by low-temperature soldering, which, unlike the usual high temperature techniques does not alter the transistor characteristics.

Unlike chips, LIDS can be characterized, and pre-selected for critical circuits; and unlike chips, they can be color-coded or similarly marked and so identified for easy and efficient production.

To learn more about Amperex LIDS, write: Amperex Electronic Corporation, Semiconductor and Receiving Tube Division, Dept. 371, Slatersville, Rhode Island 02876.

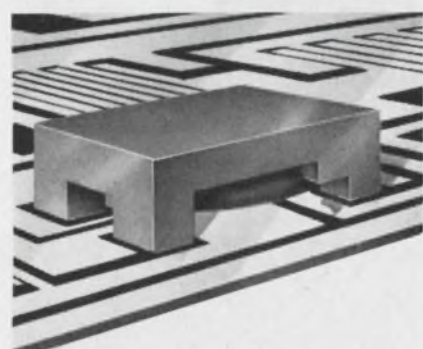

Speed Inquiry to Advertiser via Collect Night Letter  
ON READER-SERVICE CARD CIRCLE 41

## TEST EQUIPMENT

### Impedance bridge



The model 250 DE portable impedance bridge measures up to 12 Megs at 0.1%. Capacitance can be measured to 1200  $\mu\text{F}$  at 0.2% and inductance to 1200 H at 0.3%. Sensitivity is better than 20  $\mu\text{V}$  on dc and 10  $\mu\text{V}$  on ac. Direct D and Q readings for capacitance and inductance measurements are provided. Power is by 4D cells.

P&A: \$470; stock to 30 days. Electro Scientific Industries, 13900 N. W. Science Park Dr., Portland, Ore. Phone: (503) 646-4141.

Circle No. 266

### Video converter

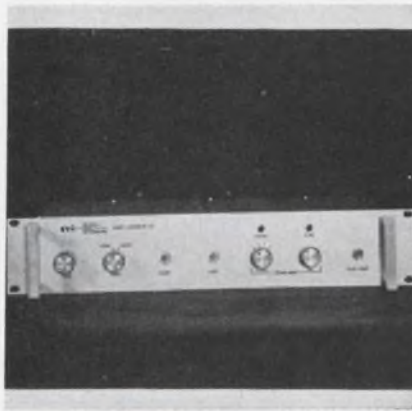

This solid-state video converter provides a "slow-scan" TV signal from "real-time" inputs. The model 201 converts by sampling instead of using storage tubes, providing superior resolution, grey scale and shading characteristics.

Slow-scan frame rates are variable from 5 s to 60 s with analog or digital output.

P&A: \$1950; 60 to 90 days. Colorado Video Inc., P. O. Box 928, Boulder, Colo. Phone: (303) 444-3972.

Circle No. 267

### Voltmeter



This VTVM features a 9-in. display and covers 0 to 1500 Vdc. Other ranges are 0 to 1500 mAdc, 0 to 1500 Vac rms and p-p, -10 to +66 dB, 0.2  $\Omega$  to 1000 Megs and 50 pF to 2000  $\mu\text{F}$ . Input impedance is 11 Megs on dc and ac tests, with 3% accuracy and ac measurement capability to 200 MHz.

P&A: \$184.50; stock. Hickok Electrical Instrument Co., 10514 Du Pont, Cleveland. Phone: (216) 541-8060.

Circle No. 268

### Voltage digitizer

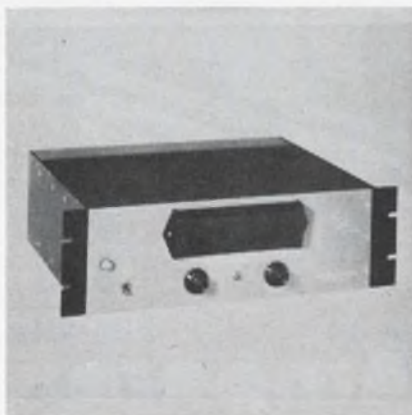

A 3-decimal digit voltage digitizer provides parallel output and sequential output in either serial or serial/parallel. The rack-mount converter is a comparator as well as a "verifier" whereby the flip-flop indicates if input changed during conversion or exceeded range. Featured are transistor PC cards, accuracy of  $\pm 0.05\%$ , speeds to 20,000 measurements/s or aperture time of 50  $\mu\text{s}$ .

P&A: \$3485; stock. Electronic Development, 423 W. Broadway, Boston. Phone: (617) 268-9696.

Circle No. 269



### Digital multimeters

The series 8000 digital multimeters feature automatic polarity and over-range indications. Four-digit readout indicates Vac, Vdc and  $\Omega$ . Input impedance is 10 Megs on all ranges with resolution of 0.01%. Dc accuracy is 0.05%. Models are available in rack-mounting configurations and with print-out capability.

P&A: From \$495 to \$695; 30 days. California Instruments Corp., 3511 Midway Dr., San Diego, Calif. Phone: (714) 224-3241.

Circle No. 270

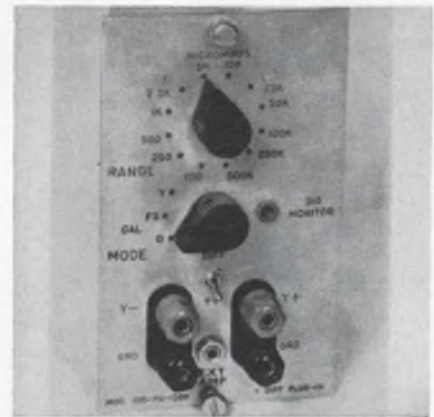

### Admittance adapter

The complex plane locus of a 2-terminal black-box admittance or the admittance difference between 2 black-boxes can be measured and plotted using this differential admittance adapter. The 100-Hz to 100-kHz adapter provides 3 Vrms across both admittances and feeds the output to a complex impedance-admittance meter. Twelve ranges up to 0.5 mhos are available.

Drantex Engineering Labs. Inc., 1233 North Ave., Plainfield, N. J. Phone: (201) 755-7080.

Circle No. 271

Now Available from General Instrument...

# HERCULEADS™

## The ULTIMATE DIODE

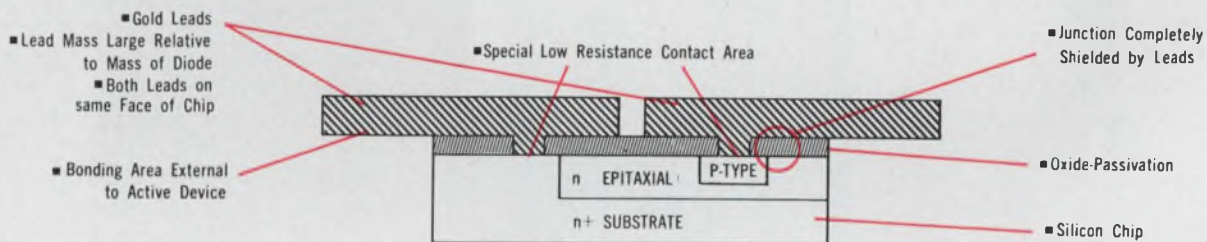

General Instrument's **HERCULEADS** beam-lead diode is a self-contained diode package with total environmental immunity—the smallest discrete diode available—and it is virtually indestructible.

### Ultimate in cost savings

The irreducible minimum in processing achieved via complete batch fabrication and self packaging offers minimum possible cost.

### Ultimate in size

The **HERCULEADS** diode is the smallest available. Together with the leads which are uniquely integrated with the diode body, it measures less than 15x30 mils.

### Ultimate in reliability

Most potential failure modes commonly associated with diodes, both electrical and

mechanical, are eliminated. All bonding leads external to the active device permit simple, economic, high rel connections without the use of eutectics, aluminum or thermal wire bonding. And total surface passivation is assured because of **HERCULEADS'** unique design and metal-over-oxide construction.

### Ultimate in versatility

Besides its use as a single, twin lead self-packaged device, the **HERCULEADS** diode is highly adaptable for use in module or stick arrays. Its design and construction make it ideal for automatic handling and positioning, and its pure

gold cantilevered leads permit high reliability bonding. Electrical parameters available are comparable to those achieved in the most advanced single-plane devices presently in use.

### Electrical Specifications for H100 Series at 25°C

PRV.....	90 V @ 10 $\mu$ A
I <sub>F</sub> .....	40 mA @ 1 V
I <sub>R</sub> .....	2 nA @ -40 V
C <sub>D</sub> .....	2.4 pf @ 0 V
t <sub>rr</sub> .....	4 ns @ I <sub>F</sub> = 10 mA to V <sub>R</sub> = -40 V

**HERCULEADS** diodes in 10-PAKS are now in stock at your authorized General Instrument Distributor.

Write for full data and specifications.

**GENERAL INSTRUMENT CORPORATION**  
**SEMICONDUCTOR PRODUCTS GROUP**

600 West John Street, Hicksville, New York



ON READER-SERVICE CARD CIRCLE 42

## Modular microwave source covers 0.25 to 40 GHz

A set of flexible plug-in units with a basic sweep oscillator and a push-button control unit are combined into a wide-range microwave signal oscillator system.

Depending on the plug-ins selected, the model 9505 can provide either single-frequency or sweep operation over a range of 0.25 to 40 GHz, or in any band thereof. The sweep speed ranges from 0.01 to 100 seconds. It can be programmed for inter-band switching times of 4 seconds with standby power applied to 65 seconds for maximum microwave tube life.

The building blocks making up the system consist of the company's model 650 series plug-in units—a sweep oscillator and from five to nine frequency units—an oscillator system controller and a regulated 26 Vdc power supply. All are contained in a standard rack console.

In addition to local control, the model 9505 can be remotely controlled and programmed by an accessory remote unit, or it can be tailored to a specific test complex configuration. More than one remote unit may be used.

P&A: About \$12,000 for a 1 to 12.4 GHz configuration, about \$16,000 for 250 MHz to 12.4 GHz coverage; 60 days. Alfred Electronics, 3176 Porter, Palo Alto, Calif. Phone: (415) 326-6496.

Circle No. 272

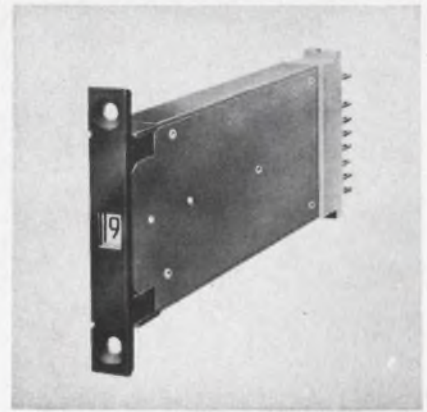
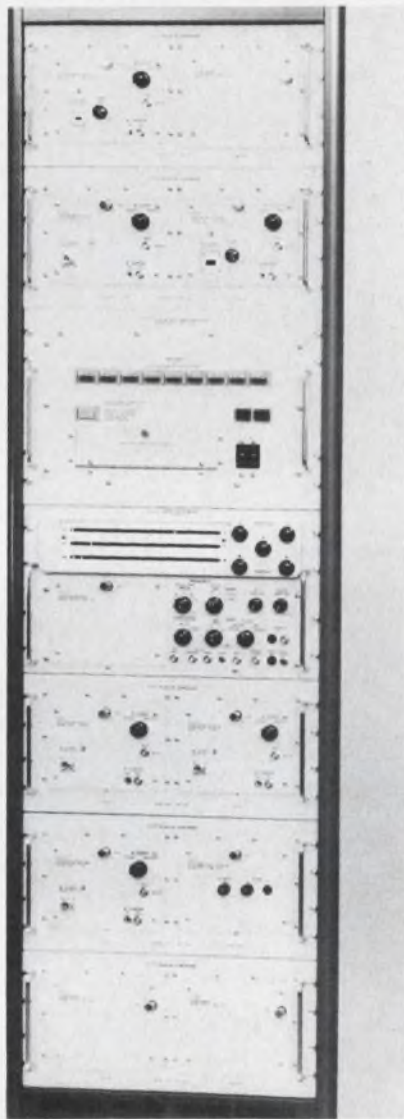

### Single decade counter

A series 444 "UNIDEC" single-decade electromagnetic counter with printout capability provides count frequencies of 60 Hz. Individual units can be grouped for high-speed counting or be used individually for control. Counters are fitted with internal contacts to permit serial or parallel operation; they can be remotely reset to zero, provide electrical readout and be used as programmable switches.

ENM Co., 5304 W. Lawrence Ave., Chicago. Phone: (312) 282-8787.

Circle No. 274



### Data modem

Model 48M data modem transmits serial digital data at rates up to 4800 bits/s in a synchronous mode over wireline networks. The unit uses a vestigial sideband technique which produces an output spectrum containing two data bits for every cycle of bandwidth. The modem is rated at  $\pm 30$  Vdc at 120 mA. Input impedance exceeds 5000  $\Omega$ .

Rixon Electronics Inc., 2120 Industrial Pkwy., Silver Spring, Md. Phone: (301) 622-2121.

Circle No. 275

### Frequency translator

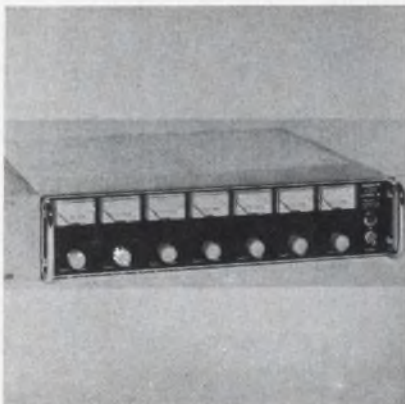

Model FT-4557 frequency translator records pre-detected 455-kHz signals. Up to 6 IF outputs are simultaneously accepted and converted to staggered frequencies between 580 kHz and 1.33 MHz. Inputs are combined into a single output signal wideband tape for recording.

Data bandwidth of the input channels is 50 kHz. Frequency conversion stability exceeds  $\pm 0.005\%$ , and harmonic distortion is less than 1%. Required input is 2 to 20 mV rms on channels 1 to 6.

P&A: \$2900; 45 days. Communication Electronics Inc., 6006 Executive Blvd., Rockville, Md. Phone: (301) 933-2800.

Circle No. 273

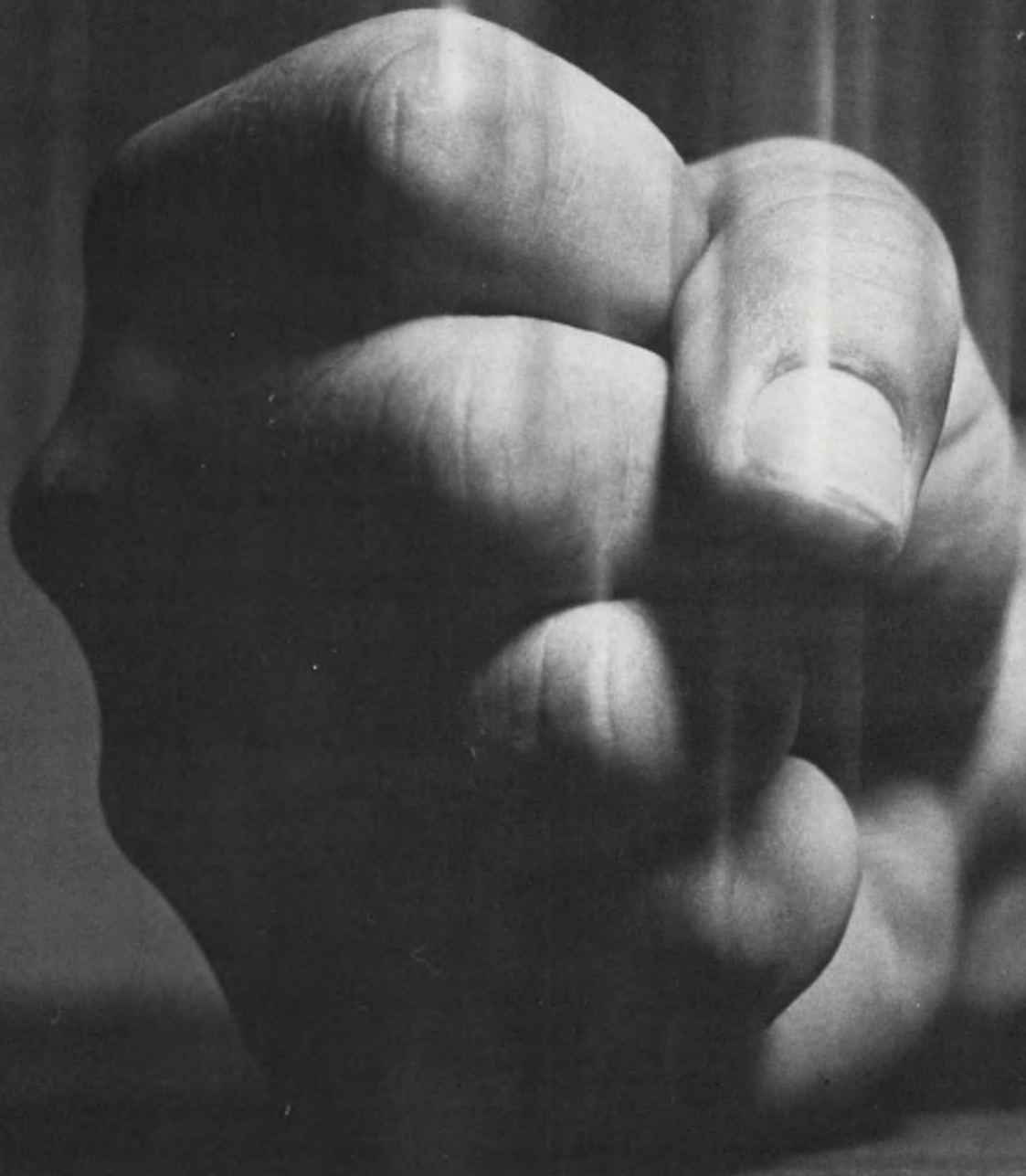

**If you felt like this the last time your subminiature relay order was rescheduled, next time call Leach**

We've got over 7,000 subminiature relays in stock at key locations throughout the country. Ready for immediate delivery. Relays like our SERIES E., a half-size unit rated for top performance in dry circuit to 2 amp switching.

Designed for printed circuit and high environmental applications, this subminiature relay offers you space and weight economies of better than 50% over full size crystal can types. Available in voltages from 6 to 26.5 VDC, the SERIES E has an operate and release time

of less than 4 milliseconds maximum, including bounce. It will withstand 100g shock, 30g vibration and operating temperatures from -65 to +125°C. Life is 1,000,000 cycles, dry circuit. Need one tomorrow? A dozen, a hundred? Then call us today. You'll have them right on time.

Leach Corporation, Relay Division, 5915 Avalon Blvd., Los Angeles, California; 90003  
Phone (Area code 213) 232-8221  
Export: LEACH INTERNATIONAL S. A.

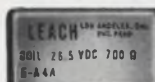

**LEACH**

## What is really important when evaluating crystal frequency standards?

## How much can you find out from aging-rate data?

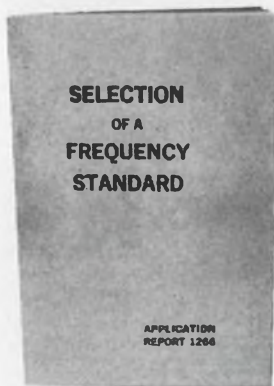

TFA-1166

Two reports will be of special help if you want to know the fine points in evaluating a crystal frequency standard.

One is "Selection of a Frequency Standard", Application Report 1266.

The other is a National Bureau of Standards report on a specific oscillator of this type.

Both are yours via the reader-service card in this magazine — or for faster response write directly to:

TRACOR, Inc.  
General Sales Offices  
6500 Tracor Lane  
Austin, Texas 78721  
Phone: 512-926-2800



**SULZER  
DIVISION**

REPRESENTATIVES IN PRINCIPAL CITIES

## SYSTEMS

### A/D converter

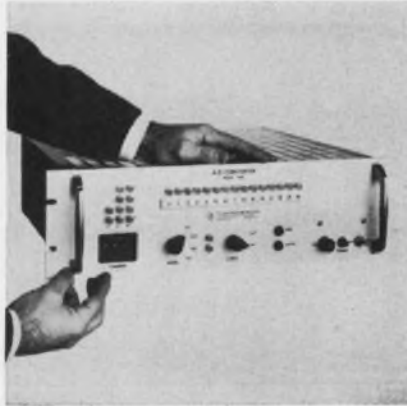

The model 848 A/D converter is a 15-binary-bit unit capable of conversion rates of 30,000/s. Accuracy is  $\pm 0.01\% \pm 1/2$  least significant bit. Up to 96 single-ended multiplexer channels can be added with plug-in circuit cards. Sample time is 5  $\mu$ s and aperture time is less than 50 ns.

P&A: About \$5000; 6 to 8 wks. Texas Instruments, 3609 Buffalo Speedway, Houston. Phone: (713) 782-9661.

Circle No. 370

### Tape block reader

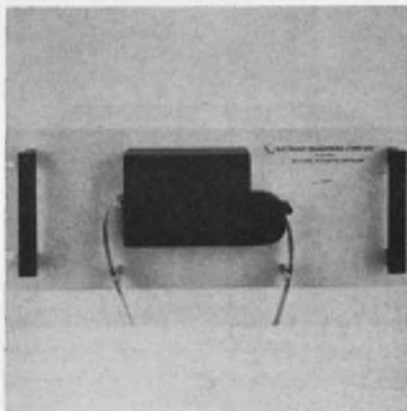

A perforated-tape block reader with capacities up to 320 bits/frame is available. Capacities are 5 to 40 eight-bit characters, equivalent to 40 to 320 bits per frame. Stepping speeds vary from 2 frames/s to 12/s. Semiconductors step-control and amplify. Outputs may be voltage levels or current switching up to 2 A.

Price: About \$1290. Electronic Engineering Co., 1601 E. Chestnut Ave., Santa Ana, Calif. Phone: (714) 547-5501.

Circle No. 371

### Digital control counter



A high-speed, digital control electronic counter, Model PS 102-1, features built-in variable dual preset. The all solid-state counter handles up to 180,000 counts per minute.

With an accuracy of 0.001% per million, the counter has a biquinary digital readout. Standard models have 2, 3, 4 and 5 decades and others are available as options.

Electro-mation, 11762 Western, Stanton, Calif. Phone: (714) 638-2822.

Circle No. 372

### Videotape recorder



A mobile broadcast videotape recorder, the VR-1100E, is 39 in. high and weighs 550 lbs.

The manufacturer states that the unit meets studio performance specifications for remote taping by broadcast stations and closed circuit TV users. Fully transistorized, the recorder is available in 50- and 60-cycle record/playback and record only models.

P&A: \$28,000 to \$50,000; May. Ampex, 401 Broadway, Redwood City, Calif. Phone (213) 367-4151.

Circle No. 373

ON READER-SERVICE CARD CIRCLE 46



# Brand **NEW** FROM **HICKOK**

## MODEL 209C 9-INCH VTVM

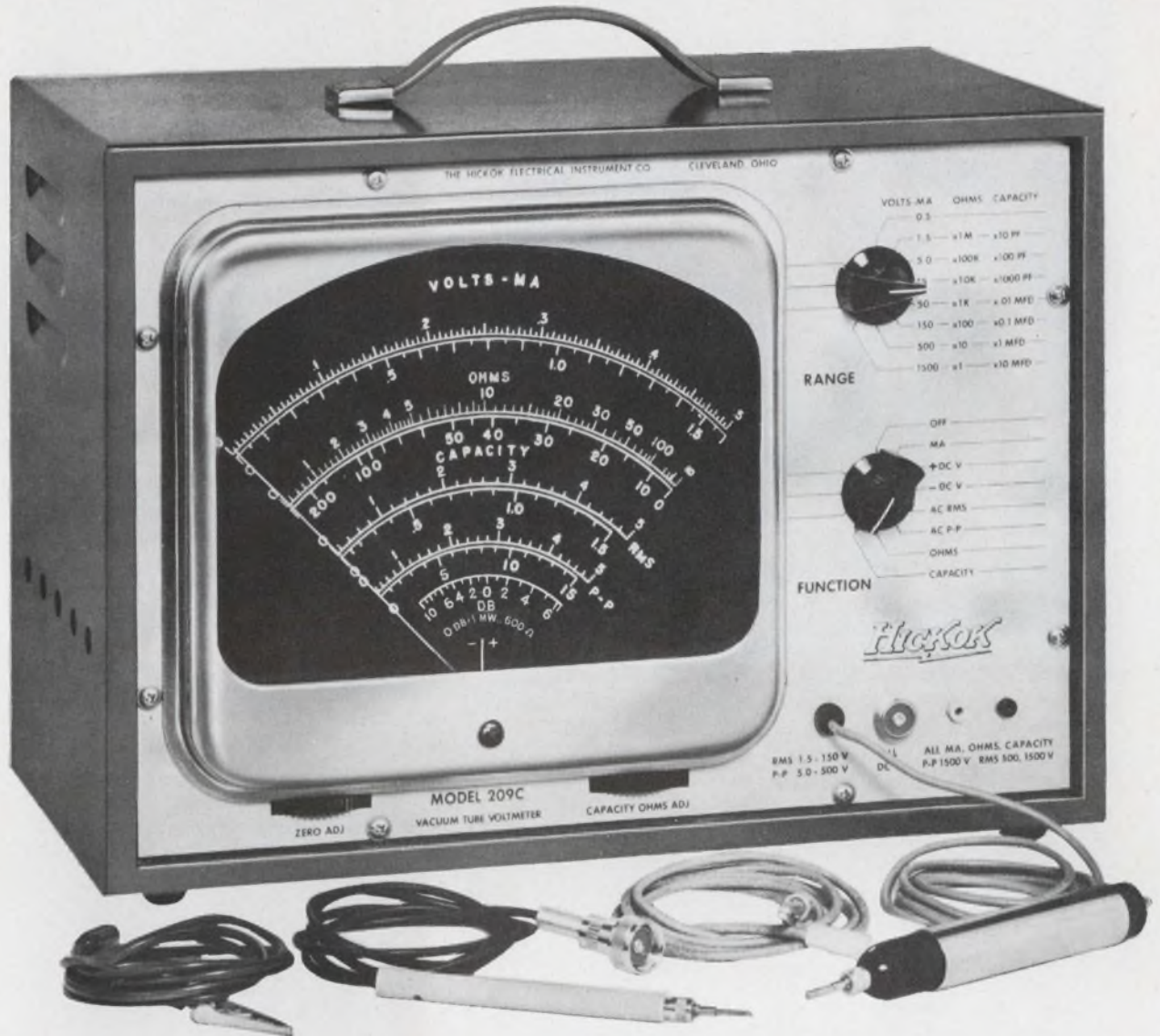

### HIGHLIGHT FEATURES

- ... Large 9" Display
- ... Ultra Stable Circuitry
- ... High Input Impedance
  - DC—11 megohms
  - AC—10 megohms, 11pf
- ... AC Measurements Up To 200mc
- ... High Accuracy
  - DCV, ACV— $\pm 3\%$  FS
  - Ohms, Capacity— $\pm 3\%$  ARC
- ... Lightweight—15 lbs.
- ... Fully Field Tested
- ... Measurement Ranges
  - DC Voltage—0-1500v
  - DC Current—0-1500ma
  - AC Voltage (RMS)—0-1500v
  - AC Voltage (P-P)—0-1500v
  - Decibels—-10db to +66db
  - Resistance—0.2 ohm to 1000 meg.
  - Capacity—50pf to 2000Mfd
  - Inductance—obtainable mathematically from scale readings

Price \$184.50

THE HICKOK ELECTRICAL INSTRUMENT CO. • 10514 Dupont Avenue • Cleveland, Ohio 44108

ON READER-SERVICE CARD CIRCLE 43

Oscilloscope designers

**THIS\***  
**WILL BRIGHTEN**  
**YOUR IMAGE!**

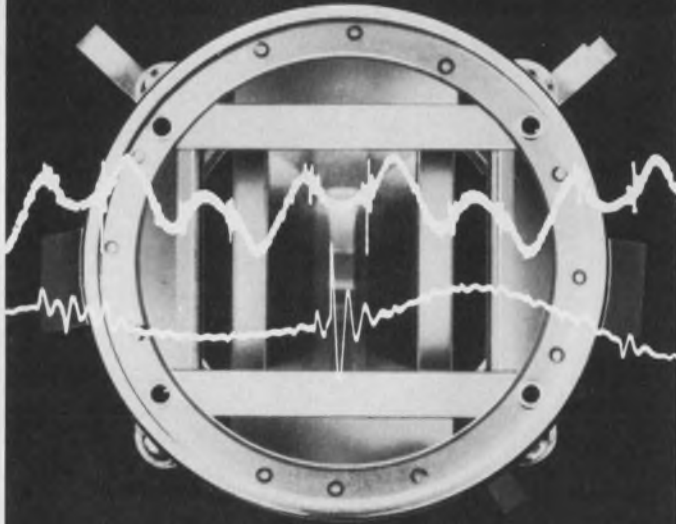

M-O V's latest precision instrument C.R.T. is the world's first dual-trace mesh P.D.A. tube. This technique produces new standards in brilliance and sensitivity.

A rectangular flat-face tube, the 1300P extends M-O V's wide range of dual-trace precision instrument C.R.T.'s.

*The new Dual-trace Tube has all these features.*

- 10 kV (Va4) operation for high brightness and writing speed.
- High deflection sensitivities—Sy 5 V/cm. Sx 10 V/cm. 1.5. kV Val.
- Deflection blanking.
- Independent astigmatism adjustment.
- Useful scan (each trace)—6 cm x 10 cm.
- Full overlap of traces.
- Rectangular flat face to save panel space 12 cm x 9 cm.
- Spot size 0.35 mm shrunk raster for a current of 5uA per beam.

\* The mesh P.D.A. assembly of the 1300P.

*For full technical specification of the 1300P write to:*

**Genalex**

**THE M-O VALVE CO. LTD.**

*North American Sales Manager:*

David LaFrenais · 9 Codeco Court

Don Mills · Ontario · Canada · Phone: 416-447-5511

ON READER-SERVICE CARD CIRCLE 44

SYSTEMS

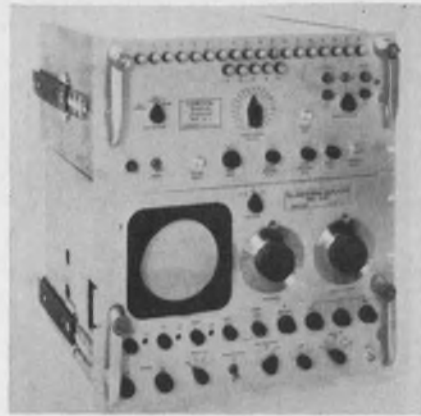

### Spectrum analyzer

A calibrator combined with a spectrum analyzer gives visual display of IRIG channels at 3 sideband check points. Sideband sequencing for channels 1 to 18 plus A through E can be automatic. The TCC-1 controls analyzer center frequency, sweep width, resolution and gain in the CAL position at 0.01% of frequency. A max drift rate of  $\pm 30$  Hz over 24 hours is reported. Both components can be used separately. Visual monitoring in the 350-Hz to 120-kHz range with a scanning unit is possible.

P&A: \$13,750; 30 days. Probe-scope Co. Inc., 211 Robbins La., Syosset, N. Y., Phone: (516) 433-8120.

*Circle No. 276*

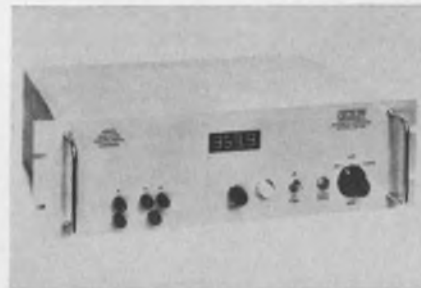

### S/D converter

This synchro to digital converter converts 3- or 4-wire synchro data into 11-bit parallel output. It meets MIL-T-21200, and features an average conversion time of 5 ms with an accuracy of  $\pm 1$  bit. Line-to-line voltages up to 90 V at 400 or 60 Hz are accommodated. Multiplexing capability permits the conversion of any of the 4-input channels.

Gap Instrument Corp., 17 Brooklyn Ave., Westbury, N. Y. Phone: (516) 333-8020.

*Circle No. 277*



### Tape recorder

The PI-6200 is a magnetic recorder featuring 3-speed operation in a 100:10:1 ratio with center speed of 3.75 in./s. In the closed-loop drive system the capstan is an integral part of the drive motor shaft. A crystal-controlled phase-locked servo system is used. FM or direct recording is provided for 8 channels. From 1 to 8 data or audio modules can be added.

P&A: About \$5400. Precision Instrument Co., 3170 Porter Dr., Palo Alto, Calif. Phone: (415) 321-5615.

Circle No. 278

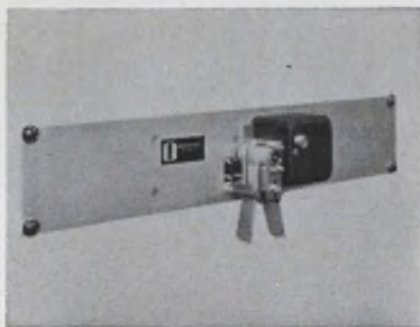

### Tape reader

Uni- and bi-directional panel-mounted tape readers operate at a speed of 0 to 30 characters /s asynchronously in either direction. A dual cross-coupled stepping mechanism permits this action. Tape sensing is by star-wheel actuated switches. The series 119 reads blocks of punched data as a conventional block tape reader. Units are available at 24, 48 or 90 Vdc.

Price: About \$320; stock. Ohtronics Inc., 111 W. 50th St., New York. Phone: (212) 581-3570.

Circle No. 279

# It's NEW!

another

## UNIMAX FIRST



*This series  
of miniature-  
subminiature  
switches  
with integral  
actuators*



ACTUAL SIZE

eliminates the use of auxiliary actuators with resulting need for time-consuming critical adjustment during or after installation.

Integral leaf, roller-leaf, or overtravel-plunger actuators with characteristics closely controlled in manufacture assure uniform performance and simplified installation. And they can be stacked five to the inch, thus saving valuable space.

All Series MM switches make and break 7 amperes at 125/250 volts a-c or 28 volts d-c. The basic switch meets MS24547-1 per MIL-S-6743.

Free Catalog 20 gives details of dimensions and operating characteristics of Series MM switches.

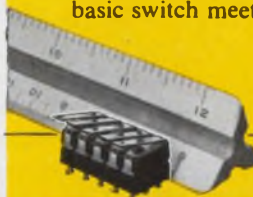

FIVE SWITCHES FIT IN ONE INCH

# UNIMAX

SWITCH

DIVISION MAXSON ELECTRONICS CORPORATION  
IVES ROAD WALLINGFORD, CONN. 06493  
Tel: 203-269-8701 • TWX: 203-269-9284

## 10-turn potentiometer

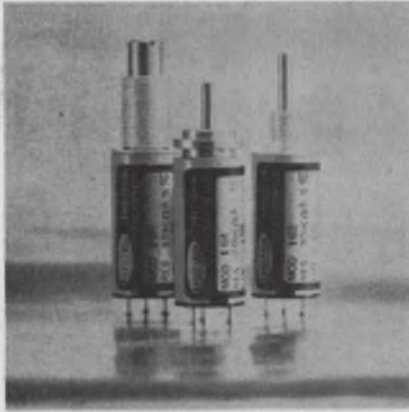

Resistance values from 100  $\Omega$  to 105 k $\Omega$   $\pm$ 5% max are offered by these 10-turn, 1/2-in. diameter pots. Standard linearity is 0.30%. Power rating is 2 W at 40°C and operating range is from -55°C to +125°C. Resolution is 0.101 to 0.015%. Model 163 features a 1/4-in. shaft while model 164 is a servo-mounting version.

Price: \$10 (1 to 9). Spectrol Electronics Corp., 17070 E. Gale Ave., City of Industry, Calif. Phone: (213) 964-6565.

Circle No. 385

## Limit switch



This miniature force ring switch can be installed in existing equipment with limited head space. Either compression or tension actuates contacts at specified loads to 1 ton. They have normally open or closed contacts and are capable of handling 5 A at 125 to 250 Vac. Accuracy and repeatability of 1% and overload safety factor of 5 are claimed.

Celtic Industries Inc., 14743 Oznard St., Van Nuys, Calif. Phone: (213) 787-3615.

Circle No. 386

## Potentiometer



A single-turn pot meeting MIL-R-12934D is available in resistance ranges from 10  $\Omega$  to 100 k $\Omega$ . Tolerance is  $\pm$ 5% from 10  $\Omega$  to 5 k $\Omega$  and  $\pm$ 3% from 10 k $\Omega$  to 100 k $\Omega$ . Power rating is 2 W at 85°C. Gangable with up to 8 cups, it functions at 150°C. The 1-5/8-in. diameter pot is wirewound and offers a  $\pm$ 0.5% independent linearity.

P&A: \$23 (1 to 9), \$21.85 (10 to 24); 4 to 6 wks. Amphenol, 120 South Main St., Janesville, Wis. Phone: (608) 754-6616.

Circle No. 387

## Triode



An axial ceramic, conical triode is for dielectric and industrial heating use. Rated to 160 MHz, the tube can be operated to 250 MHz when derated. As a class C oscillator, it will produce 8.2 kW at 82% efficiency, with a 5-kV plate voltage. The tube features thoriated tungsten mesh cathodes and mesh "K" grids. An integral radiator permits forced air cooling.

Amperex Electronic Corp., 230 Duffy, Hicksville, N. Y. Phone: (516) 931-6200.

Circle No. 388

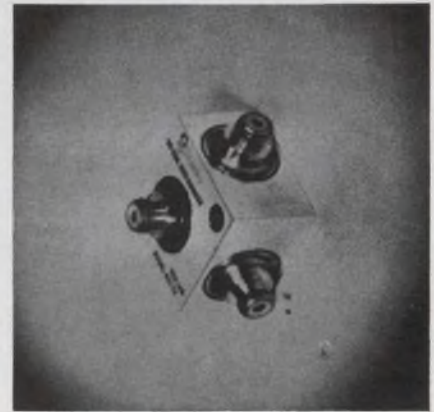

## Tri-axial accelerometer

Acceleration in three mutually perpendicular axes is simultaneously measured with the model 610-TX accelerometer. Sensitivity of the piezoelectric transducer is 8 peak mV/peak G and frequency response is  $\pm$ 5 over 1 Hz to 8 kHz with resonant frequency at 40 kHz. Vibration is 2000 peak G max and shock is 10,000 G max for 50  $\mu$ s. Amplitude linearity is  $\pm$ 1%. Temperature range is -100°F to +250°F with optional high temperature units available.

The unit measures less than 0.3-in.<sup>3</sup> and weighs less than 15 grams. Electric isolation of each accelerometer from the block minimizes ground loop problems and mechanical isolation of each transducer eliminates spurious signals.

Price: \$450 (1 to 9). Columbia Research Laboratories, Inc., MacDade Blvd. and Bullens Lane, WOODLYN, Pa. Phone: (215) 532-9464.

Circle No. 389

## Current regulators

These constant current regulators are packaged in an 8-in.<sup>3</sup> unit containing two regulators. Temperature coefficients of 0.002% to 0.03%/°C and nominal outputs of 1, 5, or 10 mA are available. Series CR can be powered in parallel from unregulated 25 to 35 Vdc sources. Regulation is 0.002% against line and load.

P&A: \$110 to \$150; stock to 4 weeks. Instrument Components Co., 5220 Lynd Ave., Lyndhurst, Ohio. Phone: (216) 442-4468.

Circle No. 390

**BURNDY LABORATORY — MC35 PRINTED CIRCUIT CONNECTORS (35 CONTACTS)**

Connectors tested: 172

Hours accumulated per connector: 1500

Connector operating hours (T): 258,000

Contact operating hours (T): 9,030,000

Number of contact failures observed (C): 0

From Poisson distribution for C: 0

and 60% confidence level T: 0.915

$$\begin{aligned} \text{connector} \\ \text{failure rate} &= \lambda \text{ connector} = \frac{\lambda T}{T} = \frac{0.915}{258,000} = 0.0000036 \\ &= \lambda 0.36\% / 1000 \text{ hrs.} \end{aligned}$$

$$\begin{aligned} \text{contact} \\ \text{failure rate} &= \lambda \text{ contact} = \frac{\lambda T}{T} = \frac{0.915}{9,030,000} = 0.0000010 \\ &= \lambda 0.01\% / 1000 \text{ hrs.} \end{aligned}$$

FAILURE: Criteria for failure were open circuits or voltage drop in excess of 30.0 millivolts (45.0 MV after salt spray.)

# **BURNDY RELIABILITY TESTS ARE RELIABLE** (HERE'S ABSOLUTE PROOF)

**FIELD CONFIRMATION — MC35 PRINTED CIRCUIT CONNECTORS (35 CONTACTS)**

Connectors in operation: 9451

Average number of hours accumulated to date: 1422

Connector operating hours (T): 13,439,322

Contact operating hours: 241,907,800

Number of failures observed (C): 0

From Poisson distribution for C: 0

and 60% confidence level  $\lambda T$ : 0.915

$$\begin{aligned} \text{connector} \\ \text{failure rate} &= \lambda \text{ connector} = \frac{\lambda T}{T} = \frac{0.915}{13,439,322} = 0.00000068 \\ &= \lambda .0068\% / 1000 \text{ hrs.} \end{aligned}$$

$$\begin{aligned} \text{contact} \\ \text{failure rate} &= \lambda \text{ contact} = \frac{\lambda T}{T} = \frac{0.915}{241,907,800} = 0.000000038 \\ &= \lambda 0.00038\% / 1000 \text{ hrs.} \end{aligned}$$

Two years ago a large systems manufacturer installed 9,451 Burndy MC35 printed circuit connectors to be used in a naval weapons system.

Their engineers reported not a single failure in more than 13 million connector operating hours — not one single contact failure in Burndy printed circuit connectors. In operation, not just the lab. 1422 hours per connector!

Just as Burndy reliability tests predicted, the rate of failure under vibration, varying temperature levels, and other environmental conditions was almost non-existent . . . performance far in excess of field expectations.

The operating performance proves Burndy connectors reliable in every way: millivolt drop, insulation resistance, connector separation force, individual contact separation, crimp-joint strength, capacitance, dielectric strength, re-

sistance to test prod damage. Just as Burndy reliability tests predicted.

The field tests mark our MC35 printed circuit connectors as reliable as we claim. More important—they prove you can rely on Burndy reliability tests.

BURNDY CORPORATION, NORWALK, CONNECTICUT



64-17

ON READER-SERVICE CARD CIRCLE 48

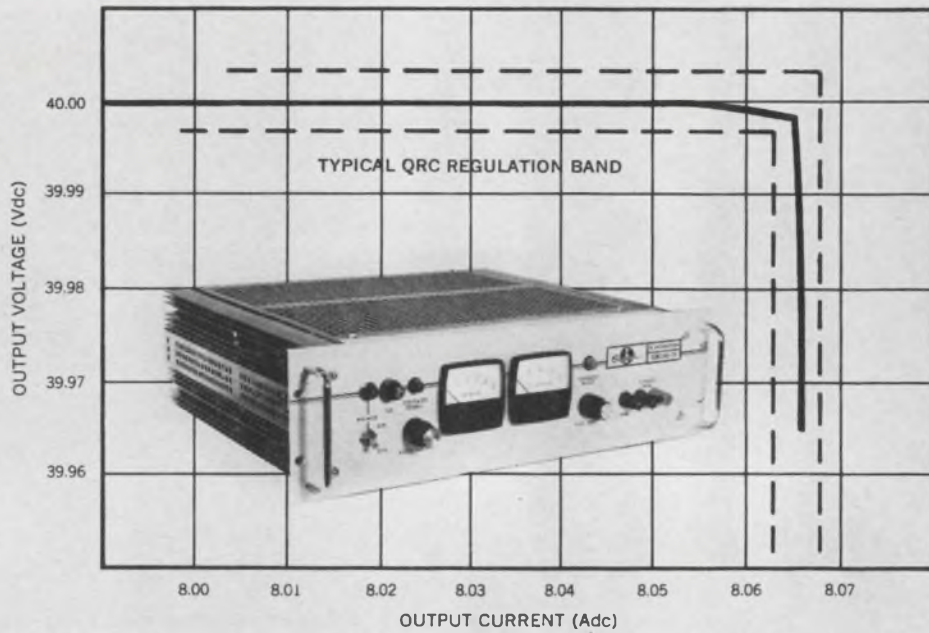

Automatic crossover between constant voltage and constant current modes

# Power Supply Specs That Set The Standard.

The Sorensen QRC series—wide range, transistorized power supplies—provide constant voltage/constant current regulation so sharp the units operate without ever leaving the specified regulation band. Voltage regulation is  $\pm .005\%$  for line and load combined. The QRC's are provided with front panel dial set adjustment of voltage and current limits, as well as voltage/current mode indicator lights. Other design features include: Low ripple...1 mV rms • No turn-on/turn-off overshoots • Re-

mate sensing and programming • Series/parallel operation • Input voltage 105-125 or 201-239 Vac, 50-400 c/s • Easily replaceable plug-in control boards • High efficiency and compact packaging. All Sorensen power supplies conform to proposed NEMA standards. For QRC details, or other standard/custom power supplies, AC line regulators or frequency changers, contact your local Sorensen rep, or write: Sorensen, A Unit of Raytheon Company, South Norwalk, Connecticut 06856.

#### ELECTRICAL & MECHANICAL SPECIFICATIONS

MODEL NUMBER	OUTPUT VOLTAGE RANGE (Vdc)	CURRENT OUTPUT RANGE (A dc)	VOLTAGE REGULATION (LINE & LOAD COMBINED)	RIPPLE VOLTAGE (rms)	CURRENT REGULATION	RIPPLE CURRENT (rms)	RACK HEIGHT (INCHES)	PRICE
QRC20-08	0-20	0-8	$\pm .005\%$ or $\pm 1$ mv	1 mv	$\pm .05\%$ or $\pm 4$ ma	2 ma	3½	\$410.00
QRC20-15	0-20	0-15	$\pm .005\%$ or $\pm 1$ mv	1 mv	$\pm .05\%$ or $\pm 8$ ma	4 ma	5¼	525.00
QRC20-30	0-20	0-30	$\pm .005\%$ or $\pm 1$ mv	1 mv	$\pm .05\%$ or $\pm 16$ ma	8 ma	7	700.00
QRC40-4	0-40	0-4	$\pm .005\%$ or $\pm 1$ mv	1 mv	$\pm .05\%$ or $\pm 2$ ma	1 ma	5¼†	315.00
QRC40-8	0-40	0-8	$\pm .005\%$ or $\pm 1$ mv	1 mv	$\pm .05\%$ or $\pm 4$ ma	2 ma	3½	450.00
QRC40-15	0-40	0-15	$\pm .005\%$ or $\pm 1$ mv	1 mv	$\pm .05\%$ or $\pm 8$ ma	4 ma	5¼	575.00
QRC40-30	0-40	0-30	$\pm .005\%$ or $\pm 1$ mv	1 mv	$\pm .05\%$ or $\pm 16$ ma	8 ma	7	775.00

†Half rack



A UNIT OF RAYTHEON COMPANY

Sorensen represented in California by Ward-Davis Assoc., 770 S. Arroyo Parkway, Pasadena, Phone 213-684-2640; 1020 Corporation Way, Palo Alto, Phone 415-968-7116; 3492 Pickett Street, San Diego, Phone 714-297-4619.



One watt at 70°!  
Sealed for pennies extra!

## 2 very good reasons why Dale sells so many Commercial Wirewound Trimmers

**PERFORMANCE:** Dale's 2100 and 2200 series are the commercial counterparts of RT-11 and RT-10 respectively. They can be sealed for just a few cents per unit, yielding mil-level performance in all areas except temperature.

**PRICE:** Competitive and then some! Check Dale's new lower commercial prices. They were made possible through an extensive value analysis program which actually improved overall unit quality.

**DELIVERY:** New automated production facilities plus a factory stocking program combine to put your order in your plant without delay.

*Simplify trimmer ordering — a call to Dale will do it.  
Phone 564-3131, Area Code 402*

### SPECIFICATIONS

	2100	2200
<b>CASE DIMENSIONS</b>	.28 high x .31 wide x 1.25 long	.18 wide x .32 high x 1.00 long
<b>STANDARD MODELS</b>	2187 — printed circuit pins, 21 AWG gold plated. 2188 — 28 AWG stranded vinyl leads. 2189 — solder lug, gold plated.	2280 — printed circuit pins, 22 AWG gold plated. 2292 — solid wire, 26 AWG gold plated. 2297 — 28 AWG stranded vinyl leads.
<b>POWER RATING</b>	1 watt at 70° C, derating to 0 at 125° C	
<b>OPERATING TEMPERATURE RANGE</b>	-65° C to + 125° C	
<b>ADJUSTMENT TURNS</b>	25 ± 2	15 ± 2
<b>RESISTANCE RANGE</b>	10 ohms to 100K ohms	10 ohms to 50K ohms
<b>STANDARD TOLERANCE</b>	± 10% standard (lower tolerances available)	

Write for Catalog B



**DALE ELECTRONICS, INC.**

1328 28th Avenue, Columbus, Nebraska  
In Canada: Dale Electronics, Canada, Ltd.



ON READER-SERVICE CARD CIRCLE 49

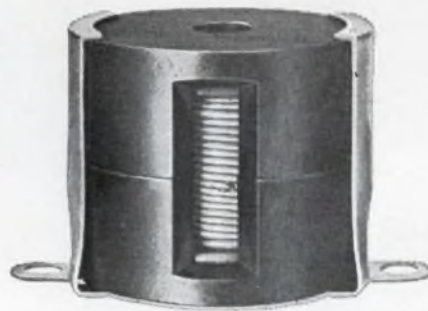
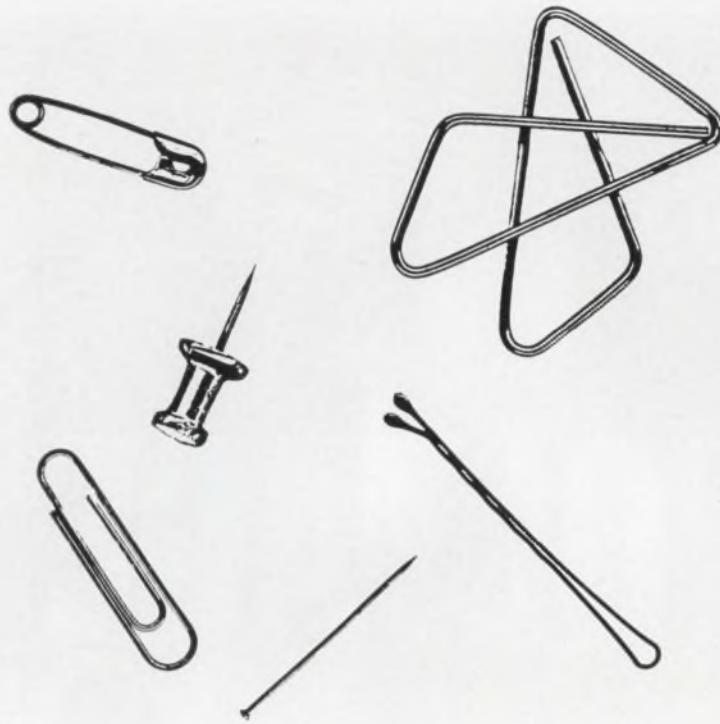

## TIMESAVERS, PURE AND SIMPLE

### Ferrite Pot Core Hardware Cuts Assembly Time 50%

A one-piece spring steel housing snaps the core assembly into place, secures it to the chassis or printed circuit board, whittles minutes out of each production hour. In applications involving high quality inductors for filters, the trimming device has been simplified for hairline adjustment.

In addition to saving time, our ferrites give you extra design advantages with their high Q values and low disaccommodation factors. We guarantee permeability over a wide temperature range ( $-55^{\circ}\text{C}$  to  $+70^{\circ}\text{C}$ ), and precision-ground air gaps

assure uniformity of inductance throughout each production lot.

Manganese zinc ferrite cores are furnished in permeabilities of 650, 900, 1300 and 2000 for frequencies up to 2 MC. A 100 perm nickel zinc core covers frequencies up to 10 MC. There are 13 different sizes, including the International Electrotechnical Commission sizes—over 200 cores in all! For more information, write *Magnetics, Inc.* Dept. 31, Butler, Pa.



ON READER-SERVICE CARD CIRCLE 50



# LOW COST HI-VOLTAGE

**NPN SILICON TRANSISTORS**

300 VOLT VCER  
HFE >40 IC=20 MA VCE 10V  
5 WATTS 25° C CASE

**70¢**

TRS 301LC

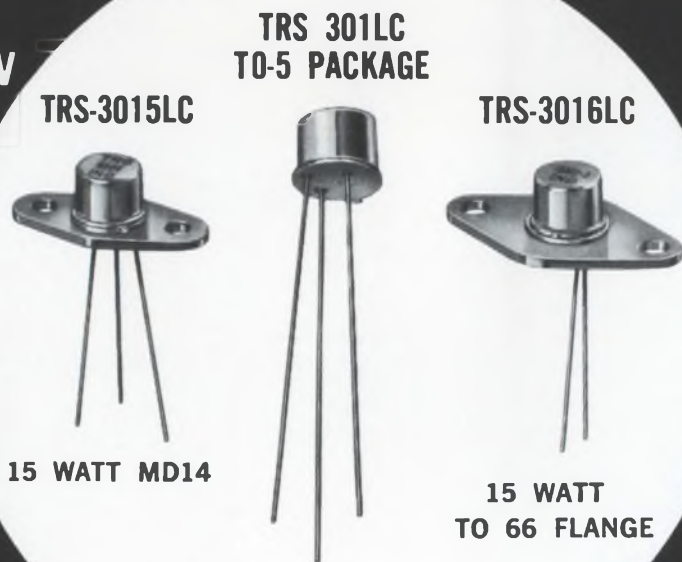

Also available  
**LOW COST**

**400V**  
**500V**  
**600V**

**INDUSTRO**

TRANSISTOR CORPORATION

35-10 36th Ave., Long Island City, N. Y. 11106 • Phone (212) 392-8000

For complete specifications  
contact any Industro  
distributor or  
sales office

## MILITARY APPLICATION

## PREMIUM LINE

### MEDIUM POWER

	$V_{CE0}$ @ $I_C = 25mA$ Sustained VOLTS	$V_{CEr}$ $R_{\theta E} = 10^\circ C$ @ 200 $\mu A$ VOLTS	$V_{CB0}$ @ 200 $\mu A$ VOLTS	$V_{EB0}$ @ 100 $\mu A$ VOLTS	NFE $I_C = 1mA$ VCE = .5V	NFE $I_C = 10mA$ VCE = 2V	NFE $I_C = 50mA$ VCE = 4V	VCE SAT. $I_C = 25mA$ $I_B = 5mA$ VOLTS	VBE SAT. $I_C = 50mA$ $I_B = 5mA$ VOLTS	$I_{CB0}$ @ 25°C VCB VOLTS < $I_B$	$I_{CB0}$ @ 100°C VCB VOLTS < $I_B$	GBW $I_C = 50mA$ VCE = 10V @ 20MC	MAX CDB $\mu A/I$ $I_E = 0$ VCB = 10V		
TRS-2804S	280	340	340	5	20	30	30	1.5	1.0	250	2	250	65	2.5	40
TRS-3204S	320	385	385	5	20	30	30	1.5	1.0	300	2	300	65	2.5	40
TRS-3604S	360	420	420	5	20	30	30	1.5	1.0	330	2	330	65	2.5	40

	$V_{CE0}$ @ $I_C = 25mA$ Sustained VOLTS	$V_{CEr}$ $R_{\theta E} = 10^\circ C$ @ 200 $\mu A$ VOLTS	$V_{CB0}$ @ 200 $\mu A$ VOLTS	$V_{EB0}$ @ 100 $\mu A$ VOLTS	NFE $I_C = 1mA$ VCE = 1V	NFE $I_C = 10mA$ VCE = 2.5V	NFE $I_C = 25mA$ VCE = 5V	VCE SAT. $I_C = 25mA$ $I_B = 2.5mA$ VOLTS	VBE SAT. $I_C = 25mA$ $I_B = 2.5mA$ VOLTS	$I_{CB0}$ @ 25°C VCB VOLTS < $I_B$	$I_{CB0}$ @ 100°C VCB VOLTS < $I_B$	GBW $I_C = 50mA$ VCE = 10V @ 20MC	MAX CDB $\mu A/I$ $I_E = 0$ VCB = 10V		
TRS-4014S	400	480	480	5	20	25	30	1.5	1.0	350	10	350	80	2.5	40
TRS-4404S	440	530	530	5	20	25	30	1.5	1.0	430	10	430	80	2.5	40
TRS-4804S	480	580	580	5	20	25	30	1.5	1.0	480	10	480	80	2.5	40
TRS-5204S	520	625	625	5	20	25	30	1.5	1.0	520	10	520	80	2.5	40
TRS-5404S	540	650	650	5	20	25	30	1.5	1.0	540	10	540	80	2.5	40
TRS-5804S	580	700	700	5	20	25	30	1.5	1.0	580	10	580	80	2.5	40
TRS-6204S	620	750	750	5	20	25	30	1.5	1.0	620	10	620	80	2.5	40
TRS-6604S	660	800	800	5	20	25	30	1.5	1.0	660	10	660	80	2.5	40
TRS-7014S	700	850	850	5	20	25	30	1.5	1.0	700	10	700	80	2.5	40

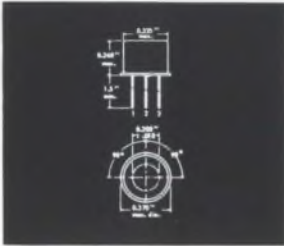

Total Dissipation @ 25°C Ambient P.D. 1W  
 @ 25°C Case Temperature P.D. 5W  
 @ 100°C Case Temperature P.D. 2W

Storage Temperature Range  $T_{stg}$  -65 to +200 °C  
 Operating Temperature Range  $T_{op}$  -55 to +175 °C  
 Peak Collector Current ICM 400 MA  
 Peak Base Current IB 50 MA

TO-5 OUTLINE

Derate 6.66 mw/°C for TA above 25°C  
 Derate 26.6 mw/°C for TC above 25°C

## MILITARY APPLICATION

## PREMIUM LINE

### HIGH POWER

	$V_{CE0}$ @ $I_C = 25mA$ Sustained VOLTS	$V_{CEr}$ $R_{\theta E} = 10^\circ C$ @ 200 $\mu A$ VOLTS	$V_{CB0}$ @ 200 $\mu A$ VOLTS	$V_{EB0}$ @ 100 $\mu A$ VOLTS	NFE $I_C = 1mA$ VCE = .5V	NFE $I_C = 10mA$ VCE = 2V	NFE $I_C = 50mA$ VCE = 4V	VCE SAT. $I_C = 25mA$ $I_B = 5mA$ VOLTS	VBE SAT. $I_C = 50mA$ $I_B = 5mA$ VOLTS	$I_{CB0}$ @ 25°C VCB VOLTS < $I_B$	$I_{CB0}$ @ 100°C VCB VOLTS < $I_B$	GBW $I_C = 50mA$ VCE = 10V @ 20MC	MAX CDB $\mu A/I$ $I_E = 0$ VCB = 10V		
TRS-2805S	280	340	340	5	20	30	30	1.5	1.0	250	2	250	65	2.5	45
TRS-3205S	320	385	385	5	20	30	30	1.5	1.0	300	2	300	65	2.5	45
TRS-3605S	360	420	420	5	20	30	30	1.5	1.0	330	2	330	65	2.5	45

	$V_{CE0}$ @ $I_C = 25mA$ Sustained VOLTS	$V_{CEr}$ $R_{\theta E} = 10^\circ C$ @ 200 $\mu A$ VOLTS	$V_{CB0}$ @ 200 $\mu A$ VOLTS	$V_{EB0}$ @ 100 $\mu A$ VOLTS	NFE $I_C = 1mA$ VCE = 1V	NFE $I_C = 10mA$ VCE = 2.5V	NFE $I_C = 25mA$ VCE = 5V	VCE SAT. $I_C = 25mA$ $I_B = 2.5mA$ VOLTS	VBE SAT. $I_C = 25mA$ $I_B = 2.5mA$ VOLTS	$I_{CB0}$ @ 25°C VCB VOLTS < $I_B$	$I_{CB0}$ @ 100°C VCB VOLTS < $I_B$	GBW $I_C = 50mA$ VCE = 10V @ 20MC	MAX CDB $\mu A/I$ $I_E = 0$ VCB = 10V		
TRS-4015S	400	480	480	5	20	25	30	1.5	1.0	350	10	350	80	2.5	45
TRS-4405S	440	530	530	5	20	25	30	1.5	1.0	430	10	430	80	2.5	45
TRS-4805S	480	580	580	5	20	25	30	1.5	1.0	480	10	480	80	2.5	45
TRS-5205S	520	625	625	5	20	25	30	1.5	1.0	520	10	520	80	2.5	45
TRS-5405S	540	650	650	5	20	25	30	1.5	1.0	540	10	540	80	2.5	45
TRS-5805S	580	700	700	5	20	25	30	1.5	1.0	580	10	580	80	2.5	45
TRS-6205S	620	750	750	5	20	25	30	1.5	1.0	620	10	620	80	2.5	45
TRS-6605S	660	800	800	5	20	25	30	1.5	1.0	660	10	660	80	2.5	45
TRS-7015S	700	850	850	5	20	25	30	1.5	1.0	700	10	700	80	2.5	45

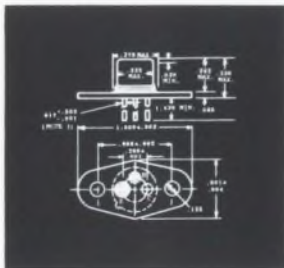

Total Dissipation @ 25°C Ambient P.D. 2W  
 @ 25°C Case Temperature P.D. 15W  
 @ 100°C Case Temperature P.D. 10W

Storage Temperature Range  $T_{stg}$  -65 to +200 °C  
 Operating Temperature Range  $T_{op}$  -55 to +175 °C  
 Peak Collector Current ICM 400 MA  
 Peak Base Current IB 50 MA

MD-14 OUTLINE

Derate 13.3 mw/°C for TA above 25°C  
 Derate 66.5 mw/°C for TC above 25°C - 100°C  
 Derate 133 mw/°C for TC above 100°C

For prices and delivery on these transistors contact **INDUSTRO** or the following **INDUSTRO** sales reps.

REPRESENTATIVES: Alpine Industries, 2236 Hepburn Ave., Dayton, Ohio, 513-CR 8-5861 • Argus Associates, Inc., P. O. Box 68, Warminster, Penna., 215-675-4131 • B & B Associates, Needham, Mass., 617-444-5562 • Domac, Inc., 1950 Bank St., Ottawa, Ontario, Canada, 613-733-3390 • Dorado Elec. Reps., 13615 Victory Blvd., Van Nuys, Calif., 213-873-4124 • J. R. Sales Eng'g Co., 6446 W. Bloomingdale Ave., Chicago, Ill., 312-889-6662 • Lectrapon Ltd., Kinbex House, Wellington St., Slough, Buckinghamshire, England, Slough 27629 • Machine & Products (European Export), 52 Wall St., New York, N. Y., WH 4-4370 • Melvin Sales, 113 Camino Real, Millbrae, California, 415-697-6922 • W. J. Stulgis Co., Inc., 698 W. Crockett St., Seattle, Washington, ATwater 2-7870 • Western Elect. Components, 4301 Birch St., Newport Beach, Calif., 714-540-1322 • White Sales Co., P. O. Box 8432, Minneapolis, Minnesota, 929-5710.



# TRANSISTOR CORPORATION

35-10 36th Avenue, Long Island City 6, N. Y. • EXeter 2-8000

	BVCER RBE @ 1MA VOLTS	BVCBO @ 1C-5MA VOLTS	BVEBO 200ua VOLTS	MIN. HFE IC-20MA VCE-10V	VCE. SAT. IC-20MA IB-5MA VOLTS	VBE. SAT. IC-20MA IB-5MA VOLTS	ICBO @25°C VCB VOLTS	<ua	GBW IC-20MA VCE-10V @ 100MC	MAX COB uuf IE-0 VCB-20V	PKG. *
TRS-301LC	300	300	5	40	2.5	1	100	10	.2	30	1
TRS-3015LC	300	300	5	40	2.5	1	100	10	.2	30	2
TRS-3016LC	300	300	5	40	2.5	1	100	10	.2	30	3
TRS-401LC	400	400	5	30	2.5	1	200	10	.2	30	1
TRS-4015LC	400	400	5	30	2.5	1	200	10	.2	30	2
TRS-4016LC	400	400	5	30	2.5	1	200	10	.2	30	3
TRS-501LC	500	500	5	30	2.5	1	300	15	.2	30	1
TRS-5015LC	500	500	5	30	2.5	1	300	15	.2	30	2
TRS-5016LC	500	500	5	30	2.5	1	300	15	.2	30	3
TRS-601LC	600	600	5	30	2.5	1	400	20	.2	30	1
TRS-6015LC	600	600	5	30	2.5	1	400	20	.2	30	2
TRS-6016LC	600	600	5	30	2.5	1	400	20	.2	30	3

		* PACKAGE #1 TO-5 OUTLINE	* PACKAGE #2 MD-14 OUTLINE	* PACKAGE #3 TO-66 FLANGE
Total Dissipation @ 25° Ambient	P.D.	1W	2W	2W
@ 25°C Case Temperature	P.D.	5W	15W	15W
@ 100°C Case Temperature	P.D.	2W	10W	10W
Storage Temperature Range	Tstg	-65 to +200 °C		
Operating Temperature Range	Topr	-55 to +175 °C		
Peak Collector Current	ICM	400 MA		
Peak Base Current	IB	50 MA		

### TO-5 OUTLINE

Derate 6.66 mw/°C for TA above 25°C  
Derate 26.6 mw/°C for TC above 25°C

### MD-14 OUTLINE and TO-66 FLANGE

Derate 13.3 mw/°C for TA above 25°C  
Derate 66.5 mw/°C for TC above 25°C—100°C  
Derate 133 mw/° for TC above 100°C

PACKAGE #1

TO-5



PACKAGE #2

MD-14



PACKAGE #3

TO-66  
FLANGE



# MILITARY & INDUSTRIAL

## MEDIUM POWER

	BVCER RBE 10: @200 uA VOLTS	BVCBO @200 uA VOLTS	BVEBO @100 uA VOLTS	HFE IC=50MA VCE=4V	VCE SAT IC=50MA IB=5MA VOLTS	VBE SAT IC=50MA IB=5MA VOLTS	ICBO @25°C VCE=10V <uA	ICBO @100°C VCE=10V <uA	GBW IC=50MA VCE=10V @20MC	MAX COB uA IE=0 VCB=10V		
TRS-1004	100	100	6	30	1.5	1	75	3	75	200	2.5	40
TRS-1204	120	120	6	30	1.5	1	100	3	100	200	2.5	40
TRS-1404	140	140	6	30	1.5	1	115	3	115	200	2.5	40
TRS-1604	160	160	6	30	1.5	1	150	3	150	200	2.5	40
TRS-1804	180	180	6	30	1.5	1	165	3	165	200	2.5	40
TRS-2004	200	200	6	20	1.9	1	100	2	100	200	2.5	40
TRS-2254	225	225	6	22	1.8	1	180	3	180	200	2.5	40
TRS-2504	250	250	6	20	1.9	1	150	2	150	200	2.5	40
TRS-2754	275	275	6	22	1.8	1	200	3	200	200	2.5	40
TRS-3014	300	300	6	30	1.5	1	200	2	200	100	2.5	40
TRS-3254	325	325	6	22	1.8	1	250	3	250	200	2.5	40
TRS-3504	350	350	6	20	1.9	1	250	2	250	200	2.5	40
TRS-3754	375	375	6	22	1.8	1	300	3	300	200	2.5	40
TRS-4014	400	400	6	30	1.5	1	300	2	300	100	2.5	40
TRS-4254	425	425	6	22	1.8	1	350	3	300	200	2.5	40
TRS-4504	450	450	6	30	1.5	1	350	2	350	100	2.5	40
TRS-4754	475	475	6	22	1.8	1	375	2	375	200	2.5	40
TRS-5014	500	500	6	30	1.5	1	350	2	350	100	2.5	40
TRS-5254	525	525	6	22	1.8	1	425	2	425	200	2.5	40
TRS-5504	550	550	6	20	1.9	1	450	2	450	200	2.5	40
TRS-5754	575	575	6	22	1.8	1	475	2	475	200	2.5	40
TRS-6014	600	600	6	30	1.5	1	500	10	500	100	2.5	40
TRS-6504	650	650	6	30	1.5	1	525	10	525	100	2.5	40
TRS-7014	700	700	6	30	1.5	1	550	10	550	100	2.5	40
TRS-7504	750	750	6	30	1.5	1	575	10	575	100	2.5	40
TRS-8014	800	800	6	30	1.5	1	600	10	600	100	2.5	40

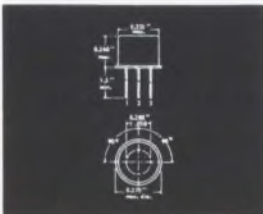

Total Dissipation @ 25°C Ambient  
@ 25°C Case Temperature  
@ 100°C Case Temperature

P.D. 1W  
P.D. 5W  
P.D. 2W

Storage Temperature Range  
Operating Temperature Range  
Peak Collector Current  
Peak Base Current

T<sub>stg</sub> -65 to +200 °C  
T<sub>op</sub> -55 to +175 °C  
ICM 400 MA  
IB 50 MA

TO-5 OUTLINE

Derate 6.66 mw/°C for TA above 25°C  
Derate 26.6 mw/°C for TC above 25°C

# MILITARY & INDUSTRIAL

## HIGH POWER

	BVCER RBE 10: @200 uA VOLTS	BVCBO @200 uA VOLTS	BVEBO @100 uA VOLTS	HFE IC=50MA VCE=4V	VCE SAT IC=50MA IB=5MA VOLTS	VBE SAT IC=50MA IB=5MA VOLTS	ICBO @25°C VCE=10V <uA	ICBO @100°C VCE=10V <uA	GBW IC=50MA VCE=10V @20MC	MAX COB uA IE=0 VCB=10V		
TRS-1005	100	100	6	30	1.5	1	75	3	75	200	2.5	45
TRS-1205	120	120	6	30	1.5	1	100	3	100	200	2.5	45
TRS-1405	140	140	6	30	1.5	1	115	3	115	200	2.5	45
TRS-1605	160	160	6	30	1.5	1	150	3	150	200	2.5	45
TRS-1805	180	180	6	30	1.5	1	165	3	165	200	2.5	45
TRS-2005	200	200	6	20	1.9	1	100	2	100	200	2.5	45
TRS-2255	225	225	6	22	1.8	1	180	3	180	200	2.5	45
TRS-2505	250	250	6	20	1.9	1	150	2	150	200	2.5	45
TRS-2755	275	275	6	22	1.8	1	200	3	200	200	2.5	45
TRS-3015	300	300	6	30	1.5	1	200	2	200	100	2.5	45
TRS-3255	325	325	6	22	1.8	1	250	3	250	200	2.5	45
TRS-3505	350	350	6	20	1.9	1	250	2	250	200	2.5	45
TRS-3755	375	375	6	22	1.8	1	300	3	300	200	2.5	45
TRS-4015	400	400	6	30	1.5	1	300	2	300	100	2.5	45
TRS-4255	425	425	6	22	1.8	1	350	3	300	200	2.5	45
TRS-4505	450	450	6	30	1.5	1	350	2	350	100	2.5	45
TRS-4755	475	475	6	22	1.8	1	375	2	375	200	2.5	45
TRS-5015	500	500	6	30	1.5	1	350	2	350	100	2.5	45
TRS-5255	525	525	6	22	1.8	1	425	2	425	200	2.5	45
TRS-5505	550	550	6	20	1.9	1	450	2	450	200	2.5	45
TRS-5755	575	575	6	22	1.8	1	475	2	475	200	2.5	45
TRS-6015	600	600	6	30	1.5	1	500	10	500	100	2.5	45
TRS-6505	650	650	6	30	1.5	1	525	10	525	100	2.5	45
TRS-7015	700	700	6	30	1.5	1	550	10	550	100	2.5	45
TRS-7505	750	750	6	30	1.5	1	575	10	575	100	2.5	45
TRS-8015	800	800	6	30	1.5	1	600	10	600	100	2.5	45

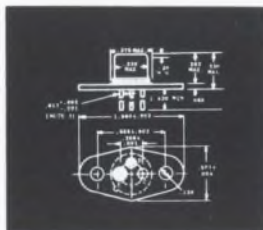

Total Dissipation @ 25°C Ambient  
@ 25°C Case Temperature  
@ 100°C Case Temperature

P.D. 2W  
P.D. 15W  
P.D. 10W

Storage Temperature Range  
Operating Temperature Range  
Peak Collector Current  
Peak Base Current

T<sub>stg</sub> -65 to +200 °C  
T<sub>op</sub> -55 to +175 °C  
ICM 400 MA  
IB 50 MA

MD-14 OUTLINE

Derate 13.3 mw/°C for TA above 25°C  
Derate 66.5 mw/°C for TC above 25°C - 100°C  
Derate 133 mw/°C for TC above 100°C

## Transformers

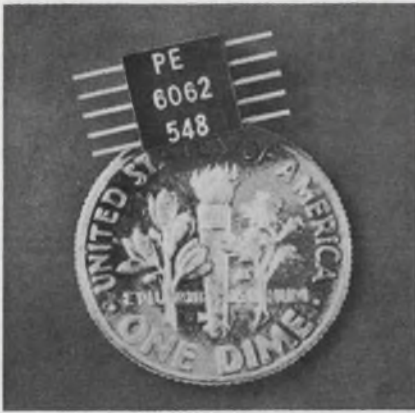

Microminiature transformers of this series can be used with sense amplifiers and discriminator circuitry and as common mode chokes. The "Flat-Tran" is compatible with ICs and standard flat pack connectors. Twelve designs are available from 25  $\mu\text{H}$  to 240  $\mu\text{H}$ . All models have gold-plated kovar leads to TO-91 packages.

P&A: \$9 each in 1 to 4 quantity; stock. Pulse Engineering Inc., 560 Robert Ave., Santa Clara, Calif. Phone: (408) 248-6040.

Circle No. 280

## Gang capacitor

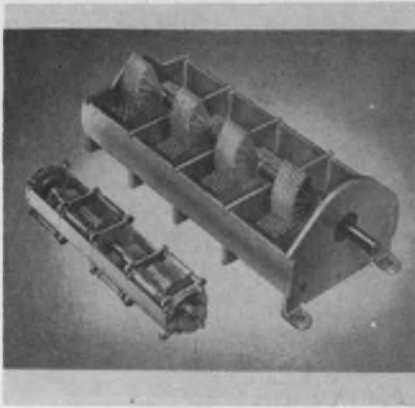

A new gang capacitor, model 6100, measures 1-1/8-in. x 1-3/16-in x 5-9/16-in. It has a capacity of 145 pF min at 9.5 pF per section (180° rotation). Shock and vibration resistance are provided by spring-type bearings and alumina support of the rotor stator. Low-temperature coefficient, low torque and smooth tuning are reported.

Johanson Mfg. Corp., 400 Rockaway Valley Rd., Boonton, N. J. Phone: (201) 334-2676.

Circle No. 281

## 10-turn potentiometer

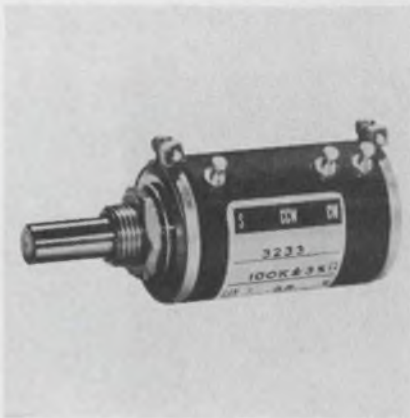

This 10-turn, wirewound pot is mounted with a 7/8-in. bushing. The model 3233 has a resistance range of 10  $\Omega$  to 200  $\text{k}\Omega$   $\pm 3\%$ . Linearity is  $\pm 0.25$  over  $-55^\circ\text{C}$  to  $+105^\circ\text{C}$ . The 2.5 W pot has a lifetime of  $2 \times 10^6$  revolutions. Uniform torque with zero backlash and 100 oz-in. stop strength are reported.

P&A: \$7.13 (250 to 499); stock. Duncan Electronics Inc., 2865 Fairview Rd., Costa Mesa, Calif. Phone: (714) 545-8261.

Circle No. 282

## B/D display

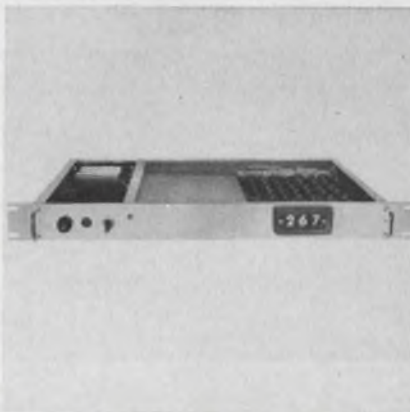

Three binary-to-decimal displays convert parallel binary data into decimals. Models 120 and 120-1 are 9-bit units with 3-digit readouts, but 120-1 is a dual unit. The 17-bit model 121 has a 5-digit readout. Logic is negative (zero=about +4 V). Input is 1 MHz max. Convert command pulse width is 2  $\mu\text{s}$ . Conversion time for the 9-bit models is 260  $\mu\text{s}$  and 33 ms for 17-bit models.

Missouri Research Labs. Inc., 2109 Locust St., St. Louis. Phone: (314) 241-7875.

Circle No. 283

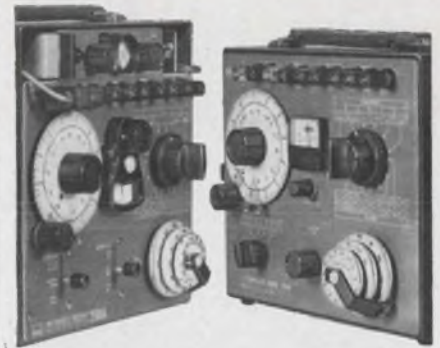

## The old master has met its match.

For more than twelve years, our 250 DA Universal Impedance Bridge ruled supreme in its field. No instrument could match its measurement performance.

Now along comes a serious challenger—our new 250 DE (at right). It has all of the reliability and accuracy of the classic model. As you can see, they look alike from the outside.

But inside, we've made many improvements. The new 250 DE is completely self reliant on its four flashlight batteries. It has a new solid-state detector with greatly improved sensitivities: better than 20 microvolts on DC, 10 microvolts on AC. For simplicity, there is a single meter null detector on the front panel. And for versatility, some useful front terminals have been added.

Why did we improve on the old master when it has delighted so many thousands with its performance in countless plants, laboratories and schools? Well, we figured eventually somebody would make a truly portable impedance bridge even better than the 250 DA. And we wanted it to be us. ESI, 13900 NW Science Park Drive, Portland, Ore. (97229).

### 250 DE Portable Universal Impedance Bridge Specifications

#### Range:

Resistance: 0 to 12 Megohms  
 Capacitance: 0 to 1200 Microfarads  
 Inductance: 0 to 1200 Henrys  
 Resistance: 0.1% + 1 dial division  
 Capacitance: 0.2% + 1 dial division  
 Inductance (Series and Parallel):  
 0.3% + 1 dial division  
 Sensitivity: Better than 20 microvolts  
 DC, 10 microvolts AC  
 Frequency: 1 kc internal  
 (External terminals provided.)  
 Batteries: 4 D size flashlight batteries  
 provide 6 months of normal service.  
 Weight: 12 lbs. Price: \$470.00

Note: The 250 DA features exactly the same accuracy specifications as the 250 DE. However, the 250 DA is AC line-operated. Price: \$495.

Electro Scientific Industries **esi**®

ON READER-SERVICE CARD CIRCLE 51

## COMPONENTS

### Load resistor

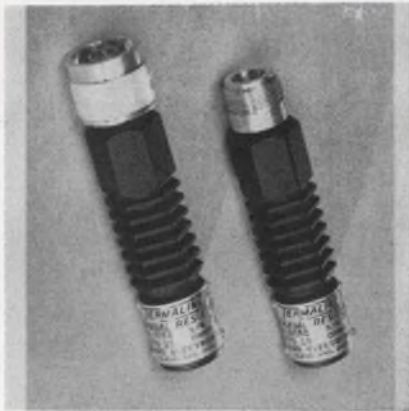

Operating from dc to 4000 MHz with negligible vswr, this precision dry load resistor utilizes broadband RF construction. A 10-W power rating results from new heat transfer materials and the addition of cooling fins to the hexagonal radiator. Available with a male or female N-connector, the resistor is used in 50- $\Omega$  transmission line or system attitude-insensitive terminations.

P&A: \$30; June. Bird Electronic Corp., 30303 Aurora Rd., Cleveland. Phone: (216) 248-1200.

Circle No. 284



### Photoconductor cells

The 4507 and 4508 photoconductor cells are spst switches which operate up to 1 kHz. They can switch or modulate dc signals in the sub-microvolt level. Illumination of the photocells with self-contained neon glow lamps actuates the switch. The 4507 has a cell for high-impedance circuits while the 4508 has a cell for low impedance.

Price: \$8 (1 to 9), \$6.80 (10 to 99). hp associates, 620 Page Mill Rd., Palo Alto, Calif. Phone: (415) 321-8510.

Circle No. 288

### Impulse counter

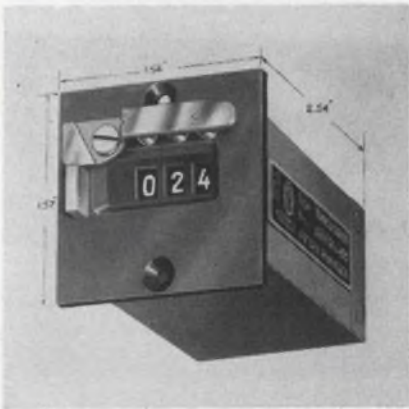

This 3-digit predetermining impulse counter counts down from the pre-set number and actuates an spdt contact at 0. Manual or electrical reset returns the counter to the pre-set. The preset number is changed with a front-panel adjustment. Operation at speeds up to 50 counts/second from  $-40^{\circ}\text{F}$  to  $+140^{\circ}\text{F}$  and coil voltages of 4 through 110 Vdc or ac are featured.

Kessler-Ellis Products Co., 46 Center Ave., Atlantic Highland, N. J. Phone: (201) 291-0500.

Circle No. 285

### Connectors



These connectors substitute an integral shoulder for an O-ring in the molded-end heads, thus assuring good contacts. As the hand-screwed cap is tightened, the lead is driven fully home; once locked in place, it cannot be pulled out. The type LGH connectors handle up to 50,000 Vdc with an average of 10 A. With ceramic or glass epoxy receptacles, temperature limits range between  $-55$  and  $+140^{\circ}\text{C}$ .

Amp. Inc., 155 Park, Elizabethtown, Pa. Phone: (717) 367-1105.

Circle No. 286

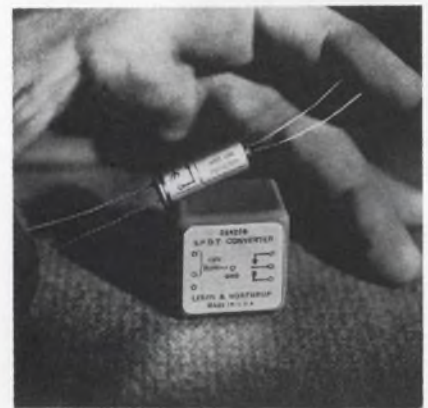

### Choppers

Both of these new photoconductive choppers are electro-optical switching devices comprising light sources and photocells for 60-Hz use. They offer less than  $1\ \mu\text{Vdc}$  offset, approximately  $0.5\ \mu\text{V}$  noise at 1 Hz and electrostatic shielding between lamp and cells. A 25,000- to 50,000-hour lifetime is claimed.

Leeds & Northrup, Components Div., North Wales, Pa. Phone: (215) 329-4900.

Circle No. 289

### 10-turn potentiometer



A wirewound, 10-turn pot has  $7/8$ -in. diameter and is  $3/4$ -in. long. Standard values are  $10\ \Omega$  to  $125\ \text{k}\Omega$ . Tolerance is  $\pm 3\%$  with  $\pm 0.2\%$  independent linearity.

The bushing-mount version is rated 1.6 W at  $40^{\circ}\text{C}$ , derating to 0 at  $85^{\circ}\text{C}$ . Ganged as well as single units are available.

P&A: \$10 (1 to 9); stock. Beckman Instruments Inc., 2500 Harbor Blvd., Fullerton, Calif. Phone: (714) 871-4848.

Circle No. 287

*A new edition  
for your  
electronics library...*

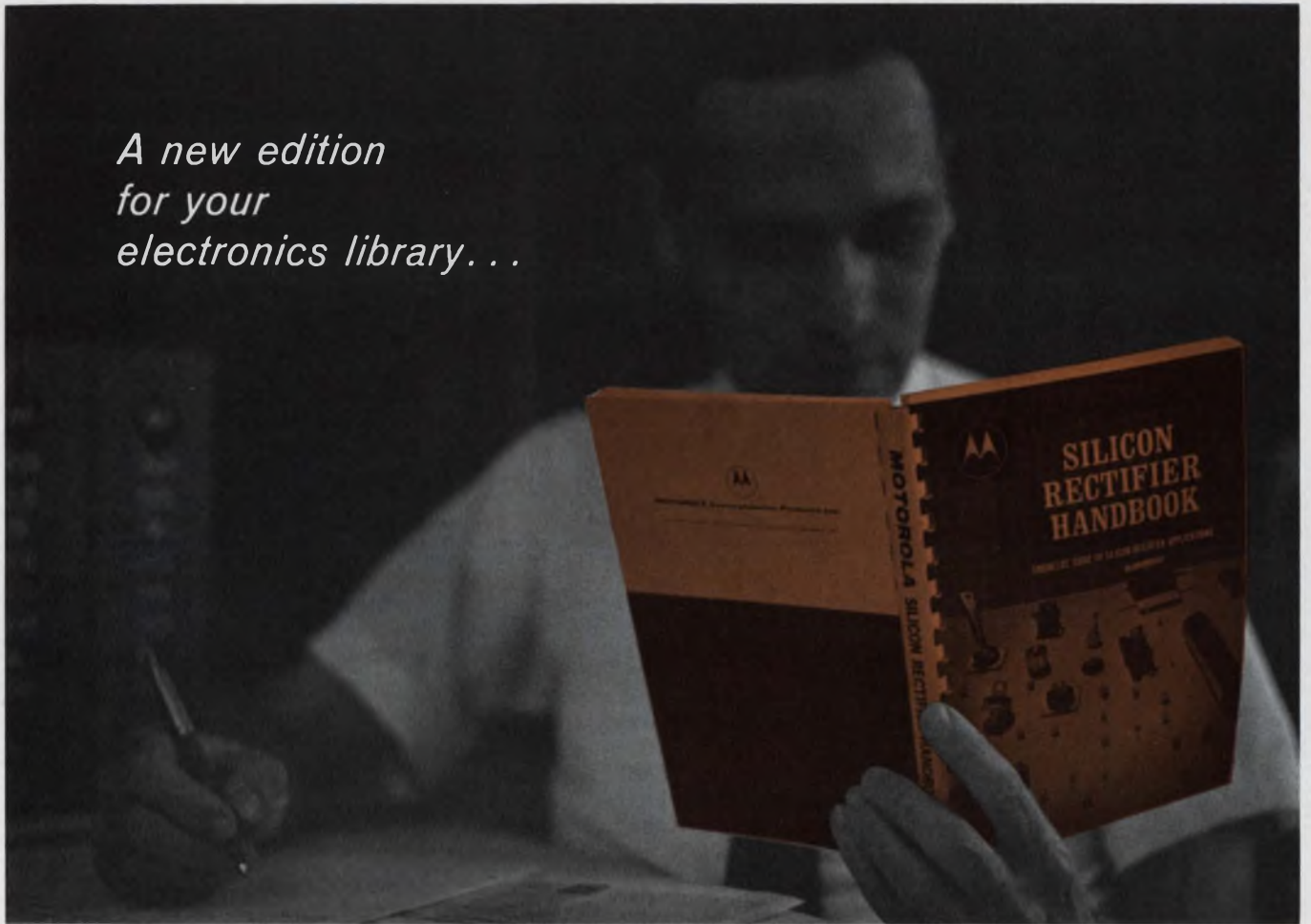

## Motorola's NEW Silicon Rectifier Handbook

*... A single source for Rectifier-Circuit design!*

Neophyte or "old hand," you'll want this authoritative reference to rectification at your elbow when designing *any* circuit involving rectifiers! Purposely (but comprehensively) brief in device theory . . . deep in *practical* rectifier circuit knowhow and written by engineers with years of industrial experience — this 216-page guide will provide the answers to your everyday circuit design problems.

### *Some of the highlights:*

- design charts for single-phase and multi-phase circuits
- heat sinking and proper cooling of devices
- over-voltage and current surge protection
- basic cell construction (written in layman's terms)
- how to understand data sheet terminology

- the Multi-Cell\* approach to very high power rectification
- practical rectifier circuits  
... *and much more!*

Send for your personal copy now . . . contact your Motorola distributor or fill out and send in the coupon below.

\*Pat. Pending

*Price: only \$1.50*



# MOTOROLA

Please send me \_\_\_\_\_ copies of Motorola's new Silicon Rectifier Handbook @ \$1.50 each.

Name \_\_\_\_\_

Title \_\_\_\_\_

Company \_\_\_\_\_

Address \_\_\_\_\_ Div/Dept \_\_\_\_\_

City \_\_\_\_\_ State \_\_\_\_\_ Zip \_\_\_\_\_

Mail with check (payable to Motorola, Inc.) to Motorola Semiconductor Products, Inc., Box 955, Phoenix, Arizona 85001

**MOTOROLA RECTIFIERS — FOR QUALITY YOU CAN MEASURE!**

ON READER-SERVICE CARD CIRCLE 52



## COMPONENTS

### Cryogenic pot

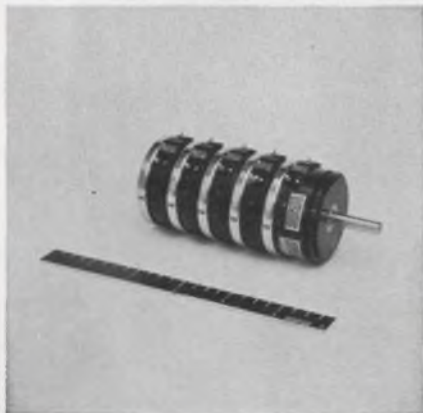

This infinite resolution cryogenic pot was originally designed for Apollo's liquid nitrogen environment. The rotary type AP32 has ambient capability of  $-300^{\circ}\text{F}$  to  $+250^{\circ}\text{F}$ . This plastic pot is supplied with 26-gauge leads or terminals in single or multi-gang. The element has  $350^{\circ}$  electrical angle with resistances of 2 k $\Omega$ , 5 k $\Omega$ , 10 k $\Omega$  and 20 k $\Omega$ . Standard linearity is 0.5%.

Markite Corp., 155 Waverly Pl., New York. Phone: (212) 675-1384.

Circle No. 374

### CRT



The D13-27 cathode ray tube has a 5-in. face and is 13.5-in. long. The tube features electrostatic focusing and deflection and has vertical sensitivity of 13 V/cm and horizontal sensitivity of 27 V/cm.

Useful scan area is 8 x 12 cm and spot size is 0.012-in. Deflection electrodes allow blanking circuitry to be referenced to ground.

Amperex Electronic Corp., 230 Duffy, Hicksville, N. Y. Phone: (516) 931-6200.

Circle No. 375



### PC transformers

A series of shielded and unshielded transformers for PC or modular circuitry is available with a 2.5, 5, 10 or 25 W rating. Shielded models have primary to secondary capacitance of less than  $5 \times 10^{-5}$  pF. Voltage breakdown is 1000 Vac and insulation resistance is 5 G $\Omega$ . Eight models, both shielded and unshielded, with 117 V, 50/60 Hz primaries are available.

P&A: \$13 to \$42; 3 to 5 wks. James Electronics, 4050 N. Rockwell, Chicago. Phone: (312) 463-6500.

Circle No. 376





## The elegant engineering solution to 20-15,000 Hz electromagnetic interference measurement problems:

### Solid-State NF-315

Noise and Field  
Intensity Meter

Here in one light, compact package is everything you need to perform rapid EMI measurements with confidence:

- Solid-state dependability
- Internal frequency and amplitude calibrators for on-the-spot checking
- 0.005 microvolt sensitivity
- Greater than 70 db spurious response rejection
- Signal range 180 db
- 8 hours continuous portable operation with built-in rechargeable battery
- Highly-stabilized circuits to eliminate recalibrations when tuning to new frequencies. All-in-all, the sophisticated simplicity which adds up to engineering elegance.

The EMPIRE NF-315 is a fast, precise, sensitive instrument with all the characteristics you need, backed by a company with an unparalleled dependability record. Military and civilian government agencies, major aerospace contractors insist on the NF-315. You should, too!



## THE SINGER COMPANY METRICS DIVISION

915 PEMBROKE ST., BRIDGEPORT, CONNECTICUT  
PHONE (203) 366-3201 • TWX 710-453-3483

Design and production of PANORAMIC • SENSITIVE RESEARCH • EMPIRE • GERTSCH Instruments for measurements

E-66-12

ON READER-SERVICE CARD CIRCLE 53

### Counting knob



Flush or panel mounted, this rear-drive counting knob fits standard 1/4-in. shafts. One turn of the knob equals 100 counts. First figure wheel has 50 sub-divisions and the knob counts from 0 to 999.

Typical applications cited for the low-torque devices include multi-turn potentiometers and instrument setting.

Landis & Gyr Inc., 45 W. 45th St., New York. Phone: (212) 586-4644.

Circle No. 377

### Photomodulators

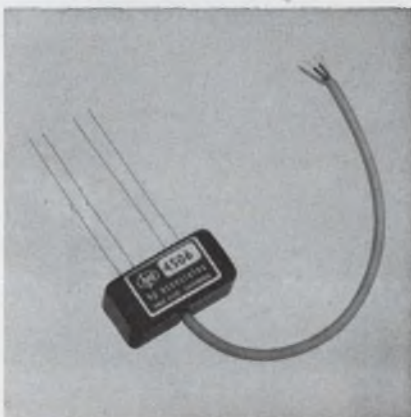

The 4505 and 4506 2-cell externally driven photomodulators operate at modulating frequencies to 1 Hz. They can also modulate dc signals in the sub-microvolt level. Modulation is by illuminating the photocells with self-contained neon glow lamps. The 4505 is for use with high-input impedance circuits and the 4506 for low-impedance circuits.

Price: \$22.50 (1 to 9), \$19 (10 to 99). hp associates, 620 Page Mill Rd., Palo Alto, Calif. Phone: (415) 321-8510.

Circle No. 378

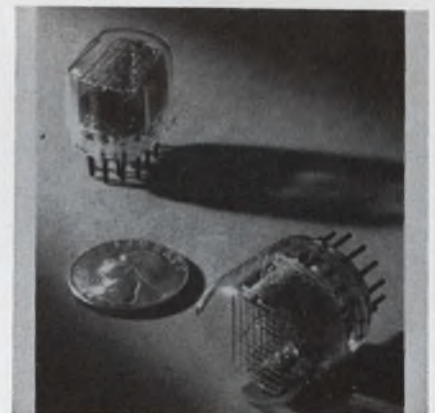

### Indicator tubes

Two end-viewing numerical indicator tubes have been introduced. The new "Datavue" tubes have conventionally shaped 5/8-in. numerals from 0 through 9. The tubes can be read from distances up to 30 ft. The CK8421 is round and the CK8422 has a rectangular cross section. Each measures approximately 1-in. by 1-in. max cross section.

P&A: About \$15.75; stock. Raytheon Co., Components Div., Lexington, Mass. Phone: (617) 862-6600.

Circle No. 379

## Film capacitors

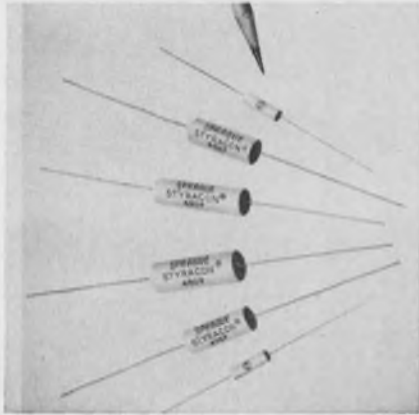

Type 490P polystyrene-film capacitors feature wrap-and-fill construction. Designed for use in filters, computers, precision timing high-Q tuned and integrating circuits, they exhibit high stability and insulation, low dielectric absorption and power factor. Standard capacitance tolerance is  $\pm 5\%$ . The capacitors are available in ratings of 35, 50, 100 and 200 Vdc, at values from  $0.001 \mu\text{F}$  to  $1.0 \mu\text{F}$ .

Sprague Electric Co., 347 Marshall St., North Adams, Mass.

Circle No. 301

## Beam emitter

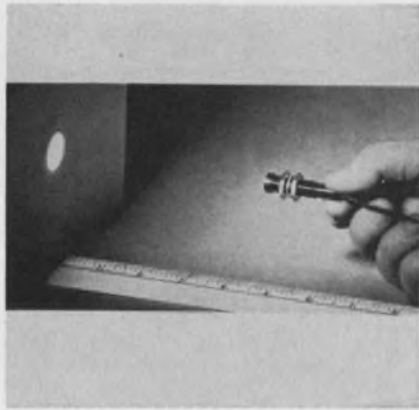

This new beam emitter will project a  $4$  to  $10^\circ$  cone of infrared and luminous energy at distances of 3 in. to 18 in. As a source of energy to activate photosensors, it has advantages of a 10,000-hour life,  $3/4$ -W consumption and variable 2- to 3-V operating range. It is designed for use with optical limit switches, optical encoders and photo switches.

Chicago Miniature Lamp Works, 4433 N. Ravenswood Ave., Chicago. Phone: (312) 784-1020.

Circle No. 302

## Coax couplers

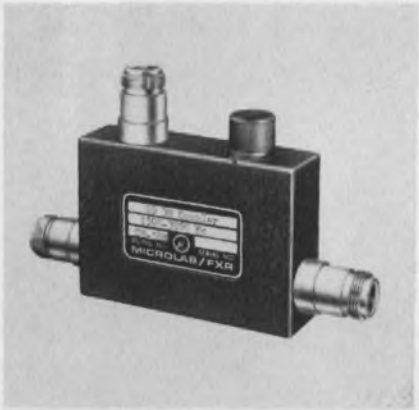

The new series CB 3 or 4-port couplers offer 25-dB directivity over a full octave with  $\pm 1$  dB coupling variation. They are available in 10, 20 and 30 dB coupling values with a mainline vswr of 1.15, and with type N and TNC connectors.

Six potted units cover from 200 to 4000 MHz in overlapping octave bandwidths.

P&A: \$90; stock. Microlab/FXR, Livingston, N. J. Phone: (201) 992-7700.

Circle No. 303

## Polyester capacitors

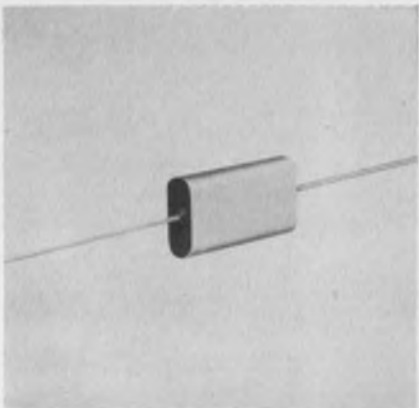

These metallized, polyester film capacitors operate over a  $-25^\circ\text{C}$  to  $85^\circ\text{C}$  range at rated voltages of 200 and 600 Vdc. Capacitance range is  $0.2 \mu\text{F}$  to  $2.2 \mu\text{F}$ . Insulation resistance is  $10^4$  Megs for less than  $1 \mu\text{F}$  and  $10^4$  Megs/ $\mu\text{F}$  for more than  $1 \mu\text{F}$ .

Power factor is less than 1% at 1 kHz and  $25^\circ\text{C}$ .

Nucleonic Products Co. Inc., 3133 E. 12th St., Los Angeles. Phone: (213) 268-3464.

Circle No. 304

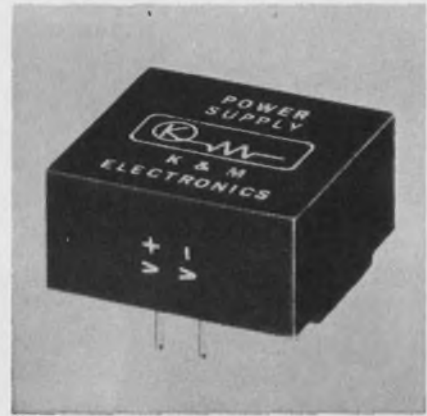

## Power supplies

A series of miniature encapsulated power supplies is designed for use with op-amps. The PS-20 modules have dual output excitation. Output voltages are from  $\pm 16$  V to 100 V at  $\pm 20$  to 3000 mA. Operating range is  $\pm 25^\circ\text{C}$  to  $+85^\circ\text{C}$ , and regulation is 0.001% to 1%. Temperature coefficients range from 0.0005% to  $0.1\%/^\circ\text{C}$ .

Price: About \$50. K&M Electronics Corp., 102 Hobart St., Hackensack, N. J. Phone: (201) 343-4518.

Circle No. 305

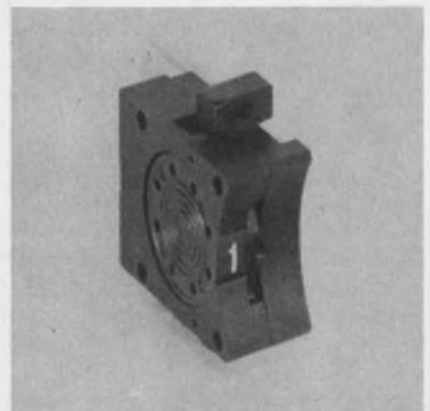

## Thumbwheel switch

An 8-position,  $45^\circ$  indexing, miniature thumbwheel switch with binary-coded octal output is available with continuous rotation action. Model 808 has octal output without complement and model 809 has octal output with complement.

Price: \$10, 1 to 9. Engineered Electronics Co., 1441 E. Chestnut Ave., Santa Ana, Calif. Phone: (714) 547-5651.

Circle No. 306

# For Fast Sorting, Incoming Inspection, and Production-Line Testing

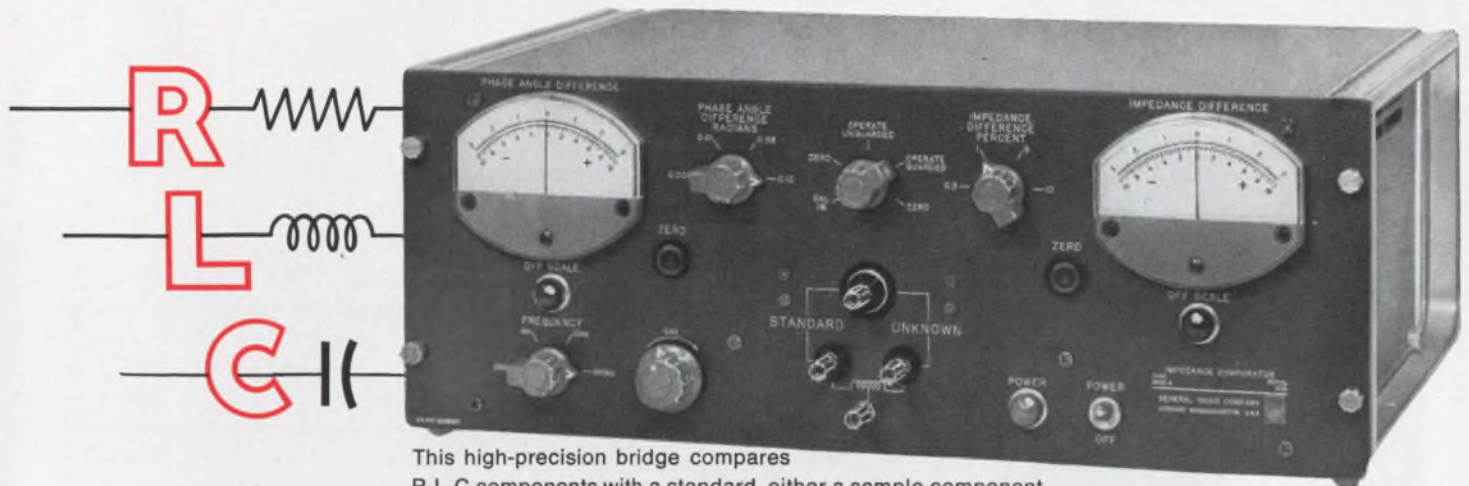

This high-precision bridge compares R-L-C components with a standard, either a sample component or laboratory standard. It is equally useful for tests on etched boards and sub-assemblies and can be operated either manually or in combination with automatic sorting equipment.

Conventional bridges can be too slow for 100% testing. For such high-volume use, a fully automatic device is often the answer, although it usually measures only one of the main parameters (R, L, or C). Where the requirements include versatility and low cost as well as speed, a third alternative, the Type 1605-A Impedance Comparator, is the best choice.

This bridge requires no manual balancing; two meters indicate the difference, in magnitude and phase, between the unknown and an external standard. Comparisons can be made with a precision of better than 0.01% for small differences. Components can be measured as rapidly as the operator can plug them into a test jig.

For matching, sorting, and production testing, the Impedance Comparator offers you the precision of manual-bridge measurements combined with the speed of the production line.

## Condensed Specifications:

There are two models of the Type 1605 Impedance Comparator: the 1605-A and the 1605-AH, which differ only in range and sensitivity. Both are available in rack and bench models.

### BASIC RANGES:

	Measurement	Impedance Range	Impedance-Mag. Difference Range	*Phase-Angle Difference Range
1605-A	Resistance (or Impedance Magnitude)	2Ω to 20MΩ	±0.3%, ±1%, ±3%, ±10%, full scale	±0.003, ±0.01, ±0.03, ±0.1 radian, full scale
	Capacitance	40pF to 800μF	Can be extended to as high as ±50% for limit tests	
	Inductance	20μH to 10,000H		
1605-AH	Resistance (or Impedance Magnitude)	20Ω to 20 MΩ	±0.1%, ±0.3%, ±1%, ±3%, full scale	±0.001, ±0.003, ±0.01, ±0.03 radian, full scale
	Capacitance	40pF to 80μF	Can be extended to as high as ±15% for limit testing	
	Inductance	200μH to 10,000H		

\*Phase-angle difference is very nearly equal to D difference (for C & L) or Q difference (for R) when either D or Q is less than 0.1.

### TEST FREQUENCY AND VOLTAGE:

Frequency (both models) — 100 Hz, 1 kHz, 10 kHz & 100 kHz, switch-selected

Voltage (across unknown & standard) — Approx. 0.3V for 1605-A  
Approx. 1V for 1605-AH

### PRICES:

Type 1605-A Impedance Comparator, \$995 in U.S.A.

Type 1605-AH Impedance Comparator, \$995 in U.S.A.

Write for complete information. Also ask about our completely Automatic Capacitance Bridge Assembly, the Type 1680-A.

BOSTON • NEW YORK • CHICAGO • PHILADELPHIA • WASHINGTON, D.C.  
SYRACUSE • DALLAS • SAN FRANCISCO • LOS ANGELES • ORLANDO  
CLEVELAND • TORONTO • MONTREAL

GENERAL RADIO COMPANY (Overseas), ZURICH, SWITZERLAND  
GENERAL RADIO COMPANY (U.K.) Ltd., BOURNE END, ENGLAND

# GENERAL RADIO

WEST CONCORD, MASSACHUSETTS

ON READER-SERVICE CARD CIRCLE 218

# Same day shipment

ON 75 STOCK ITEMS



## Chemtron\*

### REED RELAYS

OFFER YOU:

#### FAST DELIVERY

The large **CHEMTRON** line features prototype order shipment the **SAME DAY** on 75 STOCK ITEMS, plus an exclusive design flexibility that allows shipment the **SAME WEEK** on **SPECIALS**. This large stock and design flexibility also means fastest delivery on production quantities.

#### VACUUM ENCAPSULATION

A process developed specially for **CHEMTRON** relays insures maximum ruggedness and reliability.

#### 0.1" PIN SPACING FOR PC MOUNT

Board layout for **CHEMTRON** reed relays is easier.

#### MAGNETIC SHIELDING

The attractive **CHEMTRON** outer case is a magnetic shield to prevent interaction between closely spaced relays.

#### HIGH SENSITIVITY COILS

These coils allow **CHEMTRON** reed relays to be driven with low power transistors to minimize drive circuit problems.

**WRITE TODAY FOR  
YOUR FREE CATALOG**



**SELF-ORGANIZING SYSTEMS, INC.**

P.O. BOX 9918 • DALLAS, TEX. 75214 • (214) 276-9487

PLANT: 1910 N. FIRST ST., GARLAND, TEX.

\*TM SELF-ORGANIZING SYSTEMS, INC.

ON READER-SERVICE CARD CIRCLE 54

120

## COMPONENTS

### Signal conditioners

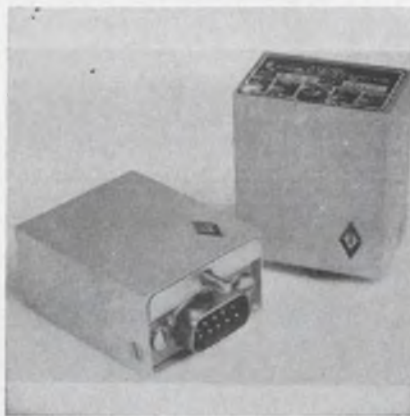

These signal conditioners convert transducer and other source outputs to standard input levels for telemetering. They meet environmental specifications for airborne applications. The TSC series measures 1.640- x 0.825- x 1.365-in. and weighs 2 oz. The units are compatible with the manufacturer's voltage-controlled oscillators and multiplexers for telemetry systems.

Availability: 60 to 90 days. United Aircraft Corp., Southampton, Pa. Phone: (215) 355-2700.

Circle No. 307

### Multiplier-divider

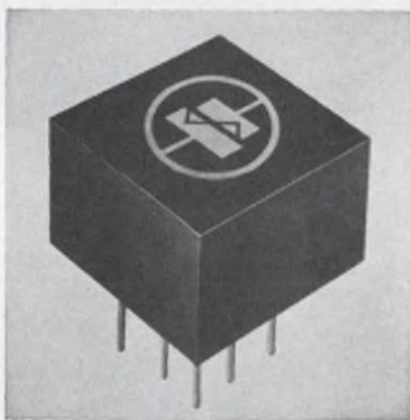

An all-dc 4-quadrant analog multiplier-divider features 1/2% accuracy. As a multiplier, the 1-in.<sup>3</sup> unit gives the product of two 0 to  $\pm 10$  Vdc inputs as a 0 to  $\pm 10$  Vdc output. As a divider, an output proportional to the product of two inputs divided by the third is given. For compatibility with op-amp integrated circuitry,  $\pm 15$  Vdc is required.

P&A: \$100; 4 weeks. Transmagmatics Inc., 134-08 36th Rd., Flushing, N. Y. Phone: (212) 539-2750.

Circle No. 308

### Lightweight relays

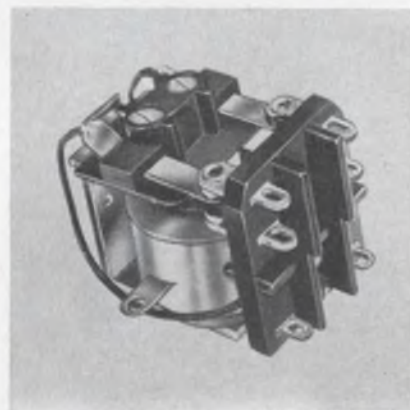

A line of molded bakelite, general purpose, open relays are rated 6, 12, 24, 115 and 220 Vac and 6, 12, 24, 48 and 110 Vdc.

These UL-approved relays are available in spdt, dpdt and 3-pole dt arrangements. They have 5-A contacts of gold-plated silver.

Artisan Electronics Corp., 5 Eastmans Rd., Parsippany, N. J. Phone: (201) 887-7100.

Circle No. 309

### Operational amplifier

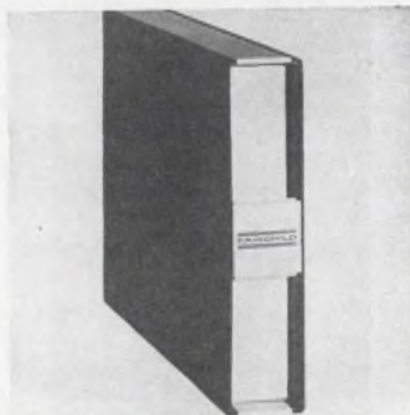

The A00-11 solid-state, chopper-stabilized operational amplifier has less than  $\pm 3 \mu\text{V}/^\circ\text{C}$  drift over the temperature range of  $-40$  to  $+100^\circ\text{C}$ .

Long term drift is said to be  $\pm 2$  mV over 100 hours. An MOS device in the modulator achieves this operating performance. Output is  $\pm 40$  mA at  $\pm 20$  V.

P&A: \$190; stock. Fairchild Instrumentation, Palo Alto, Calif. Phone: (415) 962-2451.

Circle No. 310

ELECTRONIC DESIGN



## Servo amplifier

The C70 3193 001 transistorized servo amplifier is mounted in a TO-35 case. The amplifier is a 400-Hz potted unit delivering 1.4 W at 0° phase shift. Voltage gain can be adjusted with external resistors. The amplifier meets MIL-E-5400 and delivers its rated power to a 33 V load tuned to an effective impedance of 815 Ω. It may be driven by 28 Vdc or 3-phase 400 Hz rectified power equivalent to 34.5 Vdc at 200 mA.

Availability: Stock. General Precision Inc., 1150 McBride Ave., Little Falls, N. Y. Phone: (201) 256-4000.

Circle No. 311

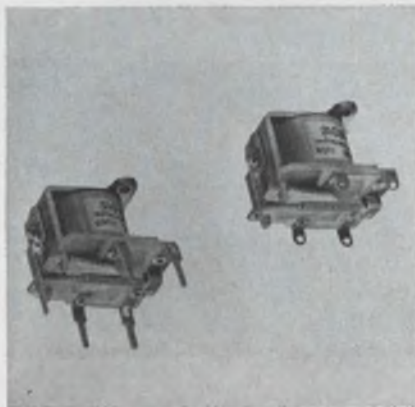

## Relays

The series 65 general-purpose spdt dc-relays are rated to switch 1-A loads 100,000 times at 29 Vdc or 115 Vac from 90-mW input signals. Operation from 6, 12, or 24 Vdc coil voltages is offered.

Sigma Instruments Inc., 170 Pearl St., Braintree, Mass. Phone: (617) 843-5000.

Circle No. 312

April 26, 1966

**Now, You Have the Smallest Rear-Projection Readout in the World!**

**It Displays Characters This Big.**



All the versatility, readability, and reliability of our patented rear-projection readouts are now available in the world's tiniest theatre: the  $\frac{3}{4}$ " H x  $\frac{1}{2}$ " W IEE Series 340. We've managed to fit everything but a projectionist in there to give you a choice and clarity of message that no other type of readout can match—regardless of size!

The tiny 340 uses *film* to project any message: numbers, letters, words, symbols, colors. *Anything* you can put on film! You're not limited to crudely formed characters that look strange to the eye. Choose type styles that human-factors tests prove to be most readable!

Your message appears clearly and sharply on a single-plane screen. There's no visual hash or camouflage-netting effect from unlit filaments. The 340 may be tiny, but your message appears *big*, up to an easily read  $\frac{3}{8}$ " in height!



### HERE'S HOW IT WORKS:

All IEE readouts are passive, nonmechanical devices built for long life. An input signal through the proper contact illuminates the desired lamp, projecting only the selected message through the lenses onto a non-glare viewing screen. This one-lamp-per-message concept eliminates character misreadings caused by partial failures.



**CLICK, IT'S IN  
CLICK, IT'S OUT!**

For quick, easy lamp replacement or change of message, just press the front of the 340, pull the whole unit out! Permanently wired base remains in assembly!



SEND TODAY FOR COMPLETE INFORMATION

**INDUSTRIAL ELECTRONICS ENGINEERS, INC.**

7720 LEMONA AVE. • VAN NUYS, CALIFORNIA • PHONE: (213) 787-0311 • TWX (213) 781-8115

REPRESENTATIVES IN PRINCIPAL CITIES

ON READER-SERVICE CARD CIRCLE 55

**Dc-dc converter**



A modified dc-dc converter features fast switching rates, ability to function at 100° C, and rapid response to transient overvoltage. The "Thin-Verter" line has 24 to 30 Vdc input and 3 to 5000 Vdc output at 40 W. The model SHU converter measures 1-5/8- x 3-1/2- x 3-5/8 in. and weighs 26 ounces.

P&A: \$195 (depending on output voltage); stock to 5 wks. Arnold Magnetics Corp., 6050 West Jefferson Blvd., Los Angeles. Phone: (213) 870-7014.

*Circle No. 313*

**Amplifier**



A solid-state plug-in replacement for popular tube-type amplifiers is announced. This amplifier, designated the A00-954, provides  $\pm 40$  mA at  $\pm 100$  V and  $\pm 10$  mA at 140 V. Applications are claimed in place of vacuum tube amplifiers to improve system reliability and avoid downtime. It operates directly on available  $\pm 300$  V supplies.

P&A: \$230; stock. Fairchild Instrumentation, Palo Alto, Calif. Phone: (415) 962-2451.

*Circle No. 314*

**Pulse transformers**

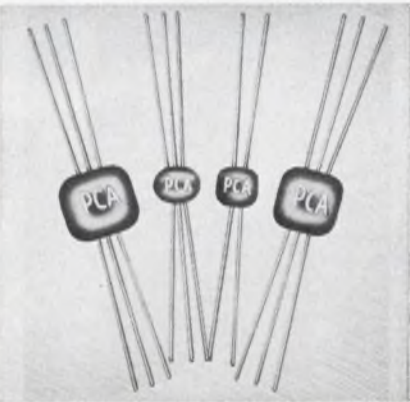

Epoxy transfer molded pulse transformers of the TT and MPT series are suitable where long life and ability to withstand a wide range of environmental conditions are critical.

Standard leads are tin-coated copper, and gold-plated dumet is optionally available.

Availability: Stock to 6 wks. PCA Electronics Inc., 16799 Schoenborn St., Sepulveda, Calif. Phone: (213) 362-0761.

*Circle No. 315*

**Ceramic capacitors**

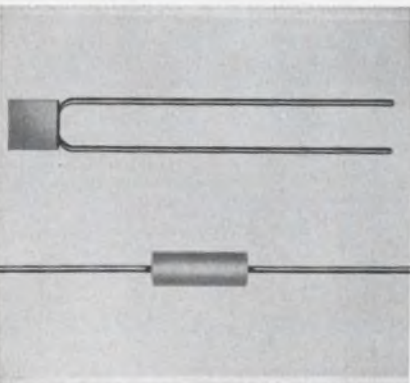

A series of rectangular and tubular ceramic capacitors with capacitance values up to  $2 \mu\text{F}$  at 50 Vdc is available. These small capacitors function at  $-55^\circ\text{C}$ .

Rectangular cases are 0.5 in. square x 0.15-in. wide with lead spacing of 0.40 in. Tubular cases are 0.312-in. dia. x 0.750-in. long.

San Fernando Electric Mfg. Co., 1509 First, San Fernando, Calif. Phone: (213) 361-8681.

*Circle No. 318*

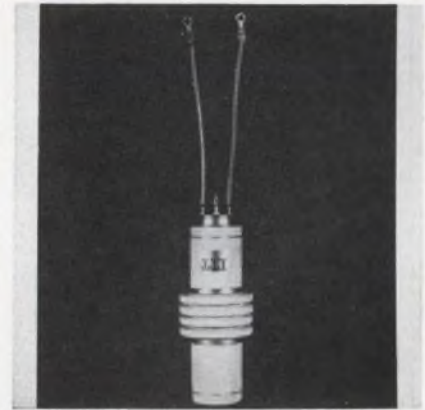

**Thyratron**

A new type of hydrogen thyratron operates at 100 kV plate potential. The tube obtains the high hold-off voltage rating with 4 potential-dividing grids equally spaced between cathode and plate. External metallic rings connected to the grids protect the ceramic envelope and seals against flashover due to transients. Peak plate current of the 10-mW tube is 200 A and drop during conduction is about 150 V. Typically the tube can be operated in a modulator at a pulse-rep rate of 1000 pulses/second with pulse width of 1  $\mu\text{s}$ .

ITT, 320 Park Ave., New York. Phone: (212) 752-6000.

*Circle No. 317*

**Directional coupler**

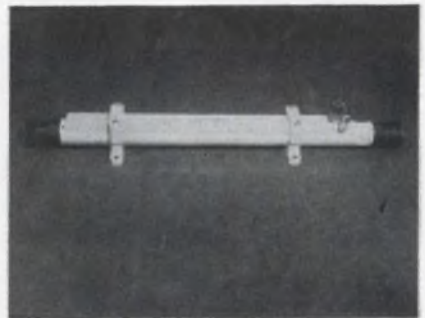

A new 2-kW, cw, 1-MW peak coupler covers 100 to 200 MHz within a length of 14-in. Mainline vswr is less than 1.1 and insertion loss is less than 0.4 dB. Coupling is  $30 \pm 0.5$  dB, with directivity in excess of 20 dB. The coupler operates from  $-65^\circ\text{F}$  to  $203^\circ\text{F}$ . LT female connectors in the mainline and an N coupled-output connector are standard.

Dynalectron Corp., 2233 Wisconsin Ave., Washington, D. C. Phone: (202) 338-4600.

*Circle No. 316*

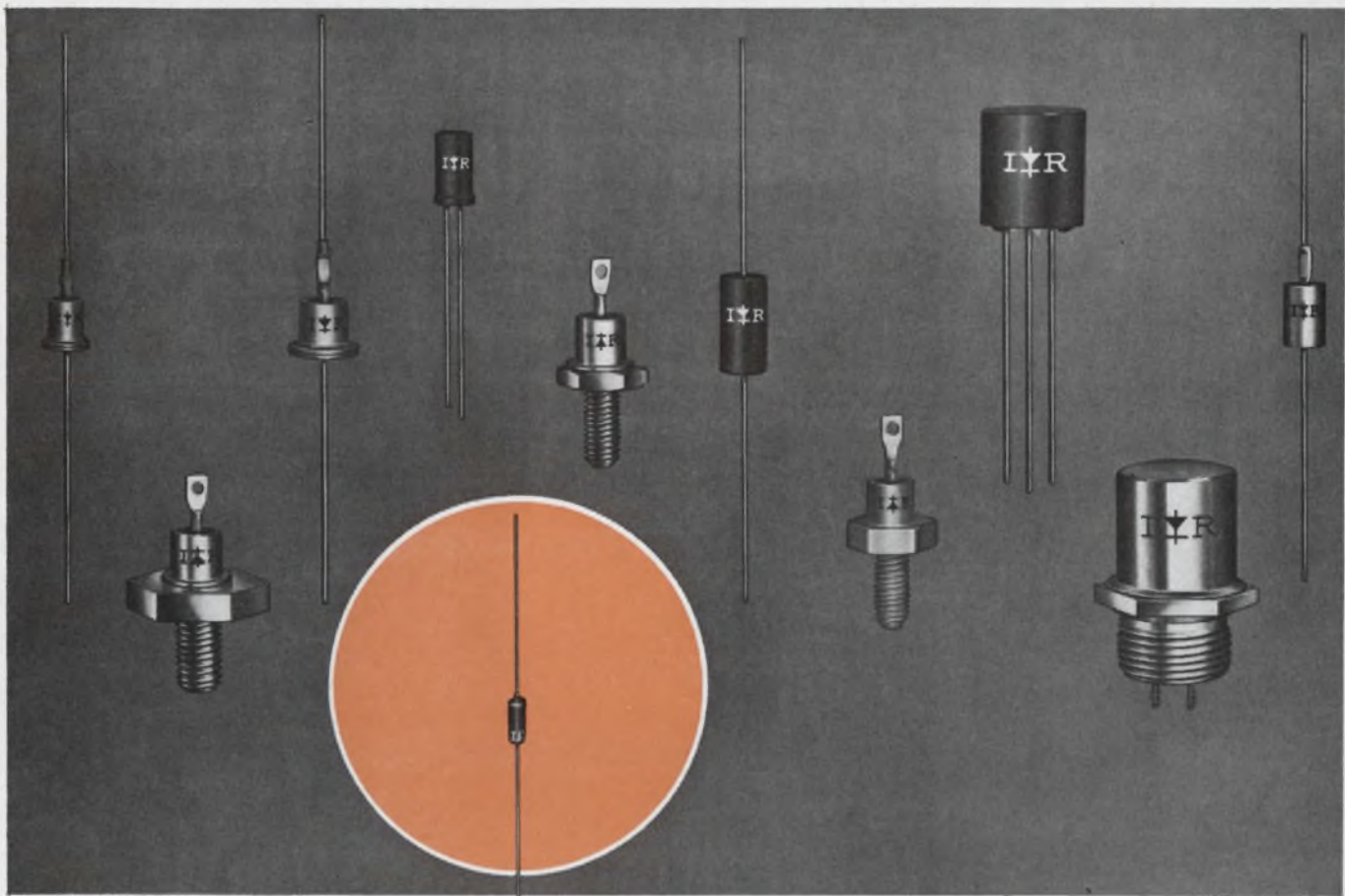

## Spotlighting ZENERS temperature coefficients up to 0.0005%/°C

Here's another addition to the IR line of guaranteed Zeners – the 1N935 through 1N939 series of voltage reference diodes. They provide an accurate reference voltage of 9.0 volts ( $\pm 5\%$ ) and 500mW dissipation – sealed in glass to assure ultimate Zener performance for life.

This series adds further versatility to IR's already broad Zener line – renowned for its superior avalanche characteristics, proved reliability. It makes IR your number-one source for all Zener needs: glass, top hat, flangeless and stud mounted from 150mW to 50 Watts, including JEDEC types and temperature compensated devices. What's more, they're all backed 100% by the only Zener lifetime guarantee in the industry.



CALL MR. RECTIFIER today for more complete information on the finest Zeners available.

**THERE'S ONLY ONE**

**IR**

WORLD'S LARGEST RECTIFIER SPECIALISTS

**INTERNATIONAL RECTIFIER**

TELEPHONE (213) OR 8-6281 • TELEX 6-74666

**EL SEGUNDO, CALIFORNIA**

ON READER-SERVICE CARD CIRCLE 219

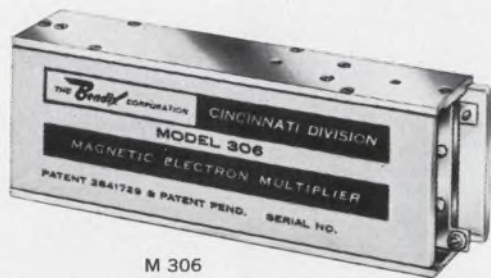

M 306

## Bendix magnetic electron multipliers offer you the largest current gains with the smallest packages.



M 308



M 310

Midget dimensions and current gains of  $10^7$  make Bendix® electron multipliers tops in the industry. These versatile detectives can handle jobs to the extreme end of the electromagnetic spectrum: photon and particle counting; ultraviolet and soft x-ray detection; high altitude solar radiation; nuclear radiation and ion detection.

Bendix multipliers are even sensitive to the hard ultraviolet range. And exposure to ambient atmosphere does not deteriorate their performance.

What about a power supply? Bendix multipliers and our model PS-304 power supply were just made for each other. It assures constant voltage differentials while levels are varied.

More information? Get in touch with us at 3625 Hauck Road, Cincinnati, Ohio 45241.

Specifications	Model M 306	Model M 308	Model M 310
Direction of view	side	end	side
Aperture (in mm)	18.3 x 15.5	10.4 x 5.3	12.5 x 12.5
Spectral response	$10^7$	$10^7$	$10^7$
Operating press. max. torr	$5 \times 10^{-4}$	$1 \times 10^{-4}$	$1 \times 10^{-4}$
Length, max. inches	4	2½	2½
Height, max. inches	.81	.93	.80
Width, max. inches	1.32	1.29	.69
Weight, nom. oz.	4½	2	2½

Bendix Cincinnati builds mass spectrometers, polarimeters, polarographic systems, viscometers and other scientific instruments for over 100 areas of research and analysis.

**Cincinnati Division**



ON READER-SERVICE CARD CIRCLE 56

## COMPONENTS



### Active limiter

A solid-state active limiter, built to MIL-specs, protects receivers from kilowatt pulse powers and features limiting greater than 60 dB. Switching speed is less than 200 ns. Insertion loss in the "off" condition is less than 0.5 dB.

Dimensions of the limiter (3-1/2- x 1-1/4- x 5/8-in.), make it suitable for airborne and portable radar.

Availability: 45 to 60 days. Micro State Electronics Corp., 152 Floral Ave., Murray Hill, N. J. Phone: (201) 464-3000.

Circle No. 319

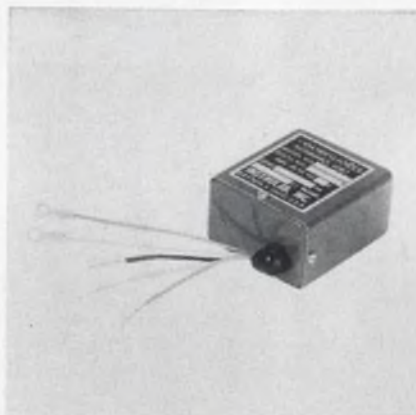

### Mercury cell eliminator

A mercury cell eliminator for X-Y plotters, recorders and computer bias circuits features line-to-output isolation of less than the equivalent of 20 pF. Input is 100 to 135 Vac, 50 to 60 Hz and output is 1.345 Vdc at 2.0 mA. Ripple is less than 50  $\mu$ Vrms for 60 and 120 Hz. Any current from 0 to 10 mA can be supplied.

P&A: \$44.50; 2 wks. Instrulab Inc., 1205 Lamar St., Dayton, Ohio. Phone: (513) 223-2241.

Circle No. 320



POWER EQUIPMENT



**Half-rack dc supply**

This new series of half-rack dc power conditioners features high power output and a lifetime warranty. Six models provide ranges of 5, 10, 20, 40, 60 or 100 Vdc, with 19.5, 14.0, 9.0, 5.4, 3.8 or 2.4 A.

Load regulation is 0.01% and stability is  $\pm 10$  mV/8 hours. Remote V and I programming and constant V and I with automatic crossover are featured.

Behlman-Invar Electronics Corp., 1723 Cloverfield, Santa Monica, Calif. Phone: (213) 393-9611.

Circle No. 321

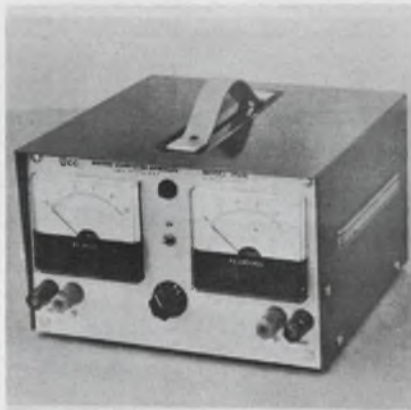

**Miniature power supply**

The model PS10 power supply is variable from 0 to 10 V. It contains a voltmeter and ammeter, and has optional rack mounting brackets. Low ripple and short circuit protection make it suitable for use with transistors and ICs. Input is 105 to 130 V at 55 to 65 Hz. Line and load regulation is 0.05% + 5 mV. Ripple is 2 mV and max current is 600 mA.

United Computer, 930 W. 23rd St., Tempe, Ariz. Phone: (602) 967-9122.

Circle No. 322

When  
you're in  
the dark...



light up  
with Hudson  
lamps

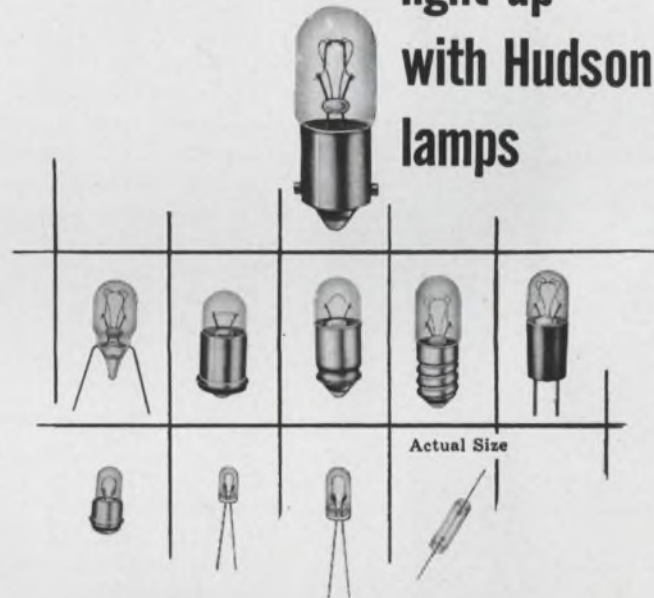

**Lives to over 100,000 hours  
Install 'em and Forget 'em!**

PROBLEMS OF SMALL SPACE ARE SOLVED in read-out devices, edge-lighted panels, illuminated switches, instruments, indicators and similar devices with miniature, sub-miniature and micro-miniature Hudson lamps immediately available from stock. Where standard lamps won't serve, special ones can be developed, such as the Tu-Pin and Axial Lead styles pioneered by Hudson to fill specific needs and now "shelf-items". You can depend on Hudson lamps to equal or better any others in standard or special applications.

Write for new catalog.

**Hudson LAMP COMPANY**

Miniature Lamp Specialists

518 ELM STREET, KEARNY, NEW JERSEY 07032

ON READER-SERVICE CARD CIRCLE 57

## Klystron

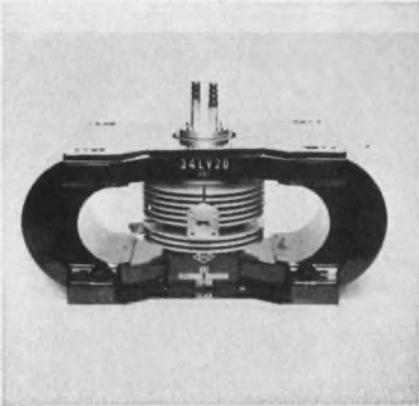

A high-power, mechanically tunable millimeter-wave klystron covers 33.2 to 34.8 GHz. Power output of 10 W at 34 GHz is reported. The 34LV20 "Laddertron" is a single-cavity, multigap klystron for communications or as a measurement power source. Either air or water cooled, the tube tunes in excess of 200 MHz. It is designed for use with 1500 to 1900 V.

Oki Electronics, 202 E. 44th St., New York. Phone: (212) 682-2989.

Circle No. 323

## Dual frequency antenna

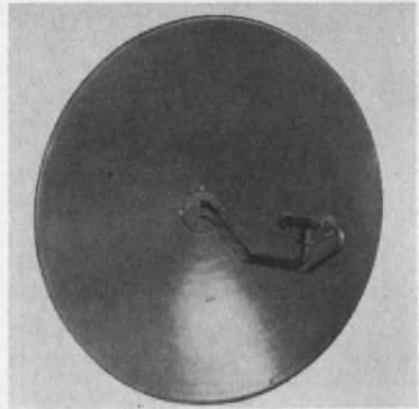

A new two-port Cassegrain-type antenna operates in the 6.575- to 6.875-GHz and 12.2- to 12.7-GHz bands. Two buttonhook feeds are mated into a common feed having a plane-polarized orthogonally arranged input for each band. Vswr is 1.15 max with polarization discrimination of 20 dB min. Typical midband gain of the 6-ft antenna is 38.8 dB for the 6-GHz band and 44.0 dB for 12-GHz band.

Andrew Corp., P. O. Box 897, Chicago. Phone: (312) 349-3300.

Circle No. 324

## Sweep oscillator



A series of microwave swept oscillators covers 1 to 40 GHz in the L, S, C, X, Ku and K bands. Better than 1% accuracy and stability is reported. Output power is 50 mW min in the 8- to 12.4 GHz band. Five independent frequency controls, each with 3-digit readout, are adjustable over the bandwidth.

P&A: \$3460 to \$6870 (depending on frequency band); stock. E-H Research Labs, 163 Adeline, Oakland, Calif. Phone: (415) 834-3030.

Circle No. 325

## C-band klystrons

Two new reflex klystrons, the VA-298 and VA-299, increase coverage of C-band radio relay communication systems. Frequency coverage extends from 5.3 to 8.5 GHz and min power of both types is 2 W. Beam voltage is 750 Vdc and beam current is 85 mA max. Reflector voltage ranges between -150 and -160 Vdc.

Varian Assoc., 611 Hansen Way, Palo Alto, Calif. Phone: (415) 326-4000.

Circle No. 326

## X-band klystrons

This 8-oz X-band reflex klystron, VA-272, is suited for pumping paramps or for doppler radar systems. Trimmable  $\pm 100$  MHz from center frequency, the klystron produces 500 mW between 8.1 and 11.1 GHz. Mechanical tuning range is  $\pm 100$  MHz and electronic tuning range is 40 MHz min. Reflector voltage is -200 to -400 Vdc.

P&A: \$450; 90 days. Varian Assoc., 611 Hansen Way, Palo Alto, Calif. Phone: (415) 326-4000.

Circle No. 327

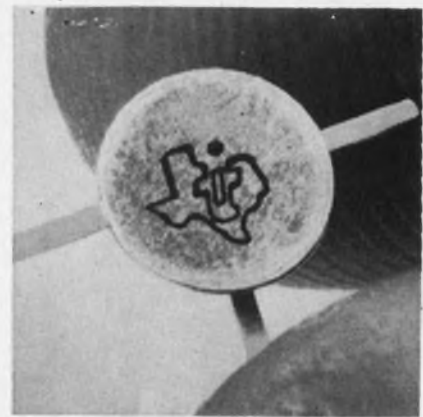

## Microwave transistors

Germanium microwave transistors operable in the 1- to 4-GHz range are said to be replacements for certain TWTs and both tunnel-diode and parametric amplifiers. Applications of the planar devices are in L and S band radar, telemetry and ECM systems. Packing is for strip-line circuitry.

The TIXM103 features a typical noise figure of 3.8 dB at 1.5 GHz and 5.5 dB at 3 GHz when adjusted for optimum noise characteristics. Max noise figure is 4.5 dB at 1.5 GHz and 7 dB at 3 GHz. Gain is typically 8.5 dB at 1.5 GHz and 6.5 dB at 3 GHz. The TIXM104 features noise figure of 5.5 dB at GHz and 10 dB at 3 GHz.

The noise figure changes less than 2 dB and gain less than 1.5 dB between -55°C and 85°C. Power consumption is less than 25 mW.

Price: TIXM103: About \$82.50 (1 to 99); Texas Instruments; 13500 N. Central Expwy., Dallas. Phone: (214) 235-3111.

Circle No. 328

## Wide-band multiplier

Model N802 step-recovery diode multiplier has an octave output range of 6 to 12 GHz. Inputs of 100 to 2,000 MHz feed through a low-pass filter to the step-recovery diode where multiplication results in a harmonic of 6 to 120 times the excitation frequency. Output is available at an N-type connector.

This unit is adapted to stable oscillator, and transmitter service in the lab and classroom.

P&A: \$150; 30 days. Somerset Radiation Laboratory, P.O. Box 201, Edison, Pa. Phone: (215) 348-8883.

Circle No. 329

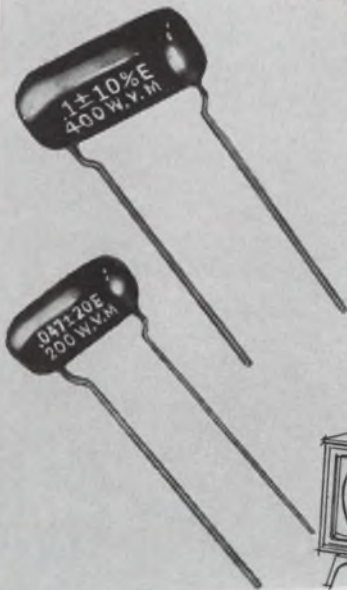

# Proof Positive of High Reliability of EL-MENCO \*MYLAR-PAPER DIPPED Capacitors

OVER 330,000,000 OF THESE HIGH QUALITY UNITS USED IN TV SETS SINCE 1959!

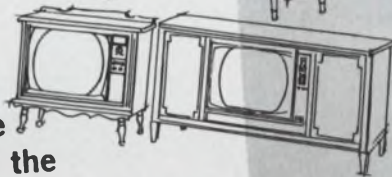
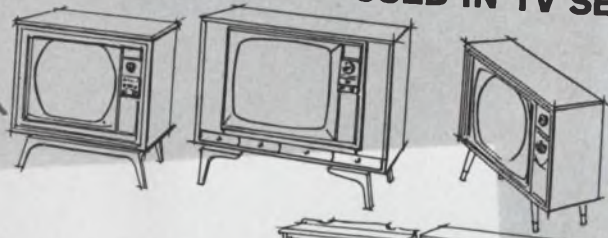

The number of EL-MENCO capacitors in TV sets is truly amazing. This figure of 330,000,000 represents more than the total population of the following countries:

- United States and Possessions
- United Kingdom and Canada
- Argentina      Belgium
- Denmark      Ecuador      Chile

299,813,929 people (1960 Census)

Even with this tremendous mass production the quality of EL-MENCO capacitors has not suffered. Here's a fine tribute of the high reliability of EL-MENCO capacitors from a leading TV manufacturer:

**"... I am certain that you are aware of the enthusiasm our Engineering and Quality people have displayed for this unit, for to us it represents the virtual elimination of capacitor field problems in the future ..."**



Imagine! Over 330 million EL-MENCO Mylar\* Paper Dipped Capacitors have been used in black and white and in color TV sets since 1959! These capacitors of the highest quality and reliability help bring programs to millions of people who have invested in TV sets... and 330 million is just a drop in the bucket! For the demand for EL-MENCO capacitors still far exceeds the supply!

Write dept. AE for descriptive bulletin #MPD

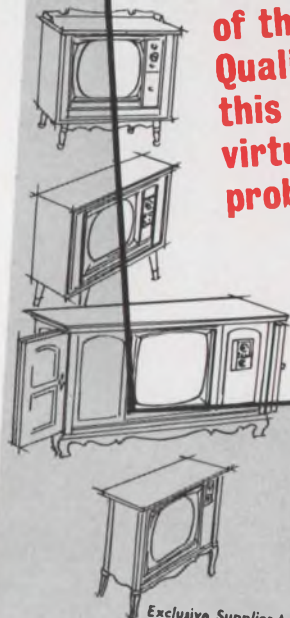

**EL-Menco**  
Capacitors

- DIPPED MICA
- MOLDED MICA
- SILVERED MICA FILMS
- MICA TRIMMERS & PADDERS
- MYLAR\* PAPER DIPPED
- PAPER DIPPED
- MYLAR\* DIPPED
- TUBULAR PAPER

**THE ELECTRO MOTIVE MFG. CO., INC.**  
WILLIMANTIC, CONNECTICUT

\*Registered Trade Mark of DuPont Co.

Exclusive Supplier to Jobbers and Distributors in the U. S. and Canada

ARCO ELECTRONICS, INC., COMMUNITY DRIVE,  
GREAT NECK, L. I. NEW YORK

West Coast Manufacturers Contact:  
COLLINS & HYDE CO., 1020 CORPORATION WAY, PALO ALTO, CALIFORNIA  
5380 WHITTIER BOULEVARD, LOS ANGELES, CALIFORNIA



## Cramped for space?

### Use Couch 1/7-size Relays

Space/weight problem? The new Couch 2X 1/7-size crystal can relay gives you tremendous savings in space and weight. 0.1" grid — plus many outstanding specs — all in micro-miniature. Thoroughly field-proven in electronics and space applications.



	2X (DPDT)	1X (SPDT)
Size	0.2" x 0.4" x 0.5"	same
Contacts	0.5 amp @ 30 VDC	same
Coil Operating Power	100 mw 150 mw	70 mw 100 mw
Coil Resistance	60 to 4000 ohms	125 to 4000 ohms
Temperature	-65°C to 125°C	same
Vibration	20 G	same
Shock	75 G	same

Broad choice of terminals, coil resistances, mounting styles. Write for detailed data sheets.

RUGGED ROTARY RELAYS  Dynamically and Statically Balanced

## COUCH ORDNANCE INC.

3 Arlington St., North Quincy, Mass. 02171, Area Code 617.  
Cypress 8-4147 • A subsidiary of S. H. COUCH COMPANY, INC.

ON READER-SERVICE CARD CIRCLE 59

## PRODUCTION EQUIPMENT

### Vacuum pencils

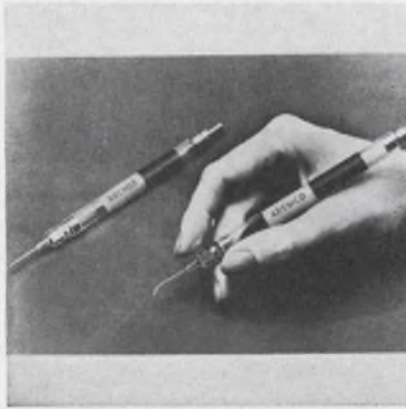

A line of vacuum pencils with 24 interchangeable pickup needles is designed for use in handling semiconductor and microelectronic components. Fingertip vacuum-control permits quick pickup of wafers, pellets or spheres. The body is clear cellulose acetate and the needle is medical hypodermic stainless steel tubing.

P&A: \$25, additional needles \$8; stock. Aremco Products, Inc., P. O. Box 145, Briarcliff Manor, N. Y. Phone: (914) 762-0685.

Circle No. 330

### Lead-gathering machine



A semi-automatic header and lead-gathering machine speeds production of TO-18 transistors. A stainless-steel perforated drum is charged with 2000 to 2500 headers from the barrel plating process. In 5 minutes, 80% of the assemblies are separated and gravity-fed to a vibrating bowl which channels them to an escapement unit. The machine then gathers the leads. Capacity is 2400 units/hour.

Lane Products Co., P.O. Box 306, Feasterville, Pa. Phone: (215) 355-2888.

Circle No. 331

### Component sorter

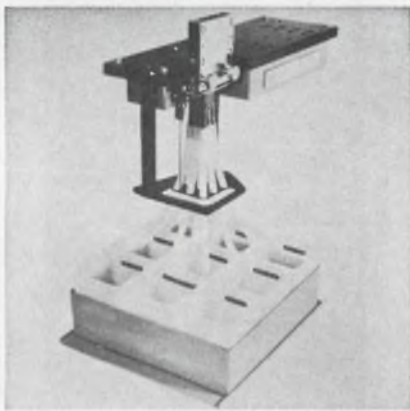

This new unit automatically sorts axial-lead components such as capacitors, resistors and diodes into nine or more discharge bins at speeds up to two parts per second.

Components to be sorted are manually or automatically dropped into the aligning funnel and automatically routed to the appropriate sorting bin by the "checkerboard sorter."

Numerical Control Corp., 3033 Jefferson St., San Diego, Calif. Phone: (714) 297-4977.

Circle No. 332

### Circuit bonder



The model 730 bonder uses infrared detection and bonds components and wiring in assemblies, to PC cards or to thin films. It welds, brazes, hard and soft solders and bonds using parallel gap or opposed heads. Temperatures from 300°F to 1400°F are controlled so that, once bonding mode and temperature are selected operation is automatic. The power supply has a capacity of 500 A at 2 V for 10 s.

P&A: About \$2000; 6 to 8 wks. Texas Instruments, 3609 Buffalo Speedway, Houston. Phone: (713) 782-9661.

Circle No. 333

## SEMICONDUCTORS

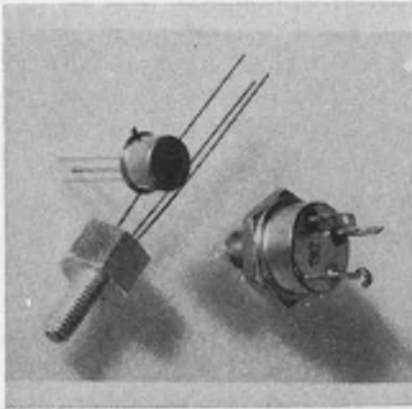

### Power transistors

The 2-A epitaxial planar transistor, 2N4300, in a TO-5 can is rated at 15 W at 100°C. Saturation voltage is 0.5 V max at 2 A. Gain is linear from 50 mA to 1 A ( $h_{fe}$  is typically 70 at both levels). Switching characteristics are 150 ns on and 1.5  $\mu$ s off typical at 1 A.

The 10-A 2N4301, in a TO-61 can dissipates 50 W at 100°C. Characteristics include a saturation voltage of 0.5 V max at 10 A, typical gain of 30 at 10 A and frequency response of 50 MHz min. Drive power requirements are 1.2 V max at 10 A.

Availability: 2N4300, stock; 2N4301; May. Texas Instruments, 13500 N. Central Expwy., Dallas. Phone: (214) 235-3111.

Circle No. 334

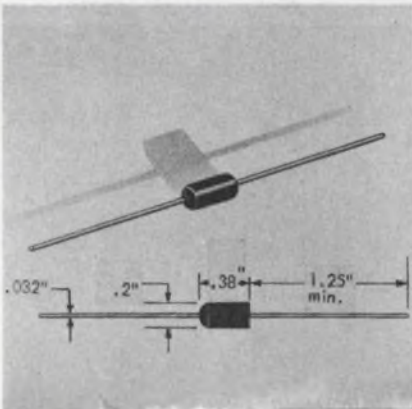

### Silicon rectifiers

Bullet-shaped molded silicon rectifiers with 150-ns recovery time are available. They are rated from 800 to 6000 PIV with forward currents from 150 mA to 1 A. The devices measure 0.2 x 0.375-in.

Electronics Devices, Inc., 21 Gray Oaks Ave., Yonkers, N. Y. Phone: (914) 965-4400.

Circle No. 335

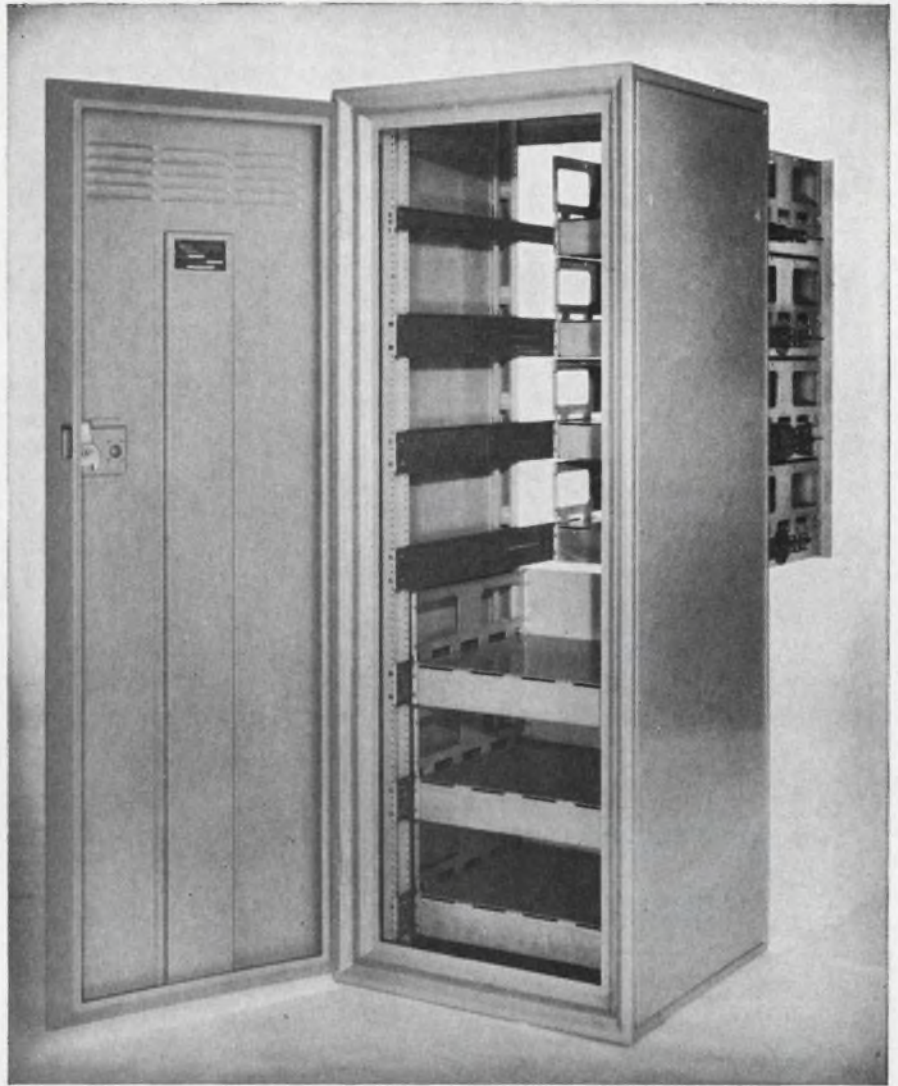

## How much Engineering goes into an Electronic Cabinet?

Countless hours of engineering have resulted in a line of electronic cabinets which meet and exceed all requirements for:

- **VERSATILITY**—simplifies inspection and provides interchangeability between standard models.
- **STRENGTH**—vertical frame posts of unique cross section construction provide exceptional strength.
- **AVAILABILITY**—Vent-Rak's Indianapolis facilities offer a central geographic location to reduce shipping time.

### DELIVERY IS GOOD TOO!

For information on Vent-Rak's complete line of electronic packaging components, write:



525 SOUTH WEBSTER AVENUE  
INDIANAPOLIS 19, INDIANA

ON READER-SERVICE CARD CIRCLE 60

## DAVEY lead formers slash P.C. assembly time

Simply →  
set the  
points  
into the  
pair of  
holes  
and lock

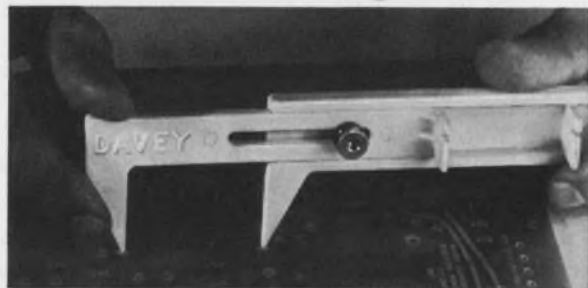

Then →  
position  
the  
component  
and  
bend the  
leads

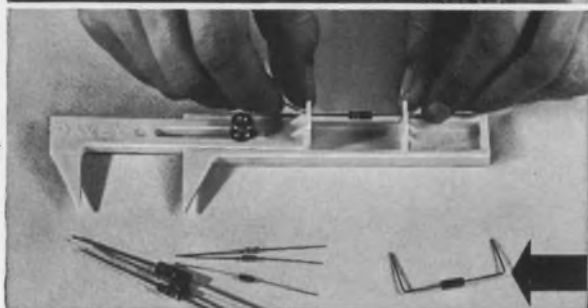

No guesswork, no waste. A Davey lets you do it right in seconds. Can't damage boards, can't nick leads, and locks in place for multiple runs. • Cost: \$6.95 ea., \$5.95 for six or more. Handles all common wire sizes and hole spacing.

**DAVEY PRODUCTS COMPANY**  
BOX 567 • FAIRFIELD, CONNECTICUT

ON READER-SERVICE CARD CIRCLE 61



**3 OUT OF 4  
GO BACK**

Most heart attack victims survive first attacks. Of those who do, three out of four go back to work, often to the same job.

This farmer is back at his plow because of improved methods of diagnosis, treatment and rehabilitation discovered through heart research.

Close to 100 million of your Heart Fund dollars, invested in research since 1949, helped make this possible.

**GIVE... so more will live  
HEART FUND**



## SEMICONDUCTORS

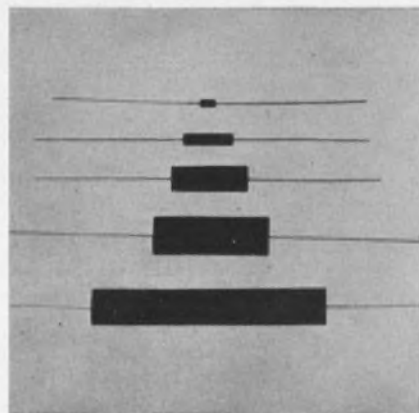

### Microminiature diodes

A line of single junction high-voltage silicon microdiodes and assemblies handles more than 100 mA. Typical single junction peak inverse voltage ratings are 1000 to 1500 V with leakage ratings better than 20 nA at 25°C. Reliability exceeds MIL-S-19500. Body size is as small as 0.05-in. x 0.1-in.

P&A: \$2.50 to \$7.50; stock. Microsemiconductor Corp., 11250 Playa Ct., Culver City, Calif. Phone: (213) 391-8271.

Circle No. 336

### Germanium planar FET

The p-channel planar germanium FET, TIXM301, is suitable for vhf amplifiers up to 500 MHz. The devices are said to have higher figures of merit and transconductance than many FETs. Transconductance is typically 0.14 to 0.12 mhos from 60 to 300 MHz. Noise characteristics of 1.8 dB are typical at 100 MHz.

P&A: \$8.60 (100-999); 90 days. Texas Instruments, 13500 N. Central Expwy., Dallas. Phone: (214) 235-3111.

Circle No. 337

### Power transistors

Plastic-encapsulated power silicon npn transistors rated at 25 W are available. The B-5000 features collector power dissipation of 25 W at 2.5 A, 10 V and 100°C. Collector-to-emitter voltage is 35 V min, and collector current is 3 A max. Max base current is 1 A and dc current gain ranges from 30 to 25 at 14 V and 0.5 A.

Price: \$0.99 (1 to 99), \$0.75 (100 to 999); Bendix Semiconductor Div., South St., Holmdel, N. J. Phone: (201) 747-5400.

Circle No. 338

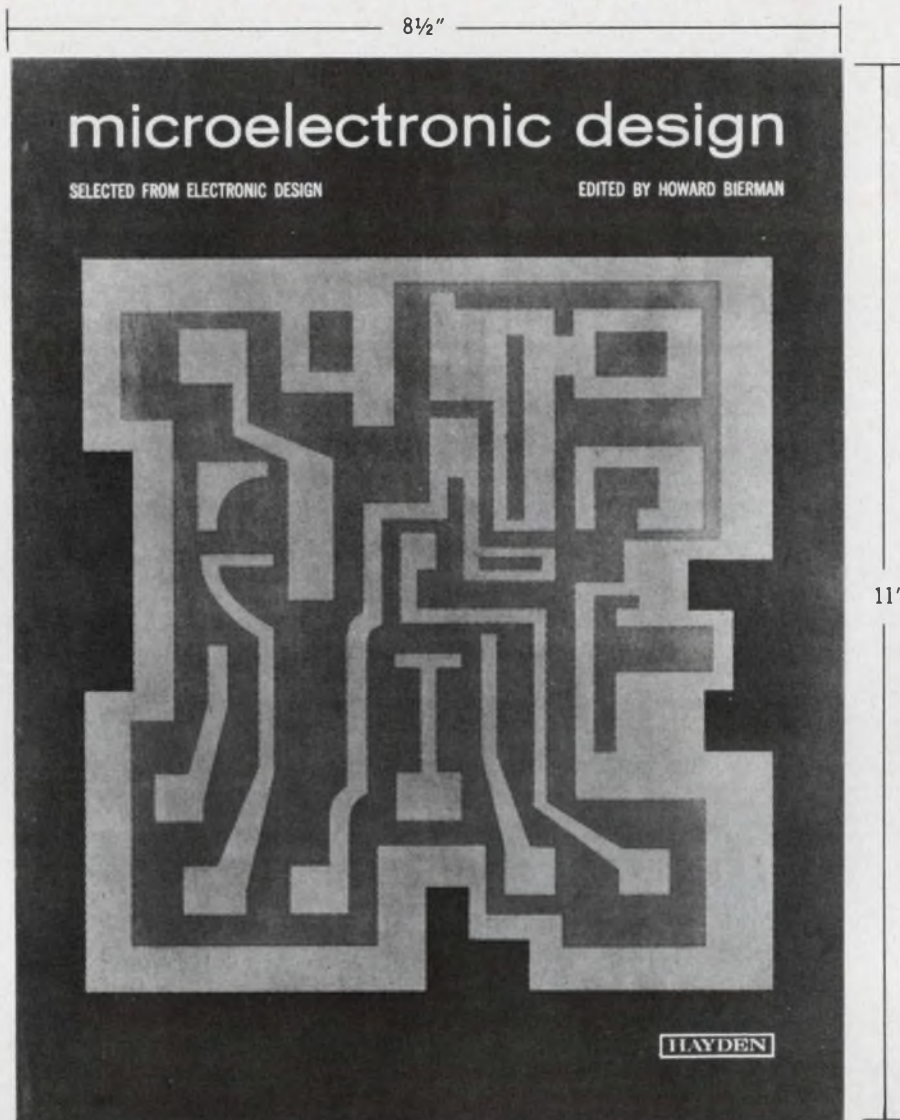

## Little things do come in big packages.

The circuits may be microscopic, but there's nothing undersized about this comprehensive and convenient reference book. Its 320 *big* pages offer you almost 90 outstanding articles on all aspects of microelectronic design, compiled from the pages of Electronic Design magazine.

MICROELECTRONIC DESIGN gives a thorough overview of the field in six sections: Theory and Basic Concepts; Fabrication and Interconnection; Circuit Conversion; Prototype Planning and Fabrication; Testing Techniques; Bibliography and Data Charts (covering over 500 devices). #5762, clothbound, \$11.50.

HAYDEN BOOK COMPANY, INC., NEW YORK

also selected from electronic design

### 400 IDEAS FOR DESIGN

All tested and proved award-winners, written by and for electronic design engineers, #5537, cloth-bound, \$8.50



HAYDEN BOOK COMPANY, INC. 116 W. 14 St., New York 10011  
Department ED-42

Please send the book(s) checked below and bill me. At the end of 30 days, I will remit payment plus a few cents postage, or return the book(s).

5762     5537     Free 1966 Catalog

Name \_\_\_\_\_

Company \_\_\_\_\_

Address \_\_\_\_\_

City \_\_\_\_\_ State \_\_\_\_\_ Zip \_\_\_\_\_

You pay the postage. I enclose \$ \_\_\_\_\_  
Same return privilege.

## Revised Motor Handbook 47 pages added



Fractional Horsepower Motor Handbook for design engineers . . . 113 pages . . . includes material on dynamic braking, performance vs frequency, overload protection, design for quietness.

Chapters on application, cost, speed reduction, reversing and speed control, care, servicing, definitions. \$1.00 a copy . . . cash, check or money order only, please.

**BODINE MOTORS**  
fractional / horsepower



Bodine Electric Co., 2528 W. Bradley Pl., Chicago, Illinois 60618  
ON READER-SERVICE CARD CIRCLE 62

## RELAYS FOR SPACE AGE ENVIRONMENTAL STRESSES...

**SILICON, ALL SOLID STATE RELAYS  
THAT CANNOT ARC, BOUNCE, OR CHATTER!**

Temperature extremes, from  $-54^{\circ}\text{C}$  to  $+125^{\circ}\text{C}$ , mechanical shock to 100 g's, for 11 ms., nothing fazes the space era's newest component—the static relay. Marin Controls Company, a prime innovator in the many arts of system control, offers a wide range of static relay contact configurations and ratings in aerospace and commercial grades.

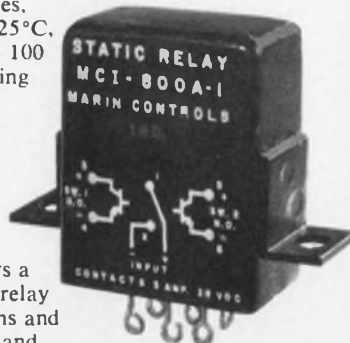

Free Applications Bulletin. The Care and Feeding of Static Relays. Just circle the number or drop us a line. We'll send the booklet, complete catalog & applications information.



**MARIN CONTROLS Co.**

517 MARINE VIEW AVENUE  
BELMONT, CALIF. 94002 - PHONE (415) 591-8924

ON READER-SERVICE CARD CIRCLE 63

## MICROELECTRONICS

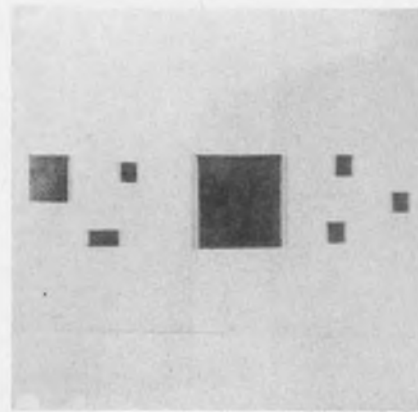

### Capacitor chips

A line of new monolithic capacitors is offered in 50 or 100 Vdc from 10 pF through 1.0  $\mu\text{F}$  at  $\pm 10\%$  or  $\pm 20\%$  tolerance.

The tiny capacitor chips meet MIL-C-11015 and MIL-C-39014, operate within a  $-55^{\circ}\text{C}$  to  $+125^{\circ}\text{C}$  temperature range and offer a temperature coefficient at 0 V of  $\pm 15\%$ .

San Fernando Electric Mfg. Co.,  
1509 First St., San Fernando, Calif.  
Phone: (213) 361-8681.

Circle No. 339

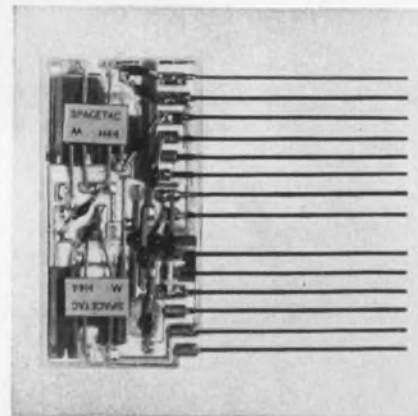

### Microwatt flip-flop

With inputs permitting counting, shifting and control to 10 MHz, the MH-44 flip-flop draws only 150  $\mu\text{W}$  from a 6V ( $\pm 1.5\text{V}$ ) source. Operating over a temperature range of  $-55^{\circ}\text{C}$  to  $+85^{\circ}\text{C}$ , the unit weighs 1-1/2 grams and is 1.2- x 0.6- x 0.080-in. large.

Packaging with nominal component densities in excess of 500 components/in. is offered.

Space & Tactical Systems Corp.,  
One Garfield Circle, Burlington,  
Mass. Phone: (617) 272-4422.

Circle No. 340



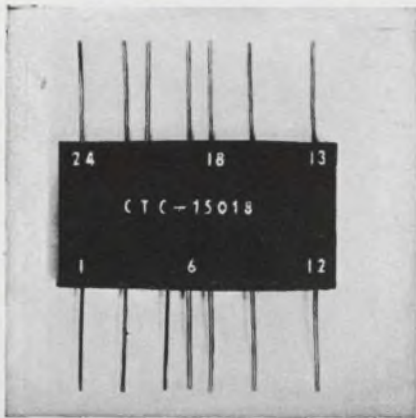

### Gated amplifier

Using chip and wire techniques, this epoxy-encapsulated flat-pack employs switching mode and linear circuits. Operating at bandwidths up to 10 MHz, this hybrid cermet film component has a gain of more than 14. Bandwidth of this video amplifier measured from the 10% to 90% amplitude points of the output pulse is less than 45 ns and gate rise and fall time is less than 50 ns.

P&A: \$90; 4 weeks. Columbia Technical Corp., Woodside, N. Y. Phone: (212) 932-0800.

Circle No. 341

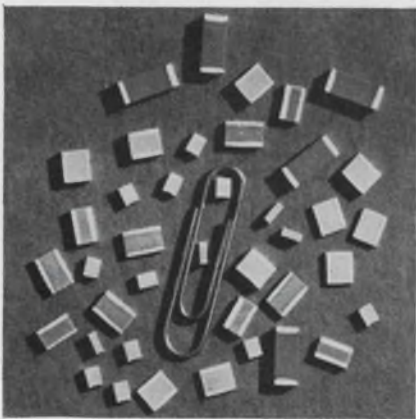

### Capacitor chips

A new line of ceramic multi-layer capacitor chips offers high uniformity of dielectric and electrode layers and high delamination resistance.

Multi-cap capacitors are available in sizes ranging from 0.152- x 0.052- x 0.055-in. to 0.375- x 0.155- x 0.065-in., with capacitance values from 330 pF to 0.5  $\mu$ F at 25 to 50 Vdc and 100 to 200 Vdc.

P&A: Dependent on value, tolerance and voltage; one week. American Lava Corp., Chattanooga, Tenn. Phone: (615) 265-3411.

Circle No. 342

# Now! a NEW HIGH STABILITY CERAMIC CAPACITOR

Typical NYTcap Stability

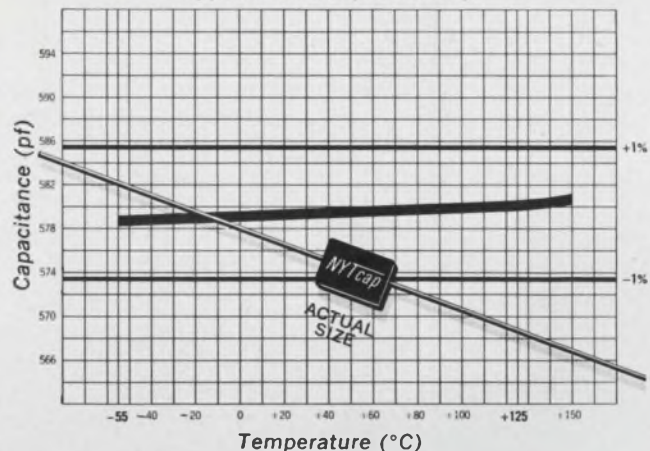

## The NEW NYTcap

Temperature Coefficient: Within 1% envelope over temperature range of  $-55^{\circ}\text{C}$  to  $+125^{\circ}\text{C}$ .

The new NYTcap now offers the design engineer these important advantages: Package size 0.350 x 0.250 x 0.1; Capacitance range 100pf. to 1000pf.; Capacitance tolerance  $\pm 10\%$ ; Standard E.I.A. values; Loss (at 1 kc) less than 0.001 at 25°C, less than 0.002 at 125°C; Voltage rating 200 Volts dc; and Insulation resistance at 25°C 1,000,000 megohms, and 125°C 10,000 megohms. 24 hour delivery.

The NYTcap is the newest product to join the Nytronics subminiature family of inductors, ceramic capacitors, precision wire wound resistors, thin film resistors, crystal filters, L-C filters, transformers, and delay lines. Use coupon for engineering data!

## NYTRONICS

Design Leaders — STANDARD Components to Meet CUSTOM Requirements

550 Springfield Ave., Berkeley Heights, N. J.

MAIL COUPON TODAY FOR COMPLETE DATA!

TO: NYTRONICS, INC.	Dept. ED
550 Springfield Avenue, Berkeley Heights, N. J.	
Please send complete engineering data on the NYTcap	
NAME/TITLE _____	
FIRM _____	
ADDRESS _____	
CITY/STATE/ZIP _____	

ON READER-SERVICE CARD CIRCLE 64

# ELGENCO Noise Generators



Model 610A

## SOLID STATE NOISE GENERATORS

Model 602A 5 cps to 5 mc, 3 Ranges \$ 290  
 Model 603A 5cps to 5 mc, 3 Ranges \$ 495  
 Model 610A 5 cps to 5 mc, 8 Ranges \$1,175  
 Series 624 (Fixed frequency) 5 cps to 500 kc  
 \$245 to \$490. Write for details on frequency  
 ranges and spectral flatness.



Model 312A

## VACUUM TUBE NOISE GENERATORS

Model 301A DC to 40 cps ..... \$1,995  
 Model 311A Two outputs DC to  
 40 cps and 10 cps to 20 kc ..... \$2,395  
 Model 312A Two outputs DC to  
 120 cps and 10 cps to 20 kc ..... \$2,495  
 Model 321A DC to 120 cps ..... \$2,095  
 Model 331A 10 cps to 20 kc ..... \$1,275

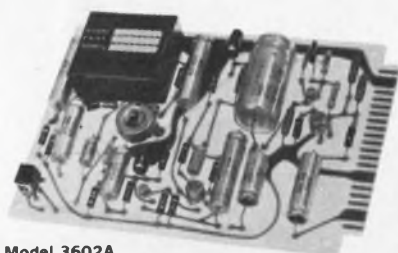

Model 3602A

## NOISE GENERATOR CARDS

Series 3602, 3603, and 3606 \$144 to \$389  
 Various frequency ranges and output flat-  
 ness available. Size: 4½" x 6½" x 1". Write  
 for details.

## ENCAPSULATED NOISE SOURCE MODULES

Series 1602, 1603, and 1606 . . \$95 to \$340  
 Various frequency ranges and output flat-  
 ness available. Size: 1¾" x 1½" x ¾". Write  
 for details.

## ELGENCO INCORPORATED



1550 Euclid Street  
 Santa Monica, California  
 Phone: (213) 451-1635  
 TWX: (213) 879-0091

For a more complete listing, write for  
 our short form catalog.

ON READER-SERVICE CARD CIRCLE 65

# New Literature

## Relay sockets

A 12-page catalog illustrates and describes a new line of relay sockets for subminiature crystal can and power relays. The catalog completely defines the new relay sockets, providing dimensions, electrical characteristics, contact types and configurations, hardware, mounting styles and dielectric composition information. Methode Electronics Inc.

Circle No. 343

## Hybrid computer

A 12-page information brochure on an analog hybrid computing system is offered. The brochure describes the features of the system, which include a solid-state addressing and readout system, automatically adjustable pots, parallel digital logic and analog and digital patch panel termination. A typical system is illustrated, and information is given on applications, computer components and system support. Electronic Associates, Inc.

Circle No. 344

## Microwave components

This new 3-ring loose leaf binder containing 40 pages in 2 colors lists more than 2000 items. Included are ferrite devices, filters and switches covering the RF spectrum from 100 MHz to 26.0 GHz. Application notes, nomographs and other design information are featured. E & M Labs.

Circle No. 345

## Laminations

The 92-page catalog PD-122 covers laminations for transformers, motors, transformer hardware, drawn metal cans and cases and magnetic shields. Illustrations and physical data for all high silicon, 50% nickel and 80% nickel alloy laminations, as well as keepers, ring and notched motor types, are provided.

Data on magnetic material properties is given in tables and graphs for unit comparison, computation and specification purposes. Arnold Engineering Co.

Circle No. 346

## Digital control counter

Technical data sheet #02 describes a high-speed, digital control electronic counter with built-in variable dual preset. Complete specifications, features and typical applications are included for this solid-state counter. Electro-mation.

Circle No. 347



## Logic handbook

A 352-page handbook on "Flip-Chip" modules incorporates material from the company's catalogs, logic handbook, logic lab workbook, application notes and computer brochures.

Included are 14 application notes, specifications and price information for more than 150 modules and accessories, notes on analog-digital conversion theory and techniques, and several experiments. Digital Equipment Corp.

Circle No. 348

## Meter catalog

A new 6-page catalog No. 10-90-6 includes electrical and physical characteristics on a complete line of meters. Covered are ammeters, control meters, frequency meters, tachometers, ac and dc voltmeters, wattmeters, power factor meters and phase angle meters.

The catalog lists edgewise, rectangular, round panel and switchboard styles in various sizes. American Machine & Foundry Co.

Circle No. 349

# AIRPAX Signal Conditioning Amplifier

The Airpax MAS50 Signal Conditioning Amplifier is a dc-to-dc amplifier. It converts a transducer signal (current or voltage) to a standard output range of 0 to +5 vdc. Input is differential and floating. • Voltage gain, 0 to 100 with a stability of  $\pm 0.01\%$  per degree C. • Linearity is within 0.1% of full scale. • Zero null stability of 0.5 microvolts per degree C. • Common mode rejection at 60 CPS is 120 db minimum.

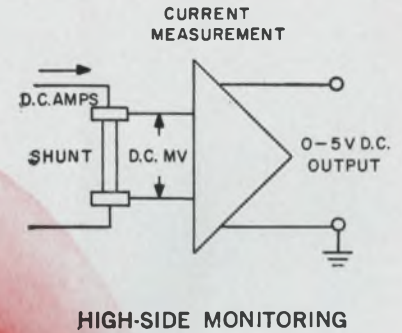
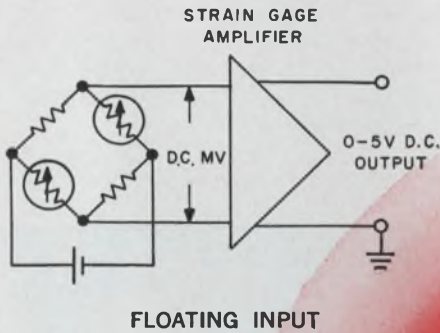

\$157

EACH

(1 to 6 pieces)



TYPE MAS50

Delivery  
from stock

**Strain-Gage Amplifier:** Extremely high rejection of common mode interference by the MAS50 enables it to operate with a floating input circuit, as in strain gage applications. The signal, after conditioning by the amplifier, can be multiplexed with other conditioned signals because any number of MAS50's can share a common ground at their outputs.

**Current Measurement:** Having its input well insulated, the MAS50 can be connected across a shunt in the high side of a line if necessary. For example, measurement of the plate or screen current of a power tube operating at high voltages can be done with the case of the MAS50 grounded.

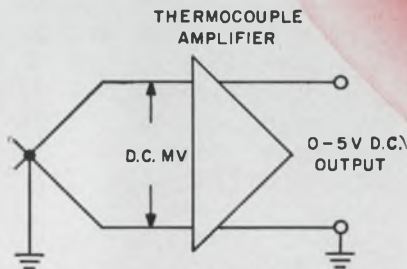

ISOLATION OF GROUNDS

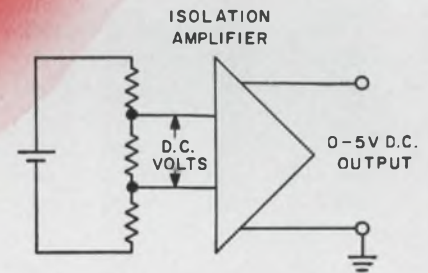

SCALE CHANGE

**Thermocouple Amplifier:** In applications such as amplification of a thermocouple output, the MAS50 combines inherently stable high gain with negligible drift in zero offset. Because input and output are electrically isolated from each other, the input can be either grounded or ungrounded while the output has one side grounded. Calibration of thermocouple lead length is unnecessary in normal-length runs because amplifier input resistance is much higher than thermocouple resistance.

**Isolation Amplifier.** Basically the MAS50 is an active 4-terminal device that produces 0 to +5 vdc output from a 0 to 50 microampere input. The amplifier provides a change of scale and of zero in several ways: by using a resistance in series with the input, by choice of a voltage gain of 1 or of 100 within the amplifier and by a bias current through the auxiliary winding. A screwdriver adjustment on the amplifier changes the gain by about 20% to calibrate the scale change and to compensate for tolerance in metering circuits.

**AIRPAX ELECTRONICS** incorporated Seminole Division, Fort Lauderdale, Florida

PHONE 305 587-1100 • TWX 305 587-1000

ON READER-SERVICE CARD CIRCLE 66

# GO AHEAD, DESIGN YOUR WHOLE SERVO SYSTEM IN SIZE 5



**HAROWE HAS  
THE HARDWARE**

Size 5 rotating servo components are all standards at Harowe. We've been in production for 5 years.

Now, you can specify Size 5 components throughout your servo system to cut size and weight. When you're ready to go from prototype to production, the Harowe hardware will be ready to go with you. Write for complete specs—



**HAROWE SERVO CONTROLS, INC.**  
20 Westtown Road  
West Chester, Pa. 19380  
(215) 692-2700

SERVO, SYNCHRONOUS AND STEPPER MOTORS  
MOTOR GENERATORS • SYNCHROS • RESOLVERS  
PANCAKE SYNCHROS • GEARHEADS

ON READER-SERVICE CARD CIRCLE 67

## NEW LITERATURE

### Thermocouple references

Technical bulletin 32-B describes the theory, operation and applications of thermocouple references. The 4-page brochure shows circuits for both single and multi-point references. Featured are wheatstone bridge types, oven types and a new type of 25-channel scanning type reference for precision computer and data logging applications. Acromag, Inc.

Circle No. 350

### Molded test accessories

This 32-page catalog No. 11-66 describes more than 240 molded electronic test accessories. Included are patch cords, cable assemblies, banana plugs, test and connecting leads and black-boxes.

Photographs, specifications, dimensions, schematics, typical applications, operating ranges and prices are given for all items. Pomona Electronics Co. Inc.

Circle No. 351

### NBS services

Complete, up-to-date information on services provided by NBS radio stations WWV, WWVH, WWVB and WWVL is offered. Included in the 12 pages of information are hourly broadcast schedules of NBS standard time and frequency transmissions. Specific Products.

Circle No. 352

### Logic unit

A high-speed, high-performance nanosecond logic unit is described in a new technical data sheet. Detailed specifications are provided together with a description of the logic unit and its application. LeCroy Research Systems Corp.

Circle No. 353

### Servo motors catalog

A 6-page catalog gives the complete thru-bore motor characteristics on 36 control servo motors. Included are eight schematic drawings of the basic motor types for reference. The catalog covers seven frame sizes, ranging from 05 to 23. A chart furnishing full shaft and pinion data is shown. Vernitron Corp.

Circle No. 354

### Hollow-cathode tubes

A new 16-page hollow-cathode tube guide aids in selection of devices for use in atomic absorption and other spectroscopic applications. Included are max current limits, operating voltages, and reproductions of spectral outputs from devices having wavelengths of interest in atomic absorption. The guide facilitates selection of gas and window and provides application data concerning operating characteristics. Westinghouse, Electronic Tube Div.

Circle No. 355



### Operational amplifiers

This catalog covers analog and hybrid plug-in modules including operational amplifiers, instrumentation amplifiers, function modules, power supplies and accessories. The 10-page illustrated brochure includes over 50 op-amps. Detailed comparative specifications are provided for general purpose, FET, IC, wideband, chopper-stabilized and high voltage series. Burr-Brown Research Corp.

Circle No. 356

### Infrared devices

A 10-page technical brochure on solid-state infrared detectors and radiation sources is offered. It contains an abstract of infrared characteristics covering such subjects as infrared generation, infrared detection mechanisms, infrared conversions, internal photoeffect, the photoconductive effect, the photovoltaic effect, and definition of detector parameters. American Electronic Laboratories, Inc.

Circle No. 357

## Silicon power supplies

Two new series of portable silicon power supplies, designed for applications requiring high regulation and low cost, are discussed in bulletin 109A. Remote sensing and remote programming, automatic series and parallel operation, as well as master-slave programming are additional features described. Deltron Inc.

Circle No. 358

## Switching system

A solid-state modular switching system, which can sequentially sample  $\mu\text{V}$  signals at rates up to 10 MHz, is covered in bulletin 108. Complete with schematics, the brochure includes applications, theory, performance and circuit descriptions. Santa Barbara Research Center.

Circle No. 359

## Solid-state isolators

An illustrated, eight-page condensed catalog contains information on 177 solid state isolator models available as standard product line. The catalog includes specifications and dimensions for the complete line of high, low and medium power, internal and external magnet coax models; waveguide, strip transmission line and Ku-band rotational type isolators. Sperry Microwave Electronics Co.

Circle No. 360

## Permanent magnet data

Temperature and radiation effects on permanent magnet materials is the subject of a new 16-page booklet. The booklet compiles information from the company's research laboratories as well as data from government research reports. Eleven pages of schematic diagrams and tables are included. General Magnetic Corp.

Circle No. 361

## PC connectors

A 14-page technical catalog covers a group of right-angle plug and socket connectors for printed circuit applications.

Complete technical specifications, outline drawings, and illustrations are included in the catalog. Continental Connector Corp.

Circle No. 362

## Germanium diodes

A new catalog specification sheet describes miniature glass germanium gold bond diodes and germanium point contact diodes. Applications cited include computer logic and high-speed switching. Nucleonic Products Co., Inc.

Circle No. 363

## Current drivers

A new technical bulletin describes the company's complete line of 20 ns current drivers. The bulletin gives detailed data on three different sets of positive-negative drivers. A series of waveform photographs shows the output current pulse from the drivers under 3 operating conditions: fastest rise time, minimum pulse width and independent control of rise and fall time. Computer Test Corp.

Circle No. 364

## Reed switches

An 8-page circular of specifications and application data is devoted to PC dry reed switches. Dimensional diagrams are used to illustrate ten basic forms. Corresponding tables list coil resistance and turns and the operate/release max voltage for nominal dc voltages. Technical information includes timing curves and explanations of the use of magnetic biasing. Automatic Electric Co.

Circle No. 365

## Transformers

A 4-page data sheet on wide frequency response, extremely shielded transformers is offered. Complete with dc resistance, inductance, open circuit impedance, frequency response and common mode rejection specifications, the data sheet includes schematics, physical dimensions and frequency response and insertion loss graphs. James Electronics Inc.

Circle No. 366

## Matched crystal filters

A data sheet on matched crystal filters providing optimum signal-to-noise ratios with pulse modulated inputs is offered. A description, typical specifications and attenuation curve are provided. Damon Engineering Inc.

Circle No. 367

# AMPERITE

## GLASS ENCLOSED Thermostatic DELAY RELAYS



Offer true  
hermetic  
sealing —

— assure  
maximum  
stability  
and life!

### Delays: 2 to 180 seconds

Actuated by a heater, they operate on A.C., D.C., or Pulsating Current . . . Being hermetically sealed, they are not affected by altitude, moisture, or climate changes . . . SPST only — normally open or normally closed . . . Compensated for ambient temperature changes from  $-55^{\circ}$  to  $+80^{\circ}\text{C}$ . . . Heaters consume approximately 2 W. and may be operated continuously. The units are rugged, explosion-proof, long-lived, and inexpensive!  
TYPES: Standard Radio Octal and 9-Pin Miniature . . . List Price, \$4.00  
PROBLEM? Send for Bulletin No. TR-81.

# AMPERITE

## BALLAST REGULATORS

Hermetically sealed, they are not affected by changes in altitude, ambient temperature ( $-50^{\circ}$  to  $+70^{\circ}\text{C}$ ), or humidity . . . Rugged, light, compact, most inexpensive.

List Price, \$3.00

Write for  
4-page  
Technical  
Bulletin  
No. AB-51

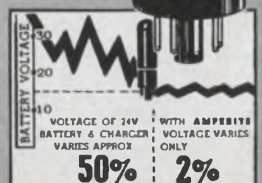

# AMPERITE

600 PALISADE AVE., UNION CITY, N.J.

Telephone: 201 Union 4-9503

In Canada: Atlas Radio Corp., Ltd.,  
50 Wingold Ave., Toronto 10

# Latronics

## CONTROLLED RECTIFIER HOUSINGS

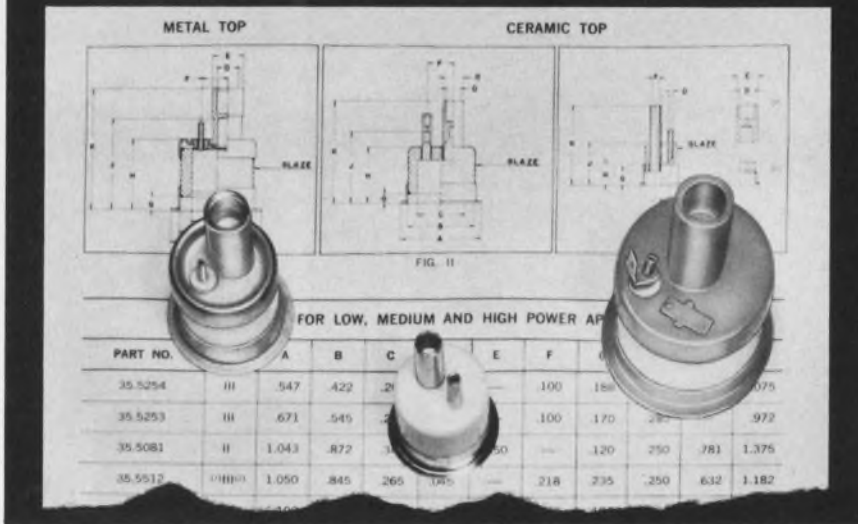

This is a typical sheet from Latronics new catalog on Ceramic and Glass-to-Metal Seals.

SEND for Latronics Catalog 100-266-1.

**Latronics Corporation**

1004 Lloyd Avenue, Latrobe, Pa. 15650 • Phone 412-539-1626 • TWX 412-594-7857  
ON READER-SERVICE CARD CIRCLE 69

# AUGAT

Low Cost • High Performance • Wide Application  
**14 CONTACT DUAL-IN-LINE SOCKET**  
for testing and packaging Monolithic Circuits

Accepts packages with flat or round leads. Has large contoured entry holes for easy insertion. Gentle wiping action of spring contacts prevent lead damage.

Can be used in panel mount or printed circuit applications. Wire-wrap® termination also available.

Fast, easy, damage-free release of circuit. Unique ejector key, as integral part, speeds up testing programs. Simple extractor tool facilitates handling in close packaging production.

Unit has molded diallyl pythalate body with gold-plated, beryllium copper contacts. Dimensions: .8L x .5W x .37H. 16 and 20 DIL sockets under development.

Write for Data Sheet 166.

© Trade Mark Gardner-Denver Co.

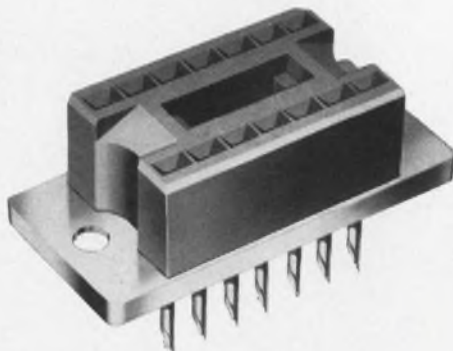

**AUGAT** INC.

31 PERRY AVE., ATTLEBORO, MASS. 02703

ON READER-SERVICE CARD CIRCLE 70

## Design Aids



### Dielectric materials

A new full-color chart shows dielectric constant and loss tangent at microwave frequencies for many dielectric materials. With dielectric constant as the abscissa and loss tangent as the ordinate, materials are plotted on the chart in the manner of a graph.

Many common and exotic materials from sapphire to dry sandy soil are included. Designed for wall or notebook mounting, the chart lists the maximum use temperature of each material, and the form in which it is available. Definitions of the various dielectric terms used are also presented. Emerson & Cuming, Inc.

Circle No. 368



### Slip-ring slide rule

A new slip-ring slide rule is offered. With this circular slide rule, the number of circuits desired is "set," and the barrel OD, flange OD and over-all capsule length are then read. Twenty circuit configurations, from 20 to 100, can be checked out. The conventional slip-ring "C" and "D" scales are included on the slide rule. Litton Industries, Poly-Scientific Div.

Circle No. 369



### Ratio measurement

The 12-page technical paper 524 considers measurements having as their objective the comparison or ratio of two voltages. Uses arise in testing of amplifiers and transformers which generate a transfer function. Ratiometers which detect both voltages simultaneously and produce a ratio in real time are discussed. Ideal ratiometer characteristics and design are covered. Techniques for making ac measurements, 3- and 4-wire measurements and low-level ratio measurements are fully explained. The brochure is complete with circuit and block diagrams. Dana Labs., Inc.

Circle No. 384

### Reprints Available

The following reprints are available free and in limited quantities. To obtain single copies, circle the number of the article you want on the Reader-Service card.

*High Volume—Low Cost: Designers' Challenge* (No. 740)

*Harmonic Generators: Is the Step Recovery Diode Best?* (No. 741)

*A Design Approach to Transistorized Voltage Controlled Crystal Oscillators* (No. 742)

### Subscription Policy

ELECTRONIC DESIGN is circulated free of charge to qualified design engineers in the U.S., Western European Continent and Britain. To establish your qualifications, send ELECTRONIC DESIGN the following information on your company's letterhead: Your name, engineering title, description of your design duties and a list of your company's major products. The letter must be signed by you personally.

Subscription rates for nonqualified subscribers—\$25 a year in the U.S., \$35 in all other countries. Single copy, \$1.50.

### Change of Address

An address change for a subscriber requires a restatement of his qualifications. To expedite the change, and to avoid missing any issues, send along a label from a back copy.

Microfilm copies of all 1961, 1962, 1963, 1964 and 1965 issues of ELECTRONIC DESIGN are available through University Microfilms, Inc., 313 N. First Street, Ann Arbor, Mich.

# Design Data from

## Wave Filters



A 14 page booklet offering guidelines for wave filter design and specification is available from ADC Products. A general discussion of LC wave filter design is coupled with a discussion of the problems encountered in writing wave filter specifications. The booklet is also intended to clarify new terminology associated with modern filter design methods.

Send for a free copy.

**ADC Products, Inc.**

6325 Cambridge Street  
Minneapolis, Minnesota 55416

# 171

## The Sig Gen—Book I



The Sig Gen Book I is a new publication available from Marconi Instruments, 111 Cedar Lane, Englewood, New Jersey. It deals with the use of signal generators in testing receivers and covers such subjects as: Source Impedance of Feeder Connected Receivers, Coupling to Loop Aerials, Signal-to-Noise Ratio, Automatic Gain Control, Plotting Response Characteristics, Measurement of Adjacent Channel Suppression and Spurious Response. A handling and mailing charge of 50¢ is asked. For your copy write:

**MARCONI INSTRUMENTS, Dept. WAB**

111 Cedar Lane  
Englewood, New Jersey

# 173

## Test Equipment Reference Data



ELECTRONIC DESIGN'S Test Equipment Reference Issue covers 12 important classes of test instruments. Included are complete up-to-date specifications for approximately 2500 off-the-shelf test instruments, arranged for quick and easy reference and comparison, and cross indexed by product category and manufacturer's name. Technical data prepared from the Directory of Technical Specification/Electronic Test Instruments, by Technical Information Corporation. Twelve application-oriented articles by industry experts complete the package. Price \$5; check or money order must accompany order.

**Hayden Publishing Company, Inc.**

850 Third Avenue  
New York, New York 10022



# Manufacturers

Advertisements of booklets, brochures, catalogs and data sheets. To order use Reader-Service Card.

## M-F Nylon Insert Lock Nuts



This book can be a valuable guide to the engineer who must specify dependable locking fasteners. It contains sixteen pages and describes all aspects of MacLean-Fogg's complete line of Nylon Insert Lock Nuts. There are tables which outline principal features and applications of the nuts. Other tables list physical properties, chemical properties, and data on tensile strength requirements. Charts on each of the company's eight styles of Nylon Insert Lock Nuts include dimensional data, weights, and part numbers. Circle number on reply card.

### MacLean-Fogg Lock Nut Company

1060 Allanson Road  
Mundelein, Illinois 60060

# 172

## How To Write Technical Articles



A guide for the engineer-author, "How to Write Articles for Electronic Design" shows how easy it is to write for publication—once the engineer knows what to write and how to write it. The Author's Guide includes a complete run-down of the types of articles published by Electronic Design—plus detailed instructions on how to prepare technical articles and short special features. A MUST for every "would-be-writer" in the electronics industry. Send for your complimentary copy by circling the number to the right.

### Electronic Design

850 Third Avenue  
New York, N.Y. 10022

# 174

## Books For The Electronics Engineer



The 1966 Hayden Book Company, Inc., catalog contains such new titles as "Microelectronic Design," "100 Ideas for Design '66," "The Electron in Electronics," "Synthesis of RC Networks with Arbitrary Zeros," "Transistor and Diode Network Calculations," and "Matrix Algebra for Electronic Engineers." As well as the expanded list for design engineers, the catalog includes Hayden and John F. Rider Publisher training texts at all levels. Send for your free catalog today.

### Hayden Book Company, Inc.

116 West 14th Street  
New York, N. Y. 10011

# 175

## Advertising Representatives

### New York 10022

Robert W. Gascoigne  
Thomas P. Barth  
Samuel M. Deitch  
Rick Brough  
850 Third Avenue  
(212) PLaza 1-5530  
TWX: 867-7866

### Philadelphia 19066

Fred L. Mowlds, Jr.  
P. O. Box 206  
Merion Station, Pa.  
(215) MO 4-1073

### Marblehead 01945

Richard Parker  
7 Redstone Lane  
(617) 742-0252

### Chicago 60611

Thomas P. Kavooras  
Berry Conner, Jr.  
720 N. Michigan  
(312) 337-0588

### Cleveland 44107

Robert W. Patrick  
8410 Treetower Drive  
Chagrin Falls, Ohio  
(216) 247-7670

### Los Angeles 90005

Stanley I. Ehrenclou  
Terrence D. Buckley  
W. James Bischof  
2930 W. Imperial Highway  
Inglewood, Calif. 90303  
(213) 757-0183

### San Francisco 94306

Ashley P. Hartman  
541 Del Medio  
Suite #301  
Mountain View, Calif.  
(415) 327-6536

### Southwestern 75235

Tommy L. Wilson  
6200 North Central Expressway  
Dallas, Tex. 75206  
(214) EMerson 1-2311

### London W. 1

Brayton C. Nichols  
44 Conduit Street

### Tokyo

Yoshihiro Takemura  
International Planning  
Service, Inc.  
Room No. 512 Nikkoh  
Mita Building  
1, Nishidaimachi, Shiba-  
Takonawa  
Minato-ku, Tokyo



## RELAY COMPONENTS OF THERMOSET PLASTICS

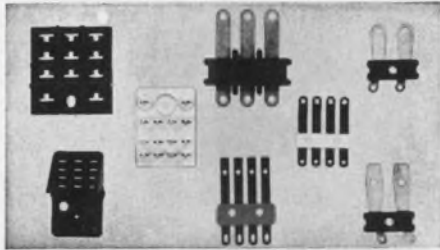

Precision relay component molding of DAP, Phenolics, Alkyds to specification. Long or short runs. Insert molding. We offer you the savings of low mold costs due to our specialized machines and techniques. Complete resources for material selection aid, design and engineering of the mold, tooling molding, quality control. Close tolerances. On time deliveries. Write or call for sample work or a quotation today.

Send for **FREE**  
brochure.

**938-7671**  
Area 312



DIVISION OF THERMOTECH INDUSTRIES, INC.  
1202 South Fifth Street, Hopkins, Minn.

ON READER-SERVICE CARD CIRCLE 73

## to your exact specifications...



## at stock prices

### METALIZED MYLAR CAPACITORS

Unique, self-healing units that remain in circuit during voltage surges with little or no loss of electrical properties. Use the M2W's where size and weight are limiting factors and long life and dependability are required. The units utilize metalized Mylar\* Dielectric with film wrap and custom formulated epoxy resin end fill. Available in round and flat styles.

\*Du Pont Trademark for Polyester Film

Samples available on your letterhead request

**Standard**

**CONDENSER  
CORPORATION**

DEPT. ED-4, 3749 N. CLARK STREET, CHICAGO, ILLINOIS 60613  
ON READER-SERVICE CARD CIRCLE 74

# Advertisers' Index

\*PARTICIPANTS IN  
NIGHT LETTER PROGRAM

Advertiser	Page
ADC Products, Inc. ....	140
Airflyte Electronics Co. ....	139
Airpax Electronics, Incorporated ....	135
Allen-Bradley Co. ....	15
*Amperex Electronic Corporation ....	103
Amperite ....	137
Analog Devices, Inc. ....	25
*Arnold Engineering Company, The ....	19
Augat, Inc. ....	138
Automatic Electric, A Subsidiary of General Telephone & Electronics ....	56
*Ballantine Laboratories, Inc. ....	101
Bendix Corporation, The Cincinnati Division ....	124
Bodine Electric Company ....	132
*Bourns, Inc. ....	4, 5, 36, 37
*Brush Instruments, Division of Clevite ....	Cover III
Clairex Corporation ....	139
Computer Logic Corp. ....	74
Computer Measurements Company ....	2
*Corning Glass Works ....	8, 9
Couch Ordnance, Inc. ....	128
Cutler-Hammer, Inc. ....	94
*Damon Engineering, Inc. ....	22
Davey Products Company ....	130
ESI/Electro Scientific Industries ....	113
Eastern Radio Corporation ....	35, 38
Electro-Motive Mfg. Co. ....	127
Electronic Design ....	33, 141
Elgenco, Inc. ....	134
General Electric Company, Semiconductor Products Department ....	30
General Instrument Corporation ....	105
General Radio Company ....	119
Globe Industries, Inc. ....	74
Gordos Corporation ....	143
Gudebrod Bros. Silk Co., Inc. ....	64
H P Associates ....	1
Harowe Servo Control, Inc. ....	136
Hayden Book Company, Inc. ....	131, 141
Hayden Publishing Company, Inc. ....	140
Hewlett-Packard ....	23, 61, 70, 71
Hickok Electrical Instrument Co., Inc., The ....	109
Honeywell Denver Division ....	29
Hudson Lamp Company ....	125
Hughes Aircraft Company, Electronic Design ....	24
Industrial Electronic Engineers, Inc. ....	121
Industrial Timer Corporation ....	143
Industro Transistor Corporation ....	112 E-F-G-H
*International Rectifier Corp. ....	123
JFD Electronics Corporation ....	99
Johanson Manufacturing Corp. ....	95
Kay Electric Company ....	27
Latronics Corporation ....	138
Leach Corporation ....	107

**Advertiser** **Page**

M-O Valve Co., Ltd. ....	110
MacLean-Fogg Lock Nut Company .....	141
Marconi Instruments Division of English Electric Corporation .....	140
Marin Controls Co. ....	132
Melpar, Inc. ....	93
Mepco, Inc. ....	28
*Motorola Semiconductor Products, Inc. ....	65, 115

Nytronics, Inc. .... 133

Parker Seal Company .....	141
*Philco, Lansdale Division .....	92
*Potter & Brumfield Division of American Machine & Foundry Company .....	6
Princeton Applied Research Corp. ....	16

RCA Electronic Components and Devices 96, Cover IV  
Robinson Technical Products Inc. .... 26

Schjeldahl Company, G. T. ....	91
Self Organizing Systems, Inc. ....	120
Signetics Integrated Circuits, A Subsidiary of Corning Glass Works .....	7
Singer Company, The—Metrics Division ..	57, 116, 117
*Sola Electric Division of Sola Basic Industries ..	39
Sprague Electric Company .....	10, 12, 20
Stackpole Carbon Company .....	32A
*Standard Condenser Corporation .....	142

TRW Capacitors .....	40
*Tally Corporation .....	75
Texas Instruments Incorporated, Semiconductors-Components Division .....	50, 51
Thermotech Industries, Inc. ....	142
Tracor, Inc. ....	108

Unimax Switch, Division Maxson Electronics Corporation .....	111
*Union Carbide Corporation .....	42
United Transformer Corp. ....	Cover II

Vent Rak, Inc. ....	129
*Victoreen Instrument Company, The .....	144

Westinghouse Capacitor Department .....	34
Wright/Div. of Sperry Rand Corporation .....	60

**Regional Advertising**

Burndy Corporation .....	112A
*Dale Electronics, Inc. ....	112C
*Magnetics, Inc. ....	112D
Sorensen, A Unit of Raytheon Company .....	112B

**Career Advertising**

Boeing .....	81
Douglas Missile & Space Systems Division .....	86
Electro-Mechanical Research, Inc. ....	78
Hughes Aircraft Company Aerospace Division ..	82
IBM Corporation .....	84
LTV Electrosystems Inc. ....	85
Lockheed-California Company .....	83
Lockheed Missiles & Space Company .....	80



**NEW!**

**Direct reading punched tape programmers control—22, 42 or 82 load circuits. Less than \$600**  
(82 channels)

Expressly designed for multiple circuit industrial control applications, this new Tape Reader combines the durability of toggle switches, the flexibility of a patchboard, the repeat accuracy of a cam timer, with the advantages of punched tape programming.

For detailed information about this direct-reading low-cost Tape Programmer, write Mr. Kenneth Kraemer, Director of Marketing.



# INDUSTRIAL TIMER CORPORATION

65 U.S. HIGHWAY 287, PARSIPPANY, NEW JERSEY  
IN CANADA: SPERRY GYROSCOPE OTTAWA LIMITED, ONTARIO  
ON READER-SERVICE CARD CIRCLE 75

The widest line of  
**magnetic reed switches**  
in the industry.

**SUGGESTED APPLICATIONS:**

- KEYBOARDS
- INTERLOCKS ■ COUNTING
- PUSH BUTTONS ■ RELAYS

Write or call today for your **FREE** copy of the **Gordos Full Line folder . . .**

. . . complete with cross referencing chart.



# GORDOS CORPORATION

250 GLENWOOD AVE., BLOOMFIELD, N.J. 07003 (201) 743-6800

ON READER-SERVICE CARD CIRCLE 76

# VICTOREEN SPARK GAPS



protect  
circuits  
from  
transients

*Firing Time 75 nanoseconds to 1 microsecond  
Tolerance  $\pm 5\%$  or better*

**Victoreen Type VX-96 Spark Gaps** now provide creative designers with circuit protection never before possible by simple, economical means. Because of extremely fast firing time, Victoreen Spark Gaps ward off catastrophic effects of pulses, spikes, even transients with extremely steep wave fronts. Available in any desired firing voltage from 150 — 5000 volts  $\pm 5\%$ . Low interelectrode capacitance enhances use in HF applications where wave deformation cannot be tolerated.

**For Ignition Applications**, as a "hold-off" device, Victoreen Spark Gaps prevent current flow until circuit voltage has reached breakdown voltage of gaps. Their excellent repeatability and long life enhance operation in continuous duty systems. Ambient temperature range  $-65^{\circ}$  to  $125^{\circ}\text{C}$ , shock resistance to 100g for 11 milliseconds, vibration resistance 10g from 55-2000 cps. Write or wire for full details. Or call Applications Engineering Department, (216) 795-8200, Ext. 306.

6400-A

**THE VICTOREEN INSTRUMENT COMPANY**  
10101 WOODLAND AVENUE • CLEVELAND, OHIO 44104



## Designer's Datebook

APRIL						
S	M	T	W	T	F	S
3	4	5	6	7	8	9
10	11	12	13	14	15	16
17	18	19	20	21	22	23
24	25	26	27	28	29	30

MAY						
S	M	T	W	T	F	S
1	2	3	4	5	6	7
8	9	10	11	12	13	14
15	16	17	18	19	20	21
22	23	24	25	26	27	28
29	30	31				

### April 20-22

**1966 Intermag** (International Conference on Magnetics) (Stuttgart, Germany) Sponsor: IEEE G-Mag; Dr. E. Pugh, IBM Corp., 1000 Westchester Ave., White Plains, N. Y.

### April 25-28

**Audio Engineering Society Convention** (Los Angeles) Sponsor: Audio Engineering Society; John C. Baumann, Ampex Corp., 8467 Beverly Blvd., Los Angeles, Calif.

### April 26-28

**Spring Joint Computer Conference** (Boston) Sponsors: AFIPS, IEEE, ACM; Dr. Harlan Anderson, Digital Equip. Corp., Maynard, Mass.

### May 2-4

**Aerospace Instrumentation Symposium** (Philadelphia) Sponsor: Instrument Society of America; William Redstreak, Moore Products Co., Sumneytown Pike, Spring House, Pa.

### May 4-6

**Electronic Components Conference** (Washington, D.C.) Sponsor: IEEE G-PMP; 345 East 47th St., N. Y.

### May 9-12

**National Conference of Standards Laboratories** (Gaithersburg, Md.) Sponsor: National Bureau of Standards; R. D. Huntoon, N.B.S., Washington, D.C.

### May 10-12

**National Telemetry Conference** (Boston) Sponsors: ISA, AIAA, IEEE; Lewis Winner, 152 W. 42 St., N. Y.

Another Brush Innovation in Recording:

The Brush Mark 280.  
Once you've seen  
it work,  
the chain makes  
a lot of sense.

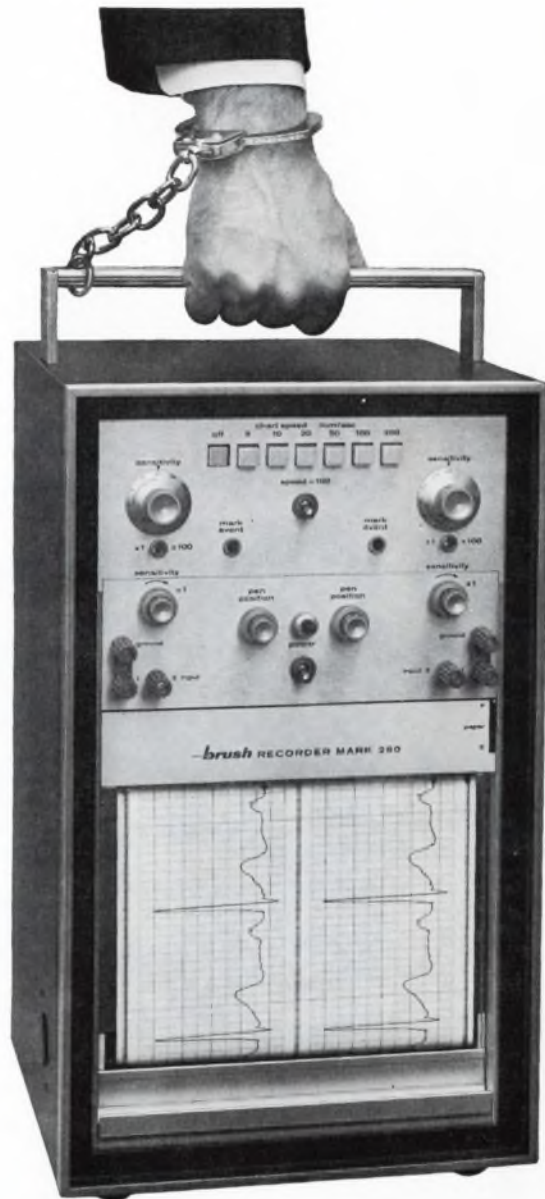

People who use the Brush Mark 280 can get pretty possessive.

No wonder.

True rectilinear traces so crisp and clear you'll never miss the message. Dual recording channels a full 80 millimeters wide. Resolution the likes of which you've never seen. A pressurized inking system. Metri-site pen positioning. Low cost chart

paper. Pushbutton choice of 12 chart speeds. Solid state electronics. Response as high as 200 cps at useable amplitude and better than 30 cps full scale. System accuracy of  $\frac{1}{2}\%$ !

And now get set for the big surprise: the performance-packed Brush Mark 280 measures just  $10\frac{1}{2}'' \times 18\frac{3}{8}'' \times 11\frac{1}{2}''$ !

Search no more for a full perform-

ance portable. No one *but no one* has anything to compare with the amazing Mark 280. Ask your Brush representative for a demonstration. Or write today for our free booklet. Brush Instruments Division, Clevite Corporation, 37th and Perkins, Cleveland, Ohio 44114.



**CLEVITE**

**brush** INSTRUMENTS DIVISION

Speed Inquiry to Advertiser via Collect Night Letter  
ON READER-SERVICE CARD CIRCLE 244

# RCA-8072

## Your Best Buy for New Equipment Mobile Transmitters

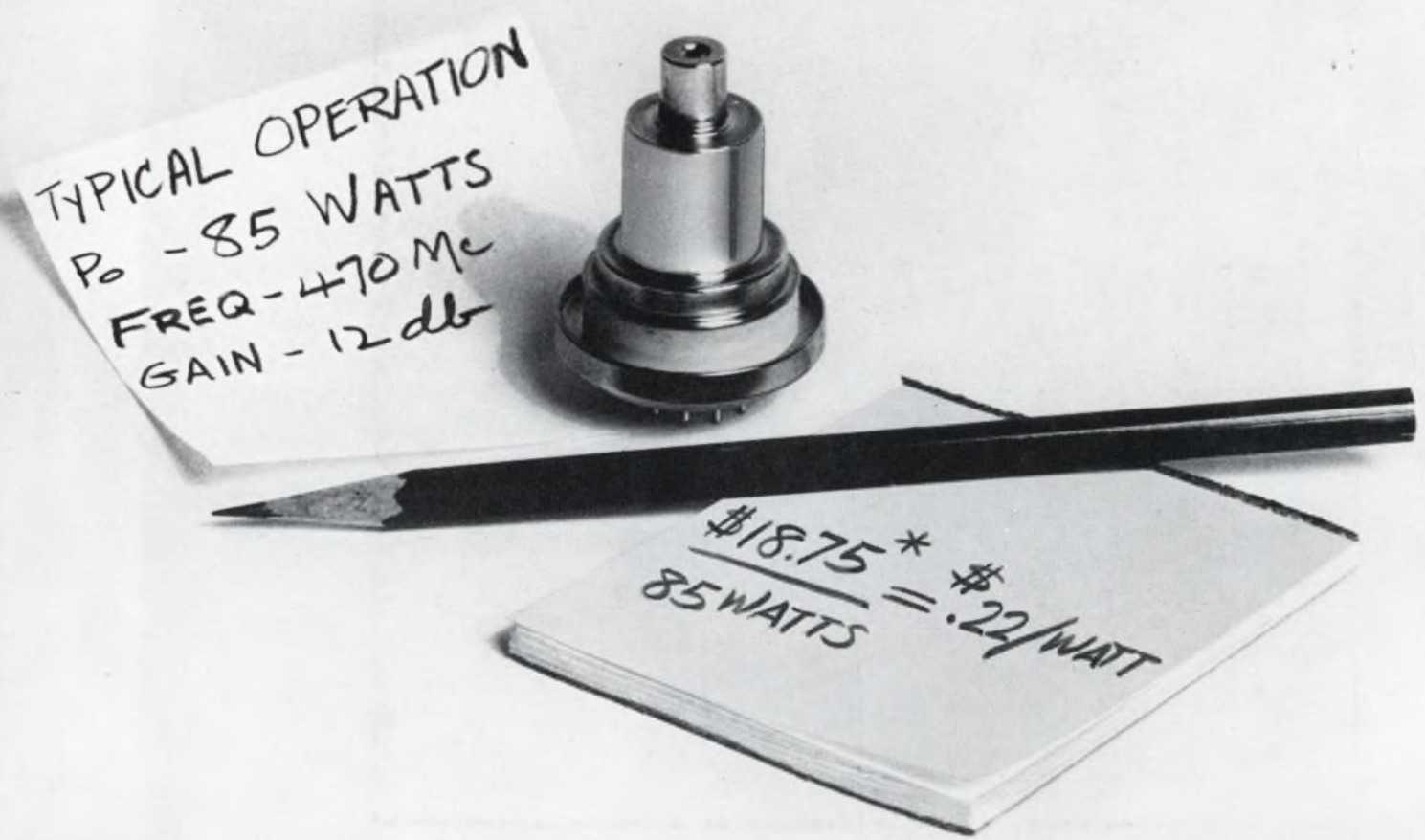

See your RCA Representative about RCA-8072 and other  
RCA power tubes. For technical data, write:  
RCA Commercial Engineering, Section D18Q4, Harrison, N.J.

ALSO AVAILABLE FROM YOUR RCA INDUSTRIAL TUBE DISTRIBUTOR

\*Optional Distributor Resale price. See your RCA Field Representative for Equipment price.



RCA Electronic Components and Devices, Harrison, N. J.

The Most Trusted Name in Electronics