

# ELECTRICIAN & MECHANIC

**Power Transmission by Alternating Currents  
Testing and Operation of Wireless Apparatus**

**List of American Wireless Stations**

**Pipes and Pipe Fitting**

**Gas Engine Driven Dynamos**

**How to Make an Early English Chair**

**Camp Building**

**Strength of Concrete Beams**

**Famous Airships**



*Courtesy of "Scientific American"*

"Zeppelin IV" — The Huge New Airship which was Recently Destroyed while on a 500-mile Voyage

**PUBLISHED MONTHLY BY  
SAMPSON PUBLISHING CO.  
6 BEACON STREET, BOSTON, MASS.**

*Thompson & Co. N. Y.*

# STANLEY

B  
A  
I  
L  
E  
Y

P  
L  
A  
N  
E  
S

## BAILEY ADJUSTABLE IRON PLANES

These Planes have had many important changes, some of which are here shown:



The cutter rests on the Iron Frog, being supported clear down to the heel of the Bevel, and very close to the cutting edge.

The front support being close to the mouth makes a solid bedding for frog and cutter.

The rear support being deep, greatly strengthens the sides and bottom of the Plane.



The frog screws, being located between the two supports, correctly distribute the pressure between them.



The screw bosses being deep, enable a great number of screw threads to engage, thus securely holding the frog in place and preventing any possibility of the Plane being drawn out of true when face of frog is screwed up hard.

No.			Each
1	Smooth,	5 1/2 inches in Length, 1 1/4 inch Cutter,	\$1.65
2	Smooth,	7 inches in Length, 1 3/4 inch Cutter,	2.05
3	Smooth,	8 inches in Length, 1 3/4 inch Cutter,	2.20
4	Smooth,	9 inches in Length, 2 inch Cutter,	2.40
4 1/2	Smooth,	10 inches in Length, 2 1/8 inch Cutter,	2.75
5	Jack,	14 inches in Length, 2 1/8 inch Cutter,	2.75
5 1/2	Jack,	15 inches in Length, 2 1/8 inch Cutter,	3.15
6	Fore,	18 inches in Length, 2 1/8 inch Cutter,	3.50
7	Jointer,	22 inches in Length, 2 1/8 inch Cutter,	4.00
8	Jointer,	24 inches in Length, 2 1/8 inch Cutter,	4.80

Write for Catalogue

**THE STANLEY RULE AND LEVEL CO.**  
NEW BRITAIN, CONN., U.S.A.



LOOKING AFT.

PLANT THAT BUILDS  
**“RACINE BOATS”**

**Up-to-date Boats**

**FOR UP-TO-DATE PEOPLE**

Now building Light-ship No. 89 for  
 U. S. Government.

We are putting on the market the product of the largest and most modern plant of our kind in the world, and putting it within the reach of every lover of boating.

Every size and style of boat from a canoe to a 200-ft. Ocean Going Steam-yacht. Our Power Boats combine every desirable quality found in all others without any of the disagreeable features found in any of the others.

Twenty-five years of actual experience in the building of Boats and Motors combined with the advantages of an up-to-date plant equipped with all modern machinery, enables us to furnish the Perfect Racine Hulls fitted with the Noiseless and Odorless Racine Engines, making the most ideal Launch about.

We are proud of our Boats and Motors and want an opportunity to demonstrate their worth.

We are offering the above outfits for the same price you would have to pay for an ordinary Launch.

Ask us for full particulars.

Catalog No. 1 describes Motor Boats, Auto Boats, Cabin Launches, Cruisers, Shallow Draft Tunnel Boats for river use, etc. Send 4 cents for postage.

Catalog No. 2 describes Row Boats, Hunting Boats, Canoes, Dinghies, Barges, Combination Row and Sail Boats, etc. Send 4 cents for postage.

**RACINE BOAT MFG. CO.**

**Box 651 MUSKEGON, MICH.**

Complete stock for inspection, trial, and immediate delivery at our branch stores.

1020 BROADWAY, NEW YORK.

182 MILK STREET, BOSTON.

38 DELAWARE AVE., CAMDEN, N. J.

182 JEFFERSON AVE., DETROIT.

1610 MICHIGAN AVE., CHICAGO.

321 FIRST AVE. S., SEATTLE.

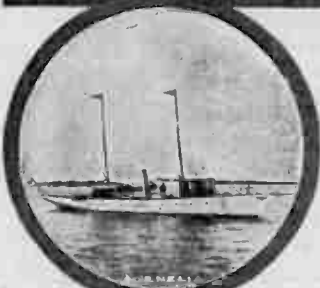

VERMONT

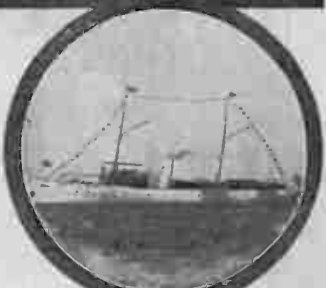

RACINE



JULIET



VENCEDOR



WHITE SOX



LOOKING FORTH

# PATENTS SECURED PROMPTLY

And with Special Regard to the  
Legal Protection of the Invention

**Handbook for Inventors and Manufacturers Sent Free upon Request**

Consultation Free. No charge for opinion as to the Patentability and Commercial Value of Inventors' Ideas. Highest References from Prominent Manufacturers.

**C. L. PARKER, Patent Lawyer**

Patents, Caveats, Trade-marks, Copyrights, Reports as to Patentability, Validity, and Infringement. Patent Suits conducted in all States.

REFERENCES:—Globe Machine and Stamping Co., Murray Engineering Co., Morgan Machine and Engineering Co., Berkshire Specialty Co., Stewart Window Shade Co., Macon Shear Co., Acme Canopy Co., Lippencott Pencil Co., Salisbury Tire Association of America, Inventors' and Investors' Corporation, Oakes Manufacturing Co., Cox Implement Co., Columbus Buggy Co., National Index Co., By-Products Co., Alabama Brewing Co., National Offset Co., Antiseptic Supply Co., Richmond Electric Co., Railway Surface Contact Supplies Co., National Electric Works.

Mr. Parker, on November 1st, 1903, after having been a member of the Examining Corps of the U. S. Patent Office for over five years, resigned his position as Examiner to take up the practice of patent law.

Address, 52 Dietz Building, Washington, D. C.

## PATENT WHAT YOU INVENT



Our Three Books Mailed Free.

"U. S. LETTERS PATENT" gives full information in patent matters.

"THOUGHTS THAT PAY" gives list of what to invent.

"THOUGHTS THAT HAVE PAID" gives history of successful inventions.

Write for them.

No charge for opinion as to patentability; send sketch or model.

Patent obtained or fee returned.

Patents advertised for sale free.

**WDDWARD & CHANDLEE, Patent Attorneys.**  
1202 F Street, WASHINGTON, D. C.

## PATENTS

Send Sketch or Model for FREE Examination and Report as to Patentability. Patents promptly secured. ADVICE FREE; Rates Reasonable; highest references and best services. WRITE FOR FREE BOOKS.

**WATSON E. COLEMAN,**

Registered Patent Attorney, Washington, D. C.

## PATENTS SECURED

OR FEE RETURNED. Send Sketch for FREE REPORT as to Patentability. GUIDE BOOK and WHAT TO INVENT, with valuable List of Inventions Wanted, SENT FREE. One Million Dollars offered for one invention; \$16,000 for others. Patents secured by us advertised free in World's Progress: Sample Free.

**EVANS, WILKENS & CO.**

100 F Street Washington, D. C.

## A PLACE FOR TOOLS



No. 101

Ⓐ Bench 6½ feet long, 25 inches wide, with 14-inch glued-up Maple top. Cabinet has roomy drawers and cupboard.

Ⓒ Just the thing for combined Bench and Tool Cabinet. Saves room and is much superior to the cheap tool-chest for storing tools.

Ⓓ Drawers and cupboard have locks insuring safety.

Write for Home Bench Catalogue

**GRAND RAPIDS HAND SCREW CO.**

930 Jefferson Ave., GRAND RAPIDS, MICH.

Largest Bench Manufacturers in the world

## Patents

Valuable Book on Patents FREE. Tells how to secure them at low cost. How to get a Patent and What to Invent for Profit. Gives Mechanical Movements invaluable to Inventors. Full of Money-making Patent Information. New Book FREE to all who write.

**O'MEARA & BROCK, PATENT ATT'YS**  
634 F Street WASHINGTON, D. C.

## INDUCTION COILS

mahogany cases, high-grade fittings, and guaranteed  
½ to ¾ inch spark, \$7 1 inch spark, \$10  
1½ inch spark, \$14

Other sizes carried in stock or made to order. Secondary and primary windings, etc., furnished separately at bargain prices. All kinds of Wireless Apparatus.

Send stamps for literature  
New England Coil Winding Co., Atlantic, Mass.

## A WICKS ENGINE

IS A TWENTIETH CENTURY PRODUCTION

Why not build one? Castings, materials, and blue-prints, for building the Wicks ½ x ¾, high speed, vertical single-acting center crank, steam engine (gas engine type), are now ready.

Complete outfit of castings, materials, and blue-print working drawings, \$2.75

Complete set of blue-print working drawings, without castings, 6 sheets 10 x 12, 50 cents, silver or money order. This amount refunded on first order for castings if within thirty days after drawings are ordered.

Three sheets of construction blue-prints and photographs, 50 cents, silver. This amount refunded on order amounting to 50 cents or more.

**B. R. WICKS, Bridgeport, Conn.**

**FREE**  
**TWO BOOKS**  
 84-Page  
 "Inventor's Guide"  
 —AND—  
 "Fortunes in Patents"  
 "What and How to Invent"

**PATENTS THAT PAY**

**Protect Your Idea**  
**SPECIAL OFFER:** Send sketches or model and description of invention for **FREE SEARCH** of Patent Office Records and Report as to patentability. You will save **TIME and MONEY.** *Highest References.*

**E. E. VROOMAN,** Regis't'd Patent Attorney  
 1160 F St., Wash., D.C.

**REFERENCES:**  
 American National Bank  
 Washington, D. C.  
 Little Giant Hay Press Co.  
 Dallas, Texas  
 Gray Lithograph Co.  
 New York City, N. Y.  
 Farmers Manufacturing Co.  
 Norfolk, Va.

**ENGINEER'S MANUAL**  
 COMPILED BY  
 New Haven Stationary Engineers Ass'n., No. 2, N.A.S.E. of Conn.  
 In One Volume 12 mo., Illustrated, 194 Pages, Cloth Binding.  
 This book was compiled by a society of working engineers and is made up of the most important and useful matter relating to steam engineering and electricity, that these engineers have collected from various sources while following their trade. Most of the rules and suggestions are those which come into daily use in engine and boiler room. Price, 50c. post-paid.  
**AMERICAN INDUSTRIAL PUBLISHING CO.**  
 Box E BRIDGEPORT, CONN., U. S. A.

**PATENTS**  
 WRITE FOR  
**PATENT PARTICULARS**  
**S. P. BUCK, 3115 Dillon St. Balto., Md.**

**UNITED STATES**  
 OR  
**Canadian**  
**PATENTS**  
**\$25.00**  
 We pay all expenses and disbursements except government fees

**WRITE** to us for preliminary opinions on all legal matters. No charge unless retained.  
 Associates throughout Continental Europe, Great Britain, the Colonies, South America, and Canada enable us to investigate and prosecute foreign interests with dispatch.  
 OUR PAMPHLET FOR THE ASKING  
**THE INDUSTRIAL LAW LEAGUE, Inc.**  
 170 Broadway - New York City, N. Y.

**Water is in every home**  
 Pat. June 28, 1896  
 Pat. Sept. 10, 1907



By attaching an adjustable Water Motor and Water Fan to your water pipes, you can make your life more comfortable without expense.  
 Send 10c. for copyrighted Booklet and write for

cash discount to Fan Department.

**The A. Rosenberg Motor & Mfg. Co.**  
 Baltimore, Md.  
 U. S. A.

Manufacturers of Water Motors and Fans adjustable every way while running



Adjustable every way while running

*The Man May Wilt But Not*



The first and only satisfactory permanent linen-wear

**Litholin Waterproofed Linen Collars & Cuffs**

They weather all weathers—hot, cold, wet or dry they keep their shape, and being linen, look linen—not celluloid or rubber. In every fashionable cut and style. When soiled they wipe white as new with a damp cloth. Wear them and bank your savings.

Collars 25c. Cuffs 50c.

If not at your dealers, send, giving style, size, number wanted, with remittance, and we will mail, post-paid. Booklet of styles on request.

**THE FIBERLOID CO.**  
 Dept. 56. 7 Waverly Place, N. Y.

WATERPROOFED LINEN

**LITHOLIN**

STYLE ECONOMY FIT COMFORT  
 COLLARS & CUFFS

## A Chat with the Editor of Lippincott's

FOUND — a love letter. Owner may receive it by sending quotation to identify same.

ALFRED HARKNESS,  
— W. 65th Street.

This advertisement was sent to the New York newspapers by a young electrical engineer, who, in the course of his day's work, picked up a folded bit of paper on Avenue A. Being blessed with a sympathetic temperament, he determined to follow out the golden rule and try his best to restore the love letter to its owner. This seemingly innocent episode is the introduction to "The Investigation at Holman Square," which is our September novelette, by Nevil Monroe Hopkins, the author of "The Strange Case of Dr. North" and "The Moyett Mystery." The murder of a business man in his New York office baffles the city's police force. Then Mason Brant — the expert detective, who has figured in two other stories by Dr. Hopkins — gets to work on this truly mystifying case, and under his skill its complications gradually fall away until the perpetrator of the deed and the cause for its doing are triumphantly revealed. It looks at one time as if the engineer himself might be gathered into the drag-net; but a happier fate is in store for this "Columbian University, '01," graduate. It is safe to say that the most astute reader is unlikely to guess the murderer until the game is nearly played to a finish, so successfully has the author covered the tracks through false leads and other skilful maneuverings.

There will be many short stories of high quality and varied themes in September; among them "The Great God News," a powerful story about a woman and a war correspondent, by Will Levington Comfort; "Memories," full of subtlest love and humor, by Fannie Heaslip Lea; "Deported," a tale of San Francisco's Chinatown before the earthquake, by H. C. Stickney; "The Disaffection of Adelaide," a happily natural outcome of modern conditions, by Laura Simmons; "The Child of a Widow," an exceedingly clever picture of child-life, both pathetic and humorous, by Lucy Copinger.

In this number of the magazine there is a charming travel sketch by Anne Hollingsworth Wharton, called "Zelphine's Wedding Journey"; and in September she is to contribute another one about the same characters, entitled "Zelphine in Warwickshire." These are advance chapters of the author's forthcoming book on foreign travel.

"Our Ways of the Hour" department for September will contain thoughts on "The Moulding of

Men," by Herman Scheffauer; "The Tyranny of Parents," by Jane Belfield; and "The Literary Spirit in the Modern Magazines," by Robert Adger Bowen.

Poems pleasing in sentiment and meter, as well as a plentiful supply of jolly jokes, will help to make our September number a memorable one.

\* \* \* \*

Editors are only human (though writers will declare that they are inhuman), and it affords them great pleasure to receive letters of appreciation. Even adverse criticism is welcomed — when it is written in a spirit of fairness, as it usually is. And it helps the editor not a little to know what readers like and what they dislike. Therefore, if at any time you feel the impulse to write a letter to *Lippincott's*, don't resist it. You are only one of a large-sized army, but your opinion will be welcomed and valued just the same.

\* \* \* \*

One appreciative subscriber writes: —

"Allow me to congratulate you on the quality of *Lippincott's Magazine* — the best monthly printed in America. My wife — the little lady-at-home all over the land is the best judge of what is wholesome — says that let all the rest stop, but make sure of *Lippincott's*. Nearly every month the magazine is worth a dollar a number. It is the only magazine that doesn't fall down."

Another reader — from Indiana — writes: —

"Enclosed find money-order for renewal of my subscription to your most, to me, valuable periodical. I have enjoyed it every month, as has my wife, and feel that it is an essential in our *twelve-month days'* enjoyment. Had it not been appreciated, this renewal would not have been made. The short story features and the novelettes, as well as the articles of more solid reading matter, have appealed to me both as a source of recreation or diversion, as well as giving expression to subjects worthy of deeper thought."

And we quote from a recent Michigan correspondent, anent our July number: —

"The whole issue looks golden to me. 'Fudge' has a paragraph or two. 'The Patchwork Lady' is exquisite in its instants of cleverness, and they are several. The Irish ballad has inimitable touches and trembles. Who is Knapp with his new Beatitudes? The gall and the glory of some of his utterances! Is he not a clean, fine, fully donored man? He must be. I liked one of his stories before.

"All through I liked the number. It seemed to have behind it not a clerk, but a heart. I think you are attracting big vital things to your office."

**LIPPINCOTT'S MONTHLY MAGAZINE, Philadelphia, Pa.**

# DO YOUR OWN PIPING



You can very soon save the cost of a complete set of tools by doing your own work.

## NO. A., SET

- 1 Set Economy Stocks and Dies,  $\frac{1}{4}$ " to 1".
- 1 14" Wells Wrench,  $\frac{1}{4}$ " to 1 $\frac{1}{2}$ ".
- 1 No. 1 Wells Pipe Cutter,  $\frac{1}{4}$ " to 1 $\frac{1}{2}$ ".
- 1 No. 1 Wells Hinged Vise,  $\frac{1}{4}$ " to 2 $\frac{1}{2}$ ".
- 1 Oil Can.
- 1 Can Pipe Joint Cement.

Packed in Handsome Hinged Chest.

PRICE, \$9.00 F. O. B. GREENFIELD

Other Sets cutting up to 2". Send for Catalogue.

Every Tool made and guaranteed by

## F. E. WELLS & SON CO.

21 RIDELL STREET

GREENFIELD, MASSACHUSETTS

## WIRELESS TELEGRAPH EXPERIMENTERS

Are you getting RESULTS from your Stations? Perhaps the receiver that you use is not sensitive. Better buy a High Efficiency Receiver while the price is low. The new type of High Efficiency Receiver is wound to 1500 ohms resistance, and lists at \$5.00, complete, with Head-band and 6-foot Cord. The Double Head Receiver, 3000 ohms, complete, with Cord, \$8.00. Until the first of October, these will be sold to readers of *Electrician & Mechanic* for \$1.00 less than the price listed above. This is to introduce the High Grade of Tuned Circuit Apparatus that I am now selling. Remember, the price only holds good for one month. Better order at once. Write for my list of Apparatus.

W. C. GETZ

645 N. Fulton Ave. BALTIMORE, MD.

## Fits in the Pocket



Our Vest Pocket Slide Rule complete with instructions specially prepared for students. Sent by mail post-paid—

**\$1.80**

Catalogue of Drawing Materials, etc., on application.

**KOLESCH & CO.**

138 Fulton Street (Est. 1885) New York

## ELECTRIC

SUPPLIES—TELEPHONES—NOVELTIES

Catalogue of 200 Free

If it's Electric we have it. Big Catalogue 4 cents

**OHIO ELECTRIC WORKS  
CLEVELAND, OHIO**

The World's Headquarters for Dynamos, Motors, Fans, Toys, Batteries, Belts, Bells, Lamps, Books

We undersell all Want Agents



We Want You to Become Familiar With  
**The Reece Threading Tools**  
Including SCREW PLATES, TAPS, DIES, etc.



**SPECIAL TRIAL OFFER**

"Reece Premier" No. 1 T Tap Wrench and one each No. 2-56, 3-43, 4-33, 6-32, 8-32, 10-24, 12-24 and 14-20 "Hercules" Machine Screw Taps. Sent post-paid to any address on receipt of \$1.25

64-Page Catalogue Free

E. F. REECE CO. - Greenfield, Mass.

# "OLIVER" MACHINERY COMPANY

Nos. 10 to 20 Clancy Street  
GRAND RAPIDS, MICH., U. S. A.

MAKERS OF

Machinery and Small Tools

FOR

## MANUAL TRAINING

Special Catalogue in Preparation

EVERYTHING HIGH GRADE

Write us for Machinery, Benches, Vises, Clamps,  
Planes, Chisels, Saws, Grinders, etc., etc.

We have them.

BRANCH OFFICES

OLIVER MACHINERY Co., Hudson Terminal,  
50 Church Street, New York  
OLIVER MACHINERY Co., First Nat'l Bank Bldg., Chicago  
OLIVER MACHINERY Co., Pacific Bldg., Seattle

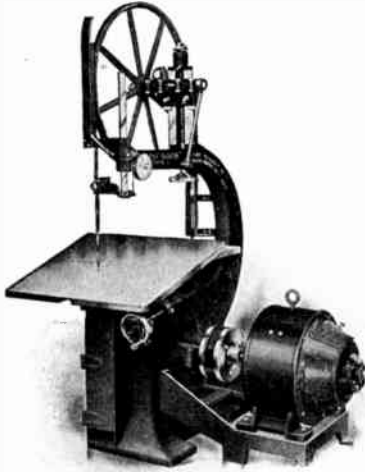

OLIVER "C" BAND SAW  
MOTOR DRIVEN

MOTOR HEAD SPEED LATHES  
A SPECIALTY

## Receiver's Sale

A \$56.00 Library For Only \$24.50

Wonderful opportunity to get these fifteen magnificently bound volumes, comprising the Library of Universal History for less than half value. The publishers have failed. We, as receiver, must dispose of enough sets to pay the obligations of the publisher. For a limited time we will send a set for free examination without asking you to pay one cent down.

**Here is Our Offer:** Send us your name and address on the coupon or a postal telling us you would like to receive for free examination the 15 vols of the Library of Universal History in your home and we will send them to you, charges prepaid. Look over these books for a week and then if you decide that you do not want them send them back of our expense. If you wish to keep this superb work send only 50c and then \$2.00 a month for twelve months — only \$24.50 for this \$56.00 library.

The Library of Universal History is a complete history of the whole world written by America's greatest historians and endorsed by America's greatest scholars.

There are over 5,000 pages, 100 finely engraved maps and 700 large full page illustrations.

Write to us at once, just put your name on the coupon. Without obligation or expense we want you to examine this grand work in your home for a week before deciding.

**15 Massive Vols.**

Each vol. 7 in. wide;  
10 in. high; wt.  
lxd., nearly

25  
lbs



E. M.  
FREE  
COUPON

American  
Underwriters  
Corporation,

Department D. 7  
240 Wabash, Chicago

Without expense or obligation to purchase, I would like to examine the Library of Universal History in my home free for a week.

Name.....  
Address.....

## Gas Review

A Magazine for the  
Gasoline Engine User

Gas Review will bring into your home—place on your library table—the wisdom, the knowledge, and the experience of the foremost experts on gas and gasoline engines.

A lesson on gas engine operation appears in each issue. Compression, ignition, mixture, battery troubles, fuel consumption, the exhaust, insulation, lubrication, wiring, electricity, and, in fact, every feature in the construction and care of gas and gasoline engines is covered fully yet in a simple, easily understood way.

Think of getting a complete course in gasoline engineering—one not only equal to but far superior to the average gasoline engine course costing from thirty to fifty dollars, all for

**50 CENTS PER YEAR**  
Sample Copies on Request

## GAS REVIEW

14 Cantwell Building

Madison . . . . . Wisconsin



## TABLE OF CONTENTS

Electrical Engineering. Chapter XXVII. Power Transmission by Alternating Currents . . . . .	<i>A. E. Watson</i> . . . . .	93
Zeppelin IV, the Famous Airship . . . . .		100
Testing and Operation of Wireless Telegraph Tuned Circuit Apparatus . . . . .	<i>W. C. Getz</i> . . . . .	101
List of Wireless Telegraph Stations in United States and Canada . . . . .		105
Farman's Aeroplane . . . . .		107
Pipe and Pipe Fitting . . . . .	<i>Carl H. Clark</i> . . . . .	108
A Few Remarks on Arc Lamp Trimming . . . . .	<i>William Harley</i> . . . . .	112
Wireless Systems of To-day. I. The Massie . . . . .	<i>Newell H. Thompson</i> . . . . .	113
Practical Notes on Gas Engine Driven Dynamos . . . . .		118
Patents . . . . .	<i>Albert G. Davis</i> . . . . .	121
How to build an Early English Chair . . . . .	<i>E. Williamson</i> . . . . .	125
Camp Building. Part III . . . . .	<i>Will B. Hunt, 2d</i> . . . . .	127
The Strength of Concrete Beams . . . . .	<i>Richard L. Humphrey</i> . . . . .	128
How to make an Electrical High-water Signal . . . . .	<i>David J. Siegel</i> . . . . .	130
A Ball-bearing Emery Grinder . . . . .	<i>C. Cheverton</i> . . . . .	130
Editorial . . . . .		132
Questions and Answers . . . . .		133
Book Reviews . . . . .		137
Geographical Membership List of the Wireless Club . . . . .		137

## WIRELESS TELEGRAPHY

The continued demand on the part of our readers for wireless information already published has led us to compile the following list of articles on Wireless Telegraphy recently published in **ELECTRICIAN & MECHANIC**. Copies of any of these numbers may still be had at 10 cents each. As the supply of the earlier numbers is very limited, we suggest immediate application for numbers wanted.

A Portable Wireless Telegraph Apparatus . . . . .	October, 1907	Wireless Telegraph Stations in Baltimore. I. . . . .	July, 1908
Automatic Calling Device for Wireless Telegraphy . . . . .	October, 1907	A Practical System of Wireless Telephony . . . . .	July, 1908
A Portable Wireless Telegraph Outfit . . . . .	November, 1907	Construction of a Silicon Detector . . . . .	July, 1908
Wireless Telegraph Distances . . . . .	November, 1907	Construction of Tuned Circuit Receiving Instruments: Tuning Coil, Potentiometer, Condenser . . . . .	July, 1908
How to make a Polarized Relay . . . . .	December, 1907	The Transformer as a Source of Wireless Current . . . . .	August, 1908
Development of the Wireless Telephone . . . . .	January, 1908	Construction of a 500-watt Transformer Coil . . . . .	August, 1908
The Wireless Telegraph on the Lusitania . . . . .	February, 1908	Construction of Tuned Circuit Transmitting Apparatus: Condenser, Spark-gap, Sending Helix or Inductance . . . . .	August, 1908
Wireless Troubles and how to overcome them . . . . .	February, 1908	Testing and Operating of Tuned Circuit Instruments . . . . .	September, 1908
Wireless Telephones in the American Navy . . . . .	April, 1908	List of Wireless Stations and Calls . . . . .	September, 1908
The Construction of a Magnetic Detector . . . . .	April, 1908	Geographical Membership List of the Wireless Club . . . . .	September, 1908
Construction of an Independent Interrupter . . . . .	April, 1908	Wireless Systems of To-day. I. The Massie System . . . . .	September, 1908
An Indoor Wireless . . . . .	April, 1908	Practical Hints on Insulating Induction Coils . . . . .	October, 1908
The Construction of a 4-inch Spark Coil . . . . .	April, 1908	Induction Coils for Wireless Telegraphy . . . . .	October, 1908
The Proper Adjustment of Wireless Telegraph Detectors when used on Tuned Circuits . . . . .	April, 1908		
A Compact Tesla Coil . . . . .	May, 1908		
How to build Aerials for Wireless Telegraph Systems . . . . .	June, 1908		
Alternating Currents of High Frequency . . . . .	July, 1908		
How to make a Wireless Telephone . . . . .	July, 1908		

ANY NUMBER MENTIONED ABOVE, 10 CENTS, POST-PAID

**SAMPSON PUBLISHING CO.      6 Beacon Street      BOSTON, MASS.**

# The TRAINED Man



Life is one continual contest of man against man, with Success as the prize—and the *trained man WINS*—not because he has more brains, but because he knows *how to use them*.

If you can bring intelligence into your work you are sure to advance. This doesn't mean that you must have an elaborate school or college education, but that you *must* have the good, sound, practical training that makes you an expert—that puts you in demand and in command. And that's the very kind of training the International Correspondence Schools have to offer.

## **How YOU Can Pull The Salary Bag YOUR Way**

Perhaps you've never quite realized how easy it is to acquire this training. *Mark the attached coupon and find out.* This costs you nothing—the coupon is simply your request for expert advice and information. Mailing it places you under no obligation. Then, do it now and learn how you can qualify for a better position *in the occupation of your choice*—how you can leave drudgery behind—how you can earn *more* than a living wage—all regardless of your age, place of residence or present occupation, and without having to buy a single book. Isn't it worth the postage?

Proof of the motto "*The Business of This Place is to Raise Salaries*" is found in the fact that every month an average of 300 students *voluntarily* report salary increases and promotions secured wholly through I. C. S. training. During December the number was 497. If these men can succeed, *you* can.

**Mark the coupon NOW.**

**International Correspondence Schools,**  
Box 930 SCRANTON, PA.

Please explain, without further obligation on my part, how I can qualify for a larger salary in the position before which I have marked X

Bookkeeper Stenographer Advertisement Writer Show Card Writer Window Trimmer Commercial Law Illustrator Civil Service Chemist Textile Mill Supt. Electrician Elec. Engineer	Mechanical Draftsman Telephone Engineer Elec. Lighting Supt. Mechan. Engineer Surveyor Stationary Engineer Civil Engineer Building Contractor Architect Draftsman Architect Structural Engineer Banking Mining Engineer
--	---

Name \_\_\_\_\_

Street and No. \_\_\_\_\_

City \_\_\_\_\_ State \_\_\_\_\_

# *Electrician and Mechanic*

*Incorporating*

*Bubier's Popular Electrician, Established 1890*

*Amateur Work, Established 1901*

---

VOLUME XIX

SEPTEMBER, 1908

NUMBER 3

---

## **ELECTRICAL ENGINEERING — Chapter XXVII**

### **POWER TRANSMISSION BY ALTERNATING CURRENTS**

A. E. WATSON, EE. PH.D.

IN a large installation for electric power, especially in one involving long-distance transmission, there might be found almost all varieties of apparatus. It would seem, therefore, interesting to describe with some detail both a diagrammatic and an actual example by which the application and interrelation of the different factors that combine to form the complete system may be illustrated.

Of course it is the dream of the engineer to prescribe one sort of dynamo, and to supply all classes of service from it without the intermediary of any transforming devices whatever, but as suggested in Chapter XVIII, the realization of this simplicity is quite unlikely. With the exception of a few worthy instances contributed by a single engineer, all long-distance transmission, and with many notable cases in which the distances were short, is accomplished with reliance upon alternating currents. When direct currents are preferred for ultimate applications, as for the most satisfactory arc lighting, for storage battery adjuncts to incandescent lighting, for electrolytic uses and the like, then "current reorganizers" must be introduced. The transformers and these intermediaries waste some power, but without them the crude energy, as it were, direct from the huge generators, cannot well be controlled for its great tasks, nor toned down to its simple and safe domestic applications.

A perspective diagram of a fairly complete general alternating current transmission and distribution system is given in Fig. 147. The several parts are lettered to allow for detailed references.

The generator is represented at A, and here is of the revolving armature type, after the design explained in Chapter XIV. It is clearly of the three-phase sort, for the three

collector rings and their brushes connecting with the line wires are apparent. An "impulse" water-wheel of the Pelton type is represented as a prime mover. Step-up transformers are shown at B. While each of these is of the simple single-phase construction, after the models of Chapter XVII, the combination is in the "Delta" arrangement, and allows for all three of the phases. When step-up transformers are employed, it is not common to wind the generator for a pressure higher than about 2000 volts. To what figure the pressure may be raised by the transformers has not yet been determined; 11,000 was at one time thought to be the limit of safe engineering, but double that was successfully met, and then 33,000. A number of installations are now regularly working at 66,000, and one at 80,000. Engineers are experimenting with apparatus hoped to withstand 150,000 volts. With the modern construction of revolving field generators, it has been found practicable to wind the armatures directly for as high as 13,000 volts, and thus for distances not exceeding 20 miles, to dispense with one set of transformers. One of the serious limitations to indefinitely high voltage is that of line disturbances from its inherent self-induction and capacity, and it has been with a view to eliminate these factors and mollify others that the single exception referred to in the first paragraph was made. This is the system devised by Thury, in France,

In the Thury system direct currents are used, and the necessary high voltage is obtained by connecting several generators in series. Each of these may be individually wound for 10,000 to 20,000 volts, so when as many as seven are put in series, and driven as if all on the same shaft, a circuit of surpris-

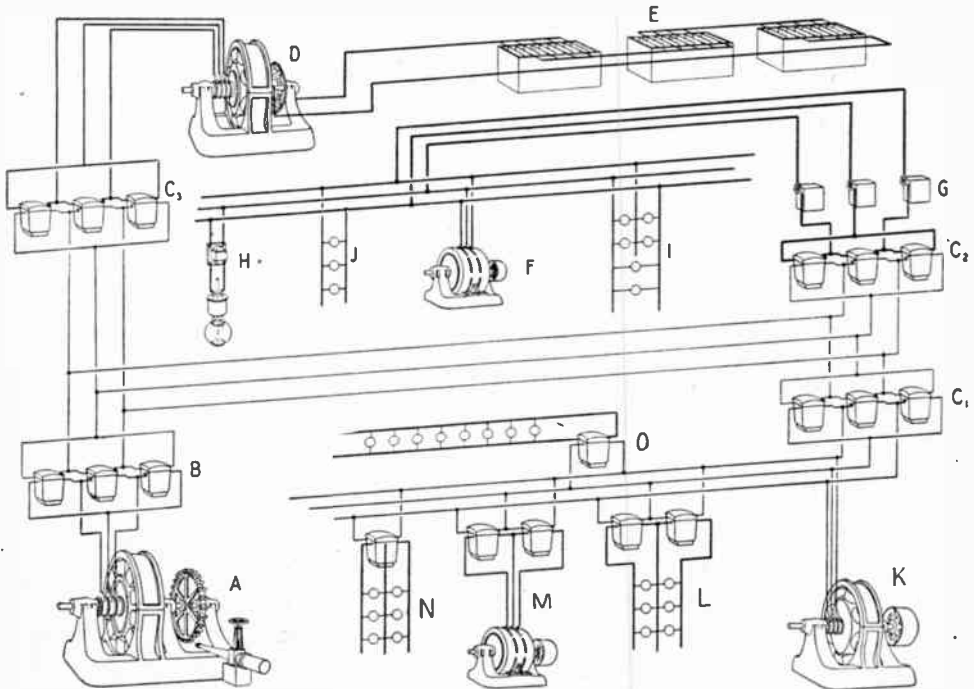

Fig. 147. Diagram Representing Long Distance Power Transmission, with Step-up and Step-down Transformers

ing vigor is possible. At the receiving end a similar set of machines also in series runs as a motor to drive such a generator as may be proper for the local needs. A number of such installations are in use, notably one sending power from the river Rhone to a distance of over a hundred miles, and destined to extend to Paris. The principal limitation of this system is its inability to permit subdivision of the energy from one set of machines to supply other than the one terminal station.

In conspicuous contrast with the above is the alternating system here being described, and with the generators working in parallel to keep the pressure constant, independent of the current load, no end of subdivision and convenience may be obtained. This feature of parallel distribution is brought out in the diagram given in Fig. 147, for at once, after passing through the transformers B, there is a division of the current, one part going to step-down transformers C<sub>1</sub>, in a sub-station at a great distance in one direction; another part passes to a second station with its step-down transformers represented at C<sub>2</sub>, while the rest is delivered in quite a different direction to transformers C<sub>3</sub> in a third station. Following the secondary mains from C<sub>1</sub>, a synchronous motor,

wound for the same voltage as the generator A, is found at K; it may be attached through the means of a friction clutch to any constant mechanical load, and started by the means shown in Fig. 68 of Chapter XV; or it may be a part of a convenient motor-generator set. In consequence of the diagram showing lamps connected at any desired place, it would be inferred that the frequency of the alternations was not lower than 50 cycles per second, but for large instalments of power the frequency would ordinarily be at 25 per second, and one application of synchronous motors would be to drive the frequency changers for the purely lighting circuits.

At O a single-phase transformer is connected to two of the three 2000-volt distribution wires, which lowers the pressure to about 100 volts for an ordinary two-wire incandescent circuit; at N a second transformer is shown, having a tap brought out from the middle point of its secondary, and supplying lamps on a three-wire system. The distinction between a "three-wire" and a "three-phase" system is suggested by the diagram, but the essential differences may here be further emphasized. In each, three wires are employed, but in the former, whether operated with direct or alternating currents, the middle wire is "neutral," and

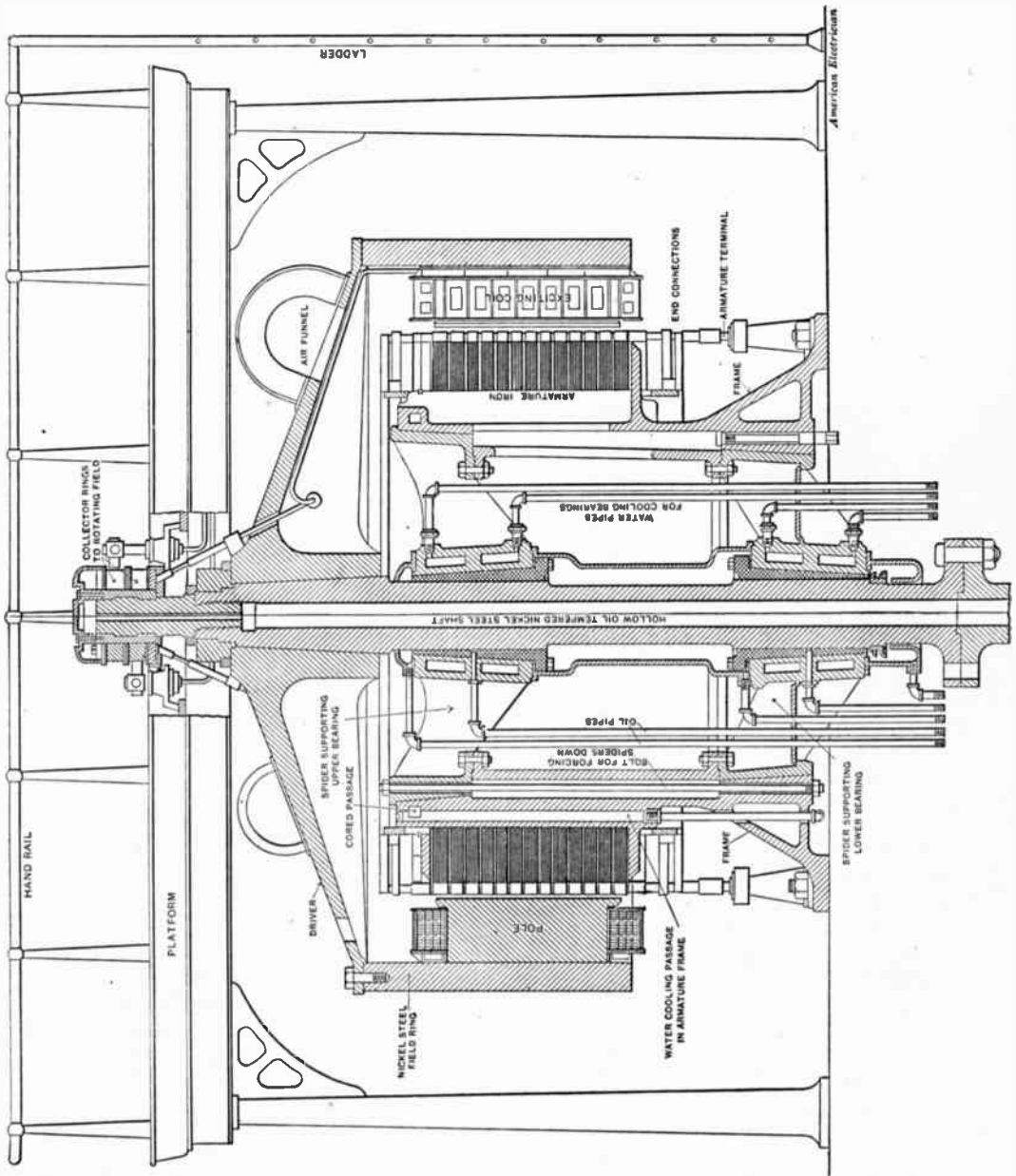

Fig. 148. Sectional View of One of the 5000 h. p. Niagara Vertical Shaft Generators

the voltage between outside wires is double that between either and the middle; as usually there is only a small current in the neutral wire, it can be of smaller size than the others, and in case of a balanced load, the system would operate without hindrance if this wire was disconnected. In the three-phase system, which implies the use of alternating currents of definite relations, all three wires are of equal importance, and there is the same voltage between any two of the wires. A wire could not be disconnected without at once reducing the circuits to ordinary single-phase character.

Since for giving strong self-starting qualities to induction motors all three phases are needed, the transformers for supplying the motor *M* are connected to the three mains. It is worth noting, however, that whereas at previous places three transformers were employed, here only two are used. When used in this manner they are spoken of as being "V" connected. They do not operate quite so economically, but for small installations it is common practice to follow this method. The same scheme of transformers is used for lights at *L*, but the system is unbalanced, for uniformity would demand that the two outer wires be continued to supply a third circuit of lamps, similarly to the arrangement shown at *I*.

From the set of transformers at *C*<sub>2</sub> the distribution mains pass through some devices marked *G*; they represent "feeder regulators" being really adjustable transformers for adding or subtracting pressure, whereby the voltage at the lamps may be preserved with considerable constancy. Often such adjuncts are operated manually by the switchboard attendant, in accordance with the indications of the voltmeters. Considerable progress has been made in recent years in the direction of automatic regulation, the necessary movement of the secondary coils being effected by small pilot motors, they in turn being controlled by sensitive relays. It will be observed that the circuits from *C*<sub>2</sub> are for local needs, and that the pressure has been reduced to the desired low value without the introduction of individual transformers as shown in the lower part of the diagram. An arc lamp is represented at *H*, but for its proper operation when the supply is at constant potential, there is included, as explained in Chapter XIII, a "choking" coil seen just above it.

From the absence of similar devices at *C*<sub>1</sub> it is not to be presumed that the district sup-

plied from them is devoid of regulation. The most likely function of the synchronous motor *K* is to run apparently free, but really as a valuable regulator. Mention of this property of a synchronous motor was made in Chapter XV. It is common practice to find a station manager installing large motors of this class rather than of the induction type, purely for the benefit upon the regulation of the voltage in the entire district. Varying the strength of the field-magnet of the motor directly affects the "power factor," and when this is at unity value, the line losses are least and the regulation best.

From transformers *C*<sub>3</sub> a rotary converter is operated, whereby direct currents are provided for charging storage batteries, for electrolytically refining copper, or performing other work for which direct currents alone are possible. If considerable variation of the direct current voltage is demanded, regulators similar to those at *G* should be inserted between the transformers and the converter, for since the ratio of conversion in the machine is a fixed quantity, the desired conditions are properly met only by impressing suitable values of the alternating pressure.

With principles and methods of representation thus in mind, a step nearer to the actual may be taken, and a description undertaken of some of the features of a plant that has been the fascination of engineers from its first inception. Without question this is at Niagara, and while enlargements are constantly being made, and five different companies are in the field, the original installation, known as the Niagara Falls Power Co., with its two houses on the American side, about a mile above the falls, is all that can here be considered. The reader who has the opportunity can well compare this equipment with those of quite different design found in the other stations. The different equipments agree in this respect, however, that they can work conjointly if need be, and thereby permit no interruption of the general service, even if one station be completely shut down.

The commercial attractiveness of Niagara lay in the immensity of its power and its nearness to extensive manufacturing industries. Except by electrical means no extensive devices for "harnessing" or distributing the power over a large area or at a great distance was known or even conceived. In its actual solution serious and untried civil, mechanical, and electrical engineering problems were presented. The first was solved by

blasting out a site for a power house 160 feet deep in the rock, and excavating a tunnel a mile long to serve as a tail race for delivering the water below the falls. The second factor consisted in providing means for bringing the energy of the water, in units of 5000 h. p., from the bottom of the pit to the dynamos that were to be located above ground. Vertical shafts were decided upon, 18 inches in diameter, and 140 feet long, their weight and that of the revolving members of the dynamos being supported partly by the upward thrust of a suitable portion of the water, the rest by oil pressure end-thrust bearings. For the third factor the generators were to be of the largest practicable output, and, though supplying alternating currents, were to operate in parallel with each other. Competitive designs and expert advice were solicited from the best engineers in Europe and America, and while the machines ultimately built have proved their rugged worth, it must be acknowledged that there was notable lack of liberality in paying for many of the features that were accepted.

The importance of running the generators in any station in parallel with each other is of the highest order, for by it only can uninterrupted service be maintained. Especially when rotary converters or synchronous motors are on the circuits must there be no failure of the current, even for an instant, for in that event the machines might next be supplied at the wrong phase, and the result be equal to that of a short circuit. Again, if for a moment a whole station be suddenly shut down, no small problem is presented in the matter of how again to resume the service. The effort of at once starting every sort of device that might be connected would be far beyond the ability of the generators to supply.

At first a frequency of 16 $\frac{2}{3}$  was proposed for Niagara power, but the ultimate decision was for 25 cycles, and that particular value has now become practically standard for the entire world for all long-distance transmissions. A speed of 250 revolutions per minute was declared feasible for the wheels, therefore with the rule that the number of cycles equals the number of pairs of poles times the number of revolutions per second, the field-magnets required twelve poles. As a mechanical assistance to the maintenance of the parallel operation, it was deemed important to give the revolving member the greatest weight possible and further to make it the external member. This is a factor now recognized as having been exaggerated, and not

incorporated in the generators belonging to the other companies, for they have internal revolving field-magnets of more ordinary appearance though with essential features to adapt them to the unusual conditions of speed and output.

With the diameter needed for the field-magnets, and the weight of the poles, and with the necessary contingent of an accidental running away of the water-wheels, it was found that nothing short of nickel steel would have sufficient tensile strength. The rings of that material are about 12 feet in external diameter, 4 feet in axial length, and 6 inches in thickness. Their expense may be judged when it is stated that the cost of a ring is equal to that of the rest of the entire material of which a generator is constructed. In the other power houses either reduced weights of this alloy have been possible or its use altogether omitted. Two-phase winding of the armatures was approved, and the reasons for that decision are well established in modern practice. Two phases in the generators or motors and three phases in the long-distance transmission give economy of material when both step-up and step-down transformers are employed.

In Fig. 148 is given a sectional view of one of the last seven of the ten machines installed in Power House No. 1. All these were made by the Westinghouse Company, previous to 1900, a similar equipment in House No. 2 being made by the General Electric Company since that date. The different parts are liberally denoted so as to make the construction fairly clear. Attention is specially directed to means for ensuring ventilation of the field and armature winding. Air ducts are numerous, and scoops arranged so as to cause strong currents downwards and outwards throughout the entire machine. The bearings are water cooled. The ladder and gallery are for the purpose of reaching the rings at the top that allow for the direct current connection for energizing the field.

The electrical efficiency of these machines is the highest allowed for any yet built, being of not less than ninety-eight per cent. This is not for the reason that the water is regarded as requiring such extreme economy, but because the shortage of two per cent from actual perfection must appear in the form of heat, and two per cent of 5000 h. p. is 100 h. p., and the amount of heat represented by this amount of energy would be equaled by burning a large hod full of coal under the dynamo every hour. (In this crude illustra-

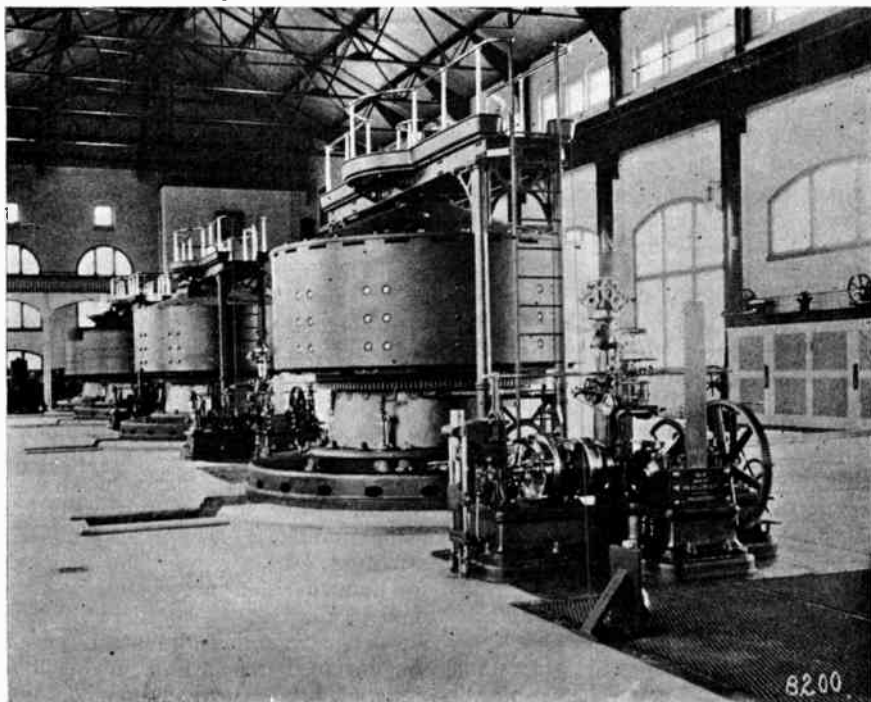

Fig. 149. View of Interior of Niagara Power House No. 1

tion allowance is made for the very low efficiency of a boiler and steam-engine arrangement.)

The actual appearance of four of the Niagara generators as set up in the power house is given in Fig. 149. It is observed that at the time of making the photograph only two of them were running. The water-wheel governors are seen between the dynamos, the one in the foreground revealing something of the intricacy and inferred importance of this adjunct. Some of the first regulators were designed and built in Switzerland, but most of them by Dr. Sellers, in Philadelphia. If the view had taken more machines, there would have been seen at the middle of the room an "elevator" for reaching the *bottom* of the pit, and there is as much interesting machinery to see on the way and at the bottom as at the top. Two direct current generators, also on vertical shafts, are beside the elevator, and these serve as exciters for the main machines. Two rotary converters are also installed in a side room, for use in case of failure of the regular exciters. Ducts lead from all the machines to two central areas, upon which elevated structures are erected, below being the

switches, and above, the attendant's instruments.

With the suspicion in mind that often safety devices produce more damage than they prevent, it was the decision of the designing engineers, especially the English, to omit them, and make the entire installation so rugged as to be able to meet and overcome any load or short circuit. Such simplicity was found to be impossible, and a narration of the experiences during the first years of operation of the station form an interesting and thrilling, if not terrifying, chronicle. Aside from the disturbances, amounting often to disasters, that accompanied accidental and malicious short circuits outside the power house, there were troubles within. Of particular weakness was found the indicating devices for synchronizing the generators for parallel running. The simple device of a pilot lamp, as described in Chapter XV, — for the act of "paralleling" an alternator is essentially the same as starting a synchronous motor, — is by no means a safe indication of the proper instant of closing the main switch; though the filament be quite dark it may still be that appreciable current be flowing, though not enough to be





sensible optically. Especially would it be disastrous, when working with large low resistance generators, to complete the circuit at the moment of departing from the right phase relations instead of approaching them. The burning out of several armatures, the melted copper running out of the machine as from a foundry crucible, when the combined output of the other generators was poured into the helpless one, was the price of errors of judgment from this source. To avoid repetitions of this expensive sort of accident, Mr. Lincoln, of the Westinghouse Company, devised a highly ingenious instrument, now called the "synchroscope," which, though requiring caution and skill in the using, leaves little excuse for actual accident. The moving element is not much larger than the coil of a voltmeter, but its two windings are actuated by energy from the bus bars to which the running machines are attached, and from the armature of the machine to be started. If the incoming machine is too fast, the pointer revolves in one direction, if too slow, in the other; when in synchronism the pointer becomes stationary, but both synchronism and opposition of phase, the concurrent conditions aimed for, are realized only when the pointer is stationary and at the top of the scale. Then is the critical instant for closing the circuit with the new machine; the gate for the water-wheel may then be

opened farther and in the attempt to go faster the generator assumes any desired portion of the load.

It is interesting to notice that these generators are so nicely balanced as to run free from tremor, sight and sound being the clearest indicators of motion. They run so free from friction, that it is possible for an idle one to run for two hours after shutting off the water. How to stop one may be a fair question to ask. This is readily accomplished by the simple expedient of short-circuiting the armature, then sending a small current around the field coils. The drag on the armature conductors serves as an invisible and frictionless brake.

As a fitting summary to this chapter and to the series of articles as a whole, a sort of spectacular diagram, illustrating about all classes of apparatus of widely different applications, for both local and distant service, is given in Fig. 150. The various uses of Niagara power are remarkably well shown for such a small scale, but with the clear references contained, the reader will appreciate the wonderful complexity of apparatus, and the special means employed to accomplish particular ends. Though the diagram represents the conditions as they existed ten years ago, the development since that time has been largely in extent rather than in methods.

THE END

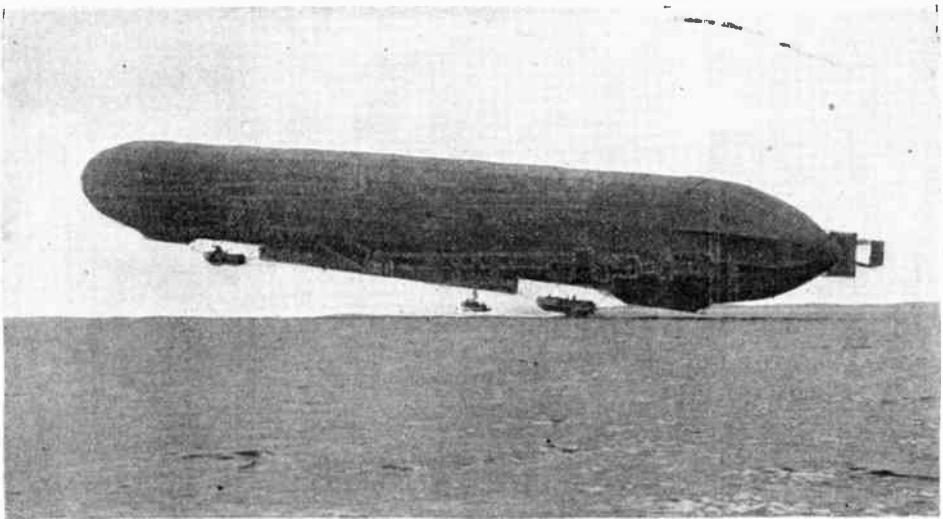

*Courtesy of "Scientific American"*

**"Zeppelin IV" — The Huge New Airship which was Recently Destroyed while on a 500-mile Voyage**

A 120 h. p. engine in each car drives two propellers. Note the stabilizing planes and rudders at the rear. The balloon is made of sheet aluminium laid over a rigid framework.

## WIRELESS TELEGRAPH TUNED CIRCUIT APPARATUS

## TESTING AND OPERATION OF THE TRANSMITTING AND RECEIVING INSTRUMENTS

W. C. GETZ

As this article is the last of the series dealing with the construction of Tuned Circuit Apparatus, for an experimental wireless station, it is therefore necessary to repeat a few of the suggestions given in other issues.

It is assumed that the experimenter has made or obtained all of the necessary instruments for both the receiving and transmitting outfits, and has connected them up as suggested according to the respective sketches. It is also assumed that he has

If at any point the buzz shows up in the receiver, leave the detector at that adjustment and vary potentiometer until proper degree is reached. If still no noise, lift slide spring of potentiometer away from winding. This should cause a click in telephone receiver. If there is no click, examine telephone cords, battery connections, and test battery. If there is a click, but the detector is still dead, remove silver-platinum point, and examine tip of platinum wire. Sometimes it gets

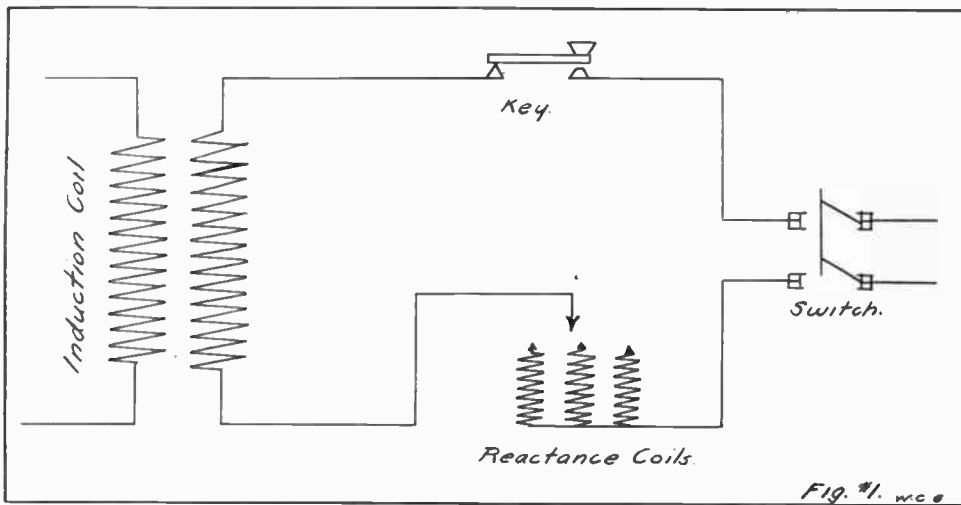

Fig. 1. Diagram of Reaction Coils

attempted to operate with more or less successful results.

We will therefore go briefly over the receiving and transmitting apparatus, and endeavor to point out the weak places. With the receiving instruments connected as shown in the July issue, and the detector in proper adjustment (explained in April issue) by pressing the button of the testing buzzer (wired as shown in April issue) a loud buzz should be heard in the telephone receiver. If no noise is heard, try the platinum-silver point (electrolytic detector being used) and put it a little deeper into solution. If this brings the buzz in, but a bubbling noise follows, readjust the potentiometer. If there is still no noise when the point enters the solution, withdraw it slowly, keeping the buzzer going.

turned over into a U-shape and will not work properly. Also disconnect condenser, and test it for a short-circuit. This should conclusively show the trouble in one or more of the above places.

After the detector circuit is found working all right, try the tuning coil in with the aerial. If you are in a place where there is a trolley car system, "splashes" caused by cars going over crossings, etc., will be heard. At any rate static "splashes" should be picked up. If, however, you do not get anything, though detector tests O. K., examine the contact slides of tuning coil, the condenser connections, aerial lead wires, and ground connections.

In the case of the ground connections, the absolute necessity of having a good ground cannot be overestimated. If an under-

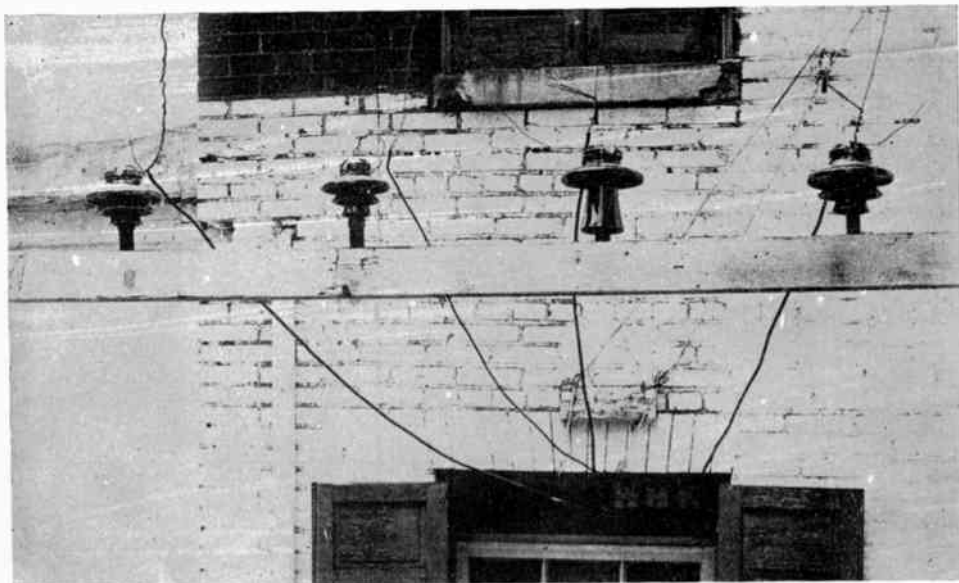

Fig. 2. A Device for Insulating the Antenna

ground water pipe line is convenient, it makes an excellent ground. Otherwise it is necessary to bury a metal plate in the earth, below the line of permanent moisture. NEVER GROUND TO THE GAS OR ELECTRIC LIGHT FIXTURES, PIPES OR CONDUITS! This would be very dangerous.

Another method of testing out your connections is to place a small sending outfit about 300 yards away, and by having a friend to make a series of dots, the apparatus can thus be properly adjusted.

By observing the above precautions and making a careful study of each instrument and its functions, but little trouble should be encountered. It is important, though, to have a good telephone receiver. A single head receiver can be had for about \$5 that will have a resistance of over 1000 ohms, and over 8000 turns of No. 40 wire on its magnets.

Regarding the potentiometer a recent article in a contemporary periodical describes a type having a low resistance. While this would work, it would also wear out the batteries in a very short while, thus proving a source of great expense. The potentiometer should have a resistance of at least 150 ohms.

On the sending side, the most trouble will be experienced in getting the open and closed

oscillating circuits in resonance, or tuned properly. By following out the suggestions given in the August issue, this may be satisfactorily accomplished.

Another point that mystifies the amateur is the small spark obtained at the spark-gap. For instance, if a 1-inch spark coil is used, the spark at the gap may be only 1-16th inch. This is due to the capacity of the condensers, and does not signify that the coil is not working properly. In fact the spark, though shorter in length, is much more intense, and is really of much greater efficiency.

If the spark at the gap suddenly falls off, examine the condensers. Sometimes a condenser breaks down, causing a low resistance leak and thus cuts out the spark-gap. Much trouble is experienced with the vibrators on coils. Where alternating current is available, even for small coils, it is sometimes best to cut out the vibrator entirely, and run the alternating current straight through the coil. In this case, reactance coils are inserted as shown in Fig. 1, the object being to prevent too great a flow of current through the induction coil. By having several of these reactance coils so that they may be inserted or cut out at will, the character of the spark can be varied.

Other troubles common to induction coils, such as breakdown of secondary, heating of

primary, short-circuit or opens, in either winding, etc., will also decrease the efficiency in part or altogether.

A serious factor in many stations is the loss or leakage from the antenna to surrounding objects. The only way to prevent this is to have the wires run as straight as possible, and to have the aerial and leading-in wires highly insulated. Figure 2 gives a view of the excellent method that Mr. Henry, of Baltimore, has adopted in insulating the antenna. His aerial now is over 750 feet long, and is at the highest, 200 feet above ground. The excellent results that he has with the transmission justifies the installation of the 50,000-volt high tension insulators. Particular attention is called to the novel method that he uses in leading in his wires through plate glass, thus securing the best of insulation at the base of the aerial. While the cost of the aerial may be increased considerably, for the experimenter who desires perfect results, this would be no handicap.

Regarding the disposal of the various instruments, the following extracts from the Rules of the United States Navy on Installation of Wireless Apparatus, may prove of value:—

“The operating room should be well ventilated and free from vibration, at the same time being as nearly sound proof as possible. The exact location of this room is not of great importance, provided a good lead to it for the aerial can be obtained. The farther this lead is from large conducting bodies, the better. Operating rooms below the water line, where long leads to the aerial are necessary, are decidedly less efficient than those on the upper deck.

“The room should have a well-insulated entrance for the aerial, and should be fitted with an operating table about 2½ feet wide, not less than 7 feet long, and of convenient height for working the sending key when sitting down.

“The table should be strongly built, and of well-seasoned wood.

“The instruments should be mounted on the table so that they are at a safe sparking distance from each other and from any part of the operating room.

“The receiving instruments should be as far away from the sending instruments as practicable. The induction coil or transformer may be mounted on the bulkhead or under the table. In any case, it should be where its terminals are not likely to be touched accidentally. The motor generator is pref-

erably installed near the operating room, but outside of it.

“The connections between all parts of the sending and receiving instruments should be as direct as possible, and in the case of the sending instruments, they should be of large surface, and well insulated by air or other non-conductors. Sharp turns in connecting wires should be avoided on account of brush discharges which always start at corners. The effect is the same as if the electricity were traveling too fast to turn corners.

“High-potential leads should be kept away from low-potential leads; and where they cross, it should be nearly at right angles.

“The ground connections should be electrically good and of large area. The diagrams of the connections and the purpose and use of each connection should be familiar to every operator. They should be well made and kept clean all the time.

“Wireless telegraph instruments, like all others, depend for their efficiency on their condition, and amply repay good care.

“Sending key contacts should be kept clean and smooth, and with faces parallel to each other.

“All sliding contacts, especially in receiver tuning coils should be clean and bright and free from foreign matter.

“Detector points should be kept in their most sensitive condition, and frequently tested by means of the buzzer furnished for the purpose.

“The best adjustment for receiving different stations should be recorded or memorized by all operators.

“A sending set working at low power, with all connections good, closed and open circuits in resonance, no sparking from edges of condenser jars or plates, nor glow from aerial, and no sparking to rigging, is utilizing its power much more efficiently than the same set pushed to the limit, but out of resonance, or with high resistance connections, and sparking at all points.

“In any case, use only current and gap necessary for good readable signals, when sending to stations at known distances.

“The insulation resistance should be tested monthly or more frequently when leaks are suspected, and all insulation aloft should be frequently examined.

“Porcelain or glass insulators are preferred. Hard rubber insulators char on the surface from leaks in wet weather, and thus become less effective as insulators.

-WIRELESS TELEGRAPH-  
MORSE CODE ALPHABET.

A	B	C	D	E	F	G
H	I	J	K	L	M	N
O	P	Q	R	S	T	U
V	W	X	Y	Z	&	
1	2	3	4	PERIOD	INTERROGATION	
5	6	7	8	COMMA	EXCLAMATION	
9	0			COLON	SEMICOLON	

Fig. 3. Morse Code

“Except where a number of tunes are ordered to be used, the operators should not alter the capacity nor inductance in either circuit except when absolutely necessary; and when, while sending, any part of the condenser is injured, it should be immediately replaced or repaired, and if this cannot be done on account of lack of spare parts, the two circuits should be readjusted to resonance.

“Operators must avoid a short or jerky style of sending. Dots and dashes must be firm and of proper relative lengths, as must also the interval between parts of a letter and the spaces between letters and words. The spark must be kept white and crackling, and have considerable volume.

A	B	C	D	E	F
G	H	I	J	K	L
M	N	O	P	Q	R
S	T	U	V	W	X
Y	Z	WAIT	UNDERSTAND	DONT UNDERSTAND	
PERIOD		INTERROGATION		EXCLAMATION	
1	2	3	4	5	
6	7	8	9		
0	CALL	FINISH.			

9234 A

Fig. 4. Continental Code

“At all stations, ship and shore, the best results are invariably obtained and the most satisfactory service given by alert and careful operators who take pride in the condition of their instruments.”

The above rules cover a number of important points that would be well for both the experimenter and operator to bear in mind, if good results are to be attained.

The principal codes in use are the Morse Code and Continental Code. Figure 3 gives the complete Morse Code, while the Continental Code is given in Fig. 4. This latter code is used by all stations of the United States government, and by the majority of the wireless companies, although the Morse Code is the favorite with the most of the commercial stations in the United States.

The principal difference in the codes is in the characters forming some of the letters. The Morse Code contains an interval of time called a space between portions of certain letters, thus making it possible to use in some cases three different letters for the same characters: for instance, “C,” “R” and “S,” of the Morse, are each made of three dots, but the “C” has a “space” between the second and third dot; the “R” has a space between the first and second dots; and the “S” consists of three dots in succession. The Continental Code contains none of these spaced letters, and while it is therefore not as rapid, it is less liable to error.

In calling a station, it is customary to send the station’s call letter several times, followed by the call letter of the home station. For instance, suppose Washington Navy Yard (Q I) is calling Annapolis (Q G), the call will be made as follows:—

Q G Q G Q G Q I

This call is repeated several times, and then the body of the message is sent. At the end of the message, the call letters are again repeated, and the message is closed by the symbol 3 followed a long dash, thus —

Q G Q G Q G Q I 3 —

which is the conventional method of ending.

The following lists give the call letter, location, wave length, and other data of wireless stations of the United States government, commercial stations in United States, and Canadian official stations. These should be placed in a convenient place in every operating room, for ready reference.

## LIST OF SHORE STATIONS IN THE UNITED STATES

Name of Station and Location	Call Letter	Wave Length Meters	System	Intended for	Remarks
Atlantic City.....	AX	600	De Forest	5 Kw.	In operation
Babylon, L. I.....	BA	400	Marconi	2 Kw.	do.
Sea Gate, Coney Island.....		300	do.		do.
Bridgeport, Conn.....	BG	400	De Forest	3 Kw.	do.
Block Island, R. I.....	BI	...	Massie	...	Not in operation
Boston, Mass.....	BN	800	De Forest	10 Kw.	do.
Brant Rock, Mass.....	BO	1800	Fessenden	15 Kw.	In operation
Buffalo, N. Y.....	BV	...	De Forest	...	Not in operation
Cape Cod, Wellfleet, Mass.....	CC	1500	Marconi	35 Kw.	In operation
Cleveland, Ohio.....	CD	700	De Forest	10 Kw.	Not in operation
Collingwood, N. J.....	CG	...	Fessenden	...	do.
Chicago, Ill.....	CH	1000	De Forest	15 Kw.	do.
Cleveland, Ohio.....	CN	...	Clark	...	In operation
Cape May, N. J.....	CP	...	Massie	3 Kw.	Not in operation
Detroit, Mich.....	CW	...	Clark	...	In operation
Portland, Me.....	D	...	De Forest	3 Kw.	Not in operation
Washington, D. C.....	DC	600	Fessenden	3 Kw.	Experimental station
Manhattan Beach, N. Y.....	DF	1500	De Forest	35 Kw.	Not in operation
Providence, R. I.....	FT	...	do.	...	do.
Galilee, N. J.....	G	425	do.	3 Kw.	In operation
Columbus, Ohio.....	CU	...	do.	...	Not in operation
Galveston, Texas.....	GV	425	do.	3 Kw.	In operation
Cape Hatteras, N. C.....	HA	425	do.	3 Kw.	do.
New Orleans, La.....	HB	425	do.	3 Kw.	do.
Hartford, Conn.....	HD	425	do.	3 Kw.	Not in operation
Port Huron, Mich.....	HU	...	do.	...	do.
Jersey City, N. J.....	JC	...	Fessenden	...	do.
Kansas City, Mo.....	KC	1000	De Forest	15 Kw.	do.
Key West, Fla.....	KW	400	do.	3 Kw.	In operation
Norfolk, Va.....	NF	400	do.	3 Kw.	do.
42 Broadway, New York.....	NY	400	De Forest	3 Kw.	In operation
Port Judith, R. I.....	PJ	400	Massie	2 Kw.	Not in operation
Paterson, N. J.....	PN	...	De Forest	...	do.
Quogue, L. I.....	Q	...	do.	...	do.
Siasconset.....	SC	350	Marconi	2 Kw.	In operation
Springfield, Mass.....	SF	400	De Forest	3 Kw.	Not in operation
Sagaponak.....	SK	351	Marconi	2 Kw.	In operation
Charleston, S. C.....	SN	400	De Forest	3 Kw.	do.
Savannah, Ga.....	SV	400	do.	...	do.
Southwest Pass, La.....	SW	450	do.	3 Kw.	do.
Philadelphia, Pa.....	WA	...	do.	...	Not in operation
Wilson's Point, Conn.....	WN	...	Massie	...	do.
Atlanta, Ga.....	AN	450	De Forest	3 Kw.	do.
New Orleans, La.....	MC	700	do.	10 Kw.	In operation
Stone Station, Cambridge, Mass.....		300-800	Stone	3 Kw.	Experimental station
Pierce Station, Harvard University,		400	Pierce	5 Kw.	do.
Houston, Texas.....	HO	...	De Forest	...	...
Mobile, Ala.....	MB	...	do.	...	In operation
Baltimore, Md.....	B	400	do.	2 Kw.	Not in operation
Pittsburg, Pa.....	SB	...	do.	...	do.
Rochester, N. Y.....	RH	...	do.	...	do.
Port Arthur, Texas.....	RA	...	do.	...	do.
New Haven, Conn.....	VN	...	do.	...	do.
Elizabeth City, N. C.....		...	do.	...	do.
Fort Morgan, Ala.....		...	do.	...	In operation
St. Louis, Mo.....	MA	1000	do.	15 Kw.	Not in operation
Jolo, P. I.....		No data	Composite	3 Kw.	
Zamboanga, P. I.....		do.	do.	3 Kw.	
St. Michael, Alaska, Safety Harbor.		do.	do.	3 Kw.	

## LIST OF SHORE STATIONS OPERATED BY THE UNITED STATES NAVY

Name of Station	Call Letter	Power	System	Wave Length Meters	Masts and Aerial
Cape Elizabeth, Me.....	PA	5 Kw.	Telefunken	....	130 ft. high 250 ft. long
Portsmouth, N. H.....	PC	3 Kw.	Stone	380-510-900	190 ft. long
Boston, Mass.....	PG	3 Kw.	do.	560-470	190 ft. long
Cape Cod, Mass.....	PH	5 Kw.	Telefunken	....	285 ft. long
Nantucket Shoal Lightship No. 66.....	PI	5 Kw.	do.	425	50 ft. long
Nantucket Shoal Lightship No. 78.....	PI	5 Kw.	do.	470	73 ft. long
Newport, R. I.....	PK	5 Kw.	do.	....	180 ft. high
Fire Island, N. Y.....	PR	5 Kw.	do.	425-600-950	200 ft. long
Navy Yard, New York.....	PT	15 Kw.	Stone	....	180 ft. high
Cape Henlopen, Lewes, Del.....	PX	3 Kw.	Massie	475-490-625	150 ft. long
Annapolis, Md.....	QG	2½ Kw.	Telefunken	337-425	275 ft. long
Washington, D. C.....	QI	15 Kw.	Massie	840-1125	300 ft. long
Norfolk, Va.....	QL	3 Kw.	Telefunken	350	170 ft. long
Cape Henry, Va.....	QN	3 Kw.	De Forest	....	180 ft. long
Diamond Shoal Lightship No. 71.....	QP	1 Kw.	Fessenden	425-320-630	75 ft. long
Diamond Shoal Lightship No. 72.....	QP	1 Kw.	do.	do.	do.
Pivers Is., N. C.....	QS	5 Kw.	Massie	....	....
Charleston S. C.....	QU	5 Kw.	do.	....	185 ft. high
Charleston, Lightship No. 34.....	QV	1 Kw.	Fessenden	....	62 ft. long
St. Augustine, Fla.....	QX	3 Kw.	Shoemaker	....	250 ft. long
Jupiter Inlet, Fla.....	RA	3 Kw.	do.	....	187 ft. high
Key West, Fla.....	RD	35 Kw.	De Forest	1200-1050-1375	300 ft. long 213 ft. high
Dry Tortugas, Fla.....	RF	3 Kw.	Telefunken	....	180 ft. high
Pensacola, Fla.....	RK	10 Kw.	De Forest	....	180 ft. high 200 ft. long
New Orleans, La.....	RO	5 Kw.	Telefunken	....	180 ft. high
San Juan, P. R.....	SA	35 Kw.	De Forest	....	300 ft. long
Culebra, W. I.....	SD	3 Kw.	Telefunken	....	....
Guantanamo, Cuba.....	SI	35 Kw.	De Forest	....	315 ft. long
Colon, Canal Zone.....	SL	35 Kw.	do.	....	208 ft. high
Navy Yard, Puget Sound.....	SP	3 Kw.	Telefunken	....	182 ft. high
Tatoosh Island.....	SV	15 Kw.	Massie	....	186 ft. high 215 ft. long
North Head.....	SX	5 Kw.	Telefunken	....	....
Cape Blanco.....	TA	5 Kw.	Massie	415-465	....
Table Bluff.....	TD	5 Kw.	do.	240-318	205 ft. long 160 ft. high
Mare Island, Cal.....	TG	2½ Kw.	Telefunken	240-318	do.
Farallon Island, Cal.....	TH	10 Kw.	do.	480-650	180 ft. high
Yerba Buena Island, Cal.....	TI	2 Kw.	do.	....	130 ft. high
Point Arguello, Cal.....	TK	3 Kw.	Shoemaker	520-640	175 ft. long
Point Loma, Cal.....	TM	10 Kw.	Massie	485-670	225 ft. long
Island of Oahu, Hawaii.....	UC	2 Kw.	Telefunken	....	....
Island of Guam.....	UK	3 Kw.	do.	....	....
Cavite, P. I.....	UT	5 Kw.	do.	....	....
Sitka, Alaska.....	SO	20 Kw.	Pierce	300-1600	180 ft. high 400 ft. long

## SHORE STATIONS CONTROLLED BY THE CANADIAN GOVERNMENT

Point Amour, Labrador.....	PR	....	Marconi	100-450	....
Whittle Rocks, Labrador.....	WR	....	do.	100-450	....
Battle Harbor, Labrador.....	BH	....	do.	220	....
Belle Island, Quebec.....	BI	....	do.	100-220	....
Fame Point, Quebec.....	FP	....	do.	100-220	....
Cape Race, Newfoundland.....	CE	....	do.	....	....
Cape Ray, Newfoundland.....	CR	....	do.	....	....
Venison Island, Labrador.....	VI	....	do.	220	....
Domino, Labrador.....	..	....	do.	....	....
Cape Sable, Nova Scotia.....	SB	....	do.	220	....
Sable Island.....	SD	....	do.	....	....
Heath Point.....	HP	....	do.	100-220	....
Cape Breton.....	..	....	do.	Ultra-Potent	....



Before closing this article a word should be said regarding wave lengths of stations. It is an erroneous idea, promoted by a certain contemporary publication, that the way to find the wave length of a station is to multiply the length of aerial wires by 4, and convert result to metric system, taking the final result as wave length in meters.

That this method is utterly misleading, is self-evident. Even for the natural wave length of an untuned oscillator, the multiplying factor has been proven to be 4.8, according to Erskine-Murray in his "Handbook of Wireless Telegraphy," page 294. The theoretical wave length of any oscillator is equivalent to —

$$2 \times 3.1416 \times V \times \sqrt{CL}$$

in which

V is velocity of light

L is the inductance in henries

C is the capacity in farads

It is evident that the joint capacity of parallel conductors is less than the sum of their individual capacities, so that even for an untuned wireless outfit it is difficult to properly figure the wave length, as such things as surrounding buildings with tin

roofs or steel frames, near-by shrubbery, etc., will follow this law, and alter, to a certain extent, the capacity of the aerial.

And in a tuned circuit system the capacity and inductance in the closed oscillating circuit have as much bearing on the wave length as the same factors in the open circuit; in fact CL of the open circuit must equal CL of the closed circuit to have perfect resonance.

The only practical way to obtain the wave length of a station is to use either a wave meter, such as the Donitz wave meter, or a Fleming cymometer. These instruments are so constructed as to give a direct reading of wave length, frequency, etc.

An approximate way to determine the wave length is to get some station to compare the positions of his tuning coil with your station sending, to the nearest station's tune that has a known wave length.

In conclusion, I would advise the experimenter to obtain the other issues of this magazine, mentioned in this article, together with "Standard Tuned Circuit Diagrams" and "Construction Drawings" that have been issued in convenient reference form.



*Courtesy of "Scientific American"*

Farman's Aeroplane making a Flight of Nearly a Mile with Two Men at Ghent, Belgium, on May 30

Note the latest modification of this machine, which consists of two vertical partitions between the forward planes and a similar third one in the middle of the tail. One of the propeller blades can be seen beside the right front wheel.

## PIPE AND PIPE FITTING

CARL H. CLARK

WHILE pipe fitting in its more complicated forms is in itself a trade, the simpler forms are very easily mastered and there are many cases where a knowledge of simple pipe fitting is of much use to the amateur.

In order that the work may be laid out and accomplished in the simplest and most direct manner a thorough knowledge of the various fittings in common use should be obtained.

The sizes of the ordinary steam, water, and gas pipe are governed by a series of "Standard Pipe Sizes" ranging from  $\frac{1}{8}$  inch upwards, the smaller sizes being given in the appended table. These sizes are based on a "nominal inside diameter," which is in almost every case smaller than the actual inside diameter, thus, referring to the table the actual inside diameter of the " $\frac{1}{2}$  inch" pipe is seen to be .62-100 or about  $\frac{5}{8}$  inch. While these sizes appear to be taken in a somewhat arbitrary manner, they are, however, accepted as a standard, and all pipe and fittings are in general made to suit them.

Referring again to the table of sizes, Fig. 1, the first column gives the nominal inside diameter, and the following in turn give the actual diameters, outside and inside, thickness, weight per foot, and the number of threads per inch on the threaded ends. This table will be found of use in deciding which size of pipe to use for a given purpose.

Nominal Size	Actual Diameter		Thickness	Weight per ft.	Thre'ds per in.
	Outside	Inside			
$\frac{1}{8}$	.405	.269	.068	.24	27
$\frac{1}{4}$	.540	.364	.088	.42	18
$\frac{3}{8}$	.675	.493	.091	.56	18
$\frac{1}{2}$	.840	.622	.109	.84	14
$\frac{3}{4}$	1.050	.824	.113	1.12	14
1	1.315	1.047	.134	1.67	11 $\frac{1}{2}$
1 $\frac{1}{4}$	1.660	1.380	.140	2.24	11 $\frac{1}{2}$
1 $\frac{1}{2}$	1.900	1.610	.145	2.69	11 $\frac{1}{2}$

FIG. 1.

Pipe of this description is usually termed "lap welded iron pipe," in distinction from

the seamless drawn tubing, which is made to a different standard. The welded pipe is made from a long strip of iron which is rolled lengthwise to form the pipe, and the edges are welded together. The drawn tubing is made by another process. Wrought iron pipe is made in three different thicknesses, viz., "standard weight," as shown in the table, Fig. 1; for ordinary pressures; "extra strong," for higher pressures; and "double extra strong" for the highest pressures. No very definite limits of pressure for each weight can be given, as it will depend largely upon the use to which the pipe is to be put. The outside diameter of all thicknesses is the same and corresponds to the table, Fig. 1, the inside diameter decreasing as the thickness increases, so that on the extra strong the inside diameter agrees quite closely with the nominal, while in the double extra strong it is considerably smaller than the nominal.

Brass pipe can also be obtained to the same standard as the iron pipe, and for many purposes is preferable.

Fittings are made of several materials, cast iron, malleable iron, brass, and sometimes of cast steel, and of varying thicknesses according to the pressure. For water pipes or low pressure steam pipes the cast iron fittings are used; for gas pipework the malleable fittings are used, as they are lighter and neater. With brass pipe the brass fittings should be used.

Pipes are joined together by threading the ends and screwing them into some form of fitting. The simplest form of fitting is the coupling shown in Fig. 2. It is simply a sleeve having a thread in each end, into which the ends of the pipes are screwed. Couplings may be obtained with a right hand thread in each end or with one each right and left hand, as may be desired. Except for a special purpose, those with both ends right hand threaded are used. When one end of the coupling is threaded smaller than the other, it is called a reducing coupling.

In Fig. 3 is shown a "flanged coupling," as it is termed. It answers the same purpose as that of Fig. 2, but is more substantial and suited to higher pressures. It consists of a pair of flanges with threaded necks into which the pipes are screwed; the flanges are then bolted together with a disk of packing between them. This form of coupling has

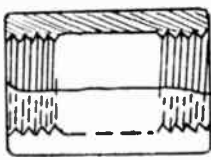

FIG. 2.

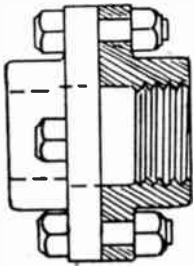

FIG. 3.

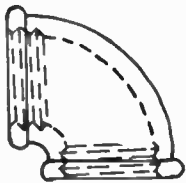

FIG. 4.

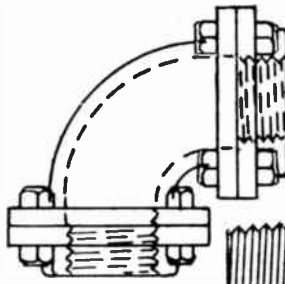

FIG. 5.

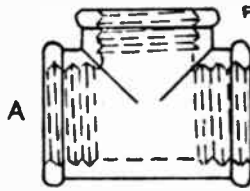

FIG. 6.

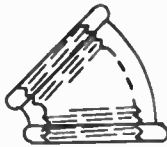

FIG. 8.

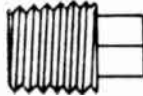

FIG. 9.

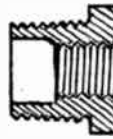

FIG. 10.

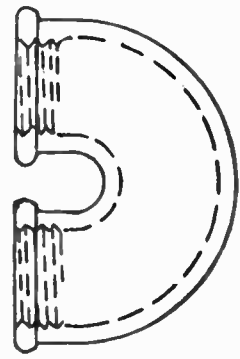

FIG. 7.

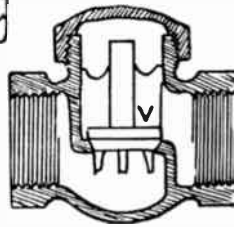

FIG. 14.

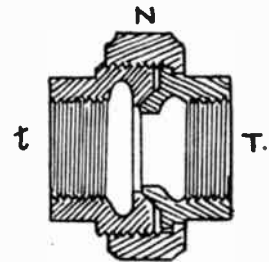

FIG. 11.

the advantage that it can be easily taken apart at any time by removing the bolts. For large size pipe for steam work the flanged fittings are most often used, as they are more convenient for large work.

In Fig. 4 are shown a pair of "elbows"  $90^\circ$  and  $45^\circ$ ; the former is used for making a right angle with two pieces of pipe, and the latter for a  $45^\circ$  angle, the pipe being simply screwed into the ends. Figure 5 shows a  $90^\circ$  elbow with flanged ends, and illustrates the method of joining the pipe to it. Flanges are used, as in Fig. 3, being bolted to the flanges of the elbow, with a disk of packing between. Elbows are made with both threads of the same size, or of different sizes or right and left hand, as desired. When the threads vary in size it is called a reducing elbow.

In Fig. 6 is shown a "Tee," which is used where a branch pipe is fitted. All threads may be of the same size, or they may vary in a number of ways. When the end B is of a smaller size than A the tee is said to "reduce on the run," while if the end C is smaller than the others, it is said to "reduce on the

outlet" or both ends B and C may be smaller than A.

A cross is similar to a tee, but with another outlet opposite the outlet C; it allows a branch pipe to be led in each direction.

In Fig. 7 is shown a "return bend," the two branches may be open as in the figure, or close together. This form of fitting is used mostly in steam heating coils and similar work.

When it is desired to close the end of a pipe, a cap, shown in Fig. 8, is used. It is usually provided with hexagonal flats, allowing the use of a wrench to screw it into place, otherwise some form of pipe wrench must be used for the purpose.

The plug in Fig. 9 is used to close the outlet of a fitting, such as one branch of a tee which is not to be used. It has a square end for turning it into place.

In Fig. 10 is shown a bushing, which in a manner takes the place of a reducing fitting; it has a thread on the outside, by which it is screwed into the fitting; the smaller pipe is then screwed into the inside thread, so that a reduction in the run of the pipe is obtained.

They may be had with hexagon flats, as shown, or plain, as desired.

The pipe thread has a slight taper, so that it is sure to become tight as it is screwed home; this must sometimes be allowed for. Thus in the bushing just mentioned, the two threads must be cut from opposite ends, otherwise the taper would not be right.

In a system of piping there must be one or more points at which the connection may be broken, in fact, this is usually necessary in order that the piping may be gotten together at all. When flanged fittings are used the line can be broken at any point, but when screwed fittings are used this is not of course possible, as it is plain that a line of pipe put together with right hand threads at all points can only be broken by beginning at one end and taking down all the pipe to the desired point. A right and left hand coupling may sometimes be used to give an easily broken connection, but this is not always convenient, and this fitting is sometimes hard to make tight. To provide a joint of this kind a "union," shown in Fig. 11, is used. It consists of a ground conical joint, the two parts of which are brought and held together by the screw thread and nut "N." The two pipes to be joined are screwed into the threads "t" and "T." In place of the ground conical joint a leather or rubber washer is sometimes used; the ground joint is, however, much the better, and is used in the best class of fittings. This joint can be disconnected at any time and as readily joined. As remarked above, it is not usually possible, nor is it desirable, to set up a line of pipe entirely with right hand fittings, and the right and left fittings are rather inconvenient to use. It is thus usual to fit unions at convenient points in the line, as it allows a length to be made up in a convenient position and then easily assembled in place. Unions are made in cast iron, malleable iron, and brass, and may be had either plain or turned. In fitting the union the parts are first separated, and then screwed on to the two pieces of pipe which are to be connected, the ends are then brought together and secured by tightening up the large nut N. This nut is provided with hexagonal flats to allow a wrench to be used. In tightening up the nut N it is usually necessary to hold the end t with a pipe wrench, otherwise there is danger of turning the whole and loosening the thread T. Where flanged fittings are used it is of course not necessary to use unions.

The fittings just described are those in

common use; there are, however, many special fittings for particular uses which can be obtained in some localities. Thus, a tee or ell may have another outlet on the side at right angles to the others, in which case it is called a "side outlet" tee or ell.

For closing the pipe against the flow some form of valve is used. The simplest and commonest of these, the "globe" valve, is shown in Fig. 12. It consists of a casting somewhat like a tee, but having a diagonal partition containing an opening or "seat." The threaded spindle S has at its lower end a plug P which, when screwed down, fits into the seat and closes the opening. A hand wheel W allows the spindle S to be turned. The space around the stem under the screw gland G is filled with packing and the gland screwed down, compressing the packing and preventing leakage around the stem. In the larger sizes of valves the plug P is made in a variety of styles and shapes, each having some special feature, but all fulfilling the same purpose. Arrangements are made so that in the case of wear, when the plug P would no longer be a tight fit in the seat, they may be ground together, with some kind of cutting powder between, until a new surface is made and the tightness restored. Except in special circumstances, it makes little difference in which direction the liquid flows through the valve, although when the flow takes place from the end t the pressure is below the plug P and does not come on the packing in the gland G. The opening t, instead of being in its present position, may be placed directly below at a right angle with the opening T, in which case it is called an angle valve.

Another form of valve, called a "gate" valve, is shown in Fig. 13. It consists of a double threaded casting as before, in the middle of which is the wedge-shaped gate V. This gate V bears evenly on the two surfaces, and entirely closes the opening through the valve. By means of the stem S, which is threaded into the top of the gate V, the gate may be raised or lowered, opening or closing the valve. When the valve is full open the gate is contained in the space directly above it. This form of valve gives an entirely uninterrupted flow for the liquid, whereas the globe valve, shown in Fig. 12, causes a considerable amount of eddies, owing to the irregular path through the valve. In the large sizes of gate valves the gate is made in parts with springs between, to make sure that the gate shall always fit the seat and close the

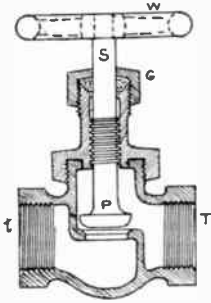

FIG. 12.

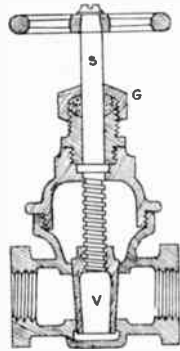

FIG. 13.

opening. In small sizes the gate valve is less used than the globe valve, as the cost is rather more. The various styles of valves are also made with the flanged ends shown in Figs. 3 and 5. There are many styles and varieties of valves of both kinds, but the cuts given show the general construction and operation of all.

There are many cases where, as in feeding a boiler, a non-return valve is required. Such a valve is called a "check" valve, and is illustrated by Fig. 14. It is somewhat similar in construction to the globe valve, but has a screw cap and no regulating wheel. The valve V is free to move vertically, and is guided by the fins above and below so as to always seat evenly. Supposing the liquid to enter at the left, the pressure will lift the valve V and allow the liquid to flow through; this will continue as long as the pressure on the left is greater than that on the right, but as soon as that on the left decreases and becomes less than that on the right the weight of the valve, aided by the pressure, will cause the valve to seat and prevent the back flow. This form of valve is used when it is desired to limit the flow to one direction. Check valves, also, are made in a variety of styles and shapes; that shown in Fig. 14 must be fitted on a horizontal pipe, as it is plain that the movement of the valve V must be vertical. It is easy to see, however, that this style can easily be arranged for a vertical pipe by properly locating the valve seat with reference to the threaded ends. In place of the valve V, a hollow brass ball is often used, and it is then called a "ball" check valve. Another style, also commonly used, and called the "swing" check, has a small hinged shutter in place of the valve V. This shutter is pivoted above and rests on a flat seat placed at an angle of about 45°. The pressure lifts the shutter, and its weight, aided by the pressure, tends to shut it. The two latter

types are also obtainable in both horizontal and vertical types.

The fittings and valves here shown do not, by any means, cover the entire available assortment, but they are those most commonly used, and are obtainable in almost any locality. In the large cities there are stores making a specialty of these goods, where an almost endless variety of styles for all purposes may be found.

Pipe may be obtained in almost any desired length, and may be ordered cut and threaded to any length wished for. It is desirable that the pipe fitter have an outfit of pipe taps and dies, but as these are expensive, it is possible for the amateur to dispense with them by judiciously ordering his pipe cut and threaded to the proper length.

Pipe may be obtained in short pieces, varying from a "close nipple," which is only long enough for the two threads, to a "space nipple" an inch or two long, and the "extra long" nipple which may be a foot or more. These nipples, in the varying lengths, may be ordered out of stock, and thus save the expense of having them cut to order. By an intelligent use of these nipples the work and expense of piping may be considerably reduced. But few directions can be given for pipe fitting, as the conditions vary so greatly. Care must be taken in screwing the pipe into fittings, as the pipe thread is tapered, and if screwed too far there is liability of splitting the fitting. In order that a joint may be surely tight it is well to smear the threads with some rather stiff substance before finally screwing them together; for ordinary work white lead is good; for the exhaust piping of gasoline engines graphite and oil work well, as the joints do not then burn together; for gasoline piping either soap or shellac should be used, as the gasoline will dissolve lead and possibly cause a leak. The material should be smeared mostly on the threads of the pipe, as if much is placed on the threads inside the fitting a portion will be pushed in ahead of the pipe, finally become loosened, and be carried along with the current to give trouble in valves and other pieces of apparatus.

There are some places where a right and left coupling may be used for joining two pipes which are not likely to require to be separated. As the pipe thread is cut on a taper, and different threads are not likely to be cut to the same depth, some care must be used in making a joint of this kind. The coupling should be screwed on to each pipe

thread as far as possible by hand, and the number of turns counted. Suppose that it can be screwed up seven turns on the left hand thread and only five turns on the right hand. In order that ends may screw up equally tight it is evident that the coupling must be screwed two turns on the left hand thread before catching the right hand thread. In this way both ends will be equally tight.

Piping in any case should be run as directly, and with as few abrupt turns, as possible. It should be remembered that the resistance of a valve or elbow is as great as that of several feet of pipe, and a little thought given to the arrangement of a line of piping will oftentimes allow it to be much simplified, saving not only the cost and labor of fitting, but also facilitating the flow.

## A FEW REMARKS ON ARC LAMP TRIMMING

WILLIAM HARLEY

"Arc lamp trimming? Why, that's easy enough. Just undo the cover, take the old pieces of carbon out, put new carbons in, shut the cover up, and away she goes," says an arc lamp trimmer, when told that his business was really an important matter, and if the truth is known, many others have thought and acted in exactly the same way.

As a matter of fact, arc lamp trimming is to the arc lamp as good firing is to the boiler or the gasoline to the motor, and it should not by any means be scamped or done in a slipshod way. It is, as a rule, only the trimmer who sees the inside of the lamp from one year's end to the other, so that he must be responsible for its efficient working. If, however, the lamps are carelessly trimmed, efficient working is out of the question, the working being usually most inefficient.

The procedure that should be adopted by the men who are responsible for this branch of lighting should be somewhat as follows:

When the old carbons are taken out, the working parts should be tried; look at the dash-pots and make sure they work free enough; look at the feeding arrangement to see whether the lamp is feeding accurately; look at the arc adjuster (if there is one), and ascertain the length of arc that is given, correcting the same if it is faulty, and lastly glance through the lamp to see if no screws or parts are missing. Although this sounds a lot, especially when a number of lamps are to be trimmed in a day, yet it is really surprising how quick the whole process can be done when a little experience is gained in this direction. I have known valuable lamps to have their terms of office greatly lessened by neglected trimmings; screws had rotted away and had been unnoticed by the attendant, and the working parts had become so stiff that it was really a wonder the lamps lit at all.

These parts, however, are not all. The fresh carbons are very often put in without any thought whatever, and in this a great deal of carelessness lies. When the fresh carbons are put in they should be pushed as high as they will go, and the springs holding them should be tried to see if they grip tightly. In flame arc lamps, when the carbons meet at an angle, care should be exercised in keeping the points level, it being often the case that little pieces of carbon have to be snipped off here and there to make a fine contact for the arc to strike. When the carbons are in place, the freedom which exists in the feeding arrangement may be reduced, and care should therefore be taken to see if there is enough room for working without any tightness whatever.

It would be a good thing if, occasionally, the trimmer would look at the chokers or resistances of the lamps to see if they are still in good condition. Cases have been known where these chokers have been burned out through neglect of the occasional visit.

Another point regarding the arc lamps is draught, much of the flickering being due to too much draught being admitted through the globe or cover or both. Where there is adjustment for this, it should be used, and the best position obtained by experimenting with each lamp. Most makers, however, design the lamp draught or find it out by experiment, and, of course, make it a constant thing; but even in these styles of lamps draught is sometimes admitted because of the catches for the globe or cover not being tight enough, the remedy being obvious.

This should be the duty of every lamp trimmer, and I am sure if these rules were adhered to, many of the faults that arc lamps are heir to would be done away with, and the miserable lights, constant flickering and jamming of carbons, would be but very seldom seen. — *The Engineer-in-Charge.*

## WIRELESS SYSTEMS OF TO-DAY

## 1. THE MASSIE

NEWELL H. THOMPSON

Of the many experimenters in the wireless field that I have chanced to meet, few, if any, knew what were the essential features of the various wireless systems of to-day. It is the purpose of a series of articles, of which this is the first, to carefully describe and illustrate the different systems that have proven themselves practical in the public eye.

This article treats of the Massie system, invented by Mr. Walter W. Massie of Providence, R. I. While not claiming to be a master of theory, like Professor Fessenden for instance, he possesses adaptability, and it is this trait that, combined with his twelve years' study of the wireless telegraph problem, has enabled him to devise a simple, strong, compact, and thoroughly reliable system. It is the old story of the unfinished work of the theorist being completed by the practical man.

receiving antenna is separated from the transmitting apparatus by means of an insulated microscopic air gap called an "anchor gap." If this were not done, the antenna would be grounded through the sending helix. Although this small gap is enough to insulate the antenna when receiving, it proves practically to be a short circuit when transmitting.

The transmitting equipment consists of the usual spark-gap, transmitting key, helix or inductance coil, transformer, condenser, interrupter (if direct current is used), and source of energy. Some of these parts deserve special mention.

The spark-gap bridges a long gap on the road towards the perfection of a constantly cool pair of electrodes. It consists of a hollow wheel slotted on its face, which is revolved by means of a motor between two

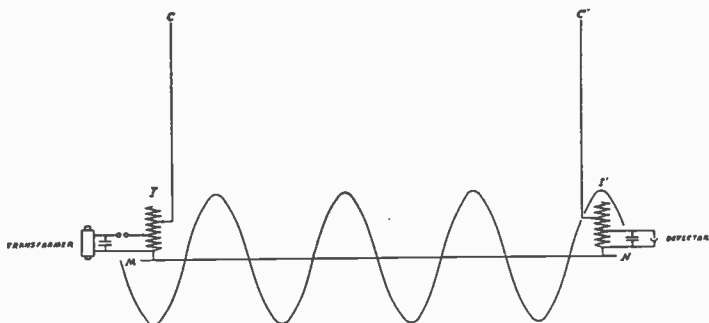

Fig. 1. Circuits of Massie System

Figure 1 shows the circuits of the system. It is controlled entirely by a simple switch. To use the powerful transmitting apparatus the switch must be so placed that the delicate receiver is entirely separated and insulated from the antenna, the battery circuits broken, and the detector short-circuited; when the switch is placed so as to throw in the receiver, the transmitter circuits must likewise be broken. This device enables an operator to change quickly from transmitting to receiving; in fact, the speed of operation is as fast as the land telegraph. Another strong word in its favor is the fact that it acts as a protective device to the entire apparatus; it being impossible to send while receiving, and *vice-versa*. The

electrodes. Air is drawn inside the wheel by a fan arrangement connected on the shaft, such as is used on blowers, and forced out through the slots on the face of the wheel. In this manner a simple and efficient means is found whereby the spark-gap may be kept constantly cool. This entire apparatus is mounted in a box through which the shaft projects to the motor. Openings in the box covered with colored glass are also provided to enable an operator to inspect the quality of the spark without danger of injuring his eyes.

In his inductance coil Mr. Massie has a very compact tuning device. The wire is wound in the usual manner on a wooden



Fig. 2. Massie Detector

frame, on the top of which is placed the hot wire ammeter and anchor gap. Tuning is obtained in this system by the formula:—

$$X = 2\pi V \sqrt{LC}$$

where

X = wave length  
 V = velocity of light  
 L = inductance  
 C = capacity

Every station is furnished with a table giving the capacity of the condensers; and by means of this table used in connection with the hot wire ammeter, sharp tuning can be obtained.

Condensers of the plate form are used and have proven themselves to be very efficient and of long life. They are built up of plates of glass kept in racks on which are secured sheets of tin-foil and are so constructed that either glass or air may be used as a dielectric. They can easily and quickly be adjusted to various capacities by means of a spring contact.

In low-power stations an ordinary Morse

key is used, and is connected directly in circuit with the primary of the transformer. A mechanical interrupter is also inserted in the circuit if a direct current generator is used as a source of energy. In a high-power station, where the current becomes difficult to handle, the key is simply used to operate a battery circuit which closes an electromagnetic switch in the primary circuit.

The Massie detector is shown in Fig. 2 and is of the electrolytic type: the silicon also being used in some installations. In the "resonaphone," as it is termed, the top notch of constructional simplicity has been reached. The entire receiving apparatus is enclosed in a box which measures only 8 x 6 x 4 inches.

Referring again to the photograph, two levers are seen on the front of the device. One is for the tuning coil, the other for the condenser, which is of the intermeshing disk type. A little above is seen the potentiometer lever. The detector is shown at the rear of the photograph, the switches being on either side, as shown, and used for the purposes designated on each. On the right side are seen two small spring jacks to insert



the telephone terminals. Graduated scales are also provided for both potentiometer and tuning coil levers, so that any station may be instantly found, once its wave length is known. This entire device is fully protected by patents, and is now in use with great success in many of the company's installations.

messages and the use of telephones. Figure 4 shows the rear of the switchboard and the generator.

The telephones used in this system are of the watchcase 1500-ohm double head-band type. Exceptionally thin diaphragms are used and make a very sensitive receiver, yet able to withstand hard usage. The tele-

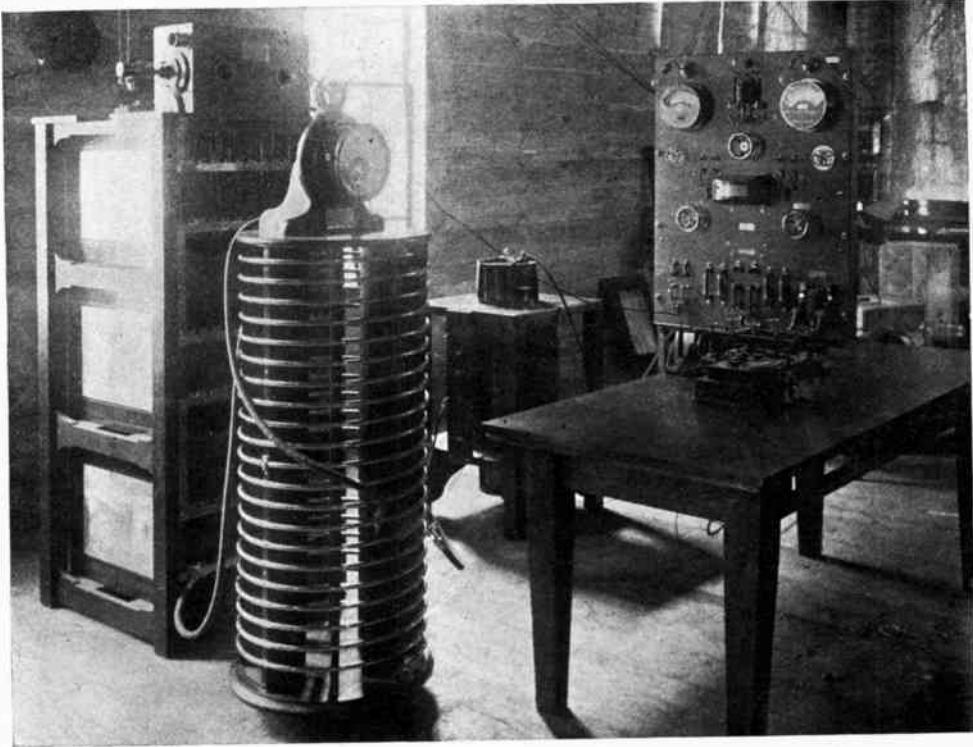

Fig. 3. Parts of 10-Kilowatt Outfit for United States Signal Corps, Alaska

Views of a 10-kilowatt outfit for use by the United States Signal Corps in Alaska are clearly shown in Figs. 3 and 4. Referring to Fig. 3, the racks of condensers are seen to the extreme left of the photograph with the rotary spark-gap and motor on top of the same. Directly in front of the condensers is the helix with the hot wire ammeter and anchor gap. A little to the right, standing on the floor, is seen the transformer. The switchboard is at the extreme right. On the table are the sending key, controlling switch, and resonaphone. From this photograph the fact is easily perceived that the Massie system leaves much more room on the operating table than any other system. There is plenty of room for the writing of

phones are well shown in Figs. 5 and 6. Beauty in design and precision in workmanship are characteristic of the apparatus used in the Massie system. In practice it has worked well. The Massie Company has already furnished the government with apparatus as follows:—

	2	portable sets
Signal Corps.....	5	10 kilowatt sets
		for use in Alaska
Coast and Geodetic Survey	3	sets
Navy Department		
Charleston, S. C.....	1	5 kilowatt
Beaufort, N. C.....	1	5 kilowatt
Cape Henlopen, Del. ...	1	3 kilowatt
Navy Yard, Wash., D. C.	1	15 kilowatt

Also eight sets ranging in power from 3 kilowatts to 10 kilowatts for use on the Pacific Coast.

In addition to the government stations on the Pacific Coast; so many private ships have been equipped with the Massie system, that in reality the latter can be said to control the Pacific Coast, no less than eighteen sets being installed there. The following boats plying on the Pacific Coast have been furnished with Massie 3-kilowatt outfits.

The Pacific Steamship Co.:—  
 SS. "Governor."  
 SS. "Queen."  
 SS. "City of Peubla."  
 SS. "President."

(This boat holds the record for the Massie system, its radius being 1300 miles.)

Matson Navigation Co.:—  
 SS. "Lurlyne."

Northern Pacific Steamship Co.:—  
 SS. "Roanoke."

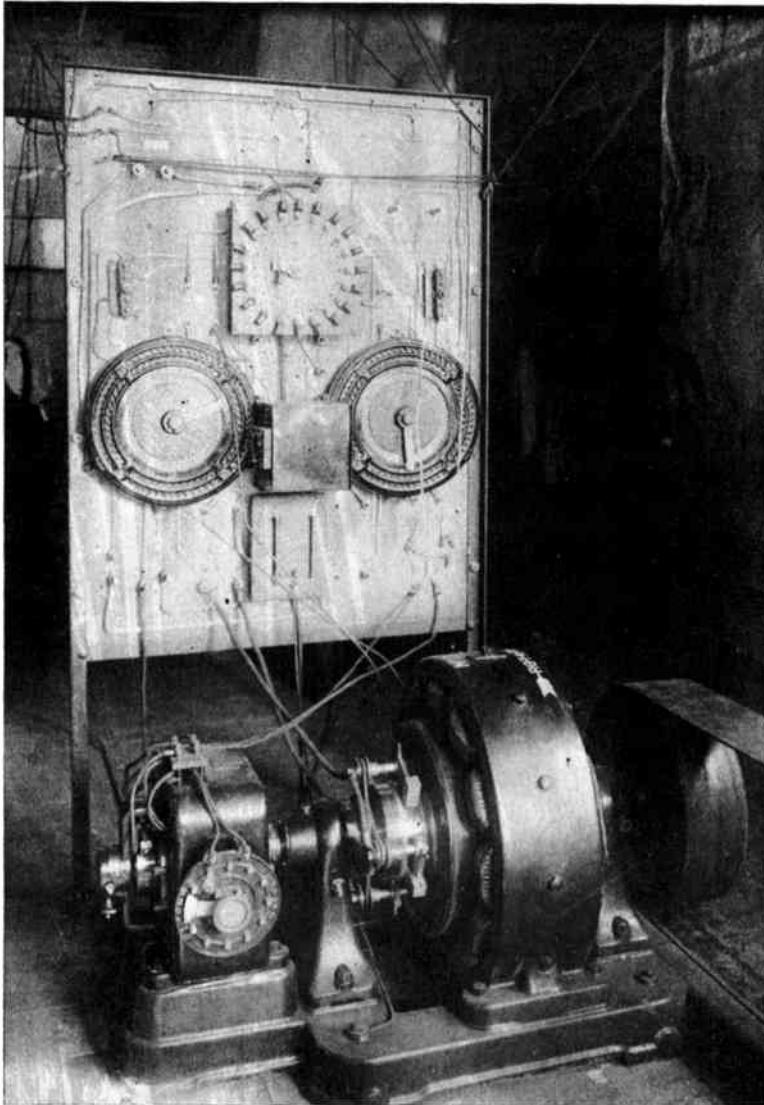

Fig. 4. Parts of 10-Kilowatt Outfit for United States Signal Corps, Alaska

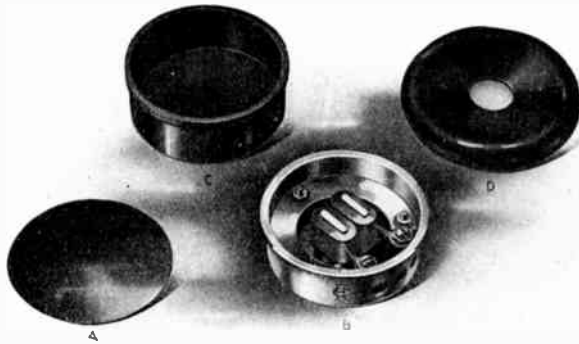

Fig. 5

SS. "G. W. Elder."  
 San Francisco and Portland Steamship  
 Co.: —  
 SS. "Rose City."  
 Commercial stations have been estab-  
 lished at; —  
 Point Judith, R. I.  
 Wilson Point, Conn.  
 Cape May, N. J.

In 1905 the New York, New Haven, and  
 Hartford Railroad Company adopted this  
 system and installed it on the boats of the  
 Fall River, Providence, New London, and  
 New Haven lines and the apparatus has been

operated since with the most satisfactory  
 results. Messages are accepted from pas-  
 sengers for transmission and sent from the  
 steamer to either the Point Judith or the  
 Wilson Point Station, where they are relayed  
 to all points reached by the Western Union  
 lines. A charge of fifty cents is made for  
 every ten words sent.

Absolute secrecy for his system is not  
 claimed by Mr. Massie, but he claims to be  
 able to shut out all messages where the dif-  
 ference in frequency is not more than ten  
 per cent, and this statement has repeatedly  
 been proven in practice.

THE Black Sea contains less animal life  
 than any other large body of water in exist-  
 ence. The lower depths are saturated with  
 a poisonous gas which kills the fish.

THE day has passed when in order to get  
 an evening's enjoyment out of a pan of  
 crisp pop-corn, some one has got to burn  
 his fingers or face over a hot stove or grate.  
 The electric corn-popper is one of the latest  
 inventions applying electricity and is meet-  
 ing with considerable favor and pleasant  
 reception. The popper is a dainty little  
 affair, shaped very much like an old-fash-  
 ioned quart dipper. It has a pair of little  
 rubber tire wheels under it to aid in circu-  
 lating the corn, and all that is necessary is  
 to make the proper connection to a lamp  
 socket, put in the corn, and begin shaking.  
 It costs about five cents an hour to operate  
 this popper, which means that any one with  
 appetite to make it could easily pop a bushel  
 basket full of crisp kernels with half the  
 cost and none of the trouble incident to the  
 old-fashioned way.



Fig. 6

## PRACTICAL NOTES ON GAS ENGINE DRIVEN DYNAMOS

"ZODIAC"

DYNAMOS driven by means of gas engines are liable to give trouble from one or other of the following causes:—

*Vibration* from engine being transmitted to brush gear, and thus causing sparking.

*Unsteady running*, causing flickering in the lights.

*Leakage gas* blackening the surface of the commutator, and thus causing heating and sparking at the brushes and insulation troubles.

*Air vibration* which may, in some cases, affect the brush gear.

*Vibration.*— It is most important that the reciprocating parts of the engine are properly balanced; this, of course, is a point for the engine maker. On the other hand, the manufacturer is often blamed for vibration due to defective foundations, there being a tendency to make the foundation far too light. The engine should stand on a good, solid, heavy foundation, which is not in direct contact with the walls of the building. If the dynamo is belt-driven, then the dynamo foundation should be quite independent of the engine foundation. For engines up to 20 or 30 h. p., a timber cap between the engine frame and the concrete foundation will often stop troublesome vibration that cannot be remedied by any other means. Clay soil is very apt to transmit vibration and thus create a noise nuisance. With such a soil the foundation should be dug out to an extra 4 or 5 feet in depth, which should be filled in with gravel and well rammed down, so that the gravel isolates the concrete foundation from the clay soil. If the engine shakes at each impulse, even at light load, the trouble is not due to the foundation, but to defective balancing.

When the dynamo is direct-coupled to the engine, vibration is very liable to be transmitted, especially if a solid coupling is used. This vibration will cause the brushes to chatter and hence set up sparking at the commutator, especially with some designs of brush holders. If the brush-holder design is such that it readily responds to such vibrations, and has, so to speak, a vibration period of its own, then considerable difficulty will be experienced in curing the fault. The writer once cured a most troublesome fault of this description by the addition of a flat plate spring, working in parallel with the spiral spring; in another instance, the trouble was

overcome by the use of rubber damping pieces between the brush springs and the brush holders. The exact arrangement, of course, depends on the particular design of brush holder. Some brush holders, consisting of a heavy carbon holder mounted pendulum fashion at the end of a long springy carrier, seem to have been designed to cause a maximum amount of trouble by vibrating with the greatest ease. The ideal brush holder should have no vibration period of its own, but should allow the brush to accurately follow the contour of the commutator in the same manner that the phonograph reproducing point or stylus faithfully follows the surface of the record.

Pneumatic holders, in which the brushes are pressed on to the commutator by means of air pistons, are exceedingly good as regards freedom from chattering; unfortunately, they are a little more complicated than ordinary holders. A properly arranged flexible coupling between engine and dynamo is most desirable, as it tends to absorb the greater part of the vibration, especially if the coupling drives through rubber blocks. Couplings with steel springs are not nearly so effective, as vibrations that the rubber can absorb seem to be transmitted through the springs themselves.

In Europe, the Zedel Voith form of flexible coupling is much used, a leather belt interlaced between the two halves of the coupling transmitting the power from the engine to the dynamo. In the writer's opinion, it is preferable to support the brush holder ring from the field-magnet frame instead of from the pedestal bearing (in the case of large machines), as by this means vibrations carried along the shaft are not communicated to the brush rocker and brush holders.

Another troublesome effect of vibration, especially with large machines, is the breaking off of the end connections close to the commutator, especially if these connections are unduly stiff and rigid. This defect is a very troublesome one to cure in a finished machine; either extra support must be provided for the connections, or they must be replaced by more flexible ones. Many makers use flexible connections, so as to ensure that they shall not be broken by vibration. In small machines the trouble can sometimes be overcome by interlacing

the connections with asbestos string, taking care to impede the ventilation as little as possible. The asbestos string should be well dried and then steeped in insulation varnish before being used.

*Unsteady Running.* — Modern gas engine governors are very sensitive and positive in action, and should the engine governor show a tendency to "hunt" it will usually be traceable to either the gear being clogged with oil or to the links, "hit-and-miss" blade, etc., being worn. "Hit-and-miss" regulation no doubt gives the greatest economy as regards gas consumption, though for dynamo driving throttling the charge certainly seems to be better. Most modern engines will not exceed three to four per cent as regards drop in speed between no load and full load; on the other hand, unless specially heavy fly-wheels are provided, the fluctuation per revolution or "cyclic irregularity" may be large enough to cause serious flickering of the lights.

For dynamo driving, the "cyclic irregularity" should not exceed plus or minus 0.02; for workshop driving the value of 0.03 to 0.04 is generally allowed. For small belt-driven dynamos of under 15 kilowatts it is very advisable to have a light fly-wheel on the dynamo shaft in order to reduce the effect of the swaying or "waving" in the belt.

A badly-made belt joint will also give trouble, as the brushes will be jerked off the commutator every time the joint passes over the dynamo pulley. The belt joint should be carefully made with a long taper splice properly stitched, rough lacing being quite out of the question. A well-sharpened smooth plane will enable the ends of the joint to be evenly tapered down, and a good coating of joiner's glue, followed by stitching, will make a first-rate job. In some engines the governor acts on the exhaust valve, either holding it open so that there is not sufficient suction to draw in the new charge; or, the exhaust valve is held closed during the idle stroke so that the old charge is retained and the pressure in the cylinder is kept too high to allow a fresh charge to enter. Such governors may at times give trouble and cause flickering of the lights, owing to sticking of the valve. The writer always insists on the governor bearings and joints being cleaned through with kerosene at least once every month so as to clear out any old gummy oil, only the very best, pure hydrocarbon (mineral) oil being used. All animal and vegetable oils become thick and gummy by absorption of oxygen

from the atmosphere, and should therefore not be used. They also develop fatty acids in the course of time, which acids corrode the metal of the bearings. Tallow and sperm oil are very liable to become rancid, due to the development of fatty acids. This is entirely absent in mineral oils. It is quite a mistaken notion of some engineers that tallow and sperm oil are superior to mineral oils, as the following table (due to Tower's experiments) will serve to show: —

Lubricant	Coefficient of friction	Max. safe pressure persq. in. on nominal area
Lard oil.....	.00172	570
Sperm oil.....	.00208	570
Mineral oil.....	.00176	625
Mineral grease.....	.00233	625

Proper attention to the cleaning and oiling of the governor gear will well repay the trouble, owing to the better running of the engine. To simply oil the governor with the first oil that comes handy is courting trouble; a light axle or spindle oil should be kept purposely for the governor, as the viscosity or body of the crank-shaft oil is too high for the governor gear. As the load on the governor bearings is, comparatively speaking, negligible (the actual link bearings, etc., between governor balls and mechanism are here referred to, and not the driving spindle bearing), the viscosity or degree of fluidity of the oil should be that of a light spindle oil so as to reduce friction as much as possible, as the greater part of the governor's energy is spent in overcoming friction. The heavier the oil, the higher the coefficient of friction within certain limits. Some attendants will tell you that "unless a heavy oil or grease is used, the governor throws off the oil all over the floor." Well, this trouble will always be readily overcome by the use of a sheet metal oil-guard.

With conical and crank-shaft governors operating throttling devices, considerable friction may be set up if the governor spindle packing gland is too tight. With a good make of engine in proper working order the voltage flicker or fluctuation, as shown on the voltmeter, should not exceed  $1\frac{1}{2}$  to 2 per cent total.

*Leakage from Glands, etc.* — In the case of large engines it seems to be almost impossible to stop slight gas leakage taking place at the various glands, etc., especially in the case of very large producer-gas engines. The amount of sulphur compounds that thus get into the air of the engine room is sufficient to

blacken any silver coins in one's pocket in quite a short time. In one instance the writer, after an hour's stay in an engine room with four large 800 h. p. engines, found all his silver coins quite black. This leakage gas is drawn into the dynamo windings and over the commutator, blackening the surface of the copper, and so impairing the commutation of the machine.

Many dynamo makers, especially in Europe, secure the armature connections to the commutator segments by means of steel grub screws and dispense with solder. With such machines the leakage gas will attack the joint, and produce a bad connection in a very short time, and it is absolutely essential that the connections are soldered so as to keep them free from the effects of the gas. In one instance, at least, trouble has occurred owing to explosive mixtures of gas being drawn into the armature and then fired by the sparking at the brushes. Some makers have even found it necessary to case the dynamos in and force fresh air in from the outside; in any case the engine-room should be exceptionally well ventilated, as quite a small percentage of leakage gas is sufficient to blacken the surface of the commutator. This is of course a defect in the gas engine design, and will no doubt be remedied in course of time. It is exceedingly difficult to get a packing absolutely gas-tight at the high temperatures met with in gas engine practice, so that ample ventilation of the engine room should be always provided for. To avoid this leakage gas causing trouble with the insulation, the whole of the machine should be well painted periodically with one of the many excellent insulating varnishes now on the market, most of which are even acid-proof. Before varnishing, all dust should be carefully removed and the windings well blown out with a pair of bellows, or, better still, an air compressor, if such is available. It is highly advisable to apply the varnish after the dynamo is thoroughly dried and warmed up, owing to its having had a good long run at full load, as in this way the machine insulation is kept up to the highest value. As is well known, all insulation absorbs moisture—for instance, cotton will readily absorb from ten to fifteen per cent from the atmosphere, which moisture considerably lowers the insulation resistance. Insulation varnishes having boiled linseed oil, or, in fact, linseed oil in any form, are, in the writer's opinion, quite unsuitable for the purpose. There are, however, quite a number of very

suitable varnishes on the market in which benzine, naphtha, or turpentine is the solvent used. The objection to casing the dynamo in is, of course, the difficulty of getting at the machine while running. It is, however, a good plan to have a sheet metal guard between the armature and the engine so as to avoid the fan action of the armature drawing the leakage gas on to the windings.

Another source of trouble (common also to steam-driven dynamos) is in connection with commutating poles. If the commutating pole winding is provided with a shunt (or diverting) resistance, and this shunt is correctly adjusted to give sparkless running when the generator is hot, it does not follow that the adjustment will be correct when the generator is cold, owing to variation in the temperature coefficient of the windings and the shunt resistance. Hence, unless the resistance is adjusted from time to time, the machine will spark and blacken the commutator during the time it is getting warmed up. If a diverting resistance is used for the commutating pole windings, it should only carry a small percentage of the total current, not more than ten per cent. This may mean trouble as regards adjusting the number of turns on the commutating pole coils when the machine is on the maker's test-bed, but it should be insisted on. In the case of a 500-kilowatt machine which came under the writer's notice, the sparking during the heating-up period was quite sufficient to seriously blacken the commutator, although when the machine was heated up the commutation was perfect.

*Air Vibration.*—This is due to the pulsation in the air caused by the trunk piston, and generally results in the windows, and sometimes even the brush gear, being caused to rattle. It is not always convenient to box the front of the engine in and connect it with the open air, although this is the most effective. As a rule, however, a fair-sized ventilation opening in the roof and one on the ground level, near the engine front if possible, will remedy the evil.—*The Engineer-in-Charge.*

#### Wireless to span the Pacific

THE British Colonial Office has recently made the announcement that the installation of a system of wireless telegraphy between Vancouver, Somos, Fiji, and Australia is entirely practical. It is understood that before long steps will be taken to effect the same.

## PATENTS

## A LECTURE DELIVERED BEFORE THE SCHENECTADY SECTION, A. I. E. E.

ALBERT G. DAVIS

THE following paper is designed to give some idea of the general object and nature of a patent. It is only a rough outline of general information, and is not to enable the reader to dispense with the services of a lawyer in any specific case.

I shall not consider copyrights, trade marks, labels, nor design patents; but patents for inventions — what we call mechanical patents.

The patent system is the outgrowth of a very odious system of monopolies, which were formally granted by the English Crown in the form of an open letter — from which comes our expression “Letters Patent.” This was an open letter under the seal of the Crown, conferring the exclusive right to practice some business in the Realm. These monopolies became particularly objectionable during the reign of Queen Elizabeth, and not long after her reign they were abolished. A statute of James I contained a provision against monopolies being granted excepting to those who introduced new manufactures into the Realm, and this theory still survives in England in the patent of importation, or “communication.”

In this country the patent law is based on a clause of the Constitution of the United States which gives Congress the right to grant to inventors, for limited periods of time, the exclusive right to enjoy the fruits of their inventions. A patent, therefore, is a Federal thing, that is, a thing of the Federal Government and not of the States. It is a grant of the exclusive right to make, use, and sell a certain invention for a certain period of time. An infringement consists in the making, using, or selling of the thing concerning which the grant was made, by some other person without authority. Patents are granted by the Government of the United States, under the seal of the Patent Office, and, of course, in accordance with the Statutes of the United States, and the Patent Law is a Statute Law. A patent is a creature of these statutes, and can only be considered with reference to them.

In this country a patent of the kind we are considering runs for seventeen years from the date of issue, not from the date of filing the application.

The following paragraph is Section 4886 of the Revised Statutes of the United States,

as now amended. It is the fundamental basis of our patent law, and is worthy of careful reading, as every word means something.

“Any person who has invented or discovered any new and useful art, machine, manufacture, or composition of matter, or any new and useful improvements thereof, not known or used by others in this country, before his invention or discovery thereof, and not patented or described in any printed publication in this or any foreign country, before his invention or discovery thereof, or more than two years prior to his application, and not in public use or on sale in this country for more than two years prior to his application, unless the same is proved to have been abandoned, may, upon payment of the fees required by law, and other due proceedings had, obtain a patent therefor.”

As I have said, every word in this statute means something. Considering the separate phrases, we have, first — “*Any person who has invented or discovered.*” This means that the application must be made by the inventor; no one else can make it; otherwise it is void. If two persons jointly invent, and one files a sole application, or if two file a joint application on an invention made by one of them, no valid patent can issue on that application. So the person who furnishes the money, or a mere assignee, cannot make the application — it must be made by the inventor.

Next in the statute are the words: “*Any new and useful.*” Of course a thing must be new, for this is the fundamental idea of a patent. (We will go a little more into detail regarding this later.)

If a thing is not “useful,” no patent should be granted, but on the other hand, a small degree of utility will support a patent. If a thing is really harmful, the patent is void. For example, a device for perpetrating fraud on the public would be void. There was a case in Connecticut of a patent on a process for producing tobacco in imitation of certain high-grade Cuban tobacco. It was found at one time, that in a certain district in Cuba, there was a parasite or fly, which, by biting the leaves of the tobacco plant, caused little white spots to appear; and the public got into the habit of looking for these spots and recognizing them as the mark of the tobacco of this particular district. This man in

Connecticut conceived the idea of going out in his tobacco fields and spraying a certain solution on the leaves, and thus reproducing these white spots. He got a patent on this, though with considerable difficulty, as the Patent Office held that it was a fraudulent thing. He stated, however, that this invention made the cigars more free-burning, and on that ground a patent was granted. He prospered in this business for some time, until some other man decided that he would try it also. This brought up litigation, and the judge without hesitation held the patent invalid, resting his decision on the grounds of lack of utility. He said that there was no proof that the cigars really were more free-burning, though he seemed inclined to rest his decision on the broader ground of the essentially fraudulent nature of the business.

What constitutes novelty? "*Not known or used by others in this country before his invention or discovery.*" If used in a foreign country, it does not affect an American patent, unless it can be shown that it is an idea brought home by the inventor, in which case the patent is void. If a man goes abroad and seeing something over there that seems to him meritorious, comes home and patents it, obviously he has not invented it. If, however, a man in this country invents a thing in good faith, the fact that it was used abroad is no bar to the patent, provided the thing was not "*patented or described in any printed publication in this or any foreign country, before his invention or discovery thereof.*" This relates to the date of his invention and not to the date of his patent. To grant to a man a patent on a thing that had been described in a printed publication before his discovery of it would be bad practice, because he might have read that publication; and in any event it would not be new, the world would be in possession of the invention. But if he had invented it in good faith before this publication was issued, he could file his application in this country within two years of that publication; otherwise it would be void.

Referring again to the statute we find the phrase — "*Not in public use or on sale in this country for more than two years prior to his application.*" This means that a man cannot make an invention and allow his device to go into use or be sold to the public for an indefinite period, and then obtain a patent; he must file his application within two years from the time such public use begins. The question is, what constitutes

public use, and this question is a very difficult one. For example, in the case where a pavement had been laid for six years on a toll road near Boston, it was held not to be in public use. The reason for this decision was that the pavement was held to be experimental, having been put down to determine whether it was serviceable. It was placed in front of a toll-gate, where the horses had to stop and start, and where the work on the pavement was the heaviest. Every few days the inventor would examine the pavement, would discuss it with the men, and find out every detail regarding it. He was held to have been experimenting, but that was an extreme case.

When a man has finished with his invention, when he is satisfied the thing is good, although capable of further improvements, then the use becomes public use under the statutes. Ordinarily, when he begins to derive profit, it constitutes public use.

Of course, an invention can be abandoned, as any other right and privilege can be abandoned. The right to own a piece of real estate can be abandoned; as is the case when a man allows the public to walk over a part of his land for a sufficient number of years; for there then accrues to the public the right of way over this particular lot of land and thus to this extent it is an abandonment of the right of the proprietor. In the same way, a man who has made an invention and obtained thereby a right to apply for a patent, may abandon that right; either definitely and formally, by publishing a statement that he has made an invention and is not going to take a patent; or indefinitely and informally, by simply allowing it to run long enough to result in an abandonment.

If we look at an American patent, we find that it usually contains a drawing, always a specification, and always certain short paragraphs which we call claims. The drawings are merely illustrations, the specification is the description, and the claim is the soul of the patent. The patent is in the nature of a contract — that is the modern view of it. The Government says to the individual: You have made an invention; you may, if you wish, keep that invention secret; you may use that invention as a secret process, and hand it down to your descendants if you can keep it secret; but if you come to us and tell us about this, explain it to us so that we can use it; then, as a reward for that, we will give you the exclusive privilege of the use of it for a term of seventeen years. The inventor



must tell all he knows about it; if he deliberately holds back one thing vital, the patent is void.

In this matter of patents for inventions there is great diversity in the practice of the different countries. Obviously, a man ought to get the monopoly of whatever new patentable thing he has invented, but the practical question comes up as to just how to ascertain what that is. It should be well and sharply defined, but a careless or incompetent patent attorney should not be able to take any right from the inventor.

Latin nations follow the French system, which is exceedingly simple — a man files a description of an invention in the French patent office, and that is all there is to it. He can file the description of anything, and they will take it and grant a patent on it, and he can enforce that patent against any one who uses any new or patentable thing found in the specification; but it is exceedingly difficult practically to find out what a French patent covers, on account of the absence of what we call the claims, and that is the difficulty with the French system.

The German system is something like the American; a man is required to claim what he has invented. He specifies in a form of words the particular thing he has invented; but the construction of the claim is so different, the phraseology is so different, that we Americans, as a rule, cannot understand the German practice.

The Japanese system is intermediate between the German and American — it is not yet settled which way they are going. As far as I can see, the tendency is toward the German practice.

In this country we have another system, which is a logical antithesis of that of the French. Here a man with an invention gives a description of some new thing, but he must do more than this; he must select and define certain things and say: "these are mine." We call these claims, and the claim, as I have said, is the soul of a patent. In a sewing machine, for example, a claim reads: "The combination of a wheel, a treadle, a shuttle," etc. Now this means that this man thinks he is the first that has ever put a wheel, a treadle, and a shuttle in the sewing machine, and if this is the case, no one else can do this without infringing. Broadly and roughly speaking, a claim is a combination, and a thing does not infringe that claim unless it contains every one of those things, every "element" of the com-

ination. The mere fact that it contains more things will not prevent it from being an infringement. We put as little into a claim as we can. For if a certain combination is new and is made up of three elements, and we put in four, anybody can use the three elements providing he does not put in the fourth one; so we have given away some of our clients' rights to the public. Obviously the patentee must sharply define his claim. He often does it badly; he is often advised by poor attorneys, and is often ignorant of the real invention. It is exceedingly rare in ordinary practice for a man to know just what he has invented. An ordinary man says, "here is my invention," and it is a matter for cross-examination to find out what really belongs to him. Even the best of attorneys frequently fail to see the real gist of the invention and claim it more narrowly than they should.

Many will remember when the Tesla patents were patents on detail improvements on electric motors; and ten years later they were foundation patents at the basis of a great art. That means, an art has grown up under those patents. So it is hard to say which patents are narrow and which are broad.

A man can obtain a patent on anything that is new, whether he has a right to use it or not, provided it fulfils the statutory requirements. If I invent a certain thing and patent it, and some one else makes an improvement to-morrow, he can patent his improvement, but cannot use my patent. The mere fact that the patent office has granted him a patent does not mean that he has a right to use that thing, but merely that he has the right to keep other people from using it. A patent grants the *exclusive* right to make, use, and sell an invention; it *excludes* others from the use of a certain thing. It is on that point that some interesting State and Federal decisions have been made.

There are a number of cases where a man has made an invention, the use of which was prosecuted as a criminal act in a State where it was against the law, the defendant maintaining that the patent was granted under the Federal laws and statutes and therefore took precedence over State laws. Take as an example the case of a man in the State of Maine making and selling whisky made by the use of a patent still, and defending himself by saying: "This is my patent, in which the Government granted me the right to make, use, and sell this invention; and I do

not care for your local laws which say that it is wrong to distil whisky." The courts would hold that to be no defense, and the true reason for this is that the patent did not grant to this man a right to do anything, but simply the right to prevent others from doing something. It is no protection for him to say that he is working under the laws of the United States. The only thing he can do is to prevent other people from distilling whisky with that particular still.

Take as an illustration the automobile tire or bicycle tire. There was once a time when somebody had the conception of running a wheel on air enclosed in a surrounding tube. That thing was or might have been patented, and there is no reason why the man should not have had a patent as broad as the idea of the pneumatic tire. Suppose he had taken out that patent, showing the old hose-pipe bicycle tire. Then suppose that in time it was found that it was difficult to repair a tire of that nature, and some one conceived the idea that the tube itself need not be circular and continuous, but could be locked into the rim at each side; and that it need not be air-tight, provided there is an air-tight tube inside, thus making the double-tube tire. Now he could patent that, of course. Then perhaps somebody wanted a means for taking off the tire more quickly, and got the idea of a quickly detachable tire, and so on; a dozen or a hundred inventions, culminating in some good automobile tire. Now the second man cannot make his tire unless the first man lets him. The man who conceived the idea of the double-tube tire must use the invention of the first man, and so on. Of course, the first man's patent will expire, and then the second will go ahead.

The ordinary process of enforcing a patent is by suit for infringement in the federal courts. As I have said, a patent is granted by the United States Government, and it is enforced in the federal courts, and is enforced by suit. The only way to protect yourself, if you own a patent, is to sue for infringement, either before a jury (which is seldom done in this country), or in equity before a judge. These suits are long, expensive, and troublesome. There is not a lawyer practicing to-day who would not be glad to see a means of shortening and making them more simple. Nobody seems to be able to find out how to do it unless we adopt the English system of trying patent cases in open court before a judge, which is a system in some respects superior to ours.

A man files in court a Bill in Equity, in which he sets forth: that he owns this patent, that it was properly granted, that defendant infringes it, and other things; and prays the court to compel this defendant to come into court and show why he is doing this wrong. The Court issues a subpoena — which is a summons — and the defendant comes into court by his lawyer and says the patent is bad — sets up any defense he pleases — and thereupon the parties take testimony; that is, have witnesses come before a Notary Public in a lawyer's office. The lawyer comes into the office, the witness is produced, the Notary Public or examiner swears him. Day after day they sit examining the witnesses, with a stenographer to take down the testimony, until they have what they call a record; that is, until they have said all they want to say, a process which frequently consumes several years and costs a great deal of money. This record is printed, and is brought into court and argued before a judge. Now in equity, if the judge finds a patent to be valid, he may grant a written injunction commanding the defendant to stop doing this thing, and that written injunction is practically the vital thing in a patent suit. The court may also award damages, or may award the profits which the patentee would have made if he had not been prevented by the defendant.

*(To be continued)*

It is stated that all the ships of the Japanese navy are now fitted with wireless telegraphy, including destroyers; these latter vessels not only have receivers, but they can also send messages. The wireless telegraph apparatus in use is the result of the experiments and combined work of Engineer Kimura, Captain Tonami, imperial navy, and Engineer Matsushiro, attached to the Ministry of Communications, who commenced their studies in 1900. According to the journal of the British Royal United Service Institution, ever since 1902 the above-named officers, after having studied all the systems in Europe and America to which they could obtain access, have obtained with the apparatus produced by themselves results which they claim to be superior to those from other systems in use abroad, and their apparatus has been adopted and installed on board all the Japanese ships. Further, Engineer Kimura is also the inventor of a wireless telephone, which has proved sufficiently practical for use on board Japanese warships.

HOW TO BUILD AN EARLY ENGLISH CHAIR

E. WILLIAMSON

THE tendency in furniture making is still strongly toward reproductions of the examples of the great periods, and to furnish rooms as near as may be in accordance with their age, either real or apparent. The an-

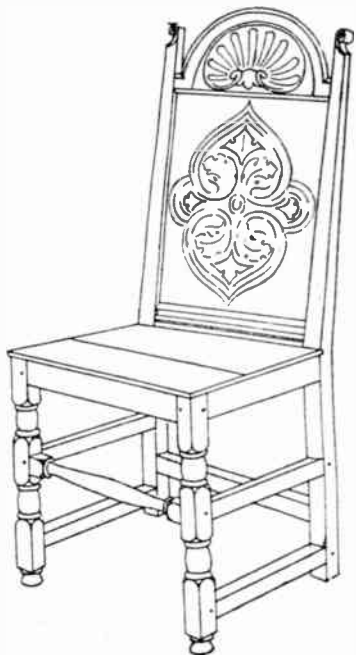

FIG. 1.—SEVENTEENTH CENTURY CHAIR.

tique models, however, have frequently to be altered and adapted, as, although we admire the work of past generations, we have somewhat different ideas as to form and finish.

The chair illustrated is an adaptation of an English example at South Kensington

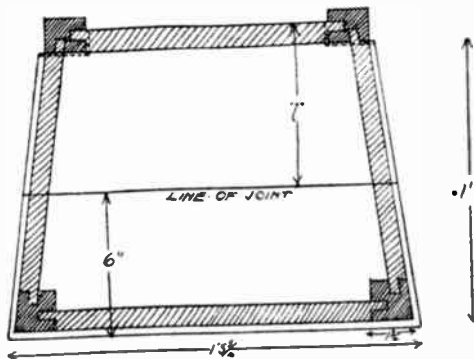

FIG. 2.—SECTION BELOW SEAT AT C—D.

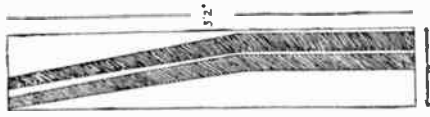

FIG. 3.—METHOD OF SETTING-OUT BACK LEGS.

Museum, seventeenth century, carved in oak, and is of pleasing and quiet design.

The illustrations show: Front and side elevations of chair (Fig. 6), together with section below seat at C—D, and all dimensions.

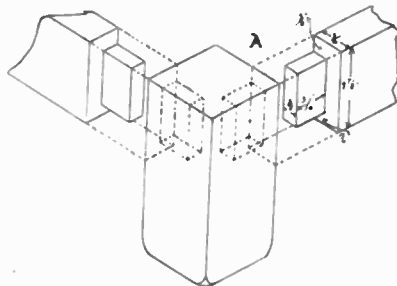

FIG. 4.—ISOMETRIC PROJECTION OF JOINT AT A.

Figure 3 illustrates the method of cutting the back legs out of one piece of wood. Figures 4 and 5 are isometric projections of the joints at A and B in Fig. 6; the tenons at A and other similar joints being placed at one side of the rails, as can be clearly seen in section, Fig. 2.

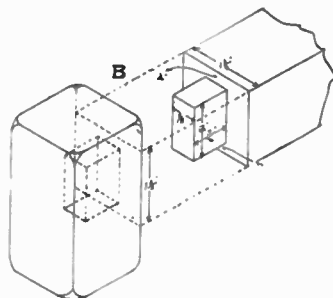

FIG. 5.—ISOMETRIC PROJECTION OF JOINT AT B

The wood required is best wainscot oak, and should be got out for the respective parts as follows: First the back legs: these are in one piece, the upper portion forming the supporting stiles for chair back, and will require a piece of wood 3 feet 2 inches x 7 1/2 inches x 2 inches to cut the two; this allowing about 1/8 inch each way for planing down (see Fig. 3).



put on an angle up through the rails. The chair, when finished, may be oiled, or fumed and oiled as required, and to fully maintain the character plenty of beeswax should be applied and well scrubbed in. — *The Woodworker.*

### CAMP BUILDING. Part III

WILL B. HUNT, 2D

Now that you have put up all uprights, rafters, etc., lay your floor. This may be built of matched boards, — seconds will do, and the use of them will also lessen the expense.

In laying the boards, be careful to keep them straight, for it is a serious difficulty to overcome if they are not laid evenly.

It is best to blind-nail the boards, thus preventing them from warping, as well as hiding the nails, making a neat looking job and a satisfactory one.

After putting up the joist for partitions, board up the outside with clapboardings. These come from 8 to 16 feet long, are grooved to fit into each other, and may be bought in Massachusetts for 6 cents per foot.

Begin at the bottom and work upwards. Do the same with the roof. In using this kind of board, no shingles are necessary, as it is water-proof.

After boarding, set in window frames, doors, etc. When the outside is done, you may finish the inside, and you will have a comfortable, secure house.

The accompanying drawing shows joist in two ways, — one in black, the other in outline. The black drawing shows uprights to be used for division of rooms on which are nailed the sheathing, but for a cheaper wall burlap may be substituted. This burlap may be painted and then stenciled, making a very artistic wall. In tacking up burlap to prevent its shrinking, apply it crosswise, not lengthwise.

Many people do not know the usefulness of burlap. It is most economical, a fair grade costing but 6 cents per yard. When painted, with ordinary house paint, it becomes durable and beautiful. It makes excellent porch blinds, as the air sifts through readily and the sunlight is prevented from showing too fierce a glare. As a wall covering, it is most satisfactory. Its surface gives an excellent place for photos and sketches; it makes a soft finish to the room, and can be adapted to any color scheme. While it may not be considered as sanitary as some other finish, it is easily renovated, and when put on in panels is not difficult to remove.

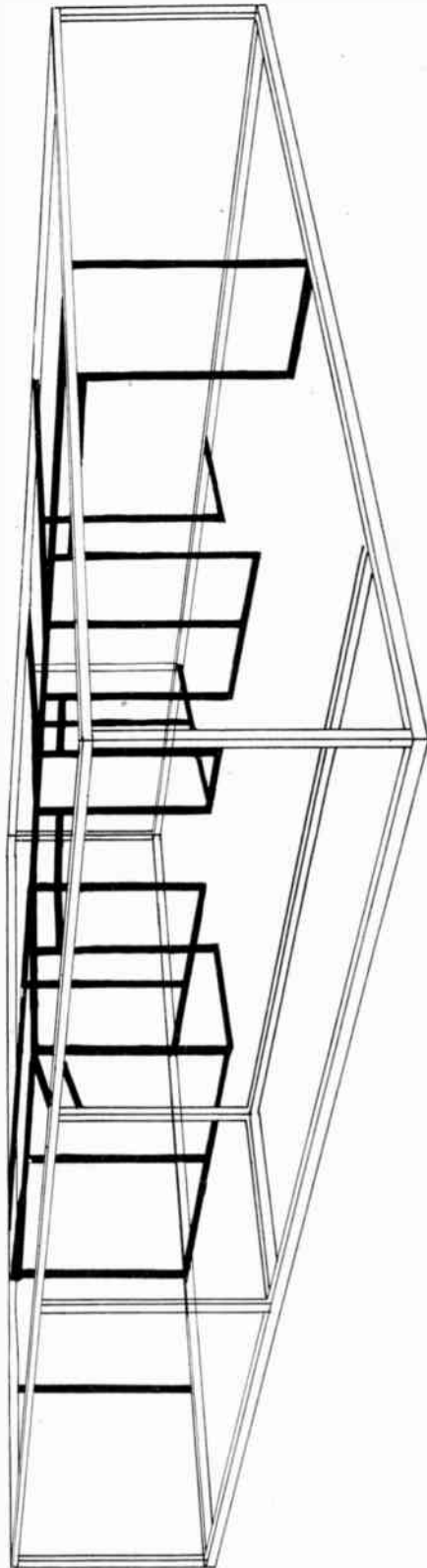

## THE STRENGTH OF CONCRETE BEAMS\*

RICHARD L. HUMPHREY

At the Structural Materials Laboratories of the United States Geological Survey in St. Louis, Mo., a series of important tests on the strength of plain concrete beams has just been completed. These tests form part of a comprehensive series of investigations undertaken by the government for the purpose of determining the strength of concrete and reinforced concrete. The results have just been printed in a bulletin of the United States Geological Survey.

The work involved in these investigations consists of a study (1) of the constituent materials of concrete, (2) of its strength when molded into various structural shapes, and (3) of the methods by which its maximum strength may be developed through various forms of metallic reinforcement.

Although it is true that concrete possesses but little strength in tension and must be reinforced with metal to resist tensile stresses, it is believed that no study of concrete would be complete without a series of tests establishing its strength without reinforcement.

The tests reported indicate that concrete is unsuitable for use under conditions where it must resist tensile stresses, because of the small loads it will sustain and particularly because of the suddenness with which it fails, in striking contrast to the behavior of reinforced concrete, which usually shows a gradual development of cracks preceding failure.

This first series of beam tests covers 144 beams without reinforcement 8 x 11 inches in section and 13 feet long, together with the corresponding compression test pieces, consisting of cylinders 8 inches in diameter by 16 inches in length and of 6-inch cubes. Of these tests those on 108 beams of 12-foot span, with their cylinders and cubes, and those on 108 beams of variable spans, 6 to 9 feet, which were made of the larger part of the 13-foot beams after rupture, are reported and comprise all of this series except the fifty-two weeks' tests.

An attempt has been made to bring out, if possible, the comparative value of gravel, granite, limestone, and cinders for use in concrete; the effect of age and consistency on the strength, as shown by the modulus of

rupture of the long and short beams and by the ultimate strength of the cylinders and cubes; and the influence of age and consistency on the stiffness, which is indicated by the unit elongation of the long and short beams and by the initial modulus of elasticity, as determined by tests of the cylinders.

Three consistencies — wet, medium, and damp — were somewhat arbitrarily chosen. Tests were made at the ages of four, thirteen, twenty-six, and fifty-two weeks.

No attempt will be made in the coming bulletin to generalize the results of the tests presented, or to draw any conclusions, however warranted they may appear from an examination of the test data. It is hoped that the matter contained will provoke discussion, and in order to promote this end extended expressions of opinion or attempted applications of theory to results have been avoided. A running commentary on the results of the tests, however, emphasizing matters of particular interest and indicating a few points that might lead to interesting analyses will be included in the report. When the results of the fifty-two weeks' tests become available, it is the intention to publish a thorough analysis of the entire series in another bulletin.

The purpose of this series of tests was to determine

- (1) The effect of age on the strength of concrete;
- (2) The effect of variation in the consistency on the strength of concrete; and
- (3) The effect of different types of aggregates on the strength of concrete.

The first question is perhaps the most important, since an early attainment of considerable strength and no subsequent decrease in strength are two essential qualities in concrete, in order that a structure may be put to the use for which it is intended as soon as possible and that there shall be no subsequent deterioration in strength.

The least age at which any tests were made was four weeks, and at that period in no case except that of the cinder concrete, wet consistency, did the compressive strength fall below 2000 pounds per square inch, while the cinder concrete had in every case a compressive strength of at least 1000 pounds per square inch.

\*Published by permission of the Director of the United States Geological Survey.

In every instance the compressive strength shows a substantial increase from four to thirteen weeks, with the single exception of limestone concrete mixed to a wet consistency, for which a decreased strength is indicated by the tests,—a decrease which continues to the age of twenty-six weeks. This decrease in the strength of the limestone concrete is unexplainable, and the results of the fifty-two weeks' tests on this material will be of value as indicating whether or not this decrease continues to the latter period. The other aggregates show either the same or a slightly greater strength at twenty-six weeks than at thirteen weeks.

The transverse tests on both the long and the short beams bear out very closely the fact indicated by the compression tests on the cylinders and cubes, and lead to the belief that the tensile and compressive strength are affected alike by both age and consistency. The effect on the strength of the variation in the consistency is clearly shown. In almost every case the concrete of the damp consistency is the strongest and that of the wet consistency the weakest. This is true for the three ages at which the concrete was tested, and is confirmed by the tests of the beams as well as of the cylinders and the cubes. Attention is called to the fact that the damp consistency used is much wetter than the damp consistency used in making mortar building blocks, for which the same conclusions may not apply.

The difference in strength of the stone and gravel concretes of the three consistencies is more pronounced than in the case of the cinder concrete. The effect of the consistency on the strength seems to depend to a great extent on the behavior of the concrete while being tamped and to the method used in tamping. Great care was taken to tamp all the concretes in the same manner. The thorough mixing of the concrete is absolutely essential and has a marked influence on the consistency.

The relatively slight influence exerted by the consistency on the strength of cinder concrete may be partly due to the structural weakness of the cinders themselves, which in the drier mixtures were to a great extent broken up by the tamper, while in the wet mixtures, the cinders would move from beneath the tamper.

While it is true that in almost every instance the drier mixtures give the greater strength, it does not follow that dry (or

damp) mixtures should be used in construction. Practical considerations warrant the use of a wet mixture. The difficulty in securing efficient tamping and, a smooth finish in a damp concrete, the loss of strength due to the unavoidable drying out of the concrete used above water, the difficulty of securing in reenforced concrete an intimate union with the steel, and the far greater ease of placing wet concrete all seem to warrant the sacrifice of what in many cases is but a slight difference in strength for a greater ease of manipulation and a thorough bedding of the steel, which is of the utmost importance in reenforced concrete work.

It is dangerous to draw any general conclusions as to the relative value of concrete made of the four aggregates used unless the character of the aggregates used in this particular series of tests is carefully kept in mind. The gravel, granite, limestone, and cinders were used as available representative types of aggregates, and while the results indicate that the granite makes the strongest concrete, it should not be assumed, therefore, that a granite concrete is stronger than a gravel, limestone, or cinder concrete. Every material should be accepted or rejected on the results of the tests of its qualities, regardless of the tests of other materials of the same type. Apparently insignificant differences in two materials which appear to be similar often cause considerable difference in the strength of concrete made from them. For instance, two limestones from the same quarry crushed and screened under similar conditions—except that one was screened while wet, which caused the dust to adhere to the surface of the stone—would make concretes of considerable difference in strength.

Because the hard, flinty gravel used in these tests gave excellent results, it does not necessarily follow that a similar well-graded gravel, but composed of soft limestone or shale, would give like results. No series of investigations, however elaborate, will do away with the necessity of careful inspection of the materials to be used. The relative value of materials to be reported in this forthcoming bulletin should be recognized, therefore, as applicable only to the particular materials from which the reported physical properties were obtained.

These investigations were carried on under the general direction of Joseph A. Holmes, expert in charge of the Technologic Branch, United States Geological Survey.

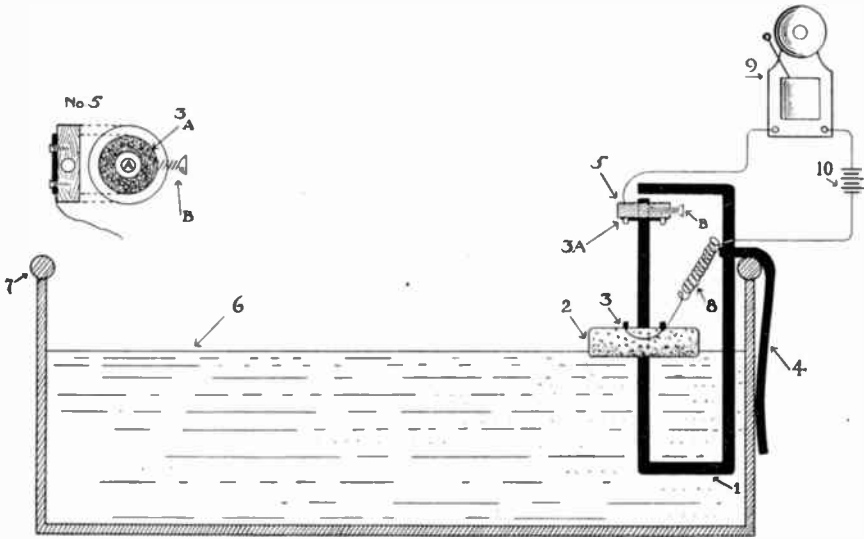

**HOW TO MAKE AN ELECTRIC HIGH-WATER SIGNAL**

DAVID J. SIEGEL

THE accompanying drawing shows a simple and practical device which I have constructed to keep the pan of our ice-chest from overflowing. The illustration shows a sectional view of the pan (7) with the water level shown at (6). An iron rod (1) is bent into a rectangular shape, as shown by the drawing, and held over the edge of the pan by spring clasp (4). On the vertical part of (1) slides freely a perforated cork, on the upper surface of which is fastened a copper washer (3), which is connected by a flexible wire (8) to the battery bell circuit. Above the cork at the top of the rod is fastened by a screw B which serves to regulate its height, a piece of wood (5), whose lower surface is fitted with another copper washer (3a), which is connected to the other side of the battery and bell circuit. The operation of the device is self-evident. The cork (2) floats on the surface of the water and when this reaches the level which has been decided upon as the danger point, the two copper washers (3) and (3a) make electrical contact and the bell rings until the water is poured off. For this purpose the whole apparatus easily lifts off the edge of the pan. The device does not present any novel features, but can easily be made by any one who is acquainted with tools.

**A BALL-BEARING EMERY GRINDER**

C. CHEVERTON

ONE of the most useful devices of the model-maker's workshop is a serviceable emery grinder. Hours of weary filing, which seem to take all the pleasure from our work, will cease upon its introduction.

I have always been among those whose ambitions to possess a lathe, good tools, and other things so dear to the mechanically inclined remain unachieved; never mind, it may not always be thus. After all, those who can produce models under such unfavorable circumstances must really be better pleased as they survey the result of patient labor.

This little tool can be made with very little trouble, the emery wheels being the most expensive item to consider. I might say here that this machine has been in use for nearly six years in the shop at which I was apprenticed, and still does its work well. ♦

In the first place an old cycle hub — from any prehistoric wreck you may come across, and there are plenty in our ponds and streams — will be required. Cut this in half, as



FIG. 1.

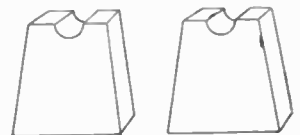

FIG. 2.



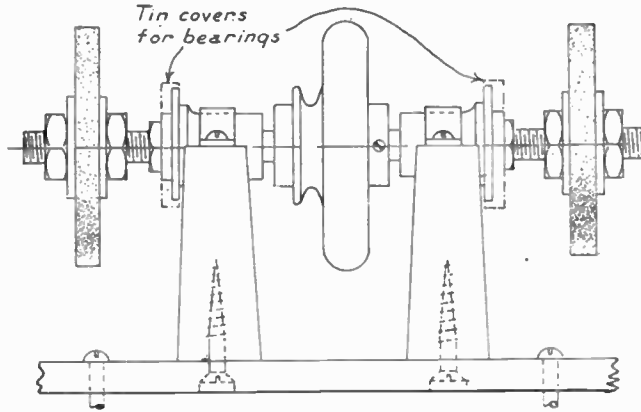

FIG. 3.

Fig. 1. The spindle may be discarded, as it is too short for our purpose. Then cut two wooden blocks as standards (Fig. 2) cutting a groove in the tops to receive the bearings which are held in place by bent

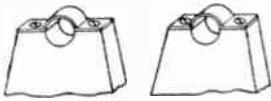

FIG. 4.

iron clips (Fig. 4). A spindle is then made about 12 inches long, threaded to take the cones about 4 inches from each end; the thread will also take the nuts that secure the emery wheels. An old sewing-machine wheel and a few washers will complete our grinder.

Mount the wheel on the center of the spindle, using the pin to fasten it, and as-

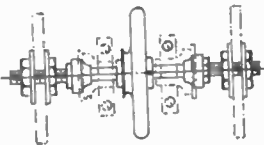

FIG. 5.

semble the bearings as illustrated (Figs. 3 and 5).

To keep dust from the bearings screw over them a tin wing or guard.

This emery grinder may be run on an old sewing-machine table, or, if you are so fortunate as to possess a lathe, from its fly-wheel. — *The Model Engineer*.

## ENGINEERING MAGNETS

IN engineering works the electromagnet is taking a very prominent place. This device dispenses with hooks, slings, and other lifting apparatus. By throwing a switch controlling the current the magnet is energized, and thereby attaches itself to the bars, castings, scrap or pig iron which it is desired to lift.

The magnet poles are shaped according to the nature of the material to be raised. For heavy rails they are oblong, and are slung from the crane hook by a short chain. Castings weighing over two tons are successfully handled by electromagnets. Another use to which the electromagnet is put is in breaking old castings so that they may be melted and utilized. To accomplish this the magnet is made to lift and drop a steel ball weighing from one to six tons.

The time lost in an engineering shop by what is known as slinging pieces is saved by electromagnets, connection being made instantaneously, and the weight liberated in the same expeditious manner. The magnet is lowered to the object needed with the current turned off. When the switch is closed, the magnet, becoming active, holds the articles to be lifted while they are raised and transported to their destination. When they are lowered the switch is opened and the magnet immediately releases them. As the operator of the crane controls the action of the magnet through the switch, this one man can attend to all the details of transferring heavy metal objects. No assistant is needed to attach them to the conveyor or to release them when they reach their destination. — *Tid-Bits*.

# Electrician and Mechanic

Incorporating

*Bubier's Popular Electrician* . . . . . Established 1890  
*Amateur Work* . . . . . Established 1901  
*Building Craft* . . . . . Established 1908  
*The American Inventor* . . . . . Established 1892

PUBLISHED MONTHLY BY

**SAMPSON PUBLISHING CO.**

BOSTON, MASS.

F. R. FRAPRIE, M. Sc. Chem. }  
 A. E. WATSON, E. E. Ph.D. } *Editors*  
 M. O. SAMPSON }

## SUBSCRIPTION, IN ADVANCE, \$1.00 PER YEAR

In the United States and dependencies, and Mexico. In the Boston Postal District and Canada, \$1.25. Other countries, \$1.50.

Subscribers wishing to have their addresses changed must give both old and new addresses. Notice of change of address must reach us by the 15th of the month to affect the number for the month following.

## SINGLE COPY, 10 CENTS

### Advertising Rates on Application

Forms close on the 5th of the month preceding date of publication.

Contributions on any branch of electrical or mechanical science, especially practical working directions with drawings or photographs, solicited, and if accepted, paid for on publication. No manuscripts returned unless postage is enclosed.

All communications should be addressed

**SAMPSON PUBLISHING COMPANY**

6 Beacon Street, Boston, Mass.

ELECTRICIAN AND MECHANIC may be obtained from all newsdealers and branches of the American News Co.

FOREIGN AGENTS — Arthur F. Bird, 22 Bedford Street, Strand, London.  
 Ramlot Frères et Sœurs, 25, Rue Grétry, Brussels, Belgium.  
 G. G. Turri & Co., 150 Queen Street, Melbourne, Victoria, Australia.

Copyright 1908, by the SAMPSON PUBLISHING COMPANY

Entered as Second-Class Matter July 13, 1906, at the Post Office at Boston, Mass., under the Act of Congress of March 3, 1879.

VOL. XIX. SEPTEMBER, 1908 No. 3

## EDITORIALS

We publish this month a list of the stations of a number of members of our wireless club. In the three or four days which have elapsed since this list was put in type, a large number of new members have already joined the club. We are pleased to see this amount of interest, and sincerely hope that many more of our readers, several thousand of whom we know to be interested in wireless, will join.

The object of this organization is to bring amateurs and operators interested in wireless telegraphy in closer touch with one another. We should be glad to put members residing near each other in communication with one another, so that they may be able to get into wireless communication if their stations are of sufficient power. We also hope that the club will be a medium for the

exchange of new ideas, and we hope that any member who has some new wrinkle will communicate it to us for publication under appropriate heading in the magazine. A little later we hope to be able to form local branches in towns where half a dozen or more members live, and should be glad to receive communications on this subject from any of our readers who may know if there are enough amateurs in their own town to make it worth while to form a branch.

Membership cards have been sent out to those who have already joined the club, and it will be advisable in communicating with us or other members, to use your number.

Certain electrical experts are inclined to feel that wireless work is engrossing too deeply the attention of electrical experimenters, and that much of this experimenting is wasted work. We, however, do not feel that this is the case. No experimental work in science can be wasted. The value of scientific experiment lies much more in the training which it gives in rigorous work, the necessity for patience and logical thought, than in the practical results. Any young man who masters wireless telegraphy to such a point that he is able to construct apparatus which works practically, has gained facility with tools and scientific knowledge which will be of great value to him, even though his work never yields him any cash return. At the same time, our knowledge of wireless telegraphy is still in such an elementary condition that there is always the possibility of even an amateur discovering valuable and patentable principles.

\* \* \*

WE are publishing this month the first instalment of a very valuable lecture on patents recently delivered in Schenectady. This gives in simple and clear language a very good idea of the necessary steps toward taking out a patent. As is usual in times of bad business conditions, inventive activity is now rampant in the United States, and the patent agencies report that many more than the normal number of applications for patents are being filed. A good patent is always a valuable asset, and we suppose that many of our readers have thought out useful devices which it would be profitable to patent. We publish each month the advertising of several reliable patent attorneys, and can assure our readers that any of our advertisers in this line will give them honorable treatment at fair prices. It is advisable to mention the ELECTRICIAN AND MECHANIC.

# QUESTIONS AND ANSWERS

Questions on electrical and mechanical subjects of general interest will be answered, as far as possible, in this department free of charge. The writer must give his name and address, and the answer will be published under his initials and town; but if he so requests, anything which may identify him will be withheld. Questions must be written only on one side of the sheet, on a sheet of paper separate from all other contents of letter, and only three questions may be sent in at one time. No attention will be given to questions which do not follow these rules.

Owing to the large number of questions received, it is rarely that a reply can be given in the first issue after receipt. Questions for which a speedy reply is desired will be answered by mail if fifty cents is enclosed. This amount is not to be considered as payment for the reply, but is simply to cover clerical expenses, postage, and cost of letter writing. As the time required to get a question satisfactorily answered varies, we cannot guarantee to answer within a definite time.

If a question entails an inordinate amount of research or calculation, a special charge of one dollar or more will be made, depending on the amount of labor required. Readers will in every case be notified if such a charge must be made, and the work will not be done unless desired and paid for.

741. **Wireless Stations.** R. M., Hooperston, Ill., asks, What is the nearest wireless station to Danville, Ill.? The list of wireless stations published by the Navy Department, corrected to August 1, 1907, gives the following information: De Forest Stations of 15 kilowatts capacity and 1000 meters wave lengths were projected for Chicago, Ill., Kansas City, Kan., and St. Louis, Mo., and also one for Cleveland, Ohio, of 10 kilowatts capacity and 700 meters wave lengths. Stations practically in operation at that time were located in Cleveland, Ohio, and Detroit, Mich., owned by Clark, size and wave length being unknown. The call letters of these stations are C. N. for Cleveland, and C. W. for Detroit.

742. **Photography.** C. M. D., Lincoln, Neb., asks (1) Where can a sensitizing solution or powders to use in preparing developing papers, such as are worked in a subdued light, be obtained? (2) Are magazine cameras made 5 x 7 size, and if so, where can they be obtained? (3) Are the so-called "Improved Fuller" battery cells, size 6 x 8 inches, suitable for heavy spark coil work, such as operating gasoline engines? Ans.—(1) It would be impossible for an amateur to coat developing paper, as it has to be done on a very large scale in continuous rolls and in a dark room. The paper is flowed with a hot gelatine emulsion, and if this were done to sheets of paper they would swell and cockle in such a way that it would be impossible to get a perfect coating. Developing paper is cheap enough, so that there should be no temptation for you to experiment with it. If you must coat paper for yourself, use the blue-print or kallitype process, full directions for which you can find in many photographic handbooks. (2) We do not know of any. (3) Yes.

743. **Photographing Silverware.** E. P. G., Meriden, Conn., asks (1) In photographing silverware, where one has to do with very bright surfaces, how can these be deadened so they will be photographed uniformly? (2) Will a ray filter aid? Ans.—(1) The usual manner of deadening the surface of silverware for photographing is to dab it with a lump of putty. This gives the surface a uniform grayness and it can easily be wiped off afterwards without doing any injury. For hollow ware, such as bowls and cups, a very successful expedient is to fill the vessel with ice cold water. In a short time dew will collect upon the surface and it may then be photographed without annoying reflections. If the weather is very damp and warm, however, the photograph must be made promptly or the globules

of water will soon become so large as to run off, leaving streaks. (2) If you use orthochromatic plate, a ray filter is always appropriate, but there would seem to be no particular advantage in using these plates for photographing silverware.

744. **Dynamo.** R. A., Cincinnati, Ohio, has a Carlisle & Finch 250-watt size of field-magnet casting, adapted for a toothed armature 4 inches in diameter and 2 inches long. He asks whether the eighteen-slot or four-slot disks should be used, and what the winding should be for 110 volts? Ans.—As you gave incomplete dimensions and made no specifications as to speed, we cannot well answer. We think you had better get the manufacturers' data. Anyway, use the eighteen-slot disks, but in consequence of eighteen being an even number, you will be obliged to use a multiple winding and brushes at four places on the commutator. Since only four insulations will intervene between adjacent brushes, a 110-volt winding will be impracticable; for that voltage, and so small a machine, two field poles only should be used.

745. **Dry Cell.** O. F., Newcastle, Pa., asks: (1) What is the normal output of a standard dry cell? (2) If a shunt dynamo gives an output of 6 volts and 2 amperes when speed is 3000, what will it give at 1000 revolutions? Ans.—(1) On open circuit the voltage is 1.4; on short circuit the voltage, of course, appears zero, and the current may reach 10 to 20 amperes, the strength depending upon the resistance of the particular ammeter employed. (2) Nothing.

746. **Telephone Generator.** H. P., Oklahoma City, Okla., asks what size and quantity of wire to put on a three-bar machine so as to give direct current for operating small motors? Ans.—One quarter pound of No. 22 is good, but you must bear in mind that the pulsating character of the current from such a generator rather unfits it for many uses.

747. **Battery Fan Motor.** A. B., St. Louis, Mo., is making a small motor of the iron-clad type, each field core being  $2\frac{5}{8}$  inches diameter, with space for a spool of  $\frac{3}{4}$  inch square section. Armature is  $2\frac{3}{8}$  inches diameter, and  $2\frac{1}{2}$  inches long, with twelve V-shaped slots, each  $\frac{5}{8}$  inch wide at top and  $\frac{1}{2}$  inch deep. Air gap is  $\frac{1}{8}$  inch. He asks (1) How can this core be used with a fifteen-segment commutator? (2) What shunt winding will be best for use as a fan motor? and (3) What batteries will be needed? Ans.—(1) At three equidistant points on the commutator solder adjacent segments together. This will

reduce the effective number from fifteen to twelve. (2) We would strongly advise you to file the slots to a rectangular section and thereby provide space for twice as much wire as at present. Use No. 20 wire on armature, No. 23 on field for shunt, or No. 17 for series. Fan motors are ordinarily series-wound, but for general experimental purposes you will find the shunt more useful. (3) Ten large Fuller mercury bichromate cells.

748. Electric "Thriller." O. B., Stevens Pt., Wis., asks: (1) What is the difference between one of these machines and an ordinary dynamo? (2) What is the difference between alternating and direct currents? (3) What is the size of the most powerful battery made? Ans. — (1) The armature is of the Siemen's shuttle type, one end of winding being grounded, the other insulated, and rubbing on a brush, as in the case of a telephone magneto. The field-magnet is of hard cast iron. In addition to the alternating character of the current, the circuit is rapidly interrupted by the brush touching upon the periphery of a toothed wheel. (2) If direct current was desired, two commutator segments and two brushes would be needed to connect with the two ends of the armature winding. (3) No battery gives much over 2 volts, so the size appears mainly in the current capacity. Primary cells are not often made to supply over 10 amperes, and ordinarily only a fraction of an ampere; storage cells may be made in sizes estimated in thousands of amperes.

749. Storage Battery. V. W. G., Willowdale Ont., is making a storage cell consisting of four positives and five negatives, each 5 x 6 inch, immersed in a solution of sulphuric acid and water, in proportion of one to two. He asks how many 6 volt 2 c. p. lamps the cell would light, when fully charged by four gravity cells for ten to twelve hours? Ans. — Since a storage cell on discharge gives but 2 volts, you will need three cells in series, requiring a dozen gravity cells and a year's time for charging them. One to twelve proportion of acid and water is altogether too weak; you need about one to four, but in any case the use of the hydrometer is indispensable. Read our two chapters on "Storage Batteries" in the Engineering series.

750. Draftsman. R. C. R., Madison, Ind., asks if a person having a talent for mechanical drawing, but who is weak in mathematics, would be able to become successful in that work? Ans. — Yes. Facility in the use of the instruments and good judgment in the design and construction of machinery can be quite independent of serious mathematical processes.

751. De W. Van P., Litchfield, Mich., asks: (1) What to do to prevent his 1½ h. p. gasoline engine from running away soon after being started? (2) Will a kite do for supporting the aerial of a wireless telegraph apparatus? Ans. — (1) You must adjust the "timer" so as to give a greater advance to the ignition. (2) Not very satisfactorily, for it would occupy no definite position. By whatever extent the antenna departs from the vertical it imitates the characteristics of a horizontal one, and this means reduced distance though giving something approaching selective direction.

752. Jump-spark Apparatus. E. F. W., Chicago, Ill., has made two induction coils for

use on a double cylinder engine, first one primary being energized, then the other, as determined by the contact on the timer. Condenser has 750 square inches of tin-foil, but the secondary gives better sparks without this adjunct than with it. Two condensers give poorer results than one. What is the reason? Ans. — It is quite as possible to get a condenser of too large capacity as of too small. Before being sure of the right size you will have to do some experimenting. Try unrolling one of the condensers, letting the tin-foil strips fall apart, to see if you can find the right value. Did you put the two condensers in series, or in parallel with each other? The former gives less capacity, the latter more. We should think two layers of No. 16 wire for primary would have been better than the three of No. 20 which you employed.

753. Telegraph Generator. G. G. C., Erie, Pa., ask for a diagram of the internal connections of a Crocker-Wheeler motor generator as adapted for telegraph operation. Supply is at 110 volts, and the negative from generator goes to switchboard while positive is grounded. Ans. — You did not state whether the two windings of the motor generator are on the same armature core, or on different ones. See our chapter on "Current Reorganizers" in the Engineering series. We propose to publish some articles on Modern Telegraphy in the near future. If you wish a complete treatise on the subject, consult Mayer's "American Telegraphy," a copy of which ought to be in your public library.

754. Tesla Coil. E. G., Butte, Mont., asks: (1) If two 8-inch induction coils with suitable condensers, etc., would make a Tesla coil? (2) Can such an outfit be used for wireless telegraphy? Ans. — (1) No, you would need only one such coil, the Tesla coil having relatively few turns of wire. (2) Yes, as explained in Fleming's arrangement and employed for oceanic transmission.

755. Self-exciting Alternator. S. L. K., Reading, Pa., sends the design of such a machine, consisting of a four-pole field-magnet with armature space 3¼ inches diameter and 6 inches long. Armature consists of three independent cores, each 2 inches long with eight large slots, and slipped on to the same shaft. He proposes to wind one of these for direct currents, suitably connected to a commutator; the other two, while in parallel with each other, are desired for two-phase currents. He asks various questions about the sizes of wire and the practicability of the design. Ans. — The design is poor, and even if you get the connections right, about which your ideas appear murky, the output will be a disappointment. If the armature slots are obtained by drilling holes near the periphery of the sheets (not casting), make only narrow saw-cuts, say, ¼ inch wide. You can purchase proper ones 3 inches in diameter with sixteen slots. The alternating current armatures should have only four holes, say, ¾ inch in diameter, and their windings entirely independent, the ends being led to four collector rings. One armature should be set 45° ahead of the other in position. Field bore should be 3¼ inches, but when allowance is made for the bunching at the ends of the armature windings, only a small part of the polar faces will be effective. Your field is large enough to take a 4-inch

diameter armature, and then you can utilize such punchings as are made by the Carlisle & Finch Co. of Cincinnati. For \$1 we can describe the proper windings for a two-phase armature on one core, but the excitation had better be by a separate machine.

756. **Electric Lighting Plant.** R. W. Roswell, N. M., has 1½ h. p. available at an artesian well ¼ mile distant from his house. He asks if it is practicable to develop this power electrically and transmit it for lighting to the house. If so, what size of dynamo, wires, etc., should be used? Ans. — Unless the cost of fuel is high, it does not ordinarily pay to utilize such small powers at such a distance. If it is likely, however, that visits to the power house would be frequent, so that sufficient attendance to the machinery would be assured, and you had use for the power by day as well as by night, you might find it profitable. You must bear in mind that water power is very, very exasperating in effecting the speed with every change of load, and effective water-wheel governors are rather expensive. Possibly the Pelton Water Wheel Co. of San Francisco could give you some good advice. The best results will be obtained by operating the dynamo at the well in connection with storage batteries at the house. A 1 kilowatt 220-volt dynamo, No. 8 line wire, with end-cell switches and a neutral from the middle point of the battery, 110-volt lamps and motors would make a consistent equipment. We think, however, that when you estimate the interest on the investment you will find gasoline for power and kerosene for light will be considerably cheaper.

757. **Bichromate Cells.** T. L., Bennettsburg, N. Y., asks: (1) What is the matter with his Fuller bichromate cells, when they run his motor better without the porous cups than with? (2) How large a miniature lamp should four such cells in proper condition light? (3) Where can small taps and dies be obtained? Ans. — (1) The two tablespoonfuls of salt in the porous cups really make a pretty weak solution; try a dilute sulphuric acid solution. It may be, too, that the cups have been used in ordinary Daniell cells, and have considerable metallic copper deposited in their pores. If this is true, soak the cups in dilute nitric acid for several days. (2) A 6-volt, 3 c. p. lamp. (3) At any city hardware store. Two manufacturers in our vicinity are the Carpenter Tap and Die Co., Pawtucket, R. I., and the Card Manufacturing Co., Mansfield, Mass.

758. **Rewinding Dynamo.** F. R. W., Norwich, Conn. (1) has a No. 27 Carlisle & Finch "Igniter" dynamo, and asks for directions for winding it for as high a voltage and current as is practicable. (2) What length of spark should an induction coil give when primary consists of two or three layers of No. 16 wire on a 1-inch diameter core of soft iron wires, and secondary is of 1½ pounds of No. 33 wire? (3) What size of condenser should be used? Will one from a telephone set answer? Ans. — (1) In consequence of the insulation occupying less room with coarse wires than with fine, you will get the greatest number of watts from the machine when the number of volts is low. Still, economy in the size of commutator, brushes, and line wires dictates a reasonably high voltage with consequent small current. Perhaps the present winding is the best. Since you have only six

commutator segments, 20 or 25 volts will be the maximum allowable without destructive sparking. (2) If the secondary is wound in sections, perhaps 2-inch sparks will be possible. (3) Try more or less of the telephone condenser to find the proper value.

759. **Wireless Telegraphy.** H. C. D., Armada, Mich., asks: (1) How he can make a tuning coil such as that shown in Fig. 1, page 400, of April number. (2) How he can make the potentiometer shown in the same figure? (3) Is it possible to receive messages from a wireless telephone with a receiving station such as is described on the same page? Ans. — (1 and 2) The construction of these instruments is described on pages 37 to 39 of our July issue. Working drawings can be obtained from W. C. Getz, 645 No. Fulton Ave., Baltimore, Md. (3) Yes.

760. **Wireless Distance.** K. B. A., Chittanooga, N. Y., wishes to establish wireless communication with a friend ten miles distant. The country between is flat. He asks what size spark coil he will need with aeriels 55 or 60 feet high. Ans. — You will need a 6-inch coil and a very considerable source of power. Probably you will find the mail or telephone cheaper, and more reliable in the long run.

761. **Wireless Telegraphy.** P. S. R., Norwich, Conn., asks: (1) If it would be possible to utilize a tree 100 feet high, 150 feet from his room as an antenna for wireless work? (2) How high a mast would he need with the tree, and what kind of a screen would he need to receive wireless messages? (3) What is the radius within which he can receive and send messages on a tuned circuit with a 1½ inch jump-spark coil? Ans. — (1) Yes. (2) No mast is required. Use an antenna such as described in our June issue. (3) About a mile.

762. **Wireless Telegraphy.** J. E., Chicago, Ill., asks: (1) Where he can purchase a silicon detector. (2) Is there a De Forest wireless station in Chicago, and if so, where? Ans. — (1) Silicon detectors are not on the market. Full directions for making were given in our July issue. (2) From the latest available information it would appear that this station is not in operation, though projected.

763. **Wireless Telephony.** E. P., New Paltz, N. Y., asks: (1) Can the wireless telephone described by Newell A. Thompson in the July issue be changed to work for a greater distance? (2) How can he make a 50-ohm induction coil for it? (3) How is it that a wireless message can be sent through the floors of a building which is full of steam, water, and gas pipes? Ans. — (1) No. The active radius of the apparatus is limited to a distance of about 25 feet. (2) It would be cheaper to buy one. Any telephone supply house will furnish one for about 40 cents. (3) Wireless telegraphs transmit messages by means of waves in the ether. As this pervades all matter, the wireless telegraph will work through matter intervening.

764. **Wireless Aerial.** H. E. D. lives a third of a mile away from two flag poles 90 feet high and 350 feet apart. He could obtain permission to string wires between them. He is planning a tuned circuit wireless outfit with electrolytic detector and 4-inch spark coil. He asks (1) If it would be practical to locate his instruments one third of a mile away from this aerial and string a wire to it? (2) What size of wire is used to connect instru-

ments and aerial? Ans. — (1) No. (2) No. 16 is the usual size for this purpose.

765. **Wireless Distances.** G. W. S., Chambersburg, Pa., says that he lives within 100 miles of Washington, D. C., but there is a mountain range within ten miles of him, between him and that city. He asks if it will be possible to hear the government station at Washington with an aerial 80 to 90 feet high. Ans. — Using the pole you mention and the apparatus given in the April number, you should have no difficulty in hearing the Washington station, which is of 20 kilowatt capacity. Mr. W. C. Getz, one of our advertisers, can furnish you drawings and information concerning the tuning arrangement and coil needed to cover the distance successfully.

766. **Electrical Engineering.** W. J. D., Lynn, Mass., asks: (1) What is a good text-book on experimental, electrical engineering? (2) Where may aluminum and German silver wire (bare) be obtained in small sizes and quantities? (3) Is the sketch of a silicon detector which I enclose satisfactory? Ans. — (1) The Electrical Engineering Department of Cornell University recommends the following: "Laboratory and Factory Tests in Electrical Engineering," by Sever and Townsend, \$2.50; "Electrical Engineering," by E. Rosenberg, \$2; "Theoretical Elements of Electrical Engineering," by C. P. Steinmetz, \$2.50. (2) New England Coil Winding Co., Atlantic, Mass. (3) The detector is perfect in every respect, and coincides exactly with the drawing given in the patent on this detector.

767. **Induction Coil.** A. E. L., Tweed, Kan., asks: (1) What are the dimensions of a 12-inch coil for wireless work? (2) Would it be advisable to insulate the secondary by coating the wire with rubber solution? Ans. — (1) Core, 19 inches long, 1½ inches in diameter, composed of No. 22 iron wire. Primary, two layers No. 10. Secondary, 12 pounds No. 34. The making of such a coil demands great care, and we would advise you to read up the subject thoroughly before starting in. (2) Rubber exposed to air is not permanent in insulating qualities. Under water it is everlasting. Equal parts of resin and beeswax, used hot, is a common insulation.

768. **Tesla Coil.** E. H., Eden, Ill., has made a Tesla coil as described in the May issue. He asks: (1) If he can have six or more secondary bobbins connected in series, and run with a magneto. (2) Should this have an adjustable capacity condenser? (3) Would powdered silicon held between two silver electrodes in a semi-vacuum make an efficient detector? Ans. — (1) No. (2) It is not necessary. (3) We should say not. If you think so, why do you not try it? The experiment will cost very little, and you will have the satisfaction of knowing from your own experiment.

769. **Wireless Telegraphy.** E. E. H., New York City, asks: (1) How is connection made between the two metal plates of the variable condenser described in the July issue? (2) How far should I be able to receive with the following instruments: 75-foot aerial, electrolytic detector, pair of 1000-ohm telephone receivers, tuning coil, potentiometer, and three dry batteries? Ans. — (1) No connection is made between the plates. They are separated by the

glass, and the device becomes inoperative if they touch. (2) About 150 miles if your apparatus is well constructed.

770. **Computing Stepped Pulleys.** J. F. S., San Francisco, Cal., asks: (1) What should be the weight of the driving wheel of a foot-power lathe of 3¼ inch center? (2) How to compute the length of a belt so that three pulleys above and three below may be used, one at a time? (3) What size gasoline engine will be needed to drive above lathe? (4) In a single-cylinder two-cycle gasoline engine, should the exhaust port be opposite the inlet port? Ans. — (1) About 18 to 20 inches in diameter, with a rim about ¾ inch thick. Use an inch belt. (2) Your question is not clear. The length of belt is easily found by measuring if the pulleys are in hand. Possibly you want to know how to calculate the sizes of the pulleys. This requires some mechanical drawing on a fairly large scale. Proceed as follows. Draw a straight line and on it lay off to scale a distance EF representing the distance between centers of the pulleys. Draw with F and E respectively as centers the circles D and d, representing the diameter of the first pair of pulleys. Draw HI tangent to the circles D and d, representing the belt. Bisect EF and erect at the center B the perpendicular BG, making the length BG equal to 0.314 x EF. With G as a center, draw a circle tangent to HI. The point G may fall either inside or outside of the belt line according to circumstances. The belt line of any other pair of pulleys must be tangent to the circle just drawn. Then if we know the diameters of the pulleys m and n, we may draw belt lines tangent to them and to the circle G. Circles with centers at F tangent to these belt lines will give the diameters of the pulleys M and N. (3) A 1 h. p. gasoline engine should give ample power, but must be belted down to allow the lathe to revolve fast enough. (4) The exhaust port should be on the opposite side of the cylinder from the inlet port, and the upper edge of it a short distance above that of the inlet port.

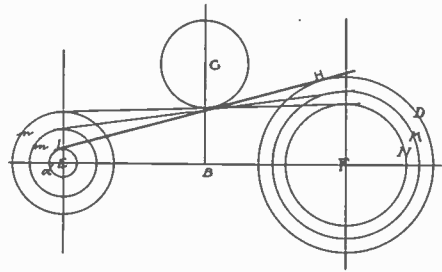

771. **Magneto.** L. J. B., San Mateo, Cal., asks: (1) What is the price of a good magneto? (2) What is the output of a "Little Hustler" motor? (3) What sizes are the two samples of wire sent? Ans. — (1) Address the Dean Electric Co., Elyria, Ohio. (2) Almost nothing; it is intended merely to run itself. (3) Nos. 22 and 26.

772. **Automatic Switch.** G. E. G., Paterson, N. J., asks how to construct an automatic switch for cutting the storage batteries out of circuit in case his gas engine stops during the charging. Ans. — This can well consist of a loop of copper wire joining the mercury in two

cups, inserted directly in one side of the circuit. This inverted U, supported on a swinging arm, is held down by a solenoid also in the main line. By addition of counterweights you can adjust the switch to open at any desired minimum of current.

773. **Induction Coil on Alternating Currents.** F. C. C., Bath, Me., asks: (1) If it is practicable to operate his coil on a 110-volt alternating current circuit instead of from batteries? (2) Will sixty-eight sheets of tin-foil 8x12 inches answer for a condenser? Ans. — (1) For some purposes you will find the alternating current satisfactory. No interrupter will be needed, but you must have a choke coil in circuit. If you could get a couple of the coils that are used in the tops of alternating arc lamps, and put them in series or parallel, as you may find best by experiment, you will have good control over the apparatus. (2) Of course with no break piece you will need no condenser, but it will add interest to your experiments to try an interrupter and various sizes of condenser.

774. **Water System.** W. M., Oxford, Mass., asks: (1) Now to predetermine with accuracy the place to sink a well? (2) If the well is 30 feet from house, can the water be brought to a faucet by use of compressed air? (3) Will  $\frac{3}{4}$ -inch pipe suffice for connecting a 12-gallon tank and utilize 180 pounds maximum pressure? Ans. — (1) Consult some old resident of your town in regard to the use of the "witch" rod. (2) Yes. (3) The pipe will answer, but 12 gallons is altogether too small a size to bother with. A beer barrel makes a good tank for its thick sides do not readily admit the freezing of the water in cold weather. If you use a metal tank, let it be of 100 or more gallons capacity. 180 pounds pressure is altogether unnecessary; 70 pounds will suffice. Consult the advertising columns of *Scientific American*.

775. **Primary Coil.** P. W. D., Hope, Ind., asks: (1) What should be the construction of the primary to fit a secondary of the following dimensions: Length of wound portion,  $1\frac{1}{2}$  inches; outside diameter, 2 inches; inside, 1 inch. It is wound with wire of size of sample. (2) Can a Leyden jar be charged with a direct current? Ans. — (1) Make a wooden spool with a  $\frac{1}{2}$ -inch diameter hole; turn it on an arbor to a diameter of  $\frac{3}{8}$  inch in central portion for a length of about 2 inches, and leave ends nearly 1 inch in diameter and  $\frac{1}{2}$  inch long. Wind on three layers of No. 18 wire, and fill the hole with 3 inches long annealed iron wires, such as tinsmiths use; the iron wire can be straightened by forcibly stretching it in long lengths. The size of secondary wire is No. 36. (2) Not for any useful purpose. The condenser is essentially for alternating currents.

## BOOK REVIEWS

A NEW NOVEL BY A FAMOUS ELECTRICIAN. The leading feature of the September *Lippincott's* is a complete detective novel, entitled "The Investigation at Holman Square," by Dr. Nevil Monroe Hopkins, an electrical engineer, who has not only achieved high honors in his chosen profession, but has displayed extraordinary versatility in other lines as well. Dr. Hopkins is at present an Assistant Professor in the George Washington University at Washington, D. C., and Chief Electrical Engineer for the United States Navy Department in the Consolidation of Navy Yard Power Plants throughout the country. He was born in 1873 in Portland, Me., and from boyhood has been devoted to the study of electricity and chemistry. His early education was received in schools in this country, in Germany, and in France, his spare hours being spent in practical work in shops and laboratories. Later he was graduated from the Scientific Department of Columbia and Harvard Universities, taking successively the degrees of Bachelor of Science, Master of Science, and Doctor of Philosophy. Dr. Hopkins has made numerous contributions to the various scientific magazines and periodicals, and has written several technical text-books. He was awarded the John Scott Medal by the Franklin Institute of the State of Pennsylvania, for work in Applied Science, and has been elected to the National Scientific and Engineering Societies. He has two other notable detective stories to his credit, "The Moyett Mystery" and "The Strange Case of Dr. North," both of which were published in *Lippincott's*. "The Investigation at Holman Square" is characterized by great ingenuity of plot. The arch criminal in the tale makes use of his electrical knowledge to further his plans, which are circumvented at last by a detective, who is also an expert in that line. The story fairly bristles with action, and should be of exceptional interest to all interested in electrical science.

THE WIMSHURST MACHINE, how to make and use it.

A Practical Handbook on the Construction and Working of the Wimshurst Machine, including Radiography and Wireless Telegraphy, etc., and Other Static Electrical Apparatus. By Alfred W. Marshall. Second edition, revised and enlarged. New York, Spon & Chamberlain, 1908. Price, 25 cents.

The Wimshurst machine does not seem to be as popular among electrical experimenters now as it used to be, but this is rather a mistake, because there are many valuable lessons to be derived from the construction and use of a machine of this type, and it offers no difficulties which cannot be overcome by the average experimenter. This little book covers the subject in a very complete and practical manner and is to be recommended to every experimenter.

## THE WIRELESS CLUB

THIS organization has started with a good show of interest, and up to August 1 we have enrolled one hundred and fourteen members. These will constitute the charter members; but as one or two interested operators have written that they supposed the membership list was closed, we hasten to assure them that this is not the case, and because of this misapprehension, we will hold the list of charter members open until October 1. Every one interested in wireless telegraphy is invited to join.

There are no dues or fees. You don't have to be a subscriber to *ELECTRICIAN AND MECHANIC*. If you buy it from a newsdealer, or read it in a library, or even borrow it from a friend, it makes no difference; you will be welcomed as a member of the club. Just write us a letter and say you want to join, and we will assign you a number and send you a membership card.

If you have a station, send us full particulars, and we will assign you a call letter, which will not

conflict with any already in use. Give us the height of your aerial from spark-gap to top, size of induction coil, and power used for transmitting.

We publish herewith a list of the numbers of all members to date, arranged by cities and towns. We shall be glad to put members into communication with other members in places near by, at any time. That is one of the purposes of the club. Later we hope to organize local sections, which can have regular meetings and exchange experiences.

## GEOGRAPHICAL MEMBERSHIP LIST

	CALIFORNIA	
Fresno.....	77	
Los Angeles.....	71, 106	
Mill Valley.....	107	
Redlands.....	84	
San Francisco.....	45	
	COLORADO	
Telluride.....	87	
	CONNECTICUT	
Ansonia.....	111	
Hartford.....	89	
Madison.....	73	
Norwich.....	85	
	ILLINOIS	
Chicago.....	69, 76	
Eden.....	78	
Panama.....	47	
Saybrook.....	21	
Woodstock.....	82	
	KANSAS	
Baldwin.....	113	
Belleville.....	83	
Kansas City.....	30, 33	
Tweed.....	20	
	LOUISIANA	
Shreveport.....	38	
	MAINE	
Augusta.....	37	
	MARYLAND	
Baltimore.....	1	
Mount Savage.....	27	
	MASSACHUSETTS	
Arlington.....	32	
Belmont.....	57, 61	
Boston.....	95, 96	
Brookline.....	2	
Cambridge.....	3	
Foxboro.....	40	
Lawrence.....	5	
Mattapan.....	4	
Natick.....	48	
Newburyport.....	67	
North Andover.....	42	
Plymouth.....	114	
Rockland.....	52	
Salem.....	103	
South Hamilton.....	105	
Waltham.....	43	
West Roxbury.....	44	
	MICHIGAN	
Armada.....	79	
	MINNESOTA	
St. Paul.....	112	
Watkins.....	14, 81	
	MISSOURI	
Springfield.....	23	
St. Joseph.....	34, 35	
	MONTANA	
Butte.....	94	
	NEW HAMPSHIRE	
Dover.....	90	
Franklin.....	108	
	NEW JERSEY	
Asbury Park.....	36	
Elizabeth.....	97	
Jersey City.....	104	
Montclair.....	110	
Newark.....	68	
Paterson.....	15	
Pompton Plains.....	101	
Summit.....	11	
Upper Montclair.....	39	
	NEW YORK	
Albion.....	91	
Ancram.....	9	
Bronxville.....	49	
Brooklyn.....	7, 70, 109	
Camillus.....	88	
Chittenango.....	60	
Fairport.....	6	
Flushing.....	65, 100	
Gates.....	99	
Kingston.....	26	
New York.....	10, 19, 46, 66	
Union.....	62	
West Webster.....	63	
West Winfield.....	72	
	OHIO	
Cincinnati.....	17	
Marietta.....	64	
Stoutsville.....	53	
West Park.....	50	
	OKLAHOMA	
Wilburton.....	29	
	ONTARIO	
Brantford.....	75	
Oshawa.....	31	
	OREGON	
Corvallis.....	92	
	PENNSYLVANIA	
Philadelphia.....	8	
	PRINCE EDWARD ISLAND	
Belle River.....	74	
	RHODE ISLAND	
Newport.....	55, 56	
Providence.....	22, 28, 54, 58	
	TEXAS	
Fort Worth.....	86	
Paris.....	98	
San Antonio.....	18	
	VIRGINIA	
Big Stone Gap.....	59	
	WASHINGTON	
St. John.....	41	
Spokane.....	80	
	WEST VIRGINIA	
Junior.....	12	
Parkersburg.....	24	
Pine Grove.....	16	
Point Pleasant.....	13	
Ronceverte.....	51	
	WISCONSIN	
Fond du Lac.....	102	
Madison.....	93	
	WYOMING	
Sheridan.....	25	



# INDIA OIL STONES

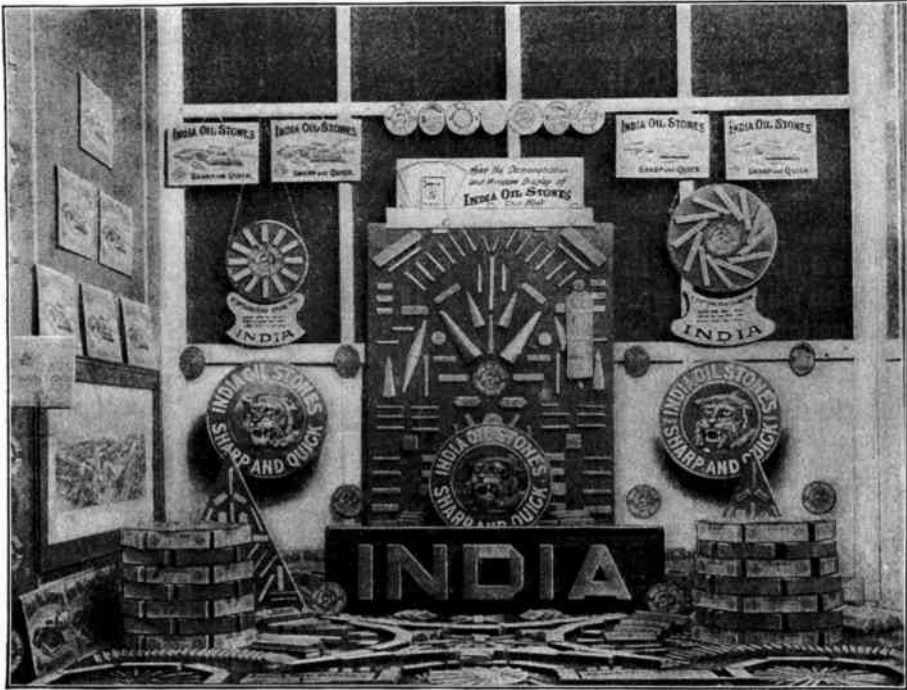

☛ The above illustration shows a hardware dealer's display window decorated with India Oil Stones, showing the innumerable different shapes and sizes in which this remarkable stone is manufactured for sharpening special tools.

☛ Remember there is an India for sharpening any and every tool.

☛ It cuts clean, cool, and quick even the hardest steel on which a file will slip.

☛ It is not an Emery Stone, but a high-class Oil Stone made from corundum, which, next to the diamond, is the hardest known mineral.

ASK FOR SOUVENIR *INDIA STONE* AND FULL INFORMATION.

Sole Selling Agents

**Pike Mfg. Co.**

PIKE, N. H.

Dept. K.



INDIA TRADE MARK

Manufactured by

**Norton Co.**

WORCESTER,

MASS.



**A New Book  
Worth Having  
IT'S FREE**

A Book packed full of new ideas in time- and labor-saving Tools for all classes of mechanics. Tools that appeal to any man, no matter what his profession or calling may be. The Book is the embodiment of Yankee ingenuity and invention, illustrated with photographic reproductions of the Tools in use.

**☞ A postal brings it if you mention this paper**

**North Bros. Mfg. Co.**  
Philadelphia, Pa., U. S. A.

## Gas Engine Manual



**This volume just published gives the latest and most helpful information respecting the construction, care and management of Gas, Gasoline and Oil Engines, Marine Motors and Automobile Engines, including chapters on Producer Gas Plants and the Alcohol Motor.**

The book is a practical educator from cover to cover, and is worth many times the price to any one using a gas engine of any type or size. Contains 512 pages, 27 chapters, 156 diagrams, size 5 1/2 x 8 1/2 inches, weighs 2 pounds, is handsomely bound, and in every way a fine volume.

**SPECIAL OFFER**

The only way the practical merit of this MANUAL can be given is by an examination of the book itself, which we will submit to the readers of ELECTRICIAN AND MECHANIC, free for examination, to be paid for or returned, after looking it over.

Upon receipt of the following agreement (which can be either cut out or copied), the book will be immediately forwarded.

*No money in advance required, sign and return*

**Theo. Audel & Co., 63 Fifth Ave., New York**

Kindly mail me a copy of "Audel's Gas Engine Manual," and, if found satisfactory, I will immediately remit you \$2.00, or return the book to you.

Name..... Address.....

# The Burning of Chelsea

*By Walter Merriam Pratt*

"The Burning of Chelsea," by Walter Merriam Pratt, is a valuable contribution to local history. The story of this conflagration, the most terrible calamity which has ever overtaken a New England community, needed to be told in a permanent form, and has been exceptionally well done. The author is a resident of the city and the son of a former mayor. He was a participant in all the stirring scenes of the fire, risked his life in saving persons and property, and acted as a volunteer fireman during the latter part of the day. A member of a militia company which was not called out, he volunteered for duty with another command and served on the provost guard as long as it was needed. He thus saw and had part in every phase of the incidents which he describes and his account is authoritative.

The book is not a dry collection of facts, but is written with vigor and force, and is full of the mingled humor and pathos which accompany all great catastrophes. It is illumined with vigorous and poetic passages of vivid description, and will hold the attention of every reader.

*Profusely illustrated with photographs of the city before, during, and after the fire*

*One volume, large octavo with decorative cover  
Price, \$1.50*

*For sale by all booksellers, or will be sent post-paid on receipt of price*

**Sampson Publishing Co.**

**Boston, Massachusetts**

**BUILD YOUR OWN MOTOR!**

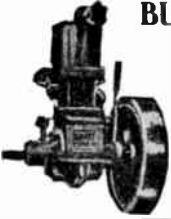

Complete sets of Castings, with blue print working drawings, for your Auto, Launch, Motor-Cycle Engine, or Workshop.

**Our Remarkable Offer!**  
6-Actual Brake Horse Power—2 Cycle—3 Port Engine. \$100 complete with accessories. IT'S GUARANTEED! We sell Blue Print Working Drawings—2 or 4 Cycle. We have Motors complete with spark plug, from \$41.50 to \$335.00. Complete Castings for building same, from \$8.00 to \$180.00. Send stamp for Catalogue.

**THE GEBHARDT MOTOR CO.**  
27th Street, above Dauphin, Philadelphia, Pa.

60 YEARS' EXPERIENCE

**PATENTS**

TRADE MARKS  
DESIGNS  
COPYRIGHTS & C.

Anyone sending a sketch and description may quickly ascertain our opinion free whether an invention is probably patentable. Communications strictly confidential. HANDBOOK on Patents sent free. (Oldest agency for securing patents. Patents taken through Munn & Co. receive special notice, without charge, in the

**Scientific American.**

A handsomely illustrated weekly. Largest circulation of any scientific journal. Terms, \$3 a year; four months, \$1. Sold by all newsdealers.  
**MUNN & Co, 361 Broadway, New York**  
Branch Office, 625 F St., Washington, D. C.

**Practical Photographic Books**

**DARK ROOM DIME SERIES**

- No. 1 Retouching for Amateurs
- " 2 Exposure Tables and Note Book
- " 3 How to Take Portraits
- " 4 Bromide Enlargements
- " 5 Manual of Photography
- " 6 Practical Development
- " 7 Popular Printing Processes
- " 8 Hints on Composition

**PHOTO BEACON DIME SERIES**

- No. 1 Development
- " 2 Photographic Printing Processes
- " 3 Beginner's Troubles
- " 4 The Elements of Pictorial Composition
- " 5 Isochromatic Photography

Any of the above, post-paid, 10 cents each

PHOTO BEACON EXPOSURE CARD. By F. Dundas Todd	\$0.25
FIRST STEPS IN PHOTOGRAPHY. By F. Dundas Todd	.25
SECOND STEPS IN PHOTOGRAPHY. By F. Dundas Todd	.50
ARTISTIC LIGHTING. By James Inglis	.50
PICTORIAL LANDSCAPE PHOTOGRAPHY. By John A. Hodges	.75

**American Photography** 6 Beacon Street BOSTON, MASS.



**I Can't Fill It**

If a good position were offered you to-day, would you have to "turn it down" because you lack the necessary qualifications? Even if you accepted the position, could you hold it—or would your lack of training compel you to step out in favor of a better trained man?

How can you expect a successful career unless you lay a good foundation? Utilize your spare moments—study at home—fit yourself properly to meet opportunity—then you will succeed. The American School of Correspondence will tell you how, if you'll clip the coupon and mail it to-day.

**ELECTRICIANS AND MECHANICS**

who wish to fit themselves for better positions can find no better way than by taking a course of instruction in our School.

The electrical courses of the American School are complete, practical, and thoroughly up to date; they are so simple that the man with a common school education can easily understand them, so authoritative that the most experienced electrical worker can profit by them.

We employ no agents. We talk to you only by mail. The money you pay is not used to maintain an expensive organization of high-priced agents, but is used to give you the best instruction at the lowest cost.

The American School of Correspondence is the only correspondence school in the country which makes a specialty of engineering instruction. Its instructors are practical men—men who have had years of actual experience in their special fields. Consult these experienced men; get their advice; profit by their years of hard experience. Let them help you plan a paying career. Remember, sending the coupon places you under no obligations.

**American School of Correspondence**

CHICAGO

..... COUPON. Clip and Mail To-day .....

Elect. & Mech. 9-28

American School of Correspondence:—

Please send me FREE illustrated 200-page handbook of engineering information. I am interested in the course marked "X."

- .. Electrical Engineering
- .. Alternating Current Work
- .. Central Station Work
- .. Electric Lighting
- .. Electric Railways
- .. The Electric Telegraph
- .. Telephone Practice
- .. Civil Engineering
- .. Mechanical Engineering
- .. Stationary Engineering
- .. Municipal Engineering
- .. Architectural Engineering
- .. Heating, Ventilating, and Plumbing
- .. College Preparatory Course
- .. Mathematical Course

Name.....

Address.....

Occupation.....

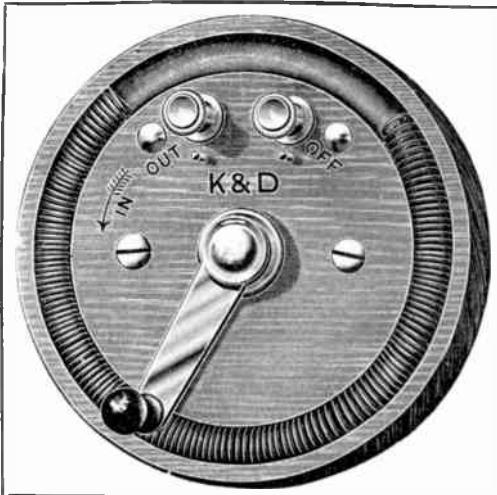

## K. & D. Improved Rheostat and Switch

No. 23

Resistance 10 Ohms. Continuous Capacity 2 Amperes.

**S**UITABLE for regulating miniature lamps, the speed of small motors, and a great variety of service which it would be impossible to mention in detail.

Owing to the peculiar construction of this rheostat, the change of resistance takes place very gradually on movement of the lever, and not by sudden jumps as in the ordinary construction.

The resistance coil has approximately 160 convolutions, and as the rate of change in the resistance on movement of the lever is by single convolutions, it will be seen to admit of very fine adjustment.

The coil is made of a special high-resistance wire, which is very strong, and will not corrode; no soldered connections with the resistance coil.

The coil is air-cooled, and works on our maximum rated capacity at a remarkably low temperature. Experimenters, dentists, surgeons, dermatologists, and all artisans and scientists will find this a most satisfactory and efficient small rheostat and switch.

The workmanship and finish is *first class*. Metal parts nickel plated. Hard rubber handles. Bases of seasoned wood, polished. Dimensions: 3 1/2 inches diameter; total thickness, including rubber handle, 1 1/2 inches.

### DIRECTIONS

When the lever rests on the button marked "out," the coil is cut out, but the circuit is unbroken. To introduce resistance, move the lever in the direction shown by arrow, and *vice versa*. When lever rests on the button marked "off," the circuit is open.

PRICE 75 CENTS

Manufactured by **KENDRICK & DAVIS, LEBANON, N. H.**

## A School Within Itself

of a dynamo or motor, and 1 chapter on electric automobiles, outlining their construction, care, and operation, and all about storage batteries and how to handle them. Each subject is carefully written and to the point. After a student studies a subject, he is questioned on that subject in such a manner as to bring clearly to his mind the points he needs to know regarding same. A **DICTIONARY** in back of book will enable him to learn the meaning of any electrical word, term, or phrase used in this book, as well as hundreds of others in common use. All required tables necessary in the study are in it.

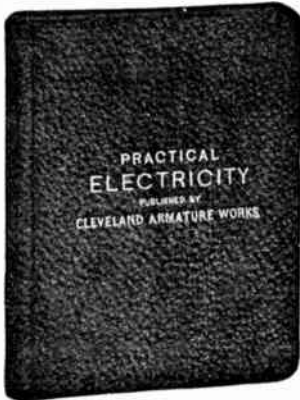

### TABLE OF SUBJECTS

Chapter	Chapter
I. Wiring	XII. Armature Reaction
II. Electric Batteries, Electro-Plating	XIII. Sparking
III. Magnetism	XIV. Winding of Dynamos and Motors
IV. The Magnetic Circuit	XV. Proper Method of Connecting Dynamos and Motors - Self-Excitation
V. Magnetic Traction	XVI. Diseases of Dynamos and Motors, their Symptoms and How to Cure Them
VI. Magnetic Leakage	XVII. Arc and Incandescent Lamps
VII. Energy in Electric Circuit	XVIII. Measuring Instruments
VIII. Calculation of Size of Wire for Magnetizing Coils	XIX. Alternating Current
IX. Calculation of E. M. F.'s in Electric Machines	XX. Automobiles
X. Counter E. M. F.	
XI. Hysteresis and Eddy Currents	

\$2.00 PER COPY - FOURTH EDITION - 20,000 COPIES SOLD

The offer we make of refunding money if book is not satisfactory upon examination is AN UNUSUAL ONE in connection with the sale of a book. But we have no fear of its return. Your decision will be what thousands of others has been. Money would not buy it if it could not be duplicated. We could print testimonials by the hundreds. It is best to order and be your own judge of its merits.

Cleveland Armature Works, Cleveland, Ohio

AMERICA'S GREATEST REPAIR WORKS  
Arms, ureas and Fields wound—Commutators filled



## ABERNATHY RAPID ACTING VISES

ARE PARTICULARLY RECOMMENDED FOR

MANUAL TRAINING SCHOOL EQUIPMENTS and for all classes of wood-workers. Seven Sizes, Styles, and Prices to select from.

Please state your requirements and write for particulars.

**THE ABERNATHY VISE & TOOL CO.**

329 Englewood Avenue

CHICAGO, ILL.

**FORTUNES ARE CARVED**



**CHANDLER & BARBER'S PERFECT TOOLS**

SEND FOR MANUAL TRAINING CATALOGUE

Chandler & Barber, 112 W. Wabash Ave., Chicago, Ill.

**TEN CENT BOOKLETS**

Each one is well written, and gives full directions for doing what the title indicates. They are well worth the price, which is very low, and most of them give fully as much information as some more pretentious books.

1. A Small Motor to be Built without Castings.
2. How to Make an Annunciator.
3. How to Grind and Set Edge Tools.
4. Making and Fixing Electric Bells and Batteries.
5. Tempering Steel, Annealing and Case-hardening Iron.

Others to follow.

SENT POST-PAID ON RECEIPT OF PRICE

**SAMPSON PUBLISHING COMPANY**  
6 Beacon Street  
Boston - Massachusetts

**This 9,059 Word Business Book is FREE**

Simply send us a postal and ask for our free illustrated 9,059-word Business Booklet which tells how priceless Business Experience, squeezed from the lives of 112 big, broad, brainy business men may be made yours—yours to boost your salary—yours to increase your profits. This free booklet deals with

- How to manage a business
- How to sell goods
- How to get money by mail
- How to buy at rock-bottom
- How to collect money
- How to stop cost leaks
- How to train and handle men
- How to get and hold a position
- How to advertise a business
- How to devise office methods

Sending for this free book binds you to nothing, involves you in no obligation; yet it may be the means of starting you on the road to a broader career. Surely you will not deny yourself this privilege, when it involves only the risk of a postage stamp! Send the coupon today.

**SYSTEM, 151-165 Wabash Ave., Chicago**  
Send on your 9,059-word free Booklet

Name \_\_\_\_\_  
Address \_\_\_\_\_  
Business \_\_\_\_\_  
Position \_\_\_\_\_

**Faucet Water Motors, \$1.00 UP**



These Motors have emery-wheel and pulley to run sewing-machines, fans, etc. Sample Motor free to Agents in sections where we have no representative.

**ENGINE INDICATORS**  
Reducing Wheels, and Planimeters for Engineers  
**ALCOHOL Stoves, Lamps, Flat-irons**  
—Send for Catalogue—  
**Lippincott M. & A. U. Dept., Newark, N.J.**

**Teachers and Professors of Engineering**

and Manual Training wanted for Colleges and Technical Schools. Salaries, \$900 to \$4000. No advance fee required. Address

**THE ALBERT TEACHERS' AGENCY**  
378 Wabash Ave. Established 23 years Chicago, Ill.



**THE WHITE EAGLE ELECTRIC MOTOR**  
Post-paid, 75c.

We make working models of inventions. Send for illustrated catalogue of Model Supplies.

**THE PIERCE MODEL WORKS**  
134 Pierce Ave. Chicago, Ill.

**BEWARE OF IMITATIONS**

For the protection of our customers we advise that Klein's Pliers are being imitated, to look like Klein's. This, however, does not make them Klein's.

**CAUTION**—Look for this stamp, M. KLEIN & SONS, on the inside of handles—none are genuine without this stamp. Use only genuine Klein's. They are the product of years of experience and have stood the test of time.

**MATHIAS KLEIN & SONS**  
97 W. VAN BUREN STREET CHICAGO, ILL.



**BOYS--EXPERIMENTERS.**



A scientifically perfect model paid drum armature, self-adjusting \$2.00 brushes, etc. Finished in black japan and nickel. Space occupied, 3 1/4 x 3 1/4 x 3 1/4 inches. Send stamp for catalog.

**H. W. PETERS MINIATURE MOTOR WORKS.**  
61 Terrace. - - - Buffalo, N. Y.

**BOUND VOLUMES**  
**ELECTRICIAN AND MECHANIC**  
Volume XVII, \$5.00      Volume XVIII, \$2.00

**AMATEUR WORK**

Volume I	. . . . .	\$5.00
" II	. . . . .	1.50
" III	. . . . .	1.50
" IV	. . . . .	2.00
" V	. . . . .	1.50
" VI (6 numbers)	. . . . .	1.00
Volumes V and VI, together,		2.00

**SAMPSON PUBLISHING CO.**  
6 Beacon Street, Boston, Mass.

# Our Book Department

**WE OFFER** our patrons and subscribers the advantages of a long established and widely experienced department, devoted to the publication and distribution of modern, up-to-date books pertaining to all branches of Engineering, Mechanics, Chemistry, Science, Industrial Arts, Trades and Manufactures. We shall be glad to aid our patrons in the proper selection and purchase of books on the subject in which they are interested. Our 112-page catalogue of general, scientific and technical books will be mailed free to any address upon application.

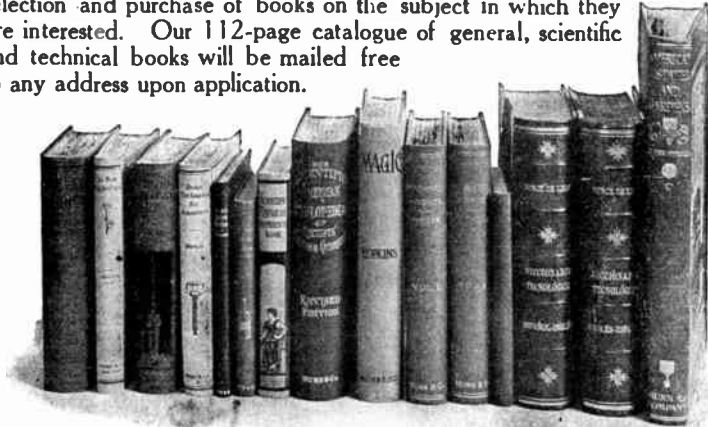

### Some of the Scientific American Publications

The Scientific American Reference Book, compiled by A. A. Hopkins, 12mo, cloth, 516 pages, illustrated.....	\$1 50
The Scientific American Boy, by A. R. Bond, 12mo, cloth, 317 pages, 320 illustrations.....	2 00
Home Mechanics for Amateurs, by Geo. M. Hopkins, 12mo, cloth, 370 pages, 326 illus.....	1 50
Experimental Science, by Geo. M. Hopkins, 2 volumes, 1100 pages, 900 illustrations....	5 00
The Scientific American Cyclopaedia of Receipts, Notes and Queries, edited and compiled by Albert A. Hopkins, revised edition, containing 15,000 selected formulas, 734 pages.....	5 00
Magic, Stage Illusions and Scientific Diversions, by A. A. Hopkins, 8vo, cloth, 556 pages, illustrated.....	2 50
The New Agriculture, by T. Byard Collins, 8vo, cloth, 374 pages, 106 illustrations....	2 00
Industrial Alcohol, Its Manufacture and Uses, by John K. Brachvogel, 8vo, cloth, 516 pages, 107 illustrations.....	4 00
Practical Pointers for Patentees, by F. A. Cresce, 12mo, cloth, 144 pages.....	1 00
American Estates and Gardens, by Barr Ferree, quarto, 11x13½ inches, 340 pages, 275 illustrations.....	10 00
The Design and Construction of Induction Coils, by A. Frederick Collins, 8vo, cloth, 400 pages, 125 illustrations. (In Preparation).....	3 00
The Technological Dictionary, Spanish-English, } Vol. I, Ingles-Español, \$8.50 } Two English-Spanish, by N. Ponce De Leon, } Vol. II, Spanish-English, 7.50 } vols.	16 00

Full descriptive circulars of the above books will be mailed free upon application

**SAMPSON PUBLISHING CO.**  
**6 BEACON STREET** **BOSTON, MASS.**

**SALE AND EXCHANGE**

Advertisements under this heading, without display, 2 cents per word, cash with order, minimum, 50 cents. Black-faced type, 4 cents a word, minimum, \$1. Exchange advertisements will be inserted for subscribers once in twelve months without charge, subsequent insertions of same copy, 1 cent a word.

**ELECTRICAL MATERIAL**

**FOR SALE OR EXCHANGE.** — In whole or in part, \$50 electric railway, hardly used. Also 'phones, telegraphs, supplies, etc. Make an offer. A. T. COLMEY, 42 Main Street, Canandaigua, N. Y. (9)

**WILL EXCHANGE.** — Edison primary batteries, in excellent condition, giving 300 amperes, with zincs, carbons, and chemicals ready to run, for a wireless outfit with  $\frac{1}{2}$  inch or longer spark. Coil must be in A1 condition. F. R. WILSON, 56 Elizabeth Street, Norwich, Conn. (9)

**FOR SALE OR EXCHANGE.** — Dynamo, 50 volts, 3 to 4 amperes, designed for extra slow speed, requiring only 600 R. P. M. for total output; 4-pole field, drum armature; very efficient; never been used; cost \$30, sell for \$20. Also have Pignolet's three-reading volt-ammeter reading 0 to 100 volts, 0 to 5 volts, and 0 to 30 amperes; new; will sell for \$12, or what have you in exchange? ALEX. ELISCHER, 183 Cooper Street, Trenton, N. J. (9)

**GRAVITY BATTERIES.** — One dozen partly used 6 x 8 inch cells. Price, \$5.50, or 50 cents each. Blue vitriol, 5 cents per pound. For information, call or write. A. LINDAHL, 64 School Street, Waltham, Mass. (9)

**WILL EXCHANGE** one telephone box, Bell, receiver hook, three-bar magneto, standard receiver, and cord. Want dynamo of equal value. JAMES E. KENDIG, Salunga, Pa. (9)

**CHEMICAL RECTIFIER,** How to make. 25 cents. TAYLOR ELECTRIC AND MANUFACTURING COMPANY, Barker, N. Y. (11)

**WIRELESS TELEGRAPHY**

**WIRELESS TELEGRAPHY.** — Send 10 cents for special number of ELECTRICIAN AND MECHANIC, devoted to this subject. Articles on how to make a 4-inch induction coil, magnetic detector, independent interrupter, indoor wireless, adjustment of detectors on tuned circuits, wireless telephony, storage batteries. Also hall seat, 16-foot launch, model engine, telephone installation, mechanical drawing, etc. List of electrical and mechanical books free. SAMPSON PUBLISHING COMPANY, 8 Beacon Street, Boston, Mass.

**WIRELESS.** — Boys, make an electrolytic detector. Very sensitive. Over 300 miles range. Blue-print, 25 cents coin. IMPERIAL WIRELESS CO., 230 So. Pacific Avenue, Pittsburg, Pa. (9)

**SILICON FOR WIRELESS DETECTORS.** — Any amateur can now make the latest and most sensitive wireless receiver. Needs no batteries. Generous piece sent post-paid, 25 cents silver. MIDDLESEX WIRELESS SUPPLY CO., 94 Antrim Street, Cambridge, Mass. (9)

**AT LAST,** a wireless detector in reach of all. Parts complete, ready to assemble, sent post-paid for 20 cents silver. WM. L. LITTLE, Ansonia, Conn. (9)

**WE CAN SUPPLY YOU** with anything in the wireless line. Our new specially coated 6-plate condenser, each plate 5 x 7 inches, with rack, spring, contacts, and brass connections, neatly finished, \$3.50, express prepaid in New England States. WIRELESS SUPPLY CO., South Norwalk, Conn. (9)

**PHOTOGRAPHS WANTED** of amateurs' electrical laboratories, apparatus, etc., with short descriptions. Prices paid vary with quality. Submit your photographs for offer. Box 117, Byhalia, Miss. (9)

**FORMULAS AND INSTRUCTIONS**

**MAKE YOUR OWN FURNITURE** from our full-size patterns. New plan. Simple and easy. Send 10 cents for sample pattern of book-rack or candlestick, and illustrated catalogue showing other pieces. THE HOME FURNITURE PATTERN CO., 2017 First National Bank Building, Birmingham, Ala.

**PRACTICAL** instruction in the engineering use of algebra, geometry, logarithms, trigonometry, slide rule, planimeter, perspective, and scales. All by mail. Write GEERT BLAAUW, 25 Broad Street, 20th floor, Room 12, New York City, N. Y. (9)

**PHOTOGRAPHY**

**AMERICAN PHOTOGRAPHY** succeeds "American Amateur Photographer," "Camera and Dark Room" and "Photo Beacon." The editors of each now join in making a magazine which should be in the hands of every photographer, professional or amateur. 15-cents monthly, \$1.50 per year. Three specimen copies for a quarter. AMERICAN PHOTOGRAPHY, 6 Beacon Street, Boston, Mass.

**KODAKS, CAMERAS, LENSES, EVERYTHING PHOTOGRAPHIC.** — We sell and exchange. Get our latest bargain list: save money. C. G. WILLOUGHBY, 814 Broadway, N. Y. (11)

**POST-CARDS**

**DO YOU COLLECT POST-CARDS** or photographs? Would you like to join a club of collectors which has 2615 members living in 1093 different cities and 118 different countries in every continent? Would you like to have correspondents in Cairo, Khartoum, Cape Town, Mexico, Havana, Rio de Janeiro, Valparaiso, Bangkok, Jerusalem, Tokio, Calcutta, Sydney, the Tonga Islands, Samoa, Berlin, Athens, Budapest, Iceland, Venice, Malta, Nijni Novgorod, Constantinople, and hundreds of smaller places in almost every country in the world? Then send your name to C. C. C., 1121 Beacon Building, Boston, Mass., and receive full particulars as to membership.

**BUSINESS OPPORTUNITIES**

**AGENTS CAN MAKE \$10 PER DAY** selling our burnished gold and silver letters for office windows, store fronts, and glass signs. Any one can apply these letters by following directions sent with each order. Write for our eight-page illustrated circular. S. H. PARRISH & CO., Clark and Adams Streets, Chicago, Ill.

**OUR DASHBOARD LINE HOLDER** making agents rich; every buggy owner buys at sight. Fortune in it. Sample, 30 cents silver. WHOLESALE SUPPLY CO., Valosta, Ga. (9)

**FOR SALE** outright, ventilator patent, U. S. No. 861,872; Canada No. 109,184. For particulars, address RODERICK MACDONALD, Glace Bay, Nova Scotia. (9)

**AGENTS.** — Big money made selling Shoestrut Stocking Supporters. Cannot be felt when worn. Sample, 10 cents. BERT SARGENT, Abrams, Wis. (9)

**AGENTS, WOMEN AND MEN.** — \$1 to \$6 a day easy. Spare time or permanent work. Choice of thirty new big sellers. Write for \$2 FREE offer. FAIR MFG. CO., D196, Racine, Wis. (9)

**WE WANT ASSISTANTS** to do advertising. No canvassing. Work leisure time. New system. Experience unnecessary. Instructions, sample, 25 cents. NOV-ELTY ADVERTISING CO., Box 151, Lima, Ohio. (9)

**BEAUTIFUL PHOTO BUTTONS** of Taft, Bryan, and other candidates. Send 10 cents for one, 15 cents for two. Larger quantities at reduced prices. A. DEHNERT, 1045 E. 59th Street, Chicago, Ill. (9)

### PRINTING

**BUSINESS CARDS**, 250 for 75 cents with case; 100 white envelopes printed for 45 cents; 100 note heads for 50 cents; 100 letterheads for 65 cents; postpaid. RICHARD D. ELLIOTT, Box 1376, St. Louis, Mo. (tf.)

### MACHINERY AND TOOLS

**FOR SALE.** — A Waterbury-Farrel No. 2½ heading and one No. 2½ reheading machine, never used, brand new, warranted; bargain. OHLEN COMPANY, Box 740, Columbus, Ohio. (9)

**FOR SALE.** — 9 inch screw cutting lathe, foot power or countershaft, good condition; bargain. JOHN OBER, South Bend, Ind., West Addition. (tf)

**TOOLS.** — The best. Many good ones listed in our new net-priced catalogue. Send name on postal for catalogue. MONTGOMERY & CO., 105 Fulton Street, New York City. (11)

**WANTED.** — Small stationary or motor cycle engine, 50 to 150 watt dynamo, 20 to 50 watt motor (prefer circular frame), and 8 inch precision bench lathe. Cash for above, or will exchange an 8 inch Cushman independent chuck, new, for any of above. E. L. BECK, Boquet, Pa. (9)

**FOR SALE OR EXCHANGE.** — One 10 inch screw-cutting foot lathe, one model engine and boiler, one ½ inch induction coil, one Midget dynamo or motor. All in perfect condition. Want motor cycle. WILBUR WORL, 1217 Church Street, New Castle, Ind. (9)

**FOR SALE.** — Few absolutely perfect Smith Premier Typewriters, \$23 each. Trial allowed. SPARK, Box 105, Waterford, N. Y. (10)

**FOR SALE.** — One electric gear with motors, tires, and all trimmings. New; price, \$100. J. L. LUCAS, Bridgeport, Conn. (9)

### LUBRICANTS

**LUBRICANTS**, asbestos, graphite, and mica candles for loose pulleys and shaftings; no drip, no dirt, economical. SWAIN LUBRICATOR CO., 250 E. Lake Street, Chicago, Ill. (2)

### BOOKS AND MAGAZINES

**SECOND EDITION** "Construction, Management, and Care of Motor Cycles." Full of suggestions and useful advice for every motor cycle rider, beginner, or prospective buyer. Sent prepaid for 25 cents stamps. ADVANCE SALES CO., St. Paul, Minn. (9)

**FOR SALE OR EXCHANGE.** — File of ELECTRICIAN AND MECHANIC from April, 1906, to August, 1908, with only September, 1907, missing. All in finest condition. ADOLPH POLANSKY, Jr., Lyons, Texas. (9)

**FOR SALE CHEAP.** — Nicely bound volumes on steam railroad, marine and electric lighting and railways. Also a set of Rogers' works. HANS C. ANDERSEN, Box 94, Wilbur, Wash. (9)

**MECHANICAL WORLD POCKET DIARY AND YEAR BOOK FOR 1908.** — We have in stock five copies of this most valuable handbook. Everybody interested in steam engines, power transmission, steam turbines, locomotives, gear and screw cutting, metal working, or any other branch of mechanics, should have this book.

Full of useful tables and data of all kinds. As good a dollar's worth as you ever saw. Just five left from a big importation. The first five letters containing a quarter will take them. Money back if they are sold. A. B. X., care of SAMPSON PUBLISHING COMPANY, 6 Beacon Street, Boston, Mass.

### MISCELLANEOUS

**BROTHER.** — Accidentally have discovered root that will cure both tobacco habit and indigestion. Gladly send particulars. No drugs. C. K. STOKES, Mohawk, Fla. (9)

The publishers of "Electrician and Mechanic" have on hand a limited number of complete

### Volumes of Electrician & Mechanic

FOR 1907-8

These include one copy of each of the twelve issues from July, 1907 to June, 1908, inclusive. These volumes are unbound and will be sent to any address, postage prepaid, on receipt of \$1.25.

Sampson Publishing Co., 6 Beacon St., Boston, Mass.

### MODEL STEAM ENGINES

Vertical, high-speed, double-acting, model steam engines and boilers. These engines and boilers make ideal power plants for running small dynamos, model boats, etc. They are well designed and finely enameled and polished. Price: —

1-16 h. p. engine, 3-4 inch bore, 1 inch stroke,	\$3.50
Brass boiler,	3.00
1-10 h. p. engine, 1 inch bore, 1-1-4 inch stroke,	4.50
Brass boiler,	4.00
1-6 h. p. engine, 1-1-4 inch bore, 1-3-4 inch stroke,	6.50
Brass boiler,	5.00

Prices are for finished engines ready to run.

D. L. JONES, 3213 E. 12 Street, Kansas City, Mo.

### WIRELESS APPARATUS

We are designers and manufacturers of high-grade apparatus, including tuning coils, transformers, condensers, spark gaps, detectors, etc. for commercial and experimental use. Our new type of tuning coil, having variable inductance, is so arranged that two of them may be used as a receiving transformer, if desired. Let us know what you are in need of and we will gladly furnish full information and prices.

### CLAPP-EASTHAM CO.

729 Boylston Street

Boston, Mass.



**THE WATER WAY**  
BETWEEN  
**BUFFALO AND DETROIT**

The D. & B. Line Steamers leave Buffalo daily at 8:30 p. m. (eastern time) and Detroit week days at 5:00 p. m., Sun-days at 4:00 p. m. (central time) reaching their destination the next morning. Direct connections with early morning trains. Lowest fares and superior service to all points west.

**Rail Tickets Available on Steamers**  
All classes of tickets sold reading via Michigan Central, Wabash and Grand Trunk Railways between Buffalo and Detroit, in either direction will be accepted for transportation on D. & B. Line Steamers.  
Send two-cent stamp for illustrated pamphlet and Great Lakes Map.  
Address L. O. Lewis, G. P. A., Detroit.

**Detroit & Buffalo Steamboat Co.**  
PHILIP H. McMILLAN, A. A. SCHAONTZ,  
VICE PRESIDENT. GEN'L. MANAGER.



## HAVE YOU SEEN THE Model Engineer and Electrician

CONTAINING SPLENDID ARTICLES ON

Electrical and Mechanical Models, Apparatus, Power Boats, Lathes, Dynamos, Steam Engines, Tools, and many other subjects, fully illustrated?

Send 8 cents for a copy

### SPON & CHAMBERLAIN

*Publishers of Technical Books*

123 Em. Liberty St., New York



### 3-IN-1 VOLT-AMMETERS

Measure low and high voltages, besides amperes and ordinary resistances. They are inexpensive and reliable. Send for catalog of portable and switchboard voltmeters and ammeters.

L. M. PIGNOLET

84 Cortland Street New York



### ELDRIDGE BATTERY VOLTMETER

0 TO 3 VOLTS DEAD BEAT

A very practical instrument for all users of batteries, either primary or storage.

WRITE FOR CIRCULAR

**ELDRIDGE ELECTRIC MFG. CO.**

12 Post Office Square - Springfield Mass.



### BUILD YOUR OWN SMALL ENGINE

We sell sets of castings up to 2 horse power. Also boilers, locomotives, gas engines, etc. 32-page catalogue for 10c. in stamps. This amount refunded on order amounting to \$1.00 or over. Contractors for light machinery of every description.

Sipp Electric and Machine Company  
River Street, Paterson, N. J.

### HOROLOGICAL DEPARTMENT

BRADLEY POLYTECHNIC INSTITUTE

Formerly Parsons Horological Institute

PEORIA, ILLINOIS  
LARGEST and BEST WATCH  
SCHOOL IN AMERICA

We teach Watch Work, Jewelry, Engraving, Clock Work, Optics. Tuition reasonable. Board and rooms near school at moderate rates. Send for Catalogue of Information.

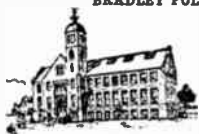

## Face to Face with OPPORTUNITY



Electricity controls more trades, directs more men, offers more opportunities, than any other power that man has yet discovered. A knowledge of electricity makes those opportunities yours. It opens to you new fields, gives you new ideas, keeps you abreast of the times. You can get that knowledge by home study, during your spare time, from the

## CYCLOPEDIA OF APPLIED ELECTRICITY

New Six Volume Edition Just Out. 5000 pages, 7 x 10 Inches. Bound in Half Red Morocco.

500 New Pages. Innumerable New Ideas.

This work will post the *electrical worker* on all the latest developments in his trade; it will teach the student the principles of electricity and its newest applications. The chapters on Electric Wiring and Testing are especially complete and authentic, as are also the chapters on Localization and Remedying of the various troubles which arise in connection with dynamos and motors, such as Sparking at the Commutator, Heating of the Different Parts, Failures of Operation, etc., with instruction for determining causes, together with their remedies.

Each section is written by an expert, illustrated by special drawing, diagram, or photograph, simplified by tables and formulas, proved by practical test questions, and carefully indexed for ready reference. To introduce our correspondence courses, from which the Cyclopaedia was compiled, we make this special 30-day offer.

**\$18.00 INSTEAD OF \$36.00**

Absolutely FREE for 5 days' examination. Sent, express prepaid, on receipt of Coupon. If you want the books, pay us \$2 within 5 days and \$2 a month until you have paid the special price of \$18.00; otherwise return them at our expense. We employ no agents.

### Some of the Subjects Treated

Electric Wiring — Electric Bell Wiring — Electric Telegraph — Wireless Telegraphy — Telautograph — Theory, Calculation, Design, and Construction of Generators and Motors — Types of Dynamos and Motors — Elevators — Direct Current Motors — Direct-driven Machine Shop Tools — Electric Lighting — Electric Railways — Alternating Current Motors — Single Phase Electric Railway — Electric Welding — Mercury Vapor Converter — Management of Dynamos and Motors — Power Stations — Central Station Engineering — Central Station Design — Storage Batteries — Power Transmission — Alternating Current Machinery — Synchronous Motor, Induction Motor, Transformer, Rotary Converter, Frequency Changer, etc. — Telephony — Automatic Telephone — Wireless Telephony — Telephone Line Protection — Telegraphone, etc.

## American School of Correspondence CHICAGO

..... Coupon. Clip and Mail To-day .....  
Elect. & Mech. 9-08

American School of Correspondence:—

Please send Cyclopaedia of Applied Electricity for FREE examination. I will send \$2.00 within five days and \$2.00 a month until I have paid \$18.00; otherwise I will notify you to send for the books. Title not to pass until fully paid.

Name.....

Address.....

Occupation.....

Employer.....

Twenty-Fifth Edition  
**Experimental Science**

By **GEORGE M. HOPKINS**

Revised and Greatly Enlarged

Two Octavo Volumes

1,100 Pages.

900 Illustrations

Cloth Bound, Postpaid, \$5.00

Half Morocco, Postpaid, \$7.00

Or Volumes Sold Separately:

Cloth, \$3.00 per Volume

Half Morocco, \$4.00

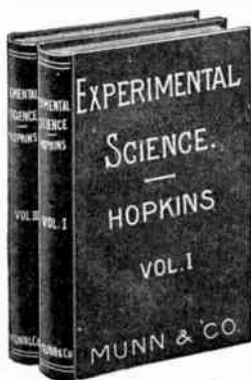

**E**XPERIMENTAL SCIENCE is so well known to many of our readers that it is hardly necessary now to give a description of this work. Mr. Hopkins decided some time ago that it would be necessary to prepare a new edition of this work in order that the many wonderful discoveries of modern times might be fully described in its pages. Since the last edition was published wonderful developments in wireless telegraphy, for example, have been made. It was necessary, therefore, that a good deal of new matter should be added to the work in order to make it thoroughly up-to-date, and with this object in view some 200 pages have been added. On account of the increased size of the work it has been necessary to divide it

into two volumes, handsomely bound in buckram. It may be interesting to note the following additions that have been made to these volumes:

Volume I contains in addition to a large number of simple, well illustrated experiments, a full description of a  $\frac{1}{4}$  H. P. electric motor made expressly for illustration in this edition of "EXPERIMENTAL SCIENCE." It is an ENCLOSED SELF-REGULATING electric motor for a 110 volt circuit. It can be operated by a current from a 110 volt lamp socket, yielding a full  $\frac{1}{4}$  H. P., or it may be used as a dynamo, furnishing a current capable of operating three 16-candle-power, 110 volt incandescent lamps. The construction of the machine is perfect enough to admit of enlarging or reducing its size if desired.

Volume II contains much on the general subject of electricity, besides new articles of great importance. Among these the subject of alternate current machinery is treated. Wireless Telegraphy and Telephony receive attention. Electrical Measuring Instruments, The Electric Clock, The Telegraphone, Experiments in High Voltage, The Nernst Lamp, and Measuring the Heat of the Stars are all thoroughly illustrated and described.

The unprecedented sale of this work shows conclusively that it is the book of the age for teachers, students, experimenters and all others who desire a general knowledge of Physics or Natural Philosophy.

Send for Descriptive Circular

**Sampson Publishing Company**

6 Beacon Street, Boston, Mass.

# Handicraft Books, 25 Cents Each

**Soldering, Brazing, and the Joining of Metals.** By Thos. Bolas, F.C.S., F. I. C. Full instructions for making and using soft and hard solders, and for joining many kinds of metal under varying conditions. With illustrations of the tools, various methods of soldering, brazing, etc.

**Pattern Making.** By Joseph E. Dangerfield. Methods explained step by step in connection with the actual patterns.

**Brass and Iron Founding.** By Joseph E. Dangerfield. The leading operations are described step by step in connection with casting from patterns made as in "Pattern Making," for the construction of lathes as in "Building a Lathe," with a few other examples.

**Building a Lathe.** By A. W. Burford, A. M., I. C. E. The minutiae of preparing, assembling, and finishing the casting as per "Brass and Iron Founding," from patterns built as per "Pattern Making," to form a workmanlike lathe for a mechanic.

**How to Build a Gasolene Motor.** By James F. Gill, B. Sc. Mechanical and electrical details made clear, and the steps in building a motor cycle fully given.

**How to Build a Bicycle.** By H. R. S. Williams. Step by step in the building of a machine for foot power, and of one for use with a petrol motor as described in "How to Build a Gasolene Motor."

**How a Steam Engine Works.** By W. E. M. Currock. The principles, terms, and calculations that underlie the designing and working of steam engines are clearly explained, with diagrams.

**How to Read a Workshop Drawing.** By W. Longland. The methods and conventions of mechanical drawings explained and illustrated for students, young draughtsmen, and machinists.

**Dyes, Stains, Inks, Lacquers, Varnishes, and Polishes.** Showing absolute beginners how to prepare and apply successfully dyes, stains, inks, lacquers, varnishes, and polishes, especially for decorative work. With many practical illustrations in the text, and six plates.

**Painting and Graining.** By S. Walter Newcomb. Deals with preparation of wood and metal work, preparation, application, and finishing of paint, distemper work, etc.

**Designing and Drawing for Beginners.** Showing absolute beginners in woodcarving, fretwork, repousse, stenciling, or other decorative work, how to become their own designers quickly and easily. With many progressive examples in the text, and six plates.

**Wood-Carving for Beginners.** Copiously illustrated with drawings to show how the tools should be handled, and containing a large variety of beautiful and practical designs.

**Gouge-Work and Indented Woodwork.** The very first steps in wood carving, with complete instructions for the two easiest sections of that art. Many diagrams in the text, and six full pages of designs for the work.

**Bent Iron or Stripwork.** By Geo. Day and C. G. Leland. Clearly giving the first steps in Venetian Bent-Iron Work, but also suggesting and illustrating ways in which the results may be made more varied and artistic.

**Pyrography or Burnt Wood Etching.** By Bolas and Leland. Revised by Ball and Fowler. Full directions for the successful practice of this most fascinating home art, with numerous full page designs and text illustrations. Twenty-eighth thousand, with additions and emendations.

**Stained and Leaded Glass.** The first book ever published which has fully described this useful craft as an amateur hobby. Instructions for making window screens, fire screens, fancy windows and transom lights, hall lamps, glass doors for china closets, etc. So simple that any deft-fingered person may learn.

**Repousse and Metal-Chasing.** Easy lessons, step by step, in the two subjects. A beginner can learn the work without other teacher than this little book. With many diagrams and six full page designs, for useful articles.

**Tools and Their Uses.** Describes the more common tools for wood and metal working, with instruc-

tions how to keep in order, to sharpen, and to use them, with a number of hints on home-made tools. Illustrated.

**Wood-Turning for Beginners.** Intended for the use of absolute novices in lathe work. Explains speeds, cutting angles, forms of tools, etc., with no less than forty-one diagrams.

**Etching on Metals, Niello, and Metal-Inlaying.** Instructions for all the simpler methods of engraving metals, by graving, etching, punching, etc., also for filling the hollows thus produced with niello, etc.

**Stencil Cutting and Stenciling.** By Jack Plans. Shows how to design and cut stencil plates in metal, paper, celluloid, etc., and how to use them on paper, fabrics, etc., with a section giving all details of stenciling in house decoration, preparation of clear-color, distemper colors, etc.

**Stone Cutting and Polishing.** By George Day. Instructions whereby an amateur, with very little outlay, may cut and polish pebbles, shells, etc., and mount them as geological specimens or as simple jewelry and small useful articles, with hints as to where and how to find the decorative stones of the seashore—agate, chalcedony, cornelian, etc.

**Home-Made Jewelry and Trinkets.** Full, simple instructions for making effective and beautiful articles of personal adornment, with the minimum of labor, and with very few and cheap tools. With six full plates of designs and details, and many diagrams in the text.

**China Decoration and Repair.** Simple instructions for painting, engraving, and otherwise decorating china, porcelain, earthenware and glass. Also repair, by cementing or riveting, with recipes for the best cements for all kinds of pottery ware. With diagrams in text and six full pages of designs.

**Glue, Gum, Paste, and Other Adhesives.** Giving full directions how to make and use various glues, gums, pastes, and mixed mucilages; fusion cements, lutes, etc. Invaluable in every home and every workshop, if only because it omits the many faulty recipes which have in some cases been copied and republished for hundreds of years.

**Bamboo Working.** Full instructions for cutting, shaping, fitting and joining bamboo and other canes. The construction of several typical articles of furniture described step by step, in plain, simple language, and illustrated by many diagrams. With six plates of designs for a great variety of bamboo articles, from the simplest to those which are fairly elaborate.

**Home Bookbinding.** Gives understandable directions for collating, refolding, sawing, sewing, and all the other operations necessary for the binding of books in cloth, with more than a score of working drawings and diagrams of details in the process, on six full page plates.

**Leather Work.** By Halton East. Simple instructions for blind and color tooling; gold blocking, leather, mosaic, applique, and patchwork, pressed, modeled and molded leather; leather-covered relief, cuir bouilli, carton cuir, and cut leather or scroll work.

**Fancy Basket-Making.** Giving all the elementary principles of basket-weaving in plain, simple words; every step being illustrated by a diagram, so the basket making may be learned by any one, without a teacher. About three dozen diagrams in the text and six full page plates giving designs and details for many fancy patterns of baskets.

**Window Ticket Writing.** Giving instructions for wording, sketching, height-lining, outlining, and in-lining window tickets and similar cards. Hints as to suitable cards, inks, paints, and tools, with paragraphs on stencil and rubber stamp methods, gilding, etc. Many diagrams, including six full page plates of alphabets, index hands, etc.

**Modelling in Clay, Wax, Etc.** A guide to modelling in plastic substances, whereby the beginner can dispense with a teacher. The author's sketch models of every elementary object are photographically illustrated, so as to show the touch and handling necessary; the few requisite tools are illustrated by diagrams. Six full page plates.

**SAMPSON PUBLISHING COMPANY, 6 Beacon Street, Boston, Mass.**

