

Oct.

BROADCAST
WRNY
STATION

25 Cent

Science and Invention

**NEW AIRPLANE
CATAPULT**
See Page 494



40
NON-TECHNICAL
**RADIO
ARTICLES**

EXPERIMENTER PUBLISHING COMPANY, NEW YORK, PUBLISHERS OF
RADIO NEWS - RADIO LISTENERS' GUIDE - SPARE-TIME MONEY MAKING - FRENCH HUMOR - AMAZING STORIES

30 Days FREE TRIAL



Single Control

7-Tube

\$ 77

RETAIL PRICE
Completely Assembled

The **Randolph** SINGLE CONTROL - ILLUMINATED DRUM

POWERFUL seven-tube radio at factory price. Test it without spending a cent. We claim the Randolph Seven will out-perform any radio and we want you to satisfy yourself that it will. To do this, we will send you this powerful radio to try for 30 days. Test it for distance, clearness, ease of operation, tone and every other way you can. Unless it more than satisfies you, return it to us. **Every Randolph set must make good before it is sold.**

Battery **ALL ELECTRIC OPERATION**

The Randolph Seven is sold for use with batteries or connected for operation direct to electric light socket—absolutely batteryless—no chargers or batteries—just plug in socket and tune in. 100% efficient either way. Its construction and performance have been tested and approved by leading radio engineers and authorities and leading radio and scientific publications.

Single Control—Illuminated Drum

One drum dial operated by one simple vernier control tunes in all stations with easy selectivity to tremendous volume. No overlapping of stations. Illuminated drum permits operation in the dark. Volume control for finer volume modulation. This is a 7-tube tuned radio frequency receiver with power transformers and power amplification. Space wound solenoid coils. Full and completely shielded. A real receiver of the highest quality. Tremendous distance, wonderful tone quality, simple to operate.

The Randolph cabinets are in themselves beautiful pieces of furniture made of carefully selected solid burl walnut. Bas-relief bronze escutcheon plates are mounted on the dial panel. In design and appearance it is a cabinet worthy of the high-quality radio it contains. Solid walnut beautifully shaped surrounds the soft verdi-green panel. Nothing has been spared to make the Randolph Seven the leading radio receiver. We are sure that it will surpass even your best hopes that we know how safe we are in making the **30 day free trial offer.**

Read What Owners Say

I have logged more than 50 stations from coast to coast.—Lloyd Davenport, Littlefield, Texas.
I have logged 52 stations from Cuba to Seattle—the set is a world beater.—J. Tampkinson, Detroit, Mich.
Your set is a revelation—has all others tied to the post for distance and selectivity.—Waldo Powers, Vergennes, Vermont.
On strength of its performance sold two more sets this week. T. Scanlow, Orlando, Florida.

Beautiful Ampliphonic Console Set

Made of the finest carefully selected solid walnut. Two-tone shaded finish. Has built-in cone loud-speaker that compares with any on the market and accurately reproduces high and low notes. Send for the folder today that shows this beautiful console in full colors and gives complete details. **Compares with most table sets in price. For battery or all-electric operation ready to plug in and tune in.** Write for complete descriptions.



Randolph Radio Corporation
711 W. Lake St. Dept. 126, Chicago, Ill.

BIGGEST DISCOUNTS to AGENTS and DEALERS

WORK either full or part time and make big money. Tremendous advertising campaign helps you sell. Regardless of whether you have ever sold before, be sure to get our proposition. The Randolph sells on first demonstration. Men and women both can make money this easy way. Get your demonstration set for thirty days **FREE TRIAL.**

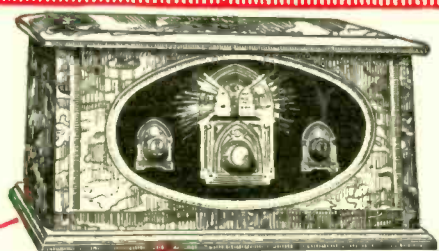

6-Tube

\$ 55

Retail Price
SINGLE CONTROL

The **Randolph**

Now you can have a new modern, single-control, 6-tube radio. Do not compare this set with old style 2-dial 6-tube sets selling for about the same price. The Randolph 1928 Senior Six has also been tested and approved by the leading radio engineers. Comes in a beautiful solid walnut cabinet of hand-rubbed finish. Single control. Illuminated Drum with space for logging. Absolutely dependable and very selective. Sent for 30 Days Free Trial. You test it before you buy.

Mail Coupon Now

The Randolph Radio Corporation are pioneers in the manufacture of radios. All of its vast and unlimited resources have been used in making and perfecting of the Randolph Receivers. Because of our long and successful experience in the radio business, we are perfectly confident in sending out a Randolph Radio on trial. We know what it will do. Mail us the coupon now for the greatest radio offer ever made.

USE THIS COUPON TODAY!

Randolph Radio Corporation,
711 West Lake Street,
Chicago, Illinois.
Send me full particulars about the RANDOLPH Six and Seven-Tube Table and Console Sets with details of your 30 Day FREE Trial Offer.

Name _____
Address _____
City _____ State _____
Mark here () if interested in Agent's proposition.

Switch to Electricity

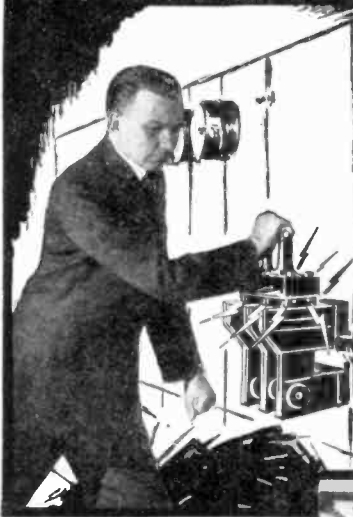

IF YOU are now earning less than \$40 a week, if you're short of schooling, you'll have to face these questions, sooner or later:

What are your chances in your present line of work? How much more will your job pay you next year? Can you overcome the handicaps of neglected education? Will you get "fired" when times get bad?

You may not like your own answers to these questions. And if you don't, my advice is, *Get into a different field*—where there are plenty jobs, big salaries and real opportunities for advancement.

ELECTRICITY—the wonder-industry—offers you such unlimited opportunities. I'll prove that to you here. And I'll tell you how you can **SWITCH TO ELECTRICITY** without losing a day's time or a dollar's pay.

World's greatest industry offers you amazing Opportunities!

Even Electricians and Electrical Mechanics are earning \$10 to \$20 a day in the larger cities. Of course, the EXPERTS are getting MORE than that. And the demand for men who know electricity is bigger than the supply—because electrical construction, installations and maintenance are moving ahead so rapidly, there's no keeping up with them. Yet Edison, Marconi, Insull and other leaders say electricity is still in its infancy, and that men who enter the field today have a bigger chance even, than the pioneers of 30 years ago.

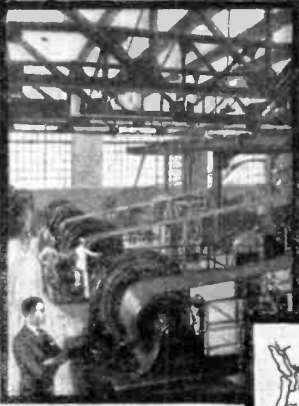

GIANT POWER PLANTS do not run themselves. It takes **MEN**—trained, expert men—to superintend them.

112,000 Miles of Electric Trunk Lines

The figures about the Electrical Industry read like a fairy story! Today we are using over a billion Kilowatts a year. 10 million horse power generated electrically. This is the Electrical age. It will pay you to go along with it.



JOBS \$60 to \$125 a Week!

There's a way for YOU to become an electrical EXPERT. Positions as Chief Electrician, Superintendent of Power Plant, Construction or Installation, or Production Superintendent are WITHIN YOUR REACH! Mail coupon for the most remarkable offer ever made to ambitious men

I WILL HELP You Get One of These Well-Paid JOBS

You don't need to be a high-school or college graduate to succeed in electricity. I have placed hundreds of men with limited education in well-paid electrical jobs, and I will be glad to tell you how I can help YOU do the same. Mail coupon and I will show you the QUICK way to raise your own pay as an Electrical Expert, at a cost and on terms you can easily afford.

CONFIDENTIAL SURPRISE OFFER to men now earning less than \$40 a week

I am prepared to enter into a written contract with any ambitious man who seeks a fine, well-paid Electrical job. To help him get ready and TO HELP HIM GET PLACED.

We are now bound by similar agreements to deliver this PAY-RAISING JOB SERVICE to over 15,000 men. Backed by our entire resources of a million and a half dollars.

I will show you how YOU can break into the giant Electrical industry, how to qualify for and GET a wonderful position, paying at least 50% more than you earn today. And offering opportunities for further advancement that are simply dazzling. And all without a penny's risk to you, I promise you that.

This offer is open to any ambitious man. Lack of schooling will not bar you. Lack of ready money will not bar you. Just send me the coupon, and I'll give you the big chance to cash in, too.

29 Noted Engineers

—men from Westinghouse, Allis-Chalmers, Western Electric, Commonwealth Edison, General Electric and other great corporations, and leading Universities of the U. S.—helped us develop this remarkable service for preparing and placing ambitious men in fine Electrical Positions. It will pay you to get all the facts of this startling service — the Coupon brings them.



Railroads

are turning from steam to electricity. The Steel Industry is 86 per cent electrified. Others are 57 to 90 per cent electrified.

Chief Engineer Dunlap, Electrical Division

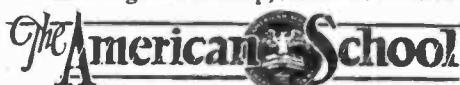

Dept. E-726 Drexel Ave. & 58th St., Chicago

Mail Coupon Now!

Chief Engineer Dunlap
Electrical Division
THE AMERICAN SCHOOL
Dept. E-726 Drexel Ave. & 58th St., Chicago

I may want to SWITCH to Electricity. I am ambitious. Send Confidential Surprise Offer to

Address.....

Age.....Occupation.....

Science and Invention

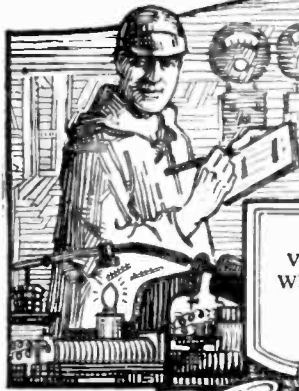

Vol. XV
Whole No.
174

October
1927
No. 6

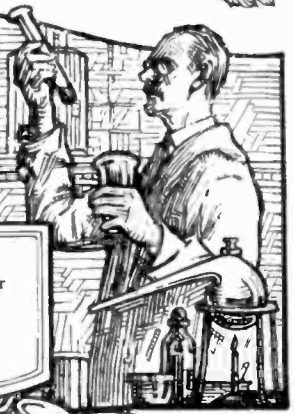

Formerly **ELECTRICAL EXPERIMENTER**
COMBINED WITH "THE EXPERIMENTER"
Member Audit Bureau of Circulations

EDITORIAL, ADVERTISING & GENERAL
OFFICES:

230 Fifth Avenue, New York City

Published by Experimenter Publishing Company, Inc., (H. Gernsback, Pres.; S. Gernsback, Treas.; R. W. DeMott, Sec'y.)
Publishers of **SCIENCE & INVENTION, RADIO NEWS, RADIO LISTENERS' GUIDE, AMAZING STORIES,**
SPARE-TIME MONEY MAKING and **FRENCH HUMOR.**

Editorial Staff

HUGO GERNSBACK, Editor-in-Chief.
H. WINFIELD SECOR, Managing Editor.
T. O'CONNOR SLOANE, Ph. D.,
Associate Editor
JOSEPH H. KRAUS, Field Editor.
PAUL WELKER, Radio Editor.
S. GERNSBACK, Wrinkles Editor.
W. J. ROMAINE, Art Director.

Contributing Editors

Astronomy—
Dr. Donald H. Menzel, Ph.D., Lick Observatory;
W. J. Luyten, of the Harvard College Observatory.
Entomology and Allied Subjects—
Dr. Ernest Bade, Ph.D.
Physics—
Dr. Harold F. Richards, Ph.D., Ernest K. Chapin,
M.A., Dr. Donald H. Menzel, Ph.D.
Chemistry—
Raymond B. Wallis, Dr. Ernest Bade, Ph.D.

Automotive Subjects— George A. Luers
Radio— A. P. Peck, Herbert Hayden.
Magic and Psychic Phenomena—
Joseph Dunninger, Joseph P. Rinn, Edward Merlin.
Foreign Correspondents—
Dr. Alfred Gradenwitz, Germany; Dr. H. Berber,
Germany; C. A. Oldroyd, England; S. Leonard Bas-
tin, England; Count A. N. Mirzoeff, France; Hubert
Slouka, Czecho-Slovakia; P. C. van Petegem, Hol-
land; Richard Neumann, Austria.

IN NOVEMBER ISSUE

New Valve-less Auto Engine
The newest engine in the automobile world which has but few moving parts.

Sound Compass Conquers Fog
The latest application of applied science which enables a ship to find its way in a fog.

Playing with Niagara
One of the leading film comedians has recently had a lot of fun with Niagara Falls. Don't miss this article telling how he did it.

Yardstick of the Sky
An interesting popular article with a graphic picture chart showing the various heights of natural and artificial phenomena.

Making a Loop-speaker
Full details are given in this article showing how to build an efficient combination loud-speaker and loop.

CONTENTS OF THIS NUMBER

Editorial	489	Handy Electrical Tool Kit	510
By Hugo Gernsback		Unique Self-Winding Clock	510
The Ionaco Swindle	490	Reseating Cane Bottom Furniture	511
By Hugo Gernsback		By R. D. Ross	
Paper Houses Furnished With Paper Fur- niture	492	Model Department	512
New Airplane Catapult	494	Experimental Chemistry	514
The Metal Emperor—A New Scientifiction Tale	496	Edited by T. O'Connor Sloane, Ph. D.	
By A. Merritt		Junior Electrician—How to Make a Geis- ler Tube	516
Does Coffee Poison the Heart?	498	Constructor Department	518
By Frederic Damrau, M. D.		Hints for the Mechanic—Monthly Prize	519
A Perpetual Motion Hoax	499	How-to-Make-it Department	520
New Fog Beacons Guide Planes	500	Wrinkles, Recipes and Formulas	521
By H. Winfield Secor		Edited by S. Gernsback	
How Movie "Film" is Made	502	Readers Forum	522
Flowers For The Winter	503	Radio Department—Radio "Ears" Guide	
By Dr. Ernest Bade		Balloons	523
Motor Hints	504	By Walter E. Burton	
Conducted by George A. Luers		The 4-Tube Cash Box Set	524
Matchcraft—\$100.00 in Prizes	505	By Wendell Buck	
\$3,000.00 Wirekraft Contest	506	Underground Antenna Reduces Static	526
By "Dunninger"		By H. Winfield Secor	
Gravity Nullifier Exposed	509	Radio Oracle	527
By the Editor		Scientific Humor	528
The Astrology Humbug	509	Latest Patents	529
By Joseph H. Kraus		Oracle	530
		Patent Advice	536

HOW TO SUBSCRIBE FOR "SCIENCE AND INVENTION." Send your name, address and remittance to Experimenter Publishing Co., 230 Fifth Ave., New York City. Checks and money orders should be made payable to Experimenter Publishing Co., Inc. Mention magazine desired. Inasmuch as we also publish **RADIO NEWS, AMAZING STORIES, RADIO LISTENERS' GUIDE, SPARE-TIME MONEY MAKING** and **FRENCH HUMOR**, a weekly. Subscriptions may be made in combination with the other publications just mentioned at special reduced club rates. Send postal for club rate card. Subscriptions start with the current issue unless otherwise ordered. Then unless we receive your order and remittance of a renewal, delivery of the magazine is stopped.

SCIENCE AND INVENTION is published on the 10th of each month. There are 12 numbers per year. Subscription price is \$2.50 a year in U. S. and possessions. Canada and foreign countries \$3.00 a year. U. S. Coin as well as U. S. stamps accepted (no foreign coin or stamps). Single copies 25c each. All communications and contributions to this journal should be addressed to Editor, **SCIENCE AND INVENTION**, 230 Fifth Avenue, New York City, N. Y. Unaccepted contributions cannot be returned unless full postage has been included.

All accepted contributions are paid for on publication. **SCIENCE AND INVENTION** Monthly. Entered as second class matter May 10, 1924, at the Post Office at New York, N. Y., under the act of March 3, 1879. Additional entry at Dunellen, N. J. Title Registered at the Patent Office. Copyright, 1927, by E. P. Co., Inc., New York. The Contents of this Magazine are copyrighted and must not be reproduced without giving full credit to the publication. **SCIENCE AND INVENTION** is for sale at all newsstands in the United States and Canada. European Agents, S. J. Wise Et Cie, 40, Place Verte, Antwerp, Belgium.

ADVERTISING REPRESENTATIVES—L. F. McClure, 720 Cass St., Chicago, Ill.; DAVIES, DILLON & KELLY, 15 West 10th St., Kansas City, Mo.; T. F. MAGRANE, Park Square Bldg., Boston, Mass.; HARRY E. HYDE, 548 Drexel Bldg., Philadelphia, Pa.; A. J. NORRIS HILL CO., 5 Third St., San Francisco, Calif.; 412 West 6th St., Los Angeles, Calif.; Leary Bldg., Seattle, Wash.

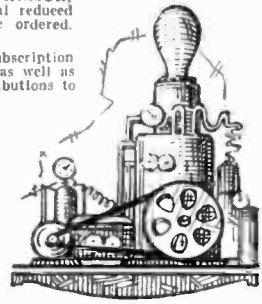
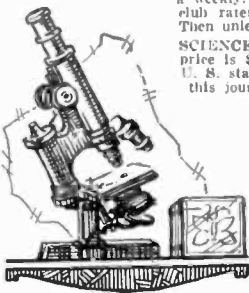

A HANDY RULE FOR YOU



Restored Enchantment



This is the Eveready Layerbilt that gives you Battery Power for the longest time and the least money.

THERE is no doubt of it—radio is better with Battery Power. And never was radio so worthy of the perfection of reception that batteries, and batteries alone, make possible. Today more than ever you need what batteries give—pure DC, Direct Current, electricity that flows smoothly, quietly, noiselessly. When such is the current that operates your receiver, you are unconscious of its mechanism, for you do not hear it humming, buzzing, crackling. The enchantment of the program is complete.

Batteries themselves have improved, as has radio. Today they are so perfect, and so long-lasting, as to be equal to the demands of the modern receiver. Power your set with the Eveready Layerbilt "B" Battery No. 486. This is the battery whose unique, exclusive construction makes it last longer than any other Eveready. Could more be said? In most homes a set of Layerbilts lasts an entire season. This is the battery that brings you Battery Power with all its advantages, conferring benefits and enjoyments that are really tremendous when compared with the small cost and effort involved in replacements at long intervals. For the best in radio, use the Eveready Layerbilt.



Radio is better with Battery Power

At a turn of the dial a radio program comes to you. It is clear. It is true. It is natural. You thank the powers of nature that have once more brought quiet to the distant reaches of the radio-swept air. You are grateful to the broadcasters whose programs were never so enjoyable, so enchanting. You call down blessings upon the authority that has allotted to each station its proper place. And, if you are radio-wise, you will be thankful that you bought a new set of "B" batteries to make the most out of radio's newest and most glorious season.

NATIONAL CARBON CO., INC.  New York—San Francisco

Unit of Union Carbide and Carbon Corporation

Tuesday night is Eveready Hour Night—9 P. M., Eastern Standard Time

- | | | | |
|------------------|-----------------|--------------------|-----------------|
| WEAF—New York | WGR—Buffalo | WGN—Chicago | WRC—Washington |
| WJAR—Providence | WCAE—Pittsburgh | WOC—Davenport | WGY—Schenectady |
| WEEI—Boston | WSAI—Cincinnati | WECO { Minneapolis | WHAS—Louisville |
| WDAF—Kansas City | WTAM—Cleveland | { St. Paul | WSB—Atlanta |
| WFI—Philadelphia | WWJ—Detroit | KSD—St. Louis | WSM—Nashville |
| | | WMC—Memphis | |

Pacific Coast Stations—9 P. M., Pacific Standard Time

- | | |
|-----------------------|-----------------|
| KPO—KGO—San Francisco | KFI—Los Angeles |
| KFOA—KOMO—Seattle | KGW—Portland |

Have you heard the new Victor record by the Eveready Hour Group—orchestra and singers—in Middleton's Down South Overture and Dvořák's Goin' Home?

EVEREADY
Radio Batteries
—they last longer

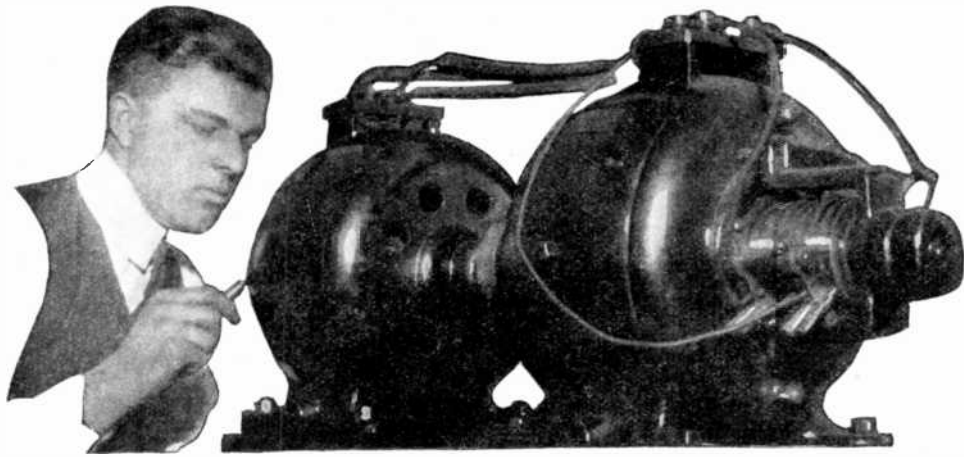

Amazingly Easy Way to get into ELECTRICITY

Don't spend your life waiting for \$5 raises in a dull, hopeless job. Now . . . and forever . . . say good-bye to 25 and 35 dollars a week. Let me show you how to qualify for jobs leading to salaries of \$50, \$60 and up, a week, in Electricity—NOT by correspondence, but by an amazing way to teach, that makes you an electrical expert in 90 days! Getting into Electricity is far easier than you imagine!

Learn Without Lessons in 90 DAYS

LACK of experience—age, or advanced education bars no one. I don't care if you don't know an armature from an air brake—I don't expect you to! I don't care if you're 16 years old or 48—it makes no difference! Don't let lack of money stop you. Most of the men at Coyne have no more money than you have.

Railroad Fare Allowed

I will allow your railroad fare to Chicago, and if you should need part-time work I'll assist you to it. Then, in 12 brief weeks, in the great roaring shops of Coyne, I train you as you never dreamed you could be trained . . . on the greatest outlay of electrical apparatus ever assembled . . . costing hundreds of thousands of dollars . . . real dynamos, engines, power plants, autos, switchboards, transmitting stations . . . everything from doorbells to farm power and lighting . . . full-sized . . . in full operation every day!

No Books—No Printed Lessons

No books, no baffling charts . . . all



Prepare For Jobs Like These

Here are a few of hundreds of positions open to Coyne-trained men. Our free employment bureau gives you lifetime employment service.

- Armature Expert \$100 a Week
- Substation Operator \$75 a Week
- Auto Electrician \$110 a Week
- Inventor - - - Unlimited
- Maintenance Engineer \$150 a Week
- Service Station Owner \$200 a Week
- Radio Expert - \$100 a Week

Now In Our New Home

This is our new, fireproof, modern home wherein is installed thousands of dollars, worth of the newest and most modern Electrical Equipment of all kinds. We now have the largest amount of floor space devoted to the exclusive teaching of practical electricity in the world. Every comfort and convenience has been arranged to make you happy and contented during your training.

real actual work . . . building real batteries . . . winding real armatures, operating real motors, dynamos and generators, wiring houses, etc., etc. That's a glimpse of how we make you a master practical electrician in 90 days, teaching you far more than the average ordinary electrician ever knows and fitting you to step into jobs leading to big pay immediately after graduation. Here, in this world-famous *Parent school*—and nowhere else in the world—can you get such training!

Jobs, Pay, Future

Don't worry about a job, Coyne training settles the job question for life. Demand for Coyne men often

exceeds the supply. Our employment bureau gives you lifetime service. Two weeks after graduation, Clyde F. Hart got a position as electrician with the Great Western Railroad at over \$100 a week. That's not unusual. We can point to Coyne men making up to \$600 a month. \$60 a week is only the beginning of your opportunity. You can go into radio, battery or automotive electrical business for yourself and make up to \$15,000 a year.

Get the Facts

Coyne is your one great chance to get into electricity. Every obstacle is removed. This school is 28 years old—Coyne training is tested—proven beyond all doubt—endorsed by many large electrical concerns. You can find out everything absolutely free. Simply mail the coupon and let me send you the big, free Coyne book of 150 photographs . . . facts . . . jobs . . . salaries . . . opportunities. Tells you how many earn expenses while training and how we assist our graduates in the field. This does not obligate you. So act at once. Just mail coupon.

Get this FREE Book



Mr. H. C. Lewis, Pres.
COYNE ELECTRICAL SCHOOL, Dept. 77-83
500 S. Paulina St., Chicago, Ill.

Dear Mr. Lewis:
Without obligation send me your big free catalog and all details of Railroad Fare to Chicago, Free Employment Service, Radio and Automotive Courses, and how I can "earn while learning." I understand I will not be bothered by any salesman.

Name.....
Address.....
City..... State.....

COYNE ELECTRICAL SCHOOL

H. C. LEWIS, President, Dept. 77-83

500 S. Paulina St., Chicago Established 1899



SUCCESS

from

CHEMICAL INSTITUTE OF NEW YORK
16 East 30th Street, New York City.

Mountoursville, Pa.

Gentlemen: I must tell you the success I have had since taking your chemistry course. My salary has been increased several times, and different industrial plants are coming to me for a little advice on different things, netting me a fair side income.

I am only sorry that I did not make My whole life study of the wonderful science.

(signed) M. E. Van Sickle.

CHEMISTRY

NOW
is the Time to Study
Chemistry

Not only are there boundless opportunities for amassing wealth in Chemistry, but the profession affords congenial employment at good salaries to hundreds of thousands who merely follow out its present applications. These applications are innumerable, touching intimately every business and every product in the world. The work of the chemist can hardly be called work at all. It is the keenest and most enjoyable kind of pleasure. The days in a chemical laboratory are filled with thrilling and delightful experimentation, with the alluring prospect of a discovery that may spell Fortune always at hand to spur your enthusiasm.

Easy Monthly Payments

You don't have to have even the small price of the course to start. You can pay for it in small monthly amounts—so small that you won't feel them. The cost of our course is very low, and includes everything, even the chemistry outfit—there are no extras to buy with our course. Our plan of monthly payments places a chemical education within the reach of everyone. Write us and let us explain our plan in full—give us the opportunity of showing you how you can qualify for a highly trained technical position without even giving up your present employment.

CHEMISTRY has no equal as a profession in the modern world. There is mystery, romance and fortune awaiting the man in the laboratory.

Millions have been made by the discoverers of the chemical formula of dynamite, bakelite and many other world known chemical products.

Opportunities in the chemical profession abound on every hand—and as modern business and competition progresses the chemist will play an important part.

Profit by the experience of Mr. Van Sickle and many others, resolve to study chemistry NOW.

YOU CAN LEARN AT HOME

To qualify for this remarkable calling requires elaborate specialized training. Formerly it was necessary to attend a university for several years to acquire that training, but thanks to our highly perfected and thorough system of instruction, you can now stay at home, keep your position, and let us educate you in Chemistry during your spare time. Even with only common schooling you can take our course and equip yourself for immediate practical work in a chemical laboratory. Dr. Sloane gives every one of his students the same careful, personal supervision that made him celebrated throughout his long

career as a college professor. Your instruction from the very beginning is made interesting and practical, and we supply you with apparatus and chemicals for performing the fascinating analyses and experimental work that plays such a large part in our method of teaching, and you are awarded the Institute's official diploma after you have satisfactorily completed the course.



T. O'CONNOR SLOANE,
A.B., A.M., LL.D., Ph.D.

Noted Instructor, Lecturer and Author. Formerly, Treasurer American Chemical Society and a practical chemist with many well known achievements to his credit. Not only has Dr. Sloane taught chemistry for years but he was for many years engaged in commercial chemistry work.

Special 30 Day Offer

Besides furnishing the student with his Experimental Equipment, we are making an additional special offer for a short while only. You owe it to yourself to find out about it. Write today for full information and free book "Opportunities for Chemists." Send the coupon right now while it is fresh in your mind. Or just write your name and address on a postal and mail it to us. But whatever you do, act today before this offer is withdrawn.

DON'T WAIT—MAIL COUPON NOW!



EXPERIMENTAL EQUIPMENT FURNISHED TO EVERY STUDENT

We give to every student without additional charge this chemical equipment, including forty-nine pieces of laboratory apparatus and supplies, and forty different chemicals and reagents. These comprise the apparatus and chemicals used for the experimental work of the course. The fitted heavy wooden box serves not only as a case for the outfit but also as a useful laboratory accessory for performing countless experiments.

Chemical
Institute
of
New York

Home Extension
Division 10
16 East 30th St.
New York, N. Y.

CHEMICAL INSTITUTE OF NEW YORK
Home Extension, Division 10
16 East 30th Street, New York City.

S.I. Oct.

Please send me at once, without any obligation on my part, your free Book "Opportunities for Chemists," and full particulars about the Experimental Equipment given to every student. Also please tell me about your plan of payment and your special 30 day offer.

NAME

ADDRESS

CITY STATE.....

Designer of Broadcast Station WEMC

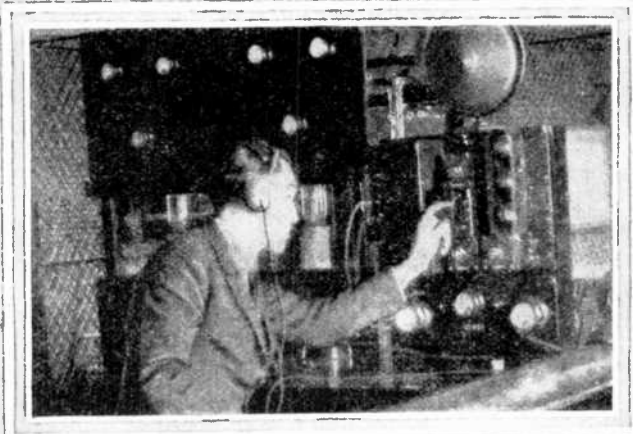

Tours Europe On Inspection Trip.

How Would You Like To Have John Fetzer's Job?

Would you like to tour Europe with all your expenses paid? You would? My friend John Fetzer DID: Maybe you'd like to hold a fine job as Chief Engineer of a widely-known American broadcast station? That's what John Fetzer is right now—Chief Engineer of Station WEMC, "The Radio Light-house," located at Berrien Springs, Mich. Read his interesting letter at the right.

Will YOU Take a Better Job—More Money?

If I offered you a job like John Fetzer's at \$100 or \$150 a week, would you take it?

If I told you that to get this job you would have to do a little studying, say half an hour a day for a few months, would you do that to?

You bet you would. You probably even think I'm foolish to ask you such questions. But, as a matter of fact, you to-day have such an opportunity in the same place John Fetzer found his—in the brand-new, growing Radio Industry.

Plenty of Plums Still Left on The Tree

We've just barely scratched the surface in the Radio business. There are plenty more opportunities just as good as the one John Fetzer grasped.

You'll have to do some studying before you can hold down one of the good jobs—only well-trained men are wanted.

But that part isn't hard—lots of men without a grade school education have done it. And it only takes a comparative short time at studying about half an hour a day. You can keep right on with your present job, and learn in the quiet of your own home.

Get My Big Free Book

300,000 new openings have been created by the swift growth of the Radio business in the past few years. During the same years I have helped thousands of men to take advantage of opportunities like these.

John Fetzer, whose picture you see above, is only one man among these thousands I've helped. Lots of the others didn't climb as high as Fetzer, but there are some, too, who have gone higher.

I'm ready to help you, too, if you are looking for a better job and more money. The good jobs in Radio pay from \$50 all the way up to \$250 a week. And the accomplishment of television, trans-Atlantic Radio telephony, the other new inventions constantly being made, all point to even greater things for the future. If you're ambitious and dis-satisfied with your job or your future, let me help you share in the Rich Rewards of Radio.

Mail the coupon below for my big free book about Radio, its opportunities, and how I train you, quickly and easily in your spare time at home, to take advantage of them. No previous experience needed. You learn by doing, with six big outfits of practical experimental material I send you at no extra cost. Mail coupon now for book—Address: J. E. Smith, President, National Radio Institute, Washington, D. C.



Dear Mr. Smith:

I went to Europe at the expense of my station, WEMC, to learn the best methods used there and bring them back for my station. I found about 20 stations in the British Isles, mostly used to relay programs from 2LO. They were very kind to me at 2LO—their equip-



ment is about like that of our own good stations. French stations, I found, don't compare with the British. There are 6 important stations in France. Eiffel Tower is the best known. I visited Holland, Belgium and Switzerland, and got a real thrill from seeing the big station at



Nauen, Germany. On my return I designed and built the new high power station for WEMC, using best features of what I had

seen. Our first program was reported in 40 States. Your training is the way to lasting success in Radio.



John C. Fetzer



J. E. SMITH, President of the National Radio Institute, Washington, D. C., has directed the training of more men for the Radio profession than any other educator. The National Radio Institute is the oldest and largest Radio home-study school in the world.

Originators of Radio Home Study Training

HERE'S THE SAME COUPON THAT FETZER CLIPPED

This Book FREE!



C O U P O N

J. E. Smith, President, National Radio Institute, Dept., MD-6, Washington, D. C.

Dear Mr. Smith: Kindly send me your free book "Rich Rewards in Radio," and all information about your practical, home-study Radio training. I understand this places me under no obligation.

Name _____
 Address _____
 Town _____, State _____

One of 4000 airports in America

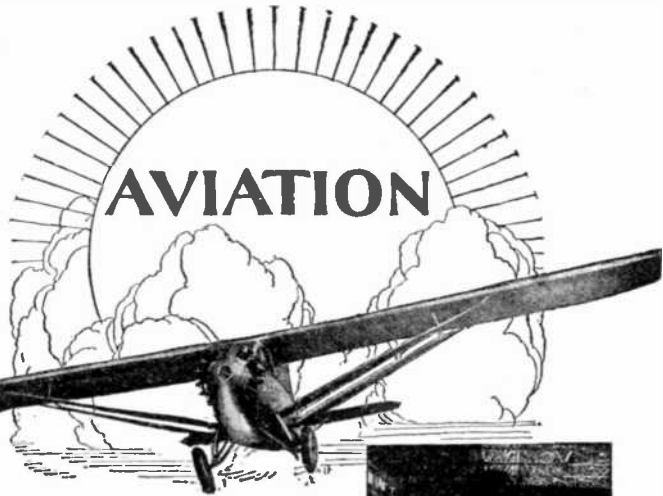

One of the busy factories

The Sun Rises offering a great, new Opportunity

MAKE big money in Aviation. Thousands of opportunities are opening every day. It's the business of the hour—the gold mine of the future. Just as in the automobile field when it was new, men who learned the fundamentals climbed to the top—just as in electricity, radio—so it will be in Aviation.



Lieut. Walter Hinton, First Trans-Atlantic Pilot of N. C. 4 fame, President of Aviation Institute.

This great, new field is open to every ambitious young man and woman. There are 53 different trades in the industry, many ground jobs. The business is humming. Manufacturing of machines and parts is growing by leaps and bounds. There are now 4,000 airports operating in America—6,000 privately owned planes. There's big money in this life of thrills, adventure, admiration. Read our Free Book, "Aviation and You."

Wide awake men are needed as mail pilots, commercial flyers, instructors, inspectors, riggers, mechanics at flying fields, besides the thousands of positions in factories.

At home in your spare time, you can learn the fundamentals of Aviation. Lieut. Walter Hinton, first Trans-Atlantic flyer, and his staff of experts will guide your instruction from beginning to end. No previous experience or training necessary.

AVIATION INSTITUTE OF U.S.A.



Walter Hinton, President

1115 Connecticut Ave., N. W. Suite 310 Washington, D. C.

The Aviation Institute Course teaches you everything you need to know, right up to the point of actual flight instruction in the air. All the principal ground work, so absolutely necessary to qualify, is secured in a comparatively short time at home, without interfering with your present employment.

When you have graduated from the Institute you are ready to take your place in Aviation.

If you wish to become a pilot, final flying instructions are given at our own flying field in Washington or at other fields in all parts of the United States in cooperation with the Institute. Five to ten hours with an instructor and you can fly alone. *First flight free to graduates.*

Get all the facts about the Institute course and the way it leads to Opportunity. Send the coupon today.

FREE



This Book Tells All

Aviation Institute of U. S. A., Suite 310, 1115 Connecticut Ave., N. W., Washington, D. C.

You may send me without obligation a Free copy of "Aviation and You."

Name

Age (Not under 16)

Street

City State

With Paper Furniture

Which are Varnished to Make Them Weather-proof

BUT the construction, even though finished three years ago, remained empty. It was Mrs. Stenman who suggested that if the house walls were made of paper, why not the tables and chairs. So the family set to work and today paper furniture graces the paper house. First, a living room set, comprising a davenport and chairs, was the goal. This being finished, a dining room set of table, chairs and lamps, requiring 4,000 newspaper sheets, was next constructed. Then the sun parlor furniture was built which consists of a square table, two chairs and a bridge lamp. It has been estimated that about 60,000 newspapers were used in the construction of the bungalow and its accompanying furniture.

The process of preparing the newspapers required both time and patience. A dozen thicknesses of newspaper were taken and glue was then applied to the paper. The entire group was then placed in a press where it remained until dry. After this, the paper slab was cut up into sheet form and applied to the house with nails. In order to enhance the artistic effect, the strips of paper were

applied to the walls in a crosswise fashion. The ordinary newspapers are used on the bottom of the house, and for the ornamental

effect, as well as for additional artistic variations, those newspaper slabs which were graced with a rotogravure section as their outer layer were nailed in place in suitable locations.

After the strips were nailed to the uprights, the outside of the house was varnished with a transparent varnish until the surface was shiny. It is this varnish which protects the house from wind and rain. In the making of the furniture, a slightly different process was employed. Here the newspapers were rolled up very tightly after the glue had been applied to one surface and then the tubes of newspaper were varnished, sawed up to the desired lengths, nailed or glued in place to form the legs, seats or table tops, and then given several other coats of varnish for further protection.

This furniture is very serviceable and has been in use by the family for quite some time. It is lighter than wood furniture, and at the same time, far more attractive. Portions of the news from long ago can be read on the furniture which alone makes it an ever-lasting sort of amusement and extremely novel.



A replica of the famous Lincoln log cabin, made of newspaper, serves as the home for Stenman's pet cat.

Electricity from Air---A Hoax

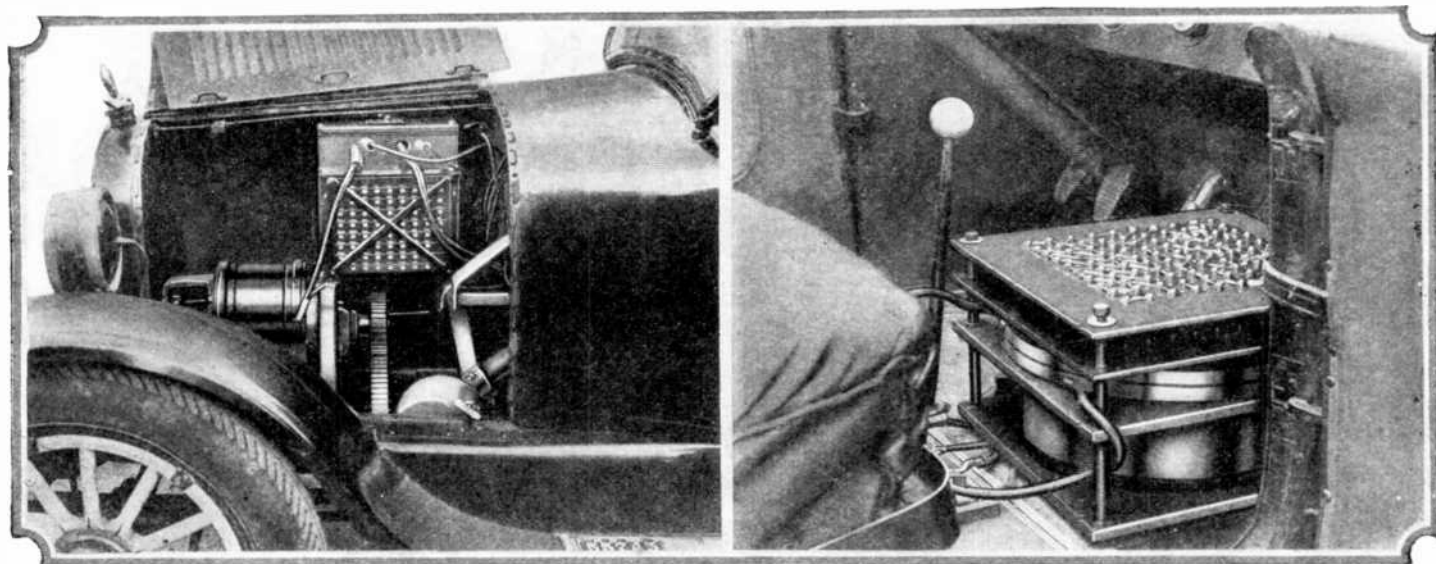

Here are two photographs which show the invention of Harry Perrigo which, it was claimed, absorbed electricity from the atmosphere and operated the electric motor used to drive the auto. The photo at the left shows the electric motor and one of the accumulators and the photo at the right shows another accumulator. The project proved to be a hoax when it was discovered where the storage batteries were hidden.

ON August 8, of this year, according to the claims, a motor car was driven at 40 miles an hour in Kansas City on power drained from the air. It was claimed that after many failures, the inventor, Harry Perrigo, demonstrated the machine in the presence of Col. Henderson, of Chicago, who claimed that the article was the greatest invention of the age. The device consisted of a plate 14 inches square which by a multiple arrangement of coils, connected together in divers ways, was said to extract electricity from the air. The current trapped, then passed through a generator (we know not

why), and thence to a regular direct current motor connected to the transmission shaft of the automobile. The weight of the motor controls and the generator was said to be about 86 pounds, and Mr. Perrigo needed reduction coils (?) to take care of the surplus current because the device was 5 times as powerful as was necessary to drive the automobile. "Forty miles an hour, why that's nothing; I can make it go more than 100," said Mr. Perrigo. And so, on the morning of August 8, Kansas City was the most important town in the universe. But that same afternoon, the Better Business Bureau and

the Blue Sky Commissioner of Missouri investigated Mr. Perrigo's device, and found that in addition to the complicated coils which, according to the claims, absorb free energy out of the atmosphere, 72 small storage battery cells were concealed within the car. Each cell measured 2"x6½"x9". These were combined into batteries of six units.

The motive behind the fake was discovered when numerous persons were found who had poured thousands of dollars into this free energy scheme as far back as fourteen years ago. *Always investigate before investing!*

NEW AIRPLANE CATAPULT

The Jenkins Catapult Permits Airplanes to Fly Off Building Roofs: His Reversible Propeller Stops Plane on Small Roof.

C. Francis Jenkins, the famous Washington, D. C. inventor, whose name has been linked with the first motion picture machine and television inventions, here proposes a new form of rotatable catapult for hurling airplanes from building roofs.

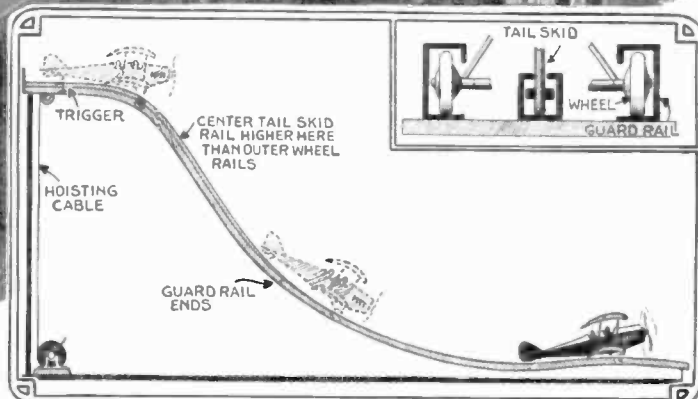

The front cover illustration shows vividly the new Jenkins rotatable catapult for launching aircraft from building roofs, while the illustration and diagram above show further details of Mr. Jenkins' invention. In the first place, this new design of airplane catapult can be rotated by electric motors so as to permit the airplane to be launched into the wind. The turntable proper has a central shaft and the outer edge of the platform revolves on a series of wheels running on a track. Thanks to the new Jenkins reversible propeller, it is possible for airplanes to stop in a very short distance, thus rendering an average size building roof available for airplane launching and landing purposes. The airplane is pulled up the catapult track by means of a cable, which is wound up on a motor-driven winch, this winch being visible underneath the framework of the catapult.

As the detail drawing of the new airplane catapult above shows, the tracks down which the plane dashes, may be covered with guards for about two-thirds of the run, to preclude the possibility of the plane jumping off the track sideways. An important feature of this invention is the arrangement of the center track along which the tail skid runs. By suitably designing the curvature of this tail skid or center track, the position of the wings, or rather their angle at a given instant, is automatically cared for, so that the plane takes off into the air with the tail and wings at the proper angle. This is important as the plane will have a very high velocity.

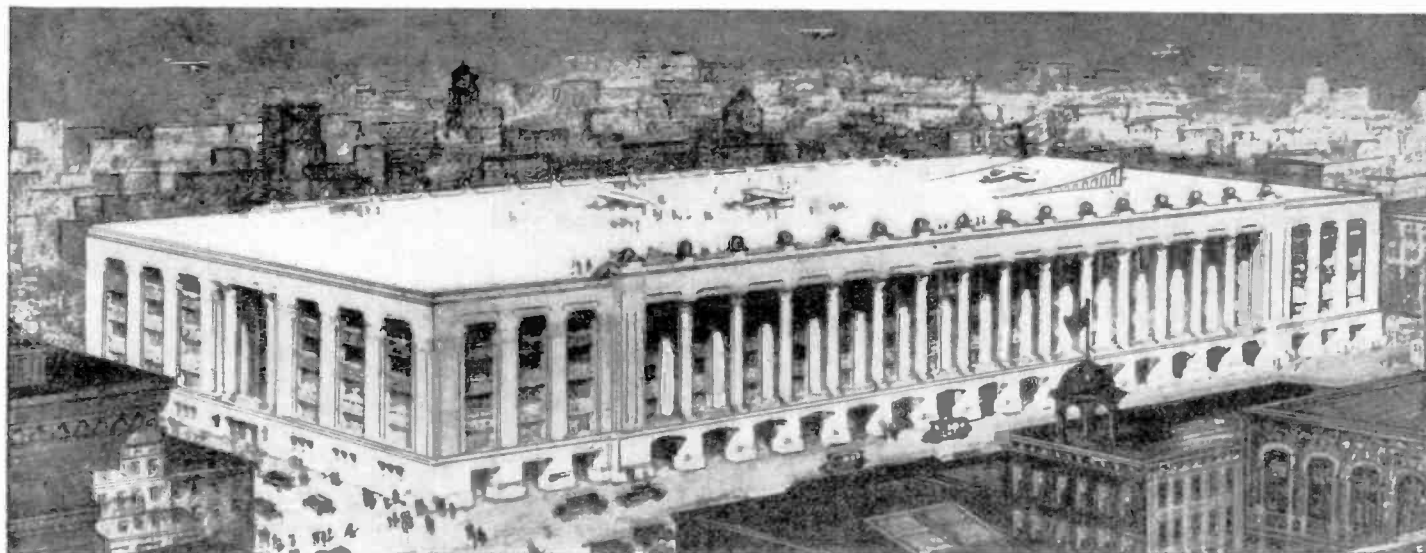

The U. S. Government Post Office Department has done a great deal for aviation in this country through the development of the air mail service. The picture above shows the design for the new Chicago

post office, which, as will be seen, is provided with a large flat roof of ample size for the launching and landing of mail planes. The government engineers are considering similar ideas for other cities.

"ROOF STATIONS" FOR AIRPLANES

Various Schemes For Launching Airplanes From Building Roofs

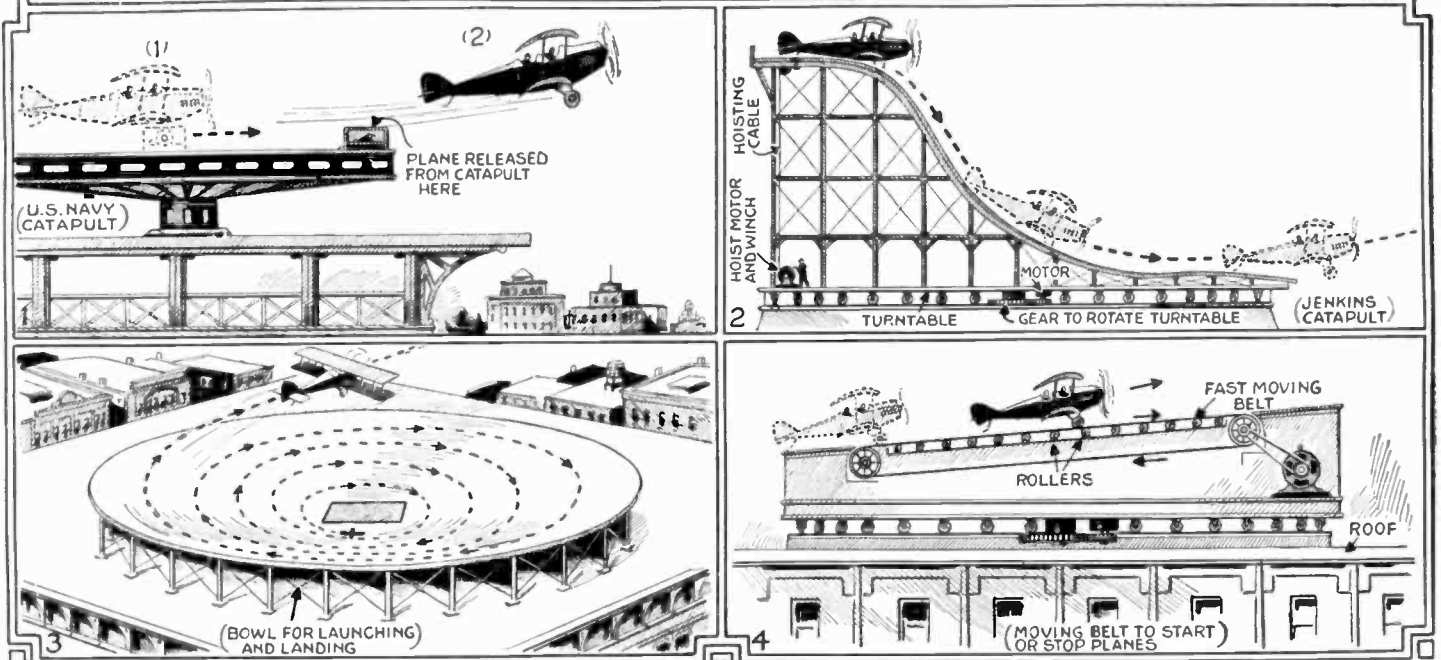

The device for launching airplanes shown at Fig. 1, has been used by the U. S. Navy on board vessels for several years. At Fig. 2 we see the catapult idea described on the opposite page. At Fig. 3 there is shown a bowl scheme for the launching and landing of aircraft.

This scheme seems to have considerable merit. At Fig. 4 is shown a moving platform idea which may be used either for launching or stopping aircraft. When used for stopping airplanes, the belt is made to move in the opposite direction to that of the planes.

Practical Ways For Stopping An Airplane in a Short Distance

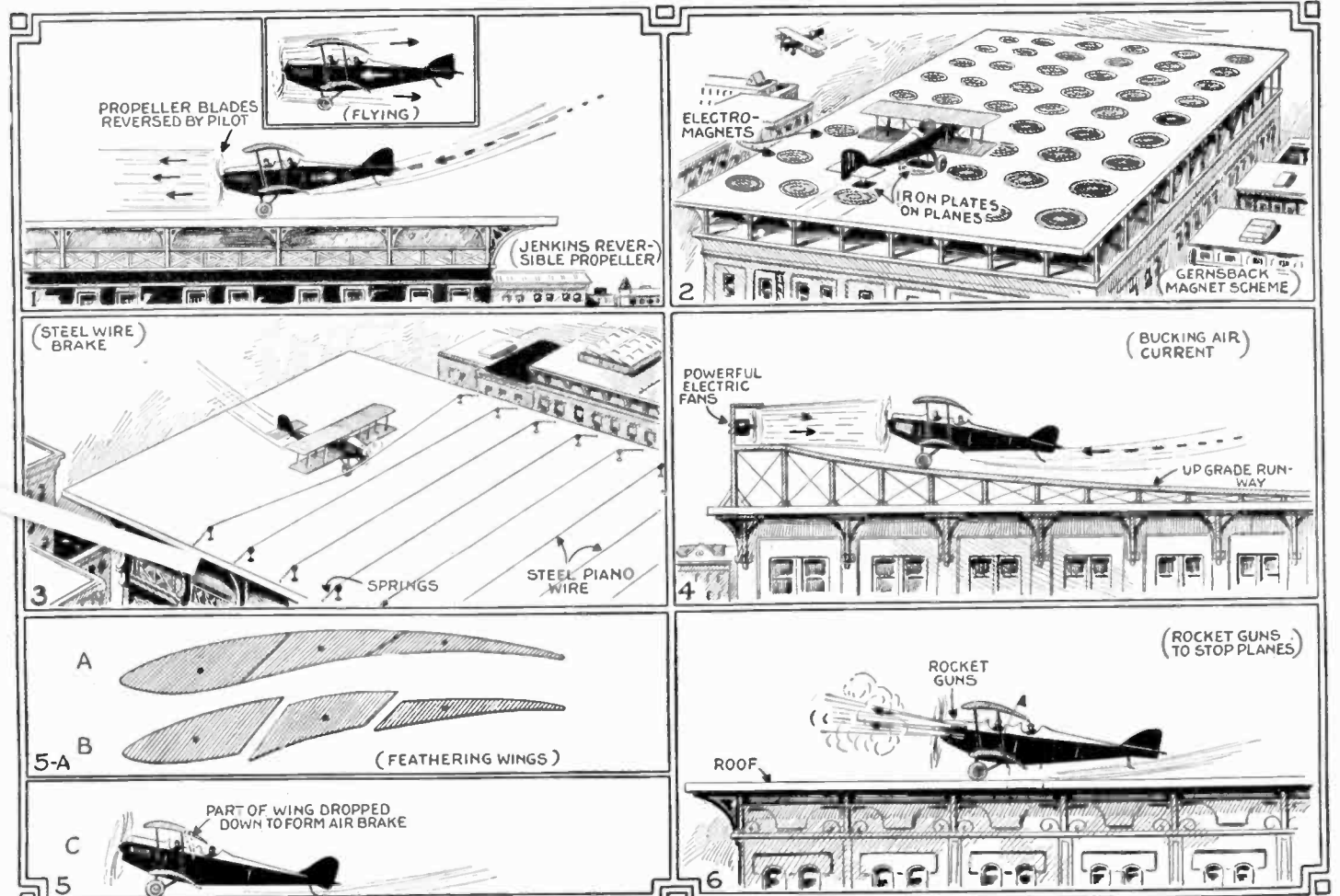

At Fig. 1 we see two pictures illustrating how the Jenkins' reversible propeller operates; when the propeller blades are reversed by the pilot, through an inter-locking safety mechanism, the reaction from the air stream, as shown, causes the plane to slow up and stop in a short distance. The propeller blades cannot be reversed while in flight, due to the inter-locking mechanism mentioned. Fig. 2 shows a scheme

proposed by Hugo Gernsback about twelve years ago, utilizing a series of electro-magnets and iron plates secured to the bottom of the plane. Fig. 3 shows piano wires under tension of springs or weights; this scheme has been used successfully. Fig. 4 shows bucking air current developed by powerful fans. Fig. 5 shows idea of feathering wings. In Fig. 6 rockets are fired to stop plane by reaction.

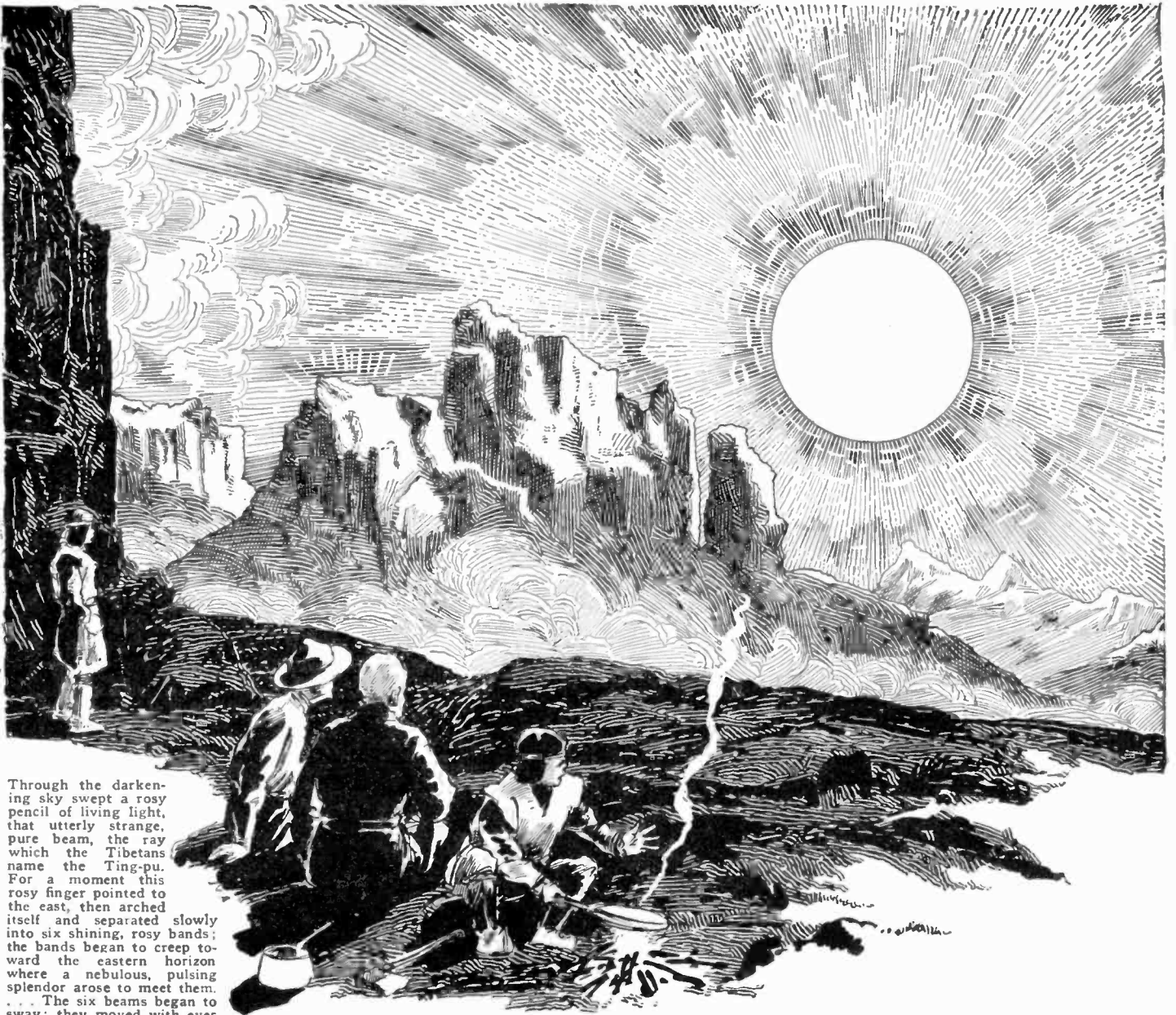

Through the darkening sky swept a rosy pencil of living light, that utterly strange, pure beam, the ray which the Tibetans name the Ting-pu. For a moment this rosy finger pointed to the east, then arched itself and separated slowly into six shining, rosy bands; the bands began to creep toward the eastern horizon where a nebulous, pulsing splendor arose to meet them. . . . The six beams began to sway; they moved with ever swifter motion from side to side in ever-widening sweep.

The Metal Emperor

By A. Merritt

Author of "The Moon Pool," "The Face in the Abyss," etc.

CHAPTER I

I DECIDE TO REVISIT TIBET

THE valley in which I had encamped was of a singular beauty; so beautiful that the first glimpse of it caught my throat and set an ache within my heart; and then that beauty had reached out and drawn me to it and had cradled me with peace.

Sleet of a late December storm had whipped my windows in New York one night when, turning over the pages of what is perhaps the most sensational of my books, "The Poppies and Primulas of Little Tibet," I had been seized by a great desire to revisit that quiet, forbidden

land. I wanted to sink myself within its high solitudes; cut myself off as though in another world from the rush and clamor of Western civilization. That desire grew not with the days but with the minutes; it became irresistible.

Nor was there any reason why I should resist it. A bachelor, none had claim on me. Fortunately free to go as I pleased and when I pleased, without leaving any anxious ones behind me, I was equally fortunate in possessing the means to go where I pleased.

Since early March I had been wandering among the hills. It was now mid-July.

In Teheran I had picked up a most unusual servant. He was a Chinese, his name Chiu-Ming. He was about fifty, and twenty of his years had been spent in the ancient

Lamasery of Palkhor-Choinde at Gyantse, west of Lhasa. Why he had gone from there, how he had come to Teheran, I never learned. I was most fortunate that he had gone and that I had found him. He recommended himself to me as the best cook within three thousand miles of Peking. He spoke the truth.

For almost three months we had journeyed together, Chiu-Ming and I and the two ponies that carried my impedimenta. We had traversed mountain roads that had echoed to the marching feet of the hosts of Darius, to the myriads of the Satraps; the highways of the Achaemenids, and the same roads that before them had trembled to the trappings of the godlike Dravidian.

We had slipped over hoary Iranian trails

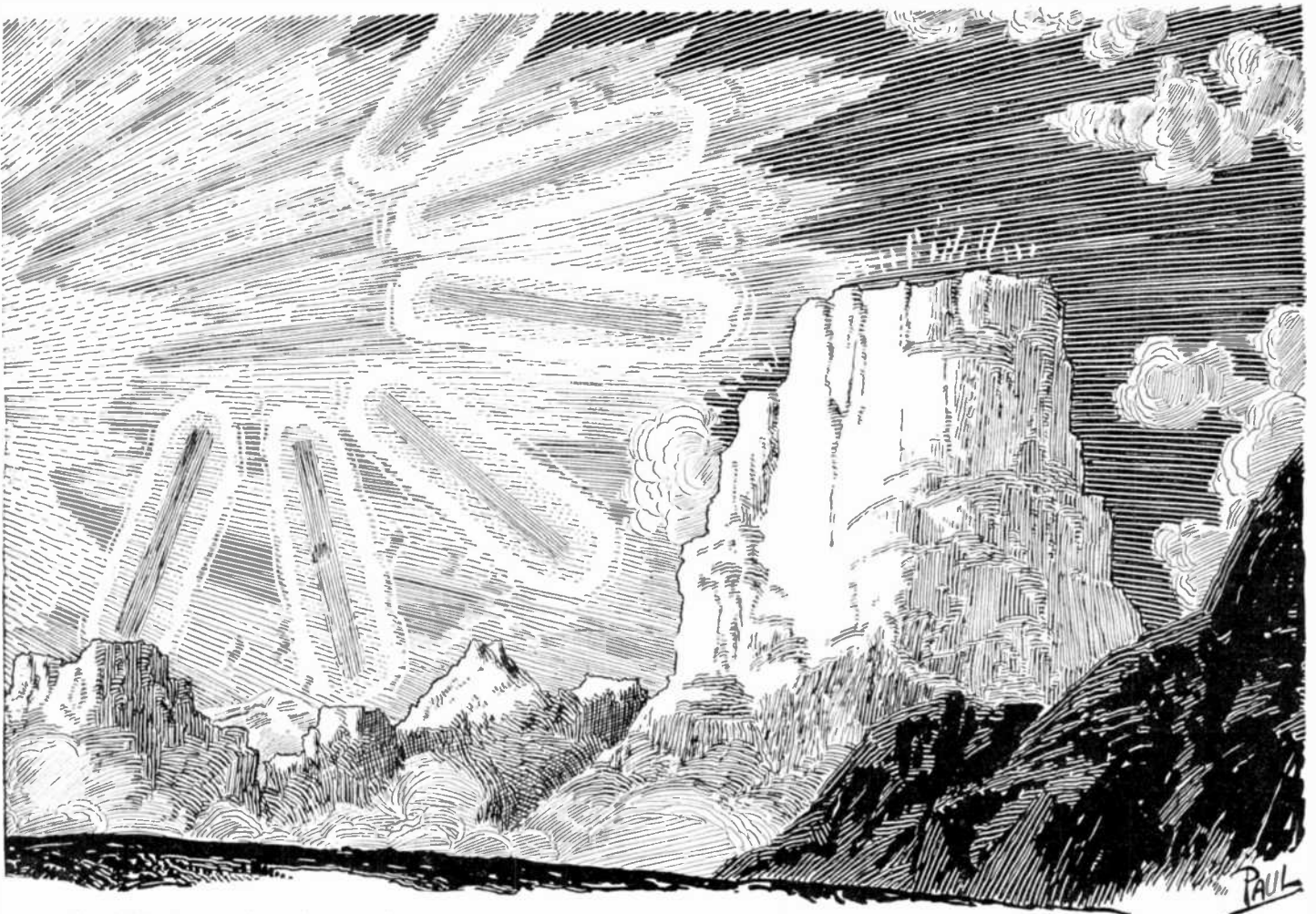

over paths which the warriors of conquering Alexander had traversed. Dust of bones of Macedonians, of Greeks, of Romans had beaten about us; ghosts of the flaming ambitions of the Sassanidae had whimpered in the winds of the gorges as we passed through—an American botanist, a Chinese, two Tibetan ponies. We had crept through clefts whose walls had sent back the howling of the Ephthalites, the White Huns who had sapped the strength of those same Sassanids until at last both had fallen before the Turks.

Over the highways and byways of Persia's glory, Persia's shame and Persia's death we had gone. For a month we had met no human soul, had seen no sign of human habitation.

A VALLEY OF ENCHANTED BEAUTY

That morning we had come out of a ragged defile into this valley of enchanted beauty; and here, although it had been so early, I had pitched our tents determining to go no further till the morrow. It was a Phocian vale; a gigantic cup filled with the very essence of peace. A spirit brooded over it, serene, majestic, immutable; like the untroubled calm which rests, the Burmese believe, over every place which has guarded the Buddha, sleeping.

At its eastern end towered the colossal scarp of an unnamed peak. On its head was a cap of silver set with pale emeralds—the snow fields and glaciers that crowned it. Far to the west another gray and ochreous giant reared its bulk, closing the vale. North and South the horizon was a chaotic sky land of pinnacles, spired and minareted, steepled and turreted and domed, each diademed with its green and argent of eternal ice and snow.

And all the valley was carpeted with the blue poppy. In wide unbroken fields, blue as the morning skies of mid-June, they rippled mile after mile over the path we had followed, over the still untrodden path

which we must take; they nodded, they leaned toward each other, they seemed to whisper—then to lift their heads and look up like crowding swarms of little azure fays, half impudently, wholly trustfully, into the faces of the jeweled giants standing guard over them. And when the breezes walked upon them it was as though they bent beneath the soft tread, and were brushed by the sweeping skirts of unseen, hastening Presences.

Like a vast prayer rug, sapphire and silken, the poppies stretched to the gray feet of the unknown mountain. Between

MR. MERRITT, who has written this absorbing narrative of travel and adventure in the mysterious land of Tibet, has given us one of the greatest stories of the year. The editors can only say that SCIENCE AND INVENTION Magazine readers are indeed fortunate in having presented to them such a well-written tale as that which Mr. Merritt unfolds, and will continue to unfold each month for some time to come. The editors have in the past few months reviewed several hundred scientific tales, but this one is the very best that has come to their attention in a long, long time. We could tell you more about this Tibetan adventure, but— Well, if you read this first installment, we'll guarantee you will read all the rest.

their southern edge and the clustering summits a row of faded brown, low hills knelt—like brown-robed, withered and weary old men, backs bent, faces hidden between outstretched arms, palms to earth and brows touching earth in the East's immemorial attitude of worship.

A MAN APPEARS IN THE WILDERNESS

Half I expected them to rise—and as I

watched, a man appeared on one of the bowed, rocky backs, with the ever-startling suddenness with which objects spring into vision in the strange light of these latitudes. As he stood, scanning my camp, there arose beside him a laden pony, and at its head a Tibetan. He waved his hand and came striding down the hill.

As he approached I took stock of him. Young, well over six feet, a square fighting jaw, his nose snubbed a bit pugnaciously, clear brown eyes.

"Name's Drake," he said without preamble, holding out his hand. "Richard Keene Drake. Home's San Francisco. Business engineering. Just now, plain tramp. But Lord, I never expected to run across another white man way up here!"

He grinned, engagingly.

"My name is Thornton," I took his hand. "Dr. Louis Thornton. I am also an Amer—"

"Why I know you," he interrupted. "At least my father did. He was Alvin Drake, and he admired you greatly. Used to say that you were the only man except himself with a sane view of the evolution of something or other from the Carboniferous up through Quaternary. Used to get quite enthusiastic about it."

I flushed with pleasure. For Alvin Drake I had a great respect, considering him one of the soundest and most brilliant of paleontologists. And then a thought struck me.

"You said, I think, your father—was?" I asked. Drake's face shadowed.

"Yes," he said. "He's dead. Died on the New Year. It's why I'm here. I was all he had and after I came back from the War we palled it pretty closely. I—was very fond—of father, Dr. Thornton. After he died I felt like getting rather far away—" he was silent for a moment. "Well, I couldn't think of anything further away than Tibet, since the Polar Caps are getting

(Continued on page 539)

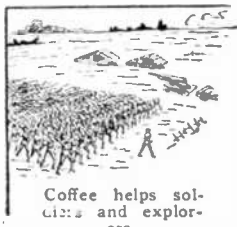

Does Coffee Poison the Heart?

Is the Drinking of Coffee as Dangerous as Some Would Have Us Believe?

By FREDERIC DAMRAU, M.D.

MANY folk are firmly convinced that the caffeine contained in coffee poisons the system and hurries the order for the tombstone. Manufacturers of coffee substitutes and decaffeinated coffees have so blatantly advertised the statement that caffeine produces heart disease that many a person is afraid to drink even a single cup of coffee for breakfast.

A host of school teachers and other disseminators of knowledge have accepted the suave statements of the anticoffee copywriter as gospel truth, and the result is that a dread of the imaginary evils of caffeine has gained considerable headway. But while the billboards and subway trains are placarded with startling announcements that caffeine ruins the heart, our standard medical treatises contain no justification for this statement.

The Encyclopaedia Britannica speaks of coffee as an "important and valuable article of food." And the authors of various medical textbooks and articles frequently refer to its uses as part of the diet of the ill as well as the healthy. Only the copywriter's layout and certain periodicals interested in the sale of coffee substitutes remain as texts urging the abolition of caffeine.

During the World War, coffee was an indispensable part of the soldier's ration. If his canteen could not hold enough for the

HOW CAFFEIN AFFECTS THE HEART

The physiologic efforts are due almost entirely to caffeine. Different brands contain from 0.7 to 1.7 per cent of this active

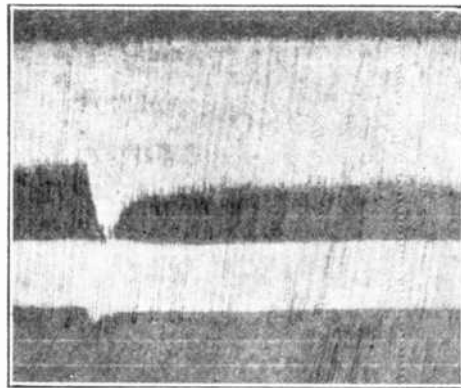

Effect produced upon an animal's heart by a large dose of caffeine corresponding to five grains in a man. The rise indicates the elevated blood pressure. Physicians have found caffeine and coffee useful as heart stimulants. —W. A. Bastedo, *Materia Medica*, W. B. Saunders Co.

principle, sometimes more. An average cup of coffee contains about 1½ grains of caffeine.

While the coffee beans are being roasted, an aromatic oil, called *caffeneo*, is produced. This oil influences the taste of the coffee but has slight physiologic effect on the body. In general, the action of coffee may be analyzed in terms of the amount of caffeine contained.

Coffee has never been shown to be a heart poison. On the contrary, when the heart is failing, caffeine is one of the most valuable stimulants at our command. It is frequently employed in the treatment of heart disease, and the results have justified our confidence in its value.

The efficiency of muscular tissue is improved by moderate amounts of caffeine. As the heart is really a big muscle, it shares in the benefit. Physiologic investigation has demonstrated that, under the influence

of caffeine, the heart beats more rapidly and a greater amount of blood is thrown into the arteries in a given time. In other words, the heart performs more work.

After the use of most stimulants there follows a period of depression. For example, the fellow who swallows several cocktails starts the evening with brilliant conversation but ends up under the table. With coffee there is no secondary period of depression. A cup of Mocha at 6 P. M. will keep your mind active; it may also keep you awake half the night.

Whatever action coffee has on the heart is purely functional; that is, it does not affect the structure of the organ itself. Coffee increases the rate and the force of the heart beat; but these effects are only temporary and soon disappear, and they are not injurious.

Since advertising writers so persistently blame coffee for heart disease, it becomes necessary to briefly mention some of the real causes of the damaged heart. Rheumatism with its lieutenants, diseased tonsils and infected teeth, stands first. It is the greatest cause of shrunken, misshapen and adherent heart valves. Syphilis and old age are the enemies of the aorta, the large arterial trunk that emerges from the left ventricle of the heart to distribute blood to the entire body. And very many of the



A cup of coffee has a tendency to stimulate an individual very rationally. There is no reaction or secondary period of depression after a cup of mocha. Its action on the heart is purely functional.



After the use of alcoholic cocktails a period of depression follows the initial stimulation. Coffee has no such reaction.

infectious diseases, such as pneumonia and scarlet fever, are prone to damage the muscular structure of the heart and thus weaken the force of the contractions.

As one reads medical treatises on the causes of heart disease, he finds very little mention of coffee. Practically all the statements that coffee is a heart poison are part and parcel of advertising literature.

The great majority of physicians agree that the moderate use of coffee does not in any way injure the healthy person. Even

(Continued on page 560)

long march, he was allowed "coffee money" to buy it on the road. The experience of the officers in the Argonne offered convincing proof that coffee helps the soldier to bear up under the rigors of a military campaign.

No arctic explorer would ever set out northward without a liberal supply of coffee. This pleasant beverage offers one of the most effective means of combating the frigid climate. In temperate climates, after a long drive on a cold day, one's first longing is for a cup of hot coffee; for nothing else gives such relief from the cold and fatigue.

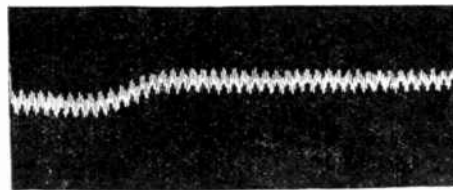

Showing how alcohol injected into the vein temporarily increases the pulse rate and raises the blood pressure. This increase is followed by a period of depression (not shown).—J. M. Fortescue-Brickdale, *Text Book of Pharmacology*, Oxford Medical Publications.

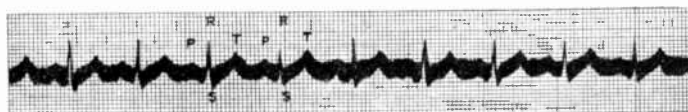

Above a normal electrocardiogram. P, contraction of auricles; R, beginning of contraction of ventricles; T, end of contraction of ventricles. The S wave is not important. At the right the graph shows premature beats with an irritable heart following two cups of coffee.

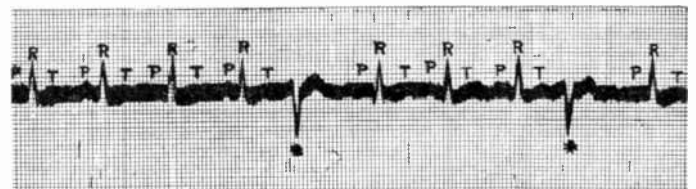

The * shows the premature beats. We must remember that coffee only occasionally produces this abnormality, and very rarely in normal hearts. Premature beats are rather common even in normal hearts. From W. D. Reid, *The Heart in Modern Practice*, Lippincott.

A Perpetual Motion Hoax

The Strange Tale of a Baffling Electrical Machine Demonstrated to the Editors and Which the Inventor Claimed Entitled Him to the \$5,000.00 Offered by This Magazine for a Demonstration of a Perpetual Motion Machine.

THIS is indeed a strange tale, mates, and it all started on a warm summer's day, August 16th, 1926, to be exact. On that memorable day the editors had the extreme pleasure of meeting one Mr. John S. Hamilton, of Kansas City, Missouri, the state where they say, "show me." We were also willing to be shown, and as the editor's letter dated August 16th, 1926, reproduced herewith, shows, we were willing to pay \$5,000.00, once we had been shown. "Shown what?" you will ask—simply this: A demonstration of a perpetual motion machine, in other words a machine which gave a greater output of mechanical or electrical energy, than the amount of energy put into it. After an electrical expert has read this article, he will of course say, no doubt, that it should have been easy to see what the whole show was all about at the start. But when an inventor brings a brand new machine to your laboratory, you will find that it is not so simple to guess what he is actually doing with several machines all mounted on a base plate, as were the three electrical machines in Mr. Hamilton's model; together with quite a number of wires running into the frames of the dynamos and motors; and just what was inside of the machines one could only guess. In fact this machine is so baffling, even after it is partially explained, that the average electrical student will still fail to see why the volt and ammeters connected to the dynamo terminals, as shown in the diagram below, should indicate a greater number of watts than that given by the volt and ammeters connected to the input of the No. 1 motor at the left of the machine. Just try it on your electrical student friends.

Mr. Hamilton visited our offices, as aforementioned, on August 16th, 1926, and asked if we would pay the \$5,000.00 challenge to him for simply demonstrating to our satisfaction, a perpetual motion machine or a machine that had a greater output than input, and as you will see we said "yes" in writing. Mr. Hamilton at that time stated to the editors that he had read our perpetual motion challenge, as published in this magazine, and the editors did not of course doubt that

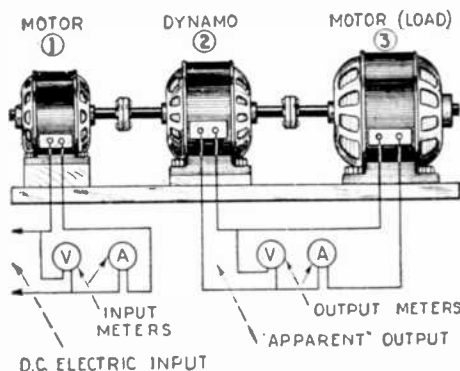

This diagram shows the actual connections of the volt and ammeters connected in the dynamo and motor circuits in the test of Mr. Hamilton's paradoxical machine, which he claimed "had a greater electrical output than input."

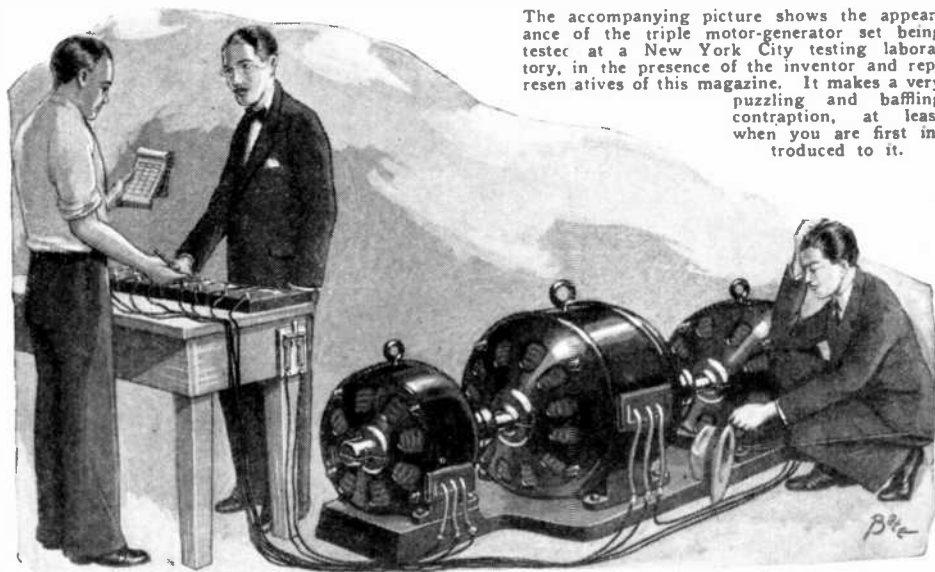

The accompanying picture shows the appearance of the triple motor-generator set being tested at a New York City testing laboratory, in the presence of the inventor and representatives of this magazine. It makes a very puzzling and baffling contraption, at least when you are first introduced to it.

letters and verbal statements in such a way, that it would seem we were understood to offer \$5,000.00, simply to look at a machine under test and which machine seemingly developed a greater amount of actually measured power on the output side than that put into it. Mr. Hamilton knew all the time that we of course considered that he was going to show us a machine which actually developed a greater amount of true energy output than the amount of energy required to operate the machine. In other words, it should duplicate the requirements of a perpetual motion machine.

But what was our surprise when we finally discovered that he expected us to pay \$5,000.00 for what really amounts to a perpetual motion hoax. Repeatedly in his arguments, both written and verbal, Mr. Hamilton says, "look at the meters, they don't lie, and they show a greater output than input." Again Mr. Hamilton has stated repeatedly to the editors, "do you consider that the second set of volt and ammeters were connected in the output side of the dynamo?" The second set of volt and ammeters are connected to the "output" terminals of the dynamo, but what Mr. Hamilton fails to take any cognizance of, is the fact that approximately seventy per cent of the electrical energy passing into and through these meters into the third machine, which is acting as a motor, is returned in the form of mechanical power through the motor shaft to the dynamo (center machine), all of which is carefully and fully explained in Mr. Secor's letter reproduced herewith. This arrangement of dynamo-electrical machinery is known to engineers as the "Hopkinson test," for measuring losses in such machinery. It is also called the "pumping back" test. The figures given in Mr. Secor's letter have been checked by several experts, among others the well-known electrical expert, Prof. F. E. Austin, Professor of Electrical Engineering at Dartmouth College. The phenomena taking place has been explained and confirmed as corresponding to the well-known Hopkinson test or pumping back method of testing dynamo-electric machinery, by Mr. Paul Findley, well-known scientist and engineer, connected with the famous Bell Telephone Laboratories of New York City, and Prof. Hehre, Department of Electrical Engineering of Columbia University.

Mr. Hamilton in his letters, as you will note, mentions a joke or two concerning

America's greatest showman and trickster, P. T. Barnum. As Barnum once put it—the public likes to be humbugged—and Mr. Hamilton apparently thought to paraphrase this by coining a new slogan—the editors like to be humbugged. It would pay everyone to study this article very carefully and remember the explanation of the effect taking place in this paradoxical electrical phenomenon, for it may save them from investing a lot of hard-earned money in some crank inventor's "perpetual motion" invention which, as usual, *he is too poor to place on the market alone.*

Here are the letters written by Mr. Hamilton and also our letters written to the inventor before and after witnessing the test.

MR. HAMILTON INTRODUCED

August 16th, 1926.

MR. JOHN S. HAMILTON,
5806 Locust St.,
Kansas City, Mo.

My dear Mr. Hamilton:

This is to certify that SCIENCE AND INVENTION Magazine will pay the sum of \$5,000.00 to you on condition that your electric machine will develop a greater amount of actually measured power on the output side than is put into it. The total input is to be actually measured under a continuous time test, over a period of not less than two hours; this is to be measured against the total output of the machine over the same period of time in horse-power hours. The total input is likewise to be measured in horse-power hours.

This test is to be made by The New York Electrical Testing Laboratories at your expense. Our Committee is to be present when tests are made and we will abide by the verdict of the Laboratory if the test comes under the above rules.

SCIENCE AND INVENTION Magazine must be assured of exclusive publication rights for 60 days after test. Results are not to be published by any other paper or magazine before their publication in SCIENCE AND INVENTION Magazine.

Cordially yours,
SCIENCE AND INVENTION,
(Signed) H. GERNSBACH,
Editor.

OUR LETTER TO MR. HAMILTON, AFTER WITNESSING TEST

June 24th, 1927.

Re: Your Machine Having Greater Apparent Electrical Output Than Input.
MR. JOHN S. HAMILTON,
5806 Locust St.,
Kansas City, Mo.

My dear Mr. Hamilton:

After witnessing the demonstration of your electrical machine, comprising two motors and a generator all rigidly connected on the same shaft, at the Electrical Testing Laboratories' plant yesterday afternoon, we have come to the conclusion that this machine does not, as you claim, have a greater electrical output than the electrical input.

(Continued on page 572)

he fully comprehended what it was all about.

In order that the reader may gain a clear idea as to what the present argument is all about, it should be pointed out that ever since Mr. Hamilton's first visit on August 16th, 1926, until he again got in touch with us, just prior to June 24th, 1927, he has very shrewdly and carefully worded all of his

Neon Fog Beacons Guide Planes

By H. WINFIELD SECOR

Remarkable Beam Seen 20 Miles Through Dense Mist

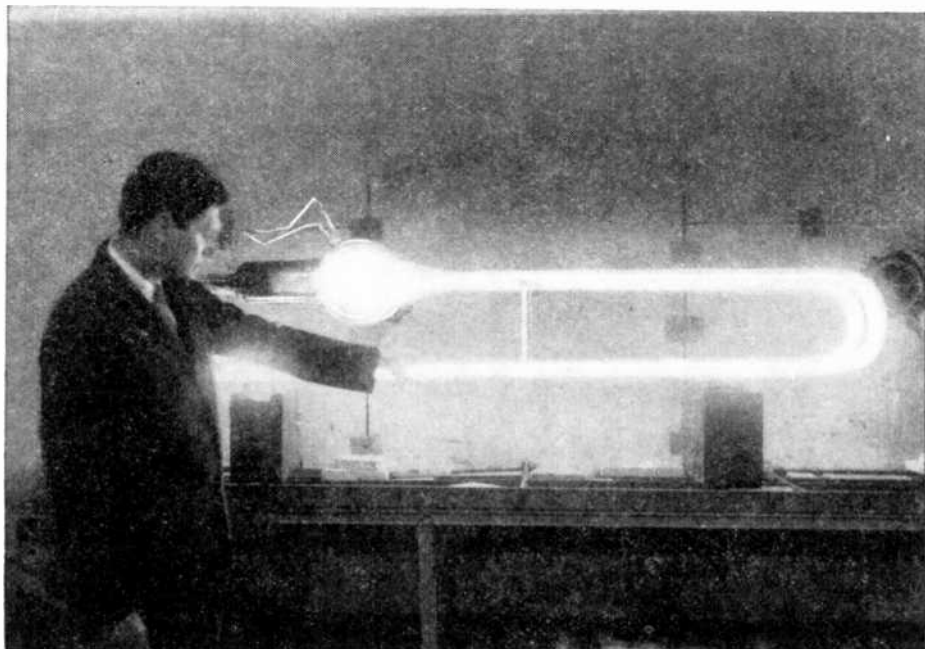

The photo above shows Mr. R. R. Machlett standing beside a neon tube on the test rack at the process station. The tube does not attain a heat which will prevent it from being handled when lighted. One virtue of the light is that it can be used with high-power energy and will produce an enormous candle-power of light.

without any mishap. The ordinary beacon light in this case proved powerless to penetrate the fog. The Commerce Department is considering installing these lights in light-houses which are ordinarily rendered useless in fogs. Thus we see that this invention will prove to be an aid to water, as well as to air navigation. The test light, as may be seen from the photo appearing on this page, is of a hairpin shape. Each unit produces about 10,000 candle-power. In spite of the amount of electrical energy delivered to the tube, it does not attain a heat which will prohibit it being handled while lighted. From the illustration shown here, it will be seen how an aviator lost in the fog, when the ordinary beacon alone is used on the field, would be able to see his way clearly if the neon lamp beacons were used. The beacons developed up to the present time have been seen 10 to 20 miles away when heavy fog obscured all. Future developments will undoubtedly see the range increased to 50 miles or more. Plans for installing the beacons at numerous aviation fields have begun. The government mail planes will be enabled to fly during foggy and stormy weather and thus delays in the service will be eliminated.

The inventor is now enroute to McCook Field, Dayton, Ohio, where he will install a beacon for final War Department tests. After the government has been fully satisfied with these tests and experiments, beacons

FOG-PENETRATING lights have been offered to the War and Commerce Departments by Mr. R. R. Machlett, a New York inventor. In tests at Hadley Field, New Jersey, and at Mitchell and Curtiss Fields, New York, it was demonstrated that the lights could be seen 20 miles away through dense fog. In clear weather, they can be seen 50 miles from the beacon, twice the distance of an ordinary aerial beacon light, which is useless in foggy weather. The new signal, known as the "rainbow light," is formed of a tube filled with neon gas. The light itself is "cold," producing no heat. While in operation, this tube throws out a deep red beam. Similar to other recent discoveries in the scientific field, the fog-pierc-

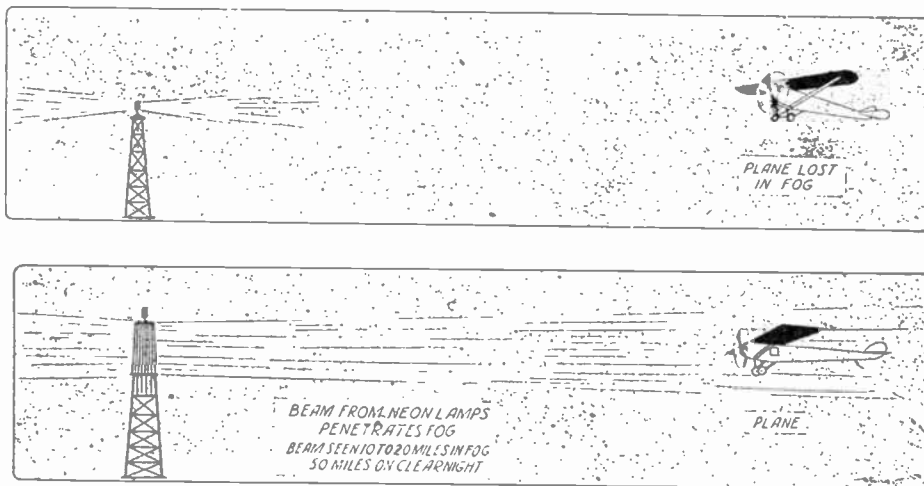

The above illustration shows how a plane would be lost in the fog if an ordinary beacon were used. Below this we see the great penetrating powers of the neon beam, which may be seen from 10 to 20 miles distant.

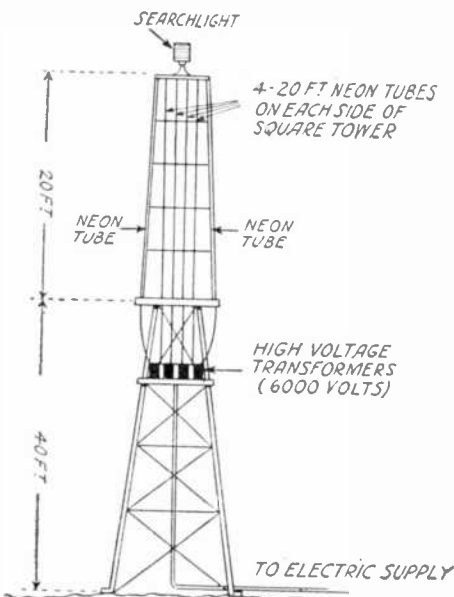

Above is a sketch of neon light beacon at Moline, Ill. On each side of the square tower, four 20 foot neon tubes are arranged.

ing light is a by-product. Neon is obtained as a by-product of liquid air. A diagram appears on this page, showing the construction of a neon beacon which has recently been erected at Moline, Ill. This light consists of sixteen 20-foot neon tubes, mounted vertically, four on each side of the tower. The lower ends of these tubes are approximately 40 feet from the ground and each tube is about 1 1/4 inches in diameter. The light emitted is a dull reddish glow resulting from the energizing of the tubes filled with neon gas under an electrical pressure of about 6,000 volts.

The government believes that these lights will prove invaluable for landing fields and air route beacons. If these beacons had been in use at Le Bourget Field, Paris, when Byrd flew over the French capital in the darkness and fog, he would have been able to land

will be installed on all government airplane landing fields throughout the country. Reports on these tests will be made to the Secretary of War for Aviation and will also be submitted to the Commerce Department, which will then direct the installation of these beacons at advantageous points. Eventually, beacons will be erected on the Hawaiian aviation field and also at San Francisco. It will be remembered that this was the route followed by Lieuts. Maitland and Hagenberger in their recent flight. The government also contemplates erecting beacons in all the outlying possessions, so that airplane communication will be possible at all times, despite the irregularities of the weather. Mr. Machlett is a son of the late Robert H. Machlett, who perfected an improved type of X-ray tube and was the first manufacturer of these tubes in this country.

How Aircraft May Find Location in Fog

Various Schemes Employing Radio, Infra Red Rays, Giant Voices and Other Methods

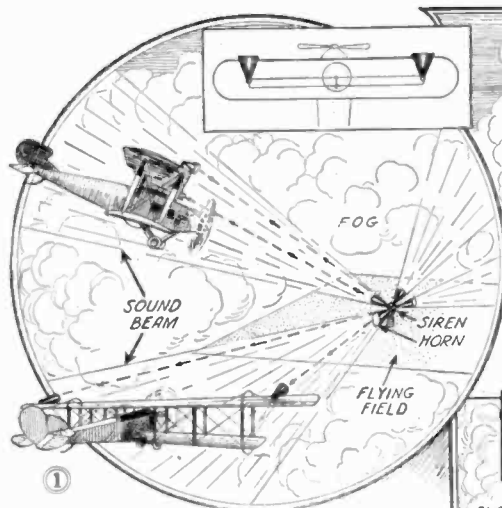

1 The fog beacon for aircraft shown above employs a powerful siren and horns to give directed sound beams. Airplanes carry movable "ears" fitted with microphones and amplifiers. Plane follows sound beam.

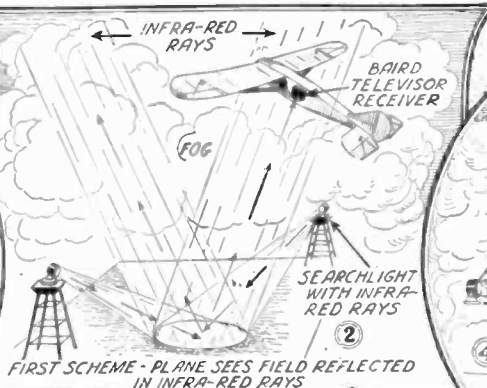

2 FIRST SCHEME - PLANE SEES FIELD REFLECTED IN INFRA-RED RAYS

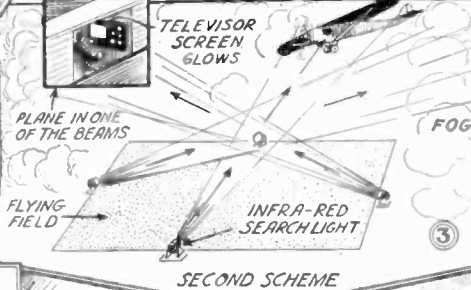
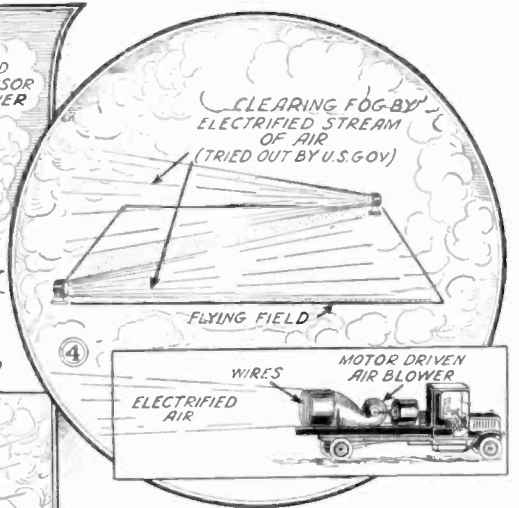

3 TELEVISOR SCREEN GLOWS
4 PLANE IN ONE OF THE BEAMS
5 INFRA-RED SEARCH LIGHT
6 FLYING FIELD

4 CLEARING FOG BY ELECTRIFIED STREAM OF AIR (TRIED OUT BY U.S. GOV)
5 FLYING FIELD
6 WIRES
7 MOTOR DRIVEN AIR BLOWER
8 ELECTRIFIED AIR

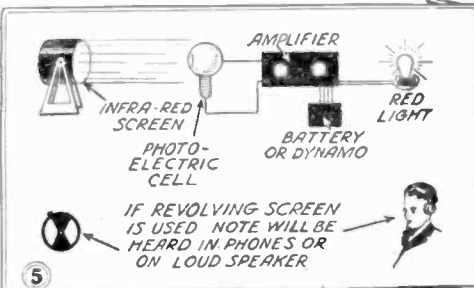

5 Infra red searchlight beams and Baird tele- visors are suggested in Figs. 2 and 3 above. In Fig. 2 the pilot could see the field in a fog; in Fig. 3 he would see a screen signal as long as he flew along a beam.

6 TO RADIO SET ON FLYING FIELD
7 RADIO BEAM
8 RADIO RECEIVING SET ON PLANE

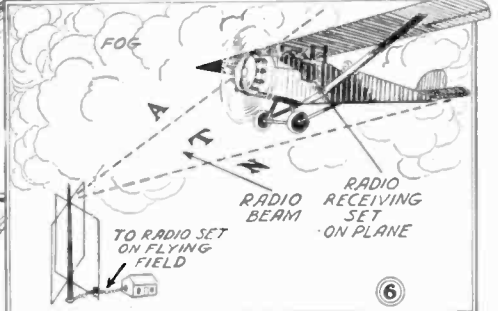
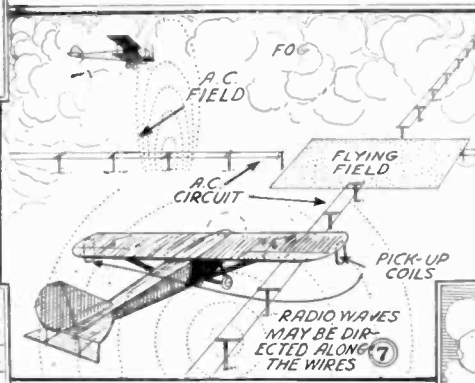

7 Above we see the fairly well-known radio beam direction indicator which is now in use. The pilot endeavors to keep the plane flying along the path of the "T" signal. Receipt of "A" and "N" signals indicate he is north or south of the course.

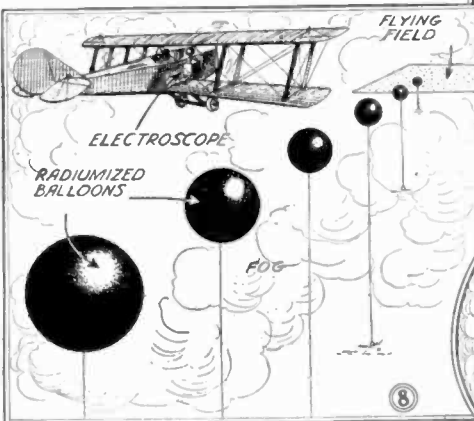

8 One of the New York to Paris fliers, stated that he believed one scheme which might have helped to land the "America" in Paris, was that involving the use of a number of gas-filled balloons anchored to the ground. Just how these balloons were to be seen by the aviators while flying in a heavy fog is not quite clear, unless they depended upon accidentally bumping into them, or else spotting them where the fog might not be so thick, with the aid of the electric landing lights carried on most airplanes to-day. Above: Mr. Joseph H. Kraus suggests radiumized balloons and a gold leaf electro-scope carried on the plane; when the gold leaves collapse the radium is close by.

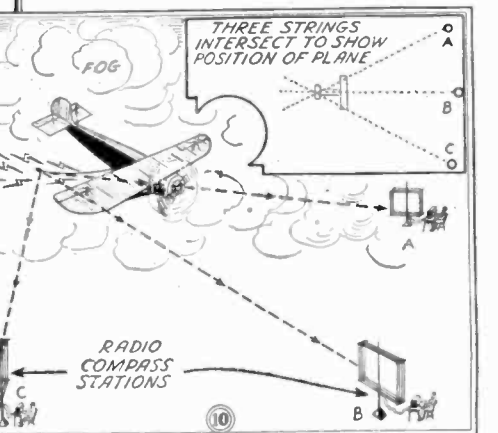
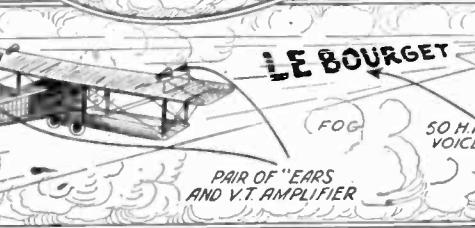
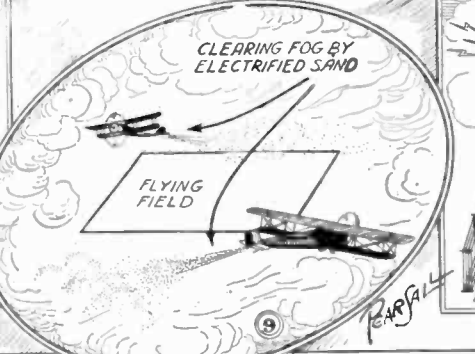

9 In the center picture at Fig. 7 one practical method of leading "blind" aircraft to a flying field during foggy weather is shown. The first idea is to equip an airplane with pick-up coils and amplifier, so as to hear the resulting sound due to intercepting the alternating current magnetic field along a wire. The second scheme would be to pass radio waves along such wires, the plane picking up the guiding wave by means of suitable apparatus. Fig. 9 shows fog being cleared by dropping electrified sand from the planes, already successfully demonstrated. Fig. 10 shows how three listening stations on land can locate an airplane from its radio signal.

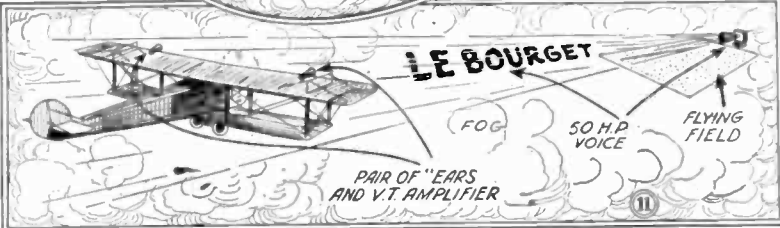

11 A giant voice which could be heard for several miles, is another scheme recently proposed to aid airplane crews in landing their ships in foggy or stormy weather. Recently an airplane with a "one kilowatt voice" flew over New York and vicinity, and the voice was easily heard by people on the ground, even on windy days. If a plane carried a pair of microphone "ears" and a vacuum tube amplifier it could hear a 50 H. P. voice for several miles.

How Movie "Film" is Made

Successive Steps in Manufacture Shown in Pictures

The panorama strip shown here illustrates the successive steps which have to be gone through, before the finished film is ready for use. Beginning with a branch of raw cotton, we see how the mucilaginous matter is removed, the cotton treated with nitric and sulphuric acid, followed by a hydraulic process. The liquid celluloid is then poured upon a heated cylinder in the shaping machine, which brings it into the form of a celluloid film. The strip is next sub-layered and then given a coating of light-sensitive emulsion. Heating the emulsion with ammonia increases its light sensitiveness and after it is cooled, it is cut up into "noodles" and thoroughly washed. The emulsion noodles are dried and are then melted by gentle heat and eventually heated with dye to give them sensitiveness to color. The emulsion now, almost ready for use, is taken to the pouring machine.

A branch of the cotton plant from which film is made is shown in Fig. 1.

Fig. 2 shows the baled cotton ready for shipment to the factory. The cotton is first treated with a caustic potash solution.

In Fig. 3 we see the centrifuging of the raw cotton with caustic potash for the removing of mucilaginous matter. After this, the cotton is removed and dried.

The next step in the process is the treatment with nitric and sulphuric acid which results in a damp gun cotton.

The damp gun cotton is next irrigated with alcohol, followed by pressure in a hydraulic press. This step is shown in Fig. 5.

The solution of dry gun cotton in ether and alcohol is next treated with camphor.

The treatment with camphor gives a syrupy celluloid which is next removed to the shaping machine, and emerges in the shape of a celluloid film.

In Fig. 8 we see how the ribbon is treated with a material which will cause the photographic emulsion to adhere better.

A warm gelatin solution containing potassium iodide and bromide is treated with silver nitrate, producing a slightly light-sensitive emulsion.

The emulsion is cut up into little cubes and then irrigated with water.

The emulsion is next heated with ammonia, thereby increasing its sensitiveness. Process shown in Fig. 11.

After heating with ammonia, the emulsion is cooled as quickly as possible. Processes 11 and 12 are for light-sensitiveness, permanency and gradation. A specially built cooler is employed for this process, and may be seen in Fig. 12. The emulsion is placed in brine and thus is thoroughly chilled.

After chilling, the emulsion is again cut up into "noodles" and thoroughly washed. The emulsion noodles are then dried and melted at a gentle heat, and eventually treated with a dye to give them sensitiveness to color. The emulsion is now almost ready for use and is taken to the pouring machine. The emulsion noodles are shown in Fig. 13 and Fig. 14 shows the pouring machine and the subsequent process which the film undergoes here. This emulsion is poured upon the film in an even layer, the film having been previously sub-layered.

The finished film is cut into strips 1 inch wide, perforated, that is, with holes along its sides for the toothed wheel of the feeding apparatus in the projecting machine. In every factory, large quantities of the material are subjected to severe tests. The finished film is now ready for delivery and it is packed into a tin can which is tightly sealed. The above 15 processes show in detail the successive steps which the raw cotton undergoes before the finished film is ready for delivery.

Courtesy Die Umschau



The roll film produced in Germany for one year would encircle the earth seven times.

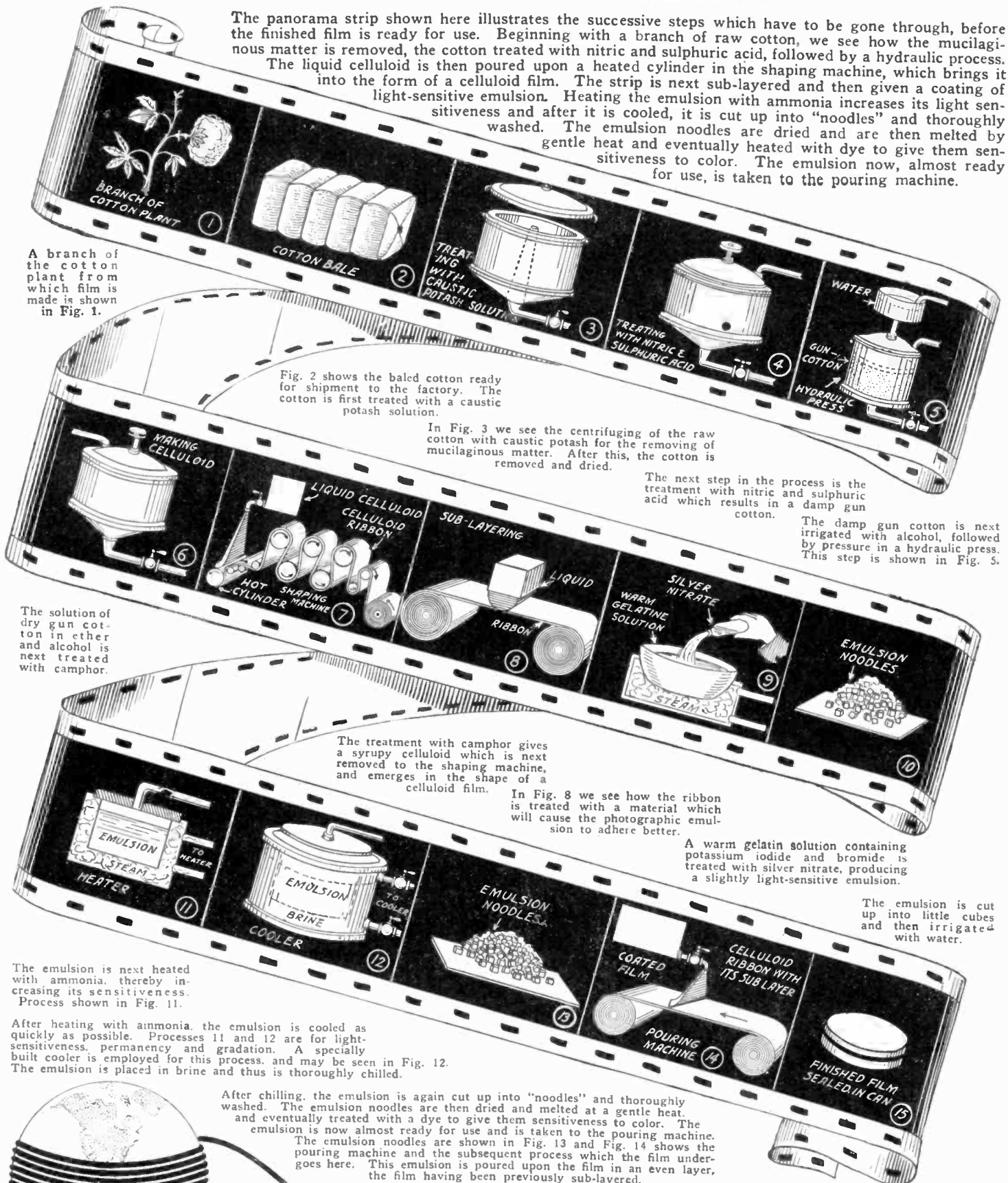

Flowers for the Winter

How to Make a Small Greenhouse Which Can Be Placed in Any Room

By DR. ERNEST BADE

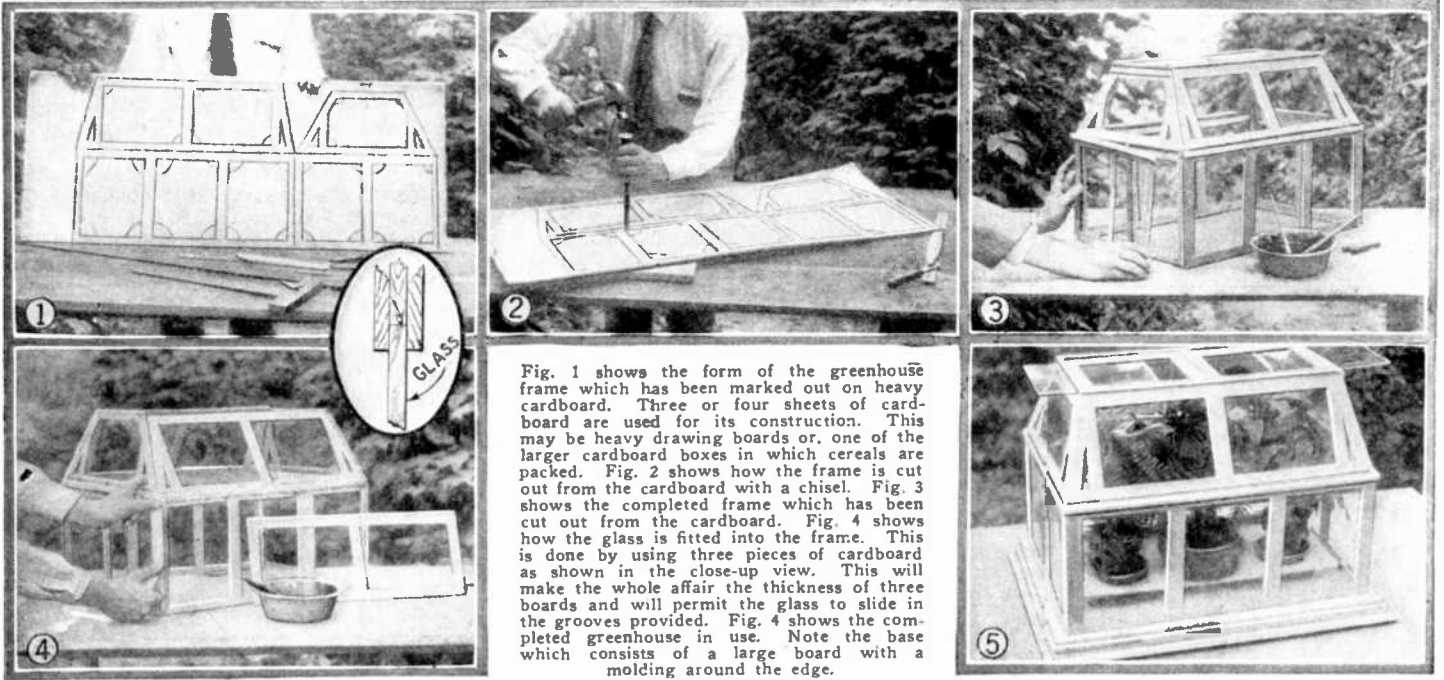

Fig. 1 shows the form of the greenhouse frame which has been marked out on heavy cardboard. Three or four sheets of cardboard are used for its construction. This may be heavy drawing boards or, one of the larger cardboard boxes in which cereals are packed. Fig. 2 shows how the frame is cut out from the cardboard with a chisel. Fig. 3 shows the completed frame which has been cut out from the cardboard. Fig. 4 shows how the glass is fitted into the frame. This is done by using three pieces of cardboard as shown in the close-up view. This will make the whole affair the thickness of three boards and will permit the glass to slide in the grooves provided. Fig. 4 shows the completed greenhouse in use. Note the base which consists of a large board with a molding around the edge.

GREENHOUSES are primarily used for the cultivation of exotic plants and secondarily for the cultivation and propagation of commoner flowering plants during the colder seasons of the year. The latter types of plants may be successfully grown in almost any window garden, that is, near a window in a warm room during the winter months. But those plants which are native to tropical and sub-tropical regions will refuse to grow under such primitive conditions. They require not only more heat, but more atmospheric moisture and this can only be given in sufficient quantities in a greenhouse.

Such a greenhouse need not be large nor extensive. It may be quite small, in fact just large enough to accommodate one plant. Here we have the simplest kind of a greenhouse providing atmospheric moisture and heat. This type is quite often used for the raising of seedlings and the propagation of plants by cuttings. It is simplicity itself—a flowerpot or other container covered with a piece of glass.

Another more elaborate miniature greenhouse may be built into a window. This is nothing more than a frame, more or less square at the bottom, with sides rising about ten inches at all four sides, the whole surmounted by a movable window sloping down and outward. The plants are placed within this glass covered enclosure and they grow just as in the greenhouse for the sun heats the air in the container while the air itself is saturated with moisture. Ventilation is provided by lifting the window. This also controls the moisture content of the enclosed atmosphere.

Such a miniature greenhouse has its disadvantages in that it is fixed in place and must remain when not in use. In addition the air is not as warm as might be desirable, as it is exposed to the outer atmosphere even though insulated by glass. Some of the plants that will grow here are Phylica, Cyclamen, Daphne, Erica, Epacris, Rhododendron, Camellia, Mimosa, (sensitive plant) Azalea, Bignonia Jasminoides, etc.

A still better greenhouse, one in which tropical and sub-tropical plants can be cul-

tivated throughout the year may be easily constructed and, when finished, placed in the window of any room where it is warm and where the plants it contains will receive sunlight. In addition to the exotic plants all and any of our more northern types may be planted, even ferns and mosses.

Three or four large sheets of cardboard are used in its construction. This may be heavy drawing boards or, which is better still, one of the larger cardboard boxes in which cereals are packed. Such an empty box may be obtained for the asking in any of the grocery stores. If the finished greenhouse is to measure at least three feet long and about one and a half to two feet wide, then take wall-board which is also a heavy fibre board and is easily worked. This is obtained from houses' selling building material.

Lay out the front and side with ruler and pencil just as you want it. Make the opening as large as the glass that you have or make your whole greenhouse and then buy the glass to fit. After laying out all four sides and top, cut out the edges first. This

is best done with a chisel. After the corners are out, take a sharp knife and cut along the lines. In this way the entire frame is cut out. Before assembling the frame, the glass must be fitted and this is done by taking a smaller frame than that cut out, gluing it to the original one, and gluing a third piece, the size of the original frame on top. This will make the whole affair the thickness of three boards, and will permit the glass to slide in the grooves provided.

After all parts have been cut out, the frame is glued together, the edges being all glued and thin strips of cloth or tape placed over each corner. This not only enhances the appearance of the finished house, but also greatly increases its strength.

After the glue has dried, the entire structure is painted, both inside and out, so that moisture will not weaken the fibres. At least three coats should be applied, waiting until each coat is absolutely dry before the next is applied.

In the meanwhile the base is made. This consists of a large board, or a number of smaller ones grooved and glued together with a molding all around the edges. This base board is also painted. The plants are not placed upon it but upon a shelf or tray. This fits within the frame of the miniature greenhouse. If different sized plants are to be grown and cultivated, a terraced frame is used. This consists of two or three steps, with boards across them. The largest plants are here placed in front while the smaller ones are placed behind upon the steps. If desired the entire assemblage of plants may be placed upon the flat tray, then the smaller are placed in front with the larger ones in the rear.

This is a real miniature greenhouse and cacti, orchids and other exotic plants may be successfully cultivated if the tiny house is placed near a window and if it is kept in a warm room during the colder season of the year. Of course other plants may also be grown and it will be of excellent service in the propagation of different kinds of plants by the various methods available, such as leaf cuttings, cuttings, etc.

PHONEY PATENTS

OUR old friends will remember the useless and brainless, but side-splitting inventions that appeared in the old **ELECTRICAL EXPERIMENTER** Magazine in the Phoney Patents Department. They are with us again, uproariously funny, and cleverer than ever, in the new **FRENCH HUMOR** Magazine, now on sale at all newsstands for 10c per copy.

\$3.00 a week is paid for the best Phoney Patent. Get in on this now. If you haven't got acquainted with this new breezy laugh-tickler, be sure to reserve your copies at once. Buy a sample copy today.



Conducted by GEORGE A. LUERS

DO YOU KNOW—

some of the new liquid carbon removers cause much difficulty in starting the engine after use. The safe method is to use it in one cylinder at a time, being sure none gets into the intake manifold. Start the engine after each cylinder is decarbonized.

PROTECTING AGAINST THE EXTREME SUMMER HEAT

If the car owner would overcome the main difficulties of hot weather troubles, a few simple rules to follow, are all that is required to drive through the hottest days without giving extra attention to the car or stopping under shade trees frequently to cool off. Personal comfort depends upon protection from engine heat and sun heat. A sheet of stove pipe asbestos under the floor boards at the driver's section of the car, keeps back engine heat. A small block at the rear edges of the engine hoods, aids the louvers in carrying the engine heat outside.

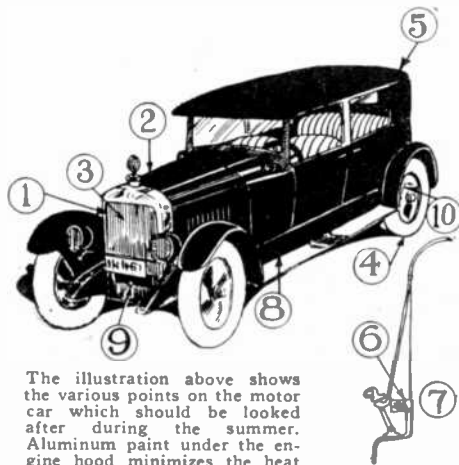

The illustration above shows the various points on the motor car which should be looked after during the summer. Aluminum paint under the engine hood minimizes the heat from the sun's rays (2). Soft rain water should be used in the radiator during the summer (1). Brakes should be free from the drums (10) and the tires should be inflated to their capacity (4). Aluminum paint may be used on the car top (5) and will do much to reflect the sun's rays. The water pump (8) should be positive in its drive and the fan belt (3) should be tightened. These rules are not difficult to apply and the resulting comfort will be entirely satisfactory.

Aluminum paint under the engine hood, keeps the sun's rays from adding to the engine heat. Soft rain water in the radiator, should be used in hot weather. Never use hard or water containing lime. The fan blades may be more effective if bent to a greater angle. A good clean fan belt, quite tight is a great aid to cooling. The pump should be positive drive and should be inspected to make certain that the pump vanes are not loose on the shaft. Brakes should be free from the drums, enough so that a visiting card will pass between the band and the drum in all positions.

Regardless of the type of tire, balloon or high pressure, in summer they should be up to and even slightly in excess of recommended pressure, so to avoid a car drag which exacts additional engine power to propel the car.

The last detail, which is that of top paint, is the use of aluminum paint on the car roof

which is recommended by several authorities on account of its ability to reflect heat. Aluminum paint will not reflect heat rays if it is painted over with dark paint.

BATTERY POST AND TERMINAL CLEANER

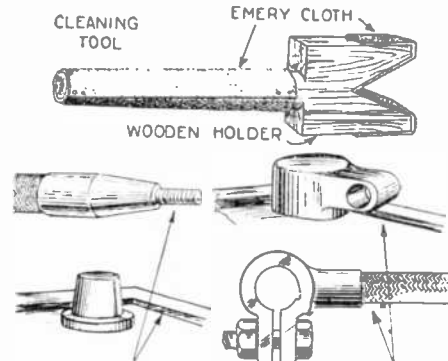

THE TOOL CLEANS THESE VARIOUS FORMS OF BATTERY CONNECTORS

The tool shown above will be found useful in cleaning battery posts and terminals. Hard wood is used for the holder which is covered with emery cloth.

A piece of oak or other hard wood, is made into a cone at one end and the opposite end is cut with a "V" groove.

Emery cloth is glued on the tapered point and a strip is placed to fold into the groove.

With this tool, the terminal end or post is quickly polished off, while the tapered end will as quickly smooth and polish the inside of the socket connection.

AIDS TO CRANKING NEW AND STIFF ENGINES

Both new and overhauled engines, especially those of six and eight cylinders, are difficult to crank, due to tight bearings and pistons.

Towing with another car, is not always resultful, for a tight engine will slide the car wheels, without turning them.

Two methods of cranking stiff engines are shown in the attached sketch, which methods are shop ideas, but worth adoption for the

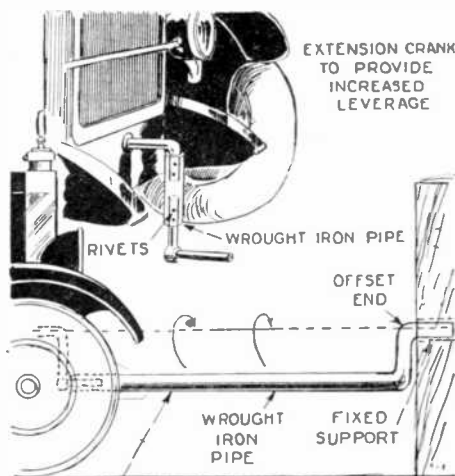

PIPE HANDLE OF SUFFICIENT LENGTH TO PROVIDE CRANKING SPACE FOR 2 OR MORE MEN

The above illustration shows two ways in which a stiff or new engine may be cranked with ease.

private owner, that he may get the stiff engine started, so that it will limber up the bearings by running under its own power.

The first method shown, is that of cutting a crank, and inserting in the handle an extension of four or five inches, to increase the length and gain more leverage. This extension is easily made from a piece of galvanized iron pipe, riveting the ends solidly to the crank.

The second means is with a piece of bent galvanized iron pipe, forming a hand hold for two or more, to turn against the starting crank of the car. The offset end, as shown in the sketch, is the same as the starting crank of the car. This offset end is inserted in a hole in a post, shop bench or other solid support to stay it while the crank bar is swung around.

HEATING HUB HELPS PULLER ON STUBBORN WHEELS

Where discs or other types of automobile wheels fail to respond to the lone efforts of the wheel puller, try heating the hub with a blow torch, while the puller is in place and the screw of the puller is set up tight.

This heating will invariably expand the hub just enough to start the wheel. Immediately it starts, no further trouble will occur, as the taper of the shaft, frees it immediately.

The heating is only to a moderate temperature, or around the point where a drop of water on the hub will just turn to steam. This means is used in a shop, servicing large eight cylinder cars. The wheels necessarily are tight, but this aid to the puller never fails to loosen them.

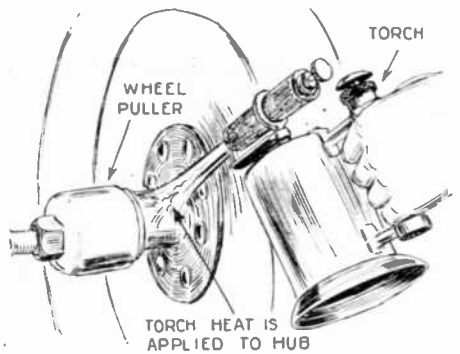

TORCH HEAT, IN ADDITION TO WHEEL PULLER WILL REMOVE WHEELS STUCK ON TAPERED SHAFTS.

When automobile wheels stick to the hub, the above wrinkle will prove to be useful. The heat invariably expands the hub so that the wheel can be pulled off.

WINDSHIELD FOR RUMBLE SEAT PASSENGERS

To protect passengers in the rumble or tonneau seat of a small roadster one owner has constructed a simple and effective shield, as shown in the accompanying drawing.

This shield is removable, being inserted in socket holes in the rear deck when in use and stowed in the rear compartment, along with the seat when not in use.

It is made from a length of quarter inch iron pipe, bent and fitted with a wooden base. Celluloid is sewed to a section of rubberized curtain material and the edges of this are

(Continued on page 555)

Matchcraft Contest

\$100.00 in Awards

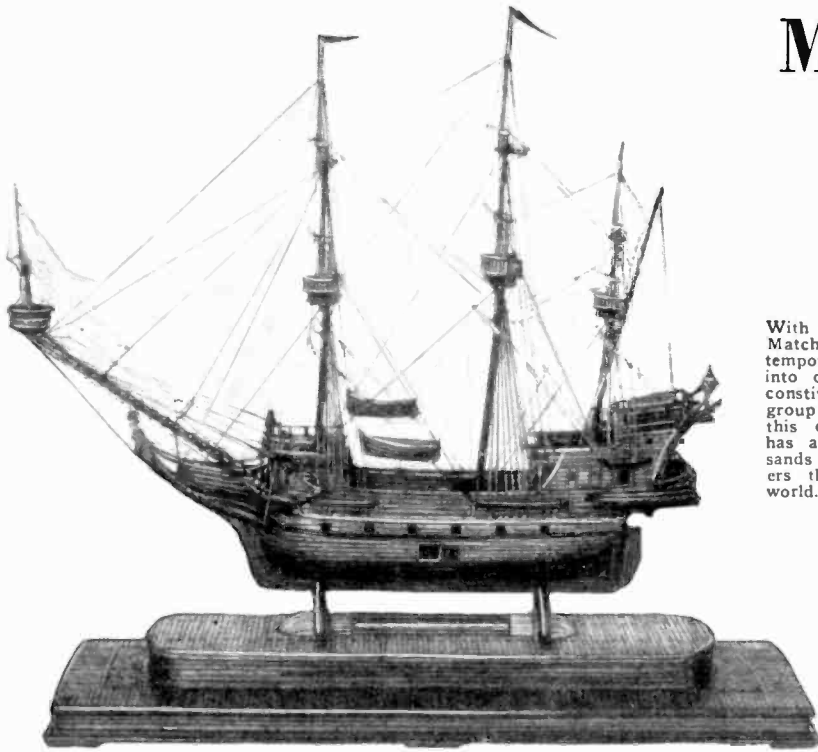

With this issue the Matchcraft Contest temporarily rides into oblivion. This constitutes the last group of awards in this contest which has attracted thousands of matchcrafters throughout the world.

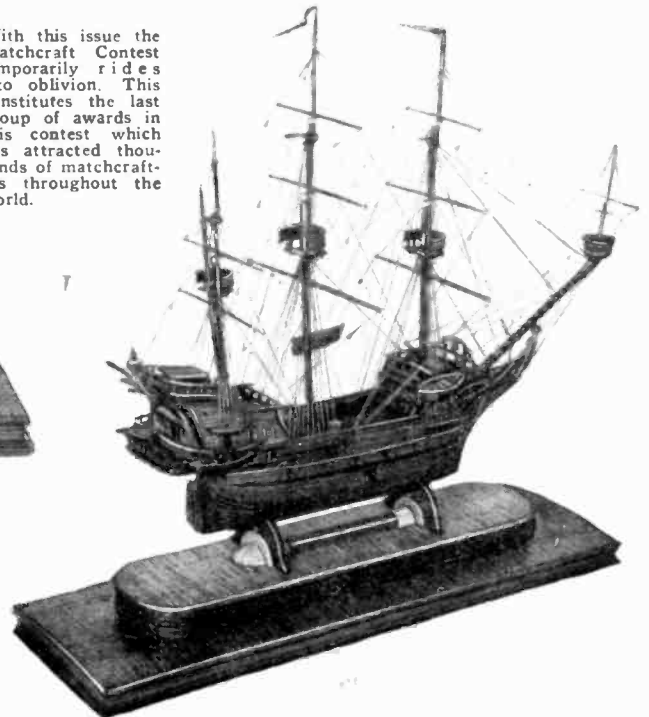

To enhance the artistic effect ink in various colors is used both on the ship and base.

First prize—\$50.00 in this, the final month's contest, to that remarkable genius of matchcraft and art, Mr. Raphael Gueril, of Brooklyn, N. Y. It is a model of an ancient war vessel 15 inches long and 15½ inches wide including the base. There are six small guns mounted on either side on the gun deck, and one considerably heavier pokes its nose through the opened port about amidships. The vessel is complete in every detail even to the figure head at the bow. The rowboats are provided with seats and with rudders. The crow's nests on the masts are artistically decorated.



Fifth prize—\$5.00 was won by G. Copeland, of Boston, Mass., for the rose illustrated here.

A matchcrafter whose name has consistently appeared in the columns of this publication because of his splendid work, is Fred Spinden, of Abingdon, Mass., who in this, the last contest of the series, again wins an award. Here is a full size sugar bowl fringed with a matchcraft border which called for an award of the fourth prize—\$10.00. There are several other names which matchcrafters will miss from the list of awards announced in this issue, names with which they have become familiar.

Third prize—\$15.00 was awarded to Robert L. Ratte, of Springfield, Mass., for the violin constructed of matches and illustrated at the right. Only the finger board and the tail piece of this model are made of different wood.



Photo shows a front view of the match violin.

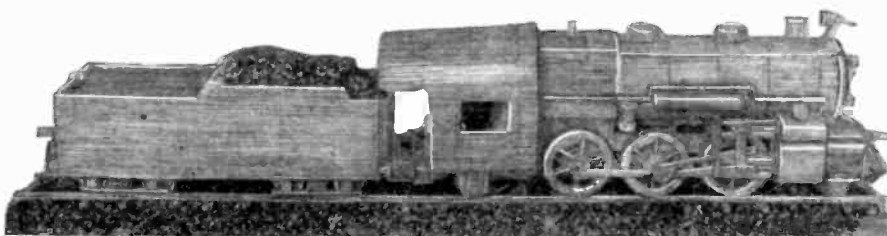

Second prize, \$20.00—Here is a model locomotive, constructed of one hundred per cent safety matches and glue. It took about eight months of spare time to build it and no blueprint was required in its construction, the imagination being drawn upon. There are fifteen thousand matches in the complete model, and the firebox door opens, the wheels turn, and the valves move when the model is pushed along its tracks. The builder was Mr. Leroy Crompton, of Newark, Delaware. The entire model is thirty-one inches long, and the bed, also made of matches, is but a trifle longer. The wheels are made by placing the matches crosswise on the flange and lengthwise on the spokes. The imitation coal in the tender, as well as on the road bed, is made of match heads.

Wirekraft

\$3,000.00

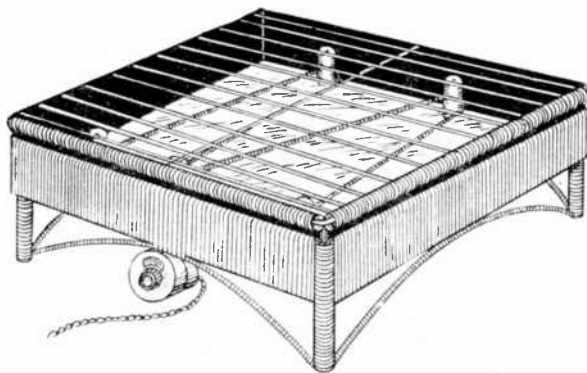

←←← This remarkable working model of an electric stove is constructed of wire. The only parts not being made of wire in this apparatus are the insulators and the switch mounted on the front. It produces a remarkable heat and because of its neat construction, is a very useful article in the home.

↑ First prize—\$100.00 was awarded to Harold Jackson, of Kankakee, Ill., for his model of an electric stove. It is constructed of heavy iron wire neatly worked into a square frame and equipped with a grill on which pans or bread for toasting may be placed. The resistance unit is composed of a long spiral spring of resistance wire mounted on porcelain insulators as shown. It was constructed by first building a frame of heavy wire and then wrapping finer wire around the frame to strengthen it and improve its appearance.

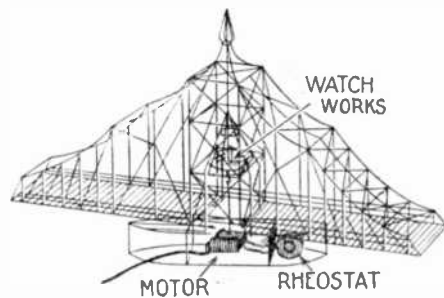

↑ Fourth prize—\$20.00 has been awarded to Selmer Wick, of Superior, Wis., for this interesting model of a drawbridge. It is a working model containing a motor also made entirely of wire. The gearing box has been cleverly adapted from an old watch by removing the spring and some of the gears and leaving just those needed. The motor operates from a six volt battery and the constructor fastened a rheostat on the frame so that the speed of rotation could be varied.

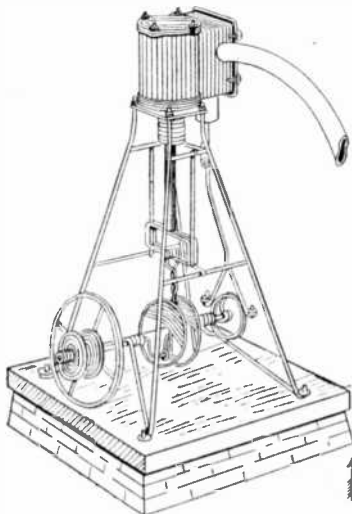

↑ Fifth prize—\$15.00. This interesting working model of a stationary steam engine, which has been awarded the fifth prize, was constructed by Frank Frumviller, of Detroit, Mich. It is constructed of square radio bus bar and brass and copper wire. It operates at a remarkable speed when driven by steam or compressed air. The single cylinder of this engine is constructed of two layers of wire soldered and filed remarkably smooth. The piston is constructed of a spiral of wire soldered to a smooth brass rod.

→ Eighth prize—\$5.00 was awarded to H. Heft, of Cincinnati, Ohio. It is an iron stand constructed of iron wire. The legs and outer frame are bent from one piece and the cross-work grille is made of finer wire. It is equipped with an asbestos pad to keep the heat of the iron from scorching the table top or ironing board. This strong, well-constructed model will appeal particularly to the housewife.

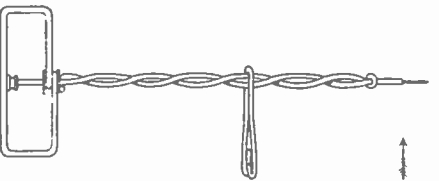

↑ Third prize—\$25.00 was won by J. A. Brooks, of Jay, Texas, for his wirekraft hand drill. This model is entirely constructed of brass wire and comprises a very useful article for the cabinet maker or radio constructor. The bit has been made from a needle filed flat to penetrate wood or soft metal. It is operated by moving the slider up and down, thus turning the bit back and forth.

←←← Second prize—\$50.00 was awarded to David Ferdinando, of Camp Lewis, Wash., for his basket. It is constructed of copper wire carefully woven into the shape shown in the illustration at the left. A heavy copper frame was first constructed and then finer wire was carefully woven around the heavy frame to complete the basket. It is very rigidly constructed and will be quite useful to hold a plant pot or a dish for fruit.

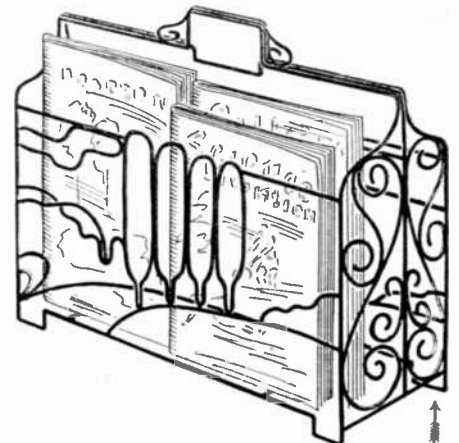

↑ Seventh prize—\$7.50 was won by Algot Anderson, Topeka, Kansas. It is a handy magazine and newspaper rack constructed of heavy iron wire and enameled black. It has been very neatly soldered together and comprises a very light durable, and useful article. One can keep all the current magazines and newspapers in this rack instead of having them strewn over the house. In this way you are assured of having the magazine you want without having to hunt for it. It is arranged with a partition through the middle to separate the different types of magazines and newspapers. Equipped with the handle, it may be conveniently moved from place to place in the living room, so that anyone may have the magazine he wishes.

Because of popular request the Wirekraft contest will be discontinued with the last group of awards to be announced in the next issue of SCIENCE AND INVENTION Magazine.

If you have not already entered your wirekraft model, it is now too late for it to win any of the prizes.

Don't fail to look for the Prize Winners in the November issue.

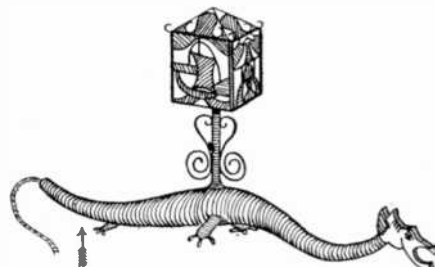

↑ Sixth prize—\$10.00 was won by G. A. Jones, of Urbana, Ill., for his wirekraft dragon lamp. It is a decorative as well as useful article being strongly constructed and carefully painted. The shade is constructed of a wire frame under which has been fastened parchment paper painted in a unique design. It is equipped with a lamp cord, so that it may be connected to a wall socket.

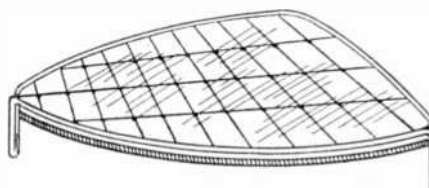

→ Ninth prize—\$3.50 was awarded to Clifford J. Cartwright, of Flint, Mich., for his candlesticks. They are very well constructed of round radio bus bar, neatly soldered. The design is very artistic and unique. These candlesticks will be worthy of the mantel-piece or library table in anyone's home.

Contest in Prizes

This very handy bank in the form of a safe is entirely constructed from wire. It has been carefully gilded to give it a neat appearance.

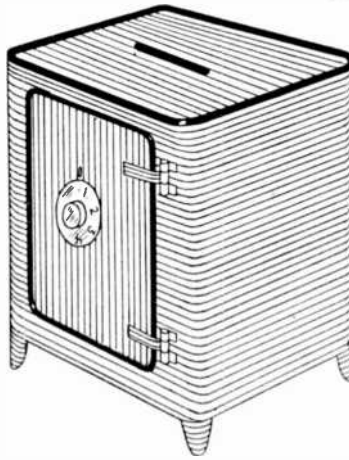

Eleventh prize — \$2.00 has been awarded to E. J. Raible, of Louisville, Ky. It is a very handy bank with a slot in the top to receive the coin and a door which is secured by a combination lock. This lock is an ingenious contrivance composed of two slotted washers made of wire which allow the door to open when in the correct position. It has been carefully soldered and painted and comprises both a useful and ornamental object.

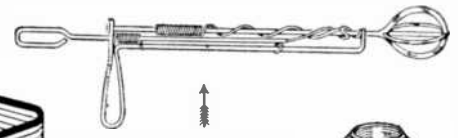

Twelfth prize — \$2.00. This egg beater constructed by Jose Ant. Munos, of Brooklyn, N. Y., is constructed of heavy iron wire. It is arranged with a spiral drive, so that by raising and lowering the handle the beater is made to operate.



Thirteenth prize — \$2.00 was awarded to Olaf Wick, of Superior, Wis. It is built of iron wire gilded to improve the appearance. The shade is made of wire covered with gold cloth and the wire ribs covered with binding.

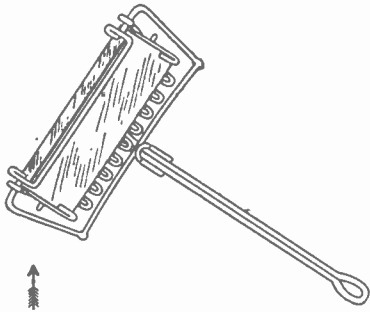

Tenth prize — \$2.00 was won by Samuel Weiss, of New York City. It is a safety razor made of round radio bus bar wire. It is arranged so that the blade may be removed very easily and is quite a useful article. The gem type of razor blades are used.

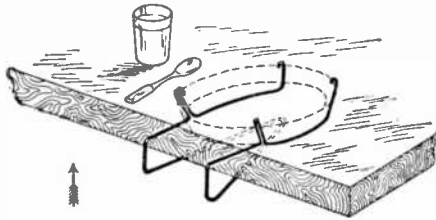

Fifteenth prize — \$2.00 was awarded to Maude E. Duke, of Hotchkiss, Colo. This device is the invention of Charles F. Holybee, also of Hotchkiss. As may be seen, it is a clamp arranged to hold a dinner plate securely to the table and is particularly adapted for use on small boats when the water is rough.

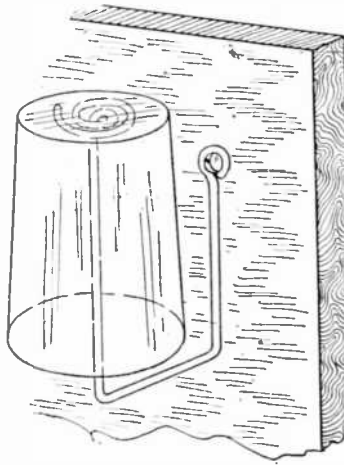

Fourteenth prize — \$2.00 was won by Gertrude Starha, of St. Paul, Minn. This is a tumbler holder, very simply built of one piece of wire as shown. It is arranged so that it may be screwed to the wall and the inverted glass placed over it. The advantages of this type of glass holder are obvious. Dust cannot collect inside of the glass and water will drip off the edge of the glass automatically drying it after use. A number of these hooks fastened in a row at the back of the closet will make a very handy rack for the tumblers.

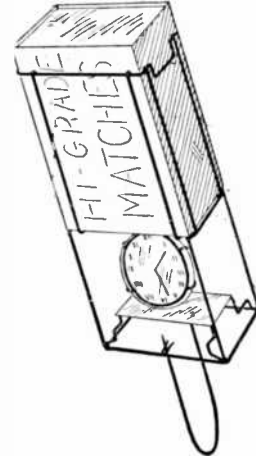

Sixteenth prize — \$2.00 was awarded to Johan Zeleznik, of Bridgeport, Ohio. It is a combination kitchen article, designed to hold a match box, a watch, and newspapers or bills. It is constructed of iron wire painted red. This unique combination could easily be duplicated by any reader.

RULES OF WIREKRAFT CONTEST ON WHICH AWARDS WERE BASED

THIS is a wirekraft contest. Hence wire is to be used in the construction of all of the models entered in this contest.

The size of the wire to be employed is limited. The heaviest wire must not be larger than No. 8 American or B and S gauge, and the smallest no smaller than No. 30 B and S gauge—or (for foreign countries not having these exact sizes), the nearest available equivalent.

No. 8 B and S gauge is .12849 inches in diameter or 3.264 millimeters. Its nearest equivalent in the Birmingham or Stubbs iron wire gauge is No. 18. In the Stubbs steel wire gauge it is No. 30; in the British Imperial Standard it is No. 10. The nearest wire to No. 30 B and S gauge which is .01002 inches or .2546 millimeters in diameter is No. 31 in the Birmingham or Stubbs iron wire gauge. In the Stubbs steel wire gauge it is No. 80; in the British Standard it is No. 33.

The builder may avail himself of the opportunity of using any intermediate sizes of wires between No. 8 and No. 30, B and S gauge.

The wire may be copper, brass, iron, steel, or these materials coppered, tinned, nickel-plated, or galvanized, or the wire may consist of an alloy. Any kind of wire available on the market may be employed.

It is preferable to use non-rusting wires. The publishers will not be responsible for the rusting of any model. To protect wire which rusts easily or for color effects, the models may be painted, lacquered, varnished or otherwise covered.

Any additional decorations or accessories may be employed to enhance the effect. (Example: Silk on a lamp shade; glass in decorative fixtures; electric motors for operating mechanisms, etc.)

Only those portions actually constructed of wire will be judged.

(Example: A red basket is suspended from a wire chain. The basket not being made of wire is NOT considered. On the

merits of the chain only will the prize be awarded.)

Wires may be twisted, spliced, soldered, welded or bound together. Wire may be used to bind other wires together. If soldered a non-corrosive soldering flux should be employed.

There is no limit to the size of the models which may be entered nor to the number of entries which any maker may submit during any calendar month.

In every case the model must be forwarded express prepaid to SCIENCE AND IN-

vention Magazine. It may be a replica of an existing object or a model of an imaginative object or effect.

The remaining prizes will be judged from either one or the other viewpoints at the discretion of the judges.

All models may remain at the office of this publication until the close of the contest at the discretion of the editors.

Due to popular request the Wirekraft Contest will be discontinued for the present. All models must be in our hands before the 1st of September to be entered in the August contest. Winners for August will be announced in the November issue. This will constitute the last group of awards.

Tools Required

THE tools required for the construction of Wirekraft articles are described in the Dec. issue of this publication, a reprint of which will be sent free upon request. The following tools may be used advantageously:

1 pair flat-nosed pliers, 1 pair round-nosed pliers, 1 wire cutter, 1 hacksaw, 1 small vise, 1 soldering iron.

The materials which are necessary are:

Solder, soldering paste or flux, nails, one piece of wood, and most important of all, wire of the sizes specified in the contest rules and regulations.

If the builder decides to weld his wires together, a small welding transformer or a storage battery may be used for this purpose. For the formation of long cylinders, a coil winding machine or a lathe may be advantageously employed. Toy motors for the operation of any devices constructed of wire could of course be procured and added to the model and the addition of miniature sockets and bulbs to illuminate the interior of any buildings constructed of wire might also find a place in some of the constructions.

\$3,000.00 In Prizes

Arranged in Monthly Awards

First Prize\$100.00
For Utility Only	
Second Prize50.00
For Artistic, Decorative or Constructive Effect—may be a replica or model of some imaginative or existing object.	
Third Prize25.00
Fourth Prize20.00
Fifth Prize15.00
Sixth Prize10.00
Seventh Prize7.50
Eighth Prize5.00
Ninth Prize3.50
10th to 16th Prizes of \$2.00 each14.00
Total\$250.00

VENTION Magazine. It should be tagged with name and address of the maker, who will prepay charges if model is to be returned.

The first prize will always be awarded to a model possessing the greatest utilitarian merits. This must be an object NOT found on the market today.

The second prize will always be awarded to an object possessing the best decorative,

Address all entries to Wirekraft Editor

SCIENCE & INVENTION MAGAZINE
230 Fifth Avenue, New York City



MAGIC "DUNNINGER"



THE MAN WHO MYSTIFIED
 Pres. Coolidge
 Prince of Wales, Ex-President
 Harding, Tatt, Roosevelt,
 and other celebrities
 Writes Exclusively for
SCIENCE AND INVENTION



NO. 55 OF A SERIES.

IMPROVED SPIRIT CLOCK

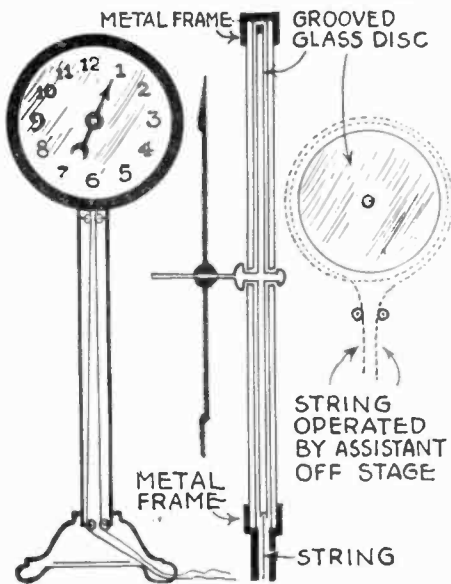

Above is a diagram of the improved spirit clock in which the hand may be commanded to rotate, even though the performer remains at a distance. In this way, the article is much superior to the present style.

IN this version of the spirit clock a large glass dial such as illustrated, is seen resting in a metal frame supported upon a stand. A pointer is examined and fixed to a pin leading from the center of the glass disk. Under mesmeric passes, the hand begins to spin in either direction, stopping at will at any given number. In this way the clock can be made to tell a person's age, pick out cards, and answer questions. The arrangement really consists of three dials of glass, the inner or middle one being in the form of a large pulley, rotated by a string around the periphery which trails off to the assistant.

THE PHANTOM CIGARETTE

IN this effect, the wizard or amateur entertainer can enter upon the scene smoking a cigarette held in a hard rubber or amber holder. Encircling his fingers around the cigarette, even though it is lit, he apparently removes it from the holder and on opening his fist, the cigarette will have mysteriously vanished. Immediately thereafter, closing his hand in the air and drawing it across the holder, he is able to make the cigarette reappear. The effect is accomplished by having the cigarette attached to a sliding cup, which moves in and out of the holder. By sucking on the holder, the cigarette rides in. It can be blown out again.



The construction of the cigarette holder enables the wizard to vanish the cigarette or restore it again at will.

THE MIRACLE SLATE

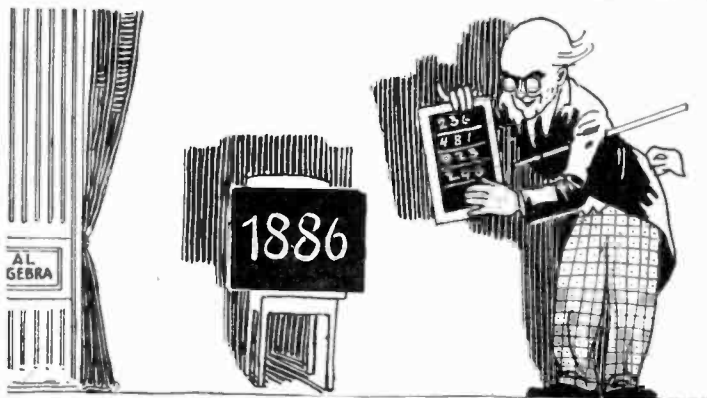

Here is one of those tricks so easy to explain, and yet so remarkable that the audience fairly gasps when they see it. The magician asks four different members of the audience to write down four numbers on a slate. While they are doing this, the magician back on the stage writes a figure on a slate. When the spectators' figures are added up,

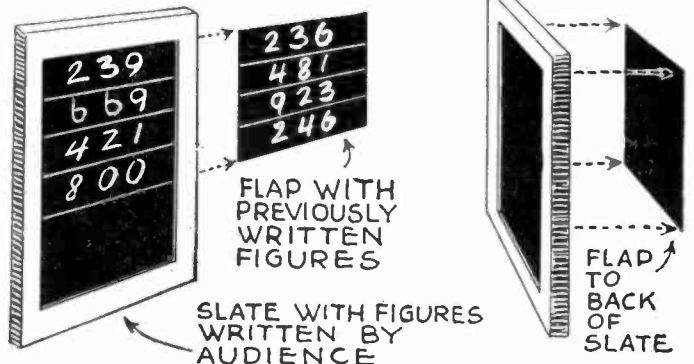

the sum is found to be identical with the number previously written on the magician's slate. The effect is produced by the aid of a thin flap originally concealed in the back of the slate. After four spectators have written their numbers, the fifth is requested to add them up, but he adds up the figures on false flap which is slipped into place before he gets it.

MULTIPLYING MATCHES

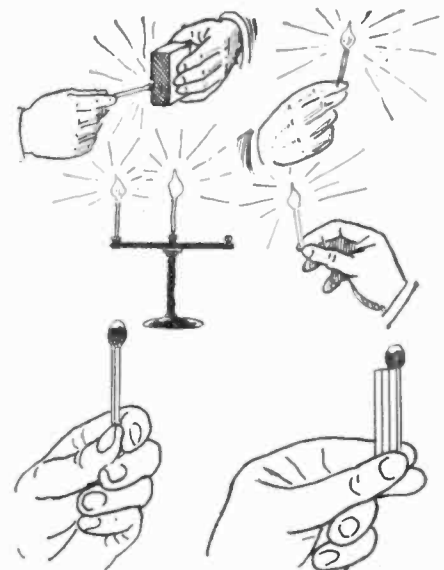

A match is struck on the side of a match box held between the fingers, then apparently split and made up into three matches, which individual splints are put in a suitable holder.

HERE is a simple effect which nevertheless possesses considerable novelty. The magician removes a wooden match from a matchbox and strikes it on the side in a perfectly natural manner. Showing both sides of the hand, he proceeds to grasp the first match which, under his magic touch, multiplies into two. He takes one of these matches, and waving his hand through the air, he again multiplies the match. The trick is worked by having three matches stuck together with bee's wax; two of these have their heads cut off.

Nullified Gravity—A Hoax

IN our issue of September, on page 398, we ran an article entitled "Gravity Nullified," with a subtitle "Quartz Crystals Charged with High Frequency Currents Lose Their Weight." At the end of the article we also ran a line, "Don't Fail to See Our Next Issue Regarding This Marvelous Invention."

Those who were wise evidently must have had their suspicions aroused by the bottom line, and the wiser ones, if they inspected the main photograph carefully, no doubt at once saw the hoax.

The article, which came to us from Germany, appeared originally in a German periodical as an April joke, but it was so excellent that we thought we could take a little liberty with our own readers. The question remains as to how many of our readers were fooled.

If you look closely at the main illustration, which we reproduce herewith, you will observe that the article labeled "1" is nothing more nor less than a microphone with a resistance. "2" is a pair of head receivers, and "3" is an old time German telephone transmitter with a mouthpiece which, in this case, serves the practical joker as a handle. Naturally the critical inspector of the picture must have wondered what two microphones and a pair of head receivers had to do with the Gravity Nullifier. Also the supporting wire does not even touch the ring on the weight. Anyhow, we ask our readers' indulgence for the little hoax, for which we hope to be pardoned because the article surrounding it seemed quite authoritative and contained really a lot of good science tending to hide the hoax.

As a matter of fact, most of the statements are true, with the exception, of course, of those statements referring to the expanded crystal and to the loss of weight

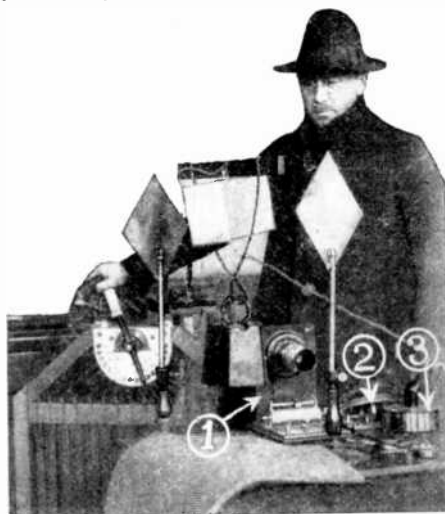

The hoax exposed. 1 is microphone with a resistance, 2 a pair of head phones, and 3, an old German telephone transmitter. Also observe that the supporting wires do not even touch the ring on the weight.

caused by the supposed high frequency currents.

There are so many wonderful things happening in science every day that he who would label anything as impossible may have to take his words back the next day. The

real fact remains that gravity will be nullified sooner or later, and most likely by some such means as shown in the hoax in the September issue. That electricity and gravitation are closely allied no one doubts, and we would therefore not be surprised if even some of our more scientifically inclined readers, who did not pay close attention to some of the details, took the article as authentic.

Scientific hoaxes are no novelty. One of the most famous, which was not exposed as quickly as this one, appeared in no less a paper than the *New York Sun*. At that time, in August, 1835, a certain professor was supposed to have submitted his report on a fantastic moon people to the *Edinburgh Journal of Science*, to which manuscript the *New York Sun* obtained the first rights, and the articles ran consecutively over a period of time. These moon articles, written in a more or less scientific vein, aroused tremendous excitement, and the Moon Hoax was actually believed by thousands upon thousands of people at that time. Needless to say, the *Sun* afterwards exposed its hoax, but even though the newspaper did so, the hoax was still believed by thousands of individuals for years.

The moral is that we should not believe everything that we see, but do a little original thinking ourselves, because we may never know, otherwise, what are facts and what are not.

As a matter of interest to the editors, we would like to hear from you as to your impression of the hoax article, and whether you believed it or not. This will give the editors a good basis for a compilation of interesting facts.

The Astrology Humbug

By JOSEPH H. KRAUS

Further Letters from Our Readers and Our Answers

BEFORE this issue of the magazine is off the newsstands, the Astrology Contest will have closed. We have received cablegrams, telegrams and letters requesting an extension of time and have likewise received many letters to the Astrological Department which, because of their quantity could not be replied to with a personal letter. Vast quantities of these letters are on hand and some of them may ultimately find their way into the pages of this publication. If any astrologer wins the award, no extension could of course be granted. We will know after October 1st.

One group of astrologers tells us that no one can possibly live up to the conditions of our contest and another group informs us that they are sending in the information called for. We wonder why?

Some astrologers accuse us of being biased. Those readers who do not believe in astrology hold that we are decidedly too lenient in our comments.

The controversy on the subject of astrology became much greater than we expected it would. Astrological magazines have published our attacks and arguments against them. We have published some of the arguments and attempted to refute them. Whether or not we have been successful depends entirely upon the opinion of the reader.

There is just one statement that we would like to drive home at this time. The claim has been made that the conditions of our contest are unfair, that no astrologer could possibly live up to them. But the peculiar part is that every astrologer claims to be able to do the very things which we ask them to do. The only additional clause that we insert is that the statements made must be definite and not contradictory. Is this asking too much?

As one result of these articles, Charles Arthur Logan, editor of *Science and Astrology*, a bi-monthly magazine, devoted to the astrological student, announces a prize contest which, as far as the businessman of Roseau, Minn., who posted the award, is concerned, is absolutely safe. The conditions of this contest are:

"\$22,000.00 will be paid to a charitable object for proof that astrology is false."

And this is the proof that is required: "\$10,000.00 in gold or 200 acres of Minnesota's finest land, free from all encumbrances, for proof that the main planet of our solar system has no influence on life or human character."

Now we wonder just exactly what is meant by the main planet of our solar system. The sun itself is not a planet. Astronomically speaking, it is a star; it is a hot self-luminous globe. Compared with

\$6,000.00

For Proofs of Astrology

SCIENCE AND INVENTION Magazine holds that there is nothing scientific in Astrology, that Astrology is not a science and that statements made by astrologers unless very general cannot be entertained seriously.

Accordingly, this publication has decided to award an Astrology Prize for \$6,000 for the following:

\$5,000 will be paid to the astrologer or forecaster who will foretell three major events of such a nature that he will have no control over the outcome of the same. He must describe in advance each event in detail, giving the location and result or the casualties if the event is an accident.

\$1,000 will be paid to the astrologer or forecaster who will produce three accurate, detailed and perfect horoscopes, free of contradictions on the lives of three people whose initials will be given him when he requests the same and the birth dates and place of birth will also be supplied by this office.

This contest closes October 1st, 1927, and all entries must reach us by that time. In event of a tie, prizes of an identical nature will be given those so tying.

Address all entries to Editor, Astrology, care of SCIENCE AND INVENTION Magazine, 230 Fifth Avenue, New York, N. Y.

other stars, it is only of medium size; compared with the earth and the moon, it is enormous and to the earth and the other planets which circle around it, it is the most important of all the heavenly bodies. But, it is not a planet.

If the challenger had inferred the largest planet, then there would probably be only one way in which to demonstrate and that is, remove Jupiter from the heavens, an experiment of which we are not yet capable.

To us the earth itself is the most important planet; to Martians, if such there exist, this earth may be of little or no practical importance, and to Venusians, another planet upon which life probably exists, this earth itself might be just another large moon in the heavens. Which then is the main planet? It therefore follows that this \$10,000.00 in gold and the 200 acres of land will remain in the hands of the challenger, until such time as the contest is so worded that the conditions can be met.

The second portion of this challenge is as follows: "\$12,000.00 or 360 additional acres of Minnesota's best lands for proof that the moon has no influence over the conduct of water, milk, or women." Notice the little "or" inserted by W. Stewart Leech who makes the award.

Scientifically we know that the moon has an effect on water. Tides are undoubtedly directly caused by the moon's attraction for the earth, as well as the sun's attraction for the earth.

We question the possibility of the moon having any influence on women. If the moon had such an influence, then all those living in a certain city should be influenced at one and the same time by the moon and "the organic functions of the reproductive system of both man and woman" should be identical in every case. We know that this is not true.

The article accompanying the awards further requests that any reader experiment with the planting of corn shall plant the corn on May 1, May 3, and May 5. Mr. Logan then asks why the stalk of the first plant is stronger than the second. It may strike Mr. Logan as being rather strange, but the writer planted some flower seeds toward the end of May, and in the early part of June and, although astrologically those plants in June should have been inferior to those in May, the reverse was the case. The moon had nothing to do with this, but the weather did. Under ordinary circumstances the seed that is planted first should naturally be taller

(Continued on page 567)

Handy Electrical Tool Kit

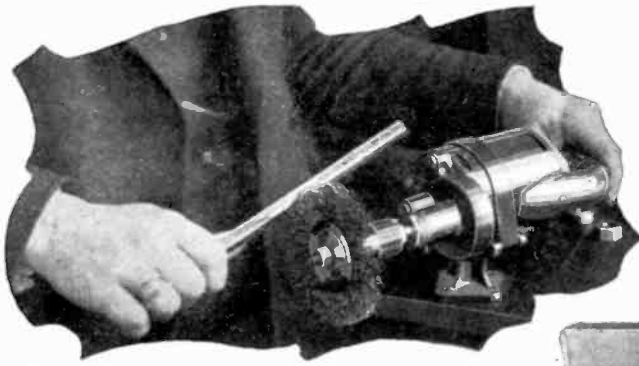

The wire brush is shown in use in the above photograph. The brush is placed in the arbor between the flanges, and the arbor is inserted in the chuck. A buffer and a grinding wheel are also furnished with the kit and are attached in the same way as is the wire brush. The tool can be mounted on a small bench stand if desired.

A RELATIVELY new tool kit which derives its driving power from a 110 volt motor is shown in the accompanying photographs. All the tools are interchangeable and may be attached to the motor in a few moments time. A spiralled steel band about an inch wide is used as a switch lock and slips on the handle of the drill. Another novel feature is the depth gauge. To control the depth of a cut, the motor is rocked in the cradle, and the drill spindle, thus being offset, makes an excellent depth gauge.

The ease in which the mechanism may be operated and moved about will prove to be a great asset. Rouge for the buffer should be secured from your hardware store. The outfit is easily carried.

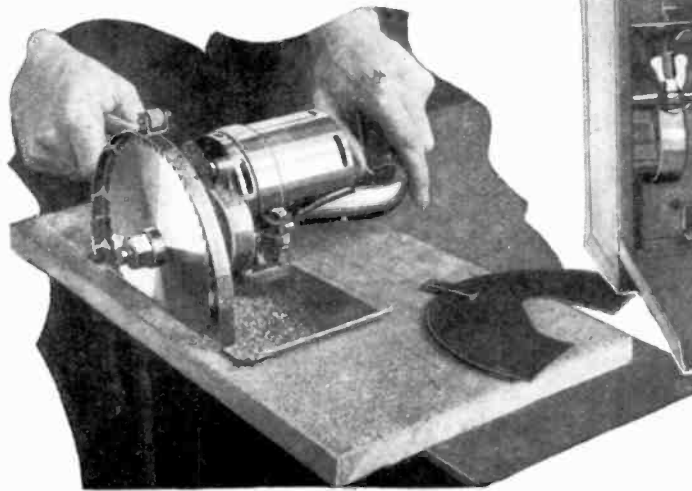

The electric hand saw and guard are shown in use above. The blade of the saw clears best when the drill handle is pointing towards the rear and about 45° upward. The blade of the saw is readily removable and can readily be replaced by the buffer, grinder, brush or drill. A small shoulder is fitted into the saw blade hole and the nut is drawn up tightly in order to center the blade properly.

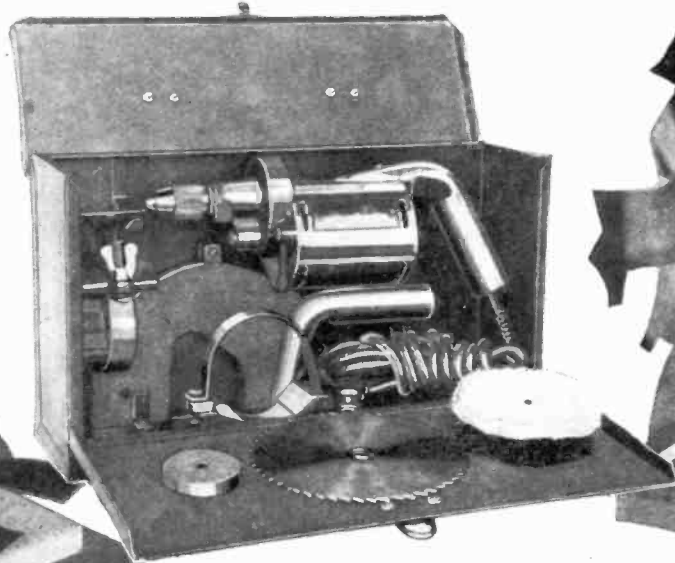

Above is a view of the kit with the tools and driving motor secured in their proper place. The kit can be carried with ease and the tools are protected by the metal case. The buffer, grinder and saw blade may be seen attached to the front of the case. The motor supplied with the kit will operate on any 110 volt lamp socket and either alternating or direct current may be used. The chuck is self-tightening and it is not necessary to use a wrench to tighten the bit. In order to open the chuck for removing the bit, a wrench may be used, although a quick twist of the chuck will generally release it. The drill may also be seen in the photograph at the extreme right. This mechanic's kit is a complete shop in itself and should find many uses in the modern home. All the tools one needs to do almost any job, are assembled in one unit and driven by one interchangeable motor.

Photos Courtesy Electro-Magnetic Tool Co.



Unique Self-Winding Clock

FRONT VIEW

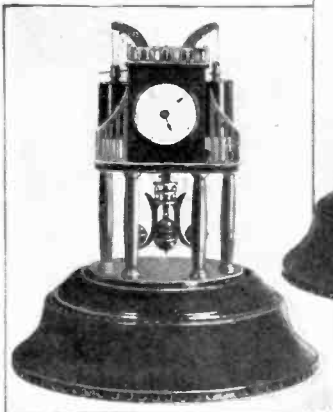

REAR VIEW

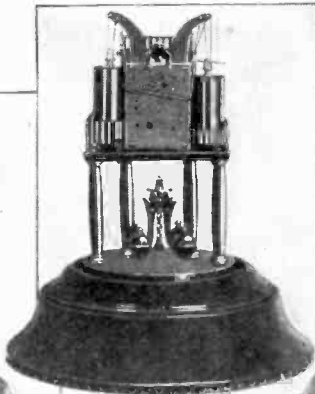

BOTTOM VIEW

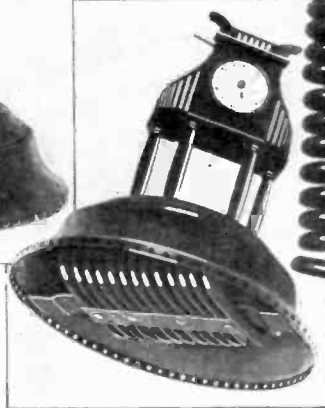

GLYCERINE-CONTAINER

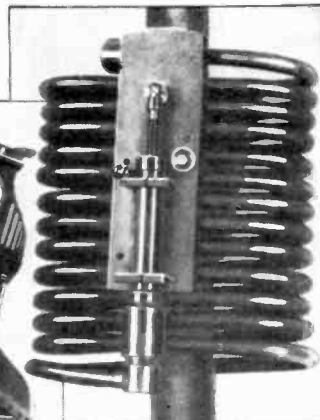

SELF-WINDER

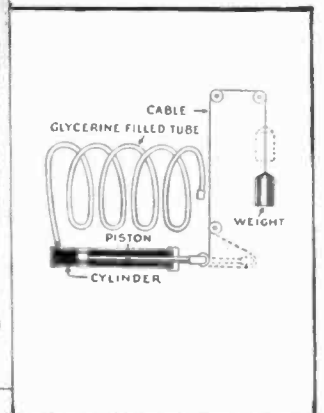

After three years of patient research and systematic experiments, a Swiss engineer, M. Charles-Henri Meier, has constructed an original clock which winds itself by utilizing temperature changes. A front view of the clock is shown in the above photograph. This clock has run for more than a year without stopping and without ever being wound.

Above we have a rear view. The weight which is raised by a cable may also be seen. The weight is acted upon by a piston in a cylinder filled with glycerine. The return of the piston to its original position has no effect.

Above we have a view of the clock showing the glycerine tube. This liquid, when acted upon by variations in the temperature of the air, expands and contracts. As glycerine freezes at 30° C. below zero, these clocks can be exposed to the weather.

A close-up view of the glycerine filled tube and cylinder are shown here. In this model the recipient containing the glycerine with its piston and piston rod has the form of a spiral. Temperature changes of 2° Centigrade per day are sufficient to run it.

The diagrammatical sketch appearing above shows how the winding mechanism works. Independent of its originality the principle operating in this clock seems to open a new horizon to the clock making industry. This utilization of atmospheric temperature will bring about important simplification. — Count A. N. Mirzoeff.

Reseating Cane Bottom Furniture

By R. D. ROSS

This Article Describes How Your Furniture May Be Repaired If the Chair Bottoms Have Broken

BECAUSE a knowledge of the method of repairing cane-seated furniture is of general use, I shall in this article outline the means employed to install new seats. It is by no means difficult, and the man with a few simple tools and plenty of patience should be successful in his efforts.

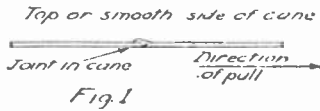

The illustration above shows how the cane is pulled so that it will not be split in weaving it.

TWO KINDS OF SEATS

There are two kinds of seats in use; those woven by hand and those formed by machine. They may be distinguished by their appearance underneath the seat. Those with hand made seats have small holes drilled

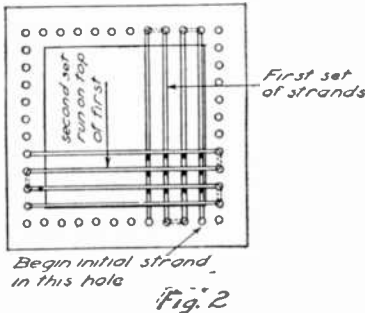

This illustration shows the beginning of the caning of a square bottomed chair. Notice that the strands are not woven but are placed in layers.

around the edges through which the strands of rattan run from hole to hole. The under side of a machine caned seat is perfectly smooth, no cane can be seen. One should not attempt to put machine cane in a chair that

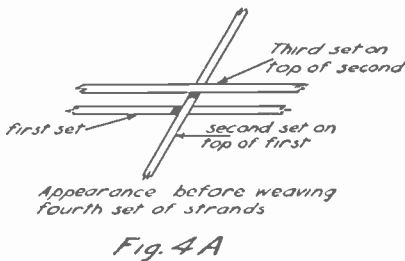

The appearance of the weaving after the third layer of cane has been placed on the chair body, is shown in the above illustration.

was previously hand caned or vice-versa. We shall first consider the method of weaving the seat by hand.

It is necessary to rid the seat thoroughly of all the old cane. The quickest way to do this is to run a sharp chisel between the cane

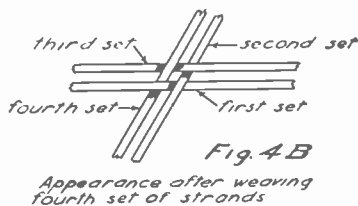

After the fourth layer of cane has been placed, the chair bottom looks somewhat like the drawing shown above.

and the wood at the points where the strands enter the holes. The chisel should be held with the bevel up and driven along with a firm push. Care must be taken to prevent its digging into the seat. The holes will now be completely exposed and ready to be cleaned out. With a nail set or other blunt instrument, force the old strands downward and out through the bottom. If some are too tightly clogged a three-sixteenths inch bit may be used to clean them out.

SQUARE SEATS

We shall first consider square seats, as they are the simplest on which to begin. The method of laying out other shapes will be discussed later. The cane comes in bunches which can be purchased from a large hardware store or furniture repair house. Several grades are used in furniture work, though usually the fine and very fine are the only grades found in household furniture. A bunch contains about fifty strands and is sufficient to cane several chairs. If the holes

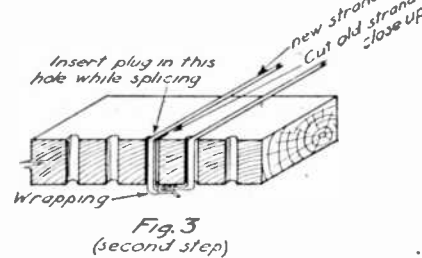
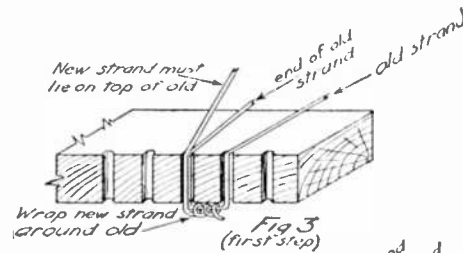

The method of joining the cane is shown in the two drawings above. The old strand is drawn through and the new one twisted around it.

are from one-half to five-eighths of an inch apart the very fine grade should be used, when they are farther apart than this the next larger grade will serve the purpose. Do not try to use too coarse a grade as it will only make trouble.

The following general directions must be observed throughout the whole process. To get a strand from the bunch grasp it near the doubled end, take hold of one of the loops, and draw it out. Just before using, each strand should be held in water for a minute to eliminate the danger of breaking at sharp bends. The joints in the cane run diagonally from top to bottom, and care must be taken to start each new strand so the direction of pull will be such as to cause the interlocking strands to pass smoothly over the joint without digging in. Figure 1 makes this clear. Usually there is a weak spot in each strand about a foot from the end. This end should be discarded. The glazed side of the cane is the top and should always be kept upward. Two small plugs should be provided, each about three inches long and tapering from a quarter of an inch at one end to an eighth at the other. The tapered ends of some nail sets will serve the purpose admirably.

A piece of cane should be inserted in the

front hole next the side corner as shown in Figure 2. One of the plugs is stuck in to hold it in position, with about four inches left projecting underneath the seat. Take hold of the other end with the right hand and put it through the hole that is directly opposite the first. With the left hand held

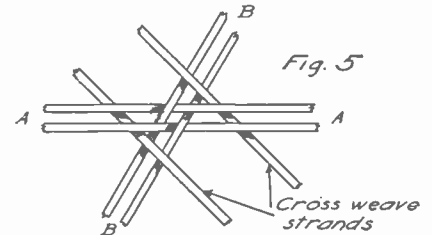

The right way: Over set B and under A. The wrong way: Over set A and under B.

This illustration shows right and wrong ways of placing the cross weave strand. They should be placed over set A, and under set B.

underneath the seat catch the cane as it comes through and turn it upwards through the next hole. Put the left thumb in the loop thus formed and with the right hand pull the whole strand through. Insert a plug

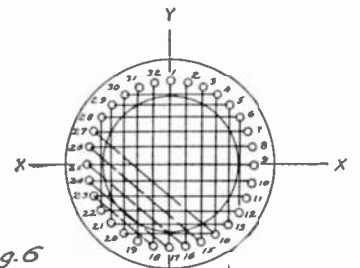

Schematic layout of round seat

The schematic lay-out of a round cane bottom chair is shown above. It is advisable for the beginner to start on a square bottom chair, as it is rather difficult to center the layout on a round bottom one.

as soon as it has been pulled taut. Continue the whole operation until the entire strand has been used up, always putting the end

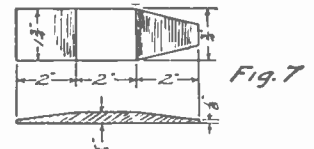

When weaving a seat with machine cane, it is necessary to construct a wedge like the one above, so that the cane can be forced into the slot.

through the hole exactly opposite the previous one.

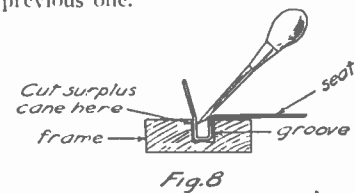

The method of removing the surplus cane from a machine cane seat, is shown above. After the cane is all in place, the chisel is driven around the edge.

It will require a little practice to acquire the knack of joining a new piece of cane to (Continued on page 532)



MODEL DEPARTMENT



Here is a sketch of the Truxton model as seen when looking down upon it. The model has also been illustrated by photographs in the previous installments of this article.

THE grating at the stern is glued directly to the top of the rail and the one in the bow should also be put on at the same time (illustration 21). When these are both in position, the next step will be to put on the cap rail all the way around the hull. This goes on and covers up the edges of the planking, frames and sheathing. It may be made from thin wood and if you can, try to get hold of some of the thin mahogany used as separators in certain cigar boxes. The actual wood of the cigar box is a little too heavy, but these separator pieces are less than one half as thick and make up to about the proper size. If you cannot get this wood make the caps out of the mahogany colored cardboard.

A sheet of the wood or cardboard is laid down on the work board and the model laid keel up on top of it so that a pencil may be run around the edge of the rail to give the proper shape. If the wood is used it may not be possible to make it all in one piece, but the same method is followed. With light wood, it is possible to cut out the shape easily with the aid of an old razor blade. The edges should be rounded off and sandpapered. When ready it is glued to the top of the rail making a molding which will add considerably to the

Building a Model of the U. S. Brig of War "Truxton"

By WILLIAM A. CROSBY

PART III

(Continued from the September Issue)

appearance, 22. When the glue is set the cap should be shellacked.

A piece of wood may be run across the after edge of the grating at the stern but you may have difficulty in making it stay down, so the mahogany cardboard will probably do better. Another piece is run across the forward edge of the grating and also across the after edge of the forward grating. These pieces are also shellacked.

A capstan is cut from a piece of soft wood and glued to the deck just forward of the main hatch. Capstan bars may be made up and glued to the sheathing between

set is made for each mast and the belaying pins themselves may be made from pins cut to length. Five belaying pins will also be needed near the stern attached to a little bracket and glued to the sheathing just about opposite to the stern hatch.

On the forward deck, just ahead of the crew's hatch, the ship's bitts are located. Two pieces of wood set in the deck about a quarter of an inch apart, the wood itself being about a quarter of an inch square. These bitts are set in holes in the deck and glued in place. They are used for securing the anchor chains.

The bowsprit is located so that it comes through the forward grating and the inside end is bevelled so that it will lie flush on the deck where it is glued. Pins may also be run through it into the stem and if these are coated with glue before being pushed through, they will hold it securely when dry. Of course it is necessary to cut away some of the grating in order to permit the bowsprit to pass through, which may be made from pine, cut down with a small plane and then sandpapered. See spar plan.

On each side of the forward grating, as shown in the deck plan, come two posts known as the catheads, 25. These are pieces of wood about three sixteenths of an inch square and an inch and a quarter long, glued to the grating, and arranged to hang over the side of the vessel about half their length. Two of the small wire eyes will be located on the forward sides of each cathead and a vertical hole will be made near the end. Catheads help carry the anchors.

Now you will have to make thirty-two little wire eyes. Each is placed in holes in the side of the hull just above the water line. The first one in each group will begin just opposite the point where a mast is to go through the deck and they are spaced toward the stern as shown and also so that the wires coming down to them will clear the gun ports. Just above these gunports where the eyes are, will come a piece of wood about a quarter of an inch wide and long enough to cover each group of eyes. The ropes from the mast come down to these wood strips, 26, the ropes being known as shrouds and the wood strips as the channels. These names will be used from this point on. Through the channels small holes should be punched with a pin to correspond with the eyes below, but in each case a little forward of the eyes to make up for the difference due to the slant of the shrouds. When all the holes are bored, the channels are glued to the side of the ship just above the tops of the gun ports.

The rail at the stern of the ship is equipped on either side with a davit made of a light piece of wood of the shape shown. An eye made of wire, will be put through the ends of each of these so that it comes on the lower side and will take the boat falls, 27. The davits are glued and pinned to the rails.

(Continued on page 553)

Rules for Model Contest

1. A handsome trophy cup engraved with your name, will be awarded as the prize for the best model submitted during the month. The decision of the judges will be final and will be based upon, A—novelty of construction; B—workmanship; C—operating efficiency of the model as related to the efficiency of the device which the model simulates, and D—the care exercised in design and in submitting to us sketches and other details covering the model.
2. Models of all kinds may be entered. They may be working models or not, according to the subject that is being handled.
3. Models may be made of any available material, preferably something that is cheap and easily obtainable.
4. Models must be submitted in all cases. Good photographs are also highly desirable and where the maker does not desire the model to be taken apart, legible drawings with all dimensions covering parts that are not accessible must be submitted.
5. Models should be securely crated and protected against damage in shipment and sent to us by parcel post, express or freight prepaid. Models will be returned when requested.
6. Models for entry in any particular contest must reach this office on or before the 25th of the third month preceding date of publication. For instance, models for the December contest must reach us on or before the 25th of September.
7. Address all entries to Editor Model Department, c/o Science and Invention Magazine, 230 Fifth Ave., New York City.

two of the gun ports on each side opposite the capstan. Four capstan bars are secured this way on each side of the boat.

A ship's pump may be arranged on deck just astern of the main or after mast. The handles are made of wire and a heavier piece of wire is used for the spout, 23. A binnacle with compass is also put on deck just forward of the steering wheel. The drawings show details of the capstan, bars, pump and binnacle.

Where the various lines are brought down to deck it is necessary to arrange rails which will take the belaying pins. The rails are placed so that they come around the masts and are made of cardboard supported on little pieces of wood about the sizes of safety matches, 24. One complete

The Truxton. Part—III

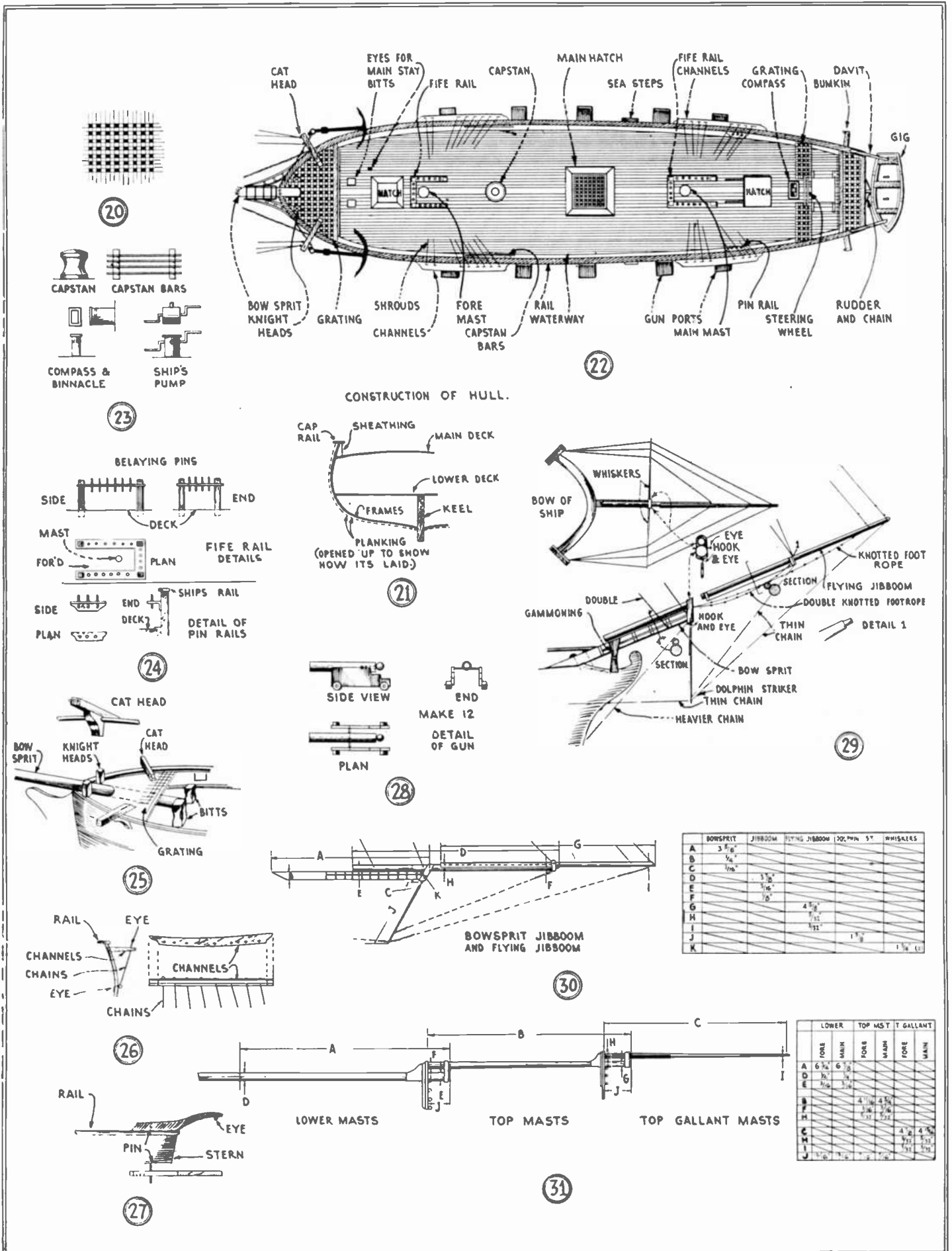

The above drawings illustrate some of the remaining stages in the construction of the U. S. Brig of War, "Truxton" Model which has been the subject of this series of articles. The illustration here gives thus far can already see that it will be a "beauty."

all of the dimensions of the spars and masts which are next to be built. In the following article on the same subject, we will enter upon the details of the rigging. Those who have built the model

Blueprints of the "Truxton" may be obtained from the Model Department.



The Ketones in Experiments

By DR. ERNEST BADE

KETONES and aldehydes are both dehydrogenated alcohols, but the former are oxidation products of secondary alcohols

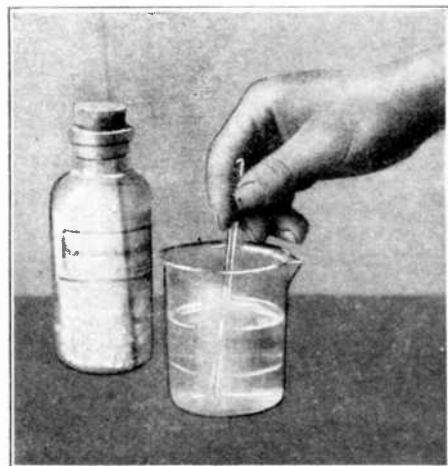

Separating acetone from its solution by the use of calcium chloride. The latter takes up the water and two distinct solutions are formed one floating on top of the other.

while the aldehydes are derived from primary alcohols. Solid and liquid ketones are known, and the simplest and most pronounced difference between the chemical group of the aldehydes and the ketones is that the reducing action of the aldehydes is entirely lacking in the ketones, the ketones not being able to produce a silver mirror with basic silver solutions.

Acetone, dimethyl ketone, is a product obtained by the dry distillation of commercial acetate of lime and is a liquid, mobile liquid having an agreeable odor, is very inflammable and burns with a smokeless flame. It boils at 36 degrees C (132.8°F) and mixes in all proportions with water, alcohol, ether,

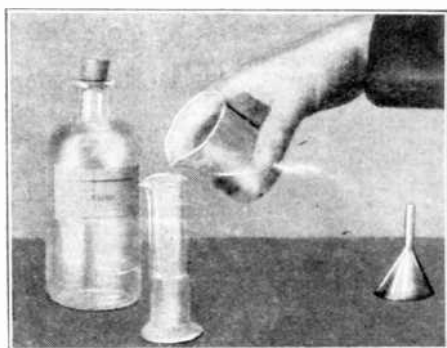

Making acetone sodium bisulphide. This product is used by photographers as an addition to developers to supply the deoxidizing constituent which makes them keep better, the natural tendency being to lose power by standing.

chloroform, and also with benzene and benzene (benzol) when free from water. It dissolves many fats and resins and is an excellent solvent for acetylene and tanins.

Acetone in a watery solution may be sep-

arated from the water by the addition of calcium chloride, whereby the acetone floats on top of the watery solution of calcium chloride. Impure acetone may be purified by first converting the acetone to a crystalline compound and then breaking up the compound by distillation. The particular compound into which the acetone is converted is an addition product of bisulphite known as acetone sodium bisulphite.

First a saturated solution of sodium bisulphite must be prepared, and this is accomplished by dissolving 10 grams of sodium bicarbonate in 30 cc of water and passing sulphur dioxide into this mixture until the solution smells strongly of the gas. The sul-

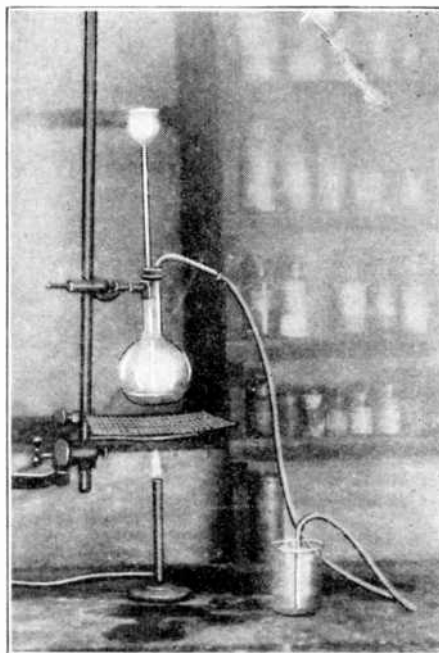

Making sulphurous acid gas from copper turnings and sulphuric acid for the production of sodium acetone sulphite. The first product is sodium bisulphite to which the acetone is afterwards added.

phur dioxide is most conveniently prepared with sulphuric acid and copper. In a 250cc flask which is provided with a thistle tube and an outlet tube place 15 grams of copper clippings. Then arrange the flask in a stand so that it may be heated, and add 30cc of concentrated sulphuric acid. Then warm the flask until the action begins and reduce the flame so that the evolution of gas proceeds steadily and not too fast. The outlet tube from the gas generator terminates in a funnel, which dips into the bicarbonate solution held in a beaker. The saturated sodium bisulphite thus prepared may be kept when the bottle containing it is tightly stoppered. If this is not the case the solution is slowly converted to the sulphate which may be noticed by the loss of the yellow color and the presence of a white precipitate.

Mix 20cc of acetone with 25cc of the concentrated bisulphite solution in a flask and cool the mixture under the tap, shaking the mixture vigorously. The product that

separates is acetone sodium bisulphite. Filter out the solid and dry. Mix with an equal weight of dry sodium carbonate and distill the mixture. The acetone passes over and

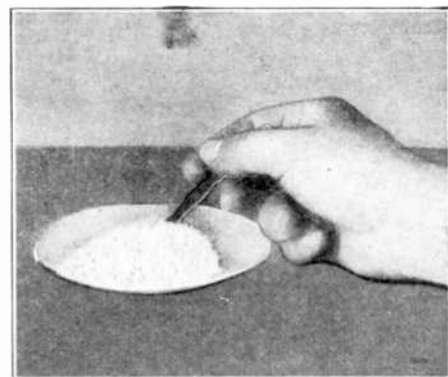

Dibenzolacetone in quantity. The preparation of this interesting crystalline acetone product is described in the text.

is dehydrated with solid fused calcium chloride and again distilled.

For the identification of acetone, the acetone is converted into a different solid having definite properties. The solid crystalline derivative of this ketone is dibenzalacetone and it may be made by allowing acetone to react with benzaldehyde. For this reaction 1cc of acetone is placed in a small flask and 4cc of water, 4cc of benzaldehyde, 20cc of ethyl alcohol and 5cc of a 10% solution of sodium hydroxide are added and mixed. Then boil gently for 5 minutes and cool the flask in cold water until crystallization occurs. A heavy yellow mass of crystals are obtained and these are filtered off, washed with about 20cc of alcohol and redissolved in another 20cc of alcohol from which, after filtering the solution, the crystals are reobtained by

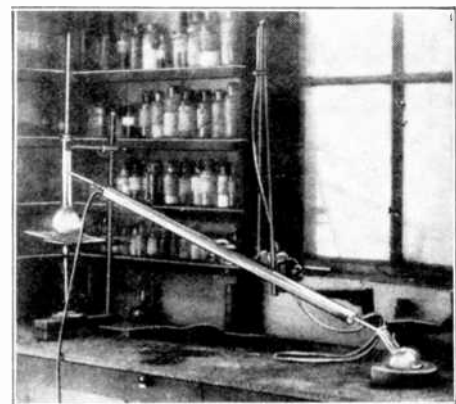

Preparation of ketones by destructive distillation of salts of organic acids.

cooling and if necessary, by slightly scratching the sides of the containing vessel. Dibenzalacetone crystallizes in small plates.

It is also possible to prepare ketones by the dry distillation of salts of the fatty acids. In this way calcium acetate yields acetone

(Continued on page 570)

Spheroidal Evaporation

By T. O'CONNOR SLOANE, Ph.D.

ONE of the principal operations in the analysis of water is the determination of the total residue by evaporating a measured quantity of the fluid. This is usually done in a platinum or equivalent vessel of non-oxidizable metal, which is weighed before and after evaporation.

The illustrations show another way of effecting this evaporation using a shallow

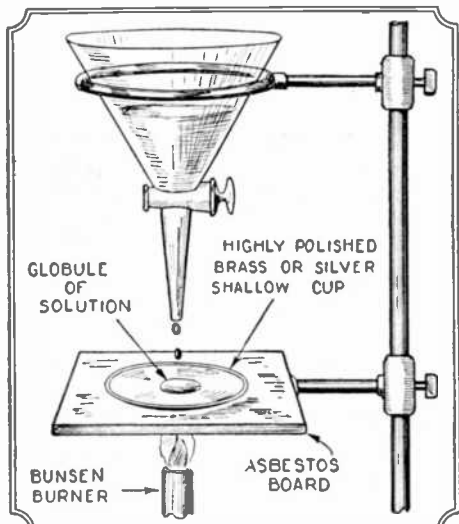

A shallow metal cup is supported on a sheet of asbestos board, covering a hole in the center; it is kept at a temperature approximating a red heat and a solution to be evaporated is added to it, drop by drop the stop-cock of the funnel being set accordingly.

cup, which may be of brass or of silver, and the writer has used a chromium-plated cup with success; but all things considered, silver would seem the preferable material.

A globule of water may be kept upon a metal plate without touching it, provided the plate is hot enough. A wire ring which should be of about the diameter of the globule serves to prevent it from rolling off. One of the illustrations shows a globule in this position. The water does not touch the metal; it rests upon a layer of steam, sometimes called a Crooke's layer. The molecules beating up and down in straight lines prevent contact, while the surface tension pulls the water into a spheroidal shape. Light can be seen under the globule between it and the metal, as indicated.

To apply the principle of evaporation of a liquid, a piece of asbestos board has a hole cut in it about an inch less in diameter than the cup, which latter may be three inches or so in diameter. The asbestos board is placed on a ring stand and the cup placed so as to cover the hole and a Bunsen burner is lighted and placed beneath it. The object of the asbestos is to deflect the hot gases rising from the burner, and the heat is concentrated upon the cup. Above the cup in the same ring stand, a separatory

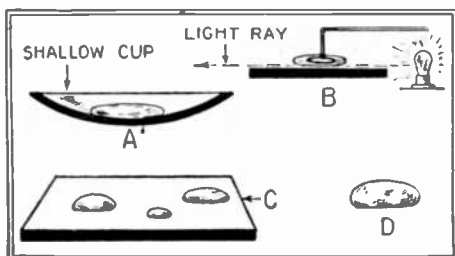

A shows the globule in the shallow cup. B shows a spheroid of water kept by a wire ring in place on a hot plate of metal. Light from a lamp can be seen beneath the globule. C and D are the salts obtained by spheroidal evaporation.

funnel is supported. When the cup is good and hot, approximating redness, and when the funnel is filled with the liquid to be evaporated, it is allowed to drop very slowly into the cup until as large a globule is present as will lie quietly there. A very slight bubbling may be observed, but if all is in order there will be none and the globule will look almost like one of mercury. By opening and closing the stop-cock of the funnel, it can be got to a position such that it will feed out the water at the rate required to keep the globule of uniform size, and not so fast as to cause any bubbling. In this way the evaporation will go on indefinitely. If a brightly polished cup is used, about one-half the flame of the burner is quite sufficient.

Evaporation goes on much faster than one would suppose. When it approaches completion, the heat being maintained, the residue begins to appear in a clouding up of the globule, and in a few minutes a solid spheroid is left which can be removed and weighed. If all is properly done, it will not adhere to the vessel. The instant the solidification takes place, the burner should be removed or the gas should be turned off. This will be found a most interesting experiment and one well worth investigation and experimenting with from the quantitative standpoint, to see how accurate will be the results obtained.

AN EASY WAY OF GOLDPLATING IRON AND STEEL

By E. A. DAANSEN

Obtain a small particle of gold-plate and free from alloy by boiling it in a test tube with 5 c.c. of conct. Nitric acid. The amount of gold left need not be any more than grains, a lump quantity of about the size of a common pinhead. Then place the precious

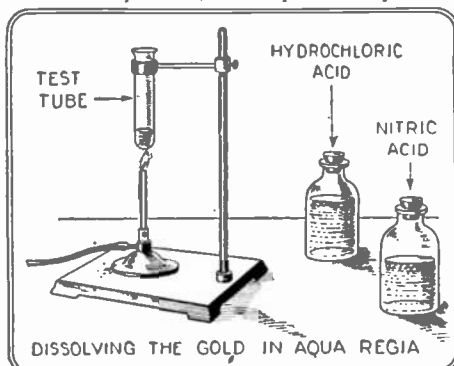

Making gold chloride by acting on the metal with a mixture of nitric and hydrochloric acids. This is to be brought into solution in ether.

metal in a test tube, covering it with 1 c.c. Nitric acid and 3 c.c. Hydrochloric acid and heat gently.

The gold will dissolve forming a light canary yellow liquid, which consists mainly of Gold Chloride, and a watery solution of Nitric acid and Chlorine.

Allow the solution to cool and add 2 c.c. of CP Ether. Incline the tube slightly in the hand and combine the fluids by rolling the tube between the fingers and gently agitating it. Do not stopper the tube with your thumb and shake it since the Ether vaporizes and the pressure would expel some of the liquid rather forcibly. This solution in contact with the skin or other carbonaceous matter soon reduces to the rather permanent purple of colloidal gold.

With the aid of a long medicine dropper remove the upper stratum of ethereal gold and place it in another vessel. Clean instruments or other iron articles to be plated by

rubbing with a good household scouring powder. Rinse and dry, then dip into the ether-gold solution and immediately plunge into a large bulk of water. A beautiful coat of shiny metal will be deposited.

Since Chloride of Gold is soluble in ether as well as in alcohol, the ether is used to separate the metal from the excess of acid used to dissolve it. For this reason the mixture should not stand for any length of time before separating or the Nitric Oxide fumes of the acid will discolor and acidify the ether solution rendering it unfit for plating pur-

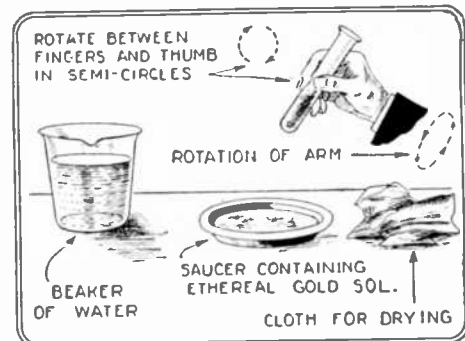

By rotating a test tube containing the solution of gold chloride along with ether the ether will pick up the gold and the solution is then poured off and kept for electro-plating; a thin but true coating is obtained in this way.

poses. Copper, silver and less electropositive metals than iron evidently convert too much of the gold chloride into colloidal gold to render their direct plating practical. If the surface the plating covers is unpolished, the gold will appear dark, as it is about one one-hundred-seventy-five thousandths of an inch in thickness. Successive platings will render it thicker, however.

MERCURY SEAL CONNECTION FOR AN AUTOMATIC PIPETTE

I have been troubled, while using an automatic pipette, with the contamination of solutions through contact with the rubber connections. A very simple and efficient connection may be made as in the above diagram.

A large piece of tubing (1) is drawn to a smaller size at one end, then placed around a smaller tube (2) and heated gently until a joint is made as (3). Another piece of tubing (4) large enough to be placed over (2) at the one end with an extension of smaller size and a little mercury complete the apparatus. The mercury is poured in to a level just below the top of the inlet tube.

This is an air tight connection and can be used in almost any ordinary work with assurance.—Contributed by E. B. Smith.

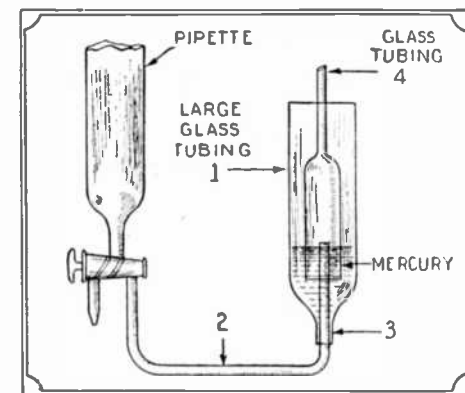

The all-efficient mercury seal is substituted here for rubber tubes and clamp. It forms a perfect valve and one which is easily opened and shut.

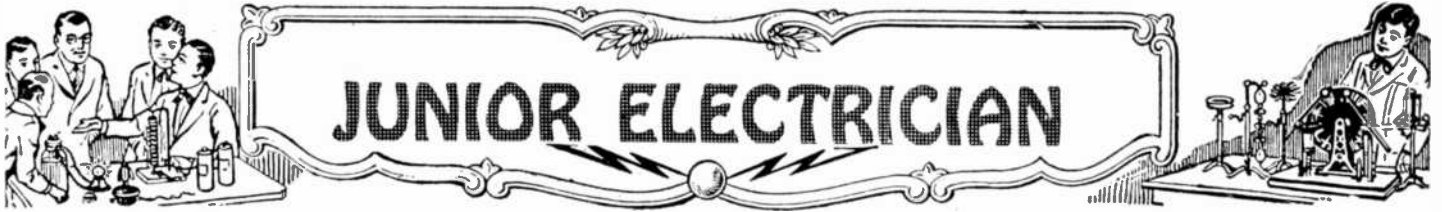

How to Make a Geissler Tube

WHEN an electric discharge is caused to pass through a glass tube from which the air has been exhausted to eight or ten millimeters of mercury, a luminous phenomenon is obtained. Instead of the characteristic blue spark obtained in

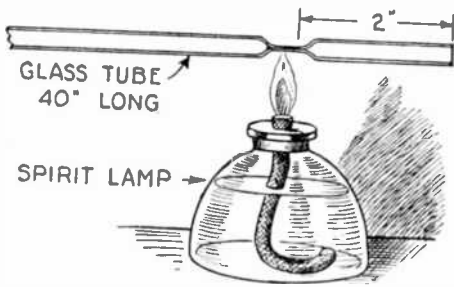

FIG. 1

Melting off a glass tube so as to close one end and produce a sort of barometer tube. The tube must be about 40 inches long in order to get the Torricellian vacuum.

open air, a beautiful luminosity results, whose color depends on the gas in the tube. These rays are known as cathode rays. They consist of negatively charged particles traveling at enormous velocities from the negative electrode or cathode, to the positive electrode or anode.

Commercial Geissler tubes are often very complicated in construction and require dexterity and perhaps a somewhat complicated apparatus to construct, but a small one of the type to be described is easy to make and will work on an ordinary Ford spark coil.

The only materials necessary are a spirit lamp or Bunsen burner, a glass tube about

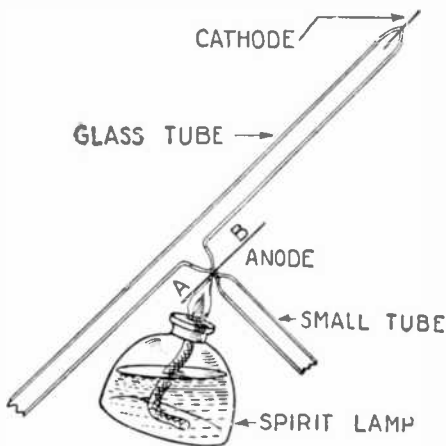

FIG. 2

Here preparations are made for introducing a platinum anode of fine wire in the side of the tube 2 inches from its closed end. The closed end, it will be observed, is traversed by another platinum wire around which the glass is melted so as to make an air-tight joint.

forty inches long, a small piece of platinum wire, and from one to two pounds of mercury, the amount depending on the size of the tube.

Our first step is to close one end of the tube. To do this heat the glass about two inches from one end at the same time grasping it with both hands, one on each side of

the heated place, and pull gently in opposite directions, as shown in Fig. 1. Draw the tube out to a very thin rod, and let it

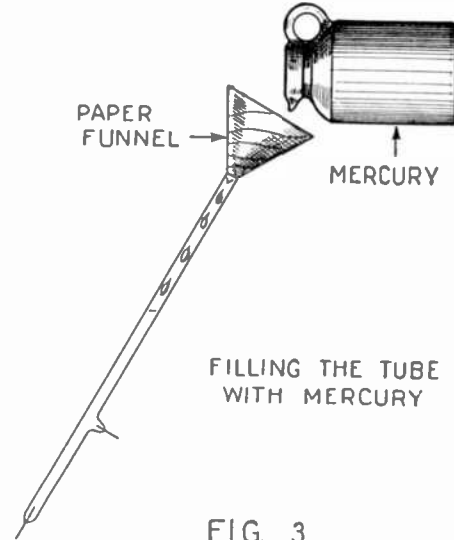

FIG. 3

Here the tube is being filled with mercury. One trouble is that the mercury will infallibly retain bubbles of air, but they can be fished out by a long glass or wooden rod. Otherwise they will destroy the vacuum.

cool slowly. When it is cold break this piece, thus leaving a small hole in the end of the long tube. Insert half of the piece of platinum wire into this hole and heat the end of the tube until this is sealed in.

Our second step is to insert the opposite electrode. To do this heat the tube with the tip of the flame at a point about eight inches from the closed end. When this spot is red hot stick the point of the short piece on it, and heat again. Then, as soon as the small tube adheres to the large, draw it out very gently until it looks like Fig. 2. Allow

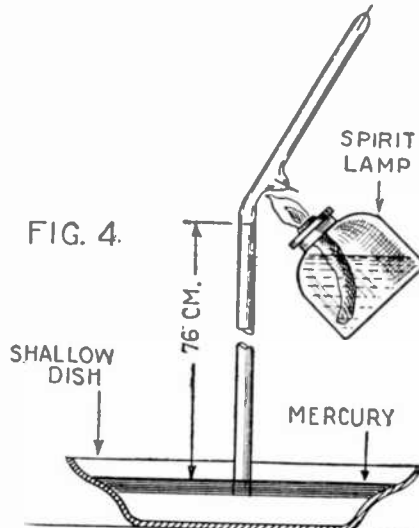

FIG. 4.

The tube has now been inverted with its open end under mercury in a shallow dish. The column falls to the barometric height and with a spirit lamp or blow-pipe, the tube is melted off below the lateral anode whose insertion was illustrated in Fig. 2. We now have a Geissler tube containing only the vapor of mercury.

it to cool and then break off the small piece at AB Fig. 2. Insert the other half of the platinum wire, and seal as before.

Next make a funnel and fill the tube with mercury (Fig. 3) pouring the residue into a large shallow bowl. Now place your finger over the open end and invert the tube

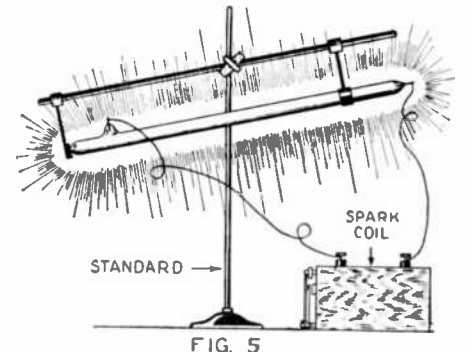

FIG. 5

How to suspend the tube safely and cause it to produce a display of beautiful light. It will not give any sparks if properly made.

until your finger is underneath the mercury in the bowl and allow the mercury to fall to its atmospheric level, or seventy-six centimeters.

The last step is illustrated in Fig. 4. Heat the glass a little below the lower electrode and well above the mercury level, allowing it to get hot slowly. Support the tube above the heated part and pull gently on it allowing it to close by its own vacuum.

If you have thoroughly sealed the openings you will have a Geissler tube.

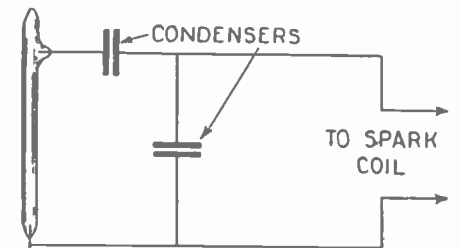

FIG. 6

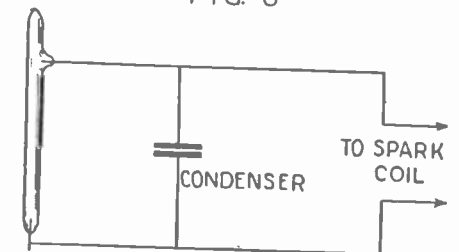

FIG. 7

These two diagrams, Fig. 6 and Fig. 7 show two methods of connecting the tube, in one case with a single condenser and in the other with two condensers.

It will work successfully if directly connected to the secondary terminals of the spark coil, but it will give greater satisfaction if connected as shown in Figs. 6 and 7. The condensers should be of the glass plate type.—William G. Pollard.

A DYNAMOMETER VOLTMETER

By ERNEST F. SHAWVER

A VOLTMETER that can be used for both A.C. and D.C. may be constructed by the amateur that will give good results as detailed in this article. This instrument is of the dynamometer type and is similar in construction to the expensive laboratory instrument of the same kind.

The necessary parts for the construction of this instrument are an old alarm clock, a suitable form upon which to wind the coils, a quantity of fine magnet wire, and a brass baseplate 4" x 5". The coil forms used in the author's instrument were made from a cylinder phonograph record with the compound removed from the outside leaving the 2" diameter cylinder of celluloid. From this celluloid cylinder cut off two smaller cylinders one of which is 2½" high and the other ¼" high. The ¼" piece is then cut and the ends lapped over to make a smaller form 1¾" in diameter. One of the over-lapping ends is filed and scraped on its outer surface while the other end is filed and scraped on its inner surface, thus making a neat fitting joint which is then cemented, using acetone to soften the celluloid and make it self-cementing. This small form with its windings is the turning element of the instrument.

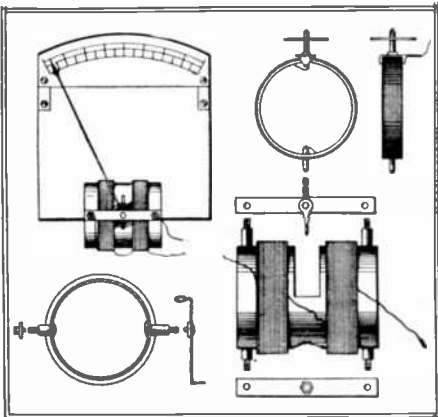

In this diagram which is explained at length in the article, a volt-meter is described with full details of its construction. It is made more or less of odds and ends such as found in most laboratories, and is very sensitive and accurate.

The alarm clock works are removed and taken apart. The balance staff and pivots of the clock are to be used on the rotating coil and the hair-spring serves as a torsion spring to return the indicator to zero. The pivots of the balance staff are located in the middle of the sides of the frame of the works, and a strip of this frame is cut off of each half, taking a pivot in the center of each. These strips have holes near the ends which are suitable for the support to be fixed to. The rim of the balance wheel is cut off leaving the one brass strip across its diameter attached to the shaft. The shaft is then cut in two, leaving the hair-spring and the balance wheel hub on one piece and the other half clean.

A pin hole is made in the small coil form at the middle of the lap and the exact opposite point determined. Be sure that the form will balance in any position between pin points before drilling the holes in the form. Now drill holes at these opposite points that are just slightly smaller than the balance shaft. Place a wooden peg in the hole at the lapped place and this form is ready for the windings. No. 36 enameled wire is used which may be taken from the secondary of a Ford spark-coil. One end of the wire is wrapped on the lower half of the balance shaft and soldered and the shaft pushed through the undersized hole from the inside and then the windings are started. Put approximately 200 turns on this form and leave a loose end at the finish for

connection to the upper half of the shaft. The wooden peg is removed and the shaft put in its place, bending the brass strips, left from the balance wheel, down tightly around the edges of the form. Solder the free end of the winding to this brass part. Notice which side of the form the end of the hair-spring is on and fix the indicator needle perpendicular to the other side. This indicator needle is a length of No. 28 enameled magnet wire twisted around the shaft and fixed solidly thereto. The length of this needle is about 5".

Parallel to the axis of the stator form scratch two lines on the outside directly opposite each other. These lines are the center lines for the holes through which the pivot strip support screws pass. The exact positions of these holes are determined from the pivot strips. At the center of one of these lines cut out a hole ½" in diameter and in the center cut out a half circle ½" wide as indicated in the illustration. The screws are then put in place and bushings placed on them. Bushings ½" long are put on the top and bushings ¼" long are put on the bottom. The windings on this form consists of two coils of 300 turns each of No. 28 enameled wire, divided between both sides of the center. The windings of these two sections are in the same direction and are continuous. The ends are secured to the outer edge of the form.

A scale 5" long is made on white drawing paper and a ¼" arc cut out of it just under the scale divisions. This is pasted on a scale-plate which is cut out of the case of the clock. The polished surface of the clock case acts as a mirror and shows a shadow of the indicator needle through the cut-out portion of the paper scale. The scale supports and the stator coils of the instrument are mounted on a 4" x 5" base plate of ⅛" brass which is drilled to take the parts. An oversized hole is drilled under the bottom pivot to allow for the adjustment screw.

The parts are now ready to be assembled. Put the bottom pivot strip in position on the stator form and then fasten it to the base plate in its proper position. Now place the turning element inside the stator and put on the top pivot strip. The indicator needle is set at approximately zero of the scale and the end of the hair-spring fixed to the movable speed adjustment lever which now become the zero adjusting lever. The scale of the instrument is then placed on its supports. One end of the stator winding is connected to the bottom pivot strip and the other end of the winding is connected to a battery. The other lead of the battery is connected to the top pivot strip and the direction of deflection noted. If the needle is deflected to the right all is well, but if it is to the left, the leads of the stator must be reversed. This instrument should be inclosed in a cabinet. The details for such a case are not given here but are left for the builder. A very good case may be made of bakelite. This the author did by getting the pieces cut to size and fitting them together by means of angle pieces of brass.

The deflection of a dynamometer instrument varies as the square of the current through it, therefore it has an unevenly divided scale which makes it necessary to calibrate the instrument with some standard voltmeter for every point on the scale.

A PUZZLE CIRCUIT

A few months ago you printed a description of a puzzle circuit. I believe that the circuit, the diagram of which I enclose, is much simpler and offers more possibilities, than the one you published. Every change of any of the switches means a different combination of bulbs so that if various colored bulbs are used the effect is rather a pretty one. Some of the combinations must

be made with one or two switches touching two taps. To light one particular bulb or any combination several may be required as the solution.

The number of combinations (31 in this case) may be increased by adding more bulbs and taps. If one is added the number jumps to 63, if two are added the total number is 127, and so on.

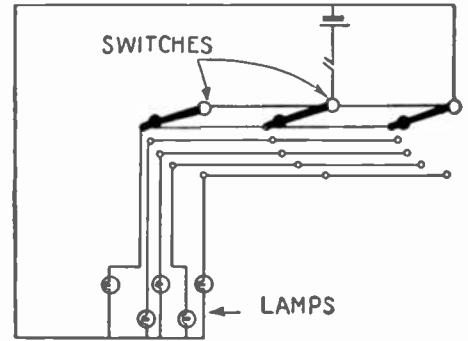

This is a trick circuit. By manipulating the switches, various results in the way of lighting the lamps are obtained. There are 31 combinations in the arrangement of the diagram and these can be increased by adding more switches and lamps. One more switch and one more lamp will give 63 combinations.

There are many ways of making any one combination. The number of ways changes if a different number of bulbs are required. It is not even the same for a like number of bulbs, but varies if different bulbs are wanted.

Duplicate taps may be added to make the solution more interesting. If it is not possible to utilize the house current, 6-volt bulbs and dry cell batteries will work.

No doubt your readers can find an arrangement suitable for themselves.—Abram Bader.

MINIATURE TELEGRAPH SET

The following method for the construction of a miniature telegraph outfit involves an expenditure of between 10c and 20c to make, besides the 1½-volt dry cell battery. The circuit is shown in the diagram. A message may be sent from A to B, or from B to A, if the receiver will hold his key down during the transmission of the message. The sender, of course, taps his.

Each of the magnets is made of 75 to 100 turns of No. 24 S.C.C. wire wound around an ordinary iron nail. The sounders are made from a piece of tin, ½ inch wide, and bent into the shape shown. They are nailed down upon the base board.

The keys are also easily made. They consist of a nail driven into the base board with a piece of tin bent over its head. The bottom magnet lead goes to the key spring.

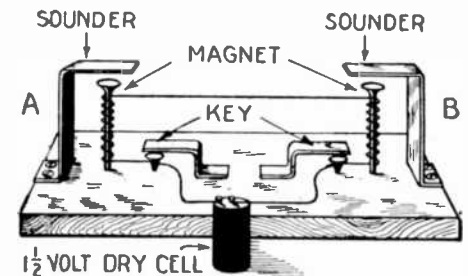

A useful sounding set for studying the code is shown above. A single dry cell will operate it. Nails and tacks driven into the wood base serve for contacts in one case and for magnet cores in the other. Thin bits of tin tacked down or screwed down serve respectively for keys and sounders. In the real construction, the sounder must be closer to the heads of the nails than is shown here.

Aside from the battery, the only thing that need be bought is the wire. We have a telegraph outfit that works perfectly, and in which two stations A and B can be separated as far as desired.—Irving Abrams.



THE CONSTRUCTOR

Articles of Interest to the Home Mechanic

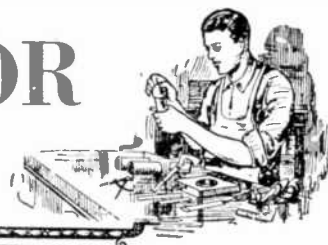

Cigarette Field Gun

Here is a scale drawing of a cigarette gun made of wood with the aid of a fretsaw and a few other odd tools. The article is both unique and artistic.

As a rule we quietly hand a cigarette to our friend. By means of this "Field Gun" case, we can literally fire one at him. This method of inviting a friend to share a smoke with us may not, strictly speaking, be the most polite, but it has at least the merit of novelty, and the completed cigarette case makes an interesting fret-work model.

While the general proportions of the gun have been kept correct, the reader will naturally understand that some modifications are necessary owing to the special nature of fret-work. Thus the gun barrel is made square, and the upper portion is altered to make room for the cigarette box. The box itself will hold about a dozen cigarettes, each in turn drops automatically into barrel, and is then fired out by means of a spring.

The wheels revolve together with their axle. That is, the axle (18) is fixed to the wheels (21) and revolves within the circular openings of the trail (11) and wheel

supports (9), which in turn are fixed to the gun table (14).

The axle is a piece of 1/2 inch dowelling, 4 inches long, the ends being tightly glued into the hub holes of the wheel. Of course, the actual fixing of at least one of the wheels is left until the other parts of this section are completed, but it should be seen that the axle will fit tightly at both ends. The end grain of the axle is afterwards hidden at each side by an embossed metal seal. These seals, lightly fixed on with fine pins make attractive hubs.

One of the most important parts of the model is the gun table (No. 14 on the full sized diagram). It is to this piece that the wheels and trail are fitted, and the gun also rests upon it. The two trails (11) are joined together by means of their two cross bars (10) and are then tenoned to the underneath side of the gun table. To this gun table are also tenoned the two wheel supports (9), these supports coming between the

trail and the wheel. The tenons of supports and trails go right through the gun table, each being finished so that it forms a kind of stud.

The gun is made up of four sides. The top (2) and bottom (3) overlap the side pieces (4), leaving a square bore of about 3/8 inch, large enough for the ordinary cigarette. The top of the gun (2) has a slot which permits of the cigarettes dropping down into position from the box. The square mouth (12) should have its inner edge filed flush and smooth with the bore; and, on account of the working spring, the breach end (15) should be fixed on with fine pin points, as well as by gluing, so that there may be no chance of its yielding to the strain.

MATERIALS REQUIRED

3/8 inch, 1/8 inch, 1/16 inch maple plywood, or other suitable wood, fretsaw and handle, fine drill to drill holes to start fret sawing, glue, sandpaper.—J. E. Lovett.

A Motorcycle Motorboat

A novel method for propelling small boats is shown here. The motorcycle does double duty and saves the expense of a boat motor. A wooden drum provided with cog wheels acts as a power transmitter between the motor and the propeller shaft. The rear wheel of the motorcycle presses against this drum and causes it to revolve with surprising speed.

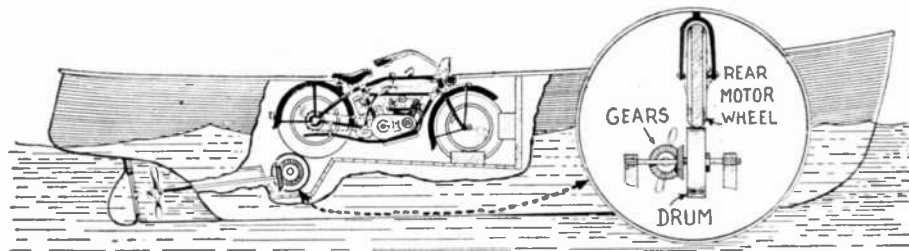

The motorcycle should be firmly mounted in an upright position and the rear wheel should make contact with the wooden drum. By means of two gears, one on the drum shaft and one on the propeller shaft, the power is transmitted to the motorboat propeller. It must be remembered that only small boats can be driven in this manner.

Above are given the details of this novel propelling system. The insert shows the arrangement of the drum and gears, and the position of the motorcycle wheel. The large drawing shows the relative positions of the motorcycle and propeller shaft.—P. C. Van Petegem, Rep. No. 13992.

TENNIS NET TIGHTENER

The illustration below gives a suggestion for keeping the tennis court net taut. This method will eliminate much annoyance and bother, as hand cranks are usually inefficient and the nets will continue to sag despite their use. As practically every court has a

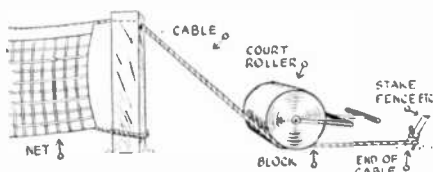

roller, this net tightener may be put into practice and used thereafter with gratifying results. A cable is arranged as shown and the roller placed upon it. A block of wood prevents the roller from moving and thus the net is always under the desired tension. To tighten the net move the roller forward.

—F. G. Mulderuk.

WINDSHIELD SAVER

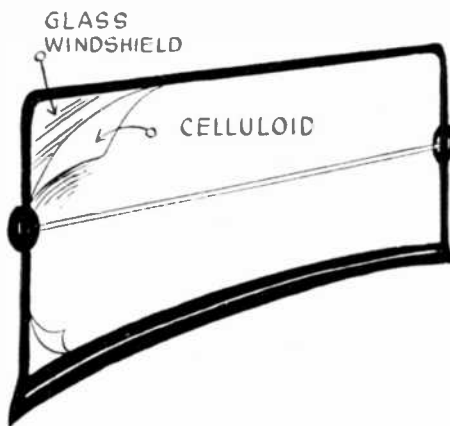

By gluing a piece of celluloid over the windshield as shown above, shattering of the glass will be prevented.

Contributor send name and address.

PIPE RADIATOR

A radiator for the workshop or laboratory can be easily made from old discarded pipes and

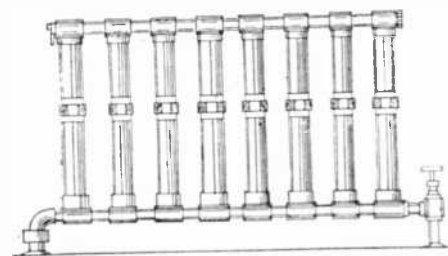

pipe fittings. The pipes themselves may even be of different diameters, provided that a reducer is used. The radiator, made of pipes, is connected to the steam or hot water supply lines in the usual manner. A valve can also be easily incorporated. A radiator of this nature will prove to be inexpensive and yet will serve its purpose efficiently.

—P. C. Van Petegem.

Hints for the Mechanic

HIGH SPEED LATHE TOOLS

FIRST PRIZE \$10.00

TOOLS FOR HIGH SPEED LATHE

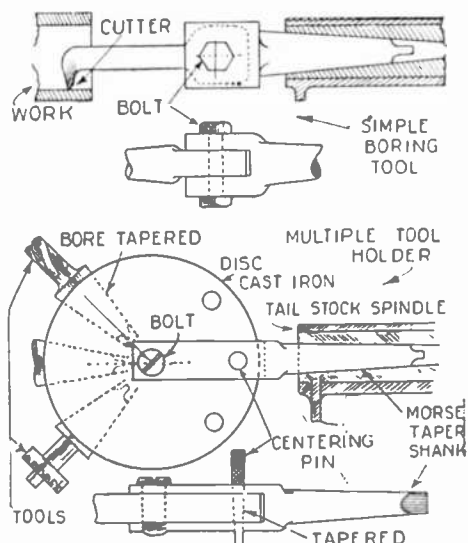

The drawing above shows numerous tools which can be made for use with a high speed lathe. The simplicity and value of these accessories are apparent.

Old files may be ground off and used for light cutting work. A set of fixed tools will also add to the capacity of a high speed machine. The first tool shown is for use in boring, the second is a triple

A New Department

BEGINNING with the May number we started this new department—"Hints For the Mechanic," in which we intend to publish wrinkles useful to mechanics in general. You can help us with this department by writing a brief description of your favorite shop wrinkle and sending this to the editor of this department, together with a pencil or pen and ink sketch of the wrinkle. The ideas published herewith will give you some idea of what we want. Our draughtsmen will make the necessary mechanical drawings, so you need not send us finished drawings. We will pay \$10.00 each month for the best Wrinkle or Hint sent in; others published will be paid for at space rates. Address all letters to Editor, Hints For the Mechanic Dept., in care of this magazine.

tool holder. On this holder a disk is mounted, having a number of openings to hold tools. The openings are made with the usual taper, but if adapters are used, straight tools may be employed. A centering pin through the tool disk and holder secures the tool, which is placed in the holder, against movement when cutting. By using the above tool, the utility and capacity of a high speed lathe will be greatly increased, almost suggesting a sort of turret lathe.—G. A. Luers.

HANDY WASHER CUTTER

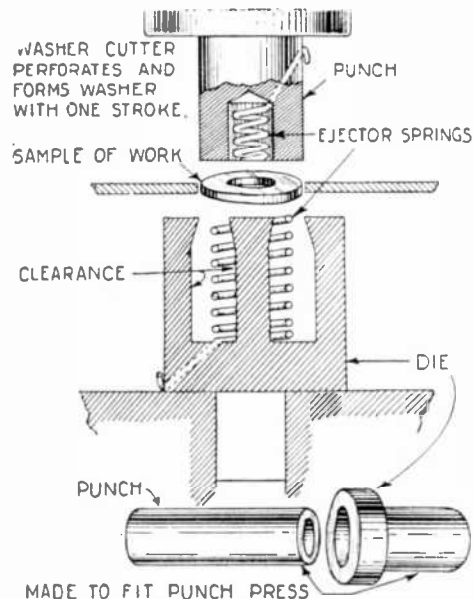

A single punch, which will cut a washer at one stroke, is shown in the above sketch. This tool is worth using for its time and labor saving advantages.

The punch consists of a die which fits in the base of the punch press. The edges of the die are cut with the usual clearance and this part is fitted with an ejector spring, which thrusts out the waste material.—G. A. Luers.

(Continued on page 570)



HOW TO MAKE IT



EXPANSION KINKS

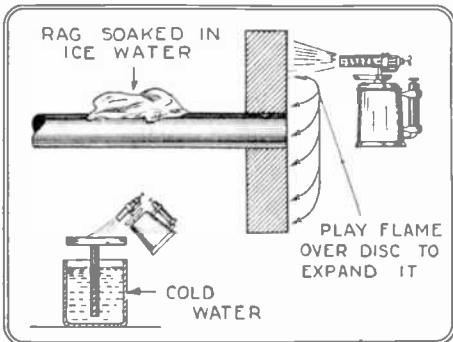
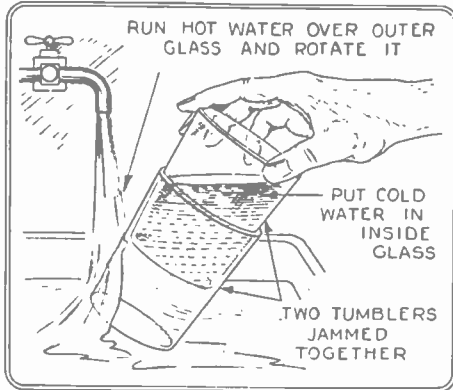

Drinking glasses often become wedged together and considerable difficulty is encountered in separating them. By putting cold water into the inner one and running hot water over the outer one, they may be easily separated.

Disks and pulleys that are sweated onto rods in machinery may be removed by heating the disk, and at the same time placing a cold cloth on the axle. The expansion of the disk loosens it.—H. G.

A NOVEL SAND MOTOR

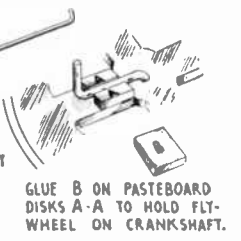
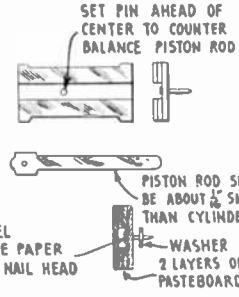
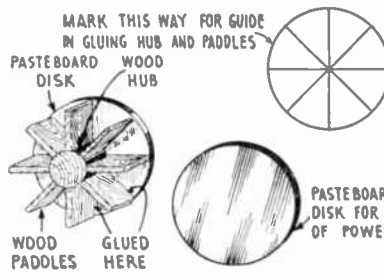
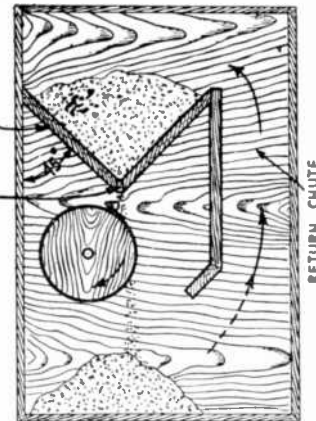
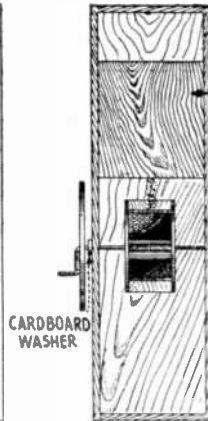
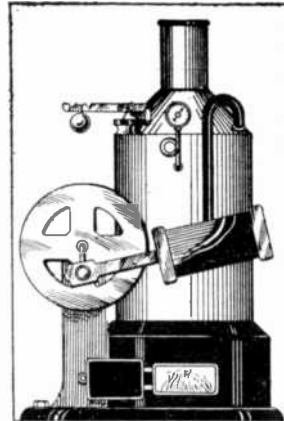

A novel sand motor can easily be constructed at home from discarded parts, by following the instructions shown above. A chute or sand hopper made of wood is fastened at the top and a 1/8 inch hole drilled in the bottom. A paddle wheel is constructed of wood and cardboard and mounted below the hole in the sand hopper. This is attached to a piston, made as shown above. A rod is bent to the shape shown and acts as an axle for the power wheel and as a cam for the piston rod. This type of motor gives very interesting results and has the advantage of not needing any motor power. When the sand has all run out of the hopper, the motor is simply turned over and is ready for use again. Some interesting machine models can be made by the inventive constructor, using this principle. The power obtained is quite remarkable.—Ili Sibly.

BUILDING A PHOTOGRAPHIC ENLARGER

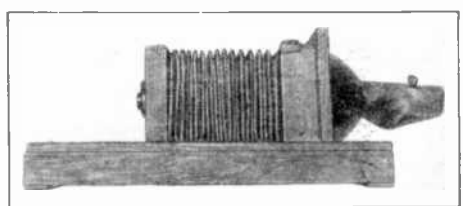
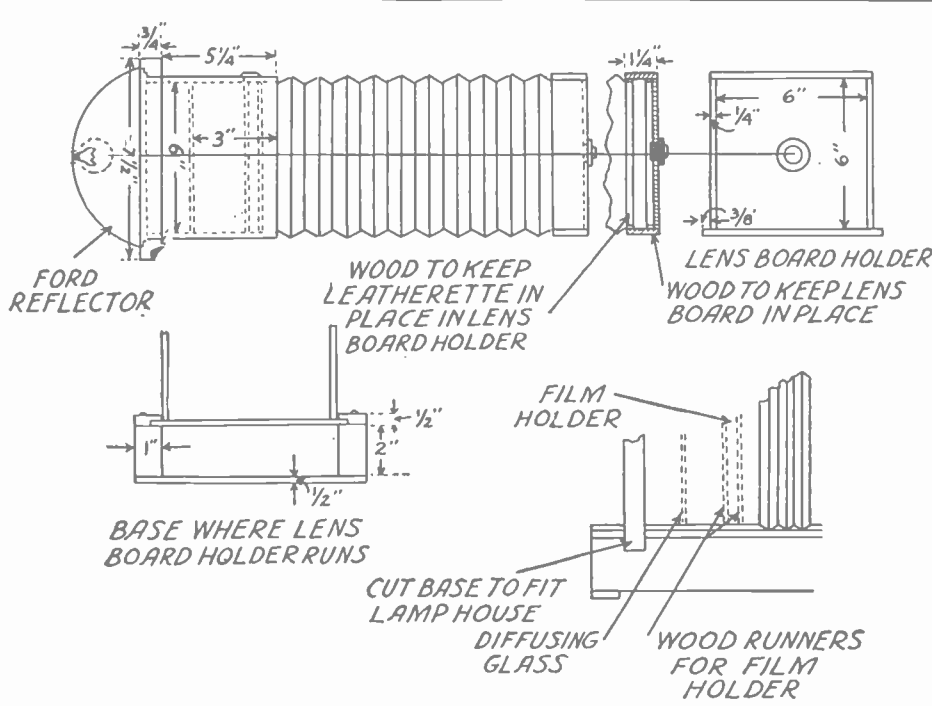

The photograph above shows the complete enlarger with the lamp housing at the left in the form of a parabolic reflector. This is obtained from a Ford headlight. We give all the details for building this enlarger which are shown with the dimensions for the base as well as for the various sides. The regular camera lens can be purchased from a photo supply shop. A 100 watt lamp is used for illumination. The diagram below indicates how the bellows is constructed.

—Thomas Scott.

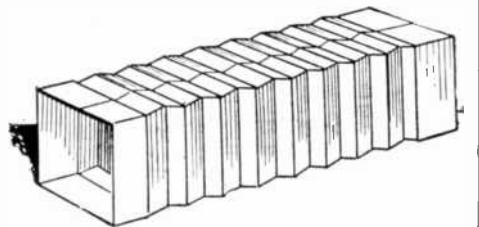



WRINKLES

RECIPES & FORMULAS



Edited by S. Gernsback

LEMON SQUEEZER

An emergency orange or lemon squeezer can be had by using a glass match holder. The ridge around the base of the holder will catch the juice. The lemon or orange is pressed over the match holder with a twisting motion, thereby squeezing out all of the juice.—Harry Hanaoka.

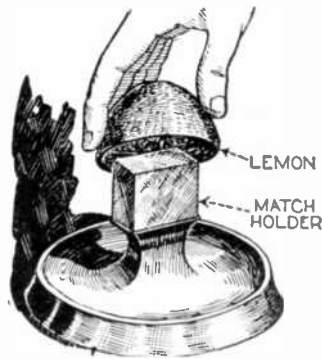

EXPLOSIVE PROTECTION

The illustration shows a novel method for keeping gasoline and other explosive products under water, to prevent danger of explosion. A string is attached to the bottle so that it may be easily removed. This hint should prove useful in the experimenter's laboratory.—C. Hickerson.

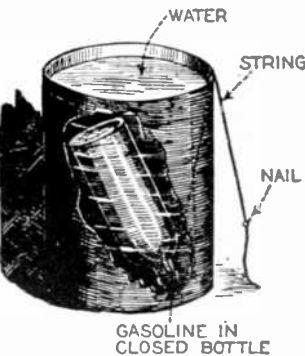

EMERGENCY ENVELOPE

By making two small envelopes, slicing off a bit of the left end of one and the right end of the other, and telescoping them to fit the size of the letter, a large envelope can easily be made. The illustration shows the method clearly.—A. Langreth.

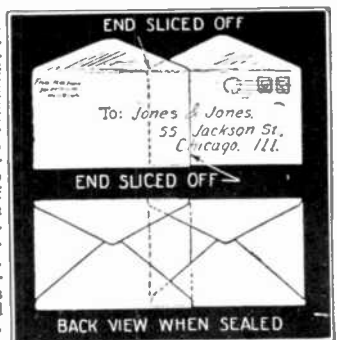

QUIETING SQUEAKING SHOES

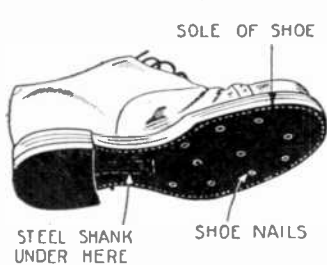

New shoes sometimes squeak horribly. This is caused by the rubbing together of the inner and outer soles. Iron shoe nails at the points shown will usually stop the squeaks.—D. S. Jenkins.

T-SQUARE PROTECTION

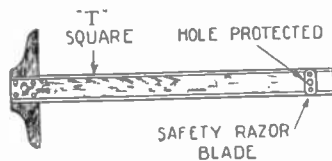

By gluing a safety razor blade over the hole in a T-square, much wear will be eliminated. The drawing shows the method clearly.—I. M. Howard, Rep. No. 19697.

TREE PROTECTOR

By affixing one or more sheets of fly paper around the trunk of a tree as shown, an efficient caterpillar eliminator can be made. The caterpillars will encounter the sticky surface and will be forced to go elsewhere.—P. A. Judd, Rep. No. 7297.



IMPROVISED ANCHOR

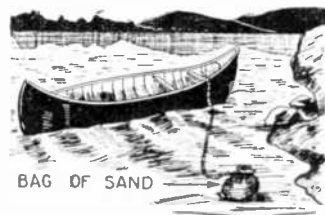

When there is no stone handy an anchor can be quickly made by filling a small cloth sack with sand. The sand may then be poured away after use.—C. A. Martin.

TWO-TONE HORN

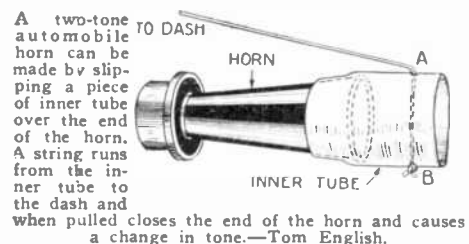

A two-tone automobile horn can be made by slipping a piece of inner tube over the end of the horn. A string runs from the inner tube to the dash and when pulled closes the end of the horn and causes a change in tone.—Tom English.

KNIFE SHARPENER

A hand knife sharpener can be made by mounting two carborundum wheels as shown. The wheels should be beveled. A block of wood serves as a base. To sharpen the knife, insert in grooves of wheels and pull towards you.—F. J. Wilhelm.

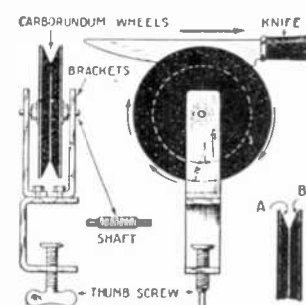

KILLING INSECTS

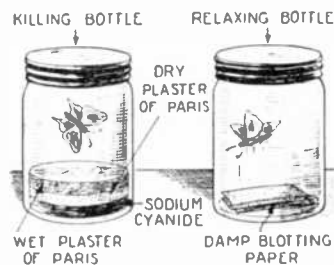

A killing bottle for insects can be made as shown at the left. A relaxing bottle will prevent the insects from becoming brittle and will allow them to be easily mounted.—C. Smoleny.

TOOL KIT

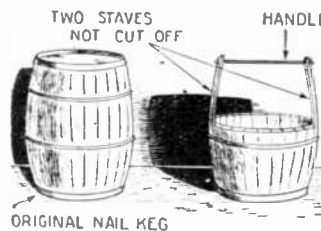

An ordinary nail keg, remodeled as shown makes an excellent tool retainer. A hand saw is the only tool necessary to remodel the keg. The illustration shows how this may be accomplished.—I. M. Howard, Rep. No. 19697.

REPAIRING BATTERY POSTS

When the battery connecting post becomes broken off, a very neat and efficient repair can be made by placing a screw into the old hole and pouring melted lead around it. A tin or cardboard form should be used to keep the lead around the screw. The screw should

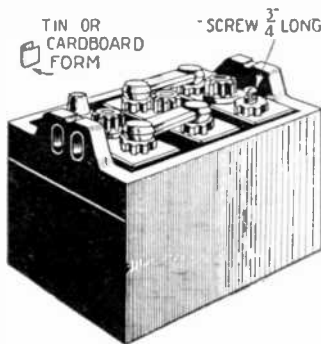

project from the battery 1/4 inch or more.—H. D. Malvin.

TRAP HINT

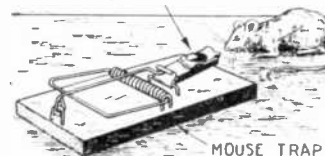

It ofttime happens that the bait in a mouse trap is stolen and the trap does not spring shut. If a thumb tack is placed in the middle of the bait and well anchored in the wood, the trap generally springs the first time. This mode of fastening the bait is much better than tying it on with a piece of string.—E. M. Quinby, Rep. No. 3852.

CLEANING BATTERY CLAMPS

Battery clamps usually become oxidized or dirty. If the clamp is placed in a solution of household ammonia it will be found to become as shiny and bright as when it was new. The ammonia need not be thrown away after being used in this manner, but can be kept and used over and over again for the

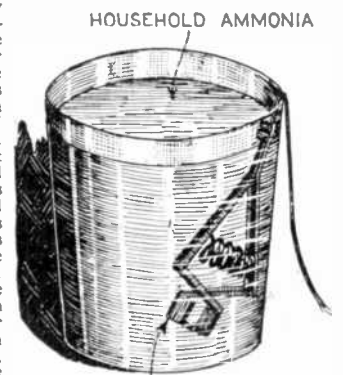

same purpose.—Contributor send name and address.

PAPER CUTTER

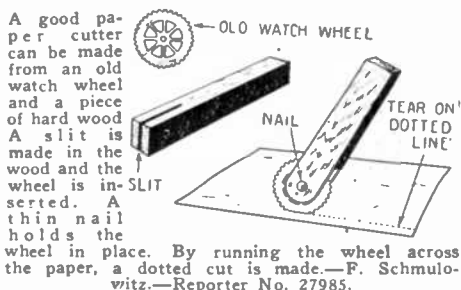

A good paper cutter can be made from an old watch wheel and a piece of hard wood. A slit is made in the wood and the wheel is inserted. A thin nail holds the wheel in place. By running the wheel across the paper, a dotted cut is made.—F. Schmulowitz.—Reporter No. 27985.

S. & I. RESEARCH LABORATORY

Editor, SCIENCE AND INVENTION:

I have read with great interest the article concerning the establishment of a research laboratory, which article appears in the July issue. I think that Mr. Boesken's idea is a splendid one. Should very much like to see such a laboratory established and feel sure that it would be an asset to science. His list of fields in which there is possibility for research includes but a few of the many. His suggestion that the stock be sold at a nominal price is certainly splendid. If such a department is to be started, it will be through the moderate investments of a large number rather than the more liberal investments of a few, that success will be possible. We all have to agree with you in the statement that the project would require heavy capitalization, but with a few well-chosen executives to start it off. I think that the necessary financial backing could be obtained. As to whether or not the plan would pay, I think we all know that "Rome wasn't built in one day," and consequently would not expect "big dividends" at the beginning.

HERBERT A. STEVENOT,
Brooklyn, New York.

(It may be remembered that Mr. Boesken suggested that SCIENCE AND INVENTION establish a research laboratory for the purpose of assisting inventors; likewise of making new researches along heretofore unknown fields and then, in some way or other, market these suggestions so that those financially interested in the laboratory would receive some compensation. The editor at that time pointed out that such a research laboratory would require years to develop into a paying proposition. While the response on the part of SCIENCE AND INVENTION readers was very great, still the plan does not seem entirely feasible, primarily because of the time factor required in development and because of the terrific expense attached to such a laboratory. Mr. Stevenot's ground is well chosen. But all readers did not take the same view of such an organization as is exemplified in the letter.—EDITOR.)

ULTRA-VIOLET RAYS

Editor, SCIENCE AND INVENTION:

In your January issue, p. 846, a correspondent inquires what substance other than quartz will transmit ultra-violet radiation. In scientific research, for example in the spectroscopy of the ultra-violet, (a subject of great theoretical importance), use is made of a substance known as fluorite, a naturally occurring form of calcium fluoride CaF_2 which transmits these radiations. It is to be noted that ordinary air absorbs ultra-violet radiation, and this is why beneficial results are obtained when ill-nourished children live on mountainous heights, since the thickness of the atmospheric layer is diminished, with less ultra-violet ray absorption in consequence. A further point of interest is that the light from a mercury arc lamp is particularly rich in ultra-violet rays.

F. E. TOMKINSON, B. Sc.,
The University of Liverpool,
Barrow-in-Furness, England.

(And we might add that the rays from an arc lamp in which iron electrodes are used instead of carbon are particularly rich in the ultra-violet end of the spectrum. Ordinarily glass does not transmit ultra-violet rays, but there is glass on the market known as the Vitaglass, made in both transparent and non-transparent forms which will transmit these rays.—EDITOR.)

BUCKET GAME

Editor, SCIENCE AND INVENTION:

Would be glad to have you furnish me with information as to the workings of tubs or buckets commonly used by concessionaires at fairs and carnivals. This game is usually worked as follows:

Person in charge urges patrons to try three free throws as an incentive to try for one of prizes offered such as dolls, blankets, etc. In most cases the customer very easily puts all three balls (free) into buckets, which usually leads to payment of real money for a try at prizes offered. In very few cases is prize ever won and it is evident that a prize cannot be won except when the concessionaire is so inclined to be generous. Apparently game is anything but a sporting proposition and should be set down as a rank swindle.

If you have any information as to just what mechanism or trick is employed, would be glad to have your advice.

ALBERT SCHNEIDER,
Cedar Rapids, Iowa.

(Approximately two years ago SCIENCE AND INVENTION Magazine exposed the bucket game such as is used at the various fairs and in summer amusement places. The buckets or tubs are either placed at an angle or upright, in accordance with the wishes of the operator or the particular design of the construction. The object is to try to toss three balls into the bucket for money or other prizes. The buckets are large, the balls small, so that the trick appears to be very easy and the stunt can really be performed if the buckets are not tricked. Unfor-



SCIENCE AND INVENTION desires to hear from its readers. It solicits comments of general scientific interest, and will appreciate opinions on science subjects. The arguments pro and con will be aired on this page. This magazine also relishes criticisms, and will present them in both palatable and unpalatable forms. So if you have anything to say, this is the place to say it. Please limit your letters to 500 words and address your letters to Editor—The Readers Forum, c/o Science and Invention Magazine, 230 Fifth Avenue, New York City.

AMAZING STORIES

IN OUR
OCTOBER ISSUE:

AROUND THE UNIVERSE, by Ray Cummings. If you love interplanetary stories, and

who doesn't—here is a story that will do your heart good. It is written in an entirely different vein, and yet contains excellent science all the way through. Incidentally, the astronomy contained therein is most excellent as well as correct, and gives you an insight into the wonders of the universe that perhaps few other "space" stories can boast. We know you will greatly enjoy this story. It is a classic.

TREASURES OF TANTALUS, by Garrett Smith (A serial in 2 Parts). Here is one of the most daring and exciting stories which we have ever read. Now that we have television, the idea of the author's Telephonoscope, by which it is possible to spy upon people and see what is happening right in their own homes and offices is of tremendous interest. How one man succeeded in practically controlling the entire world thereby, is told in inimitable style by this famous and well-known author, who has also written "After A Million Years," "On the Brink of 2000," and other famous scientific tales.

ÆPYORNIS ISLAND, by H. G. Wells. One of the few stories by this famous master of scientific fiction written in lighter vein. Nevertheless, this story about the extinct bird of Madagascar, is an excellent scientific tale.

THE WINGED DOOM, by Kenneth Gilbert. Now that aviation has come to the fore again, through the exploits of our American flyers, this story gives you a peep into the future, and you see what may happen when a powerful nation is about to invade this country. Here we have aviation to the nth degree, and yet, as you read on, you will become convinced of the possibilities contained in the story.

tunately for the player, the bottom of the bucket is free. It can be made to tilt if the operator of the stand so desires. With the bottom at the proper angle, the balls dropped into the bucket, rebound and bounce out of the receptacle again. If the angle is increased, the balls striking the bottom of the bucket rebound, strike the side and remain within the container. It is absolutely impossible to win at this game, unless the game is played on the level.—EDITOR.)

MASS VS. VOLUME

Editor, SCIENCE AND INVENTION:

As I was reviewing a few of the SCIENCE AND INVENTION issues of the past few months, I came to page 1117 of the April issue where a chart is given showing the value of the banana as a nutritious food in comparison with other foods. I noticed that the pound was used as the standard of mass. This gave the inspiration to the follow-

ing question: If the standard of mass in the same comparison would have been a unit volume, say a cubic inch, would the results have been the same? I would say, no. I wish you would solve this question by publishing a chart of the same comparison and use a unit volume as the standard of mass. I should think it would be a worthy experiment.

ERNEST BRASCH,
Nez Perce, Idaho.

(In modern practice it is not customary to order meat by the cubic inch, nor is any ordinary commodity purchased in this way. In order to find out the number of cubic inches in a pound of meat, one would probably have to use some sort of a mechanism to measure the amount of displaced water when the meat is immersed in the water. It is obvious that the weight of 40 cubic inches of sirloin steak would be considerably greater than the weight of 40 cubic inches of bacon. The same is true of other articles of food stuffs. Surely a sponge cake is as light as a large potato pancake and this, in spite of the fact that the volume of the latter would be much smaller than that of the former. One could not possibly compare the bulk of one nutritious food with that occupied by another. The weight comparison is the only ethical method.—EDITOR.)

AIR BREATHING

Editor, SCIENCE AND INVENTION:

In an article on Houdini in SCIENCE AND INVENTION Magazine, October issue, our class noted the statement that he breathed 20 cubic feet of air per hour. Is this an error or are we mistaken in thinking so? By spirometer we found that a person will breathe approximately 5.3 cubic feet of air per hour.

Would you mind telling us if we are right or wrong? We are studying the subjects of oxygen, nitrogen and carbon dioxide and our instructor brought this magazine to show us how a man can live in an air-tight box. This is how the matter came up.

EDWARD BERGHOLM,
L-8 Grade Burbank School,
Berkeley, Calif.

(You must remember that the conditions in your particular case are decidedly different from those in the case of the late Harry Houdini, who in his experiments at the Shelton Pool, was in an enclosed casket in which he had to breathe the same air over and over again. As a result, the number of respirations per minute, due to the fact that each cubic foot of air did not contain as much oxygen as was formerly present, was greatly increased. During ordinary quiet breathing, about 300 CC of air is taken into the lungs and expelled with each inspiration and expiration. This quantity of air is known as vital air. By forced respiration, an additional quantity known as complementary air is taken in and the volume of this is about 1700 CC. The air that can be expelled by an effort after an ordinary expiration has been completed is known as supplemental air and this measures approximately 1500 CC. Then there is a quantity of air remaining in the chest amounting to about 1000 CC, called residual air. If the person expels forcibly and then inhales to the fullest extent we obtain what is known as the vital capacity which in a typical case is approximately 3500 CC. But all of these quantities naturally vary with different individuals and under different circumstances and conditions. The figures are given to indicate a rough average. Now then, whenever the proportion of carbon dioxide in air is raised to .07 volume percent, the air becomes very close. It is this carbon dioxide which renders rooms stuffy. Air can even contain as much as 25% carbon dioxide and can be breathed safely for a short time, if there are no other impurities in it and if it contains plenty of oxygen. The figures which you obtained are relatively low. Your calculations indicate that a quantity of 8.6 cubic inches of air was inhaled and expelled at one normal breath. Physiologically and citing average figures, each breath contains approximately 30 cubic inches of air in an adult human being. Roughly, the air breathed in one hour would be 14.6 cubic feet during which time .73 cubic feet of oxygen is absorbed and .63 cubic feet of carbon dioxide excreted, but this citation is for a normal case where the air is vital. It is not the figure which one would obtain when the individual to be measured is excited to a greater or lesser degree and when the air itself is rapidly becoming close, and when the temperature of the confining tank is 99.2 and much of the oxygen in the air has been absorbed while carbon dioxide has been given out. In one hour, if the person is kept in a sealed tank, that individual would have rendered 2,000 cubic feet of air close.—EDITOR.)

LIVING AFTER BEING FROZEN

Editor, SCIENCE AND INVENTION:

The Sunday News ran an article, a clipping of which I enclose, which stated that a Dr. Hotham, after returning from Switzerland, made an extraordinary discovery. While climbing St. Gothard Glacier, he found under a great thickness of ice, the body of a man fully preserved just as if it had

(Continued on page 567)



RADIO

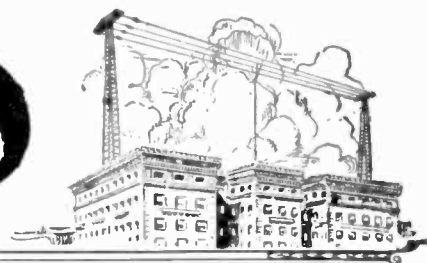

Radio "Ears" Guide Balloons

By WALTER E. BURTON

Using Loop Receivers Aeronauts Find Position of Gas Bag

Below are three photos showing the apparatus used in determining the position of the balloons. The photo at the left shows W. T. Van Orman using the air sextant which is employed in checking the findings of the radio compass. The photo below this shows a super-heterodyne receiver with the loop and the compass which is used so that the direction of the broadcasting station can be determined. The loop can be folded up when the equipment is to be stored away.

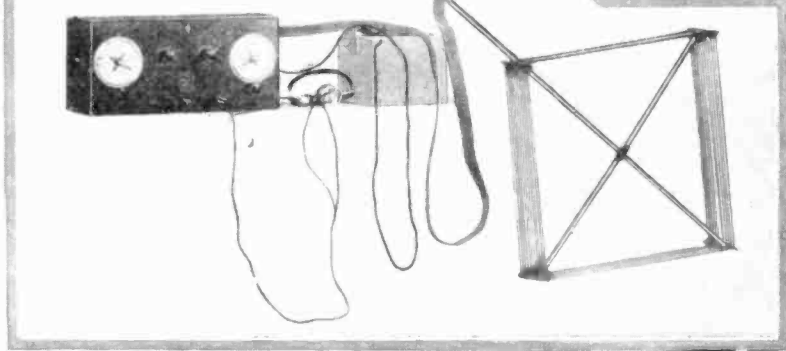
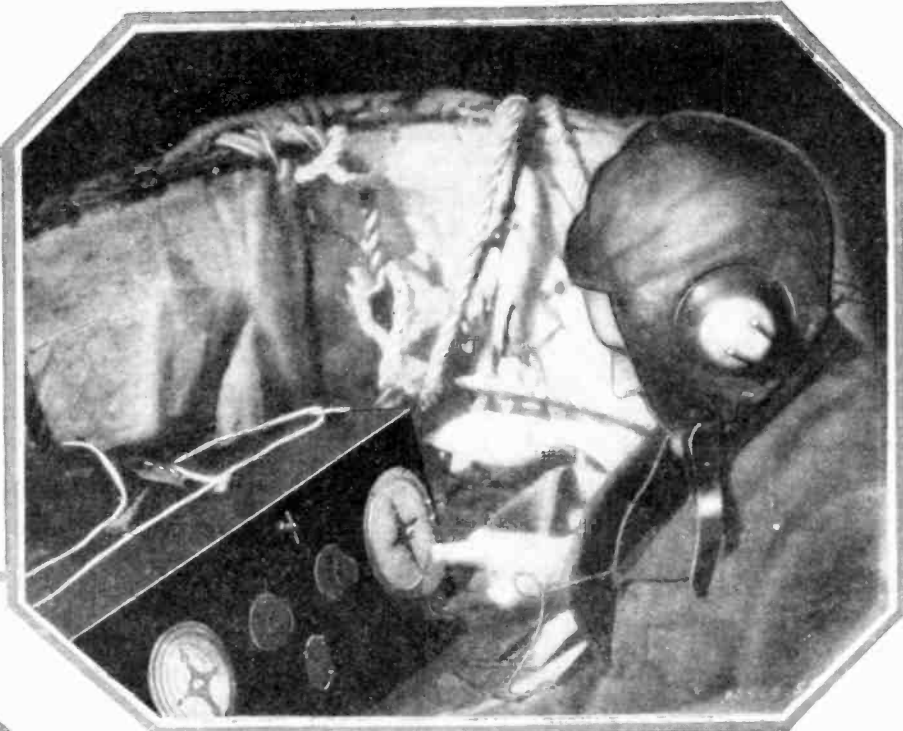

The above photo shows the balloon basket equipped with a super-heterodyne receiver. The battery case is discarded before the balloon lands, thus lessening its weight. The complete outfit weighs about 37 pounds.

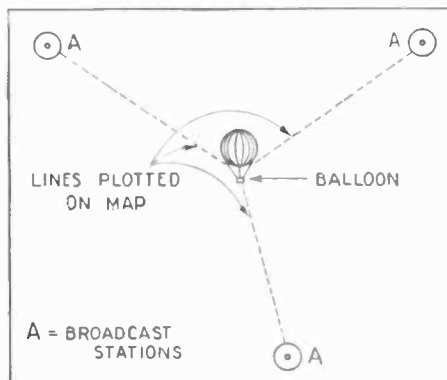

By referring to the above diagram, we see how the balloonist is enabled to plot his position on the map, after using the loop receiver.

THE radio receiving set has won for itself a place of first importance among the many pieces of equipment carried by a free racing balloon. Compact, reliable receivers perform several services. They enable the balloonist to obtain latest weather reports and news about other balloons in the race. They bring music to break the monotony of long, cheerless hours of flying. They make it possible to locate and avoid thunderstorms. Most important of all, loop aerial sets used as radio compasses, enable the crew to determine the exact position of a balloon when other means fail.

When radio sets were first used in balloons, an aerial several hundred feet long and a counterpoise of equal length were suspended from the basket. This worked well except in thunder storms. At such times the wires were drawn in because of the danger from lightning. Lightning, by the way, does not bring much cheer to the balloonist, who has many thousands of cubic feet of inflammable hydrogen gas above his head.

Receivers now used on balloons are of the loop-aerial type. The super-heterodyne and tuned radio frequency circuits have proved satisfactory. One type of portable outfit weighs 37 pounds complete.

Nearly absolute accuracy in determining

the position of a balloon is possible with the radio compass used in conjunction with a sextant. The accuracy varies as the distance from the station changes. Two or more broadcasting stations are tuned in and the loop is turned until they are heard the loudest. A reading is then taken on the compass and a line is drawn on the map in that direction. At the point where the lines cross, is the position then occupied by the balloon. The distance of thunderstorm centers may also be determined.

When radio sets were first used in balloons,

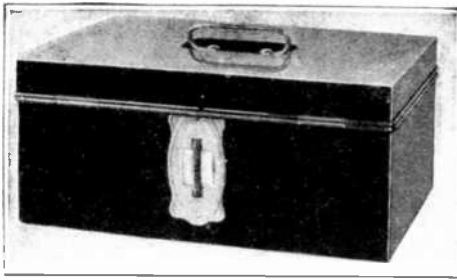

The completed semi-portable receiver is shown above. Note that the back of the box is used as the front panel.

TO the man who has use for a compact and efficient set of the knock-about type, the "Cash Box" receiver shown here offers several interesting and worth while features. At first glance the reader may be apt to consider the outfit more as an interesting novelty than as a dependable radio set that will bring him radio entertainment with all the quality and volume he expects from much more elaborate equipment.

It will be seen from the circuit diagram that the receiver uses sound principles from start to finish. From the photographs showing the layout and construction of the set you will notice an outfit that is not only unusually compact and rugged, but one that is logically and simply designed.

Rather than crowd the receiver, tubes, batteries, loud speaker and aerial in one case, and thereby sacrifice a certain amount of efficiency in the interest of portability, the "Cash Box" set is built in two small cases. One contains the receiver, the other all the necessary batteries.

BUILT IN A STANDARD CASH BOX

This four-tube single control set is built in a sturdy metal cash box which measures only $13 \times 9 \times 6$ inches. Such a box can be purchased at any well-stocked stationery or hardware store at a cost of about \$1.50. The cash box carrying case will stand almost any amount of rough usage and banging around. The box used for the model described in this article came equipped with a strong handle and two keys.

The "Cash Box" receiver has the added advantage of light weight, for complete in its metal case it tips the scales at slightly less than twelve and a half pounds. A second cash box of similar design houses all batteries, and this weighs only a bit more than twenty pounds.

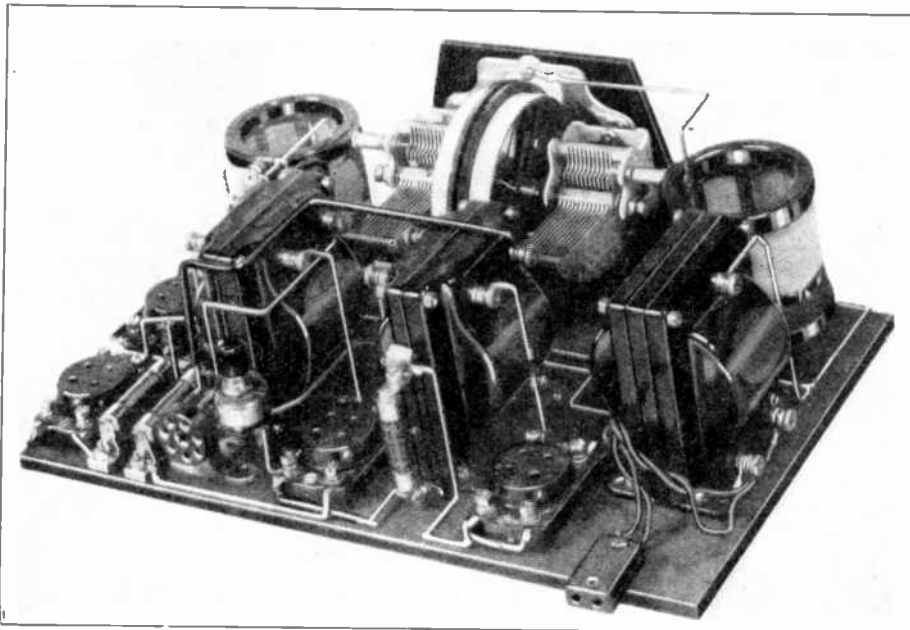

A rear view of the receiver before it has been placed within the cash box is shown in the photograph above. If the specifications given here are followed carefully, the complete assembly will be perfectly balanced. This will make it much easier to carry, than if the weight was unevenly distributed.

The 4-Tube

Total Shielding and Novel De-

By WENDELL

The receiver itself offers the builder many splendid possibilities and every assurance of excellent tone quality and volume. Surely nothing in radio could be simpler to operate. The tuning is strictly one control, free from trimmers, compensators or other accessory devices so frequently associated with one-control tuning. On the front of the receiver you will find simply the drum controlling the variable tuning condensers. To operate the set one has only to rotate the tuning drum until the desired station comes in with the volume required.

THE CIRCUIT USED

The circuit used is an old reliable one calling for four tubes—one radio frequency, detector, and two audio. No attempt has been made to devise a new or revolutionary hook-up. Rather, attention has been paid

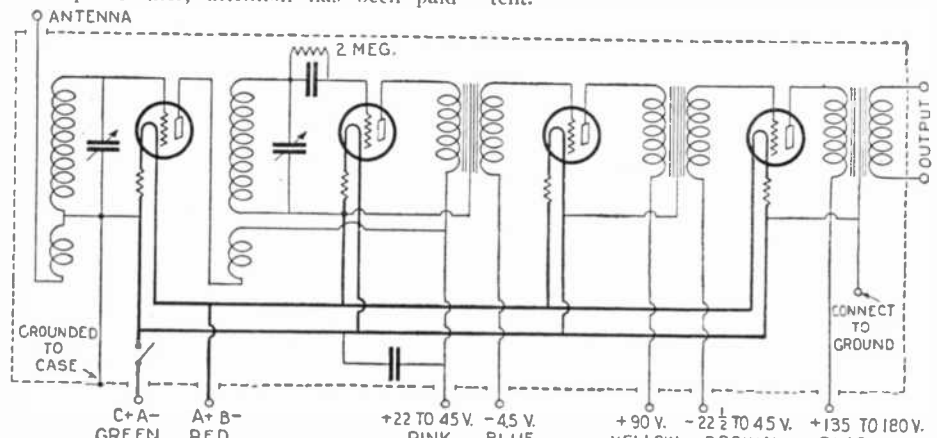

The schematic diagram of the set is shown above. Note that the cores of the audio frequency and output transformers are grounded. All battery leads have been marked with the colors which correspond with the coloring used in the battery cable.

to working out every detail of this standard four tube circuit so as to secure the very best results from it.

On the radio frequency side of the set we find a simple circuit, yet one which provides remarkably sharp tuning.

In the audio frequency side provision has been made for the use of a wide range of

B battery voltages. Much of the final success of the circuit can be attributed to the specifications and layout of the audio frequency amplifier. The tone quality is bound to please even the critical ear. The volume, even when the 99 type tube is employed, will prove somewhat of a surprise.

An output transformer is used in the assembly to make possible a wide range of B voltages on the audio amplifier. Either 135 or 180 volts of B potential may be used. The use of 180 volts always gives a marked step-up in volume, as well as a certain crispness and depth of reproduction, which is lacking with lower voltage. In either case the output transformer provides protection for the speaker windings as well as improving reproduction to a certain extent.

STARTING TO BUILD THE SET

In the "Cash Box" receiver spacing and relation of parts assumes more than usual importance, since the proper distribution of weight is a point not to be overlooked. In the directions which follow, the side of the box with the lock will be called the back, and the side with the hinges the front. Now on the back of the metal box lay out with a compass or scriber two holes as shown in Figure A. The circle is to receive the battery cable running from the battery box, and the rectangle is for the output connector for the speaker.

These openings may be made easily by using a small drill for metal work (about $\frac{1}{8}$ -inch) and drilling a series of holes just inside the markings for the circle and the rectangle. When the holes have been drilled around each, the openings may be broken out with a pair of pincers or pliers, and the rough edges smoothed down with a file.

On the left side of the box (looking at it from the front) cut two small circles as shown in Figure B. These are to be fitted with hard rubber bushings. Antenna and ground wires run through them when the set is placed in operation.

Now an opening must be cut on the front to receive the drum controls of the tuning unit. This can best be done by using the metal escutcheon plate supplied with the tuning unit as a template. First take the metal plate and cut off the protruding end of the ellipse which comes above the small hole at either end. This small piece need be cut from one end only, so the plate fits up snugly to the turned over metal edge of the box. However, if this small part of the escutcheon plate is not cut off

"Cash Box" Set

sign Feature This Semi-Portable

BUCK

at one end, the plate will not line up properly with the drum control of the unit in the assembly inside the box.

Center the escutcheon plate on the front of the box, with the end which has been cut set flush against the metal rim securing the hinges. With a pencil or scriber mark out an opening on the box the same as the opening in the metal plate. Cut this opening out to size in the same manner as the others were done. This completes the work of getting the cash box ready to take the receiver assembly.

BUILDING THE SET

First prepare a piece of 3/16-inch hard rubber as shown in Figure C. This will be used to hold the tuning unit in place in the assembly. Fasten this strip to the long edge of the wood baseboard, which is 12 1/2" X 8 1/2", with wood screws.

Now mount the tuning unit in place on the hard rubber strip, fixing it in position by means of bolts at the top and bottom of the metal frame work. In mounting the apparatus on the wood baseboard, it is important that none of the screws pierce through the bottom of the board and make contact with the metal case when the receiver is placed in the box. It will be noted from the schematic diagram of the circuit that the metal case is grounded.

The photograph showing the complete assembly of the set indicates clearly the position of all parts with the exception of the grid condenser and the .005 mfd. by-pass condenser. These two condensers mount behind the first audio frequency transformer and slightly to the left of it.

The work of assembling and wiring the set is done, needless to say, with the baseboard outside of the cash box. The receiver should be completely wired, tested, and working to your satisfaction before it is placed in the box and fastened in place by two bolts passing through the frame of the tuning unit.

Mount the parts on the baseboard as shown, slipping the assembly into the cash box for a minute to line up the cable connector block with the circle cut in the back of the box, as well as the rectangle with the extension cord connector for the speaker. With the position of these determined and the other parts mounted and screwed down, proceed to wire the receiver.

The model shown in this article is wired

with tinned bus wire. Flexible rubber covered wire may be used instead, but the bus wire when handled by a good workman, certainly makes a mighty neat and attractive job of the completed set. A little spaghetti may be used where leads come close together, or run near the side of the box.

After the wiring is done, turn the assembly over and make sure that no screws have come through the baseboard. Place the baseboard assembly in the cash box and line up the tuning drums with the opening in the front of the box. Run a bolt through the two holes in the metal plate on front, through the hard rubber strip and through the metal chassis of the tuning unit. Fasten the nuts down tight on the inside of the box. This completes the work on the receiver itself. The next thing is to prepare the other cash box and connect the batteries to the battery cable.

THE BATTERY BOX

The cash box which holds all the batteries is the same size as the one in which the receiver is built, 13 X 9 X 5 inches. When complete and equipped with all A, B and C batteries necessary, the battery box weighs slightly more than twenty pounds. This is with 135 volts of B battery. The box will hold 180 volts of B blocks if you wish to use this voltage.

On the side of the battery box with the lock, cut a hole five-eighths of an inch in diameter for the battery cable. This hole is spaced in the center, directly under the lock.

With the box open, a groove will have to be cut in the edge at the top, two inches from the right of the center of the lock. This groove can be made with a coarse round file and cut about three-eighths of an inch down into the box. When the battery box is being carried, the cable is looped through this groove, with the connector plug concealed inside.

Slip the battery cable through the hole cut in the center of the box under the lock. Have the loose connection leads inside the box, and the cable connector plug on the outside.

BATTERIES USED

Three 45 volt vertical B batteries, one 22 1/2 volt C battery (with a tap at 4 1/2 volts) and three or four dry cell A batteries are required. Using the set as a semi-

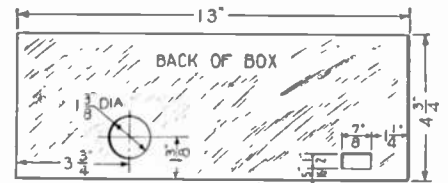

FIG - A

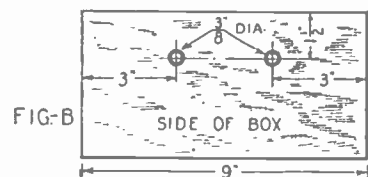

FIG - B

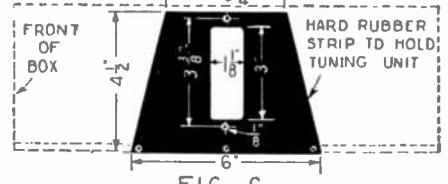

FIG. C

The illustration above shows the manner in which the cash box has to be cut in order to accommodate connections for the tuning dial, battery cable aerial and ground.

portable, most people will prefer the 99 type of tube, which calls for three 1 1/2 volt A batteries. Others may prefer the 5 volt, 01A type of tube, even though it is to be operated from four dry cells, which is admittedly not an economical way of operating this tube.

Now connect all the batteries as indicated from the diagram, following out the color scheme on the cable.

The battery cable may be longer than you will require most of the time, but rather than cut it, it is better to tuck the extra cable inside the battery box. The additional cable may come in handy some time when you want to put the set on a table and the battery box down below on a shelf or on the floor.

TUBE COMBINATIONS

For dry cell type tube operation: type 199 for R. F., detector, and first audio stages, type 120 for second audio stage.

For five volt tube operation: type 201-A in the R. F.; type 200-A as detector; type 201-A in first audio; type 171 in second audio.

OPERATION

Antenna and ground, wires are run through the two holes, fitted with bushings, in the side of the box. The aerial wire is run to the top of the first R. F. coil. The ground lead runs to the connection marked ground or earth on the output transformer.

(Continued on page 558)

ANTENNA

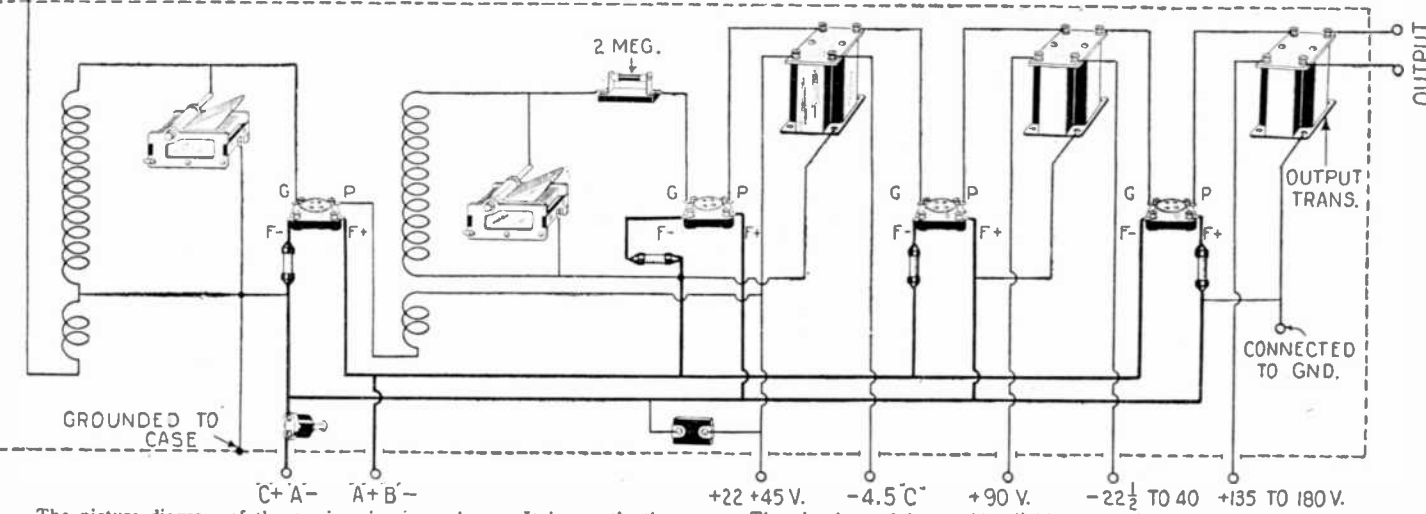

The picture diagram of the receiver is given above. It is exactly the same as the schematic, but is reproduced here for the benefit of those who have difficulty in following the other type of diagrams.

The circuit used is an old reliable one calling for 4 tubes—one radio frequency, detector and two audio. A receiver of this nature provides remarkably sharp tuning and should prove to be a "DX" getter.

Underground Antenna Reduces Static

How to Install Sheathed Antenna in Yard or Cellar—Receiving Range not Reduced

By H. WINFIELD SECOR

ONE of the most impressive happenings in our every-day life is the peculiar fact that so many inventions are made before the public is really ready for them. Recently there has been placed on the American radio

was proved during the World War by tests conducted by the U. S. Navy Department, is the underground antenna.

Dr. James Harris Rogers, whose laboratory at Hyattsville, Md., was a scene of much radio engineering research during the World War, is the inventor of the underground and under-water antenna. It was the writer's good fortune to have paid a visit to Dr. Rogers in his laboratory during the hectic days of the war, and it was a very remarkable experience indeed to hear many of the famous radio stations of the world coming in on one or another of Dr. Rogers' buried aerials.

Some of the trenches which Dr. Rogers had arranged to receive his underground antennas, ran for several thousand feet in certain geographical directions. In some cases these trenches crossed streets and other people's property. Speaking of the geographical direction of an underground aerial, with respect to the maximum response from a given station, it should be noted that when a lead sheathed insulated copper wire for instance, is buried in a straight line in a trench two feet deep and perhaps one hundred feet long, that the maximum reception is in the direction in which the aerial points. Thus if the aerial used in a given instance, runs east and west, then the direction of maximum radio reception lies in this line. In the ideal installation several underground aerials or sets of aerials are used, pointing to the several important points of the compass. By means of a suitable switch the receiving set is connected to the respective aerials, the particular aerial used being one which lies in the direction of the station to be received from.

In the accompanying illustrations Fig. 1 shows how one of the new underground antennas can be arranged with a minimum of labor, by simply winding the lead sheathed insulated antenna in several spirals, each spiral being covered with a layer of soil, and the hole finally filled up with soil, all of which is wetted down and kept moistened if necessary.

Figure 2 shows the most desirable form of underground antenna, where the sheathed insulated wire runs in a straight line in a trench. The writer has been using with very good results, through the summer months, one of these underground aerials buried in the form of several spirals, in the manner illustrated in Fig. 1. Using a shielded super-heterodyne of the standard eight tube type, all the New York stations are received at a distance of twenty-six miles, with practically the same strength as they are when using an outside antenna or loop above ground. Not only was this the case but a number of other sets, including a simple three tube regenerative receiving set, showed very good results and brought in Pittsburgh 350 miles away; which is very good for summer reception on such a concentrated form of underground aerial as this. Many people will not care to go to the trouble of digging a trench, say two ft. deep and 75 to 100 ft. long, in order to bury one of these underground antennas, and so it is important to note that the concentrated multiple spiral form, illustrated at Fig. 1, will bring in the stations with a minimum of static and interference from other electrical disturbances, such as power line leakage, etc.

Reception from Philadelphia is always very poor in the vicinity of New York City, and with this concentrated spiral underground antenna, as shown in Fig. 1, Philadelphia has been heard regularly through

the summer, which is in some ways superior to results obtained with outside aerial.

During the war the official naval tests from time to time showed some very interesting comparisons between the degree of

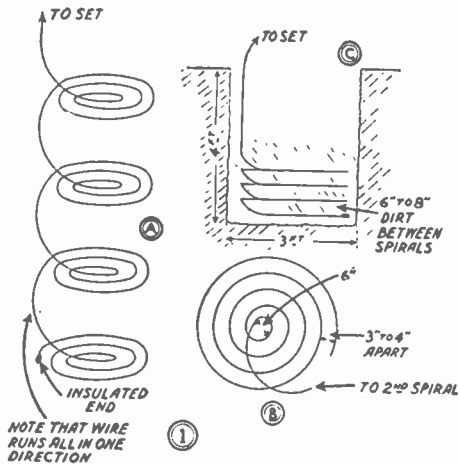

The illustration above shows how an underground antenna can be made with a minimum of labor—Illustration Courtesy Cloverleaf Mfg. Co.

market an underground and under-water aerial or antenna, known as a subantenna, and in view of the fact that there have been numerous phoney devices sold in the radio market at prices ranging from \$1.00 up to \$10.00 and more, which were "guaranteed" to eliminate static, quite naturally the radio public looks askance at any new device of a static eliminator nature.

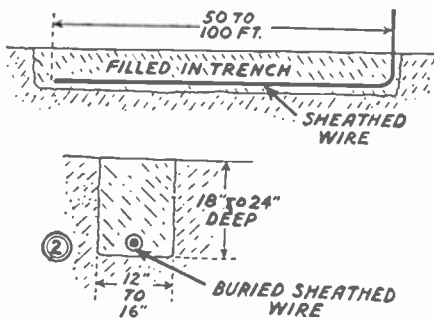

Above is shown one of the most desirable forms of underground antenna. The insulated wire runs in a straight line.

One of the few methods that have been devised by radio engineers and scientists in the past twenty years, which actually reduces the degree of static interference, as

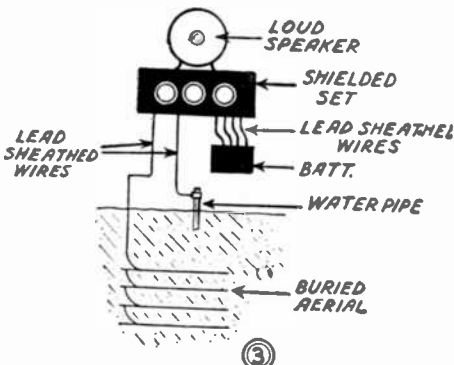

When installing an antenna of this nature, all leads to the set should be placed in a metal sheath as well as the set and batteries.

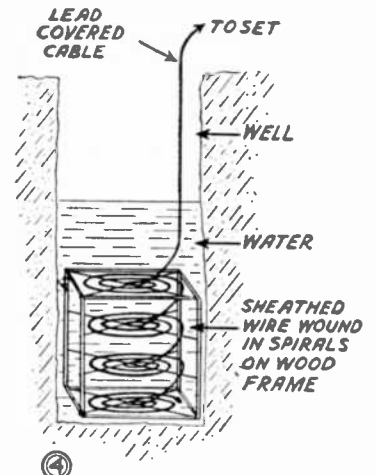

The spiral antenna may be used under water as well as underground. Above we see an antenna installed in an old well.

signal strength, as compared to the static signal strength, when using the underground antenna. At New Orleans, for example, it was found possible to carry on steady radio reception from a distant station, when using the underground antenna for reception, while a heavy electric storm was directly overhead. It is practically impossible to accomplish

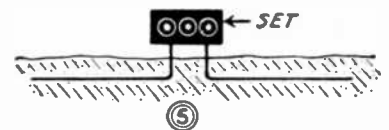

Two wires buried under ground, may be used in place of the regular antenna and ground. Both wires should be shielded.

anything like this, when using a regular elevated aerial, and it is very dangerous.

One of the most important points to remember, if you are going to install one of these underground aerials, is that you will not of course reap the full benefits of static reduction, unless you use a shielded set. If your receiving set does not already have shielded condensers and coils, the set can be shielded by placing aluminum or copper shielding all around inside the cabinet, and then grounding this metal lining of the cabinet. It is important to remember that the lead sheathed cable must extend up to the set, and also that the ground wire must be a piece of lead sheathed cable. It is well to place the batteries, including both A and B, in a metal-lined box, this lining being grounded; the battery wires, unless they are very short, should be lead

(Continued on page 558)

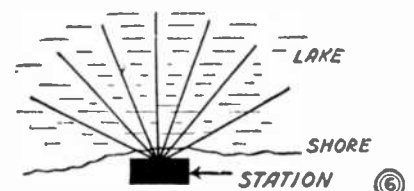

Above we have a fan shaped system of wires, extending beneath the surface of the water which are used as the antenna. If desirable, this same system may be used under ground.

RADIO ORACLE

In this department we publish questions and answers which we feel are of interest to the novice and amateur. Letters addressed to this department cannot be answered free. A charge of 50c. is made for all questions where a personal answer is desired.

A. C. TUBE CONNECTIONS

(575) J. C. Warner, Paulina, Iowa, writes:
Q. 1. I have a four tube radio receiver which uses six volt storage battery tubes. Will you please publish a diagram showing how these tubes may be replaced by the new A. C. vacuum tubes of the UX-226 and UY-227 types with a 210 type tube in the last stage?
A. 1. On this page you will find the circuit diagram showing the filament connections which

by the mathematical equations which are commonly used in acoustics. From such analysis it is found that it will tend to have certain definite resonances, and also will almost completely cut off certain frequencies. A response curve of a horn-type loud speaker is most illuminating, and it is really rather surprising that the ear can appreciate the sound output as tolerable speech and music. Broadly summed up, a good horn speaker can be made to give surprisingly equal

dial division increases as the condenser is turned toward maximum capacity, and the unit which was advanced gains capacity more rapidly than the others. This feature has caused at least one important manufacturer of uni-control receivers to return to the semi-circular plate shape.

It may be noted that the effect of "straight line wavelength" and "straight line frequency" condensers is strictly a slow motion action, having a variable reduction, gradually lessening as the condenser is advanced. The same result can be and, in fact, has been accomplished by a slow motion dial so constructed as to automatically vary its reduction ratio, to give the effect of a "straight line frequency" plate when used with a "straight line capacity" condenser.

The disadvantage of the semi-circular plate shape was first realized in connection with the construction of wavemeters. This was long before there were enough broadcast stations for the problem of station separation to be serious. As the relation between capacity and wavelength is not a direct proportion, a dial calibrated in wavelengths will not have equal divisions over its scale if a semi-circular plate shape is used. This not only makes the instrument more difficult to read, particularly as to the estimation of readings which fall between divisions, but involves difficulty in calibration, as the space between two points, ten meters apart for instance, could not be divided into ten equal one-meter divisions. A plate shape which would give equal divisions for equal wavelengths, i.e., "straight line wavelengths," was highly desirable, and a condenser with such a plate shape was first used commercially in a wavemeter, introduced in 1916. When the multiplication of broadcast stations began, "the straight line wavelength" plate was introduced for condensers used in receivers, and became very popular, due to the better separation of stations resulting from its use.

Broadcast stations continued to multiply, however, until all channels in the wavelength range allotted to broadcasting were filled. The transmission channels were assigned on the basis of uniform frequency rather than uniform wavelength separation, and, as they all became occupied, the difficulty of crowding a great many more than half the stations into the lower half of the dial again rose. The obvious step was, of course, the "straight line frequency plate" shaped to give equal frequency divisions over the dial. This plate shape not only improves the distribution of stations over the dial, but is the only type of condenser which can be used in a single-control super-heterodyne, where there is a constant difference of frequency between the two circuits being tuned.

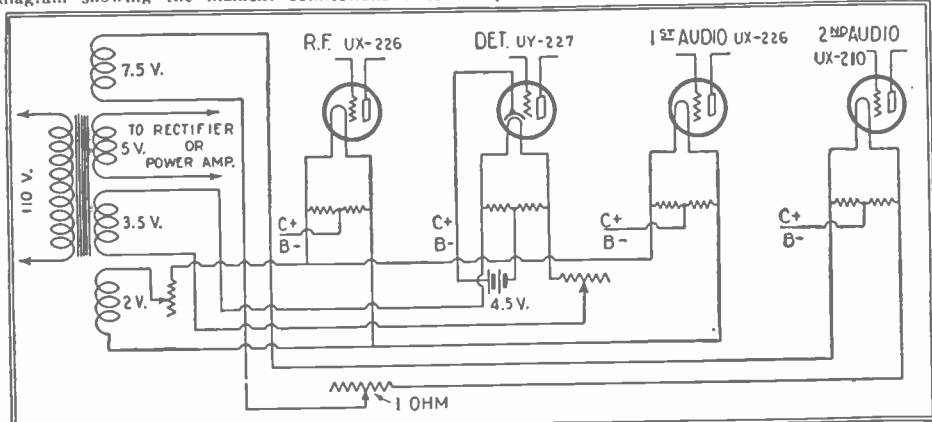

The filament circuit diagram showing the necessary connections for the new A.C. tubes, is shown in the above illustration. Note that the grid and plate returns are made to the mid-point of a center tapped resistance.

you will have to make in order to install A. C. tubes in your receiver. The transformer will cost in the neighborhood of eight to ten dollars and provides four different voltages. The grid and plate returns are made to the mid-point of a center tapped resistance. This will eliminate any hum which may result. The detector tube is of the heater element type and is relatively quiet in operation. The 210 type tube in the last audio stage is supplied with A. C. current directly from the transformer. It must be remembered that the amperage required by these tubes is considerably more than that for the ordinary six volt vacuum tubes. The filament circuit should be wired with No. 14 or No. 16 insulated wire. When using the five prong type of the A. C. tubes, the C+ and B- connections are made to the fifth prong. Rheostats will be required, but when once set will need no further adjustments, so that they may be placed behind the panel. The C+ and B- connections are made to the mid-tap of the center tapped resistance when the four prong A. C. tube is used.

CHOKE COIL CONSTRUCTION

(576) J. B. Gamer, New York, N. Y., asks:
Q. 1. Will you give me the data necessary for the construction of a choke coil which is to be used with condensers, in order to eliminate interference in the radio set which arises from electric motors?

A. 1. A good type of choke coil to be used in connection with condensers for eliminating interference in power lines from electric motors consists of 100 turns of No. 18 double cotton covered wire, wound in a single layer on a fiber tube of about 3 in. diameter.

HORN VS. CONE TYPE SPEAKER

(577) W. H. Berman, Severn, Md., writes:
Q. 1. Will you list briefly the comparative merits of the horn and cone type loud speakers and the outstanding features which are claimed for these instruments?

A. 1. First of all let it be stated very definitely that substantially perfect reproduction can more easily be obtained with a diaphragm type of loud speaker, that is, one which is not provided with any form of sound conduit. However, a well-designed horn speaker may give far more pleasing results than an inferior cone or diaphragm type, and, unfortunately, there are many instruments of the latter type now being manufactured.

Let us consider the mode of operation of a horn-type speaker. It is provided with a small metal diaphragm rigidly clamped round its periphery; this is under a steady pull from the permanent magnets and the driving mechanism, and it can be very easily shown mathematically that a diaphragm of this nature cannot give a linear response over the entire band of speech and music frequencies. To begin with, the diaphragm will have a natural resonance of its own. At the upper and lower frequencies its response will be very poor. Next we have to consider the effect of the horn. The object of the horn is partly to set into vibration a larger volume of air than can be energized by a small diaphragm. A horn is somewhat similar to an ordinary organ pipe, and its acoustic properties can easily be examined

reproduction over a useful frequency range, in spite of its cutting off both top and lower registers, and introducing at certain points certain undesired resonances, in addition to a certain amount of characteristic coloration.

With the cone or diaphragm type of speaker the air is energized entirely by the direct vibration of a diaphragm of appreciable area. The mode of vibration of the diaphragm will be determined by the manner in which the edge is fixed; it may be either "fixed" or "free." If the diaphragm has a fixed edge its mode of vibration will not be a direct function of the manner in which it is energized by the driving mechanism. If, however, the diaphragm is reasonably rigid, and has a perfectly free edge, then its vibration will be nearly equivalent to that of the driving mechanism. It is, however, vastly more difficult to produce a good speaker of the diaphragm type than it is to produce a good horn type. Many diaphragm type of speakers which the writer has examined are very deficient in their response to the higher frequencies, and many of them tend to produce harmonics very badly. This has the effect of making the whole characteristic of the transmission high-pitched and tinny, and the result is certainly not so pleasing as that obtained from a good horn speaker. But the difference between a good diaphragm type and a good horn type is an individual choice, and anyone with only a reasonable ear for music can soon determine which type loud speaker they prefer.

CONDENSER PLATE SHAPES

(578) Walter Bode, High Barnes, Sunderland, England asks:

Q. 1. Will you please tell me why variable air condensers have different shaped plates, and also, publish a drawing showing the plates which are most commonly used today.

A. 1. Variable air condensers are made with three general types of plate shapes, although there are many modifications of each type. On this page you will find illustrated the three types most generally used.

The first rotary variable condensers were made with "straight line capacity" plates. These plates were semi-circular in shape and are called straight line capacity because the curve of capacity plotted against dial divisions (angle of rotation) is a straight line. The relation between capacity, wavelength, and frequency are such that this plate shape tends to result in the crowding of stations at the lower end of the capacity range. That is, there are more transmitting channels for each dial division at the lower end of the scale than the upper. This objectionable feature has led to a widespread use of other plate shapes.

The straight line capacity plates have, however, one distinct advantage when used in single-control set ups. Where it is desired to tune several circuits with one control, some form of capacity adjustment is nearly always necessary to compensate for different zero capacitances in the several circuits. If semi-circular (straight line capacity) units are used, this adjustment can be made by slightly advancing one or more of the units. If this be done with condensers having other plate shapes, the capacities will become unbalanced as the control dial is advanced. This is due to the fact that if the plate shape is not "straight line capacity," the capacity variation per

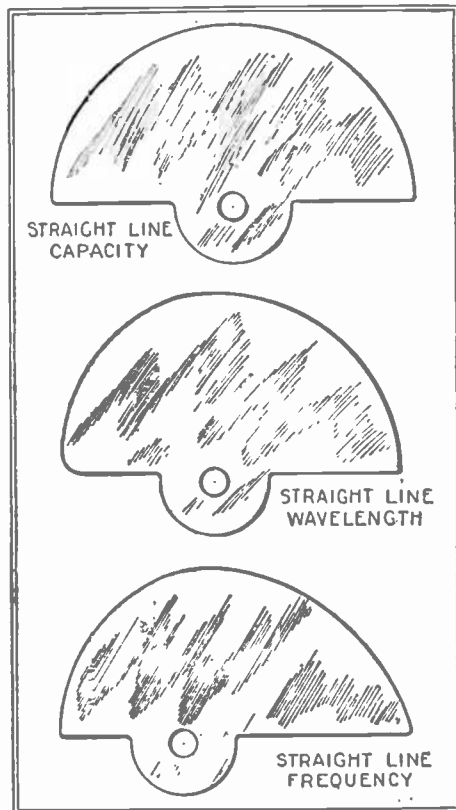

The three types of condenser plates most generally used today, are illustrated in the above drawing. There are of course many modifications of these three general types but space does not permit them to be shown.

Scientific Humor

BETTER THAN THE IVORY JOKE

Two old men were discussing the merits of their respective heads. One of the fellows was bald-headed and the other was a solid grey. Finally one of them ended the discussion like this:

"Well, Si, I will admit that having a head of hair is better than having a bare space on the map as you have."

"But, I say it ain't, Jim," replied the shiny-headed one.

"Well listen, Si, let me tell you something. When a man gets old the roots of his hair get deeper into his skull. If they strike a lot of grey matter like mine, he gets grey hair. Now if the roots of the hair penetrate into the skull and find nothing, he gets bald, as you are."—*Halter K. Wulfkuehler.*



WOOD BE APPROPRIATE

LADY: "This is our Wooden Wedding, I want something appropriate."

COOK: "Yes, ma'am, how about some decoy ducks?"—*Leslie Carpenter.*

VERY LIGHT

"Astronomers are making an attempt to weigh light."

"That's easy, the grocers have been doing it for years."—*Lazarus Mallan.*

MORE FOR THE MONEY

"Shut off der radio, mine Bennie."

"But, papa, its a swell piano solo."

"Eggsactly, don't be wasteful, Bennie, my boy, tune in on a full orchestra or toin der radio off."—*Oden D. Gilfilcn, Rep. No. 29, 434.*



LOWER-HIGHER, SAP!

SAP (peering out of a window on the twelfth floor): "I see Bill down there, Ap."

AP: "Why don't you hail him?"

SAP: "It it quite impossible, old thing."

AP: "Impossible! how so?"

SAP: "Well, you see, old dear, we are on the twelfth floor, now should I hail Bill I should lower my voice, but Bill is quite far away and to make him hear me I should have to raise my voice."—*Henry Clifford.*

First Prize \$3.00 THE MISSUS CAN DISSOLVE IT QUICKER

PROF.: "Do you believe the five dollar gold piece I hold will dissolve in this solution?"

STUDE: "No sir! You wouldn't put it in, if it would."—*Louise Krauss.*



ORIGINALITY PLUS

Editor of "AMAZING STORIES" to author: "Are you sure this story is perfectly original?"

AUTHOR CONTRIBUTOR: "Well, not entirely, you may find one or two words in the dictionary."—*Winston C. Juengst.*

WE receive daily from one to two hundred contributions to this department. Of these only one or two are available. We desire to publish only scientific humor and all contributions should be original if possible. Do not copy jokes from old books or other publications as they have little or no chance here. By scientific humor we mean only such jokes as contain something of a scientific nature. Note our prize winners. Write each joke on a separate sheet and sign your name and address to it. Write only on one side of sheet. We cannot return unaccepted jokes. Please do not enclose return postage.

All jokes published here are paid for at the rate of one dollar each, besides the first prize of three dollars for the best joke submitted each month. In the event that two people send in the same joke so as to tie for the prize, then the sum of three dollars in cash will be paid to each one.



"ALWAYS SCRAPING"

FLINT: "She's got a mean pair of knees!"

STEEL: "Yeah, they're always knocking each other!"—*Earle Coler.*

BIPED FRETIS STOCKINGUS HUMANUS

TEACHER: "A biped is anything that goes on two feet. John, can you name one?"

JOHN: "Yes, ma'am, a pair of stockings."—*Mildred Leedy.*

AUDIBILITY POOR

(KIND OLD LADY TO TRAMP): "Didn't you hear me calling you, are you deaf?"

(TRAMP): "No, ma'am, but I have been, and I'm so used to not hearing things that it's just a habit."—*Edward J. Jenowski.*

NO DYING WHEN YOU DIE

ENID: "What did you do when you found that first grey hair?"

ETHEL: "Oh, I laughed till I thought I'd dye."—*Louise Krauss.*

THE CAT

MILDRED: "Sister can see in the dark."

MOTHER: "Impossible."

MILDRED: "Last night on the porch I heard her tell her beau he needed a shave."—*Louise Krauss.*



STATE-LIMITATION

CHEMISTRY TEACHER: "Fred, give the class an example of a substance changing its state."

FRED (after a little thinking): "Well, things that float down the Missouri through several states."—*John Boycn.*

CUT IT OUT

FATHER: "Willie, what makes your set squeal so?"

WILLIE: "I am twisting the pig's tail connection on the condenser."—*Howard Troup.*



FISHY APPLES

MRS. SMITH: "Those apples you sold me yesterday have a fishy taste."

GROCEER: "Sure lady, they're crab apples."—*Joseph Wallace.*

UNDERFOOT METHOD!

RELAX: "Would you like to know of a sure method of making money fast?"

REFLUX: "Sure thing."

RELAX: "Well then, try gluing it to the floor!"—*Henry A. Courtney.*

SCIENTY SIMON, Scientist

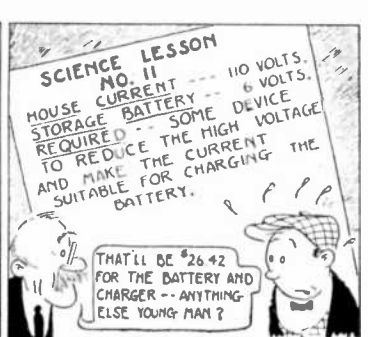



LATEST PATENTS



TOY BLINKING EYE

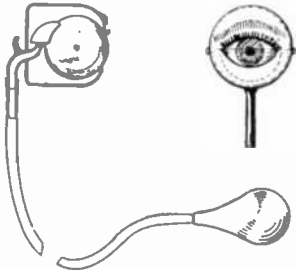

No. 1,585,340, issued to George Bruce Fitzgerald. The novel device shown above is a blinking eye which is to be used with child's toys. The eye is manually operated by an air-discharging means which preferably takes the form of a soft rubber ball. A casing is made to cover or expose the eye thereby producing the effect of winking. A front elevation view and a transverse section are shown above.

BATTERY CARRIER

No. 1,578,105, issued to John Taylor. The device shown here consists of a pair of U-shaped hooks and a handle connecting with the hooks. The battery engaging hooks may have their positions reversed. In practice it is advantageous to have the hooks engage the battery from the inside. The carrier may be conveniently folded in a compact manner, so that it may be easily carried when not in use.

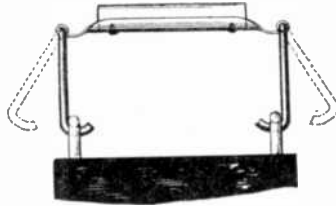

FLYING-DUCK DECOY



No. 1,629,442, issued to Joseph R. Geisinger. This invention provides for flying duck and geese decoys. The decoys are mounted upon an inclined plane and their wings are moved by wind pressure. The wind pressure will afford the appearance of ducks flying against the wind and downwardly as if about to alight. A number of parallel strands of wire are arranged on an inclined plane so that a number of decoys may be mounted at one time. The decoys may also be moved by means of a flexible wire in the absence of wind pressure.

PROTECTOR FOR SHOES AND STOCKINGS

No. 1,577,716, issued to Ruth Herrick. The invention shown here is a protector for shoes and stockings and is adapted to be worn underneath overshoes. It comprises a boot constructed of thin fabric and tapes secured to opposite sides thereof in position to be tied over the stockings of the wearer. A front piece and a sole piece are also attached to the protector. The protector is made of fabric which may be frequently washed or cleaned.



ADVERTISING PACKAGE

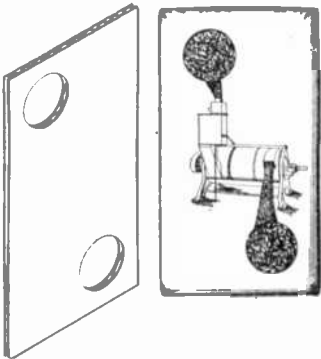

No. 1,633,444, issued to Henry A. Fruitema. The advertising package shown above provides a means for displaying samples of grain and the like, showing the article before and after entering the machine. Openings in the board are covered with sheets of transparent material.

KEY CASE

No. 1,615,059, issued to Daniel J. Wulffing. The case shown here provides a key retainer which is similar in structure to a pocket knife. The case is made of some flexible material and the keys are held in the case by means of a pivot. The case may also be adjusted so that it can be lengthened or shortened and thus hold a more or less number of keys.

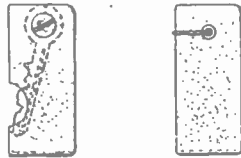

DRAFTING TRIANGLE

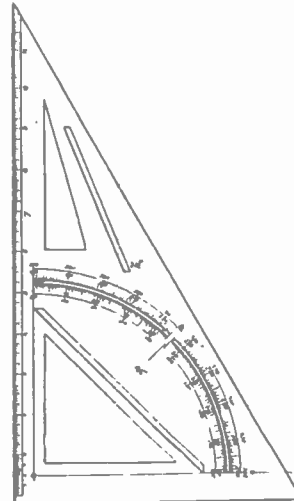

No. 1,598,690, issued to Jerome A. Petronio. This drafting instrument consists of a 30° right angled triangle having a 45° triangular opening in the angle formed between the two sides and a 15° triangular opening in the angle formed between the hypotenuse and one side. The arcuate slots have protractor scales at opposite sides.

RADIOCHART

No. 1,534,055, issued to James P. Coughlin. The chart shown here comprises an oblong card bearing the representation of a map. A ruler is attached to the map so that the distances between various radio stations and the receiver may be calibrated directly. Colored stickers are also provided and are placed over the stations which have been received. A handy reference sheet is attached to the map.

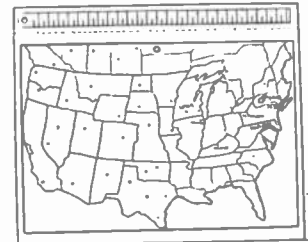

MECHANICAL TOY

No. 1,580,820, issued to Frank John Gensicki. The toy shown here provides for the operation of a saw by two mechanical figures. The articulated limbs of the operators are capable of executing a number of movements. The toy is of simple character and is operated by means of a spring motor. The two figures are pivoted upon metal racks, which in turn are acted upon by the motor, and are thus made to move and represent the operation of sawing a block of wood.

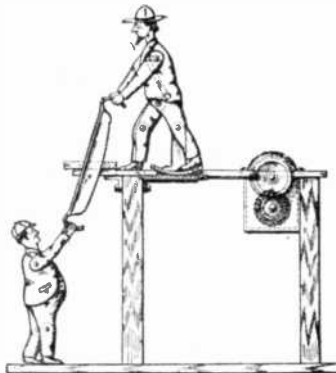

FLEXIBLE PROTECTOR FOR CARBON PAPER

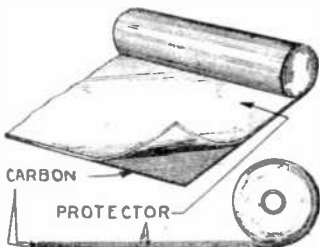

No. 1,575,230, issued to Chas. P. Schmitt, Jr. The invention shown here provides a thin flexible sheet which serves as a protector for carbon paper, and is adapted to cover the upper surface thereof. The protector absorbs the shock of type indirectly striking against the carbon.

SOLDERING IRON



No. 1,630,990, issued to Harley A. Wagg. The soldering iron shown here comprises a body shaped like a pistol, a fixed copper tube extending through the barrel, and a conductor extending through the handle and connecting to the tube. A wire electrode is frictionally received in the tube and is directed toward the barrel. The iron is operated by a trigger. The iron is being sold.

SWITCH

No. 1,574,475, issued to Ross Fox. This invention relates to a new and improved device for operating automobile signals. Leaf-like contact members are placed upon the rim of the wheel so that contact can be made by grasping the wheel at different points.

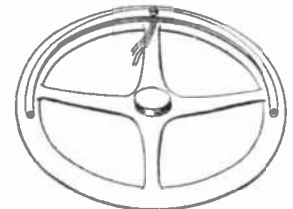

NOTICE TO READERS. The above illustrated and described devices have recently been issued patent protection but are not as yet to our knowledge available on the market. We regret to advise that it is impossible to supply the names and addresses of inventors of the above devices to any of our readers. The only records available, and they are at

the Patent Office at Washington, D. C., give only the addresses of the inventors at the time of application for a patent. Many months have elapsed since that time, and those records are necessarily inaccurate. Therefore, kindly do not request such information as it is practically impossible to obtain up-to-date addresses.

—EDITOR.



THE ORACLE



The "Oracle" is for the sole benefit of all scientific students. Questions will be answered here for the benefit of all but only matter of sufficient interest will be published. Rules under which questions will be answered:

1. Only three questions can be submitted to be answered.
2. Only one side of sheet to be written on; matter must be typewritten or else written in ink; no penciled matter considered.

3. Sketches, diagrams, etc., must be on separate sheets. Questions addressed to this department cannot be answered by mail free of charge.

4. If a quick answer is desired by mail, a nominal charge of 50 cents is made for each question. If the questions entail considerable research work or intricate calculation, a special rate will be charged. Correspondents will be informed as to the fee before such questions are answered.

RESHARPENING FILES

(2199) C. A. Hahn, Buffalo, New York, writes:

Q. 1. Is it possible to resharpen files and if so could you give me some information concerning the method used?

A. 1. Worn files may be improved temporarily by dipping them into dilute sulphuric acid and then washing them with water. Some firms make a specialty of recutting files, but in general it is usually cheaper to buy new ones. They can also be improved by an electrolytic process.

STOVE LINING

(2200) C. F. Cotton, Mexico City, Mexico, asks:

Q. 1. How may a good lining for stove fire boxes be prepared?

A. 1. We suggest that you try a mixture of three parts of common clay thoroughly pulverized and mixed with one part portland cement. The powder should be made into a thick paste by adding water.

REMOVING MERCUROCHROME STAINS

(2201) J. Berglund, Hoquiam, Washington, asks:

Q. 1. How can the stains produced by mercuriochrome antiseptic be removed?

A. 1. According to the experts at the U. S. Bureau of Standards, this red-colored stain can be removed by the application of benzaldehyde followed by 25% hydrochloric acid solution and by sponging with alcohol and then water. The stains must be fresh in order to be entirely removed.

PORTRAIT ATTACHMENT

(2202) G. R. Koski, Keene, New Hampshire, writes:

Q. 1. Can you give me information concerning the portrait attachment which is used with modern cameras and something of its working principles?

A. 1. The portrait attachment is a supplementary single meniscus lens which is intended to shorten the effective focus of the lens over which it is placed, so as to make it possible to focus objects at a short distance without too great an extension of the camera bellows. With the ordinary camera the extension of bellows will not permit subjects to be focused which are nearer than 6 feet, while with the box cameras, which have no focusing attachment, photographs will not be sharp if the object is within 10 feet, unless this attachment is used. The portrait attachment, therefore, enables one to place the camera nearer the subject and thus obtain larger, sharply focused images than would otherwise be possible.

COMPOSITION OF MARGARINE

(2203) L. F. Richards, Ely, Nevada, asks:

Q. 1. What are the compositions of the various margarines which are made in this country?

A. 1. On the basis of the fats entering into their composition, there are only two kinds of margarine made in this country. One is made of animal fats, vegetable fats, salt and milk. The other, commonly called nut margarine, is made of vegetable fats, salt and milk. For the fiscal year ending June 30, 1926, the principal articles of food used in the manufacture of margarine, according to the Annual Report of the Commissioner of Internal Revenue, were oleo oil, oleo stock, oleo stearin, neutral lard, peanut oil, coconut oil, cottonseed oil, milk, butter, and salt. It should be borne in mind that no manufacturer ever puts all of these foods into any one brand of margarine. He selects the ones that he likes best for each one of the brands he makes. The names of most of these food products indicate their source or origin. Some of them are well known.

LEAP YEAR OCCURRENCE

(2204) Miss Burnes, Habana, Cuba, writes:

Q. 1. In a recent issue of your publication I find the statement that a leap year occurs once every four years. I have heard other definitions presented; which do you consider correct?

A. 1. Referring to the query which you mention, it appears that both the question and the answer are in error where they say that a leap year falls every four years. The rule which is generally accepted is that the century-years divisible by 400 without a remainder, and all other years evenly divisible by 4, are leap years. The year 1896 was a leap year (because divisible by 4, without a remainder) but the century year 1900 was not, because not evenly divisible by 400, so that no leap year fell until 1904 (divisible evenly by 4)—a stretch of 8 years. Had the Gregorian calendar which was introduced in A.D. 1582, started with the year 1 A. D., it would have comprised 19 secular or century years, 4 only of which—400, 800, 1200, and 1600—would be

leap years. The 15 other century years would not be such.

PERPETUAL MOTION

(2205) Mr. Albert Drapeau, Lewiston, Maine, asks:

Q. 1. What progress, if any, has been made toward the solving of the eternal problem of perpetual motion? What sort of principle should such an apparatus operate upon.

A. 1. Up to the present time there has been no advancement made in perpetual motion. From the time of Archimedes and Hero the ideas concerning perpetual motion have changed but slightly. Perpetual motion today is as impossible as it was in those ancient times, and it is evident that the greater the number of assisting pieces of apparatus, the less efficient can the device be, and consequently the less liable to operate.

We know that there are motors today which are running on the temperature principle. Every single day in the year there is a change in temperature of from 5° F. to 50° F. This temperature change, a perfectly natural force, may be employed to operate a clock winding motor and to keep it running practically perpetually. The same thing is true of the humidity in the atmosphere, which has been put to use in a similar manner. Barometric pressure serves another important method. Power from the waves; power from the sun; power from waterfalls and flowing water; power from the tides, etc., could all be construed as being perpetual, but that is not the accepted meaning of the word perpetual motion. *By this is inferred a motor which will run actuated by gravity only, or by forces originating within itself.*

We doubt if such a device will ever be made, although we are willing to grant that possibilities always exist, even though the possibility of such a device being designed is very close to absolute nothingness.

Up to the present time, and we have examined thousands of perpetual motion ideas, we have found nothing new. No feature contained in any of them will cause the system to operate, either theoretically or practically.

A.C. ELECTRO MAGNET

(2206) J. W. Rainey, Stratham, Georgia, writes as follows:

Q. 1. It is my intention to build a large A.C. electro-magnet to be used for frying eggs on a block of ice. Can you give me the necessary information for doing this?

A. 1. The data for the electro-magnet is as follows: A core 18 inches long and 3 inches square is assembled from silicon steel strips or wire. Three layers of 90 turns each of No. 6 D.C.C. copper wire are wound on the core. Using 110-volt A.C. the magnet will draw about 40 amperes.

TIGHTENING THREADS

(2207) G. R. Grange, Tuxedo, New York, writes:

Q. 1. In turning the thread of a three-inch pipe in a lathe the diameter was made a trifle too small through error. The fitting screws on so loosely that it turns right up to the shoulder. Can this condition be remedied?

A. 1. The joints can be made tight by wrapping around the thread a length of brass wire cloth of from 60 to 80 mesh. This should be daubed freely with litharge or red lead.

TRANSFERRING PRINTS TO GLASS

(2208) Mr. S. A. Stevens, Long Beach, Calif., inquires:

Q. 1. Can you give me a formula for transferring positive prints to glass?

A. 1. It will be almost impossible for you to transfer a positive print to glass, unless you merely mean to paste it thereon. In this case, ordinary paste may be used.

In transferring negatives the following method is usually employed: Immerse the negative in a formaldehyde solution until the emulsion has become almost insoluble and impermeable. Then it is placed in a solution of sodium carbonate until the gelatin has absorbed a sufficient quantity of it. When the negative is immersed in weak hydrochloric acid, carbon dioxide is liberated, and the little bubbles of gas which lodge themselves between the emulsion and the film cause a separation of the two, so that the emulsion may be stripped off. After having hardened the emulsion with formaldehyde, it is a lengthy process to saturate it with sodium carbonate as above. It is advisable to use a combined bath of 1 part

of carbonate, 3 parts of 40% formaldehyde, and 20 parts of water. Its tanning action is enhanced by the alkaline reaction, and two operations are superseded by one. After 10 minutes' soaking, the surface must be wiped and dried. A sharp knife is then used to cut all around the emulsion a slight distance from the edge, and when this is done the negative is put into a 5 per cent solution of hydrochloric acid, when the film will probably float off unaided; if necessary, it may be assisted by gently raising one corner. The film may then be floated on to a clean glass sheet, removed from the solution and allowed to dry.

FINISHING MAPLE

(2209) Mr. T. N. Cortese, New Brunswick, New Jersey, asks:

Q. 1. Please send me information regarding the varnishing and polishing of maple wood.

A. 1. We are giving you herewith some information relative to the polishing and varnishing of hard-wood maple.

In finishing hard wood with a wax polish, the wood is first coated with a "filler" which is omitted in the case of soft wood. The filler is made from some hard substance, very finely ground; sand is used by some manufacturers.

The polish is the same as for soft wood. The simplest method of applying wax is by a heated iron, scraping off the surplus, and then rubbing with a cloth. It is evident that this method is especially laborious; and for that reason a solution of the wax is more desirable. It may be dissolved rather freely in turpentine spirit, and is said to be soluble also in kerosene oil.

The following recipes give varnish-like polishes:

1.—Dissolve 15 parts of shellac and 15 parts of sandarac in 180 parts of spirit of wine. Put some of this liquid on a ball of cloth waste and cover with white linen moistened with raw linseed oil. The wood to be polished is rubbed with this by the well-known circular motion. When the wood has absorbed sufficient polish, a little spirit of wine is added to the polish, and the rubbing is continued. The polished articles are said to sustain no damage by water, nor will they show spots or cracks.

2.—Orange shellac, 3 parts; sandarac, 1 part; dissolved in 30 parts of alcohol. For mahogany add a little dragon's blood.

3.—Fifteen parts of oil of turpentine (dyed with aniline, or undyed), and 4 parts of scraped yellow wax are made into a uniform mass by heating over a water bath.

4.—Melt 1 part of white wax on the water bath, and add 8 parts of petroleum. The mixture is applied hot. The petroleum evaporates and leaves behind a thin layer of wax, which is subsequently rubbed out lightly with a dry cloth rag.

Caustic Potash 60 parts

Yellow Laundry Soap 10 parts

Water A sufficient quantity

Heat together until a homogeneous mixture is formed.

5.—Yellow Wax 25 parts

Yellow Laundry Soap 6 parts

Glue 12 parts

Soda Ash 25 parts

Water A sufficient quantity

Dissolve the soda in 400 parts of water, add the wax, and boil down to 250 parts, then add the soap. Dissolve the glue in 100 parts of hot water, and mix the whole with the saponified wax.

SEARCHLIGHT REFLECTORS

(2210) Q. 1. Mr. Kenneth Evans, Alameda, Calif., wants to know where reflectors for home-made searchlights may be purchased, and requests answers to several questions of design.

A. 1. Reflectors of the type you mention, can be purchased from the following concerns.

The Bausch and Lomb Co., 1 Pershing Square, Rochester, N. Y.

The Eastman Kodak Co., Rochester, N. Y.

The focusing lenses should be placed exactly at the focal point of the apparatus, this all depends upon the radius of curvature of the reflector. If you want a small beam of light, a reflector having a curvature of approximately 10 inches will be fine. However, if you want a large beam of light, one having 30 inches of curvature, will serve your purpose.

A metal spinner can build you a reflector to suit your needs after which you can have it nickel plated, giving you very good results. In any case, the reflector should be approximately not more than eight inches in diameter for your 1000 watt concentrated filament type lamp.

Plug In—and Tune In

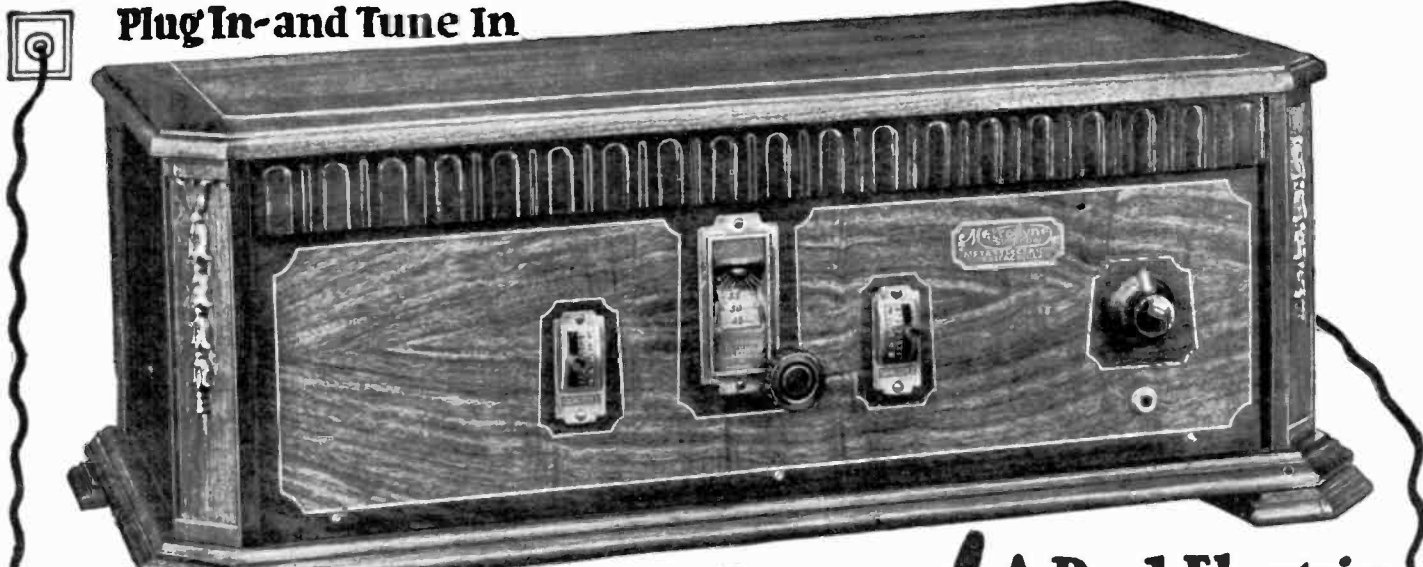

**30
Days
Free
Trial**

Now! **A Real Electric
Radio Set**
Three Year Guarantee
Shipped direct from our factory at
rock bottom prices—cost less than
most battery sets

**No Batteries, Chargers or Eliminators
No Acids; No Liquids—Plug In—Press Button—“Tune In”**

Metrodyne
ALL ELECTRIC RADIO

**AGENTS! DEALERS!
BIG PROFITS!**

Make big money taking orders for Metrodynes. All or part time. Metrodyne All Electric Radios are in a class by themselves. Unequaled for quality, performance and price. Demonstrate at home and take orders. Lowest wholesale prices. Your demonstrating set on 30 days' free trial. Mail coupon below for details.

7 Tubes—Single Dial Set

100% Electric Radio

At last! The radio you've dreamed about! If you have electricity in your home you can now really enjoy coast to coast radio reception without the care, bother and muss of batteries, chargers, eliminators, etc. The Metrodyne All Electric is a real, genuine batteryless radio set. Simply insert the plug in the socket, press the switch button and "tune in." You could not possibly buy a better radio set than the Metrodyne All Electric, no matter what price you paid.

**BEAUTY—EFFICIENCY
DEPENDABILITY**

The Metrodyne All Electric Radio is a 7 tube, single dial set. Only the highest quality low loss parts are used throughout. Solid walnut cabinet, beautiful two-tone effect, with handsome gilt metal trimmings. Size of cabinet, 28 inches long, 13 inches deep, 10 inches high. Has electrically lighted dial so that you can log stations in the dark. Only one dial to tune in all stations. Excellent tone qualities—wonderful volume—very selective.

Costs Less Than Most Battery Sets

Do not confuse the Metrodyne electric radio with ordinary light socket sets, because the Metrodyne is truly an all electric radio—consumes less than 2c worth of power a day. Comes to you direct from the factory. Its low cost brings it down to the price of an ordinary battery set. We are so confident that you will be delighted with this wonderful, easy-to-operate batteryless radio that we offer to ship it to your home for thirty days' free trial—you to be the judge.

Mail This Coupon

We are one of the pioneers of radio. The success of Metrodyne sets is due to our liberal 30 days' free trial offer, which gives you the opportunity of trying before buying. Thousands of Metrodynes have been bought on our liberal free trial basis—**WRITE TODAY!**

METRO ELECTRIC COMPANY

2165 N. California Ave. Dept. 627 Chicago, Illinois

METRO ELECTRIC COMPANY
2165 N. California Ave., Dept. 627
Chicago, Illinois

Send me full particulars about Metrodyne All Electric Radio and your thirty days' free trial offer.

Name _____

Address _____
If you are interested in AGENT'S proposition place an "X" in the square

MAIL COUPON NOW!



**Gorgeous Console
Electric Radio**

Here is the Metrodyne All Electric Console Radio—a gorgeous, genuine walnut cabinet, in a beautiful two-tone finish. Has a built-in genuine Metro-Cone large size speaker. Brings in programs with great volume, reproducing the entire range from the lowest to the highest notes with remarkable clearness and distinction. All metal parts are finished in old gold. Wonderful electric radio, in a cabinet that will beautify the appearance of any home.



Columbia University

Courses for Home Study

IF YOU are one of the many to whom circumstances have denied academic careers or who have been unable to carry them on as far as you wished, you will welcome the opportunity now offered by Columbia University. After the most careful consideration Columbia decided that, under conditions of supervision rigidly and exactly regulated, instruction of University grade could be given, away from the University.

If You Can Not Come to Columbia Columbia Will Come to You

A wide range of subjects now available:

- | | | |
|----------------|--------------|-------------------------------------|
| French | Latin | Psychology |
| Religion | Poetry | Short-Story |
| Italian | Business Law | Art |
| Banking | Drafting | Greek |
| Spanish | Marketing | Physics |
| History | Finance | Astronomy |
| English | | Courses in |
| Composition | | Writing |
| Courses in | | English |
| Literature | | Grammar |
| Personnel | | Accounting |
| Administration | | Mathematics |
| | | High School and College Preparatory |

There are many more courses available. If the subject in which you are interested is not listed above, mention it specifically when writing for information.

Every Home Study Course is conducted by a regular member of the University teaching staff. Direct contact is maintained throughout the course between the student and the instructor personally. Papers are corrected and returned with the instructor's personal detailed comment. The instructor adapts each course and adjusts the material to the particular needs of each student.

Write to the University for Full Information

The University will be glad to send on request full details regarding the scope and conduct of the Home Study Courses. Just fill out and send the attached coupon.



Columbia University
University Extension—Home Study Dept.
New York, N. Y.

Please send me full information about Columbia University Home Study Courses and their conduct. I am interested in the following subject: (Sel. & In. 10-27)

Name.....
Street and Number.....
City and State.....

Reseating Cane Bottom Furniture

By R. D. ROSS

(Continued from page 511)

the old one. Bring the old piece through the last hole so the end may be on top of the seat. Insert the end of a new piece through this same hole and leave about four inches protruding beneath the seat, the rest being on top. Now pull the end of the old piece tight and plug the hole. Tuck the end of the new strand under the loop formed by the old and wrap it around several times. Remove the plug and pull both strands tight, making sure the new strand lies on top of the old at the point where they emerge from the hole. The old piece should be cut off close up to this point as soon as the splicing process is completed. The plug is then replaced until the new strand has been run across, after which it may be removed. Figure 3 shows two stages in the operation and should make the whole process clearer than can be done by words.

The caning is continued until all the holes are filled, and all the strands in one direction are complete. The next operation is the placing of strands at right angles to the first. Figure 2 shows how this should be done. The pieces are run across the tops of the others and are not interwoven. When all the strands are run in this direction a third layer is placed over the top of the other two and running in the same direction as the first layer. The seat will now have a layer of cane running, say, north and south, one going east and west on top of that, and lastly one going north and south again. When these operations are complete the seat is ready for weaving.

The strands are woven in the same direction as those of the second layer. The process is begun at the side and progresses as before, except that the piece is woven as it goes along. The end is put under the first layer and over the third just the opposite of the way the second layer passes between the other two. Figure 4 gives a detail of the weaving process. The whole strand is not pulled through after each crossing, but is left until about six inches have been woven. If too many crossings are made the tension required to pull it through will cause it to break, while if too few are woven at a time the work is made much slower. The correct number will have to be determined in each individual case, depending on the closeness of the strands and the thickness of the cane. Be sure to always keep the weaving strand on the same respective side of the other one coming out of the same hole. For instance, if the weaving strand is on the right of its second layer one, it must be kept on the right for all succeeding rows. While weaving, it is very important to keep the strand from becoming twisted. The top side should be found again after each operation of pulling through.

PRACTICE IN WEAVING ESSENTIAL

It takes much practice to be able to weave rapidly. One hand should be held underneath the seat and the other above it. Grasp the strand with the thumb and forefinger as it comes through and give it a jerk with the wrist. Then turn it up through the next hole and pull it through with the upper hand. Be careful not to kink the piece, as it may crack and cause a subsequent break. When the process is completed the strands should be pushed up close to each other so as to make well defined rows and spaces.

Cross weaving is next in order. The strands are woven diagonally across the seat, beginning at one of the corners. They are woven over the pairs that run lengthwise of the seat and under the crosswise ones, or it may be just the opposite, depending upon the way in which the first weaving was done. Fig. 5 shows the proper way to run them. The cane is woven across to the corner diagonally

opposite, where it is cut off. The strand must now be woven in the other direction at right angles to the first cross weave. In this operation the cane is carried over and under the lateral strands exactly the opposite from the way the other weave runs through. This will be made clear when the worker comes to do it himself. The same general rules for cross weaving apply as for the other operations.

THE BORDER

The border comes next. Two pieces of cane are used for this, one for the actual border strip and the other to hold it down. The border piece should be wider than the cane used for the rest of the seat. It will not pay the amateur to buy a complete bunch of the wide material as it will be found much cheaper to buy only a few pieces, unless a large number of chairs are to be done. A piece of this wide cane is cut off a little longer than the perimeter of the seat and placed with one end at the back of the work. The binding piece of ordinary cane is made fast beneath the seat, brought up through the nearest hole, and then thrust back through the same hole. This forms a loop through which the end of the border piece is placed. The loop is then pulled tight, the cane brought up through the next hole, over the border strip, and down through the same hole. This forms another loop which is pulled tight as before. The process is repeated in successive holes around the entire seat. When the holes are very close together it is a better plan to form the loops in every other hole, thus lessening the time taken to complete the border. When the starting point has been reached, cut the cane off and fasten it beneath the seat. Then cut the surplus end off the border piece close to the end of the last loop, and the job is complete.

It is best for the beginner to make his first attempt on a rectangular seat. After he has gained the experience from this he should be able to do a circular or other shape of seat without any trouble. Figure 6 shows the scheme of starting the first strands of a round seat. First, the center line XX and YY are located by means of some line of symmetry of the chair, usually by counting equal numbers of holes from the legs. The position of the extreme strands is then located by counting an equal number of holes on each side of the center line.

For instance, let it be desired to find which holes to put the first strand in. The horizontal center line passes through holes 9 and 25, referring to Figure 6. By counting 5 holes on each side we arrive at holes 4 and 14 on the right and 20 and 30 on the left. It is seen, then, that the initial strand should be run in holes 14 and 20 and the caning continued to holes 4 and 30. If strands are placed in every hole of a round seat the spacing near the edges will not be great enough. In this case some of the strands are omitted near the edge; for instance, the strand 5-13 might have been left out had it been too crowded here. The extreme strand should also lie about half an inch from the hole opposite its mid-point, that is, the distance from strand 6-12 to hole 9 should be half an inch. It is this consideration that determines the number of holes to be counted from the center line when determining the position of the extreme strand.

For a machine-caned seat the procedure is totally different. The cane is forced into a groove running around the border, and cut off. A strip of wood or rattan, called spline, is then hammered into the groove and glued in place, thus holding the cane fast.

The first thing to do is to clear away the
(Continued on page 538)

are roof and loop aerials doomed?

Why, when modern radio sets are built to reproduce music in all its original beauty, should you tolerate static and other foreign noises with which the air is filled? That's why we ask, "Are roof and loop aerials doomed?" Because you no longer need to put up with noisy reception from the air. Clear, loud, static-free, noise-free reception from the GROUND is now possible with your present set. All you need is a Subantenna.

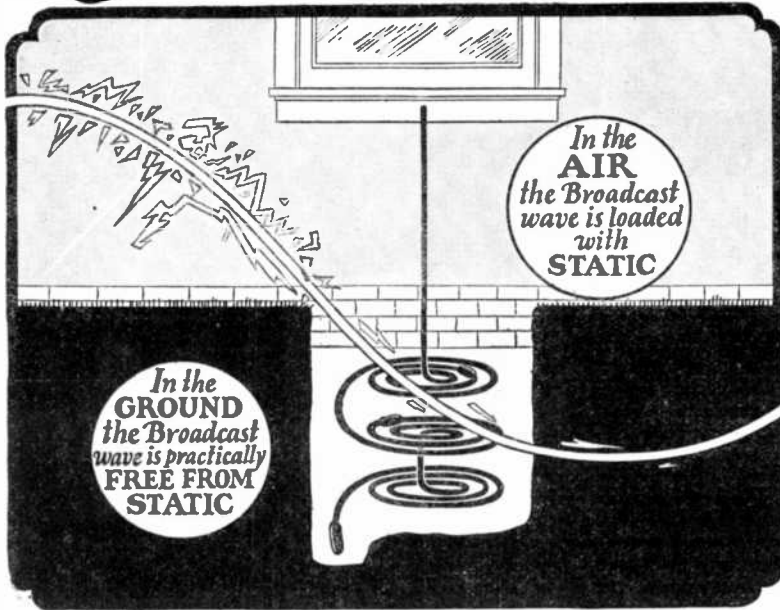

SUBANTENNA

- does away with STATIC nuisance
- gives crystal CLARITY Summer and Winter
- increases DISTANCE
- improves SELECTIVITY

Testing laboratories find, and users testify that SUBANTENNA is, beyond all doubt, the greatest means of improving radio reception yet placed within the reach of listeners. Freedom from static nuisance in all seasons and weathers—greater distance—better selectivity—all are made possible by this great, new underground antenna.

Thousands know the joy of Radio with Subantenna

"I get plenty of stations with my Subantenna, on the loud speaker, that I have never been able to reach with my outside aerial. It absolutely cuts down interference to the minimum, cuts static out too—not just partly out—but ALL out!"
H. S. M., North Carolina

Results—Almost Unbelievable!
"After 4 years of testing aerials I at last found the master in the Subantenna. The first night I used it was a very hot summer night. Static was very bad on my outdoor aerial. I connected my Subantenna and one could hardly believe the results. It was wonderful."—F. L. C., Mass.

Better Than Music from the Air
"We have the Subantenna installed and it is all you claim it to be. It works fine, we enjoy it very much. We would not want to go back on the high-in-the-air aerial again as we get so much better reception on Subantenna."—A. J. L., Maine.

Surprised and Satisfied!
"I received the Subantenna and installed it the same night and believe me I was surprised with the result for I was quite suspicious about it. I am well satisfied."—R. E. G., Canada.

Uses Static-Free Ground Waves

The same radio wave you have always taken out of the air, also travels thru the ground. Only, in the ground, the wave is practically static-free! Subantenna intercepts the broadcast wave while it is in the ground, and brings it to your set unadulterated as when broadcasted. Think what this means to you! Loud, clear distance summer and winter, regardless of how much static or noise there is in the air. No wonder thousands of fans have taken advantage of our FREE TRIAL OFFER, then permanently changed to Subantenna.

Does Away with the Unsightly Cluttering-Up of Roof Tops

The same device which will make radio a thousand-fold greater pleasure for you, will also alleviate the need for cluttering up your roof top with a tangle of wires, posts and cross sticks. Only a short lead-in comes out of the ground from Subantenna up to your set—a wire so small it cannot be noticed. Quite a contrast to the long, dangling lead-in the roof-type aerial requires—and what a joy to be rid of the sprawling, ungainly looking loop. If Subantenna did nothing more than merely do away with the roof and loop types of aerials it would be worth its price many times over.

Very Easy to Install

No climbing around on slippery roofs to install Subantenna. No frames to build—no insulators to fool with. Just dig a 3 foot hole in your basement or outside your house, bury Subantenna, connect it to your set, and the job is done. Anyone can do it, with assurance of the same kind of perfect results fans are

constantly writing us about. And, when once installed, Subantenna

Never Needs Attention

Day in, day out, year after year Subantenna provides the same loud, clear reception. Never needs cleaning or repairing like an aerial does, and of course, it can't blow down. In fact, Subantenna improves with time. The harder the earth becomes packed around it, the louder it brings the stations in.

TRY IT ON FREE YOUR SET FREE

Install Subantenna. Leave your old aerial up. Select a bad night when DX is almost impossible with the ordinary aerial. Make a comparison station for station, connecting first your aerial, then Subantenna. If, from stations that are just a mess of jumbled noise with the old aerial, you don't get reception that rivals local in sweetness and clarity the instant you switch to Subantenna, this test won't cost you even a single penny. Obtain a Subantenna from your dealer or send coupon at once for scientific explanation of Subantenna and for particulars of GUARANTEE and FREE TRIAL OFFER. SEND COUPON NOW!

SUBANTENNA

THE NEW UNDERGROUND ANTENNA

CLOVERLEAF MANUFACTURING CO.
2713-D CANAL STREET CHICAGO, ILLINOIS

CLIP AND MAIL AT ONCE

CLOVERLEAF MFG. CO.
2713-D Canal Street, Chicago, Illinois
Tell me all about SUBANTENNA, your unqualified, unconditional guarantee and your FREE TRIAL OFFER.

Name.....

Address.....

Townsend "B" Socket Power "Best in World!"

Says A. W. GALE
of Gloversville, N. Y.



COMPLETE

Only
\$6.85
\$1.00 Down
Balance
C.O.D.

Below is a reproduction of Mr. Gale's letter of May 8th, 1927.

48 W. Fulton St.,
Gloversville, N. Y.

"Received the Townsend all O. K. It is the best in the World and that is saying some. I have a Radiola 4 tube. Get more stations than ever before. Some of them are CFCF, CKNC, WGY, KDKA, WGZ, WIP, WWJ, KTHS, KOP, KOA, WHAS, WTAM and KSD—besides 4 in Chicago, all in the East and then some."

A. W. Gale.

Replaces "B" Batteries

The letter above speaks for itself—proves beyond doubt that the Townsend "B" Socket Power is the most remarkable value in Radio today. Sam E. Fry of 1415 Holmes St., Kansas City, Mo., writes: "Eliminator works fine. Showed it to a friend and he wants one also. I will say it sure beats batteries. I get stations I never got before on a 6 tube set." Charles Ellis, 88 Jones Ave., Columbus, Ohio, says, "Your Eliminator is working fine. Have had station WJAX and others over 1,000 miles distant. Picked up 22 different stations one evening and around 30 another time. My neighbor has a \$27.50 Eliminator and I don't see that it works any better than yours."

Delivers up to 100 volts on any set, on D. C. or A. C.—any cycle. Full tone, clarity and volume.

Tested and approved by America's leading Radio authorities—Radio News and Popular Radio Laboratories

ORDER TODAY!

Simply fill out the coupon and slip it into an envelope with only \$1.00 and mail at once. Your Townsend "B" Socket Power Unit will be sent promptly. Deposit only \$5.85 plus postage with the postman. Try out for 10 days—then if not delighted with improvement in reception, return it to us and purchase price will be refunded.

TOWNSEND LABORATORIES
713 Townsend St., Dept. 35 Chicago, Ill.

Attach Only \$1.00
to this Coupon!
SEND TODAY



TOWNSEND LABORATORIES
713 Townsend St.
Dept. 35 Chicago, Ill.

Gentlemen: Attached find \$1.00. Kindly send at once Townsend "B" Socket Power Unit, C. O. D., for \$5.85, plus postage, on guaranteed 10-day free trial.

Name _____
Address _____
City _____ State _____

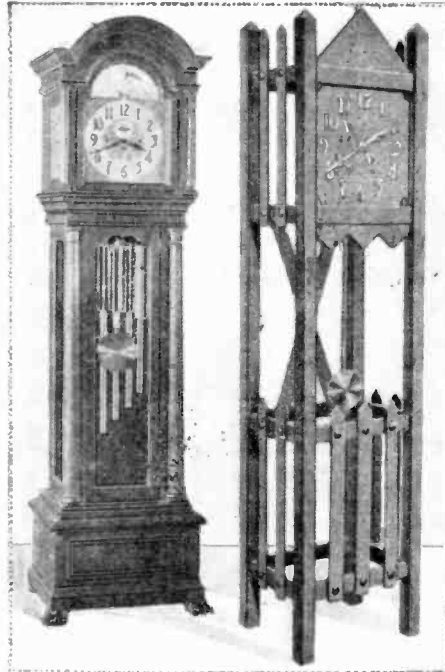

Above we have a photograph showing two grandfather clocks. One of these models is housed in an ornate home-made case and the mission clock frame may be built at an insignificant cost.

AN enterprising Philadelphia manufacturer has discovered that there is still a warm spot in most everyone's heart for the old grandfather chime clocks. The dial and clock movement are supplied by the manufacturer, and blueprints may be obtained from the same concern, which prints show the constructional details of various size cases. The most expensive clock movement costs over \$300.00, while other chime clock movements are supplied at a very low cost. This movement is supplied with chimes which are rung every quarter of an hour. Manual training classes in various high-schools have taken advantage of the opportunity, and each boy has bought a small movement and built the case himself. Small movements for table clocks are also manufactured. The hall clock is not only a time piece, but is an article of fascinating furniture, about which the movements of the whole household revolve. It requires an instrument of good quality to fill so important a place in the home, and the blueprints and movements furnished by this manufacturer will fill the need.



An elaborate hall clock dial is shown above. This dial not only shows the correct time but also the position of the moon. The movement supplied with dial is made entirely of brass. Photos courtesy American Chime Clock Co.

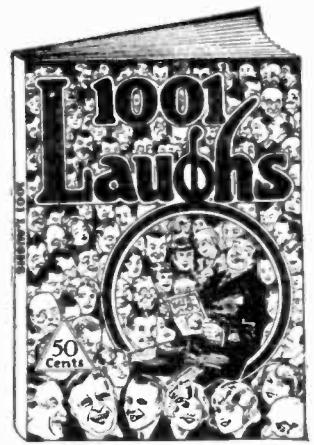

LAUGH
an hour a day
for the rest
of your life

"1001 LAUGHS"

The newest and funniest
joke book in the world

Did you ever pick up a French, German or Spanish joke magazine and wonder what their specially good cartoons said? Here's a brand new laugh book with hundreds of the best Foreign jokes and illustrated cartoons translated into English for you, together with plenty of good American humor and cartoons.

Altogether this is the greatest, funniest, most uproarious book of jokes and cartoons ever presented to Americans.

Each leaf of this book is one merry round of pleasure. Every joke is a winner.

Relax from your daily grind, spend an hour a day in good old-fashioned laughter. It's a healthy recreation.

"1001 Laughs" is an extra-large size book 9 x 12 inches, with over 300 illustrations.

50c. ONLY

116 PAGES OF
UPROARIOUS JOKES

and
HUNDREDS OF SELECTED
ILLUSTRATED CARTOONS.

BUY YOUR COPY NOW!

ASK YOUR NEWSDEALER
OR ORDER DIRECT

EXPERIMENTER PUB. CO., Inc.,
230 Fifth Avenue, New York City

PATENTS
TRADE-MARKS—DESIGNS
FOREIGN PATENTS

MUNN & CO.
PATENT ATTORNEYS

*Associated since 1846 with the
Scientific American*

SCIENTIFIC AMERICAN
BUILDING
24 West 40th Street
New York City

SCIENTIFIC AMERICAN
BUILDING
Washington, D. C.

TOWER BUILDING
Chicago, Ill.

HOBART BUILDING
San Francisco, Cal.

VAN NUYS BUILDING
Los Angeles, Cal.

Books and Information on Patents and
Trade-Marks By Request
Associates in all Foreign Countries

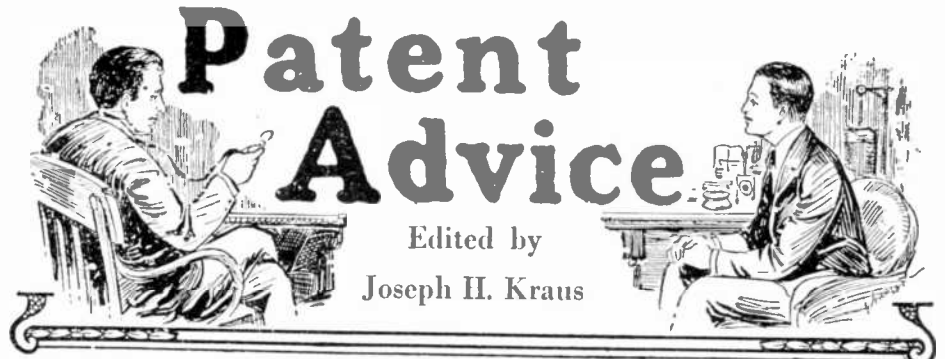

In this Department we publish such matter as is of interest to inventors and particularly to those who are in doubt as to certain patent phases. Regular inquiries addressed to "Patent Advice" cannot be answered by mail free of charge. Such inquiries are published here for the benefit of all readers. If the idea is thought to be of importance, we make it a rule not to divulge all details, in order to protect the inventor as far as it is possible to do so.

Should advice be desired by mail a nominal charge of \$1.00 is made for each question. Sketches and descriptions must be clear and explicit. Only one side of sheet should be written on.

NOTE:—Before mailing your letter to this department, see to it that your name and address are upon the letter and envelope as well. Many letters are returned to us because either the name of the inquirer or his address is incorrectly given.

ANIMAL TOY

(1043) Wilton R. H. Bosch, New Orleans, La., asks whether his invention of a walking toy is original and would be a success. It is springless, leverless and requires no mechanical power whatever to make it operate.

A. 1. It is difficult for us to advise whether such an article would meet with a market because you have not explained the principle of operation and we, consequently, cannot give definite counsel. Some years ago a wooden toy appeared on the market in which there were five legs, mounted on a revolving spindle. One leg entered the body as another descended. This toy seemed to possess a life-like walk and contained no springs. There are also the walking toy clowns and animals which move down an incline of their own accord and exhibit lifelike movements and there are toy dolls which walk when led. The dolls or the clowns mentioned contain neither levers nor mechanically moving parts. They are operated by gravity.

Some years ago we also described a toy dog which was operated by buck shot. Any of these ideas may be similar.

If you care to submit further information, we will be glad to make our advice more definite.

MEASURING DEVICE

(1044) H. Gunes, Burlington, Iowa, submits a diagram of a measuring device consisting of a rubber tired wheel having a circumferential length of one foot and directly coupled by means of a chain drive with a reel upon which a steel tape runs, the idea being that the tape unwinds from one reel and winds upon another, indicating the number of feet traversed by the wheel.

A. 1. Why go through all this trouble employing chain drives, making slippage of the wheel more likely and using a steel tape, when a single wheel mounted on a forked stick and provided with a revolution counter will do the same work. If the wheel has a circumference of one foot, then the distance traversed in feet may instantly be read by the revolution counter and the reset mechanism on the counter will permit the user to start measuring another tract of land immediately after recording his first group of figures. The latter suggestion is quite old and we believe it was used originally in Washington's time when Washington was still a lad. Of course, the revolutions of the wheel were probably counted at that time instead of being automatically recorded, but the principle is the same. We do not advocate that you apply for a patent on the suggestion because it is inferior to existing material.

COMB-MIRROR COMBINATION

(1045) Jacob Dorfman, New York, N. Y., submits a suggestion for a combination comb and mirror and requests our advice.

A. 1. Several years ago, SCIENCE AND INVENTION Magazine ran a combination contest in which readers were requested to submit suggestions for the combination of two well known articles such as for instance, a pen and pencil, a comb and brush.

a pencil sharpener and eraser, etc. Among these suggestions there were combination mirrors and combs, but practically all of them were inferior to the design indicated by you. While we believe that when once your combination article has been placed upon the market it would meet with fair success, we would not advocate applying for a patent on the same until a thorough search revealed that no other similar object was patented. We would advocate that you write to a patent attorney and request that he institute a search on the suggestion and that he supply you with copies of patents most nearly approaching your idea.

INFANT SEAT

(1046) Proctor G. Dill, Phoenix, Ariz., submits an idea for a toilet seat for kiddies which has the property of being affixed directly to the regular seat and which can instantly be lowered into position. He requests our opinion.

A. 1. As you undoubtedly know, there is a toilet for infants attachable to the regular toilet seat, on the market at the present time. This is held in place by a clip and two circular suction disks. The idea is thoroughly practical, its only disadvantage being that it must be removed before the ordinary lid can be brought down into place. While your particular suggestion seems to us to be quite practical, it cannot be made in the form of an attachment and would have to be made as a complete unit. As such, the cost would be quite high. Therefore, the sale of the same would be limited in accordance with this cost. It must be obvious that a smaller seat can only be employed for a certain length of time and then for the rest of the life of that particular user, it is of no practical value. It follows that those seats now in use which are removable would probably meet with greater favor than your particular article. Your suggestion is not without value and we advise that you have a search made on the idea and that you also work upon it further, with a view toward simplifying it.

GRAFTING WAX

(1047) E. K. Kirby, Bluefield, W. Va., asks if we think he would be able to patent a grafting wax. He claims to be destroying 300 pounds of this compound per day.

A. 1. There are several organizations that could use your output of grafting wax. It would be best for you to write to the various nurseries throughout the United States, giving them quotations on your material. We think that it is foolish to destroy 300 pounds of material of this nature per day and believe that there are many other uses to which the wax can be put. We advocate considerable experimental work along this line.

Of course, you did not state whether this wax was accidentally being destroyed or whether you were purposely throwing it away. If it is a by-product from some other process, you could probably make very good use of it.

PERPETUAL MOTION AGAIN

(1048) A. A. Munsey, Paden, Okla., would like to know how much it will cost to get a patent on a perpetual motion machine and whether he would be eligible for the \$5,000.00 SCIENCE AND INVENTION prize contest.

A. 1. Inasmuch as it is much easier to secure the \$5,000.00 offered by SCIENCE AND INVENTION than it will be to secure the patent on the suggestion, and in view of the fact that you will get publicity following your discovery which will guarantee your priority claim, we do not believe that it will be necessary for you to apply for your patent first. The cost would vary from \$120.00 up. However, it makes little difference to us whether the article is patented or not. We desire to see a working model and do not want the right to the invention, nor do we care to share in the profits derived therefrom after it is patented. Our only request is that we be given permission to tell the story about the discovery exclusively and that you be permitted to describe it first.

(Continued on page 538)

PATENTS

TO THE MAN WITH AN IDEA

I offer a comprehensive, experienced, efficient service for his prompt, legal protection and the development of his proposition.

Send sketch, or model and description, for advice as to cost, search through prior United States patents, etc. Preliminary advice gladly furnished without charge.

My experience and familiarity with various arts frequently enable me to accurately advise clients as to probable patentability before they go to any expense.

Booklet of valuable information and form for properly disclosing your idea, free on request. Write today.

RICHARD B. OWEN, Patent Lawyer
164 Owen Building, Washington, D. C.
41V Park Row, New York City

TRADE-MARKS REGISTERED

INVENTORS who derive largest profits know and heed certain simple but vital facts before applying for Patents. Our book Patent-Sense gives those facts; rent free. Write

LACEY & LACEY
644 F STREET, WASHINGTON, D. C.
Established 1869

INVENTORS PROTECT YOUR IDEAS

Send for our Guide Book, HOW TO GET A PATENT, and Evidence of Invention Blank, sent Free on request. Tells our terms, methods, etc. Send model or sketch and description of your invention for **INSPECTION and INSTRUCTIONS FREE. TERMS REASONABLE. BEST REFERENCES.**

Name

Street

City

RANDOLPH & CO.
Dept. 172, WASHINGTON, D. C.

At the right is a view of my drafting and specification offices where a large staff of experienced experts are in my constant employ.



All drawings and specifications are prepared under my personal supervision.

PATENT ATTORNEYS

My Patent Law Offices
Just Across Street From U.S. Pat. Office



Protect Your Ideas

Take the First Step Today—Action Counts

If you have a useful, practical, novel idea for any new article or for an improvement on an old one, you should communicate with a competent Registered Patent Attorney AT ONCE. Every year thousands of applications for patents are filed in the U. S. Patent Office. Frequently two or more applications are made for the same or substantially the same idea (even though the inventors may live in different sections of the country and be entirely unknown to one another). In such a case, the burden of proof rests upon the last application filed. Delays of even a few days in filing the application sometimes mean the loss of a patent. So lose no time. Get in touch with me at once by mailing the coupon below.

Prompt, Careful, Efficient Service

This large, experienced organization devotes its entire time and attention to patent and trademark cases. Our offices are directly across the street from the U. S. Patent Office. We understand the technicalities of patent law. We know the rules and requirements of the Patent Office. We can proceed in the quickest, safest and best ways in preparing an application for a patent covering your idea. Our success has been built on the strength of careful, efficient, satisfactory service to inventors and trademark owners located in every state in the Union.

Strict Secrecy Preserved—Write Me in Confidence

All communications, sketches, drawings, etc., are held in strictest confidence in strong, steel, fireproof files, which are accessible only to authorized members of my staff. Feel free to write me fully and frankly. Your case will have my personal attention. It is probable that I can help you. Highest references. But FIRST—clip the coupon and get my free book. Do THAT right now.

No Charge for Information On How to Proceed

The booklet shown here contains valuable information relating to patent procedure that every inventor should have. And with it I will send you my "Record of Invention" form, on which you can sketch your idea and establish its date before a witness. Such evidence may later prove valuable to you. Simply mail the coupon and I will send you the booklet, and the "Record of Invention" form, together with detailed information on how to proceed and the costs involved. Do this NOW. No need to lose a minute's time. The coupon will bring you complete information entirely without charge or obligation.

Clarence A. O'Brien

Registered Patent Attorney

Member of Bar of: Supreme Court of the United States; Court of Appeals, District of Columbia; Supreme Court, District of Columbia; United States Court of Claims.

PRACTICE CONFINED EXCLUSIVELY TO PATENTS, TRADEMARKS AND COPYRIGHTS

Inventors
Write for these
Free Books



Mail this Coupon Now

CLARENCE A. O'BRIEN

Registered Patent Attorney

53-C Security Savings & Commercial Bank Bldg., Washington, D. C.

Please send me your free book, "How to Obtain a Patent," and your "Record of Invention" form without any cost or obligation on my part.

Name

Address

(Important: Print or Write name clearly)

U.S. PATENTS



SEND FOR THIS FORM

Don't Lose Your Rights

Before disclosing your invention to anyone send for blank form "Evidence of Conception" to be signed and witnessed. A sample form together with printed instructions will show you just how to work up your evidence and establish your rights before filing application for patent. As registered patent attorneys we represent hundreds of inventors all over the U. S. and Canada in the advancement of inventions. Our schedule of fees will be found reasonable. The form "Evidence of Conception" sample, instructions relating to obtaining of patent and schedule of fees sent upon request. Ask for them,—a post card will do.



Registered Patent Attorneys in U.S. and Canada
255 Ouray Bldg., Washington, D. C.
"Originators of form Evidence of Conception"

A Personal Service for INVENTORS

I maintain an unexcelled organization and thoroughly equipped laboratories, to render the following services.

I PREPARE APPLICATIONS for patents for filing in the United States and foreign countries.

I PLACE INVENTIONS with responsible manufacturers, with whom I am acquainted, under arrangements that are made profitable to the inventor.

I SPECIALIZE in Electrical, Mechanical, Chemical, and Radio Devices.

I INVITE CORRESPONDENCE with reputable inventors, Scientists, Chemists and Physicists, regarding their inventions and uncompleted experiments.

H. R. VAN DEVENTER

Licensed Professional Engineer
Registered Patent Attorney

342 Madison Avenue, New York City

PATENTS

BOOKLET FREE HIGHEST REFERENCES
PROMPTNESS ASSURED BEST RESULTS

Send drawing or model for examination and advice.

WATSON E. COLEMAN, Patent Lawyer
724 9th Street, N. W., Washington, D. C.

NEW YEAR - NEW IDEA PATENT YOUR IDEAS

Call or send me a sketch of your invention. Phone **LONG** 3088

FREE Inventors Recording Blank Confidential Advice

U. S. and Foreign Patents secured by
Z. H. POLACHEK Reg. Patent Attorney
Consult. Engineer
1234 Broadway, New York

INVENTIONS Commercialized

ON A CASH OR ROYALTY BASIS
PATENTED or UNPATENTED

In Business 25 Years - Complete Facilities - References.

Write **ADAM FISHER MFG. CO.**
205D Enright Ave. St. Louis, Mo.

Patent Advice

(Continued from page 536)

LOUD SPEAKER

(1049) Paul P. Schroeder, Greenwich, Conn., asks our opinion of a loud speaker provided with a series of vibrating wires acted upon by magnetic fields of different intensities. He claims to have the apparatus in operation.

A. 1. It is our opinion that your loud speaker as designed is entirely too expensive to market. We also do not believe that the tonal quality of the same would be superior to that obtained from the ordinary loud speakers because the reeds or vibrating wires have a natural period of their own which would be detrimental to voice reproduction as well as would produce inferior reproduction of anything except string music. Before commenting further on the suggestion, we would advocate that you compare this with some of the modern good loud speakers or if you desire, submit it directly to the *Radio News* Laboratories for their opinion on its merit.

RECIPE

(1050) Alexander Mailhot, Toronto, Ont., Canada, asks whether or not it would be of any value to patent a means of reducing metric measure to the English measure and also wants our opinion as to the patentability of recipes for making flavoring extracts.

A. 1. Inasmuch as tables for changing the metric measure to the English system can be found in practically every text book, we do not believe that it would be to your advantage to try to protect any such system, unless it should happen to be a sliding scale capable of instant conversion from one table to the other in any of its many forms as for instance, dry measure, liquid measure, weights, distance, etc.

Appertaining to the protection of recipes for making soft drinks, we would advise that you cannot patent a simple mixture. The best method of protecting this idea is to keep the nature of the contents a secret so that only an expert analytical chemist could discover what are the contents of the bottle of flavoring extract.

Reseating Cane Bottom Furniture

(Continued from page 532)

old cane and spline. The spline is dug out of its groove with a one-eighth inch chisel and mallet. In doing this, great care should be exercised not to chip away the wood of the seat, especially at the corners. Use hot water to soften the glue. When the spline is all out, the groove will have to be cleared of all traces of old cane and glue. This is done with the chisel, kept sharp to facilitate the work. After this, the seat is ready for the new cane.

The machine cane is bought by the square foot. When measuring a seat, an inch and a half must be allowed all the way around to permit the cane to be forced into the groove without falling short. First, a wooden wedge must be shaped as shown in Figure 7. The glue is next in order. It is best to use flake glue which has been prepared in a double boiler. A small brush should be on hand with which to apply it. A piece of spline, obtainable at a supply house, is cut a little longer than the length of the groove. It should fit the groove loosely so as to allow room for the cane and yet wedge tightly when driven in. If the proper size cannot be purchased, a larger one may be gotten and planed down.

When everything is ready, apply a coat of glue to the groove, wet the cane well, and lay it on the seat. Starting at the middle of the back, drive the cane down into the groove with the wedge and mallet. Proceed to do this until the corner is turned. Now, with a chisel and mallet cut the cane off at the back of the groove as shown in Figure 8. Apply glue to the surface of the spline and hammer it down into the groove, causing it to wedge tightly and hold the cane in place. Then knock some more cane in, cut it off with the chisel, and ram home the spline. This cycle is repeated until the whole seat has been gone around. Let the work stand for a day, scrape off the surplus glue, and give the seat a coat of shellac. This completes the work, and if it has been carefully done, the seat will be as good as new.

1000 NEEDED INVENTIONS!

Here is the most remarkable book ever offered to inventors. One Thousand needed inventions listed and described. Arranged as follows: General Problems; Automotive; Mechanical; Electrical; Chemical; Radio; Marine. Separate chapter on the Ten Most Needed Inventions. This book may give you one idea that will win you a fortune. Nothing else like it has ever been published. Compiled at enormous expense. Edited by Raymond Francis Yates, formerly Managing Editor of a leading scientific magazine. Over 100 pages, durably bound. Send no money. Pay postman only \$1.00 plus postage on arrival (*Outside U. S. \$1.20. Cash with Order*). Money back after 10 days' examination if desired. Limited edition. Write NOW.

BUREAU OF INVENTIVE SCIENCE
Dept. 710 Rochester, New York

Inventors Service Bureau

Prepares and files applications for patents. Makes patent searches. Negotiates sales of patents. A complete service for the inventor. Low rates. Easy terms. Write for particulars.

Box 1648 Washington, D. C.

C. L. PARKER

Ex-Examiner U. S. Patent Office

Attorney-at-Law and Solicitor of Patents
McGill Building, Washington, D. C.
Patents, Trade Mark and Copyright Law

BLUE BOOK ON PATENTS

and Priority Record blank gratis.
MONROE E. MILLER, PATENT LAWYER,
411-6 Ouray Building, WASHINGTON, D. C.
ELECTRICAL AND MECHANICAL EXPERT



INVENTORS

IDEAS DEVELOPED AND PERFECTED
Models, Experimental work; labor-saving machinery for manufacturers. 20 years' experience.
Bernard & Heller, 275-B Water St., N.Y.C.

150 RADIO HOOKUPS

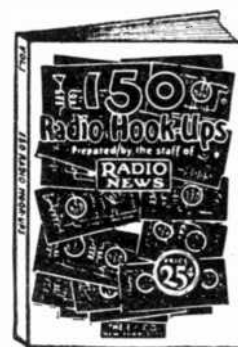

What more could you ask?—150 of the very finest, selected hookups most popular today. Each one completely explained and fully illustrated so that a complete receiver can be constructed from the information. No out-of-date hookups—all the finest and best in common use today. 64 pages, illustrated. Large size, 6 x 9 inches.

Don't miss this opportunity—All Radio and news dealers have fresh copies Now. If there is no dealer near you write us direct enclosing 25 cents.

25c. The Copy

THE CONSRAD CO., INC.
230 Fifth Ave. New York, N. Y.

The Metal Emperor

By A. MERRITT

(Continued from page 497)

so crowded up with expeditions. And here I am."

"Perhaps I had been feeling, without realizing it, the need of companionship of my own kind. At any rate, as I led the way back to my little encampment I began to wonder whether he would care to join me in my own journeyings. I was turning the matter over in my mind while I was instructing Chiu-Ming as to just how I wanted supper prepared. Looking at Drake I saw upon his face an expression almost of awe.

"Blessed bones of Buddha," he said. "You mean to say you get what you want to eat and not what he wants you to eat! And for two months I've suffered—" He paused, a speculative gleam in his eyes.

His gaze dwelt, fondly, upon the Chinese busy among his pots and pans. And ever that oddly speculative gleam grew stronger as he made away with Chiu-Ming's artful concoctions.

"Come, my son," I said to myself. "If I make up my mind to ask you along, I'm thinking Chiu-Ming has well paved the way."



She jumped up like a little fury, and fired a pistol point blank at them. . . . They simply flew into the timber."

"Came here to find peace, and I guess I struck just the right place." Drake sighed at last, drawing out his pipe. "A marvel of a cook, Professor!"

THE MARVELLOUS SUNSET OF TIBET

Then a silence fell upon us. The sun had dipped down behind the flank of the stone giant guarding the valley's western gate. The whole valley swiftly darkened. A flood of crystal-clear shadows poured into it. It was the prelude to that miracle of unearthly beauty seen nowhere else on this earth—the sunset of Tibet.

We turned expectant eyes to the west. A little, cool breeze raced down from the watching steps like a messenger, whispered to the nodding poppies, sighed and was gone. The poppies were still. High overhead, a homing kite whistled.

As if it were a signal, there sprang out in the pale azure of the western sky row upon row of cirrus cloudlets, rank upon rank of them, thrusting their heads into the path of the setting sun. They changed from mottled silver into faint rose; deepened to crimson.

"The dragons of the sky drink the blood of the sunset," said Chiu-Ming.

As though a gigantic globe of crystal had dropped upon the heavens, their blue abruptly turned to a clear and glowing amber—then as abruptly shifted to luminous violet. A soft green light pulsed through the valley.

Win a Buick

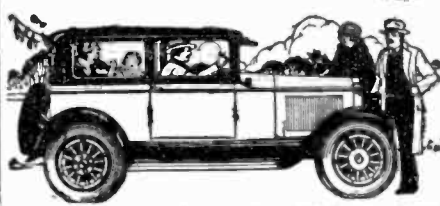

OR
\$1500⁰⁰
in cash

I am going to give away a brand new, latest model Buick Sedan to someone who answers this adv. We have already given away many autos to advertise our business. This is the most liberal offer ever made. It is your chance to win this ideal car for your very own. You can win it; why not try! The Sedan is fully equipped and will be delivered to the winner by the nearest Buick Dealer. Or winner may have the full value of the Buick in cash (\$1,195.00)!

SOLVE THIS PUZZLE

2 2 1 9 3 1 1 7 9 2 2 5 1 4

SEND ANSWER TODAY

Can you make out the two words spelled by the numbers in the squares above? The alphabet is numbered, A is 1, B is 2, etc. What are the two words? Send your answer today—not a cent of cost to you now or later.

\$305.00 Cash Extra For Promptness

I will also give away a Chevrolet Coach, Orthophonic Victrola and many other valuable Prizes—besides hundreds of dollars in Cash—and \$305.00 Special Extra Prize for Promptness. First Prize winner will receive \$1,500.00 cash or Buick Sedan and \$305.00 cash. All who answer can share in cash and prizes. In case of ties the prizes will be duplicated. **EVERYBODY REWARDED.** Someone gets the new Buick Sedan! Why not you? Now, get out your pencil and solve the puzzle—send your answer today with name and address plainly written.

WILLIAM LEROY, Dept. 3797, 315 So. Peoria St., Chicago, Ill.

PATENTS TRADE-MARKS AND COPYRIGHTS

OUR OFFER: FOR THE PROTECTION OF YOUR INVENTION

YOUR FIRST STEP. The inventor should write for our blank form—"RECORD OF INVENTION." This should be signed, witnessed and returned to us together with model or sketch and description of the invention for INSPECTION and INSTRUCTIONS FREE!

Our Four Books Mailed Free to Inventors

Our Illustrated Guide Book

HOW TO OBTAIN A PATENT

Contains full instructions regarding U. S. Patents. Our Methods, Terms, and 100 Mechanical Movements illustrated and described.

OUR TRADE-MARK BOOK

Shows value and necessity of Trade-Mark Protection. Information regarding Trade-Marks and unfair competition in trade.

OUR FOREIGN BOOK

We have Direct Agencies in Foreign Countries and secure Foreign Patents in shortest time and lowest cost.

PROGRESS OF INVENTION

Description of World's Most Pressing Problems by Leading Scientists and Inventors

All Communications and Data Strictly Confidential. Interference and Infringement Suits Prosecuted.

IMPORTANT

TO MAKE YOUR CASE SPECIAL AND AVOID DELAY YOU SHOULD HAVE YOUR CASE MADE SPECIAL IN OUR OFFICE to secure protection, save correspondence and obtain early filing date in Patent Office. To secure special preparation of your case send \$25.00 on account with model or sketch and description of your invention.

Highest References—Prompt Attention—Reasonable Terms

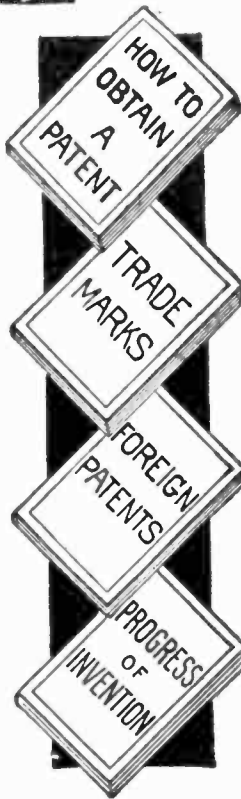

FREE COUPON

VICTOR J. EVANS & CO.

Registered Patent Attorneys

MAIN OFFICES: 779 Ninth St., Washington, D. C.

New York Offices, 1007 Woolworth Bldg.; Philadelphia Offices, 518-519 Liberty Bldg.; Pittsburgh Offices, 514 Empire Bldg.; Chicago Offices, 1114 Tacoma Bldg.; San Francisco Offices, 1010 Hobart Bldg.

Gentlemen: Please send me FREE OF CHARGE your books as described above.

Name
Address

5¢ Gas!



Frank Andrews
I want you to make big money easier and faster than you ever have before in your life. I guarantee \$15.00 a day to any man who becomes my distributor. Use the Coupon NOW.

Cadillac, La Salle and Delco Light now use as standard equipment Thermostatic Carburetor Control under Blanche License

Great new invention brings gasoline cost down for 8,000,000 Ford Owners. Hundreds of our men are earning more than they ever made before or thought possible introducing the famous Blanche Thermostatic Control. A proved success, backed by 351,272 public and private tests, which show beyond a doubt that it is possible for Ford Owners to reduce gasoline cost to 5¢ a gallon (Affidavits on file). Below are reproduced a few testimonials taken out of hundreds:

"Please ship us another 100 controls. Other 100 came yesterday and the writer sold 9 dozen today."

I. J. Phillips, Sr., Ga.

"Send four dozen controls and two demonstrating boards. I ordered two dozen but retail sales have already exceeded that number."
P. I. Cutler, Ore.

"We had a test run Saturday and Sunday through level and hilly country, from Washington, D. C., to Martinsburg, W. Va., and back—about 208 miles. Made it on 5 gallons of gas. The attachment is a wonder."
Charles F. Rougeou, D. C.

\$15.00 A DAY

Guaranteed to Distributors

Can you imagine anything easier to sell than gas at 5¢ a gallon? No wonder our men are coming money! No wonder we can afford to offer you the most liberal, most worthwhile proposition you could ever dream of. The coupon will bring you full details. Get it into the mail today!

Get Free Trial

Act at once if you want to get started with a *sure thing*. Make real money with the backing of a big, well-known responsible firm. Don't delay. We want to assign men right *now* to the profitable territories we have left open. Get in with a live proposition that is different. Be successful. Be independent! Make \$15.00 a day and large commissions. Mail me coupon quick for free trial, proof, and full details of a big proposition that will surprise you.

Frank Andrews, Pres.

BLANCHE AUTO DEVICES CO.
154 E. Erie St., Dept. 863-N, Chicago, Ill.

WE PAY OUR DISTRIBUTORS \$15.00 A DAY

Frank Andrews, Pres.,
BLANCHE AUTO DEVICES CO.
154 E. Erie St., Dept. 863-N, Chicago, Ill.

Dear Sir: I am interested in selling gas at 5¢ per gal. Send full details and free trial. No obligation to me.

Name

Address

City State.....

Under it, like hills ensorcelled, the rocky walls about us seemed to flatten. They glowed, and all at once pressed forward like gigantic slices of palest emerald jade, translucent, illumined, as though by a circlet of little suns shining behind them.

The light faded, robes of deepest amethyst dropped around the mountain's mighty shoulders. And then from every show and glacier-crowned peak, from minaret and pinnacle and towering turret, leaped forth a confusion of soft peacock flames, a host of prismatic gleamings. Great and small, interlacing and shifting, they ringed the valley with an incredible glory.

A WONDER OF THE HEAVENS

Through the darkening sky swept a rosy pencil of living light, that utterly strange, pure beam, the ray which the Tibetans name the *Ting-pu*. For a moment this rosy finger pointed to the east, then arched itself and separated slowly into six shining, rosy bands; the bands began to creep toward the eastern horizon where a nebulous, pulsing splendor arose to meet them.

The six beams began to sway; they moved with ever swifter motion from side to side in ever-widening sweep, as though the hidden orb from which they sprang was swinging like a pendulum, was being rocked like a search-light. Faster and faster the six

Station
WRNY
NEW YORK
309.1 Meters—970 Kilocycles
is owned and operated by the publishers of this magazine
Our Editors will talk to you several times every week—
See your Newspaper for details
TUNE IN ON WRNY

high-flung beams swayed—and broke. The severed ends ribboned aimlessly, bent, turned down, and darted earthward into the welter of clustered summits at the north. And swiftly were gone.

"Did you see that?" It was plain Drake doubted his own eyes.

"I saw it." I was struggling with my own bewilderment. "Of course I saw it. But I never saw anything like it before." I ended, most inadequately.

"It seemed—purposeful," he said. "It was deliberate. As though something reached up to the rays and broke them. And drew them down like willow withes."

"Devils dwell there!" It was Chiu-Ming, his voice quavering.

"It's most probably some magnetic phenomenon," I was angry at my own touch of panic. "Light can be deflected by passage through a magnetic field. Of course that's it, certainly."

"I don't know. It would take a whale of a magnetic field to do that—Professor. It's inconceivable. It was so—so damned deliberate," he repeated.

"Devils—" muttered the Chinese.

"Look!" Drake pointed again to the north. A deeper darkness had grown there while we had been talking, a pool of blackness. A gigantic lance of misty green fire darted from it and thrust its quivering point into the heart of the zenith. Following it, a host of sparkling spears of light leaped into the sky. Now the blackness was like



NEVER TOO OLD to Learn

IS MUSIC one of the big things in life you've missed? Don't give up. It's never too late to start with a



True Tone Saxophone

This is the one instrument you know you can learn to play. If you can whistle a tune you can't fail with a Buescher. You can learn to play quickly, and with comparatively little effort.

Join the Home Town Band

With the aid of the 3 lessons given on request with each new Buescher, many learn scales first hour and play tunes first week. You can teach yourself, and in 90 days join the Band, or play with an orchestra, at good pay.

Only Buescher Assures Success

But only with a Buescher is this rapid progress assured. You don't have to fuss and favor for certain notes. Just open the key and blow normally. Every tone full, clear and true.

Six Days' Trial. Easy Terms

Take any Buescher Instrument home for 6 days' trial. If you like it, pay a little each month. Send coupon for beautiful catalog and details of this liberal plan. There will never be a better time to start. Write today.

BUESCHER BAND INSTRUMENT CO.
Everything in Band and Orchestra Instruments
2124 Buescher Block Elkhart, Indiana

BUESCHER BAND INSTRUMENT CO. 866
2124 Buescher Block, Elkhart, Ind.
Gentlemen: Without obligating me in any way please send me your free literature. Mention instrument interested in.

Age:..... Name instrument.....

Name.....

Address.....

SAVE 25% TO 60% on every book you buy

Write for
BOOK BULLETIN No. 5

CONSRAD CO.

230 Fifth Avenue :: New York

MAGIC Earn \$250 to \$1000 Monthly

Now! Different! Teaches you Big Tricks, Illusions, Stage Stunts, "Patrol" and the Principles of Magic. Learn at home. Earn \$250 to \$1,000 a month. Write today for special offer. **TARBELL SYSTEM, INC.**
226 Sunnyside Ave., Studio 94-27 Chicago, Ill.

an ebon hand, brandishing a thousand javelins of tinsel flame.

The green lances fell back. The blackness gathered itself together. Then from it pulsed billows of radiance, spangled with darting swarms of flashing corpuscles like hosts of dancing fireflies. Higher rolled these billows—phosphorescent green and iridescent violet, weird copperous yellow and metallic saffrons and shimmerings of ash of rose. They wavered; they split; they formed into gigantic, marching curtains of sparkling splendor.

A circle of light sprang out upon the folds of the flickering, rushing curtains. Misty at first, its edges swiftly sharpened until it rested upon the glittering glory of the northern sky like a ring of cold white flame. And all about the ring the aurora began to churn, to heap itself, to revolve like a whirlpool. Toward the ring from every side raced the sparkling curtains of the aurora. They drew themselves together. They waved and seethed around it, and then poured over it—and through.

Into the mouth of the ring the aurora streamed in a columned flame to earth.

A mist swept over all the northern sky, hiding that incredible vision.

"Magnetism!" Drake was the first to break the silence. "I guess not!"

IMPORTANT

TO NEWSSTAND READERS

IN order to eliminate all waste and unsold copies it has become necessary to supply newsstand dealers only with the actual number of copies for which they have orders. This makes it advisable to place an order with your newsdealer, asking him to reserve a copy for you every month. Otherwise he will not be able to supply your copy. For your convenience, we are appending herewith a blank which we ask you to be good enough to fill in and hand to your newsdealer. He will then be in a position to supply copies to you regularly every month. If you are interested in receiving your copy every month, do not fail to sign this blank. It costs you nothing to do so.

To Newsdealer

Address

Please reserve for me copies of **SCIENCE & INVENTION** every month until I notify you otherwise, and greatly oblige,

Name

Address

"Devils!" whimpered Chiu-Ming. "Purposeful," said Drake. "Purposeful and deliberate. I tell you, Dr. Thornton, there was intelligence behind all that."

"Intelligence?" I said. "What human intelligence could break the rays of the setting sun or suck down the aurora?"

"I don't know," he answered. "I—don't know. And I didn't say—human intelligence."

"What other is there?" I asked, impatiently.

"Devils," croaked Chiu-Ming. "The devils that defied Buddha—and have grown strong—"

"Purposeful," breathed Drake, again. "Deliberate."

Far to the west a sound came to us. First it was a whisper, then a rushing, a prolonged wailing, a vast crackling. A light flashed through the veiling mist, glowed about us, and faded. Again we heard the wailing, the rushing, the retreating whisper.

Then silence and darkness dropped together upon the valley of the blue poppies.

CHAPTER II

THE MARK ON THE ROCK

DRAKE slept soundly; I, who had not his youthful resiliency, lay, for long

Wake Up Your Lazy Muscles!

Fill Your Body With Manly Vigor

—STRONGFORT Tells How



STRONGFORT
Builder of Men

Your body is full of lazy muscles—you're asleep in most of your anatomy—you're not exerting half the power that you can arouse by stirring up those flabby worthless muscles—you haven't half the vigor and pep and stamina you could have if you sounded the alarm clock and awakened those sleepy muscles and put them to work! No, man—you, perhaps, like thousands of others, are not more than half a man—you're not a full functioning physical machine—you're not the powerful fellow you ought to be, and can be if you'll listen to me and wake up.

You Can Be Strong

You can be a man who will command the admiration of women for your physique and of men for your powerful muscular ability. You can be a man to be feared in combat—a winner in sports. I know what I am talking about—I can prove by tens of thousands of delighted pupils that my methods of body development are beyond any ordinary gymnasium or physical culture course.

It was through my experience in developing my own body to a perfect physical condition—building up a body at once symmetrical, perfectly proportioned and full-functioning—and afterwards training and conditioning boxers, wrestlers, and other athletes—and particularly in restoring thousands of weak men to vigorous health and manly strength—that I evolved the science of

STRONGFORTISM

For Building Up Bodies

STRONGFORTISM works wonders with run-down, weakly, skinny fellows. It builds them up to health through internal muscular development, then rounds them out into robust physical specimens, by bringing into play every muscle and making every muscle do its work as Nature intended. You'll be astonished how quickly you'll feel the benefits of this wonderful health and strength course.

You'll feel like a new man almost from the first day you start under my instructions—and you'll look like a new man! You'll be surprised at the lazy muscles you wake-up when you begin, and they'll wake you up in turn. You'll quickly realize that a new day has dawned for you as you feel the red blood coursing through your whole body like a bounding mountain stream. The old, stupid, sluggish feeling will disappear like magic. That gloomy outlook will vanish as though a heavenly hand had brushed it away. Oh, it's a great feeling! Great to feel like a man! And you surely will when you adopt Strongfort as your instructor and guide—Strongfort, "the builder of men."

Strongfortism Restores Power

by ridding the human organism of distressing ailments and irregularities that have clogged its normal action and thrown its delicate machinery out of gear. The heart, lungs, liver, stomach, brain, all act in harmony in health. Strongfortism restores this harmony; helps to create new red blood; strengthens the vital organs; brings back health, strength, vigor, vitality—the ability both to do things worth while and to enjoy to the fullest the good things of life.

I Want to Send You My FREE BOOK

This book of many pages and dozens of pictures tells of my wonderful experience. It tells what I have done for others, what I can do for you. It doesn't mince words. It tells plain truths. "Promotion and Conservation of Health, Strength and Mental Energy," points the way from disease and weakness to health and strength. It is priceless. I'll send it to you on request—FREE. Write for your copy today.

Send This FREE Consultation Coupon ABSOLUTELY CONFIDENTIAL

Mr. Lionel Strongfort, Strongfort Institute, Dept. 388, Newark, N. J.—Please send me absolutely free my copy of your book, "PROMOTION AND CONSERVATION OF HEALTH, STRENGTH AND MENTAL ENERGY." I have marked (x) before the subjects in which I am most interested.

- Catarrh
- Colds
- Asthma
- Headache
- Rupture
- Thinness
- Pimples
- Insomnia
- Overweight
- Constipation
- Weak Back
- Weak Eyes
- Rheumatism
- Nervousness
- Short Breath
- Weak Heart
- Great Strength
- Lung Troubles
- Round Shoulders
- Stomach Disorders
- Increased Height
- Muscular Development

Private Ailments

Name

Age Occupation

Street

City State

STRONGFORT INSTITUTE

LIONEL STRONGFORT, DIRECTOR

Physical and Health Specialist
DEPT. 388 NEWARK, N. J., U. S. A.

Saved Again!



Size: 30" high; 32" long; 10" wide

Another great victory has been won by Old Ironsides and she will be saved for posterity

While the Frigate Constitution is in dry-dock undergoing rehabilitation the World's Largest Manufacturer of Ship Models has produced a model of the historic ship in knock-down form. The parts are cut-to-fit and ready-to-assemble. So simple is the plan that

You can put these models together in a few hours of pleasant pastime

You need not know anything about ship building to assemble one of these models. As a matter of fact if you have never seen a ship you can put the model of the Constitution together in a few hours by following our diagrams and instruction sheet, which is so written that a school boy can understand it. All you need is a small hammer. The parts are numbered on the diagram to make the process even more simple. As long as you can understand such instructions as these (actually taken from assembling chart that is included with every model of the Constitution) you cannot fail: "Take No. 57, place it in front end of No. 56 and tap lightly with hammer. Next take No. 58 and place it up against No. 57 and tap with hammer to bring it into place."

Easy? Nothing simpler. The instructions are just like that from beginning to end. Do this and that—and before you realize it a beautiful model has grown before your eyes. The model of the Constitution is exact in every detail. The hull, masts, spars, cannons, anchors and rigging correspond to those on the original ship in every way. After you have completed building one of our models from the \$6.98 kit you will be so well satisfied that you would not take \$50.00 or even \$100.00 for the model.

Besides the model of the Constitution we manufacture parts for other historic ships. The Santa Maria and the Mayflower have been the most popular ship models ever built. We have sold these models to people in every part of the world and are shipping a large quantity of them daily to various parts of the United States, Europe, South America and even to Africa.

Send for our beautifully illustrated catalog which contains information and photographs of all our models. Fill in the coupon below today and send it to us and we will act upon it immediately.

Miniature Ship Models, Inc.

3818-20-22-24 Baring Street
Philadelphia, Pa.

CANADIAN BRANCH:

1485 Bleury St. Montreal, Canada

MINIATURE SHIP MODELS, DEPT. S
3818-20-22-24 Baring St., Phila., Pa.

Please send me the complete parts, cut to fit, and ready to assemble for the model Constitution. I will pay postman \$6.98 plus postage (a few cents).

PLEASE PRINT NAME AND ADDRESS PLAINLY

Name
Street or R. F. D.
City
State

sleepless and uneasy. I had hardly sunk into troubled slumber before the dawn awakened me. But during the night I had made up my mind about him, and as we breakfasted, I opened up the matter.

"Drake," I asked. "What, actually, are your plans?"

"I go with you—if you'll let me," he answered promptly. "I'm foot loose, and fancy free. And honestly I think you ought to have somebody with you to help watch over your cook. Something might happen to him."

"Good!" I exclaimed. "I'm thinking of striking over the ranges soon to the Manasarowar Lakes."

"It's all the same to me, Professor," was all he said.

We clasped hands on the partnership, and soon were on our way to the valley's western gate; our united caravans stringing along behind us. Mile after mile we trudged through the blue poppies. We discussed the enigmas of the twilight and of the night—but in the light of day their breath of terror was dissipated. The smiling sapphire

\$21,000.00

for Spirits

Dunninger, who writes exclusively for SCIENCE AND INVENTION Magazine and who is the Chairman of our PSYCHICAL INVESTIGATION Committee will personally pay \$10,000.00 to any medium or spiritualist who can present any psychical manifestation in so-called spiritualism, that he will not explain or that he cannot reproduce by natural means.

More than two years ago SCIENCE AND INVENTION Magazine offered a prize of \$11,000.00 to anyone who could demonstrate his or her ability to communicate with the spirits or to give some definite form of a psychical demonstration which in itself was not trickery.

The result has been that mediums and spiritual organizations have been afraid to place proofs before us. Those weak attempts which have been made to demonstrate psychical phenomena were almost instantly proven fraudulent, and no medium has dared to contradict our findings.

In view of these facts, should we not consider all mediums fraudulent?

To the \$10,000.00 which has been offered by Joseph F. Rinn through this publication for Spiritual proofs and the \$1,000.00 in addition offered by SCIENCE AND INVENTION Magazine we now add Dunninger's \$10,000.00.

So now we have a total of \$21,000.00 offered for proofs of Psychical Manifestations. Spiritualists—get busy.

floor rolled over on before us. Whispering little playful breezes flew down the slopes to gossip for a moment with the nodding flowers. Flocks of rose finches raced chattering overhead to quarrel with the tiny willow warblers, the *chi-uteb-tok*, holding fief of the drooping, graceful bowers bending down to a little laughing stream that chuckled and gurgled along like a friendly water baby beside us.

Mid-afternoon came. The spell of the valley upon us, we had gone leisurely. The western mount was close, the mouth of the gorge, through which we must pass, plain before us. It did not seem as though we could reach it before dusk without hurrying, and Drake and I were easily reconciled to spending another night in the peaceful vale.

I had proven, almost to my own satisfaction, that what we had beheld, if not a magnetic phenomenon—and this I could hardly believe it to be, considering the magnitude of its effects—had been an optical illusion; mirage created by the extraordinary atmospheric attributes of these highlands, an atmosphere so unique as to make almost anything of the kind possible. But Drake was not convinced at all.

"I know," he said. "Of course I understand all that—superimposed layers of warmer air that might have bent the rays, vortices in the higher levels that might have



LEARN TO DRAW AT HOME

Students say: "IT'S EASY"

Trained artists earn from \$50 to over \$250 a week. W. R. Kent, one of our graduates in New Jersey writes, "I have sold a drawing, which took less than a day to do, for \$100." Tremendous demand right now for good art work. Magazines, newspapers, advertisers, printing houses, etc.

Become an artist through wonderful, simple method right at home in spare time as Kent and many others have done. Learn Illustrating, Designing and Sketching. Actual fun learning this way. Learn to Draw and Earn Big Money. Many of our students earn big money while learning.

Send for FREE BOOK

Just printed—a new book which describes the latest developments and wonderful opportunities in Commercial Art, and gives full details of this remarkable method of learning to draw. Tells all about students—their success—what they say—actual reproductions of their work—and how many earned big money even while learning. Write for this FREE BOOK and details of ARTISTS OUTFIT GIVEN WITH COURSE. Write name plainly. State age and whether Mr., Mrs., or Miss. Mail postcard or letter NOW. (No salesman will call.)

WASHINGTON SCHOOL OF ART, Inc.
Room 2610-E 1115 15th St., N. W.
Washington, D. C.

Orders - Inquiries

60 pages
Send for
FREE COPY

Can be Secured by MAIL

POLK'S REFERENCE BOOK and Mailing List Catalog

Gives counts and prices on over 8,000 different lines of business. No matter what your business, in this book you will find the number of your prospective customers listed. Valuable information is also given as to how you can use the mails to secure orders and inquiries for your products or services.

Write for Your FREE Copy

R. L. POLK & CO., Detroit, Mich.

Largest City Directory Publishers in the World
Mailing List Compilers—Business Statistics
Producers of Direct Mail Advertising

10 DAYS FREE TRIAL - MONEY BACK IF NOT SATISFIED

THE NEW INKOGRAPH SELF FILLER
IMPROVED

The Perfect Writing Instrument

Writes with ink easy as a lead pencil. Won't skip, blot, scratch, leak or soil hands. In ready uniform flow of ink. In-crease hand-writing.

1

A hard, round, smooth ball-tip. Makes three carbon copies with original in ink. Guaranteed—Send No Money—Pay postman \$1.50 plus postage.

INKOGRAPH CO., Inc.
197-43 Centre St., New York City

AGENTS Send for an Inkograph or sales plan booklet which shows how to make big money.

PIMPLES

Cleared Up—often in 24 hours. To prove you can be rid of Pimples, Blackheads, Acne Eruptions on the face or body, Barbers' Itch, Eczema, Enlarged Pores, Oily or Shiny Skin, simply send me your name and address today—no cost—no obligation. CLEAR-TONE re-plied and tested in over 100,000 cases—used like toilet water—is simply magical in prompt results. You can repay the favor by telling your friends; if not, the loss is mine. WRITE TODAY. E. S. GIVENS, 468 Chemical Bldg., Kansas City, Mo.

produced just that effect of the captured aurora—I admit it's all possible. I'll even admit it's all probable, but damn me, if I believe it. I had too clearly the feeling of a conscious force, of something that knew exactly what it was doing—and had a reason for it."

Plodding along, deep in thought, I was startled by an exclamation from him. He was staring at a point some hundred yards to his right. I followed his pointing finger. The cliffs were a scant half mile away. At some distant time there had been a great fall of rock. This, disintegrating, had formed a gently-curving breast which sloped down to merge with the valley's floor. Willow and witch alder, stunted birch and poplar had found root hold and clothed it, until only their crowding outposts, thrusting forward in a wavering semicircle, held back seemingly by the blue poppies, showed where it melted into the meadows. And in the center of this breast, beginning half way up its slope and stretching down into the flowered fields was an imprint, a gigantic track—as if some colossal creature had stamped there with its foot.

The mark stood out grey and brown against the green and blue of the slope and level; a rectangle all of thirty feet wide.



"The Tibetan shrieked and fled; the ponies scrambled after him. I heard a sob from Chiu-Ming. He fell. We placed him between us and thrust each an arm through his own. Then, like swimmers, heads bent, we pushed on, buffeting that inexplicable flood. . . ."

two hundred long, and from its higher end, like claws, four triangles radiating in twenty foot wide star points. It was like a footprint. Yet what was there whose tread could leave such print as this?

I ran up the slope—Drake already well in advance. The mark was fresh, there was no mistaking that. At its upper edges were clipped bushes and split trees, the white wood of the latter showing where they had been sliced—and at the lower edges drooped shaved poppy stems that plainly the day before had held high their little azure banners. I stepped out upon the mark. It was as level as though planned. I bent down, and could not believe what my eyes beheld. Rock and rubble had been crushed and compressed into a smooth, microscopically-grained, adamantine complex, and in this matrix poppies still bearing traces of their coloring were imbedded like fossils.

But what force was there which could take the delicate petals of a flower and set them like inlay within the surface of a stone?

"What could have done it?" said Drake. "The foot of Shin-je," it was Chiu-Ming's voice, tremulous. "The Lord of Hell had trodden here!"

"Has the Lord of Hell but one foot?" Asked Drake, politely.

"He bestrides the mountains," said Chiu-

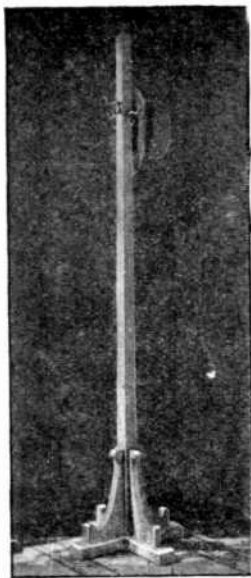

COSTUMER
See LePage's Book, page 10



SPANISH SHIP MODEL
See LePage's Book, page 1



HANGING BOOK SHELVES
See LePage's Book, page 25



TABLE DESK
See LePage's Book, page 15



Send 10 cents for this NEW
LePage's Home Work Shop Book

Just write your name and address on the coupon below, tear it out and mail to us 10-day with 10 cents in coin or stamps, and we will at once send you a copy of LePage's New Home Work Shop Book, postage paid. Address LePage's Craft League, 568 Essex Ave., Gloucester, Mass. Tear out the coupon now so you won't forget it.

LEPAGE'S
LIQUID GLUE
Handiest Tool in
your Work Shop

How to make Attractive Furniture for Christmas

LePage's New Home Work Shop Book
will show you how

WITH the approach of Christmas, comes this NEW LePage's Home Work Shop Book to show you how to make 20 different pieces of gift furniture, designed by an expert—attractive, artistic, useful, practical and easy to make. Each piece is ideally suited to be a Christmas gift.

New Book—greatly improved

THE first LePage's Home Work Shop Book, published a year ago, proved so popular that, though advertised only a few times, over 30,000 copies were sold—an enormous edition for a book of this kind. Now the new book, just off the press, represents a wonderful improvement over the old one. Of its 20 complete projects, 16 are entirely new and never offered before.

Each project is presented in three parts—a photographic illustration of the finished project, a complete dimension drawing of its parts, and simple, easy-to-follow directions, for making, given step by step from start to finish.

Designed by Expert

For each of the 20 gift furniture projects, the design, dimension drawings and photographs, as well as the actual articles, were made by William W. Klenke, Instructor in Woodworking, Central Commercial and Manual Training High School, Newark, New Jersey. Assurance is therefore given that each project and the directions for making it is perfectly practical.

In addition to the four pieces illustrated above, the book includes the following 16 projects: Occasional Table, Folding Sewing Screen, Fernery Stand, Tilt Top Table, Piano Bench, Priscilla Sewing Box, Cedar Chest, Smoking Cabinet, Desk Chair, Card or Console Table, Book Stand, Turned Bench, Dressing Glass, End Table with Book Trough, Foot Stool and Back Rest. Where else could you get complete directions for making all these things for only 10 cents?

In addition, this new LePage's book contains full information on how to secure plans for making eighteen more new projects, prepared by Frank I. Solar, Teacher of Manual Training in Detroit Public Schools, and widely-known tool craft writer.

Mail this coupon

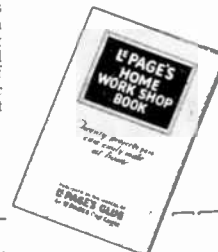

LEPAGE'S CRAFT LEAGUE,
568 Essex Ave., Gloucester, Mass.
Gentlemen: Enclosed please find 10 cents (coin or stamps) in payment for LePage's New Home Work Shop Book. Please send a copy of this book to:
Name
Street
City State

Speed Way Drill & Saw Kit



FREE TRIAL
Long before your ten-day free trial is over you will know what a wonder it is. Works from any lamp socket. Just the tool for your garage, workshop or repair bench. A real money maker and time saver for the small job man.

5 Tools in Case
Outfit packs into handy steel case (No. 11). Take it to the job. Handy, compact.

Here They Are

1. SpeedWay Portable Drill; 1/2" in steel; 1/4" in wood.
2. Guard and handle for saw driven by Drill motor.
3. Saw blade—1"
4. Buffer wheel for polishing.
5. Wire scratch brush.
6. Cradle to convert the Portable to a Bench Drill.
7. 1/4" Emery Wheel.
- 8, 9, 10. For attaching above.
11. Steel Carrying case.

Pay While Using
We ship on receipt of small down payment. Pay balance in small monthly amounts, while you are using it.

A Money Maker
The SpeedWay electric drill in the Kit is either a portable or stationary drill. Just attach the blade, with guard, and your drill becomes a handy, husky, portable saw, ready to go to work on any sort of a job. Takes but a moment to put Grinder, Buffer, or Polisher into action.

WRITE TODAY
Get full information about this wonderful combination of Portable Electric Tools. Just sign your name on the margin.

ELECTRO MAGNETIC TOOL COMPANY
Dept. 280, 1830 S. 52d Ave. (Adj. Chicago) Clearo, Ill.
The world's only manufacturers of a complete line of Portable Electric Saws, Hammers, Drills and Grinders.

Learn Photography at HOME
Make money taking pictures. Prepare quickly during spare time. Also earn while you learn. No experience necessary. New easy method. Nothing else like it. Send at once for free book, *Opportunities in Modern Photography*, and full particulars.

AMERICAN SCHOOL OF PHOTOGRAPHY
Dept. 1427 3601 Michigan Ave., Chicago, U. S. A.

MODEL MAKING
When you have made your Model Boiler, you will naturally wish to mount it with the best Steam Fittings obtainable. We can supply accurately made miniature Steam and Water Gauges, Steam Valves, Pumps, etc., also finished Engines and Boilers suitable for Model boats and stationary purposes. Special work to order. Large illustrated catalog 20c (refunded on first order).

BATHE MFG. CO.
Dept. 2, 5214 Woodland Ave., Phila., Pa.

MAKE 7 1/2 DOLLARS EVERY DAY Right In Your Home, Start Anywhere. Any Time. 1 Dollar Money Order will bring you complete Information and VALUABLE OFFERS Magazine for 12 Months.

A. CERVENEC SYSTEM, Box 4, Buffalo, N. Y.

Ming. "On the far side is his other footprint. Shin-je it was who strode the mountains and set here his foot!"
Drake cast a calculating glance up to the cliff top.

A MONSTER WITH 2000 FOOT LEGS?

"Two thousand feet, about," he mused. "Well, if Shin-je is built in our proportions that makes it right. The length of this thing would give him just about a two thousand foot leg. Yes—he could just about have straddled that hill."

"It is like a die," I said. "See the absolutely mathematical nicety with which these edges are stamped out. It's as if some tremendous force had pressed a seal here like—like a giant die in a mountain's hand."

"Look——" said Drake, "except for this one place there isn't a mark anywhere. All the bushes and the trees, all the poppies and the grass are just as they ought to be. How did whatever it was that made this, get here and get away without leaving any trace? There's the mystery. Damned if I don't think Chiu-Ming's explanation puts less strain upon the credulity than any I could offer."

"Those noises on the night," I said. "That light that broke through the mists. It was then, I think, that this mark was made."

"I think so too," Drake nodded. "I'm for pushing up a notch or two and getting into the gorge before dark. I'm willing to face anything human—but I'm not keen to run

WANTED

Copies July 1926, Science and Invention. Write I. S. Manheimer, c-o S. & I., 230 Fifth Avenue, New York City.

the risk of being pressed into a rock like a flower in a maiden's book of poems."

We travelled fast and just at twilight we drew out of the valley into the pass. We went a full mile along it before darkness forced us to make camp. The gorge was narrow. The far walls were only a hundred feet away; but we had no quarrel with them for their neighborliness. Their solidity breathed confidence back into us.

And after we had found a deep niche capable of holding the entire caravan we filed within it, ponies and all, I for one perfectly willing to spend the night so; let the air at dawn be what it would. We dined on bread and tea, and then, tired to the bone, sought our places upon the rocky floor. I slept well, awakened only once or twice by Chiu-Ming's groanings; his dreams evidently were none of the pleasantest. If there was an aurora that night I neither knew nor cared.

CHAPTER III
TERRORS OF THE HAUNTED HOLLOW

THE dawn, streaming into the niche, awakened us. A covey of partridges, venturing too close, yielded three to our shooting. We breakfasted well, and a little later were pushing on down the cleft.

Its descent, though gradual, was continuous, and therefore I was not surprised when soon we began to come to evidences of semi-tropical vegetation. Giant rhododendrons and tree ferns gave way to occasional clumps of stately *kopek* and clumps of the hardier bamboos. We added a few snow-cocks to our larder—although they were out of their habitat, having flown down into the gorge from their peaks and table-lands for some choice titbit no doubt. All that day we

Have You a TYPEWRITER? Would You Like to Have One?
For Fast Business-Like Correspondence for

Professors Teachers Clergymen Prominent People
Salesmen Club Sec'y's Students Storekeepers



For a Full-Time Well-Paid Position for Stenographers Clerks Bookkeepers Telegraphers
For Profitable Spare Time Income for Housewives Office Girls Students Clerks

10 Days' FREE TRIAL
A Year to Pay

ILLUSTRATED CATALOG
of all standard machines remanufactured from top to bottom at saving of 40 to 60%—Free. (Mail coupon.)

Young Typewriter Co.
654 W. Randolph St.
Dept. 116A, Chicago

Without obligation send me free catalog of bargain typewriters and EZ pay plan.

Name

Address

City..... State.....

Note! A less expensive machine may answer your need. Indicate type of work. We may have a bargain for you.....

free Wholesale Radio Catalog Send today for it

1928 Catalog Dealers, set builders — make this your biggest radio season. Shure's great wholesale catalog insures the best in quality at lowest prices. This wonderful book is jammed full of the newest offerings of Nationally known radio parts, kits, sets, accessories, table and console cabinets, etc. Also contains short wave sections showing the finest electrical apparatus for short wave receiving and transmitting. Your request on letterhead brings our book of a thousand bargains, price list and discount sheet.

2000 Items **Big Values**

Shure Radio Company
337 1/2 Madison St. Chicago, Ill.

PRINT YOUR OWN
Cards, Stationery, Circulars, label paper etc. Save money. Print for Others, Big Profits. Complete Outfits \$8.85 up. Job press \$11 up. Rotary \$14.95. All easy rules sent. Write for catalog EXCLESIOR press type, etc. The Kelsey Co., B-47, Meriden, Conn.

THIS CLASS PIN 30c.
12 or more, Silver plate, Single pins 40c ea. choice 2 colors enamel, 3 letters, date. Sterling Silver, 12 or more 50c ea. Single pins 60c ea. Free Cat. above Pins, Rings, Emblems 75c to \$1 ea.

685 METAL ARTS CO., Inc., 773 Portland Ave., Rochester, N. Y.

DON'T FAIL to write for —

BOOK BARGAIN BULLETIN No. 5

Remarkable savings on all kinds of Books

CONSRAD COMPANY, INC.
230 Fifth Ave. New York

marched on, and when at night we made camp, sleep came upon us quickly and overmastering. An hour after daybreak we were again on our way.

It was close to two when we caught the first sight of the ruins.

The soaring, verdure-clad walls of the canyon had long been steadily marching closer. Between their rims the wide ribbon of sky was like a fantastically shored river, shimmering, dazzling; every cove and headland edged with an opalescent glimmering as of shining pearly beaches. Now this high overhead river was but a brook; became a thread. It vanished. We passed into a tunnel, fern walled, fern roofed, garlanded with tawny orchids, gay with carmine fungus and golden moss; and then we stepped out into a blaze of sunlight.

Before us lay a wide green bowl, held in the hands of the clustered hills. Around it the peaks crowded, craning their lofty heads to peer within.

Three miles in diameter was this hollow, as my gaze then measured it. Three openings it had—one that lay like a crack in the northwest slope, the tunnel mouth through which we had come, and a road that lifted itself out of the bowl, creeping up the precipitous bare scarp of the western barrier straight to the north, clinging to the rock, up and up, until it vanished around a far distant shoulder. It was a wide and bulwarked road; a road that spoke, as clearly as though it had tongue, of human hands which had cut it there on the mountain's breast—an ancient road, weary beyond belief beneath the tread of countless years.

Out from the green hollow groped to greet us the very soul of loneliness!

Never in desert depths had I felt even an approach to the desolation of spirit that lay within that verdant bowl. Its influence, too, was physical, for within the breast grew a dull, intolerable aching; the pulse was checked.

Half the width of the valley away—the ruins. They huddled in two bent rows to the bottom. They crouched in a wide cluster against the cliffs. From the cluster against the cliffs, a curving row of them ran along the southern crest of the hollow. A flight of cyclopean steps lifted to a ledge, and here a crumbling fortress stood. Irresistibly did the ruins resemble a colossal hag, flung prone, and lying listlessly against the barrier's base. The huddled lower ruins were the legs, the cluster, the body, the upper row an outflung arm, and above the neck of the stairway the ancient fortress, with two ragged apertures in its northern front, was like an age bleached skull staring up to where, round the distant breast of rock, the weary road crept and vanished.

"Something wrong here," Drake turned to me. "But I'd rather chance whatever it is than go back. What do you say?"

I nodded; we stepped over the rim, rifles on the alert; close behind us crowded the two servants and the ponies. We trod the fragments of an olden approach to the green tunnel, so the descent was not difficult. Here and there, beside the path, upreared huge broken blocks. On them I thought I could see faint traces of carvings—now a suggestion of gaping, arrow-fanged dragon jaws, now the outline of a scaled body, a hint of bat-like wings.

We reached the first of the crumbling piles that stretched down into the valley's center, and there, half fainting, I fell against Drake, clutching to him for support.

A stream of despair had raced upon us, swirled and eddied around us, clutching at our heart. From every shattered heap that tide seemed to pour. It sapped the life. A weariness ineffable filled me, desire to drop down upon the stones, to die. I felt Drake's body quivering and knew that, like myself, he was drawing upon every reserve of strength.

The Tibetan shrieked and fled; the ponies
(Continued on page 547)



Go after the Big-Pay Job!

"Know electricity as experts know it and get an expert's Pay"

DON'T be satisfied to worry along in little jobs with little pay. Master the finer points of electrical practice and bring the big-pay job within your reach. Croft will show you how. Through his famous books he will teach you electricity as experts know it and put you in line for an expert's pay. Fifty-nine thousand men are using these books to step ahead—WHY NOT YOU?

The Croft Library of Practical Electricity

A Combined Home Study Course and Reference Library
8 volumes—3000 pages—2100 illustrations—flexible Keratol binding
Now \$19.50—Soon \$23.50

No method of teaching electricity offers a quicker, surer way to success than the Croft books.

Starting right in with the ABC's of modern electrical practice, Croft takes you through his books in easy steps. He gives you the secrets of success in electricity in plain words, figures and illustrations.

Croft teaches you electrical practice complete—inside and outside work—central stations and the whole subject. He takes you in quick, easy steps from the simplest principles to the complete and economical operation of a great central station.

He tells you things you need to know about motors, generators, armatures, commutators, transformers, circuits, currents, switchboards, distribution systems—electrical machinery of every type, installation, operation and repair—wiring for light and power—how to do it mechanically perfect, in accordance with the National Electrical Code—wiring of finished buildings—Underwriters' and municipal requirements—how to do a complete job, from estimating it to completion—illumination in its every phase—the latest and most improved methods of lighting—lamps and lighting effects, etc.

The Sure Way to Bigger Pay

Big salaries are paid in the electrical field for expert knowledge. The man who knows electricity in all its many phases—the man who has completely mastered the subject from A to Z—can pick his own job and name his own salary. The only way you can earn more is to learn more. Small knowledge means small pay. Learn the way to bigger pay. Become an expert.

FREE TRIAL

The proof of all we have said is in the books themselves, and it costs you N-O-T-H-I-N-G to examine them. There are no charges of any kind to pay. We pay everything. We send the books to you for 10 days' examination and let you be the sole judge as to their value.

EASY PAYMENTS

If you decide to take this sure road to promotion, you need send only \$1.50 in ten days and pay the balance at the rate of \$2 a month. You do not have to send any money to see the books. You do not have to buy them unless you feel that they actually will mean more money to you.

YOU
HAVE
10
MONTHS
TO PAY

FREE
EXAMINATION

NO MONEY
IN
ADVANCE

SEND YOUR
COUPON
NOW



FREE
Examination
Coupon

McGraw-Hill
Book Co., Inc.,
370 Seventh Ave.,
New York

Gentlemen:—Send me the LIBRARY OF PRACTICAL ELECTRICITY (shipping charges prepaid), for 10 days' free examination. If satisfactory, I will send \$1.50 in ten days and \$2 per month until the special price of \$19.50 has been paid. If not wanted, I will write you for return shipping instructions.

Name

Home Address

City and State

Employed by

Occupation S.I.-10-27

Now You Can Have a Short Wave Receiver of Marvelous Tone Quality

The "RADIO NEWS" Special Short Wave Broadcast Receiver

THERE are many "Short Wave" circuits obtainable but few are designed with any thought to real quality of Reproduction.

Now that so many broadcasters are turning to the more efficient short wave broadcasting, every set builder should provide himself with a good receiver and be prepared to capitalize on a demand.

Complete constructional information, with circuit diagram and other illustrations on the RADIO NEWS Special Short Wave Receiver will be found in the October issue of RADIO NEWS now on all newsstands.

WRNY BROADCASTING ON SHORT WAVES

Listen-in for the "RADIO NEWS" Station
WRNY—Now Broadcasting on
30.91 Meters

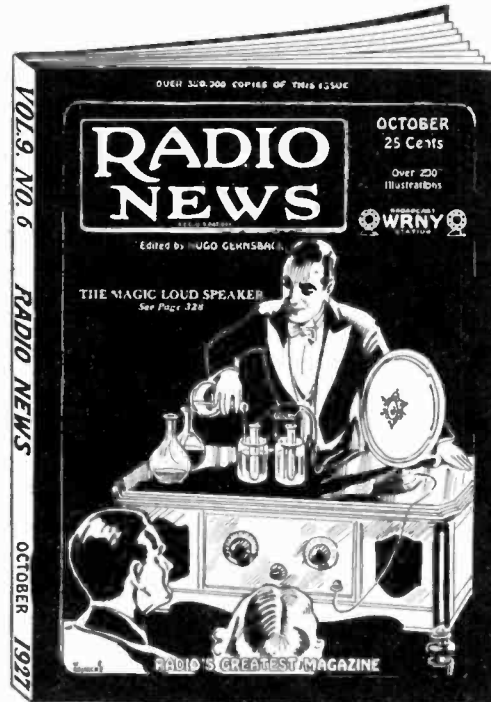

More About the Famous Strobodyne

Some very interesting and instructive information on the great Strobodyne Receiver is published in October RADIO NEWS. Every one building this circuit should read Mr. Lacault's latest data.

The Knickerbocker Four

A very fine circuit, with some unusual design improvements, is presented this month in RADIO NEWS for set builders. It is called the Knickerbocker Four.

Some Interesting Facts on Sub-Antenna

H. Winfield Secor, a contributing editor to RADIO NEWS presents some facts on the efficiency of a Sub-Antenna that will surprise every Radio man. Don't miss his startling article on this interesting subject.

Over 130 Pages of Radio—Illustrated

25c—ON ALL NEWSSTANDS

Subscriptions \$2.50 the Year

EXPERIMENTER PUB. CO., INC.
230 Fifth Avenue New York City

THE WINGED DOOM
by Kenneth Gilbert

AROUND THE UNIVERSE
by Ray Cummings

TREASURES OF TANTALUS
by Garret Smith

The image shows the cover of the October 1927 issue of 'AMAZING STORIES' magazine. The cover features a futuristic, multi-wheeled vehicle. The text on the cover includes 'October', '25 CENTS', 'AMAZING STORIES', 'HUGO CERNISBACH EDITOR', and 'Stories by H.G. Wells, Ray Cummings, Garret Smith'.

AEPYORNIS ISLAND
by H.G. Wells

THE PARADISE OF THE ICE WILDERNESS
by Jul. Regis

ALL IN

Five amazing, master stories in one great October Number. Stories, the like of which you have never read before. A combination of thrilling fiction and the marvel, mystery and action of Science.

25¢ On All Newsstands

OCTOBER

"AMAZING STORIES" publishes the works of such famous authors as H. G. Wells, Jules Verne, Garret Serviss, Ray Cummings, Edgar Allan Poe and many others. There's a big, pleasant surprise, packed with thrills in the October issue of "AMAZING STORIES." Ask your dealer for a copy today.

EXPERIMENTER PUB. CO., INC., 230 5th Ave., N. Y.

The Metal Emperor

By A. MERRITT

(Continued from page 545)

scrambled after him. I heard a sob from Chiu-Ming. He fell.

Drake stopped, and drew the Chinese to his feet. We placed him between us, and thrust each an arm through his own. Then, like swimmers, heads bent, we pushed on, buffeting that inexplicable flood.

As the path rose, its force lessened; my vitality grew. The terrible desire to yield and be swept away waned. Now we had reached the foot of the stairs. Now we were half up them. And now as we struggled out upon the ledge on which the watching fortress stood, the clutching stream shoaled swiftly; the shoal became safe, dry land, and the currents swirled harmlessly beneath us.

We stood erect, gasping for breath, like swimmers who have fought their utmost and barely, only barely, won.

A GIRL APPEARS

There was an almost imperceptible movement at the side of the ruined portal. Then out darted a girl. A rifle dropped from her

\$5,000 for Perpetual Motion

The editors have received thousands of different designs of perpetual motion devices, and have received hundreds of circular letters soliciting finances for the building of perpetual motion machines.

The editors know that if they receive these letters, there are thousands of others in this country who get similar letters and who fall for the claims made in the numerous prospectuses giving the earning capacities of the various machines.

Most of the shares of stocks for these perpetual motion machines are being sold at a rate of \$1.00 per share, although some inventors are trying to sell shares of stocks at \$100.00 per share.

Therefore the editors of this publication say, "Just come in and show us—merely SHOW us—a working model of a perpetual motion machine and we will give you \$5,000.00. But the machine must not be made to operate by tides, winds, water-power, natural evaporation or humidity. It must be perpetual motion."

hands. She sped straight toward me. And as she ran I recognized her.

Ruth Ventnor!

Martin Ventnor's little sister. Martin Ventnor, geologist, hunter-out of hidden places, who had been my companion on many a perilous wandering. What was Ruth Ventnor doing here in this forgotten corner of the world?

She had reached me, thrown soft arms around my neck; was weeping on my shoulder.

CHAPTER IV

OUT OF THE PAST

"LOUIS!" she sobbed. "Oh, thank God! Thank God you're here!"

She drew herself from my arms, catching her breath, laughing shakily.

I took swift stock of her. Save for the fear plainly upon her, she was the same Ruth that I had known three years before; wide, deep blue eyes that were now all seriousness, now sparkling wells of mischief; petite, rounded and tender; the fairest skin; piquant nose with just a suggestion of impudence; shining clusters of intractable curls; a girl all human, sparkling and sweet.

I introduced Drake, noting the admiration in his brown eyes.

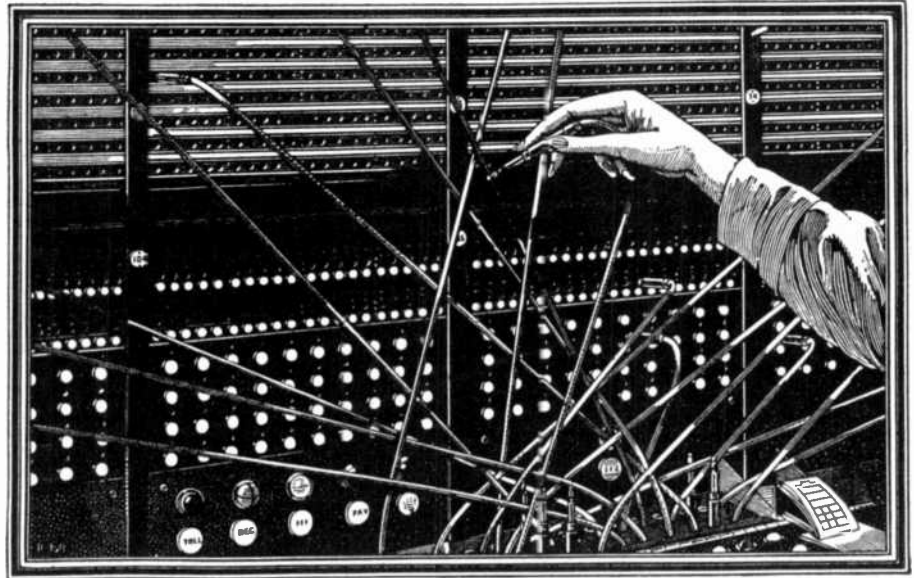

The Switchboard

An Advertisement of the American Telephone and Telegraph Company



A WEB of cords plugged into numbered holes. A hand ready to answer signals which flash from tiny lamps. A mind alert for prompt and accurate performance of a vital service. A devotion to duty inspired by a sense of the public's reliance on that service.

Every section of a telephone switchboard typifies the co-ordination of human effort and mechanism which makes possible America's far-reaching

telephone service. Its cords link for instant speech those who are separated by a few miles or by a continent. Its guardian operators are of the telephone army—men and women vigilant to meet a nation's need for communications.

In plant and personnel, the Bell System is in effect a vast switchboard serving a nation that has been transformed into a neighborhood through telephone growth and development.



I Positively Guarantee

to increase your arms one-half inch in size, chest one full inch, strength 25%, health, 100% in one week's time, by following my instructions and using my exerciser 10 minutes mornings and at night. Send \$1 for complete course and exerciser. Satisfaction guaranteed or \$1 refunded.

PROF. J. A. DRYER
Box 1850-L Chicago, Ill.

Earn \$75 Weekly Building Radio Sets

Join the Association! We train you to build and repair radio sets—start you in business—enable you to earn \$3 an hour upwards. Free 5-Tube Radio Set to Members. Write for special limited-time plan whereby your membership need not cost you a cent. Write today!

RADIO ASSOCIATION OF AMERICA
Dept. SN-10 4513 Ravenswood Ave., Chicago, Ill.



Messy Drudgery Now Removed

Remarkable Discovery **AGENTS** Removes Drudgery from polishing table silver, auto trimmings—all metalware—and furniture. Abolishes sticky pastes, messy liquids and powders. Agents Wanted. Experience unnecessary. Startling Demonstrations make sales self-closing. Low price—two-thirds profit—quick cash gains. Protected territory. **TEST SAMPLES FREE.** Write Today for details.

G. W. LIGHTNING CORP.
1773 Greenleaf Ave. Chicago

AMAZING NEW ADDING PENCIL

Guaranteed Absolutely Accurate. Fountain pen size. Ends all mistakes. Send for yours Today.

AGENTS Great money maker. Everybody interested. Reserve territory immediately.

MOUK ADDING PENCIL CO., Dept. 20 St. Louis, Mo.

Prices: \$1.98, \$2.75, \$3.50, \$4.25, \$5.00, \$5.75, \$6.50, \$7.25, \$8.00, \$8.75, \$9.50, \$10.25, \$11.00, \$11.75, \$12.50, \$13.25, \$14.00, \$14.75, \$15.50, \$16.25, \$17.00, \$17.75, \$18.50, \$19.25, \$20.00



Are you afraid you will be fired?

ARE you sitting on the anxious bench wondering what will happen to you if business slacks up? Are you one of the many small-salaried, untrained workers who are always the first to go when employers start cutting the salary list?

Why have this spectre of unemployment hanging over you all the time? Why not decide today that you are going to make yourself so valuable to your employer that he can't get along without you?

You can do it if you really want to, right at home in spare time, through the International Correspondence Schools. In just an hour a day you can get the special training that you must have if you are ever going to get—and keep—a real job at a real salary.

You're ambitious, aren't you? And you want to get ahead? Then don't turn this page until you have clipped the coupon, marked the line of work you want to follow and mailed it to Scranton for full particulars.

Surely it is worth at least a two-cent stamp to find out all about the I. C. S. and what it can do for you.

Mail the Coupon for Free Booklet

INTERNATIONAL CORRESPONDENCE SCHOOLS
"The Universal University"
Box 6202-E, Scranton, Penna.

Without cost or obligation, please send me a copy of your booklet, "Who Wins and Why," and full particulars about the course before which I have marked X:

BUSINESS TRAINING COURSES

- | | |
|--|---|
| <input type="checkbox"/> Business Management | <input type="checkbox"/> Salesmanship |
| <input type="checkbox"/> Industrial Management | <input type="checkbox"/> Advertising |
| <input type="checkbox"/> Personnel Organization | <input type="checkbox"/> Better Letters |
| <input type="checkbox"/> Traffic Management | <input type="checkbox"/> Show Card Lettering |
| <input type="checkbox"/> Business Law | <input type="checkbox"/> Stenography and Typing |
| <input type="checkbox"/> Banking and Finance Management | <input type="checkbox"/> English |
| <input type="checkbox"/> Accountancy (including C.P.A.) | <input type="checkbox"/> Civil Service |
| <input type="checkbox"/> Cost Accounting | <input type="checkbox"/> Railway Mail Clerk |
| <input type="checkbox"/> Bookkeeping | <input type="checkbox"/> Common School Subjects |
| <input type="checkbox"/> Private Secretary | <input type="checkbox"/> High School Subjects |
| <input type="checkbox"/> Spanish <input type="checkbox"/> French | <input type="checkbox"/> Illustrating |
| | <input type="checkbox"/> Cartooning |

TECHNICAL AND INDUSTRIAL COURSES

- | | |
|---|--|
| <input type="checkbox"/> Electrical Engineering | <input type="checkbox"/> Architect |
| <input type="checkbox"/> Electric Lightings | <input type="checkbox"/> Architects' Blueprints |
| <input type="checkbox"/> Mechanical Engineering | <input type="checkbox"/> Contractor and Builder |
| <input type="checkbox"/> Mechanical Draftsmanship | <input type="checkbox"/> Architectural Draftsman |
| <input type="checkbox"/> Machine Shop Practice | <input type="checkbox"/> Concrete Builder |
| <input type="checkbox"/> Railroad Positions | <input type="checkbox"/> Structural Engineer |
| <input type="checkbox"/> Gas Engine Operating | <input type="checkbox"/> Chemistry <input type="checkbox"/> Pharmacy |
| <input type="checkbox"/> Civil Engineering | <input type="checkbox"/> Automobile Work |
| <input type="checkbox"/> Surveying and Mapping | <input type="checkbox"/> Airplane Engines |
| <input type="checkbox"/> Metallurgy <input type="checkbox"/> Mining | <input type="checkbox"/> Agriculture and Poultry |
| <input type="checkbox"/> Steam Engineering <input type="checkbox"/> Radio | <input type="checkbox"/> Mathematics |

Name.....
Street Address.....
City..... State.....
Occupation.....

If you reside in Canada, send this coupon to the International Correspondence Schools Canadian, Limited, Montreal

Play the HAWAIIAN GUITAR
Just as the Natives Do

FREE when you enroll
15 HAWAIIAN GUITAR and Case

Only 4 Motions used in playing this fascinating instrument. Our native Hawaiian instructors teach you to master them quickly. Pictures show how. Everything explained clearly.

Easy Lessons
After you get the four easy motions you play harmonious chords with very little practice. No previous musical knowledge necessary.

Free Guitar and Outfit in Genuine Seal Grain Fabricoid Case as soon as you enroll. Nothing to buy—everything furnished. No delay.

Write at Once
You'll never be lonesome with this beautiful Hawaiian Guitar. Write for Special Offer and easy terms. A postcard will do. ACT!

OTHER COURSES: Tenor Banjo, Violin, Tiple, Tenor Guitar, Ukulele, Banjo Ukulele—under well-known instructors.

FIRST HAWAIIAN CONSERVATORY OF MUSIC, Inc.
First Floor, Woolworth Bldg., Dept. 440, New York, N. Y.
Approved as a Correspondence School Under the Laws of the State of New York.

"I—I watched you struggling through that dreadful pit. I could not see who you were—but oh, my heart almost died of pity for you, Louis," she breathed." What can it be—out there?"

I shook my head.

"Martin could not see you," she went on. "He is watching the road. But I ran down—to help."

"Mart watching?" I asked. "Watching for what?"

"I——" she hesitated, oddly. "I'd rather tell you before him."

We passed through the broken portal, and into the fortress. The floor of the ruined chamber we entered was strewn with fragments fallen from the crackling, stone-vaulted ceiling. Through the breaks, light streamed from the level above us. We picked our way among the debris to a crumbling stairway and crept up it, Ruth fitting ahead. We came out opposite one of the eyelike apertures. Black against it, perched high upon a pile of blocks, was the

MODEL DEPARTMENT BLUEPRINTS

Correct—Easy to Follow

- 1-2 Horizontal Steam Engine details.....set \$1.00
- 3-4 Boiler construction for aboveset \$1.00
- 5 880 Ton Bark..... 50c
- 6-7 Twin Cylinder Steam Engine and Boiler set \$1.00
- 8-9 Gasoline Fired Locomotiveset \$2.00
- 10-11 U. S. S. Constitution, "Old Ironsides"set \$1.00
- 12 13th Century Man-of-War 50c
- 13-14 Chinese Junkset 50c
- 15-16 Electrically driven Automobileset \$1.00
- 17-18 How to Build a Reflecting Telescope \$1.00
- 19 Roman Ballista 50c
- 20-21 Simple Steam Engine, set 50c
- 22 "Santa Maria," complete 50c
- 23-24 Model U. S. S. Portsmouthset \$1.00
- 25 Building a Model Tug-boat 50c

Send Orders to

MODEL DEPARTMENT
SCIENCE AND INVENTION

230 Fifth Avenue
New York City

long, lean outline of Ventnor, rifle in hand, gazing intently up the ancient road whose upper windings were plain through the opening. He had not heard us.

"Martin," called Ruth, softly.

He turned swiftly. A shaft of light from a crevice in the gap's edge struck his face, flashing it out from the semi-darkness of the corner in which he crouched.

"Mart!" I cried.

"Louis!" he shouted, tumbling down from his perch, shaking me by the shoulders. "Thornton! How did you get here?"

"But you?" I cried. "How did you and Ruth come to be in this——"

"Which way did you come?" he interrupted. I pointed toward the south.

"Not through the hollow?" he asked, incredulously.

"It cost us our ponies and most of our ammunition," I answered, ruefully.

"But you made it—could we try it now, do you think?" he asked eagerly.

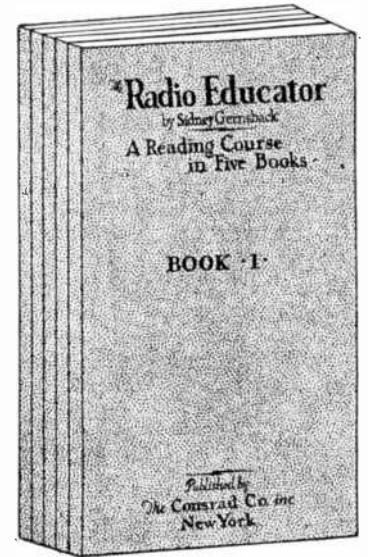

Price \$1.97

A RADIO EDUCATION

IN 5 VOLUMES

"THE RADIO EDUCATOR"

Theory, Design, Construction, Operation and Maintenance

LEARN AT HOME

THESE five component parts of a complete Radio Instruction Course are outlined in five volumes that contain not merely the essentials as so many books do, but more, they contain all that any modern up-to-the-minute textbook on any subject would cover. They are in themselves a COMPLETE radio education teaching every possible portion of Radio science.

Size of each book 6 by 9 inches, handsomely bound and illustrated with charts, diagrams, descriptions of equipment, etc. Each volume 52 pages.

SEND NO MONEY for these books. Just forward your name and address. We send you the books at once. On receipt of same you pay the postman \$1.97 plus a few cents postage and then they are yours.

Distributed by

The Consrad Co.

Incorporated

230 Fifth Ave., New York, N. Y.

"Not—not for a little while," I stammered. "Well," he nodded, understandingly, "We'll wait a bit, then."

"But why are you staying here? Why didn't you make for the road up the mountain? What are you watching for, anyway?" asked Drake.

"Your turn, Ruth," Ventnor gave her a grim grin. "It was your party you know. Tell 'em."

"Mart!" she cried, blushing. "Tell 'em," he said. "I'm busy. I've got to watch."

"Well,"—Ruth began, "we'd crossed the passes. That was about a month ago. The fourth day out we ran across what looked like a road running south. We thought we'd take it. It was sort of old and lost—but it was going the way we wanted to go. It took us first into a country of little hills; then to the very base of the great range itself; finally into the mountains—and then it ran blank."

"Slap dash against a prodigious fall of rock," interjected Ventnor, looking around. "We couldn't get over it."

"So we cast about to find another road," went on Ruth. "All we could strike were—just strikes."

"No fish on the end of 'em," said Ventnor. "God! But I'm glad to see you, Louis! You too, Mr. Drake! Believe me, I am. However—go on, Ruth."

"At the end of the second week," she said, "we knew we were lost. We were deep in the heart of the range. All around us was a forest of enormous, snow-topped peaks. The gorges, the canyons, the valleys that we tried led us east and west, north and south. It was a maze, and we seemed to be going ever deeper into it. There was not the slightest sign of human life. It was as though no human beings except ourselves had ever been there. Game was plentiful. We had no trouble in getting food. And sooner or later, of course, we were bound

to find our way out. We did not worry. "It was five nights ago that we camped at the head of a lovely little valley. There was a mound that stood up like a tiny watch-tower, looking down it. The trees grew about it like tall sentinels. We built our fire on that mound; and after we had eaten Martin slept. I sat watching the beauty of the skies, and of the shallow vale. I had heard no one approach—but something made me jump to my feet and look behind me.

RUTH SCARED BY A MYSTERIOUS MAN

"A man was standing just within the glow of firelight, watching me."

"A native?" I asked. She shook her head.

"Not at all," said Ventnor. "Far from it. That's just the trouble. Ruth screamed, and awakened me. I caught a glimpse of the fellow before he disappeared. A short purple mantle hung from his shoulders. His chest was covered with fine chain mail. His legs were swathed and bound by the thongs of high buskins. He carried a small, round, hidecovered shield and a short two-edged sword. His head was helmeted. He belonged, in fact—oh, at least twenty centuries back."

He laughed, in plain enjoyment of our amazement.

"Go on, Ruth," he said, and took up his watch.

"But Martin did not see his face," she took up her story. "And oh, but I wish I could forget it! It was as white as mine, and cruel, so cruel; the eyes glowed and they looked upon me like a—like a slave dealer. They shamed me—I wanted to hide myself.

"I cried out and Martin awakened. As he moved, the man stepped out of the light and was gone. I think he had not seen Martin; he had believed that I was alone.

"We put out the fire, and moved farther into the shadow of the trees. But I could

HOME-STUDY COURSES

THAT LEAD TO BUSINESS CAREERS

DO YOU WANT an important, high-salaried position? You can have one if you can do the work. LaSalle experts will show you how, guide you step by step to success and help solve your personal business problems thru the time-saving LaSalle Problem Method. Our salary-increasing plan enables you to prepare during your spare hours, without interference with your present duties. Simply mark on the coupon the field in which you desire success, and we will mail you a valuable book describing the opportunities in that field, together with an outline of our salary-increasing plan. Also copy of "Ten Years' Promotion in One." There is no cost or obligation. Find out how the salary-increasing plan starts average men and women on the high road to success and financial independence. Check and mail the coupon NOW.

— Find Yourself Thru LaSalle —
LA SALLE EXTENSION UNIVERSITY
 The World's Largest Business Training Institution
 Dept. 10384-R Chicago

I should be glad to learn about your salary-increasing plan as applied to my advancement in the business field checked below. Send also copy of "Ten Years' Promotion in One," all without obligation.

- Business Management
- Higher Accountancy
- Traffic Management
- Modern Salesmanship
- Railway Station Management
- Law—Degree of LL.B.
- Commercial Law
- Industrial Management
- Modern Foremanship
- Personnel Management
- Banking and Finance
- Modern Business Correspondence and Practice
- Expert Bookkeeping
- C. P. A. Coaching
- Business English
- Commercial Spanish
- Effective Speaking
- Stenotypy



Name

Present Position

Address

Insure your copy reaching you each month. Subscribe to SCIENCE and INVENTION—\$2.50 a year. Experimenter Pub. Co., 230-5th Ave., N. Y. C.



BUILD YOUR OWN GRANDFATHER'S CLOCK

We furnish instructions, plans and specifications, sell you the clock works as low as \$5.00 and up to \$250.00. Westminster and Whittington chimes that play every quarter hour and a wide variety of dials and movements. Improve your spare time by making good, sure profits. There is always a market for Grandfather Clocks.

Get our catalog of dials, works, prices and instructions.

American Chime Clock Company
 1679A Ruffner St. Philadelphia, Pa.

Mail This Coupon

American Chime Clock Co.,
 1679A Ruffner St.,
 Philadelphia, Pa.
 Gentlemen:—Please send me your fully illustrated catalogue and free instructions for building a Grandfather's Clock.

Name

Address

City..... State.....



Learn at Home to Make Clever SHOW CARDS

A profitable Business of Your Own for full or spare time. Earn \$25 or more a week in spare time. Double your full time pay. This practical method of home instruction has simplified everything.

Why work for low pay? Clever "sales-increasing" display material is always needed by progressive business enterprises of every description. \$10 to \$20 is often paid for a single attractive show card. Skilled Show Card Writers command high salaries—right from the start.

Prepare now. No special ability needed. Learn at home in spare time through this most complete, practical method. Student R. A. Hart writes: "I make not less than \$2.00 an hour making show cards in spare time." Ray Underwood (while still a student) wrote: "Am with a large sign company. People ask me to do work after regular hours and I clear \$25 to \$35 a day." Hundreds have learned Show Card Writing this quick easy way So Can You.

Take advantage of the money-making opportunities open in the Show Card field. Make Show Cards for your present employer or for several merchants at one time. Have a profitable business of your own. Earn up to \$100 a week—more if you're ambitious.

Send for FREE Book

Get busy. Boost your pay. Don't delay another hour. Send coupon now for big, Free Illustrated Book and full information. Mail coupon now. No obligation. No salesman will call.

Washington Show Card School, Dept. 2610-E
1117-15th Street, N. W., Washington, D. C.

Washington Show Card School, Dept. 2610-E
1117-15th Street, N. W., Washington, D. C.

Please send me FREE and without obligation, a copy of the new 32-page book, "Quick Success in Show Card Making."

Name
(Write name plainly and state whether Mr., Mrs., or Miss)
Address
City State
Age

5 TUBE RADIO
ONLY \$19.98

It's a wonder for power and selectivity. Famous ARL circuit. Coast to coast reception! Finely built of selected, tested parts. Thousands now in use. FREE Log and Call Book and New 132-p. Catalog with thousands of nationally advertised bargains. Latest in radio at big savings. Write for Free copy.

AMERICAN AUTO & RADIO MFG. CO.
HARRY SCHWARTZBERG, PRES.
Dept. 271 American Radio Bldg., Kansas City, Mo.

500 MAGIC BOOK 10c

Latest 1927 Edition—100 Pages Profusely Illustrated. Over 500 Tricks described and explained. Reduced Price Catalog of Magic—Illusions—Escapes—Jokes—Puzzles—Books and European Novelties Included. Amaze and Mystify your Friends—it's easy! Send 10c today. Lytle Douglas, Station A-3, Dallas, Texas.

not sleep—I sat hour after hour, my pistol in my hand," she patted the automatic in her belt, "my rifle close beside me. The hours went by—dreadfully! At last I dozed. When I awakened again it was dawn. Two men were looking down on me. One was he who had stood in the fire-light. Their faces were terrible—leering, wicked—"

"They were talking," interrupted Ventnor again, "in archaic Persian."

"Archaic Persian!" I repeated blankly. "Very much so," he nodded. "I've a fair knowledge of the modern tongue, and a rather unusual command of Arabic. The modern Persian, as you know, Louis, comes straight through from the speech of Xerxes, of Cyrus, of Darius whom Alexander of Macedonia conquered. It has been changed mainly by taking on a load of Arabic words. Well—there wasn't a trace of the Arabic in the tongue they were speaking. It sounded odd, of course—but I could understand them quite easily. They were talking about Ruth. To be explicit they were discussing her with exceeding frankness—"

"Martin!" she cried wrathfully.

"Well, all right," he went on, half repentantly. "As a matter of fact, I had seen the pair steal up. My rifle was under my hand. So I lay there, quietly listening. You can realize, Louis, that when I caught sight of those two, looking as though they had materialized from Darius's ghostly hordes, my scientific curiosity was aroused—prodigiously. So, in my interest, I passed over the burden of their speech. Not alone because I thought Ruth asleep and unhearing, but also because I took into consideration that the mode of polite expression changes with the centuries—and these gentlemen clearly belonged at least twenty centuries back. Oh, well, the real truth is, of course, that I was consumed with curiosity."

"They had got to a point where they were detailing with what pleasure a certain mysterious person whom they seemed to regard with much fear and respect would contemplate Ruth. I was wondering how long my desire to observe—for to the anthropologist they were most fascinating, Louis—could hold my hand back from my rifle, when Ruth awakened.

"She jumped up like a little fury, and fired a pistol point blank at them. Their amazement was—well—ludicrous. I know it seems incredible, but they seemed to know nothing of firearms—they certainly acted as though they didn't. They simply flew into the timber. I took a pot shot at one, but I missed. Ruth hadn't, though; she had winged her man; he left a red trail behind him. We didn't follow the trail. We made for the opposite direction—and as fast as possible.

"Nothing more happened that day or night. Next morning, creeping up a slope, we caught sight of a suspicious glitter a mile or two away in the direction we were going. We found shelter in a small ravine. In a little while, over the hill and half a mile away from us, came about two hundred of these fellows marching along.

"And they were indeed Darius's men! Men of that Persia which has been dead for so many centuries. There was no mistaking them, with their high, covered shields, their great bows, their javelins and armor. Two hundred of those fellows out of the past—think of it.

"They passed; we doubled. We built no fires that night—and we ought to have turned the pony loose, but we didn't. It carried my instruments, and ammunition, and I felt we were going to need the latter. The next morning we caught sight of another band—or the same one, I don't know. We doubled again. We stole through a tree-covered plain. We struck another ancient road. It led south, into the peaks again. We followed it. It brought us here.

Thrifty Travelers

invariably select the Hotel Martinique as their headquarters in

New York

There are good reasons for it. This popular hotel offers to every guest the

Comfort

of home—splendid food at reasonable prices and "the best without extravagance" in every form of perfect hotel service. It will be our

Pleasure

as well as yours to welcome you and prove that you can live right at the right price while in New York.

A. E. SINGLETON, Res. Mgr.

"The BEST without extravagance"

Hotel Martinique

Affiliated with Hotel McAlpin

Broadway — 32nd to 33rd Streets
New York

Electrical Engineering

Course for men of ambition and limited time. Over 5000 men trained. Condensed course in Theoretical and Practical Electrical Engineering including the closely related subjects of Mathematics and Mechanical Drawing. Students construct motors, install wiring, test electrical machinery. Course designed to be completed in one college year.

BLISS ELECTRICAL SCHOOL

Prepare for your profession in the most interesting city in the world. Catalog on request. 150 Takoma Ave., Washington, D.C.

LEARN TO ENTERTAIN WITH

Master Magic

The World's Largest Manufacturers OF TRICKS AND PUZZLES.

Send 10cents for new illustrated catalogue. HUNDREDS OF TRICKS YOU CAN DO.

Dept. A "SHERMS" BRIDGEPORT, CONN.

"It isn't, as you observe, the most comfortable of places. We tried to make it across the hollow to the crevice—we knew nothing of the entrance you came through. The hollow was not pleasant, either. It was penetrable then, however.

"We crossed. But as we were about to enter the cleft there issued out of it a most unusual and disconcerting chorus of sounds—wailings, crashings, splinterings."

I started, and shot a look at Drake.

"So unusual, so—well, disconcerting is the best word I can think of, were those noises, that we were not encouraged to proceed. Also, the peculiar unpleasantness of the hollow was increasing rapidly. We made the best time we could back to the fortress. And when next we tried to go through the hollow, to search for another outlet—we couldn't. You know why," he ended abruptly.

"But men in armor. Men speaking ancient Persian. Men like those of Darius," Drake exclaimed. "It—it's incredible!"

"Yes," agreed Ventnor, "isn't it? Yet there they were. Of course I don't maintain that they were relics of Darius's armies. They might have been of Xerxes before him—or of Artaxerxes after him. But, there they certainly were—living, breathing replicas of exceedingly ancient Persians.

"Why, they might have been the wall carvings on the tomb of the Khosroes come to life. I mention Darius because he fits in with the most plausible hypothesis. When Alexander the Great smashed his empire, he did it rather thoroughly. There wasn't much sympathy for the vanquished in those days. And it's entirely conceivable that a city or two in Alexander's way might have gathered up a fleeing regiment or so for protection, and have decided not to wait for him. To hunt for cover. Naturally they would have gone into the almost inaccessible heart of the high ranges. There is nothing impossible in the theory that they found shelter at last up here. As long as history runs this has been a well-high unknown land. Penetrating some mountain-guarded, easily defended valley they might have decided to settle down for a time, to build a city, have raised a government: lie low. In a sentence, wait for the storm to blow over.

"Why did they stay? Well, they might have found the new life more pleasant than the old. They might have been locked in their valley by some accident—landslides, rockfalls sealing up the entrance. There are a dozen reasonable possibilities."

"But those who hunted you weren't locked in," objected Drake.

"No," Ventnor shrugged his shoulders. "No, they certainly weren't. Maybe we drifted into their preserves by a way they don't know. Maybe they've found another way out. I'm sure I don't know. But I do know what we saw."

"The noises, Martin," I said, for his description of them had been the description of those we had heard in the valley of the poppies. "Have you heard them since?"

"Yes," he answered, curtly.

"And you think those—those soldiers you saw are still hunting for you?"

"Haven't a doubt of it," he replied. "They didn't look like chaps who would give a hunt up easily—at least not a hunt for such novel, interesting, and therefore desirable and delectable game as we, or at least one of us, appeared to them."

"Martin," I said decisively, "where's your pony? We'll try the hollow again. At once. There's Ruth—and we'd never be able to hold back such numbers as you've described."

(Second Serial Rights)

Don't miss next installment of
"THE METAL EMPEROR"



BIG PROFITS

in your own business
No Competition!

Be an exclusive Nestler operator and make money. Modern scientific Nestler Process makes old tires as good

as new. Saves car owners ONE-HALF their tire bills. Big demand for Nestler service everywhere.

Some men spend their lives working for others. They start and quit work when the whistle blows. Their biggest ambition is to "get a raise."

Other men know the thrill of being their own boss. The profits they make belong to themselves, not to an employer. Their hours are their own. There are no dull moments in their days. They enjoy life to the full!

This is the type of man who becomes a Nestler operator. He owns his own business, and he makes money because he furnishes a valuable service to automobile owners that *nobody else* in his locality can offer.

What the Nestler Rubber Fusing Process Is

The Nestler Rubber Fusing Process is the only modern, scientific method of repairing and retreading automobile tires. A Nestlerized tire will give as much mile-

age as a new one, at ONE-HALF the cost to the owner, and at a substantial profit to the Nestler operator. There are hundreds of busy, money-making Nestler stations all over the world, with *no competition*, because the Nestler Process is fully protected by patents, and each Nestler operator has his own exclusive territory.

Previous Tire or Garage Experience Not Required

Any red-blooded man with a very little capital can become a successful Nestler operator. Nestler Rubber Fusing equipment is built for life-time service, and the Nestler Manual, given free to every operator, makes every step in retreading tires and repairing blowouts as simple as A-B-C. Many men have started Nestlerizing tires in a garage or basement in their spare time, and have launched into a full-time business of their own after they could see big profits waiting to be picked up.

Send for an Amazing Book "The Nestler Plan"—It's FREE

How tires are Nestlerized—what Nestler equipment consists of—how the Nestler method will make money for YOU—everything you want to know about Nestler Tire Servicing as a full-time or spare-time business is fully explained and illustrated with photographs in a vitally interesting book, "The Nestler Plan." Send coupon below for a Free Copy TODAY. And if you are in New York City, call at Nestler headquarters and ask for a free demonstration of the Nestler Process.

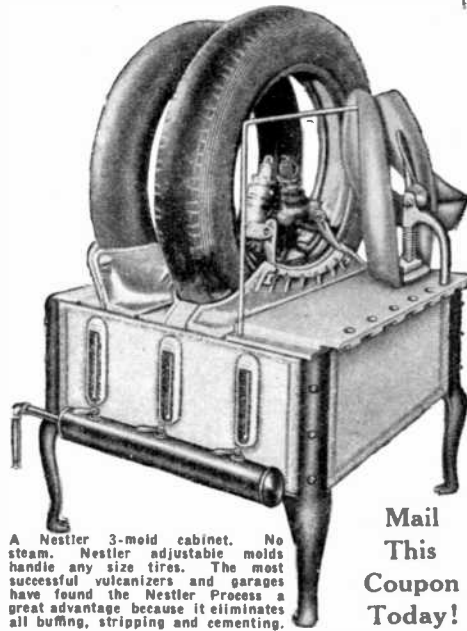

A Nestler 3-mold cabinet. No steam. Nestler adjustable molds handle any size tires. The most successful vulcanizers and garages have found the Nestler Process a great advantage because it eliminates all buffing, stripping and cementing.

Mail This Coupon Today!

Nestler Rubber Fusing Co., Inc., Dept. 20
245 West 55th Street, New York, N. Y.

Without obligation on my part, send me your book, "The Nestler Plan."

Name
Address

CHEMISTS



Our new catalog listing 5000 Chemicals, 2500 illustrations, Laboratory Apparatus and 1000 books, sent on receipt of 50c.

Laboratory Materials Company
635 East 71st St., Chicago, U.S.A.

MAKES A COMPLETE MACHINE SHOP

EVERY-USE Electric Motor Attachment
Fastens on shaft of small motor in a jiffy.
Holds attachments for Grinding, Polishing,
Sawing, Drilling, etc. MADE TO FIT 3/8-
inch, 1/2-inch and 3/4-inch shafts.



Write Us YOUR Requirements.
UNITED ELECTRIC MOTOR CO.
178-F Centre Street, New York

ONLY \$3.95

FLY THE METEORPLANE



Build this plane and learn by practical experience to construct and operate aircraft. Use your motorcycle engine or the IRWIN 20 hp. motor. Parts furnished very reasonable to build this little "Meteorplane," the World's first light plane. Send \$3.50 for complete set of blue prints and parts price list of this latest Model.

IRWIN AIRCRAFT COMPANY, Sacramento, California

MEN WANTED TO LEARN Motion Picture Projection

\$2,000 to \$4,000 a Year
Quickly learned. Short hours, big pay. Best equipped school in Michigan. Projectionists for Movie Houses and Road Shows.

MOVIE OPERATORS SCHOOL
61 Sproat Street, Dept. 4, DETROIT, MICHIGAN

Insure your copy reaching you each month. Subscribe to Science and Invention—\$2.50 a year. Experimenter Publishing Co., 230 Fifth Avenue, N. Y. C.

TELEVISION

Picture Transmission—the Marvel of the Century

Newest and greatest authority, just published, gives History, facts and complete instruction to build a home television set

THE marvel of Radio Broadcasting, the transmission of the voice and music over the air is no longer the greatest achievement of this precocious 20th century.

We now have TELEVISION—the transmission of events over land wires or by radio. A tremendous step ahead of even Radio.

For many years experiments on television have been diligently made by many famous inventors and engineers. Step by step machines have been corrected, improved and simplified—until today—practical machines

are in constant operation, annihilating distances in picturing events to the eager public.

Here is the first and only book in print that gives you the complete story of television from earliest experiments to the present day machines.

The book is the most complete publication of its kind. It gives you *the history, the facts* and the full instructions on how to build, in your own home, an up-to-date model Television apparatus.

Like Radio in 1921

Television is ready for the world. Like Radio in 1921, it waits only for you experimenters to invent, develop and perfect the apparatus. You may be fortunate enough to develop an idea that will be worth many dollars—start now with a copy of this book.

Great Future for practical Experimenters

Television will be as popular as Radio. Even now the public is showing great interest in telephoto pictures from Europe and elsewhere. Get your apparatus together. You are in for many days of fascinating experiments that beat anything you've ever tried. 4 special chapters in this book deal exclusively with how to construct an experimental set.

**COPIES 50¢ EACH
AT ALL
NEWSSTANDS**

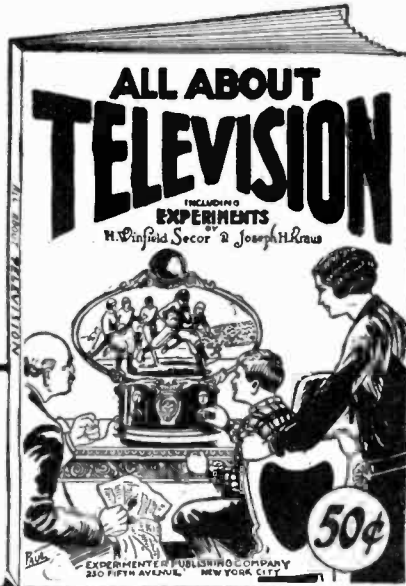

If Your Newsdealer Cannot Supply You - Order Direct
EXPERIMENTER PUBLISHING CO.
230 Fifth Ave., New York, N.Y.

1000 Hours of Fun with SAM LOYD

THERE are more than one thousand hours of truly amazing fun and frolic—in Sam Loyd's "Tricks and Puzzles." There is only one Sam Loyd, the Puzzle King, the incomparable, a true master mind, and he has crowded in this new volume, "Tricks and Puzzles," the best work of his lifetime.

In this book are thousands of puzzles of every conceivable nature, games, tricks, conundrums. Hundreds of illustrations. Scores of real brain-teasing puzzle stories, dozens of humorous anecdotes.

With this inexhaustible gold mine of lively entertainment at hand you need never be at loss for an evening's party program or a rainy day's delight.

It's a book for young and old folks alike—Riddles for the youngsters—Brain teasers for the grown-ups.

The kind of a book every home should have in its book-rack. 116 pages, 100 or more illustrations, large size, 9 x 12 inches with beautiful 2-color cover.

50c THE COPY EVERYWHERE

or you can order direct

EXPERIMENTER PUBLISHING CO., Inc.
230 Fifth Ave. New York, N. Y.

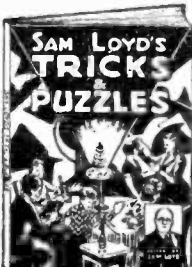

SECRETS of your HANDS

96 page Book on the revelation of character, fortune, etc.--in Hands

FINGERPRINTS are used throughout the world as a means of apprehending criminals—but fingerprints are but a small portion of the secrets of your character that your fingers, your palm, even your handshake reveals.

Every inch of your hand has been charted by the experts of this highly developed science, and so simply and accurately that anyone can learn the telltale signs by heart.

Here is a brand new book with all the latest information—written in such a way that you can quickly master "Palmistry."

Everything is simplified, easy to understand, the book contains 96 pages, hundreds of illustrations and is the large size 9x12 inches.

50c THE COPY EVERYWHERE

or you can order direct

EXPERIMENTER PUBLISHING CO., Inc.
230 Fifth Ave., New York, N. Y.

Building a Model of the U. S. Brig of War "Truxton"

By WILLIAM A. CROSBY
(Continued from page 512)

The guns should be made next. There will be six of these on each side and one gun port will be left blank with the cover down. The guns are made out of a short length of black, shiny spaghetti tubing, such as is used in radio sets to cover bus-bar wire, and are mounted on carriages made of the heavy malogany cardboard or of light wood. Each carriage consists of two pieces arranged in steps at one end. The gun is secured between these pieces by passing a pin through the whole thing and then gluing it from the underside so that it will not loosen up. The inboard end of the gun should have a black headed glass pin placed in it and glued, the diameter of the glass head being just a little smaller than that of the gun.

Each gun is equipped with little wheels made by gluing small black or white beads to the carriages, two on each side. When completed the guns are placed in the ports and glued down. The gun ports, 28, have covers made of the same material as the planking and each is hinged by means of a piece of paper and held open by a short length of the picture wire arranged to hook to the railing.

The bowsprit should be put into position now and the inboard end glued down to the deck. A pin may be run through it also to the stem and the whole securely glued and dried. This bowsprit may be cut from a piece of white pine or any other soft wood and a small plane will prove much better for the work than the usual jack knife arrangement.

Paper hooks should be arranged to go around this bowsprit about every half inch apart from the place where it comes outside the hull to the end. These bands are simply little, narrow strips about one sixteenth or less wide and are glued around to represent the iron hoops with which the bowsprit is strengthened. At the very end of this bowsprit will come the cap which is used to hold the jib-boom in place and before this is put on, a wire eye should be placed on each side of the bowsprit and one underneath just astern of where the cap will come. The cap will be about an eighth of an inch wide.

A short spar extends down toward the water directly underneath the bowsprit, 29. This is called the dolphin striker and the upper end of this may be arranged with a small wire hook which will connect with the wire eye on the underside of the bowsprit. Two more pieces, the same size and length will come out from the side eyes on the bowsprit, but outside of making preparations to take these now, they should not be put in place yet. The side pieces are known as the whiskers.

The jib-boom is secured to the bowsprit with a proper overlap and runs through the cap which may be made of the cardboard and glued to the end of the bowsprit. The jib-boom actually extends almost to the forward rail of the ship, so great is the overlap, 30. It may be glued and pinned in place.

The end of this will also have a cap but not as large as the other as it really is simply a band through which the next spar is thrust when it is used. This outer spar is known as the flying jib-boom and it overlaps the jib-boom almost all the way back to the bowsprit cap. The bowsprit and jib-boom are painted white and the flying jib-boom is painted a dark yellow, almost an orange.

By looking at the rigging plans you will see that there are two lines which run from

Be An Electrical Expert

Come to New York

See this wonderful city while learning a high pay profession,

ACTUAL EXPERIENCE



PRACTICAL LESSONS



Enjoy the Wonders of New York the modern Bagdad while learning Electricity

OUR GRADUATES IN DEMAND.

Graduates of the NEW YORK ELECTRICAL SCHOOL are in demand by all the big electrical companies. Or, if you prefer the independence of a business of your own, there are thousands of opportunities for efficient, dependable men to become electrical contractors. When you are your own boss the money you can make is limited only by your own energy and ability.

PERSONAL INSTRUCTION.

The NEW YORK ELECTRICAL SCHOOL is not a correspondence school. You learn by doing—by personal instruction on full size standard electrical equipment under the personal supervision of trained instructors.

At N. Y. E. S. you train your hands and mind at the same time. You learn the theories of electricity—and then you are shown how to put the theories into actual practice by solving the problems with your own hands.

The man who has learned electricity by actually doing electrical work under intelligent personal instructors can go to any part of the world and be sure of a good living. There are N. Y. E. S. graduates in all the countries of the world.

Write today for the 48-page booklet giving full information about the N. Y. E. S. Course and showing pictures of the equipment available for your personal use in our two seven-story buildings. IT IS ABSOLUTELY FREE TO YOU.

The NEW YORK ELECTRICAL SCHOOL
29 W. 17th St., New York

MAIL TODAY

The New York Electrical School
29 W. 17th Street, New York.

Please send me FREE your 48-page booklet. It is understood that this request puts me under no obligation.

Name

Address

Enjoy Powerful 6, 7 or 8 tube Radio: 30 Days FREE

FACTORY PRICES SAVE 1/2
Choice of fine cabinets offered

BIG NEW
Ultra Selective

BATTERY or All Electric

MIRACO Dial Sets

Delighted thousands report Miraco's get programs Coast to Coast, also Canada, Cuba, Mexico, with magnificent, clear cathedral tone. Built like latest \$200 sets—don't confuse with cheap "Squawky" radios. Unless 30 days' trial proves your Miraco the MOST SELECTIVE, RICHEST, FULLEST TONED and MOST POWERFUL DISTANCE GETTER among highest grade sets, don't buy it! Every

FREE! BEAUTIFULLY ILLUSTRATED CATALOG and AMAZING SPECIAL OFFER

30 DAYS FREE TRIAL

Only 49

RETAIL
for 7 Tube Model
COMPLETELY ASSEMBLED
(8 Tube \$69.75)

SPECIAL WHOLESALE PRICES
to user-agents who show the set to friends
MAIL THE COUPON

Miraco comes completely assembled, rigidly tested and fully guaranteed. 3 yr. guarantee. Operate your Miraco with batteries or FROM ELECTRIC HOUSE CURRENT—as you prefer. Choice of beautiful consoles (with built in orthophonic type speakers) or table cabinets insure complete satisfaction and save or make much money on sets, speakers, tubes, batteries or A. B. and C light socket power units—deal direct with one of America's oldest reliable makers of fine radios (8th successful year).

MIDWEST RADIO CORPORATION, Pioneer Builders of Sets
119 B. Miraco Bldg., Cincinnati, Ohio
WITHOUT OBLIGATION, send me free literature, AMAZING SPECIAL WHOLESALE PRICE OFFER, testimony of nearby users, etc.

NAME

ADDRESS

ALL METAL SHIELDED CHASSIS

Only 49



"I'm going to raise his salary"

"I've had my eye on him for some time and I know he can handle bigger work."

"He studies those I. C. S. textbooks every chance he gets, and I want to tell you it has made him a valuable man for this business."

"I'm going to raise his salary and give him that new job we were talking about. I wish we had more men like him."

How do you stand when your employer checks up his men for promotion? Does he pass you by as just a routine worker, or does he think of you as a man who is ambitious to get ahead? Won't you be far more likely to get the promotion if he knows you are studying at home and are really preparing yourself to handle bigger work?

Think it over. Then act. It takes only a moment to mark and mail the coupon and find what the International Correspondence Schools can do for you, yet that one simple little step may be the means of changing your whole life. "Do it now."

INTERNATIONAL CORRESPONDENCE SCHOOLS

"The Universal University"
Box 6203-E, Scranton, Penna.

Without cost or obligation, please send me a copy of your booklet, "Who Wins and Why," and full particulars about the course before which I have marked X:

BUSINESS TRAINING COURSES

- | | |
|--|---|
| <input type="checkbox"/> Business Management | <input type="checkbox"/> Salesmanship |
| <input type="checkbox"/> Industrial Management | <input type="checkbox"/> Advertising |
| <input type="checkbox"/> Personnel Organization | <input type="checkbox"/> Better Letters |
| <input type="checkbox"/> Traffic Management | <input type="checkbox"/> Show Card Lettering |
| <input type="checkbox"/> Business Law | <input type="checkbox"/> Stenography and Typing |
| <input type="checkbox"/> Banking and Finance | <input type="checkbox"/> English |
| <input type="checkbox"/> Management | <input type="checkbox"/> Civil Service |
| <input type="checkbox"/> Accountancy (Including C.P.A.) | <input type="checkbox"/> Railway Mail Clerk |
| <input type="checkbox"/> Cost Accounting | <input type="checkbox"/> Common School Subjects |
| <input type="checkbox"/> Bookkeeping | <input type="checkbox"/> High School Subjects |
| <input type="checkbox"/> Private Secretary | <input type="checkbox"/> Illustrating |
| <input type="checkbox"/> Spanish <input type="checkbox"/> French | <input type="checkbox"/> Cartooning |

TECHNICAL AND INDUSTRIAL COURSES

- | | |
|---|--|
| <input type="checkbox"/> Electrical Engineer | <input type="checkbox"/> Architect |
| <input type="checkbox"/> Electric Lighting | <input type="checkbox"/> Architect's Blueprints |
| <input type="checkbox"/> Mechanical Engineer | <input type="checkbox"/> Contractor and Builder |
| <input type="checkbox"/> Mechanical Draftsman | <input type="checkbox"/> Architectural Draftsman |
| <input type="checkbox"/> Machine Shop Practice | <input type="checkbox"/> Concrete Builder |
| <input type="checkbox"/> Railroad Positions | <input type="checkbox"/> Structural Engineer |
| <input type="checkbox"/> Gas Engine Operating | <input type="checkbox"/> Chemistry <input type="checkbox"/> Pharmacy |
| <input type="checkbox"/> Civil Engineer | <input type="checkbox"/> Automobile Work |
| <input type="checkbox"/> Surveying and Mapping | <input type="checkbox"/> Airplane Engines |
| <input type="checkbox"/> Metallurgy <input type="checkbox"/> Mining | <input type="checkbox"/> Agriculture and Poultry |
| <input type="checkbox"/> Steam Engineering <input type="checkbox"/> Radio | <input type="checkbox"/> Mathematics |

Name.....
Street Address.....
City.....State.....
Occupation.....
If you reside in Canada, send this coupon to the International Correspondence Schools Canadian, Limited, Montreal

LEARN RADIO

at home by our new and improved method. Be a RADIO SPECIALIST with PLEASANT WORK and BIG INCOME. Our course in—

RADIO CRAFTSMANSHIP

is COMPLETE, PRACTICAL, UP TO DATE. Write for free particulars and our INSTRUCTION PLUS SERVICE POLICY.

INTERSTATE RADIO SCHOOL

Roosevelt Blvd. Vineland, N. J.

Build Business with Air!

Only \$12 monthly for a few months brings the best business builder and advertisement your shop can have if you sell to the car owner. Tire Stores, Garages, Battery Shops, Filling Stations are making big money with the new low-priced IIB Automatic Air Compressor—priced \$75 to \$100 less than similar equipment on the market. Ask for bulletin AC6—Tells all about it.

HOBERT BROTHERS CO.
Box S1071 Troy, O.



the end of the flying jib-boom to the mast. One is at the extreme end and the other is in just a little. Another line comes from the end of the jib-boom and the next from the end of the bowsprit. The last one comes from well back on the bowsprit or almost exactly over the billet head. Notice that the first one nearest the bow of the ship is double and made of rather heavy material. The next one is single and also heavy while the third one is slightly lighter but also single. The two from the end of the flying jib-boom are light and single, of course.

Now the dolphin striker should be put into position. It is hooked through the little eye on the under side of the end of the bowsprit and a light chain, the very lightest that you can find, is run from the end of the jib-boom to the lower end of the dolphin striker. A short length of the same size chain is run from the dolphin striker back to each side of the hull just under the catheads. Little wire eyes are used to fasten the wire to the hull itself.

Another piece of the chain is run from the end of the jib-boom to a point on the dolphin striker just above where the other stay was placed. These should be placed in position tightly and if necessary strings may be used at first to hold the dolphin striker secure. When complete the proper angle for the dolphin striker is exactly perpendicular to the water line.

The whiskers should be hooked into position and light white linen thread run from the ends of the flying jib-boom to the outer end of each whisker and from there to an eye in the bow just forward and slightly above the one used for the chain eye just described. Of course the same thing is done to both sides of the model.

A second stay is run from the end of the jib-boom to a point just inside the place where the other line is secured to the dolphin striker. This is carried on through to the same eye on the hull.

In the actual ship there was a terrific strain on this entire arrangement and it was necessary to actually rig the bowsprit and its boom with a weight of some sort hanging from the outer end, to spring it down a little. The bowsprit, at the point just after it leaves the railing of the ship is bound securely with black thread to a slot which should be cut in the stem just below this point. This is known as gammoning and it played an important part in holding the bowsprit in its proper position. In later ships this was made quite often of chain instead of rope. The gammoning is shown in the drawings.

The lower masts should come next and they may be measured for length and cut accordingly, 31. Remember in all these spars that it is better to make things too light rather than too heavy for the lighter the spars, yards, etc. will make the model look much more realistic.

Articles in October "Radio News"

A Set for Each Member of the Family—By Armstrong Perry.

Further Notes on the Strobodine Receiver—By R. E. Lacault.

Low Loss—By E. H. Rietzke and S. K. Macdonald, Jr.

How to Build Radio Sets—By C. A. Randon.

The Magic Loud Speaker—By A. Binneweg, Jr.

The RADIO NEWS Special Short-Wave Broadcast Receiver—By Kendall Clough.

Experiments on Five Meters—By John L. Reinartz.

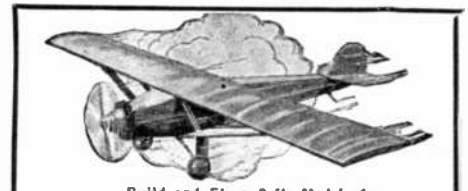

LINDBERGH'S NEW YORK-PARIS MONOPLANE

Build and Fly a 3-ft. Model of
LINDBERGH'S
NEW YORK-PARIS
MONOPLANE

Plans for Other Model Airplanes 25c per set
FOKKER North Pole Plane
CURTISS J N 4 D-2 Plane
DeHAVILLAND World Flyer
NC-4 Naval Seaplane
Bleriot, Nieuport or Taube Monoplanes
Cecil Peel Racer Plane
[All 9 plans for \$2.00]

This IDEAL New York-Paris Monoplane is a perfect copy, 3-ft. size, of the "Spirit of St. Louis," in which Lindbergh crossed the Atlantic Ocean. Any bright boy can build this model. The IDEAL Construction Outfit contains everything needed: all parts, fittings, materials and supplies, including careful instructions, plans and diagrams. The model is wonderful; has many features of the original and is guaranteed to fly. Complete Construction Outfit—\$7.50 (West of Denver, Colo., and in Canada, price is \$8.00)

Ask your dealer or order direct. Plans and Instructions Only (No materials included) Sent Postpaid for 25c. Ideal Aeroplane & Supply Co. 165-169 Spring St., N.Y.C.



Catalog of Model Airplanes, Parts, Supplies, etc. 5c post paid

New Lowest Prices on Standard TIRES

Size	Tires	Tubes
30x3	\$2.50	\$1.35
30x3 1/2	2.50	1.35
32x3 1/2	2.75	1.45
31x4	3.00	1.75
32x4	3.00	1.75
33x4	3.00	1.85
34x4	3.00	1.85
32x4 1/2	3.25	2.00
33x4 1/2	3.25	2.00
34x4 1/2	3.50	2.10
35x4 1/2	3.50	2.10
36x4 1/2	3.50	2.35
30x3	4.00	2.60
31x3	4.00	2.60
35x5	4.00	2.75
Slightly Used Balloons		
Size	Tires	Tubes
29x4.40	\$2.75	\$1.50
30x5.25	3.25	2.00
30x5.77	3.25	2.00
31x5.25	3.25	2.00
33x6.00	3.50	2.25
32x6.20	3.50	2.25

BIG REDUCTIONS on U. S., Goodrich, Good-year, Firestone, Flsk, Kelly and other tires only slightly used—due to owners changing to balloons. Thousands of satisfied customers report tremendous mileage. Send Only \$1.00 deposit for each tire wanted—balance C.O.D. State whether clincher or straight side. You run absolutely no risk in buying from us. If for any reason the tires are not satisfactory upon delivery, return them to us for refund.

ORDER NOW.

AMERICAN TIRE COMPANY
1329 So. Michigan Blvd., Dept. 863-N, Chicago, Ill.

RESHAPE YOUR NOSE

to beautiful proportions—while you sleep!

ANITA NOSE ADJUSTER is SAFE, painless, comfortable. Speedy, permanent results guaranteed. Doctors praise it. No metal to harm you. Small cost.

Gold Medal Won 1925 Write for FREE BOOKLET BEFORE-AFTER

ANITA CO., Dept. L-73 Anita Bldg., NEWARK, N. J.

DRAW CARTOONS

TURN YOUR TALENT INTO MONEY
Cartoonists earn from \$50 to \$150 per week—some even more. Remarkable new Circle System of Drawing teaches you in half the usual time. Send for booklet and sample lesson plate explaining full details of the Course. No salesman will call.

THE NATIONAL SCHOOL OF CARTOONING
628 Penton Building Cleveland, Ohio

MONEY AT HOME

in spare time by mail. Receive hundreds of letters with 25, 35 and 50 cents in every one. A clever, legitimate plan of business you can operate in spare time with a total cash capital of \$10. You can make more money evenings than you do all day addressing envelopes; every envelope you address will bring you 25, 35 or 50 cents. No special education required. If you want to step into a good paying business of your own send \$2 for complete instructions or addressed stamped envelope for further particulars. \$35 to \$50 a week easy working two or three hours every evening. Our instructions will show you every trick of the business.

METROPOLITAN NEWS BUREAU
BOX 1038 WASHINGTON, D. C.

Motor Hints

(Continued from page 504)

secured by stitching and tacking to the frame. This special shield is readily duplicated by the owner or in any shop where tops are made and repaired.

DETACHABLE WINDSHIELD FOR THE TONNEAU SEAT

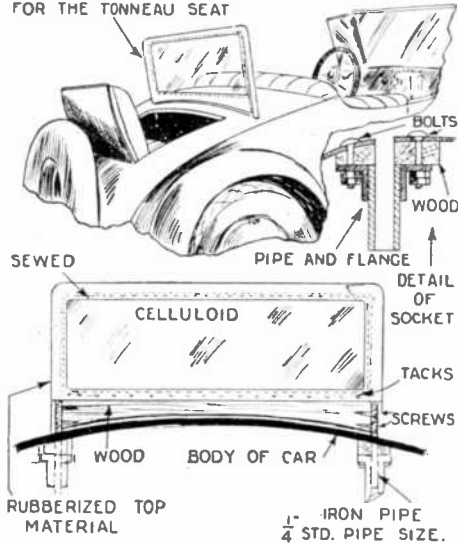

A detachable windshield affixed to the body of the car, as shown, makes tonneau seat riding more pleasant. The details of the shield are given above and may be duplicated with ease.

A BACKING LIGHT AIDS IN TURNING OR ENTERING GARAGE

Frequently drivers take unusual risks in backing a car at night, for turning on a road, in getting out of parking spaces or backing into the garage. These risks are frequently attended by getting down into a ditch, running into a fence post or jamming the car.

A backing light solves the needs in backing the car, and such a light is readily provided for, using one of the small portables, which are carried for tire and other repair work.

This portable can be mounted by one of several methods. A leather strap will fasten it to the bar of the rear bumper, a "Y" shaped brass spring holder can be made or

SMALL PORTABLE LIGHT

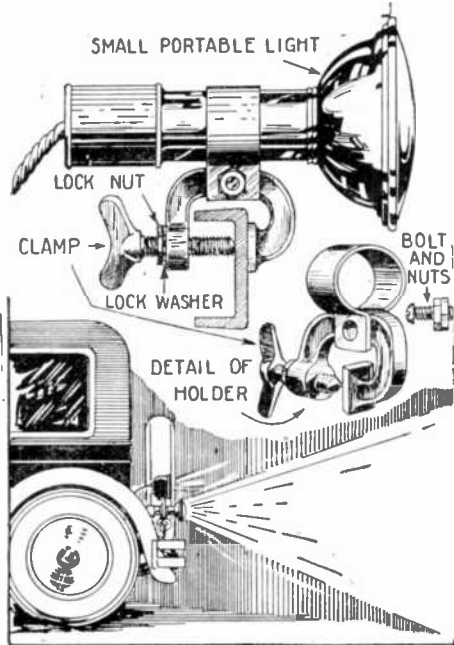

A backing light solves the needs in backing the car into the garage. A small portable light is fixed to the rear of the car with a clamp as shown in the above illustration.

O "ACE HIGH" WITH THE YOUNGER CROWD!

ORDINARILY, this modern generation scorns precedent. History is nevertheless repeating—in a way which we find interesting and gratifying. Something about Fatima—its greater delicacy, its more skillful blending of flavors—has made it, as in other days, an outstanding favorite with the younger set.

FATIMA

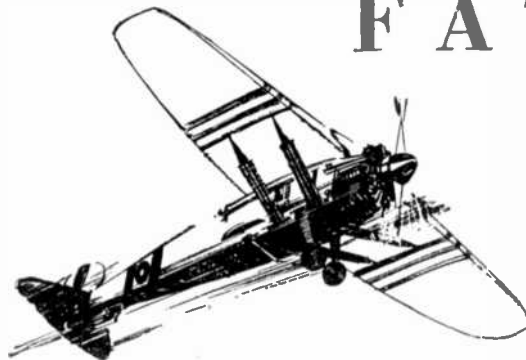

QUALITY that makes friends everywhere!

LIGGETT & MYERS TOBACCO CO.

TRAVEL FOR "UNCLE SAM"

Railway Postal Clerks

\$158 TO \$225 MONTH

Mail Coupon Before You Lose It

Franklin Institute, Dept. P185, Rochester, N. Y.

Sirs: Rush to me without charge 32-page book, "How to Get U. S. Government Jobs," with list of positions obtainable and full particulars telling how to get them.

Name:

Address:

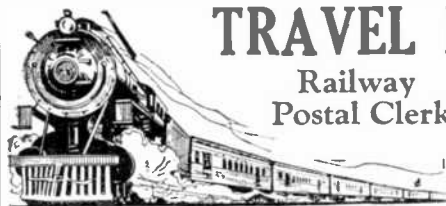

Steady Work—No Layoffs Paid Vacations

Travel—See Your Country
Common Education Sufficient
Men—Boys 18 Up

STOP WATCHES

Needed for Accurate Laboratory Timing. The "Pastor" is a guaranteed fifth-second time-piece. Unbreakable crystal. Price only \$7.50. Start, stop, flyback hand. Or a fifth-second Timer only, 30 minute register, 6 jewel. Price only \$11.25.

Write today to
Sterling Stop-Watch Co., M'n'f'r
15 East 26th St. New York, N. Y.

LIVE SALESMAN WANTED

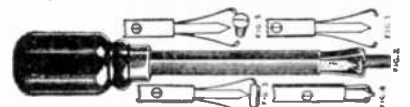

Sell Cox HoldFast Screw Drivers. Self holding. Self re-leas-ing. For Mechanics, Radio and Auto work. Proposi-tion and sample Auto size 50c; Radio, 75c.
S. J. Cox, Dept. J. Franklin, Pa.

Be My Candy Agent

Make big money. Sell chocolate bars, fruit drops, nut clusters, chewing gum and popular packages, 30 kinds. All fast sellers. I make the best. Season just starting. Free sample. Need agent at once. So answer this ad NOW.
Gordon Candy Co. 1416 Vine St. Cincinnati, O. Dept. 1431



Candy Floss Machines \$100 Dally, Parks and Fair's. 1 lb. sugar brings \$2. Elec. or hand, \$150. Catalog Free. Nat'l Candy Machine Co. 1638 E. 35th St., N.Y.C.



FRENCH HUMOR



120

FRENCH HUMOR

MODESTY



—C'est un homme bien peu recommandable, je l'ai souvent rencontré dans certains endroits où j'aurais rougi d'être vu moi-même.

"He's a man I wouldn't recommend very highly. I've often seen him where I would have blushed to be seen myself."

FRANCE sends its matchless wit and humor to every American Home

FRANCE, the magic land of humor, wit, and keen, knife-edged "parlay," now offers humor-loving Americans its choicest, finest humor through the new weekly magazine, "FRENCH HUMOR."

Americans (who have never been in France) invariably hold the opinion that anything French in humor or jokes must be smut with a Capital S. This is, of course, all tommyrot. The average far-famed Gallic wit is no more smutty than the average Chicago citizen is a Gun-man.

This new magazine will show America what makes the Frenchman laugh—also that humor is international. It will

foster a better understanding between Americans and Frenchmen as a whole. Illustrated jokes in "FRENCH HUMOR" are printed first in French—and then in the English translation—this will be of great interest and help to those who are studying or who have a smattering of this important world language.

All illustrations are by French artists.

The first copy of "FRENCH HUMOR" will prove what we say—it's the funniest, wittiest and most entertaining magazine you have ever read.

Copies are sold on all newsstands, large size magazines 9x12 inches, profusely illustrated with genuine French illustrations.

10¢ WEEKLY
ON ALL NEWSSTANDS

EXPERIMENTER PUB. CO., INC.
230 Fifth Ave. New York, N. Y.

Motor Hints

(Continued from page 555)

the method shown in the attached sketch of holding it with a small screw clamp can be used.

The light should have the clamp bolted on, by means of a piece of sheet brass, which permits of its being tilted up or down.

Clamp this holder to a tire bracket, frame member or other support on the left rear of the car, so that the driver has good illumination on his side.

This rear light cord can be rolled and a socket connection made from the tail light wire connection to the rear.

In addition to solving the backing problem, the rear light aids in reading the gas tank gauge and also in filling the tank, while the clamp added to the light makes it conveniently removable and attached at any place about the car for repair work.

PUNCTURE MENDER

A new invention, which has recently appeared on the market, should be welcomed with open arms by the automobilist. This

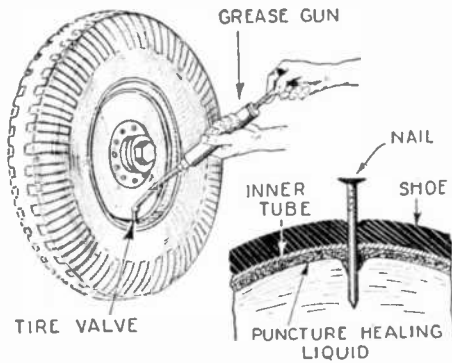

The method of injecting the puncture sealing fluid into the tire, is shown above. An ordinary grease gun is used to inject the liquid. The way in which this liquid heals punctures is also shown.—Illustration Courtesy Puncture-Nix Corp.

preparation not only stops leaks in tires, but heals them permanently. The ordinary tire will give many more miles of service if protected with this liquid. The tire valve is removed and the puncture healing fluid is injected with a grease gun. The tires do not have to be removed from the wheels, and the air pressure within them is not lessened when the puncture fluid is used. The puncture healing fluid banishes slow leaks, valve leaks, pore leaks, and ordinary punctures. Balloon tires, puncture easily, often because of their larger size. Thus, by using this preparation in balloon tires much trouble can be saved and danger of accident eliminated. The liquid will not freeze in winter or boil in summer. The fluid remains the same as long as the tube or tire lasts, and will not dry or become hard. It will not effect the working of the valve, as it seals from the inside only, and the air-pressure will force it away from the valve when the tire is being inflated. The tube can be vulcanized even though this liquid has been introduced within it. An ordinary Ford tire requires only 8 ounces of the fluid. The air pressure within the tire forces the liquid to the puncture and thoroughly and permanently stops up the hole. The tires on your car will last twice as long when treated with this preparation, and a big saving will be made in repair, expense, time and labor. The last unpleasant feature of motoring has now been banished, and science has now added another triumph to its long growing list.

NOW! Make Things At Home with The New **RED JACKET**

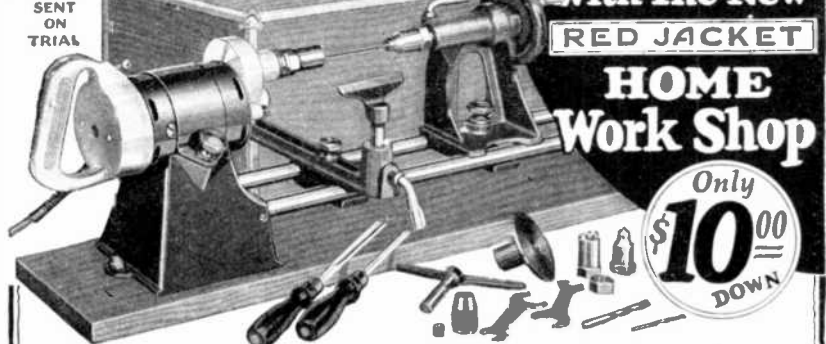

WACO CRAFTSMANS WONDER WORKING LATHE

CRAFTSMANSHIP is now accomplished without labor. Red Jacket electrically driven tools turn out work like magic. Here is a complete made to order workbench equipment of perfect, efficient and powerful craftsman's tools that are small and compact enough for portable use and so inexpensive that any man or boy may have one.

A chest full of tools designed by a master for the private use of tool lovers and men who want to build, construct, invent and create at home. You will be able to make everything— attractive odd furniture, toys, home and garden improvements, all around manufacturing, repairing.

The Complete Equipment consists of a powerful Red Jacket Motor, with direct drive to the Waco precision wood turning lathe (capacity 9 in. x 34 in.); a bench saw, that has depth and side gauges, scroll and jig saw; and all accessories for both portable and stationary power drilling, buffing, grinding and cleaning. Attaches to any light socket and converts your work bench into a complete private tool and machine shop.

THE WACO GUARANTEE — If It Is Not What You Want When You Get It — Send It Back

10 Days' Free Trial Our literature tells you how to start a job of your own. If you are not pleased return the Shop.

Special Crafts Course and blueprint service is free to Red Jacket Shop owners—all that there is to know about handicraft methods, raw materials, woods, carving, sawing, turning, designing, carpentering, decorating, is taught by special correspondence.

Buy On Your Own Terms Only \$10.00 down. Liberal discounts for cash. Easy monthly payment plans. It is no hardship to own a Red Jacket

MAIL THIS TO WACO

WACO TOOL WORKS
542-4 N. Parkside Ave., Chicago

Manager, Dept. 210. Please send me particulars about 10-day free trial, free blueprints, and \$10 down payment.

Name.....
Address.....

REG. U.S. PAT. OFFICE
F.P.M. Helps You Win CONTESTS! Cuts Wood & Iron

The F.P.M. saw cuts wood, iron and bakelite at any angle. Used and recommended by experts in every line. Unequaled for sturdy, lasting construction and fine workmanship. Blades of finest tempered steel. Get the F.P.M. Saw at any hardware store or order direct. Send for circular.

1 F.P.M. Saw and 7 Blades sent prepaid \$1.00
DEALERS Write for Discounts JOBBERS

F.P. MAXSON, 3722 N. Ashland Ave. Chicago

The Amalgamated Sixty
Only \$55.00 F. O. B. Chicago

FINEST SMALL ENGINE MADE

We also handle castings for other Engines, Bearings, Belting, Blue Prints, Books on Mechanical and Scientific Subjects, Brass Castings, Compressors, Gears, Lathes, Motors, Saws, Shafting, and Supplies of every kind for **MODEL MAKERS, MECHANICS and HANDY MEN.**

Complete Catalogue 25c., which is allowed on first \$2 order.

AMALGAMATED SALES & SERVICE CORPORATION
327K South LaSalle St., Chicago, Ill., U. S. A.

EARN \$10 to \$20 per day

The Best Pay Trades

Paperhanging - Decorating - Sign Painting - Show Card Writing - Graining & Marbeling - Auto Painting - Furniture Decorating.

Learn in a few weeks in the best equipped school in America.

CATALOG FREE

CHICAGO PAINTING SCHOOL
132 WEST AUSTIN AVE., CHICAGO, ILL.

BECOME A RAILWAY POSTAL CLERK

Pay has been raised from \$1900 to \$2700 a year. Steady job. Pleasant work. Common education sufficient. No "pull" necessary. Mail coupon for FREE Catalog.

A. R. PATTERSON, Civil Service Expert, Patterson School, Dept. 9010, Rochester, N. Y.

Slrs: Send me without charge your Catalog, describing this and other U. S. Government positions.

Name.....
Address.....

The whole
COUNTRY
is
praising
AMERICA'S
FIRST
RADIO
ENCYCLO-
PEDIA



\$2

A place in every
home, every library,
every laboratory

S. GERNSBACK'S RADIO ENCYCLOPEDIA is the only standard work ever published in America attempting to classify alphabetically the countless words used in the highly specialized science of RADIO. The ENCYCLOPEDIA is written in plain English so that everybody can understand the definitions and descriptions.

No expense has been spared, covering over two years in compilation, to make it worthy a place in your library.

It is published in one volume—168 pages—size 9x12 inches, nearly an inch thick and nicely accommodates the beautiful illustrations and the large, easy to read type.

Every page is replete with illustrations—to make the text easily understandable.

REMEMBER THIS IS A REAL ENCYCLOPEDIA—NOT A DICTIONARY.

The book contains as a supplement a classified cross-index designed to bring together radio references under one heading having relations in common.

All circuits new and old are described by word and picture.

The work contains 1,930 definitions, 549 photographs, drawings and diagrams.

SEND NO MONEY—Just forward your name and address. We will send you the Book at once. You pay postman \$2, plus postage on delivery.

Order Direct from
S. GERNSBACK
230 Fifth Ave., New York

NEW YORK, N. Y. . . . It is the best work of the kind we have ever seen and shows considerable painstaking and laborious effort.—*Telegram*.

NEW YORK, N. Y. . . . The volume amounts to practically a compact review of all that has been done in radio up to this date.—*Examiner*.

WASHINGTON, D. C. . . . It presents a complete classification of the latest authoritative data in radio.—*Evening Star*.

SAN FRANCISCO, CAL. . . . A book that will be of value to all that are interested in practical radio work.—*Examiner*.

PITTSBURGH, PA. . . . Many radio fans will be interested in the new Radio Encyclopedia by Sidney Gernsback.—*Sunday Post*.

PITTSBURGH, PA. . . . It would be of great engineering interest.—*Examiner*.

PITTSBURGH, PA. . . . It is a really good reference.—*Examiner*.

PITTSBURGH, PA. . . . It is a complete classification of the latest authoritative data in radio.—*Day Tribune*.

PITTSBURGH, PA. . . . Mr. Gernsback is author of other volumes on radio and his encyclopedia may be recommended as authoritative.—*Daily Press*.

CHICAGO, ILL. . . . S. Gernsback has aimed to provide not merely a dictionary of radio terms but an actual ready reference.—*Herald and Examiner*.

ST. LOUIS, MO. . . . S. Gernsback's new radio encyclopedia holds all needed facts.—*St. Louis Star*.

ST. LOUIS, MO. . . . book of radio information is S. Gernsback's radio encyclopedia.—*Globe Democrat*.

MACON, GA. . . . Gernsback's radio encyclopedia fills a demand that has been made by every radio fan as well as technical expert since the industry has started.—*Telegraph*.

DALLAS, TEXAS. . . . This encyclopedia is readily understandable to anyone who reads English and is thorough and readable.—*Sunday News*.

LOS ANGELES, CAL. . . . Its references cover every item of importance relative to the radio industry.—*Sunday Times*.

OTTAWA, CANADA. . . . It is an encyclopedia in the true sense of the meaning and not a mere dictionary.—*Journal*.

BUFFALO, N. Y. . . . Here is the world of radio, all in one volume, and it is one of the most comprehensive, enlightening and illuminating publications that has yet been issued.—*Courier-Express*.

BRIDGEPORT, CONN. . . . All radio terms are fully described in layman's style, and the explanation of the whys and wherefores of various circuits are also given.—*Herald*.

BOSTON, MASS. . . . A practical handbook with references covering every item of importance relating to radio.—*Globe*.

PHILADELPHIA, PA. . . . In his Encyclopedia Mr. Gernsback has succeeded in reducing high sounding electrical and technical terms to every day speech.—*Daily News*.

S. GERNSBACK 230 FIFTH AVE., N. Y.
Send me 1 copy of your Radio Encyclopedia. I will pay postman \$2 plus postage on delivery.
Name
Address
City
State

The 4-Tube "Cash Box" Set
By WENDELL BUCK
(Continued from page 525)

Plug the cable connector from the battery box into the terminal block on the back of the receiver. Connect the speaker. Turn on the A battery switch inside the receiver case.

Bringing in stations simply calls for the rotation of the two drum controls on the front of the receiver. Most of the time best results will be had by working the two drums at identically the same setting for a given station. The circuit is quite sharp, and it may take a few minutes to get the knack of tuning.

The better your aerial and ground the better the receiver will operate. While the "Cash Box" set will work with a short, makeshift antenna of thirty or forty feet, much better reception will be had with one eighty or a hundred feet long and with a really good ground to go with it.

LIST OF PARTS

- 2—Audio frequency transformers.
- 1—Output transformer.
- 1—Tuning unit, consisting of two .00035 mfd. variable condensers and 2 R.F. coils, mounted as a unit.
- 1—.005 mfd. fixed condenser.
- 1—.00025 mfd. grid condenser.
- 1—5 megohm grid leak.
- 4—Self-adjusting filament resistances.
- 1—Filament switch.
- 4—Cushion sockets.
- 1—Extension cord connector.
- 1—Multi-plug and cable, base mounting type.
- 1—Wood baseboard, 8½" × 12½".
- 2—Metal cash boxes, 13" × 9" × 6".

Names of manufacturers of parts recommended by SCIENCE & INVENTION for the construction of this receiver will be furnished free upon request.

TOOL LIST

- Pliers, several kinds.
- Screw drivers, several sizes.
- Hammer, hacksaw and blades.
- Hand drill.
- Twist drills, several sizes.
- Scriber.
- Center-punch.
- Soldering iron, electric or other type.
- Wire solder, self-fluxing or plain solder and non-corrosive flux.
- Rule, steel or wood.
- Center finder for dials.
- 1 three or four cornered reamer and handle for expanding panel holes for shafts, jacks, etc.
- Small tool and awl handle very useful.
- Volt and ammeters for testing set, batteries, etc.
- 1 countersink.

Underground Antenna
Reduces Static
By H. WINFIELD SECOR
(Continued from page 526)

covered, and in any case all lead sheathing on the wires must be connected to earth. This is the regular practice in broadcast station plants, all of the wires having lead sheaths and the sheaths in turn being grounded to earth, i. e., to a water pipe or to a piece of pipe driven several feet into moist earth.

To realize the highest efficiency when using an underground antenna for the reduction of static and interference, it is best

to use batteries for the supply of both A and B current, and to place these in a metal lined box which is grounded, as aforementioned. If a B eliminator, operated from the 110 lighting circuit is used, there is liable to be feedback of static noises through the eliminator, especially in country districts where elevated electric light feed wires branch off from a pole and thence proceed to the house. In the city where the electric light wires are all shielded and grounded and led into a building underground from conduits buried in the street, there is very little chance of a B eliminator fooling you in this respect. This considers that the electric wiring in the house is placed in conduit, properly grounded.

Figure 3 shows the arrangement of the batteries and grounded sheathed lead wires to the buried underground antenna. Where an old well is available, as is often the case in the country, the multiple spiral form of underground antenna may be adopted, the several spirals being wound on a wooden framework, and the whole dropped down into the water in the well. In any case it should be noted that the insulated copper wire inside the lead sheathing is not connected at the free end to the sheathing, but it is thoroughly insulated from the sheathing and the ground by tar or other suitable insulating material.

The diagram, Fig. 5 shows the use of two medium size underground aeriels, each say 50 to 75 ft. long, one of them acting as a counterpoise, or the equivalent of a ground connection. This arrangement is the one preferred by Dr. Rogers, who devised this method of radio reception. At Fig 6 is shown a scheme tried out at the Great Lakes Naval Training Station during the war. Here a number of insulated wires were submerged in the lake waters at the station mentioned, and as becomes evident, it was possible to make a number of valuable experiments by connecting the receiving set to the aeriels which pointed in the different directions. In one of these experiments the underground antenna was buried directly under the huge transmitting aerial of the station. Remarkable to relate, reception from distant points was carried on the underground antenna, while the transmitter rated at many kilowatts, hurled forth powerful signals on the overhead elevated aerial. These results are all a matter of official naval record, copies of which the writer had the pleasure of reading.

"Do you really mean to tell me that simply by burying a piece of sheathed insulated wire underground, that you can reduce static sixty to seventy per cent?" asks the man in the street. The answer is, yes, for the official naval records show it, the data having been accumulated at various government radio stations where the signal and static strength were measured by suitable instruments, and the tabulations accompanying the reports show that static is reduced.

As will be seen there is opened up a very interesting field of experiments once more after a lapse of ten years, and as mentioned at the start of this article, it is strange indeed how inventions very frequently are made quite a few years before they are really due, so far as the public is concerned.

Listening to the claims of some of the radio set manufacturers, particularly those turning out super-heterodynes, a few years ago, it seemed that all we had to do was to save our pennies, buy eight, ten or twelve tubes and the necessary transformers and condensers, build ourselves a nice big super-heterodyne, and thanks to its fine reception on a small coil of wire, known as a loop antenna, the static would be practically eliminated. We are much the wiser now, however, after having had super-heterodynes with us for several years, and we know that when there is plenty of static, the loud speaker is very quick to apprise us of the fact. There-



**Come Now to
the Nassau
at Long Beach L.I.**

Just 40 minutes from New York by train

THE BOARDWALK IS GLORIOUS
THE AIR IS LADEN WITH HEALTH
THE HOTEL IS A PLEASANT TREAT

**Sea Baths ♪ Music ♪ Dancing
Festive Week-Ends**

Room Plus Food ~ Only \$ 8⁰⁰ per Day

OPEN ALL YEAR
TELEPHONE - LONG BEACH-100
Henry H. Gerard ~ Managing Director

**WORLD'S FINEST
(3 FT. CONE) LOUD SPEAKER
"ENSCO" KITS—\$10.00**



The choice of leading engineers.
Write for booklet on how to make this in less than an hour.

ENGINEERS SERVICE COMPANY
25 Church St., Desk 10 :- New York



**LEARN CARTOONING
At Home—Simple Method**

Just think—\$50 to over \$250 a week paid to good cartoonists for work that's fun! And YOU can learn cartooning at home—no matter if you've never touched a drawing pencil. Send postcard for FREE Book describing our simplified method and Offer to New Students. WRITE NAME PLAINLY. State age and whether Mr., Mrs., or Miss. (No salesman will call.)

WASHINGTON SCHOOL OF CARTOONING,
Room 2610-E, 1113 15th St., N. W., Washington, D. C.

**TRAVEL FOR
"UNCLE SAM"
RAILWAY POSTAL CLERKS
MAIL CARRIERS**



\$1700 to \$2700 Year— See your country on government pay

Many other U. S. Government Jobs obtainable

MEN—BOYS, 17 UP SHOULD MAIL COUPON IMMEDIATELY

Steady Work No Layoffs Paid Vacations

COUPON →

Name.....
Address.....

FRANKLIN INSTITUTE
Dept. P180, Rochester, N. Y.
Sirs: Rush to me WITHOUT CHARGE FREE 32-page book with list of U. S. Government positions and full particulars telling how to get them.



\$150 to \$300 MONTHLY PROFIT—30 DAYS' TRIAL
Charges batteries in 1/3 the time required by others and get the business. BIG YEAR ROUND PROFITS. Best paying business in automobile field. Requires no special experience, uses small space. 30 DAYS' FREE TRIAL at our risk under absolute money back guarantee. Write today for Bulletin X, giving full particulars.

HOBART BROS. CO. Box 5107 TROY, OHIO





Big Salaries Paid Automobile Experts

Fastest growing industry in U. S. A. offers unusual opportunities to trained men

THE automobile industry is one of the biggest and fastest growing industries in the United States. There are more than 18,000,000 cars registered in this country and the number is increasing every day.

The best way to prepare for success in the automobile field is to study, and there is no better way to do this than through a home-study course with the International Correspondence Schools.

We say this because many of the leading figures in the automobile world today are former I. C. S. students. The list includes Jesse G. Vincent, Vice-president of the Packard Motor Car Co.; Walter P. Chrysler, President of the Chrysler Corporation; E. V. ("Eddie") Rickenbacker, of the Rickenbacker Motor Car Co.; and Hiram Walker, Chief Engineer of the Chandler Motor Car Co.

Just mark and mail the coupon and we'll send you information about the I. C. S. Automobile Courses or any other course in which you are interested.

Write for Free Booklet

INTERNATIONAL CORRESPONDENCE SCHOOLS "The Universal University"

Box 6201 E. Scranton, Penna.

Without cost or obligation on my part, please tell me how I can qualify for the position or in the subject before which I have marked an X:

- | | |
|--|--|
| <input type="checkbox"/> Complete Automobile Course | <input type="checkbox"/> Gas Engine Operating Course |
| <input type="checkbox"/> Automobile Electric Equipment | <input type="checkbox"/> Complete Gas Engine Course |
| <input type="checkbox"/> Electrical Engineering | <input type="checkbox"/> Architect |
| <input type="checkbox"/> Electric Lighting | <input type="checkbox"/> Architects' Blueprints |
| <input type="checkbox"/> Mechanical Engineer | <input type="checkbox"/> Contractor and Builder |
| <input type="checkbox"/> Mechanical Draftman | <input type="checkbox"/> Architectural Draftsman |
| <input type="checkbox"/> Machine Shop Practice | <input type="checkbox"/> Concrete Builder |
| <input type="checkbox"/> Railroad Positions | <input type="checkbox"/> Structural Engineer |
| <input type="checkbox"/> Civil Engineer | <input type="checkbox"/> Chemistry ☐ Pharmacy |
| <input type="checkbox"/> Surveying and Mapping | <input type="checkbox"/> Airplane Engines |
| <input type="checkbox"/> Metallurgy ☐ Mining | <input type="checkbox"/> Agriculture and Poultry |
| <input type="checkbox"/> Steam Engineering ☐ Radio | <input type="checkbox"/> Mathematics |

BUSINESS TRAINING COURSES

- | | |
|---|---|
| <input type="checkbox"/> Business Management | <input type="checkbox"/> Salesmanship |
| <input type="checkbox"/> Industrial Management | <input type="checkbox"/> Advertising |
| <input type="checkbox"/> Personnel Organization | <input type="checkbox"/> Better Letters |
| <input type="checkbox"/> Traffic Management | <input type="checkbox"/> Show Card Lettering |
| <input type="checkbox"/> Business Law | <input type="checkbox"/> Stenography and Typing |
| <input type="checkbox"/> Banking and Banking Law | <input type="checkbox"/> English |
| <input type="checkbox"/> Accountancy (Including C.P.A.) | <input type="checkbox"/> Civil Service |
| <input type="checkbox"/> Nicholson Cost Accounting | <input type="checkbox"/> Railway Mail Clerk |
| <input type="checkbox"/> Bookkeeping | <input type="checkbox"/> Common School Subjects |
| <input type="checkbox"/> Private Secretary | <input type="checkbox"/> High School Subjects |
| <input type="checkbox"/> Spanish ☐ French | <input type="checkbox"/> Illustrating |

Name
Street
Address
City State.....

Occupation
If you reside in Canada, send this coupon to the International Correspondence Schools Canadian, Limited, Montreal

DOUBLE Your PROFITS

Send for our catalog, just off the press, check-full with all the latest best sellers in Novelty Jewelry, Silverware, Cutlery, Leather Goods, Electrical Appliances, Useful Household Articles, Gifts, etc.



Sample Bargain Offer 4 Piece
FRENCH BRIAR PIPE SET
\$12.00 Dozen
Sample Outfit \$1.25 Plus Postage
Amberlite stems, plus lined box. Retail as high as the \$10.00 price stamped on box.

H. SHAPIRO, Dept. D26, 81 Brewery, New York, N. Y.

fore, the buried antenna seems to present one of the most interesting and valuable inventions in the realm of radio communication and broadcast reception; particularly in view of the fact that the major item in the expense of installing one of these buried antennas, lies in the removal of a few shovelfuls of dirt from a hole in our cellar, or yard, plus the really small cost of the sheathed aerial wire itself.

These sheathed static eliminator aerials come in several sizes. One of the main things to remember is that you must use a shielded set, in order to realize the marvelous results obtainable with a properly installed underground antenna; also that you must watch out and see that the lead wires, including those to ground and to the aerial are sheathed. See to it that the metal sheaths are made continuous, if more than one piece of wire has to be employed. In other words, if by some chance you have to piece out the lead-in wire or the ground wire, a regular soldered joint is made of the inner copper wire terminals; this joint is then taped up with rubber and friction tape, and then a piece of thin lead may be wrapped around the joint, so as to thoroughly join the two sections of sheathing at either side of the joint. Ground clamps, or their equivalent in the form of home-made circular strips of copper or brass, fitted with machine screws and nuts, will help to clamp up tight all such joints.

Does Coffee Poison the Heart?

By FREDERIC DAMRAU, M. D.

(Continued from page 498)

the abuse of coffee, say as much as eight or ten cups a day, does not really damage the heart. It may cause nervous irritability and sleeplessness; but the only apparent effect on the circulation is likely to be a more rapid heart beat. As soon as the individual stops drinking coffee to excess, the rate of heart beat comes down to normal.

Neurotic persons frequently complain of "palpitation of the heart." By palpitation is meant a rapid action associated with consciousness of the heart's beat. This disturbance is usually due to the nervous condition rather than the heart itself. The heart's action is largely regulated by nerves that pass to it from the brain, and whatever

Who should not drink coffee!

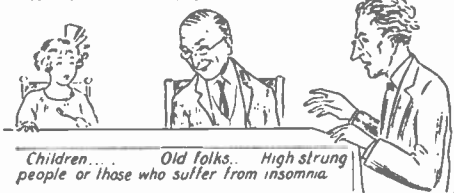

rôle coffee plays in causing "palpitation" comes from this source. Naturally persons with this trouble are likely to fare better without coffee.

PERSONS WHO SHOULD NOT DRINK COFFEE

The average person can drink three or four cups of coffee a day without suffering any ill effects. Of course, some individuals are more susceptible than others. I know a man who will lie awake half the night if he takes a demi-tasse for dinner, while another acquaintance can take three big cups at midnight and not lose a wink.

The time of day when coffee is taken is a matter of great importance. One or two cups for breakfast, an almost universal habit, give one the necessary impetus for a good day's work and enable many of us to keep our jobs. But the same amount of coffee in the evening would stimulate the brain to such an extent as to make sleep impossible.

How To Work Wonders With Your SUBCONSCIOUS MIND



Give me just 60 minutes and I'll unlock the floodgates of that vast reservoir of mental power—your Subconscious Mind. Note the immediate effect on your business, social and everyday life.

By DAVID V. BUSH

A VAST reservoir of mental energy! A huge storehouse of brain power! That's the Subconscious

Mind. You've got it. Your friends have it. Everyone has it. But not one in a thousand knows how to use it.

In 60 minutes I can show you exactly how to awaken your subconscious mind—how to harness it—how to make it work for you—how to make it solve problems—how to make it remember things—how to use its vast creative powers to boost your success and double your money-making ability. In my book, "Functions of the Subconscious Mind," I tell just what the Subconscious Mind is—just how to reach it—just how to control it—just how to get the most out of it. It's simple as A. B. C.

ONLY 50 CENTS

Write today for this amazing book of more than 100 pages, "Functions of the Subconscious Mind." Send only 50 cents in full payment. If you are not delighted, return the book within 5 days and your money will be instantly refunded.

DAVID V. BUSH, Publisher

225 N. Michigan Blvd., Dept. T-10910, Chicago, Ill.

Handifax

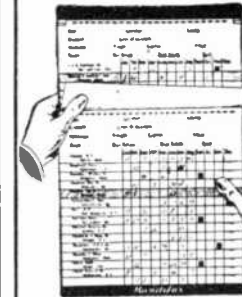

Sheets of Cards or Visible Records

Handifax—A wonderful invention—Helps business. Visualizes facts to executives. 50 Cards—sheets show 1000 cards. Visible space on each card 1/2 or 1 in. Easy to analyze.

Color signals "flag" your attention. Costs record-keeping costs 40%. Quick for use in reference or posting.

Good for all kinds of records. Any size—100—1,000—10,000—1,000,000. Your present system can be used. Very low cost—very compact.

Sales Agents Wanted

ROSS-GOULD CO.

404 N. 10th St., St. Louis, Mo.

Send for Free Samples

The Whole World is the Workshop of Professional Photographers

\$50. to \$250. a Week in Photography

FREE BOOK Tells How

You can quickly qualify for big-paying position in Motion Picture, Portrait, Commercial or News Photography or start your own business. No experience needed.

CAMERA FREE Learn at home or in our great New York Studios. Earn while learning. Write today for Free Book, job chart and Free Camera offer.

NEW YORK INSTITUTE OF PHOTOGRAPHY
Dept. 82 10 West 33rd St. New York

\$800% PROFIT In One Month!

Geo. Larson, McCarrie graduate writes: "We turned out \$1100 worth of work in April—a profit of about \$800 for two of us. This has been about the average since the first of the year." Learn Mechanical Dentistry and go as Larson did.

Free Book

We teach you in a few months of individual instruction to make plates, crowns, bridges, etc. for dentists. Day or night schools in Chicago, Philadelphia, Boston, Detroit, Cleveland. No books or classes—work your way thru school—we help you obtain employment. Write for interesting book on mechanical dentistry.

McCarrie School of Mechanical Dentistry
1338 S. Michigan Avenue Dept. 141 Chicago, Ill.



FRANK TRUMBAUER
Leader, Saxophone Soloist Jean Goldkette's Victor Recording Orchestra. Has probably done more recording than any other saxophonist, all on a Holton.

EVERY one of the 27 sockets on a Holton Saxophone is silver-brazed to the body—a hand operation requiring extreme care and skill. Just as a machine-made violin can never imitate a Stradivarius, so machine-made saxophones lack the perfect tune and rich resonance of a Holton.

Four other Holton superiorities described in "A Message from the Boss". Write for your copy.

FRANK HOLTON & COMPANY
326 Church St., Elkhorn, Wis.

Holton
America's Greatest
Band Instruments

6 TUBE RADIO
ONE DIAL Latest advanced circuit. All steel chassis totally shielded. Balanced parts of best quality. Marvelous power and selectivity. Gets the long range stations as clear as a bell. One dial single control. An unsurpassed value—just one of our many mighty bargains.

Only \$32.50

FREE Log and Call Book and Big New Catalog—just off the press. Full of Radio Bargains. Send for your free copy now!

American Auto & Radio Mfg. Co.
JERRY SCHWARTZBERG, Pres.
Dept. 272 American Radio Bldg., Kansas City, Mo.



EARN MORE MONEY

YOU HAVEN'T A CHANCE UNLESS YOU CAN READ BLUE PRINTS

You may be a first-class mechanic but if you can't read blue prints you haven't a chance for a good foreman's job. By my simple method I train you quickly. Learn how men of your ability have succeeded.

Send Today for Facts—State Trade
CARROLL L. RUMSEY
Dept. S-3 Drexel Bldg., Phila.

LEARN TO Mount Birds

We teach you At Home by Mail to mount Birds, Animals, Heads, Tax Furs and Make Rugs. Be a taxidermy artist. Easily, quickly learned by men, women and boys. Tremendously interesting and fascinating. Decorate home and den with beautiful art. Make Big Profits from Spare Time Selling Specimens and Mounting for Others.

Free Book—Yes absolutely Free—beautiful book telling all about how to learn taxidermy. Send Today. You will be delighted. Don't Delay!

Northwestern School of Taxidermy 3797 Elwood Bldg. OMAHA, NEB.

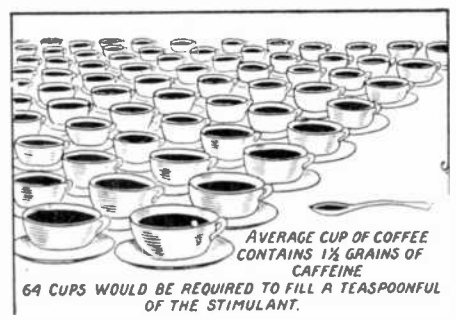
The time of day when coffee is taken is a matter of great importance. One or two cups for breakfast, an almost universal habit, give one the necessary impetus for a good day's work and enable many of us to keep our jobs. But the same amount of coffee in the evening might stimulate the brain to such an extent as to make sleep impossible.

There are three great classes of persons who are unquestionably benefited by abstinence from coffee; namely, children, old folk and individuals who are high-strung or suffer from insomnia.

Practically all physicians agree that coffee should not be given to children. Caffein is a brain stimulant, and certainly children are nervous and high-strung enough and do not need an additional push to the nervous system. Then, too, statistics have shown that children who are allowed coffee with their meals are, on the average, below the normal weight, height and strength. This condition is due not to any direct poisonous effects of caffein but to the peculiar cravings of appetite that it may produce in children.

Old people, in many cases, do not tolerate coffee well. It is only too likely to keep them awake nights and make them irritable during the daytime. If the bladder is unduly sensitive, as is often the case, coffee will probably aggravate the disturbance.

Many doctors are in the habit of forbidding coffee for their nervous patients. This is good counsel, as coffee stimulates the activity of the brain and thus interferes with the needed rest. But many people misunderstand the doctor, when he tells a nervous patient to keep away from coffee, and take his advice to mean that caffein is universally harmful.

The wakefulness produced by a cup of Mocha may last for a number of hours. Nothing is better to keep you awake during dull after-dinner speeches; but it may also ruin your sleep after you get to bed. Anyone who suffers from insomnia should limit the amount of his coffee to one or two cups a day and take these not later than the noonday meal.

COFFEE SAFE FOR MOST OF US

For the average healthy person who has no trouble with his sleep, the coffee percolator may serve a useful as well as ornamental purpose. Coffee has indeed proved one of the truest friends of mankind, helping the soldier in the field, the worker in the cold, and the thinker in the office. General experience as well as the technical knowledge of physicians combine to place the advertising writer's allegation that coffee poisons the heart and causes heart disease in the class of light fiction.

Radio Wrinkles Wanted!

The Radio Editor, Mr. Paul E. Welker, wants to hear from you, if you have a good idea or wrinkle. Make a pencil or pen and ink sketch of the contrivance, write 50 words or so of description, and mail to the Radio Editor, c/o this magazine.

if-
you pledge
yourself to secrecy we will
teach you the secrets of
Real Professional
Magic



Dr. Harlan Tarbell, internationally known magician and teacher of some of the world's greatest magicians.

Learn to be a Magician

For the first time in the history of Magic the age-old, sacredly guarded secrets of the Mystic Art are being revealed. Now at last you can learn to be a Real Professional Magician. Yes, and you can learn this wonderful art easily and quickly AT HOME. You are taught the mysterious Principles by which the Professional Magician works. You are taught everything from wonderful impromptu effects to massive stage illusions. But before you can study, you must sign the Magician's Solemn Pledge of Secrecy. This means that you are getting the guarded secrets of the Magic Profession. Think of that!

Earn \$250 to \$1000 a Month

There's a big demand for Magic entertainment. Magicians get big money. Dr. Tarbell gets as high as \$250 for a half hour's work. Unlimited opportunities for you!

Special Limited Offer

Write Today Quick Action is necessary for you to come in on this wonderful offer. The time is limited. Mail the coupon NOW!

Tarbell System, Inc., Studio 14-27
1920 Sunnyside Avenue, Chicago, Ill.

Gentlemen: Without any obligation send me your free literature and information all about your wonderful "Tarbell Course in Magic." Also tell me about your great Special Price Offer and Easy Payment Plan - offered NOW for limited time only

Name.....
Address.....
Age.....

Buy or BUILD with confidence and Insure Permanent Enjoyment of Your Radio Set!

USE
"THE DIRECTORY OF
STANDARD RADIO SETS"
for
buying

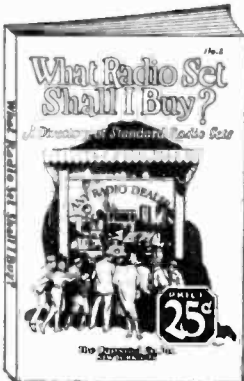

THERE is one easy—simple way to decide on what Radio Set to buy. If you are particular as to the style of the set, the power, the sensitivity, the price, or anything that has to

do with a manufactured set you will find a complete answer in the "DIRECTORY OF STANDARD RADIO SETS."

Photographs of all standard manufacturers are shown together with an exhaustive printed description furnished by the manufacturers themselves.

This book is absolutely impartial. It is the only printed book in existence that gives you this information.

40 pages of descriptions and illustrations, size 6 x 9 inches with handsome colored cover.

PRICE, 25c.

USE
"HOW TO TUNE YOUR
RADIO SET"

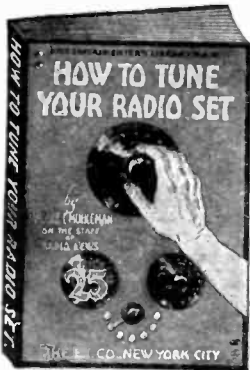

to
enjoy all
programs

RADIO Receivers know no rules of etiquette—they cannot be taught to act on best behavior when company and friends are judging them—but they can be made to act properly if the operator understands the few simple factors that effect tuning or the proper adjustment of the Receiver's controls.

Be one of those on the safe side. Don't be afraid to invite friends and show them that good tuning means good reception and enjoyable programs.

The 64-page, illustrated book on How to Tune Your Radio Set (Consrad—25c) is a carefully prepared, yet simplified, instruction book on tuning alone.

Receivers, of different types, individual characteristics are handled separately. All there is to know, all that must be known before one can really say to understand the tuning of a set—is given in this book.



only
\$1.00

buys an entire set of these four books of vital importance to every one owning or contemplating the purchase of a radio set.

They can be bought separately if desired at

25c each

Fill out the coupon below and mail it with your remittance today.

All orders filled promptly.

USE
"THE RADIO TROUBLE
FINDER"

to insure
permanent
satisfaction

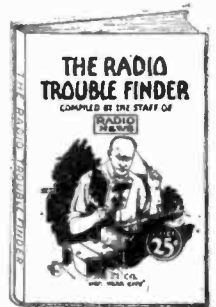

THE "RADIO TROUBLE FINDER" is a book prepared by a Radio Expert with many years of practical experience. It is a proven fact that 99 out of every 100 complaints from Radio set owners can be traced to simple and minor troubles that a child could repair with a simple book of instructions—and only once in a lifetime the average man need pay an expert to repair his set—if he has a copy of the "RADIO TROUBLE FINDER."

This simplified 64-page book charts all troubles and how to correct them.

It is the simplest thing imaginable to use it. Even the more difficult jobs of changing internal mechanism of the set can be accomplished successfully.

The "RADIO TROUBLE FINDER" contains 64 pages, many of which are illustrated. It is size 6 by 9 inches with a colored cover—PRICE 25c.

USE
"150 RADIO HOOKUPS"
for
BUILDING



THIS 68-page book of the Consrad Company is the latest compilation of Hookups in Radio. The Hookups are those that have been tried, tested and perfected by time and by thousands of Radio Listeners.

This priceless book contains: 18 Crystal Detector circuits, 39 Regenerative, 21 Reflex, 23 Radio Frequency, 10 Super-Regenerative, 10 Amplifier and Oscillator, 5 Super-Heterodyne and other valuable Hookups.

All circuits are shown by simplified drawings and each is explained in detail. The book is 6x9 inches in size, illustrated, and is contained in a special attractive 2-color cover.

PRICE 25c

CONSRAD CO., INC., 230 5th Ave., New York.
Gentlemen, I enclose \$..... for one copy of

- Directory of Standard Radio Sets.
- Radio Trouble Finder.
- How to Tune Your Radio Set.
- 150 Radio Hookups.

Name

Address

City, State

Will You Accept a 1927 ATLAS

Given to readers of this magazine who take advantage of this offer now made in connection with

Webster's New International

Dictionary The Merriam Webster
The "Supreme Authority"

A complete reference library in dictionary form, with 3000 pages and type matter equivalent to a 15-volume encyclopedia, all in a single volume, can now be yours on the following remarkably easy terms:

The entire work (with 1927 ATLAS) **Delivered for \$1.00**

and easy monthly payments thereafter [in United States and Canada]. You will probably prefer the beautiful India-Paper Edition which is

Reduced About One Half in thickness and weight

as compared with the Regular Edition Over 408,000 Vocabulary Terms and in addition, 12,000 Biographical Names, nearly 32,000 Geographical Subjects, 3000 pages, 6000 Illustrations. Constantly improved and kept up to date.

"To have this work in the home is like sending the whole family to college." "To have it in the office is to supply the answers to countless daily questions."

To Those Who Send This Coupon NOW!



G. & C. MERRIAM CO. Dept. S, Springfield, Mass.

Please send me free of all obligation or expense, complete information, including "125 Interesting Questions" with references to their answers, striking "Facsimile Color Plate" of the new bindings, specimen pages of India and Regular paper with terms of your Special Atlas offer on Webster's New International Dictionary to readers of Science and Invention. (10-27.)

Name

Address



RADIO WHOLESALE

Write for my Big 1928 Radio Catalog —just off the press. Thousands of marvelous bargains in nationally advertised goods. All the LATEST IN RADIOS and equipment. Lowest wholesale prices.

FREE

It's a regular encyclopedia on Radio. All about it! Includes: **FREE Log and Call Book and Catalog.** Get your copy today. Send postcard now! American Auto & Radio Mfg. Co. HARRY SCHWARTZBERG, PRES. Dept. 273 American Radio Bldg., Kansas City, Mo. 3

DEALERS NEW 1928 CATALOG Wanted.

WADE BENCH LATHE

Cap: 4" dia. x 12" length. Slidest has travel entire length of bed. Lead-screw inside bed. Hollow spindle. Turning, facing, boring, drilling, winding, thread-cutting. No. 1 Lathe, plain headstock \$28.00. No. 2 Lathe back-gear headstock \$58.00. Either lathe, 4"x18" \$7.00 extra. Complete line of accessories. Catalog sent free. The Gerold Co., Dept. S-25, 120 Liberty St., New York



10 BIG WEEKLY ISSUES 10

of The Pathfinder, America's liveliest, most unique, most entertaining weekly magazine. Full of wit, humor, information, news events, pictures, special features, best fiction. Once you read THE PATHFINDER you will never do without it. Send your name and 10 cents IMMEDIATELY! THE PATHFINDER, Dept. G271, WASHINGTON, D. C.

The Ionaco Swindle

By HUGO GERNSBACK

(Continued from page 491)

netic field. One might as well try to influence the iron in a bunch of spinach.

WILSHIRE'S RHAPSODY IN CATALYZERS

Of all the highfaluting nonsense, peruse the following copied verbatim from Wilshire's booklet, entitled "The Short Road to Health":

"However, not only does Ionaco act indirectly as a catalyzer through the iron but it also acts directly, for electro-magnetism is itself a catalyzer and induces metabolism. Nowhere may this be better seen than in the wonderful cures performed by sunlight, and light is but an electro-magnetic phenomenon.

"The magnetic flux from the Ionaco acts directly upon the electronic structure of the molecular iron in the system and seems to restore the proper catalytic action in pathologic conditions. The result is that normal oxidation takes place and this explains the marvellous therapeutic results from using the Ionaco."

Of course the above is all nonsense, and has no foundation in fact at all, for the reasons explained before. It may be said that with direct current (if the IONACO is used with direct current) no possible effect can be had at all. It is admitted, however, that with alternating current, there is an effect, but so slight that it is impossible to either observe it or to claim any curative effect for it. We know, of course, that certain currents having a frequency from 100,000 cycles per second to several million cycles per second can produce an effect upon a person through an intervening air gap as is exemplified in the auto-condensation couch, but there is quite a difference between a current with a frequency of 60 cycles and one with a frequency of 100,000 cycles. This difference is not apparent to the average layman, but is of vast importance to the electro-therapist. Some people might argue that it is a mere matter of frequency of the current and this could make little if any difference. To these we might answer that there is no difference between the current in your storage battery which operates the starter of your car and that current which runs the electrified railroad trains and will even electrocute an individual if he places one foot on the third rail, except the potential difference of from 500 to 1500 volts. The percentage of difference is considerably less here than it is in comparing the 60 cycle with the 100,000 cycle current.

Magnetism has been studied for well over a century, and the effects not only on the human body, but on practically every known substance, are well-known and have been thoroughly investigated. You may rest assured that if magnetism had any curative effect upon the human system, and would cure any human ailment, every doctor and every hospital would be using such a device. The reason that they do not use such is obvious, for magnetism in any known form has no curative effect whatsoever.

Appended herewith is a report, which alone is good authority that the IONACO is a fake plain and simple. The report makes excellent reading.

Report of the Seattle "Better Business Bureau" (Seattle, Washington).

Participants:
The Commissioner of Health of Seattle.
Secretary of Public Health League of Washington.
Secretary of the Washington Pharmacy Ass'n.

(Continued on page 565)

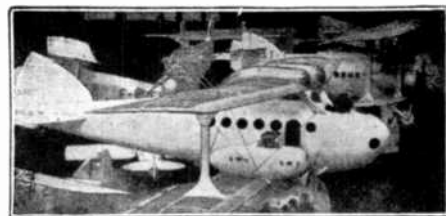

Aviation Brings Quick Success

TO young men of daring no other field of work offers such a fascination, such high pay, nor such opportunities for quick success as the field of Aviation. As yet, aviation is practically in its infancy. But now is the time to get in.

Amazing Opportunities in Airplane Industries

In the automobile industry and in the moving picture business hundreds of men got rich by getting in at the start. They made their success before others woke up. Today, these lines offer no greater opportunities than a hundred and one others. BUT AVIATION IS NEW. Get in while the opportunities are big. All over the country there will be a clamor for trained men. It will not be a question of pay but of getting capable men.

Become an Aviation Expert

The study of aviation is almost as fascinating as the actual work. Every lesson is full of interest. That is why it is easy to learn aviation. You do not have to make yourself study—it is like reading an interesting book that tells you things you have always wanted to know. Only one hour each evening will give you the basic training in a surprisingly short time.

One student, S. F. McNaughton, Chicago, says: "Your lessons are like a romance, and what is more, after one reading, the student gets a thorough understanding. One never tires of reading them." James Powers, Pa., another student, says, "I am indeed surprised that such a valuable course can be had from such practical men for so little cost."

PICK YOUR JOB!

- Airplane Instructor
- Airplane Engineer
- Airplane Repairman
- Airplane Assembler
- Airplane Mechanician
- Airplane Inspector
- Airplane Builder
- Airplane Salesman
- Exhibition Manager
- Airplane Contractor
- Airplane Motor Expert
- Airplane Designer

Personal Instruction

by Experienced Men
Men who have had actual experience give you personal attention. They select the lessons, lectures, blueprints and bulletins. They tell you things that are essential in everyday practice. Each lesson is easy to read and understand.

Get Big FREE Book—Now

Send coupon below for New Book, just out, Opportunities in the Airplane Industry. It is interesting and instructive. It will show you many things you never knew before about aviation. We have but a limited supply of these books—send the coupon before they are all gone.

American School of Aviation
3601 Michigan Ave., Dept. 1427,
Chicago, Ill.

American School of Aviation
3601 Michigan Ave., Dept. 1427,
Chicago, Ill.

Without any obligation, send me your Free Book, Opportunities in the Airplane Industry, also information about your course in Practical Aeronautics.

Name Age

Street

City State

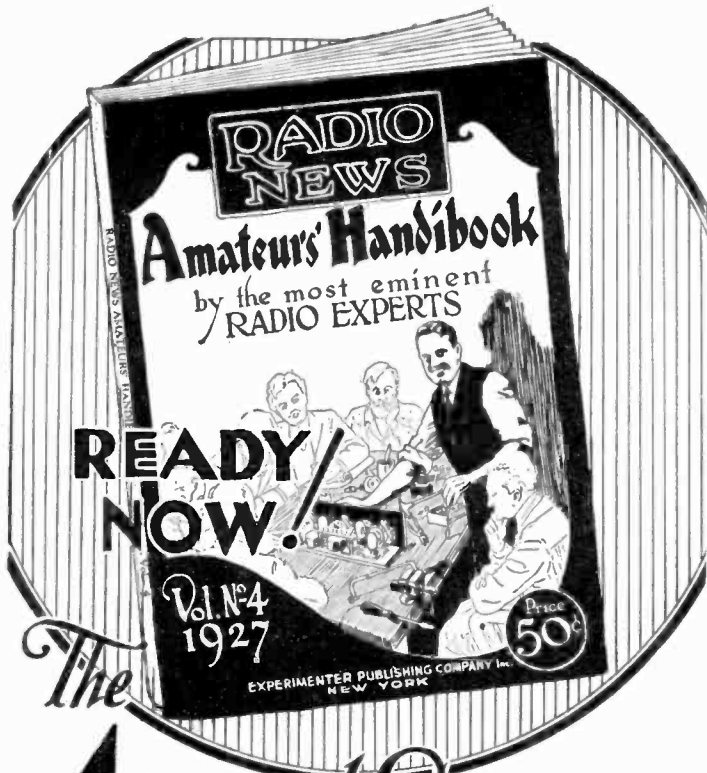

The Companion- of every RADIO SET



the first - and most important book - for every Radio Set owner or builder.

The **4th** and Greatest edition of



AMATEURS' HANDIBOOK

HERE is the greatest Radio Handibook ever published! Right up to date—a brand new edition of the very finest selected articles that have appeared in RADIO NEWS, Radio's Greatest Magazine, this year.

All new Radio—Plenty of latest model circuits with blueprint diagrams, ready for building. This is the most popular Radio Book ever printed. The past three editions were completely sold out.

—And you we offer the biggest and best edition of them all—116 pages of 1927 Radio complete with elaborate circuit diagrams and illustrations and parts. Size 9x12 inches.

Copies are going fast, get your order in now—or see any newsdealer. Only 50c.

50c ON ALL NEWSSTANDS

If your newsdealer cannot supply you write direct

EXPERIMENTER PUBLISHING CO., Inc.,
230 Fifth Ave. New York

Like a Tourist Guide—a Railroad Time Table—an Instruction Book—and a Construction Manual all in one—that is what the new "Fall Edition" of RADIO LISTENERS' GUIDE and CALL BOOK is to a Radio Listener.

It guides you in touring the Air—with its most complete, up-to-date and comprehensive list of Broadcast Stations the World over.

It gives you the power, the Wavelength and the Ownership of all stations.

It contains a number of pages devoted exclusively to hints and practical suggestions on keeping a set in good order.

—and it publishes a wide selection of the very latest and finest Radio Circuits with complete building instructions.

In this issue is complete information on the renowned "STROBODYNE," the amazing circuit from France.

176 pages in all. Hundreds of illustrations. Size 9 x 12 inches.

Get your copy today—Keep it by your set—You'll find it helpful every day of the week.

50c Everywhere

If your newsdealer cannot supply you
USE THIS COUPON

CONSRAD CO., Inc.,
230 Fifth Ave., New York.

Gentlemen: I enclose 50c for one copy of the fall edition of RADIO LISTENERS' GUIDE and CALL BOOK.

Name

Address

City-State

DIAMONDS

WATCHES JEWELRY CASH OR CREDIT



No. 833
\$27.50
\$1.00
a Wk.



No. 68
\$119
\$3.00
a Wk.



No. 12
\$69
\$1.75
a Wk.

Terms Pay 10% down — we ship at once. Balance weekly, semi-monthly or monthly, as convenient.

Free! Big Diamond Book — Write for It! Shows 2000 illustrations and descriptions of fine jewelry bargains.

Blue-White Diamond Rings of rare beauty and surpassing elegance at lowest market prices. We can give you more value for your money because we import diamonds direct from Europe and sell direct to you by mail.



Wedding No. 824—The Elite—15-K
Rings white gold
All Platinum, 18-K with 6 Diamonds,
\$501 6 Diamonds, \$1017 Diamonds, \$250
9 Diamonds, \$1000 circled
by Diamonds, \$2000.



Rectangular Watch
No. 16—
14-K white
gold, 15-J
\$14.85

17-Jewel Elgin No. 15—Green Gold, Elgin Watch 25-year quality case; 12 also gilt dial. \$20.95 down \$1.00 a week

LOFTIS

BROS. & CO. EST. 1888

Stores in Dept. E.-22 108 N. State St., The Old Reliable
Leading Cities Chicago, Illinois Original Credit Jewellers

The Ionaco Swindle

(Continued from page 563)

Technician from the Victor X-ray Corp. One Businessman.
An M.D. specializing in X-ray and radium. Dean of the College of Engineering of the University of Washington.
Another M.D. X-ray specialist.
A Construction Engineer, City Lighting Department of Seattle.
Made in Seattle, Washington, at the instance of the "Better Business Bureau" of Seattle, January 1927.

Report:

1. Apparatus. Simple solenoid producing with D. C. a weak stationary magnetic field and with A. C., a weak alternating magnetic field. The small coil is energized by the alternating magnetic field of the larger coil and is simply a spectacular means of demonstrating the presence of the alternating field in the larger coil.
2. The cost of materials in the entire apparatus is approximately \$5.75.
3. The large coil contains approximately 2,763 feet of wire instead of a mile as claimed by Mr. Wilshire. (The sample which we have contains approximately 3,411 feet.—Editor.)
4. The claim that such an apparatus works equally well on direct and alternating current is unwarranted. The electrical effects produced are entirely different, the direct current producing a weak stationary magnetic field and the alternating current producing a weak fluctuating magnetic field.
5. The iron in the blood is in a non-magnetic form and, therefore, cannot be influenced by any electro-magnetic field.
6. It is the opinion furthermore of the medical men on the committee that such a weak magnetic field as produced by this apparatus has no possible therapeutic effect on the human body.

In an article in the February, 1927, issue of *Hygeia*, Arthur J. Cramp, M.D., goes into the history of Gaylord Wilshire, and further quotes the findings of the Public Health League of Washington, when it co-operated with the Better Business Bureau of Seattle to investigate Ionaco. He published the following report on it, which is here excerpted:

" . . . The cost of the materials for making an Ionaco should not exceed \$5.00. As a cure for any physical ailment it is not worth 5 cents.

"The Ionaco advertising leads the public to believe that the device will cure practically all human—and some canine—ailments, and restore gray hair to its original color. Should the public be sufficiently inquisitive to ask how a simple coil of wire can accomplish such miraculous results, an explanation is at once forthcoming and, doubtless, the explanation, like a well-known brand of cigarettes, satisfies; the Ionaco cures by magnetizing the iron in the blood. Just that! Elemental, my dear Watson! The nontechnically trained public does not, of course, realize that one might with equal success try to magnetize the iron in a bunch of spinach.

"The chief advertising asset of the Ionaco, as in all quackery, is testimonials."

Commenting further on the testimonials with which Ionaco is replete, the article further states:

"In several pieces of advertising that have been put out by the Ionaco concern, it has been declared that Dr. Annie G. Lyle, family physician to Dr. David Starr Jordan, was trying out the Ionaco, and Dr. Lyle was quoted as follows:

"I want to say that I have fallen for the Ionaco strongly. It appeals to me because it brings the electro-magnetic force into the simplest, most effective and most convenient

The Biggest Failures Are Those Who Work Hardest

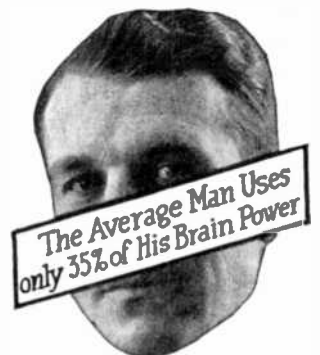

EVERYBODY knows the bookkeeper who works 10 or 12 hours a day, without ever getting anywhere. He begins life on a salary of \$15 a week and ends it in penury on a pension. He is not the only one. The harassed subdepartment head working after hours, the clerk, buried under a mass of detail, the merchant who stays "on watch" in his store from opening to closing time without achieving a margin of profit large enough to expand and grow on—they all end the same way.

Will You Be One Of Them?

Statistics show that over 54 per cent of all men are dependent at 60. Why? Men are nearly all ambitious; most of them are "hard workers." Yet they do not succeed! They simply never learn how to use their natural gifts!

You will never succeed merely by working hard. You can succeed only by developing your mind to its fullest capacity and by learning to use it efficiently. Science has shown that most men use only 35% of their brain power.

Pelmanism, the science of applied psychology, will teach you to put all your faculties in action. It will teach you to overcome mind wandering, forgetfulness, mental sluggishness, weak will-power, lack of personality. It will train you to concentrate, to be methodical, to remember the things you should remember—it will increase your power of perception, give you a more alert and disciplined mind, enable you to approach any ordinary task with a feeling of self-confidence and power.

Hundreds of Thousands Testify

We hesitate to say too much about Pelmanism. We prefer to understate rather than overstate. A horn fool will doubtless remain one, with Pelmanism or without it. If anyone's will-power is so weak and his regard for his future is so small that he will not give 20 to 30 minutes a day to self-development, Pelmanism cannot help him.

But an average man or woman cannot fail to benefit by it. And results will show within a few weeks. Thousands of Pelmanists testify that the course has helped them amazingly. They tell of the development of faculties whose existence they scarcely suspected, of incomes increased one hundred, two hundred, and as high as a thousand per cent. These testimonials are hard facts—proof positive of the value of these scientific secrets of the mind. Can you afford to miss your opportunity?

Free Booklet "Scientific Mind Training"

Resolve today to stop slaving and drudging. The successful men and women are those whose trained minds make work seem more like play. Make up your mind now to let Pelmanism help you as it has helped thousands all over the world. The principles of Pelmanism are for everybody, man, woman, or child.

Send the coupon below for the free 64-page booklet, "Scientific Mind Training," which describes the course in detail. This may be the great turning point in your life. If you can make up your mind to send this coupon you are the sort of person Pelmanism can help. The Pelman Institute of America, Suite 3210, 71 West 45th Street, New York City.

Approved as a correspondence school under the laws of the State of New York

The Pelman Institute of America
71 West 45th Street, Suite 3210
New York City.

I want you to show me what Pelmanism has actually done for over 600,000 people. Please send me your free book, "Scientific Mind Training." This places me under no obligation whatever.

Name

Address

City..... State.....

TYPEWRITER

PRICES CUT



Your choice of the World's best typewriters—Underwood, Remington, Lyster—full size, late model, completely rebuilt and refinished brand new. Prices slashed down to half. Act quick!

\$2 and it's yours Free Trial

Just send your name and address and we will mail you our complete FREE CATALOG, fully describing and showing actual photographs of each beautiful machine in full colors. Tell us every detail of our direct-to-you small-payment plan. Write now for tremendous savings. No obligation whatever. Still time if you act now.

International Typewriter Exchange
386-388 W. Lake Street. Department 1017 Chicago, Ill.

ACCESSORIES at WHOLESALE



Radio Sets, "B" Eliminators, Chargers, Tubes, Kits, Parts—everything now in Radio at lowest wholesale prices. Thousands of nationally advertised bargains. Catalogs and FREE Cash Book.

132 Pages of valuable Radio information—trouble finding, easy building—Radio knowledge of all kinds. Write today. HARRY SCHWARTZBERG FREE.

AMERICAN AUTO & RADIO MFG. CO.
Dept. 274 America Bldg.
Kansas City, Missouri



Wonderful, new device, guides your hand; corrects your writing in few days. Big improvement in three hours. No failures. Complete outline FREE. Write C. J. Oment, Dept. 44 St. Louis, Mo.

FOREST RANGERS

Men, get Forest Ranger job; \$125—\$200 mo. and home furnished; permanent; hunt, fish, trap. For details, write Norton, 2650 McMan Bldg., Denver, Colo

"BECOME A LIGHTNING TRICK CARTOONIST"



Send \$1.00 for Beginners Instructions with Laugh Producing Program of 23 Comic Trick drawings. Catalog of Chalk Talk Supplies Free

BALDA ART SERVICE, Dept. 4. Oshkosh, Wisconsin

SQUAB BOOK FREE



Breed squabs and make money. Sold by millions. Write at once for free 40-page book beautifully printed in colors telling how to do it. You will be surprised. PLYMOUTH ROCK SQUAB CO. 506 N St., Melrose Highlands, Mass.



Examine these five great books on electrical maintenance and repair for ten days free:

1. The five books in this library discuss actual repair jobs and show you step by step what to do when anything goes wrong.
2. They show you how to locate and remedy motor and generator troubles.
3. They show you how to reconnect motors to meet any condition of voltage, phase, frequency and speed.
4. They give you suggestions for preventing electrical machinery troubles.
5. They cover fully rewinding of motors.
6. They present information that will help you get better service out of electrical equipment.
7. They give you tables, data, kinks and diagrams that you will find of priceless value every day on every job.

See the books FREE
 Fill in and mail the coupon attached and we will send you the entire set of five volumes for 10 days' Free Examination. We take all the risk—pay all the charges. You assume no obligation—you pay nothing unless you decide to keep the books.

McGraw-Hill Book Co., Inc.,
 370 Seventh Ave.,
 New York City.
 Gentlemen: Send me the Library of Electrical Maintenance and Repair, all charges prepaid. If satisfactory I will send you \$2 in ten days and \$2 a month until \$14 has been paid. If not to my satisfaction I will write for shipping instructions.

Name.....
 Address.....
 Position.....
 Company.....
 81-10-27

form for use in treating disease. I am big enough to use anything advertised or not that may help my patients to get well.

"Dr. Lyle was written to and asked for the facts. She replied in part as follows:

"My name has been used in the advertisements entirely without my knowledge and without my consent. I do not know Mr. Wilshire. I never made any of the statements ascribed to me in the advertisements. It is evident that Mr. Wilshire's publicity man has drawn on his imagination for the facts."

"Mr. Wilshire has claimed that a Los Angeles physician has alleged that his (the physician's) daughter has been relieved of exophthalmic goiter by the Ionaco. The doctor was written to and replied that there was not the slightest justification for the claim. The advertising has stated that Dr. Arbuthnot of Los Angeles 'had a long standing case of wry neck instantly relieved' by the Ionaco. Dr. Arbuthnot was written to and agrees that she might just as well have used the left hind foot of a rabbit.

"Another case reported in December, 1925, by Wilshire himself was described as follows:

"We had another case reported this morning of Cancer. Mrs. Virginia Clements of Riverside, who is under the care of Dr. H. A. Atwood, M.D. This woman now reports after a month's treatment that the ulcerated surface is looking very much better, the pain is gone and there is no longer an offensive odour. She has also made a great improvement in her strength and general health."

"We wrote to the only H. A. Atwood, M.D. there is in Riverside, quoting the paragraph just given and asking him if there was any truth in the statement and asking, further, for the present condition of Mrs. Clements. Dr. Atwood replied that he knew nothing of the case!

"Testimonials are always good business getters. As evidence, of course, they are not worth the paper on which they are printed. Their value was well expressed by one of the attorneys-general for the postmaster-general—a man who, in the course of his work, had occasion to investigate thousands of medical testimonials published by concerns that were later declared frauds by the government. The attorney-general said:

"Speaking generally it may be said that in all my experience in this office never has a medical concern, no matter how fraudulent its methods or worthless its treatment, been unable to produce an almost unlimited number of these so-called testimonial letters."

The Seattle Record has published a series of articles warning its readers against the Ionaco quackery.

A Dr. Proctor has also come forward with a horse collar which, instead of treating eighty-four different diseases successfully, is more conservative in the list of diseases, only thirty-two of which are given in his pamphlet. The outfit is practically identical with Ionaco, except that its name differs, the latter instrument being called Circlestone. Several clippings, from the Ionaco News and advertisements illustrate this article.

Here is YOUR High School Education!

These twelve wonderful books prepare you quickly at home for bigger pay, broader culture, social and business success. Every high school subject taught by fascinating "Question and Answer" method—English, French, Spanish, Latin; Ancient, Modern and American History; Literature, Biology, Physics, Algebra and Economics.



GREATEST BARGAIN IN BRAIN POWER

Increase your earning power this easy way. Don't be held back by lack of education. Here is your chance to get your high school education in spare time at amazingly little cost. These books are used in thousands of little schools. Quality for Certificate.

SEND NO MONEY

Examine these twelve books FREE. No money in advance, pay nothing on delivery. Keep the books 5 days. Then decide. Return them if you choose. Otherwise send \$3.85 first payment and \$1.00 monthly for 3 months—total only \$15.85 (10% discount for cash, making price only \$14.27). Send name and address NOW.

High School Home Study Bureau, Dept. 2410
 31 Union Square New York, N. Y.

Electricity!
 Learn in Los Angeles

Be an electrical specialist. Gain quick success in this most fascinating and profitable field. Learn at National in the center of tremendous electrical projects costing more than \$100,000,000.00—unlimited opportunities now.

Practical, intensive training by National's job-experience method in 6 to 9 months. All technical essentials included. School endorsed by leaders in electrical industry. You learn all branches of electricity, including radio. Million dollar institution; all modern equipment and training facilities. Life scholarship. No age limit. Free employment service. Earn living expenses while training. Over 17,000 successful graduates. 23rd year. Big, illustrated 84-page catalog sent FREE. Write today.

NATIONAL ELECTRICAL SCHOOL
 Dept. 286, 4006 So. Figueroa, LOS ANGELES, CALIF.

Sousa
 SAYS "get into music."
 The great bandmaster advises young people to cultivate the musical "bump" in school band and orchestra. For his own band, Sousa chooses Conn instruments as the finest in tone, easiest to blow. You will profit by his example.

FREE TRIAL, Easy Payments on any Conn for the band or orchestra. Send for free literature and details. C. G. Conn, Ltd., 1056 Conn Bldg. Elkhart, Ind.

CONN BAND INSTRUMENTS

ZIP-ZIP SHOOTER
 CAMPER and TOURIST:
 Here is the very thing for you. Campers tell us that this is the greatest weapon to be had where firearms are prohibited. Zip-Zip Shooter is noiseless, powerful and effective and is used by a great number of tourists and campers. Thousands of boys are made happy with this wonderful Zip-Zip Shooter. If your dealer happens not to have them order from us. Zip-Zip Shooter, 35c or three for \$1.00

AUTOMATIC RUBBER CO., Dept. BB, Columbia, S. C.

Insure your copy reaching you each month. Subscribe to Science and Invention—\$2.50 a year. Experimenter Publishing Co., 230 Fifth Ave., N. Y.

PLUMBING & HEATING CATALOG FREE

Buy direct and save 50% on Plumbing and Heating Supplies of the highest quality. Send for OUR FREE CATALOG showing net plumber's prices on Bathroom Outfits, Kitchen Sinks, Laundry Tubs, Lavatories, Toilet Outfits, Bathtubs, Boilers, Heaters, Pipe and fittings, Paint, Tools, etc. Install them yourself. Money Back Guarantee with every purchase. (Members Phila. Chamber of Commerce)

PENN MDSE CO. 3RD & MARKET STS. PHILADELPHIA, PA.

\$10.75, \$16.50, \$25.00

MAIL COUPON

PENN MDSE CO., INC.
 3RD & MARKET STS., PHILA., PA.

Without obligating me in any way, please send me your free book showing net low prices for plumbing supplies.

Name.....
 Street.....
 State.....

Add Colorful Charm to Your Home with

UNDECORATED Grey Iron Castings

Easily colored with oil paints. Liquid sealing wax, bronze or lacquer. Book Ends, Door Stops, Candlesticks, Anilrons—nearly 200 designs in all. Our FREE Catalog, beautifully illustrated in colors, shows the rich decorative effects possible at small expense. Write for it today.

ALBANY FOUNDRY CO., Albany, N. Y.

Exposés of Scientific Swindles appear often in SCIENCE AND INVENTION

If you know of some hokus-pocus scheme being used to swindle the public—write the Editor about it.

Thousands Use These Ingenious TRANSMITTER UNITS

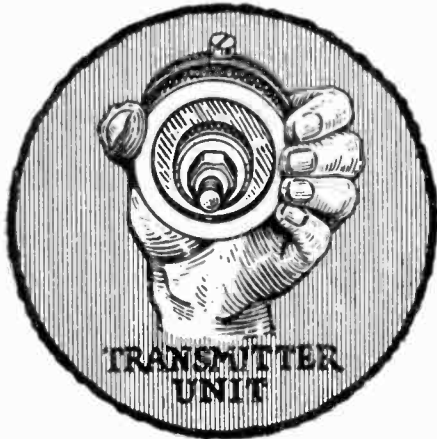

Here's a marvel of engineering design—a practical miniature transmitter, used by thousands of radio fans and experimenters for amplification purposes. It is a most novel unit, having hundreds of uses. Every amateur should have two or three of these amplifiers in his laboratory.

A FEW USES FOR THESE UNITS

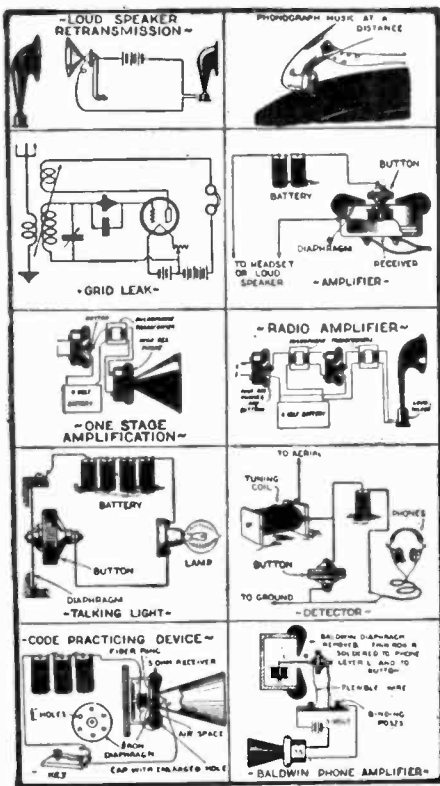

With each unit is mailed an eight-page instruction pamphlet containing suggestions for innumerable uses. Our supply is limited; avoid disappointment by ordering today. The coupon below is for your special convenience.

SPECIALY PRICED AT 95c
(or Two for \$1.75) per unit

THE PRESS GUILD,
16-S East 30th St., New York, N. Y.
Enclosed find 95c/\$1.75 for which send me postpaid one/two amplifier units as advertised.
Name _____
Address _____
City, State _____

Readers Forum

(Continued from page 522)

been frozen into the ice only a few hours before. The body was cut out, carried to a neighboring hut and put into warm water. A short time thereafter, the frozen one came to life and declared that he was born in 1619 and was caught in the avalanche in 1650. The discovery caused much newspaper comment in the press of Switzerland and the press of the world when the story was first published 100 years ago.

I realize you will be interested in this inasmuch as you claim that anything really frozen cannot be brought back to life.

RALPH J. POWELL,
Floral Park, L. I., N. Y.

(The story above is pure buncombe. But many of our readers have misinterpreted our claims in the article on artificial hibernation. The only findings which we could arrive at were that when fish or other animals were frozen by artificial means, that is to say, in either refrigerators or by liquid air, the fish did not come back to life. We asked our readers in various parts of the country to make the experiments under more natural conditions, that is, on a cold day in the winter months to go down to their local ponds and chop out a fish, frozen in ice. Take that fish home, thaw it out and see whether it comes to life. In making an experiment of this nature, it is absolutely necessary that the person be assured the fish is really frozen in the block of ice.

Since our request, many of our readers have nobly answered the call to the aid of science. The peculiar angle which we obtain is that some investigators claim to be able to thaw the fish out and make it come back to life and others maintain that the fish never did come back to life. Stranger still is the fact that the same species of fish from two different ponds in approximately the same latitude reacted differently to the test. Some winter, scientists will undertake to carry on a series of experiments which will definitely settle this question, one way or the other. Our own conclusions are: if artificial freezing is conducted, fish cannot be made to hibernate. Neither can they be revived upon being thawed out. —EDITOR.)

The Astrology Humbug

By JOSEPH H. KRAUS

(Continued from page 509)

than the seed planted later. Torrential rains interfere greatly with the growth of the seed.

The editor of this astrological magazine further inquires: "Why is it that *all* (italics ours—Editor) people in all climes are more vigorous and active from noon to noon and from evening till midnight, than they are from noon to evening, and from midnight till dawn?"

We wonder whether by use of the word "all," the editor implied everybody or whether he meant the majority. In New York City it is found that those who frequent the night clubs become far more active from midnight till dawn than they are from evening until midnight. Mode of life has much to do with this. A person can be active during any portion of the day he desires by properly regulating his hours of sleep and awakening. There are many who work at night and it is just as essential that their business be carried on as it is for others who remain at their places of employment or at their professions during the daytime. More anon.—Editor.

MRS. KEMBLE'S ASTROLOGY

Editor, SCIENCE AND INVENTION:

I am enclosing a page of the Grand Rapids Herald, Sunday edition, which should be interesting, considering your stand on astrology. This is probably a syndicated article which you have already seen, but I am enclosing it in case it should be new to you.

Perhaps you can decipher this astrological hodge-podge and get some sense out of it, but it looks like all the rest of this humbug to me. Like all the rest of astrologers, Genevieve Kemble takes great pains to be very indefinite and make no positive statements, or if she does make a rather definite statement, it is on something which anyone can guess as well as she, such as predicting an advance in radio, or the continuation of women in politics.

Also, notice her lucid (?) forecast for President Coolidge:

"The coming year MAY establish whether Calvin Coolidge will pass into history as politician or large visioned statesman." Then she gave us the startling information that he has both friends and enemies.

There is a nice collection of indefinite words used, though she tires out at the end and resorts to "may" almost entirely. Here is the list I counted with the number of times used:

possible 1; plausible 1; if 1; suggested 1; seems 2; should 3; MAY 20 times.

SCIENCE AND INVENTION is the best science magazine published and I wish you all success in your challenge to spiritualism, astrology, perpetual motion, and any other humbug you can expose.

G. E. VALENTINE,
Grand Rapids, Mich.

(As we have always stated, astrologers have a tendency to hedge. Consequently, our astrological contest rules insist upon horoscopes with definite statements, free of contradictions. Any statement

(Continued on page 569)

Beck Makes \$8000 a Year!

"If it wasn't for you and the training you gave me, Mr. Dobe, I wouldn't be making \$8000 a year now."

Lewis Beck.

Learned Drafting at Home—So Can You!

Beck answered my advertisement and got my free book on Draftsmanship. That's what I want you to do now. Beck was then a helper making \$12.00 a week, but he took my simple, easily understood and quickly learned course in drafting at home without giving up his job. You can do the same thing. Will you? "I often look back to the time I answered your advertisement," writes Beck, "and wondered how I could take up your course as I was not able to save enough out of \$12.00 a week to make the first payment. But I finally did it and it was the best money I ever spent in my life. Thanks to your training I am not afraid to tackle any work along drafting lines and can readily master all the architect's plans."

Mail this Free Coupon or Write Today for FREE Book!

Beck asked for the Free Book first! Will you ask for it today? Certainly you are not obligated at all by writing for "Successful Draftsmanship." Get it and read it. Then make up your mind how successful you can be. This man is making real money and you know the old adage "What man has done man can do." So mail the Free Coupon below—or write a letter or a post card. Do that now. No man who is dissatisfied with what he is making now should fail to get and read "Successful Draftsmanship."



DOBE EASY DRAFTING

1951 Lawrence Ave. Div. 14-27 Chicago

Dobe Easy Drafting
1951 Lawrence Ave., Div. 14-27 Chicago
You may send me free your book "Successful Draftsmanship" and names and addresses of more Dobe winners.

Name _____ Age _____
Address _____
Post Office _____ State _____

The New and Improved Consrad BOOK Pattern

Complete—4 full size Blueprints—many pages of Constructional Information and Pictures and Illustrations—all contained in a beautiful BOARD COVERED BOOK

The STROBODYNE

THE sensational Strobodyne Circuit, the greatest of Super-Heterodyne receivers that combines the best features of every circuit: the circuit that has amazed Radio, is now ready for home and community set builders.

Consrad, the greatest Pattern publishers in Radio, have printed an entirely different kind of Pattern for this amazing circuit. Instead of a simple envelope or soft cover—the complete Strobodyne building information with all blueprints is contained in a regular, handsome board covered book, with a 2 color beautiful cover. Size 9x12 inches.

The book contains the complete authentic description of the circuit to the last detail.

FULL SIZE BLUEPRINTS

Also carefully arranged, folded and bound into the book are the following blueprints—all full size.

- No. 1—Panel layout Blueprint—Size 11x27 inches.
- No. 2—Underside view of Sub-Panel Blueprint, size 15 by 27 inches.
- No. 3—Template for Sub-Panel—size 16 by 27 inches.
- No. 4—Wiring for Apparatus—(Shown in perspective form) size 23 by 27 inches.

Until you have studied the Strobodyne you are a back number in Radio—a man of the older school—The Strobodyne is not just a new circuit—It is an epoch in Radio.

50c THE COPY

USE THIS COUPON

CONSRAD COMPANY, Inc.,
230 Fifth Ave., New York.

Gentlemen: I enclose 50c for one copy of the New Official STROBODYNE BOOK containing complete constructional information and all Blueprints.

Name

Address

City, State

BEAUTIFUL
2 COLOR
STIFF
COVERED
BOOK

ONLY
50c

Contains
all
Blueprints
and
Other
Data Neces-
sary
to Build
the
Strobodyne

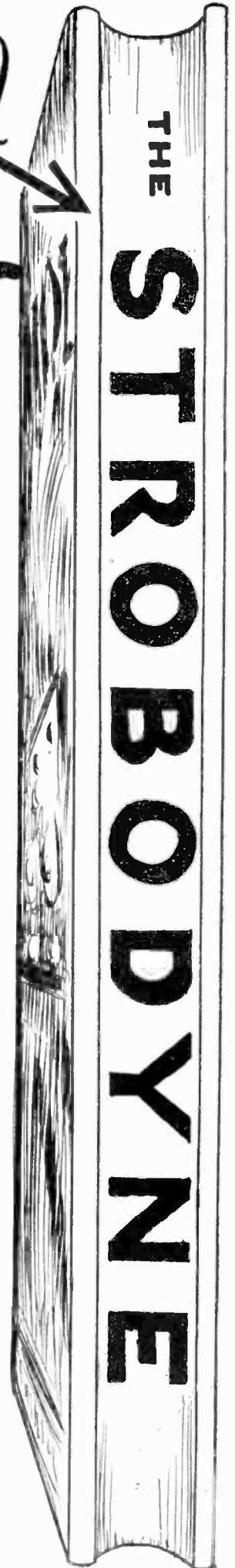

The SOLDER of 1000 uses

YES, and even more than a thousand uses. Kester Metal Mender solders metal as easily as glue sticks to paper. The skill is all in the solder—requires only heat.

In the average home there are innumerable metal articles from attic to cellar. Some are absolutely unserviceable for the lack of a touch of Kester Metal Mender.

You know these things need attention, and yet to have some one fix them would probably cost as much as replacing the articles.

A touch of heat and a touch of Kester and the job is done. It's so easy to use Kester that soldering has become an interesting and profitable fad for thousands of people.

Buy a can from your hardware dealer, general store, auto supply shop or druggist.

Free Sample upon request



KESTER METAL MENDER

The Household Solder

CHICAGO SOLDER COMPANY
4210-10 Wrightwood Ave.
Chicago, U. S. A.

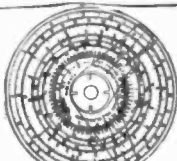

THE MIDGET SLIDE RULE instantly adds, subtracts, multiplies, divides, solves proportion, gives all roots and powers. Logarithms, Sines, Cosines, Tangents, Cotangents, Etc. Also gives decimal equivalents, lettered and numbered drill and tap sizes.

More than 110,000 sold, more than 2000 unsolicited testimonials. The Engine-divided scales are on white finished aluminum and are grease and waterproof. Diameter 4 7/8. Price with Instruction Book, \$1.50. Pocket Carrying Case, 50c extra. Cash or C.O.D. Catalogue free. Your money back if you are not satisfied.

GILSON SLIDE RULE COMPANY, Stuart, Florida

BIG NEW CATALOG FOR RADIO BUILDERS

FREE My big 1928 Radio Catalog, Call Book and Trouble Finder. 132 pages about Radio. Chock full of newest circuits—kits, transmitter parts, short wave outfits, eliminators and speakers. Thousands of bargains at lowest wholesale prices. A regular Radio Encyclopedia—Free. Write today.

American Auto & Radio Mfg. Co.
HARVEY SCHWARTZBERG, Pres.
Dept. 275, American Radio Bldg., Kansas City, Mo.

LATEST RADIO CIRCUITS



BECOME AN EXPERT ACCOUNTANT

Executive Accountants and C. P. A.'s earn \$3,000 to \$10,000 a year. Thousands of firms need them. Only 9,000 Certified Public Accountants in the United States. We train you thoroughly at home in spare time for C. P. A. examinations or executive accounting positions. Previous experience unnecessary. Training under the personal supervision of William B. Casterholz, A. M., C. P. A., and a large staff of C. P. A.'s, including members of the American Institute of Accountants. Write for free book, "Accountancy, the Profession That Pays."

LaSalle Extension University, Dept. 10384-H Chicago
The World's Largest Business Training Institution



can make a good penman of you at home during your spare time. Write for my FREE BOOK, "HOW TO BECOME A GOOD PENMAN." Your name elegantly written on a card if you enclose stamp. Write today. F. W. TAMBLYN, 423 Hideo Bldg., Kansas City, Mo.

The Astrology Humbug

(Continued from page 567)

in which the words "may," "seems," "should," "it is possible," or "perhaps," is employed, cannot be considered as being definite. In every one of the horoscopes which have appeared in the newspapers on or about the first of each year, we find the use of these which make the clauses following entirely non-specific. If the astrologer then guesses quite correctly, and the events subsequently prove her guess was partially correct, she immediately proclaims herself as having made a fulfilled prediction. For instance, one astrologer has resorted to the statement that "Mussolini's life will be in danger if . . ." Should Mussolini meet with a serious accident, the astrologer will proclaim her forecast. On the other hand, should "Il Duce" continue to administer the affairs of Italy during 1927, the astrologer can always revert to her original statement, and claim that the contributing features did not occur, and it was for this reason that Italy's premier successfully outfoight the fates.

We are at a loss to understand why it is that some astrologer did not come forward with the statement that during 1927 a practically unknown youth would upset the entire world to such an extent that the crowned heads of Europe would be anxious to shake his hand, that the government of the United States would recall him from abroad on a government warship, the Smithsonian Institute would cast a medal for him, that the Post Office Department would have a special stamp made for him, and that honor after honor would be heaped upon the shoulders of a twenty-five year old youth. Yet that is what actually occurred. Colonel Lindbergh has been honored by France, Belgium and England and has been responsible for the greatest display of emotion and for more columns of news in the daily press than any other man in history; or than any other event, including the entrance of the United States into the World War. In no forecast for the year of 1927 have we seen the slightest mention of an event as important as this one proved to be. At no time in the history of the powers of the world has there been a feeling of greater friendship than that at present. After he has made his niche in the Hall of Fame the astrologers, phrenologists, numerologists and the soothsayers tell us of his capabilities.)

ASTROLOGY IS SCIENCE?

Editor, SCIENCE AND INVENTION:

Your Kevah Deo Griffis' horoscope of the late Kaiser of Germany, page 596, November SCIENCE AND INVENTION does not agree at all with the horoscope of the Kaiser as cast by E. S. McKeever, 1447 O'Farrell St., San Francisco, Calif., page 14 of his March, 1926, Prenatal Astrology—for the planets are not at all in the same places, although he says the birth time was 2:51 P.M., very close to the 3 P.M. used by Griffis. I suggest you get a copy of McKeever's chart which is a double one showing that the Astral Form is attached to the ovum of the Mother at a certain Moon period somewhere in the neighborhood nine months prior to birth. McKeever, as a scientific astrologer, says out and out that the Birth Horoscope is not an adequate index to a person's life and prophecy of the events to come. However, he seems to change the birth hour, when furnished to him, to agree with this Prenatal Moon epoch. E. H. Bailey of London, Editor of the British Astrologers Journal had written a book on the Prenatal Epoch in which the sex degrees of the zodiac were parcelled out. I wrote C. C. Zain of the Brotherhood of Light, Box 1525, Los Angeles, Calif., who has written 41 lessons on Astrology and he tells, in one of the lessons, that the Prenatal Epoch will only work seven out of ten times, which is not a science.

Some other astrologers, reacting, no doubt, to the statement of McKeever that the Birth Chart alone was not adequate—have taken McKeever to task for guess work and for setting the time of birth around to suit the Prenatal Epoch. But W. Gornold—nicknamed Sepharial, of London, running mate with Bailey, has out a book called the Solar Epoch—contending that to make a real "blown in the bottle trade marked" horoscope one must have this Solar Epoch. And William Raphael—whose real name I take it is "Cross," in his 1927 Almanac and Ephemeris predicts (Page 56) a fundamental change in the American System of Government—anarchy in the central states (Page 58) and a seceding from the Union of Southern and Western States.

But practical problems of life are of no interest as considerable of Gornold's energy is given over to horse racing tips and Stock market problems—another form of gambling.

However, astrologers like Professors Brodey and Cheney openly declared that the planets had no effect on man and Professor Cheney ridiculed the idea that an aspect formed 30 days after birth could have an influence 30 years after birth and in this Lyman E. Stowe of Detroit was in agreement.

Editor Kingdom of Heaven Advocate,
Grand Rapids, Mich.

(Little need be added to your communication, except that the time of the Kaiser's birth forwarded by us to Mrs. Griffis was directly taken from an astrological book. Perhaps the astrologer mentioned by you shifted the hour to agree with his calculations.—EDITOR.)



Send For This FREE Book!

Telling of Fame and Rewards Won by Men Who Solve Finger Print Mysteries

" . . . Shortly before midnight a young couple slipped away from the dance in a long, low, rakish roadster. Early next morning they were found dead beside the road."

Who had committed the murder?

Read the rest of the story on page 15 of our new Finger Print book. Find out how the murderers were traced, tried and convicted, and how a certain finger expert solved five murder mysteries and secured 97 convictions in less than a year.

In these thirteen stories of crime, daring robberies, mysterious murders, thrilling escapes, you'll read of men who achieved fame, big rewards and important positions in a short time through the study of finger prints.

Find out how you, too, can become a Finger Print Expert.

Finger Print Experts Needed

More and more the detection of crime resolves itself into a problem of identification. More trained men are needed. University of Applied Science graduates get first choice at the big positions.

You can learn finger print identification in a few months in your spare time—at home.

Send Coupon!

This book cannot be bought at any newsstand or book store—but it will be sent to you FREE if you write to us at once. Thirty-two pages, illustrated in color with weird crime pictures. This book explains your opportunities in Finger Printing and tells how you can get a professional finger print outfit FREE. Write today.

University of Applied Science

1920 Sunnyside Ave., Dept. 14-27 Chicago

University of Applied Science, Dept. 14-27
1920 Sunnyside Ave., Chicago, Ill.

Please send me free your 32-page illustrated book, "Finger Prints." I understand that there is absolutely no obligation. Also tell me how I can become a finger print expert by studying a few months in spare time—and how I can get a professional finger print outfit FREE.

Name.....
Address.....
City..... State.....



Be the BOSS!

Make \$40 to \$100 a week in Auto "Up-Keep"

Any man who will take the trouble to expertly learn the mechanical and electrical end of automotive "maintenance" is sitting pretty these days. For up-keep has become the BIG-MONEY end of the great auto industry. They only build 3 million new cars a year, but there are 22 million autos, trucks, tractors, taxis and buses TO SERVICE.

Get away from the grease — BE AN AUTO EXPERT!

Garages, Service Stations, Repair and Electrical shops are looking for EXPERTS—men who are worth \$50 to \$100 a week. So I urge you to aim for the job HIGHER UP. Be foreman, manager or superintendent. Or go into business for yourself. YOU CAN—if you're only willing to devote a part of your spare time to learning.

LEARN AT HOME—

the quick, sure, easy way!

No studying, no memorizing, no trade courses—no lessons or examinations. Here is a better way. You don't have to keep a million facts in your head—if you know where to put your finger on them. Eleven noted auto engineers have prepared this material, 2500 pages, over 2000 blue prints, wiring diagrams and illustrations. In 5 big volumes. Jiffy-indexed for instant reference.

Start with the COUPON!

We'll loan you this AMERICAN AUTO ENGINEERING LIBRARY so you can see for yourself how other men JUST LIKE YOU have jumped to better-paid auto jobs. By occasional reading. By LOOKING UP the answer to problems as they arise in the day's work. By using our "question and answer" service. At a cost less than a fourth of the price of trade courses.

AMERICAN TECHNICAL SOCIETY
Dept. A725, Drexel Ave. & 58th St., Chicago

LOANED FREE!

American Technical Society, Dept. A725, Drexel Ave. & 58th St., Chicago, Ill. Please loan me for 15 days, free, the 5 volume library of "Auto Engineering" if I will pay the few cents delivery charges when books are received, and I have the privilege of returning them at your expense within 15 days, in which case I will owe you nothing. If I decide to keep them, I will send \$2. after 15 days, then \$3 a month until your special advertising price of \$24.00 is paid.

Name.....
Address.....
Attach a letter stating employer's and reference's names and addresses, or write same plainly in margin.

Don't send a Penny



High School Course in 2 Years

This simplified, complete High School Course—specially prepared for home study by leading professors—meets all requirements for entrance to college, business, and leading professions.

20 Other Courses

Over 200 noted Engineers, Business Men, and Educators helped prepare the special instruction which you need for success. No matter what your inclinations may be, you can't hope to succeed without specialized training. Let us give you the practical training you need.

American School
Drexel Ave. & 58th Street
Dept. H-726, Chicago

Money Back When You Finish If Not Satisfied

American School, Dept H-726, Drexel Ave. and 58th St., Chicago
Send me full information on the subject checked and how you will help me win success in that line.

- | | |
|---------------------------|---------------------------|
|Architect |Electrical Engineer |
|Building Contractor |General Education |
|Automobile Engineer |Lawyer |
|Civil Engineer |Mech. Shop Practice |
|Structural Engineer |Mechanical Engineer |
|Business Manager |Steam Engineer |
|C. P. A. & Auditor |Sanitary & Heating |
|Bookkeeper |Surveyor & Mapping |
|Draftsman & Designer |High School Graduate |

Name.....
Address.....

Hints for the Mechanic
(Continued from page 519)

DETACHABLE CENTER DRILL



The usual procedure in drilling the centers of objects which are to be turned in a lathe, necessitates the removal of the existing lathe center, and its replacement by the drill chuck carrying the center drill. The illustration shown here, which has been adapted from English Mechanics, depicts a very useful and simple device consisting of the ordinary split drill chuck with a locking screw for holding the drill tight, on one side, and a conical recess of the same taper as the lathe center on the other. The chuck is merely slipped over the lathe center and held against rotation.

SHEET METAL CRIMPER

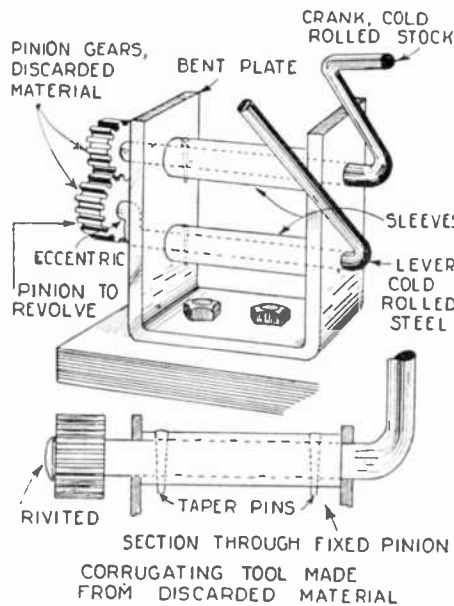

The tool shown here is serviceable for corrugating the ends of thin metal pipe and metal strips. Two shafts of 3/8" rolled steel are mounted as shown with two small pinion gears affixed at one end of the shafts. The bracket mounting these is made from a piece of pipe about 3/4" in diameter and the small collars are also made from pieces of pipe. The eccentric is for obtaining pressure between the gears. The crank turns one of the pinions. The two gears may be obtained from an old automobile. Both the lever and the crank are made from cold rolled steel. A fixture as shown can be readily made up of odds and ends; no fine machine work is required and the job may be completed in an hour or two.—G. A. Luers.

The Ketones in Experiments
By DR. ERNEST BODE
(Continued from page 514)

In this way calcium acetate yields acetone which comes over and is collected in the receiver while calcium carbonate remains behind.

Such mixed ketones can not be purified by the bisulphite process for only those ketones which contain the methyl group in union with the ketonic group will give these additional products.

It is quite easy to make a ring compound from acetone by a process of condensation with the aid of sulphuric acid. Here concentrated sulphuric acid is added to acetone. The liquids are mixed and the mixture distilled whereby a liquid boiling at 165 degrees C. (329°F.) passes over. This is mesitylene, an aromatic hydrocarbon also known as 1-3-5-trimethylbenzene.

R.E.Lacault
Knows-
SUPER-HETERODYNES

*Originator and designer of the nationally known 'ULTRADYNE,' Radio Engineer, and former Editor with many years practical experience on Super-Heterodynes.

He has written this book for you



R. E. LACAULT has been an Editor of R. Radio magazines for many years. He has specialized in the greatest and most powerful of all Radio Circuits, "The Super-Heterodyne." He has studied, originated and developed to marvelous perfection the "ULTRADYNE" Super-Heterodyne. He has advised thousands of set owners and builders in Super-Heterodyne problems.

—and now he has used his immense experience, his clear mind and his editorial ability to write, by far the most lucid, interesting, instructive and plainly written book on the theory and construction of Super-Heterodynes that has ever been published.

You who already own Super-Heterodynes will find this book especially helpful in locating and correcting troubles. A special trouble chart is printed for detecting and correcting common faults.

SEND NO MONEY

Just send us a card mentioning the book with your name and address. We will mail you the book. You pay the postman \$1.97 plus a few cents postage on delivery.

Distributed by

THE CONSRAD CO., Inc.

230 Fifth Ave., New York, N. Y.

MONEY-MAKING OPPORTUNITIES

SALESMAN SELLING TO MEN
We have side line for you that will sell along with any line you may now be handling and make more money for you, provided you are now selling to men. Get facts at once. Address, Salesmanager, 850 West Adams, Dept. 186, Chicago.

Twenty-Seven Dollars Daily Selling Fifth Avenue Clothes. Sell every man. Four times as much profit. Prices to fit every pocket book. \$19.75, \$24.75, \$29.75, \$34.75. Commission \$3.00 to \$7.00. Also overcoats and raincoats. Majority of salesmen with us two and three years doing a record-breaking business. Leatherette case, with all-wool patterns, actual photos free. Write H. W. High, Pres., Harrison Brothers, Dept. 857, 133 West 21st Street, New York.

Agents wanted to advertise our goods and distribute free samples to consumers; 50c an hour; write for full particulars; American Products Co., 9464 Monmouth, Cincinnati, O.

Agents. \$250 month. Raincoats. All colors. Your choice. \$2.65. Full time, 82 hour. Complete line 60 patterns, silks, suedes, tweeds, leather-Lyke. Outfit sent free, postage prepaid. Write Comer Manufacturing Co., Dept. TS-3, Dayton, Ohio.

Old estab. mfg. co. gives you credit; starts you in business (city or country) selling 185 widely known household necessities. Permanent business; steady customers; large profits. McConnon, Dept. TH, Winona, Minn.

New lines just out. Everything in hosiery, underwear and rayon lingerie for men, women, children. Beautiful, irresistible. Catalog and samples now ready. New special big money plans. Cash bonus, service awards, rapid promotion. No capital needed. Choice territories going. Rush reply to World's Star Knitting Co.; 788 Lake St., Bay City, Mich.

Make Four Hundred Dollars Every month and collect your thirty-three and one-third per cent commission daily, selling nationally known line of monogrammed and signed Xmas Greeting Cards to business, professional and society people. Write today for full details, exclusive territory and free sample outfit. Card Dept., Process Engraving Co., Inc., Troy at 21st St., Chicago.

94c an hour introducing new Dozal Stove and Nickel Polish. Clean polishes—one operation. Quick demonstration delights housewives. Many order dozen tubes. Your profit over 100%. Write or wire for territory and free sample if you're ready for action. Dozal, Montclair, N. J.

HOSIERY FREE and \$12 daily. Sell nationally known Pure Silk Hosiery. Amazing values. Free sample outfit. PURE SILK HOSIERY CO., 208 W. Monroe, Chicago.

New! Reversible Patented One-Piece semi-soft collars; 30 per cent commission. Send 25 cents sample collar your size; outfit free. Bitrite Collars, 935 Broadway, N. Y. C.

\$100 WEEKLY REPRESENTING LARGE SHIRT company—direct to wearer—wonderful opportunity for financial independence. Big commissions—easy to take orders—we start you with a sales-compelling outfit free. Write at once. Supreme Shirt Co., Desk M96, 276 Fifth Ave., New York.

Make \$100 weekly selling better-quality all-wool made-to-measure suits and overcoats. Highest commissions. Extra bonus for producers. Large swatch samples free. W. Z. Gibson, Inc., 157 W. Harrison, Chicago.

Sell Christmas Cards! Beautiful en-graved assortment of 15 sells on eight, \$1.00 per box. Send 65 cents, sample box, free plan. Make \$10.00 daily. Engravo Co., 442 West 42nd Street, New York.

Agents: Amazing new 3-in-1 lingerie combination for women making sensational hit. \$15.00 daily easy. Spare or full time. Free Outfit. French Fashion Company, Dept. N-100, 9 North Franklin, Chicago, Ill.

WANT \$500? Sell Beautiful Dresses, Coats, Scarfs, Sweaters. Amazing low prices. We deliver. Exp. unnecessary. Complete outfit free! Write Hirshey Knitting Mills, 2003 South Californian Avenue, Chicago.

Zip-Zip-Zip—profits just roll in. Amazing new Zipper-Dimmer for all makes autos sells at eight. Foot controlled. Prevents accidents. \$15-\$25 daily, selling owners and dealers. Zipper-Dimmer Co., Dept. A-15, Lorain, Ohio.

Great neckwear line now free! Features finest quality neckwear at factory prices. Collect big commissions daily. Write for FREE tie offer and FREE outfit. Nawco Neckwear, Desk 10-ZC, Covington, Ky.

MAKE BIG MONEY HANDING OUT MYSTIC "ZIPPO" Red Hot 60c Household Soliers! New Amazing Discovery! Quick Demonstration Brings Immediate, Huge, Cash Profits for Agents! Write Quick "ZIPPO" Company, Fort Wayne, Ind.

BIG PAY EVERY DAY! Complete guar-anteed line direct to wearer. Dress Shirts, Work Shirts, Flannels, Overalls, Pants, Leather Coats, Sweaters, Playsuits. \$10-\$25 daily! Experience unnecessary. Big Outfit FREE! Nimrod Co., Dept. 58, 4929-29 Lincoln Ave., Chicago.

Agents: \$13.80 Daily (in advance), Spare time will do. Introduce 12 monthly guaranteed hosiery, 67 styles, 39 colors, for men, women, children; including latest "Silk to the Top" Ladies' Hose. No capital or experience needed. We furnish samples. Silk hose for your own use free. New plan. Milton Matthews, Road 22810, Cincinnati, Ohio.

Make More Money!

Here are opportunities to make more money immediately—to earn and save enough for the better things of life.

Here responsible, nationally known, square deal firms seek the services of ambitious people. They offer dignified positions (full or spare time) which pay handsome incomes and lead to wonderful futures.

No experience required. Ambition is the only necessary qualification. Read these offers carefully. Then write for complete information about the ones that attract you most. Please do not write unless you mean business.

To the Public: These firms offer you merchandise values, a convenient service that you cannot duplicate elsewhere.

To Manufacturers: For advertising rates, address Publishers Classified Service, c/o East 45th St., New York.



Women Representatives Wanted. New invention prevents shoulder straps slipping. No more discomfort. Women adore it. Write for particulars, free offer. Lingerie "V" Company, 5 Lake St., North Windham, Conn.

Send 25 Cents for a \$1.00 Pocket Cigar Lighter and learn how to make \$10.00 a day easy. Sells on eight. Particulars FREE. Rapid Manufacturing Co., 799C Broadway, New York.

TAILORING SALESMEN make real money selling Davis virgin wool, made-to-measure suits. Low-priced, perfect-fitting, guaranteed. Beautiful fabrics. New merchandising plan doubles sales. Liberal bonuses, cash prizes. Write now. P. H. Davis Tailoring Co., Station 30, Cincinnati, Ohio.

Will you wear a pair of genuine tailor-made shoes at my expense? Will you show them to your friends and take their orders? I will ALSO send you FREE our big selling outfit, showing 70 shoe styles and 60 actual leather samples. I pay my agents \$8.00 daily. Write quick. Tailor-Made Shoe System, 932 Wrightwood, Dept. A10, Chicago, Ill.

Large Manufacturer Wants Agents to sell, to wearer, world's greatest shirt values. Experience unnecessary. Big commissions paid daily. \$100 weekly. Extra bonuses and profit-sharing. Samples free. Carlton Mills, 114 Fifth Ave., Dept. 348-R, New York.

EARN \$87-\$116 WEEKLY SELLING CHRISTMAS CARDS. Full or spare time. \$10 sample book FREE. Weekly payment. Experience unnecessary. We co-operate. John Hertel Co., 320 Washington, Chicago, Ill.

Sensational New Adjustable Cap fits everybody. Sells at eight. Make \$50 to \$75 weekly writing orders. Commissions in advance. Complete outfit free. Fits-U Cap Co., Dept. CL-105, Cincinnati, Ohio.

I Will Pay You \$2 An Hour to take orders for Carlton dresses and coats. Women in every home, store, factory and office eager to save a third on our stunning Paris styles. Everything supplied free but only applications stating territory, experience and references will be considered. Carlton, Inc., 206 South Wabash, Dept. 232-B, Chicago.

A PAYING PROPOSITION OPEN to representative of character. Take orders shoes, hosiery, direct to wearer. Good income. Permanent. Write now. Tanners Shoe Mfg. Co., 109 C St., Boston, Mass.

\$40.00 Suits for \$23.50! All one price. Union made of finest quality Virgin Wool. You don't have to know anything about selling clothing. We guarantee your success if you are honest and willing to work. Write at once. WILLIAM C. BARTLETT, 850 Adams, Dept. 566, Chicago, Illinois.

Salesmen: Tremendous Money-Making Sensation. Combination fountain pen and check protector. No competition. Protected by patents. Wholesale sample pen and selling outfit, \$3.75. Write Security Pen Corp., 606 Jackson, Chicago.

FREE! To honest men over 18: new patented cigarette lighter. Show your friends and make \$90 weekly. Send 25c to cover mailing costs and mention name of this magazine. E. Z. Lite, Dept. G-2, 15 Westminster Road, Brooklyn, N. Y.

AGENTS MAKE \$3.00 HOUR TAKING orders for 40 fascinating "Handy Things" for Kitchen. Sell on eight! Write General Prod. Co., Dept. SM2, Newark, N. J.

Sell custom tailored shirts. Earn \$20.00 a day. Men buy quick at factory prices. Beautiful fabrics free. Novo-Tex, 3rd & Sedgley Ave., Phila., Pa.

The greatest book on money making stunts that has ever been published will be mailed to you if you will send us 15c in cash or stamps. There are over 50 up-to-date workable plans. Address SPARETIME MONEY MAKING, 230 Fifth Avenue, New York City.

\$55 for Photoplay Plots. Stories revised, copyrighted, marketed. Estab. 1917. Booklet free. Universal Scenario Co., 200 Western & Santa Monica Bldg., Hollywood, Calif.

What? Suits and overcoats 2 for \$29.50? Yes sir! And the value is there, too. Union made. Latest Broadway styles. Many of our agents making \$5 on every 3 orders. Every man in your neighborhood will buy. No experience necessary. We show you how. Write for free outfit today. James Carroll, Inc., Dept. CT-1, 663 Broadway, New York.

Sell by Mail During Spare Time! Earn 90 cents profit on dollar orders. No peddling. Large Catalog free! M. Eifco, 525 So. Dearborn St., Chicago.

Write the Words for a Song. We com-pose music. Our composer wrote many song hits. Monarch, 236 West 55th St., Dept. 179, New York.

Your Face Is Your Fortune! Famous British psychologist now in America will tell you from your photograph how to be successful in business, society, love. Send \$3 with photo for complete personal psychological analysis. Or send personal photograph and learn the real truth. Has led thousands to complete success and happiness. D. Jasper Jones, Psychologist, Dept. 24, Youngstown, Ohio.

Twenty Dollars a Day Extra Easy! Sell blotter, the new all-wool, tailored, serviceable, dressy, showerproof and spotproof suit. Guaranteed one year. Worth \$35.00. Sells for \$19.95. Commission \$3.00 and \$4.00. Thirty-seven features. No competition. Expensive outfit free. Harrison Bros., Dept. 557, 133 W. 21st St., New York. Please mention this magazine when writing.

Quick Easy Profits Selling Personal Xmas Greeting Cards. Beautiful new assortments sell at eight. Big cash commissions in advance. Sample outfit free. Midland Arts Company, Dept. 65, Camden, Ohio.

Windows washed in 10 seconds without pail, sponge or brush. A fast \$1.95 seller. 90% profit. Demonstration sample \$1.20. Satisfaction or money back. Wonder Washer, Dept. SM2, 33 East 10th St., New York.

Earn \$80 weekly taking orders for charming Fashion Frocks for women and children. Factory prices. Advance commissions. No experience necessary. Fashion Frocks, Inc., Dept. H-100, Cincinnati, Ohio.

\$100 WEEKLY IN ADVANCE. NEW Line \$30.00 Tweed Suits \$24.00. Genuine All Virgin Wool. Fit guaranteed. Nothing like them in America. Big samples free. Manager, 44 North Ada, Chicago, Ill.

Make \$25.00 daily selling colored Rain-coats and Slickers. Red, Blue, Green, etc. \$2.95. Hat Free. Commissions daily. Outfit Free. Elliot Bradley, 241 Van Buren, Dept. AF-10, Chicago, Illinois.

Agents, distributors—over 100% profit selling Auto Tow Line—strongest, lightest on market. Retail \$2.00. Sample \$1 postpaid. Less in quantities. Special offer and amazing new selling plan FREE. Wilman Co., Dept. L-65, Toledo, Ohio.

75 miles on 1 gallon. New moisture humidifier and Gas Saver. All cars. Agencies wanted everywhere. I Free to introduce. Critchlow, A-374, Wheaton.

Twenty Dollars a Day Asking Women to guess price of new ventilated Laundry Bag. They say worth \$2.00. Quick repeat sales at only \$1.25. One hundred per cent profit. Hanes in closet or back of door. Always closed. Always open. Every home needs three. Send \$1.00 for sample and selling plan. Money back if not satisfied. Sam-Kay Laundry Textile Mills, 1009 Diamond Street, Philadelphia, Pa.

Canadians—established firm wants men of good character. If you can be trusted with funds and depended on. Address Salesmanager, P. O. Box 984, Montreal, Quebec.

KNOWLEDGE IS POWER! Learn While You Earn!

HIGH-SALARIED POSITIONS waiting for you in automobile, tractor and airplane work. I'll train you in eight short weeks so you can earn \$450.00 per week—unlimited future for good men. Quality as an expert and own your own garage or service station. Write me TODAY for big FREE AUTO BOOK. Your Railroad fare included in this big special offer. The opportunity of a life time—don't miss it by delay. J. H. McSweeney, The Auto Man, Address, Y300-654 E. McMillan, Cincinnati, or Y300-1815 E. 24th St., Cleveland, Ohio. Please mention this magazine.

Jack Dempsey Talking: I made \$750,000 in 45 minutes—maybe you can do the same! For the first time I will expose to you my secrets of boxing and physical instruction that have given me physical perfection, wealth and ease. Study and train at home in spare time—results achieved in first thirty days will astound you and your friends. Pupils receive personal instructions, photo signed diploma; and secret course. Write at once and receive newly invented Life Size Training Dummy Free. Jack Dempsey Institute, 565 Fifth Avenue, New York City. (Enclose 10 cents to cover postage, etc.)

Hotels Need Trained Executives. Nationwide demand for trained men and women; past experience unnecessary. We train you by mail and put you in touch with big opportunities. Write at once for particulars. Lewis Hotel Training Schools, Suite UL-W637, Washington, D. C.

U. S. Govt. wants men. \$1,900-\$2,700 at start. Railway Postal Clerk exams coming. Our former government examiner prepares you for this and other branches. Free booklet. Dept. 269, Patterson School, Rochester, N. Y.

Earn \$25 Weekly. Spare Time. Writing for Newspapers, Magazines; exp. unnecessary. Copyright Book "How to Write for Pay," Free! 1307 Press Syndicate, St. Louis, Mo.

Men, get Forest Ranger Job; \$125-\$200 month. Home furnished; hunt, fish, trap on side; permanent; no strikes or shut-downs; full pay vacations. For details, write Norton, 270 McMann Bldg., Denver, Colo.

Make \$75 to \$250 Weekly; Motion Pict. Portrait and Commercial. Camera free. For special offer, write N. Y. Inst. of Photography, Dept. 111, 10 W. 33rd St., New York.

U. S. GOVT JOBS. Men—Women. 18 up. \$1,400-\$3,000 year. Steady, pleasant work. Paid vacation. Short hours. Experience unnecessary. Common education sufficient. List positions and sample coaching with full particulars—FREE. Write today sure. FRANKLIN Inst., Dept. L-D1X, Rochester, N. Y.

CHEMISTRY

STUDY AT HOME

ONE of the best ways to prepare for a good position as a Chemist is through the home-study courses offered by the International School of Chemistry. These courses are complete and practical because they were prepared by some of the best-known chemists in this country, including ALLEN ROGERS, B.S., M.S., Ph.D.,—Head of Department of Industrial Chemistry, Pratt Institute; L. M. TOLMAN, Ph.D.,—Formerly Chief Chemist, Wilson & Co., Now Vice-president, United Chemical and Organic Products Co.; BRADLEY STROUGHTON, B.S.,—Head of the Department of Metallurgy, Lehigh University, and OWEN L. SHINN, Ph.D.,—Professor of Applied Chemistry, University of Pennsylvania. Just mail the coupon and we'll gladly send you Free Booklets describing these CHEMISTRY COURSES.

Mail the Coupon for Free Booklet

INTERNATIONAL SCHOOL OF CHEMISTRY
Associated with the
International Correspondence Schools
Box 6204-E, Scranton, Penna.

Without cost or obligation, please send me full details of your home-study course in

<input type="checkbox"/> Analytical Chemistry	<input type="checkbox"/> Metallurgical Chemistry
<input type="checkbox"/> Chemical Engineering	<input type="checkbox"/> Short Chemistry Course
<input type="checkbox"/> Industrial Chemistry	<input type="checkbox"/> Pharmacy

Name.....
Address.....



PARKS

Manual Trainer

\$35.00

Without Motor

For your home shop! Combination 11-inch hand saw and 11-inch wood-lathe. If you have a knack for wood-working you can turn out first-class bridge lamps, cabinets, furniture, ship models, etc., in fast time. Get one! Write for specification circular.

THE PARKS WOODWORKING MACHINE CO.
1533 Knowlton Street Cincinnati, Ohio
Canadian Factory: 208 Notre Dame, E. Montreal, Can.

GOV'T. POSITIONS

\$35 TO \$75 WEEKLY

() Railway Mail Clerk	() Meat Inspector
() P. O. Clerk	() Special Agent (Investigator)
() Forest Ranger	() Stenographer-Typist
() File Clerk	() Immigrant Inspector
() Matron	() City Mail Carrier
() General Clerk	() U. S. Border Patrol
() Chauffeur-Carrier	() Typist
() Skilled Laborer	() Seamstress
() Watchman	() Steno-Secretary
() Postmaster	() Auditor
() RFD Carrier	

Mr. Ozment, Dept. 383, St. Louis, Mo.
Send me particulars about positions marked "X"—salaries, locations, opportunities, etc.

NAME.....
ADDRESS.....

RADIO AGENTS

Make Big Money

Easy to sell American Radios and Supplies. Nationally advertised, high quality merchandise at wholesale. Big profit on every sale. No capital to invest. No stock to carry. Order direct from my huge warehouse as you sell.

Get My Liberal Offer and also Big New 122-page Catalog and Guide—"How to Sell Radios"—Free. Full of hints—all latest in Radio. Write today.

HARRY SCHWARTZBERG, PRES.
Dept. 276 American Radio Bldg., Kansas City, Mo.



A Perpetual Motion Hoax

(Continued from page 499)

The writer spent considerable time since seeing you yesterday, in carefully calculating what is going on in the triple motor-generator set, which you demonstrated to us with standard volt and ammeters, connected in the circuits to the first motor on the shaft, and also in the generator circuit.

According to the demonstration conducted by one of the engineers at the laboratory yesterday, the apparent output of the generator was 1295 watts, as compared to the apparent input of 935 watts.

The main fallacy in your arrangement of the two dynamos and motor on the one shaft, the dynamo supplying electrical energy through volt and ammeter to the second motor connected on the opposite end of the shaft to the first motor, lies in the fact that the true output of the generator is not 1295 watts, but this quantity is actually 388.5 watts, representing the 30 per cent electrical and mechanical losses in the second motor. The efficiency of this motor is 70 per cent, and thus there is a 30 per cent loss in this motor, made up of mechanical and electrical losses.

As the apparent output of the generator is 1295 watts, as indicated by the volt and ammeter connected in the circuit to the second motor, it is at once evident that the electrical and mechanical losses through the second motor, which is returning power to the generator shaft in the form of mechanical energy, is 30 per cent of 1295 watts, or 388.5 watts. In other words, the generator is receiving 906.5 watts returned to it by the second motor.

There is no over-all efficiency for this particular machine, as there is no real output.

The specific efficiency with regard to the generator only, which is the only efficiency that can be considered, is from the above facts, equivalent to 388.5 (the true generator output) divided by 935 watts, supplied to the first motor from the laboratory power supply, which gives us 41 per cent efficiency.

This corresponds very well with the theoretical efficiency, which any engineer arrives at immediately, when he has three machines to deal with, viz., the theoretical over-all efficiency in this case would be $70 \times 70 \times 70$, or 34.3 per cent, if we assume that our machine had an efficiency of but 70 per cent.

Report of Test Conducted By Us

Here is the data on a similar line-up of two motors and a dynamo on one shaft, except that the figures are in round numbers to make the explanation simple. The volt and ammeters are connected in the same way, as in the demonstration given by the Electrical Testing Laboratories yesterday with your machine.

The direct current generator output as registered by the volt and ammeters, is 1000 watts. The efficiency of the generator is 80 per cent. The mechanical input to the generator, expressed in watts, is, therefore, 1000 divided by .80, or 1250 watts (mechanical input). The second motor, which is electrically coupled (load) to this generator, takes the 1000 watts from the generator, and as this motor has an efficiency of 80 per cent, it returns 800 watts (80 per cent of 1000 watts) in the form of mechanical power to the generator shaft, and helps to turn the generator.

Therefore, we find immediately that the true generator output is 1,000 watts, minus 800 watts, delivered back to it by the second motor, or 200 watts. This 200 watts is the real work being done by the generator, with regard to its electrical output.

Now let us look for a moment at the first electric motor on the shaft, which is being supplied with energy from the laboratory power supply. This motor rated at two horse-power, and with an efficiency of 80 per cent, requires 100 watts to operate it with no load. The total input of electrical energy to this motor is, therefore, 100 watts (no-load energy) plus 450 watts, representing the I²R and mechanical losses in the generator and second motor, or a total of 550 watts from the laboratory power supply.

It is at once seen of course, that the true generator electrical output is, as aforementioned, 200 watts, and that the efficiency, with regard to the generator only, is therefore, 200 divided by 550, or 36 per cent (generator efficiency) with regard to the power supply.

As outlined above, there is no over-all efficiency, as there is no real output from this machine.

The D. C. meters in the input circuit are really measuring merely the electrical and mechanical losses in the three machines, as pointed out yesterday by Mr. Koenig, the engineer in charge at the Electrical Testing Laboratories, and by Mr. Paul Findley (of the Bell Telephone Laboratories), and Prof. Hehre (of Columbia University).

If a physical proof of our analysis of your machine is required, it is very simple to produce this by simply connecting a torsion dynamometer between the second motor and the generator, in order to indicate the amount of mechanical energy returned by this second motor to the generator; which of course will have to correspond to the figures given in the above analysis.

Cordially yours,
SCIENCE AND INVENTION,
(Signed) H. WINFIELD SECOR,
Managing Editor.

Dict. H. W. Secor
SH.

(Continued on page 573)

\$25.00 Drawing Course for \$2.98

Haven't you often wished that you could draw cartoons, illustrate some idea, sketch some pretty face, etc.? You can do all of these things. One of America's most famous Cartoonists and Illustrators has developed a great, simple system for success in all branches of Commercial Art. This system has revolutionized the entire theory of drawing. It means that drawing can be as easy for you as writing—much simpler than learning short hand, bookkeeping or typewriting.

We are now placing this original system for learning Drawing, Art and Cartooning, consisting of 34 lessons with over 500 illustrations, within reach of every one. If you will devote a few hours each week to the course WE ABSOLUTELY GUARANTEE that you will learn to draw and draw well before you have half finished the Course. If we fail to make this claim good we will refund every cent paid us. By eliminating a large office force for answering correspondence, expensive catalogs, etc., we are enabled to make a price of \$2.98, the cheapest price ever known for a high-grade home-study course. Many have sent us letters similar to that of Robt P. Davis of Detroit, who wrote: "I can't see how you ask so little, when others with inferior Courses get \$20 to \$60 for theirs. It is more than I expected." Learn to draw. It is a big asset, no matter what field you are in.

Send No Money

Just order the Course, and \$2.98 plus a few cents postage on arrival pay postman in full for the entire Course and Free Drawing Outfit. If not entirely satisfied, return within five days and we will REFUND MONEY. Address:

LEDERER SCHOOL OF DRAWING, Dept. 4502-V
Chattanooga, Tenn.

Orders from outside the U.S.A. are payable \$3.28 cash with order.

FREE: If you order the Course at once we will include a drawing outfit, consisting of artist's pencils, pens, paper, erasers, thumb tacks, etc., enabling you to go to work without any additional cost.



PLUMBING-HEATING

Install Your Own—Save Half

Lowest wholesale prices on highest quality Grade A goods. Any Handy Man can install his own Plumbing and Heating BY OUR NEW EASY METHOD. Get the best and pay only a little each month.

Send for FREE Book.

New bargain catalog just issued. With our cut-to-fit systems you save waste material and high labor cost. 50 years of economical service to home owners, farmers, builders and mechanics. Million Dollar Plans back up our Bonded Guarantee. FREE book gives you the whole story. Write for your copy today.

OVER 50 YRS. HARDIN-LAVIN Co. EST. 1876
104-14 West Pershing Rd., Chicago, Ill.

FREE CATALOG

Hunting shoes, leather hats, caps, and jackets. 40 items.

L. L. BEAN
23000 Main Street
Freeport, Me.



SELF STARTING POCKET LIGHTER.

WINNER FOR AGENTS

New pocket lighter: What makes it light? Why can't a bilizard blow it out? No flint—No friction—No troublesome parts. Why fool with matches now? Instant—infalible—guaranteed. Send 50c for sample and selling plans. Sample Gold and Silver Plated.....\$1.00

NEW METHOD MFG. CO. Box S.I.-10 Bradford, Pa.



MUSIC LESSONS IN YOUR HOME

You can read music like this quickly



Write today for our **FREE BOOKLET**. It tells how to learn to play Piano, Organ, Violin, Mandolin, Guitar, Banjo, etc. Beginners or advanced players. Your only expense about 2c per day for music and postage used.

AMERICAN SCHOOL OF MUSIC, 57 Manhattan Bldg., Chicago

You can be quickly cured, if you STAMMER

Send 10 cents for 288-page book on Stammering and Stuttering. "Its Cause and Cure." It tells how I cured myself after stammering 20 yrs. B. N. Bog 8145 Bogue Bldg., 1147 N. 111 St., Indianapolis

Oh! See All!

Big 3 1/2 Ft. Telescope

Lend wings to your eyes! People and objects miles away seem close. Wonder telescope brings new pleasures to home, farm, camp, travel, sport. Study the mysterious Sun spots; see Moon and Stars as never before. See people on the beach, on the mountains, etc.

FREE Yes, absolutely free! A handsome leather carrying case and shoulder strap. Also solar eye piece to view the Sun—a special feature—found only on expensive instruments.

5 Sections
8 Power Lenses
Brass bound; measures 12 in. closed; powerful achromatic lenses protected by dust caps.
Thousands Pleased
Watched writes: "rines three miles off coast." Ed. Foster: "all time on clock five miles away." C. Scribner: "See lighthouse 18 miles away." Mrs. Yarbrough: "Could tell color of airplanes four miles away." B. H. Gearheart: "Can see man working seven miles away." A. R. Walker: "Would not take \$10 for it."
Travel and Sport
Study the Heavens
At the Races

SEND NO MONEY

On delivery of Telescope, free Case and Eye Piece pay Postman only \$1.85, plus postage. (2 complete outfits \$3.60.) Satisfaction guaranteed or money refunded. Send today, entertain your friends!

FERRY & CO., Dept. 1258, Chicago

At Last! Control of Radio Reception from Your Easy Chair

Turn set on and off—get station after station—swiftly—surely—DX—without leaving your easy chair.



The NEW Thermodyne
Remote Control Radio Tuning Unit
No other tuning unit in the world like it. Tune your set from any room of your home. Attached to your single dial receiver with removable dial in a few minutes by removing old dial and attaching adapter plate with Remote Control Unit.
Mechanical Model...\$18
Electrical Model...\$60
West of Rockies add 10%
Write today for circular describing radio's newest and most revolutionary development.

ALGONQUIN ELECTRIC COMPANY, Inc.
Leo Potter, President
245 Fifth Avenue, New York City

A Test Every Man Past 40 Should Make

Medical authorities claim that 65% (nearly two-thirds) of all men past middle age suffer with a disorder of the prostate gland. But now a well-known American scientist has written a free book which tells how this gland may be reached by a new kind of hygiene, without drugs or surgery. If you have prostate trouble or any of the common symptoms such as aches in feet, legs and back, sciatic pains, broken sleep, often arising from prostate trouble, write immediately for this booklet, which will be sent free without obligation. Simply ask for "Why Many Men Are Old at 40." The Electro Thermal Company, 457 1/2 Main St., Steubenville, Ohio.

POPULAR CHEMISTRY
A Monthly Chemical Magazine
Latest chemical news, experiments, formulas, answers to chemical questions, new compounds and their preparation, etc. Three trial copies 50 cents. \$1.00 per year. Substibility chart and book catalog sent free to yearly subscribers.
POPULAR CHEMISTRY COMPANY
Dept. B Swedesboro, N. J.

Wrestling Book FREE
Tells how to be a great athlete and scientific wrestler—how to WIN. Starring secrets taught in wonderful lessons by world's champion Farmer Burns and Frank Gotch. Be strong, healthy, athletic. Handle big men with ease. Learn self defense. Be a leader. Men and boys, write for Free Book today. State your age.
Farmer Burns School, 3797 Railway Bldg., Omaha, Neb.

Insure your copy reaching you each month. Subscribe to **SCIENCE & INVENTION**—\$2.50 a year. Experiment Publishing Co., 250 5th Ave., N. Y. C.

MR. HAMILTON REPLIES

New York City,
June 28th, 1927.

MR. H. GERNSBACK, Pres.,
SCIENCE AND INVENTION,
230 Fifth Avenue,
New York City.

Dear Sir:

Replying to yours of the 24th inst., regarding the outcome of the test at the Electric Testing Laboratory, I wish to call your attention to the following:

If you take a glance at your contract with me, dated last August, you will find that the machine was to be submitted to an actual test, and the output was to be measured by the legal yardstick, and the electric meters, as well as the input. Furthermore, the same contract says that you will abide by the verdict of the laboratory.

If you will consult the written reports of the laboratory, you will see that the power recorded by the meters on the output side was greater than that recorded by the meters on the input side.

If you will consult your lawyer and submit your contract, and the written report of the laboratory, you will be informed that you have violated your contract by refusing to pay me \$5,000.

The same lawyer will tell you that I lived up to my side of the contract.

It is well understood that when those who occupy what they presume to be an impregnable fortress, suddenly find the enemy inside, confusion results and they resort to every weapon at hand to out the enemy.

Better yet, it might be said that complacency, when surprised, does some very inconsistent things.

Your reference to Professors Findley and Hehre, and Mr. Koenig, is entirely beside the point and is in direct violation of your written agreement to abide by the verdict of the laboratory.

In settling electrical power measurements, the tongues of professors are not used, one does not pile a lot of text books alongside the machines, or even consult the users of the electric meters. The electric meters do all the talking, and settle the question.

In your letter of June 24th, you make reference to apparent energy. If you gaze at the construction of direct current voltmeters and ammeters, you will find that they know nothing about apparent energy, and can record nothing but actual energy.

If you look at the laboratory report, you will find that when the generator outer circuit was open, that the ammeter registered zero, because no energy was flowing through the circuit.

The meters were honest and totally indifferent to professional opinion; they gave an impartial reading.

Before the test was made, neither the laboratory nor your committee questioned the hook-up, and had no comments until, in their amazement, they saw the meters record a greater output than input.

I have con-ulted the Better Business Bureau, submitting your contract, and the laboratory report of the meter readings. I was informed that your failure to abide was a crime, but strange to say, not criminal; in other words, I would have to enter civil suit.

Upon my presenting your written contract and the written report of the meter readings to a lawyer, he informed me that it was a very pretty case of breach of contract. He has taken steps to sue.

When the papers reach you, your lawyer will undoubtedly tell you that you have no leg to stand on, because his source of information is the same as that of my lawyer.

The unfortunate part of the affair is that when I came here from Kansas City I paid your honesty the highest compliment I could, by not bringing enough money to return. Your failure to live up to your contract is embarrassing. Perhaps if you look closely at your agreements and the laboratory meter readings, you will see that no professor, no textbook, nor anyone's opinion helps you. The actual test placed the entire affair beyond the opinion stage.

The universal opinion was against me to start with, and you agreed to submit the machine to an actual test and submit to the meter readings.

It is to be hoped that you will see the justice of my claim, and will pay me the \$5,000 which I have earned by 16 years' study, the expenditure of several thousand dollars in experimental work, and railroad fare from Kansas City to your city on two occasions.

Your assistant, Mr. Secor, told me that if you were to publish the result of the test, you would be laughed at.

Last August I told you that I did not think you possessed the courage to print the findings, if they were in my favor; because it would run counter to the prevailing scientific opinion. You assured me that you had the courage to print anything.

Apparently your courage has failed you.

There is nothing in the contract forcing you to publish the affair, but it is incumbent upon you to pay me the \$5,000, because I accepted your word in good faith, spent hundreds of dollars that I can ill afford to lose, and delivered a machine which the meters say had an output that exceeded input. For two days my address will be the Herald Square Hotel, 116 W. 34th St., after which, 5806 Lecust St., Kansas City, Mo.

Again I suggest that you consult a lawyer, who will tell you to pay at once.

Hoping to receive your check within the next two days, I am

Yours very respectfully,
(Signed) JOHN S. HAMILTON.
(Concluded in next issue)

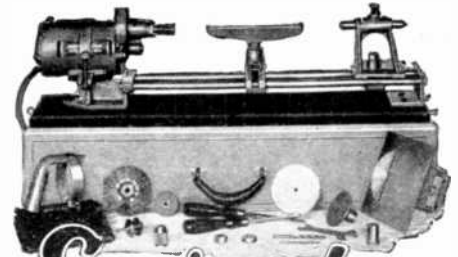

Easy to - Make Things at Home! with Speedway Shop!

HAVE fun and make money! Try it for ten days right in your own home. See how practical this wood and metal working outfit is. For mechanics, repair men, handy men and all tool lovers.

Yours for 10 Days Free!

Take advantage of our 10 days' free trial offer! Test the Super Speedway Shop in your own home! If it fails to do what we claim for it, we will cheerfully refund the ten dollars.

Eight Motor-Driven Tools

Super Speedway Shop gives you a privately owned machine shop right in your home. This sturdy combination of tools gives you a complete Lathe—a Bench Saw—a Jig Saw—a Portable or Stationary Power Drill, especially equipped for buffing, grinding and cleaning. Works from any lamp socket.

Only \$10.00 Down

Pay while you are enjoying your Super Speedway Shop. Only \$10 down and balance in easy monthly payments, puts one of these sturdy, efficient Super Speedway Shops in your home.

Free Blue Prints

We furnish 24 working blue prints free with each Speedway Shop. Enables you to make attractive furniture, novelties, toys, radio work, bric-a-brac for gifts or sale.

Don't Delay—Write Today
Remember—the Shop is a money-maker for the small-job man, and fun for the man who has learned the joy of working with tools at home. Write today.

SpeedWay—A Complete Line

The makers of Super Speedway Shop are the world's only manufacturers of a complete line of Portable, Electrically Driven Saws, Hammers, Drills, etc.

Sales and Service in All Principal Cities—

ELECTRO MAGNETIC TOOL CO.
1830 S. 52nd Ave., Cicero, Ill. (Adj. Chicago)
Manager, Dept. 3-O. Please send me full particulars about your 10-day free trial on the Speedway Shop.
(If interested in other tools, please write.)
Name
Address

You can now Own a Typewriter!

\$3.00 DOWN and its yours *guaranteed for 5 years*

Think of it! You can now get a Genuine Underwood for only \$3 down and small monthly payments.

Special FREE TRIAL Offer
Don't send any money now, just mail in the coupon for full information about our special free trial offer and special prices and terms.

Any One Can Operate a Typewriter

You can learn to write on this machine in a week's time! We will give you FREE a typist's manual and a FREE course in touch typing! Write at once, don't delay, send the coupon NOW!

Shipman-Ward Mfg. Co.,
2187 Shipman Bldg., Chicago
World's Largest Rebuilders

Name
Address

Opportunity Ad-lets

YOU will find many remarkable opportunities and real bargains in these columns. It will pay you to read and investigate the offerings made every month by reliable firms, dealers and amateurs from all over the country. No matter what you may be seeking, whether supplies, automobile accessories, the opportunity to make money, or anything else, you will find listed here the best and most attractive specials of the month.

Advertisements in this section twelve cents a word for each insertion. Name and address must be included at the above rate. Cash should accompany all classified advertisements unless placed by an accredited advertising agency. No advertisement for less than 10 words accepted.

Ten per cent discount for 6 issues, 20 per cent discount for 12 issues. Objectionable or misleading advertisements not accepted. Advertisements for the December issue must reach us not later than October 15.

EXPERIMENTER PUBLISHING CO., INC., 230 Fifth Avenue, New York, N. Y.

Advertisers and Distributors

Earn \$8. Distribute 400 free Samples Stopleak Rivets. Send 6c stamps for samples and secure territory. Rivet Co., Cohoes, N. Y.

Advertising Agencies

Advertise 50 magazines \$4.00 inch, thrice \$8.00; circulation proven. King, Box 672 I, Wilmington, Delaware.

Agents Wanted

Salesman Selling to Men: We have side line for you that will sell along with any line you may now be handling and make more money for you, provided you are now selling to men. Get facts at once. Address Salesmanager, 844 West Adams, Dept. 210, Chicago.

Agents—90c an hour to advertise and distribute samples to consumers. Write quick for territory and particulars. American Products Company, 9243 Monmouth, Cincinnati, Ohio.

\$75.00 Weekly to Introduce "Chieftain" 3 for \$4.95 Guaranteed Tailored Shirts. Full working outfit free. Your own shirts free. Cincinnati Shirt Company, Lane 27010, Cincinnati, Ohio.

Agents—startling new automatic device banishes can openers! Patented. Absolutely unique. Boods can on wall. Simple turn of crank cuts top out. Clean. Sells fast. Write for Free Test Offer. CENTRAL STATES MANUFACTURING CO., Dept. M-951, 4500 MARY AVE., ST. LOUIS, MO.

Agents—Make \$500.00 monthly. Pay daily. No investment. Rhinestone Initial buckles and Novelties. Sell easy everywhere. Exclusive territory. CIATON NOVELTY CO., 606 Blue Island, Chicago.

Earn \$10 daily silvering mirrors, plating, refinishing metalware, headlights, chandeliers, bedsteads. Outfits furnished. N. Decis Laboratories, 152 E. 23 Street, New York.

New Invention—100% profit. Liquid quick mend for Fabrics and Hosiery. Stops runs. Every woman buys. Hundred other fast sellers. J. E. JOHNSON CO., Dept. 857, 6129 Wentworth Ave., Chicago.

Don't sell for others. Employ agents yourself. Make your own products. Toilet articles, Household Specialties, etc. 500% profit. We furnish everything and show you how. Valuable booklet free. Write at once. National Scientific Laboratories, 1995 W. Broad, Richmond, Va.

Agents—Fred Chapdelaine made \$70.00 one week. Start your own business. Make 100% profit. New magic powdered hand cleaner. Entirely different. Washes hands cleaner and in half the old time. A man's job. Big repeater. Free samples furnished to be given away. Write for free trial package. R. Magnus Chemical Co., 728 Atlantic Ave., Brooklyn.

Show and sell nationally known Pure Silk hosiery and lingerie. Amazing values. Make \$12.00 daily. Experience unnecessary. Free sample outfit. PURE SILK HOSIERY CO., 208 W. Monroe, Dept. R182, Chicago.

Open Rummage Store. We furnish everything. \$75.00 daily, write for free particulars. B. Young, 2549 S. Halsted, Chicago.

We Start You in Business, furnishing everything; men and women, \$35.00 to \$100.00 weekly operating our "New System Specialty Candy Factories." Few dollars start you home or small room anywhere. Booklet free. W. HILL-YER RAGSDALE, Drawer 129, East Orange, N. J.

Agents—New Plan, makes it easy to earn \$50.00 to \$100.00 weekly, selling shirts direct to wearer. No capital or experience needed. Represent a real manufacturer. Write now for FREE SAMPLES. Madison Company, 566 Broadway, New York.

Radio Agents—Make Big Money—Easy! Selling Marvelous New Sets and Accessories. Buy from factory at lowest prices. Get Big New Catalog with thousands of nationally advertised bargains. FREE Call Book. Write today. American Auto and Radio Co., Dept. 278, Radio Bldg., Kansas City, Mo.

\$10 daily silvering mirrors, plating and refinishing lamps, reflectors, autos, beds, chandeliers by new method. Outfits furnished. Write Gunmetal Co., Ave. D, Decatur, Ill.

Agents—Best seller; Jem Rubber Repair for tires and tubes; supercedes vulcanization at a saving of over 800 per cent; put it on cold. It vulcanizes itself in two minutes and is guaranteed to last the life of the tire or tube; sells to every auto owner and accessory dealer. For particulars how to make big money and free sample, address Amazon Rubber Co., Philadelphia, Pa., Dept. 601.

\$60—\$200 a week. Genuine Gold Letters for store windows. Easily applied. Free samples. Liberal offer to general agents. Metallic Letter Co., 441 B., North Clark, Chicago.

Make Money Silvering Mirrors, refinishing auto headlights, tableware, metal plating, bedsteads, chandeliers. Outfits furnished. International Laboratories, Dept. 69, 309 Fifth Ave., New York.

Big money and fast sales. Every owner buys gold initials for his auto. You charge \$1.50; make \$1.35. Ten orders daily easy. Write for particulars and free samples. American Monogram Co., Dept. 71, East Orange, N. J.

\$50.00 Weekly easy, applying Gold Initials on Automobiles. No experience needed. \$1.45 profit every \$1.50 job. Free Samples. "Ralco Monograms", R1013, Washington, Boston, Mass.

Agents Wanted (continued)

Just Out—Patented Apron. No strings or straps; on or off instantly; \$20 a day easy; every demonstration a sale; over 100% profit; commissions daily; write today for free offer. Sta-Put Co., Dept. 510, St. Louis, Mo.

Gold Leaf Window Letters & Script Signs. No experience; 500% Profit. Samples free. Consolidated, 69-R-West Van Buren, Chicago.

You Are Wanted to Resilver Mirrors at Home. Immense profits plating autoparts, tableware, etc. Write for information. SPRINKLE, Plater, 955, Marion, Indiana.

Succeed With Your Own Products. Make them yourself. Formulas, Processes, Trade-Secrets. All lines. Catalog, Circulars free. D. Thaxly Co., Washington, D. C.

Make \$25.00 daily selling colored Raincoats and Slickers, Red, Blue, Green, etc. \$2.95—Hat Free. Commissions daily. Outfit FREE. Elliott Bradley, 241 Van Buren, Dept. Ad-10, Chicago.

\$40.00 Suits for \$23.50! All one price. Union made of finest quality Virgin Wool. You don't have to know anything about selling clothing. We guarantee your success if you are honest and willing to work. Write at once. WILLIAM C. BARTLETT, 850 Adams, Dept. 587, Chicago.

Men or Women—to advertise and distribute to consumer. The World's Ice Saver. 149% profit; experience not necessary, write for sample. Insulated Fabric Specialty Co., 183 Race St., Butler, Pa.

Airplanes, Aviation

Send dime for 12 inch mounted propeller and circulars on free three foot model aeroplane. No selling. Aero Shop, 3050 Hurbit Ave., Detroit, Mich.

Biggest, Best Catalog Model Airplanes, Parts, Supplies; 5c postpaid. Ideal Company, 169 1/2 Spring Street, New York.

Airplanes—Send for free cuts and Plans of our wonderful two Place, Companion type, small, high life wing monoplane, and information. How to build this ship, and be sure it will fly, also Propeller literature. Crawford Airplane Manfr., 2225 American Ave., Long Beach, Calif.

Learn Aviation! Earn your way if you lack the cash. Varney Aircraft Co., Peoria, Ill.

Books

Art and Book Lovers—Send 3 red stamps for our interesting valuable offers. Dr. Lorenzo, 5851 Wentworth Ave., Chicago.

The Scientist—12 large pages. Sample 5c—year 60c. Stories, Experiments. Scientist, 7 East Broadway, New York City.

Free—My Illustrated Circulars on Newthought, Selfculture, Healing, Yoga Philosophy, Occult, Mystic and Scientific Books. Martens Publisher, Inc., Burlington, Iowa.

Mesmerism-Hypnotism, practical book, 25c. Mind reading 25c. Special! Both books 40c. Housinger Novelties, 8236 Cornell, Chicago.

Business Opportunities

Sell By Mail!—Books, novelties, bargains; large profits! Particulars FREE! E-Elco, 525 South Dearborn, Chicago.

Print 250 Signs or Pictures an hour without press, type or machinery. Sample and particulars 10c. Straco, 1015 1/2, Springfield, Ohio.

Would twenty dollars a day interest you? Spare time. At home. Very small investment. Permanent. Instructions \$2. E. L. Onstott, Brady, Nebr.

Sell by Mail—Free literature tells how. Mason, 3902 Broadway, Room 6, Chicago.

Cameras and Photography Supplies

Make money in Photography. Learn quickly at home. Spare or full time. New plan. Nothing like it. Experience unnecessary. American School of Photography, Dept. 5332, 3601 Michigan Avenue, Chicago.

Chemistry

Your Chemical problems solved and working process furnished for Five Dollars. Write me, W. Sledman Richards, Consulting Chemist, Box 2402, Boston, Mass.

Learn Chemistry at Home. Dr. T. O'Connor Sloane, noted educator and scientific authority, will teach you. Our home study correspondence course fits you to take a position as chemist. See our ad on page 486 of this issue. Chemical Institute of New York, 16 E. 30th St., New York City.

Solubility chart free. See POPULAR CHEMISTRY ad on page 573.

Correspondence Courses

Used correspondence school courses sold on repurchase basis. Also rented and exchanged. Money-back guarantee. Catalog free. (Courses bought). Lee Mountain, Pisgah, Alabama.

Home Study—Engineering, Bookkeeping, Higher Accountancy, High School, and other courses. Write Carnegie College, Rogers, Ohio.

Drawing

Cartooner Makes anyone draw cartoons. Complete sample 12c. Cartoonist Longway, Wabasha, Minn.

Electricity

Electric Fun! Seventy stunts, 110 volts, \$1. Cuttington, Campbell, Calif.

For Boys

Luminous Paint Bargain. Paint skeletons, etc. Large bottle 25c coin. Chemix Company, Box 1473, Denver, Colorado.

For Inventors

Inventions Commercialized. Patented or Unpatented. Write Adam Fisher Mfg. Co., 205 Enright, St. Louis, Mo.

Unpatented Ideas Can Be Sold. I tell you how and help you make the sale. Free particulars (Copyrighted). Write W. T. Greene, 808 Jenifer Bldg., Washington, D. C.

Patents Obtained under cooperative payment plan. Write for particulars. W. E. Berk, Registered Patent Lawyer, 953 Jenifer Bldg., Washington, D. C.

Formulas

Manufacturing Pays Big Profits. Latest, dependable Formulas, Processes, Trade-Secrets. Best Sellers. Valuable information free. Specialty Mfg. Service, 801 So. Farragut, Bay City, Mich.

Any formula free. See POPULAR CHEMISTRY ad on page 573.

We are Better Able to Supply you with reliable formula service because of our twenty-five years' experience as research chemists. No matter what kind of formula service you may require be sure to get our advice first. Formulas and methods are constantly improving and only the best and most up to date are worth while. We supply practical working formulas for Flavoring Extracts, Soft Drinks, Shoe Polishes, Toilet Preparations, Barber Supplies, Automobile Specialties, Paints, Food Products, etc. Make your own goods at home and make the long profits. Why give it to the other fellow? Lists free. ARTHUR WINDECKER RESEARCH LABORATORIES, Box 536-BB, Oak Park, Ill.

Invisible Ink—Make your own invisible ink for fun and profit. Formula 25 cents. Valco, Box 1, Ottawa, Ill.

For Sale

For Sale—Patented hair curler, ends clamped and wound to head—makes beautiful curl. L. L. Flood, Okeechobee, Fla. Box 742.

Games and Toys

Boys! Boys! Look! Big illustrated catalogue of Tricks, Puzzles, Novelties, Jewelry. Send 10c for your copy today. Sincere Studios, 24 E. 21st St., New York, Dept. 12.

Health

Nervous Sufferers, my course "Nervous Breakdown" will help you. Complete Instruction One Dollar. Arthur Moore, Tappan, N. Y.

Help Wanted

Firemen, Brakemen, Baggage-men (white or colored), sleeping car, train porters (colored), \$150-\$250 monthly. Experience unnecessary. 897 Railway Bureau, East St. Louis, Ill.

You Are Wanted. Men—Women, 18 up. Get U. S. Government Life Jobs. \$95.00 to \$250.00 Month. Steady work. Short hours. Paid summer vacation. Full or experience unnecessary. Common education sufficient. We coach you without leaving home. 32-page book with full particulars FREE. Write immediately. Franklin Institute, Dept. P4, Rochester, New York.

You Are Wanted. U. S. Government Life Jobs. \$95.00 to \$250.00 Month. Men-women, 18 up. Steady work. Vacation. Experience unnecessary. Common education sufficient. 25 coached free. List positions and full particulars FREE. Write today sure. Franklin Institute, Dept. P4, Rochester, N. Y.

Men, get Forest Ranger job; \$125-\$200 mo. and home furnished; permanent; hunt, fish, trap. For details, write Norton, 265 McMann Bldg., Denver, Colo.

Country representative for credit Bureau. Liberal drawing account, commission. Western Credit Index, 3207 Lankership Bldg., Los Angeles, Calif.

South American Jobs, one dollar for facts and names of employers; just returned over eighteen years Central and South America. Write, 609 N. 10th St., Reading, Pa.

Government Forest Rangers, Meat Inspectors, Patrol Guards, Special Agents, Mail Clerks, Chauffeur-Carriers needed often. \$125-\$250 month. "How to Qualify" mailed free. Write, Ozment, 293, St. Louis, Mo.

Help Wanted (continued)

Men Wanting Outdoor Work, qualify for forest ranger position. Start \$125 monthly; cabin and vacation; patrol the forests, protect the game; give tourists information. Write Mikane, Dept. M-34, Denver, Colo.

Silvering Mirrors, French plate. Easily learned. Income-producing. Plans free. Wear Mirror Works, 16 W. Evesham Springs, Mo.

Detectives Earn Big Money. Travel. Excellent opportunity. Great demand everywhere. Experience unnecessary. Write American Detective System, 2190 Broadway, N. Y.

Distributors—No canvassing, no capital. Honorary. Roseto, Pa.

Be A Detective. Work home or travel. Experience unnecessary. Particulars free. George Wagner, 2190 Broadway, N. Y.

Instruction

Learn Chemistry at Home. Dr. T. O'Connor Sloane, noted educator and scientific authority, will teach you. Our home study correspondence course fits you to take a position as chemist. See our ad on page 291 of this issue. Chemical Institute of New York, 66 W. Broadway, New York City.

Dancing—Full instructions \$1.00. Stewart's, 3116 North Third Street, Philadelphia, Penna.

Inventions Wanted

Inventions Commercialized, Patented or Unpatented. Write Adam Fisher Mfg. Co., 205 Enright, St. Louis, Mo.

Will buy approved invention. Write W. L. Kendig, 416 N. Duke Street, Lancaster, Pa.

Machinery and Tools

Concrete Building Block Machines and Molds. Catalog free. Concrete Machine Co., 5 N. First St., St. Louis, Mo.

Magic and Games

Free with \$25 order our large die box. Send 20c for our large catalogue of tricks, puzzles, wigs, sensational escapes. Oaks Magical Co., Dept. 511, Oshkosh, Wis.

Card tricks, Coin tricks, Hypnotism, Ventriloquism. 61-page books. Complete guides 10c. each. G. Fenner, 2101 Jefferson, Louisville, Ky.

Magic—For something new and different, send 10c for large magical catalogue. Sterling Magic Co., Box 33, Danville, Va.

Manuscripts—Short Stories Wanted

Earn \$25 weekly, spare time, writing for newspapers, magazines. Experience unnecessary. Details Free. Press Syndicate, 987, St. Louis, Mo.

Make \$25 Weekly at home, spare time, writing short stories for photoplays. Experience unnecessary. Outline free. Producers League, 603, St. Louis, Mo.

Miscellaneous

Beautiful Registered Bull Pups, \$15. Bulldogs, 501 Rockwood, Dallas, Texas.

Forms to cast Lead Soldiers, Indians, Marines, Trappers, Animals, 151 kinds. Send 10c for Illustrated Catalogue. H. C. Schiercke, 1034-72nd St., Brooklyn, N. Y.

Build Your Own Boat using our KNOCK-DOWN frames and ready-cut materials. 55 Models. Cruisers, runabouts, speed, outboard motor speedsters row and sail. Send 25c for catalog. BROOKS BOAT CO., Inc., King Street, Sackinaw West Side, Mich.

Hunting Hounds Cheap; trial. Dixie Kennels, CI, Herick, Ill.

Cash's Woven Names. For marking men's, women's, children's clothing. Sample free. Imperial Mail-Order House, 186 Collette, Dept. 15, New Bedford, Mass.

Underground Treasures. Simple, scientific method for locating explained free. T. Santschi, Glenellyn, Ill.

Films and Machines, dirt cheap. Stamp for lists. Box No. 5836, Westport Station, Kansas City, Mo.

Models and Model Supplies

Gears and Model Supplies of every description. Catalog 5 cents. Experimenters Supply House, Box 10, Station Y, New York City.

Motorcycles—Bicycles

Motorcycle Bargains. Used, rebuilt. Guaranteed shipped on approval. Catalog free. Floyd Clymer, 812 Broadway, Denver, Colo.

Moulds

Moulds Making Toys. See ad on page 478. Miscellaneous. H. C. Schiercke.

Musical Instruments

Violins—Deep, Mellow, Souful—on easy credit terms. High grade, wonderful instruments of my own make. Development of many years' experience. Write for book. Gustav A. Henning, 2424 Gaylord St., Denver, Colo.

Old Coins

California Gold, quarter size, 27c; half-dollar size, 53c. Columbian nickel and catalogue, 10c. Norman Shultz, Box 716, Salt Lake City, Utah.

Old Money Wanted

\$2 to \$500 Each paid for hundreds of Old or Odd Coins. Keep all old money. It may be very valuable. Send 10c for new illustrated Coin Value Book, 16c. Guaranteed Prices. Get Posted, we pay Cash. Clarke Coin Company, 11 Street, Leltoy, N. Y.

Partner Wanted

Partner Wanted—One who understands the psychological phases of induction to assist woman with THE Wonder Invention of the age. Address, Invention, Box 587, Asbury Park, N. J.

Patent Attorneys

Millions spent annually for ideas! Hundreds now wanted! Patent yours and profit! Write today for free book—tells how to protect yourself, how to invent, ideas wanted, how we help you sell, etc. American Industries, Inc., 212 Victor Bldg., Washington, D. C.

Richard E. Babcock, Patent Lawyer, Washington Loan & Trust Bldg., Washington, D. C., Booklet.

Monroe E. Miller, Ouray Bldg., Washington, D. C. Patent Lawyer, Mechanical, Electrical Expert. Booklet and Priority Record blank gratis.

Patents—Send for form "Evidence of Conception" to be signed and witnessed. Form, free schedule information free. Lancaster and Allvine, Registered Patent Attorney in United States and Canada, 212 Ouray Bldg., Washington, D. C.

Patents Procured; Trade Marks Registered—A comprehensive, experienced, prompt service for the protection and development of your ideas. Preliminary advice gladly furnished without charge. Booklet of information and form for disclosing idea free on request. Richard B. Owen, 130 Owen Bldg., Washington, D. C., or 41-F Park Row, New York.

Patents. Send for free booklet. Highest references. Best results. Promptness assured. Send model or drawing for examination and advice. Watson E. Coleman, Patent Attorney, 721-9th Street, N. W., Washington, D. C.

Unpatented Ideas Can Be Sold. I tell you how and help you make the sale. Free particulars. (Copyrighted). Write W. T. Greene, 809 Jenifer Bldg., Washington, D. C.

Patents. Time counts in applying for patents. Don't risk delay in protecting your ideas. Send sketch or model for instructions or write for Free book, "How to Obtain a Patent" and "Record of Invention" form. No charge for information on how to proceed. Communications strictly confidential. Prompt, careful, efficient service. Clarence A. O'Brien, Registered Patent Attorney, Security Bank Building (directly across street from patent office), Washington, D. C. See page 537.

Patents; Trade-Marks. Ten years experience in Patent Office. Consultation invited. Booklet. Geo. Beeler, 9 Park Place, New York.

"Inventor's Advisor", Valuable Patentbook sent free. Labiner, 3 Park Row, New York.

Patent, Trade-Marks, Copyrights. Reliable services by an experienced practitioner devoting personal attention to each case. Inquiries invited. References furnished. B. P. Fishburne, Patent Lawyer, 525-D McGill Building, Washington, D. C.

Patents obtained under Co-operative Payment Plan. Write for particulars. W. E. Beck, Registered Patent Lawyer, 952 Jenifer Bldg., Washington, D. C.

Get your own patents. Forms, complete instruction \$1 Cuttingbros, Campbell, Calif.

Patents secured for inventors on our new financial plan assuring prompt filing of application. Inventors' Service Bureau, Box 1018, Washington, D. C.

ADAM E. FISHER, Registered Patent Attorney, in business 25 years; references; personal attention and promptness assured; Dept. E, 205 Enright, St. Louis, Mo.

Patent Sense—As one of the oldest firms in America we give inventors, at lowest consistent charge, a service noted for results, evidenced by many well-known Patents of extraordinary value. Book, Patent-Sense, free. Lacey & Lacey, 641 F St., Washington, D. C. Estab. 1869.

PATENTS of careful protection by registered attorney. Former examiner Patent Office. Albert Jacobs, Barrister Building, Washington.

"Inventors' Guide" free on request; gives valuable information and advice for all who have original ideas or improvements. Frank Lederhann, Registered Attorney and Engineer, 17th Floor, Woolworth Bldg., New York.

Patents. Write for Instructions. Carl Miller, Registered Patent Attorney (former Patent Office Examiner), McGill Building, Washington, D. C.

Inventions Patented. Send sketch or model for advice and costs. M. Miller, 910 Gee Street, Washington, D. C.

Patents

Inventions commercialized. Patented or unpatented. Write Adam Fisher Mfg. Co., 205 Enright, St. Louis, Mo.

Patents Wanted

Inventions Commercialized. Patented or Unpatented. Write Adam Fisher Mfg. Co., 205 Enright, St. Louis, Mo.

Mr. Inventor—If you have a patent or invention for sale, write Hartley, 38 Court St., Bangor, Me.

Personal

Books and Imported French Novelties. Samples and Illustrated list 25c. Photo Institute, McAdoo, Pennsylvania.

Photography

Have you a Camera? Write for free sample of our big magazine, showing how to make better pictures and earn money. American Photography, 118 Camera House, Boston, 17, Mass.

Transfer Photographs to metal, china, etc. Patented process. Makes beautiful miniatures. A real art. Lot of fun and profit. Anyone can do it. Outfit supplied to members only. Write about membership. Kyograph Photo System, 21-D W. 17th St., New York

Photoplays Wanted

\$\$\$ For Photoplay Plots, Stories accepted any form, revised, criticized, copyrighted, marketed. Estab. 1917. Booklet free. Universal Scenario Co., 223 Western & Santa Monica Bldg., Hollywood, Calif.

Pipe Smokers

Join Thousands smoking South Clayschaum pipes. No nicotine bite or parch. Healthy, satisfying, economical. Six, \$1.00; three, 50c; two, 55c, postpaid. Send postal for description. Clayschaum Pipe Company, Importers, 118 Park Road, Dept. K-3, Washington, D. C.

Printing Outfits and Supplies

Print your own cards, stationery, circulars, paper, etc. Complete outfits \$8.85; Job Presses \$11, \$29; Rotary \$149. Print for others, big profit. All easy, rules sent. Write for catalog presses, type, paper, etc. Kelsey Company, P-6 Meriden, Conn.

200 Letterheads and 100 Envelopes, \$1.00, postpaid. OBERMAN COMPANY, Box 1268, Chicago.

250 Letterheads and 125 envelopes, \$1.50, postpaid. Oberman Company, Box 1268, Chicago.

Radio

Boys! Don't overlook this. The "Itason" Baby Detector, Greatest detector ever brought out with molded base. Fully adjustable. See former advertisements in this publication, or our catalogue. Detector with Galena Crystal complete 50c., the same detector with Radioelectric Crystal 75c. prepaid. Send for yours today. Radio Specialty Company, 100 Park Place, New York City.

30H, 50MA Shielded Chokes, \$2.25. Write for quotations on your requirements and lists of specials. Radio Parts Sales Co., Orange, N. J.

Salesmen Wanted

66 Miles on 1 Gallon—Amazing New Moisture Gas Saver. All autos. 1 Free. Critchlow, B-863, Wheaton, Ill.

TAILORING AGENTS. Earn \$35.00 to \$75.00 weekly, showing fine 100% Pure Virgin Wool \$23.50 suits, union hand tailored to measure. Equal usual \$35 to \$40 suits. Old reliable \$1,000,000.00 firm offers pay in advance. Exclusive territory, generous backing and big outfit of hundreds of large samples FREE. Write J. B. Simpson, 813 Adams St., Dept. 1382, Chicago.

40% Commission selling printed business stationery at knock-out prices. Free outfit. M Process Service, Minneapolis, Minn.

Punchboard Salesmen, 2 hours daily. \$100 every week. New line. Lowest prices. Full commission on repeat business. Catalog Free. Puritan Novelty Co., 1111-A Jackson, Chicago.

Song Poems

Song Poem Writers—Send for proposition. Ray Hih-beler, D21, 2101 N. Keystone Ave., Chicago.

Stamps and Coins

Stamps 100 All Different 3 cents. S. I. Quaker Stamp Company, Toledo, O.

100 Different Stamps FREE to Approval Buyers. Postage 3c. Write NOW. Winholt Stamp Co., Woodbine 27, Penna.

75 Stamps .07, 50 French Colonials .14. Koehler, 612 Meredith St., Dayton, Ohio.

Telegraphy

Telegraphy—Both Morse and Wireless—taught thoroughly and quickly. Tremendous demand. Big salaries. Wonderful opportunities. Expenses low; chance to earn part. School established fifty years. Catalog free. Dodge Institute, Stone St., Valparaiso, Ind.

Typewriters

Typewriters, all standard makes, \$10 up. Fully guaranteed. Free trial. Write for complete illustrated lists. Northwestern Exchange, 121 N. Francisco Ave., Chicago.

Wanted

Detectives Earn Big Money. Work home or travel. Experience unnecessary. Write, George Wagner, 2190 Broadway, N. Y.

**DON'T FAIL
to write for —**

**BOOK
BARGAIN
BULLETIN
No. 5**

**Remarkable savings
on all kinds of Books**

CONSRAD COMPANY, INC.
230 Fifth Ave. New York

FREE

This Perfect Writing Instrument THE NEW IMPROVED INKOGRAPH

Never before has any manufacturer of a standard writing instrument which is guaranteed to give perfect satisfaction, offered you so great a value. Remember, the Inkograph answers the purpose of both pen and pencil combined. Its point is shaped like a fine lead pencil point and writes with ink free and easy without a miss, skip or blur. The steady uniform flow of ink actually improves your handwriting. Won't blot, scratch, leak or soil hands.

You who already possess a standard fountain pen will find the Inkograph a most valuable addition to your writing equipment. For it will do everything any fountain pen can do and many very important things which it is impossible to accomplish with any fountain pen at any price.

HERE is your chance to get at no cost the new improved INKOGRAPH—a perfect writing instrument that operates like a fountain pen. The INKOGRAPH is guaranteed to give perfect satisfaction. It is a beautiful, finely shaped pen of exceptionally high standard of manufacture, strong, durable and handsome materials are used throughout. It is a pen that will stand "heavy duty service." It is a pen that anyone would be proud to own. Same size and shape as regulation \$7 and \$8 fountain pens.

We offer you one of these standard regulation INKOGRAPH pens as illustrated on this page ABSOLUTELY FREE merely for getting two of your friends or acquaintances to subscribe to either RADIO NEWS, SCIENCE and INVENTION, AMAZING STORIES, or SPARETIME MONEY MAKING. All four of these magazines are more fully advertised in another part of this magazine.

Easy to Get Subscriptions

It is the easiest thing in the world to get your friends to subscribe to these magazines. Every one of them who owns a radio set will be glad to have RADIO NEWS around; SCIENCE and INVENTION tells how to save money on building things for the home, and tells all about the marvelous inventions of the day; AMAZING STORIES is the biggest, finest, and cleanest fiction story magazine now being published; and SPARETIME MONEY MAKING will help those who want to make an extra income on the side.

So you see, you have many selling arguments. Convince two of your friends, take their subscriptions and we will send you one of these beautiful pens FREE.

Save Money

Your friends can save money by subscribing. That's one of your strongest talking points. The subscription price of SCIENCE and INVENTION is \$2.50 a year. Single copies sell for 25c each, or \$3.00 a year. They save 50c. The same saving is offered to subscribers for RADIO NEWS and AMAZING STORIES. The subscription price of SPARETIME MONEY MAKING is \$1.50 per year. The price on a single-copy basis would be \$1.80 per year. And these subscription copies are delivered by mail, whereas other readers must go out and purchase their issues at the stands. Furthermore a subscriber is always sure of receiving his copy, but the single-issue buyer, unless he gets to the stand on the day the magazine is received, may find all copies sold—and additional issues as scarce as hen's teeth.

The coupon below will be accepted by us as a regular subscription order. Clip it out, check the magazines you desire, enclose the correct amount and we will enter the subscriptions at once and send you a pen immediately.

The subscription prices are as follows: Radio News, \$2.50; Science & Invention, \$2.50; Amazing Stories, \$2.50; Sparetime Money Making, \$1.50.

Combines Features

of both pen and pencil, minus the weak points of both, plus improvements not found in either. The lead pencil smudges, the point breaks and its writing soon is obliterated. Most fountain pens skip, scratch, flood, clog, leak, blot, soil hands and clothing. The old stylographic ink pencil dries up, balks, blots, writes heavy, flows unevenly and is never reliable. The Inkograph feeds as fast and uniform on the 20th page as it did on the first.

Cannot Leak

Not the tiniest drop of ink will spill, although one filling is sufficient to write thousands of words. Will write on any quality of paper.

Makes 3 to 4 Carbon Copies

at one time with original in ink. Bear down as hard as you like without fear of bending, spreading, injuring or distorting its 14 Kt. solid gold point. Are you a salesman?—use an Inkograph, make out your orders in ink and retain a duplicate for your records. Do you wish to keep a copy of your private correspondence?—use an Inkograph. Do you do office work which requires clear carbon copies?—use an Inkograph. Do you make out bills or sales slips?—use an Inkograph and make a permanent original in ink with carbon copies. You can permit any one to write with your Inkograph, for no style of writing can affect the Inkograph point as it will a fountain pen.

What Users Say Counts Most

My Inkograph is the smoothest writing instrument with which I have ever written. That is saying a lot. I am a teacher by profession. I have a \$7.00 pen and another that cost more than the Inkograph, but Inkograph is better than either. It is the greatest improvement in writing instruments since the Babylonians recorded their thoughts on clay tablets with a triangular pointed reed. John R. Atwell, Chadwick, N. C.

I wouldn't take \$5.00 for the pen I am writing this letter with. I have a good fountain pen but don't write any more with it. I am proud of the Inkograph and that I can say this to you and mean every word of it. R. H. Wilson, Beckley, W. Va.

In making out local requisitions, it is necessary to make an original and two carbon copies on very heavy paper, and the Inkograph does this twice as well as the hardest indelible pencil, and is much neater and the original is much more legible. Wm. L. Fortney, Placerville, Ia.

It sure has improved my hand writing—I never took home any medals for penmanship but I can almost read my own writing since I got this pen. M. F. Johnson, Medina, Wis.

I want to thank you for the return of my Inkograph pen, which you repaired for me. I feel rather lost without this pen in my pocket. I prefer it to any pen I ever carried principally because of the ease with which one can write with it, not having to be careful whether you slide the pen to the North, East, South or West, it flows freely in all directions. Wm. B. Brown, New York, N. Y.

Delighted: It writes bully—you have invented a pen that is perfection. It is so much more rapid than my \$9.00 fountain pen. I wish you abundant success. S. L. Carlton, Aurora, Ill.

MAIL the COUPON NOW

EXPERIMENTER PUBLISHING CO., INC., 230 5th Ave., New York, N. Y.

Gentlemen: I enclose \$..... for 1 year (12 months) subscription to RADIO NEWS, SCIENCE AND INVENTION, AMAZING STORIES, SPARETIME MONEY MAKING. Send one "Inkograph" to me FREE.

My name is	Send	Send
My address is	(Mention name of magazine)	(Mention name of magazine)
City, State	to	to
.....	Name	Name
.....	Address	Address
.....	City, State	City, State

NOTE:—You must inclose full price for TWO subscriptions. Be sure to mention magazine or magazines desired and write plainly.

Let These Guides

Solve Your Problems

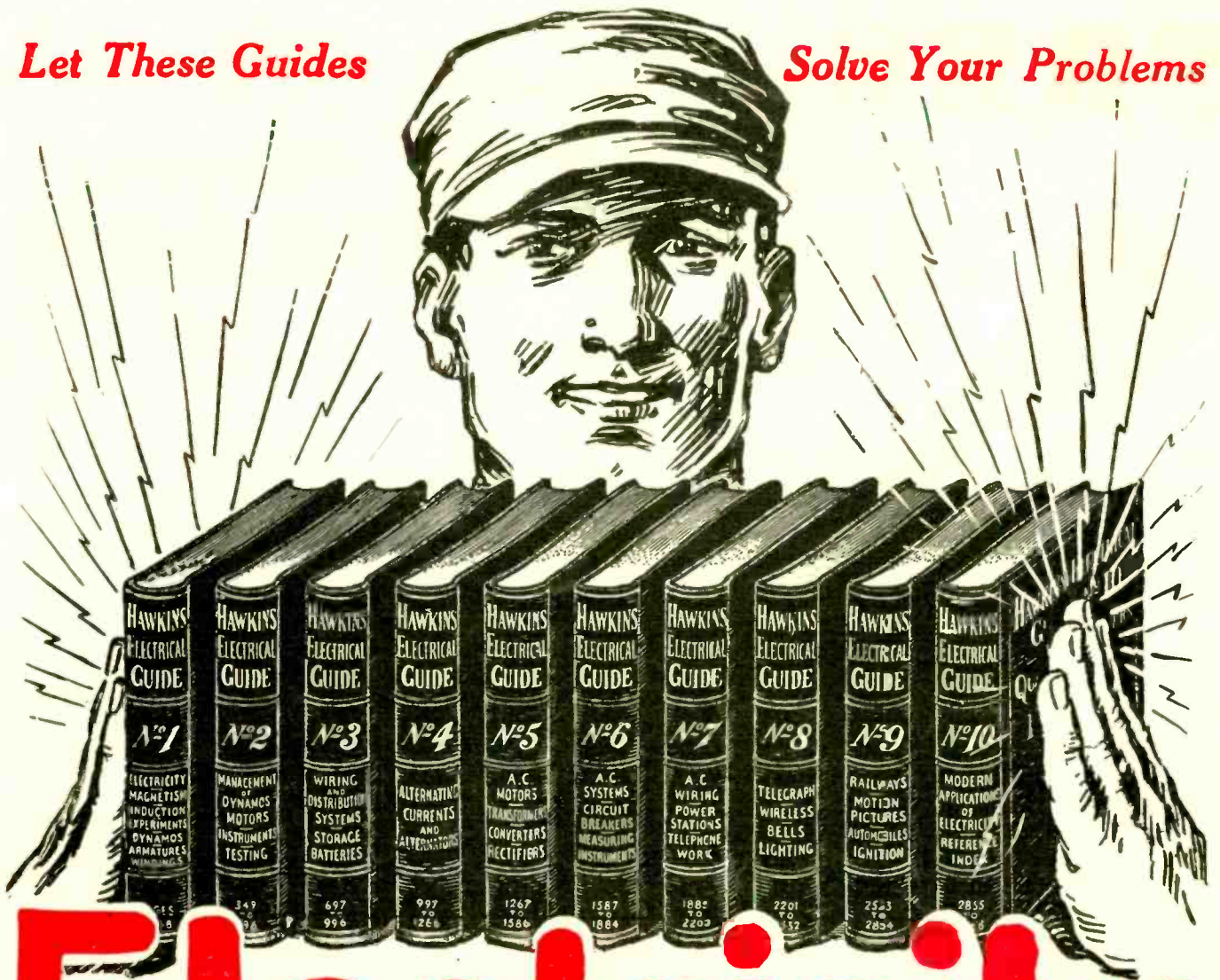

Electricity at your finger ends

HAWKINS ELECTRICAL GUIDES IN TEN VOLUMES

**3500 PAGES
4700 PICTURES**

**\$1 A VOLUME
\$1 A MONTH**

SEND NO MONEY—SEND ONLY THIS COUPON

Know the facts in Electricity. They mean more money and better position for you. Hawkins Guides tell you all you need to know about Electricity. Every important electrical subject covered so you can understand it. Easy to study and apply. A complete, practical working course, in 10 volumes. Books are pocket size; flexible covers. Order a set today to look over.

LEARN ALL ABOUT

Magnetism—Induction—Experiments—Dynamometers—Electric Machinery—Motors—Armatures—Armature Windings—Installing of Dynamometers—Electrical Instrument Testing—Practical Management of Dynamometers and Motors—Distribution Systems—Wiring—Wiring Diagrams—Sign Flashers—Storage Batteries—Principles of Alternating Currents and Alternators—Alternating Current Motors—Transformers—Converters—Rectifiers—Alternating Current Systems—Circuit Breakers—Measuring Instruments—Switchboards—Wiring—Power Stations—Installing—Telephone—Telegraph—Wireless—Bells—Lighting—Railways. Also many Modern Practical Applications of Electricity and Ready Reference Index of the ten numbers.

SHIPPED FREE

Not a cent to pay until you see the books. No obligation to buy unless you are satisfied. Send Coupon now—today—and get this great help library and see if it is not worth \$100 to you—you pay \$1.00 a month for ten months or return it.

THEO. AUDEL & CO.

65 West 23rd Street, New York City.

Please submit me for free examination, HAWKINS ELECTRICAL GUIDE (Price \$1 a number). Ship at once prepaid, the 10 numbers. If satisfactory, I agree to send you \$1 within seven days and to further mail you \$1 each month until paid.

Name

Occupation

Employed by

Home Address

Reference

S. I., Oct.

**30
DAYS
FREE
TRIAL**

7 Tube Set Single Dial Radio



Metrodyne Radio Sets

Are Equipped
For
**BATTERY or
ELECTRIC**
operation

The Metrodyne

ONLY ONE DIAL TO TUNE

RETAIL PRICE

\$75⁰⁰

**Completely Assembled
Big Discounts to
Agents and Dealers**

Wonderful offer direct from the factory! The world's greatest radio! A perfect working, single dial control, 7 tube receiver! And just to prove our claims, we will ship it to your home for **30 days' free trial**. Test it under all conditions. Test it for distance, volume and tonal quality—and if you are not convinced that it is the best single dial set you ever heard, return it to the factory. We don't want your money unless you are completely satisfied.

Three Year Guarantee

BIG PROFITS TO AGENTS AND DEALERS

Our Agents and Dealers make big money selling Metrodyne Sets. You can work all or part time. Demonstrate the superiority of Metrodynes right in your home. Metrodyne Radios have no competition. Lowest wholesale prices. Demonstrating set on 30 days' free trial. Greatest money-making opportunity. Send coupon, a letter or a postal for our agent's proposition.

Metrodyne Super-Seven Radio

A single dial control, 7 tube, tuned radio frequency set. Tested and approved by Popular Science Institute of Standards, Popular Radio Laboratory, Radio News Laboratory and by America's leading Radio Engineers. Designed and built by radio experts. Only the highest quality low loss parts are used. Magnificent, two-tone walnut cabinet with beautiful, gilt metal trimmings. Very newest 1928 model, embodying all the latest refinements.

Easiest set to operate. Only one small knob tunes in all stations. The dial is electrically lighted so that you can log stations in the dark. The volume control regulates the reception from a faint whisper to thunderous volume, 1,000 to 3,000 miles on loud speaker! The Metrodyne Super-Seven is a beautiful and efficient receiver, and we are so sure that you will be delighted with it, that we make this liberal **30 days' free trial offer**. You to be the judge.



30 Days' Free Trial—3 Year Guarantee

Metrodyne Super-Six

Another triumph in radio. Here's the new 1928 model Metrodyne 6 tube, two dial, long distance tuned radio frequency receiving set. Approved by leading radio engineers of America. Highest grade low loss parts, completely assembled in a beautiful walnut cabinet. Easy to operate. Dials easily logged. Tune in your favorite station on same dial readings every time—no guessing.

Mr. Howard, of Chicago, said: "While five Chicago broadcasting stations were on the air I tuned in seventeen out-of-town stations, including New York and San Francisco, on my loud speaker horn, very loud and clear, as though they were all in Chicago."

We are one of the pioneers of radio. The success of Metrodyne sets is due to our liberal 30 days' free trial offer, which gives you the opportunity of trying before buying. Thousands of Metrodynes have been bought on our liberal free trial basis.

**6
Tube Set
\$48⁵⁰**
RETAIL PRICE
Completely
Assembled

**MAIL THIS
COUPON** 
or send a postal or letter. Get our
proposition before buying a radio.
Deal direct with manufacturer—
SAVE MONEY—WRITE NOW!

MAIL COUPON BELOW

Let us send you proof of Metrodyne quality—our **30 days' free trial offer and 3 year guarantee**

Mrs. Wm. Leffingwell, Westfield, N. J., writes: "The Metrodyne Radio I bought of you is a wow! This is as good as any \$225 machine I have ever seen."

N. M. Greens, Maywood, Ill., writes: "My time is up and the Metrodyne works fine. I got Havana, Cuba, Oakland, Calif., Denver, Colo., Toronto, Canada, all on the loud speaker."

J. W. Woods, Leadville, Colo., writes: "Received the 7-tube Metrodyne in fine condition. Had it up and working same day received. Was soon listening to Los Angeles, San Diego, Oakland and other California points; also St. Louis, Kansas City and other east and south stations—all coming in fine. Am more than pleased. Sure enjoying it."

We will send you hundreds of similar letters from owners who acclaim the Metrodyne as the greatest radio set in the world. A postal, letter or the coupon brings complete information, testimonials, wholesale prices, and our liberal **30 days' free trial offer**.

METRO ELECTRIC COMPANY
2161-71 N. California Ave., Dept. 27
Chicago, Illinois

Gentlemen:

Send me full particulars about Metrodyne 6 tube and 7 tube sets and your **30 days' free trial offer**.

Name.....

Address.....

If you are interested in AGENT'S proposition, place an "X" in the square

METRO ELECTRIC COMPANY

2161-71 N. California Ave. • Dept. 27 • Chicago, Illinois