

Sept.

25 Cents



# Science and Invention

IN PICTURES

LIFE SUSPENDED  
IN ICE

See Page 406

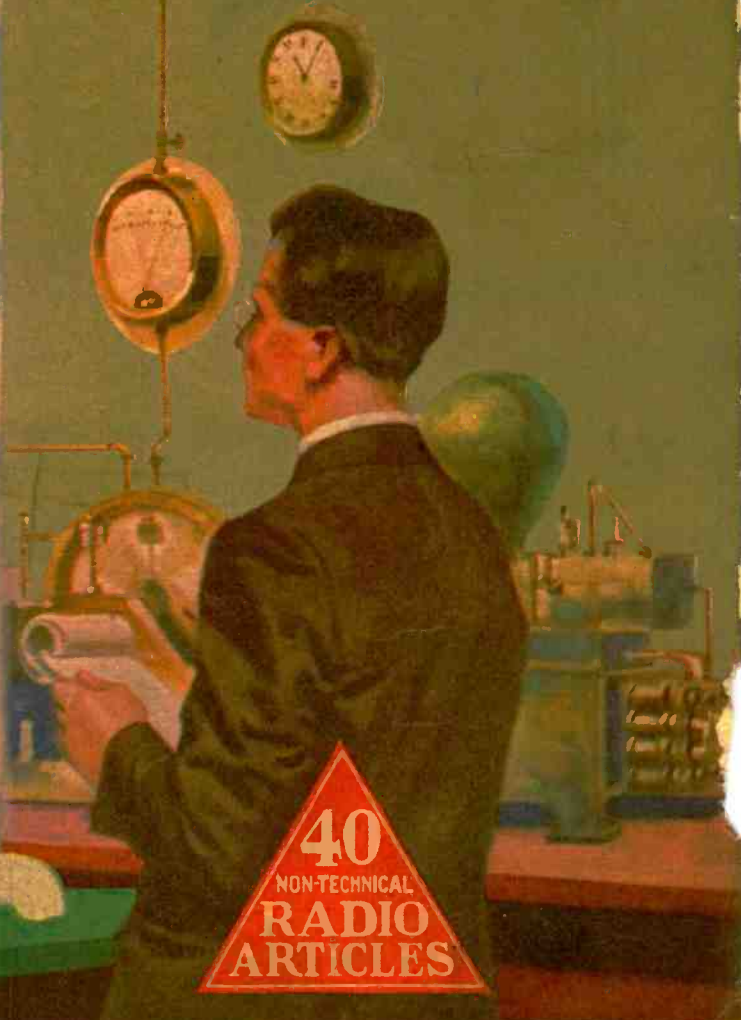

**40**  
NON-TECHNICAL  
**RADIO**  
**ARTICLES**





# BURIED TREASURE

can still be found in

# CHEMISTRY



## Good Chemists Command High Salaries

and you can make yourself independent for life by unearthing one of chemistry's yet undiscovered secrets.



**T. O'CONNOR SLOANE,**  
A.B., A.M., LL.D., Ph.D.  
Noted Instructor, Lecturer and Author. Formerly Treasurer American Chemical Society and a practical chemist with many well known achievements to his credit. Not only has Dr. Sloane taught chemistry for years but he was for many years engaged in commercial chemistry work.

Do you remember how the tales of pirate gold used to fire your imagination and make you want to sail the uncharted seas in search of treasure and adventure? And then you would regret that such things were no longer done. But that is a mistake. They *are* done—today and everyday—not on desert islands, but in the chemical laboratories throughout your own country. Quietly, systematically, the chemist works. His work is difficult, but more adventurous than the blood-curdling deeds of the Spanish Main. Instead of meeting an early and violent death on some forgotten shore, he gathers wealth and honor through his invaluable contributions to humanity. Alfred Nobel, the Swedish chemist who invented dynamite, made so many millions that the income alone from his bequests provides five \$40,000 prizes every year for the advancement of science and peace. C. M. Hall, the chemist who discovered how to manufacture aluminum made millions through this discovery. F. G. Cottrell, who devised a valuable process for recovering the waste from flue gases, James Gayley, who showed how to save enormous losses in steel manufacture, L. H. Baekeland, who invented Bakelite—these are only a few of the men to whom fortunes have come through their chemical achievements.

### What Some of Our Students Say of This Course:

I have not written since I received the big set. I can still say that it far exceeded my anticipations. Since I have been studying with your school I have been appointed chemist for the Scranton Coal Co. testing all the coal and ash by proximate analysis. The lessons are helping me wonderfully, and the interesting way in which they are written makes me wait patiently for each lesson.—MORLAIS COUZENS

I wish to express my appreciation of your prompt reply to my letter and to the recommendation to the General Electric Co. I intend to start the student engineering course at the works. This is somewhat along electrical lines, but the fact that I had a recommendation from a reliable school no doubt had considerable influence in helping me to secure the job.—H. VAN BENTHUYSEN.

So far I've been more than pleased with your course and am still doing nicely. I hope to be your honor graduate this year.—J. M. NORRIS, JR.

I find your course excellent and your instruction, truthfully, the clearest and best assembled I have ever taken, and yours is the fifth one I've studied.—JAMES J. KILLY.

From the time I was having Chemistry it has never been thus explained to me as it is now. I am recommending you highly to my friends, and urging them to become members of such an organization.—CHARLES BENJAMIN.

I shall always recommend your school to my friends and let them know how simple your lessons are.—C. J. AMDAHL.

I am more than pleased. You dig right in from the start. I am going to get somewhere with this course. I am so glad that I found you.—A. A. CAMERON.

I use your lessons constantly as I find it more thorough than most text books I can secure.—WM. H. TIBBS.

Thanking you for your lessons, which I find not only clear and concise, but wonderfully interesting. I am.—ROBT. H. TRAYLOR.

I received employment in the Consolidated Gas Co. I appreciate very much the good service of the school when a recommendation was asked for.—JOS. DECKER.



### Experimental Equipment Furnished to Every Student

We give to every student without additional charge this chemical equipment, including forty-nine pieces of laboratory apparatus and supplies, and forty different chemicals and reagents. These comprise the apparatus and chemicals used for the experimental work of the course. The fitted heavy wooden box serves not only as a case for the outfit but also as a useful laboratory accessory for performing countless experiments.

## CHEMICAL INSTITUTE OF NEW YORK, Inc.

Home Extension Division 9  
66-S—WEST BROADWAY NEW YORK CITY

## Now Is the Time to Study Chemistry

Not only are there boundless opportunities for amassing wealth in Chemistry, but the profession affords congenial employment at good salaries to hundreds of thousands who merely follow out its present applications. These applications are innumerable, touching intimately every business and every product in the world. The work of the chemist can hardly be called work at all. It is the keenest and most enjoyable kind of pleasure. The days in a chemical laboratory are filled with thrilling and delightful experimentation, with the alluring prospect of a discovery that may spell Fortune always at hand to spur your enthusiasm.

### You Can Learn at Home

To qualify for this remarkable calling requires elaborate specialized training. Formerly it was necessary to attend a university for several years to acquire that training, but thanks to our highly perfected and thorough system of instruction, you can now stay at home, keep your position, and let us educate you in Chemistry during your spare time. Even with only common schooling you can take our course and equip yourself for immediate practical work in a chemical laboratory. Dr. Sloane gives every one of his students the same careful, personal supervision that made him celebrated throughout his long career as a college professor. Your instruction from the very beginning is made interesting and practical, and we supply you with apparatus and chemicals for performing the fascinating analyses and experimental work that plays such a large part in our method of teaching, and you are awarded the Institute's official diploma after you have satisfactorily completed the course.

### Easy Monthly Payments

You don't have to have even the small price of the course to start. You can pay for it in small monthly amounts—so small that you won't feel them. The cost of our course is very low, and includes everything, even the chemistry outfit—there are no extras to buy with our course. Our plan of monthly payments places a chemical education within the reach of everyone. Write us and let us explain our plan in full—give us the opportunity of showing you how you can qualify for a highly trained technical position without even giving up your present employment.

### Special 30 Day Offer

Besides furnishing the student with his Experimental Equipment, we are making an additional special offer for a short while only. You owe it to yourself to find out about it. Write today for full information and free book "Opportunities for Chemists." Send the coupon right now while it is fresh in your mind. Or just write your name and address on a postal and mail it to us. But whatever you do, act today before this offer is withdrawn.  
**DON'T WAIT—MAIL COUPON NOW!**

CHEMICAL  
INSTITUTE  
OF NEW YORK  
Home Extension  
Division 9  
66-S—West Broadway  
New York City

Please send me at once, without any obligation on my part, your free Book "Opportunities for Chemists," and full particulars about the Experimental Equipment given to every student. Also please tell me about your plan of payment and your special 30 day offer.

NAME .....

ADDRESS .....

CITY..... STATE.....

S.T. Sept 23



*Electrical Experts are in Big Demand!*  
—L.L. Cooke!

# I Will Train You at Home to fill a Big-Pay Job!



## Look What These Cooke Trained Men Are Earning



### Makes \$700 in 24 Days in Radio

"Thanks to your interesting Course I made over \$700 in 24 days in Radio. Of course, this is a little above the average but I run from \$10 to \$40 clear profit every day, so you can see what your training has done for me."

FRED G. McNABB, 848 Spring St., Atlanta, Georgia



### \$70 to \$80 a week for Jacquot

"Now I am specializing in Auto Electricity and battery work and make from \$70 to \$80 a week and am just getting started. I don't believe there is another school in the world like yours. Your lessons are a real joy to study."

ROBERT JACQUOT, 2005 W. Colorado Ave., Colorado Springs, Colo.



### \$20 a Day for Schreck

"Use my name as a reference and depend on me as a booster. The biggest thing I ever did was answer your advertisement. I am averaging better than \$500 a month from my own business now. I used to make \$18.00 a week."

A. SCHRECK, Phoenix, Arizona

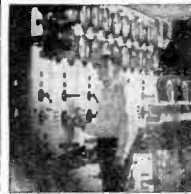

### Plant Engineer—Pay raised 150%

"I was a dumbbell in electricity until I got in touch with you Mr. Cooke, but now I have charge of a big plant including 600 motors and direct a force of 34 men—electricians, helpers, etc. My salary has gone up more than 150%."

GEORGE ILLINGWORTH, 63 Calumet Road, Holyoke, Mass.

It's a shame for you to earn \$15 or \$20 or \$30 a week, when in the same six days as an Electrical Expert you could make \$70 to \$200—and do it easier—not work half so hard. Why then remain in the small-pay game, in a line of work that offers no chance, no big promotion, no big income? Fit yourself for a real job in the great electrical industry. I'll show you how.

## Be an Electrical Expert Earn \$3,500 to \$10,000 a Year

Today even the ordinary Electrician—the "screw driver" kind—is making money—big money. But it's the trained man—the man who knows the whys and wherefores of Electricity—the Electrical Expert—who is picked out to "boss" the ordinary Electricians—to boss the Big Jobs—the jobs that pay \$3,500 to \$10,000 a Year. Get in line for one of these "Big Jobs." Start by enrolling now for my easily learned, quickly grasped, right-up-to-the-minute, Spare-Time Home-Study Course in Practical Electricity.

**Age or Lack of Experience No Drawback**  
You don't have to be a College Man; you don't have to be a High School Graduate. As Chief Engineer of the Chicago Engineering Works, I know exactly the kind of training you need, and I will give you that training. My Course in Electricity is simple, thorough and complete and offers every man, regardless of age, education, or previous experience, the chance to become, in a very short time, an "Electrical Expert," able to make from \$70 to \$200 a week.

**No Extra Charge for Electrical Working Outfit**  
With me, you do practical work—at home. You start right in after your first few lessons to work at your profession in the regular way and make extra money in your spare time. For this you need tools, and I give them to you—5 big complete working outfits, with tools, measuring instruments, and a real electric motor—5 outfits in all.

**Your Satisfaction Guaranteed**  
So sure am I that you can learn Electricity—so sure am I that after studying with me, you, too, can get into the "big money" class in electrical work, that I will guarantee under bond to return every single penny paid me in tuition, if, when you have finished my Course, you are not satisfied it was the best investment you ever made. And back of me in my guarantee, stands the Chicago Engineering Works, Inc., a two million dollar institution, thus assuring to every student enrolled, not only a wonderful training in Electricity, but an unsurpassed Student Service as well.

**Get Started Now—Mail Coupon**  
I want to send you my Electrical Book and Proof Lessons, both Free. These cost you nothing and you'll enjoy them. Make the start today for a bright future in Electricity. Send in Coupon—NOW.

L. L. Cooke, Chief Engineer  
**Chicago Engineering Works**  
2150 Lawrence Ave., Dept. 26  
Chicago



**5 big outfits given to you—no extra charge**

**MAIL COUPON FOR MY FREE BOOK**

Name.....

Address.....

Occupation.....

*The "Cooke" Trained Man is the "Big Pay" Man*

# Science and Invention

FORMERLY  
**ELECTRICAL EXPERIMENTER**

Member Audit Bureau of Circulations

EDITORIAL & GENERAL OFFICES: 53 Park Place, New York City  
GENERAL ADVERTISING DEPT.: 53 Park Place, New York City  
Published by Experimenter Publishing Company, Inc.  
(H. Gernsback, Pres.; S. Gernsback, Treas.; R. W. DeMott, Sec'y.)

Publishers of **SCIENCE & INVENTION, RADIO NEWS, THE EXPERIMENTER**  
and **MOTOR CAMPER & TOURIST.**

## EDITORIAL STAFF

HUGO GERNSBACK, *Editor-in-Chief.*  
H. WINFIELD SECOR, E. E.,  
*Managing Editor.*  
DR. T. O'CONNOR SLOANE, Ph.D., M. A.,  
*Associate Editor.*  
JOSEPH H. KRAUS, *Field Editor.*  
A. P. PECK, Assoc. I. R. E.,  
*Radio Editor.*  
S. GERNSBACK, *Wrinkles Editor.*  
J. KELLY BURLEIGH, *Art Director.*

## CONTRIBUTING EDITORS

**Astronomy**—  
Dr. Donald H. Menzel, Ph.D., University of Iowa.  
Isabel M. Lewis, M.A., of the U. S. Naval Observatory.  
**Entomology and Allied Subjects**—  
Dr. Ernest Bade, Ph.D.  
**Physics**—  
Dr. Harold F. Richards, Ph.D.  
Ernest K. Chapin, M. A.  
**Automotive Subjects**—  
Tom C. Plumridge.  
George A. Luers.  
**Chemistry**—  
Raymond B. Wailes.  
Dr. Ernest Bade, Ph.D.  
**Radio**—  
Sylvan Harris.  
Leon L. Adelman.  
**Magic and Psychic Phenomena**—  
Joseph Dunninger.  
Joseph F. Rinn.  
Edward Merlin.  
**Foreign Correspondents**—  
Dr. Alfred Gradenwitz, Germany.  
Dr. H. Becher, Germany.  
C. A. Oldroyd, England.  
S. Leonard Bastin, England.  
A. N. Mirzaoff, France.  
Hubert Slouka, Czecho-Slovakia.  
P. C. van Petegem, Holland.  
Richard Neumann, Austria.

## IN OUR NEXT ISSUE

### Did You Ever See the Moon Reversed?

In the southern hemisphere, the moon and the stars appear to be in different positions than in the northern hemisphere. Isabel M. Lewis, M. A., will explain why this is so.

### Do You Know What Is Meant By Organic Glass?

This is a new transparent resin which is a product of the chemical laboratory. Ismar Ginsberg, B. Sc., Chem. Engr., will tell all about it.

### What Is the Universe's Greatest Engine?

The sun undoubtedly supplies the greatest amount of energy of any source that we know of. Prof. Donald H. Menzel, Ph.D., will tell what this power amounts to.

### Have You Ever Seen Trick Motion Pictures Made?

Another article by that incomparable expert on trick photography, Edwin Schallert, will detail the latest artifice resorted to by motion picture producers.

### Have You Even Been Fooled By a Spiritualistic Medium?

If so, you will recognize some of the tricks used in the description by the Rev. Crawford Trotter.

## Contents for September

Editorial.....	399	Everyday Chemistry.....	429
By H. Gernsback.....		By Raymond B. Wailes.....	
Rain Making Again.....	400	Scientific Problems and Puzzles.....	430
By George F. Paul.....		By Ernest K. Chapin.....	
Did "Charleston" Cause Building Collapse?.....	401	Progress in Medicine.....	431
By Joseph H. Kraus.....		Edited by Joseph H. Kraus.....	
Dirigible Mooring Mast and Landing Platform.....	402	An Easily Made Selenium Cell.....	432
Plants and Animals That Shoot.....	403	By Raymond B. Wailes.....	
By Dr. Ernest Bade.....		Home-Made Movie Camera.....	433
Roman Steam Power.....	404	By Roy A. Clapp.....	
By Charles Beecher Bunnell.....		Angle Guide for Artist.....	434
Life Suspended in Ice.....	406	By J. Kelley Burleigh.....	
By H. Gernsback, Member Am. Physical Society.....		Exposure Meter.....	434
Airplanes and Tanks in the Next War.....	408	How-to-Make-It Department.....	435
By H. Winfield Secor, E. E.....		Wrinkles, Recipes and Formulas.....	436
Einstein Refuted.....	411	Edited by S. Gernsback.....	
By George Appel.....		Readers' Forum.....	437
Maps from Aerial Photos.....	413	Circus Broadcast by Relayed Radio.....	438
By J. B. Beadle.....		Real Estate and Radio.....	439
Night Photos.....	414	Low-Loss Condenser.....	439
Mathematical Cross-Number Puzzle.....	415	A Suitcase Portable Super-Heterodyne.....	440
By Richard Hoadley Tingley.....		By Sidney E. Finkelstein, Assoc. I. R. E.....	
Latest Devices.....	416	Hints to Radio Builders.....	441
Boat Travels on Air.....	417	By Leon L. Adelman, Assoc. I. R. E.....	
Unusual Hypnosis.....	418	The Radio Constructor.....	442
Record Fall.....	418	By A. P. Peck, Assoc. I. R. E.....	
Novelties.....	419	Make Your Own "B" Battery Eliminator.....	446
Tarrano the Conqueror—Part 3.....	420	Herbert E. Hayden's One-tube Portable Set.....	448
By Ray Cummings.....		Radio Oracle.....	447
Medium's Tricks Exposed.....	422	Scientific Humor.....	451
By Edwin Merlin.....		Latest Patents.....	452
Aerial Ball.....	423	Non-Science.....	453
Anti-Aircraft Nets.....	423	The Oracle.....	454
Dr. Hackensaw's Secrets.....	424	\$1,000 Monthly Prize Awards.....	456
By Clement Fegandé.....		Patent Advice.....	464
The Night Air Mail.....	426	Edited by A. P. Peck.....	
By Richard M. Douglas.....		Radio Wrinkles.....	481
Magic for Everybody.....	428	Book Review.....	479
By Prof. Joseph Dunninger.....			

HOW TO SUBSCRIBE FOR "SCIENCE AND INVENTION." Send your name, address and remittance to Experimenter Publishing Co., 53 Park Place, New York City. Checks and money orders should be made payable to Experimenter Publishing Co., Inc. Mention the name of the magazine you are ordering inasmuch as we also publish RADIO NEWS, THE EXPERIMENTER and MOTOR

CAMPER & TOURIST. Subscriptions may be made in combination with the other publications just mentioned at special reduced club rates. Send postal for club rate card. Subscriptions start with the current issue unless otherwise ordered. ON EXPIRATION of your subscription we enclose a renewal blank in our last number to you, and notify you by mail. Then unless we receive your

order and remittance for a renewal, delivery of the magazine is stopped. CHANGE OF ADDRESS: Notify us as far in advance as possible, giving your old address as well as the new one to which future magazines are to go. It takes several weeks to make an address change on our records.

SCIENCE AND INVENTION is published on the 10th of each month. There are 12 numbers per year. Subscription price is \$2.50 a year in U. S. and possessions. Canada and foreign countries \$3.00 a year. U. S. coin as well as U. S. stamps accepted (no foreign coin or stamps). Single copies, 25 cents each. A sample copy will be sent gratis on request. All communications and contributions to this journal should be addressed to Editor, SCIENCE AND

INVENTION, 53 Park Place, New York City, N. Y. Unaccepted contributions cannot be returned unless full postage has been included. ALL accepted contributions are paid for on publication.

SCIENCE AND INVENTION, Monthly. Entered as second class matter May 10, 1924, at the Post Office at New York, N. Y., under the act of March 3, 1879. Additional entry at Long Island City, N. Y., and

San Francisco, Calif. Title Registered at the Patent Office. Copyright, 1925, by E. P. Co., Inc., New York. The Contents of this Magazine are copyrighted and must not be reproduced without giving full credit to the publication. SCIENCE AND INVENTION is for sale at all newsstands in the United States and Canada; also at Brentano's, 27 Avenue de l'Opera, Paris. Member of the Audit Bureau of Circulations.

New England Advertising Representative Western Advertising Representatives Pacific Coast Advertising Representatives Kansas City Advertising Representatives  
T. F. Magrane Finucan & McClure A. J. Norris Hill Co. Davies & Dillon  
Park Square Bldg., Boston, Mass. 720 Cass St., Chicago, Ill. Hearst Bldg., San Francisco, Cal. 15 W. 10th St., Kansas City, Mo.



**NEW!** *Radically different!*

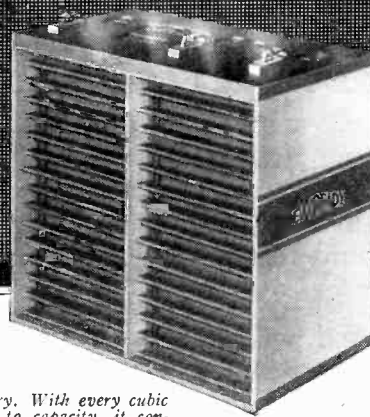

No. 486 Eveready Layerbilt "B" Battery. 45 volts. Length, 8 3/16 inches. Width, 4 7/16 inches. Height, 7 3/16 inches. Weight, 14 1/4 pounds. Price, \$5.50.

It's all battery. With every cubic inch packed to capacity, it contains about 30 per cent more electricity-producing material. All chance of loose or broken connections avoided by contact of full area of carbon plate against zinc plate. The scientifically correct construction.

## The greatest improvement ever made in "B" Batteries

ABSOLUTELY new in construction—perfected through years of research, the new Eveready Layerbilt "B" Battery is as superior to the old type "B" Battery as a tube set is to a crystal.

Heretofore, all dry "B" Batteries have been made up of cylindrical cells—no one knew how to make them any other way. The new Eveready Layerbilt is made of *flat* layers of current-producing elements compressed one against another, so that every cubic inch inside the battery case is completely filled with electricity-producing material. Layer-building heightens efficiency by increasing the area of zinc plate and the quantity of active chemicals to which the plate is exposed.

After the most rigid laboratory tests, more than 30,000 of these new Eveready Layerbilt "B" Batteries were manufactured and tested by use under actual home-receiving conditions. These tests proved that this new battery is far superior to the famous Eveready Heavy-duty Battery No. 770, which up to now we have ranked as the longest lived "B" Battery obtainable.

On 4-tube sets, 16 mil drain, it lasts 35% longer.  
 On 5-tube sets, 20 mil drain, it lasts 38% longer.  
 On 6-tube sets, 24 mil drain, it lasts 41% longer.  
 On 8-tube sets, 30 mil drain, it lasts 52% longer.

The new Layerbilt principle is such an enormous stride forward in radio battery economy that we will bring out new sizes and numbers in this Layerbilt form as fast as new machinery is installed. For the present, only the extra-large 45-volt size will be available.

Buy this new Eveready Layerbilt No. 486 for heavy drain service. It far exceeds the performance for which Eveready Radio Batteries always have been famous and is, we believe, by far the most economical source of "B" current obtainable.

Manufactured and guaranteed by  
**NATIONAL CARBON CO., INC.**  
 New York San Francisco  
 Canadian National Carbon Co., Limited, Toronto, Ontario

**EVEREADY HOUR EVERY TUESDAY at 8 P.M.**  
*Eastern Standard Time*  
 Beginning Sept. 29th, 9 P. M. *Eastern Standard Time*  
 For real radio enjoyment, tune in the "Eveready Group." Broadcast through stations—  
 WEA New York WGR Buffalo WWJ Detroit  
 WJAR Providence WCAE Pittsburgh WCCO Minneapolis  
 WEEI Boston WEAR Cleveland WOC St. Paul  
 WFI Philadelphia WSAI Cincinnati WOC Davenport

# EVEREADY

## Radio Batteries

*- they last longer*

# SCIENCE and INVENTION READERS' BUREAU

## Time and Postage Saver

**I**N every issue of SCIENCE and INVENTION you undoubtedly see numerous articles advertised about which you would like to have further information.

To sit down and write an individual letter to each of these respective concerns, regarding the article on which you desire information, would be quite a task.

As a special service to our readers, we will write the letters for you, thus saving your time and money.

Just write the names of the products about which you want information, and to avoid error the addresses of the manufacturers, on the coupon below and mail it to us.

If the advertiser requires any money or stamps to be sent to pay the mailing charges on his catalogue or descriptive literature, please be sure to enclose the correct amount with the coupon.

We will transmit to the various advertisers your request for information on their products.

This service will appear regularly every month on this same page in SCIENCE and INVENTION.

If there is any Manufacturer not advertising in this month's issue of SCIENCE and INVENTION from whom you would like to receive literature, write his name, address and the product in the special section of the coupon below.

TEAR ALONG THIS LINE

**READERS' SERVICE BUREAU,**  
Experimenter Publishing Co., Inc., 53 Park Place, New York, N. Y.

S. & I. 9-25

Please advise the firms listed below that I would like to receive detailed information on their product as advertised in the ..... issue of SCIENCE and INVENTION.

**THIS FORM SHOULD NOT BE USED FOR TECHNICAL QUESTIONS**

NAME	ADDRESS (Street—City—State)	List here specific article on which you wish literature.	If Catalogue of complete line is wanted, check in this column.
.....	.....	.....	.....
.....	.....	.....	.....
.....	.....	.....	.....
.....	.....	.....	.....
.....	.....	.....	.....
.....	.....	.....	.....
.....	.....	.....	.....

**THIS FORM SHOULD NOT BE USED FOR TECHNICAL QUESTIONS**

Use this space if you desire information from a manufacturer whose advertisement does not appear in this month's issue.

NAME	ADDRESS (Street — City — State)
.....	.....
.....	.....
.....	.....

Your name.....	Dealer's name.....
Your address.....	His address.....
<input type="checkbox"/> If you are dealer check here. City..... State.....	City..... State.....





*You may escape the collection ~ but not the need of* **OZARKA SERVICE**

**T**HE satisfaction you receive from your radio depends not on what it does once in a while—but night after night and month after month. Whether you grin or cuss depends on the service behind your radio.

Ozarka radio instruments are *only* sold by trained factory representatives, men who not only specialize in radio but sell and service Ozarkas only. 3,100 of these men, trained directly under Ozarka engineers constitute a service force, unequalled elsewhere in radio today.

When you buy a radio you'll compare appearance, tone, volume and selectivity by having various instruments set up in your own home but—that isn't enough—compare the service behind each one.

Any Ozarka factory representative will set up an Ozarka in your home—he will not even operate it himself, but depend for his sale on what you yourself do. If you, by your own operating, do not bring in the distance, the volume and tone, you expect a radio to give, then

do not buy the Ozarka. If you do buy it, you can rest assured, no matter what happens, a competent service man is at your call at all times. No Ozarka representative can sell Ozarka Instruments without giving Ozarka service. You are entitled to such service—demand it!

The Ozarka Representative knows every part, every wire of the Ozarka. In fact he completely assembles his own instruments. His training on installations, aerials, ground connections, operation and service comes directly under our own engineers who designed and perfected the Ozarka circuit.

That is why our book, "Ozarka Instruments No. 200," describing all models of Ozarka should be of particular interest to you. This book and the name of the Ozarka representative near you will be sent immediately at your request. Please give the name of your county.

**We Have Openings for a Few More Ozarka Factory Representatives**

**O**ZARKA Incorporated, is now entering its 4th year. From a beginning with one engineer, one stenographer, one salesman—our present president, the Ozarka organization has grown to over 3100 people. There must be some good reason for this growth.

Ozarka instruments have made good—they have more than met competition. Ozarka representatives have made good not only because Ozarka instruments were right, but because they have been willing to learn what Ozarka engineers were willing and capable to teach them—Ozarka unusual salesmanship and Ozarka service.

There are still openings for the right men in this organization—men who believe in the future of radio—men who are tired of working for some one else—men who want a business of their own. Prove yourself by sales and willingness to learn and exclusive territory will be given you. The man we want has lived in his community for some time. He has the respect of his fellow men because he has never "put anything over" just to make money. He may not have much money, but he is not broke and is, at least, able to purchase one demonstrating instrument.

**Check Coupon for FREE Selling Book**

Radio offers a wonderful opportunity to men who are willing to start at the bottom and build. You need not know salesmanship, but will you learn what we will gladly teach you? You may not know radio, but we can and will teach you if you will do your part. With such knowledge and willingness to work, it doesn't seem possible that you cannot make good. Sign the coupon below, don't fail to give the name of your county. Better still write a letter, tell us about yourself and attach the coupon. If interested in our salesman's plan ask for "Ozarka Plan No. 200."



**OZARKA**

122 Austin Avenue K  
Chicago, Illinois



**INCORPORATED**

122 Austin Avenue K  
Chicago, Illinois

Gentlemen: Without obligation send book "Ozarka Instruments No. 200" and name of Ozarka representative.

Name .....  
Address ..... City .....  
County ..... State .....

Gentlemen: I am greatly interested in the FREE book "The Ozarka Plan" whereby I can sell your radio instruments.

Name .....  
Address ..... City .....  
County ..... State .....

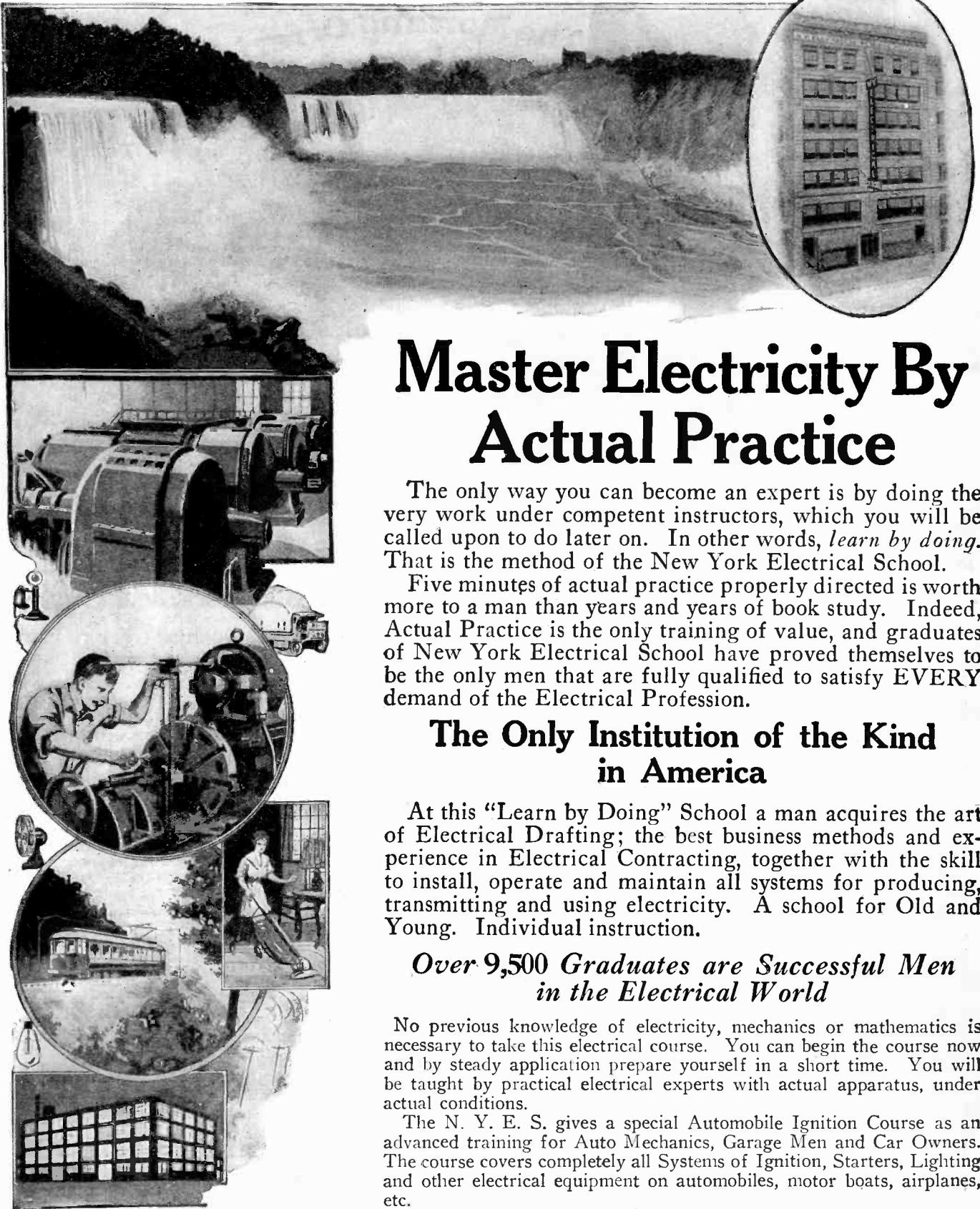

# Master Electricity By Actual Practice

The only way you can become an expert is by doing the very work under competent instructors, which you will be called upon to do later on. In other words, *learn by doing*. That is the method of the New York Electrical School.

Five minutes of actual practice properly directed is worth more to a man than years and years of book study. Indeed, Actual Practice is the only training of value, and graduates of New York Electrical School have proved themselves to be the only men that are fully qualified to satisfy EVERY demand of the Electrical Profession.

## The Only Institution of the Kind in America

At this "Learn by Doing" School a man acquires the art of Electrical Drafting; the best business methods and experience in Electrical Contracting, together with the skill to install, operate and maintain all systems for producing, transmitting and using electricity. A school for Old and Young. Individual instruction.

## Over 9,500 Graduates are Successful Men in the Electrical World

No previous knowledge of electricity, mechanics or mathematics is necessary to take this electrical course. You can begin the course now and by steady application prepare yourself in a short time. You will be taught by practical electrical experts with actual apparatus, under actual conditions.

The N. Y. E. S. gives a special Automobile Ignition Course as an advanced training for Auto Mechanics, Garage Men and Car Owners. The course covers completely all Systems of Ignition, Starters, Lighting and other electrical equipment on automobiles, motor boats, airplanes, etc.

*Let us explain our complete courses to you in person. If you can't call, send now for 64-page book—it's FREE to you.*

New York Electrical School  
29 W. 17th St., New York, N. Y.

Please send FREE and without obligation to me your 64-page book.

..... NAME  
 ..... STREET  
 ..... CITY ..... STATE

# New York Electrical School

29 West 17th Street, New York



# Science and Invention

Editorial and General Offices, - - - 53 Park Place, New York

*"Those Who Refuse to Go Beyond Fact Rarely Get As Far As Fact" . . . HUXLEY*

## Gravitation

By HUGO GERNSBACK

ONE of the great scientific mysteries of all time is one of the best known and most universal of things—Gravitation.

Gravitation is a universal force which permeates everything, not only on earth, but throughout the universe. It is a tremendous force and the entire universe, with all its contents, is under its domination at all times. We can not take a step, can not lift a finger, and we can not make a move, in whatever direction, without remaining under its all-pervading influence.

If you pick up a stone and release it from your hand, the stone falls to the ground. It does so for two reasons; first, because the earth attracts the stone, and second, because the stone attracts the earth. This is according to Newton's law of universal gravitation.

### I BELIEVE THAT:

future city buildings will be equipped with filters to keep out all noises.

There is a definite gravitational pull between the earth and the stone. The effect of the stone in pulling up the earth is, however, inconsequential, and while the stone does exert a certain amount of pull towards the earth, the earth is so enormously larger that the effect on it is not felt at all.

All we know about gravitation today is the effects it produces. We can calculate these effects to a nicety, not only on falling bodies on our own earth, but, thanks to Newton, we can figure the attraction between the different heavenly bodies and its influence on their motions.

Notwithstanding this, we have not the slightest inkling of what this tremendous universal force is. It has, so far, defied all analysis of our scientists, and we know no more about it today than was known in the days of Archimedes, over two thousand years ago.

It is now thought, but this is merely a theory, that gravitation is a wave motion, similar to electro-magnetic waves, which include light waves, as well as our radio waves. It is thought that these gravitational waves pass through solids, just the same as light passes through a block of glass, or as radio waves pass through buildings and through other solid obstructions.

So far, however, no one has succeeded by the use of apparatus or instruments in producing these gravitational waves, if indeed, they are such.

Furthermore, a few minutes' reflection must show that whatever gravitation is, it seems to act instantaneously. The speed of gravitational attraction between two bodies seems to be much greater

than the speed of light, which is 186,000 miles per second. The solar system, as well as the universe, could not hold together if there were not instantaneous transmission of the gravitational impulses between the different planets and between the different universes.

In this sense, gravitation must be thought of as a solid substance. For instance, take the earth and the sun. They must be thought of as united by a gigantic solid metallic rod, much stronger than steel, and with no flexibility. If the earth were to budge one yard out of its accustomed course, the moon as well would be dragged along that course *instantly*, just as if the two bodies were united by the aforementioned rod. This is exactly how gravity acts, and the universe could not hold together unless this were so.

Scientists, of course, have been busy for ages trying to devise a gravity insulator, gravity nullifier, or a gravitation screen, all these terms meaning the same thing. The theory is to invent some sort of a screen or other means, so that if you repeat our stone experiment of opening your hand and letting go of the stone, the stone will rest in exactly the same position in space after you take your hand away. There being no attraction between the earth and the stone, and *vice versa*, the gravitation having been successfully cut off so that the stone can neither fall nor rise, it must stay suspended in mid-air.

If you were suspended on a trapeze above a gravitation screen, and the gravity were cut off, the trapeze could be removed and you would stay suspended in space. You would then be weightless and you could float around the room by jerking yourself sideways or up and down. This is one ideal which has been sought by scientists.

Instead of dragging around our heavy bodies through our houses and working places we shall probably be relieved of our weight; and we shall be able to work a hundred times as efficiently as we can today, and with practically no effort. Today thanks (?) to gravitation, most of our muscular efforts are to overcome gravitation.

Every time you lift your arm in the act of writing, either by pen or by typewriter, you have to work against gravitation; 90 per cent. or 99 per cent. or even more, of the effort is used to overcome gravitation force, while the microscopic balance goes into the work.

### I BELIEVE THAT:

there will be no revolution in the building of radio sets for years to come.

### THE GOLDEN AGE OF SCIENCE

is symbolized by the golden cover OF SCIENCE & INVENTION, LOOK FOR THE GOLD COVER every month!

Mr. Hugo Gernsback speaks every Monday at 8 P. M. (E.S.T.) from Station WRNY on various radio and scientific subjects.

# Rain-Making Again

By GEORGE F. PAUL

Perched on top of an old oil derrick in Huntington Park, Calif., is the weird building shown in the photograph at the left. Housed in this structure is a high frequency outfit which William Haight and D. W. Davis, the designers, claim will produce rain by bringing about condensation of the water vapor in the air.

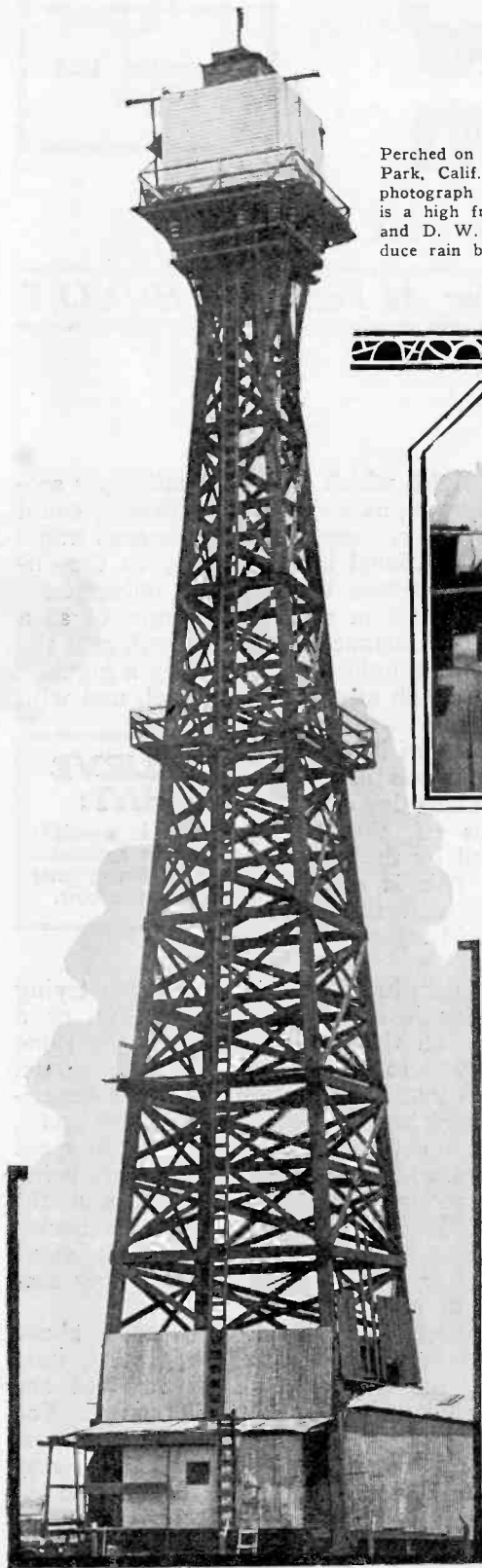

The circuit diagram of the connections of the instruments used for this so-called rain-making device is shown herewith. The fan keeps the spark gap from overheating. The high frequency coil is of the usual type.

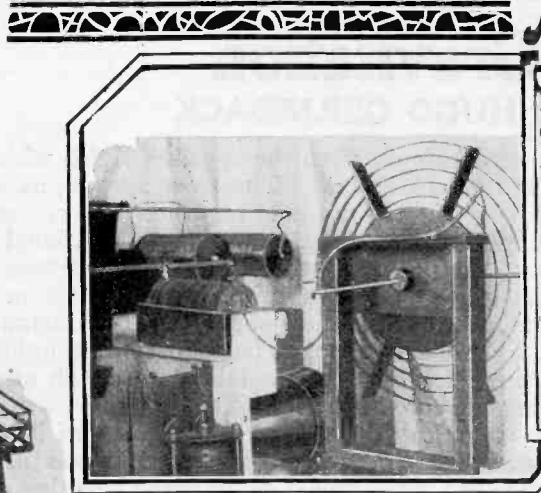
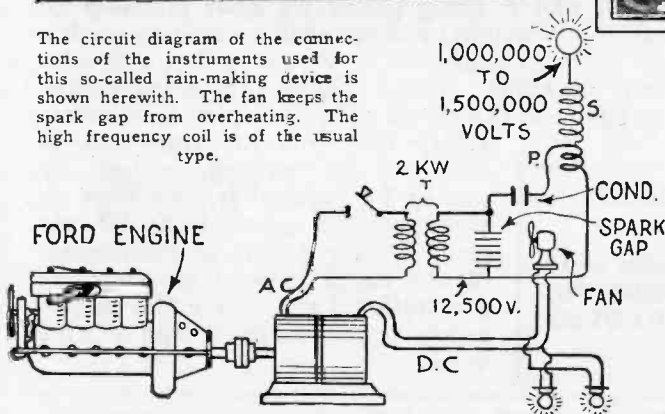

Above: The supply apparatus which furnishes the high potential for operating the large high frequency coil.

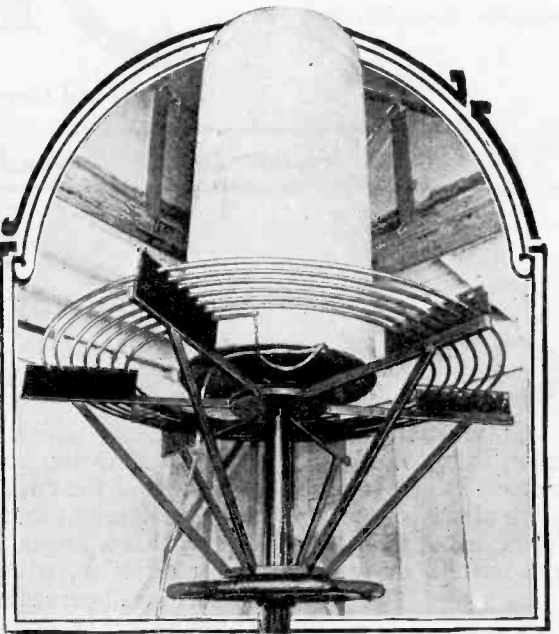

The gigantic high frequency coil is illustrated above. This is mounted near the top of the structure placed on the oil derrick and produces the induction, which is supposed to cause rain. The initial current is supplied by the generating plant illustrated directly below.

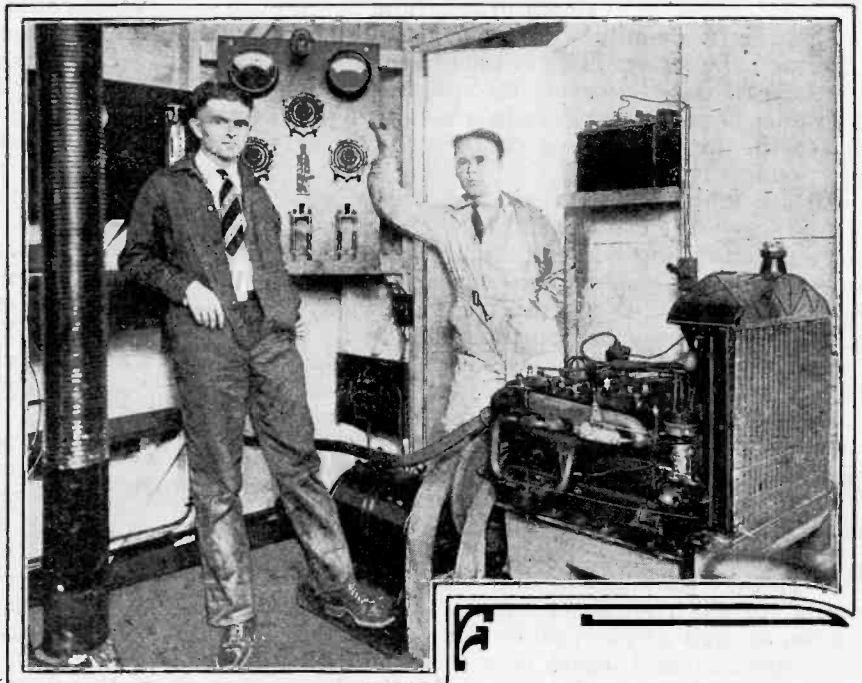

The theory of operation of this system for producing rain as explained by its inventors is that the positive pulsations of the alternating high-frequency current go to the ground, while the negative pulsations go to the upper strata. From this the inventors deduce that a pulsating direct current is established between the ground and the upper atmosphere and that this current brings about condensation and produces rain. (We add—maybe!—Editor.) They claim that rain can often be produced even on a clear day in less than an hour after the machinery is started. It is said that they have been able to operate over a range of approximately 15 miles. During one of their tests it is reported that when operating near clouds that have previously reached a fairly heavy point of saturation, a precipitation can be brought down in from 15 to 30 minutes. Changes in barometer readings of from 3 to 10 points have supposedly been noticed in less than an hour after operation was started. With the system now in use, no ground connection is used, the entire apparatus being insulated.



# Did "Charleston" Dance Cause Building Collapse?

By JOSEPH H. KRAUS



The photo at the right shows the partially suspended roof of the ill-fated Boston dance hall—the Pickwick Club—which collapsed while merry-making couples were celebrating the Fourth of July. At the time the building collapsed, there were approximately one hundred and twenty-five to one hundred and seventy-five guests at the club.

The theory that the building collapsed due to the partially weakened structure caused by a previous fire, and the dancing of the "Charleston," is held by a great many scientists. District Attorney Thomas E. O'Brien of Boston, Mass., wired this publication that a dance was in progress at the time of the collapse.



Photo at the left shows two couples dancing the "Charleston." The thuds produced by the feet as the dancers bounce up and down might well cause the floor to vibrate. The constant even tempo might then vibrate the timbers and bring on the crash.

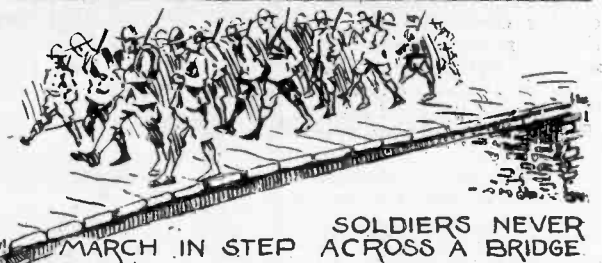

When the floors and ceilings of the Pickwick Club fell, forty-four guests were killed and eighteen were injured. That the cause of the fall was due to vibration set up by dancing feet is highly probable. Of course, it is essential that the tempo be identical with that of the natural period of vibration of the floors or building. This might accidentally have been produced at the time of the crash. The experiments illustrated on the right demonstrate how easily such a thing could take place. If a thin steel bar is placed across two supports as illustrated, and water be permitted to drop upon it, the drops can be so regulated that the bar will eventually vibrate vigorously. Thin glasses may be shattered by trying to imitate their sound.

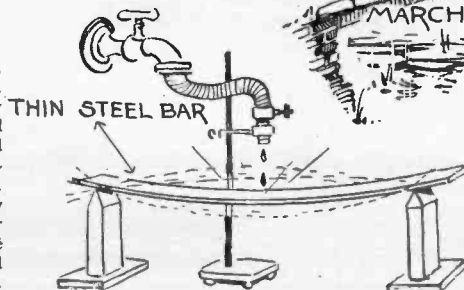



# Dirigible Mooring Mast and Landing Platform

This Device Provides for Comfortable Landing Facilities

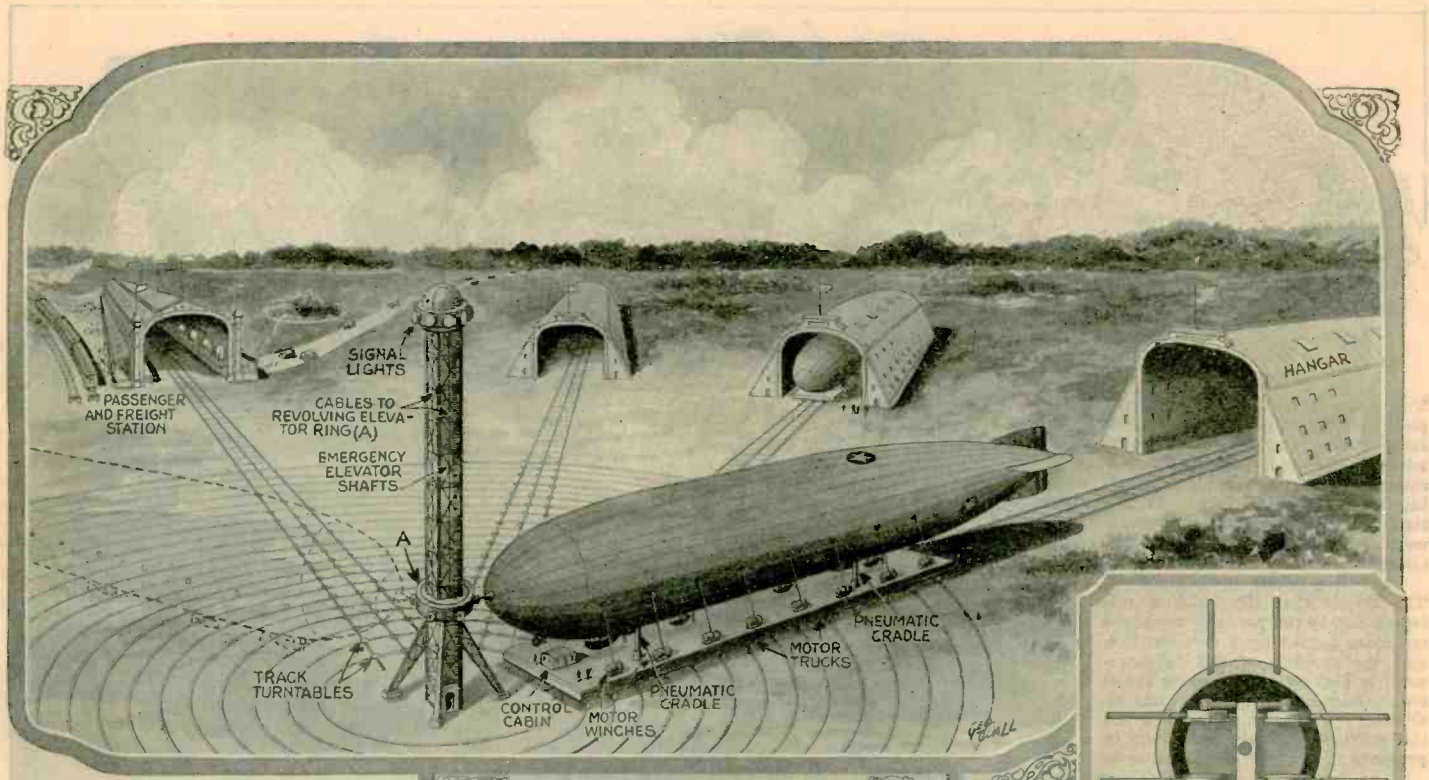

The illustration directly above shows the dirigible in position on the landing car and the dotted lines show how it can be shifted and reorientated according to the wind. Progressive drawings at the right show the various stages of landing.

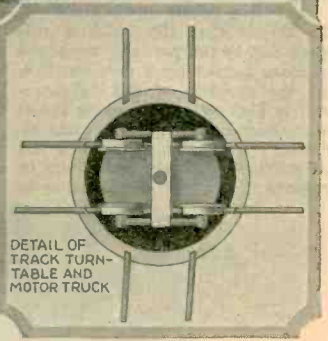

DETAIL OF TRACK TURN-TABLE AND MOTOR TRUCK  
Above: Details of track turntables which are indicated in the drawing at left above.

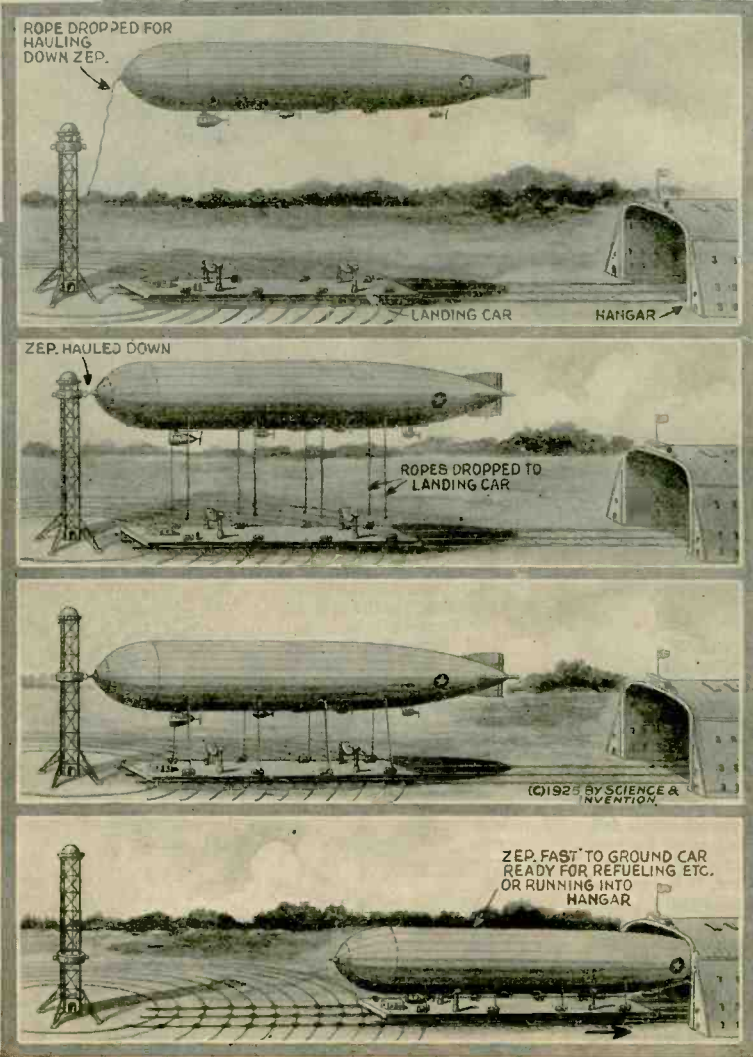

This new type of combination mast and landing platforms for dirigibles, designed by Joseph B. Strauss, Chicago engineer, who prepared the designs for the great 4,000-foot bridge across the Golden Gate, consists essentially of a stationary mooring mast and a movable landing platform which is capable of being rotated around the fixed mast as a center or of being drawn into the hangar. This platform is mounted on wheels placed in a series of trucks, as in the insert in the upper right-hand side of this page. The rails upon which the wheels travel are equipped at intervals with turntables, by means of which the trucks can be turned through 90° to adjust the wheels to travel on the circular rails. Similarly, they can be transferred from the circular to the straight tracks. In this way, after landing, the dirigible can be guided into any one of the hangars.

The details of the method used for mooring a dirigible to this new mast are given in the four progressive drawings at the left. First, a line is dropped from the nose of the ship and its end is raised to the top of the mooring mast by means of an elevator. This rope then pulls the nose of the dirigible down until it fits in the socket provided at the top of the tower. Other ropes are then dropped from the ship as in the second illustration and are fastened to winches on the landing car. The ring to which the nose of the ship is moored is then lowered on the mast, while the winches take up the slack in the mooring ropes. Gradually the ship settles until it is securely fastened to the landing car. The entire ship can then be run into a hangar for refueling or for taking on passengers and freight. Thus the work and risk involved in landing a ship of this nature is reduced to a very great extent.



# Plants and Animals That Shoot

By DR. ERNEST BADE

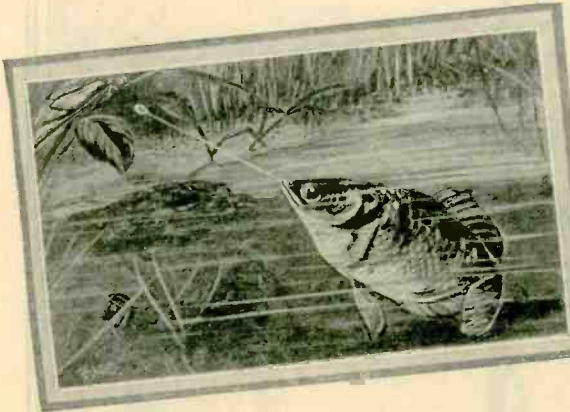

↑ The shooting fish captures insects by hitting them with a drop of water as above.



↑ The ant-lion larva shoots sand at insects which causes them to fall into the ant-lion's sandy funnel where the insect is devoured.

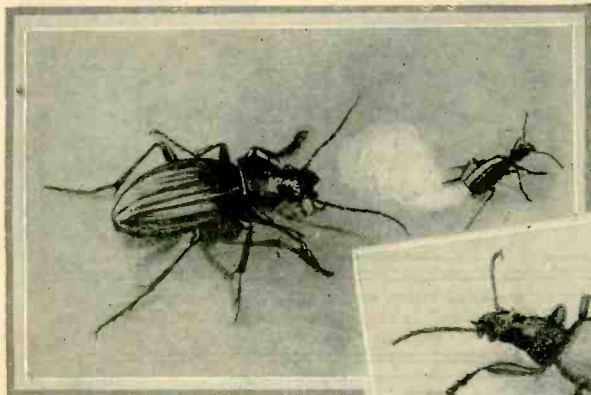

↑ The bombardier beetles throw out a gas attack when pursued by any creature such as a ground beetle, Calosome, above.

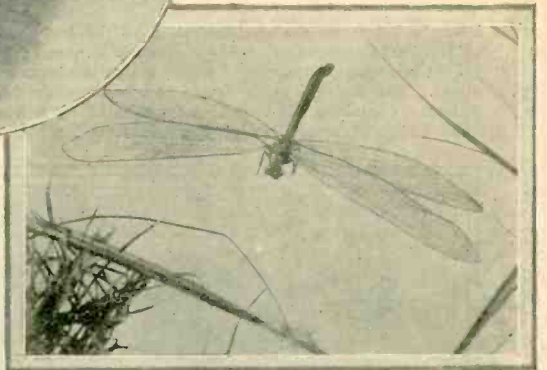
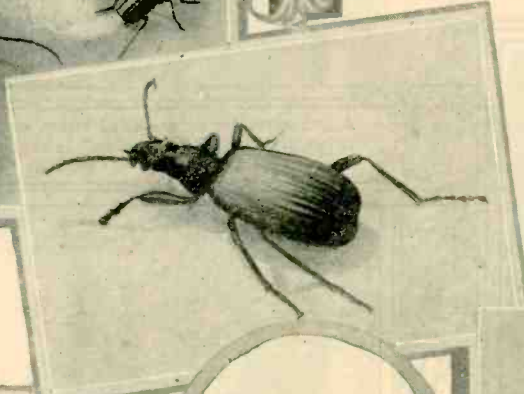

The adult ant-lion is a graceful flying creature far different from the ugly larvae.

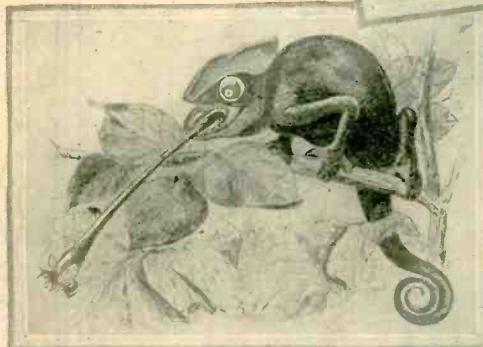

↑ The bombardier beetle capable of throwing out a gas resembling nitric acid in odor.



↑ The horned toad can shoot blood at its attacker during its moulting period.

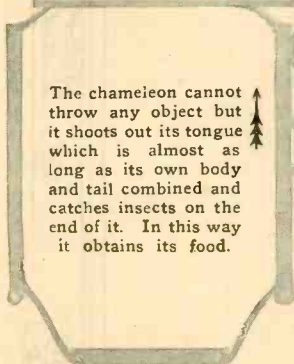

The chameleon cannot throw any object but it shoots out its tongue which is almost as long as its own body and tail combined and catches insects on the end of it. In this way it obtains its food.

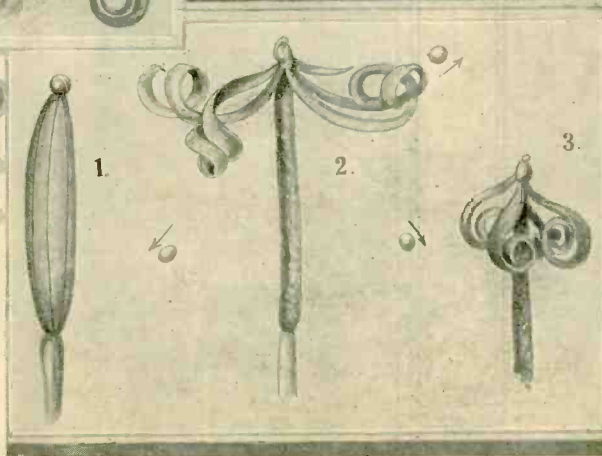

The process through which a shooting plant goes is shown above. The seed capsule is closed at 1, partly unfurled at 2, shooting its seeds away, while the empty seed capsule is shown at 3.



↑ The flowering "touch-me-not" or lady slipper, which shoots seeds to quite a distance.



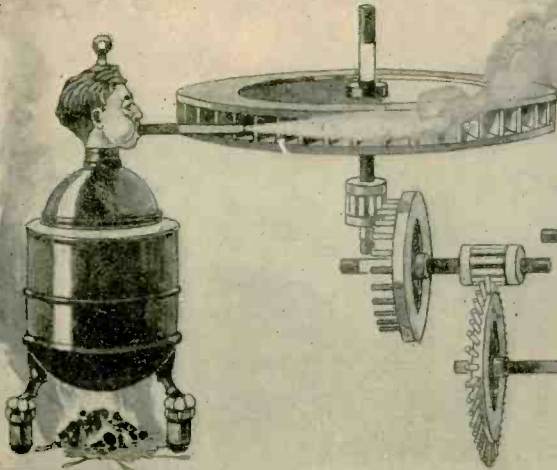

The "Steam Turbine Drug Mill" of Giovanni Branca of 1629 illustrated above is probably the first actual application of steam to commercial purposes. A turbine effect was produced and the steam was generated in a simple boiler.

Directly below we see an illustration of the forty-fifth proposition of Hero's "Pneumatika" being a small boiler, maintaining a vertical jet of steam on the top of which a ball is supported and dances about. The device is most simple in operation, the large decorated urn is a container for water, and is heated by a fire, and steam, upon being generated, raised the ball from its basket-like cradle.

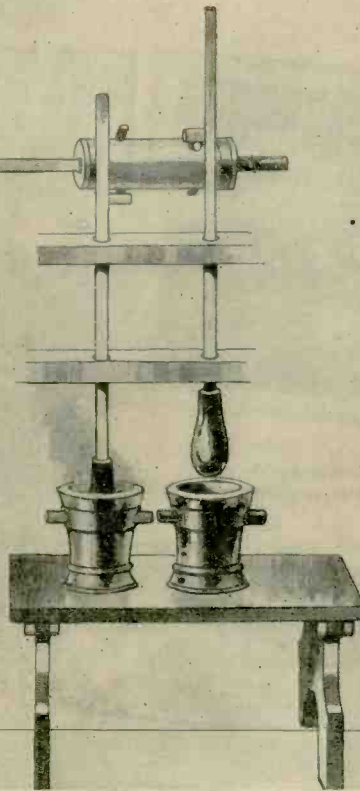

A generator for super-heated steam constituting the seventy-fifth proposition of Hero's "Pneumatika" is shown below and is described on the opposite page.

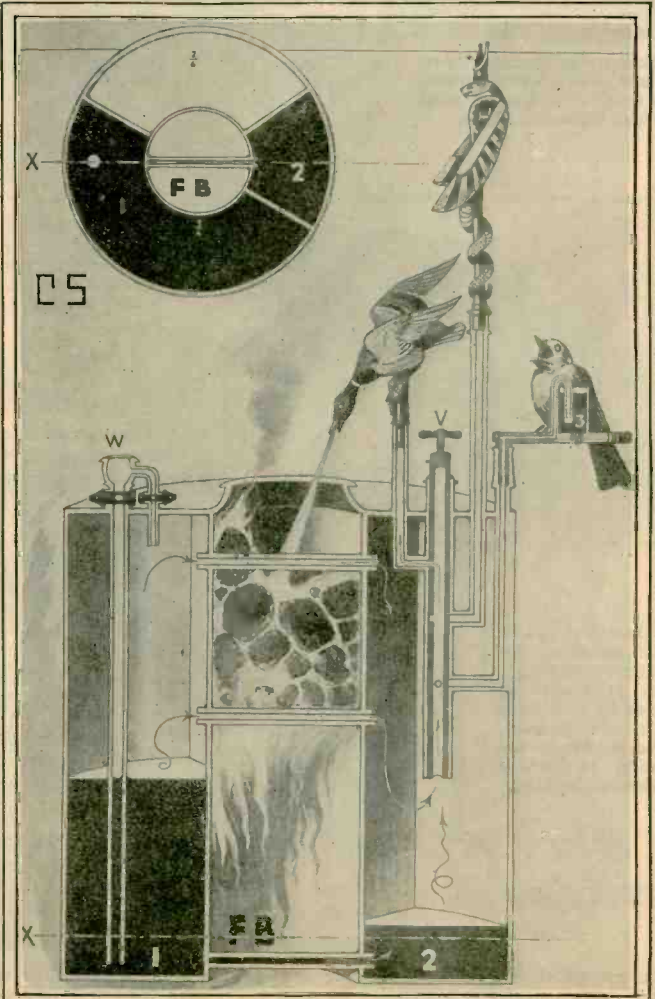



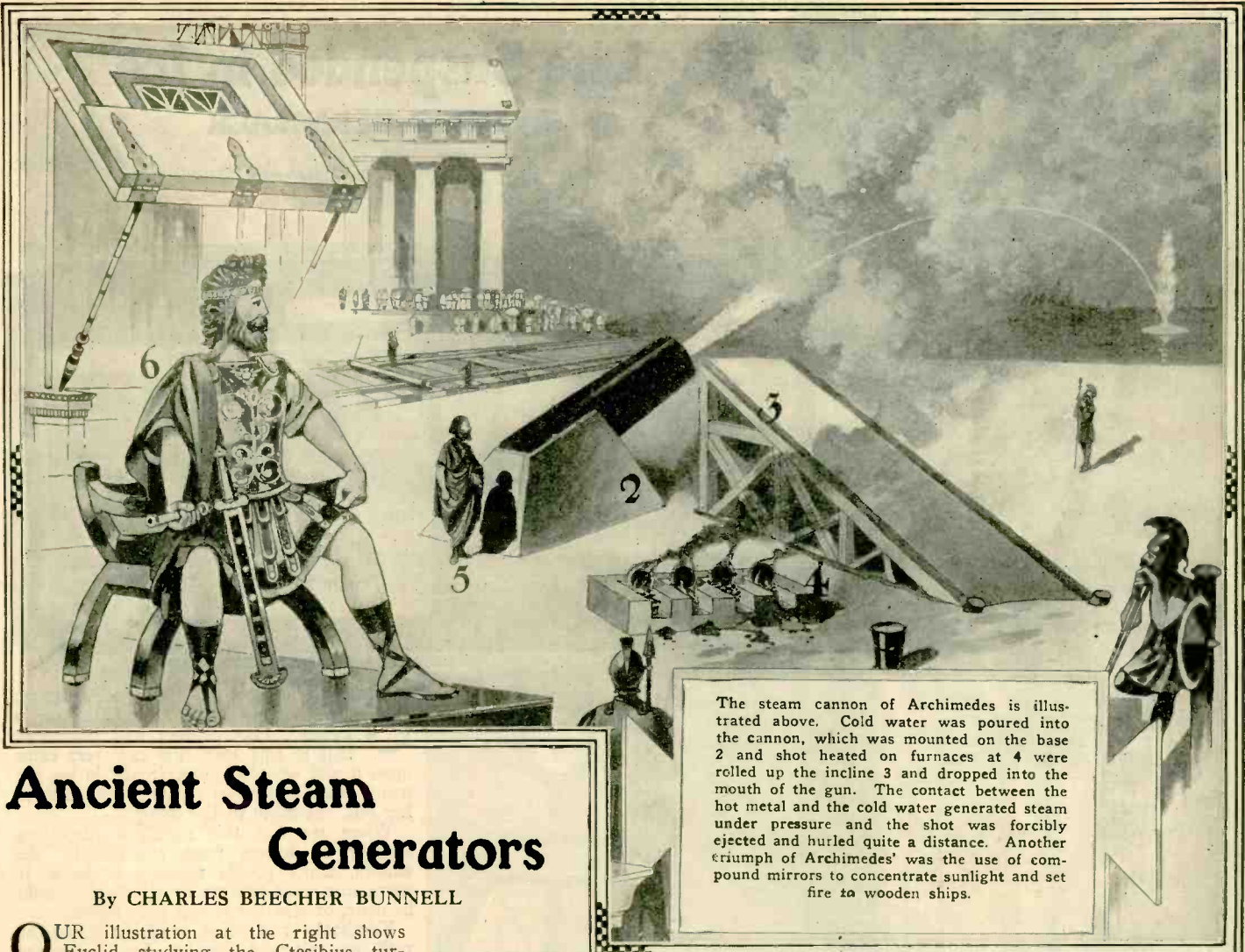

The steam cannon of Archimedes is illustrated above. Cold water was poured into the cannon, which was mounted on the base 2 and shot heated on furnaces at 4 were rolled up the incline 3 and dropped into the mouth of the gun. The contact between the hot metal and the cold water generated steam under pressure and the shot was forcibly ejected and hurled quite a distance. Another triumph of Archimedes' was the use of compound mirrors to concentrate sunlight and set fire to wooden ships.

# Ancient Steam Generators

By CHARLES BEECHER BUNNELL

OUR illustration at the right shows Euclid studying the Ctesibius turbine, the steam engine described in Hero's fiftieth proposition. This turbine depends upon the reaction of jets of steam against the atmosphere. The insert (S) shows the details of this device wherein the water is boiled in the caldron at (W) and the steam rises through the pipe (C) into the ball at (B) and out into the atmosphere through the external bent pipes.

Now let us look at the Fig. CS on the opposite page. Refer first to the cross-section of the boiler, which reveals four compartments. FB, in the center, is the fire-box. In operation, water was introduced at (W), shown on the large cross-sectional view, whereupon this liquid filled, or partly filled, the compartment 1. Compartment 2 received water when the snake ornament was removed. Steam from the heated water in compartment 1 would then go through the two upper pipes and join the steam in compartment 2. This steam would then go through the three-way valve (V), the port of which is to be open so that steam can pass through the goose. The jet of steam was then ejected downward into the fire-box, as shown. By turning the valve 90° to the right, the port for the songbird opened and the steam rushing out, blew the whistle with its open end immersed in the watertank (3), producing a warbling note. If the valve (V) was rotated again through 90°, the goose and the songbird were both shut off. The only path left for the steam was through the center port and out through the snake, giving vent to a life-like hiss. The most curious feature of this boiler is the triple flues or pipes. The two upper ones connect both compartments, while the lower flue is only connected to compartment 2 and does not lead into 1. It can be readily seen that this boiler produced super-heated steam.





# Life Suspended in Ice

By HUGO GERNSBACK

Member American Physical Society

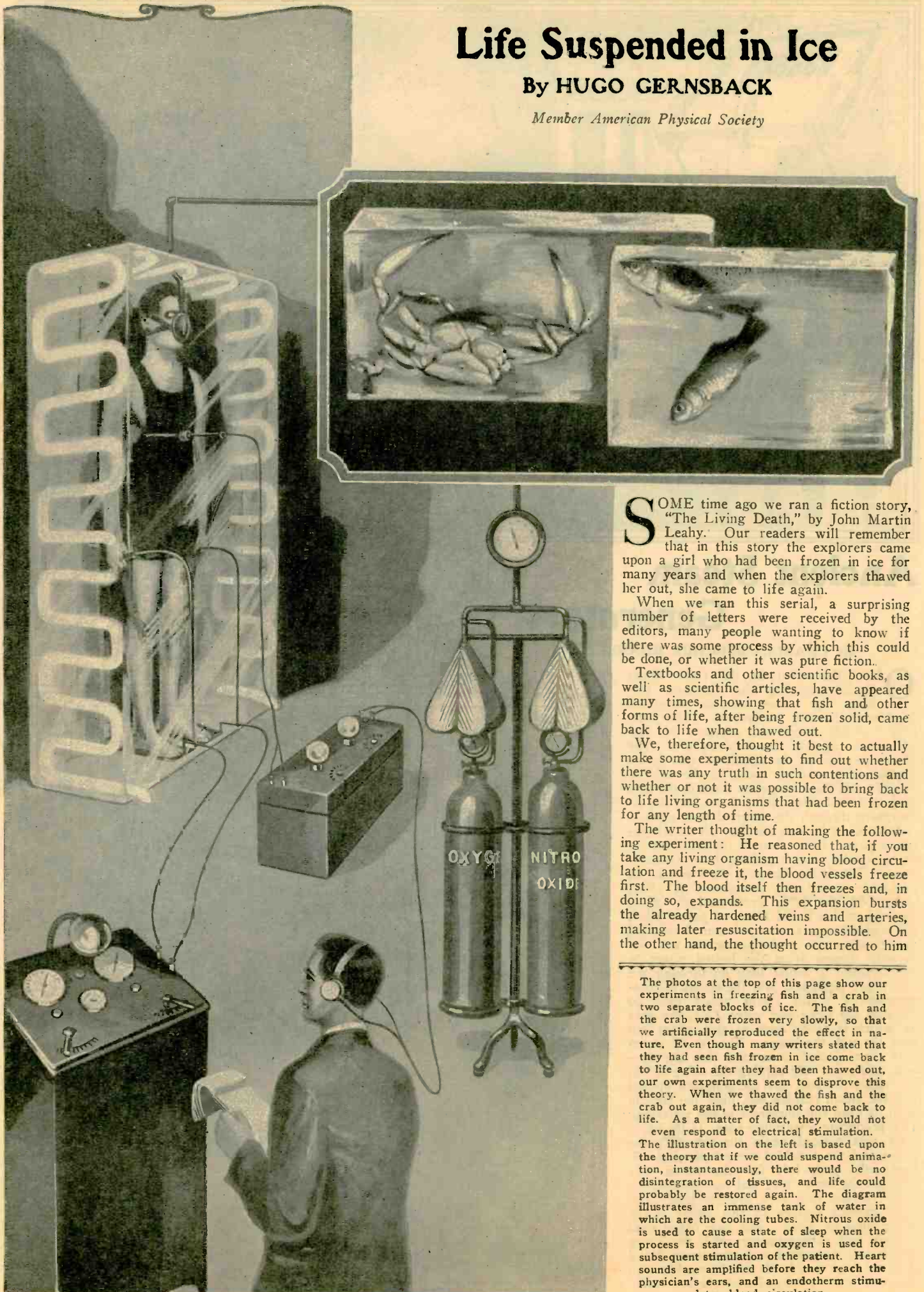

**S**OME time ago we ran a fiction story, "The Living Death," by John Martin Leahy. Our readers will remember that in this story the explorers came upon a girl who had been frozen in ice for many years and when the explorers thawed her out, she came to life again.

When we ran this serial, a surprising number of letters were received by the editors, many people wanting to know if there was some process by which this could be done, or whether it was pure fiction.

Textbooks and other scientific books, as well as scientific articles, have appeared many times, showing that fish and other forms of life, after being frozen solid, came back to life when thawed out.

We, therefore, thought it best to actually make some experiments to find out whether there was any truth in such contentions and whether or not it was possible to bring back to life living organisms that had been frozen for any length of time.

The writer thought of making the following experiment: He reasoned that, if you take any living organism having blood circulation and freeze it, the blood vessels freeze first. The blood itself then freezes and, in doing so, expands. This expansion bursts the already hardened veins and arteries, making later resuscitation impossible. On the other hand, the thought occurred to him

The photos at the top of this page show our experiments in freezing fish and a crab in two separate blocks of ice. The fish and the crab were frozen very slowly, so that we artificially reproduced the effect in nature. Even though many writers stated that they had seen fish frozen in ice come back to life again after they had been thawed out, our own experiments seem to disprove this theory. When we thawed the fish and the crab out again, they did not come back to life. As a matter of fact, they would not even respond to electrical stimulation. The illustration on the left is based upon the theory that if we could suspend animation, instantaneously, there would be no disintegration of tissues, and life could probably be restored again. The diagram illustrates an immense tank of water in which are the cooling tubes. Nitrous oxide is used to cause a state of sleep when the process is started and oxygen is used for subsequent stimulation of the patient. Heart sounds are amplified before they reach the physician's ears, and an endotherm stimulates blood circulation.



that if the freezing were to be done so rapidly that there was no chance for the individual blood vessels to expand and burst, then, perhaps, there might be some chance of reviving the organism.

That this thought was partially correct was proved afterwards.

We first took a goldfish and put it in a cardboard tray. We then poured liquid air over it, and this froze the fish very rapidly. The boiling point of liquid air is  $-191$  degrees Centigrade or  $-311.8$  degrees Fahrenheit.

When the fish was thawed out afterwards, in tepid water, he appeared dead. The writer then took two radio "B" batteries, giving a tension of about 90 volts, and proceeded to attempt resuscitation of fish electrically. This was done, as shown in the illustration; namely, by placing one wire in the water near the tail of the fish and dipping the other wire rapidly and intermittently in the water. This, of course, opened and closed the circuit, and part of the current traveled through the fish.

An immediate reflex action was noted, and it could be seen that the fish's gills worked convulsively, and the tail, as well as the fins, seemed to have some life.

The resuscitation process was continued for some minutes, but the fish did not return to life. Only this one experiment was made, but its effect has been sufficient to encourage the writer to think that, if other forms of life, perhaps not as delicate as a goldfish, were frozen, and after thawing out, electrical resuscitation were resorted to, some specimen might be found that will be revived.

The theory of using liquid air is that the freezing process will be done so quickly that the blood vessels will have no time to expand and burst, although, of course, there is a chance that they might do so on thawing out.

Nevertheless, in the liquid air experiment, no decomposition of the fish had set in, although similar fish, frozen in ice, started to decompose almost the instant thawing commenced.

The next experiment was to take similar goldfish and freeze them in a pan by artificial Frigidore refrigeration. Our illustration shows how this was accomplished. Two fish were used in the experiment. They were slowly frozen and slowly thawed out. After thawing out, the fish showed decomposition at the fins. There was no reflex effect at all when they were treated electrically, with many different voltages. The nervous system of the fish apparently was just as dead as the fish itself. There was no trace of muscular reaction due to nerve

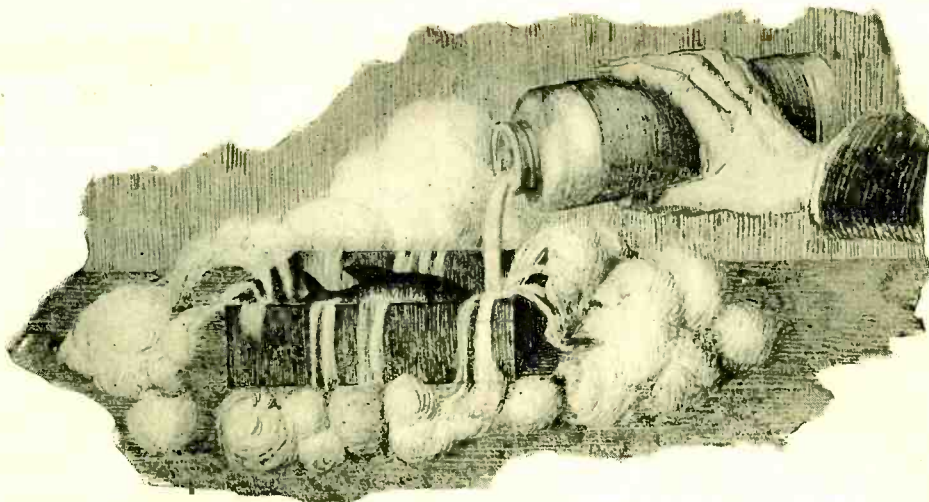

The illustration above shows the method we employed in attempting to suspend animation instantaneously. Liquid air having a temperature of minus 311.8 degrees Fahrenheit was poured upon the fish, which in this instance was placed in a cardboard box. The fish, of course, was frozen almost instantaneously. Every attempt to bring the fish back to life again failed. Although the fish frozen with liquid air responded to electrical stimulation, there were no voluntary movements at any time.

stimulation, as was the case in the liquid air experiment.

The same experiment, that is, using the usual ice-freezing means, was next tried with a crab, with the same negative results. After the crab had been thawed out, no reflex of any nature could be observed, the freezing apparently having killed the crab as completely as it had disposed of the goldfish.

The conclusion to be drawn from the experiments is that it is not possible to bring living organisms, after freezing, back to life. The statement found ever so often in text books, that fish in ponds have been frozen solid and thawed out in the spring, may, therefore, be questioned.

Probably upon the approach of a freezing temperature the fish go to unfrozen regions at the bottom of the pond or lake and stay there until the ice thaws out, but we doubt very much if fish actually freeze and then come back to life. There may be certain species that do so, but we have yet to find them.

Our cover illustration shows a problematical experiment where this freezing process is applied to a human being. In connection with a warm-blooded being, as our experiments have shown, a slow freezing would be out of the question. If some means could be found of *instantly* producing a greater cold than that of liquid air, as, for instance, absolute zero, there is just a possibility that

at some future date a human being might be frozen instantaneously. This would immediately stop all the various organic processes, and there would be no time for the blood vessels to burst, because the entire body would be frozen in an instant.

It would, of course, be necessary to provide the subject with a mask over his mouth and nose, with a pipe leading to the outside, so that in the ensuing thawing out the subject would not drown—hence the mask as shown in our illustration. An endotherm might be employed to cause the arteries to expand and contract as the current is intermittently turned on and off.

As soon as the thawing-out process begins, the resuscitation could be effected by vibratory electrical currents, and there is a chance that the subject would then come to life again.

Of what use would such an experiment be? Frankly, we do not know, but for biological reasons and for scientific purposes, many things might be discovered during such an experiment that are entirely hidden from us now.

For instance, there are a number of diseases which, under such a treatment, might possibly vanish altogether. Certain bacteria, certain infectious diseases, might be stamped out entirely by a few hours' freezing treatment of this kind. We know from previous experiments that tissue and flesh can be preserved sometimes for years when frozen in ice. We also know that at present most low organisms are killed off, by the icing process. All this is an argument that the freezing process, if it can ever be effected, will in time to come be of great interest to humanity, very much more so than we can discern today.

Furthermore there are a great many sufferers of various diseases for which no cures have as yet been found. If we were able to suspend animation for a period of years, we could take those afflicted with incurable diseases and place them in a large sanitarium and suspend animation there. Attendants would be on hand at all times to keep the temperature constant and to maintain a vigilant watch over those in the frozen state. In later years when scientists actually discover a method for relieving the sufferers of malignant diseases, those afflicted with the particular disease for which a cure has been found, could be brought out of the sanitarium and thawed out to be treated the instant they show signs of life again. Of course this is pure theory.

Refrigeration during the past forty years has done wonders for mankind, our big cities could not possibly be without it today, as they are dependent upon frozen meat from outside

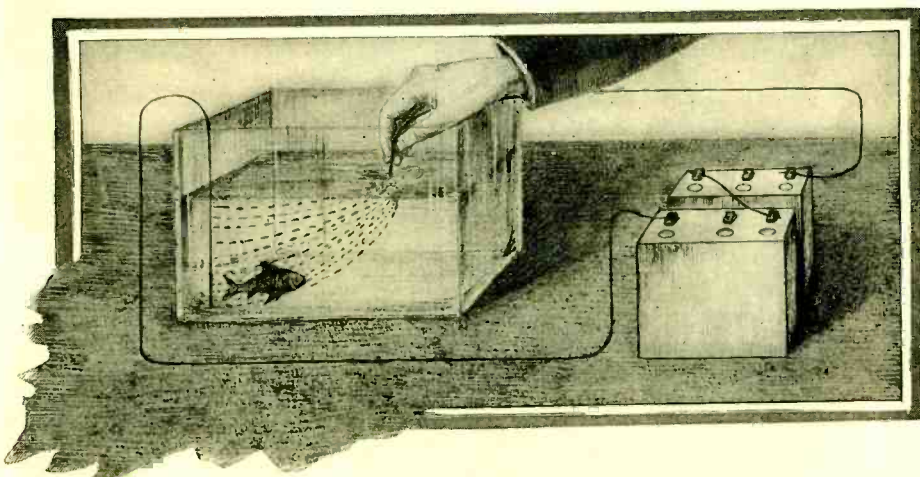

The above illustration shows how attempts were made to artificially stimulate the heart and incidentally stimulate the muscles of the fish, so that the mouth and gill covers would move, causing a flow of water over the gills. One wire from the "B" batteries was led to the bottom of the water, and another bare wire intermittently touched the surface of the water. The current passing through the fish caused muscular twitchings which did not, however, resuscitate the creature.



# Airplanes and Tanks in the Next War

By H. WINFIELD SECOR, E. E.

SUBJECT OF A TALK GIVEN BY AUTHOR AT WRNY, JUNE 23rd

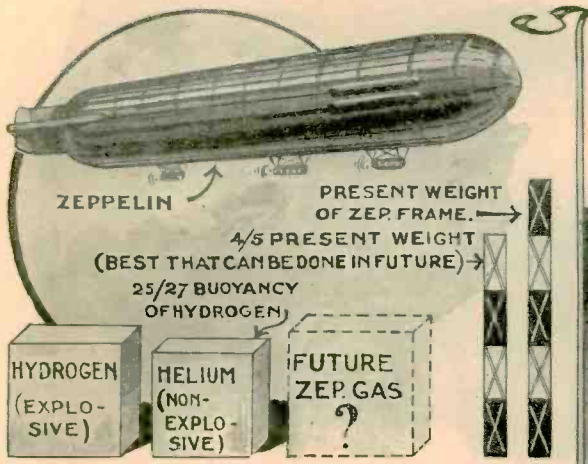

As pointed out by Prof. Norris F. Hall, of Harvard University, in an interesting new book, "The Next War," the factors concerning dirigibles align themselves as above. A substitute for helium is improbable. Hydrogen mixed with air is combustible.

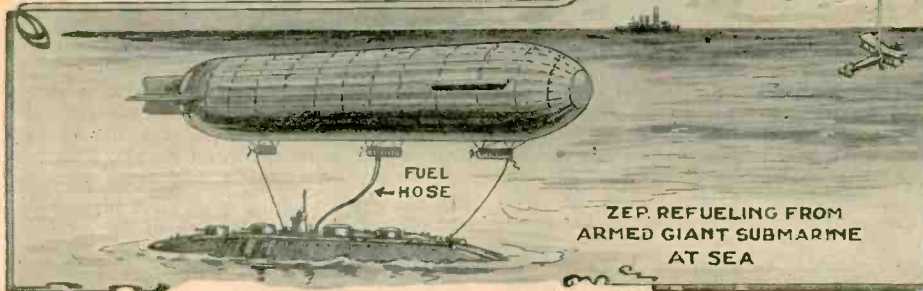
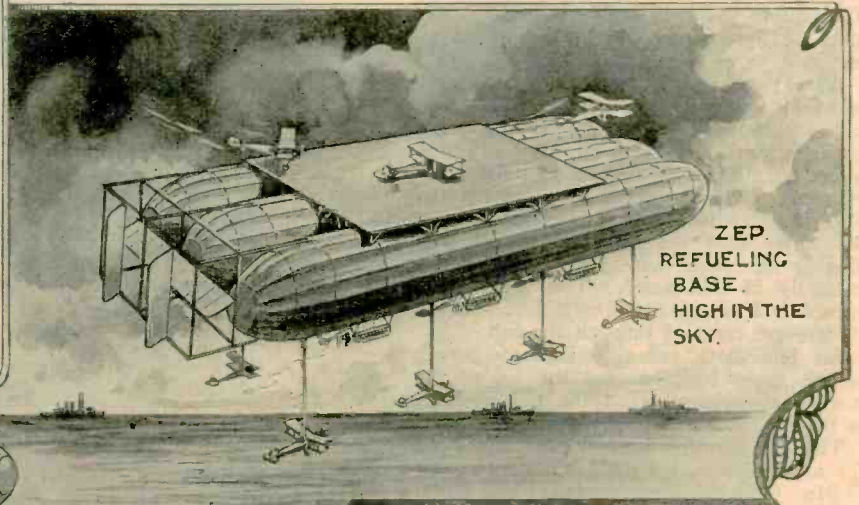

In his interesting prediction of the role of science in future wars, Prof. Hall predicts that airplanes will refuel in the air, landing on a dirigible supported platform or else connecting with suspended cables and hooks. Zeppelins may refuel from giant submarines at sea, as shown in the interesting picture above. If the dirigibles are filled with non-inflammable helium gas and are heavily armed, they will have a fair chance in battle.

THE next war, even if waged within a few years, will be one fought by airplanes and tanks, say our scientists. The infantry will be infantry no longer, for they will go into battle encased in tanks. The reason why the tanks will have such a large share of the work in any future great wars, is due to the fact that first, the men are fairly well protected as compared with their position in trench warfare, and secondly, the tanks are mobile and can transport a large number of troops, which otherwise might be trench-locked for months. A picture of a tank and airplane battle in a war of to-morrow presents a startling spectacle to the mind's eye. Picture hundreds, yes thousands of tanks, traveling over the ground at speeds of twenty-five to thirty miles per hour, knocking down trees, and buildings as they go, and wallowing through seas of water, mud and gas. Military experts are now devising and building tanks which can travel thirty miles per hour or more, and they are being designed gas-tight and water-tight as well. Troops will be moved by huge fleets of tanks as well as by airplanes, and the illustration at the left shows troops being transported to a flanking position.

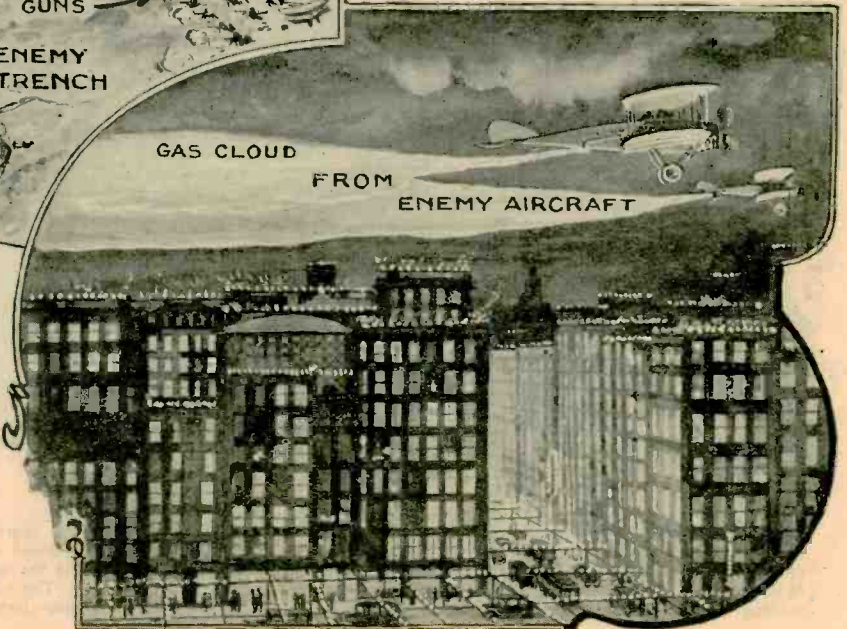
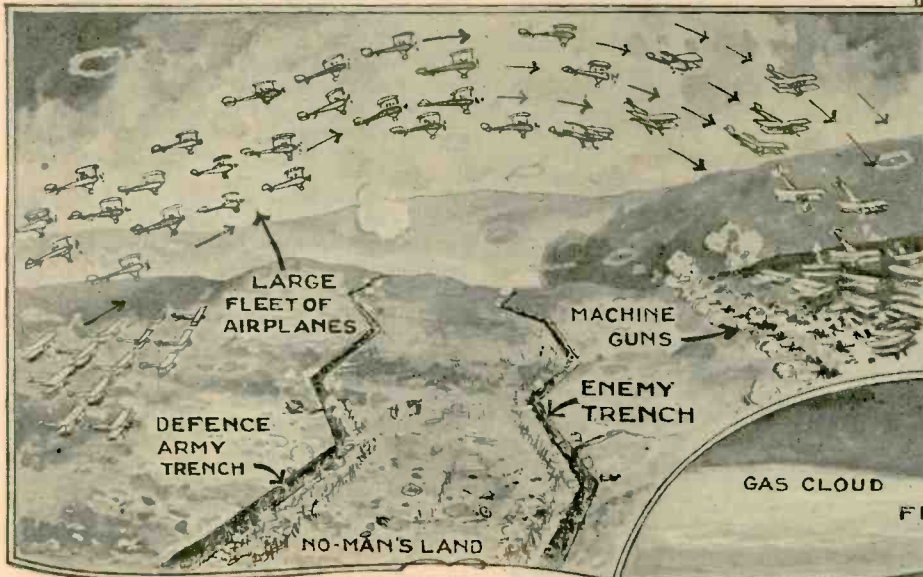

IN the next war, if it should occur, one of the greatest problems the army experts will have to solve will be how to protect our cities and towns from gas attacks by the enemy. Imagine for a moment what it would mean if enemy airplane carriers or large submarines carrying collapsible aircraft, should make a gas attack at night on a city like Philadelphia or New York. It does not take very much gas, such as Lewisite, to render a city uninhabitable. If such an attack was made unexpectedly, or at the start of hostilities, the fatalities would be enormous without a doubt. It seems to the writer that one way of combatting a gas spread over a city would be to lay down a neutralizing gas cloud from other aircraft. Prof. Hall describes the scheme illustrated at right, comprising thousands of gas jets kept burning over buildings and streets.





The pictures above show camouflaged tank and two corps of tanks attacking each other. Above: Opposing fleets of battle planes are about to begin an attack. The airplanes on the left are laying a smoke screen above their tanks, so that the enemy planes will have difficulty in bombing the tanks. Anti-aircraft guns will be carried on tanks.



Machine gun nests in pillboxes will be wiped out in the next war by dropping gas as well as thermite bombs on them. And tanks will squash what is left of the pillbox.



Tank carrying submarines of huge size are predicted by Prof. Hall. The picture above shows a fleet of these vessels landing tanks on an enemy shore. Modern tanks carry radio and can also lay land mines. They climb hills easily.

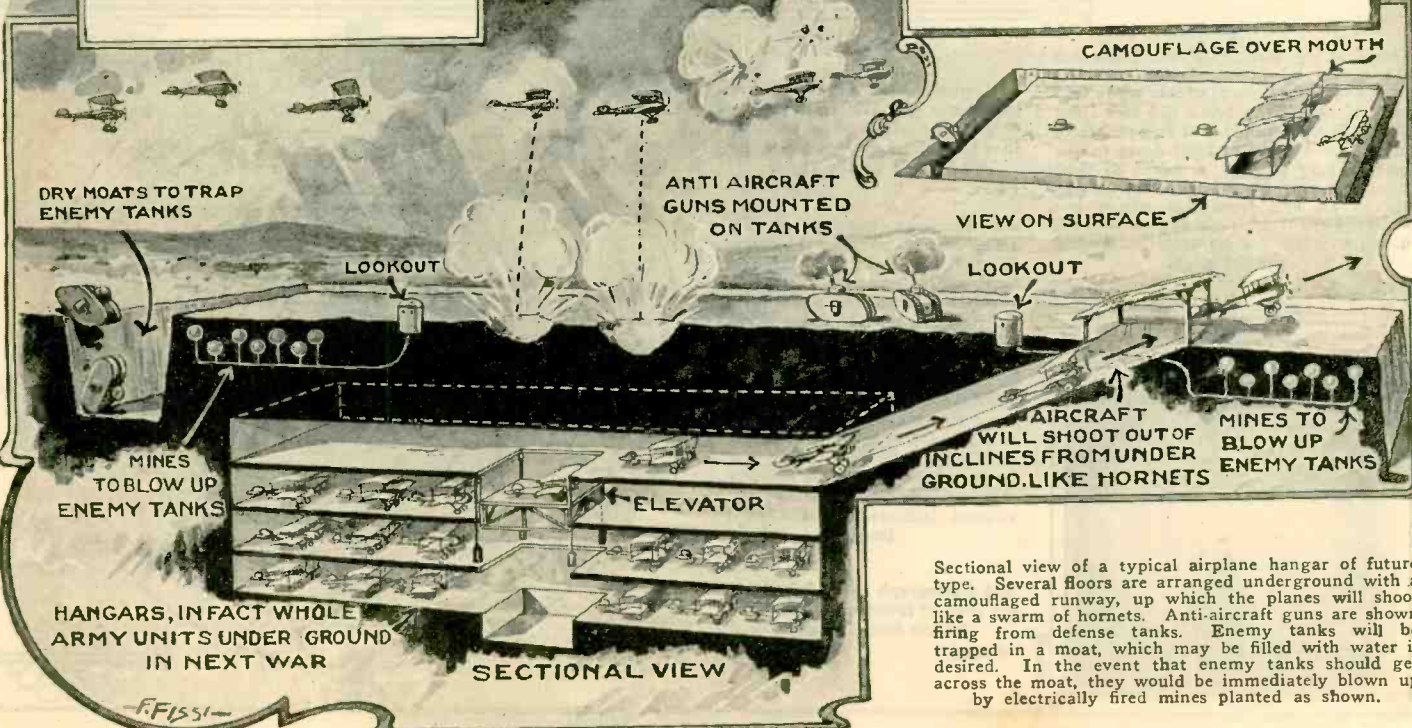

Sectional view of a typical airplane hangar of future type. Several floors are arranged underground with a camouflaged runway, up which the planes will shoot like a swarm of hornets. Anti-aircraft guns are shown firing from defense tanks. Enemy tanks will be trapped in a moat, which may be filled with water if desired. In the event that enemy tanks should get across the moat, they would be immediately blown up by electrically fired mines planted as shown.



# The Improved Interferometer

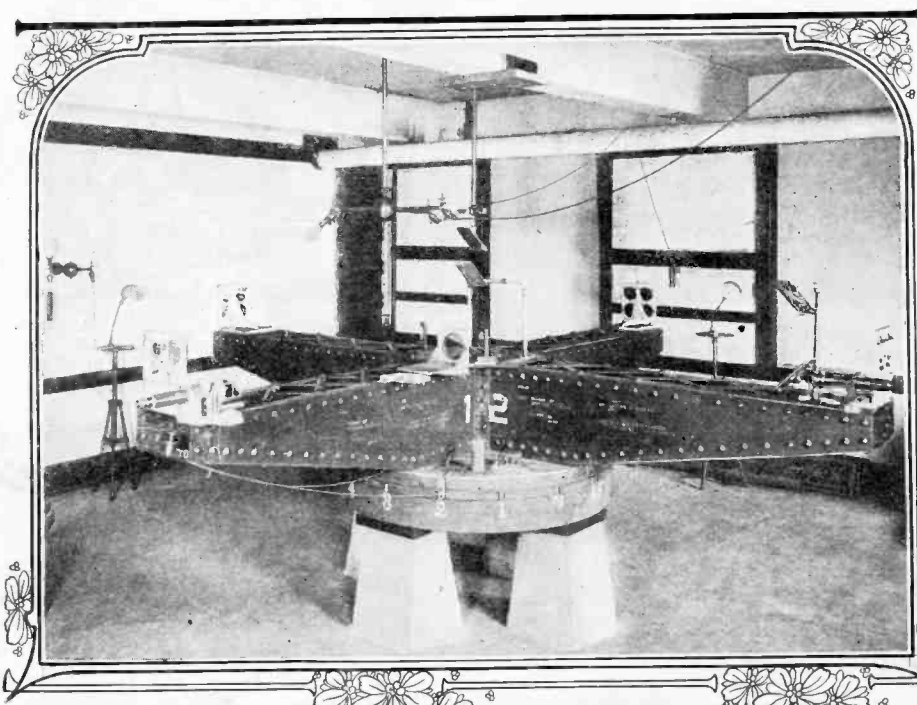

Above: Prof. Miller's interferometer with arms 14 feet long.

**I**NASMUCH as the Einstein theory is based almost entirely upon its promulgator's assumption that there is no such thing as the luminiferous ether, on which so many scientists have based much of their reasoning, the refutation of this assumption would naturally relegate the theory to the realms of the blasted hopes of many other dreamers. An improved type of interferometer used by Prof. Dayton C. Miller has recently been constructed and tests made with it have gone to show that there is such a substance as *ether*, and that there is an *ether drift*; in other words, the earth is going through the ether and setting up an ether wind, just the same as when we travel fast through the air we seemingly set up a breeze. In reality, the air stands still and we go through it. In just the same way, the ether stands still and the earth travels through it. Because of this fact, light will travel faster when going with the ether drift than when going against it, and the interferometer is so constructed as to measure this difference. It makes use of a beam of light divided so as to virtually give two beams of light traveling in different directions, which register according to their speeds. When the speeds are different, interference of the beams is encountered.

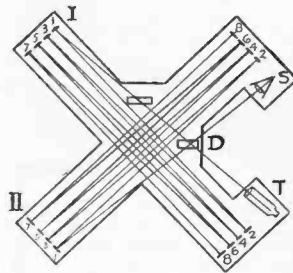
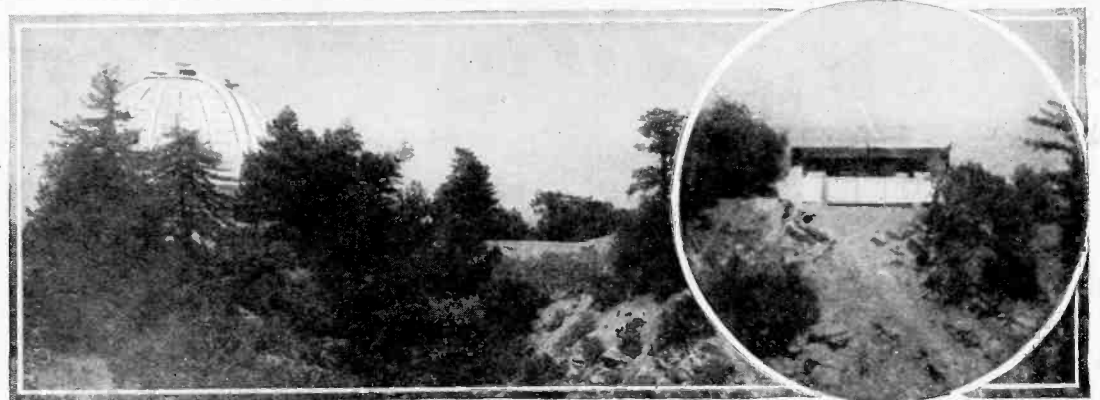

The drawing directly above illustrates the action of interferometer with its four sets of mirrors which make the path of each light beam 120 feet long. Using this instrument, it is possible to measure the speed of light down to one part in four billion. A beam of light from S is split by the half-silvered mirror at D, and from this mirror two beams go out at right-angles to each other, with the results described on the opposite page.

The photograph directly above shows the Mt. Wilson Observatory at the left and the building in which the new interferometer is located at the right.

An excellent analogy of the ether drift is given in the drawing at the right. Imagine a bobber situated at a point equally distant from four floats in a body of water. If there is no current and the bobber is moved, waves will spread out and will cause each float to move at the same instant. If, however, there is an appreciable current, as indicated by arrow, the waves will be distorted from their circular form and will reach the extreme right float first, taking the courses indicated by the solid lines.

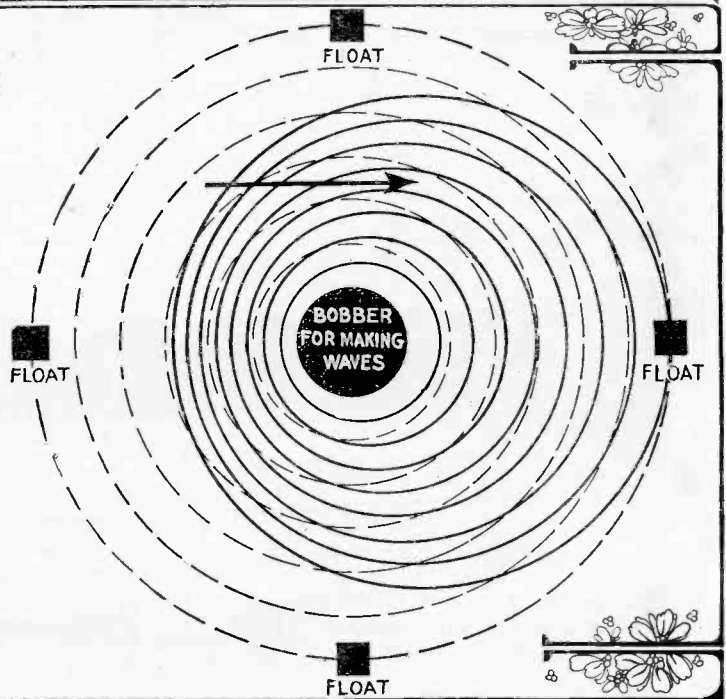

The photograph at the left shows the lines of interference produced by the interferometer.

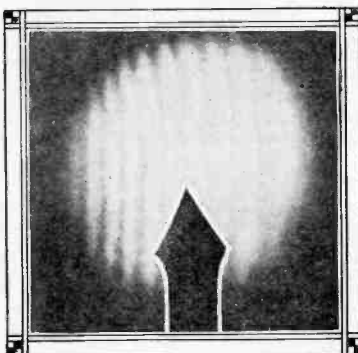

# Maps from Aerial Photos

Specially written for SCIENCE AND INVENTION

By J. B. BEADLE\*

IF we recall the fascinating novelties of our first railroad journey, we may remember how curiously the landscape seemed to act when watched from the car window. The rails and ties of the adjoining track, the telegraph poles, fences and other objects along the right of way seemed to be rushing madly to the rear of us. The nearest fields glided by less swiftly. The most distant trees and houses seemed to be going our way. They moved in leisurely fashion, but we had a hard time of it to gain on them.

Most travelers will recognize these events. Perhaps few will know them under the name of parallax. It is the apparent change in the position of objects due to a change in the point of view.

## EFFECT OF PARALLAX

What the eye can see the camera can record. If the traveler took two snapshots through the car window in quick succession, his pictures would be affected by parallax. The house and tree in the diagram, Fig. 1, have swapped relative positions on his two plates. In the first the house is to the right of the tree. In the second the tree is to the right of the house. If another snapshot had been taken half way between, the tree and house would have come together on the plate.

The second diagram, Fig. 2, shows two snapshots taken closer together. On the two views the house and trees have not swapped positions, but the apparent distances between them have changed. Each tree has seemed to move from the house, but the change is much more pronounced for the tree further from the house. In fact, if the camera is held right, and other conditions are exact, the distances on the plates change precisely with the distances on the ground, measured perpendicular to the plates. To say the same thing, using symbols, the difference between the length  $h_2$  on the first negative and  $h_1$  on the second is a measure of  $d_2$ . In like ratio the smaller change between  $h_1$  and  $h_1'$  stands for the smaller distance  $d_1$ .

## PARALLAX USEFUL IN AERIAL MAPPING

Such parallax measurements on photographs are now put to use in aerial mapping. During the war pictures were taken looking down from airplanes and pieced together as a sort of map of the fighting area. The same thing has been done since to give the engineer a view of a large area where he is planning work. But the engineer demands more of his map. He doesn't want the houses and trees shown in positions to which parallax may shift them. He wants an orthographic projection so he can put his scale or dividers between any two points on it and get a measure of the distance unaffected by perspective. He wants not only a true scale horizontally, but a showing of

\*Engineer, Brock & Weymouth, Inc., Phila., Pa.

elevations, which he represents on a map by contour lines joining points of equal height. Parallax is the key to both. It supplies at once the means of conquering the perspective and projecting the contours. For in pictures taken vertically each point registers a parallax value for its elevation just as each tree in our diagram recorded a parallax for its horizontal distance from the house. Suppose a series of snapshots taken through the car window and the analogy with aerial photography for mapping is fairly complete. Each picture through the car window is in part a new view of something in the picture before it; so in aerial mapping each picture overlaps its predecessor and successor in a series.

## MEASURING HEIGHTS HORIZONTALLY

In each case the two views of the same thing are affected by parallax; and in each case the parallax is a measure of distances in a direction at right angles to the plates. In the train pictures that direction is horizontal, the plates are vertical and the parallax is a measure of horizontal distances.



In aerial mapping the plates should be horizontal and the parallax will be a measure of vertical distances, viz., elevations of the ground. If the aerial plates are not horizontal, the parallax values are modified.

## CHECKING UP AERIAL VIEWS

In practice it is impossible to keep the plates precisely horizontal. The rapid movements of an airplane slightly tilt the camera this way and that, and this occurs in spite of all efforts to hold it. But here again the parallax measurements come to the rescue. If the elevations of a few points on the ground are known, their parallax values on horizontal plates can be computed, and by comparison the picture parallaxes for the same

points give the angles at which the camera was tilted when the exposures were made. With that information it is possible to reproject the photographic negatives so as to get new plates equal to horizontal exposures. Then parallax measurements truly represent ground elevations and serve to fix the height of each hill, the slopes of the ground and the location of the contour lines.

This calls for precise measurements. An inch on the airplane photograph may represent several hundred feet or more on the ground. An elevation of 25 feet may cause a parallax of only a hundredth of an inch. Obviously highly refined machines are necessary for accurate work.

## SPECIAL STEREOSCOPE LOCATES CONTOURS

The Brock stereoscope for this purpose measures a thousandth of an inch or less. It locates the contours with mechanical accuracy. With the stereoscopic feature the operator sees not the ordinary picture but the ground in bold relief. The topographic shapes stand out clearly beneath his eyes and the measuring devices reduce to routine the exact determination of elevations. A machine setting can be made for a particular height and the contour line quickly built up for that elevation. The product is a set of photographic plates with etched contour lines. But these are not yet good maps. The parallax has been used to fix elevations, but it is still in the picture. No picture as such can be rid of perspective. The contours are correct in shape, but each has a distinctive horizontal scale. The higher contour, which was nearer the camera, has a larger scale than the lower one further from the lens and plate. Just as the plates needed correction for tilt, they now call for conversion of the data they contain to the desired uniform scale. Here it is necessary to change over from the form of a picture to that of a hand-made drawing or tracing, the engineer's standard form of map record. First a skeleton of controlling points is carefully plotted. Then each contour in turn is projected to the scale of the drawing or tracing.

## ADVANTAGES OF AERIAL MAPPING

This process of mapping offers some marked advantages. Its speed exceeds that which was possible by older methods. Its accuracy is beyond that attained at reasonable expense for a large area by more familiar surveying instruments. Its operations are largely office routine, independent of weather, free from interruption, susceptible of partition among operatives and draftsmen to attain maximum speed. So compelling are the measurements that errors in ground surveys have been repeatedly pointed out and as often confirmed by check measurements. It offers a means of cheaper surveys, but the principal savings are in time and in the more efficient engineering plans that can be made with better maps of large areas.

# All Planets May Be Inhabited

Professor William Campbell, President of the University of California and director of the Lick Observatory has put forth a theory that every one of the planets may be inhabited by some form or other of life adapted to the particular atmosphere of his habitation. He states, however, that the form of

life on other planets may be as different from our conception of human beings as man is from many of the lower animals. In a recent interview, the Professor, referring specifically to the discoveries of William Beebe in the Sargaso Sea said:

"Even on our own planet there are forms

of life of which we know hardly anything. Life is everywhere evolved in conformity with its environments. Thus, forms of life on earth and in the sea are very different. A fish would doubtless wonder how man was able to live on dry ground."

We may yet learn more about our neighbors.

# Night Photographs

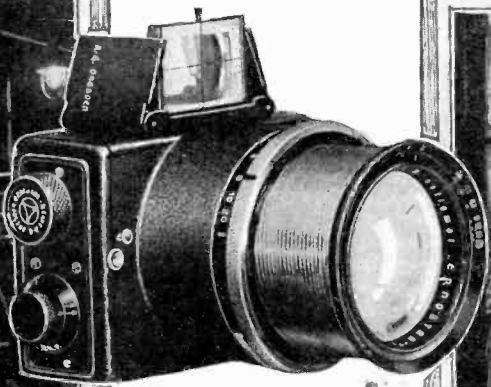
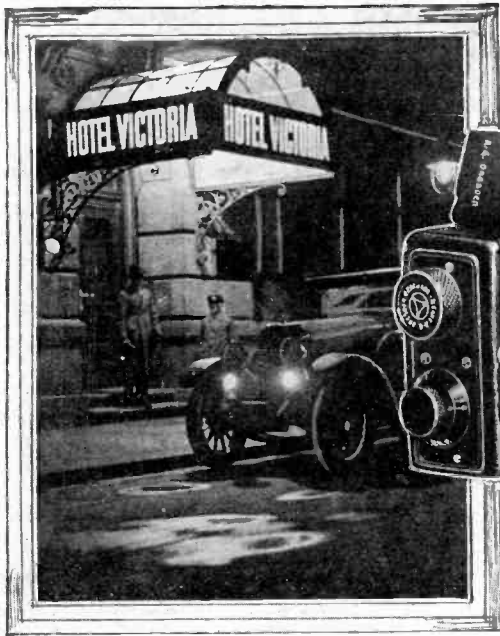

The camera above has a lens which is almost as big as the film upon which the pictures are taken. With such a camera instantaneous photographs may be taken at night.

The photograph above was taken in England and as the lights show it is a night photograph. The time of exposure was one-tenth of a second, which was sufficient to catch the moving hotel guest.

The photograph above was taken in front of a shop window in London. Here again an exposure of one-tenth of a second overcame all motion and gave this very fine example of night photography with the new camera.



Not only can the camera pictured above be used for out-door photography at night, but scenes in a theatre may be photographed while the performance is going on. The three photographs immediately above were all taken during the performances of different plays in Europe. Notice that

in spite of the fact that action is present in each of the scenes there is no blurring of images in any of them. The photographs were taken with an exposure of one-twenty-fifth of a second from a box seat in a London theatre. Scenes from Tannhauser, Flora's Awakening and Le Train Bleu.

## Drawing

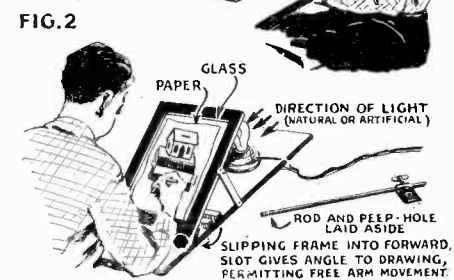
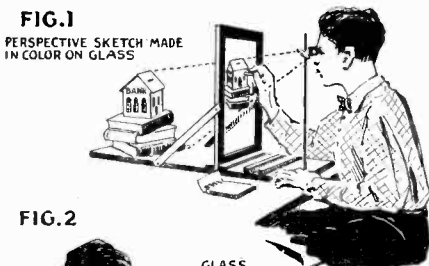

In Fig. 1 above a simple method of learning how to draw is illustrated. A glass upright plate is placed in front of the object to be drawn. The pupil looks at the object through a peep hole and sketches it on the glass with colored chalk. The drawing is subsequently traced on paper as indicated in Fig. 2.—Die Umschau.

## How Lake Dried River

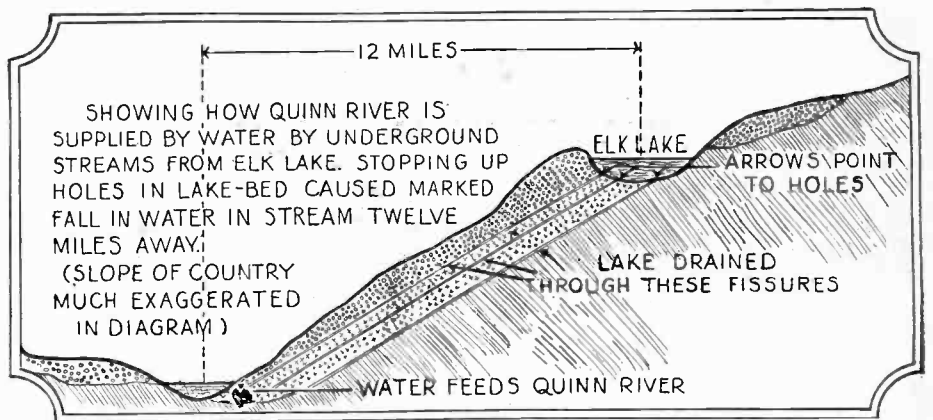

Last summer, owing largely to the prevailing drought, Elk Lake, situated on the Century Drive in Oregon, was lower than it ever had been before. As the water lowered, a large number of huge holes in the bottom were revealed—underground outlets. One of these was twenty feet square; others were no more than two feet in diameter. As fast as the outlets showed themselves they were filled with concrete—seventeen in all. Now comes the report that Quinn River, twelve miles away, has reduced in flow to one-tenth its former value. The theory held by geologists in the vicinity is that Quinn River, previously fed by underground channels from Elk Lake, is now deprived of its water supply by the blocking of the holes. It is probable that the springs which fed the stream originated from Elk Lake, reappearing after a subterranean journey of twelve miles. —Gene Deachem, Ph.D.



# Mathematical Cross-Number Puzzle

Here you are, cross-word puzzle fans, here is a puzzle that will tax your ingenuity to the utmost. The answers are given on page 458, but for your own sake do not refer to them until you have finished the puzzle or exhausted your fund of information. This puzzle is radically different from the usual type in which letters are inserted in blank space to form words. In this one,

definitions are given which, by dint of hard thinking, can be worked out into numerals which numerals are inserted in the correct order in the blank spaces and which will line up both vertically and horizontally in the same way as the letters do in the ordinary cross-word puzzle. The first answer, 1 horizontal, is 654,323. We have named this new brain teaser "Cross-Number Puzzle."

### HORIZONTAL

- 1—Take 87,771,212 and multiply the digits together—then multiply by 59,614.
- 5—Add a V to the square feet in 10 acres.
- 10—One-tenth of the abbreviation for Maryland.
- 12—Three C's followed by a couple of X's.
- 13—The atomic weight of aluminum.
- 15—Subtract 71,082 from 40 times the number of miles from here to the moon.
- 18—Specific gravity of pig-iron—decimal between the two figures.
- 19—Chemical symbol for lithium.
- 20—One-tenth of the distance from here to the sun.
- 21—Specific gravity of aluminum—decimal between the two figures.
- 22—The difference between the boiling point of water by the Fahrenheit and Centigrade thermometers.
- 24—Ten times the current year, according to the Hebrew calendar.
- 25—The difference between the boiling point of water by the Fahrenheit and Reaumur thermometers.
- 26—Abbreviation for the Lehigh Valley railroad.
- 27—Chemical symbol for carbon.
- 28—Two less than the number of sheets in a quire of paper.
- 29—Familiar contraction for the year of the great gold rush to California.
- 30—A force necessary to raise this number of thousand pounds a foot high in a minute; this is equivalent to theoretical horse-power.
- 31—Square 0.10 and place a decimal in front of the first figure.
- 32—Five times the nearest whole number that is the cube root of 1,728.
- 34—The number of players on a foot-ball team.
- 35—Atomic weight of radium.
- 37—Interest on \$10,000 for 18 days based on a 360-day year.
- 39—Length of a Japanese mile compared with ours—decimal after first figure.
- 41—17,325 years from now this figure will represent the current year A. D.
- 43—The year of the Hegira.
- 45—Three saw-horses, a V, and a personal pronoun first person singular.
- 46—151,473.285 stone.
- 48—The number of which 24,389 is the cube.
- 49—The decimal 0.78125 equals how many 64ths?
- 50—Seven will go into this number 705,152 times.
- 51—The number of years it will take a given amount of money to double itself at  $2\frac{1}{2}$  per cent. simple interest.
- 52—The gold values of a French franc—decimal after the second figure.
- 53—Fourteen less than the square of 26.
- 55—1,578.75 cords in cubic feet.
- 56—The Greek letter pi which, multiplied by the square of the radius of a circle, will give the area—decimal after the first figure.

1		2	3	4			5	6	7	8		9
		10				11		12				
13	14		15		16		17				18	
19			20								21	
22		23		24						25		
		26			27				28			
	29			30			31			32		
33		34			35	36			37			38
39	40			41				42		43	44	
45			46					47			48	
49			50								51	
		52						53		54		
55							56					

### VERTICAL

- 1—Subtract 1,090 from the number of inches in 10 miles.
- 2—A saw-horse, an I, and a personal pronoun first person singular.
- 3—One less than the square of 60.
- 4—Subtract 3 from the last decimal figure of the natural tangent of 63 degrees and 55 minutes—place a decimal point after the first figure.
- 6—Subtract 4 from the last decimal figure of the natural co-tangent of 16 degrees and 26 minutes—place a decimal after the first figure.
- 7—The linear feet in a mile.
- 8—One-sixth of the number of degrees in a circle.
- 9—From 10,000 less than the number of minutes in a year (not leap year) subtract a tenth of the cube of 31.
- 11—Sixty less than 10 times the current year, according to the Mohammedan calendar.
- 14—DCCXI.
- 16—1,000 long tons in pounds less 28, multiplied by 395.6.
- 17—Take the diameter of the earth at the poles in feet—nearest foot; multiply by 2.54; then add 58,080.
- 18—Six less than the cube of 9.
- 23—10,620.5 Japanese miles.
- 25—One less than 2,109.5 fathoms.
- 33—20.04 more than the square of 351.4.
- 36—Logarithmic sine of 9 degrees and 34 minutes.
- 38—The cube of 90.
- 40—One more than the number of feet in 140 meters.
- 41—The square yards in an "are"—decimal after the third figure. Use .38 as the decimal.
- 42—Natural sine of 15 degrees and 26 minutes—decimal after the first figure.
- 44—One-tenth of the weight in pounds of 35.84 cubic feet of water.
- 46—Natural sine of 14 degrees and 25 minutes—decimal before the first figure.
- 47—Logarithm of 443.
- 52—A dozen.
- 54—0.328125 equals how many 64ths?  
(Answer on page 458)

## Insomnia Cure

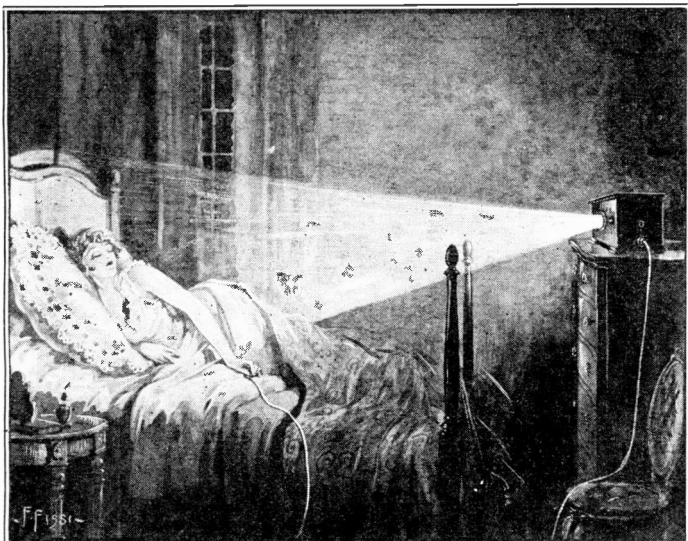

A novel device designed to cure insomnia has been patented by an English inventor. The principle of it depends upon the action of light upon the retina of the eye. It flashes a series of 12 different colored rays at a certain pre-determined speed and in a definite sequence. It is said that these rays affect the eye in such a way as to induce sleep even in the most stubborn cases of insomnia that have failed to respond to other treatment. The flashing lights are supposed to have no bad effects on the eyesight.

# Latest Devices

A SMALL, handy washing machine, easily used over a sink, washbowl, or on a table, has recently been placed on the market for convenience of persons who do not wish to wait for a regular wash day to have cleansing of garments done. It is of special use in the nursery and does a personal wash of dainty pieces in a few minutes, saving them from the wear and tear of an ordinary wash. For the professional or business person who is away from home during the day, it is of particular value as he or she can keep a wardrobe in cleanliness at all times by doing two or three washings a week, taking a few minutes for each time. When not in use all parts of this tiny washer are kept within the container, thus saving space. The device is of great use in the summer home as garments as large as towels and shirts can be washed in it by the mere process of turning the crank.

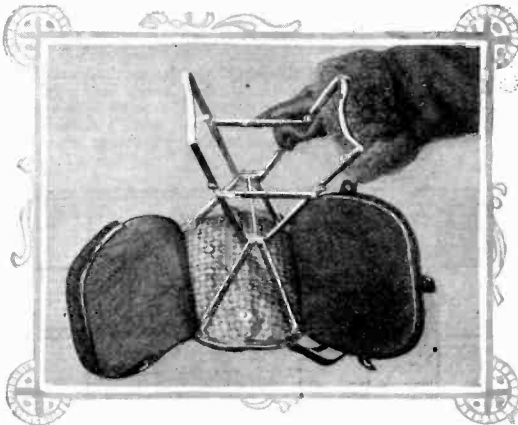

A new type of folding seat which will appeal to sportsmen and all those who have occasion to carry a chair with them is illustrated above. This device made of strong yet light steel bars and comfortable upholstery can be completely folded until it resembles a hand bag. The photograph shows a view of the seat unfolded and ready to be inverted into a usable position.



The sharp back of the average paring knife will often cut the hand of the user. The little metal device shown above protects this edge and prevents harm.



The device illustrated above is designed for mincing and chopping foods for the preparation of various dishes. Four sharp blades on the end of the rod perform this work.

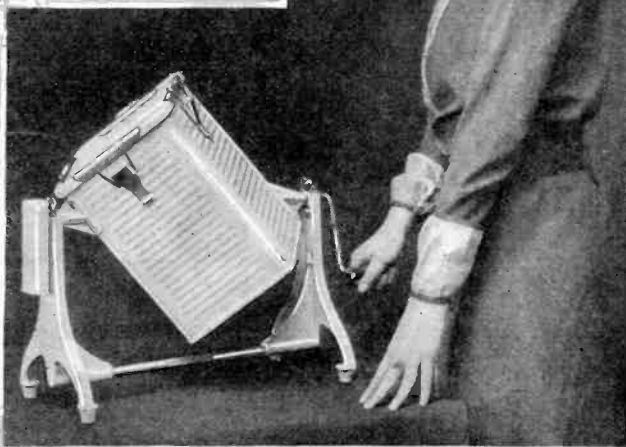

Another boon to milady's toilet is the small and compact curling iron illustrated in use below. The device is heated by means of a gasoline torch which is supplied with it and the prongs are then applied to the hair in the usual manner. In this way a young lady may keep her hair looking its best under all conditions. Despite its small size, this iron is said to be effective in every way and perfectly satisfactory in operation.

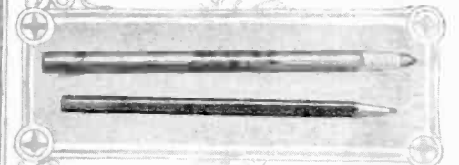

Something new in the line of an easily carried eraser is shown above. It is similar to the ordinary pencil constructed on the paper roll idea, and requires only a nick from a knife or pin and the removal of a curl of paper to expose a new, clean erasing surface. The eraser is shown compared with an ordinary pencil directly below it.

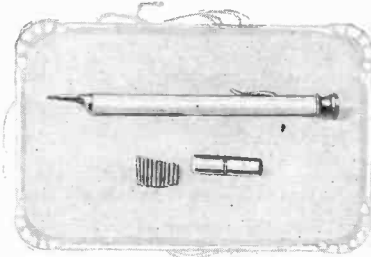

A pencil which can be made to write in five different colors is illustrated above. It works on the same principle as the average automatic pencil but contains a five barreled magazine which can be rotated so as to bring the desired colored lead into action. This pencil comes supplied with a case containing ten refills.



The carrying case for the small curling iron shown in use at the left is illustrated directly above. The large handle of the iron covers the small gasoline torch supplied for heating purposes, while the prongs of the iron slide into a cylinder fastened to the side of that one containing the gasoline torch. The entire telescoped unit may be carried in the neat case shown beside it.





# Boat Travels on Air

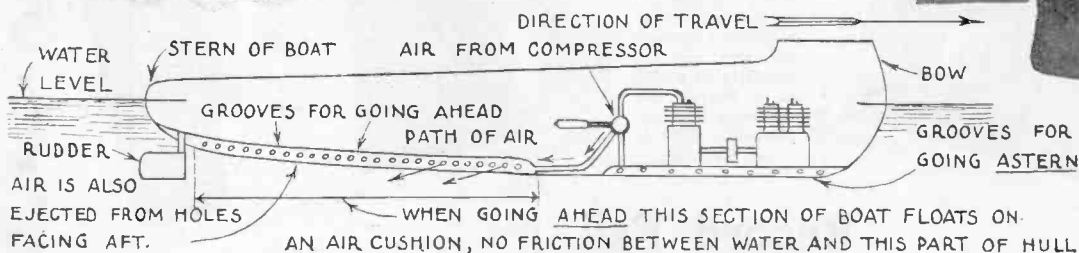
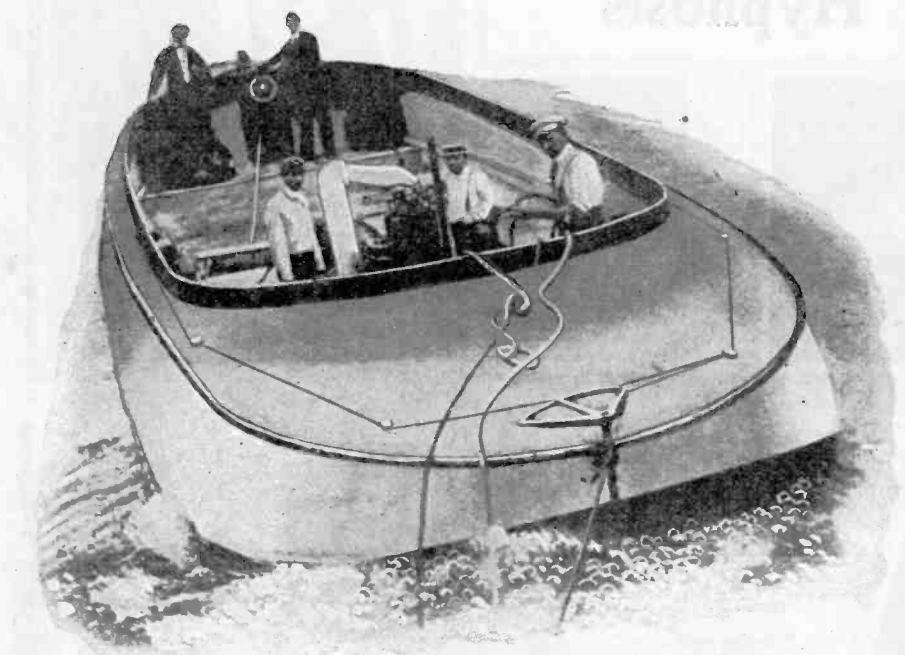

A boat which is designed to be propelled on a somewhat new principle is illustrated above. The young lady at the right is holding a small working model of the boat. One boat which has been completed is shown in operation at the left above. The details of the principle of propulsion are given in the line drawing. A gasoline engine is coupled

to an air compressor. This in turn is connected by pipes to a series of holes at the rear of the boat and also to a smaller series in the bow. A valve controls the flow of air to either set of holes. Air issuing from the stern holes causes the boat to go ahead. Forcing air out of the front holes reverses the action.

—C. A. Oldroyd.

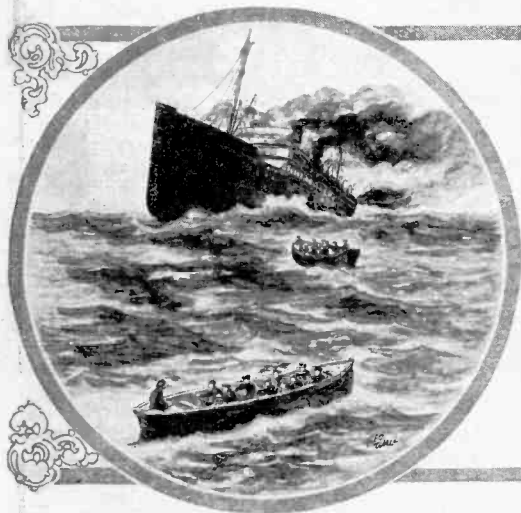

## Lever Propelled Life Boat

A new type of life boat which is propelled by levers instead of oars is illustrated in detail at the right. Pulling and pushing on the levers rotates a gear which drives a pinion, which in turn revolves the propeller.

It is said that the new type of life boat shown herewith is more efficient and much simpler in operation than the ordinary type of oar-propelled boat. With 42 people in one of these boats, eight men at the levers easily maintain a speed of 3 miles an hour. With two men to each lever, facing each other, it is quite possible that the speed would be doubled. One great advantage of this type of boat is that the operators need not be experienced. With just one seaman in the boat for steering, totally inexperienced people can keep the boat moving steadily. A simple reverse lever is incorporated in this boat which reverses the propeller without any change on the part of those operating the levers. In the ordinary oar-propelled boat, inexperienced oarsmen often lose their oars. There are no oars in this type of boat.



# Unusual Hypnosis



"To Rhama" is entertaining in Germany in a rather novel fashion. He first hypnotizes animals, which are shown in the photos above, and then submits himself to a rather novel test.

Claiming self-hypnosis, "To Rhama" permits needles to be pushed through the arm and his hands to be nailed to a board. On removing the implements, there is no bleeding.



# Record Fall

**T**HERE is an old theory that when a man falls from a considerable height, he is dead before he reaches the ground. This theory has at last been exploded by two Army aviators, who leaped from an airplane at Mitchell Field, L. I. A short time ago there was an article in a newspaper concerning a man who jumped off the Brooklyn Bridge, and who was supposed to have died before he hit the water. At least that was the opinion held by the writer of the article. Parachute experts contended that a falling person retains his senses, and a test was attempted. Accordingly Staff Sergeant Randle L. Bose and Corporal Arthur Bergo went aloft in a Martin bombing plane. At a height of 3,000 ft. they jumped. The men shot through the air twisting, whirling, somersaulting. When they reached the level of 2,000 ft., they pulled the rip cord. This opened the parachute and checked their descent. The parachutes permitted them to sail down to the fields like

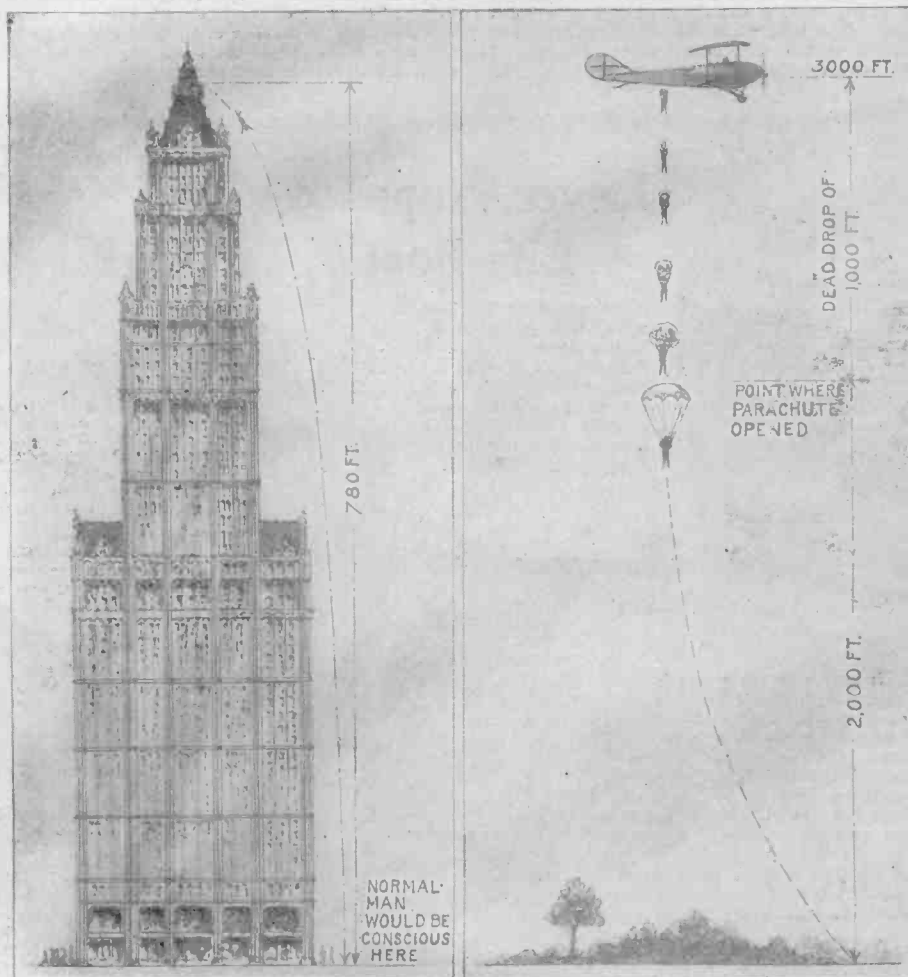

a couple of birds. Before any of the crowd could question either Bose or Bergo, they again ascended in the bombing plane to repeat the test.

Both men testified that at no time did they lose control of themselves. They experienced the greatest thrill when their flights were suddenly checked by the opening of the parachutes. Of course if they once lost their hold on the cords, they would have had a thrill which one gets but once in a lifetime, but they would have been unable to tell about it. By this test it has been definitely proven that a person leaping from the Woolworth Building will be fully conscious up to the moment he strikes the ground. Only in cases of heart trouble would the person die before his body struck the pavement.

Thin as the parachutes may seem, they certainly have proven their efficacy. Little wonder then that the Army aviators are compelled to equip themselves with parachutes when flying.



# Novelties



The photo at the left shows how artificial leopard skin is being made at the present time using the much maligned rabbit fur. A stencil is placed upon the rabbit skin and then an aniline dye is used to produce the spots. After the stencil is removed, the fur appears as indicated in the photo at the right. The fur can then be made into coats, or as was the style during the past year, it may be used to line or half-line a coat. Not only is the coat warm, but it is attractive as well. Milady ought to know, she was wearing a coat lined with imitation leopard fur last year.



The photo at the right shows half a dozen hailstones that fell in the vicinity of New York recently. It appears that they are quite a handful. Each one measures about an inch and a half in diameter. These hailstones are not the largest that have fallen by any means. A few years ago districts thirty miles from New York City suffered a hailstone storm in which the hailstones were as large as baseballs. Naturally hailstones as large as this do considerable damage, breaking windows and often killing poultry and other animals, at the same time destroying crops. The exact formation of a hailstone is not known, although there are several theories as to its formation. One of the most popular is that a small particle of ice is formed, and this is carried up to the colder stratas by wind currents. Here the water surrounding the particle of ice freezes. The operation is supposed to be repeated dozens of times.



The instrument shown below is one of the earliest models of an explosion engine known. It was developed in the early part of the Nineteenth Century and was probably the forerunner of our modern internal combustion engines.

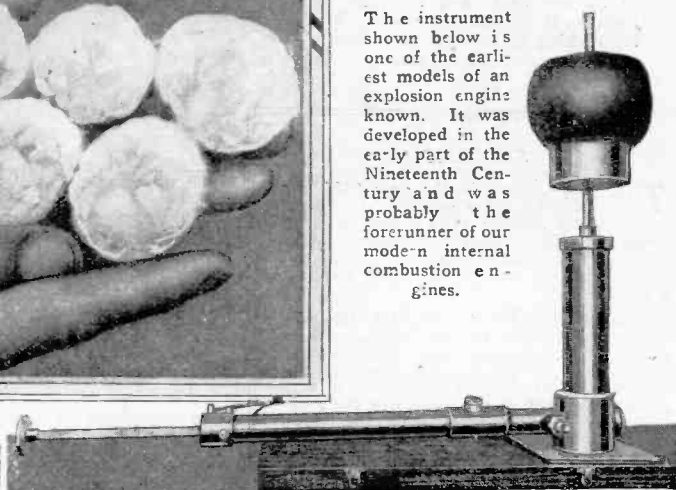

It is quite difficult to prepare a fountain-pen for use in temperatures down to fifty or sixty degrees Fahrenheit below zero. Such a pen has been prepared, and is shown in use in the photo below.



GOLD PLATED HOUSING FOR HEATING ELEMENT  
6 WATT NICKLE CHROMIUM ASBESTOS INSULATED HEATING UNIT  
PEN  
HARD RUBBER PROTECTING CASE

In the making of a fountain-pen for use in temperatures of fifty or sixty degrees below zero Fahrenheit, several interesting phases are presented. Heat is required surrounding the pen to keep it normally warm enough to accomplish the purpose, but not warm enough to over-heat the pen. The photo above shows the pen, the rheostat used to control the heat and the clips with which the leads are connected to the storage battery. Walls of metal with a thickness of .007 inch house the resistance wire between them. The pen tip projects just beyond the heater tube to prevent the ink from freezing there.



# Tarrano the Conqueror

THIRD INSTALLMENT

By RAY CUMMINGS

First American and Canadian Serial Rights

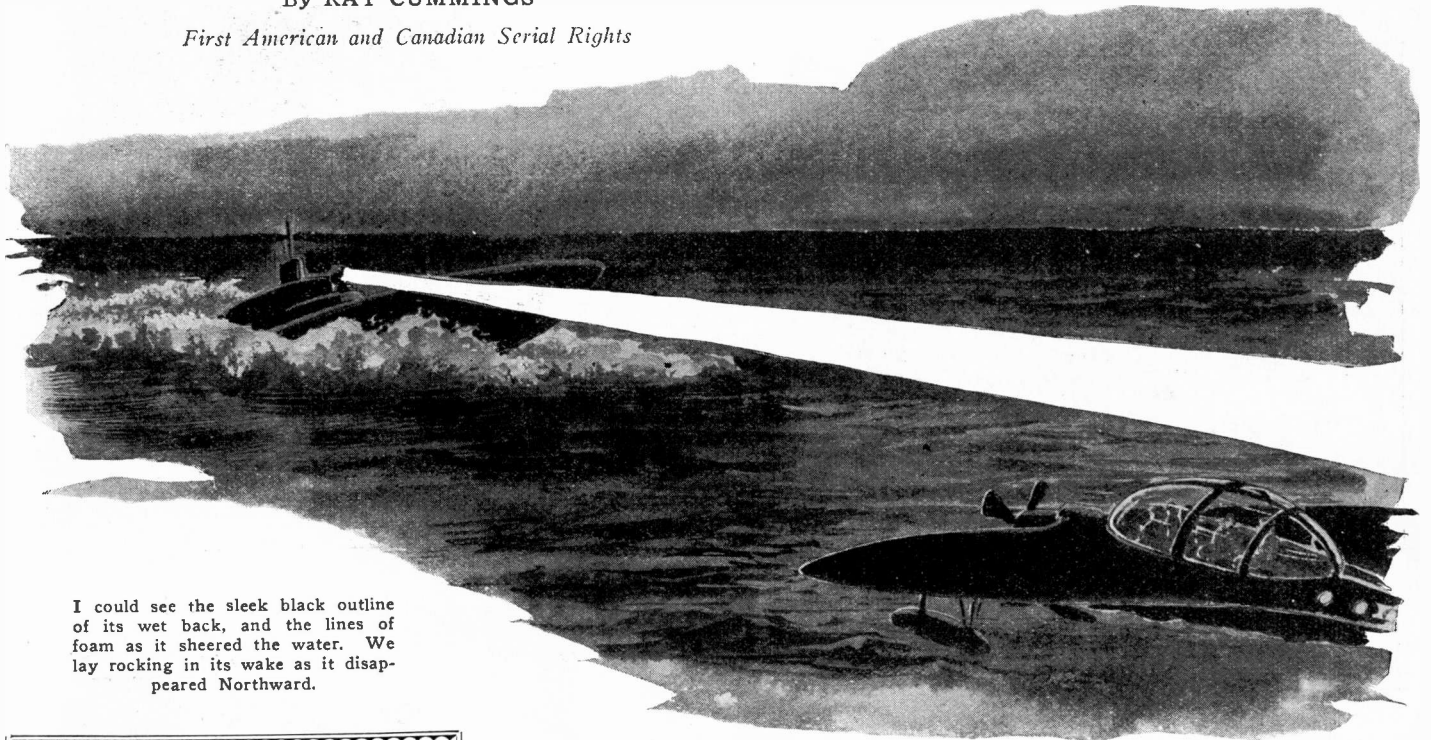

I could see the sleek black outline of its wet back, and the lines of foam as it sheered the water. We lay rocking in its wake as it disappeared Northward.

## SYNOPSIS

**T**HE story opens in the year 2325 and is related by Jac, a writer of that time, employed by a large news organization of Great New York. On the afternoon of May 12 of that year, the President of the Anglo-Saxon republic is murdered in the midst of a speech.

Immediately after the murder, the narrator of this story, together with the thousands of other listeners, were hurried away from the spot on the moving sidewalks that were in general use. This happened at 5:10 P. M. At 6:15 of the same day the ruler of Allied Mongolia was murdered. Ten minutes later the leader of the negroes of Africa was killed while asleep. This left the earth without leadership. Jac and Graysen, a co-worker of his, suspect that the murders are the result of a plot on the part of the inhabitants of Venus. At 8:26 the mail from Venus landed. At 8:44 a message by helio from that planet announced the murder of the ruler of the Venus Central State. A warning came with the same message and read in part, "City being attacked . . . Tarrano, beware . . . you are in danger of . . ." The message broke at this point and further communication was impossible.

At 9 P. M. Jac was summoned to North-east Island, off the coast of Maine, by a Dr. Brende. He goes and is welcomed by the Doctor and informed that the Martian ruler of the Little People had also been assassinated and at the same time communication had become impossible with Mars.

Tarrano, the Doctor states, was at one time a lower official of the Cold Country of Venus. The Doctor then announces that he, Brende, has perfected a medical method whereby human beings may be kept from growing old.

Unable to communicate with the Doctor's laboratory in northern Siberia, they set out for that point in Brende's car. Arriving there they found no one outside and upon entering the laboratory building, were set upon by a group of "Venus-men."

## CHAPTER V THE OUTLAWED FLIGHT

**D**R. BRENDE was dead. We knew it in the moment that followed our sudden assault and capture. Elza knelt there sobbing. Then she stood up, her tears checked: and on her

face a look of pathetic determination to repress her grief. Now that we had yielded, the Venus-men, searching us for our weapons, cast us loose. We bent over Dr. Brende, Georg and I. Dead. No power in this Universe could bring him back to us.

Georg pressed his lips tightly together. His face, red from the exertion of his fight, went pale. But he showed no other emotion. And, as he leaned toward me, he whispered: "Got us, Jac! Say nothing. Don't put up any show of fight."

Elza now was standing against the wall, a hand before her eyes. I went to her.

"Elza, dear—"

Her hand pressed mine.

Our captors stood curiously watching us. There seemed to be at least ten of them—men as tall as myself, though not so tall as Georg. Swarthy, gray-skinned fellows—one or two of them squat, ape-like with their heavy shoulders and dangling arms. Men of the Venus Cold Country. They were talking together in their queer, soft language. One of them I took to be the leader. Argo was his name, I afterward learned. He was somewhat taller than the rest, and slim. A man perhaps 30. Paler of skin than most of his companions—gray skin with a bronze cast. Dressed like the others in fur. But his heavy jacket was open, disclosing a ruffled white shirt, with a low black stock about his throat.

A shifty-eyed fellow, this Argo. Smooth-shaven, with a mouth slack-lipped, and small black eyes. But his features were finely chisled; and with that bronze cast to his skin, I guessed that he was from the Venus Central State. He seemed much perturbed that Dr. Brende was dead. Occasionally he burst into English as he rebuked one of the others for the killing.

No more than a moment had passed: Georg joined Elza and me. We stood waiting. Georg whispered: "They killed Robbins and his helpers. In there—" He gestured. "I saw them lying in there. If only I had—"

Argo was standing before us. "This is a very pleasant surprise—" He spoke the

careful English of the educated foreigner. His tone was ironical. "Very pleasant—"

Abruptly he turned away again. But in that instant, his eyes had roved Elza in a way that turned me cold.

They led us away, down a padded hallway into the instrument room. It was in full operation; our Inter-Allied news-tape was clicking; the low voice of the announcer droned through the silence. I started toward the tape, but Argo waved me away. He had volunteered us nothing, and again Georg advised me to be silent.

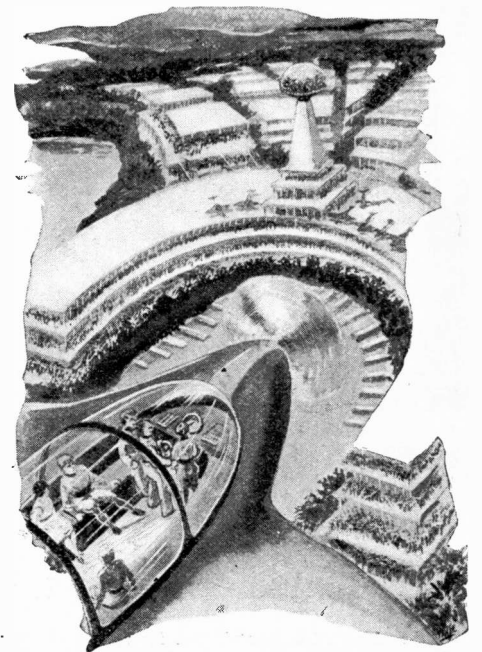

We seemed now to have passed within the patrol line. There were no more official vessels to be seen. We clung low, and at 12° South, 67° 20' West, at 10:16 that morning we descended in Venia, capital of the Central Latina Province, largest immigrant colony of the Western Hemisphere.



Argo had given his orders. Through a window I saw men carrying apparatus from the house. A small metal frame, of sun-mirrors, prisms and vacuum tubes. Georg whispered: "Father's model."

The man with it passed beyond my sight. Others came along, carrying the cylinders of books—Dr. Brende's notes—and a variety of other paraphernalia. Carrying it back from the shore toward the headlands of the Cape, where I realized now they had an aero secreted.

Argo was at a mirror; he had a headpiece on; he was talking into a disc—talking in a private code. I could see the surface of the small mirror. A room, with windows. Through one of the windows, by daylight, palms and huge banana leaves were visible. A room seemingly in the tropics of our own hemisphere.

Argo was triumphant—explaining, doubtless, that he had captured us. Mingled with his voice, the Inter-Allied announcer was saying:

*"Great—New York 10.32 Martian Helio, via Tokyohama: Little People Proclamation—"*

A man standing near the tape switched off the droning voice. At the receiving table, every few seconds came the buzz of the laboratory's call. Wrangel Island again calling Robins; but no one paid any heed. Argo finished at the mirror. He glanced over the tape, smiling sardonically. Then, methodically, deliberately, he swept the instruments to the floor, jerked out the connections, turned out the current—wrecked it all with a few strokes. A moment later we were taken away.

Outside, from back by the low reaches of the Cape, we saw an aero rising. They had loaded it with Dr. Brende's effects, and in it half of the men were departing. It rose vertically until we could see it only as a speck in the blue of the morning sky—a speck vanishing to the North over the Pole.

With four or five of the men—all those remaining—Argo took us three to the Brende car. We did not pass Dr. Brende's body, lying there in the outer room. Elza and Georg gazed that way involuntarily; but they said nothing. The greatest grief is that which is hidden, and never once afterward did either of them show it by more than an affectionate word for that father whom they had loved so dearly.

Soon we were back in the Brende car

in which we had landed no more than an hour before. It was a standard Byctin model—evidently Argo and his men knew how to operate it perfectly. We were herded into the pit, and in a moment more were in the air.

Argo seemed now rather anxious to make friends with us. He was in a high good humor. His eyes flashed at me sharply when I questioned him once or twice; but he offered us no indignities. To Elza he spoke commandingly, but with that deference to which every woman of birth and breeding is entitled from a man.

We rose straight up and, at 18,000 feet, headed Northward—by a point or two West. We would pass the Pole on our right—too far to sight it with the naked eye, I realized; but I knew, too, that the Director there would see the distant image of us on his finder, even though we refused connection should he call us. And we had no right to be up here in the 18,000-foot lane. They'd order us down—shut off our power, if necessary.

We could not escape observation on this daylight flight. Heading this way, it would take us past the Pole and on Southward, down the Western Hemisphere over the Americas. We could not refuse connection for long. We would be challenged, then brought down. Or, if Argo answered a call, some Director would examine our pit with his finder—would see Elza, Georg and me as prisoners. We could gesture surreptitiously to him. . . .

My thoughts ran on. Argo's soft, ironic voice brought me out of them.

**OCEAN SUBWAY!**

A brand new engineering conception in building a subway across the Atlantic. Don't fail to read all about it in the October number.

"We will answer the first call that comes," he said smilingly. "You understand? We are the Inter-Allied News on Official Dispatch." He was addressing me, his glance going to the insignia on my cap. "You are of the Inter-Allied?"



Still there was in his voice and on his face nothing but kindness and a queer whimsical look of reminiscence. He broke off at the buzz of a disc that hung from his belt by a golden chain. He jerked it loose from its snap, and to his ear clasped a small receiver. Like a mask his gentleness dropped from him. His voice rasped: "Yes? . . ." The receiver murmured into his ear. He said: "Connect him—I'll listen to what he has to say."

A moment; then on the tiny mirror fastened to his wrist with a strap, I saw a face appear—a face known throughout our Earth—the face of the War-Director of Great London. Tarrano listened impassively.

"Yes," I said.  
 "What's your name?"  
 I did not like his tone. "None of your—"  
 "Quiet, Jac" Georg warned.  
 "Jac II, son of Hallen," I amended.  
 "Yes. Division 8, Manhattan," he read from my cap. "Well, when the first Director calls—from the Pole perhaps—you will tell him we are Inter-Allied Officials. He will see us here—I do not believe, the way we are sitting, that he will think anything is wrong. He will see us of Venus. There are Venus-men employed by the Inter-Allied. Is it not so?"

I had to admit that it was. He nodded. "You will fool the Directors, Jac Hallen. You understand? You will get the reports on weather today down the 67th Meridian West. And ask if we can have power to the Equator and below." His eyes flashed. "And if you attempt any trickery—you will die. You understand?"

I did, indeed. And I knew that his plans were well laid—that I would be helpless to give us over without paying for it with my life—with the lives of Elza and Georg as well.

From up here in the 18th lane, the Polar ocean lay a glittering white and purple expanse beneath us. Then, again, a fog rolled out down there like a blanket. We passed the Pole, a hundred miles or more to one

(Continued on page 458)

"The wire, Argo." He took the length of wire, gleaming white-hot, as the leering, gloating Argo turned the current into it—Tarrano took it, lashed it upon the poor wretch's naked back and legs.



# Tricks of Mediums

By EDWIN MERLIN

A Reformed Spiritualist.

ON this page we show a series of pictures illustrating another group of effects that are found in the repertoire of most spiritualists. All of these effects have actually been worked in dark room seances by the author of the article, and are being used by a great many would-be mediums throughout the country, even at the present time. Even though the effects are surprisingly simple, they produce very uncanny results in the dark.



↑ The above illustration shows a medium tied in a sack. On her lap is placed a slate which is held by two sitters. The medium writes with a thin pencil through the meshes of the sack.

→ The two photographs at the right illustrate a typical effect often performed in a seance room. A heavy cord or wire is passed through the cuff button holes in the sleeves of the medium's shirt. The cord is held by the sitters. The medium slips off the cuffs and does his work without interference, while the sitters believe that his hands are in absolute control.



↑ The luminous band on the end of the trumpet seemingly floats with the trumpet around the room. As it passes the medium's lap, he covers the trumpet band with a black cloth and exposes a round circular band previously hidden in the cloth. This he moves with great dexterity, and at high velocity in front of the sitters' faces, demonstrating in this way remarkable "spirit control."



↑ The medium sits in a creaky chair and rocks it before the seance starts. When the room is darkened, he stands up and rocks the chair with his foot. Joining two trumpets together end to end, he is able to cause the luminous band to move around the room at a distance of ten or more feet from the chair. The creaky noise makes the sitters believe that he still occupies the seat.



The medium knows that spirit manifestations are taking place. He asks Miss Steinmetz to hold his left hand, meanwhile operating the trumpet with his right. He then says, "Hold my right hand, Miss Foote," and he operates the trumpet with his left. After repeating the phrases for a while, he insists that both hands be held tightly. With his hands under control he lifts the trumpet to his mouth with his feet, as the three accompanying photographs illustrate.





# Aerial Ball

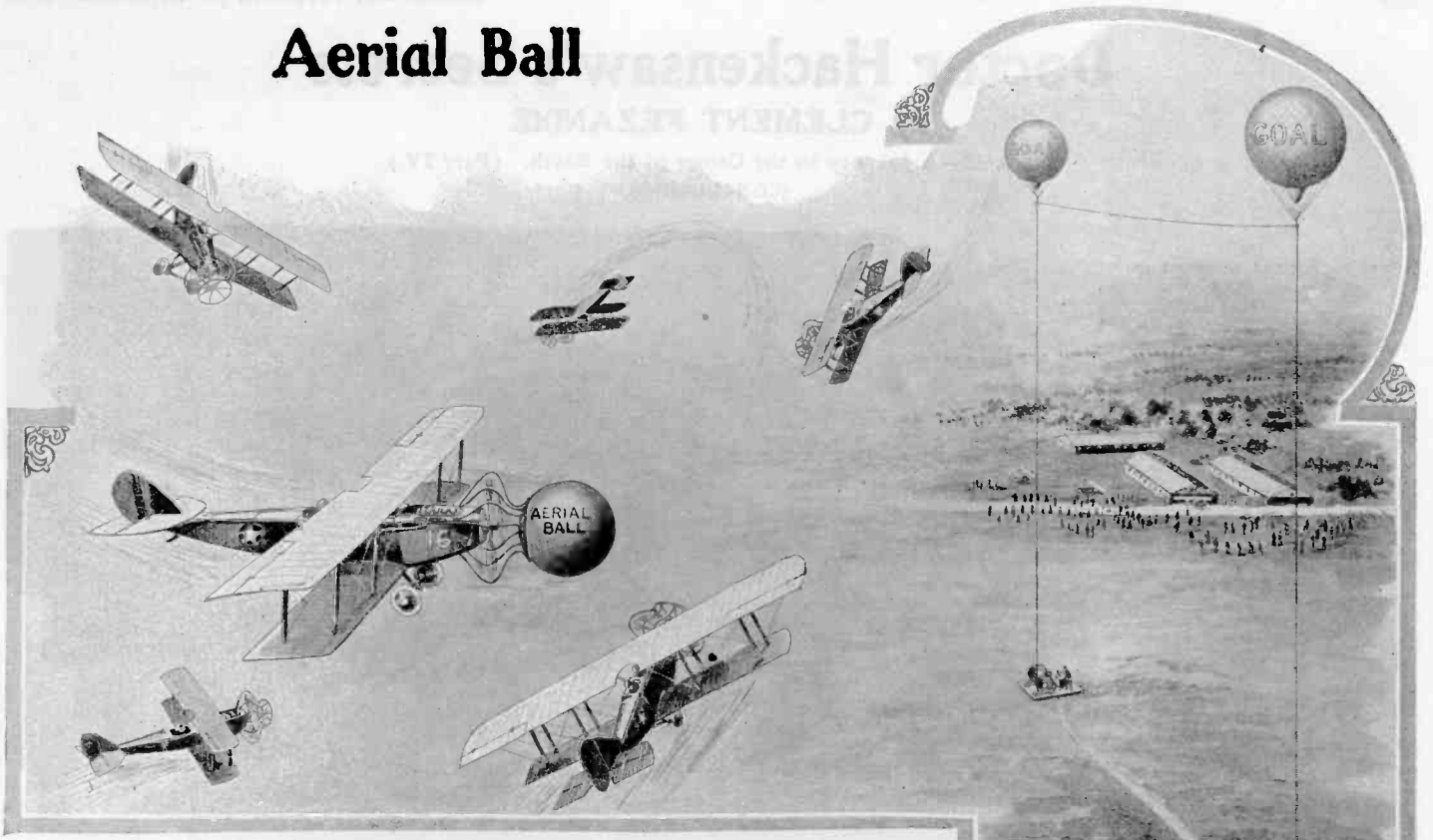

**A** RATHER unique and novel game has been suggested for army and navy aerial forces. It is called "aerial ball" and resembles football, except that it is played with airplanes instead of the feet. We have horse polo, motorcycle polo and even automobile polo, so why not a sort of aerial polo? The goal lines are marked by balloons held captive at the two ends of the field, perhaps twenty miles apart. The ball itself is buoyant. The object of the game is to push the ball to the goal. The opposing planes try to knock the ball out of the basket-like pusher and carry it to their own goal line. Skill in maneuvering will prevent accidents, and the great speed at which the planes travel also minimizes the danger. For practice the game is preferably played over a body of water. This game certainly aids war-time maneuvers.—J. Kay London.



# Anti-Aircraft Nets

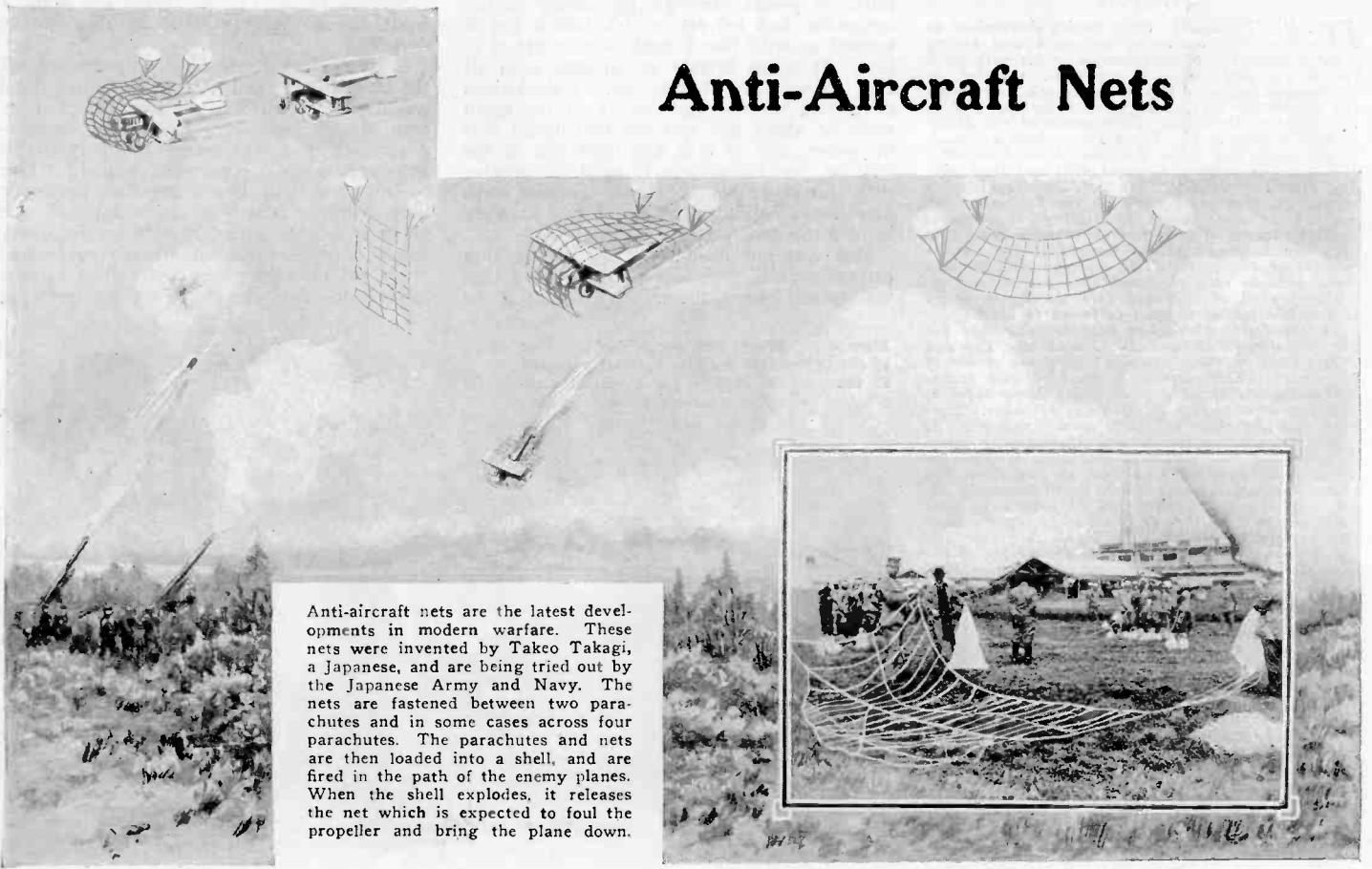

Anti-aircraft nets are the latest developments in modern warfare. These nets were invented by Takeo Takagi, a Japanese, and are being tried out by the Japanese Army and Navy. The nets are fastened between two parachutes and in some cases across four parachutes. The parachutes and nets are then loaded into a shell, and are fired in the path of the enemy planes. When the shell explodes, it releases the net which is expected to foul the propeller and bring the plane down.

# Doctor Hackensaw's Secrets

By CLEMENT FEZANDIE

No. 43—A Journey to the Center of the Earth. (Part IV.)  
(CONCLUSION)

It was merely one enormous sea of air with islands of various sizes floating in it. These islands were particles of the solid rock which had become broken off and hurled upward.

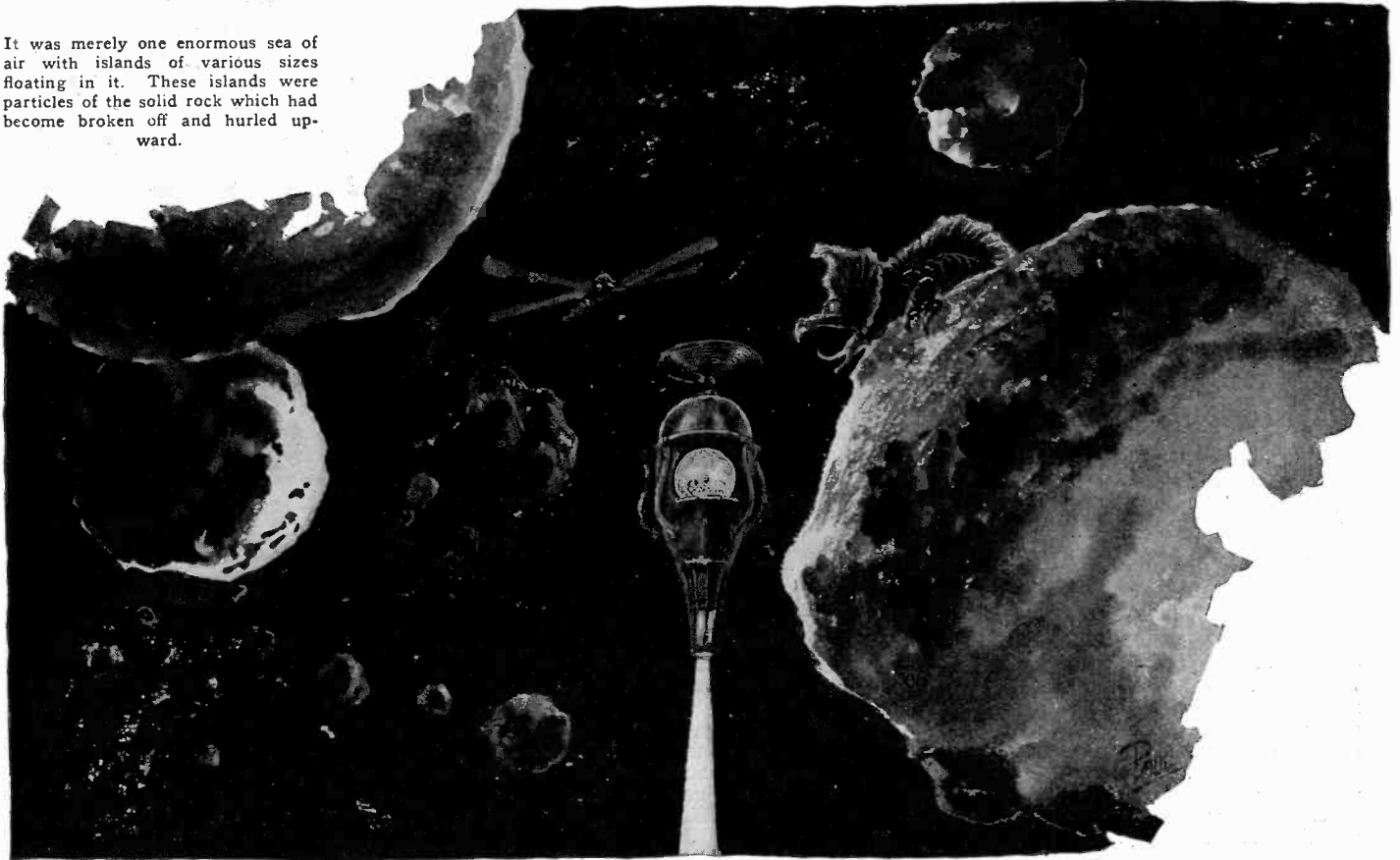

## SYNOPSIS

**DR. HACKENSAW**, after having determined to explore the center of the earth and having made preliminary observations, asks his very good friend Pepita Perkins, a newspaper reporter, to accompany him on a trip to the South Pole where the excavation was to be started for the trip to the center of the earth. They arrive at Dr. Hackensaw's village at the South Pole where a crevice in the earth five miles deep has been discovered. Working first with a diamond drill and then with an "atomic force drill," one of Dr. Hackensaw's inventions, they start work on the bottom of the pit. After some hours of drilling, observations made by means of a special microphone show that they are nearing another natural cavern in the interior of the earth. The diamond drill is once more brought into play and soon pierces the remaining shell of the rock into the lower cavity in which a partial vacuum is found to exist.

In the Dart, which has been reconstructed for the special work at hand, Dr. Hackensaw, Pep and Miggs start on their journey toward the center of the earth. Their machine is provided with brakes and automatic speed devices which allow them to travel at an even rate of 100 miles per hour. Soon they find that their weight is greatly reduced. At 1,200 miles below the surface of the earth calculations show that something has gone wrong. At 1,500 miles below the surface the travelers find that their weight, which has been constantly decreasing, is nothing and that they have to hold on to the sides of the car in order to prevent their floating around within it. Upon this fact the Doctor bases an assumption that the center of the earth is hollow, the crust being 3,000 miles thick.

After proceeding some distance further on they suddenly see, while looking down through the bottom of the car, a phosphorescent light miles ahead. Soon they emerge into the hollow center and find themselves surrounded by masses of curious rock-resembling plants, as well as animals and birds. All of them emit a phosphorescent light.

"**W**ELL Pep!" cried Doctor Hackensaw, "you see I was right! Here we are at the center of the earth and we find there is nothing here but an immense hollow filled with air. My experiments in sending directed radio currents from the surface of the earth, at

different points, through the center to the antipodes, had led me to this belief, but it seemed so wild that I could not accept it at first. It seems utterly at variance with all that science has taught us. Calculations show that the average density of the earth must be about five and one-half times that of water, and as it is less than this at the surface, we know that it must be greater than this down below. Then, too, the earth acts like a rigid body. No, I can scarcely believe my own senses."

Pep was not listening. She was gazing earnestly at this wonderful new world that was spread before them.

"Please switch off the light," she said, "I want to see what this looks like in the dark."

Doctor Hackensaw obediently turned off the searchlight and the new underground world was revealed in all the beauty of its own phosphorescence. It was an extraordinary sight. Every animal or plant of this grotesque world of creatures seemed to shine by its own light like a gigantic firefly or glow-worm. And yet the colors of the phosphorescence varied in each species, every color of the spectrum being represented from red through green and yellow to blue and violet. And the forms were marvelous;

Meanwhile, Miggs had caught hold of one of the immovable animals that were rooted to the ground, and he got a violent electric shock for his pains.





altogether different from anything our friends had ever seen before.

Plants and animals there were of many varieties and, strange to say, some of the stationary forms appeared to be animals, while some of the movable ones appeared to be plants, capable of flying around in the air from spot to spot, but with seemingly no mouth, eyes or other definite organs except their wings.

Animals, too, there were that could walk around from spot to spot, evidently by means of suction pumps on their feet, similar to those that enable flies to walk along a ceiling without falling. Had it not been for these specialized feet, life would have been difficult to these subterranean creatures, as the muscular exertion of their movements, here, where bodies had no weight, there to perish miserably from hunger and thirst.

Other creatures there were, but these were provided with wings. A few were quadru-

ped, but most of them had six feet. Some were beautiful to look at—others grotesque and uncouth. There was one flying creature with two long trunks, resembling an elephant's trunk, where its eyes should have been, and an eye at the point which its mouth should have occupied. It seemed to have six mouths, one at the extremity of each foot. The snake-like wrigglers through the air have already been mentioned. These did not seem to be provided with wings of any kind, but appeared to glide through the air much as a snake glides through the water.

"Pop!" cried Pep, "can't we land here? I'd like to see these creatures from nearby!"

Doctor Hackensaw hesitated, for in the distance he had caught sight of some huge unearthly-looking monsters half hidden in the peculiar vegetation. However, he was as anxious as Pep was, to get a nearer view of the flora and fauna of this strange land, so he assented, and with a turn of the rud-

The doctor had brought along with him several pairs of suction boots designed to enable the wearer to walk up and down the perpendicular walls of the pit.



He raised his pistol and shot straight for the crocodile's tail. A tremendous explosion was heard and the rear end of the crocodile's body was hurled skyward in infinitesimal fragments.

der brought the car right up to the rocks. Here a peculiar problem presented itself. How was he to moor the car to the rocks? As objects now possessed no weight, the slightest wind might blow the car away beyond reach.

"It is something of a problem," remarked the doctor, "but only a secondary one. I can fasten the car to some of this vegetable growth, though I haven't much faith in the strength of those stems. I could at a pinch fasten the car to one of these moving animals. The only drawback would be that the frightened beast would be likely to plunge into the jungle, dragging us after him. A third solution seems to me much more feasible. But before I do anything at all I must ascertain whether this air is fit for us to breathe."

"It must be," replied Pep, "because both animals and plants live here, and animals cannot live without air."

"Nor plants either," replied the doctor, at least, not our terrestrial ones. All animals and plants require some source of energy and obtain that energy from the chemical union of oxygen with some element. Hence they require air. Warm-blooded animals require more oxygen than cold-blooded ones. I have myself kept a sleeping snake under water for 24 hours. As a snake cannot breathe under water he could not obtain any fresh oxygen during that time, and hence his consumption of the element, while asleep, must have been very slight. Plants require still less oxygen, but a delicate thermometer will show an increase of temperature during certain periods of flowering, showing that the vital processes, even in plants, require oxygen. But plants with green leaves manufacture much more oxygen than they consume. Parasitic plants that live on the juices of other plants, and saprophytes (as the botanists call the mushrooms and other plants that live on organic matter formed by other plants or animals), do not manufacture their own oxygen. Some of the bacteria, as a matter of fact, are anaerobic; that is to say, they cannot live in air."

"Well," cried Pep, triumphantly, "that means that I am right, and that the air here must contain oxygen."

"Not necessarily. Conditions here may be, and certainly are, entirely different from those on the surface of the earth. All our

(Continued on page 470)



# The Night

By RICHARD M. DOUGLAS,  
 Exclusive Official Photos By  
 By Artist  
 New Brunswick,



The greatest difficulty encountered in the inauguration of the night air mail between New York and Chicago, and which it is rumored will be extended to cover the entire country, was the provision of suitable landing lights. A flood light giving half a billion beam candlepower was developed, and a photograph taken by its light of a hangar a quarter of a mile distant is shown in Fig. 1.

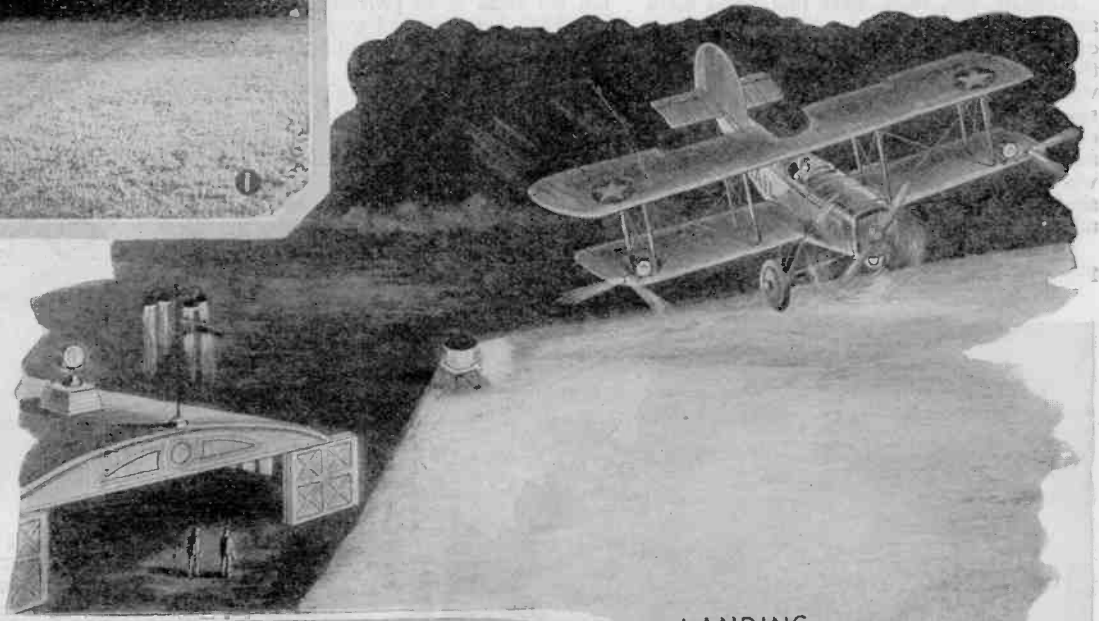

LANDING

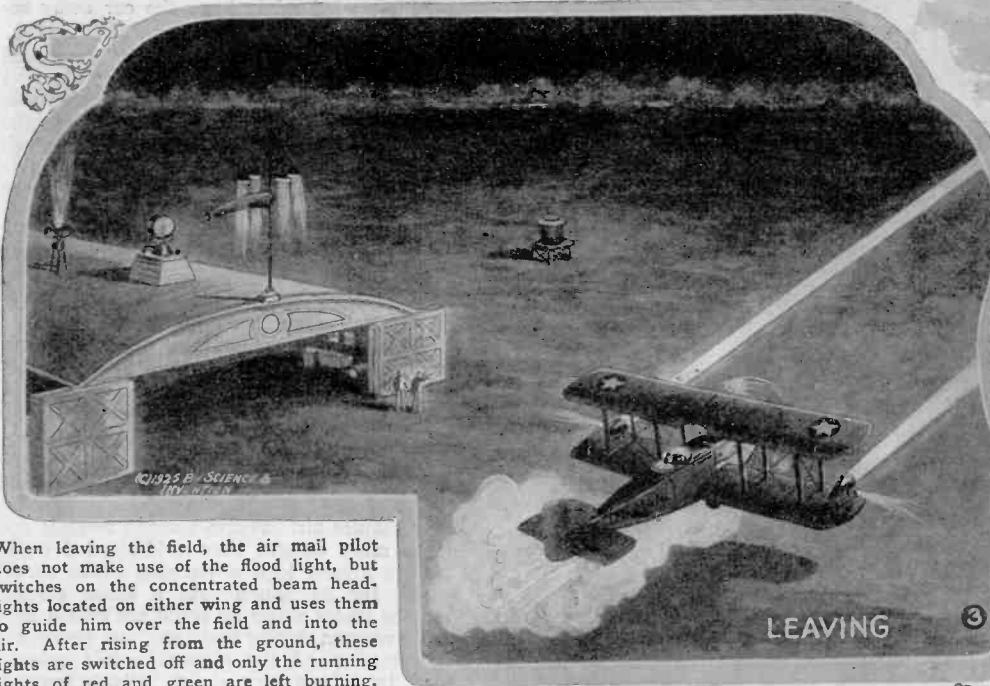

LEAVING

When leaving the field, the air mail pilot does not make use of the flood light, but switches on the concentrated beam headlights located on either wing and uses them to guide him over the field and into the air. After rising from the ground, these lights are switched off and only the running lights of red and green are left burning.

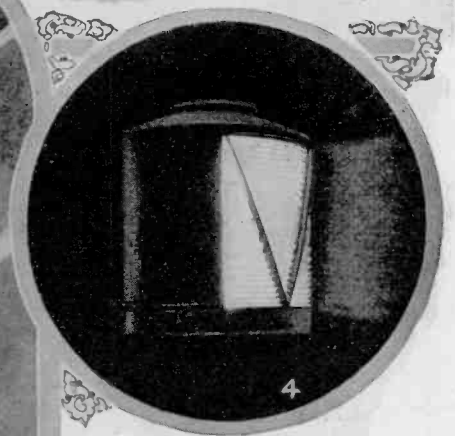

In Fig. 2, the powerful flood light is shown in action with one of the mail planes making ready to land. The pilot has flown over the field getting his bearings and will swing around in a circle and eventually land on the far side of the field, whereupon he will "taxi" into the hangar.  
 Fig. 4: Flood light in action.



The housing and lens of the enormously powerful flood light are shown in Fig. 5 at the left. This light is of the arc type with a combination of hand and motor feed. The lens is so constructed that, when the housing is completely opened, it will throw out a broad flood beam covering an angle of almost 180°. The switchboard which controls the amount of power supplied to the arc is shown in Fig. 6. The current is obtained from a motor generator unit having an output of 25 kilowatts at 120 volts D.C. The motor is driven from a special 110 volt A.C. line. The two meters on the board indicate the voltage and amperage being fed to the arc contained in its housing just outside of the shelter built over the switchboard.

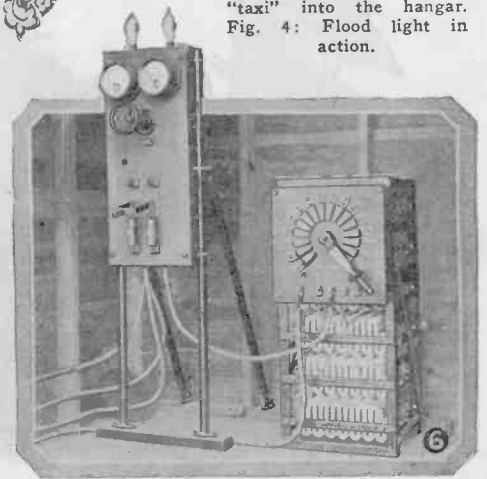



# Air Mail

Reporter No. 7510

Author. Drawings Made  
At Hadley Field,  
New Jersey

PROBABLY the most romantic undertaking that has ever been pushed forward to a satisfactory conclusion by the United States Government is the installation of the *night air mail*. Flying during broad daylight and under ideal flying conditions is one thing, but regular flights during darkness, night after night, regardless of weather conditions, is quite a different proposition. To safeguard the pilots who undertake the hazardous occupation of guiding their mechanical birds through the night, the mail service officials have installed numerous beacons and guide lights along the entire course and have provided excellent landing fields that, when required, are illuminated in the best possible manner. Furthermore, each pilot is equipped with an efficient type of parachute and, at the end of every flight, each plane is thoroughly gone over in every detail. This servicing is as complete as possible and includes inspection of every wire, turnbuckle and hinge on the whole machine. Besides the regular terminal fields where the mail is changed from one plane to another or from the plane to motor trucks or train, there are emergency landing fields located only a few miles apart over the entire course. Each of these fields is equipped with a revolving beacon of 500,000-beam candlepower, such as that shown in Fig. 11, and points between the fields are equipped with other revolving lights of the type shown in Fig. 12, which serve to guide the flier and keep him on his course.

With the new regular service, air mail rates have been reduced enormously and it is now possible to post a letter in New York in the evening and have it delivered by the first mail carrier in Chicago the next morning.

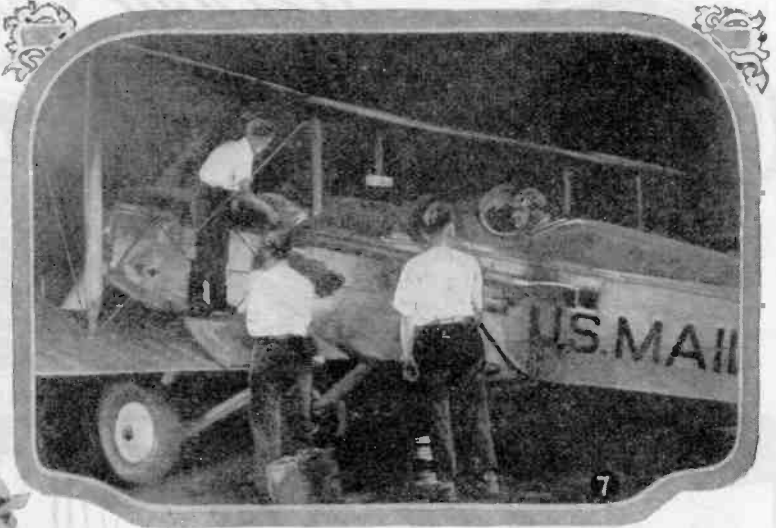

Removing the mail from its compartment in one of the mail planes. The pilot has just arrived at the eastern terminal at Hadley Field. The mail goes by truck and train to New York City.



One of the huge incandescent lights used at the landing fields.

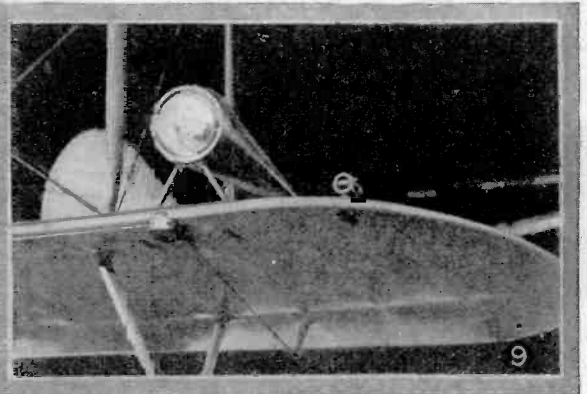

In Fig. 9, above, the beam headlights and the running lights located on the wing tips of the mail planes are plainly shown. The running lights are each equipped with two lenses showing the standard red and green colors. One of the lenses, pointed forward, warns approaching pilots, whereas the second lens, pointed toward the side, serves to prevent damage by planes flying across the line of flight. These lights are supplied with current by a generator driven from the motor.

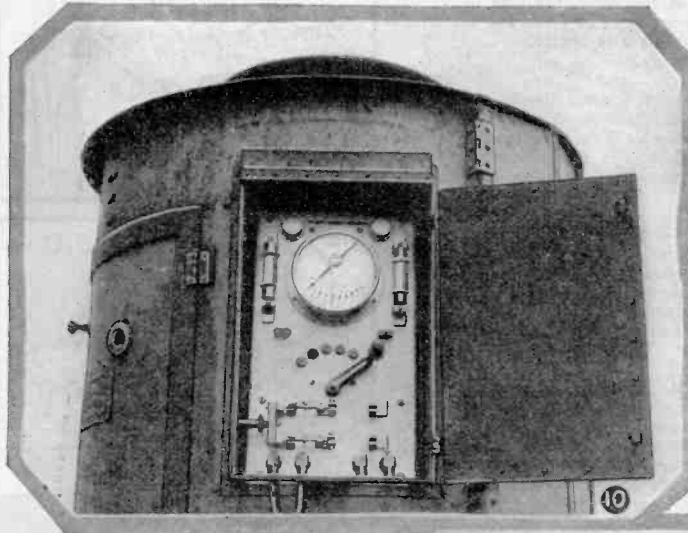
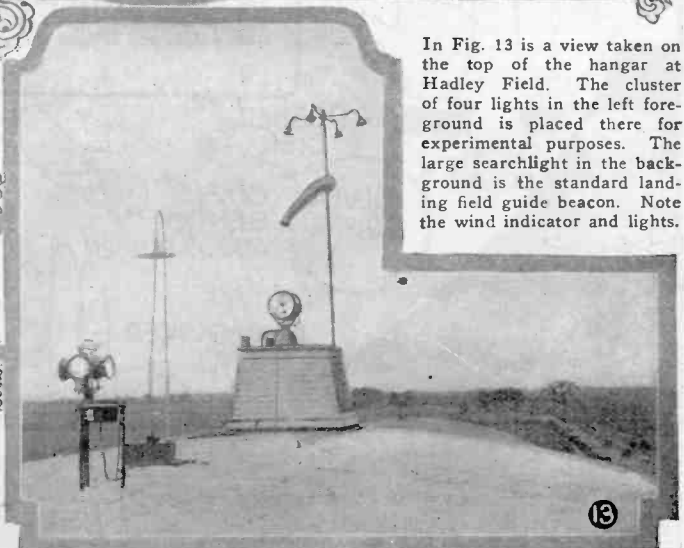
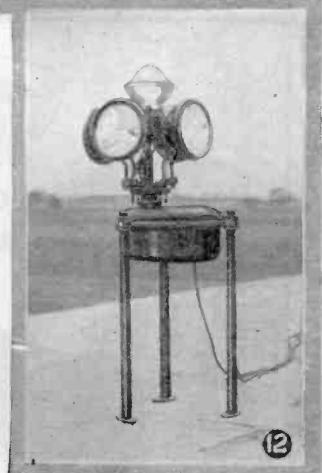

Fig. 10, above, shows the switchboard built into the side of the flood light housing which controls the speed of the motor which drives the carbons of the arc and keeps them at the correct distance apart. If the carbons burn faster than usual, the motor can be speeded up so as to keep pace with the consumption of the electrodes. Hand adjustments are also provided.

The group of lights shown in Fig. 12 are of the type that will add a high prominent points along the air mail route. Each one of the lights is tilted at a slightly different angle from the horizon so that one of the beams is sure to catch the eye of the pilot as he flies through the night and thus they keep him on the correct course. A motor located in the base revolves the lights as well as the commutator which allows current to be fed to the incandescent bulbs.



In Fig. 13 is a view taken on the top of the hangar at Hadley Field. The cluster of four lights in the left foreground is placed there for experimental purposes. The large searchlight in the background is the standard landing field guide beacon. Note the wind indicator and lights.



# MAGIC "DUNNINGER" By

## THE MAN WHO MYSTIFIED Prince of Wales, Ex-President Harding, Taft, Roosevelt, Pres. Coolidge and other celebrities Writes Exclusively for SCIENCE AND INVENTION



NO. 30 OF A SERIES

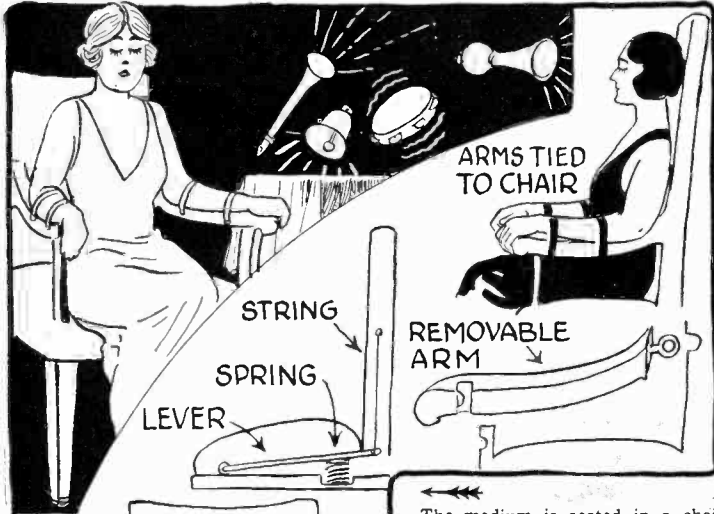

ARMS TIED TO CHAIR

STRING  
SPRING  
LEVER

REMOVABLE ARM

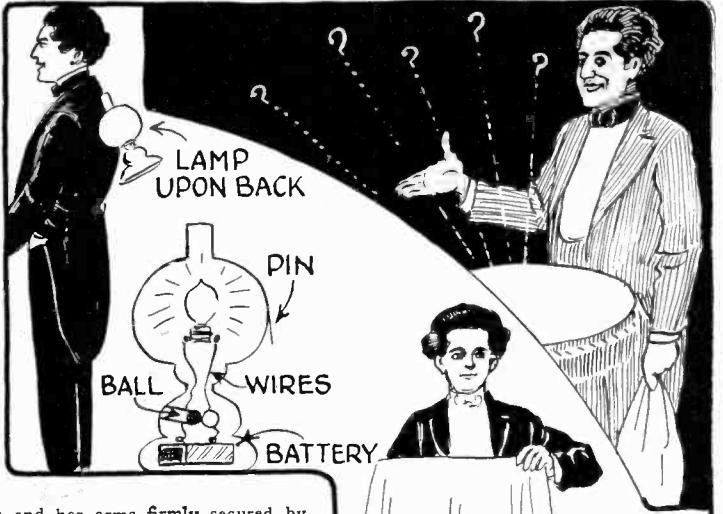

LAMP UPON BACK

PIN  
BALL  
WIRES  
BATTERY

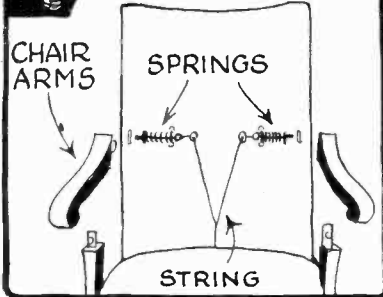

CHAIR ARMS

SPRINGS

STRING

The medium is seated in a chair and her arms firmly secured by means of cords knotted and then sealed. The lights are turned out and tambourines, bells and horns are sounded. When the lights are turned on again, the medium is found tied in the same place. The secret lies in the construction of the chair, the arm of which comes out and permits of free movements. The latch for the arms is released when the medium is seated.

A large glass lamp which may be passed for examination is placed upon the table. This is covered with a cloth, which on being removed shows the lamp to have vanished. The lamp is then made to reappear. Under cover of the cloth, the magician fastens the lamp to his back and makes it reappear when he desires.

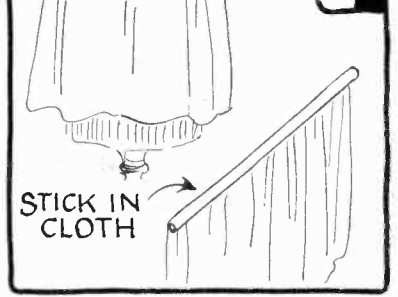

STICK IN CLOTH

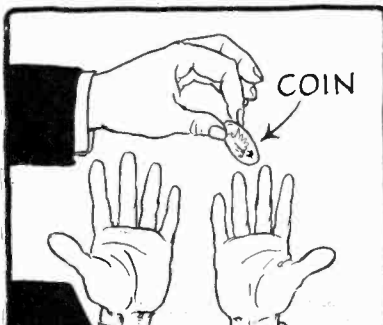

COIN

FLESH COLOR

RUBBER DISK

SILVER COLOR

COIN BENDS ABOUT FINGER

SLIDES UNDER RING

For the amateur trickster the coin illustrated here is of particular value. The coin is merely a rubber disk, silver colored on one side, and flesh colored on the other. Because of its flexibility, it can be passed around the finger, placed under a ring or concealed between the fingers. A coin of this nature saves many hours of practice and is very deceptive at a distance.

The celluloid ball is tossed into the air by the magician, and finally dropped into a glass globe containing water, to which a little ink has been added to color it. On command the ball sinks or rises. The secret lies in the beeswax pellet to which a hair is attached. The hair passes through a small lead weight, which acts as a pulley. Both weight and ball are dropped into the globe containing the colored water.

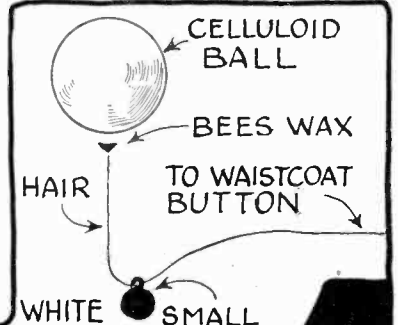

CELLULOID BALL

BEEES WAX

HAIR

TO WAISTCOAT BUTTON

WHITE BALL

SMALL LEAD WEIGHT

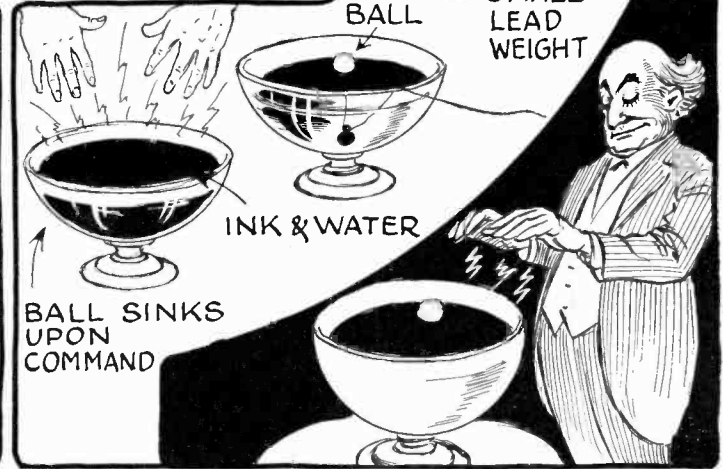
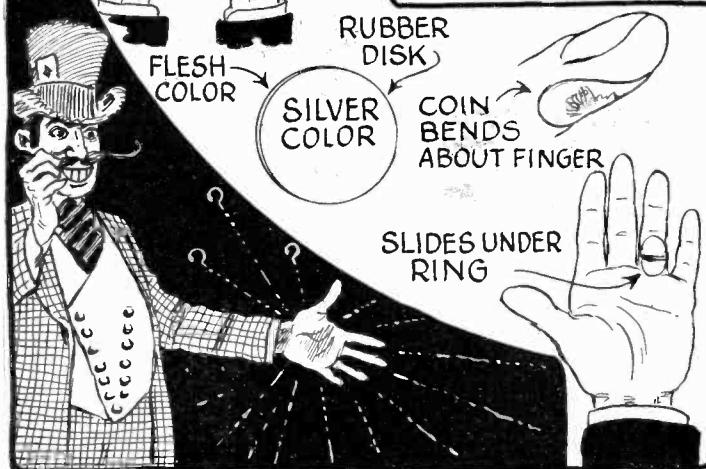

INK & WATER

BALL SINKS UPON COMMAND



# Progress in Medicine

Edited By JOSEPH H. KRAUS

One of the most wonderful recent advances in medicine, and particularly in X-rays, is the method outlined on this page this month, for the taking of X-ray photographs of moving organs. There is no doubt but that the time will soon come when every muscle, nerve and blood-vessel will be photographed on the X-ray plate.

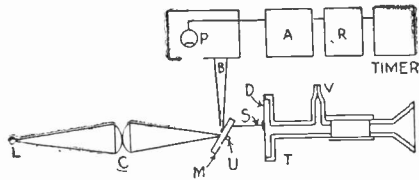
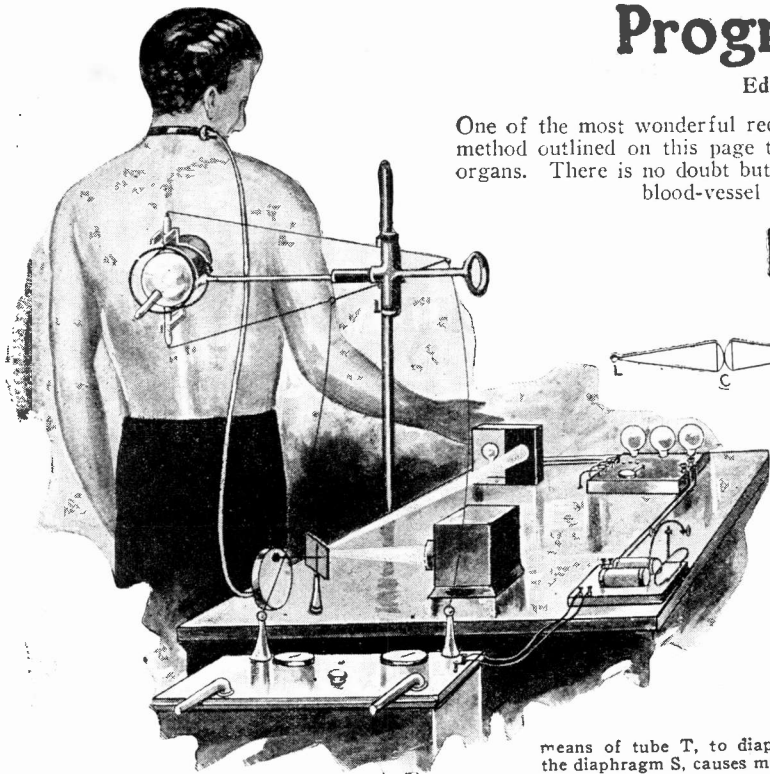

↑ The above schematic drawing shows the outline of the new apparatus which will enable one to take X-ray photographs of the heart and lungs. L is the light, C a condensing lens, M is a mirror pivoted at U, F the funnel, connected by

means of tube T, to diaphragm D. The arm on the diaphragm S, causes mirror to move and projects light ray B upon selenium cell F. The current produced is amplified in amplifier A which controls timer on X-ray machine.



A new instrument has been designed for the taking of X-ray photographs of the heart and lungs while they are at rest, and has been placed in practical use at the Phipps Institute of the University of Pennsylvania. This device is to aid in the diagnosis of such diseases as tuberculosis. It was invented by Charles N. Weyl, of the University of Pennsylvania, and is so delicate that even the weakest infant will cause it to operate. It is a known fact that any lesion of the lung may be recorded by the X-ray, but the organs of the chest due to their complex physiological movements often cause a blurred image. Now, however, a photograph may be taken at any cycle of the heart beat. When the patient's heart beats, an impulse is sent down the air column inside the rubber tube, which operates the diaphragm, and in turn the mirror. The funnel is placed over the carotid artery. The light affecting a selenium cell intermittently permits the passage of current through the amplifier and controls the relay, which in turn operates the control for the X-ray tube. Thus at a definite phase of the heart beat, the X-ray tube is excited and produces a clear cut picture.

↑ A new internal germicide having the germicidal power of about fifty times that of phenol has recently found its way to the market. This product is called Hexylresorcinol. The substance is not toxic when taken by the mouth in therapeutic doses. It passes through the stomach and is absorbed from the intestines. It is then taken up by the blood stream and carried to the kidneys to be excreted into the urine. It is particularly adapted to infections of the urinary tract. As post-operative treatment in such cases as operations of prostatectomy, the product will often aid in preventing wound infection.



←←← To the left is illustrated a new mastoid bandage to take the place of the old style of bandage. The photo at the top shows the bandage, and the right lower photo shows it applied over sterile fluffs. The photo at the left shows the usual method of bandaging following the operation.—Max Bulock.

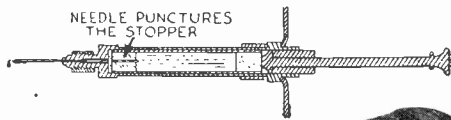

The diagram at the left and the photos below show a new type of hypodermic syringe. This device may well be called the automatic of hypodermic syringes, inasmuch as the syringe is loaded from the breech with sterile carpules. These carpules are pushed forward, so as to cause the needle to puncture one end of the carpule. The other end then acts as part of the piston.

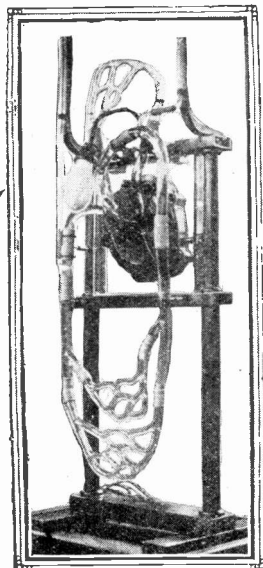

The diagram above illustrates the new type of hypodermic syringe fitted with a carpule. Note how the needle punctures one end of the carpule, while the opposite end is pushed forward by the plunger. The photo at the right shows how the hypodermic syringe is loaded.

←←← The photo at the left shows a glass model of the heart and blood circulation. This device is on exhibit in Germany.

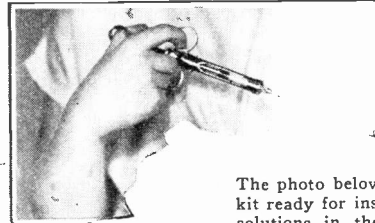
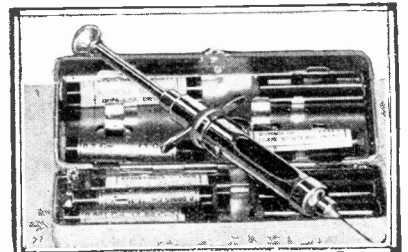

Photo at the left shows a similar hypodermic syringe for tonsil operations.

The photo below shows a physician's kit ready for instantaneous use. The solutions in the carpules are absolutely sterile.





# THE CONSTRUCTOR



## Making A Simple Selenium Cell

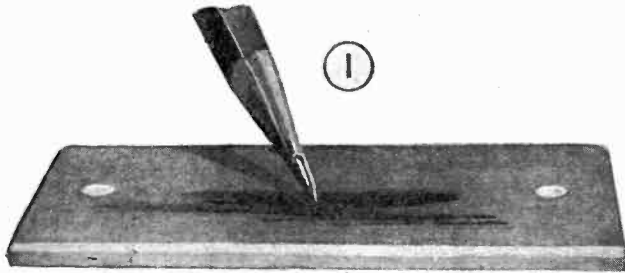

1. Covering the smooth, sandpapered surface of a piece of slate 3 inches long by 1 inch wide with carbon from a soft pencil.

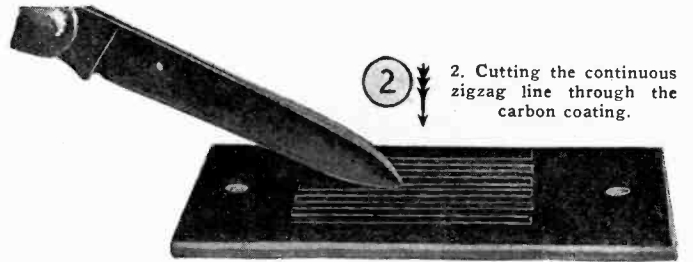

2. Cutting the continuous zigzag line through the carbon coating.



3

3. Smoothing off the melted selenium on the surface of the cell. 5. Testing the cell with a sensitive meter and a battery.

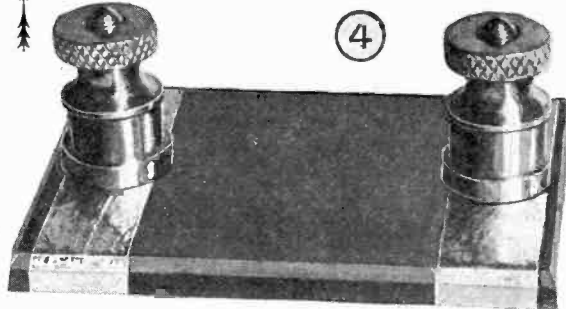

4

4. The finished cell with binding posts and tinfoil connections.



2A

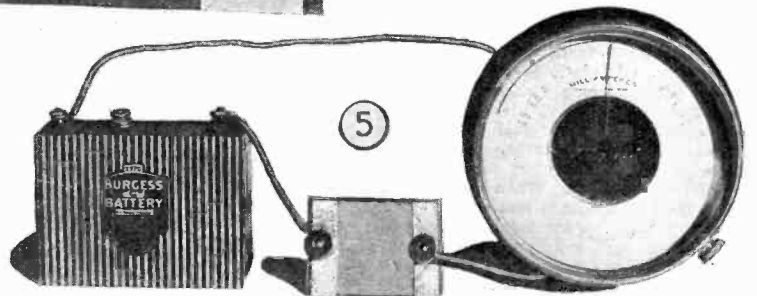

5

To make this cell, cover the surface of a piece of slate with a carbon or graphite deposit from a soft pencil as in 1. With a sharp knife, cut through this coating forming one continuous zig-zag line as in 2A. Place on an iron sheet over a burner and melt selenium on the coated surface of the slate. Spread carefully with the back of a hacksaw blade. Turn

down the burner till the glossy black surface slowly turns gray. Increase the heat as much as possible, but do not allow the glossy color to reappear. Keep at this temperature for about an hour and then cool. Strips of tinfoil making contact with the graphite surface are bound around the cell and binding posts provided as in 4.—Raymond B. Wailes.

## Photo Helps

A dark room safe-light.

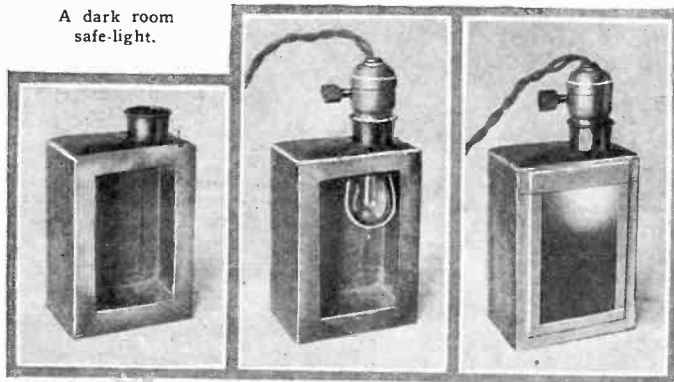

Procure a small can such as varnish comes in and with a can opener cut a rectangular hole in one side as shown. Paint the outside black and the inside with aluminum paint. Place an electric light bulb and socket as shown and fasten a ruby glass over the opening with wide strips of gum paper or adhesive tape. —Sam Y. Caldwell.

Fasten strip of cardboard to print trimmer with thumb tacks. Distance from edge of cardboard to edge of trimmer equals width of margin. Line up edge of photo with cardboard and trim. Even margins result.

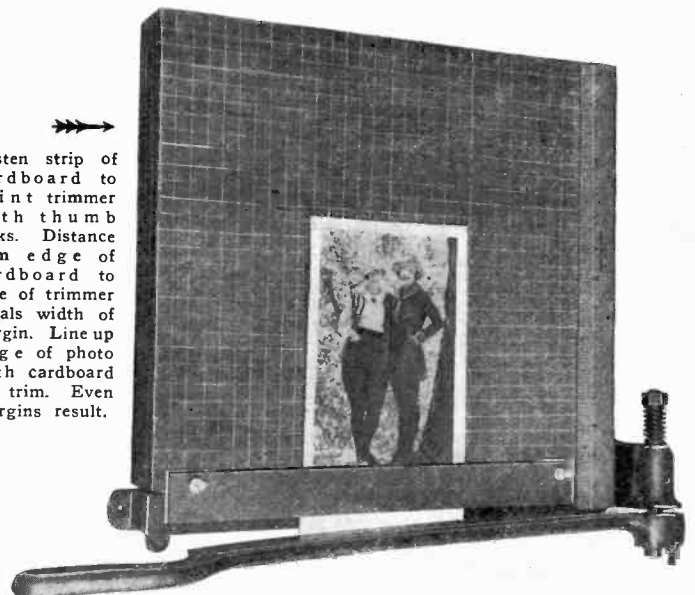



# Home-Made Movie Camera

By Roy A. Clapp

EVERYONE wants a movie camera and who can think of a better way of obtaining one than to make it at home for a very small sum? The writer built the one illustrated herewith for the small sum of \$8.00, exclusive of the lens. The case is a light-tight box  $3\frac{3}{8}'' \times 6'' \times 9''$ . A brass plate which serves as a bearing is screwed to the side of the box as in Fig. 8. A door is provided on the opposite side, the joints being lined with velvet to exclude light. The aperture plate is made of  $\frac{3}{32}''$  brass, cut, drilled and provided with guide rails as in Fig. 1. The shutter is illustrated in Fig. 2 and the bearing for the same in Fig. 3. The claw which moves the film intermittently is made of  $\frac{1}{16}''$  thick brass or aluminum as shown in Fig. 5. Two magazines which are nothing more than light-tight boxes are made to fit in back of the case and the take-up reel is fitted with a 1-inch pulley and is belted to the feed sprocket shaft. The crank is attached to the main drive gear as below. A sprocket on the cam shaft, 1 inch in diameter, drives another of the same size located on the shutter drive shaft as in Fig. 8. All of the gears and sprockets can be obtained from a motion picture supply house.

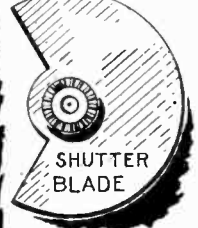
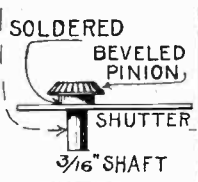
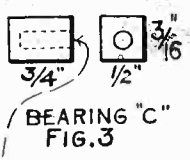
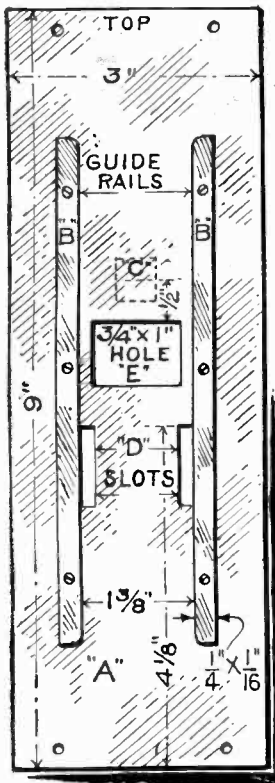
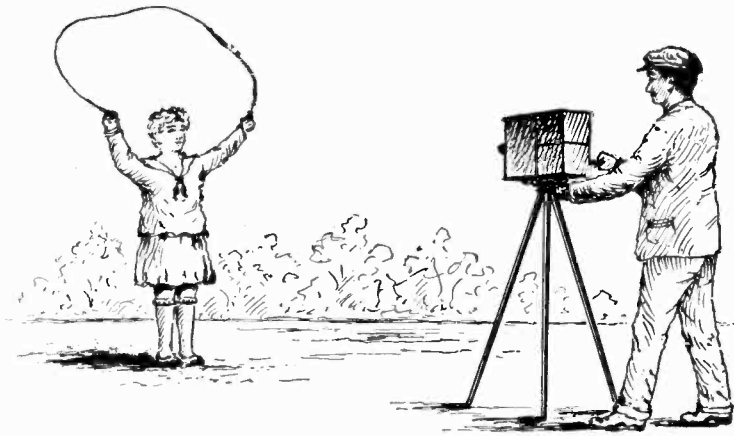

FIG. 2

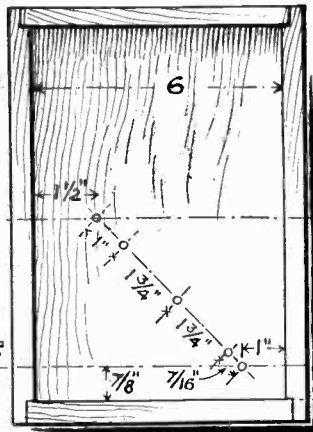

FIG. 4 WOOD CASE

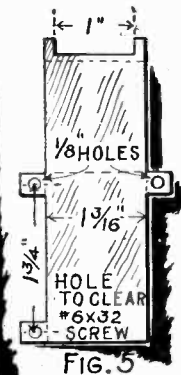

FIG. 5 CLAW

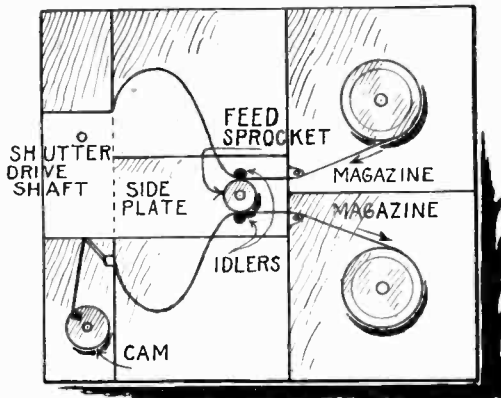
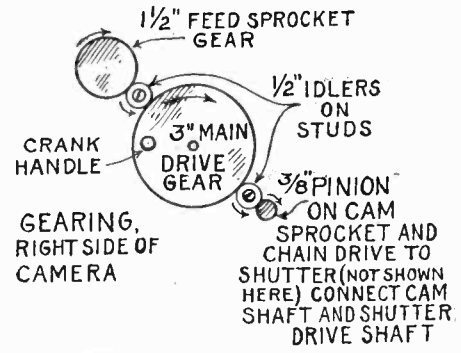

FIG. 6

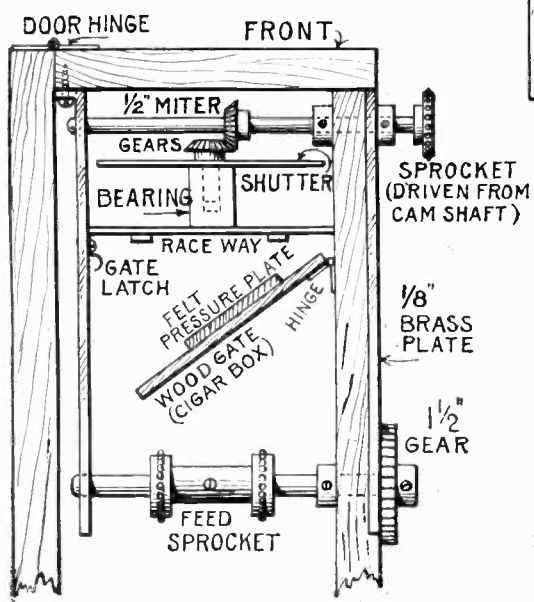

FIG. 8

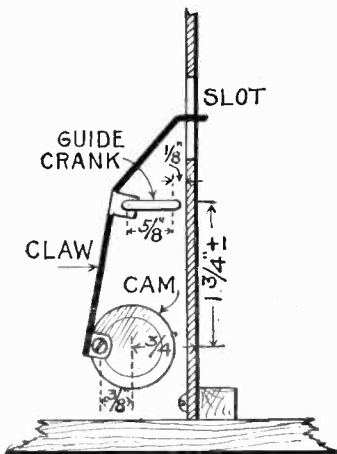

FIG. 5 A CLAW ASSEMBLY

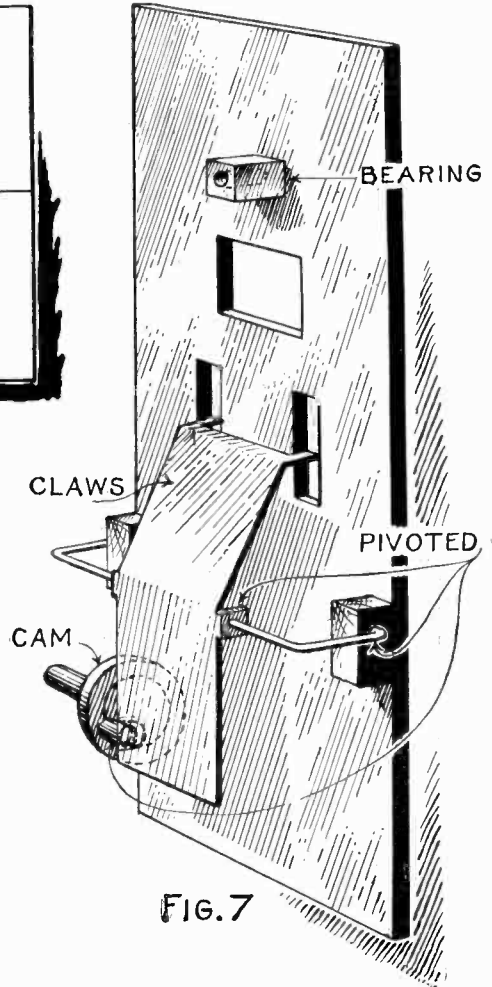

FIG. 7

# Angle Guide for Artists

By J. KELLEY BURLEIGH

A simple method of determining the correct angles of any building or other object is illustrated herewith. With this system, an outline of the principal features may be made on the spot and the drawing completed at leisure. In essence, the idea is as follows: A drawing board is pivoted at the top and very heavy cardboard is used for drawing. This is also pivoted, being fastened to the drawing board in the center. Vertical lines are determined by looking directly over the drawing board at the object to be illustrated and projecting the lines down. The lines from the eye are indicated by 1. The horizontal lines are obtained by tilting the drawing board until its top edge is parallel with the line to be drawn. The T square is then placed across the board and an accurate reproduction of the line is drawn to scale. Illustrated at 2.



## Exposure Meter

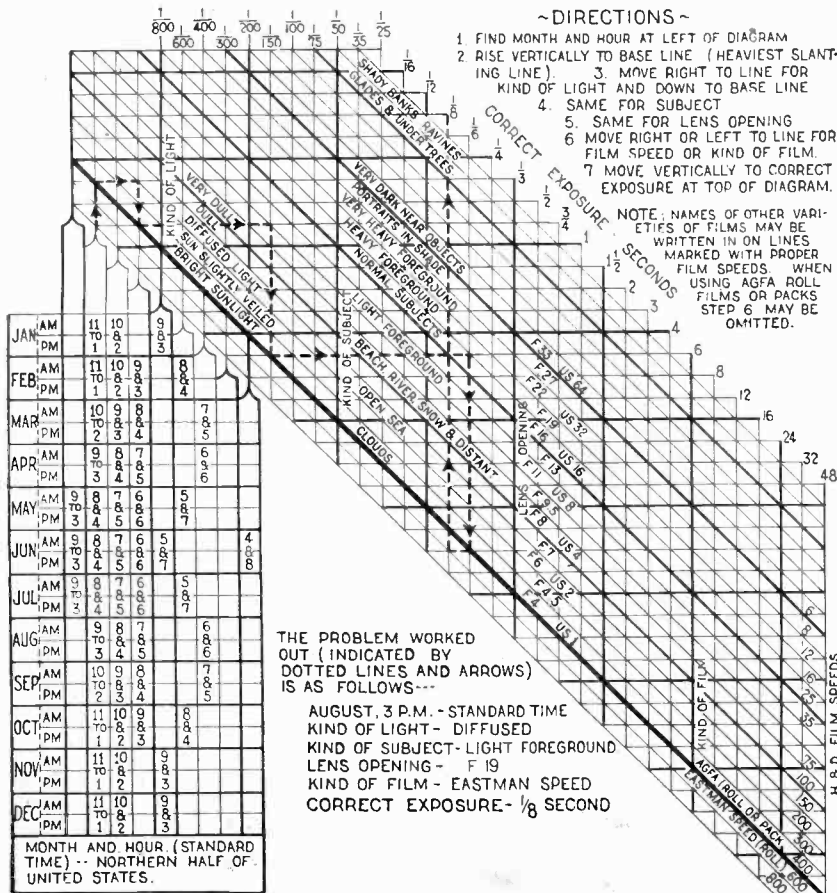

## Anti-Rattler

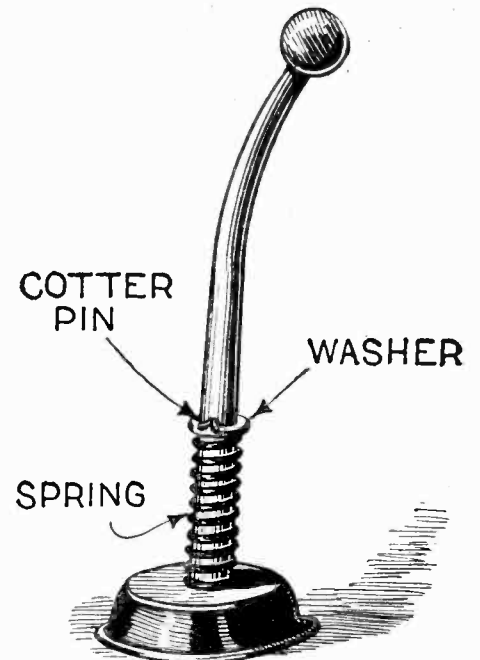

If the gearshift lever on your car rattles, drill a hole in it and place a spring, washer and cotter-pin as shown. The spring should be slightly compressed. —C. W. Caldwell.

An exposure meter which the author designed for his own use and which has stood the test of many months of actual use is reproduced in detail at the left. Clip the drawing and directions from this page, paste on a piece of cardboard, and keep the meter with your camera. It will come in handy hundreds of times. —S. I. Phillips.





# HOW TO MAKE IT



## Simplified Solutions

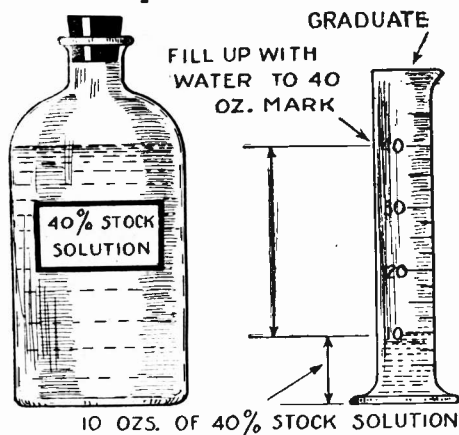

Accurate percentage solutions can be made up quickly from a 40% stock solution. Use as many ounces of the stock as is represented by figure of desired percentage and fill graduate to 40 ounce mark with water as above for 10% solution. —C. A. Oldroyd, Rep. 4433.

## Odd Fountain

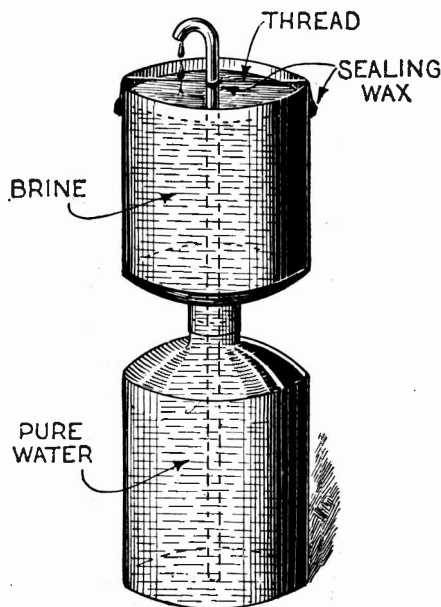

Without an explanation, the experiment illustrated above seems to disprove the fact that water cannot run up hill. However, if two containers are joined as shown, a tube bent as illustrated, inserted and the lower jar filled with pure water while strong brine is placed in the upper, the pure water will flow out of the tube due to the greater density of the brine. —G. H. Waetjen.

## Rubber Stoppers

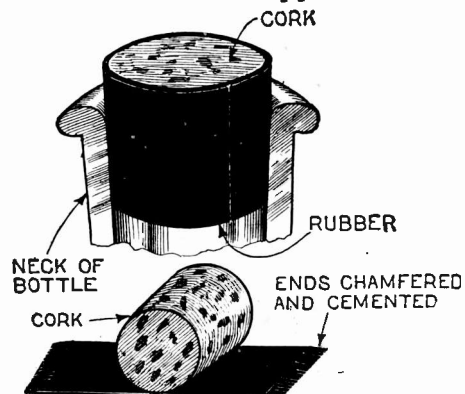

A substitute rubber stopper may be made from a strip of rubber and a cork as above. Bevel or chamfer the edges of the rubber strip and cement firmly to the cork. A stopper of this nature will hold its place firmly. —C. A. Oldroyd, Rep. 4433.

## Hammer Head Retainer

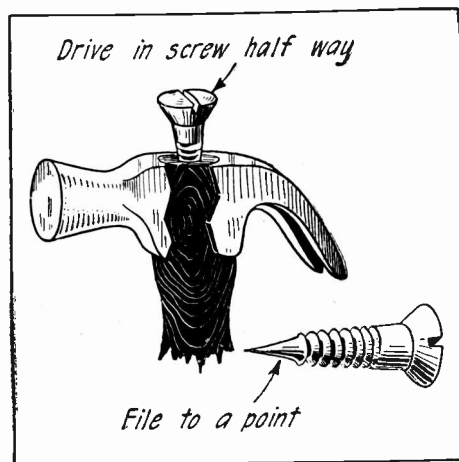

A screw filed to a point and driven in the end of a hammer handle will hold the head firmly in place. —Pan. (Please send address.)

## Bicycle Horn

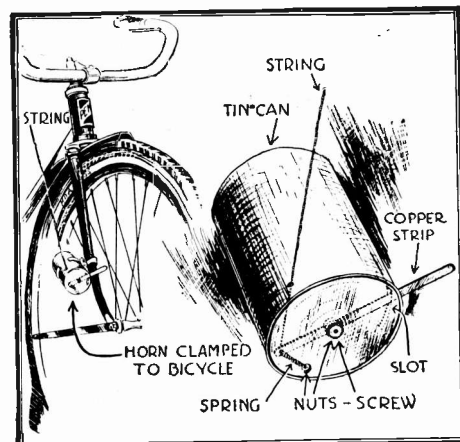

A bicycle horn may be made from a tin can if arranged with a metal strip as shown above. Place the unit so that the strip hits the spokes when the cord is pulled. —B. Piopongco, Rep. 12,894.

## Ice in Boiling Water

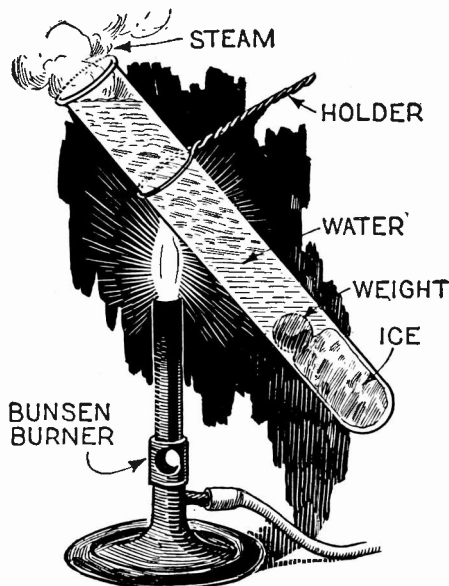

A very pretty experiment which illustrates the fact that heated water rises to the top of a container may be made as above. Drop a piece of ice in a test tube and weight it down with a leaden ball. Fill the tube with ice water and hold over a Bunsen burner at a 45° angle. The water will soon boil, but the ice will remain solid. The convection currents in the water have kept the heat away from the ice. —G. H. Waetjen.

## Printing

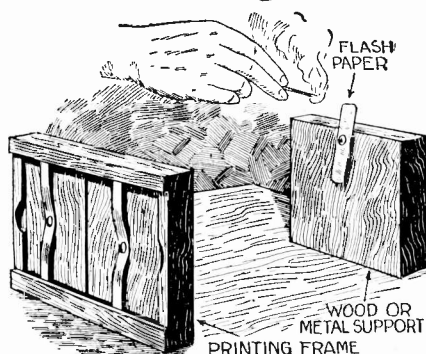

A piece of flashlight paper about 1" x 1/2" placed about a foot away from a printing frame will give ample light for an exposure. Vary the distance according to the density of the negative. —Morris Goldstein, Rep. 1,029.

## Ink Dropper

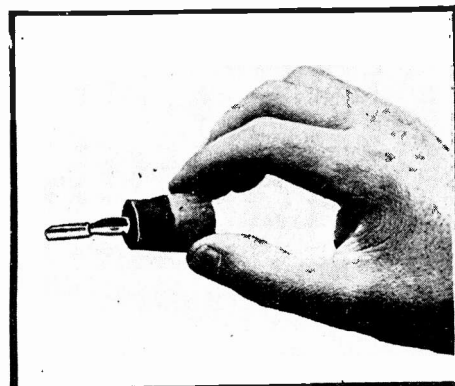

A simple filler for a drafting pen is shown above. A steel pen thrust into a cork is dipped into the ink and then used as a quill. —(Author please send address)



435

# WRINKLES

## RECIPES & FORMULAS

Edited by S. Gernsback



### Wire Stands

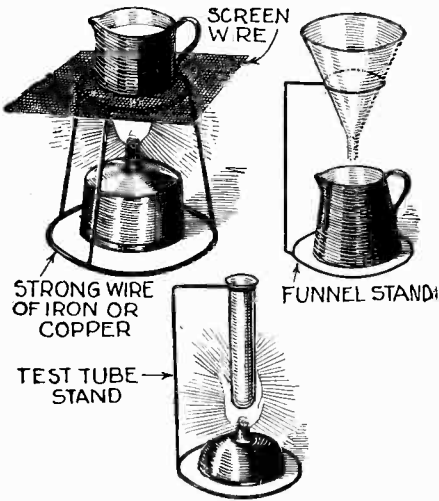

Ring stands and supports for funnels and test tubes may be quickly and easily made from sections of strong wire. The ends and joints should be firmly clamped.

—F. S. Yamamoto, Rep. 11,324.

### Repairing Bulb

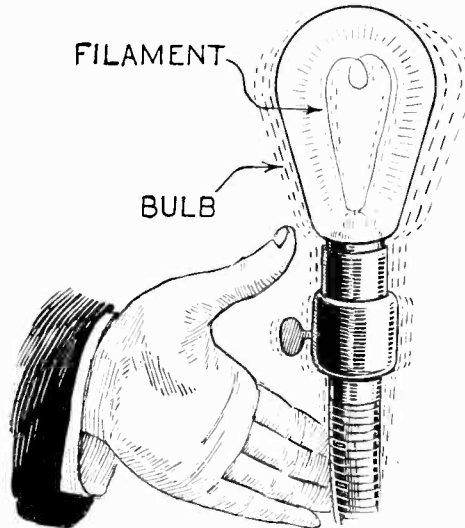

A burned out bulb can often be repaired by agitating violently while the current is turned on. The broken ends may weld together.

—S. Lang.

### Stain Removing

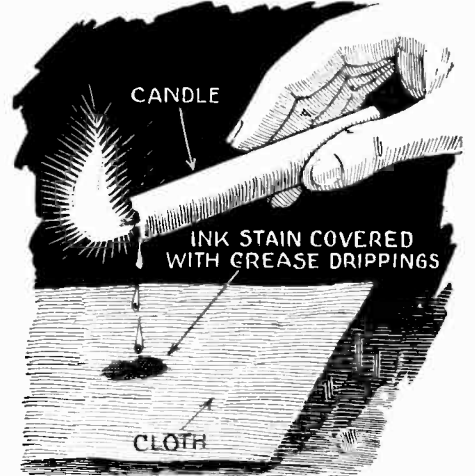

Ink stains on a table cloth should be immediately covered with candle wax as above. Washing the cloth in very hot water will remove practically all of the stain. If any remains, use a stain remover.—C. A. Oldroyd, Rep. 4,433.

### Tack Puller

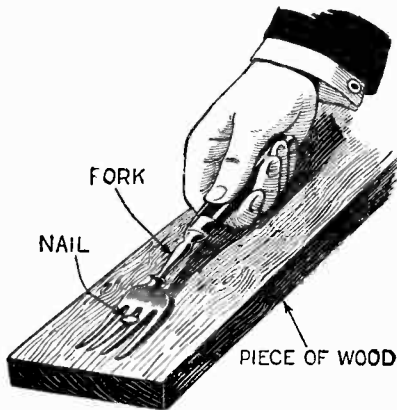

A very effective puller for small nails and tacks can be made by pressing a fork into service as above.

—George H. Kuester.

### Creeping Coin

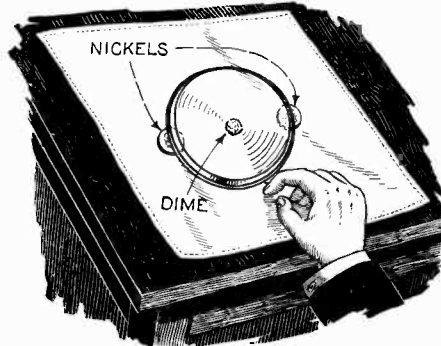

Place a dime under a pan which is supported on two nickels as shown. Scratch the cloth with the forefinger and the dime will slowly creep out from under the pan.—Arthur Kern.

### Easy Erasing



When erasures are made on a typewritten sheet, place a small piece of glass under the paper, and erase as usual. The work is done quicker and neater. Protect edges of glass with binding tape.—C. A. Oldroyd, Rep. 4,433.

### Keeping Soldering Iron Clean

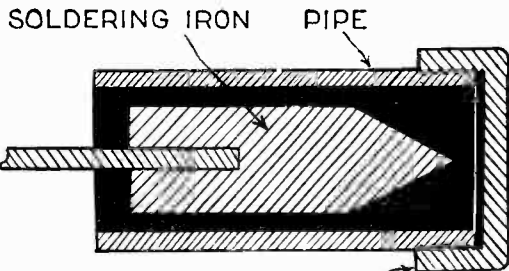

CAP ON END OF PIPE

An iron pipe as above will keep the soldering iron clean while heating it in an open flame. This is particularly advantageous when heating the iron in a coal or wood fire.

—Floyd Burket.

### Simple Battery



A cent and nickel placed on the tongue as above form a simple battery and a tingling sensation will be felt when they touch each other.

—A. A. Blumenfeld.

### Blade Holder

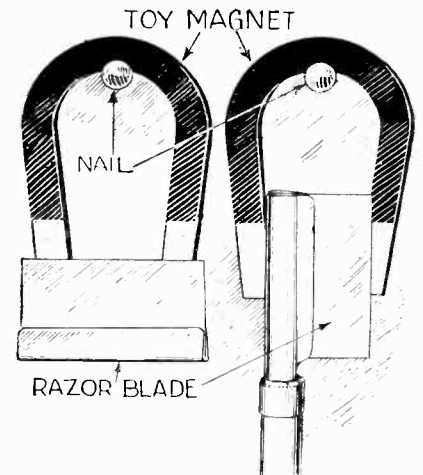

Razor blades are handy for various purposes but are hard to keep out of danger. Suspending them on a magnet as above solves the problem.

—E. F. Staber.



**PUBLISHED BEFORE**

Editor, SCIENCE AND INVENTION:

As many of your readers inform you as to what they think of your magazine and contests, I am, therefore, taking this opportunity to give you my opinion. I know your magazine is the best I ever read in its field, and it is the only magazine I ever buy. It is written the way I like; it contains short articles, drawings and pictures; in fact, I like them in every way except the contest. I have seen a joke in SCIENCE AND INVENTION twice. I have seen articles appear in other magazines and then in yours. The *Mirror* published an article on peep-hole mirror, and this was described in the March issue of SCIENCE AND INVENTION by Mr. B. G. Switzer, and also in the April issue of *Popular Mechanics*. I am saying this because you returned several of my articles marked "published before in other periodicals." I wish to state that a magazine cannot be published without some old material being in it. I think it is a good thing to publish real old and not well-known articles, because I have read about many that were new to me and interesting.

The reason I don't get angry when manuscripts are returned to me is because I know it is quite a job to go through 3,000 to 5,000 manuscripts a month, and we contestants should have some sympathy for the editors, and the reason I think the editors give prizes to professors, doctors, etc., is because they contribute in a better way. Therefore, I don't object to that, but you will surely hear from me if I think you cheated me too much. I want to tell you three interesting incidents. My friend and I were experimenting in our laboratory and seemingly "discovered" a method of soldering, using a piece of carbon connected to the storage battery, as the soldering iron, and connecting the bus bar wires which were to be soldered, with the other pole of the battery. This same principle was described in the September *Practical Electrician*, now called *The Experimenter*.

I thought there was no use in contributing this on the ground that it was probably old material, and imagine my surprise when four months later I saw it published.

My greatest shock was when I started to write about a battery carbon rheostat. The manuscript was practically ready, and I was hunting through an issue for the contest rules, when I turned upon the idea already in print.

I then thought of a method to tell when the tubes in a radio set are actually lit, but before sending this in I discovered it in *Popular Mechanics*. This same article also appeared in the March issue of SCIENCE AND INVENTION.

At any rate, I want the contest to continue, and I hope that along with the other "unlucky" contributors I will win a prize in the near future.

GEORGE N. BUNTIN,  
Hermitage, Tenn.

(Of course, we cannot help it if an idea occurs in our March issue, and is then found in the April issue of another publication. As a matter of fact, this same suggestion appeared two years ago in



SCIENCE AND INVENTION desires to hear from its readers. It solicits comments of general scientific interest, and will appreciate opinions on science subjects. The arguments pro and con will be aired on this page. This magazine also relishes criticisms, and will present them in both palatable and unpalatable forms. So if you have anything to say, this is the place to say it. Please limit your letters to 500 words and address your letters to Editor—The Readers Forum, c/o Science and Invention Magazine, 53 Park Place, New York City.

this publication. Often some of our pages are made up months in advance, and no doubt other publications do the same. Consequently, there is a possibility of the same idea occurring in two publications. However, we try to get as much original material as possible. Nevertheless, if you try hard enough, you will undoubtedly come across an idea suitable for publication in this magazine.

Doctors and professors do not get all the prizes in this publication. In the June issue of SCIENCE AND INVENTION, the second prize of \$75.00 was awarded to Mr. A. G. Penrod. This was the first article ever submitted by Mr. Penrod to a scientific publication. Mr. Schallert does not hold any degrees either, and he won one of the two \$50.00 prizes and has been a constant winner of large prizes. Mr. P. Henrikson, a winner of quite a few of our previous awards, won one of the third prizes of \$35.00, and Mr. Von Stein, as well as Mr. Robbins, both of whom won prizes in the June issue, are too well known to our readers to require further introduction. You will find a great many prize winners in each issue whose names probably never appeared in print before. Some of these gentlemen cannot even write English, but they make a fair sketch, and the idea when properly worked up by our artist wins a prize. Mr. Edoard Merlin has never written for publication before, and you will find his article on "Spirits" quite interesting.—EDITOR.)

**TRAIN SPEED**

Editor, SCIENCE AND INVENTION:

In the March edition of SCIENCE AND INVENTION, page 1107, Elliot R. Meyer gives a method how to tell the speed at which a railroad train is traveling. In a way he is correct, and then again he may be only within six or seven miles of being correct. Being employed by a large trunk line as locomotive fireman I am sometimes called upon to fire a passenger train locomotive, and once while traveling a mile a minute I tried to ascertain the speed by counting the rail joints by my figures. We were traveling between 53 and 54 miles per hour, and the speed recorder in the engine cab showed 60 miles per hour. Believing that perhaps the recorder was wrong, I timed again, this time by the mile posts, and sure enough we cut the mile post in two every minute. Upon arrival at the terminal I promised myself that I would solve the problem. So figuring that the rails were 30 feet long, it would take 176 rails for every mile, and on this basis it will figure the speed of a train at 20.4 or 20.5 seconds correctly. With a 50-foot tape measure I measured a length of rail and the rail measured 33 feet. Using rails of this length, it would take 160 of them to a mile, or 16 lengths less than if 30-foot rails were used. Figuring this out, the result instead of 20.4 or 20.5 seconds came to exactly 22½ seconds. The next day while returning on the engine when the recorder showed 50 miles per hour, I began counting the rail joints, and sure enough I counted 50, which proves that if one wishes to ascertain the speed, he must first ascertain if 30- or 33-foot rails are used, and then again at grade crossings a certain trunk line uses 66-foot rail lengths to save them tearing up the crossings, due to low rail joints. In my estimation the only reliable way of ascertaining the train speed correctly is by the mile post. So you see, Mr. Weyer, there is more to this click method than you were aware of. Your method is an old one, I having heard of it more than ten years ago; in fact, when 30-foot rails were a standard length on all roads. The leading trunk lines of today almost all use the 33-foot rail.

JOSEPH A. DZURENDA,  
Hornell, N. Y.

(We must commend you on your observation, detailed description and investigation, and gladly publish your letter for the benefit of many of our other readers, who are interested in calculating the speed of trains by the method of listening to the clicks produced by the wheels as the wheels cross the rail joints. An additional trouble is that many roads are set with staggered rail joints which makes the click method unavailable to those unable to distinguish the different sounds.—EDITOR.)

**A WORLD OF GOOD**

Editor, SCIENCE AND INVENTION:

In the August issue of SCIENCE AND INVENTION of 1924, you published an article on my invention which has done me a world of good. I now take this means to thank you, and express my appreciation to your organization. I think that every inventor should read your wonderful magazine as I find lots of inspiration and ideas in it.

I am selling many of my instruments, and send you herewith a copy of a letter which I received from Germany through your magazine. Again thanking you, I beg to remain,

WALTER H. SAMMONS,  
Philadelphia, Pa.

(The copy of the letter which Mr. Sammons received from Germany relates to a large order for his hair curler and comb. This device includes in its handle a thermometer which indicates whether the hair curling iron is hot enough for curling purposes, or whether the device is too hot for use.—EDITOR.)

**SYNTHETIC GOLD**

Editor, SCIENCE AND INVENTION:

I would like to say, in regard to an article appearing in the November number of SCIENCE AND INVENTION, entitled "Gold from Mercury," by Dr. A. Gradenwitz, regarding Professor Mieth's method of procuring gold from mercury, that mercury being used in recovery of gold in the gold industry, small particles of gold could be suspended in the mercury. I believe this is the case in Dr. Mieth's "work," because a small amount of gold was produced from a large amount of mercury, ten millions of dollars calculated as requisite to produce one pound of synthetic gold. Prof. Mieth's explanation is that mercury atoms contain one electron more than gold atoms and withdrawing one electron from the mercury atom by placing the mercury in a mercury vapor lamp containing at one end a high power suction pump one atom of gold is formed from one atom of mercury.

But as mistakes will happen, I may be mistaken, but so may the Professor.

WARREN TAUBER,  
Baltimore, Md.

(It is quite possible that there was gold present in the mercury which Prof. Mieth used, and consequently one cannot definitely state that synthetic gold was produced. Prof. Mieth is held in high repute, and consequently his discovery cannot be lightly tossed aside. Attempts are now being made to verify the findings of his research, and when definite information is available, SCIENCE AND INVENTION Magazine will publish the results.—EDITOR.)

**PICTURE COURSE IN PHYSICS**

Editor, SCIENCE AND INVENTION:

I suggest that you conduct a course in physics in your magazine. Illustrate the greater part of it, and use as little written explanation as possible.

(Continued on page 477)

**\$250.00  
for Killing Rats**

The Federal Government and State Departments are doing all they can to exterminate the rats. SCIENCE AND INVENTION MAGAZINE now offers prizes for the best new methods for exterminating rats. See July issue of this magazine for full details.

The prizes to be awarded are as follows:

- First Prize .....\$100.00
- Second Prize ..... 50.00
- Third Prize ..... 30.00
- Fourth Prize ..... 25.00
- Fifth Prize ..... 20.00
- Sixth Prize ..... 15.00
- Seventh Prize ..... 10.00

Suggestions must be accompanied with photographs or affidavits sworn to before a Notary, or if a trap is entered, a model must be submitted.

Contest closes at noon in New York on October 15th. All suggestions must be in our hands at the time.

The number of entries per person is not limited.

In event of a tie for any of the awards, an identical prize will be paid to the contestants so tying.

Address entries to Editor, Rat Contest, c/o Science and Invention, 53 Park Place, New York City.

**WRNY  
SCIENCE, COMEDY  
AND MUSIC**

Our new broadcasting station at the Hotel Roosevelt is rapidly "stepping out." Hundreds of letters have been received commending the management of the station for supplying "Science" over the air. Radio, chemistry and general scientific subjects are broadcast nightly, liberally interspersed with good comedy and the highest class music.

Have you heard the "DX" hound program—"Toonerville Trolley" at 12 midnight Saturday evening? Heard Radio News, Orlando's or Ben Bernie's Orchestras? Then tune in WRNY on 258.5 meters.



# RADIO

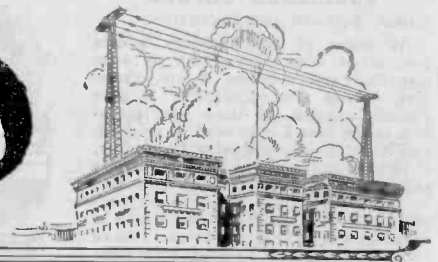

## Circus Broadcast by Relayed Radio

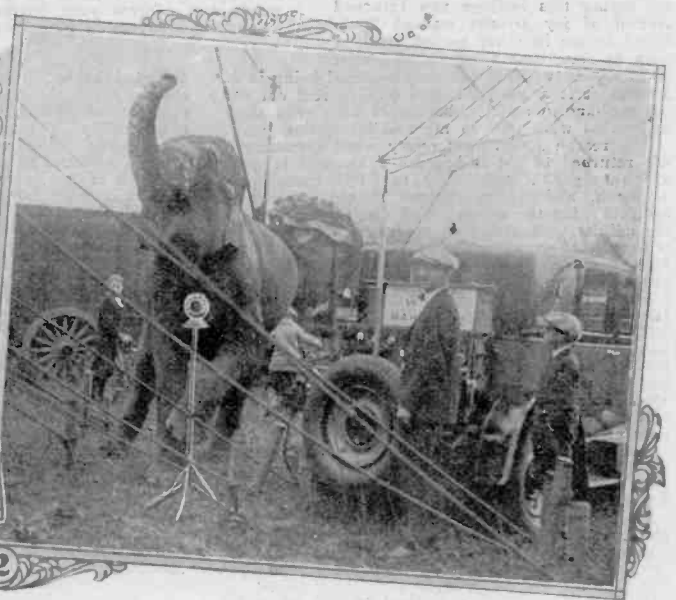

A RECENT test with a portable short-wave transmitter conducted in connection with one of the standard wave broadcast stations on Long Island, N. Y., resulted quite satisfactorily. A bit of comedy was injected into the test when the portable transmitter, entirely contained in an automobile, stopped at a circus and on its short wave-length sent out the voices of some of the performers and the noises made by the animals. As shown in Fig. 4, these short waves were picked up at the main broadcast station, whereupon they were fed into a standard wave transmitter and again sent out into the ether for the enjoyment of broadcast listeners. Fig. 1 shows the complete traveling unit used in these tests. Even with the short, low antenna shown, quite satisfactory results were achieved. In Fig. 2, Jumbo is shown broadcasting his views on animal evolution to the world at large. He seems to enjoy his experience. In Fig. 3, one of the many merry-makers and his pets are going through their repertoire for the benefit of the listeners-in.

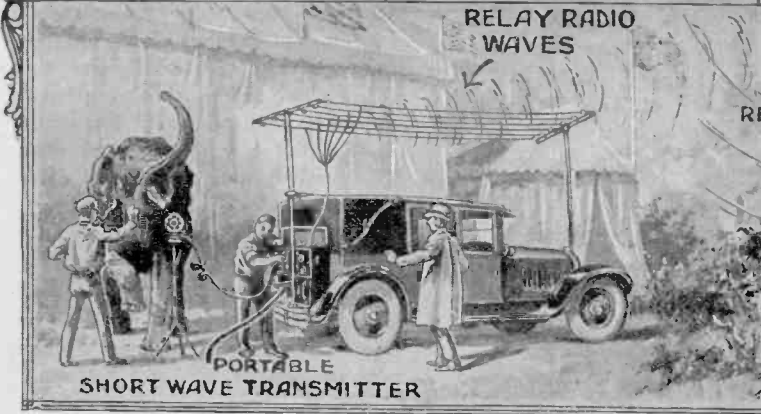



# Real Estate and Radio

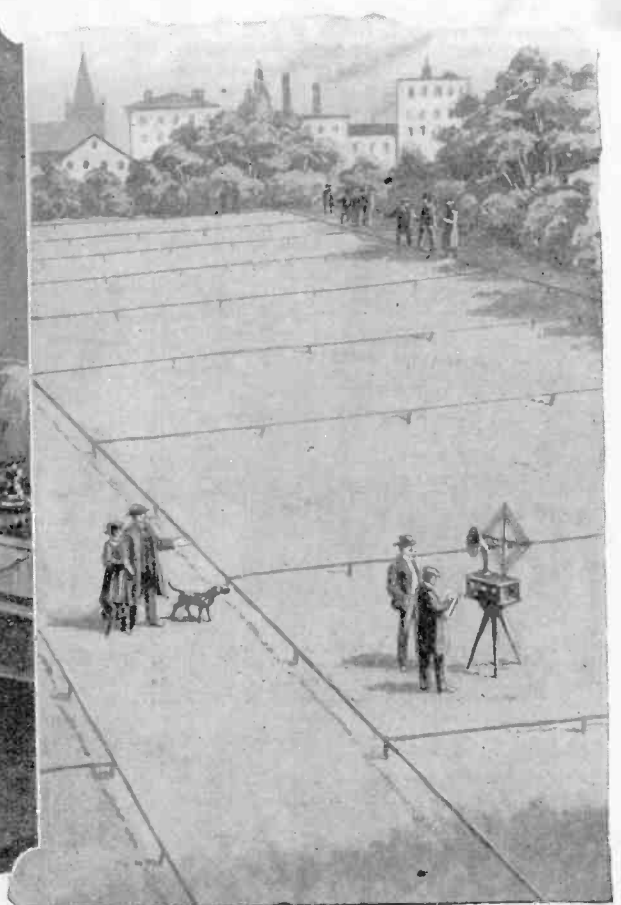

Nowadays when a customer buys property from a real estate agent, he should be shown where his property is located and the effect that his property has on the reception of radio signals. Although it is acceptable from every point of view, the realtor will not be able to sell the property unless radio signals are well received. Every real estate office should have a map, not only showing the location of the property, but also curves illustrating the audibility of signals received from a station.

The real estate agent should set up a radio receiver and demonstrate for the customer by actual reception of signals from a broadcasting station the desirability of the property, not only from the viewpoint of location, but from the quality of the reception of broadcasts.

## Low-Loss Condenser

The condenser illustrated showed up very well in all laboratory tests. It is of very original construction and has several features worth mentioning. It is of the square law type, and employs a unique bearing arrangement.

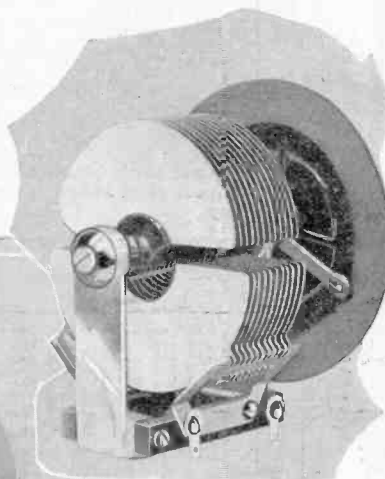
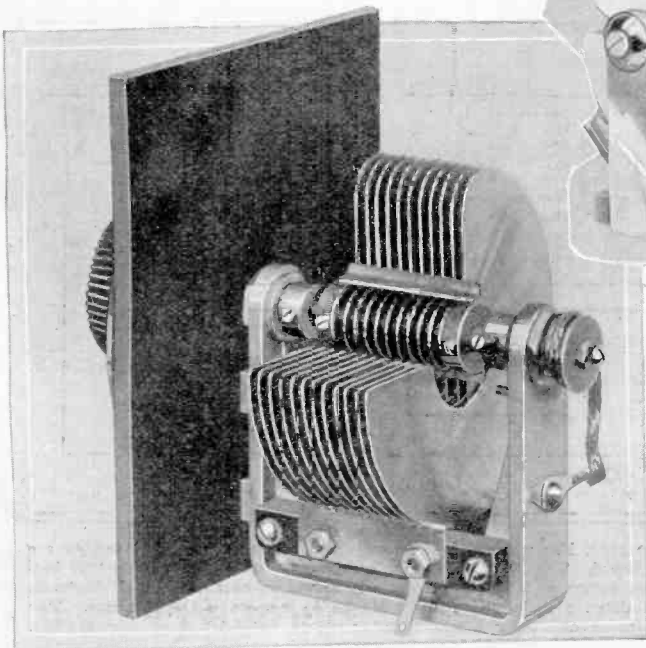

Note carefully its excellent mechanical design. A flexible pig-tail connection is used, and insures perfect electrical contact with the rotor. The condenser is provided with a vernier which affords very sharp tuning. The plates are of low resistance stiff and rigid metal, and the insulation employed is of the very best order, being made of small hard rubber strips which hold the stator plates in position. Friction washers permit adjustment without changing the relation of the plates.

## Double Detector

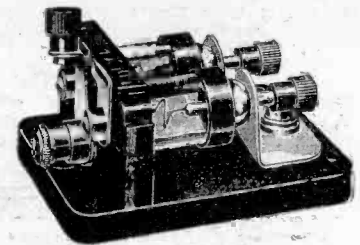

A novel departure in this British detector is the use of two crystals with a switch mounted on the base for the selection of either crystal.

## Novel Rheostat

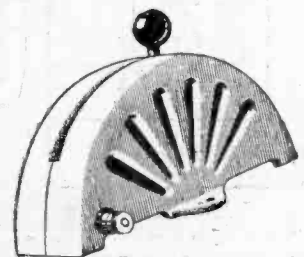

The toggle rheostat shown is something new in the design of rheostats. It can be mounted either on a table or against the panel by using the flanges provided on the sides of the case enclosing the resistance element. British make.

# A Suitcase Portable Super-Heterodyne

By SIDNEY E. FINKELSTEIN, Assoc. I. R. E.

In portable receivers, freaks may come and freaks may go, but standard circuits go on forever. Here one of the most complete and compact portable multi-tube sets that it has been the editor's privilege to examine is illustrated in use by the author at the right. A standard seven-tube super-heterodyne circuit is employed, but the parts are so arranged that they take up a comparatively small space and that they operate at their highest efficiencies. Mr. Finkelstein is shown adjusting the rotor or feed-back coil of the combined oscillator and detector tube circuit.

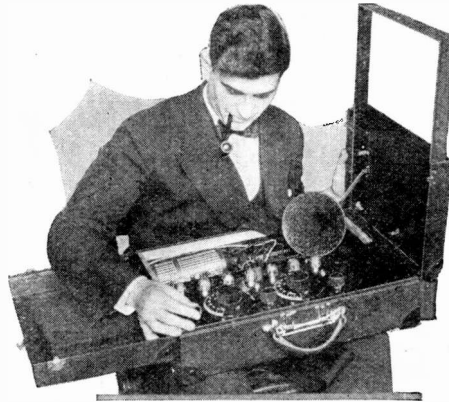

In the set under discussion, the loop is contained within the carrying case when folded, and consists of a rectangular frame about 1½ inches wide, around which 11 turns of stranded, insulated wire are wound. The loop is then fastened to one half of the specially designed cover by means of three small brass brackets. Flexible leads connect the loop to the correct instruments contained within the case. The directional effect of this part of the equipment is obtained by swinging the entire unit into the desired position.

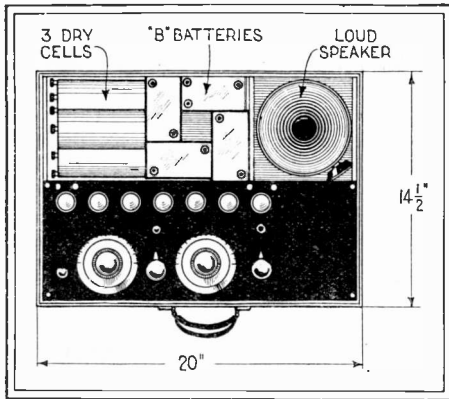

A top view of this portable super-heterodyne is shown above. The placement of the three dry cells and the four small block "B" batteries can be plainly seen. Note the simplicity of the instrument panel.

The only instrument that is used in the construction of this Super-Heterodyne that is not found in any ordinary set is the small, compact loud speaker which can be seen above and at the left. Even these small speakers are now coming into extensive use for sets of all types whether portable or permanent. In this particular case, a small space was left in one corner of the cabinet so that the speaker, with its horn removed and placed over the reproducing unit can be tucked away safe from harm. Three dry cells are found amply sufficient to operate the seven UV-199 tubes for a considerable period of time—long enough, in any event, for the usual vacation period.

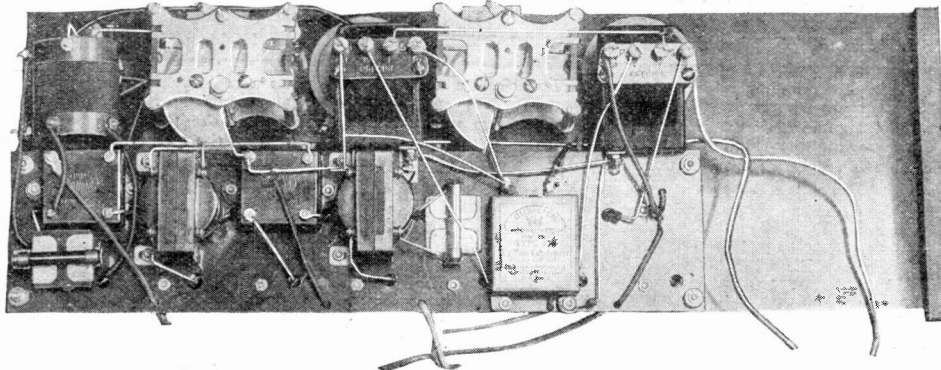

A view beneath the panel of this set shows us a series of compactly and neatly arranged instruments, hooked up with short leads. The sockets are mounted between sub-panel and panel proper.



Pipe and all, the author is ready for the wide open spaces where radio sets are radio sets—maybe, but with this set, positively.

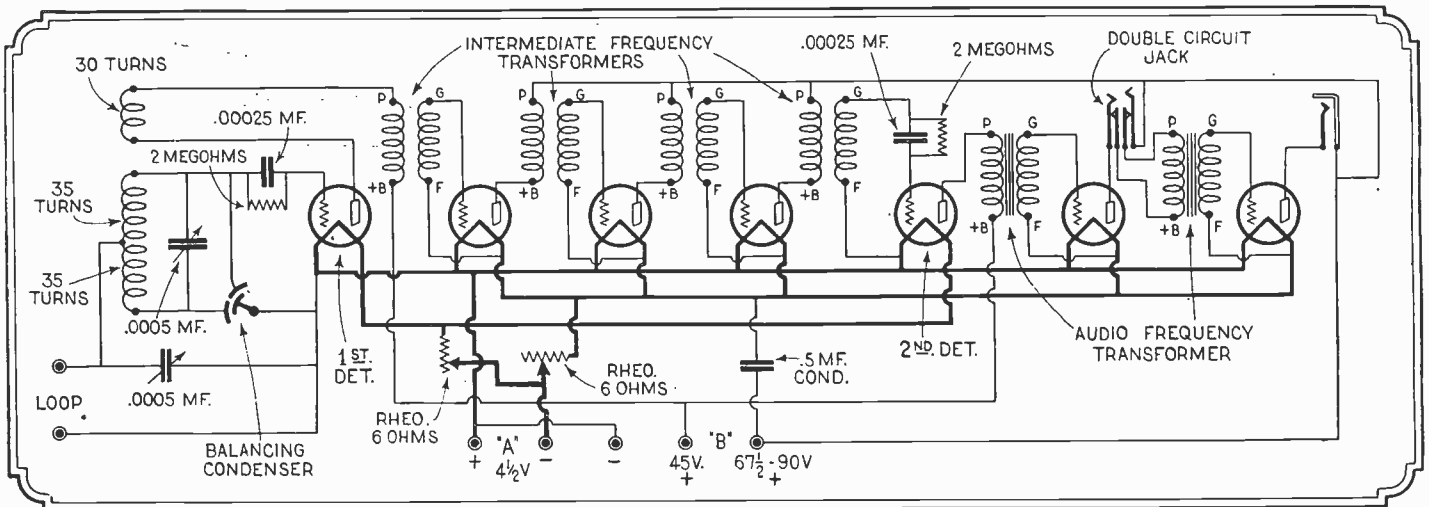

The above circuit diagram shows how simple it is to wire a super-heterodyne of this type. One tube is saved by combining the oscillator and the detector and making the first tube function as both. A small balancing condenser in this circuit aids in keeping the set stable in operation. No potentiometer is used as with the instruments employed it was found un-

necessary. For volume, two stages of audio frequency amplification are employed. The .5 mf. condenser connected across the "A" and "B" batteries serves to keep the set quiet in operation even if the "B" batteries run down a little. Use low ratio audio frequency transformers. The balancing condenser has two stator plates, insulated from one another.



# Hints to the Radio Builder

By LEON L. ADELMAN, Assoc. I. R. E.

## FREE END

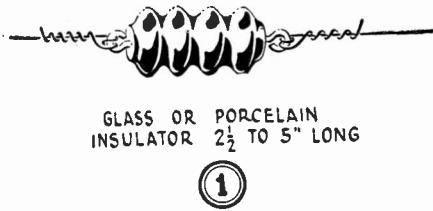

## LEAD-IN END

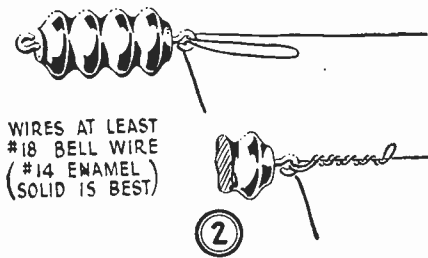

## SPlicing SINGLE WIRES WESTERN UNION JOINT

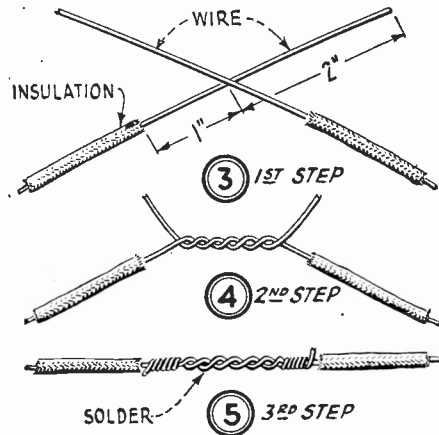

## PIG TAIL CONNECTIONS

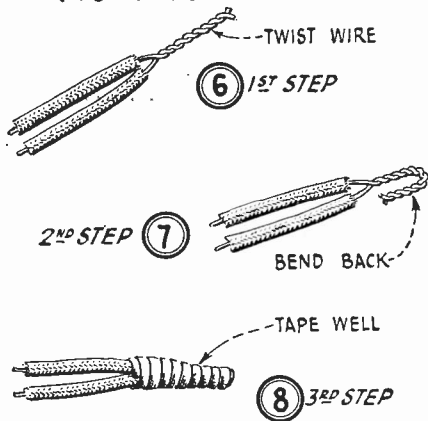

## PHONE CORDS

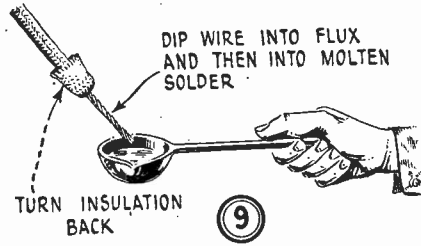

## MENDING A PHONE CORD

- 1-TURN COVERING BACK.
- 2-SOLDER ENDS WELL.
- 3-LAP OVER EACH OTHER AND BIND WITH SEVERAL TURNS OF BARE #28 WIRE. THEN SOLDER.
- 4-TAPE WELL.

## MAKING TAPS

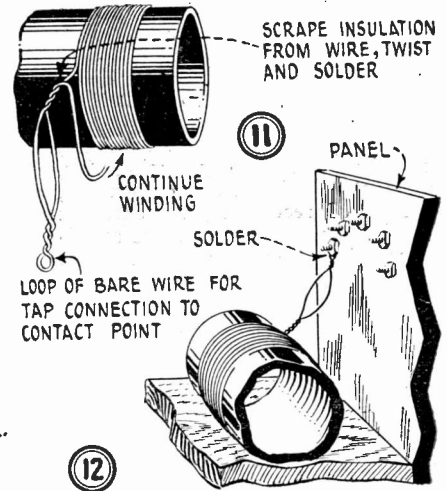

## LENGTH OF LEADS for 3 CIRCUIT REGENERATIVE RECEIVER

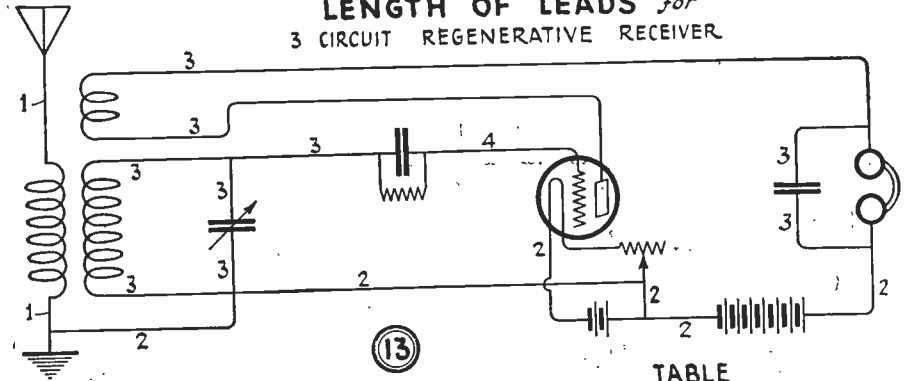

TABLE

1 - VERY LONG.....	1 TO 100 FEET
2 - LONG.....	1 TO 3 FEET
3 - SHORT.....	6 INCHES TO 1 FOOT
4 - VERY SHORT.....	0 TO 6 INCHES

ON this page we show several hints that will be of interest and value to all of those interested in radio constructional work. Fig. 1 shows how the aerial wire and the wire supporting the aerial should be fastened to the insulator. Five or six closely wound turns of wire serve this purpose. At the lead-in end of the aerial, the same piece of wire may be used for both the aerial and the lead-in if a loop is taken in the wire, run through the eye of the insulator and twisted back on the aerial proper, as in Fig. 2. In this way, a joint is avoided. When splicing single wires, the Western Union joint is the best to use and is illustrated in Figs. 3, 4 and 5. Solder at the point indicated in Fig. 5. Pig-tail connections where wires run parallel and are connected at the ends should be made as in Figs. 6, 7 and 8. Rugged ends for phone cords may be made as in Fig. 9, and flexible wire of this type should be mended as in Fig. 10. The proper method of making taps and of connecting them to switch points on a panel is detailed in Figs. 11 and 12. The wire should be soldered at both points indicated for best results.

## CONNECTIONS FOR MORE PHONES OR LOUDSPEAKERS

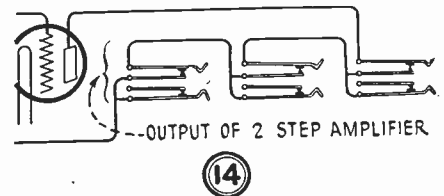

## SHORT GRID LEAK CONNECTIONS FOR HIGH EFFICIENCY

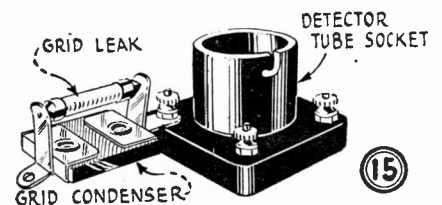

Certain leads in a regenerative receiver should be kept short and a chart which will show you just what leads should be short and which can be long is given in Fig. 13. The facts given apply to any radio receiving set that uses regeneration.

To connect several phones or loud speakers to the same set, use the jack system illustrated in Fig. 14. As shown in the chart, Fig. 13, the grid lead should be very short. This can be best accomplished by mounting the grid leak and condenser on the socket as in Fig. 15.

# The Radio

How to Build a Two-Tube

Full Details On

By A. P. PECK,

PROBABLY everyone of our readers who is interested in radio reception is a DX fan and enjoys the thrill of bringing in stations thousands of miles away. For just this type, the set described on this and the three following pages was selected. With its one stage of tuned, neutralized radio frequency amplification, when properly designed and constructed, this system of reception gives excellent results. Used with the two stage amplifier described by the writer in the August, 1925, issue of this magazine, loud speaker results are to be noticed in almost every instance. Usually it is only necessary to use one stage of audio frequency amplification to accomplish this. In the photograph at the right the writer is shown testing the set for volume and selectivity. After the set was properly neutralized and the variable grid leak was set at the correct value, determined by experimentation, local stations could be easily and quickly separated and distant stations tuned in.



IN this circuit, with the home-made coils described on page 445 or with the standard manufactured type, a fixed series antenna condenser is necessary for best results. This is shown in the diagram below, but not in the photographs, or the progressive circuits. In the particular set illustrated this series condenser was an external adjunct and was permanently connected in the antenna lead-in. A flexible wire from this condenser was brought in through the back of the cabinet and the end of it connected to one or the other of the aerial binding posts. For short aerial connect the post S and for a long one to post A. Many users of sets of this type have found that it will work very well on an aerial only ten feet long. Of course, if you desire, this condenser can be incorporated in the set. Photographs courtesy of National Co., Inc., Allen Bradley Co., Alden Mfg. Co., Radiall Co., and Radio Specialty Co., Inc.

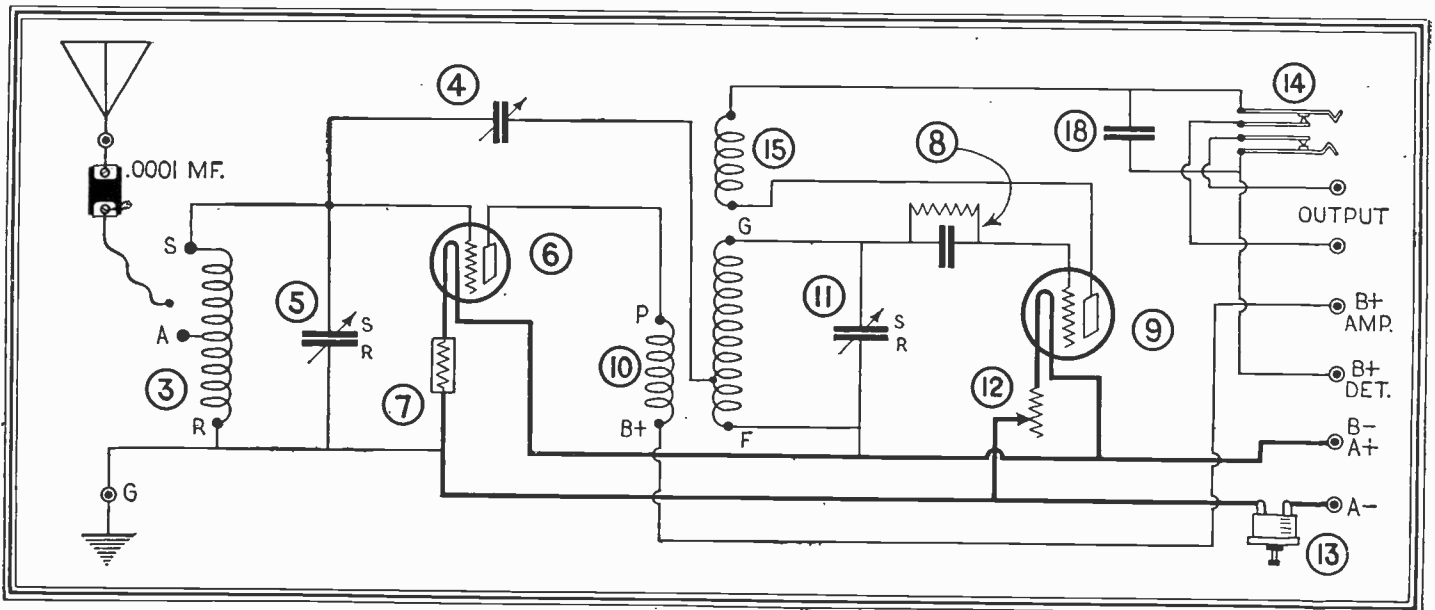

The above circuit diagram shows all of the connections for this two-tube Browning-Drake unit. The parts have been carefully selected and the

home-made coils wound for the very best results. Follow directions carefully and you will have a set that will justify all your troubles.

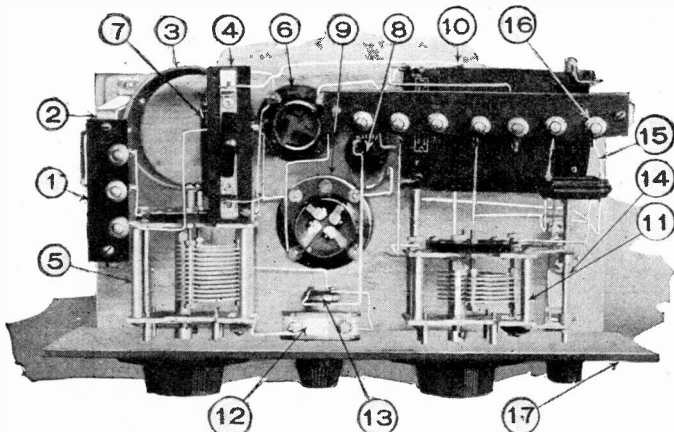

In the top view of this receiving set, shown above, all of the parts are assigned numbers. These are carried out through the entire article so that reference can be made quickly and easily. Manufactured parts are illustrated, but home-made coils are described on page 445.

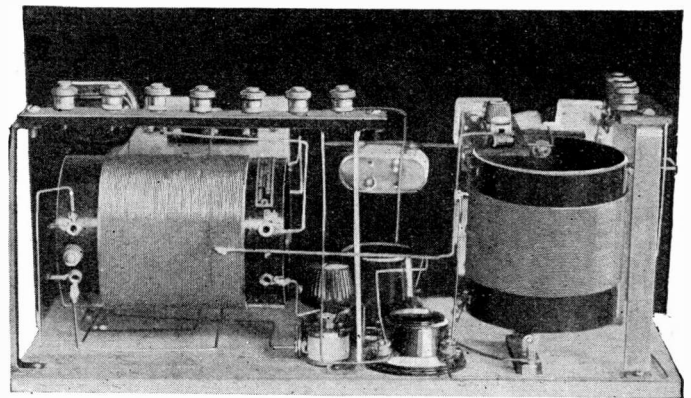

A rear view of the completed set is shown above. Note the mounting of the neutralizing condenser in a convenient location and the long supports used for raising the binding post strips to a point where they can easily be reached. The fixed filament resistance, 7, is located on the baseboard under the antenna tuning coil.



# Constructor

Browning-Drake Receiver.

The Coils Used.

Assoc. I. R. E.

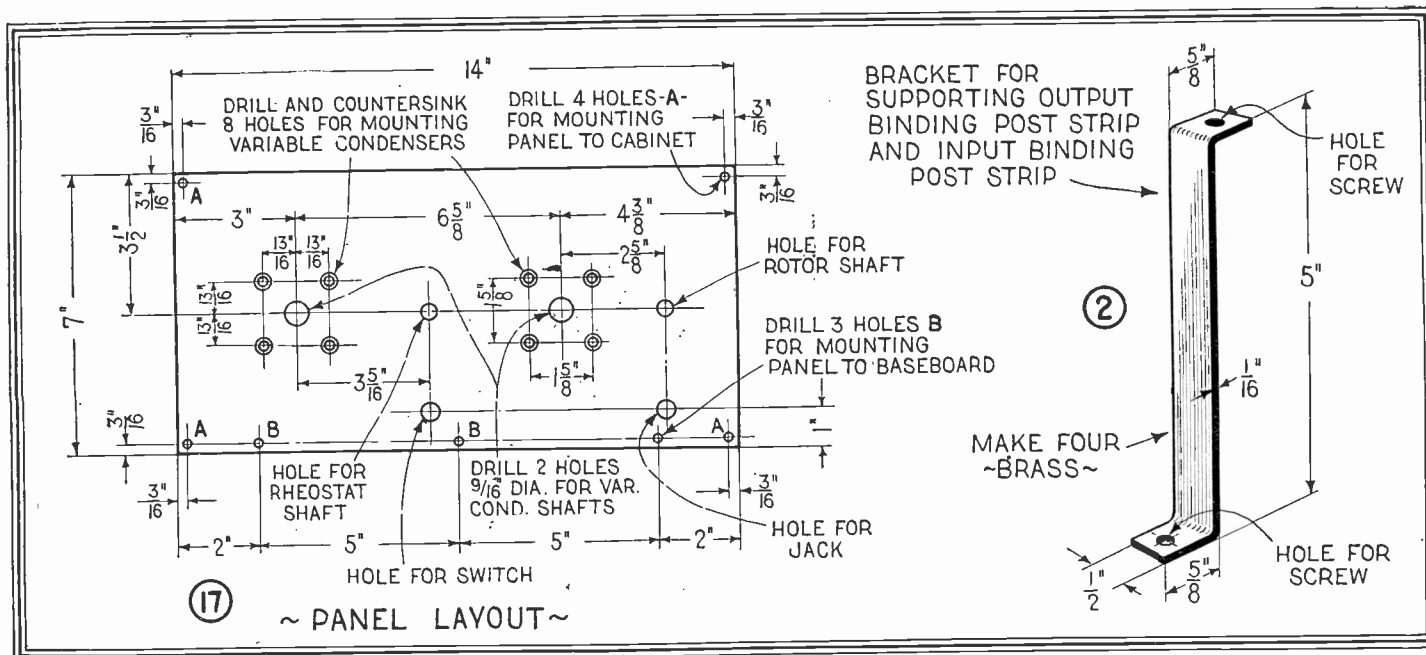

THE illustration directly above gives all of the details for laying out the panel of this receiver and for making the brackets which support the binding post strips. The numbers correspond with those on the photograph on the opposite page. The panel is laid out for using the standard condensers furnished with the Browning-Drake kit and the holes are placed to allow the use of the vernier dials supplied with that kit. When you make the brackets for the binding posts strips, you may have to turn the bases towards the other side in order to get them on the baseboard. In any event, this can be quickly determined when you are arranging the lay-out of the parts.

At the right is given the first of the series of our justly famous progressive wiring diagrams first introduced to our readers in the July, 1925, issue of this magazine. In this diagram, all of the parts are shown with the baseboard and the panel laid flat, instead of at right angles to each other. In this way the parts can be more plainly seen and the wiring diagram is easier to follow. Only the filament connections are shown in this section while those for the grid and plate circuits will be found on the next page. If you proceed with wiring of your set by following these diagrams one at a time, you cannot go wrong. Wire first the filament circuits; then put in the grid connections and finally the plate wires.

(Continued on next page)

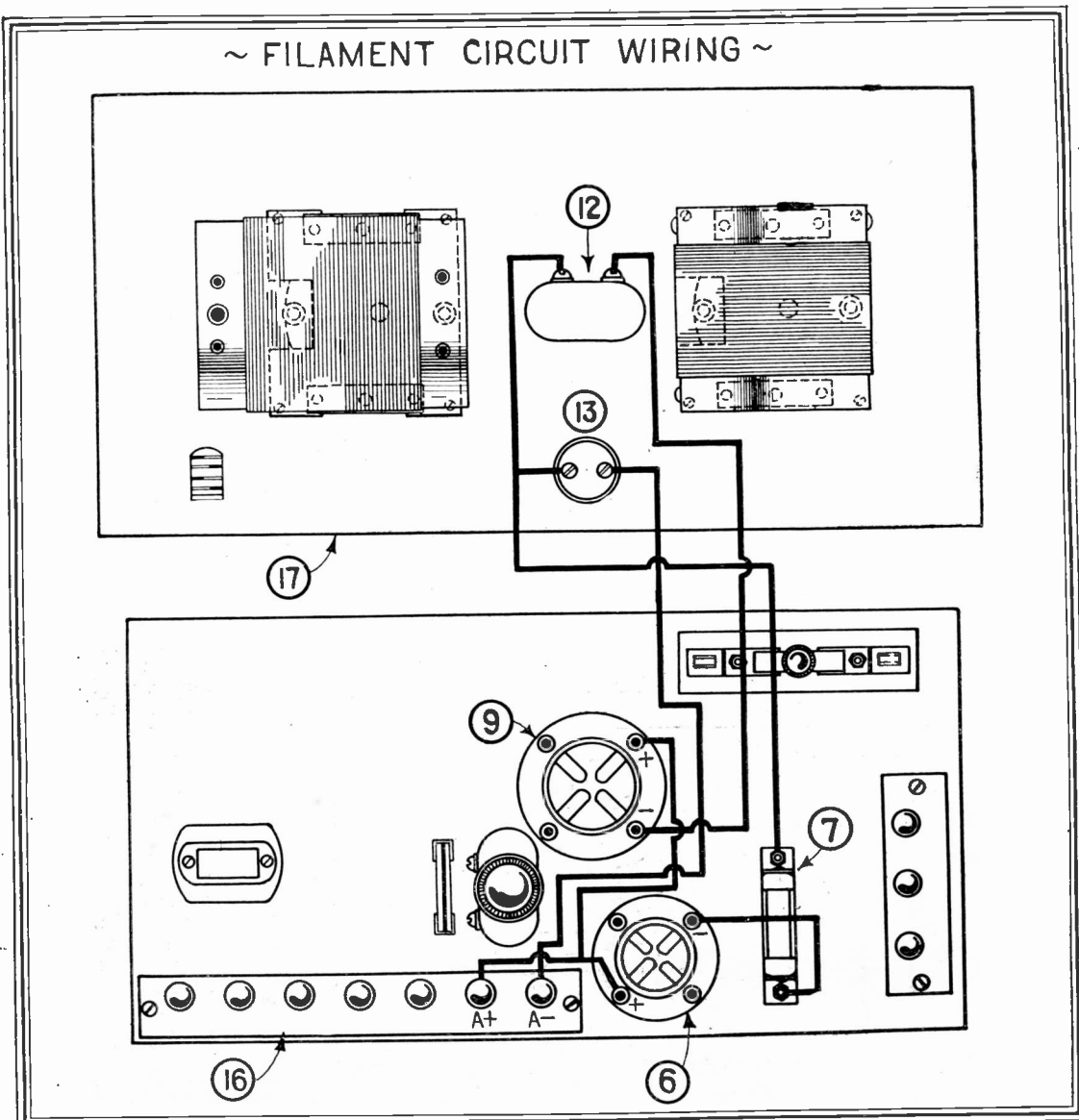

# The Radio Constructor

THE diagram at the right shows all of the connections for the grid and filament circuits of this set. The grid wires are shown in heavy lines while the filament connections that were shown in detail on page 443 appear in fine lines. The neutralizing condenser 4, which is mounted on a little bracket fastened to the antenna tuning condenser is shown here placed on the baseboard for the sake of clarity only. Mount it as shown in the photographs on page 442 when you come to the actual construction of this set. In this way it is easily accessible for neutralizing the set. The combination grid leak and condenser, 8, is placed on the baseboard inasmuch as the leak does not require frequent adjustment. A fixed resistance capable of operating a UV-199 tube directly on a storage battery is shown at 7. In this way, a special rheostat or a tapped "A" battery is not necessary.

The remainder of the connections for this set are shown below in the plate circuit wiring diagram. The fixed condenser, 18, should be connected across the two outside springs of the jack rather than across the two leads to the output binding posts, as shown in the photographs. The reason for this is that with the connections shown below, the condenser will be in shunt with the phones, when they are plugged into the jack, 18, and will also be across the audio frequency amplifying transformer when this two-tube set is used with an additional unit. If the condenser is placed across the output leads, it will not be in the circuit when the phones are used. This is not to be desired. In the diagram below, the rotor, 15, is shown. This is controlled by a long shaft placed beside the detector tuning condenser and protruding through the panel a short distance away from the dial controlling that instrument. A small knob placed on the end of the shaft allows the operator to turn the rotor and thus control regeneration. In this set, because of the neutralized radio frequency amplifier, radiation to an appreciable degree cannot take place even though the tickler is coupled so closely to the detector tuning coil that the set squeals.

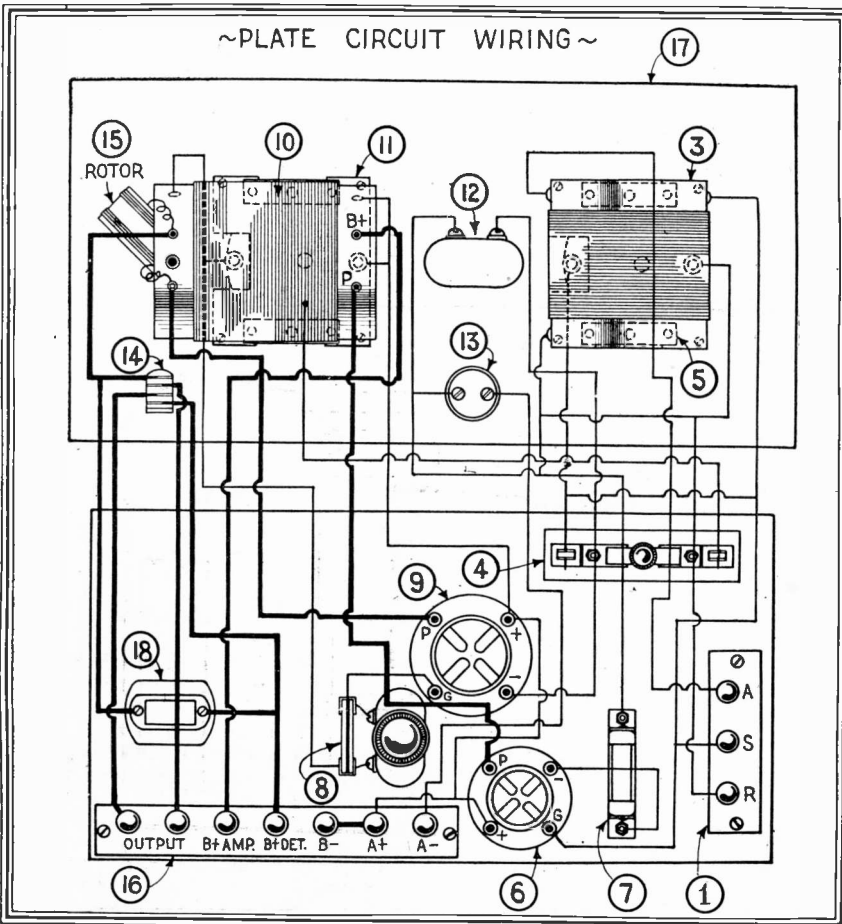
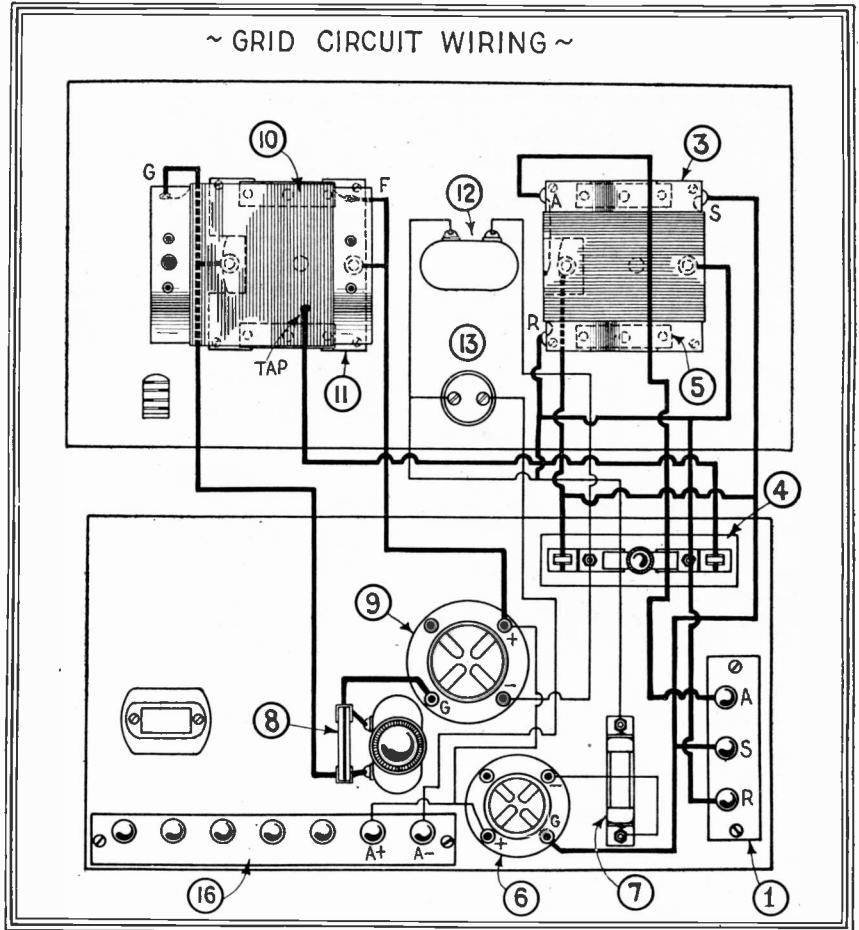

YOU may wonder why two different types of tubes are used in this receiving set. The reason is that a UV-199 or a DV-3 tube is a somewhat better radio frequency amplifier than a UV-201A and is much easier to neutralize and that the latter is a good detector. Therefore, we use one of these low-power tubes for the amplifier and control the filament of it with a fixed resistance unit that will allow the three-volt filament to operate on a six-volt storage battery, without fear of burning it out. The resistance is of a well known cartridge type and serves the purpose very well.

The method of balancing or neutralizing this set is as follows. After connecting everything correctly and placing the aerial and ground wires on their binding posts, tune in a local station and take the resistance unit out of its clip. Now re-tune the set slightly and the local station will be heard. Adjust the set until the station is at its loudest and then set the balancing condenser, until changes in the antenna condenser do not affect the signal strength. This point is usually identical with the setting of the balancing condenser for minimum signal strength. Now replace the resistance unit and the set is ready for operation. A good way to test for the proper operation of the set is to place the tickler coil at various settings until, by placing a finger on the stator plates of the detector tuning condenser, 11, a "pluck" will be heard in the phones or loud speaker. This shows that the detector circuit is oscillating. Tune in a station by the well-known squeal method and then adjust the tickler coil until the station is clear and there is no whistle generated by the set itself.

A set of this nature, used with an audio frequency amplifier, will give excellent results on DX. On the Eastern coast, reception of California stations has often been reported using only a 30- or 40-foot aerial. Of course, much depends upon the correct construction of the set.



# (Continued from page 443)

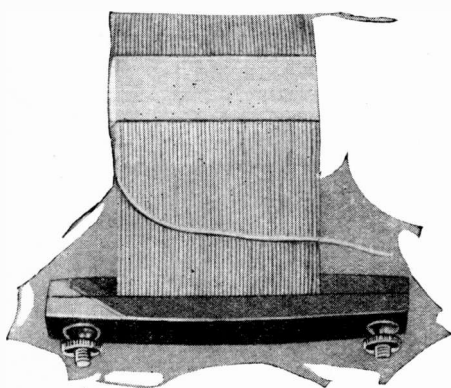
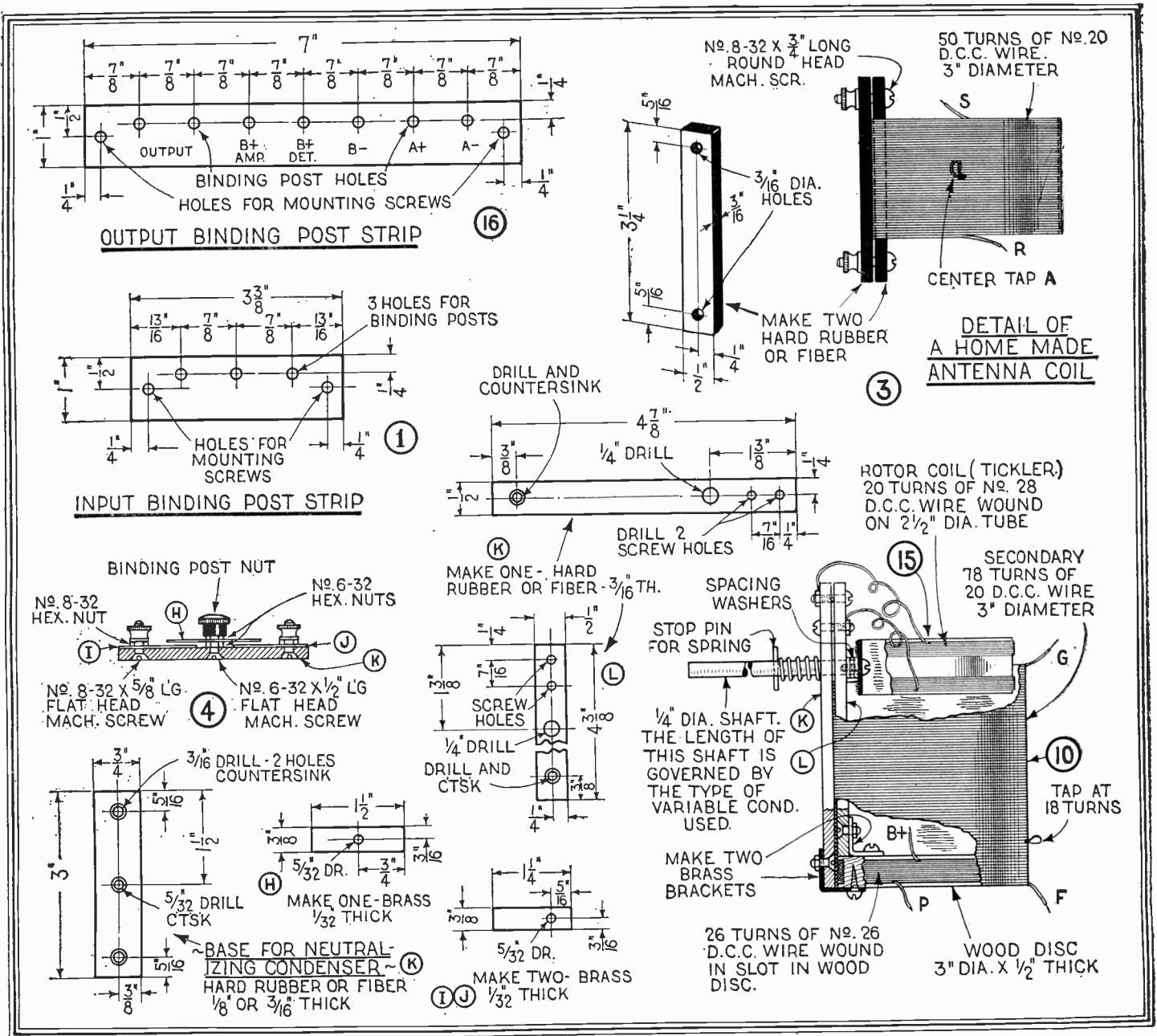

Above is shown a photograph of a home-made antenna tuning coil, the constructional details of which are shown at 3 in the upper right hand corner of this page. This coil is self supporting, being made as described at the right, and is mounted on two short insulating strips. The two connections can be fastened to the two machine screws and the latter used as binding posts.

A home-made coupler for use in this set is illustrated at the right and the details are shown at 10 and 15 above. For compactness this coil

is mounted in back of the variable condenser whereupon a long shaft is necessary for controlling the tickler. To make these self-supporting coils, lay four strips of adhesive tape, with the sticky side up, lengthwise on a round glass bottle and space them equally distant around the circumference. Wind the wire over these strips and when completed fold the ends over as shown. Coat the coil with collodion and remove the bottle. If necessary, break the bottle. The primary is wound in a groove cut in a wooden disk as shown in detail above. The exact number of turns on the rotor or tickler coil can best be determined by experimenting. Use as few turns as possible, but have enough to make the set oscillate steadily when desired.

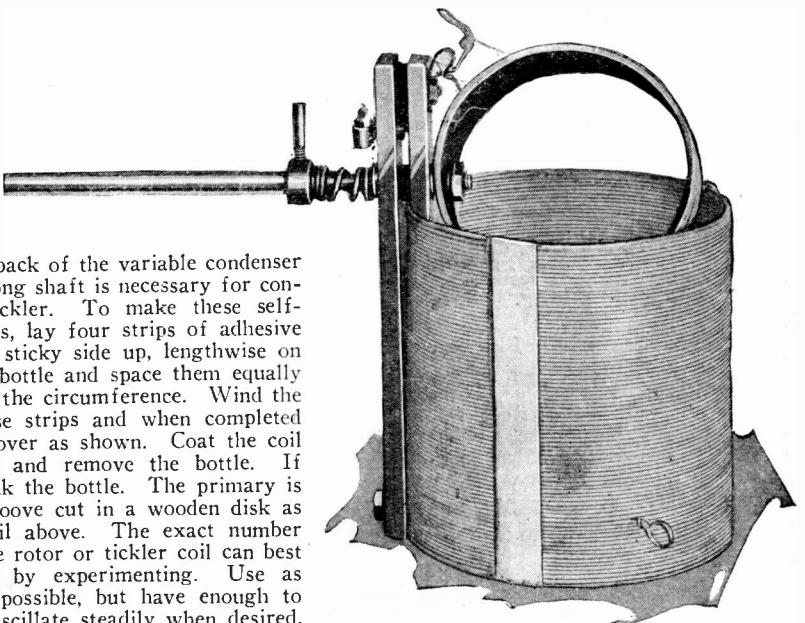

# Make Your Own

### Complete Details Which Give

THE subject of "B" battery eliminators is one which we know interests all our readers. In response to hundreds of queries regarding these units, we have collected together authoritative material from several sources and are presenting herewith sufficient data to enable anyone to build one of them. Different types are shown from the simplest and cheapest to the more complex and expensive. The choice of the type that you will build will rest entirely with yourself. The eliminators illustrated in Figs. 1 to 5 inclusive were designed by Moe Joffe.

In Fig. 1 is shown one of the simplest and least expensive types of rectifiers to be used for the purpose of eliminating "B" batteries. This makes use of what is known as an electrolytic rectifier and a filter system. The latter is probably the most important part of any eliminator. All rectifiers deliver a pulsating direct current which, if connected directly to the set, would cause considerable noise in the loud speaker or headphones. Therefore, it is necessary to smooth out this current so that it is what is commonly known as pure D.C. and this is done by means of the filter. Generally speaking, a filter consists of a large choke coil made of many turns of wire wound on an iron core and one or more large capacity fixed condensers. The details of a choke coil suitable for use with almost any "B" eliminator unit are given at A in Fig. 1. The core is thin strips of silicon steel and an air gap is provided by inserting a piece of cardboard 1-32nd of an inch thick in the position shown. All other corners of the core are overlapped and the entire core may be clamped in any convenient manner. The condensers used in the filter system are of the paraffin paper and tinfoil type.

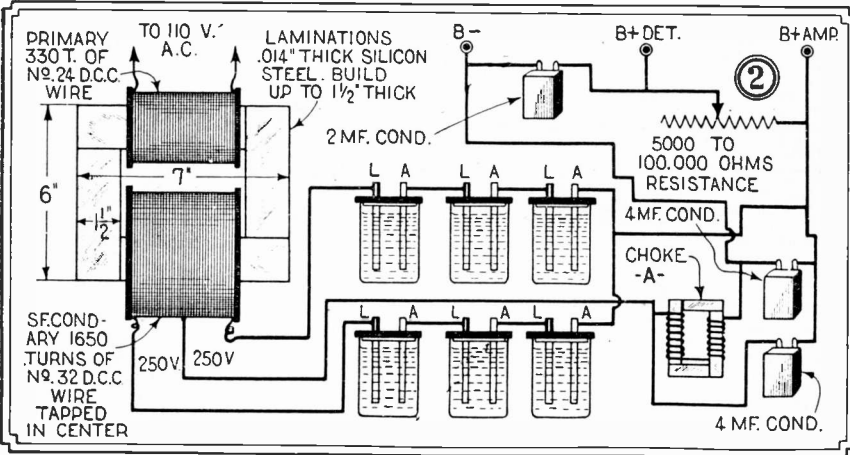
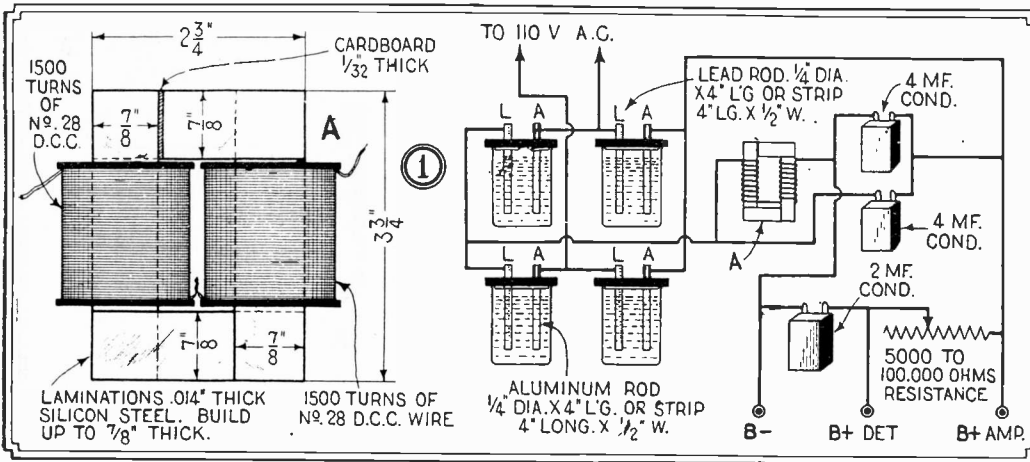

THE "B" eliminators shown in Fig 1 and 2 use electrolytic rectifiers consisting of lead and aluminum rods or strips of the dimensions indicated, placed in a saturated solution of borax and water. Be sure that you use pure aluminum. Dissolve the borax in warm water and allow to stand for 24 hours. Pour off the clear top liquid and use in the rectifier. A layer of oil 1/4 of an inch thick floating on top of the electrolyte will prevent evaporation of the liquid. In the type of rectifier shown in Fig. 2, 6 jars are used and are supplied with current by means of a transformer, the details and dimensions of which are given. An eliminator of this type will supply sufficient voltage for the largest of receiving sets, whereas the one shown in Fig. 1 is for use on smaller sets. When putting one of these eliminators into use, it will be found that the aluminum plates must be formed. To do this, hook up the entire unit as illustrated and close the A.C. circuit momentarily. Open the circuit and repeat the process several times, never leaving it closed for more than two seconds at any one time. When this has been done for 5 or 10 minutes, the plates will be formed and ready for use.

The eliminators shown in Figs. 3 and 4 use vacuum tubes of the same type that you employ in your receiving set and use them to rectify the A.C. This type of rectifier does not have some of the drawbacks that are found in the electrolytic style, but on the other hand, the vacuum tube rectifier is more expensive to build. Specially designed transformers, the details of which are given on the drawing are used with these rectifiers and supply both the current for lighting the filaments of the tubes and the voltage that is to be rectified and filtered and eventually used for operating the receiving set. A potentiometer aids considerably in producing pure D.C. at the receiving set and should by all means be included and adjusted to best results.

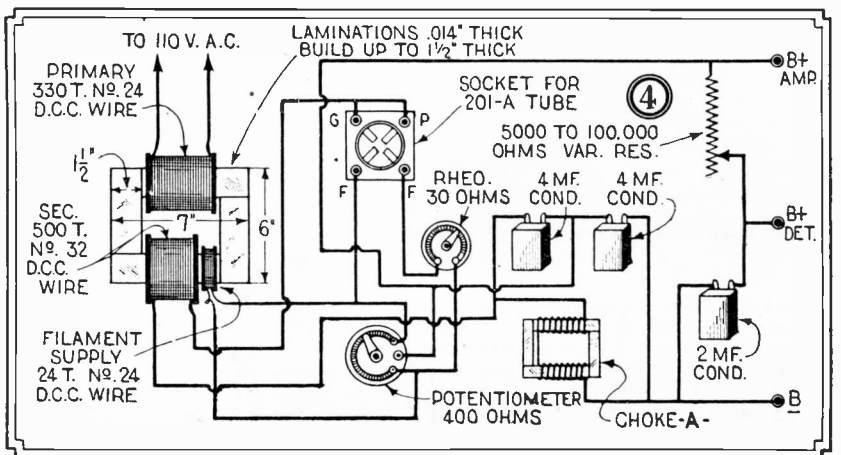
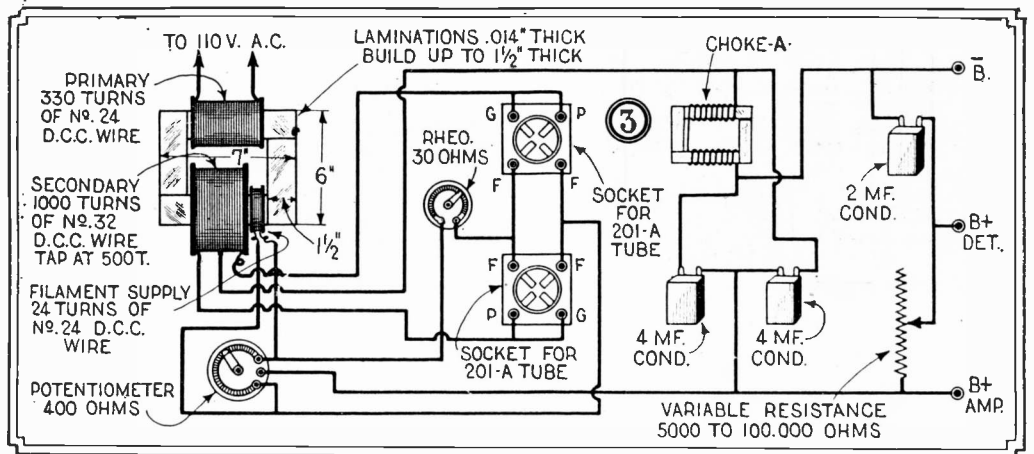



# "B" Battery Eliminator

On Several Types  
Good Results

IN the two vacuum tube rectifiers or eliminators illustrated in Figs. 3 and 4 on the opposite page, the same choke coil illustrated at A, in Fig. 1, is employed in the filter.

In Fig. 5 is shown another type of tube rectifier employing what is known as an "S" tube, which does not have a heated filament. Therefore, the transformer used with this device needs only one secondary winding and all of the details are given. The filter system that we illustrate in connection with this device is different from those shown on the opposite page, inasmuch as three choke coils are used. They may be wound on small audio frequency amplifying transformer cores and are all identical in construction. The electrolytic condensers can be purchased on the market and are far superior to the usual paraffin paper and tinfoil type. They are known as self-healing and if they break down under an abnormal strain, they immediately regain their usefulness automatically.

## "B" Eliminator Controller

An excellent method of controlling the output of a "B" eliminator is by placing a variable reactance in the primary circuit as in Fig. 6. This is a very simple instrument consisting merely of one-half pound of No. 28 D.C.C. wire, wound on a suitable spool. The core is made up of a bundle of iron wires bound together and provided with a handle. The further the core is inserted into the spool, the lower will be the voltage delivered by the eliminator. This instrument may be used with any type of rectifier by connecting it in series with one side of the A.C. line. It matters not whether a transformer is used.

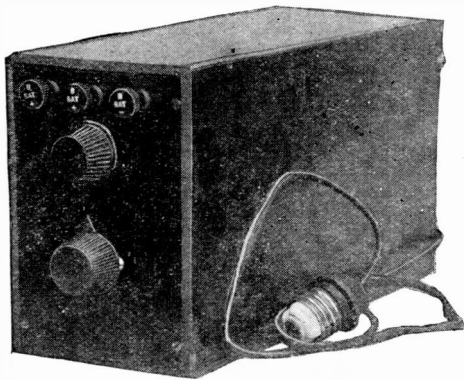
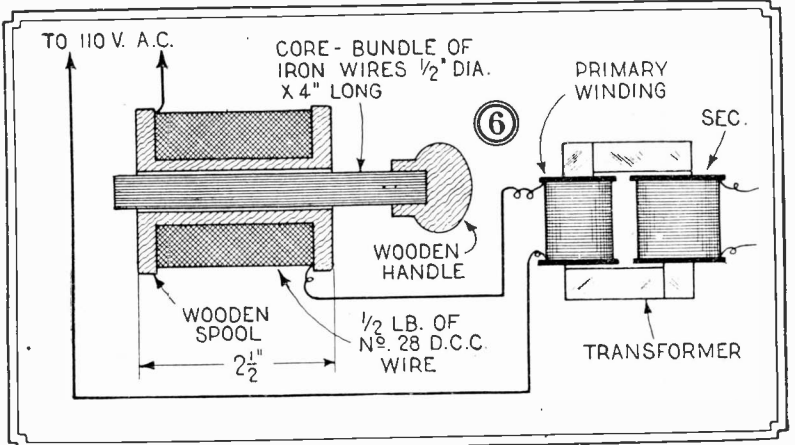
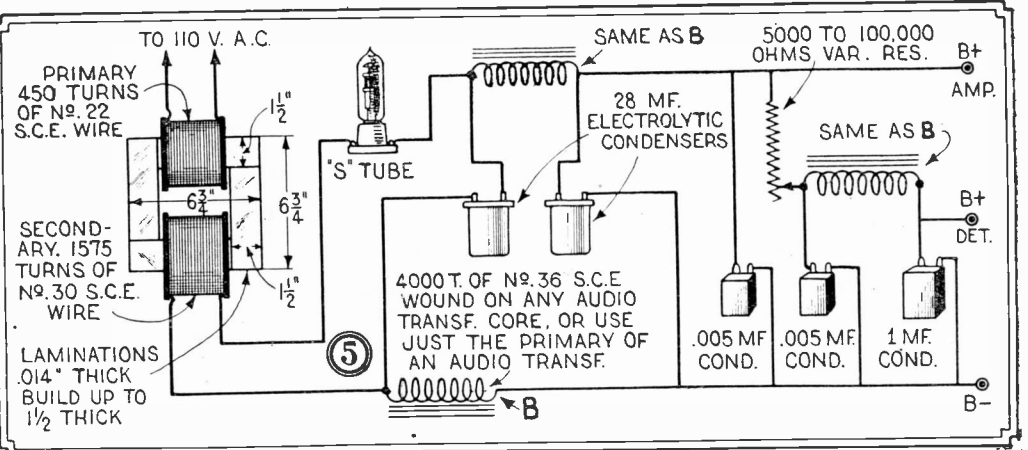

Above: The "B" eliminator mounted in a cabinet and ready for use.

Here we have a very simple home-made type of "B" eliminator constructed by Max Kuhne from standard parts that can be obtained almost anywhere. Mr. Kuhne makes use of the primary of an audio frequency amplifying transformer for a choke coil and uses two 2 mf. condensers in connection with it for the filter system. If you do not get good results with this instrument, try a larger filter condenser in place of the one that is connected from the B+ side of the audio frequency transformer to the filament binding post on the tube socket. A second audio frequency amplifying transformer provides the current to be rectified and also the filament potential for the rectifying tube. It is reconstructed as described below.

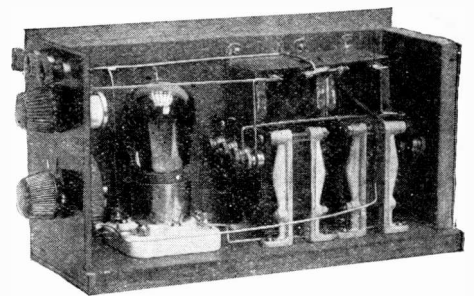

A view of the interior of Mr. Kuhne's "B" eliminator is shown directly above. The filter condensers are mounted over the two audio frequency amplifying transformers.

IN connection with this unit, the primary of an audio frequency amplifying transformer is connected directly to the 110 volt A.C. line. The secondary, therefore, furnishes the high voltage which is to be rectified by the single vacuum tube. This transformer is first taken apart by unbolting the frame and taking off the leg of the core opposite the winding. On this core a quantity of No. 28 S.C.C. wire is to be wound. The exact amount will depend upon the other windings of the transformer used. We would suggest that you wind about 200 turns, replace the leg, and hook up the transformer. Measure the voltage across this new winding. If it is not at least six volts, wind on more turns. If it is more than six volts, remove turns until the voltage is correct. This winding supplies the filament of the rectifying tube.

It may be that you will have a little trouble in eliminating all of the hum with this unit. In such a case, try connecting a potentiometer across the filament supply secondary and connecting the wire which leads from the common connection between the two condensers to the filament, to the center post of that instrument. Adjusting this potentiometer will probably aid considerably in smoothing out the current supplied to the set.

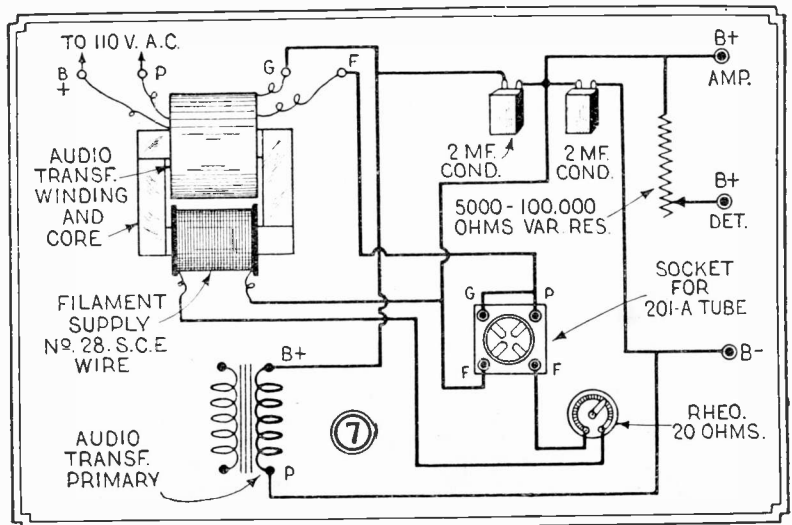

# Herbert E. Hayden's One Tube Portable Receiver

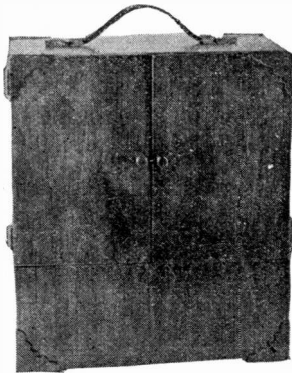

Above: The complete receiver in its cabinet with the protecting doors closed.

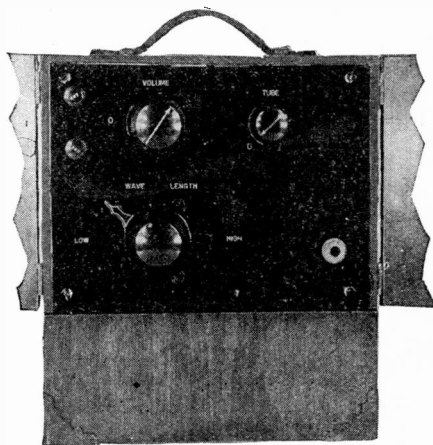

Above: A panel view of this excellent receiver ready for operation. Note simplicity of control.

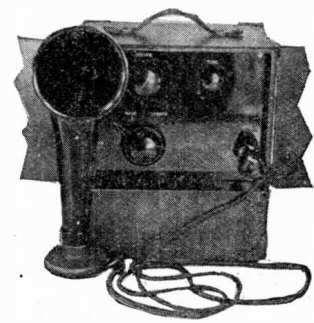

A small loud speaker of the type shown makes a good companion for the set.

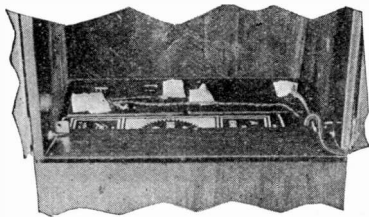

The "A" and "B" batteries are enclosed in the lower part of cabinet as above.

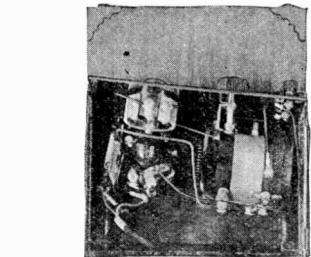
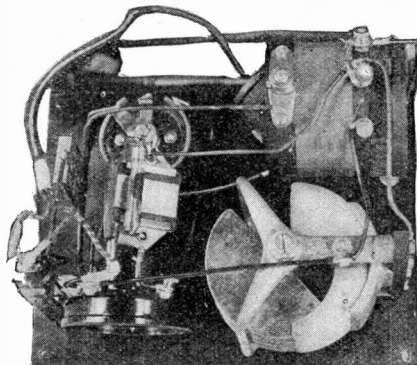

A top view of the instruments in this set shows their arrangement clearly.

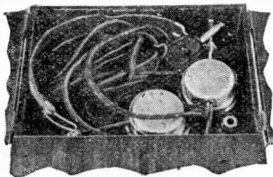

A pair of phones may be placed in the cabinet between the panel and the doors.

Note the compact yet simple arrangement of the coupler, condenser, and other instruments above.

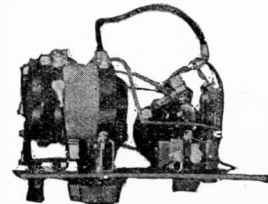

Another view of the receiver which will aid you in placing the parts correctly.

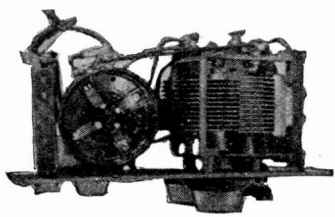

A view from the base of the receiver showing the jack and socket mountings.

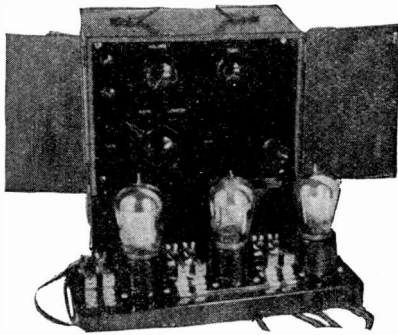

For home use, a three-stage amplifier such as above may be added to this receiver for volume.

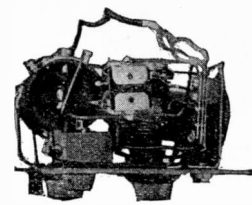

A side view of the receiver as above shows location of by-pass condenser.

A splendid type of receiver that is made according to standard practice and which will amply repay the builder for any trouble involved is illustrated in detail on this page and the circuit diagram of the same is given at the right. The set can be incorporated in a cabinet with an over-all height of 9½" while the width and depth need only be 8" and 5" respectively. This size allows the placing of the necessary batteries in the base, since the panel size is only 5¾x7½". A handle makes the set easily portable and convenient.

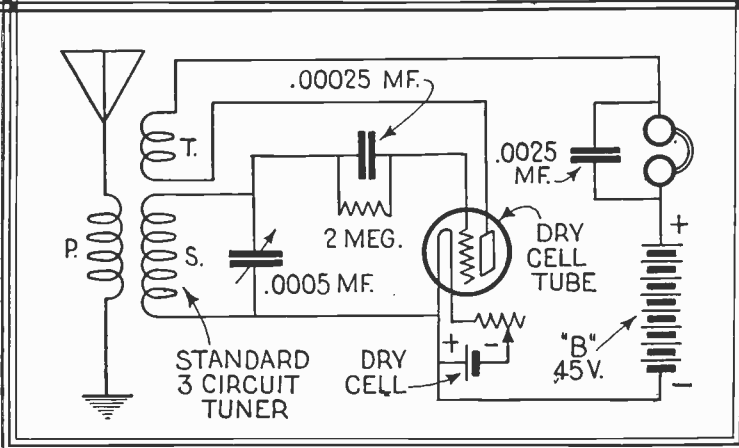

A set of this nature need not be used only for places where a small and compact set is necessary or desirable, but can provide all-around entertainment in the home as well. For this use, while, of course, the phones can be used, it is desirable to have loud speaker volume. In such an event, a three-stage resistance coupled amplifier as shown in the lower center photo above may be connected to the set, or a standard amplifier such as that described in the August, 1925, issue of this magazine may be employed. In either event, excellent results will be obtained.

# RADIO ORACLE

In this Department we publish questions and answers which we feel are of interest to the novice and amateur. Letters addressed to this Department cannot be answered free. A charge of 50c. is made for all questions where a personal answer is desired.

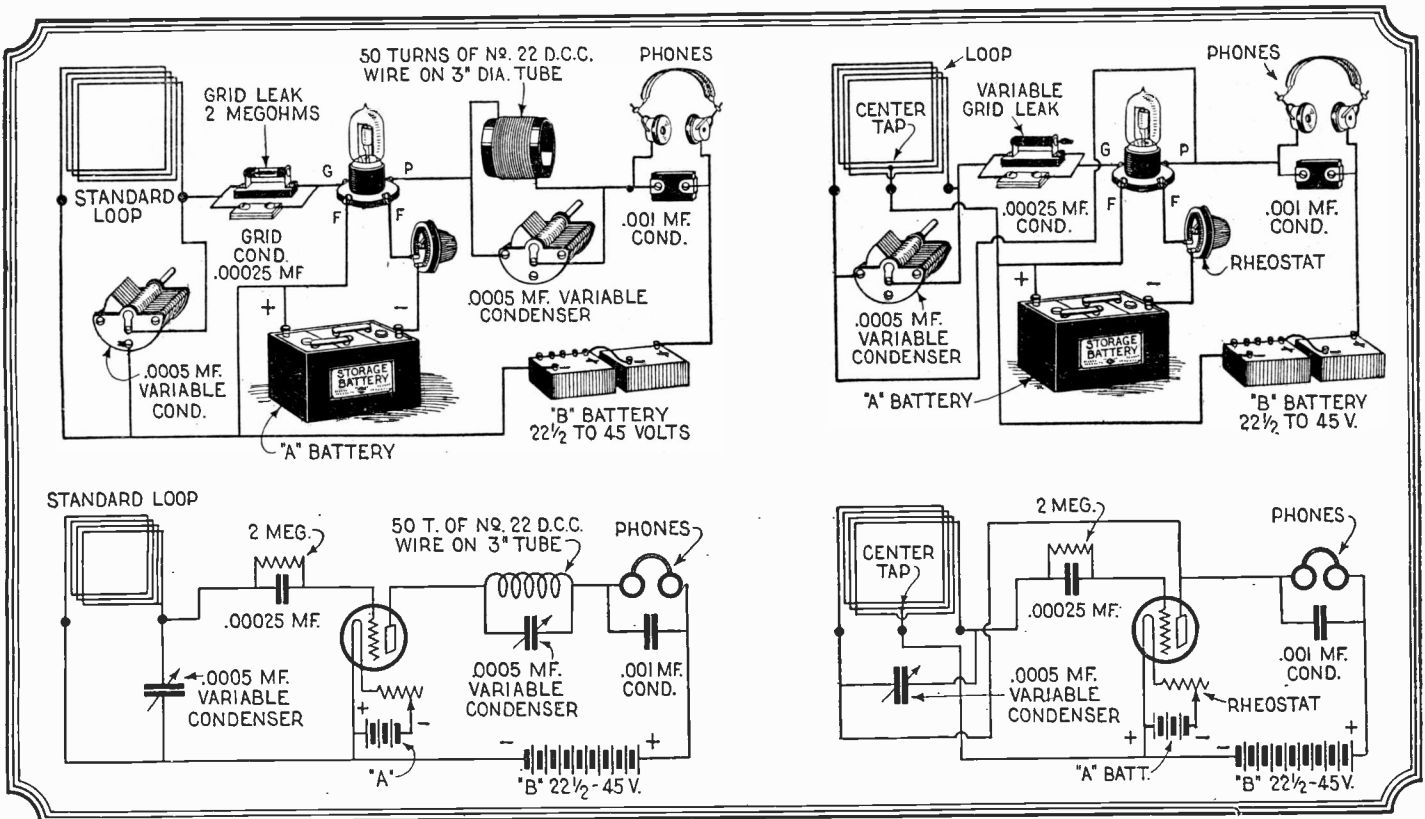

Some very interesting results can be obtained with a single tube and a loop aerial when regeneration is employed to build up the signal strength.

Two circuits for this work are given above. One uses a standard loop and the other a home-made type with a center tap.

## REGENERATIVE LOOPS

(373) Q. 1. E. V. Donald, New York City, asks whether it is practical to use regeneration in a single tube which operates with a loop aerial. The entire set is to be used for reception over short distances.

A. 1. This work can be easily done, although it must be realized that a set of this nature cannot bring in any DX. It will probably give satisfactory results up to a distance of 25 miles under good conditions. We are showing here two circuits for doing it. In one a standard loop is used. Regeneration is obtained by means of the tuned plate method. Either an inductance coil and a variable condenser or a variometer may be used in the plate circuit.

In the other, a loop with center tap is employed. The number of turns in this part of the circuit should be experimented with until the best results are obtained. A rheostat that can be critically adjusted should be used, as the regeneration may be controlled more easily from this point.

Still a third method which may interest experimenters is the use of two loops, one in the grid circuit, as usual, and the other in the plate circuit, the two loops being inductively coupled. Feed-back regeneration is thus obtained.

## RADIO AND WEATHER

(374) Q. 1. Heinrich Polsfut, Sawyer, N. Dak., asks us whether or not in our opinion radio broadcasting affects the weather in any way.

A. 1. Radio broadcasting has no effect whatsoever upon the weather. Investigation shows this to be a fact and there is no authentic record of radio waves of any description having any such action.

## MEGOHM

(375) Q. 1. Robert H. Phelps, Kansas City, Mo., asks us whether or not 7 megohms is the same as 70,000 ohms.

A. 1. Seventy thousand ohms is not equivalent to 7 megohms. Seven megohms means 7,000,000 ohms; 1 megohm = 1 million ohms.

## INTERFERENCE

(376) Q. 1. Donald Reuss, Easton, Pa., says that he is operating a radio set a very short distance away from a motion picture theatre in which the projectors are equipped with arc lights. He says that he has considerable trouble from this source as the arcs interfere with his reception. Changing the direction and length of his aerial has had little or no effect on the interference. He asks our advice.

A. 1. The only thing that we can suggest is that you install a more sensitive set and use a loop antenna. Two or three stages of radio frequency amplification with a loop will give you quite good reception and a directional effect that should enable you to practically eliminate the interference.

## FIXED RESISTANCES

(377) Q. 1. Emile Hennon, Brussels, Bel-

gium, says that in the country where he lives he cannot buy the fixed resistances which are often recommended in the construction of radio sets. These resistances that he mentions are the ones used to control the filament current of the tubes. He asks if rheostats can be used in place of these resistances and whether or not a rheostat is necessary in the filament circuit of each tube.

A. 1. It is entirely possible to replace these fixed resistances with rheostats and the only objection is that the control of the set is thus somewhat complicated. It is not necessary to incorporate one rheostat for each tube, although it is advisable inasmuch as it gives much greater flexibility to the set and allows for the slight differences which are sometimes noticeable in the filaments of tubes.

## PORTABLE RECEIVER

(378) Q. 1. Wh. Hampton, Millville, N. J., says that he has been looking for a diagram of a two-tube set that will fit in a small storage battery box. He asks us to furnish him with such a circuit.

A. 1. The size of the cabinet in which a radio set will fit does not depend at all upon the circuit, but depends upon the parts employed and the mechanical arrangement of them. Practically any two-tube set could be built so as to fit in the box you mention. The mechanical arrangement will depend upon yourself. No special hookup is necessary for such a purpose.

## WANTED!!! RADIO ARTICLES

WE want descriptions of new radio ideas which you have worked out in practice. Take photographs of the important parts and make pencil or pen and ink sketches of the hook-ups or mechanical details, et cetera. We are particularly

desirous of obtaining new hook-ups and descriptions of single tube sets, reflex and other types which have proven satisfactory. We like articles on new single tube receptors. We will pay good prices for your ideas. —Editor.



**FRYING NOISE**

(379) Q. 1. Jesse L. Fitzwater, Wabasha, Minn., says that he has considerable trouble with his five-tube set in that a continual frying noise is noticeable during reception. He asks our opinion as to the source of this noise.

A. 1. There are several sources where trouble of this nature could start. The most obvious one is a poor fixed condenser somewhere in the set. This might be the grid condenser or it might be one of the by-pass condensers. Try removing these condensers from the circuit, replacing them with others, and see if any noticeable difference is obtained. If not, try shunting the secondary of the first audio frequency transformer with a variable grid leak and then use a resistance which is variable from 10,000 to 100,000 ohms. One or the other of these resistances may clear up your trouble. Furthermore, make sure that the trouble does not originate in the loud speaker itself. This may be done by substituting another speaker for the one already in use or by trying your present speaker on another receiving set. Try different grid leaks.

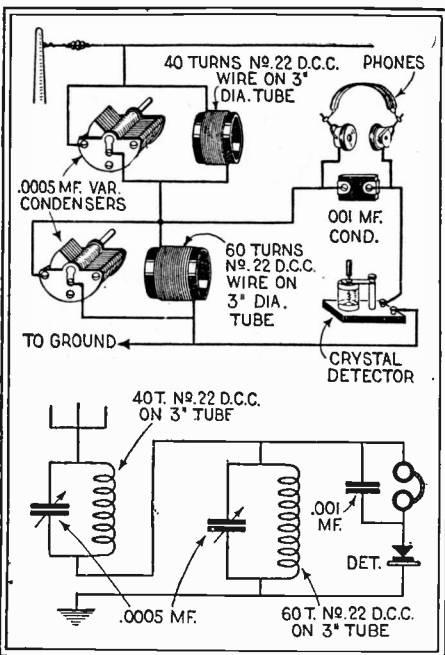

The above circuit diagram is given for the benefit of the thousands of crystal detector owners who are always looking for a more selective circuit.

**SELECTIVE CRYSTAL SET**

(380) Q. 1. C. Herman, Chicago, Ill., asks for a circuit diagram of a crystal receiving set employing two inductances and two variable condensers which will be quite selective.

A. 1. Probably the best system for you to use is a series wave-trap and a tuning circuit, such as we have shown in the diagram given herewith.

**PHONE TRANSMISSION**

(381) Q. 1. R. B. Prichard, St. Petersburg, Fla., asks us to give him the circuit diagram of a phone transmitter to be operated on a wave-length of 80 meters.

A. 1. We must inform you that only C.W. (continuous wave) transmission is allowed on the short wave bands. Phone transmission is not allowable. Do you desire a circuit of a C.W. transmitter for short waves?

**INSTRUMENT CHANGE**

(382) Q. 1. Oliver Malmanger, Huxley, Iowa, says that he is planning on building a Neutrodyne receiver and asks whether or not a variocoupler can be used in place of the first neutroformer.

A. 1. This change is entirely possible and

the only objection to it is that another control will be added to the receiver. If you make this change, the primary of the variocoupler should consist of about 10 or 12 turns of comparatively heavy wire, say No. 18 D.C.C.

**COUNTERPOISE**

(383) Q. 1. Albert Molyet, Old Fort, Ohio, asks for some information on a counterpoise, how it should be erected and whether or not it would be of any assistance in reception.

A. 1. A counterpoise is merely what might be called a second aerial. It should be about the same length as the regular aerial and may run either parallel with it or at an angle to it. The counterpoise should be about 8 feet above the ground. The use of such an extra aerial is quite common in transmission, but is seldom used for reception. However, some experimenters report good results along this line, and if you are interested we would advise you to try a counterpoise which is to be connected in place of the regular ground. Try your set both with the counterpoise and aerial alone and then with the aerial connected in the regular manner and both a counterpoise and ground connected to the ground binding post.

**TYPE OF SET**

(384) Q. 1. J. Metcalfe, Spring Hill, Tenn., says that he is trying to build a radio receiving set using a variometer and a 23-plate condenser for the tuning unit. He says that he has not been able to find a hook-up that is satisfactory to him and asks us to help him out.

A. 1. We would advise that you discard your variometer and purchase a three-circuit coupler using this instrument and a variable condenser for your tuning unit. A good constructional article using this type of tuner appeared in the July, 1925, issue of this magazine.

**FIXED COUPLER**

(385) Q. 1. C. J. Lovell, Fredericktown, Ohio, asks us whether the primary and secondary windings in a standard fixed three-circuit coupler are to be connected together, and if so, how?

A. 1. Fixed couplers of the type you mention are usually supplied with these two windings unconnected. However, in some types of sets, the ground binding post of the primary is connected to the filament binding post of the secondary.

**STATIC**

(386) Q. 1. Ernest F. Prucha, Howells, Nebr., asks us to give him information regarding static, particularly those wave-lengths upon which static is most noticeable, how static can be measured and where complete information on the subject can be obtained.

A. 1. Static manifests itself on all wave-lengths, but at any one particular time it may be stronger on certain bands than on others. There are no fixed rules for this, and on evenings when the broadcast band is comparatively free from static, that manifestation may be so severe on 40 and 80 meters that C.W. (continuous wave) communication becomes impossible. Static exists in all bands which have as yet been investigated. The nature of the discharge is a highly damped radio frequency oscillation.

Atmospherics and static can be measured by means of an electrostatic galvanometer. The subject of static receives scant attention by authorities on radio and only mere mention of it is made in the usual text-book. It is a separate study entirely, and we have no record on hand of any book dealing solely with atmospheric electricity as affecting radio.

**GRID RETURN**

(387) Q. 1. Ted R. Parrish, Belmont, Nebr., wants to know what is meant by the term "grid return."

A. 1. By the grid return is meant the connection which begins at the grid, goes through the secondary circuit and terminates at the positive terminal for the detector tube and negative terminal for the amplifier tube.

**RADIO FREQUENCY TRANSFORMERS**

(388) Q. 1. R. Benson, Union City, N. J., wants to do some experimental work with radio frequency transformers, particularly toward the determination of the most efficient number of turns for a given band of wave-lengths. He asks what type of form to use for this work.

A. 1. While an ordinary insulating tube may be used for this purpose, a more compact form, and one which is easier to wind, may be made as shown in our illustrations herewith. This may be turned on a lathe from 2-inch stock or may consist of seven

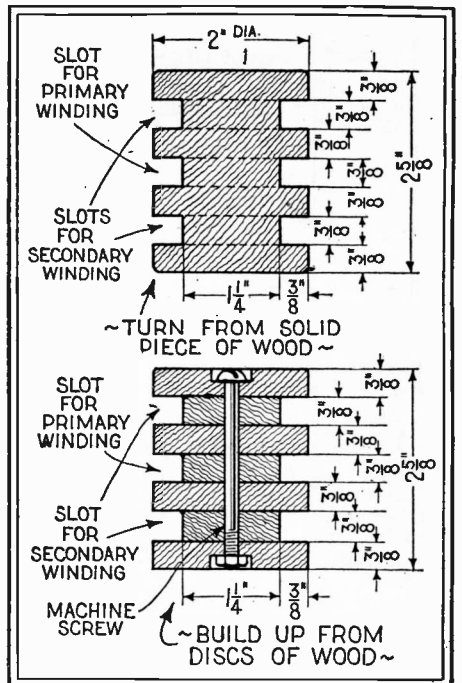

The experimenter will find much of interest in constructing various sizes of radio frequency transformers. A form such as the one illustrated will aid materially in this work.

discs of 3/8-inch thick wood bolted together as shown. In the latter case, four of the discs will be 2 inches in diameter and three of them will be 1 1/4 inches in diameter.

For experimental use, wind the primary in the center slot and the secondary in two halves, each half in a slot on opposite sides of the primary. With a form of this kind you can experiment with the number of turns to your heart's content.

**INCREASING WAVE-LENGTH**

(389) Q. 1. William G. Parkes, Nashville, Tenn., says that his broadcast receiver will only receive from stations over a band of 200 to 360 meters and asks how he can change the set so as to tune in broadcasting stations up to 550 meters.

A. 1. Would advise that in order to increase the wave-length reception range of your set, you should wind an additional 30 turns on the primary, increasing your aerial if possible also. Replace the grid variometer by means of a 43-plate condenser which is shunted across the secondary. This will increase your wave-length range sufficiently for your purpose. Would advise a 43-plate vernier condenser.





# LATEST PATENTS

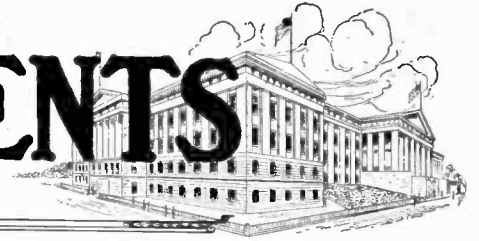

## Land, Mud and Water Motor Car

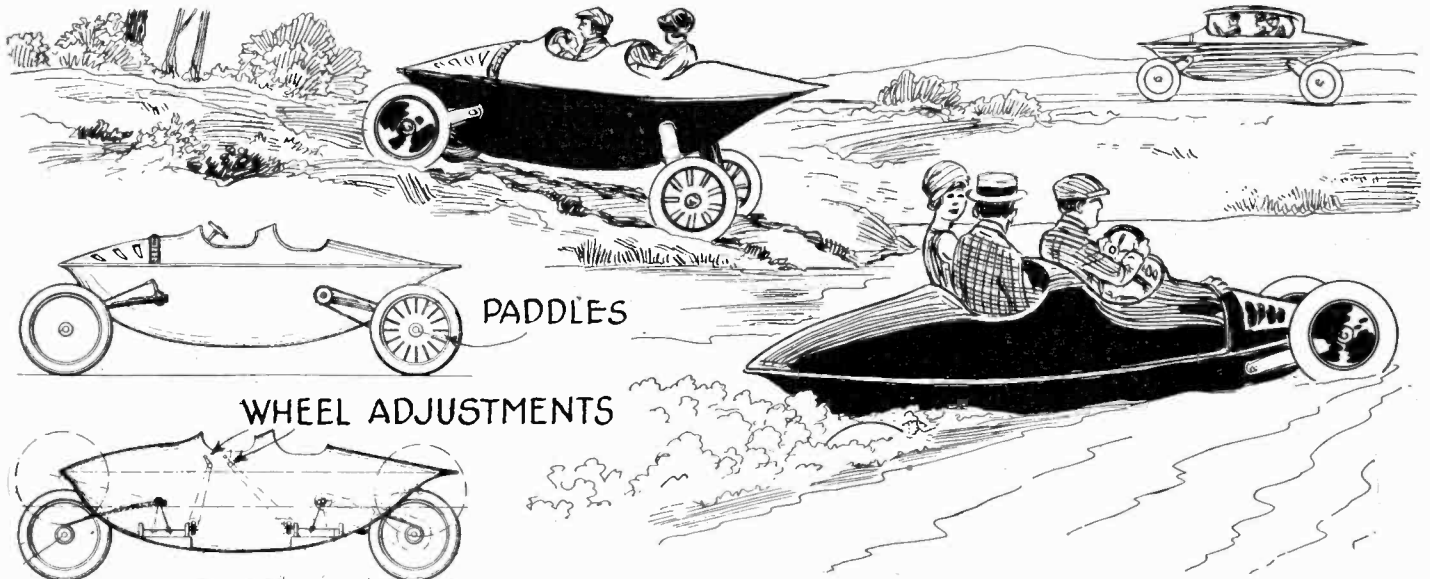

No. 1,537,319, issued to W. Luge, covers a radically new design in the body and placement of the wheels in a motor car. The entire vehicle is so designed that when it becomes necessary, it can be made to travel on land, in water or over rough and muddy terrain that otherwise could not be negotiated by an ordinary motor-driven vehicle except of the caterpillar type. The essentials of this vehicle can be seen from our illustrations above. The rear wheels are fitted with a series of paddles,

one clamped to each spoke. These serve to propel the vehicle forward when it is in the water. The wheels can be regulated as to position by means of the adjustment shown. In this way, the vehicle can be driven over surfaces of an extremely rough nature and in the capacity of a boat the front wheels can be drawn out of the water, thus lessening resistance when the device is so used. This is shown in the lower right-hand corner above.

### Railroad Crossing

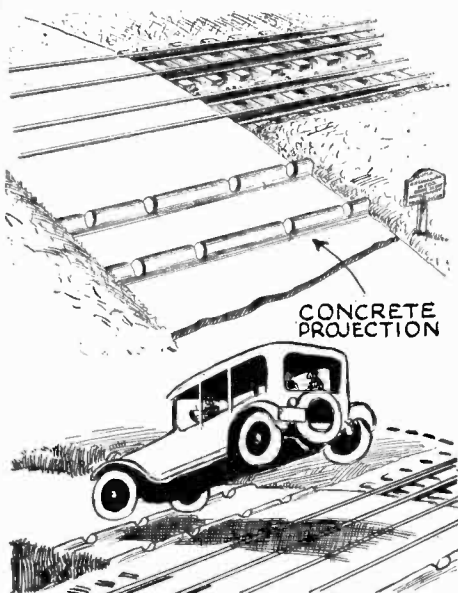

No. 1,532,633, issued to W. Noble, protects the idea illustrated above. A series of concrete projections are to be built across the road and equipped with notches through which the wheels of an automobile can easily travel. The purpose is to cause vehicles to slow down when approaching crossings so that the driver can be sure to steer into the grooves. We hesitate to contemplate the catastrophes that would result from the use of this arrangement.

### Airplane

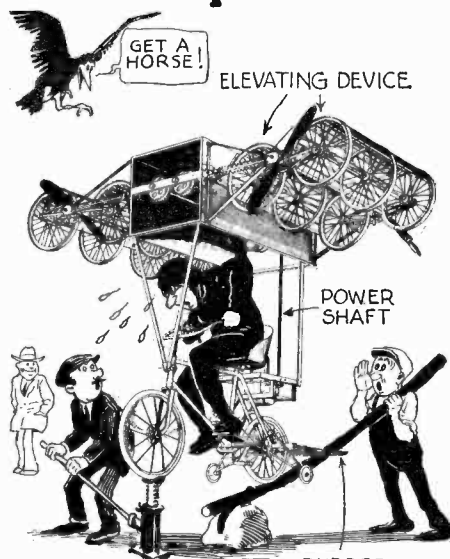

No. 1,504,534, issued to I. I. Ziperstein, describes an aeronautical device designed to operate by means of the leg power furnished by the pilot. Connected to the pedals are a series of semi-cylindrical elevating devices, plainly shown above. These are supposed to raise the machine off the ground, whereupon the standard propellers shown will cause it to travel in a forward direction. The power is transmitted to the various parts through a series of gears and drive chains. We fear that Mr. Ziperstein will never leave the ground with this device unless he resorts to the methods suggested in the drawing.

### Novel Toy

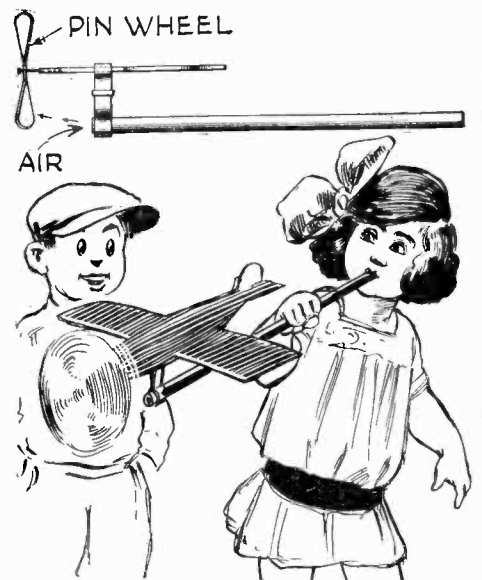

No. 1,529,568, issued to Hohannis A. Ananian, covers a new type of pin-wheel toy that surely will amuse all the youngsters. A tube of any size desired is employed and a cardboard device shaped like an airplane is mounted upon it by means of a clamp. One end of the propeller of the simulation airplane is directly in front of one end of the tube. Blowing through the tube causes the propeller to revolve, giving a very realistic effect.



# Non-Sc(i)ence

## "ELECTRO MOTOR" FORCE



Describing how K. D. K. A.'s signals were picked up in Australia, the April 17th issue of the *St. Louis Star* says: "The signals were picked up on 63 motors (meters?)." We wonder if the signals were strong enough to run the motors. Perhaps the motors were strung up on the antenna to reduce the antenna resistance, or maybe the motors were used in place of ear phones. We would like to be further enlightened.—*W. C. Woolley.*

## A FISHY SCHOOL

In the New York *Sunday World* of April 26th we note that "Dr. Rogers is the discoverer of the principals of submarine wireless communication." We have heard of school principals, but never of submarine wireless principals. They must be a brand new species—probably radio hounds propounding new dog(mas). We wonder if they teach the ether wave theory as being somewhat flattened at the poles.—*H. G.*



## WHEELLESS AND SENSELESS



In the Lost and Found Column of the *Buhl Herald* in the June 4th issue I found the following: "Lost—Between Buhl and 5 miles south of Castleford, a Ford differential."

As it is quite likely that the rear wheels and axles went with the differential and a range of 15 miles is allowed for the loss, the versatile Ford must have rambled right along with the rear seat waving out behind. Mr. Ford deserves a congressional medal. We do not know why the owner advertises for a return of the differential, as if he can manage to get along on two wheels, he would have less tire trouble, less greasing and less washing to do. We would like to know how he managed it.—*Bert W. Eustis.*

## WHOLEY HOLEY

The *Sterling Kansas Bulletin* in their issue of May 21st, say, "The thief or thieves drilled a hole into the steel gasoline tank, and after drawing an unknown quantity of liquid a wooden hole was driven into the hole."



We were always under the impression that a hole was just a hole but differed only by reason of the surrounding material. This must be a new kind of a hole driven into the hole in the steel gasoline tank to make it whole again. It reminds one of the story of the inebriate who said that he fell from the cellar to the garret and poked a knot hole into his eye.—*Harold S. Wilson, Reporter No. 15286.*

## Money for Science Mistakes

The newspapers throughout the country, as well as the magazines, occasionally err. Sometimes these errors are misprints. At other times they are pure scientific misstatements. If you happen to see any of these humorous mistakes in the press, we will be glad to have you clip them out and send them to us. Give the name of the newspaper or magazine in which the error appeared and accompany the inclosure with a few humorous lines. The most humorous ones will be printed in this department, and for each one accepted and printed we will pay \$1.00. No NON-SC(i)ENCE entry will be accepted, unless the printed original accompanies the same. Address all NON-SC(i)ENCE entries to:

Editor, NON-SC(i)ENCE Dept.,  
c/o Science & Invention Magazine,  
53 Park Place, New York City.

## NOT PEDIGREED



The following item appeared in the *Pasadena Post* of May 20th: "For sale—One Jersey bull calf 2 weeks old. Will soon have some real pups, half hound and half shepherd."

Now I consider this quite a feat for a bull calf. It would have been quite an accomplishment for a cow. Maybe the pups will have kittens, and the kittens, elephants, who can tell.—*R. S. French.*

## AVOIRDUPOIS PLUS

The day following the staging of an annual track meet, the following write-up appeared in the *San Francisco Examiner*:

100-Pound Class  
440-yard relay  
—Poly won; St. Ignatius, second.....  
770-Pound Class

So no doubt all the fat men are not in the circus.—*Marcel Mailhebau.*



## FULL OF GAS



The *Birmingham Mail* of Feb. 10th advertises as follows: "Electrician; must be competent man and capable of putting in wire installation for gas and power. State wages and experience." Evidently the electrician must use some of this new spaghetti wire we have heard so much about. If not, how could the gas travel through the wire? He would have a heck of a time shooting the gas through stranded copper wires.—*Sadie Lieb-ling.*

## PRETTY SOFT—IT STRETCHES

On page 167 of the June issue of SCIENCE & INVENTION MAGAZINE we notice: "The size of the panel is seven inches wide by twenty-six inches long. There is nothing hard about it."



Wonder if this is one of the new-fangled self-supporting panels or whether it is made of soft rubber, so that the operator can pull the panel toward him without disturbing the set. On the other hand, perhaps it is kneaded into shape. Whatever it is, we would like to see it.—*Steve Goff.*

## FACE ABOUT



The *Evening News* of London, England, in an article on "One In a Hundred Parachute Death." in their May 27th issue, describing a leap to earth, advise: "The man falls with his face on his back towards the earth, according to how he wears the 'knapsack.'"

Evidently putting his face on his back was necessary, as the aviator needed something to back him up for the parachute descent. How can he face his friends now? Every time he does so, he will have to turn his back to them. What a "facer!"—*C. A. Lynwood.*

## BURNING REPORTS

The following item is extracted from the *Los Angeles Evening Herald* of March 31st, in their daily bulletin describing the movements of vessels, they have as a headline, "Fireless Report." We never knew that reports were liable to fire. If they use a quenched spark gap there is not much danger that the reports would ignite. Furthermore, any damp wave that they send out ought to quench the conflagration quite quickly. Why not report on asbestos. It is fire-proof.—*August H. Niemann.*



## HE A-DOOR-ED IT



The *Boston Sunday Post Magazine* of May 24th, 1925, contains the following: "Mr. Groten shook his head, and, as soon as the door closed, took it between his hands and seated himself on the edge of the bed."

Certainly this man Groten has a most disconcerting habit. Imagine a man eccentric enough to take the chamber door in his hands and sit upon the bed. The story does not relate that Groten spread the door-jam (b) on his bread.—*E. L. Richardson.*



# THE ORACLE



The "Oracle" is for the sole benefit of all scientific students. Questions will be answered here for the benefit of all but only matter of sufficient interest will be published. Rules under which questions will be answered:

1. Only three questions can be submitted to be answered.
2. Only one side of sheet to be written on; matter must be typewritten or else written in ink, no penciled matter considered.

3. Sketches, diagrams, etc., must be on separate sheets. Questions addressed to this department cannot be answered by mail free of charge.
4. If a quick answer is desired by mail, a nominal charge of 50 cents is made for each question. If the questions entail considerable research work or intricate calculations, a special rate will be charged. Correspondents will be informed as to the fee before such questions are answered.

## FIRE-PROOF INSULATOR

(1887) Q. 1. T. B. Marsden, Hyde Cheshire, England, asks how wood can be made both fire-proof and an insulator for electricity up to 400 volts D. C.

A. 1. Dry wood is normally a fairly good insulator and if it is coated with several coats of water glass, allowing each coat to harden, it will become quite fire-proof and at the same time its insulating properties are increased because the coat has made the wood water-proof and, therefore, it cannot absorb moisture and become a partial conductor.

## MAGNETIC METALS

(1888) Q. 1. Jesse Taylor, Blandinsville, Ill., asks what magnetic metal is cheap and soft enough so as to be easily shaped to required sizes.

A. 1. Iron is a very cheap magnetic metal but in its soft form does not hold permanent magnetism of any amount for any considerable length of time. The best way to obtain the results you desire would be to form the shape you need from soft steel, harden the same and then magnetize it. If you desire to ask any more specific questions on the above work, we will be only too glad to answer you.

## BURNING CARBON

(1889) Q. 1. Fred Bacher, Pasadena, Calif., asks how the carbon is burned from an automobile cylinder and piston without the necessity of removing the head of the engine.

A. 1. This is done by removing the spark plugs or valve plugs from the cylinders after having drained the carburetor so as to reduce danger from fire. An oxygen tank is provided as shown in the illustration and attached to it is a suitable handle equipped with a valve and semi-flexible nozzle. A match or piece of cloth or waste saturated with alcohol and lighted is thrown into the cylinder through the opening provided by removing either the spark plug or valve plug, the oxygen is turned on after the nozzle has been introduced through the hole. Immediately the carbon and oxygen unite and burn. By working the semi-flexible nozzle around, all the surfaces of the piston head and cylinder will be freed from carbon. Of course, it must be

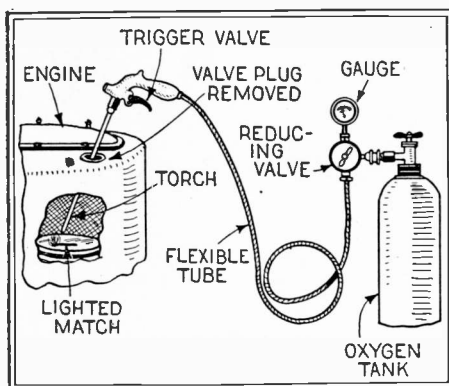

The method used by some garage repairmen for burning carbon from the inside of cylinders of automobile engines is illustrated in detail above. The metal tube from the valve to the nozzle is sometimes flexible for convenience' sake.

understood that the piston is to be at the top of its stroke when this work is being done and that both valves must be closed as otherwise the valve stems are liable to become burned and give trouble at a future date.

Q. 2. What objections are there to this system?  
A. 2. One objection is the danger of fire. Another one is that while the cleaning is complete, still the engine does not always run as one might expect it to after the carbon has been removed. This is because of the fact that after using this process, the valves are seldom ground and the engine, therefore, is not in as good shape as if the head were removed, the carbon scraped off and the valves ground at the same time.

## GRAVITATIONAL PUZZLE

(1890) Q. 1. Raymond Mack, Fairhaven, Mass., sends us a small illustration which we reproduce herewith and asks if the picture is correct and if the men in the figure pulled the wire, would the wire remain equally distant from the surface of the earth?

A. 1. We have referred your query to Ernest K. Chapin, well known author of Scientific Problems and Puzzles appearing in this magazine, and the following is his answer:

"In my judgment, the wire would not remain at a constant distance from the earth. Gravity would certainly tend to pull it toward the earth and whatever tension the men could apply to it



A rather puzzling problem which nevertheless is interesting in its discussion is illustrated above.

would have the same effect too. Of course, if the wire be thought of as a solid ring and perfectly rigid the ring could not touch the earth as long as the ends were held in position, but I would not consider that possibility admissible unless it were so stated in the puzzle.

"One other point. How far is the wire from the earth? If the picture is drawn to scale, the men would have to be giants and the wire would be at a considerable distance from the earth. In such a case centrifugal force acting on the wire would tend to make it move outward in the equatorial region and it might be sufficient to more than balance the effect of gravity and thus cause the wire to take on some such shape as indicated in the diagram. The wire would have to be over fifty thousand miles from the earth's surface, however, before its centrifugal force would counter-balance the pull of gravity. So unless some extraordinary interpretation be put on the puzzle, I would say that the wire would not remain as indicated in the picture, but would fall to the earth just as every other object would."

## AIRPLANE NOISE

(1891) Q. 1. George J. Murray, Wyandotte, Mich., has taken part in a discussion which involves an airplane traveling at high speed without any muffler on the motor. "A" says that the noise coming from the plane is caused by the propeller. "B" says that it is caused by the motor exhaust. He asks us which is correct, considering the principal noise only, it being understood that both the propeller and the motor make some noise.

A. 1. In regard to your query on the noise emanating from an airplane traveling at high speed, we would say that the same is caused practically entirely by the exhaust of the motor. The propeller makes a sort of a humming noise which sometimes, when close to the plane, is noticeable, but in most cases the drone of the motor overpowers the propeller noise.

## PELLIER CROSS

(1892) Q. 1. Christian Topel, Fremont, Ohio, refers to an article published in a past issue of this magazine wherein it was stated that when two certain metals, namely bismuth and antimony, are soldered together, the junction of these two

metals would become cold upon the passage of a current of electricity in a certain direction. He asks for further details.

A. 1. There are very few details to be given on the experiment you mention, all of them being contained in the article. The junction of the two metals will become cold when the current is passed in a certain direction and hot when the current is reversed. However, except when the experiment is performed in a room at a very low temperature, the water will not become cold enough to freeze, but the chill will be noticeable. In this experiment, the junction is cold when the current passes from the bismuth to the antimony, whereas the junction becomes heated upon the reversal of the current.

## REMOVING LETTERING

(1893) Q. 1. West Todd, Toronto, Canada, asks us to inform him as to how gold lettering may be removed from the leather cover of a notebook without resorting to chemicals.

A. 1. The only method we know of for accomplishing the work you mention is by scraping, and even then, in the majority of cases, the imprint of the letter will still be left on the leather.

## HOW BALL CURVES

(1894) Q. 1. Frank Hunter, Portland, Ore., asks: Can you explain to me the principle upon which a ball, when thrown as in playing baseball, can be made to curve?

A. 1. We explain below and illustrate herewith the principle: Let us refer to the illustration. Suppose that the ball is spinning upon an axis perpendicular to the paper upon which it is illustrated. It is spinning in the direction of the curved arrow and has been propelled forward in the direction of the straight arrow. Now, as this ball rotates, it drags the air with it from A to C, whereupon a greater forward movement is given to the air between A and C than is imparted to it between the points C and B, where the surface of the ball is spinning backward. From this we can see that the force of the air against the ball between A and C is greater than between B and C and the result is that the ball is forced from its straight path CD toward the curve CE. The lines P represent the forces (air) against which the ball acts.

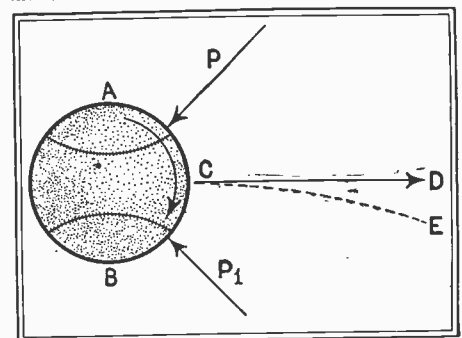

The forces which tend to cause a thrown baseball to pursue a curved path are illustrated above. The complete description of the relationship between the rotation of the ball and the curvature of its path will be found in the text.

## SOLDERING ALUMINUM

(1895) Q. 1. Albert D. Myers, White Haven, Pa., asks what metal and flux should be used for soldering aluminum.

A. 1. Several methods of soldering aluminum have been outlined in the Oracle Department in past issues of this magazine. One of the simplest ones does not make use of any flux. The process is as follows:

Thoroughly clean the parts to be soldered. Then cover with melted solder and while the latter is in a liquid state, scrape the surface of the aluminum directly under the solder with a sharp point. The effect is to break up the oxide coating which rapidly accumulates on a freshly exposed surface of aluminum. When this coating is removed, solder will be found to adhere to the metal very well.

**CURLING CELLULOID**

(1896) Q. 1. H. R. Gottfried, Erie, Pa., sends us a sample of a piece of celluloid curled in a spiral form. He asks how this can be duplicated with ordinary strip celluloid.

A. 1. We are not sure as to the exact process used for causing celluloid to curl as per the sample which you submitted to us. However, the desired results can be obtained by following the process outlined below.

Warm the celluloid gently, preferably over a water bath and quite a distance away from the open flame. When the material is thoroughly warmed, scrape it across the edge of the table or any other fairly sharp corner, pulling it quite taut and at an angle at the same time. Repeat this several times if the desired results are not obtained at first, keeping the celluloid thoroughly warm during the entire process. By careful manipulation, you can undoubtedly obtain the desired results.

**PROTECTIVE DEVICE**

(1897) Q. 1. D. C. MacDonald, Chicago, Ill., asks us if it would not be possible for the average person to protect himself against thugs and highwaymen by using a finger ring equipped with an extensible needle point dipped in some solution which would cause swift unconsciousness lasting at least until the criminal could be surrendered to the authorities and yet have no harmful after effects.

A. 1. While you could no doubt obtain the results you desire with a finger ring and a needle point, still how many people would want to go around with such a deadly device on one of their fingers? We do not believe that the use of such a device would be looked upon with favor by the authorities, as if such devices were to come into use among the criminal classes, the results would be much worse than the promiscuous sale of guns and revolvers. We regret to say further that we cannot give you the information for the preparation of a substance to be used in such a ring.

**CORRECTIONS**

(1898) Q. 1. R. G. Lewis, Oklahoma City, Okla., refers to an article entitled "Everyday Chemistry" in the December, 1924, issue of this magazine and asks if in regard to item No. 5 therein the material stated to be sodium chloride should not be sodium fluoride.

A. 1. We have referred this letter to the author of the article and he advises us that the caption should read as our correspondent suggests.

Q. 2. In No. 9 of the same article it is said that when salt is used with copper plates for an electrical ground that copper sulphate is formed. As the common salt generally used is sodium chloride, should not the compound formed in the presence of copper be a chloride of copper?

A. 2. Our correspondent has somewhat misinterpreted the statement. Mr. Wailes' answer to this query is as follows:

"I consider that copper sulphate is better than sodium chloride for ground-impregnations. One basis for this belief is that if the ground pipe be iron, the copper of the copper sulphate will plate copper out upon the iron pipe, thus enhancing its life duration. This is readily perceived when a nail, penknife blade or anything of iron or steel is immersed in a copper sulphate solution. Mr. Lewis is right when he says that, when sodium chloride is used, no copper sulphate will be produced as the caption of the article states. Disregarding this miscalled by-product, the truth of the little picture is absolutely correct in its aim that copper sulphate is better than sodium chloride for dry grounds."

**PHONOGRAPH REPRODUCERS**

(1999) Q. 1. Mr. Edward Roman, Fairview, N. J., wishes to know how phonograph reproducers operate.

A. 1. In the laterally cut records, the needle of the reproducer moves from side to side, thereby causing the diaphragm to vibrate through a



HILL AND DALE TYPE

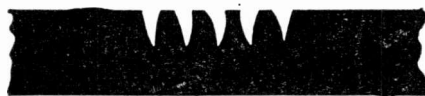

LATERAL CUT TYPE

The difference between the two main types of phonograph record grooves is shown above.

lever arm and producing sound. By variations in the side motion of the needle different sounds will be produced and by a combination of these sounds speech and music is produced. In the so-called "hill-and-dale" records, the needle moves up and down acting on the diaphragm and producing sound as in the other system.

**LOUDIN COIL**

(1900) Q. 1. Erwin Graham, Carroll, Iowa, requests constructional details on an Loudin coil to be used with a 1/4 K. W. step-up transformer.

A. 1. In regard to the construction of an Loudin coil for experimental use, we would advise you to follow the specifications given herewith.

The secondary is wound on a 5-inch tube, 2 1/2 feet long with No. 34 enameled wire, spacing the turns 1/32nd of an inch apart. This can be best done by winding in parallel with the wires a thin cord which cord can be removed when the winding is finished. The latter should be thoroughly shellacked.

The primary is to be spirally wound on a form 10 inches in diameter and should consist of 5 turns of either flat copper ribbon or No. 4 or 6 bare copper wire.

**INVISIBILITY**

(1901) Q. 1. Wm. H. Ketter, Camden, N. J., asks whether or not we ever published an article telling how by means of certain colored costumes on the stage and spotlights in the balcony of a theatre, characters on the stage could be made to seemingly disappear and reappear.

A. 1. In the December, 1921, issue of this magazine there was an article dealing with the changing of the color of costumes on the stage by means of various colored spotlights. This method, however, did not cause the actor to seemingly disappear, and in fact we have never published an article that dealt with just this form. The only way in which this can be done is to have the actors clothed completely in black, the black cloth covering every portion of them. If they are then placed against a black background and the strong lights directed from the front of the stage toward the audience, the actors will be invisible.

**SPIRIT LEVEL**

(1902) Q. 1. Joseph Rolnick, Jersey City, N. J., asks how a spirit level is made, and whether or not the glass containing the liquid is curved.

A. 1. Usually a spirit level is made of a glass tube nearly filled with alcohol or ether, a small space being left in the tube so that a bubble is formed after the tube is hermetically sealed.

**BUBBLE**

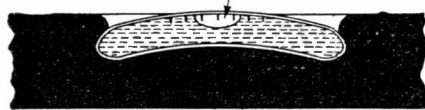

The principle of construction of a spirit level may be seen from the above drawing.

Our illustration shows how the usual spirit level tube is slightly curved, following the arc of a large circle. In the highest grade of levels the inside of the curved tube is carefully ground so as to be absolutely accurate. The best of levels are very sensitive and in this type the curvature of the tube is slight but accurate.

**CLEANING STORAGE BATTERY PLATES**

(1903) Q. 1. Paul Lefever, Strang, Nebraska, refers to instructions published some time ago in this magazine for the making of storage battery plates and asks why directions were given to immerse the lead plates to be used in the storage battery in nitric acid.

A. 1. The lead plates used in the storage battery you mention are soaked in nitric acid so that they will be thoroughly clean and so that the minute crevices in the metal will contain no residual dirt or grease.

**SMOKE SCREEN**

(1904) Q. 1. Alfred Lupinacci, New York City, requests a formula for a material which when ignited will give forth a large volume of smoke.

A. 1. The following formula is that originated by the United States Bureau of Mines for use in the air service when a smoke screen is to be laid:

- Zinc, 35.4 parts.
- Carbon tetrachloride, 41.6 parts.
- Sodium chlorate, 9.3 parts.
- Ammonium chloride, 5.4 parts.
- Magnesium carbonate, 8.3 parts.

If the mixture is ignited it makes a cloud which results in practically absolute concealment.

This formula is somewhat similar to that used for sky-writing, but is not exactly the same. The exact formula for this work is not available at the present time.

**INK ERADICATOR**

(1905) Q. 1. Paul Merchem, Bellingham, Wash., asks for a formula and method of operating an ink eradicator.

A. 1. We are giving you herewith the formula for a good ink eradicator. Mix together equal parts of citric acid and alum, adding an equal volume of water. Apply the liquid to the part to be erased and after the ink is dissolved, absorb with a blotter. This mixture works very well on practically all inks. Then wash or sponge off thoroughly to remove all traces of the chemicals.

**WATER PUMPS**

(1906) Q. 1. Alfred Phillips, Utica, N. Y., asks how water is circulated through the radiator of automobiles.

A. 1. Some cars use what is known as the thermo-siphon system which operates on the principle of water rising upon being heated. Other

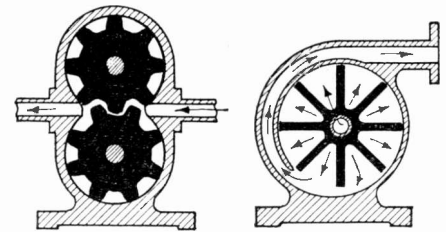

-A- -B-  
Two common types of automobile water circulation pumps are shown at A and B and described in the text.

cars use pumps. Two different types are illustrated herewith. One is known as the gear type and in it the water is carried from the inlet to the outlet by means of the gear teeth. The other usual type is known as the centrifugal pump and is also illustrated. In this the water enters at the hub and is thrown upward and outward by the revolving blades. It then, of course, passes through the outlet. Either of these types are used to force the water from the radiator of the car through the water jacket on the motor and back again to the radiator where it is cooled and then is recirculated.

**OSCILLATING MIRROR**

(1907) Q. 1. J. C. Kaytor, Cleveland, Ohio, asks how a mirror 1/16th inch in diameter can be made to oscillate at a frequency of approximately 3,000 vibrations per second.

A. 1. The answer to your query depends to a very large extent upon the method you desire to employ. If you wish a mechanical method of causing the mirror to oscillate, a tuning fork of the correct frequency could undoubtedly be used.

If electricity is to be used, a method similar to that used in the ordinary oscillograph could be used. This depends upon a small coil of wire suspended between the ends of a permanent magnet. When a current of electricity of a certain frequency passes through the coil, the coil will oscillate in accordance with the frequency. A small mirror attached to the supporting wire or to the coil itself would also oscillate.

We regret to say that we are unable to supply constructional details for any of the above devices, but from the suggestions given you could undoubtedly work out the necessary features yourself.

**TIMING DEVICE**

(1908) Q. 1. E. H. Donham, Canton, Ohio, asks how he can arrange an alarm clock so as to open and close a circuit at a certain hour.

A. 1. Providing you wish to both open and close a circuit by means of an alarm clock, we would advise the placing of an insulated contact on the face of the clock situated at such a point that the hour hand or minute hand will strike the same in its revolution.

The hand used for the contact will depend upon the length of time you wish to have the circuit remain closed. If the contact touches the minute hand, the circuit will be closed for only a short period. If, however, the contact touches the hour hand, the circuit will be closed for many minutes. Varying the width of the contact arm and stud will also serve to vary the length of time that the circuit is made. One connection is made to the contact and the other to the frame of the clock. The mechanism is then placed in series with the instrument to be controlled.

**CONDENSER TEST**

(1909) Q. 1. A. B. Lotze, San Bernardino, Calif., asks how a condenser can be tested by means of both A.C. and D.C.

A. 1. Alternating current will pass through a condenser, and if by test you mean a test for a short circuit in the condenser, the same should be conducted with D.C. and not with A.C. Merely connecting the condenser in series with the D.C. source and some piece of apparatus such as an electric lamp will indicate whether it is shorted. If the lamp lights, the condenser is broken down. Otherwise the condenser is O. K.

Q. 2. How are battery carbons made and can carbons of higher resistance than those usually found in dry batteries be constructed?

A. 2. Battery carbons are usually made by molding the material into the required forms and sizes sometimes by forcing the plastic mixture through a die-plate and then baking. If you want to make these carbons of a higher resistance, you may do so by cutting down the cross-sectional area; in other words, making the rods smaller in diameter. There are many details in the processes used.



# Prizes of More Than \$28,000.00 Offered by Science and Invention Magazine

## \$5,000.00 in Prizes For Perpetual Motion

MANY of our readers have written to ask whether we had received any entries in the Perpetual Motion prize contest. The answer is "Yes," we have received a great many entries, but not one of the contestants have lived up to the rules and regulations for the Perpetual Motion Contest. They have instead submitted drawings and photographs.

We want all of our readers to know that not one single working model of a perpetual motion machine has been entered in this contest. We are not adverse to receiving drawings or photographs, but neither may be entered in this contest. The rules call for a working model, and this we must have before an award is made. We have no working model on hand, nor have we seen any device work for more than two minutes.

We advise all of our readers not to invest in perpetual motion stock. If an inventor has a machine which operates, he may submit it to us and we will pay that inventor the sum of \$5,000.00 for merely looking at the machine. This will easily enable him to secure a patent, upon which we desire no rights whatever. This publication brands as impostors all who have claimed to have developed a working model of a perpetual motion machine, and who "destroyed it for fear that the idea would be stolen."

## \$11,000.00 in Prizes For Psychological Phenomena

WE have just received a small printed pamphlet through one of our investigators which is published by the General Assembly of Spiritualists of the State of New York, who challenge all tricksters to duplicate some of their psychical (?) manifestations. Among other things this organization claims to be able to materialize etheric or astral forms while the medium is locked in a wire enclosure. They claim to be able to write on slates or paper intelligible messages in the handwriting of a person who is dead, and these writings are produced on the inside of sealed slates. They also claim that they can levitate ponderable bodies without application of physical or mechanical force, and that they can produce independent voices.

Now Mr. Joseph F. Rinn and SCIENCE & INVENTION MAGAZINE are very anxious to see these things done, and have a standing award totaling \$11,000.00 in prizes which will be paid for just such effects as the General Assembly claim they are capable of producing.

We, therefore, publicly challenge the General Assembly of spiritualists of the State of New York, or any of their members to produce any of the effects they claim they are capable of doing. We will furnish the committee of judges.

### Other Pending Contests

Thirty Combination Pen-Pencils Awarded as Prizes in the Clock Spring Contest. Contest announced in the August issue and closes October 1, 1925.  
 \$250.00 in Prizes Awarded for the Best Methods for Exterminating Rats. Contest Announced in the July Issue and Closes Noon, October 15, 1925.

## \$1000.00 Monthly Contest Awards

FIRST PRIZE \$100.00	
Einstein Refuted, by George Appel.....	410-411
SECOND PRIZE \$75.00	
The Night Air Mail, by Richard M. Douglas, Rep. No. 22539.....	426-427
TWO PRIZES OF \$50.00 EACH	
Maps from Aerial Photos, by J. B. Beadle.....	412-413
Mediums' Tricks Exposed, by Edwin Merlin.....	422
THREE PRIZES OF \$35.00 EACH	
Plants and Animals That Shoot, by Dr. Ernest Bade.....	403
A Suitcase Portable Super-Heterodyne, by Sidney E. Finkelstein.....	440
Make Your Own "B" Battery Eliminators, by Moe Joffe.....	446-447
FIVE PRIZES OF \$25.00 EACH	
Rain Making Again, by George F. Paul.....	400
A Simple Selenium Cell, by Raymond B. Wailes.....	432
Home-made Movie Camera, by Roy A. Clapp.....	433
Hints to the Radio Builder, by Leon L. Adelman.....	441
Portable Receiving Set, by Herbert E. Hayden.....	448
FIVE PRIZES OF \$20.00 EACH	
Night Photography (author please send address).....	414
Mathematical Cross Number Puzzle, by R. H. Tingley.....	415
Boat Travels on Air by C. A. Oldroyd, Rep. No. 4433.....	417
Exposure Meter, by S. I. Phillips.....	434
"B" Battery Eliminator, by Max Kuhne.....	447
TEN PRIZES OF \$15.00 EACH	
How Lake Dried River, by Gene Deachem.....	414
Washing Machine, B. G. (author please send address).....	416
Food Chopper, by J. B. Roswick.....	416
Paring Knife, by J. B. Roswick.....	416
Eraser, by P. H. Manning.....	416
Colored Pencil, by P. H. Manning.....	416
Dark Room Lamp, by Sam Y. Caldwell.....	432
Print Trimmer (author please send address).....	432

Ink Dropper (author please send address).....	435
"B" Eliminator Controller, by W. M. Cummings.....	447
FIFTEEN PRIZES OF \$10.00 EACH	
Mastoid Bandage, by Max Bulock.....	431
Gear Shift Anti-Rattler, by C. W. Caldwell.....	434
Simplified Solutions, by C. A. Oldroyd, Rep. No. 4433.....	435
Printing, by Morris Goldstein, Rep. No. 1029.....	435
Rubber Stoppers, by C. A. Oldroyd, Rep. No. 4433.....	435
Hammer Head Retained by Pan (author please send address).....	435
Wire Stands, by F. S. Yamamoto, Rep. No. 11324.....	436
Keeping Soldering Iron Clean, by Floyd Burkner.....	436
Tack Puller, by George H. Kuester.....	436
Stain Removing, by C. A. Oldroyd, Rep. No. 4433.....	436
Mute, by H. Bernard.....	477
Aerial Support, by Robert J. Williams.....	481
Vernier Neutrodon, by B. McCarthy.....	481
Ladder Mast, by J. Seidman, Rep. No. 12001.....	485
Radiation Eliminator, by E. E. Laufer.....	485
TEN PRIZES OF \$5.00 EACH	
Bicycle Horn, by B. Piopongo.....	435
Repairing Bulb, by S. Lang.....	436
Easy Erasing, by C. A. Oldroyd, Rep. No. 4433.....	436
Blade Holder, by E. F. Staber.....	436
Terminal Kink, by Detmar Standley.....	481
Absorption Tuning, by C. A. Oldroyd, Rep. No. 4433.....	483
Remote Control, by Wayne B. Grieve.....	483
Solderless Jack, by F. E. Thompson, Jr.....	483
Crystal Detector, by Charles Mohr.....	485
Handy Wrench, by Robert J. Williams.....	485
FIFTEEN PRIZES OF \$2.00 EACH	
Creeping Coin, by Arthur Kern.....	436
Simple Battery, by A. A. Blumenfeld.....	436
Powder Horn Speaker, by M. W. Hemeon.....	483
No further entries.	

## \$12,000.00 in Prizes for Articles

82 monthly prizes will be given as follows:

FIRST PRIZE \$100.00	
SECOND PRIZE \$75.00	
2 PRIZES OF \$50.00 each	
3	" " 35.00 "
5	" " 25.00 "
5	" " 20.00 "
10	" " 15.00 "
15	" " 10.00 "
10	" " 5.00 "
15	" " 2.00 "
15	" " 1.00 "

Last year SCIENCE AND INVENTION Magazine paid for articles \$13,320.00 to 1,112 prize winners. Hundreds of SCIENCE AND INVENTION reporters won prizes, and up to the time of going to press there were more than 22,000 reporters in the field.

Every month this publication pays \$1,000.00 or more in prizes, exclusive of money paid to those authors who are on contract, and who receive their own rates. At the left the list of prizes issued monthly is itemized, and above are the names of the prize winners for this issue. In order to assist our reporter correspondents in securing available material for publication, we issue without charge the reporter's card, a sample of which is illustrated at the right. Send a postal card for one. It will act as an open sesame in securing news. Address Field Editor, SCIENCE AND INVENTION, 53 Park Place, New York City.

REPORTER

### Science and Invention

CORRESPONDENT REPORTER'S IDENTIFICATION

NO. 10000

L. H. Shackner

THE BEARER OF THIS CARD IS AN AUTHORIZED CORRESPONDENT-REPORTER OF SCIENCE AND INVENTION MAGAZINE. THE PUBLISHERS OF SCIENCE AND INVENTION WILL APPRECIATE ANY COURTESY EXTENDED THEIR REPRESENTATIVE.

EXPERIMENTER PUBLISHING CO.

(over) *Shackner* PRESIDENT

(Note—Unavailable material not accompanied by postage will not be returned.)

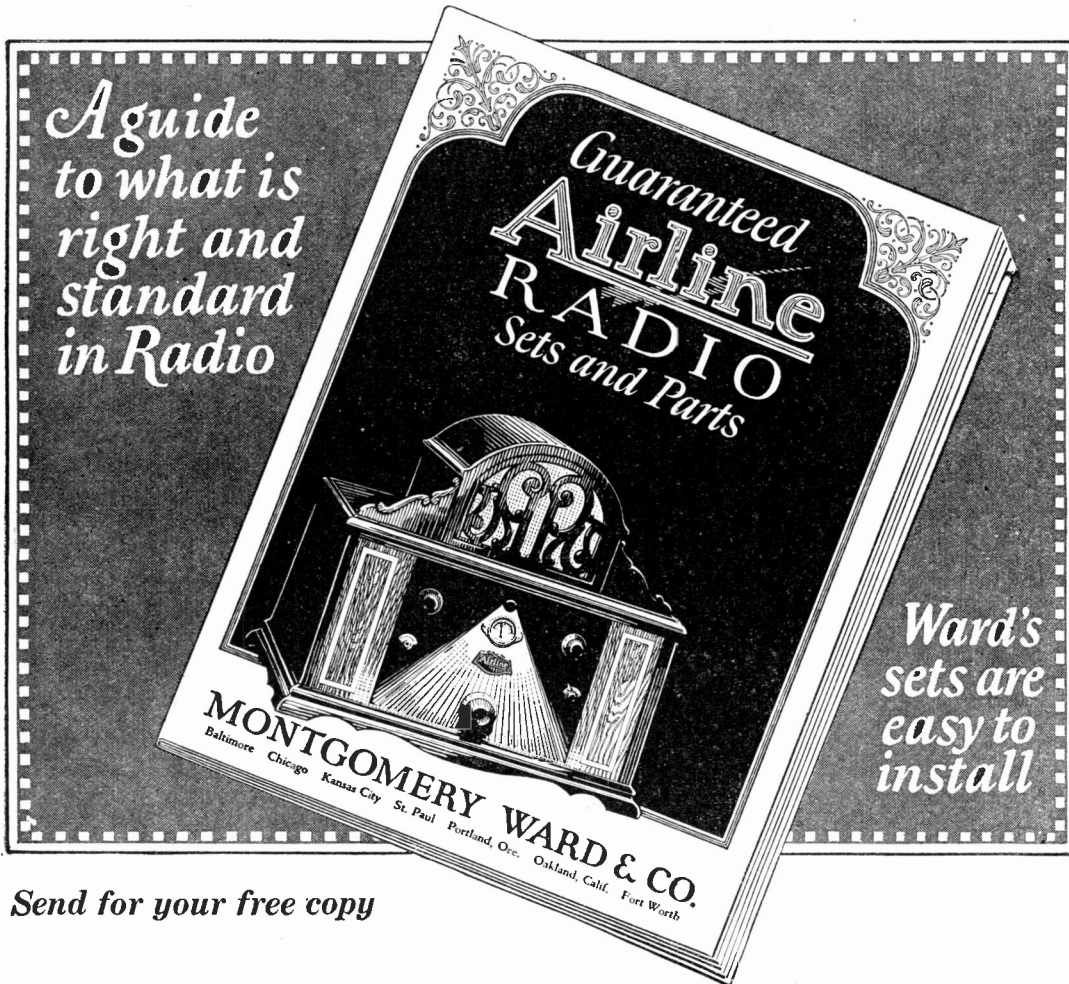

Send for your free copy

## Ward's New Radio Catalogue

The best radio experts made this catalogue. It is one of the very best and most complete books on Radio ever published.

Its 52 fully illustrated pages are simply invaluable to everyone interested in radio. And one copy is to be yours Free—merely for the asking!

It shows guaranteed Radio sets, one tube sets that give remarkable results, and sets of every variety up to Ward's new five-tube one-dial control. Think of tuning in one station after another by turning a single dial!

It shows guaranteed, tested parts, batteries, cabinets, contains a list of stations, a radio log for recording stations. It is a complete radio manual—sent entirely free!

### Ward's is Headquarters for Radio

And best of all, the catalogue offers you everything new in Radio at a big saving in price.

At Ward's, everything for Radio is sold without the usual "Radio Profits." Thousands of pleased customers write us of their constant delight with Ward's Radio products.

### Our 53 year old Policy

For 53 years we have sold our quality merchandise under a Golden Rule Policy. You can rely absolutely upon the quality of everything shown in this Radio Catalogue.

Be sure and ask for Radio Catalogue No. 40-R

ESTABLISHED 1872  
**Montgomery Ward & Co.**

The Oldest Mail Order House is Today the Most Progressive

Baltimore Chicago Kansas City St. Paul Portland, Ore. Oakland, Calif. Ft. Worth

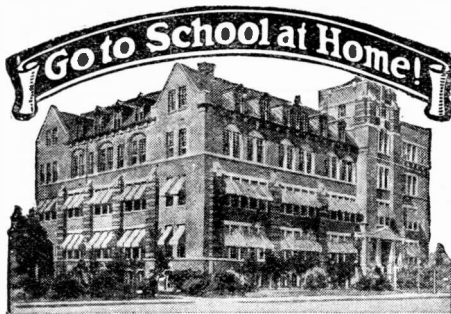

# HIGH SCHOOL COURSE IN TWO YEARS

**YOU ARE BADLY** if you lack **HANDICAPPED** High School training. You cannot attain business or social prominence. You are barred from a successful business career, from the leading professions, from well-paid civil service jobs, from teaching and college entrance. In fact, employers of practically all worth-while positions demand High School training. You can't hope to succeed in the face of this handicap. But you can remove it. Let the American School help you.

**FIT YOURSELF FOR A BIG FUTURE** This course, which has been prepared by some of America's leading professors, will broaden your mind, and make you keen, alert and capable. It is complete, simplified and up-to-date. It covers all subjects given in a resident school and meets all requirements of a High School training. From the first lesson to the last you are carefully examined and coached.

**USE SPARE TIME ONLY** Most people *idle* away fifty hours a week. Probably you do. Use only one-fifth of your wasted hours for study and you can remove your present handicap within *two years*. You will enjoy the lessons and the knowledge you will gain will well repay the time spent in study.

Check and mail the coupon NOW for full particulars and Free Bulletin.

## American School

Dept. H. 626  
Drexel Ave. and 58th St., Chicago

- American School  
Dept. H. 626 Drexel Ave. & 58th St., Chicago  
Send me full information on the subject checked and how you will help me win success.
- |                              |                            |
|------------------------------|----------------------------|
| .....Architect               | .....Lawyer                |
| .....Building Contractor     | .....Machine Shop Practice |
| .....Automobile Engineer     | .....Photoplay Writer      |
| .....Automobile Repairman    | .....Mechanical Engineer   |
| .....Civil Engineer          | .....Shop Superintendent   |
| .....Structural Engineer     | .....Employment Manager    |
| .....Business Manager        | .....Steam Engineer        |
| .....Cert. Public Accountant | .....Foremanship           |
| .....Accountant and Auditor  | .....Sanitary Engineer     |
| .....Bookkeeper              | .....Surveyor (& Mapping)  |
| .....Draftsman and Designer  | .....Telephone Engineer    |
| .....Electrical Engineer     | .....Telegraph Engineer    |
| .....Electric Light & Power  | .....High School Graduate  |
| .....General Education       | .....Fire Insurance Expert |
| .....Vocational Guidance     | .....Wireless Radio        |
| .....Business Law            | .....Undecided             |

Name.....  
Address.....

# Mathematical Cross-Number Puzzle

(Continued from page 415)

### HORIZONTAL

- 1—Product of digits is 10,976 by 59. 614 is 654,323.
- 5—435,605.
- 10—MD is 1,500—150.
- 12—CCCXX is 320.
- 13—27 times the weight of hydrogen.
- 15—Moon's distance is 238,857, by 40 is 9,554,280, less 71,082 is 9,483,198.
- 18—7.2 times the weight of water.
- 19—LI is 51.
- 20—92,830,000 miles, divided by 10 is 9,283,000.
- 21—2.6 times the weight of water.
- 22—212 less 100 is 112.
- 24—5,686 by 10 is 56,860.
- 25—212 less 80 is 132.
- 26—LV is 55.
- 27—C is 100.
- 28—24 less 2 is 22.
- 29—1849 ('49).
- 30—33,000 pounds.
- 31—The square of one-tenth is one one-hundredth (0.01).
- 32—Cube root of 1,728 is 12, by 5 is 60.
- 34—11
- 35—Radium weight 226 times hydrogen—atomic weight.
- 37—35 dollars.
- 39—2.44.
- 41—17,325 plus 1925 is 19,250.
- 43—Flight of Mohammed from Mecca was in year 622.
- 45—XXXVI is 36.
- 46—A stone is 14, by 151,473,285 is 2,120,626.
- 48—Cube root of 24,389 is 29.
- 49—Fifty 64ths.
- 50—Seven times 705,152 is 4,936,064.
- 51—Forty years by interest tables.
- 52—19.3 cents.
- 53—676 less 14 is 662.
- 55—128 cubic feet in a cord—202,080.
- 56—3,14160.

### VERTICAL

- 1—52,800 is 633,600, less 1,090 is 632,510.

6	5	4	3	2	3		4	3	5	6	0	5
3		1	5	0		1		3	2	0		1
2	7		9	4	8	3	1	9	8		7	2
5	1		9	2	8	3	0	0	0		2	6
1	1	2		5	6	8	6	0		1	3	2
0		5	5		1	0	0		2	2		1
	4	9		3	3		0	1		6	0	
1		1		2	2	6		3	5			7
2	4	4		1	9	2	5	0		6	2	2
3	6		2	1	2	0	6	2	6		2	9
5	0		4	9	3	6	0	6	4		4	0
0		1	9	3		2		6	6	2		0
2	0	2	0	8	0		3	1	4	1	6	0

- 2—XLI is 41.
- 3—3,600 less 1 is 3,599.
- 4—Nat. tangent is 2.0428 less 3 is 2.0425.
- 6—3,3904 less 4 is 3,3900.
- 7—5,280.
- 8—360 divided by 6 is 60.
- 9—365 by 24 by 60—minus 10,000—subtract 29,791 divided by 10 which is 2,971—512,621.
- 11—Year 1344 by 10—13,440 less 60 is 13,380.
- 14—711.
- 16—2,240,000 less 28 is 2,239,972 by 395.6 is 886,132,923.
- 17—7,900 miles—41,712,000 feet by 2.54 is 105,948,480 plus 58,080 is 106,006,560.
- 18—729 less 6 is 723.
- 23—10,620.5 by 2.44 is 25,914.
- 25—2,109.5 by 6 less 1 is 12,656.
- 33—351.4 squared is 123,481.96 plus 20.04 is 123,502.
- 36—22,062 from tables.
- 38—729,000.
- 40—3.28 by 140 plus 1 is 460.
- 41—119.38—metric system.
- 42—0.2661.
- 44—2240 divided by 10 is 224.
- 46—0.2490.
- 47—6,464.
- 52—12.
- 54—21.

# Tarrano the Conqueror

By RAY CUMMINGS  
(Continued from page 421)

side, and headed Southward. No challenge. Under us, occasional local cars swept by; but up here we were clear of traffic. Elza prepared our lunch, in the little electric galley forward of the observation pit. The Great London-East Indies Mail Flyer crossed us, coming along this same level. It was headed toward the Pole from the British Isles. Its pilot challenged us before it had come up over the horizon. A crusty fellow. His face in the mirror glared at me as I accepted connection. He ordered me down, Inter-Allied or no. Argo was at my elbow. His pencil-ray dug into my ribs. Had I made a false move it would have drilled me clean with its tiny burning light. I told the pilot we would descend. It placated him; but he saw Argo's face, mumbled something about damned foreigners—general orders probably coming tomorrow to clean out Venia—damned well rid of the traitors. Then he disconnected. Venia, Georg and I were sure, was where Argo was now taking us. But the rest of his comments I did not clearly understand until later. We descended, and the flyer came up over

the horizon and passed us overhead. We were pointing Southward now, had picked up the 67th West Meridian and were following it down. The Hays station\* challenged us; but they were satisfied with my explanation. Argo had us up in speed around 400. We went down Davis Straight, over Newfoundland, avoiding the congested cross-traffic of mid-afternoon in the lowest lanes, and out over the main Atlantic. Night closed down upon us. It was safer for Argo now. We flew without lights. Outlawed. Had they caught us at it, we would have been brought down, captured by the patrol and imprisoned. Yet Argo doubtless considered the chance of that less dangerous than a reliance upon my ability to trick the succeeding directors. With darkness we ascended again to the upper mail lanes. Over the main Eastern Atlantic now, and out here this night, there was little local traffic. The mail and passenger liners went by at intervals—the spread-

\*Hayes Peninsula, Northwest Greenland, near the present site of Etah

(Continued on page 460)



# Pacent

## Engineering Achievements

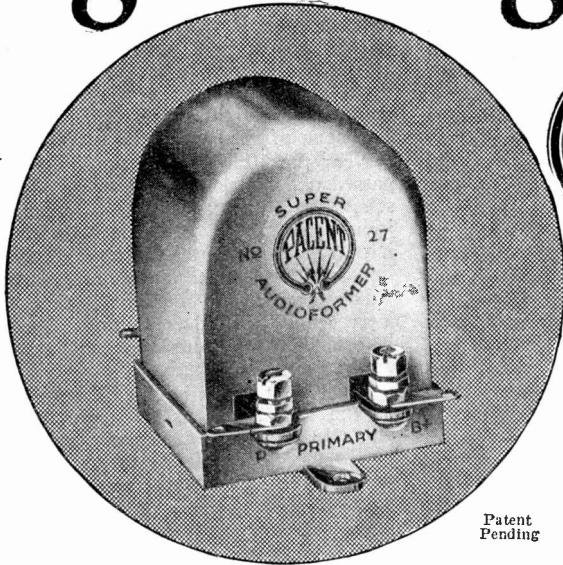

Patent Pending

### The Last Word In Transformers

## The Pacent Super-Audioformer

We announce the "giant brother" of our No. 26 audioformer—the Pacent No. 27 Super-Audioformer. A man-size transformer for a man-size job, the result of several years' experience and engineering research.

The ratio is 3 to 1—being high enough for energy amplification of 500 to 1 per audio step (using 201-A tube or equivalent) and yet low enough so that higher frequencies are not distorted. Uniform amplification down to 100 cycles and up to 8000 cycles.

Especially designed with power amplification requirements in mind, with insulation to stand plate potentials up to 500 volts.

Characteristic Pacent solidity, ruggedness of construction, and neatness of appearance. Shipped in all standard types.

**MANUFACTURERS OF BETTER SETS—**

*We have the right transformer for you.*

Manufacturers, Jobbers and Dealers  
WIRE OR WRITE FOR PARTICULARS.

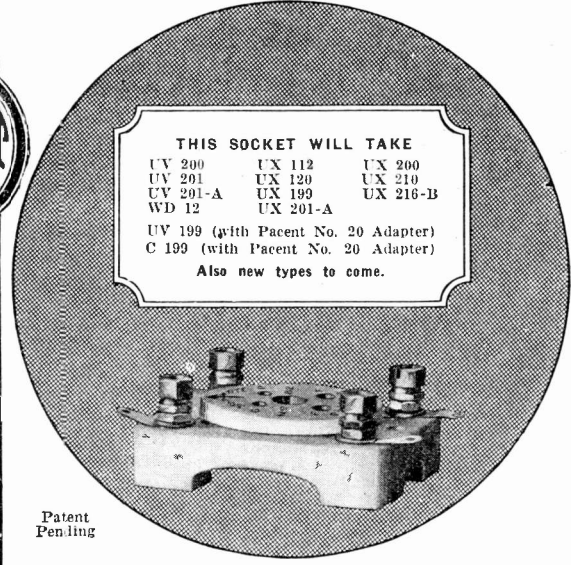

Patent Pending

### The Last Word In Sockets

## The Pacent Universal Socket

No need to worry about the change in radio tube bases. Pacent progressiveness and forethought have resulted in the development of this UNIVERSAL SOCKET to give you an interchangeable tube holder. It will take the new X type tubes as well as the old standard U, V, and C types. (Excepting old 199 types, which require Pacent No. 20 Adapter.)

The socket being, with the exception of its metal parts, entirely of Isolantite, negligible dielectric losses and negligible capacity effect between plate and grid naturally follow.

One piece phosphor bronze contact members, with exclusive Pacent self cleaning, side wiping contact for each tube prong.

Supplied in popular mounting type and also for mounting on sub-panels.

**MANUFACTURERS OF BETTER SETS—**

*We have the right socket for you.*

Manufacturers, Jobbers and Dealers  
WIRE OR WRITE FOR PARTICULARS.

Do you know about the PACENT TRUE STRAIGHT LINE FREQUENCY CONDENSER?

Do you know about the PACENT MICRO-VERN?

**PACENT ELECTRIC CO., Inc., 91 Seventh Ave., New York City**

OFFICES: CHICAGO—MINNEAPOLIS—BUFFALO—BOSTON—PHILA.—WASH., D. C.—SAN FRANCISCO—ST. LOUIS—PITTSBURGH  
JACKSONVILLE—DETROIT—CANADIAN LICENSEE—WHITE RADIO LTD., HAMILTON, ONTARIO

**DON'T IMPROVISE — PACENTIZE™**

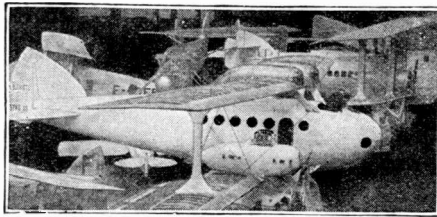

# Aviation Brings Quick Success

**T**O young men of daring no other field of work offers such a fascination, such high pay, nor such opportunities for quick success as the field of Aviation. As yet, aviation is practically in its infancy. But now is the time to get in.

## Amazing Opportunities in Airplane Industries

In the automobile industry and in the moving picture business hundreds of men got rich by getting in at the start. They made their success before others woke up. Today, these lines offer no greater opportunities than a hundred and one others. **BUT AVIATION IS NEW.** Get in while the opportunities are big. All over the country there will be a clamor for trained men. It will not be a question of pay but of getting capable men.

## Become an Aviation Expert \$50 to \$100 per Week

The study of aviation is almost as fascinating as the actual work. Every lesson is full of interest. That is why it is easy to learn aviation. You do not have to make yourself study—it is like reading an interesting book that tells you things you have always wanted to know. Only one hour each evening will give you the basic training in a surprisingly short time.

One student, S. F. McNaughton, Chicago, says: "Your lessons are like a romance, and what is more, after one reading, the student gets thorough understanding. One never tires of reading them." James Powers, Pa., another student, says, "I am indeed surprised that such a valuable course can be had from such practical men for so little cost."

### Fascinating—Daring—Big Paying

Prepare Now for One of These Positions

- Aeronautical Instructor \$60 to \$150 per week
- Aeronautical Engineer \$100 to \$300 per week
- Aeronautical Contractor Enormous profits
- Aeroplane Repairman \$60 to \$75 per week
- Aeroplane Mechanic \$40 to \$60 per week
- Aeroplane Inspector \$50 to \$75 per week
- Aeroplane Salesman \$5000 per year and up
- Aeroplane Assembler \$40 to \$65 per week
- Aeroplane Builder \$75 to \$200 per week

### Personal Instruction by Experienced Men

Men who have had actual experience give you personal attention. They select the lessons, lectures, blueprints and bulletins. They tell you things that are essential in everyday practice. Each lesson is easy to read and understand.

## Get Big FREE Book—Now

Send coupon below for New Book, just out, "Opportunities in the Airplane Industry." It is interesting and instructive. It will show you many things you never knew before about aviation. We have but a limited supply of these books—send the coupon before they are all gone.

**American School of Aviation**  
3601 Michigan Ave., Dept. 1426 Chicago, Ill.

**American School of Aviation**  
3601 Michigan Ave., Dept. 1426 Chicago, Ill.  
Without any obligation, send me your Free Book, "Opportunities in the Airplane Industry", also information about your course in Practical Aeronautics.

Name.....

Street.....

City..... State.....

# Tarrano the Conqueror

(Continued from page 458)

ing beams of their lurid headlights giving us warning enough so that we could dive down and avoid being caught in their light. I prayed that one of their lights might pick us up, but none did.

North of Bermuda, a division of the North Atlantic patrol circled over us. The ocean was calm. Argo dropped us to the surface. We floated there like a derelict—dark, silent, save for the lapping of the water against our aluminite pontoons. The patrol's searching beams swept within a hundred feet of us—missed us by a miracle. And as the patrol passed on, we rose again to our course.

Argo gave us one of the small cabins to ourselves that night. He was still deferential to Elza, but in his manner and in the glitter of those little black eyes, there was irony, and an open, though unexpressed, admiration for her beauty.

We slept little. Georg and I—one or the other of us—was awake all night. We talked occasionally—not much, for speculation was of no avail. We wondered what could be transpiring abroad through all these hours. Hours of unprecedented turmoil on earth, and on our neighboring worlds. We wondered how the Central State of Venus might be faring with the revolution. Would they ask aid of the earth? This Tarrano—merely a name to us as yet, but a name already full of dread. Where was he? Had he been responsible for all this? Dr. Brende's secret was in his hands now, we were sure. What would he do next?

About three o'clock in the morning—a fair, calm night—our power died abruptly. We were in the Caribbean Sea not far above the Northern coast of South America, at 15° North latitude, 67° west longitude. Our power died. Elza was fast asleep, but the sudden quiet brought Georg and me to alertness. We joined Argo in the pit. He was perturbed, and cursing. We dropped, gliding down, for there was no need of picking a landing with the emergency helicopter batteries—glided down to the calm surface. For a moment we lay there, rocking—a dark blob on the water. I heard a sudden sharp swish. An under-surface freight vessel, plowing from Venezuelan ports to the West Indian Islands, came suddenly to the surface. Its headlight flashed on, but missed us. It sped past. I could see the sleek black outline of its wet back, and the lines of foam as it sheered the water. We lay rocking in its wake as it disappeared Northward.

Then, without warning, our power came on again. An inadvertent break perhaps; or perhaps some local or general orders. We did not know. Argo was picking from the air occasional news, but he said nothing of it to us; and he was sending out nothing, of course.

Dawn found us over the mountains. The Director at Caracas challenged us. Argo kept me by his side constantly now. Dutifully we answered every call. The local morning traffic was beginning to pick up; but we mingled with it, at 8,000 feet and more, to clear the mountains comfortably.

Elza again cooked and, with Argo joining us, we had breakfast. Argo's good nature continued, as we successfully approached the end of our flight. But still he volunteered nothing to us. We asked him no questions. Elza was grave-faced, solemn. But she did not bother Georg and me with woman's fears. Bravely she kept her own counsel, anxious only to be of help to us.

We passed over the Venezuelan Province, over the mountains and into Amazonia, headwaters of the great river—still on Meridian 67 West. The jungles here were sparsely settled; there were, I knew, no more than a dozen standard cities of a million population, or over, in the whole region of Western Brazilana. As we advanced, I noticed an unusual number of the armed government flyers above us. Many were hovering, almost motionless, as though waiting for orders. But none of them molested us.

Near the 10th parallel South latitude, we passed under a fleet of the white official vessels, with a division of the Brazilana patrol joined with them. A hundred vessels hovering up there in an East and West line—a line a hundred miles long it must have been.

Hovering there, for what? We did not know; but Argo, leering up at them insolently, may have guessed. They challenged us, but let us through.

"You are the last one in," this sub-director of the patrol told us. I could see him in our mirror as his gaze examined our pit—a dapper, jaunty fellow with the up-tilted mustache affected in Latina. "Last one in—your Inter-Allied are a nuisance."

He was more particular than those directors we had passed before. My badge and my verbal explanation were not enough. He made me show him the Inter-Allied seal which I always carried, and I gave him the pass-code of the current week.

"Last one in," he reiterated. "And you wouldn't get in now without those refugees with you. Venia's closed after noon of today. Didn't you know it?"

"No," I said.

"Well, it is. They shut off the power early this morning for all low vibrations—yours and under. Brought 'em all down for a general traffic inspection. Then changed their minds and threw it on again. But if you're coming out North again, you've got to get out by noon. And you go in at your own peril."

He assumed that Argo and his men were Venus refugees going with me into Venia! I only vaguely understood what might be afoot, but I did not dare question him. Argo's side glance at me was menacing. I agreed with this director obediently and broke connection.

We seemed now to have passed within the patrol line. There were no more official vessels to be seen. We clung low, and at 12° South, 60° 20' West, at 10:16 that morning we descended in Venia, capital of the Central Latina Province, largest immigrant colony of the Western Hemisphere.\*

We landed on a stage of one of the upper crescent terraces. A crowd of Venus-people surrounded us. Even in the turmoil of our debarkation, I wondered where the official landing director might be. None of the governing officials were in sight. The place was in confusion. Crowds were on the spider bridges; the terraces and the sloping steps were jammed. Milling, excited people. The foreign police, pompous Venus-men in gaudy tropical uniforms, were herding the people about.

But none of our Earth officials! Where were they, who should have been in charge of all this confusion?

My heart sank. Something drastic, sinister, had occurred. We had no time to guess

\*Now Matto Grosso State, Brazil.

(Continued on page 462)

# "BUILD YOUR OWN" WITH "RASCO" PARTS!

## Buy from the Oldest and Original Exclusive Radio Parts House in the United States

We pay ALL transportation charges in U. S. ALL GOODS SENT PREPAID IN 24 HOURS

Order direct from this page.

### SPECIAL PRICES FOR SEPTEMBER

Money refunded if goods do not satisfy

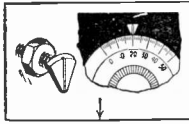

**Dial Marker**  
The big little thing you have been waiting for. Just drill a hole in the panel and mount the marker above the dial. Nickel plated and polished. \$738 Dial Marker, three for .....\$1.10

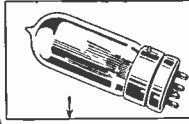

**Vacuum Tubes Specially Priced**  
Only best make tubes carried in stock. Any tube replaced if defective, providing filament lights. \$701A 5 v., .25 amp. \$1.65 \$799 3 v., .06 amp. 1.65 \$72 1 1/2 v., .25 amp. 1.65 \$6699 Melotone... \$6.90

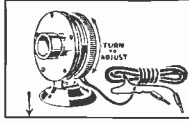

**Melotone Loud Speaker**  
The greatest and most powerful loud speaker phonograph attachment made. If, after five days trial, you do not proclaim it the best and most powerful speaker return it for refund. \$6699 Melotone... \$6.90

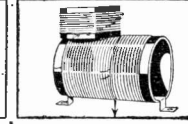

**Cockaday Coil**  
Guaranteed best make. Three windings of No. 18 Magnet wire. Has brass brackets for panel or base mounting. Satisfaction guaranteed or money back. \$2750 Cockaday coil \$1.50

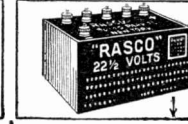

**Tapped "B" Batteries**  
We positively guarantee these batteries to be of long life. We carry only fresh stocks. All with taps. \$225 Sm. 2 1/2 v. . \$ .85 \$225 Medium Navy size, 2 1/2 v., ..... 1.20 \$4500 Medium large size, 4 1/2 v. .... 2.30

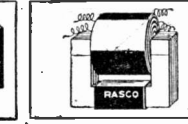

**Audio Frequency Transformer**  
No better Transformer made. Highest class materials. Impregnated coils. Silicon steel stampings used. Save 50 per cent by assembling it yourself. \$1100 Ratio 4 1/2-1. \$1.85 \$1150 Ratio 6 1/2-1. 1.85

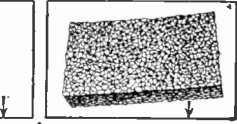

**Sponge-Rubber Cushions**  
Get rid of tube noises due to vibration. Softest sponge rubber made. Size 2 1/2" x 3", 3/8" thick. \$8989 Sponge-rubber cushions, each ..... \$1.12 Six for ..... \$6.20

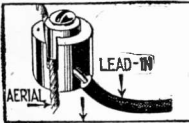

**Antenna Connector**  
At last the solderless antenna connector, made entirely of brass in three pieces; clamps aerial and lead-in with vice-like grip, keeping perfect contact at all times. Dia. 3/8", height 1/2". \$4244 Connector... \$0.20

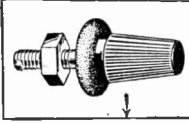

**Rasco Vernier**  
Why use a vernier condenser when a vernier attachment will do anything and everything a vernier condenser accomplishes? Cleverest vernier made. Can be used with any dial. Silk rubber ring engages dial. Nothing to come apart. \$1450 Vernier..... \$1.18

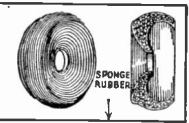

**FONEKUSHIONS**  
Made of sponge rubber. Make wearing your receivers a pleasure. Positively exclude all noises and make reception a pleasure. Sponge rubber will last for years. Light as a feather. Sanitary. \$3550 Fonekushions, set of two ..... \$3.35



**Dial Button**  
Made in blue enamel and gold, to be worn in button hole. Every radio fan wants one. 3/4" diameter, best gold plate. Perfect reproduction of radio dial. \$7799 Dial Button, Each ..... \$0.25

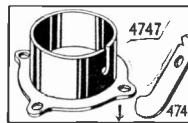

**Vacuum Tube Shell**  
Nickel plated shell for the man who builds his own. 4 holes to attach to sub-base. Each shell comes complete with 4 phosphor bronze socket contacts. See illus. 4748. \$4747 Vacuum Tube Shell and Contacts ..... \$0.16

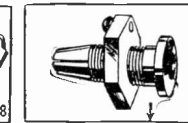

**Cord Tip Jack**  
Takes place of binding posts. Cord tip firmly gripped by jack. Made of brass, nickel plated. Screw to attach lead wire. No soldering necessary. \$1500 Cord tip jack. Each ..... \$3.15

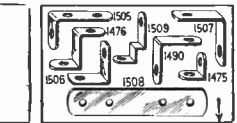

**Brass Nickel plated Brackets**  
All illustrations 1/4" size. \$1505 Bracket, each \$.05 \$1507 Bracket, each .05 \$1509 Bracket, each .04 \$1476 Bracket, each .05 \$1506 Bracket, each .05 \$1490 Bracket, each .04 \$1475 Bracket, each .03 \$1508 Bracket, each .05

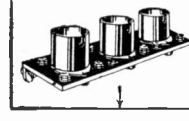

**Three-Gang Socket**  
Aluminum shells, genuine heavy bakelite base, 3 brackets for mounting, 12 nickel binding posts. Length 7/8". \$5995 3 gang socket \$1.50

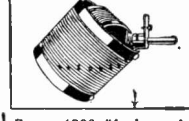

**Rasco 180° Variocoupler**  
Silk wire wound on bakelite tubes. Six taps. Wire length, 150 to 600 meters. For panel mounting. 3/4" shaft. Your money refunded if it is not all we claim. \$3100 Variocoupler prepaid ..... \$1.50

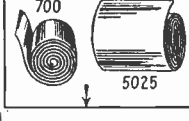

**Copper Ribbon**  
.005" thick. \$700 3/4" wide; \$701 1/4" wide; \$702 3-16" wide. Made of best material. All sizes per foot... \$0.01 \$001" thick. 4" wide. \$5025 Copper Foil, per foot ..... \$0.10 \$10-foot length ..... \$0.80

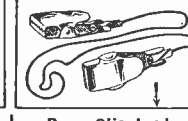

**Rasco Clip Leads**  
Invaluable for experimental work. Clip lead hooks in a tiffy onto any wire binding post or conductor. Safest experimental connection. Brass clips, 1 foot silk wire, green or red. \$7887 Clip Leads, ea. \$1.12 Dozen lot ..... \$1.35

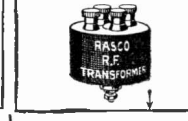

**Radio Frequency Transformers**  
Best Radio Frequency Transformer developed so far. Designed by R. E. Lacault, Inventor of Ultradyne. Air core type. 200-600 meters. \$2900 Transformer, size 1 1/2" x 2 1/2" ..... \$1.35

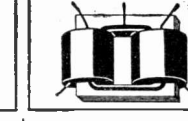

**PUSH-PULL Transformer**  
Push Pull Transformer for many new circuits. See any radio magazine. Made of best materials. Coils impregnated. Silicon steel laminations. Save 50 per cent by assembling yourself. Sim- ilar instructions furnished. \$1159 Push-Pull Transformer, ratio 6 1/2 to 1 \$3.40

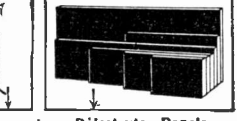

**Dielectric Panels**  
Highest dielectric strength as per Bureau of Standards. Beautiful high finish. \$7100 7x10x3-16" .. \$0.70 \$7120 7x12x3-16" .. .85 \$7140 7x14x3-16" .. .95 \$7160 7x18x3-16" .. 1.25 \$7200 7x24x3-16" .. 1.45 \$7240 7x31x3-16" .. 1.65

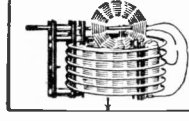

**Low Loss Tuner**  
Same type as used in our L.O.L.O.S EXPLORER. Tunes from 200 to 600 meters. Hard rubber insulation throughout. Silver plated primary. Secondary D. C. C. Tickler silk insulated wire. \$2690 Tuner ..... \$5.00

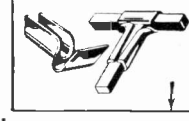

**"T" Wire Connectors**  
This big little article solves all troubles when making "T" wire connections. Made to take 1/16" square or round bus-bar wire. Can be attached with a pair of pliers. \$2975 "T" Wire Connectors, 12 for..... \$0.05

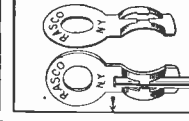

**Nosolder Lugs**  
Finally a real solderless lug is here. Soldering positively done away with. Takes square or round bus-bar, which it holds with a vice-like grip. Perfect connection. Just slide bus-bar into slip-grip. \$3727 Lux. 25 for... \$1.15



**Low Loss Coil**  
Same type coil as used in Freshman and other Tuned Radio Frequency sets. D.C.C. wire. 200-550 wavelength. 3" diameter, 1" wide. 5-16" thick. 4 connections. 2 primary, 2 secondary. \$2629 Low Loss Coil \$7.70

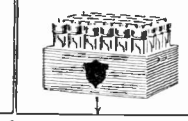

**Storage "B" Battery**  
48 volts, 4 1/2 amp. hours. Buy storage "B" batteries by capacity, not by looks. Charge lasts one month. Rubber tops and vents, wooden tray. Sent Express Collect. \$948 Storage "B" Battery ..... \$14.00

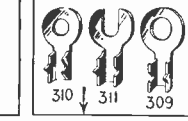

**Tinned Nickel Lugs**  
All our lugs are tinned. \$310 Brass Lugs for Nos. 8 screw, doz. .... \$1.10 \$311 Copper Lugs for Nos. 6 and 8 screws, doz. \$1.10 \$309 Copper Lugs for Nos. 1, 6 and 8 screws, doz. \$1.10 \$308 Copper Lugs for 6-32 screw, doz. .... \$1.10

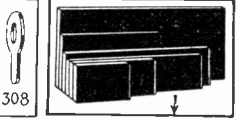

**Formica Panels**  
Clearance Sale As we are discontinuing these particular sizes, this material is now offered at cost. All 3-16" thick. \$352 9x12" each ... \$1.25 \$354 6 1/2 x 9 1/2" ea... 1.60 \$356 6x14" each ... 1.20 \$397 6x1" each ..... 45

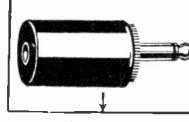

**Phone Plugs**  
Sold from 50c to 75c everywhere. Hard rubber composition shell and patented cord tip holder. Finest workmanship throughout. \$1030 Rasco Telephone Plug. Each ..... \$3.35



**Bakelite Socket**  
Octagon shape. Four nickel binding posts, phosphor bronze contact springs. Best brown bakelite. \$6510 Bakelite socket \$4.40 \$6500 Tube Socket. Made entirely of composition. Best made. Each... \$3.35



**Binding Post Name Plates**  
Dia. 3/8". These styles: Phones, Ground, - Output, "A" Bat., "B" Bat., - Loud Speaker, "C" Bat., - Aerial, + Input, "A" Bat., + "B" Bat., + Loop "C" Bat., + New! "A" Bat. + "B" Bat. \$6000 Name Plates, Dozen ..... \$2.25

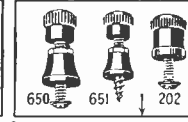

**"Rasco" Posts**  
Made of black composition. \$650-51 Each ..... \$0.08 \$202 Has nickel-plated bottom, each ..... \$0.08 Dozen, each style... \$0.90 \$122 Initialed Binding Posts. Six popular styles. Each ..... \$0.06

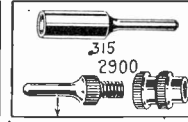

**Cord Tips**  
Standard phone cord tips, nickel. \$315 Each ..... \$0.03  
**Separable Cord Tips**  
No solder required. Wire goes in ferrule. Shank holds it tight. Nickel plated. \$2960 Each ..... \$0.06

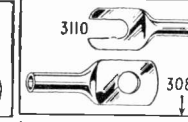

**"Perfect" Lugs**  
These new and improved lugs are brass, nickel plated, flattened on top as shown. Made of a single piece of metal. Lead wire goes into tube. \$3110, \$3080 "Perfect" Lugs. Each ..... \$0.02 Dozen lots ..... 20

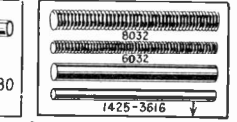

**Brass Rods**  
Sold in 6" lengths only. \$8032 Rod 8-32" thread length ..... \$0.08 \$6032 Rod, 6-32" thread length ..... \$0.06 \$1425 Rod, plain, 1/4" round, length ..... \$1.10 \$3616 Rod, plain 3-16" round, length ..... \$0.06



**Panel Mounting Grounded Rotor Condensers**  
Positively no better condenser made. Lowest losses, all insulation hard rubber. Have binding posts, aluminum plates, rugged construction. Used by 9 big set manufacturers. \$5113 13-plate ..... \$1.10 \$5123 23-plate ..... 1.20 \$5143 43-plate ..... 1.30

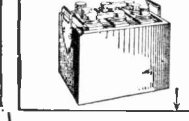

**Storage Batteries**  
Guaranteed for two years. Only NiW material used. Acid proof terminals. Patent vents. \$2400 Two volt, 40 amp. hours ..... \$3.90 \$640 Six volt, 40 amp. hours ..... 7.25 \$656 Six volt, 60 amp. hours ..... 8.90 Shipped express collect.

## New 1925 "Rasco" Catalog No. 12

CONTAINS 75 VACUUM TUBE HOOK-UPS, 300 ILLUSTRATIONS, 500 ARTICLES, NOW 100 PAGES

All Armstrong Circuits are explained clearly, all values having been given, leaving out nothing that could puzzle you.

Just to name a few of the circuits: The V.T. as a detector and one-step amplifier; all Armstrong circuits; one-step radio frequency amplifier and detector; three stage audio frequency amplifier; short wave regenerative circuits; 4-stage radio frequency amplifiers; radio and audio frequency amplifier; inductively coupled amplifier; all Reflex Circuits.

# FREE

A POSTAL CARD BRINGS IT

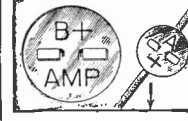

**NEW Battery Lead Tags**  
Latest wrinkle, made in metal, nickel-plated, polished. Clamp tag on battery wire, and it won't come off. These five styles: "B", "B + Det.", "B -", "A +", and "A". \$8030 Tags, set of 10 \$1.15

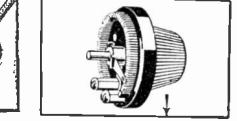

**Rheostats and Potentiometers**  
High heat dielectric base. Come with tapered, knurled knob, 2 1/2" dia. Complete with pointer. \$4310 6 ohm ..... \$3.38 \$4311 30 ohm ..... 44 \$4312 Potentiometer 200 ohms ..... 65

# RADIO SPECIALTY COMPANY, 100 Park Place, New York City

Factories: Brooklyn, N. Y. Elkridge, Md.





## Choose as Your Profession ELECTRICAL ENGINEERING

Electricity offers a brilliant future to the young man who is about to choose his career. Never before has there been such wonderful opportunity in this great field. Big paying positions in electrical work the world over are open to trained men—men who possess specialized, practical knowledge. Come to the School of Engineering of Milwaukee—the largest and best equipped electrical school in America. Here you are trained in both theory and practice by a faculty of experts. You learn in large, finely equipped laboratories. If you have 14 high school credits or equivalent, you can become an Electrical Engineer with a Bachelor of Science degree in 3 years. If you lack these credits, they can be made up in our Institute of Electrotechnics in a short, intensive course.

**B. S. Degree  
in 3 Years**

## A Complete Practical Electrical Education

Learn by the thorough, approved scientific methods which our twenty years of specializing enable us to give you. In addition to Electrical Engineering, the following complete courses are given: D.C. and A.C. Motors and Generators, Armature Winding, 3 mos.; Electric Light, Heat and Power Wiring, 3 mos.; Practical Electricity, 6 mos.; Automotive Electricity, 3 mos.; Radio Sales, Service and Radiocasting, 3 mos.; Junior Electrical Engineering, 12 to 30 mos.; Electrotechnics, 1 yr.; Commercial Electrical Engineering, 1 yr.

### Earn While You Learn

By our special system you may earn while learning. Our employment department will secure you a position to which you may devote part of each day, spending the remainder at the school. This plan both solves the student's financial problems and provides splendid experience at the same time. Low tuition fees. Board and room reasonable. Daily Broadcasting WSOE. School Orchestra. Fraternities.

Enter At  
Any Time

### Write for Free Catalog

LECTURES ON  
ELECTRICITY  
Given Daily from  
WSOE  
Radiocast Station.  
Ask for Free Scholarship  
Contest Information.

Write today for free, illustrated catalog just off the press. Read about this wonderful institution and the great opportunities that lie before you. Find out about our specialized method of training and the details of our "Earn While You Learn" plan.

## SCHOOL of ENGINEERING of Milwaukee

Dept. SI-925A, 415 Marshall Street, Milwaukee, Wisconsin

SCHOOL OF ENGINEERING OF MILWAUKEE,  
Dept. SI-925A, 415 Marshall St., Milwaukee, Wis.

Please send me your free illustrated catalog on Electrical Engineering, and give me details of your "Earn While You Learn" plan. (Be sure to give your age and education.)

Name .....

Address .....

Town ..... State .....

Age ..... Education .....

## Tarrano the Conqueror

(Continued from page 460)

what it might be. Argo drove us forward, with scant courtesy now, down in a vertical car, through a tunnel on foot to what they called here in Venia the Lower Plaza. We crossed it, and entered one of their queerly flat buildings at the ground level; entered through an archway, passed through several rooms and came at last into a room whirring with instruments.

Argo said triumphantly, yet humbly: "Tarrano, Master—we are here."

A man at a table of helio-sending instruments turned and faced us. We were in the presence of the dread Tarrano!

### CHAPTER VI THE MAN OF DESTINY

Tarrano! He rose slowly to his feet, his gaze on us for an instant, then turning to Argo.

"So! You took them? Well done, Argo!"

His gesture dismissed his subordinate; Argo backed from the room. From a disc, an announcer was detailing dispatches. Tarrano frowned slightly. He advanced to us as we three stood together. I had heard Elza give a low, surprised cry as we entered. She stood with a hand upon my arm. I could feel her trembling, but her face now was impassive.

Georg whispered to me: "This Tarrano—"

But our captor's voice checked him. "Come this way, please." He signalled, and three men came forward. To them he issued short commands; they took their places at the instrument tables. Then he led us from the room through an arch, over a small trestle, into a tiny inner courtyard. A tropical garden, surrounded by blank circular walls of the building. A patch of blue sky showed above it. A garden secluded from prying eyes, with only a single spider bridge crossing overhead. Vivid flowers and foliage made it a bower. Brown bark paths laced it; a tiny fountain splashed in the center.

Tarrano sat on the rim of the fountain; he gestured to a white stone bench where we three sat in a row, Elza between us. It made me feel like a child.

"Your father is dead." He was addressing Elza; and then Georg. "That is unfortunate. He was a good man. I'm sorry."

His voice was soft and musical. He sat there on the fountain rim, an elbow on his crossed knees, chin resting in his hand, his eyes studying us. A small, slight figure of a man, no more than 35. Simply dressed; white trousers of the tropics, with a strip of narrow black down the leg-fronts; a girdle of gold; ruffled white shirt, with sleeves that flared a trifle, and a neck-piece of black. From his belt dangled a few instruments and several personal weapons—beautifully wrought, small—almost miniatures—yet deadly-looking for all that.

He was bareheaded; black hair closely clipped. A face smooth-shaven. Thin, with a nose hawk-like, and black eyes and heavy brows. His mouth was thin-lipped, though smiling now, disclosing even, white teeth. Yet a cruel mouth, with the firm jaw of determination and power under it. The familiar gray Venus skin, but with that bronze cast of the people of the Central State.

At first glance, not an unusual or particularly commanding figure. Yet the man's power of personality, the sheer dominant force of him, radiated like a tower code-beam. No one could be in his presence an instant without feeling it. A power that enwrapped you; made you feel like a child. Helpless. Anxious to placate a possible

wrath that would be devastating; anxious—absurdly—for a smile. It was a radiation of genius, humbling every mediocre mortal it touched; dominating by the sheer instinctive force of the will behind it.

I felt it—felt all this from the moment I came into his presence. Felt like a child, sitting there on that bench. Vaguely frightened; sullen, with childish resentment at my superior. And over it all, my man's mentality made me angry at myself for such emotions; angry at the consciousness of my own inferiority, forced upon me now more strongly than ever anything or anyone had made me feel it before.

Tarrano was smiling gently. ". . . . killed your father. I would not have had it so. Yet—perhaps it was necessary. The Lady Elza—"

I could feel Elza trembling again. Georg burst out: "What do you want of us? Who are you?"

Tarrano's slim gray-brown hand came up. "The Lady Elza remembers me—" He seemed waiting with his gentle smile for her to speak.

"They called you Taro then," she said. Her voice was the small, scared, diffident voice of a child.

"Yes. Taro. A mere sub-officer of the Central State. But destined for bigger things than that, as you see. They did not like what they called my ambitious ways—and so they sent me to the Cold Country. That was soon after I had met you and your father, Lady Elza. You hardly remarked me then—I was so insignificant a personage. But you—I remembered you—"

Still there was in his voice and on his face nothing but kindness and a queer whimsical look of reminiscence. He broke off at the buzz of a disc that hung from his belt by a golden chain. He jerked it loose from its snap, and to his ear clasped a small receiver. Like a mask his gentleness dropped from him. His voice rasped:

"Yes? . . ." The receiver murmured into his ear. He said: "Connect him—I'll listen to what he has to say."

A moment; then on the tiny mirror fastened to his wrist with a strap, I saw a face appear—a face known throughout our Earth—the face of the War-Director of Great London. Tarrano listened impassively. When the voice ceased, he said without an instant's hesitation: "No!"

A decision irrevocable; the power almost of a deity seemed behind its finality. "No! I—will—not—do—it!" Careful, slow enunciation as though to make sure an inferior mentality could not mistake his words. And with a click, Tarrano broke connection. The mirror went dark; he hung his little disc and ear-piece back on his belt. Again he was smiling at us gently, the incident forgotten already—dismissed from his mind until the need to consider it should again arise.

"I remember you, Lady Elza, very well." A vague wistfulness came into his voice. "I wish to speak with you alone—now—for a moment." He touched two of the metal buttons of his shirt-front together. A man appeared in the narrow tunnel-entrance to the garden. A small man, no more than four and a half feet tall; a trim, but powerfully made little figure, in the black and white linen uniform worn also by Tarrano. Yet more pretentiously dressed than his superior. A broad belt of dangling weapons; under it, a sash of red, encircling his waist and flowing down one side. Over his white

(Continued on page 468)



The Simplest Practical Radio Set Made

\$ 1<sup>00</sup>

The RADIOGEM

The simplest radio outfit made—yet as practical as the most expensive. A crystal receiving set that you can operate and enjoy even though you know absolutely nothing about radio. You receive the RADIOGEM unassembled, together with a clearly written instruction book, which shows you how to quickly and easily construct the set, using only your hands and a scissors. The outfit comprises all the necessary wire, contact points, detector mineral, tube on which to wind the coil, etc., etc. The instruction book explains simply and completely the principles of radio and its graphic illustrations make the assembling of the RADIOGEM real fun.

AERIAL OUTFIT

Complete aerial outfit for the RADIOGEM, consisting of 100 ft. of standard copper aerial wire and two special porcelain insulators. Price .....50c.

- Radiogem - - - \$1.00
- Aerial Outfit - - - .50
- Radiogem and Aerial Outfit - - - 2.50

RAGEMCO

Radio Headquarters for the Finest and BEST Radio Tools



RADIO TOOLSET

This is the handiest set of tools ever made for Radio Work by the makers of the famous "YANKEE" Tools. It contains the following: 1 Ratchet Screw-driver, 6 1/2 in. long holding all attachments; 1 Blade, 5 1/2 x 3-16; 1 Blade, 3 1/2 x 1/4; 1 Blade 2 1/2 x 1/4; 1 Countersink; 2 Socket Wrenches for all small nuts; 1 Reamer to enlarge holes in panel from 1/8 x 1/2; 1 Wrench, one end 5-16" square or hex. for jack, other 1/2" hex., etc. PRICE per set—No. 701.....\$3.00



HAND DRILL

The hardwood handle is hollow to store drills. Iron frame, nicked parts, ball bearing three jawed chuck holding and centering accurately round shank drills, from 0 to 3-16. Length of drill, 12 inches. PRICE—No. 303.....\$2.25

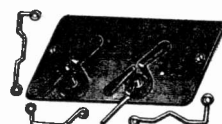

WIREBENDING TOOL

For making eyes, loops, bends, and offsets on Bus Bar wire. With this device any Radio Constructor can wire his set to compare favorably with any factory made set. Easier to use and more accurate than pliers. Full directions in box. Made of heavy steel, blued and finished. PRICE—No. 203.....\$1.00



CIRCLE CUTTER

Especially designed for the Radio Constructor. Made of the finest material and equipped with the highest grade high steel cutting bits. It does three things at once. It drills its own pilot, cuts out plug and puts bead or scroll around the hole in one operation. Cuts holes 3/8 to 4 in. in diam. PRICE—No. 402.....\$3.00 401. Same tool but smaller and not fitted with bead or scroll in one operation. PRICE—No. 401.....\$2.00

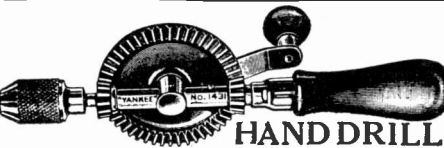

HAND DRILL

Especially designed for Radio Work by the makers of the famous "Yankee" Tools. A beautiful balanced, small, powerful drill with 4 to 1 ratio of gears for speed. Special chuck 9-32" capacity, to take largest drill, mostly furnished with drill or tool sets. Length over all, 9 1/2 in. Weight 1 1/2 lbs. PRICE—No. 302.....\$2.75



Three-in-One Nut Wrench. Consists of handle with hollow stem 6 inches in length and three interchangeable sockets fitting popular sizes of nuts. The hexagon sockets grip the nut solidly. PRICE per set—No. 301.....65c

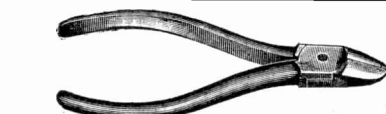

Side Cutting Nipper, Lap Joint. For cutting all kinds of wire. Jaws hardened and oil tempered. Natural steel finish with polished jaws. Length 6 inches. PRICE—No. 201.....75c

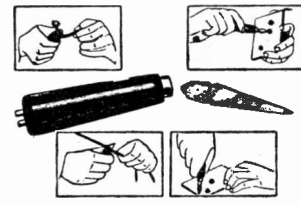

RADIO HANDI-TOOL

Bends Bus Bar or wire strips and scrapes wire, bores and reams holes, etc. Tool consists of 4 in. black japanned handle, to which is attached wire bending device, with nicked ferrule and 3 in. long two sided reamer. PRICE—No. 702.....50c



TOOL CHEST

Set consists of "LOCK-GRIP" master handle, 5" long, black Rubberoid finish with steel chuck, nickel plated, buffed and with the following 9 tools: Saw, brad-awl, large screwdriver, file, scratch awl, gimlet, reamer, chisel, small screwdriver. Each tool of fine steel, drop forged, tempered, hardened, and nicely finished. Set comes in leatheroid box with tray. PRICE—No. 703.....\$1.85

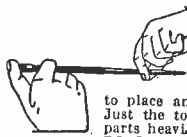

SCREW STARTER and DRIVER

Holds any screw by its slot with a firm grip, makes it easy to place and start screws in difficult places. Just the tool for the Radio Constructor. All parts heavily nicked and polished. PRICE—No. 304.....\$1.00

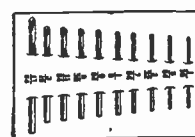

RADIO DRILL SET

Composed of 10 straight shank twist drills, fitting all hard and breast drills. The selection of these drills has been especially made for Radio Constructors and consists of the following sizes: 1-16, 5-64, 3-32, 7-64, 1/8, 9-64, 5-32, 11-64, 3-16, 17-64. Drills are mounted on white Holland Linen with sizes clearly marked. PRICE—No. 305.....\$1.25

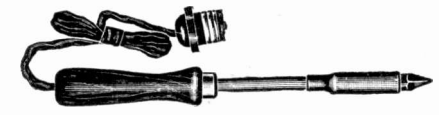

ELECTRIC SOLDERING IRON

A perfect tool for Radio Work. Operates either on 110-volt A.C. or D.C. The heat element is of Nichrome, which prevents overheating and assures the desired even temperature. Size of Iron, 10 1/2 in. long. A 4-ft. cord and plug is furnished. PRICE—No. 800.....\$2.00



Combination Plier, Wire Cutter, Wire Former and Wrench. Drop forged, slender but exceptionally strong. 6 in. long. PRICE—No. 202.....75c

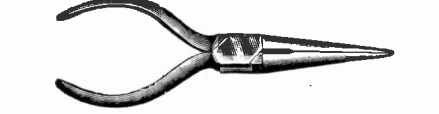

Long Sharp Nose, Side Cutting Pliers. Just the pliers for the radio constructor. Bends and cuts all kinds of soft wire. Nose 1 1/2 inches long, black body, polished jaws. Length 5 1/2 inches. PRICE—No. 200.....75c

Order all tools by order number. All goods are shipped free of transportation charges to all parts of the United States and possessions the same day as the order is received.

MONEY REFUND GUARANTEE

If you are not satisfied money will be refunded on return of goods.

The RADIOGEM CORP., 66-S W. Broadway, New York

# U.S. PATENTS



**SEND FOR THIS FORM**

**Don't Lose Your Rights**

Before disclosing your invention to anyone send for blank form "Evidence of Conception" to be signed and witnessed. A sample form together with printed instructions will show you just how to work up your evidence and establish your rights before filing application for patent. As registered patent attorneys we represent hundreds of inventors all over the U. S. and Canada in the advancement of inventions. Our schedule of fees will be found reasonable. The form "Evidence of Conception" sample, instructions relating to obtaining of patent and schedule of fees sent upon request. Ask for them,—a post card will do.

**LANCASTER & ALLWINE**

Registered Patent Attorneys in U.S. and Canada  
255 Ouray Bldg., Washington, D. C.  
"Originators of form Evidence of Conception"

# Patent Advice



Edited By  
**A. P. PECK**

In this Department we publish such matter as is of interest to inventors and particularly to those who are in doubt as to certain patent phases. Regular inquiries addressed to "Patent Advice" cannot be answered by mail free of charge. Such inquiries are published here for the benefit of all readers. If the idea is thought to be of importance, we make it a rule not to divulge all details, in order to protect the inventor as far as it is possible to do so.

Should advice be desired by mail a nominal charge of \$1.00 is made for each question. Sketches and descriptions must be clear and explicit. Only one side of sheet should be written on.

**NOTE:**—Before mailing your letter to this department, see to it that your name and address are upon the letter and envelope as well. Many letters are returned to us because either the name of the inquirer or his address is incorrectly given.

### CAM LEVER MOVEMENTS

(904) Jack Strobel, Baltimore, Md., asks which is the easiest way of converting cam movements into reciprocating movements in which the reciprocating movement must be larger or smaller, or the power greater or less than that produced at the cam.

A. The ordinary laws of the lever are applicable to the cam transmissions, the simplest of which are indicated here. These, of course, are made to fulfill your requirements as there are other movements than those shown.

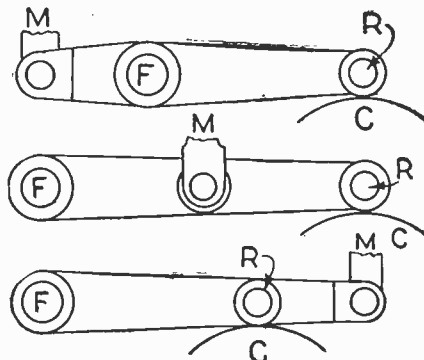

Various types of cam lever movements as requested by Mr. Strobel are illustrated above.

### SOLID AUTOMOBILE TIRE

(905) C. L. Stocks, Gainesville, Texas, asks if he should patent an automobile wheel of metal using a solid tire but giving resiliency.

A. We have had approximately three hundred automobile wheels called to our attention which do not use pneumatic tires. There is but one of these on the market, and this one is just a trifle different from all the others.

The hard rubber tire does not seem to operate as well as the pneumatic tire, and it seems as if it is almost impossible to secure such resiliency in a hard rubber tire as is obtained in the pneumatic type. Skidding on hard rubber tires is much more frequent, and more likely to result disastrously.

We would, therefore, advise that unless you are

positively assured of a market for your automobile wheel, you do not waste too much time and effort upon the idea. The possibilities of a market for the same are very slight at present in fact we might even say that there is no market for such a device.

### CORK EXTRACTOR

(906) Tracy R. Welling, Riverside, Utah, has designed a cork remover in the form of tweezers flattened at the jaws with small, sharp projections placed at right-angles to the jaws at the extremities. He asks our advice on the practicability and patentability of this cork extractor.

A. 1. With reference to your cork extractor, we would advise that we disagree with you with regard to the size of corks, which your extractor will remove from bottles.

Let us assume that you have an ordinary four-ounce bottle which is quite full, and the cork slips down into the neck. It is evident that the hinge will not permit the jaws of your cork extractor to open sufficiently wide to permit you to grasp the cork. How then would you remove it with this device? This would be particularly true if the bottle had a very narrow, long neck. One of the simplest cork extractors which the writer has seen, and which is almost infallible in its operation, is the device made of four pieces of iron wire. These are all twisted together at the handle and have a sleeve which slides down, permitting the cork to be gripped tightly at four places instead of two, as in your system. The cork, therefore, must come up through the neck of the bottle and must align itself with the neck, because of the fact that it is gripped evenly. It is evident that such an extractor is much cheaper to manufacture and answers the purpose better than your device. We would not advise you to apply for a patent on your system.

(Continued on page 466)

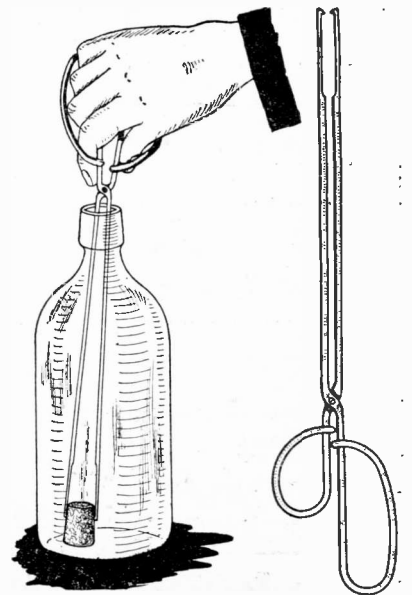

The cork extractor shown would be rather expensive to manufacture and impractical in use.

## AMERICAN PATENTS

Trade Marks, Copyrights

Foreign and Domestic

All patent and trade-mark applications are prepared and prosecuted by patent experts of many years' experience. Send us a sketch and description of your invention for our free and expert advice.

We have associate Patent Lawyers in all foreign countries.

**F. V. WINTERS, M. E.**

Registered Patent Lawyer

1133 Broadway, N. Y., Tel. Watkins 4748

## 1000 NEEDED INVENTIONS!

Here is the most remarkable book ever offered to inventors. One Thousand needed inventions listed and described. Arranged as follows: General Problems; Automotive; Mechanical; Electrical; Chemical; Radio; Marine. Separate chapter on the Ten Most Needed Inventions. This book may give you one idea that can win you a fortune. Nothing else like it has ever been published. Compiled at enormous expense. Edited by Raymond Francis Yates, formerly Managing Editor of a leading scientific magazine. Over 100 pages, durably bound. Send no money. Pay postman only \$1.00 plus postage on arrival. Money back after 10 days' examination if desired. Limited edition. Write NOW.

**BUREAU OF INVENTIVE SCIENCE**  
DEPT. 79 ROCHESTER, NEW YORK

## INVENTORS PROTECT YOUR IDEAS

Send for our Guide Book, **HOW TO GET A PATENT**, and Evidence of Invention Blank, sent Free on request. Tells our terms, methods, etc. Send model or sketch and description of your invention for **INSPECTION** and **INSTRUCTIONS FREE. TERMS REASONABLE. BEST REFERENCES.**

Name .....

Street .....

City .....

**RANDOLPH & CO.**  
Dept. 172, WASHINGTON, D. C.



was very queer, perhaps very impressionable. He knew he had nations and worlds to conquer—a destiny to fulfill. Not alone because of you, little Elza. I would not make you think that. But for you to share. The great Tarrano, master of the Universe, and his Lady Elza! Worlds for you to toy with, like gems on a thread adorning your white throat—”

He must have swayed her, the sheer power of him. Impulsively she touched his knee. “I am not worth—”

His face clouded with a frown. “I would not try to buy your love—”

“Oh,” she said. “No, I did not mean—”

“I would not try to buy you. I want to share with you—these worlds—as your due. To make myself master of everything, so that you will look to me and say, ‘He is the greatest of all men—I love him’ . . . Soon I will be the greatest of all men throughout the ages. And very gentle always, with you, Lady Elza—”

A buzz came from the disc at his belt. He answered the call—listened to a voice.

“So? Bring him here.” He disconnected. “. . . very gentle with you, my Elza—”

His voice drifted away. He seemed waiting; and Elza, her head whirling with the confusion of it all, sat silent. A moment; then Argo appeared, driving a half-nude man before him. A native official of Venja, stripped of his uniform. Argo flung him down in the garden path, where he cowered, his face ashen, his eyes wild, lips mumbling with terror.

Tarrano barely moved. “So? You tell me he was asleep at the mirrors, Argo?”

“Master, I could not help it! Since first you made your move in Great-New York at Park Sixty, I have sat there. Two nights and a day—”

“And you fell asleep without asking for a relief?”

“Master, I—”

“Did you?”

“Yes. I did not realize I was sleeping—”

A gesture to Argo, and the man was flung closer to Tarrano’s feet. Elza shrank away.

“Left a mirror unattended. So? . . . The wire, Argo.” He took the length of wire, gleaming white-hot, as the leering, gloating Argo turned the current into it—Tarrano took it, lashed it upon the poor wretch’s naked back and legs. Welts arose, and the stench of burning flesh. A measured score of the passionless strokes, with the man writhing and screaming under them.

It turned Elza sick and faint. Shuddering, she crouched there, hiding her face until the punishment was over and the half-unconscious culprit was carried away.

“Very gentle with you, my Elza. . . .”

She looked up to find Tarrano smiling at her; looked up and stared, and wondered what might be her fate with such a man as this.

(To be continued)

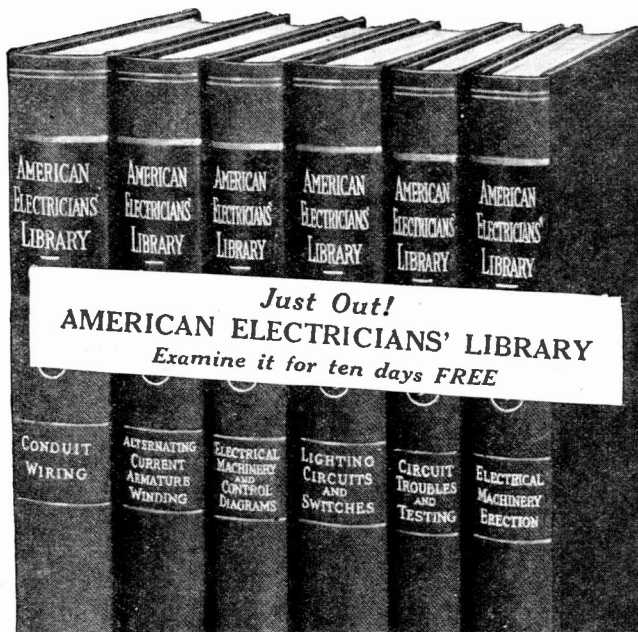

## A New Electrical Library for ambitious electrical men

This new electrical library is for the ambitious man who knows the fundamentals of electrical practice and wants to go ahead to the bigger, broader and more advanced branches of electrical work. It is the work of Terrell Croft—the outstanding American author of practical electrical books.

The six helpful and practical books cover the whole wiring field, giving you sound usable details about new and better ways of doing the work you have to do—telling you what experience has proved to be best—showing you what to look out for and what to avoid—outlining for you step by step the surest, quickest ways of testing, controlling, moving, erecting and caring for electrical machinery, locating troubles and remedying them, planning and installing wiring for all purposes, etc.

## American Electricians' Library

Six volumes—over 2000 pages—thousands of illustrations—thousands of diagrams.  
Special durable library binding.

\$2.00 in ten days and \$2.00 monthly for seven months.

The six books in this new library give you a plain and practical explanation of every up-to-date electrical method coming under the six volume headings:

- |  |  |
|--|--|
| Volume I—Conduit Wiring                              | Volume IV—Lighting Circuits and Switches |
| Volume II—A-C Armature Winding                       | Volume V—Circuit Trouble and Testing     |
| Volume III—Electrical Machinery and Control Diagrams | Volume VI—Electrical Machinery Erection  |

They tell you in clear, easily-understood language just what you have to know about these branches of electrical practice to qualify for the bigger paying jobs.

### These books fit you for the biggest jobs in electricity

The publication of this library is without question the biggest publishing event of the year in the field of electrical books. In it you get the helpful, detailed information you need every day on the job if you are concerned in any way with electrical wiring work. Even special problems like theatre lighting—conduit wiring in glue houses, in cold storage plants, in dry kilns—determination of insulation resistance, etc., are thoroughly covered. And all the common methods, practices, troubles and remedies in circuits are explained and described in detail. Nearly a thousand good-sized wiring diagrams—many of them not available anywhere else in such convenient form—are included.

### Six reasons why you should examine this library

- 1—This library is made up of the latest electrical books, presenting the latest data on circuits, circuit troubles and testing armature winding, electrical machinery erection, control and maintenance and wiring problems generally.
- 2—It offers you nearly a thousand wiring diagrams—many of them not available anywhere else in such convenient form.
- 3—It gives you step-by-step, practical information on pretty nearly every phase of electrical wiring and connecting.
- 4—It interprets and explains National Electrical Code rules in each case as they apply.
- 5—It shows diagrams and gives descriptions of many complicated circuits and control methods, many special wiring problems and many unusual armature winding problems for which experienced electricians are constantly looking.
- 6—It shows how to locate circuit troubles quickly and surely and how best to remedy them.

### Free examination—send no money Pay for the set as you use it

Don't send a penny. Just tell us you would like to look at this new fact-packed electrical library. We will send it to you at our expense. We will bring it back at our expense if you don't want it. To keep it, you need send only \$2.00 in ten days and \$2.00 a month until the special price of \$16.00 is paid.

Be sure to mail this free examination coupon

TODAY

McGraw-Hill Book Co., Inc., 370 Seventh Avenue New York

Gentlemen—Please send me the American Electricians' Library (shipping charges prepaid), for 10 days' free examination. If satisfactory I will send \$2.00 in ten days and \$2.00 per month until \$16.00 has been paid. If not wanted, I will write you for return shipping instructions. (Write plainly and fill in all lines.)

Name.....  
Address.....  
Position.....  
Company.....

S.I.9-1-25

### Interesting Articles in September "Radio News"

The Interflex Circuit. By H. Gernsback

This circuit includes the very latest adaptation of crystal and tube combination.

What Is the Nature of Fading. By J. H. Dellinger, Chief of the Radio Division of the Bureau of Standards.

See With Your Radio. By W. B. Arvin

The Dunoyer-Toulon Experiment. By Prof. C. B. Bazzoni of the University of Pennsylvania.

Underground Radio for Amateurs



## Many Star Salesmen make \$10,000 to \$15,000 a year

"THE man who knows how to sell goods," said a prominent sales manager recently, "is always in demand, and there is practically no limit to the salary he can earn. For he can show definitely what his efforts are yielding and he has something on which to base his demands for a larger income."

Many star salesmen earn \$10,000 to \$15,000 a year. Thousands earn \$5000 to \$10,000 a year. The former sales manager of the National Cash Register Company started as an office boy and at the age of 29 was getting a salary of \$72,000 a year.

These star salesmen aren't successful because of luck or accident—no, it isn't that—but because they've made a sincere study of their profession. And you've got to do the same thing if you ever want to get into the big money class.

The International Correspondence Schools have trained hundreds of star salesmen through spare-time study at home, and they will help you too if you will only make the start.

**Just mark and mail the coupon and we'll send you full particulars by return mail**

**INTERNATIONAL CORRESPONDENCE SCHOOLS**  
Box 6218-D, Scranton, Penna.  
The oldest and largest correspondence schools in the world  
Without cost or obligation on my part, please tell me how I can qualify for the position or in the subject before which I have marked an X:

SALESMANSHIP

- |   |   |
|---|---|
| <input type="checkbox"/> Business Management            | <input type="checkbox"/> Advertising            |
| <input type="checkbox"/> Industrial Management          | <input type="checkbox"/> Private Secretary      |
| <input type="checkbox"/> Personnel Organization         | <input type="checkbox"/> Better Letters         |
| <input type="checkbox"/> Traffic Management             | <input type="checkbox"/> Show Card Lettering    |
| <input type="checkbox"/> Business Law                   | <input type="checkbox"/> Stenography and Typing |
| <input type="checkbox"/> Banking and Banking Law        | <input type="checkbox"/> Business English       |
| <input type="checkbox"/> Accountancy (including C.P.A.) | <input type="checkbox"/> Civil Service          |
| <input type="checkbox"/> Nicholson Cost Accounting      | <input type="checkbox"/> Railway Mail Clerk     |
| <input type="checkbox"/> Bookkeeping                    | <input type="checkbox"/> Common School Subjects |
| <input type="checkbox"/> Spanish                        | <input type="checkbox"/> High School Subjects   |
| <input type="checkbox"/> French                         | <input type="checkbox"/> Illustrating           |

**TECHNICAL AND INDUSTRIAL COURSES**

- |   |  |
|---|--|
| <input type="checkbox"/> Electrical Engineering                           | <input type="checkbox"/> Architect                                   |
| <input type="checkbox"/> Electric Lighting                                | <input type="checkbox"/> Architects' Blueprints                      |
| <input type="checkbox"/> Mechanical Engineer                              | <input type="checkbox"/> Contractor and Builder                      |
| <input type="checkbox"/> Mechanical Draftsman                             | <input type="checkbox"/> Architectural Draftsman                     |
| <input type="checkbox"/> Machine Shop Practice                            | <input type="checkbox"/> Concrete Builder                            |
| <input type="checkbox"/> Railroad Positions                               | <input type="checkbox"/> Structural Engineer                         |
| <input type="checkbox"/> Gas Engine Operating                             | <input type="checkbox"/> Chemistry <input type="checkbox"/> Pharmacy |
| <input type="checkbox"/> Civil Engineer                                   | <input type="checkbox"/> Automobile Work                             |
| <input type="checkbox"/> Surveying and Mapping                            | <input type="checkbox"/> Airplane Engines                            |
| <input type="checkbox"/> Metallurgy <input type="checkbox"/> Mining       | <input type="checkbox"/> Agriculture and Poultry                     |
| <input type="checkbox"/> Steam Engineering <input type="checkbox"/> Radio | <input type="checkbox"/> Mathematics                                 |

Name.....  
Street.....  
Address.....

City..... State.....

Occupation.....  
If you reside in Canada, send this coupon to the International Correspondence Schools Canadian, Limited, Montreal

### For Your Boat



**Elto** Ole Evinrude's New Quick Detachable ROWBOAT MOTOR

Easily carried. Quickly attached to any boat (without tools). Drives boat any speed, 2 to 10 miles per hour. No rowing, no work, no bother.

**Fast—Light—Powerful**  
**Easy to Carry**

Has 12 exclusive features, all described in our new Free Catalog. Write for it today.

**Elto Outboard Motor Co.**  
Manufacturer's Home Bldg.  
Dept. 48  
Milwaukee, Wis.

**The Motor that Starts with a Touch**

Insure your copy reaching you each month. Subscribe to SCIENCE & INVENTION—\$2.50 a year. Experimenter Publishing Co., 53 Park Pl., N. Y. C.

# Doctor Hackensaw's Secrets

By CLEMENT FEZANDIÉ

(Continued from page 425)

terrestrial animals and plants owe their oxygen to the direct action of the sun. It is only in the sunlight that the chlorophyll or green coloring matter of the leaves can split up the carbon dioxide of the air into carbon and oxygen and so furnish the energy necessary for animal and plant life. Animals and plants obtain their energy by the re-combination of this carbon and oxygen into carbon dioxide again. It is the sun's heat that furnishes the energy used by plants and animals. Even man, with all his boasted inventions, has not yet succeeded in producing food except by means of the direct heat of the sun. If the sun's rays were suddenly cut off from the earth we should starve and suffocate as soon as the existing supply of food and oxygen was consumed. Energy exists in coal and other mineral products—the storage products of past ages of the sun's heat, but man has not yet found the key that would enable him to fully utilize these treasures. We shall certainly find it some day—chemistry is making rapid strides every year—but so far we have not met with success.

"Nature, however, may have forestalled us. There is no reason why she should not have evolved animals and plants that do not require oxygen in any form. They would, of course, require energy, but energy may be obtained from chemical combinations into which no oxygen enters. In fact, I am inclined to believe that these animals and plants that we see, are dependent for their energy upon some sort of electrical action—due, of course, to chemical action of some sort in their bodies. I imagine these creatures are really nothing but a kind of dry cell. Their phosphorescence is different from that with which we are familiar in glow-worms and fireflies. This looks more like the discharge witnessed in a Geissler tube. And you will notice occasional sparks and hear crackling noises. Evidently many, if not all, of these animals are highly electrified—probably, like the electric eel, they possess the power of producing this electricity at will. But, however that may be, my first step must be to admit a little of the outside air into the car and test it thoroughly."

No sooner said than done. The air was admitted and on test was found to be sufficiently oxygenized to render a landing possible without the use of the clumsy diving suits. How the air became oxygenized with no sunlight to furnish energy and no green plants to split up the carbon dioxide, the doctor was unable to determine. All he saw was that the air was respirable, so he proceeded to make the car fast to the rocks.

This was accomplished in the following curious but ingenious manner: The doctor had brought along with him several pairs of suction boots designed to enable the wearer to walk up and down the perpendicular walls of the pit. These boots have already been described. A steel framework, or basket, was worn by the climber under his clothing. This framework was rigidly attached to the boots and supported the wearer comfortably, enabling him without fatigue to walk up a perfectly vertical wall, his own body being horizontal.

It was Doctor Hackensaw's plan to use a pair of these suction boots as anchors for the car. This was accomplished in a trice, and when the air was exhausted from the boots, the car was moored to them and thus held securely. Meanwhile, our friends had each donned a pair of the suction boots after

removing the body framework, which was, of course, unnecessary in the present case. Then they cautiously landed on the rocks and prepared to explore this wonderful new land that they had discovered.

Fresh marvels greeted them on every side. Here was one peculiar creature that looked very much like an erect fan on three legs. Another one had what looked like a dog's head with three prehensile tails dangling behind. The creature used these for climbing over the peculiar tree-like stationary animals, curling their tails around the boughs or limbs. The nose of the creature was like an open funnel.

It would be impossible even to attempt to describe the strange plants and creatures presented to view. Most of them were decidedly grotesque, but some were exceedingly beautiful, among others a wonderful flying creature that looked like a large soap-bubble with a beautiful iridescence that flashed all the colors of the rainbow. Three gauze-like wings, the third vertical on the top of the body, enabled the creature to fly with ease.

Huge monsters there were, too; large, ungainly reptiles that fortunately kept at a distance. These all seemed to have six feet and some of them strangely suggested terrestrial insects in their general aspect. One of these creatures with a long, pointed bill, armed with sharp teeth, looked angrily at our adventurers and uttered a sound halfway between a bellow and a roar. For an instant it looked as if he were going to attack them, but then he thought better of it and turned around and moved slowly away.

Meanwhile, Miggs had caught hold of one of the immovable animals that were rooted to the ground, and he got a violent electric shock for his pains.

"Gee!" said he, as he rubbed his shoulder. There's some voltage there, you bet! I'd like to use this animal-plant to run my wireless set. No fear of not having enough juice!"

Doctor Hackensaw was specifically interested in noticing the various means by which the different species of animals and plants counteracted the lack of gravitation. Objects having no weight, the slightest movement of an animal was liable to shoot it off into the air, where it must perish miserably from hunger and thirst unless enabled in some way to get back to land again. Nature had provided some with wings, others with suction feet resembling those of flies, others still were rooted to the ground like plants, while still others were provided with a slimy substance like birdlime that glued them to the ground and yet allowed them to move about at will. But some of the creatures appeared to have no means at all of adhering to the rocks. These lived in burrows and seemed to depend entirely on the friction of their bodies in the burrow to keep them from flying off. This seemed evident from the fact that some of their dead bodies were floating around in the air, while others were evidently dying, having, through some accident, loosed their hold of the earth and been carried up into the air, and being unable to get back again.

Pep took pity on these poor creatures. "I'm going to catch them and put them back on the rock again," she cried, and suiting the action to the word, she suddenly let the air into the vacuum chamber of her suction boots, at the same time springing upward with all her might.

Her experience in the car ought to have taught her better. There being no attraction of gravitation here, the result could have been readily foreseen. The impetus of Pep's leap sent her flying high up in the air, turning a series of rapid somersaults as she went spinning up. Up! Up! Higher and higher she went, for she had got a good start, and Miggs and the doctor gazed at her in open-mouthed astonishment as she ascended.

"Gee!" cried Miggs. "She'll be dizzy all right. That beats anything that happened in the car! I bet she'll go a mile before she stops!"

She didn't go a mile, but she went up quite a distance before the resistance of the air finally brought her to a complete stop. There, faint from dizziness, she remained motionless a few moments and then started swimming slowly down through the air.

But several of the beasts had noticed her flight, and one monster, more venturesome than the others, decided that she might be good to eat. This was a ferocious-looking creature with crocodile-like jaws, a horn on the middle of his forehead, a pair of bony wings and a crested back.



## The telephone door

More people enter our homes and offices by telephone than in person. Through the telephone door, traveling by wire, comes a stream of people from the outside world on social and business missions. Important agreements or appointments are made, yet the callers remain but a few seconds or minutes and with a "good-bye" are gone. We go out through our telephone doors constantly to ask or give information, buy or sell things, make personal calls and on dozens of other errands.

None of the relations of life is more dependent upon co-operation and mutual consideration than these daily millions of telephone journeys. It is the telephone company's part to furnish the means of calling and to place courteous and intelligent employees at the service of the public. Good service is then assured when there is a full measure of co-operation between users.

Only by mutual care and consideration can everyone enjoy the full pleasures and benefits of calling. Telephone courtesy is for the good of all who use the telephone door.



AMERICAN TELEPHONE AND TELEGRAPH COMPANY  
AND ASSOCIATED COMPANIES

**BELL SYSTEM**

One Policy, One System, Universal Service

**Electrical Engineering**  
Course for men of ambition and limited time. Over 4000 men trained. Condensed course in Theoretical and Practical Electrical Engineering including the closely related subjects of Mathematics and Mechanical Drawing taught by experts. Students construct motors. Install wiring, test electrical machinery. Course complete

**In One Year**  
Prepare for your profession in the most interesting city in the world. Established in 1893. Free catalog.

**BLISS ELECTRICAL SCHOOL**  
249 Takoma Ave., Washington, D. C.

**Print Your Own**  
Cards, Stationery, Circulars, Paper, etc. Save money. Print for others, big profit. Complete outfits \$8.85 Job press \$12, \$35, Rotary \$150. All easy, rules sent. Write for catalog presses type etc. **THE PRESS CO., Y-47, Morden, Conn.**

Looks Like a Real **AUTOMATIC** \$1.48

Protect yourself from coughs and hold-up men. Most amazing automatic 4 1/2 in. long; gun-metal finish. Can't tell from real automatic until you pull the trigger and presto! you have Opera Glass, Reading Glass, Telescope, Pocket Mirror, Magnifying Glass, Mirror, Sun Dial, Compass, etc. Loads of fun; useful, instructive. A real protector.

**Send No Money**

**MAKES 10 USEFUL ARTICLES** Just send name. On arrival of "Automatic" deposit with Postman \$1.48 plus a few pennies postage. Satisfaction guaranteed or deposit refunded.

Supply limited. Order now. Big Barrain Catalog sent FREE.

**FERRY & CO., Dept. 1256, 3224 N. Halsted St., Chicago, Ill.**

**AGENTS WANTED SALESMEN DISTRIBUTORS**

To sell Blanche Thermostatic Carburetor Control. Makes Ford's run on 94% air. Doubles gas mileage. Sells on sight. Cadillac now uses thermostatic control under Blanche license. No experience needed. \$250. to \$2,000. a month profit. Write today.

**A. C. BLANCHE & CO., Dept. 863-M 602 W. Lake St., CHICAGO**

Insure your copy reaching you each month. Subscribe to Science and Invention—\$2.50 a year. Experimenter Publishing Co., 53 Park Place, N. Y. C.

### IMPORTANT

#### TO NEWSSTAND READERS

IN order to eliminate all waste and unsold copies it has become necessary to supply newsstand dealers only with the actual number of copies for which they have orders. This makes it advisable to place an order with your newsdealer, asking him to reserve a copy for you every month. Otherwise he will not be able to supply your copy. For your convenience, we are appending herewith a blank which we ask you to be good enough to fill in and hand to your newsdealer. He will then be in a position to supply copies to you regularly every month. If you are interested in receiving your copy every month, do not fail to sign this blank. It costs you nothing to do so.

To ..... Newsdealer

Address .....

Please reserve for me ..... copies of SCIENCE & INVENTION every month until I notify you otherwise, and greatly oblige,

Name .....

Address .....

Poor Pep's heart sunk as she saw the monster fly toward her. Doctor Hackensaw and Miggs gazed helplessly at the sight, and then the doctor, suddenly remembering that he had some atomic-energy pistols in the car, clambered up the ladder and emerged a few moments later carrying a pistol in each hand. These were peculiar-looking weapons. They hurled a bullet not much larger than BB shot, but the bullets were so constructed that, on striking an object, there ensued a release of atomic force which exploded the missile with undreamt-of violence.

Doctor Hackensaw was too late, however. The monster was already so close to the girl that the doctor dared not fire.

And now a fresh actor appeared upon the scene. Among the grotesque creatures in this strange land was one who bore a head that somewhat suggested the head of a man. Instead of arms, the man had four tentacles like those of an octopus. He had no wings, but he had two peculiar tails that curled up in a comical fashion. This creature appeared to possess intelligence. He, too, had watched Pep's flight through the air and his eyes followed her greedily. But it was evident he wanted her for a mate, not for a dinner. When he saw the winged crocodile start, his own mind was made up in an instant. He jumped on the back of a creature that slightly resembled a dragon-fly,



**what's new in radio?**

Developed by  
**R. E. LaCault**



**no panel  
no dials**  
**\$ 135.00**  
*Completely Wired*  
**built-in  
loudspeaker**  
*Write for Details*  
**ULTRADYNE**  
 MODEL L-3  
*Out Sept. 10<sup>th</sup>*  
**PHENIX RADIO CORP.**  
 114 E. 25<sup>th</sup> ST. N. Y. C.

and using two of his tentacles to drive the creature, he started off in hot pursuit. Though he had no wings of his own he had intelligence enough to use the wings of other creatures.

As usual, mind triumphed over matter. The light dragon-fly, even though encumbered with a rider, was far swifter than the heavier reptile and reached the crocodile just as the latter had opened his enormous jaws to swallow down poor Pep.

The rider had no weapons, but he seized the reptile with two of his tentacles and switched on his electric current. The shock must have been something frightful, for the monster gave a wild jump and then remained motionless—absolutely paralyzed.

The man, if so we may call the rider, grabbed Pep with his two free tentacles and then started his steed for land. Vainly Pep tried to disengage herself from this new monster's grasp. She had escaped one danger only to meet another worse one. Doctor Hackensaw looked vainly on, but dared not fire.

Meanwhile, the crocodile had slowly recovered from the stunning blow it had received, and perceiving that its enemy had not yet landed, it started in pursuit. Possibly it knew that the foe, having discharged its thunder, was powerless for awhile. At any rate, on came the reptile and, traveling faster than the dragon-fly with its double burden, reached the latter just as the man was about to land, and seizing him by the hindquarters, crushed them in its powerful jaws.

But now Doctor Hackensaw saw his chance. He raised his pistol and shot straight for the crocodile's tail. A tremendous explosion was heard and the rear end of the crocodile's body was hurled skyward in infinitesimal fragments.

The doctor then seized Pep, who, frightened but unhurt, had extricated herself from the loosened tentacles of the wounded man, and unwilling to remain longer in this dangerous region, he regained the car.

The rest of the journey is soon told. Doctor Hackensaw resolved to push on at once to the very center of the earth, and carried this resolution into effect, but he found nothing of special interest. It was merely one enormous sea of air with islands of various sizes floating in it. These islands were particles of the solid rock which had become broken off and hurled upward. Most were barren, but some of them contained animal and plant life.

The largest of these islands was about two miles in diameter. Here the party landed, and Pep was surprised to find that even on this large island the attraction of gravitation was inappreciable. But Doctor Hackensaw explained the matter as follows:

"Newton's law," said he, "is that the attraction varies as the mass of the attracting body, and inversely as the square of the distance from the center of attraction. Our earth has a radius of 4,000 miles. This island has a radius of one mile. The masses are as the cubes of the radii, hence the mass of the earth exerts a pull 64,000,000,000 times that of the island. But this figure of 64,000,000,000 is partially offset by the fact that here we are only one mile from the center of attraction, while on the earth we are 4,000 miles away. Hence the pull due to nearness is 16,000,000 times as great here. Taking both factors into consideration, the attraction on this island is only one four-thousandth of what it is on the earth. Miggs, who weighs, I believe, 100 pounds, would weigh here only one-fortieth of a pound—say, one-third of an ounce.

"Now, if Miggs were on the earth's surface and weighed only one-third of an ounce, he would shoot up into the air—not like a balloon, but like a sky-rocket. His buoyancy would be greater than that of a cork

**FREE!**

**12-Cell — 24-Volt Storage 'B' Battery**

Positively given free with each purchase of a WORLD "A" Storage Battery. You must send this ad with your order.

WORLD Batteries are famous for their guaranteed quality and service. Backed by years of successful manufacture and thousands of satisfied users. Equipped with Solid Rubber Case, an insurance against acid and leakage. You save 50 per cent and get a

**2-Year Guarantee**

**Bond in Writing** "tell their friends." That's our best proof of performance. Send your order in today.

<b>Solid Rubber Case Radio Batteries</b>	
6-Volt, 100-Amperes . . . . .	\$11.25
6-Volt, 120-Amperes . . . . .	13.25
6-Volt, 140-Amperes . . . . .	14.00
<b>Solid Rubber Case Auto Batteries</b>	
6-Volt, 11-Plate . . . . .	\$11.25
6-Volt, 13-Plate . . . . .	13.25
12-Volt, 7-Plate . . . . .	16.00

**Send No Money** Just state battery wanted and press C. O. D. subject to your examination on arrival. **FREE "B"** Battery included. **Extra Offer:** 5 per cent discount for cash in full with order. Buy now and get a guaranteed battery at 50 per cent saving to you.

**WORLD BATTERY COMPANY**  
1219 So. Wabash Ave., Dept. 42 CHICAGO, ILL.

**World** For **AUTO and STORAGE BATTERIES RADIO**

KDKA — WEAF — WGN — WJS — KHJ — KGO — KFAF — WJY — KOP

**I WILL PAY YOU TO TRY MY NEW INVENTION**



My new patented device which saves from 25% to 50% of gasoline is now ready for car owners. I want agents and am willing to send a sample at my risk. If it does not amaze and please you, I will pay you for trying it. Write for full particulars today. **J. A. Stransky, 100 Yale St., Pukwana, S. D.**

**SEXUAL KNOWLEDGE**

320 Pages; Illustrated; Cloth  
By Winfield Scott Hall, M.D., Ph.D.  
**SEX FACTS MADE PLAIN**

What every young man and every young woman should know—What every young husband and every young wife should know—What every parent should know.

Plain wrapper Table contents and commendations on request

**AMERICAN PUB. CO., 945 Winston Bldg., Philadelphia**

**SEND FOR THE INTERNATIONAL CATALOG**



Our net price list. Full line of auto bodies and accessories for Fords at Wholesale Prices. Save big money on bodies by buying Direct from Factory.

FOR FORD—Prices from \$27.85 up. Factory to consumer direct—Pay only One Profit

**International Body Wks, 914 W. Ohio St., Dept. 4, Chicago, Ill.**

**You can be quickly cured, if you**

**STAMMER**

Send 10 cents for 288-page book on Stammering and Stuttering, "Its Cause and Cure." It tells how I cured myself after stammering 20 yrs. **B. N. Bogue, 8120 Bogue Bldg., 1147 N. Ill. St., Indianapolis**

**\$1 DOWN \$1 PER MONTH EXPERT Home Training**

New Manual Plan on one of oldest, best, courses. Easy, Practical, Thorough. Brings success and money. For beginners or experienced men. **FREE 5 Days Trial, Send for Free Catalog.** Burgess Electrical School, 524-127 N. Dearborn St., Chicago

Insure your copy reaching you each month. Subscribe to **SCIENCE & INVENTION—\$2.50 a year.** Experimenter Publishing Co., 53 Park Pl., N. Y. C.

**Tire Agents Wanted**

Use and Introduce **MELLINGER CORD TIRES**  
**15,000 MILES GUARANTEED**

Lowest Wholesale Prices in America. Shipped prepaid on approval. Make big money all or part time. No capital or experience. Sample sections furnished.

**YOUR TIRES FREE!**

Simply send name today for FREE BOOK, telling how thousands do big business. Special Agents' Offer, Wholesale Prices and FREE Sample Kit.

**MELLINGER TIRE & RUBBER CO.**  
Dept. 311, Philadelphia, Pa., or Kansas City, Mo.

**C. L. PARKER**  
Ex-Member Examining Corps, U. S. Patent Office  
**Attorney-at-Law and Solicitor of Patents**

American and Foreign Patents secured. Searches made to determine patentability, validity and infringement. Pamphlet of Instructions sent upon request

**McGILL BUILDING WASHINGTON, D. C.**

Now if we decide to quit believing in ether, the question arises, how is light transmitted?

Einstein believes that light is really countless little particles of pure energy shot out from the luminous body. He treats these particles as "quanta." In effect this is an abandonment of the wave theory of light, and in the line of a return to the corpuscular theory. Newton, for example, held that light is made up of exceedingly minute corpuscles emitted by the luminous body. Many others of the old-time scientists believed the same. But they conceived tiny particles of matter, where Einstein conceived tiny particles of energy. Perhaps this is a distinction without a difference, for some scientists suspect that the electron, the ultimate particle of matter, is simply a particle of energy.

Certain actions of electrons and of heated bodies seem to give some support to this quantum theory of light.

Then came the question of how gravity operates without any intervening ether. Einstein's explanation was very ingenious.

He said "Suppose you step into an elevator carrying a heavy stone in your hand. As the elevator speeds up, the stone feels much heavier, because of the resistance of the inertia of the stone to the acceleration.

"Now suppose the elevator were off in space, away from the gravitation field of the earth, or of other bodies. When the elevator is at rest, the stone would weigh nothing. If you let go of it, it would float in space. But if the elevator is started, and constantly accelerated, the stone would seem to have weight. It would drop to the floor if you opened your hand. No ether is necessary for this effect."

From this line of reasoning, he predicted a certain shift in the lines of the sun's spectrum, so that it would not quite match up with the spectra of similar elements as observed on the earth. He also reasoned that gravitation has a pulling effect on light, and predicted that during an eclipse it would be found that certain stars near the sun were displaced slightly from their true position, due to the bending of the rays of their light by the gravitational field of the sun.

These two effects are still in controversy. Three eclipses have been observed since 1918, and scientists are still squabbling as to whether they proved or disproved Einstein. The effect is difficult to measure. For example, the refraction of the air, may produce displacement 50 times as great as Einstein's prediction. Moreover the laws governing the refraction of the air are imperfectly known, making this error very difficult to correct.

The spectrum shift is also in difficulties. The most delicate tests with a very sensitive spectroscope at the Mt. Wilson Observatory have failed to reveal it. On the other hand, two students of Bonn University believe they have found it.

But the ether drift is no longer in controversy. Prof. Miller has conclusively demonstrated its existence by an experiment that involves direct readings and no corrections. Unless the Relativity Theory can be modified as to explain the ether and ether drift, it must go down to defeat.

In the autumn of 1905, the same year in which Einstein published his first paper on relativity, Professors Morley and Miller had a third interferometer built of steel. This they mounted on top of a hill near Cleveland.

The location was 300 feet above Lake Erie, or some 800 feet above sea level. The country round about was open and free from large obstructions.

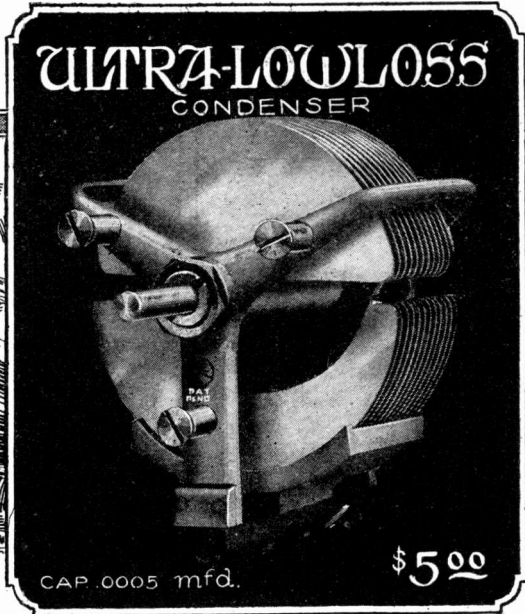
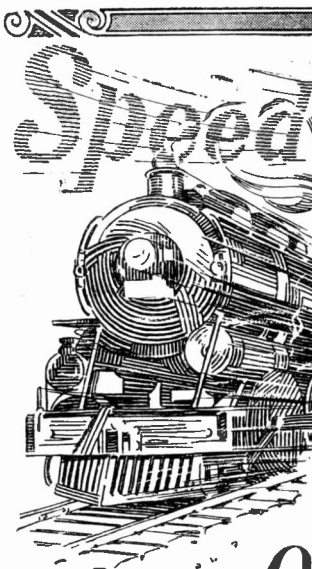

## Quick, positive tuning

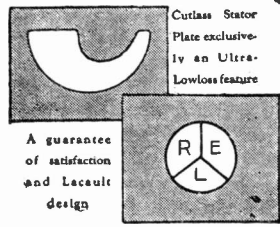

A guarantee of satisfaction and Laccault design

Cutlass Stator Plate exclusively an Ultra-Lowloss feature

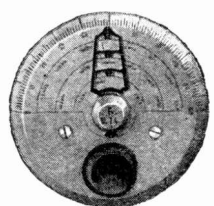

ULTRA-VERNIER TUNING CONTROL

Simplifies radio tuning. Pencl record a station on the dial—thereafter, simply turn the fnder to your pencil mark and you get that station instantly. Easy—quick to mount. Eliminates fumbling, guessing. A single vernier control, gear ratio 20 to 1. Furnished clockwise or anti-clockwise in gold or silver finish.

Silver, \$2.50  
Gold, \$3.50

Speed—ability to turn directly to any station, to tune-in instantly and get your station without interference from broadcasting on similar wavelengths—is the outstanding feature of the Ultra-Lowloss Condenser.

With one station of known wavelength located on the dial, all others can be found instantly. Special design of Cutlass stator plates distributes stations evenly over the dial—each degree on a 100 degree dial represents approximately 3½ meters difference in wavelength.

In addition, losses common in other condensers are reduced in the Ultra-Lowloss to a minimum by use of only one small strip of insulation, by the small amount of high resistance metal in the field and frame, and by a special monoblock mounting of fixed and movable plates. Designed by R. E. Laccault, E.E., originator of the famous Ultradyne receiver and Ultra-Vernier tuning controls.

At your dealer's; otherwise send purchase price and you will be supplied postpaid.

## ULTRA-LOWLOSS CONDENSER

PHENIX RADIO CORP., 114 E. 25th Street, NEW YORK

### PERSONAL STATIONERY 200 SHEETS and 100 ENVELOPES \$1.00

Printed with your Name and Address  
Clear, white bond paper, with envelopes to match. Your name and address printed in beautiful, rich blue ink, on both paper and envelopes, and sent to you postpaid for only \$1.00. (West of Mississippi river and outside of U. S. \$1.10.) If inconvenient to send the money, we will ship C.O.D. Money returned if you are not more than satisfied. Order today. Write name and address plainly.  
AGENTS MAKE BIG MONEY taking orders for us. Write us today for our agent's proposition.  
**ELITE STATIONERY COMPANY**  
5030 Main Street Smethport, Pa.

### HEAT Without Coal

Amazing invention does away with coal or wood: The Instant-Gas Oil Burner sets in firebox of any stove or furnace; burns 86% air and 4% oil; Gives three times the heat of coal, and cheaper; Better cooking and baking; Installed without damage to stove in five minutes—to furnace in an hour. Over 60,000 in use; Sold on money-back guarantee; 30 DAY FREE TRIAL and low introductory price to first users in locality. Write today for Free Book, "Scientific Oil Burning." Mention whether for stove or furnace. **International Heating Co.** Dept. 131-J 117S. 14th St., St. Louis, Mo.  
Agents: We pay \$60 a week. Write for Free Sample Offer

Insure your copy reaching you each month. Subscribe to Science & Invention—\$2.50 a year. Experimenter Publishing Co., 53 Park Place, N. Y. C.

**10 Days Trial FREE** **8 POWER PR M**



See objects miles away with these POWERFUL

**MILITARY BINOCULARS**

**ARRIVED!** Limited quantity GENUINE imported French and German Army Officer's Binoculars. 8-Power Achromatic lenses; **Premiere Qualite**—Genuine Prisms of remarkable light-gathering, light-transmitting properties. Central focusing, easily adjusted to any eyesight. Beautifully finished, superbly constructed. Prisms in each barrel permit of great field of vision, many times the area of Field Glasses. We have supplied hundreds of them to U. S. Army and Navy Officers. Such powerful Binoculars usually sell for \$40.00 to \$50.00. Our price (while they last) complete with genuine leather case and carrying straps **\$21**

Send NO Money! NOTHING To Pay Postman! See them! Examine them! Try them! If satisfied, after 10 DAYS' TRIAL, you may pay at rate of

**\$4 A MONTH**

or, if you wish to pay cash, after 10 DAYS, take **\$19.50** Discount and send check or money order for

**BROADEN** your field of vision! Don't live in a cooped-up area! A new world will open up for YOU with a pair of these wonder Glasses. You'll see things others can't. People, Scenes, Views, Games of ACTION brought right to your feet! The joys of outdoors are not complete without them. The greatest pleasure giving INVESTMENT one can make. Indispensable for sports—baseball games, motoring, camping, yachting, hunting, hiking, races, bird and nature study, etc.

Sent on 10 Days' FREE TRIAL!

**ACT! QUANTITY IS LIMITED! ORDER TODAY! Send NO Money!**



**WASHINGTON JEWELRY CO.**

Importers and National Mail Order House

365 Washington Street, Boston, Mass.

For prompt attention address Import Dept. 66

Gentlemen: Please send me 8-power Binoculars. I enclose NO money, and pay NOTHING to Postman. If I am satisfied after 10 DAYS' TRIAL, I have the privilege of paying for them at the rate of \$4.00 monthly—or of deducting \$1.50 and sending \$19.50 in FULL SETTLEMENT. Otherwise, I shall return them.

NAME .....  
ADDRESS .....

Please write PLAINLY! Tear this coupon out NOW! If you wish to tell us something about yourself it will be appreciated. S.I. Sept.

**Will You Wear This Suit?**



Show it to your friends and neighbors as a sample of our fine quality, hand-tailored All-Wool Suits, guaranteed \$40 values at a amazing low price of \$23.50, take their orders, keep handsome profit for yourself and send orders to us.

**Agents Making BIG MONEY**

\$3.00 to \$5.00 an hour in spare time, \$75 to \$150 a week for full time. We supply handsome Swatch Line Outfit, large size samples and all latest styles in elegant Leather Cases. Positively finest selling outfit ever furnished salesmen. Write for yours at once, pick out your suit and get started making the Big Money right away. Address Dept. 166.

**JAMES OLIVER, Inc.**

848 W. Adams Street Chicago Write name and address below and mail at once.

Name.....  
St. and No..... R. F. D..... Box.....  
Town..... State.....

Insure your copy reaching you each month. Subscribe to Science & Invention—\$2.50 a year. Experimenter Publishing Co., 53 Park Pl., N.Y.C.

Observations made here in 1905 and 1906 showed a small but positive ether drift, very much greater than any effect that could have been found in the basement. This indicated that the conception of the ether drag on the ether was justified. It indicated, also, that the drag decreased with altitude.

Nothing more was done until 1919 when the first eclipse observation following the publication of the General Theory of Relativity, brought the attention of the world to matters of that sort. Then Prof. Miller decided to work the experiment again, this time on top of a mountain.

Mt. Wilson, California was chosen. Its summit is 6,000 feet above sea level. It is equipped with laboratories and other accommodations making it desirable. The heads of the observatory placed a suitable structure at Prof. Miller's disposal, and he set up his interferometer.

117 sets of observations were made that year, and they indicated an ether drift much greater than the one found in Cleveland. But Prof. Miller wished to be sure, so he made no announcement at that time. The interferometer used was steel, and he feared that the observed effect might be due to some magnetic disturbance. He made another of concrete. Brass and aluminum mountings eliminated every possibility of magnetic effect.

In December 1921, more readings were made with the concrete interferometer, showing the same results.

Though fully satisfied in his own mind, Prof. Miller again withheld announcement to the world. The results involved our whole conception of the universe. The opposing camp of relativists would assail them if they were not beyond all doubt. He did not take any chances. He returned both interferometers to Cleveland, where he subjected them to every possible test during the next two years. Every effort was made to eliminate even the most remote possibility of error. As it had been found that the steel interferometer worked as well as the concrete, it was decided to use it in the final tests.

The steel interferometer was taken back to Mt. Wilson last summer, and during the fall and winter observations were made. Final results were reported to the National Academy of Science last April.

These results indicate a relative motion of the ether and the earth of 10 kilometers per second at Mt. Wilson. Allowing for the drag, this is not out of harmony with astronomers' calculations.

Obviously, Prof. Miller concludes, there cannot be an ether drift without ether, and to quote Charles L. Poor, professor of celestial mechanics at Columbia University, "The very basis of the Relativity Theory is destroyed, and the whole Einstein structure collapses."

Prof. Miller himself is reluctant to say that Einstein is wrong. He contents himself with the following statement; which is taken from his address to the National Academy:

**CONCLUSIONS—**

"The ether drift experiments at Mt. Wilson during the last four years, (1921-1925) lead to the conclusion that there is a relative motion of the earth and the ether at this observatory of about 10 kilometers per second, being one third of the orbital motion of the earth. By comparison with the Cleveland observation this suggests a partial drag of the ether by the earth, which decreases with altitude.

"It is believed that a reconsideration of the earlier Cleveland observations, from this point of view, will show that they are in accordance with the Mt. Wilson results, and will lead to the conclusion that the Michelson-Morley experiment has never given a true zero result, and therefore it cannot be

**A new Parks!**

**Cabinet Shop Special**  
No. 7  
**\$250**  
AS ILLUSTRATED WITH MOTOR

You ought to have this handy Parks in your shop!  
A compact, complete machine designed just like a big production outfit at one-fifth the cost. Nothing extra to buy. Motor is included, operating from any light socket. Fits in a corner of your basement. Does any kind of cabinet and joinery work. Circular saw, jointer and bandsaw on permanent all-steel frame. Add lathe, shaper and other attachments at small cost. You can make money with this Parks! Write for circular.

**The Parks Ball Bearing Machine Co.**  
1553 Knowlton St., Cincinnati, Ohio  
Canadian Fac: 200 Notre Dame East, Montreal, Can.

**PARKS WOODWORKING MACHINES**

**Easy to Play Easy to Pay**

**BUESCHER True-Tone Saxophone**

**CLYDE DOERR** Of Clyde Doerr and His Orchestra, with his Buescher True-Tone Saxophone.

Easiest of all instruments to play and one of the most beautiful. Three first lessons sent free give you a quick easy start—in a few weeks you can be playing popular tunes. No teacher necessary. You can take your place in a band or orchestra in ninety days, if you so desire. Most popular instrument for dance orchestras, home entertainments, church, lodge and school. A Saxophone player is always popular socially and has many opportunities to earn money. Six Days' Trial and easy payments arranged.

**Free Saxophone Book** Shows all Buescher models and gives first lesson chart; also pictures of famous professionals and orchestras. Just send your name for a copy. Mention any other instrument in which you may be interested.

**BUESCHER BAND INSTRUMENT CO.** (168)  
Everything in Band and Orchestra Instruments  
725 BUESCHER BLOCK, - - ELKHART, INDIANA

**SELL to STORES CANDY GUM AND MINTS**

**40% to 160% Profit**

I will put you in business as my DIRECT FACTORY AGENT AND JOBBER, to take orders for my full line of candies, chocolate bars, mints and chewing gum. Unlimited opportunities for hustlers. No experience needed. I furnish everything. Every store and everybody buys. Work spare time or full time. Write today for catalog, selling plan and FREE SAMPLES. Exclusive territory. ACT QUICK.

**MILTON GORDON, 809 Jackson St., Cincinnati, O.**

**Straightens Shoulders —Increases Speed**

**THE NATURAL BODY BRACE**—Corrects stooping shoulders, straightens the back, gives the lungs chance for normal expansion, induces proper breathing. Brings restful relief, comfort, energy, and pep. For men and women.

**Costs nothing to try it**  
Write for 30 days free trial offer and free book.  
**NATURAL BODY BRACE CO.**  
Howard C. Rash, Pl. 286 Rash Bldg., Salina, Kansas

**1.25¢ By MAIL**

**QUESTIONS and ANSWERS**  
AIDS TO ELECTRICIAN EXAMINATIONS  
QUESTIONS and ANSWERS

Electricians' Examinations  
Diagrams, symbols, tables, notes and formulas for preparation for license.  
**READE PUB. CO.**  
296 Broadway, N. Y. City



considered as basic experimental evidence for the Einstein Theory of Relativity."

But that modest statement looks like complete defeat for Einstein. The Swiss scientist himself says: (Section XVI "Relativity"):

"Comparison with the discussion in section XII shows that also from the standpoint of the Theory of Relativity, this solution (that of Lorenz and Fitzgerald for the apparent failure of the ether drift experiment in 1887) was the right one.

"According to this theory there is no such thing as a specially favored (unique) co-ordinate system to occasion the introduction of the ether idea, or any experiment to demonstrate it."

In other words, he says, "there is no ether, no ether drift, and no experiment can demonstrate their existence."

If the other effects predicted by Einstein, had showed up as clear cut, and beyond doubt, the theory might stand, but apparently they have not.

A clever French mathematician (Painleve), has recently stated that the mathematical series which is the basis of the Einstein Theory, is one of a great number of similar series. He also says that one of these series corresponds to Newton's law of gravity.

## Trombone Mute

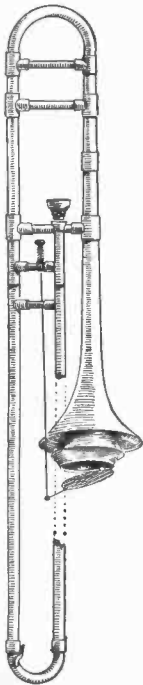

The illustration at the left shows a new type of wah-wah mute which is made for the trombone. The mute may be removed from the instrument at any time by simply pulling it out of the bell of the horn. The device is operated by the player's thumb who presses upon a small button within his easy reach, opens or closes the mouth of the mute, causing a characteristic sound to be produced. The mechanism is the invention of Mr. H. Bernard, who also designed that small fish-like musical instrument which whistles like a bird, and which is called the Octavet. Both instruments were featured from Station WRNY recently.

### Reader's Forum

(Continued from page 437)

ble. I think that a course of this kind would be welcomed by a great many persons who find that it is rather difficult to follow the meaning in a written explanation.

I would suggest that you give illustrations of easily made apparatus that can be used in such a course. I know that such a plan would be welcome in my case. I have been looking for a suitable textbook on this subject, but find that most of the experiments given in them require rather elaborate equipment.

CLARENCE SAMPSON,  
Fosston, Minn.

(Many of the important experiments in physics are illustrated in SCIENCE AND INVENTION Magazine. The time-worn hackneyed experiments are generally illustrated in any laboratory physics manual or any college textbook on the subject. Consequently SCIENCE AND INVENTION makes a bid for the better or newer experiments in physics, which are not generally found in those textbooks available to the reading public. Nevertheless, the editors would like to hear from the readers on the points brought up by Mr. Sampson.—EDITOR.)

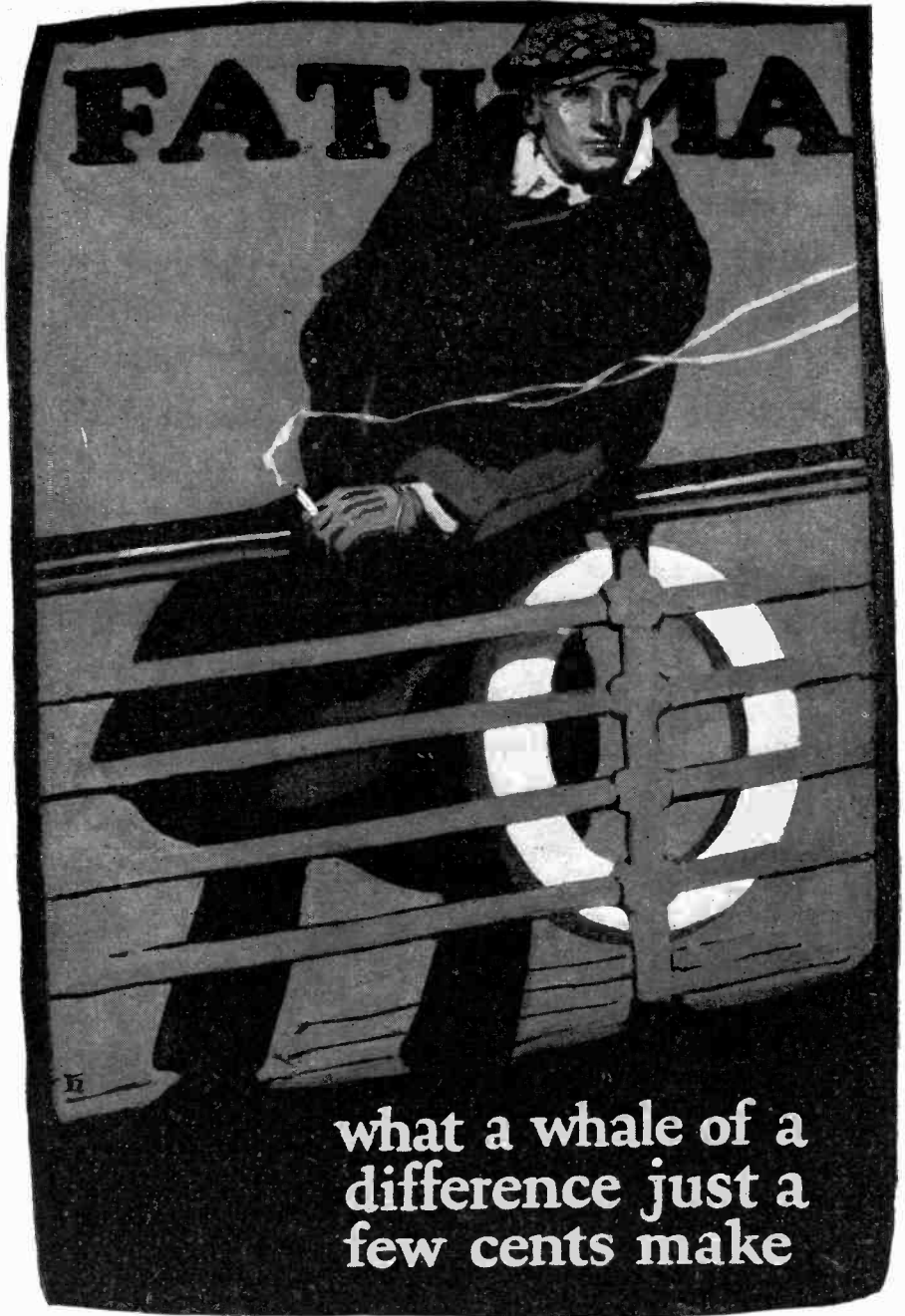

what a whale of a difference just a few cents make

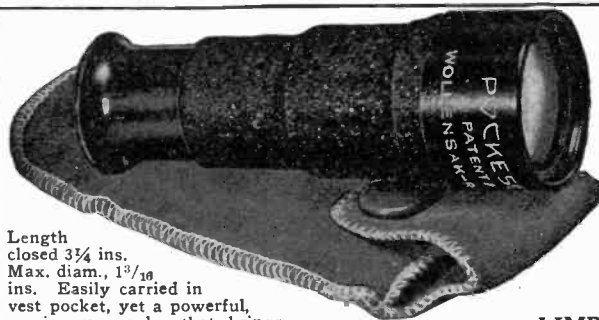

6 POWER, ACCURATE, STEADY, CLEAR,

Pocket Telescope

(Genuine) \$2  
(Wollensak)

POSTPAID WITH LIMP LEATHER CASE

Length closed 3 1/4 ins.  
Max. diam., 1 3/16 ins.  
Easily carried in vest pocket, yet a powerful, precise monocular that brings distant objects close, in full detail, without the "vibration" present when high power telescopes are used. Mighty neat, black, baked-in enamel with non-slip grip. A wonderful little 'scope for hunting, boating and general use. \$2 postpaid. Check, money order or C.O.D. Money back if not thoroughly satisfied in every respect.

BOSTON SPORTING GOODS CO. DEPT. B 80 BOYLSTON ST. BOSTON, MASS.

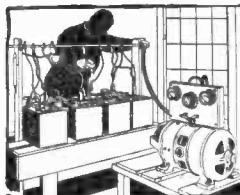

**HB ONE DAY BATTERY CHARGING EASILY CLEANS \$150 to \$300 MONTHLY PROFITS**  
Start a money-making battery charging business and add \$150 to \$300 every month to your income. Thousands of HB owners with no previous experience now own the big battery service station of their city. You can do it, too. Only \$35 cash brings a complete HB One Day Battery Charging Outfit, ready to use. Your monthly profits easily carry the small monthly payments. 30 days' free trial on money-back guarantee. The best and lowest-priced complete outfit on the market. Write for free bulletin. Start your own money-making business.  
HOBART BROS. CO. Box S9 TROY, OHIO  
NOW ONLY \$35 PER MONTHLY MAKING SERVICE IN YOUR SHOP

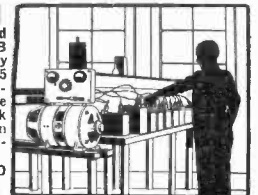

# The woman who entertains well—

There's something indescribably fine about the woman who entertains well. From the cheery appearance of her home to the service she so deftly affords—everything is so natural—yet so charmingly different.

Such splendid hostesses, once very rare and belonging only to the idle classes, are now to be found everywhere. They grace homes in every walk of life—making them happier through the many friends they attract.

Advertisements keep these women ahead of the commonplace. Advertisements tell of the newest and most delightful things. Advertisements announce new customs and practices. They tell what the world approves as correct.

The woman who entertains well must read the advertisements. Not only to keep pace with progress—but to learn how to do so on a limited purse. For advertisements are more than harbingers of style—they are announcements of economies that may be practiced safely.



*Read the advertisements—  
to know what is new, what is correct—  
and what is economical*

### ANOTHER S. & I. BOOST

*Editor, SCIENCE AND INVENTION:*  
I came across SCIENCE AND INVENTION on the bookstall recently, and after a careful study of its contents I am quite convinced that there is nothing like it on "this side of the herring pond." The only other paper in this country that I know of that is something like SCIENCE AND INVENTION is so technically dreary and likewise so small for the value given for it, that I have been compelled to look elsewhere for something of its nature, and the fates were kind to me when the golden cover of SCIENCE AND INVENTION caught my eye. (That last looks like poetry, but it was quite unintentional.)

Then again SCIENCE AND INVENTION seems to have a broader outlook than any English publication I have read. Mr. Gernsback's article on "Boys as Inventors" has my heartiest applause, but it would not meet with much encouragement from many of our somewhat narrow-minded educational experts on this side.

JOHN S. MORISON,  
Edinburgh, Scotland.

*(The constantly increasing number of pleased readers from the other side of the "pond" shows how popular SCIENCE AND INVENTION Magazine is becoming in foreign lands. It is the kind appreciation of readers like yourself that do much toward making the magazine what it is.—EDITOR.)*

### SUN SPOTS AND THE ICE AGE

*Editor, SCIENCE AND INVENTION:*  
In reading your magazine, I have come upon something which is quite puzzling. In the April issue there is an article on "Will There Be Another Ice Age?" In one of the illustrations it is stated that if the sun were to be covered with sun spots, the transmission of heat to the earth would be reduced.

In the May issue there is an article on page 76 wherein it is stated that "when there are few sun spots as in 1923 and 1924, the sun burns low. The time for many sun spots is now approaching, and like a fire when fresh coals are raked forward, the sun will send out more heat."

In reading the latter article I understand that the more sun spots there are on the sun, the greater the heat transmission to the earth, while in reading the first article I noted that when there is a lot of sun spots, the heat to the earth is reduced.

Will you kindly advise me of your opinion on this matter?

B. DE GRAAF, JR.,  
Yonkers, N. Y.

*(This interesting letter from Mr. De Graaf, Jr., is answered by Isabel M. Lewis, M.A., of the U. S. Naval Observatory, as follows:*

*"It is true that if the ENTIRE surface of the sun were covered with sun spots, the transmission of heat to the earth would be reduced for the temperature of the sun spot regions is 3,000 degrees C., while that of the normal solar surface is 6,000 degrees C.*

*"It is also true that the total solar radiation is greatest during the sun spot maximum period, in spite of the increase in the number of sun spots. Sun spots are but one of the signs of an increase in the intensity of solar activity, and though the temperature of these local solar storms called sun spots is low, and their number and the area they cover is increased very considerably over what it is at the sun spot minimum period, they still cover but a very small part of the total solar surface. The increase in the intensity of solar radiation from the unspotted areas more than offsets the decrease in radiation from the COMPARATIVELY SMALL sun spot areas. So the statements made in both articles are correct.*

*"It may seem strange and paradoxical, but it is also true that during the sun spot maximum periods when the solar radiation as a whole is increased, the surface temperature of the earth is lower by about two degrees than it is during the sun spot minimum period.*

*"This is believed to be due to the fact that there are more radiations of short wave-length from the sun during the sun spot maximum period than at any other time, and the effect of such radiations on the earth's atmosphere is to induce cloudiness and other temperature reducing effects, and so lower the earth's surface temperature in spite of the increase in the intensity of radiations from the sun. It is as if Old Mother Earth changed the texture of her atmospheric blankets at such times to protect herself against the increased intensity of the solar radiations."*

*Both articles are, therefore, correct.—EDITOR.)*

### S. & I. GIVES SERVICE

*Editor, SCIENCE AND INVENTION:*  
YOUR SCIENCE AND INVENTION MAGAZINE for June, 1925, shows a great improvement over other issues. The articles that proved of most interest to me were on page 126 by Dr. Harold Richards, Ph.D., and by Dr. Russell G. Harris on pages 127, 136 and 138. Also "Tests on Einstein's Theory" on page 39. We hope you will try and encourage this good work. Thanking you for the good service your magazine is rendering me, I am

A READER,  
Leighton, Penn.

*(Well, now, isn't that an interesting letter? The editors are liable to become conceited if many more of this type are sent to them, but they will always try not to become so, and will try to please.—EDITOR.)*

## WANTED-MEN TO LEARN RADIO



**\$75 to \$200 a Week**  
Right now, everywhere, big, easy money is being made in Radio. Field unlimited. You can master radio quickly at home in spare time. No previous experience necessary. Now is the time to enter this new, uncrowded field.

**1,000 Mile Receiving Set—FREE**  
Our new home-study methods make everything about radio amazingly simple. No other course like it. Makes you expert on radio operation, repairs and installations of all kinds. Send for literature telling all about opportunities and how we give 1,000 mile receiving set FREE. Don't miss this big offer—ACT. Write now for big free book.  
**Radio Association of America**  
4513 Ravenswood Ave., Dept. 69 Chicago

## Play a Conn SAXOPHONE



This Free Book tells about exclusive features which make the Conn easiest of all wind instruments to play. Send now for your copy and details of Free Trial! Easy Payments on any Conn instrument for band or orchestra.  
C. G. CONN, Ltd.  
956 Conn Bldg., Elkhart, Ind.



Creighton Hale, famous movie star and accomplished saxophonist uses a Conn, as do most prominent stars

Insure your copy reaching you each month. Subscribe to Science & Invention—\$2.50 a year. Experimenter Publishing Co., 53 Park Place, N. Y. C.

## Book Review

**PLAIN AND REINFORCED CONCRETE CONSTRUCTION.** By H. A. Saurbrey. Edited by W. S. Lowndes, Ph.B. Half leather covers, 5 3/4" x 8 1/2", 96 pages. Published by International Textbook Co., Scranton, Pa. \$1.50.

This is one of the most complete and easily understood treatises on concrete construction that has come to the reviewer's attention. It is thoroughly illustrated with extra clear line drawings and sketches, and the simple tables and rules given in the treatment on concrete construction will enable any mason or layman interested in the subject to compute the amount of sand, cement and rock needed for any size wall. The instructions given are progressive, and carry the reader right along through the elements of reinforced concrete construction, and simple examples are given on how to carry out this work. The book winds up with several excellent drawings of a large reinforced concrete building showing how the floors, columns, etc., are reinforced and poured. A closing chapter deals with concrete block wall construction, one of the new developments in cellar and building walls. This book is easily worth five times its cost to anyone interested even in a general way, in the subject of concrete construction.

**THE THEORY OF RELATIVITY,** by Erwin Freundlich. Hard covers, 5" x 7 3/4", 98 pages. Published by E. P. Dutton & Co., New York City. \$2.00.

We are informed that this book with a contents of only four items and no index is a simple but penetrating exposition of relativity. Alexander Pope in his essay on man, says: "God said let Newton be and all was light." The disposition of the present day would be to apply this quotation to Einstein, but everybody does not have good eyes. The book is by one of his German adherents. Viscount Haldane gives a nice introduction, and says that Dr. Freundlich explains his topics with lucidity.

**THE FOUNDATIONS OF EINSTEIN'S THEORY OF GRAVITATION,** by Erwin Freundlich. Hard covers, 5" x 7 3/4", 140 pages. Published by E. P. Dutton & Co., New York City. \$2.50.

Dr. Freundlich here gives us another volume on Einstein. This time it is preceded by a short preface by Einstein himself, whose concluding sentence says: "May his booklet prove a source of pleasure to many!" While it is not crowded with mathematics, when formulas are used they generally run into the calculus, and the book cannot be read appreciatively unless the reader brushes up on the higher mathematics. The absence of an index greatly impairs the value of the book.

**THE STORY OF BAKELITE,** by John Kimberly Mumford. Hard covers, 5 1/4" x 8 1/4", illustrated, 80 pages. Published by Robert L. Stillson Co., New York City. \$1.00.

This book is quite interesting as it deals with the early work on the synthetic resins before coming to Dr. Baekeland's great discovery. Some four years he worked with phenol resins, encountered the greatest difficulties in obtaining results, but at last developed bakelite, and by those who know in the radio field is duly blessed.

**SPACE TIME MOTION.** By A. V. Vasiliev, Alfred A. Knopf, New York. 5 x 7 1/2 inches, stiff cloth cover, \$2.50.

This volume by the famous mathematician and physicist, Vasiliev, translated from the Russian by Mr. Bertrand Russel, is to the mind of this reviewer, one of the most satisfactory he has come across in clearing up the present day advances in the philosophical conceptions of the "absolute" is space and time.

To the man in the street who has little, if any, mathematics—or if he has had them is rather rusty in their use—this volume will create a desire to dig out the old calculus book so that he may follow the simple mathematical conditions which are given. The book holds the attention—that is probably the best criticism which may be rendered on it.

Before attacking this book, the reviewer had started on more than seven other volumes dealing with the Einstein theories and had managed to survive each without the matter seriously affecting him, i.e., he was not forced by interest to continue them. Therefore, if you are not genu-

Sizzling Sun—Cold—Rain—Snow—Jars—Shocks—Exposure—  
do not affect the new SHOCK-PROOF

## Waltham "Sportsman" Strap Watch

REMARKABLE Waltham achievement. Designed for Camping, Hunting, Golfing, Fishing; all Outdoor Sports. Has wonderful SHOCK-PROOF movement with Steel Wheels, plates, escapement. Built into special DUST-PROOF, MOISTURE-PROOF case. Impervious to weather and shocks! We have sold hundreds to big business men, professional men, sportsmen. They are ASTONISHED at its marvelous performance! Regular price \$30. We bought several hundred of them at special price concessions. Our price (while they last).....\$22.75



2 Generations of Honorable Dealings

**WASHINGTON JEWELRY CO.**  
Importers and National Mail Order House  
365 Washington Street, Boston, Mass.  
For prompt attention address DEPT. 70  
Gentlemen: Please send me Waltham "SPORTSMAN" Strap Watch. I enclose NO money, and pay NOTHING to Postman. If I am satisfied, after 10 DAYS' TRIAL, I have the privilege of paying for it at the rate of \$1.00 monthly or of deducting \$1.75 and sending \$21 in FULL SETTLEMENT. Otherwise, I shall return it.

NAME .....

ADDRESS .....

Please write PLAINLY! Tear this coupon out NOW! If you wish to tell us something about yourself, it will be appreciated. ST-Sept.

SEND NO MONEY

10 DAYS' FREE TRIAL  
NOTHING TO PAY TO POSTMAN  
Wear it! Time it! Test it—under most strenuous conditions. If satisfied after 10 DAYS, you may pay at the rate of ..... \$4 a MONTH  
or, if you wish to pay cash within 10 DAYS, take \$1.75 Discount, and send check or money order for \$21

THE Strap Watch is here to STAY!—Increasing in popularity daily! It is so HANDY—SO CONVENIENT! No need to unbutton coats! No need to fumble in pockets! "A twist of the wrist—there's the time." THE WALTHAM "SPORTSMAN" is designed for dress affairs or sport. It is SMART looking. Handsome CUSHION shape that wins admiring glances. GOLD FILLED Case, double stock. RADIUM numerals and hands that show time in darkness VIVIDLY! STRAP is genuine pig-skin. A handsome, sturdy Watch for red-blooded Men! TODAY! Quantity is Limited. ORDER Send NO Money! 10 Days' Trial.



## WANTED

Men to manufacture Metal Toys and Novelties. Good chance to start your own well-paying business producing such big sellers as Toys, Novelties, Ash Trays, Book-blocks, Souvenirs, Advertising Specialties, Paper Weights etc. We furnish forms with complete outfit for speedy production. Absolutely no experience or tools necessary; no special place needed. Small investment puts you on road to success. Demand exceeds supply and we assist and co-operate with our manufacturers in selling their products. We put you in touch with the buyers and assure an outlet for your goods. Strictly a business proposition and thorough investigation invited. A splendid opportunity for an enormous and profitable business for ambitious men. No others need apply.

Catalog and information mailed on request.



Metal Products Co., 1696 Boston Rd., New York, N. Y.

## WANTED

### RAILWAY POSTAL CLERKS

\$1900 to \$2700 Year  
(Postal Salaries Just Raised)

TRAVEL—See Your Country  
MEN—BOYS, 18 UP SHOULD MAIL COUPON IMMEDIATELY  
Steady work. No layoffs. Paid Vacations



COUPON  
FRANKLIN INSTITUTE, Dept. G182, Rochester, N. Y.  
Sirs: Send me without charge: (1) Specimen Railway Postal Clerk Examination questions; (2) Schedule showing places of coming U. S. Government examinations; (3) Free sample coaching.  
Name.....  
Address.....

Insure your copy reaching you each month. Subscribe to Science & Invention—\$2.50 a year. Experimenter Publishing Co., 53 Park Place, N. Y. C.



# CHICAGO TECHNICAL COLLEGE



[22nd Year]

A MAXIMUM of practical training in a minimum of time is offered you by one of "America's oldest and largest schools of specialized engineering" . . . technical training of college standard for men who have neither the time, money nor preliminary education to attend a university. Over 1000 men enroll each year in day and evening classes.

### Short, Intensive Training

of a very practical sort puts you immediately into a high salaried position. Many of our students are assisted to responsible positions before graduation . . . they earn while they learn.

Chicago Technical College Bldg.



If you can't come to Chicago **STUDY AT HOME**

Ten months from today you can be a trained draftsman. . . Trained men are in demand. . . at high salaries. Enter a profession, without sacrificing time. Study

#### DRAFTING

in your spare time. . . We have been giving technical training for 22 years. . . Instructors are experts, the same instructors as in the resident school.

#### FREE TRIAL LESSON

To see how much you will like this high-grade profession, and

**FREE OUTFIT** a regular \$25 draftsman's outfit is included in the price of the course.

Send for **40-Page Book** of facts about drafting. . . send for it. . . free. Write today for the free trial lesson in drafting, sample drawings made by students and the book of information. Address Dept. 945

Courses are arranged to suit your needs: 2-year diploma; 3-year B. S. degree; special short courses adapted to the individual. Instructors are experts, actively at work in the very professions they teach. Tuition is low, terms easy. Enter any time.

### Write for Free 72-Page Blue Book

It tells about the courses (full descriptions); about the great demand for Chicago Technical College trained men; about college athletics and other interesting facts you'll want to know. Send for the Blue Book now, without obligation! Address

## Chicago TECHNICAL College

Dept. 59, 118 East 26th St., Chicago

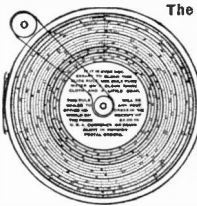

The Famous KON-VER-TER Slide Rule Instantly adds, subtracts, divides, multiplies, converts fractions or decimals of an inch. Gives sines, co-sines, versed sines, co-versed sines, tangents, co-tangents, secants co-secants of angles directly. Gives square roots, squares, cube roots, cubes and fifth roots and powers of all numbers. Logarithms, co-logarithms, anti-logarithms. Instructions with rule. DeLuxe Model \$3. Cash or C.O.D. New England Novelty Company Wakefield, Mass.

**PURE WOOL District Salesmen Wanted** Experienced men can earn easily \$100.00 a week at start. Our union made suits and overcoats at \$23.50 (none higher) are America's biggest values. We show latest nifty colors and styles for men and young men. Only pure wool fabrics. The overcoats are satin lined. Protected territory. Can use sparetime men in some towns. Write today for application blank and free sample of the world's greatest clothing values. Address F. W. HARVEY, Box 00, CHICAGO

inely interested in the subject, this book will cause you to become interested—and will satisfactorily give you at least some idea as to "what it is all about."

**THE AIRPLANE.** By Frederick Bedell, Ph.D. Hard covers, 6 x 9 1/4 inches, illustrated, 257 pages, with index. Published by D. Van Nostrand Co., New York City. \$3.00.

The author of this book has produced a really admirable manual. It is very practical, bringing out some of the features of airplane sustentation, little known to and appreciated by many, illustrating with numerous diagrams the action of the wings or airfoils which for a long time was so little known, bringing out the curious feature that an airplane carries its load principally by vacuum over the upper surface of the plane and very little by pressure below. It follows that the all-important thing about a wing is the curves given to the upper surface, a straight lower surface being practically as good as any.

Lateral stability, the securing of which was one of the great points in the claims of the Wright Brothers, is discussed, and it is brought out that ailerons hinged to the wings or between them, are now the usual appliances, the warping wing being but little used. The author gives practical details about flying, such as the approved methods of taking off and landing, but avoids the describing of how to do stunts, giving the book a conservative touch that is very much to be commended. Mathematics are used, but only elementary ones within the reach of all, and numerous diagrams clarify the subject.

**THE METALLURGY OF ALUMINUM AND ALUMINUM ALLOYS.** By Robert J. Anderson, B. Sc., Met. E. Hard covers, 6" x 9 1/4", profusely illustrated, 913 pages. Published by Henry Carey Baird & Co. Inc., New York City. \$10.00.

Looking through the table of contents of this book we find the subjects treated progressively, beginning with the ores of aluminum, including the famous, as we may call it, bauxite. A most interesting point brought out in the introductory portion is synthetic cryolite. This, it will be remembered, is the solvent of bauxite in the electrolytic production of aluminum, and an enormous amount has been imported from Greenland, but it seems that the synthetic cryolite is now preferred to the natural mineral. We are told how labradorite, a feldspar, has been used experimentally as a source of aluminum and potassium. It is fair to say that the production of potassium from feldspar is one great end to be achieved, and if the production of aluminum leads to this result, it will be a very epoch making development.

The production of aluminum receives a complete chapter giving an account of a number of processes, and going down into such details as the manufacture of the carbon electrodes. The chemistry, the physics and the mechanics of aluminum and a treatise on aluminum alloys is the subject of a most valuable and interesting chapter. Alloys are specifically dealt with again in later chapters, the practical manufacture as well as the uses thereof, and their qualities being considered. Then comes foundry practice, die casting and general mechanical treatment, and a very elaborate chapter is devoted to the thermal equilibrium of aluminum alloys. We often are asked how to solder aluminum, so here we have a whole chapter devoted to soldering and welding. We note that the spelling "aluminium" is used throughout, and while the spelling aluminum is perhaps oftener used, we feel that the author has done wisely in taking what is the better spelling of the word. The recovery of aluminum from foundry wastes and the like presents quite a problem. The affinity of heated aluminum for oxygen is so great that a finely divided mass of little globules or other scrap in many cases will not coalesce when melted, the coating of oxide preventing the globules formed in the melting from running together. Even such a fine point as this is treated under the head of secondary aluminum, the term being applied by the author definitely to the re-melting in order to save the metal of aluminum scraps. This naturally, as the author states, has grown to be a large branch of the industry. No less than ten million dollars worth represent the recovery in a single year in 1923.

We have said so much about the generalities of this subject that we have little room to speak of the subjects to be found further on. It will be enough to say that such topics as the physical and chemical properties of aluminum and its alloys are treated. The latter is most exhaustively treated, and all details including preparation, melting, foundry practice and the like are given. One chapter is devoted to an elaborate consideration of the thermal equilibrium of aluminum alloy systems. An interesting feature of this book of which we have said all too little, is that every chapter has its own bibliography, and a very nice feature is a double index, one of authors, and the other of subjects.

## Lead the World in LATHE Value

Quantity Production reduces our costs. We pass the saving on to you.

Prices	Quick Change Gear Lathes
9" x 3"	\$241.00
11" x 4"	288.00
13" x 6"	366.00
16" x 8"	498.00

Easy Payments if desired. Write for Catalog No. 84.

### SOUTH BEND LATHE WORKS

603 E. Madison St., SOUTH BEND, IND.

15" x 6" Quick Change Gear Lath, Price \$431.00.

**\$3.25 (CO)**

## RADIO Storage "B" Battery

**Lasts Indefinitely—Pays for Itself**

Economy and performance unheard of before. Recharged at a negligible cost. Approved and listed as Standard by leading Radio Authorities, including Pop. Radio Laboratories, Pop. Sci. Inst. Standards, Radio News Lab., Lefax, Inc., and other important institutions. Equipped with Solid Rubber Cases, an insurance against acid and leakage. Extra heavy glass jars. Heavy, rugged plates. Order yours today!

**SEND NO MONEY** Just state number of batteries wanted and we will ship day order is received. Extra Offer: 4 batteries in series (96 volts), \$12.70. Pay expressman after examining batteries. 5 per cent discount for cash with order. Mail your order now!

**WORLD BATTERY COMPANY** Chicago, Ill.  
1219 So. Wabash Ave., Dept. 92  
Makers of the Famous World Radio "A" Storage Battery  
Prices: 6-volt, 100 Amp. \$11.25; 120 Amp. \$13.25; 140 Amp. \$14.00.  
All equipped with Solid Rubber Cases.

# World FOR RADIO

**STORAGE BATTERIES**

KDKA - WEA - WGN - WJS - KHJ - KGO - KFAF - WJY - KOP

## OWN A TYPEWRITER

**\$3 and it's yours**  
if you clip this now

The ace of writing machines—at a bargain price! A free trial, and easiest monthly payments if you buy! This Underwood No. 5—rebuilt from top to bottom—five-year-guaranteed—removes the last reason for not owning your own machine. Get our proposition with new and valuable Typewriting Manual, free.

**FREE!** full particulars of free course in touch writing, if you mail this to SHIPMAN-WARD MFG. Co., 2166 Shipman Bldg., Chicago.

Name.....  
Address.....

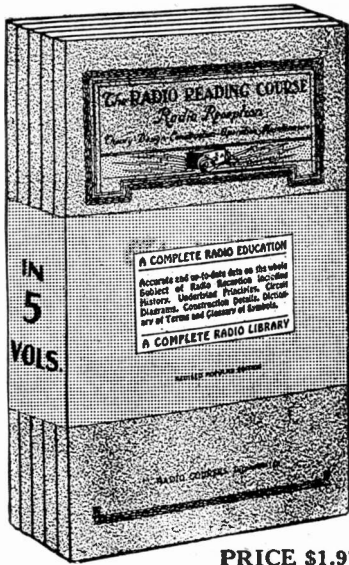

PRICE \$1.97

# A RADIO EDUCATION

IN 5 VOLUMES

Theory, Design, Construction, Operation and Maintenance

LEARN AT HOME

These five component parts of a complete Radio Instruction Course are outlined in five volumes that contain not merely the essentials as so many books do, but more, they contain all that any modern up-to-the-minute textbook on any subject would cover. They are in themselves a COMPLETE radio education teaching every possible portion of Radio science.

Size of each book 6 by 9 inches, handsomely bound and illustrated with charts, diagrams, descriptions of equipment, etc.

SEND NO MONEY for these books. Just forward your name and address. We send you the books at once. On receipt of same you pay the postman \$1.97 plus a few cents postage and then they are yours.

Distributed by

**The Conrad Co.**

233 Fulton St., New York, N. Y.

## RADIO WRINKLES

UNDER this heading we are going to publish items of interest to everyone who likes to build radio instruments. In order to continue this department it is necessary for our readers to tell us about their latest experiments. Write us a short description of some time- or money-saving kink you have discovered and send it to us along with a few sketches. Our regular prizes will be paid for this material. Be brief and try to put everything in the drawing. Don't be too elaborate. Address "RADIO WRINKLES" editor, care of Science and Invention.

### TERMINAL KINK

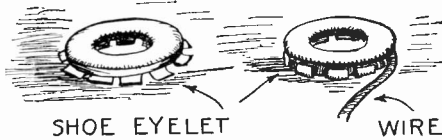

SHOE EYELET

WIRE

If the bare end of a connecting wire is fastened to the ordinary shoe eyelet it makes the matter of fastening a very simple matter. This is a real time-saver and prevents the wire from continually getting shorter due to breakage.  
—Detmar Standley.

### AERIAL SUPPORT

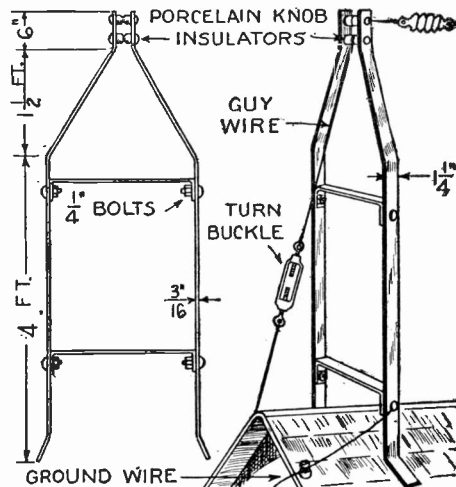

When in the course of installing your radio set you find that it is a difficult proposition to place your antenna on the roof because it is of the gable type, you will do well to construct this mast. There is no necessity for drilling holes in your roof or otherwise defacing it.  
—Robert J. Williams.

### VERNIER-NEUTRODON

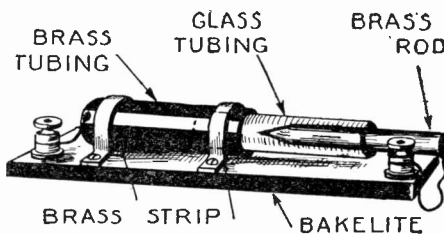

A combination vernier condenser and neutrodon or neutralizing condenser is readily made from the odds and ends found lying about. On a strip of bakelite is mounted a short length of brass tubing in which is placed a piece of glass tubing. A brass rod completes the device.  
—B. McCarthy, New Zealand.

(Continued on page 483)

When in  
**NEW YORK**  
LIVE RIGHT  
at the RIGHT PRICE

THE next time you visit New York, stop at the popular Hotel Martinique. A modern, fire-proof building, in the very midst of the shopping, theatrical and business districts, the Hotel Martinique offers every convenience to the busy visitor.

From the Martinique, you can go direct to any place in the city without even stepping out-of-doors, via enclosed subway.

The rates at the Hotel Martinique are as low as \$2.50 per day. Club breakfast 45c—delightful table d'hote dinner at \$1.25. Special luncheons are also served at the most moderate prices possible.

Investigate the extraordinary service and economy of the Hotel Martinique, by stopping here on your next visit.

A. E. SINGLETON, Res. Mgr.

The BEST without extravagance!  
**Hotel Martinique**  
Affiliated with Hotel McAlpin  
Broadway-32<sup>nd</sup> to 33<sup>rd</sup> Sts.  
NEW YORK

Play the **HAWAIIAN GUITAR** Just as the Natives Do

**FREE** when you enroll **\$15 HAWAIIAN GUITAR and Case**

Only 4 Motions used in playing this fascinating instrument. Our native Hawaiian instructors teach you to master them quickly. Pictures show how. Everything explained clearly.

Play in Half Hour After you get the four easy motions you play harmonious chords with very little practice. No previous musical knowledge necessary.

Easy Lessons Even if you don't know one note from another, the 52 printed lessons and the clear pictures make it easy to learn quickly. Pay as you play.

Free Guitar and Outfit in Genuine Seal Grain Fabrikoid Case as soon as you enroll. Nothing to buy—everything furnished. No delay.

Write at Once You'll never be lonesome with this beautiful Hawaiian Guitar. Write for Special Offer and easy terms. A postcard will do. ACT!

FIRST HAWAIIAN CONSERVATORY OF MUSIC, Inc.  
9th Floor, Woolworth Bldg., Dept. 40, New York, N. Y.  
Approved as a Correspondence School Under the Laws of the State of New York

Learn to Write

Begin Today—Write for My FREE BOOK. I can make a good penman of you at home during spare time. Write for My FREE BOOK, "How To Become a Good Penman." It contains specimens and tells how others mastered penmanship by the Tamblyn System. Your name will be elegantly written on a card if you enclose stamp to pay postage. Write today for book.

F. W. TAMBLYN, 424 Ridge Bldg., Kansas City, U.S.A.

Insure your copy reaching you each month. Subscribe to SCIENCE & INVENTION—\$2.50 a year. Experimenter Publishing Co., 53 Park Pl, N. Y. C.

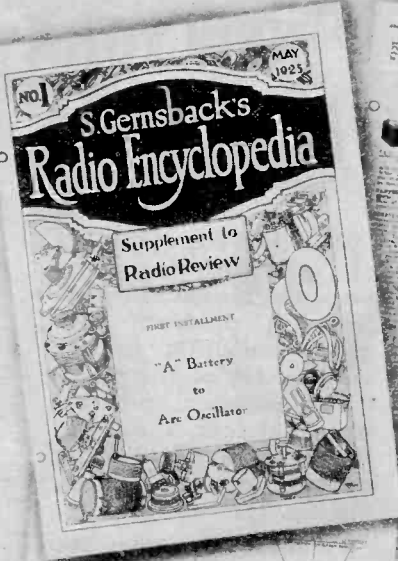

# RADIO REVIEW

Reg. U.S. Pat. Off.

## A Digest of the Latest Radio Hookups

Don't Miss the September Issue which Contains Many Important Features

### The Newest Thing in Radio Literature

A complete 100 page illustrated magazine containing hookups and constructional Radio articles, gleaned from the entire radio press the world over.

Large magazine size 9 x 12 inches, printed on fine paper and profusely illustrated.

**IN EVERY ISSUE A 16-PAGE SUPPLEMENT OF ONE INSTALLMENT OF S. GERNSBACK'S RADIO ENCYCLOPEDIA**

This real Encyclopedia of Radio explains every word used in Radio, by means of photographs, drawings, charts or tables. (Some sample pages are shown in this advertisement). This supplement is arranged in loose-leaf form.

35c the copy on all Newsstands and Radio Stores

Subscription price \$3.50 for 12 issues

Published by

**THE CONSRAD CO., Inc.**  
233 Fulton St., New York, N.Y.

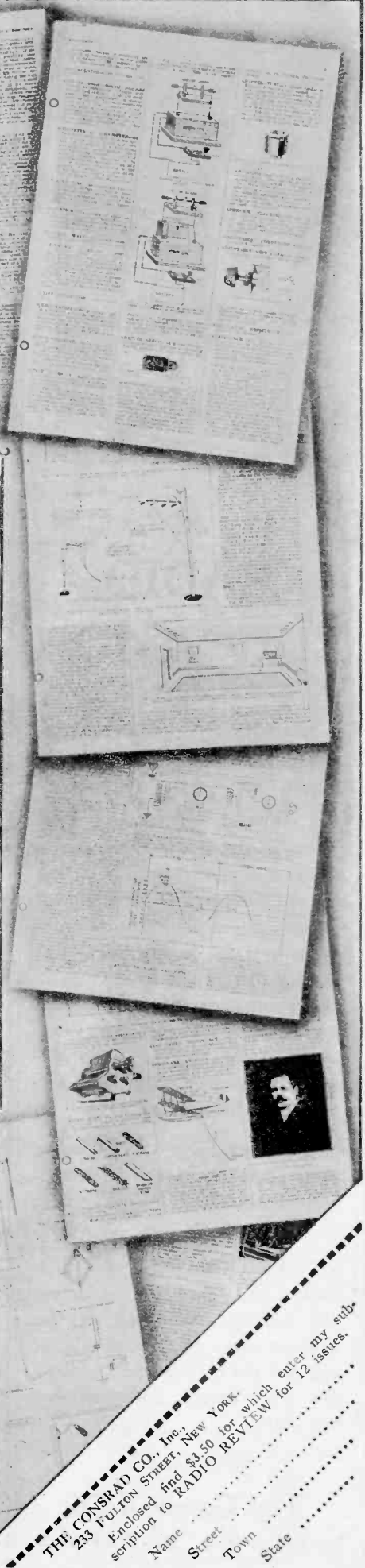

THE CONSRAD CO., Inc., New York.  
233 FULTON STREET, New York.  
Enclosed find \$3.50 for which enter my subscription to RADIO REVIEW for 12 issues.

Name .....

Street .....

Town .....

State .....



**ABSORPTION TUNING**

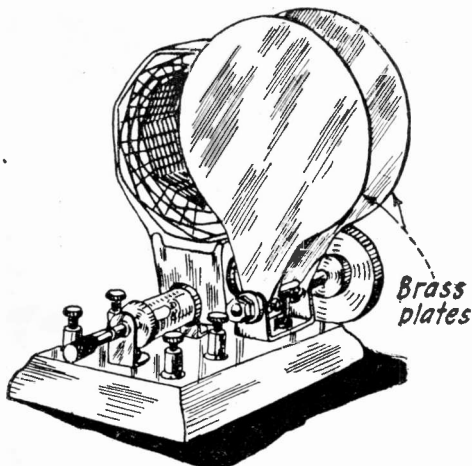

By mounting two brass plates so as to shield a honeycomb coil, it is possible to eliminate switch points and variable condensers and still obtain remarkably fine selectivity. A sensitive glass-enclosed crystal detector is used with this combination. —C. A. Oldroyd.

**POWDER HORN SPEAKER**

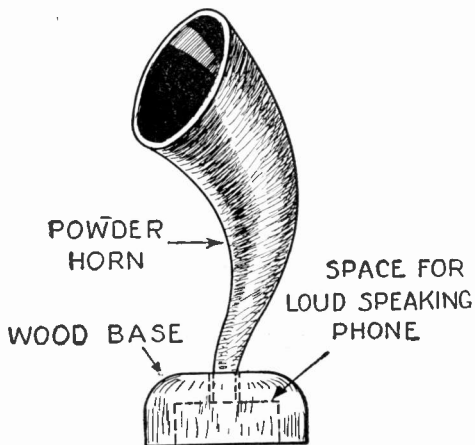

An old powder or cow's horn makes an excellent loud speaker. It should be as large as possible. One end is cut off and inserted into a wooden base which is recessed and into which is placed the phone unit. —M. W. Hemeon.

**"REMOTE CONTROL"**

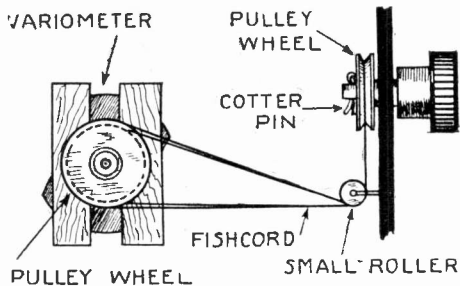

Not only is it sometimes unhandy to mount cumbersome instruments such as variometers, but often troublesome body capacity is experienced. If you mount the instruments using the remote control system, you will have not only protection from body capacity, but achieve a smooth vernier control. —Wayne B. Grieve.

**SOLDERLESS JACK**

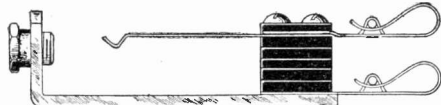

Providing a jack with the well-known Fahnestock clips makes it a very handy device which is always easily connected or disconnected in any circuit. No soldering is necessary. —F. E. Thompson, jr.

(Continued on page 485)

**I Fit You for Big Electrical Jobs Like These**

**You Can Be Ready in 20 WEEKS**



From common laborers to ownership of the U. & F. Electrical Company is what these boys did.

**S. & H. Fits You for Jobs Like These**

**A**FTER many years' study and experimental work there has been developed this remarkable way of teaching electricity right in your own home. This shop type home training is an exclusive copyrighted feature. You can get it nowhere else. And you receive a diploma actually certified and endorsed by the Lincoln Institute of Technology. You get theoretical knowledge as well as experience of doing practical work. That's why this amazing training is the quickest and the simplest ever devised. Electricity needs you. Right now hundreds of big pay jobs want men. The experts of this great institution know exactly what you need to fit you for these jobs. You can soon be equipped to demand and get the high salaries this profession pays.



G. Melrose is earning \$400.00 a month now because he was wise enough to take this electrical training of the famous S. & H. Engineering School.



Free offer of a complete outfit of electrical apparatus, instruments and appliances. Our big Free catalog gives you full information. Find out what S. & H. will do for you. Also about our big Free Employment Bureau. Do not delay. Mail the coupon now.

**S. & H. ENGINEERING CO.**  
In Affiliation with Lincoln "Tech"  
Dept. L-2, 1422 W. Monroe St., Chicago, Ill.

**Send for Big Book FREE**

If you want to be an electrical expert, send the coupon at once. All who send immediately will receive an amazing

**CHIEF ENGINEER**  
**S. & H. ENGINEERING CO.**  
1422 W. Monroe St., Dept. L-2, Chicago, Illinois  
Please send me catalog and full information about S. & H. Training, your Free Outfit, your Employment Bureau, etc. No obligation.  
Name .....  
Address .....  
City ..... State .....

**Learn Electricity - the Big-Pay Profession!**

...Big opportunities for men with limited time and money. We train you by actual practice on quarter-million dollars worth of new electrical equipment. Expert instructors. Short easy courses. Low tuition rates. No previous education required. 14,000 successful graduates.  
—FREE HANDBOOK—  
Big illustrated book shows you how to become an Electrical Expert and earn while learning. Write Dept. 569

**NATIONAL Electrical School**  
Los Angeles

**Learn Aviation**



**Take a W. A. C. Course in Applied Airplane Engineering**

At Home in your spare time. Be an expert Airplane Engineer.  
**EARN \$3,500 TO \$10,000 A YEAR**  
Practical course—takes only a few months. Write for special offer on free airplane parts and free catalog.  
**WESTERN AIRPLANE CORPORATION**  
Dept. S-9, Monadnock Bldg., Chicago

**JOHNSON'S NICKEL SILVER COMBINATION RULE** can be used as a Square, Hook-rule, Caliper-gauge, Protractor, Triangle or Tri-square, and can be applied to practically all classes of mechanical work.  
No. 46—6" Rule \$2.50; No. 45—12" Rule \$3.50  
Including chamois cases. Money refunded if not satisfied. Circular on request.  
**E. P. JOHNSON RULE MFG. CO.**  
565 W. Washington Blvd. Chicago, Ill.

**Make Money Taking PICTURES**



Tremendous, big-paying opportunities are open for ambitious men in Modern Photography. This is the picture age. Magazine and newspaper publishers buy thousands of photographs each year. Every manufacturer sends out high priced pictures of his products. Every home wants portraits. Photography is a business running into millions of dollars each year. And there is a great shortage of trained photographers.

**Get \$100 for Flood Pictures**  
"I took pictures of a flood and sold them for \$100. I have been able to buy my house and lot from the sale of pictures."  
C. M. Cole, Washington, \$97 in 2 Days!  
"I made \$285 in December. Went out two days last week on home portrait work and made \$97."  
A. G. Hughes, Kentucky.

**Earn \$3,000 to \$10,000 a Year**  
Hundreds of men are earning big money and establishing their own businesses. Even during spare time, while training, you can make \$75 a week easily—no matter where you live!

**Amazing New Easy Method**

I show you at home, how to do the kind of work turned out by the big studios in New York and Chicago! I show you how to make big money within 30 days! C. M. Cole bought a home with money he had made when only half way through his training. So well do I know what I can do for you that I guarantee

under bond to return every cent of your tuition if you are not thoroughly satisfied.

**Professional View Camera FREE!**

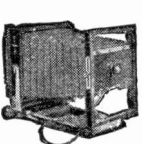

Write at once for Free Camera Offer—I give you, free, a splendid professional view camera. You will be astonished and delighted. This offer open for short time only—so act quick! No obligation.

**INTERNATIONAL STUDIOS, Inc.**  
Dept. 1426  
3601 Michigan Ave., Chicago, U.S.A.

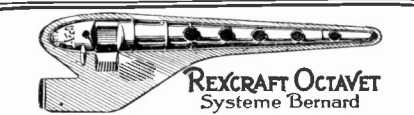

**REXCRAFT OCTAVET Systeme Bernard**  
\$1.00 postpaid. A whistle-like instrument. Cheapest, complete FAST scale made. 2 1/2 half tones from six holes (one complete flats and sharps). Aluminum 7 1/2 inches.  
Hear it September 11th, 9 P.M., WRNY.  
**OCTAVESHOP, 35 Duffield, Brooklyn, New York**

# The New Radio Stamp Fad

Here is the DX Radio Stamp Album just like the ones we owned in our youth, in which were placed the rare stamps of the countries of the world. Some were hard to get, some couldn't be purchased for love or money; but the fun of the hobby was the seeking of rare stamps and the eventual possession. So it will be with the DX Radio Stamp Album. There will probably be some stamps you will

never be able to own, but there will be many you will be proud to have and be able to show to other radio enthusiasts. It's an interesting game. Below the Album is shown the "Proof of Reception Cards" of which a generous supply is furnished with each Album. A dime placed in the hole in the card and sent to the station you heard brings back a stamp for your Album.



## You can get this handsome Stamp Album *FREE*

This beautiful EKKO Stamp Album, illustrated above, will be given away absolutely free, with a subscription to any one of our four magazines: "Radio News," "Science and Invention," "The Experimenter," "Motor Camper and Tourist."

Don't pass up the opportunity to get this valuable premium. With this album, you can keep through the means of beautiful engraved stamps, a certified record of every broadcast station you have heard on your radio set. Your friends will enjoy seeing it.

The album consists of 96 pages, size 9 x 12 and is bound in extra heavy stiff cover.

With the Album is furnished a large Crams comprehensive radio map of the United States and Canada; a supply of "Proof of Reception Cards" and also some stickers. The Album contains a list of broadcast stations of the United States and Canada with wave-lengths and columns for recording dial setting, a table of stations arranged according to wave-lengths and a section for log records.

We have acquired 1,000 of these Albums especially for our subscribers. The coupon on this page filled out and mailed to us with \$2.50 will entitle you to a twelve months' subscription to any one of our four magazines and one of these EKKO Stamp Albums free.

EXPERIMENTER PUBLISHING CO., INC., 53 Park Place, New York, N. Y.

Gentlemen: I have decided to take advantage of your special offer. I am enclosing \$2.50 for 1 year's subscription to ( ) "Radio News," ( ) "Science and Invention," ( ) "The Experimenter," ( ) "Motor Camper and Tourist" and one EKKO Stamp Album which you will send me free. (Mark to which magazine you wish to subscribe)

NAME ..... CITY .....  
ADDRESS ..... STATE .....

DON'T FAIL TO USE THIS COUPON

## McWilliams Selenium Cells



McWilliams selenium cells with a ratio of 50 to 1 for voice modulation and experiments with the amplification of Radio by light rays. Complete instructions and diagrams for simple experiments with the amplification of Radio by light rays free with each cell, or sent prepaid on receipt of 50c.

### Micro-amp Relay

Works with a current of 10 Micro-amperes. Contact points will not stick. Works in any position. Not influenced by shocks or jars. Double relay action. The most reliable instrument for relay work.

Prices and descriptive matter mailed on request.

**Electric B. G. Products Co.**  
ITHACA, MICHIGAN

### CRYSTAL DETECTOR

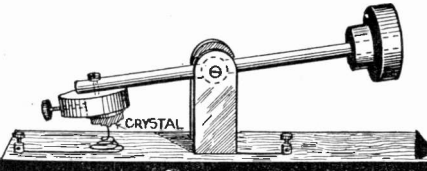

A new and novel method of mounting a crystal so that it is entirely dust proof is depicted herewith. The catwhisker is a spiral of springy phosphor bronze wire.

—Charles Mohr, Paris.

### ANTENNA MAST

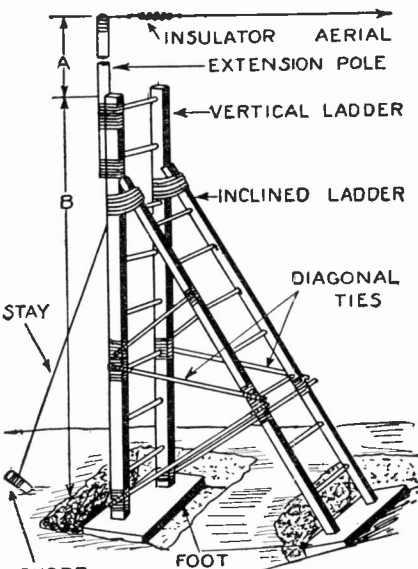

A very strong and substantial mast for the antenna support can readily be made by bracing together a few old ladders as shown in the diagram above. An extension pole, "A," no more than 25 feet long is wired securely in place.

—J. Seidman, Rep. 12001.

### HANDY WRENCH

SOLDERED  
HERE



No. 8 STIFF GALVANIZED WIRE

On many occasions it is necessary to use a small wrench for placing nuts in position. If a short length of heavy galvanized wire is bent and soldered as shown, it is found to be very useful. Several of these can be made for the various size nuts employed on a radio set.

—Robert J. Williams.

### RADIATION ELIMINATOR

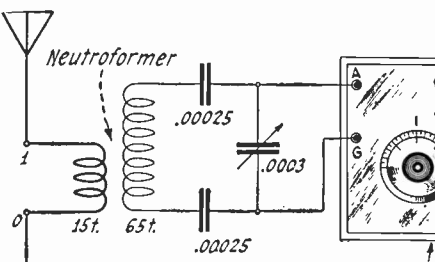

Regenerative Set

If you have a troublesome regenerative circuit which squeals and is not very selective, construct a wave trap by using a neutroformer in conjunction with two small fixed condensers. This acts both as an exceptionally fine wave trap and radiation eliminator which is bound to increase your receiving range to a great extent.

—E. E. Laufer.

## Rouse Your Bigger and Better Self to Action!

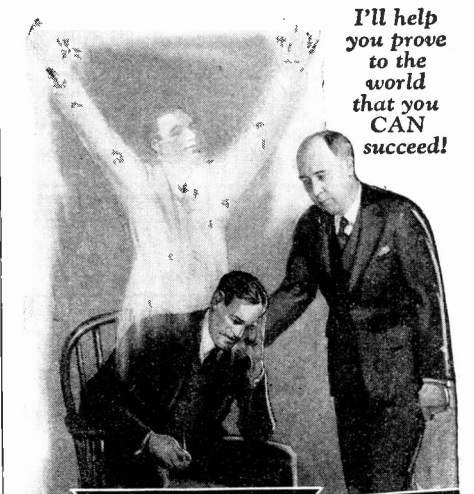

I'll help you prove to the world that you CAN succeed!

## ELECTRICITY

Remember, there is no substitute for personal training in great shops.

**—Will Fascinate You!  
—Will Thrill You!  
—Will REWARD You!**

**12 Happy Weeks at Coyne provides Complete Electrical Training**

**WHY LEAD AN INFERIOR EXISTENCE!** No need to drag through life with little or nothing of this world's goods in return for your hard, earnest labor. The chances are 100 to 1 you've got the right stuff in you. You've simply got to APPLY IT IN THE RIGHT DIRECTION!

**EVERY HONEST, SINCERE, WORTHY, AMBITIOUS FELLOW** is entitled to an even break in life. Right now is the time to solemnly promise yourself to get rid of the jinx that's chasing you through life!

**Hundreds of COYNE-Trained Men Earn \$60 to \$200 a Week**

I have perfected an unusual course of instruction in Electricity, a course that is absolutely thorough, is easy to master, covers every single phase and factor of the subject, fits men for HIGH electrical jobs — HIGH-SALARIED jobs.

**RAILROAD FARE TO CHICAGO**

from any point in the U. S. also extra courses in Radio Electricity and Auto, Truck and Tractor Electricity included WITHOUT EXTRA COST if you act promptly. Remember, Chicago is a wonderful city to see at any time of the year. It is a city of opportunities and the great electrical center of the world. Clip the Happiness Coupon below at once.

Tune in on COYNE Radio Station WGES

# COYNE

## ELECTRICAL SCHOOL

H. C. LEWIS, President      Established 1899

1300-10 W. Harrison St., Dept. 5336, Chicago

COYNE does not teach by correspondence, but by personal, practical training in the wonderfully equipped COYNE Shops



Get full details of Special Offer of Railroad Fare and Two Extra Courses. Send the coupon at once

H. C. LEWIS, President  
COYNE ELECTRICAL SCHOOL  
1300-10 W. Harrison St.  
Dept. 5336 Chicago, Illinois

Dear H. C.—You can just bet I want one of those big handsome FREE 12x15 books with 151 actual photographs of electrical operations and shop scenes, printed in two colors. Send it quick, before the supply is exhausted. Be sure and tell me all about Special Offer of Extra Courses and Railroad Fare.

Name \_\_\_\_\_

Address \_\_\_\_\_

## Cuts Gasoline Cost to 10 Cents a Gallon

James A. May of 863-M St., Sioux Falls, S. D., has perfected an amazing new device that is enabling car owners to cut their gasoline bills in half by doubling their mileage from gasoline used. Many owners have made over 40 miles on a gallon. It also removes carbon, increases motor power and pep, prevents spark plug trouble and overheating. Anyone can install it in five minutes. Mr. May wants agents, and is offering to send one free to one auto owner in each locality. Write him today.

### "LIGHTING FIXTURES"

READY TO HANG

Direct from the manufacturer. Completely wired including glassware. Send for new Catalogue No. 27 (Just reduced prices)

Special Proposition to Dealers

ERIE FIXTURE SUPPLY CO.  
Desk B      Erie, Pa.





## Opportunity Ad-lets

YOU will find many remarkable opportunities and real bargains in these columns. It will pay you to read and investigate the offerings made every month by reliable firms, dealers and amateurs from all over the country. No matter what you may be seeking, whether supplies, automobile accessories, the opportunity to make money, or anything else, you will find listed here the best and most attractive specials of the month.

Advertisements in this section twelve cents a word for each insertion. Name and address must be included at the above rate. Cash should accompany all classified advertisements unless placed by an accredited advertising agency. No advertisement for less than 10 words accepted. Ten per cent. discount for 6 issues, 20 per cent. discount for 12 issues. Objectionable or misleading advertisements not accepted. Advertisements for the November issue must reach us not later than September 10th.

**The Circulation of Science and Invention is over 175,000 and climbing every month**

EXPERIMENTER PUBLISHING CO., INC., 53 Park Place, New York City, N. Y.

### Agents Wanted

**Succeed with Your Own Products**—Make them yourself. Formulas, Processes by experts. Trade-Secrets. Modern master methods. Catalog free. D. Thaxly Co., Washington, D. C.

**Earn big money fast** applying gold initials to autos. Every owner buys—\$1.45 profit on \$1.50 sale—particulars and samples free. Write quick. Lithogram Co., Dept. 19, East Orange, N. J.

**Agents Wanted Full or Part Time** to sell on liberal commission new Thermomatic Automatic Carburetor control Attachment for Ford cars. Increases mileage 100%. No holes to drill. Attached in 2 minutes. Does automatically exactly what Ford Manual instructs driver do by hand. Cadillac now using Thermomatic Carburetor Control under Blanche license. Write at once. A. C. Blanche & Co., Dept. 863MX, 602 W. Lake St., Chicago.

**Robt. H. Ingersoll** of \$1 Watch fame wants good men to sell his Dollar Stropping outfit, an ingenious invention for sharpening all makes of safety razor blades. Great Economic value. Meeting with nationwide approval. Easy to sell. Big repeat business. Agents having remarkable success. Full particulars. Robt. H. Ingersoll, 47611 Broadway, New York City.

**Agents—Best seller;** Jem Rubber Repair for tires and tubes; supersedes vulcanization at a saving of over 800 per cent; put it on cold. It vulcanizes itself in two minutes and is guaranteed to last the life of the tire or tube; sells to every auto owner and accessory dealer. For particulars how to make big money and free sample, address Amazon Rubber Co., Dept. 601, Philadelphia, Pa.

**Agents—Write for Free Samples.** Sell Madison "Better-Made" Shirts for large Manufacturer direct to wearer. No capital or experience required. Many earn \$100 weekly and bonus. Madison Mfgs., 511 Broadway, New York.

**Big money and fast sales.** Every owner buys gold initials for his auto. You charge \$1.50; make \$1.35. Ten orders daily easy. Write for particulars and free samples. American Monogram Co. Dept. 71, East Orange, N. J.

**Earn \$10 daily** silvering mirrors, plating and refinishing metalware, chandeliers, bedsteads, headlights. Outfits furnished. N. Deele Laboratories, 1133 Broadway, New York.

**\$60—\$200 a week.** Genuine Gold Letters for store windows. Easily applied. Free samples. Liberal offer to general agents. Metallic Letter Co., 441 B., North Clark, Chicago.

**Write and learn how to start profitable business** without capital or experience. Silvering mirrors, refinishing auto headlights, tableware plating. Outfit furnished. International Laboratories, Dept. 25, 369 Fifth Ave., New York.

**\$10 daily silvering mirrors, plating and refinishing lamps, reflectors, autos, beds, chandeliers** by new method. Outfits furnished. Write Gunmetal Co., Ave. D, Decatur, Ill.

**Wonderful invention eliminates needles** for phonographs. Preserves records. Abolishes scratching. Day's supply in pocket. \$20 daily. Sample on approval if requested. Everplay, Desk H9, McClurg Bldg., Chicago.

**New Wonderful Seller.** Cost 10c, profit \$1.40, monogramming Autos. Experience unnecessary. Free samples. Worcester Monograms, B110, Worcester, Mass.

**\$100 Weekly Pleasant Work.** Appointing local agents to introduce Mother Hubbard Foods; no canvassing, no delivering, no money invested. Adam Inthout, 556 Congress, Chicago.

**Rummage Sales Make \$50 Daily.** Offer wonderful values. We start you. Wholesale Distributors, Dept. 171, 609 Division St., Chicago.

**Big Money and fast sales;** every owner buys gold initials for their auto. You charge \$1.50, make \$1.44. 10 orders daily easy. Samples, information free. World Monogram, Dept. 32, Newark, N. J.

**Skat Sales Agents Wanted.** All or Part Time for Skat Hand Soap, Metal Polish, etc. Strictly Commission. The Skat Company, Hartford, Conn.

**New camera takes and finishes photos** in one minute. Make money selling cameras or taking photos. Exclusive territory. Crown Co., Dept. 966, Norwalk, Conn.

### Agents Wanted (Continued)

**Agents—Make \$75 to \$100 a week.** "Fixit" Rubber Repair seals punctures and blowouts. Sample free. Marquette Rubber Company, 2325 N. Wolfram St., Chicago.

**Easy Money Applying Gold Initials, Monograms** on automobiles. Anyone can do it. Simply transferred from paper; takes 5 minutes. Make \$1.30, cost 5c. Samples free. "Balco," 1013 Washington, Boston, Mass.

**Your spare time—You can make from \$3.00 to \$5.00 an hour** in your spare time for every hour you put in, provided you really put it in and really work. If you are willing to do this, we are willing to take you, train you and fit you out with an outfit that will make it possible for you to make such money sure and from the very start. But make no mistake about it—this is no get-rich-quick, easy-money scheme. It is a straightforward legitimate selling proposition, for men who are salesmen or ambitious to be and want to put their spare time to good use. Ordinarily we don't bother with spare-time men, but we are willing to take and train a few men of character who will really work and make it worth their while and ours. If you are such a man let us hear from you. We'll consider your application carefully and give you a quick decision. Address Dept. 573, William C. Bartlett, Inc., 850 West Adams Street, Chicago.

**Only one sale a day means \$200 per month!** Marvelous new adding machine. Retail \$15.00. Work equals \$250 machine. Adds, subtracts, multiplies, divides, automatically. Computes feet and inches. Speedy, accurate, durable, handsome. Five year guarantee. Offices, Stores, factories, garages, lumbermen buy one to dozen. A fortune for live agents. Write quick for protected territory and free trial. Lightning Calculator Co., Dept. W, Grand Rapids, Michigan.

**New Plan for Agents—Goods supplied on credit.** Big line. Fine outfit free. No Money Needed. Write quick. Blair Laboratories, Dept. 56, Lynchburg, Va.

**Agents—Here's the best line of food flavors, perfumes, soaps, toilet preparations, etc., ever offered.** No capital needed. Complete outfits furnished free to workers. Write today for full particulars. American Products Co., 2267 American Building, Cincinnati, O.

### Battle Photos and War Relics

**For Dens:** Relics Collected from Europe's Battlefields. Firearms, medals, helmets, etc. Illustrated catalogue and sample War photographs 25c. Lieut. Welch, 1889 Albany Ave., Brooklyn, N. Y.

### American Made Toys

**Opportunity to start Manufacturing Metal Toys and Novelties.** No experience necessary. Enormous demand exceeds supply. We furnish, at cost, casting forms for production and buy entire output, also place yearly contract orders. Casting forms made to order. Catalog, advice and information free. Metal Cast Products Co., 1696 Boston Road, New York.

### Books

**Free—Upon request will send you my literature illustrating the following books.** Astrology, Character, Clairvoyance, Concentration, Healing, Hypnotism, Magnetism, Mediumship, Personal Magnetism, Personality, Physiology, Salesmanship, Seership, Success, Sex, Will, Yogi Philosophy, Gazing Crystals, etc. A. W. Martens, E. E. 6, Burlington, Iowa.

### Business Opportunities

**You can have a business-profession of your own and earn big income** in service fees. A new system of foot correction; readily learned by anyone at home in a few weeks. Easy terms for training, openings everywhere with all the trade you can attend to. No capital required or goods to buy, no agency or soliciting. Address Stephenson Laboratory, 18 Back Bay, Boston, Mass.

**Stop Plodding! Be Successful.** Operate a Tire Repair Shop. Make big profits in any locality. We teach you and furnish complete equipments \$100 up. Book of Opportunity free. Haywood's, 1312 South Oakley Avenue, Chicago.

### Business Opportunities (Continued)

**Get Money in Your Mail.** "Lambert's Mail Order Secrets" contains successful methods never before published. \$1.00 postpaid. Particulars free. Leon Lambert, Wichita, Kansas.

**Learn a trade and be independent.** Complete course in show card making. Clean, Dye, and Pressing or Candy Making for \$2.00, no extras. McPherson Co., Kewanna, Indiana.

**You want a Big Money making business of your own,** a sure winner, write for information on how to make beautiful marble, onyx, agate and turquoise from common cement. Spencer Laboratories, 315 Andrews Bldg., Dallas, Texas.

### Chemistry

**Learn Chemistry at Home.** Dr. T. O'Connor Sloane, noted educator and scientific authority, will teach you. Our home study correspondence course fits you to take a position as chemist. See our ad on Inside Front Cover of this issue. Chemical Institute of New York, 66 W. Broadway, New York City.

### Correspondence Courses

**Used correspondence courses of all schools sold, rented and exchanged.** List free. (Courses bought.) Lee Mountain, East Chattanooga, Tenn.

### Instruction

**Learn Chemistry at Home.** Dr. T. O'Connor Sloane, noted educator and scientific authority, will teach you. Our home study correspondence course fits you to take a position as chemist. See ad on Inside Front Cover of this issue. Chemical Institute of New York, 66 W. Broadway, New York City.

**Correspondence Courses sold complete;** one-third usual prices because slightly used; easy terms; money back guarantee. All schools and subjects. Write for special Free catalog. Courses bought for cash. Economy Educator Service, H202, West 49th St., New York.

### For Inventors

**We Develop Your Ideas** into commercial shape for presentation to purchasers making working models, drawings, experiments or tests. Courtesy, efficiency, secrecy and ample equipment; 30 years' experience. Ducorron-Rich Engineering Co., 304 Pacific Mutual Bldg., Los Angeles, Cal.

**Unpatented Ideas Can Be Sold.** I tell you how and help you make the sale. Free particulars (Copyrighted). Write W. T. Greene, 803 Jenifer Bldg., Washington, D. C.

**Your Chemical problems solved and working process** furnished for Five Dollars. Write me. W. Stedman Richards, Consulting Chemist, Box 2402, Boston, Mass.

**Expert Mechanical Designer and Draftsman,** over 20 years of Patent Office Work, Technical Engineering (Electrical and Mechanical) with Practical Laboratory, Machine Shop and Foundry experience, can be of Valuable and Strictly Confidential assistance to those with Ideas, and to Inventors or Attorneys having meritorious Devices and Novelties still Commercially Imperfect. Robert H. Moore, 400 West 23rd Street, New York City.

**Get Cash for your patent or invention** under our new plan. Write at once to Inventors' Syndicate, 22 Palladium Bldg., St. Louis, Missouri.

### For the Photographer

**Have you a Camera?** Write for free sample of our big magazine, showing how to make better pictures and earn money. American Photography, 118 Camera House, Boston, 17, Mass.

### For Advertisers

**Advertising in all magazines and newspapers** at publisher's lowest rates. Rate Book free. Taylor's Advertising Service, Dept. 6, Freeport, Ill.

**Advertising Agents**

I Write letters, folders, booklets, complete followup for manufacturers, mail order dealers. Long experience. Write for details. L. Taylor, Box J44, Freeport, Ill.

**Help Wanted**

Silvering Mirrors, French plate. Easily learned, immense profits. Plans free. Wear Mirror Works, Excelsior Springs, Mo.

All men-women, 18 to 65, wanting to qualify for Government Positions, \$140-\$300 monthly, home or traveling, write, Mr. Ozment, 293, St. Louis, Mo., quickly.

Men to Build Radio Sets in spare time. Leon Lambert, 670-H Kaufman Bldg., Wichita, Kansas.

Easy Money! Silvering mirrors, auto parts, tableware. Outfits; Plans Free. Sprinkle, Plater, 955 Marion, Indiana.

Absolutely no competition selling Val-Style millinery. Every woman buys. You make \$25 to \$150 a week. Write for Special Offer and Exclusive Territory. Val-Style Hat Co., A82, Val-Style Building, Cincinnati, Ohio.

Get a U. S. Government Job. Men 18-35. Railway Mail Clerks. Commence \$1900 year. Steady. 25 coached free. Write immediately. Franklin Institute, Dept. G21, Rochester, N. Y.

**Machinery and Tools**

Concrete Building Block Machines and Molds. Catalogue free. Concrete Machine Co., 305 South Third St., St. Louis, Mo.

**Miscellaneous**

Beautiful registered bull pups cheap. Bulldogs, 501 Rockwood, Dallas, Texas.

**Games and Entertainment**

Free with \$25 order our large die box. Send 20c for our large catalogue of tricks, puzzles, wigs, sensational escapes, Oaks Magical Co., Dept. 549, Oshkosh, Wis.

**Motorcycles—Bicycles**

Don't buy a Bicycle Motor Attachment until you get our catalogue and prices. Shaw Mfg. Co., Dept. 6, Galesburg, Kansas.

**Musical Instruments**

Violins—Deep, Mellow, Soulful—on easy credit terms. High grade, wonderful instruments of my own make. Development of many years' expertness. Write for book. Gustav A. Henning, 2424 Gaylord St., Denver, Colo.

**Old Money Wanted**

\$2 to \$500 Each paid for hundreds of Old or Odd Coins. Keep all old money, it may be very valuable. Send 10c for new illustrated Coin Value Book, 4x6. Guaranteed Prices. Get Posted, We pay Cash. Clarke Coin Company, 14 Street, LeRoy, N. Y.

**Patent Attorneys**

Millions spent annually for ideas! Hundreds now wanted! Patent yours and profit! Write today for free book—tells how to protect yourself, how to invent, ideas wanted, how we help you sell, etc. American Industries, Inc., 212 Kresge Bldg., Washington, D. C.

Inventors—Send for form "Evidence of Conception" to be signed and witnessed, Form, fee schedule, information free. Lancaster and Allwine, Registered Patent Attorneys in United States and Canada, 242 Ouray Bldg., Washington, D. C.

Monroe Miller, Ouray Bldg., Washington, D. C. Patent Attorney; Mechanical, Electrical Expert. Free Blue Book gives candid advice.

Patents Procured; Trade Marks Registered—A comprehensive, experienced, prompt service for the protection and development of your ideas. Preliminary advice gladly furnished without charge. Booklet of information and form for disclosing idea free on request. Richard R. Owen, 130 Owen Bldg., Washington, D. C., or 41-T Park Row, New York.

Patents. Send for free booklet. Highest references. Best results. Promptness assured. Send model or drawing for examination and opinion. Watson E. Coleman, Patent Attorney, 644 G Street, N. W., Washington, D. C.

**Patent Attorneys (Continued)**

Inventors write me about patents. My fees payable monthly. Booklet free. Frank Fuller, Washington, D. C.

Unpatented Ideas Can Be Sold. I tell you how and help you make the sale. Free particulars (Copyrighted 1923). Write W. T. Greene, 809 Jenifer Bldg., Washington, D. C.

Lacey Patent-Sense. "The book the inventor keeps." Free. See page 466.

"Inventor's Advisor," the valuable Patentbook with 139 Mechanical movements and illustrations, sent free upon request. M. I. Labiner, Patent Attorney, 3 Park Row, New York.

"Inventors' Guide" free on request; gives valuable information and advice for all who have original ideas or improvements. Frank Ledermann, Registered Attorney and Engineer, 17th Floor Woolworth Bldg., New York.

Herbert Jenner, Patent Attorney and Mechanical Expert. 606 F Street, Washington, D. C. I report if patent obtainable and exact cost. Send for circular.

Get your own patents. Application blanks, complete instructions \$1. Cutting Bros., Campbell, Calif.

**Patents**

Inventions commercialized. Patented or unpatented. Write Adam Fisher Mfg. Co., 205 Enright, St. Louis, Mo.

**Patents For Sale**

Patent for Sale. Write information. James Morelly, 10 Christine St., Worcester, Mass.

Patents. Time counts in applying for patents. Don't risk delay in protecting your ideas. Send sketch or model for instructions or write for Free book, "How to Obtain a Patent" and "Record of Invention" form. No charge for information on how to proceed. Communications strictly confidential. Prompt, careful, efficient service. Clarence A. O'Brien, Registered Patent Attorney, 9295 Security Bank Building (directly across street from patent office), Washington, D. C. See page 465.

**Personal**

Lonely Hearts—Exchange letters; make interesting new friends through our romantic club. Write Eva Moore, Box 908, Jacksonville, Florida.

Get acquainted. Make new friends. Exchange Letters. Enclose stamped envelope for plan. The Lilly Club, Station H, Cleveland, Ohio.

Exchange Cherry Letters with new friends. Write Betty Lee, Inc., Box 820, City Hall Station, New York City. Stamp appreciated.

Lonesome: Make friends everywhere through our Club. Write Eva Burchard, Box 75, Portland, Oregon, for particulars.

**Printing Outfits and Supplies**

Print your own cards, stationery, circulars, paper, etc. Complete outfits \$8.85; Job Presses \$12, \$35; Rotary \$150. Print for others, big profit. All easy, rules sent. Write for catalog presses, type, paper, etc. Press Company, A-6 Meriden, Conn.

**Radio**

Three Tube Set \$22. Parts Cheap. Box 17 Sta. A, New Haven, Conn.

2650 Miles Distance with one tube. Any Novice understands our Simplified Instructions. Big Free booklet tells the story. Vesco Radio Co., Box 11781, Oakland, Calif.

Attention! 50 Vacuum Tube Hook-Ups. The greatest collection of Vacuum Tube Circuits ever brought under two covers at such insignificant cost. These diagrams will be found in the great "Rasco" catalogue which contains raw materials and parts in a greater profusion than any other catalogue. 15c in stamps or coin will bring the catalogue to you. Radio Specialty Company, 100 Park Place, New York City.

Boys, don't overlook this! The "Rasco" Baby Detector. Greatest detector ever brought out with molded base. Fully adjustable. See former advertisements in this publication or our catalogue. Detector with Galena Crystal complete, 50c; the same Detector with Radiocite Crystal, 75c, prepaid. Send for yours today. Radio Specialty Co., 100 Park Place, New York City.

200,000 satisfied customers hear distant stations on Lambert Crystal Sets. Copyrighted plans \$1.00. Complete kit and plans \$5.00. Leon Lambert, 670, Wichita, Kansas.

Powerful, ultra selective, four tube receiver covering 40 to 600 meters. Circuit with instructions, \$3.00. Easy when you know how. W. G. Conger, Independence, Missouri.

One tube set, phones, batteries and tube \$19.75. Also parts at ten per cent. below list, everything new. Raehrs, 3679 3d Ave., Los Angeles.

**Salesmen Wanted**

Salesmen—You want the greatest return for your efforts. You get it with our line of all wool suits and overcoats made to special order at low price of \$21.50. This price includes \$5.00 profit for you which you get cash with order. We also pay big cash bonus to producers and give protected territory. Our selling outfit is without an equal in selling field. Our services unexcelled, the co-operation of our sales organization powerfully effective. If you are looking for a proposition that is genuine, and you yourself are genuinely in earnest and sincere, let us hear from you. We'll send you the full facts at once. Address Dept. 777, Goodwear Chicago, Inc., 844 W. Adams St., Chicago.

Salesmen given protected territory to sell Doublewear Shoes direct from factory to wearer. Our new measure board insures perfect fitting. Write for particulars and list of open counties. Doublewear Shoe Co., Manufacturers, Minneapolis, Minn.

A Salesman wanted in every town or city within 25 miles of a broadcasting station to sell Radiogem, the complete radio receiving set that retails for \$2.50. With Radiogem there is nothing else to buy—the outfit includes the Radiogem receiving apparatus, 1,000-ohm phone, and aerial outfit. The cheapest radio outfit on the market—yet as practical as the most expensive. Big money to the right men. Send \$2.00 for sample outfit. The Radiogem Corp., 66R West Broadway, N. Y. City.

Newest Invention! Automatically takes slack and kinks from cords on telephones, electric irons, etc. \$25 daily. Sample on approval if requested. Neverknot, Dept. 97, McClurg Bldg., Chicago.

**Song Poems**

Song Poem Writers—Send for proposition. Ray Hibbeler, D24, 4010 Dickens Ave., Chicago.

**Stamps and Coins**

500 Mixed Stamps from 40 different countries, Australia, North, Central, and South America, Russia, Africa, China, Japan, British, French, Colonies, War Issues, etc. Also 500 stamp hinges, pocket stock book, perforation gauge, and 3 United States stamps issued before 1872 all for 25c. Biggest bargain ever offered, satisfaction guaranteed or money back. Hussman Stamp Co., Dept. S.I., St. Louis, Mo.

California Gold, quarter size, 27c; half-dollar size, 53c. Columbian nickel and catalogue, 10c. Norman Shultz, Box 146, Colorado Springs, Colo.

Stamps 100 All Different 3 cents. S. I. Quaker Stamp Company, Toledo, O.

**Technical School**

Chicago Technical College offers short, intensely practical courses in Drafting and Engineering—civil, mechanical, electrical, structural—Architecture, Building, Construction, Plan Reading, etc. Courses fitted to your needs. No time wasted. Instructors are experts. Graduates in demand at big salaries. Opportunities for part-time work while studying. Day and evening classes. 22nd year. Enter any time. No special preliminary training required. Low tuition—easy terms. Write for 52-page illustrated Blue Book, describing opportunities open to our graduates. Chicago Technical College, 24 Chicago Tech. Building, Chicago.

**Typewriters**

Typewriters, all standard makes. \$10 up. Fully guaranteed. Free trial. Write for complete illustrated lists. Northwestern Exchange, 121 N. Francisco Ave., Chicago.

**Ventriloquism**

Ventriloquism taught almost anyone at home. Small cost. Send 2c stamp today for particulars and proof. Geo. W. Smith, Room 8-25, 125 N. Jefferson Ave., Peoria, Ill.

**Will \$20.00 Help You?**

YOU can easily earn \$20.00 extra this month by selling us your spare time. Thousands of busy men and women are increasing their income by taking subscription orders for our four popular magazines—*Science and Invention*, *Radio News*, *The Experimenter* and *Motor Camper & Tourist*. You can do the same.

All particulars and instructions will be mailed immediately on request. No obligation. Simply fill in your name and address below and

EXPERIMENTER PUBLISHING CO.  
Box 100, 53 Park Place, New York City

Name .....

Street .....

City ..... State .....

# HOOK-UPS

# VIA RADIO

### Get a Big "Circuitgram Book" and Receive the Latest Hook-Ups by Radio

The book contains five sets of blanks, called Skeleton "CIRCUITGRAMS."

"CIRCUITGRAMS" are a patented novelty in Radio and Radio Broadcasting, covering several important uses.

"CIRCUITGRAMS" are the handiest things ever published for the man who makes his own hook-ups, the student, the radio engineer, and all those who wish to draw a hook-up or a circuit in a minimum of time.

The Skeleton "CIRCUITGRAM" blanks are of five different kinds: for one, two, three, five and nine tube Radio receiving sets. When making your own hook-up, all you need to do is to draw the connections between the symbols representing the different parts of the Radio set.

With this book you can receive any hook-up being broadcast from different radio stations throughout the country. Every fan interested in new radio circuits should have one of these books on hand.

### EXPERIMENTER PUBLISHING COMPANY

53 Park Place - NEW YORK, N. Y.



## Price 25c

Our "CIRCUITGRAM" books are sold by All Radio and Newsdealers. If your dealer cannot supply you, send us 25c and we will mail you a book postpaid.

PUBLISHED BY THE EXPERIMENTER PUB. CO. N.Y.

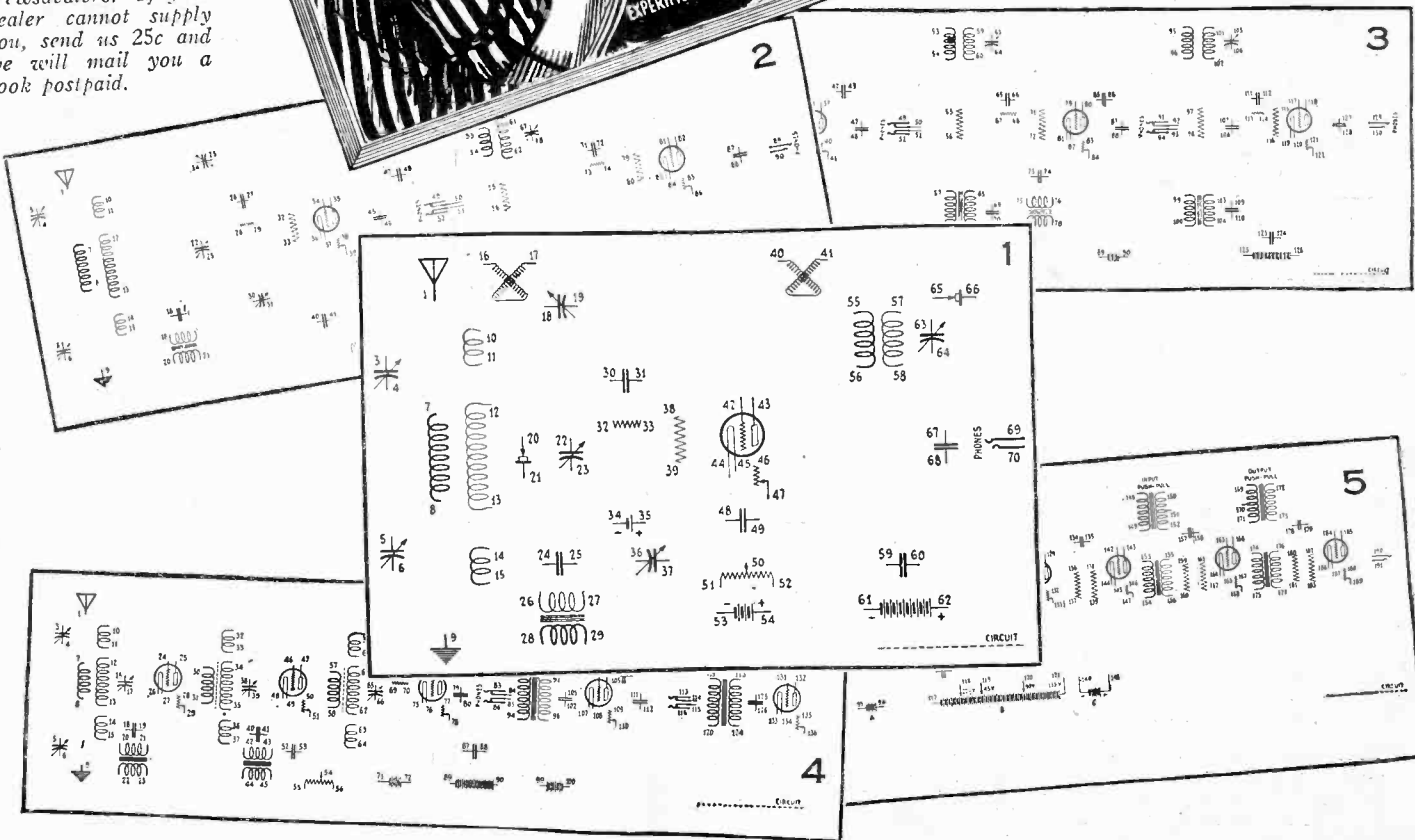



Let These Guides

Solve Your Problems

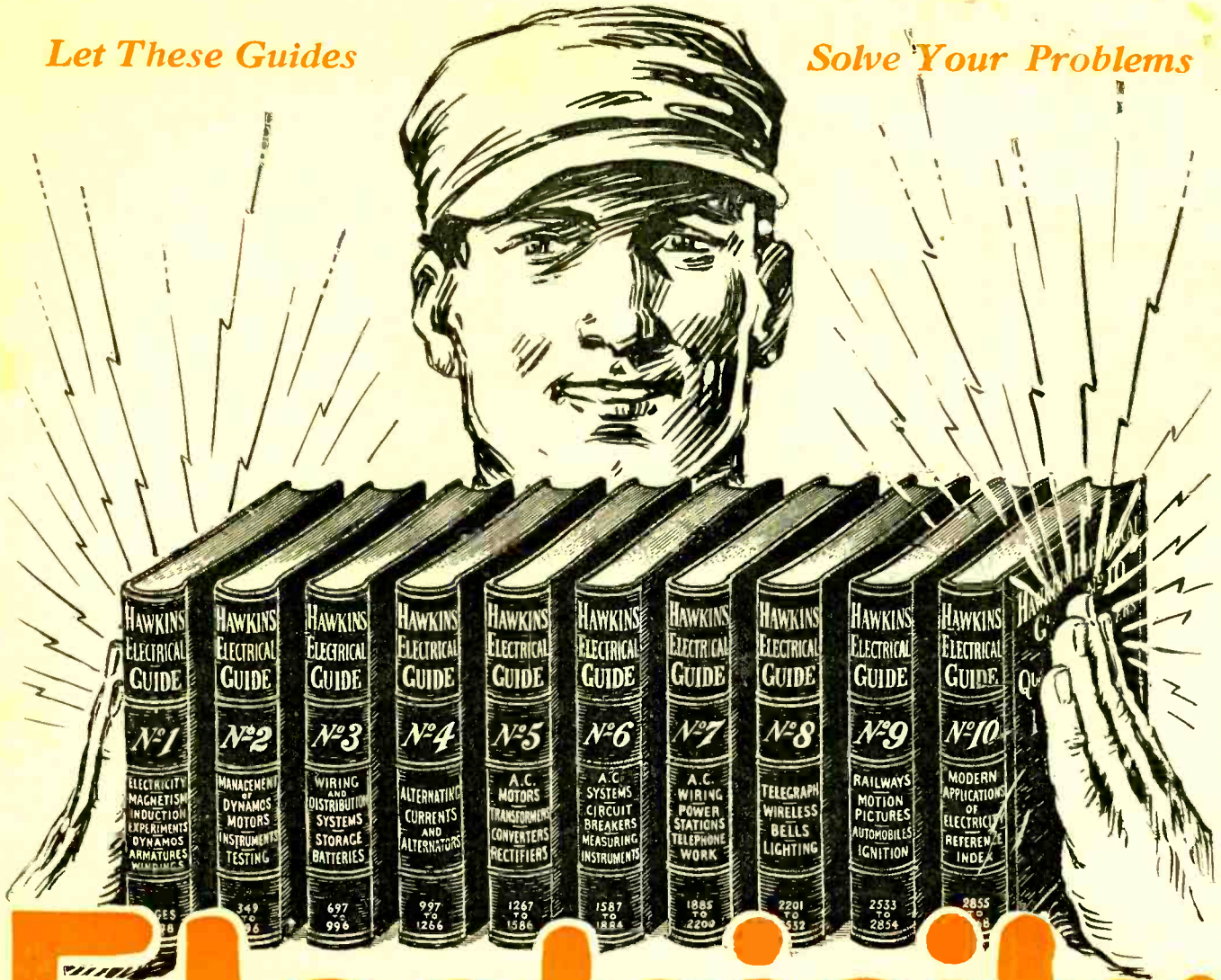

# Electricity at your finger ends

**HAWKINS ELECTRICAL GUIDES** IN TEN VOLUMES

3500 PAGES  
4700 PICTURES

\$1 A VOLUME  
\$1 A MONTH

SEND NO MONEY—SEND ONLY THIS COUPON

Know the facts in Electricity. They mean more money and better position for you. Hawkins Guides tell you all you need to know about Electricity. Every important electrical subject covered so you can understand it. Easy to study and apply. A complete, practical working course, in 10 volumes. Books are pocket size; flexible covers. Order a set today to look over.

**LEARN ALL ABOUT**

Magnetism—Induction—Experiments — Dynamos — Electric Machinery—Motors—Armatures—Armature Windings—Installing of Dynamos—Electrical Instrument Testing—Practical Management of Dynamos and Motors—Distribution Systems—Wiring—Wiring Diagrams—Sign Flashers—Storage Batteries—Principles of Alternating Currents and Alternators—Alternating Current Motors—Transformers—Converters—Rectifiers—Alternating Current Systems—Circuit Breakers—Measuring Instruments—Switchboards—Wiring—Power Stations—Installing — Telephone—Telegraph—Wireless—Bells—Lighting—Railways. Also many Modern Practical Applications of Electricity and Ready Reference Index of the ten numbers.

**SHIPPED FREE**

Not a cent to pay until you see the books. No obligation to buy unless you are satisfied. Send Coupon now—today—and get this great help library and see if it is not worth \$100 to you—you pay \$1.00 a month for ten months or return it.

**THEO. AUDEL & CO.,**  
65 W. 23rd. St., New York City

Please submit me for free examination, HAWKINS ELECTRICAL GUIDE (Price \$1 a number). Ship at once prepaid, the 10 numbers. If satisfactory, I agree to send you \$1 within seven days and to further mail you \$1 each month until paid.

Name .....

Occupation .....

Employed by .....

Home Address .....

Reference .....

S.I. Sept.



**INSTALL YOUR OWN**

**FREE PLANS**

**HOT WATER HEATING PLANT CUT-TO-FIT**

**GUARANTEED**

Complete Hot Water Plant ready for shipment with set of tools. Outfits complete as low as \$200.00

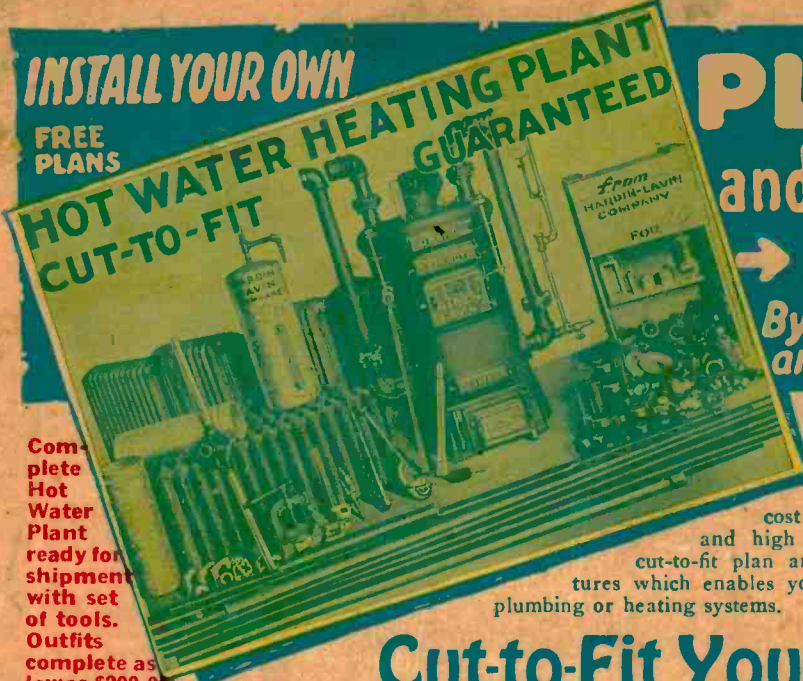

# PLUMBING and HEATING

**→ SAVE HALF ←**

**By our New Easy Method and Lowest Wholesale Prices.**

## SPECIAL PLANNING SERVICE

Send us a rough sketch of the arrangement of your rooms, or a blue print if you have one, and our engineers will design a heating plant to exactly meet your needs. This service is free. Our Bargain Catalog gives full particulars. Send coupon today for your copy.

You make *Two Big Savings* when you buy from us. *First:* You save 1-3 to 1-2 because of our wholesale factory-to-user price. *Second:* You save the cost of unnecessary waste and high labor because of our cut-to-fit plan and easy installing features which enables you to put in your own plumbing or heating systems.

## Cut-to-Fit Your Home

Send the coupon for our FREE bargain catalog which explains our new easy method of installing factory fitted heating plants and plumbing systems. For fifty years we have been saving our customers hundreds of thousands of dollars in the cost of Hot Water Heating Plants, Steam Heating Plants, Boilers, Warm Air Heating Plants, Pipeless Furnaces, Water Supply Systems, Water Heaters, Bath Room Outfits, Radiators, Valves, Pipe and Supplies. Everything you get from us is guaranteed to be highest quality, grade A merchandise with new, exclusive features. We supply FREE installing plans and show you how with simple diagrams and clear instructions. All necessary tools loaned FREE.



## "Chicago" Bathroom Outfit

Highest grade, snow white porcelain and enamel. Complete as shown. For many other styles see our bargain catalog.

**SPECIAL \$59.95**

## Super Improved Automatic Electric Water Supply System

Complete with 42 gal. Galvanized Tank

One of the most carefully designed, substantially constructed Automatic Electric Water Supply Systems on the market. Absolutely reliable, fool-proof and simple. Can be depended upon to give lasting service with practically no attention. No better outfit made for shallow wells or cisterns where water is not over 22 feet below the surface.

### Noiseless Pump

Our pump runs in oil, is noiseless, double acting, brass fitted throughout and fully enclosed and lubricated by the "New Splash System." All moving parts run in oil bath, which insures lasting service. The outfit is complete in every respect. No extras. Includes latest type oversized, 1 1/2 Horse Power electric motor, which operates economically and is thoroughly reliable. Plenty of surplus power to drive pump under all conditions.

For other styles and sizes see our bargain catalog.



## HARDIN-LAVIN Super Improved PIPELESS FURNACE

**Special at \$64.75**

For 5 Room Size



**THIS SUPER ALL-CAST PIPELESS FURNACE** insures quick and economical heating. We furnish complete installation instructions. Any man can do the work himself and make a second big saving over our special wholesale prices.

### Burns Any Fuel

Hardin-Lavin all-cast Pipeless Furnace will burn any kind of fuel with equal satisfaction. Designed to give the best heating results. No other Pipeless Furnace will give more heat from fuel than the Hardin-Lavin.

**Double Casting—No Heat Lost** A double-air-and-asbestos-insulated heavy galvanized casing encloses the Furnace. Outside of casing is a cold air chamber, which draws air from all parts of the house, insuring perfect circulation. Furnace will keep basement cool and living rooms warm as toast. You get our wholesale prices and bonded guarantee of satisfaction.

	Fire Pot	Register	Htg. Captr.	Special Price
B-85	18 In.	25 x 25 In.	10,000 Ft.	\$ 64.75
B-89	20 In.	28 x 28 In.	13,000 Ft.	76.50
B-90	22 In.	30 x 30 In.	16,000 Ft.	89.90
B-91	24 In.	32 x 32 In.	20,000 Ft.	104.83
B-92	26 In.	36 x 36 In.	40,000 Ft.	124.98

## Plans Free

Send us a rough sketch or blue print of the arrangement of your rooms and we will figure the wholesale cost of your heating plant or plumbing system. We will show you many kinks and wrinkles where you can make savings that will surprise you. We furnish a heating plant or plumbing outfit for the exact job and we thread and mark all the larger pipes so that any handy man with the aid of our simplified plans can do the installing by our new easy method.

## 50 yrs. & Million Dollar Plants Behind our Bonded Guarantee

Every Hardin-Lavin system is figured to eliminate long runs of piping, to save valuable time and unnecessary

materials and expensive labor. Our catalog fully explains. The coupon will bring you a copy. You have the FREE help of our plumbing and heating engineers. They will work with you to get the best possible results at the lowest possible price. Many years' experience with all kinds of conditions and all types of construction has equipped them for practical, money saving service to home owners, builders, realtors, contractors, mechanics, institutions, etc. Write us about any plan or problem you have. We will help you without obligation. Estimates FREE. All orders are shipped out of our Chicago plant the day they are received. It means a lot to know you'll get prompt service and square dealing.

## Mail Coupon for FREE Catalog Today

We are helping thousands to save money and to MAKE money. Our FREE Bargain Catalog explains how. Send for your copy today.

# HARDIN-LAVIN COMPANY, ESTB. 1876

When in Chicago Visit Our New plant at 104-114 W. Pershing Road, Chicago, Illinois

Our Bonded Guarantee and Label Protects You

**FREE Bargain Catalog**



HARDIN-LAVIN COMPANY, 104-114 W. Pershing Road, Chicago, Illinois.

Gentlemen: Please send me your free Bargain Catalog with special wholesale prices. I am interested in

- ( ) Hot Water Htg. Plants
- ( ) Steam Heating Plants
- ( ) Pipeless Furnace
- ( ) Warm Air Furnace
- ( ) Water Supply Systems
- ( ) Bath Room Outfits

Name .....  
Address .....  
City ..... State .....

**Send for Your Copy TODAY**