

July

25 Cents

# Science and Invention

IN PICTURES

40  
NON-TECHNICAL  
RADIO  
ARTICLES

THE ISOLATOR

See Page 214

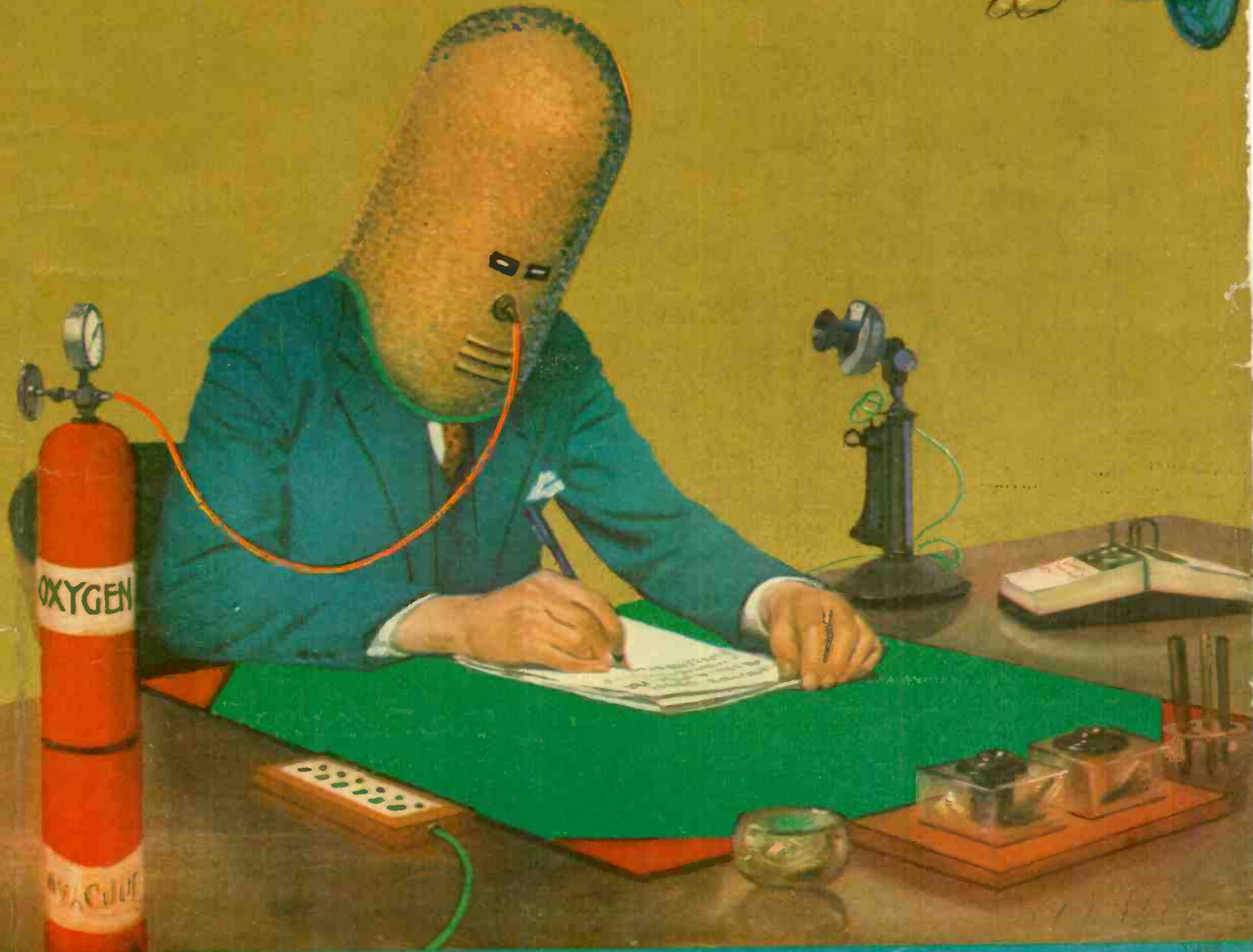
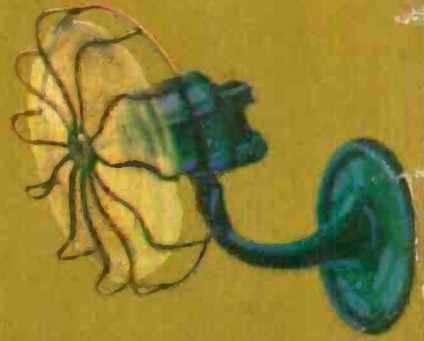

EXPERIMENTER PUBLISHING COMPANY, NEW YORK, PUBLISHERS OF  
RADIO NEWS - SCIENCE & INVENTION - THE EXPERIMENTER - MOTOR CAMPER & TOURIST

# The Original A. C. RECEIVER

OPERATING WITH NO STORAGE BATTERY—USES ORDINARY A. C. HOUSE CURRENT

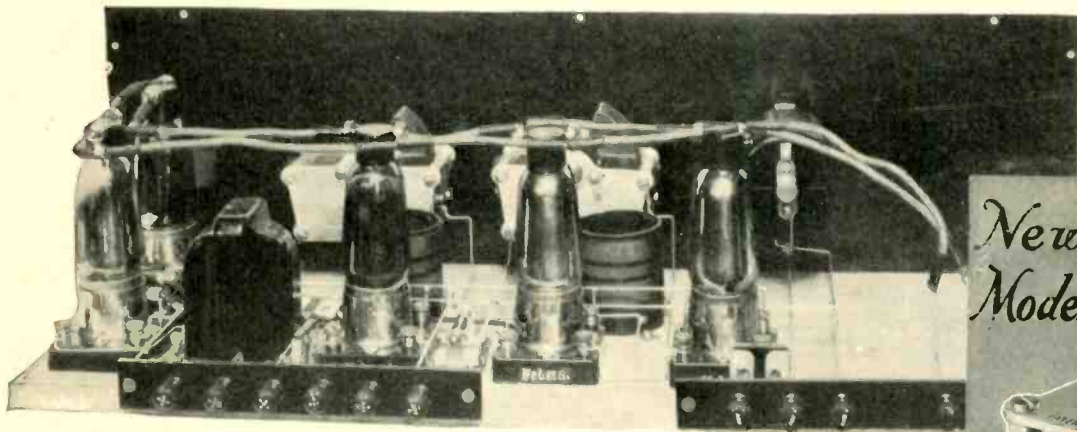

Designed and Built by LAWRENCE M. COCKADAY  
Technical Editor of Popular Radio

## Was Equipped with Hammarlund Condensers

THE new A-C Receiver, shown above, was developed by Mr. L. M. Cockaday after many months of intensive work. His efforts to produce a most efficient receiver are responsible for the use of "Hammarlund" condensers in his models. This A-C Receiver as designed by Mr. Cockaday, is built around the McCullough A-C tube which operates directly from the house lighting system and

### Absolutely Eliminates the Storage Battery

It operates either on out-door or in-door antenna.

- can be logged.
- produces no hum on alternating current.
- gets distance.
- is economical in operation.

Complete working instructions with full size blueprints showing how you can build this latest development in radio receivers at home, may be obtained by clipping out the coupon below and mailing it NOW.

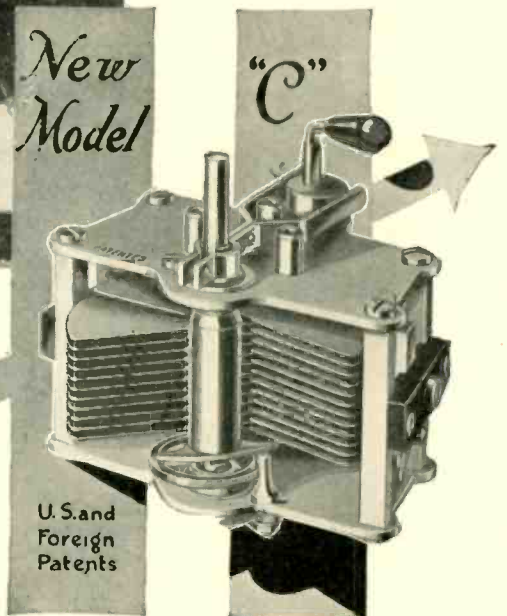

## 9 Points of Superiority

1. Soldered brass plates; chemically treated against corrosion; perfect alignment.
2. Stator plates specially shaped for easy tuning on low waves.
3. Adjustable ball-bearing rotor shaft, grounded through metal end-plates.
4. Soldered clock-spring pig-tail, with automatic stop.
5. Minimum dielectric; losses too small to be measured.
6. Rugged, compact construction; cannot warp.
7. Micrometer vernier; moves all plates; no backlash.
8. Takes any size dial.
9. The product of 14 years' experience, making precision instruments.

All capacities, plain and vernier; Single, Dual and Triple Models; Also "Hammarlund, Jr."—a precision Midget.

HAMMARLUND MANUFACTURING CO.,  
424-438 West 33rd St., New York, N. Y.

Gentlemen:

Enclosed find 25 cents (coin or postage) for which kindly send me 1 complete set of blueprints and descriptive working instructions for building the original A-C Receiver.

NAME .....

ADDRESS .....

CITY—STATE .....

For Better Radio  
**Hammarlund**  
PRECISION  
CONDENSER

**Read My  
16  
Smashing  
Guarantees**

# Be a Cooke Trained Electrical Expert

Earn \$3,500 to \$10,000 Yearly

Here's the biggest offer yet—So big that I can't explain it all on this page. You don't know what guarantees are—You don't know what wonderful things I do for my students—and what I guarantee to do for you—till you get my book "The Vital Facts." Send for it now. Get the details of my 16 smashing, world beating guarantees.

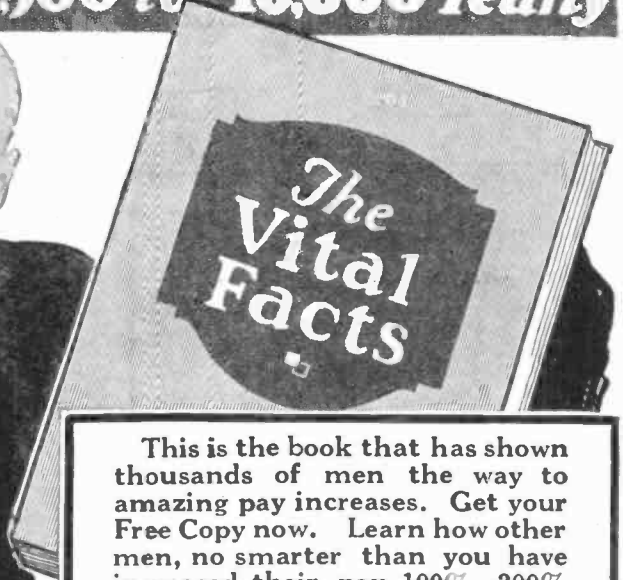

This is the book that has shown thousands of men the way to amazing pay increases. Get your Free Copy now. Learn how other men, no smarter than you have increased their pay 100%—200% and even 500% through Cooke Training. Send Coupon Now!

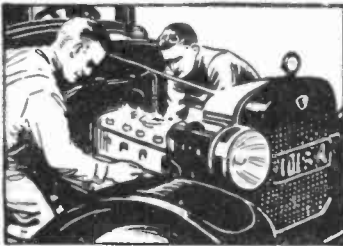

Auto Electricity Pays Big. W. E. Pence, Albany, Oregon, specializes in Auto Electricity and makes \$750.00 a month. Was formerly a mechanic earning \$30.00 a week.

**E**VEN ordinary electricians are earning \$10 to \$12 a day and thousands of big jobs paying \$70 to \$200 a week are going begging for want of trained men to fill them. Electrical Experts (trained men) are needed everywhere now. Electricity—the fastest growing industry and best paying profession in the world NEEDS YOU. I will train you just like I trained the three men whose pictures you see to the left, and thousands of others. Get the details of my training and my 16 smashing guarantees.

### I Will Train You at Home—in Spare Time

In my training you get my own 20 years of experience as an engineer; the knowledge and experience of 50 other noted engineers and full time and services of 10 college trained and practical engineers whom I employ to assist me in the work of training my students.



**4 Big Free Outfits**

\$2 Articles in all given to you Free

### My Training Pays Its Own Way

Most of my students make many times the monthly payments for my training in spare-time work. Beginning with your 6th lesson I give you special spare-time work instruction.

You earn while you learn. My training is not an expense it pays its own way.

### Cooke Trained Men Most Successful

Cooke Trained Men easily get the big jobs in electricity because employees know me—They know the value of my training and the reputation of the big two million dollar institution behind me. Over 3000 of my men reported big pay increases to me last year in addition to the men I actually placed in big electrical jobs myself.

### Go Into Business With My Money

Every month I give two of my students \$500 in cash to go into business for themselves. No strings to this offer. It's an outright gift—all explained in my book.

### Get the Facts—Write Me Now

The coupon will bring you the big story of the opportunities for you in Electricity. Don't decide on any training till you get my book. Learn how hundreds of other men get into the big-pay class. Get my 16 smashing Guarantees. Mail Coupon Now.

**L. L. Cooke, Chief Engineer,  
Chicago Engineering Works, Inc.,  
Dept. 2-B, 2150 Lawrence Ave., Chicago, Ill.**

**L. L. COOKE,  
Chief Engineer,  
Chicago Engineering  
Works, Inc.,  
Dept. 2-B,  
2150 Lawrence Ave.,  
Chicago, Illinois.**

Send me at once without obligation full particulars of your home training in Electricity and details of your 16 smashing guarantees and plan for financing your students.

Name .....

Address .....

City..... State.....

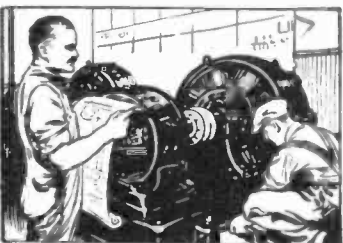

Big Money in Electrical Construction. A. F. Klemz, 4449 Kerwin, Detroit, Michigan, earns over \$5000 a year in Electrical Construction work. He formerly earned \$5 a day.



Get Into Electrical Contracting. John Jirinec, 1133 Fourth Ave., Astoria, L. I., New York, makes \$800 to \$1000 a month in business for himself. He says Cooke Training is responsible for his success.

**The "Cooke Trained Man is the "Big Pay" Man**

Vol. XIII.  
Whole No. 147

# Science and Invention

FORMERLY  
**ELECTRICAL EXPERIMENTER**

July, 1925  
No. 3

Member Audit Bureau of Circulations

EDITORIAL & GENERAL OFFICES: 53 Park Place, New York City  
GENERAL ADVERTISING DEPT.: 53 Park Place, New York City  
Published by Experimenter Publishing Company, Inc.

(H. Gernsback, Pres.; S. Gernsback, Treas.; R. W. DeMott, Sec'y).

Publishers of SCIENCE & INVENTION, RADIO NEWS, THE EXPERIMENTER  
and MOTOR CAMPER & TOURIST.

## EDITORIAL STAFF

HUGO GERNSBACK, *Editor-in-Chief.*  
H. WINFIELD SECOR, E. E.,  
*Managing Editor.*  
DR. T. O'CONNOR SLOANE, Ph.D., M. A.,  
*Associate Editor.*  
JOSEPH H. KRAUS, *Field Editor.*  
A. P. PECK, Assoc. I. R. E.,  
*Radio Editor.*  
J. KELLY BURLEIGH, *Art Director.*

## CONTRIBUTING EDITORS

**Astronomy**—  
Dr. Donald H. Menzel, Ph.D., University of Iowa.  
Isabel M. Lewis, M.A., of the U. S. Naval Observatory.  
**Entomology and Allied Subjects**—  
Dr. Ernest Bade, Ph.D.  
**Physics**—  
Dr. Harold F. Richards, Ph.D.  
Ernest K. Chapin, M. A.  
**Automotive Subjects**—  
Tom C. Plumridge.  
George A. Luers.  
**Chemistry**—  
Raymond B. Wailes.  
Dr. Ernest Bade, Ph.D.

**Radio**—  
Sylvan Harris.  
Leon L. Adelman.  
**Magic and Psychic Phenomena**—  
Joseph Dunninger.  
Joseph F. Rinn.  
Edward Merlin.  
**Foreign Correspondents**—  
Dr. Alfred Gradenwitz, Germany.  
Dr. H. Becher, Germany.  
C. A. Oldrovd, England.  
S. Leonard Bastin, England.  
A. N. Mirzaoff, France.  
Hubert Slouka, Czecho-Slovakia.  
P. C. van Petegem, Holland.

## IN OUR NEXT ISSUE

### Do You Like To Build Decorative Objects?

If so, you will undoubtedly be interested in the constructional article by William Butterfield which deals with the making of ornamental garden arbors.

### How Fast Can An Airplane Travel?

As the possible speed at which an airplane can travel has gradually been increased, much speculation has been aroused regarding the ultimate speed. William P. Sullivan will discuss the possibilities of increasing the speed and will show why this cannot be done indefinitely.

### What Is the Safest Place In a Thunder Storm?

This is a subject that everyone is interested in as it affects us all. H. Winfield Secor has made an exhaustive study of this subject and presents items of great interest that will tend to make us all feel safer in the next thunder storm.

### Are You An Electrical Experimenter?

Almost everyone is, either actively or passively, and we all enjoy articles by authorities on electrical subjects. Raymond B. Wailes will outline a series of experiments with A.C. that will be found most interesting to everyone.

## Contents for July

Editorial .....	207	Death to the Rat .....	233
By Hugo Gernsback.		By Joseph H. Kraus.	
Exploring Sargasso Sea .....	208	Magic for Everybody .....	236
By J. W. Von Stein.		By Prof. Joseph Dunninger.	
25 New Flowers in 25 Years—Bur-		Everyday Chemistry .....	237
bank .....	211	By Raymond B. Wailes.	
By H. H. Dunn.		Progress in Medicine .....	238
S.S. "Homeric" Answers S.O.S. ....	212	Edited by Joseph H. Kraus.	
By H. Winfield Secor, E. E.		Latest Devices .....	239
The Isolator .....	214	Child's Auto Runs on Air .....	240
By Hugo Gernsback.		Light Ray Hands for Clocks .....	241
A Movie Stadium .....	215	Simple Telescopes .....	241
By Dr. Albert Neuburger.		Measuring Heights with Match Box ..	242
Science News of the Day .....	216	How-to-Make-It .....	244
Oenothera, the Evening Flowering		Readers' Forum .....	245
Primrose .....	217	Wrinkles, Recipes and Formulas ..	246
By Dr. Ernest Bade, Ph.D.		Edited by S. Gernsback.	
Our Earth's Atmosphere .....	218	Photos Sent 5000 Miles By Radio ..	247
By Joseph M. Howard.		WRNY—Radio News, New York ..	248
The Lime Rays of the Moon .....	219	Circuitgrams via Radio .....	250
By Donald P. Beard.		By Hugo Gernsback.	
How to Photograph the Stars .....	219	Three-Circuit Tuner—Push-Pull Am-	
Talking Movies in the Home .....	220	plifier .....	252
By Russell Raymond Voorhees.		Four-Tube Portable .....	253
What Is Gravitation? .....	222	By Sidney E. Finkelstein, Assoc.I.R.E.	
By Donald H. Menzel, Ph.D.		The Radio Constructor .....	254
Tarrano, the Conqueror .....	224	By A. P. Peck, Assoc.I.R.E.	
By Ray Cummings.		Radio Broadcast .....	257
Tricks of Mediums .....	226	Radio Oracle .....	259
By Edward Merlin.		Scientific Humor .....	261
Keeping the Kitchen Cool .....	227	Latest Patents .....	262
By Christine Frederick.		Non-Sci(ence) .....	263
Dr. Hackensaw's Secrets .....	228	Oracle .....	264
By Clement Feazandis.		Awards in \$1000 Monthly Contest ..	266
Prize Awards in Inner Tube Contest ..	230	Patent Advice .....	272
Sound Waves Measure Ocean		Edited by A. P. Peck.	
Depths .....	232	Radio Wrinkles .....	289
By S. R. Winters.			

HOW TO SUBSCRIBE FOR "SCIENCE AND INVENTION." Send your name, address and remittance to Experimenter Publishing Co., 53 Park Place, New York City. Checks and money orders should be made payable to Experimenter Publishing Co., Inc. Mention the name of the magazine you are ordering inasmuch as we also publish RADIO NEWS, THE EXPERIMENTER and MOTOR

CAMPER & TOURIST. Subscriptions may be made in combination with the other publications just mentioned at special reduced club rates. Send postal for club rate card. Subscriptions start with the current issue unless otherwise ordered. ON EXPIRATION of your subscription we enclose a renewal blank in our last number to you, and notify you by mail. Then unless we receive your

order and remittance for a renewal, delivery of the magazine is stopped. CHANGE OF ADDRESS: Notify us as far in advance as possible, giving your old address as well as the new one to which future magazines are to go. It takes several weeks to make an address change on our records.

SCIENCE AND INVENTION is published on the 10th of each month. There are 12 numbers per year. Subscription price is \$2.50 a year in U. S. and possessions. Canada and foreign countries \$3.00 a year. U. S. coin as well as U. S. stamps accepted (no foreign coin or stamps). Single copies, 25 cents each. A sample copy will be sent gratis on request. All communications and contributions to this journal should be addressed to Editor, SCIENCE AND

INVENTION, 53 Park Place, New York City, N. Y. Unaccepted contributions cannot be returned unless full postage has been included. ALL accepted contributions are paid for on publication. SCIENCE AND INVENTION Monthly. Entered as second class matter May 10, 1924, at the Post Office at New York, N. Y., under the act of March 3, 1879. Additional entry at Long Island City, N. Y., Chicago, Ill., Los Angeles and San Fran

cisco, Calif. Title Registered at the Patent Office. Copyright, 1925, by E. P. Co., Inc., New York. The Contents of this Magazine are copyrighted and must not be reproduced without giving full credit to the publication. SCIENCE AND INVENTION is for sale at all newsstands in the United States and Canada; also at Brentano's, 37 Avenue de l'Opera, Paris. Member of the Audit Bureau of Circulations.

New England Advertising Representative Western Advertising Representatives Pacific Coast Advertising Representatives Kansas City Advertising Representatives  
T. F. Magrane 720 Cass St., Chicago, Ill. A. J. Norris Hill Co. George F. Dillon  
Park Square Bldg., Boston, Mass. Finucan & McClure Hearst Bldg., San Francisco, Cal. Republic Building, Kansas City, Mo.

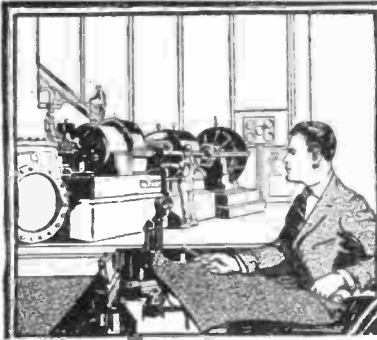

Be Superintendent of an Electrical POWER PLANT



Own Your Own Electrical REPAIR SHOP

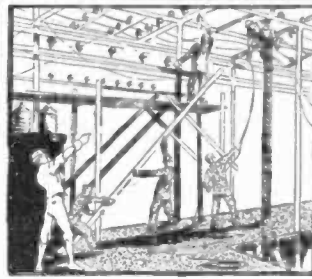

Boss Electrical Construction Jobs

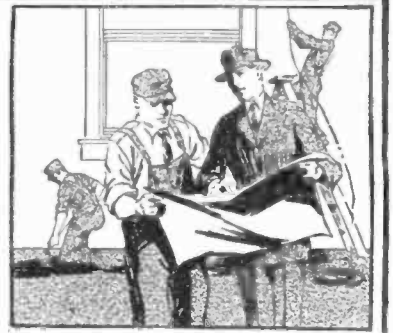

Be an Electrical CONTRACTOR



Chief Engineer Dunlap

I guarantee you a **JOB** and a **50% RAISE** or money refunded

If you are now earning less than \$40 a week

enroll for my home training in Electricity and I will guarantee you a permanent, satisfactory job after you finish—guarantee you at least 50% more pay—or refund every cent of your money. I give you this written guarantee because my training actually makes you an Electrical Expert. The AMERICAN SCHOOL stands back of this guarantee with resources of over a million dollars.

# GO INTO ELECTRICITY —the Business of a Million Opportunities

Go to Electrical School AT HOME!

While you're at it, while you're spending your time and money to be a success, Train for the big-pay Boss jobs in the world's fastest growing industry. The world's work is now being done by Electric power. Autos, ships, buildings, aeroplanes, all electric equipped. Electric lights, everywhere. Think of Radio, Telephones, Telegraph,

Electric railways. This business DOUBLED in the last 9 years, and they say it will double again in the next 6 years!

**\$60 to \$200 a Week for Electrical Experts**

Enormous demand for all-around Electrical Experts as Power Plant Superintendents, Chief Electricians, Foremen of Construction, Electrical Draftsmen, Radio Engineers, etc. And with my training you can go into business for yourself with little capital and make \$3,000 to \$12,000 a year.

4 Electrical Outfits

**Given** You don't have to leave your home or quit your job, you don't need post-graduate Laboratory courses when you are Dunlap-trained. I send you these 4 costly, complete Electrical Outfits, all the Laboratory and Shop apparatus you need to understand Electrical laws, theories and principles easily and quickly. Not one penny extra for this equipment.

Write Me AT ONCE!

Don't enroll for any home-training until you get a copy of my job-and-raise guarantee—until you get my sensational offers. Compare my 4 outfits with others—compare my training with others—compare my guarantee with others before you decide. I will show you how to become an Electrical Expert right in your own home—in spare time, for the least cost and in double quick time. Mail coupon for free book, surprise offers and complete information.

Earn While You Learn

As early as your eleventh lesson, I give you special training in wiring, Radio, Electrical repairing, motors, etc., so you can go out and start turning your instruction into cash. It's no trick to earn enough in a single evening to pay one month's tuition cost. So you needn't let lack of ready money or anything else keep you from this wonderful home-training.

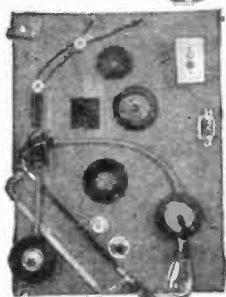

Wiring Outfit 1 Wiring Outfit

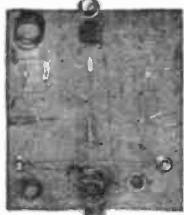

2 Motor and Volt Ammeter 3

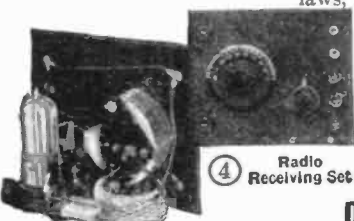

4 Radio Receiving Set

## 22 Noted Electrical Engineers

This is not a one-man, one idea school. 22 famous Engineers and Executives of the following corporations and universities helped me make Dunlap-training the most complete and up-to-date:

1. General Electric Co.
  2. Commonwealth Edison Co.
  3. Crocker-Wheeler Co.
  4. Cutler-Hammer Mfg. Co.
  5. American Telephone & Telegraph Co.
  6. Westinghouse Electric & Mfg. Co.
  7. Western Electric Co.
  8. Underwriters Laboratories, Inc.
  9. Columbia University
  10. Dartmouth College
  11. Massachusetts Institute of Technology
  12. Lehigh University
  13. University of Vermont
  14. Armour Inst. of Technology
  15. University of Kansas
- AND MANY OTHERS

MAIL COUPON QUICK!

Chief Engineer Dunlap, AMERICAN SCHOOL, Dept. EB26, Drexel Ave. & 58th St., Chicago.

Please rush guarantee of a job and a 50% raise, free book, surprise offers and complete information on how I can become a real Electrical Expert at home in spare time.

Name.....

St. No.....

City..... State.....

Chief Engineer DUNLAP, Electrical Division

**AMERICAN SCHOOL**

Dept. EB 26, Drexel Ave. & 58th St., Chicago

# SCIENCE and INVENTION READERS' BUREAU

## Time and Postage Saver

**I**N every issue of SCIENCE and INVENTION you undoubtedly see numerous articles advertised about which you would like to have further information.

To sit down and write an individual letter to each of these respective concerns, regarding the article on which you desire information, would be quite a task.

As a special service to our readers, we will write the letters for you, thus saving your time and money.

Just write the names of the products about which you want information, and to avoid error the addresses of the manufacturers, on the coupon below and mail it to us.

If the advertiser requires any money or stamps to be sent to pay the mailing charges on his catalogue or descriptive literature, please be sure to enclose the correct amount with the coupon.

We will transmit to the various advertisers your request for information on their products.

This service will appear regularly every month on this same page in SCIENCE and INVENTION.

If there is any Manufacturer not advertising in this month's issue of SCIENCE and INVENTION from whom you would like to receive literature, write his name, address and the product in the special section of the coupon below.

TEAR ALONG THIS LINE

READERS' SERVICE BUREAU,

S. & I. 7-25

Experimenter Publishing Co., Inc., 53 Park Place, New York, N. Y.

Please advise the firms listed below that I would like to receive detailed information on their product as advertised in the ..... issue of SCIENCE and INVENTION.

**THIS FORM SHOULD NOT BE USED FOR TECHNICAL QUESTIONS**

NAME	ADDRESS (Street—City—State)	List here specific article on which you wish literature.	If Catalogue of complete line is wanted, check in this column.
.....	.....	.....	.....
.....	.....	.....	.....
.....	.....	.....	.....
.....	.....	.....	.....
.....	.....	.....	.....
.....	.....	.....	.....
.....	.....	.....	.....
.....	.....	.....	.....
.....	.....	.....	.....
.....	.....	.....	.....

**THIS FORM SHOULD NOT BE USED FOR TECHNICAL QUESTIONS**

If you desire information from a manufacturer whose advertisement does not appear in this month's issue, use this space.

NAME	ADDRESS
.....	.....
.....	.....
.....	.....
.....	.....

Your own name here.....

If you are a dealer check here.

Address.....

City..... State .....

# The SUPER-HETERODYNE

## USE THIS BLANK TO ORDER

Just clip out this coupon, check the patterns or books you want and mail it to us with full remittance.

The Consrad Co., Inc.  
233 Fulton St., New York, N. Y.

Gentlemen: I have checked below the patterns and books I desire. Enclosed find \$..... the full price. Kindly send me the items checked postpaid.

### Consrad Patterns—50c each

- ....No. 2. How to Make a Two-Stage Amplifier.
- ....No. 4. How to Make a Reinartz Receiver.
- ....No. 5. How to Make a Reflex Receiver.
- ....No. 6. How to Make a Cockaday Receiver.
- ....No. 7. How to Make a Neutrodyne Receiver.
- ....No. 8. How to Make the Autoplex Receiver.
- ....No. 9. How to Make the S. T. 100 Receiver.
- ....No. 10. How to Make the Ultradyne Receiver.
- ....No. 11. How to Make a Five Tube Cockaday Receiver.
- ....No. 12. How to Make a Portable Receiver.
- ....No. 13. How to Make a Harkness Receiver.
- ....No. 14. How to Make the Original Genuine Super-Heterodyne. List \$1.00.
- ....No. 15. How to Make a Low Loss Receiver.
- ....No. 16. How to Make a Tropadyne Superadio.
- ....A. Radio Map of the U. S. on Cloth.
- ....B. 20 Radio Diagrams and Hook-ups. New Edition.
- ....C. All About Aerials and Their Construction.
- ....D. Radio Amateurs Practical Design Data.

### Radio Books—25c each

- ....No. 1. Tips for the Radio Constructor.
- ....No. 2. How to Make Practical Radio Receivers.
- ....No. 3. Radio Questions Answered.
- ....No. 4. Radio Frequency Amplification.
- ....No. 5. Loud Talkers and How to Build Them.
- ....No. 6. How to Tune Your Radio Set.
- ....No. 7. One Hundred Radio Hook-ups. New Edition.
- ....No. 8. All About Radio Parts.
- ....No. 9. History and Operations of Vacuum Tubes.
- ....No. 10. The Neutrodyne and All About It.
- ....No. 11. How Radio is Received.
- ....No. 12. How to Locate Troubles in Your Radio Set.
- ....No. 13. Reflex Radio Receivers.
- ....No. 14. The Super-Heterodyne Theory and Construction.

### Special Books

- ....Radio News Amateurs' Handbook.....\$1.00
- ....Radio Log Book......50
- ....Wireless Course in 20 Lessons—Leather Binding 2.00
- ....The Radio Instructor..... 1.00
- ....The Radio Listeners' Guide & Call Book..... .35
- ....The Radio Review..... .35

Name .....

Address .....

City ..... State.....

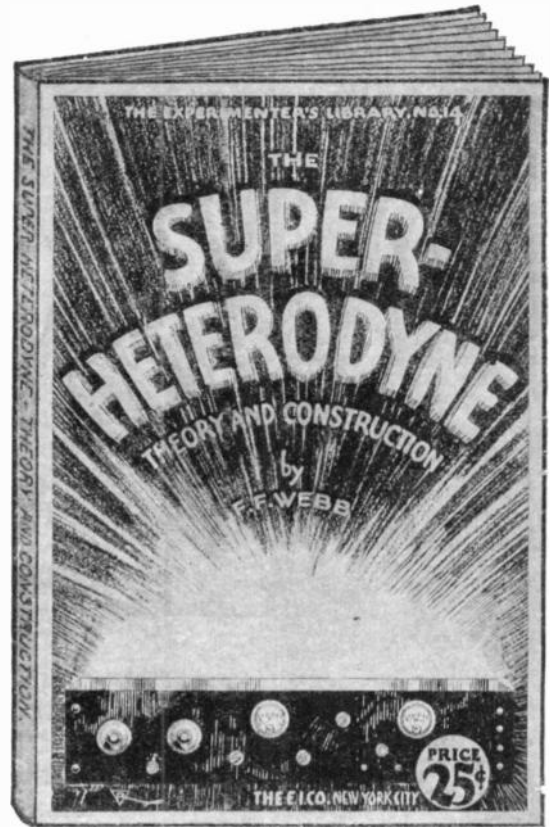

Here's the finest, most complete book of data and information ever compiled on the Standard Super-Heterodyne.

This is the big book of instruction and information on the various standard "supers" in common use today; a complete, up-to-the-minute, impartial 64-page book covering all the builder or user of this type of set might want to know. The Super-Heterodyne is written by a radio authority who not only has years of trade and practical experience but is constantly designing modern radio apparatus. It is a handy useful size, 5½ x 7½ inches, printed clearly, profusely illustrated, easy to read and bound with a handsome two color cover.

This is the very latest of the complete library of Experimenters Handbooks on radio, a list of which is printed on this page. These books are complete practical guides to almost every important phase of radio transmission and reception.

The famous Consrad patterns are also listed on this coupon for your convenience. They are radio's finest patterns for the building of the most successful standard receivers.

You can get any of these books or patterns at your radio or news dealer or direct from us by using the coupon attached to this page.

## The CONSRAD COMPANY

Sole distributors to the E. I. COMPANY  
233 Fulton St. New York, N. Y.

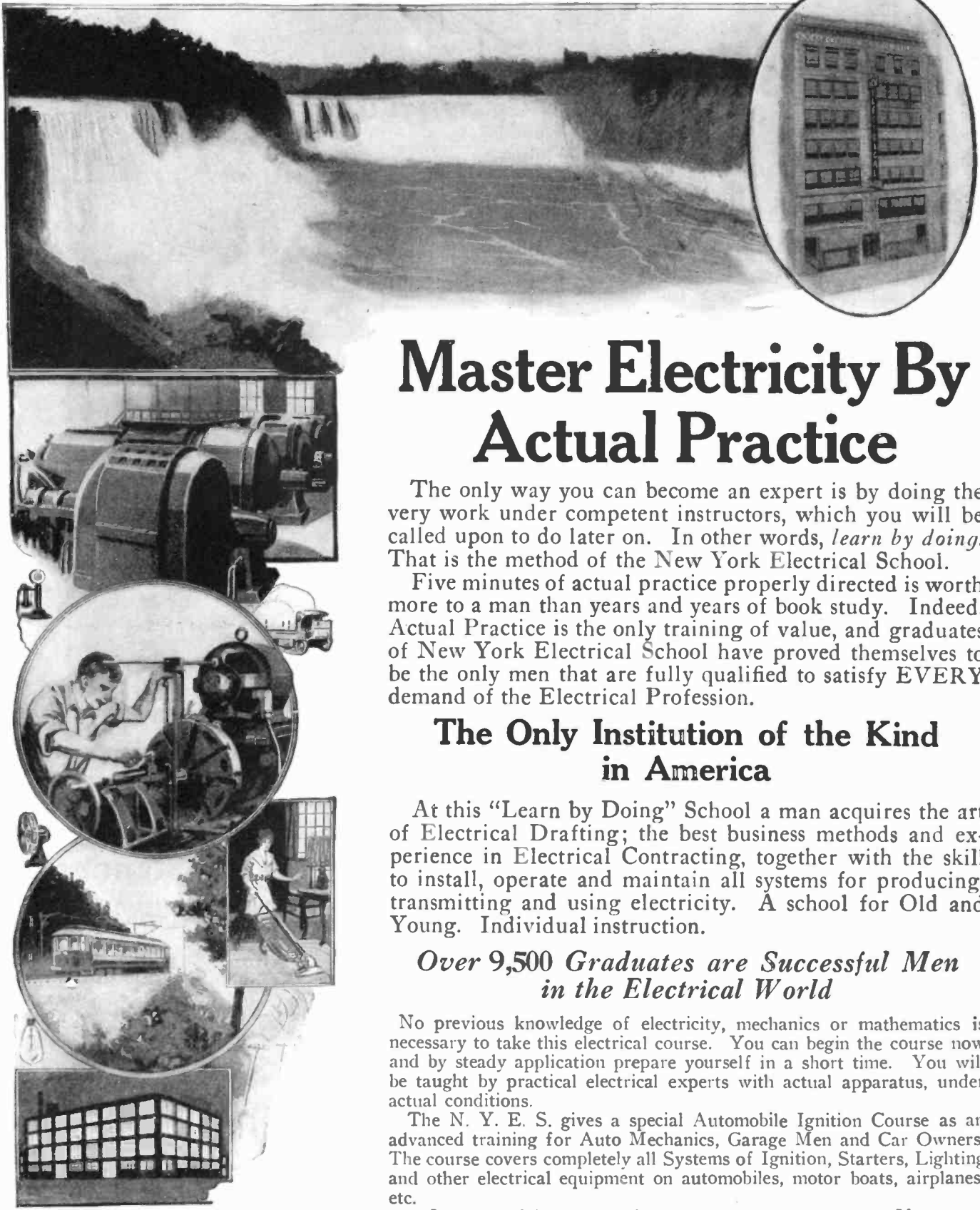

# Master Electricity By Actual Practice

The only way you can become an expert is by doing the very work under competent instructors, which you will be called upon to do later on. In other words, *learn by doing*. That is the method of the New York Electrical School.

Five minutes of actual practice properly directed is worth more to a man than years and years of book study. Indeed, Actual Practice is the only training of value, and graduates of New York Electrical School have proved themselves to be the only men that are fully qualified to satisfy EVERY demand of the Electrical Profession.

## The Only Institution of the Kind in America

At this "Learn by Doing" School a man acquires the art of Electrical Drafting; the best business methods and experience in Electrical Contracting, together with the skill to install, operate and maintain all systems for producing, transmitting and using electricity. A school for Old and Young. Individual instruction.

### Over 9,500 Graduates are Successful Men in the Electrical World

No previous knowledge of electricity, mechanics or mathematics is necessary to take this electrical course. You can begin the course now and by steady application prepare yourself in a short time. You will be taught by practical electrical experts with actual apparatus, under actual conditions.

The N. Y. E. S. gives a special Automobile Ignition Course as an advanced training for Auto Mechanics, Garage Men and Car Owners. The course covers completely all Systems of Ignition, Starters, Lighting and other electrical equipment on automobiles, motor boats, airplanes, etc.

*Let us explain our complete courses to you in person. If you can't call, send now for 64-page book—it's FREE to you.*

# New York Electrical School

29 West 17th Street, New York

New York Electrical School  
29 W. 17th St., New York, N. Y.

Please send FREE and without obligation to me your 64-page book

..... NAME  
 ..... STREET  
 ..... CITY ..... STATE



# Science and Invention

Editorial and General Offices, - - - 53 Park Place, New York

*"Those Who Refuse to Go Beyond Fact Rarely Get As Far As Fact" . . . HUXLEY*

## Directed Radio Waves

By HUGO GERNSBACK

**W**HEN Heinrich Hertz first made his memorable researches with electro-magnetic (wireless) waves, he found out quickly that these new waves acted in every respect the same as their sister waves—those of light. He discovered that wireless waves could be projected in the form of a beam, the same as you can project light waves with a searchlight. By using a huge pitch prism Hertz was also able to refract his wireless waves, just exactly as you can refract light waves by means of a glass prism.

### I BELIEVE THAT:

Power transmission by radio will be accomplished within ten years.

Although these properties of radio waves have now been known for over twenty-five years, not much use has been made of them. So far, we have used radio waves just as we use the electric arc and incandescent light. A modern radio station, just like your light bulb, throws out the waves in all directions, hence the name broadcasting. If you place a light globe in the center of a room, light will be broadcast in every direction: namely, sideways, up and down. It is exactly so with radio waves. But the idea of throwing a radio wave in the form of a beam, the same as a searchlight, has only lately been considered in a practical way.

Marconi, in England, was the first one to try beam radio transmission on a large scale. As a reflector, Marconi used an aerial arranged in the form of a reflector, having a parabolic cross-section, in the focus of which the radio transmitter is placed. It is found that when using such a reflector, practically no waves leave the reflector at the sides and in the rear. All the energy is transmitted from the open part of the reflector, exactly as with a searchlight.

This means that if you have a radio receiver behind or towards the sides of such a radio reflector, no signals or messages will be received in that position. Marconi has been able to transmit his beam waves in any desired direction, achieving thereby not only better and more efficient transmission, but partial secrecy as well, because nothing is received in other than one direction, that in which the beam is pointed.

Of course this does not mean full secrecy either, because a receiver located in the direction of the beam can receive the signals.

This beam transmission opens up numerous interesting possibilities. For instance, for war purposes, or even during peace, an airship or airplane could be equipped with a

beam transmitter, making it possible to communicate with a designated base only, to the exclusion of practically all other listeners-in. Vice versa, the ground station could communicate with an airship or airplane, without any one else being able to listen in, except over a small area, where it would not do much harm.

The writer advances what appears to him to be a novel thought, which he believes has not been tried out as yet. According to Nikola Tesla and Dr. James Harris Rogers, it is now possible to transmit radio waves through the earth. Thus, for instance, Rogers has found out to his satisfaction that transmission through the earth is vastly better than through the air, all static being practically absent. Suppose, now, we have a transmitter in New York and wish to transmit to Tokio, Japan, so that no one else, only the very small circle covered by the directed beam, can possibly listen in. We could then build a reflector that would direct the beam, not in a horizontal sense, but rather in a strictly vertical sense, namely underfoot.

By consulting a globe of the earth, the angle at which the reflector was to be set, can easily be found out. If the beam was sufficiently concentrated, no other city, with the exception of Tokio, would be able to listen in, for the transmitted waves would go practically through the mass of the earth, coming out within a small area in Tokio.

If we wished to transmit to Melbourne, Australia, we would have to change our reflector angle somewhat and in this case only Melbourne could listen in. It can be seen from this, that we could have a number of stations working in New York side by side, transmitting to other cities of the globe, without much or any interference. This transmission should be far more effective, for the simple reason that if the waves go over the surface of the globe, say from New York to the Antipodes, the distance would be, roughly, 12,000 miles, while right through the center of the earth, the distance would be only about 8,000 miles.

There is another point worth thinking about. A large manufacturing plant, let us say, has its offices in New York, its plant in Pittsburgh. The plant, by putting up beam transmission, could send and receive beam messages to the practical exclusion of nearly all others, unless located within the beam.

### I BELIEVE THAT:

the Patent Office is the best barometer of our civilization and culture.

### THE GOLDEN AGE OF SCIENCE

is symbolized by the golden cover OF SCIENCE & INVENTION. LOOK FOR THE GOLD COVER every month!

# Exploring

## Captain Wm. Beebe's Expedition

By J. W.

ON this page are shown the detailed drawings, photographs and descriptions of the equipment on board the S.S. Arcturus, Captain William Beebe's ship, sent out by the N. Y. Zoological Society to the Sargasso Sea. This is that portion of the Atlantic Ocean from about Latitude 20° to 35° North between the Azores and the Bahamas which has been immortalized by fiction writers. It has been supposed that the lost land "Atlantis" is somewhere along this section of the ocean. The ocean here abounds with large quantities of sea weed, and tradition would have it that the ships passing through the mass of sea weed frequently foul their propellers and remain there until Father Neptune, demanding his toll, converts the vessels into wrecks. From these fiction stories, the appellations, the "Ocean Graveyard" and the "Port of Missing Ships," arise. On this trip to the Sargasso, it was difficult to communicate via radio with the Arcturus, and it was feared that the ship had met disaster. The next report from the vessel came as it was passing through the Panama Canal en route to the Galapagos Islands, where Captain Beebe and his party are to continue their research begun there last year. Bad weather in the Atlantic Ocean caused them to abandon dredging operations. They are to return to the Sargasso in July or earlier. The Arcturus resembles an old pirate ship. She is of all wood construction. Her main drawback lies in the fact that she labors too heavily during the dredging operations. Each time a dredge or a trawl is lowered or raised, the ship is at the mercy of the waves. It requires two hours to lower and two hours to raise a dredge to and from a depth of three miles. During this time the heavy seas pound the vessel considerably. The members of the expedition have already captured fish with scales like hair or feathers, and some with fins like hands. Fish with lights were numerous in the trove already caught. A large laboratory has been built forward of the bridge deck. This laboratory contains every facility for the examination and study of the specimens.

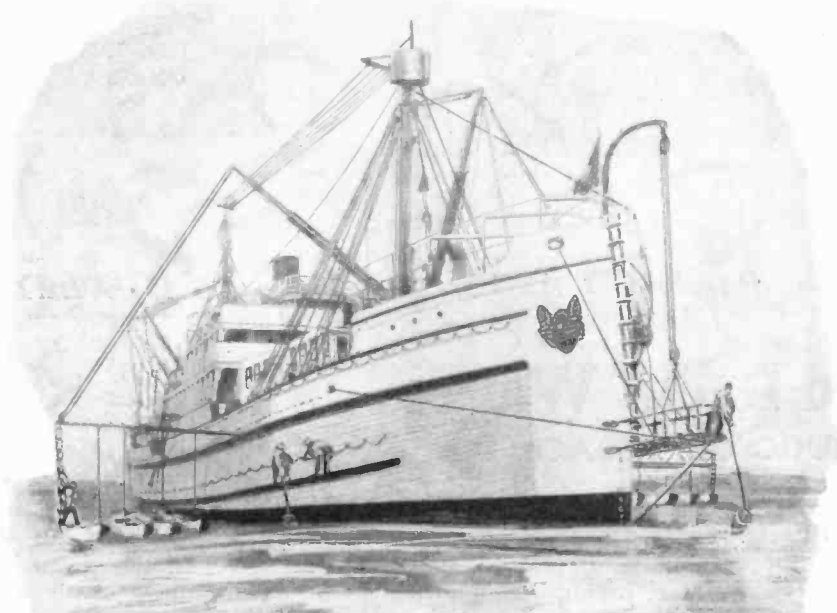

The above photo shows the Arcturus in full regalia. The bow pulpit extending from the bow of the vessel is used for netting floating organisms. This platform, resembling a cowcatcher, projects from the bow of the vessel just above the surface of the sea. It may be raised or lowered at will.

The photo at the left is that of Captain William Beebe.

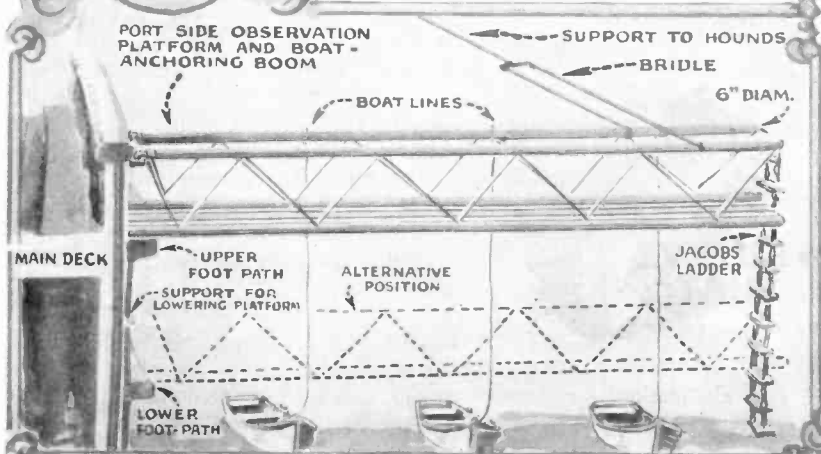

The photo-diagram above shows the port side observation platform and boat anchoring boom. This platform is supported by two booms six inches in diameter thirty feet long, and held two feet apart. The flooring consists of three, six-inch planks with one inch space between, and two-inch manila ropes form the sides. The platform may be lowered for close surface observation.

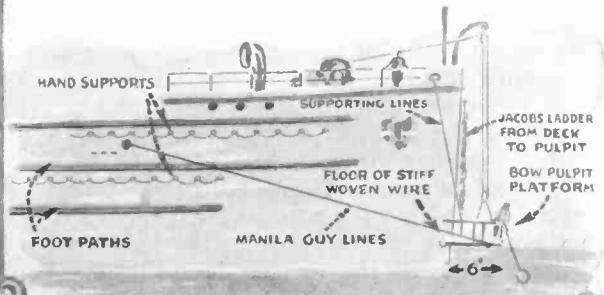

The above diagram is a side view of the bow pulpit for surface observations and netting. This is adjustable to any required level by means of block and tackle from the bow davit. The sides and general framework are of angle iron, and the bottom of stiff woven wire over angle iron braces.

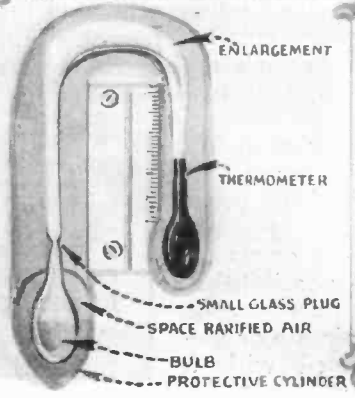
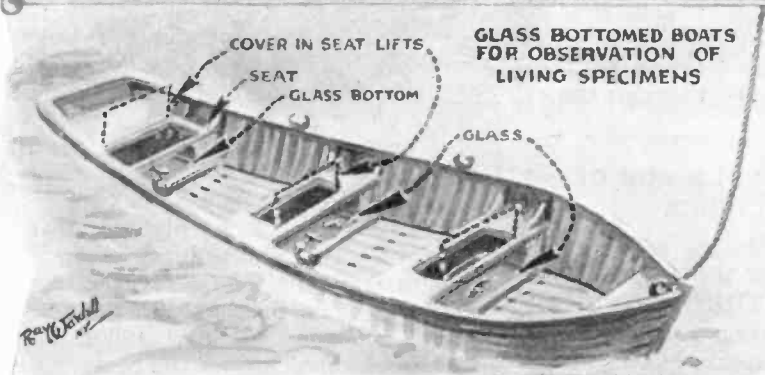

The row boats with which the expedition is equipped have glass bottoms under the seats. Lifting the seat the observer can look down into the waters beneath. The thermometer at the left is used for determining deep sea temperatures. This thermometer makes a complete revolution when the messenger is sent down breaking the column of mercury. It comes up, as shown.

# Sargasso Sea

and Equipment on the S. S. Arcturus

Von Stein

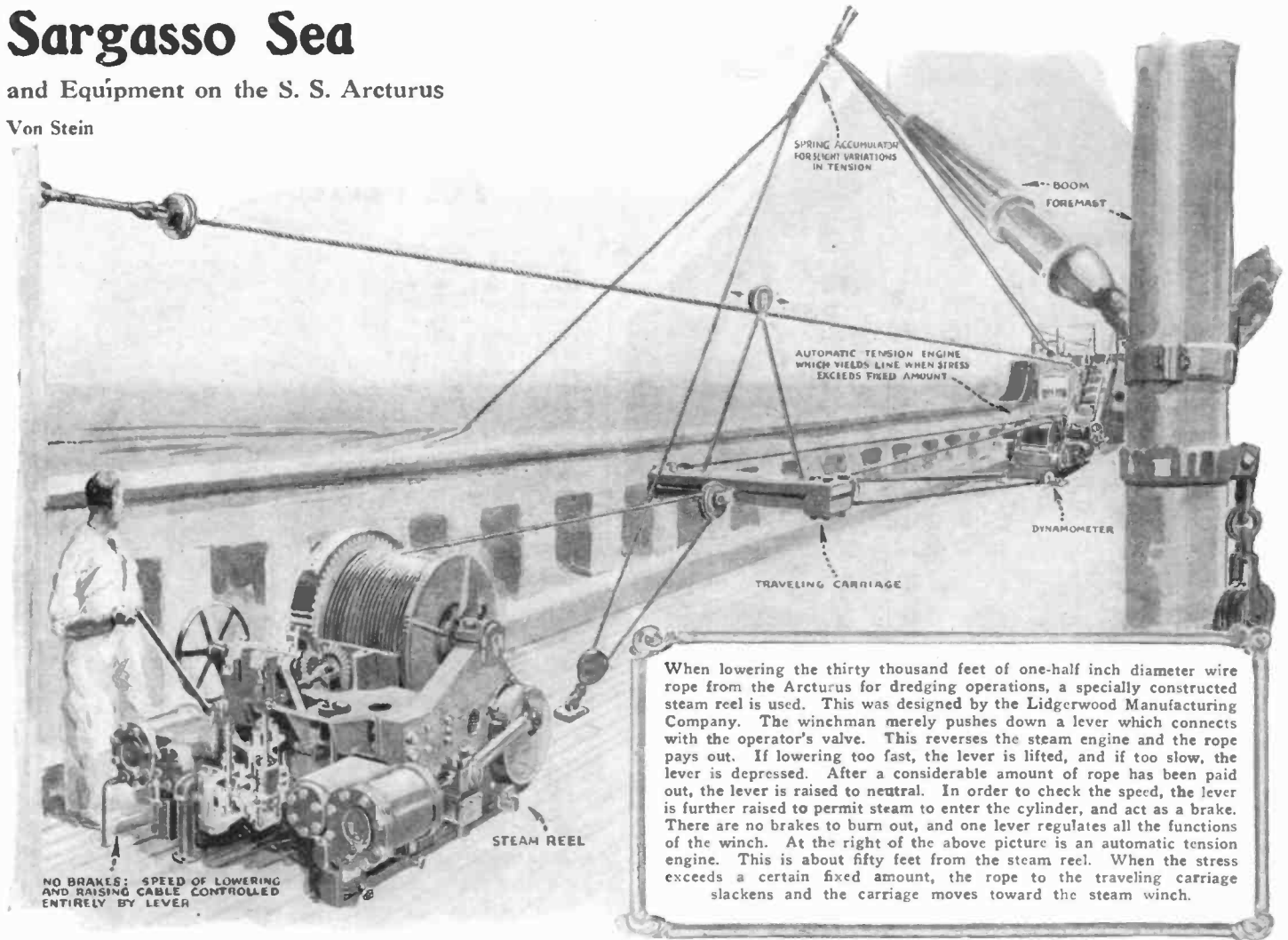

When lowering the thirty thousand feet of one-half inch diameter wire rope from the Arcturus for dredging operations, a specially constructed steam reel is used. This was designed by the Lidgerwood Manufacturing Company. The winchman merely pushes down a lever which connects with the operator's valve. This reverses the steam engine and the rope pays out. If lowering too fast, the lever is lifted, and if too slow, the lever is depressed. After a considerable amount of rope has been paid out, the lever is raised to neutral. In order to check the speed, the lever is further raised to permit steam to enter the cylinder, and act as a brake. There are no brakes to burn out, and one lever regulates all the functions of the winch. At the right of the above picture is an automatic tension engine. This is about fifty feet from the steam reel. When the stress exceeds a certain fixed amount, the rope to the traveling carriage slackens and the carriage moves toward the steam winch.

NO BRAKES: SPEED OF LOWERING AND RAISING CABLE CONTROLLED ENTIRELY BY LEVER

IN order to appreciate the length of line which the steam winch is capable of controlling, the illustration below has been drawn to correct scale. For an ocean depth of 18,000 feet, 30,000 feet of line will approximately be paid out. This line is shown sagging diagonally across the picture. The tiny ship on the surface of the water is the Arcturus, with a length of 281 feet over all. In order to further give a better example of the depth of the sea, the skyline of New York has been drawn in as though totally submerged at the bottom of the sea at this depth. The Woolworth Building, 792 feet high,

may be seen in silhouette. This is put here only for the purpose of comparison. Along the line the various nets used in Captain Beebe's Expedition have been strung. Of course, these nets are not shown in proportion. Some of them are about twenty feet long, while others are much smaller. Most of the nets may be closed at any time desired by sending a messenger down along the line. This messenger is merely a weight which strikes a release permitting the net to fall and lock itself. Other nets are kept open while the vessel in motion, but close automatically when movement stops.

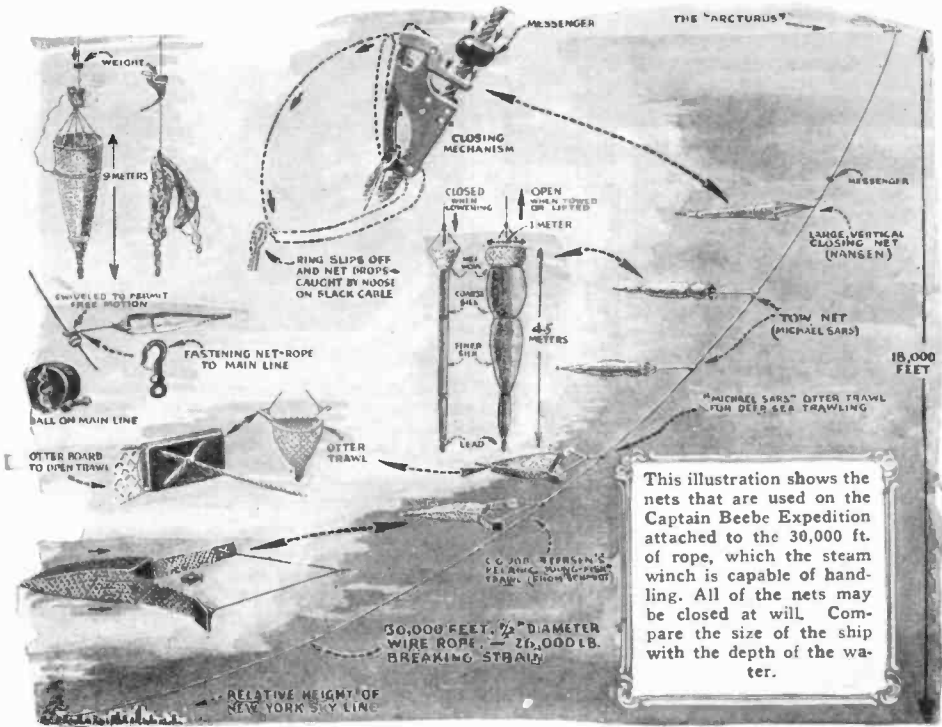

This illustration shows the nets that are used on the Captain Beebe Expedition attached to the 30,000 ft. of rope, which the steam winch is capable of handling. All of the nets may be closed at will. Compare the size of the ship with the depth of the water.

WHENEVER the submarine recording thermometer makes a complete revolution, the column of mercury is broken at the point marked "small glass plug" in the illustration on the opposite page, and as the thermometer swings around, the mercury flows around the enlargement so marked in the illustration, and then down the opposite side. This illustration shows how the mercury stood after being reversed. In the apparatus shown in diagram at the top of this page, the automatic tension machine produces a very important operation. This engine yields the line if the strain exceeds a fixed amount. Notice that a dynamometer is connected to one of the ropes which indicates the stress upon it. When dredging at three knots per hour, and using this automatic tension engine, a warning of twenty seconds is given to the operator of the winch machine if his line becomes fouled. Formerly rubber accumulators were used. These accumulators have a range of but ten feet, and a warning of two seconds was the maximum that a device of this type would give if dredging were done at three knots. If the line is fouled, the traveling carriage moves toward the operator, who pays out more line and notifies the pilot to swing the ship about.

# Some Examples of Burbank's Wonderful Work in the Production of Enormous Yet Perfect Flowers

Luther Burbank, as he appeared on his 76th birthday, March 7, 1925, when he announced that he is preparing to give to the world nearly a score of new fruits, vegetables and flowers, and expects the next ten years of his life to be the most productive he ever has had. Burbank believes that his accumulated experience has prepared him for the greatest work of his life.

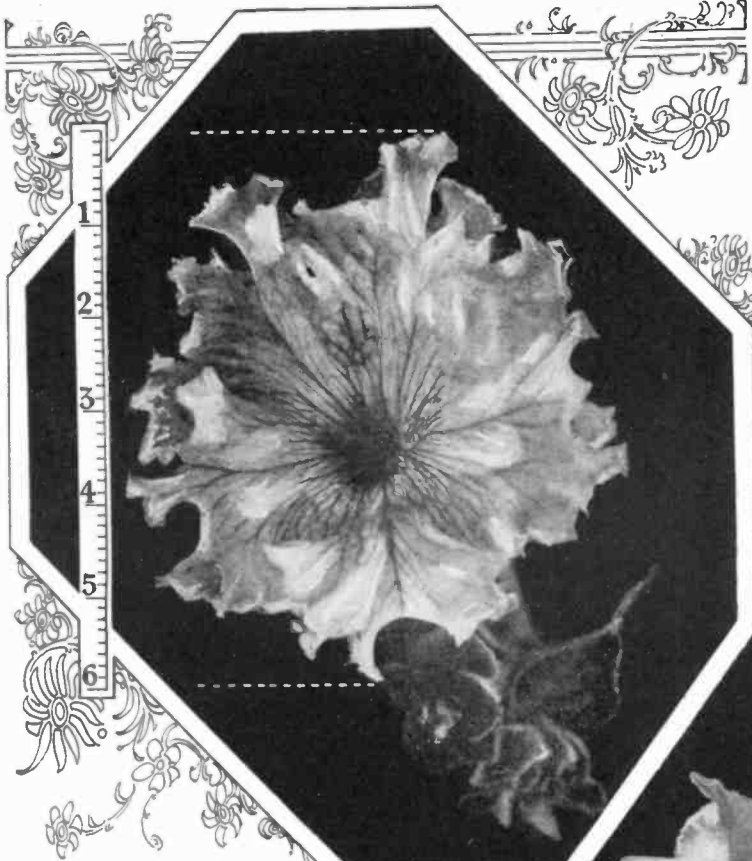

The famous blue petunia, a development completed by Burbank in 1925 and the only blue petunia grown in the world. The flower is shown in all its glory and is a full six inches in diameter. This enormous bloom has been developed from the ordinary small petunia familiar to all those interested in the beautiful science of floriculture.



The largest and most fragrant sweet pea in the world, a pink and white variety given to the world in 1925, as a result of more than 20 years' experimenting and selective cross-breeding of sweet peas by Mr. Burbank. Many of the flowers of this variety are more than two inches in diameter. The particular bloom shown at the right has attained an extreme diameter of 3 inches, most unusual for a normally small flower.

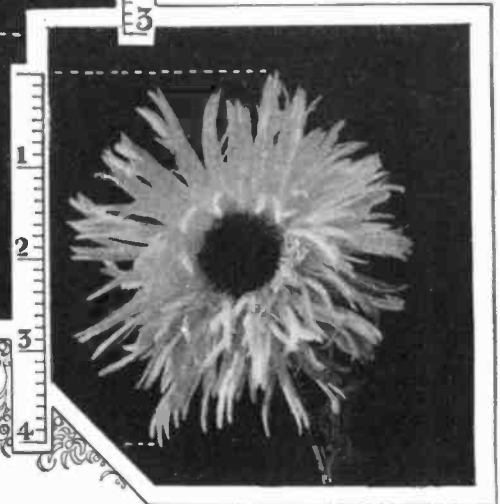

The "Triple Shasta Daisy," which, as a matter of fact, has seven layers of petals. This is Burbank's latest flower development, which he has grown from the original single daisy found wild on the slopes of Mount Shasta, California. The flower illustrated above has an outside diameter of fully 4 inches and its graceful petals and beauty as compared with the ordinary daisy are most noticeable features.



At the left is shown an interior of one of the great Burbank green-houses. The flowers growing so profusely on either side of the center walk are white tuberous-rooted begonias. These plants have been especially planted and prepared for later conversion into all colors of the rainbow by the selective cross-breeding process developed to a high degree of accuracy and efficiency by the plant wizard, Burbank.

# 25 New Flowers in 25 Years—Burbank

By H. H. DUNN

WITH seventy-six years of his life behind him, sixty of them devoted to the development of new and improved varieties of trees, vegetables and flowers, Luther Burbank, the California plant magician, is devoting this, his seventy-seventh year, to the beginning of a 25-year program in which he plans to present from 20 to 25 new members of the vegetable kingdom to the world. At a time when most successful men are resting on their honors, looking backward with satisfaction on their accomplishments, Burbank is looking forward to "the most successful and most productive years" of his life.

In addition to this, he is turning over a new leaf in plant breeding. With the exception of some three or four vegetable forms, which he has been developing for the past 20 years, Burbank will devote all his attention for the remainder of his life to the production of new varieties, larger blossoms, different perfumes and stronger fragrance in flowering plants alone. His vegetable experiments, the results of which are to be given to the world this year, thereby clearing the slate for exclusive devotion to flower development, include a new asparagus with stalks one to one and one-half inches in diameter; a new tomato with a mild pepper flavor, so that it may be used directly for the making of pepper sauces, without the addition of Chile or other peppers; an artichoke with buds three inches in diameter and blossoms 18 inches wide; a blackberry without thorns on the canes or seeds in the fruit which is more than two inches in length; and a chestnut tree which attains to full bearing in three years from the seed.

Mr. Burbank has had these plants in various development stages for the past 20 years, with the exception of the chestnut, which has been fifteen years in its experimental life. Some experiments, involving selection, cross-breeding, elimination, cross-fertilization, budding, grafting and other factors, have required thirty years for the production of the perfected fruit or vegetable. One of these is the fast-growing black walnut, which attains full size in 20 years, as compared with the 40 or 50 years required by the American black walnut. The average time for a successful plant development, however, is twenty years, according to Burbank, who further told me that more than 25,000 plants had been grown, destroyed or preserved, cross-fertilized by hand, and carefully developed, to produce the asparagus, tomato, artichoke, blackberry and chestnut above mentioned. There are at present about 2,500 plants of these four varieties growing in his experimental gardens at Santa Rosa, California, but out of these only about 200 will be permitted to survive, the others failing in one way or another to pass the rigorous tests of the plant-breeder.

But it is in his new flower work, of which this is the first announcement, and of which the first photographs are shown herewith, that Burbank is planning the most radical developments he ever has made in plant life. One of the floral experiments now virtually completed is a huge petunia, of a sparkling, sea-blue color, the first blue petunia ever grown in the world. The blossoms are four to five inches in diameter, and the plant is much harder than any other petunia now known, so that it can be grown far north, some of his correspondents in Alaska having produced these blossoms up near the Circle. This flower also has an odor different from that of any other petunia, for Burbank has

## Plant Magician, After Sixty Years of Work, Turns Attention to Perfuming the Rose and Painting New Colors Into the Lilies of the Field.

introduced into it the fragrance of the sweet-pea, while the blossoms are of such strong texture that they remain perfect on the plant for two to three weeks.

And, speaking of sweet-peas—which Burbank calls "the poor man's orchids"—he has enlarged the blossoms on these until they are from two to four times the size of any now known. He also has developed a sweet-pea which produces such heavy stalks that it will stand without support, and thus can be grown as dahlias and other heavy-stalked flowers are grown, without frames on which to climb. One pink and white sweet-pea, which is to be given to the world this year, after twelve years of development, has blossoms three inches in diameter, grows three to five blossoms on the stem, while the stem itself is 18 inches to two feet in length.

### Listen In! WRNY is Broadcasting

About the time you are reading this, WRNY, our new broadcasting station located in New York City will be on the air. Tune in to 258.5 meters and hear fine music, tidbits of science, latest radio hook-ups "via the air," answers to your technical questions, et cetera. The last word in broadcasting service. See page 248.

the largest and most fragrant of all sweet-peas. In connection with this flower, Burbank has produced a high climbing sweet-pea, suitable for porch covering, with a perennial, instead of annual life, and bearing thick clusters of small sweet-peas, closely produced all over the vine.

Burbank considers his most valuable flower development that of new colors and perfumes for roses. It is an old trick with the plant wizard to make a climbing rose out of a bush, or a bush-rose out of a climber, but now he has succeeded in producing twelve new colors in roses, ranging from a deep-rich orange, to a red so deep as to be almost black, through several shades of pink, ivory, copper, brass and the lighter reds. Each of these new roses can be grown either as a climber or a bush, the result depending entirely on the pruning of the plant, and each of them is fragrant, with a fragrance entirely different from any one of the other eleven in the group. Yet all are developed from existing strains of roses, and the experiments which have given these twelve results have been going on in the Burbank gardens for fifteen years.

There is also a new Shasta daisy which

has seven rows of petals, each petal being a long, narrow streamer of snow-white, set around a dark center. This, like the large single daisy of the same name, was developed from the comparatively small wild daisy which grows only on the slopes of Mount Shasta, in California. In considering these developments, it should be remembered that Burbank has never *created* a new species of plant or flower. What he has done is to take already known and established species, either wild or domesticated, and develop them by careful selection, cross-fertilization, grafting and budding, into forms better than anything which could have been produced had the plants been left to their own devices in their original surroundings. In other words, as Burbank himself says, "by intensive work I do in twenty or twenty-five years what Nature would require several centuries to accomplish." He has produced crosses and hybrids which appear so different from their parent plants that they seem to be new species, yet they are merely mixtures of the best qualities of the several ancestor plants which Burbank has used; they are not in any sense new species. The Burbank potato, his first and greatest success; the Burbank plum, one of his greatest discoveries; the Shasta daisy, possibly his most notable flower, are of this class, and only time will tell how many of these cross-breeds eventually will revert to the original types. Down to date, the plum and the potato have not done so. Neither has the strange "potamato," the freak cross which produces potatoes underground and tomatoes on the surface. This plant has no commercial value, but is interesting as showing what the plant breeder can do in the way of developing hybrids.

"Some of the colors on my new roses are radically different from any shades ever before seen on the queen of flowers," said Mr. Burbank to the writer, on the seventy-sixth birthday of the plant magician, in the spring of 1925. "In size, all are considerably larger than any rose now grown, and the richness and volume of their perfume is not only different, but far greater than from any other roses. Some were developed from wild roses sent me in the form of seed and cuttings from my collectors in Asia, Africa and South America, while others come from already known domesticated varieties. My success with these roses over a period of fifteen years has led me to take up flower development exclusively, and, in the next 25 years, I shall present from 20 to 25 new flowers."

The picture of a man six years beyond the allotted three score and ten, moving as quickly and with as certain step as that of a man of forty, amid more than 2,500 experiments in plant breeding, occupying more than 20 acres of gardens, is one not soon forgotten. In one hand he carries a powerful reading glass, in the other a camel's-hair brush. With the glass he looks deep into the corollas of the selected blossoms, and with the brush he removes almost invisible clumps of pollen grains, transferring them with firm and practiced hand to another equally strong and perfect flower. At his side walks his wife, notebook in hand, recording in detail each experiment, while back of them comes an employe, with a bag full of tags, one of which he attaches to each newly-fertilized plant, after writing on the tag a number which corresponds to the number of the experiment as recorded in Mrs. Burbank's notebook.

"There is no magic to plant-breeding," Burbank said, as he completed the fiftieth  
(Continued on page 285)

# S. S. "Homeric" Answers S.O.S.

## Difficulty of Rescues on Stormy Seas

By H. WINFIELD SECOR, E. E.



The recent sea disaster when the S.S. Homeric answered the SOS of the Japanese ship Raifuku Maru is shown in the pictures herewith. Oil poured on the waves by the Homeric proved fruitless. Life rafts or boats were not lowered due to sixty-foot waves. High wind, sleet and rain prevailed.

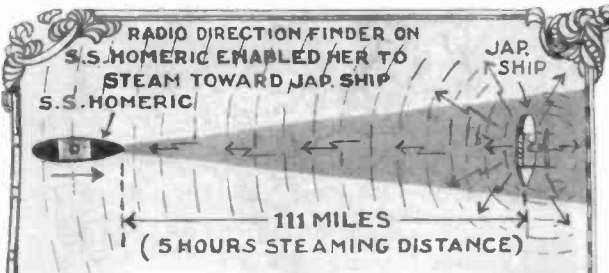
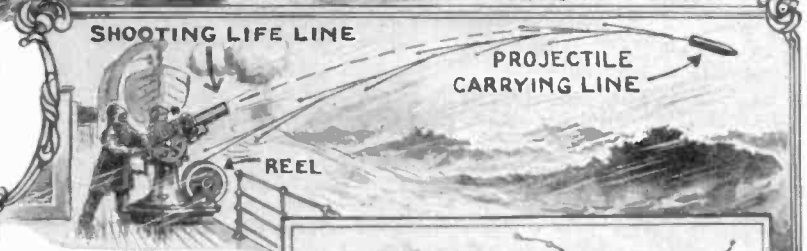

The Homeric steered toward the Japanese ship by directional radio, as shown above. The distress signals from the Jap ship spread in all directions, however.

All ocean-going steamships should carry lifeline guns, which, in the case of severe storms, may result in the saving of lives. Mr. H. Gernsback has proposed a new form of lifeline having branch lines, as shown at right.

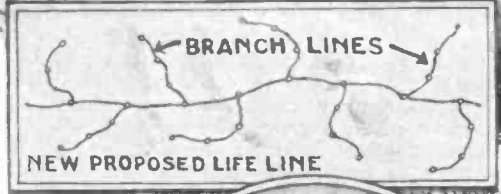

If Homeric's boats had approached Jap ship, they might have been sucked down with her. The Jap ship went down quickly.



With Homeric close, wreck might have struck her, as below.

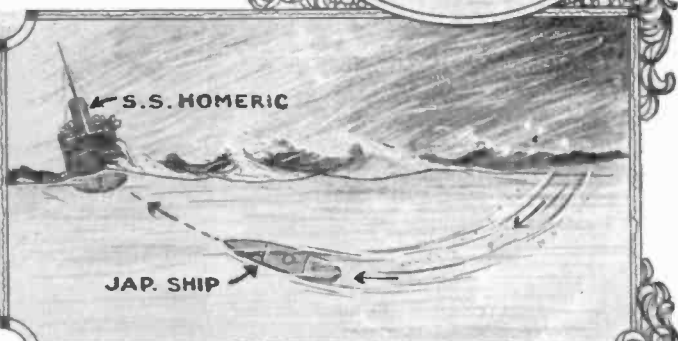
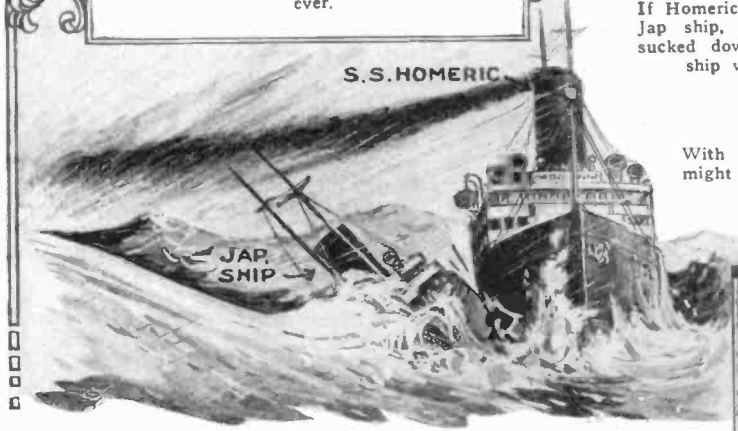

As one sea captain explained, if the Homeric had approached too close to the distressed ship, a mighty wave might have picked up and hurled the vessel into the giant Homeric, with a possible chance of disaster to that ship. Ships on a stormy sea dare not approach very close.

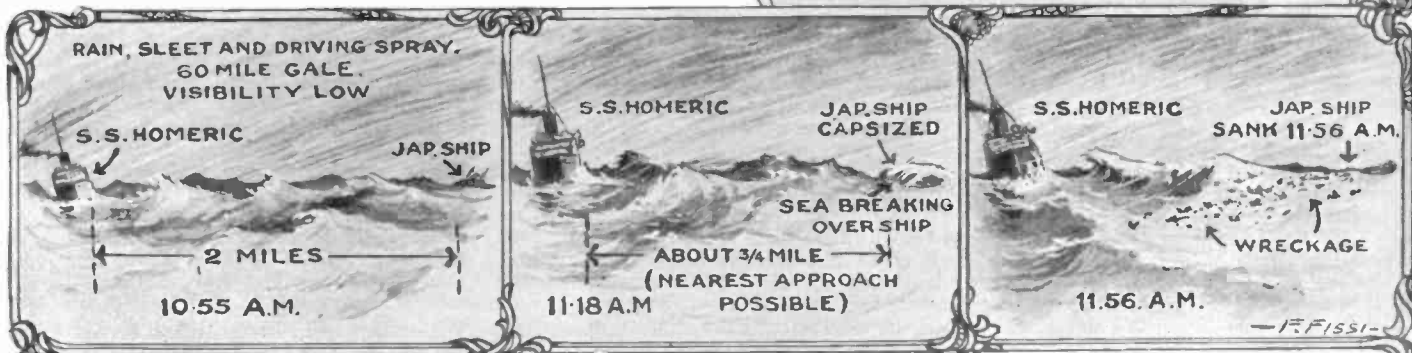

Three pictures above show progressively what happened from the time the Homeric arrived about two miles away from the Jap ship. A high wind with rain prevailed.

In about twenty minutes the Jap ship capsized and the seas broke over her, washing the few survivors off. Eye-witnesses differ as to seeing men swimming in sea.

At 11:56 A. M., the Jap ship disappeared and the sea was strewn with wreckage. The Homeric dared not approach closer than about 3/4 mile.

- F. FISSI -



The picture above, drawn by our marine artist, Mr. F. Fissi, gives one some impression as to what kind of conditions the officers and crew of the Homeric encountered as they stood by helplessly, while the Japanese ship Raihaku Maru foundered and carried her crew of thirty-eight officers and men to their death, without a single survivor. Civilian eyewitnesses among the passengers of the Homeric agree that the waves were of mountainous proportions, fifty to sixty feet in height, and that doubtless life boats, if they had been lowered by the captain of the Homeric, would have been smashed instantly.

It seems to the editors that a life-line gun, if carried by the Homeric, might have been of some avail under these extremely stormy conditions. One of the officers of the Homeric told the writer that no one, unless they had been on the ship themselves, could judge the conditions fairly. He stated that in all his twenty-two years of experience at sea he had never seen such a terrible storm as this one, and that it was humanly impossible to do anything toward saving the few survivors standing on the bridge of the doomed ship. Homeric's life rafts might have helped, but the huge waves would probably have defeated their purpose.

# The Isolator

By HUGO GERNSBACK

MEMBER AMERICAN PHYSICAL SOCIETY



The author at work in his private study aided by the Isolator. Outside noises being eliminated, the worker can concentrate with ease upon the subject at hand.

fitted greatly thereby, but our work would be accomplished more quickly and the results would be vastly better.

The writer, who has to perform, almost daily, in connection with his editorial duties, many tasks that involve considerable concentration, has found out that it is almost impossible to keep his mind on a subject for five minutes without disturbance. For that reason, he constructed the helmet shown in the accompanying illustrations, the purpose of which is to do away with all possible interferences that prey on the mind.

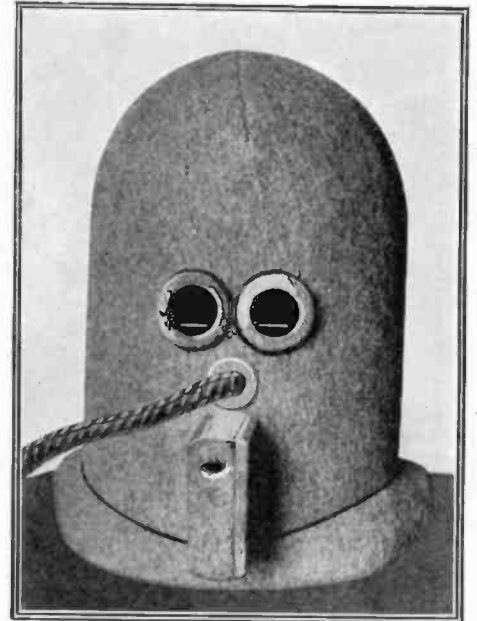

The above photograph shows a close-up view of the Isolator helmet. The oxygen supply enters the helmet via the tube shown.

**P**ERHAPS the most difficult thing that a human being is called upon to face is long, concentrated thinking. Whether you are a lawyer, trying to formulate or memorize the pleading of a special case, whether you are an inventor with an intricate problem to be solved, whether you are a playwright trying to hatch out a knotty plot—assiduous concentration on the subject becomes necessary.

Most people who desire thus to concentrate find it necessary to shut themselves up in an almost soundproof room in order to go ahead with their work, but even here there are many things that distract their attention.

Suppose you are sitting in your study or your work room, ready for the task. Even if the window is shut, street noises filter through, and distract your attention. Some

one slams a door in the house, and at once your trend of thought is disturbed.

A telephone bell or a door bell rings somewhere, which is sufficient, in nearly all cases, to stop the flow of thought.

But even if supreme quiet reigns, you are your own disturber practically fifty per cent. of the time. You will lean back in your chair and begin to study the pattern of the wallpaper, or you will see a fly crawl along the wall, or a window curtain will be moving back and forth, all of which is often sufficient to turn your mind away from the immediate task to be performed.

The writer repeats that the greatest difficulty that the human mind has to contend with is lack of concentration, mainly due to outside influences.

If, by one stroke, we can do away with these influences, we will not only be bene-

The problem was first to do away with the outside noise. The first helmet constructed as per illustration was made of wood, lined with cork inside and out, and finally covered with felt. There were three pieces of glass inserted for the eyes. In front of the mouth there is a baffle, which allows breathing but keeps out the sound. The first construction was fairly successful, and while it did not

(Continued on page 281)

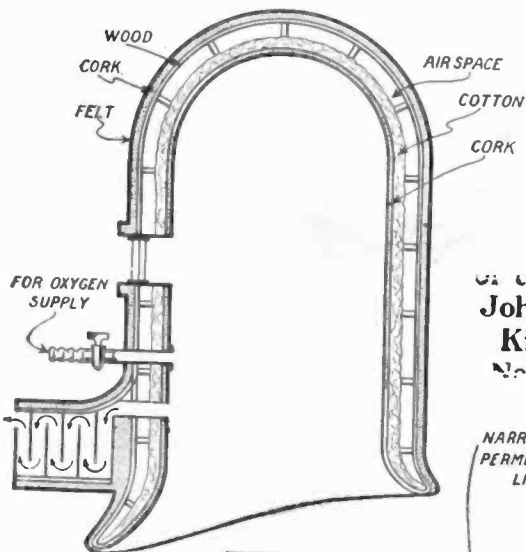

OF THE SUBJECT  
**John Smith  
Kingston  
New York**

NARROW VISION SLIT  
PERMITS OF BUT TWO  
LINES OF TYPE  
SHOWING

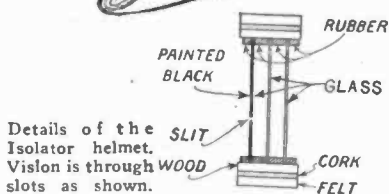
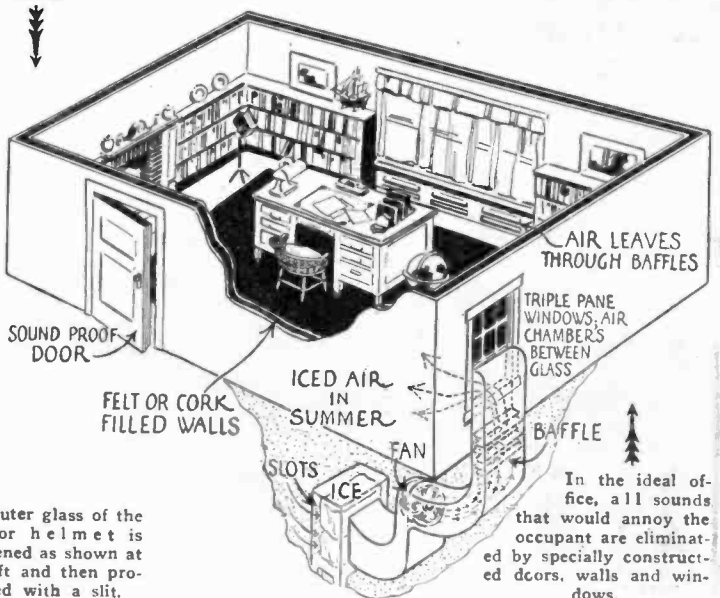

In the ideal office, all sounds that would annoy the occupant are eliminated by specially constructed doors, walls and windows.



# A Movie Stadium

By DR. ALBERT NEUBURGER

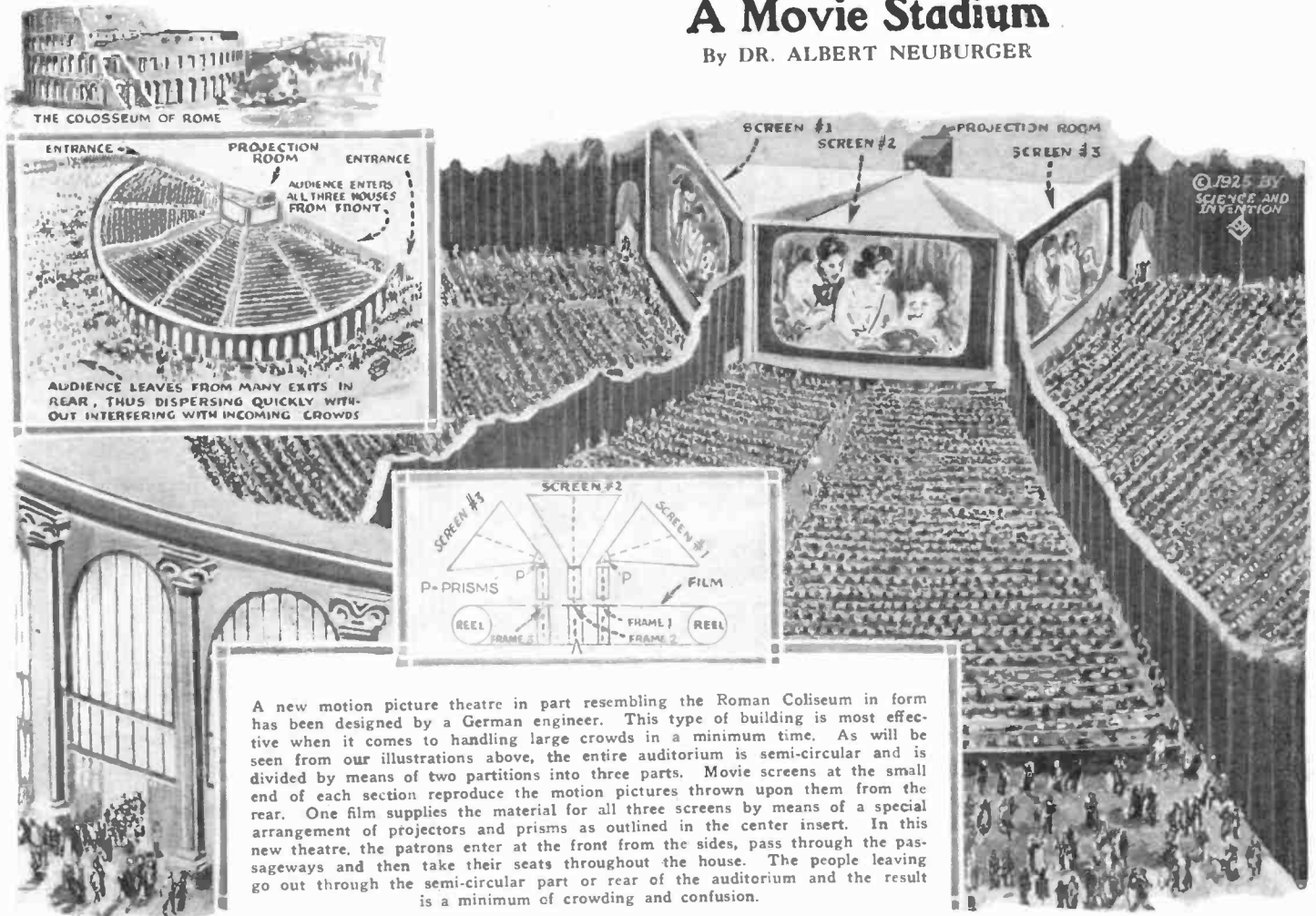

A new motion picture theatre in part resembling the Roman Coliseum in form has been designed by a German engineer. This type of building is most effective when it comes to handling large crowds in a minimum time. As will be seen from our illustrations above, the entire auditorium is semi-circular and is divided by means of two partitions into three parts. Movie screens at the small end of each section reproduce the motion pictures thrown upon them from the rear. One film supplies the material for all three screens by means of a special arrangement of projectors and prisms as outlined in the center insert. In this new theatre, the patrons enter at the front from the sides, pass through the passageways and then take their seats throughout the house. The people leaving go out through the semi-circular part or rear of the auditorium and the result is a minimum of crowding and confusion.

# The Newspapers of the U. S.



Each day there are enough daily papers published in the United States to cover an area equal to 2 4/10ths Central Parks. See Fig. 1.

Right, Fig. 2—A, pile of United States daily newspapers printed yearly. B, pile of all newspapers of U. S. printed yearly.



All daily papers would cover an area about equal to that of Rhode Island. There are 15,000,000,000 newspapers printed annually in the United States.

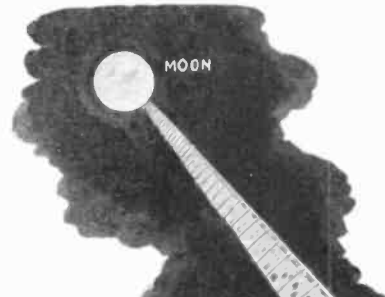

Left, Fig. 2, C shows yearly height of weekly papers. D, yearly height of Sunday papers. Fig. 4, 9/10ths volume of great pyramid about equals volume of yearly papers. Fig. 5, morning and evening papers published daily piled flat would reach 18 1/2 miles—one half of them would equal 88 Washington monuments. Fig. 6: end to end, annual printing of papers would reach 21 times to the moon. Fig. 7, all papers printed yearly would cover an area about equal to 80 New York cities. —Charles Nevers Holmes.

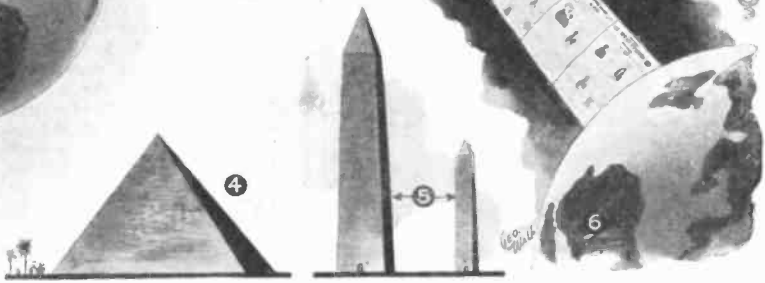

# Science News of the Day

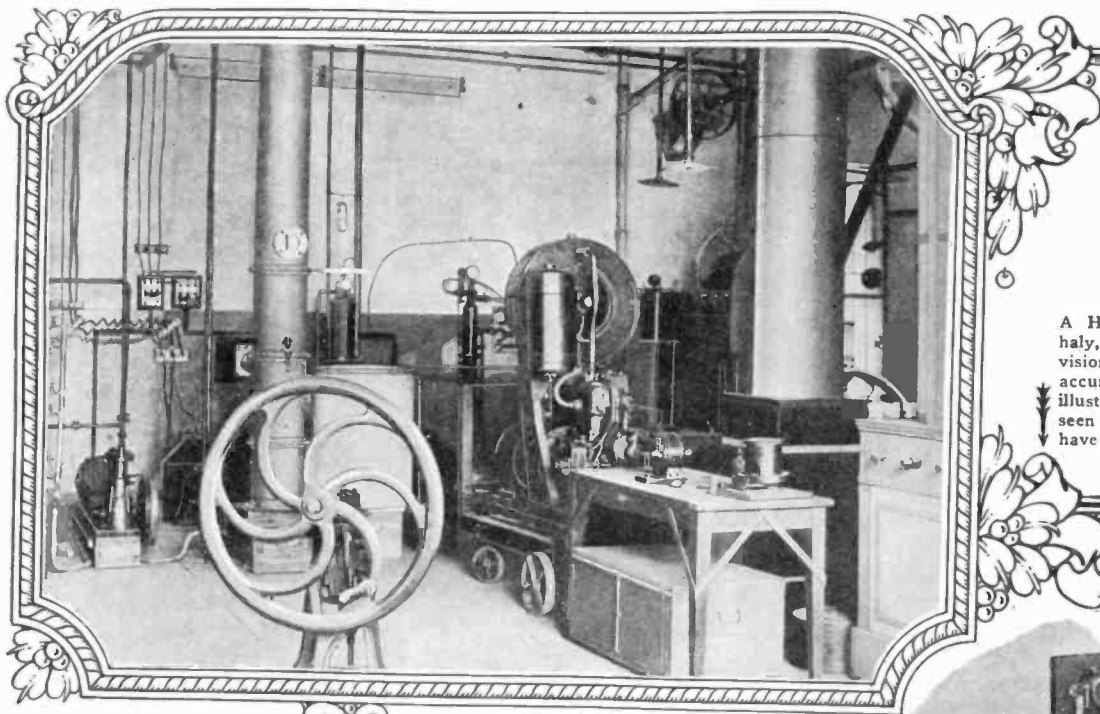

↔ The world renowned French scientist, Prof. d'Arsonval has recently invented a direct current generator capable of developing half a million volts. This is 200,000 volts higher than the largest direct current generator ever built, although A.C. machines have attained higher voltages.

↘ A Hungarian engineer, Dienys von Mihaly, has recently completed a radio television device which is said to be most accurate and efficient in operation. The illustrations or actions transmitted are seen directly on a screen and do not have to be first recorded on a paper or other surface.

One of the two known models of ancient water clocks used by the Romans in the time of Julius Caesar. The particular clock illustrated was made by John Peel of York, England, in 1664, at which time they were also in quite extensive use. →

Prof. Riviere, an eminent French scientist, was recently elected French correspondent of the American Academy of Medicine. He is shown below using his invention, the "Solenoid of d'Arsonval." ↘

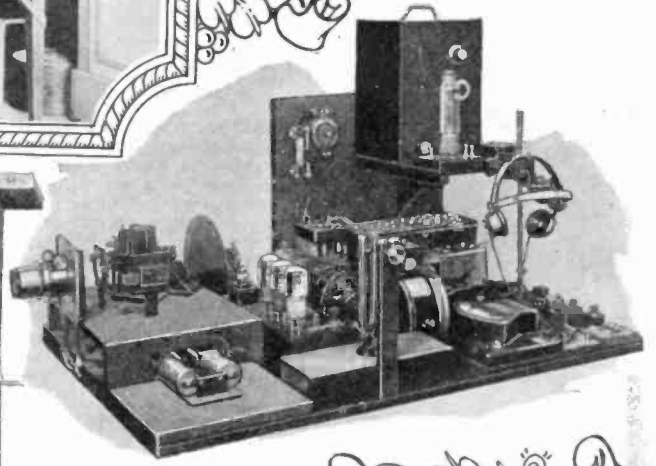

↔ The Bureau of Standards has recently set out to determine the actual weight of our earth by first determining, with greater accuracy than has heretofore been obtained, the gravitational constant or the attraction of one body for another. This is accomplished by the apparatus shown, situated in a deep cellar and observed by a system of mirrors so that the body of the observer will not affect the mechanism. Dr. Heyl, the designer of this apparatus, hopes to reduce the error of the constant mentioned to one-tenth its present amount.

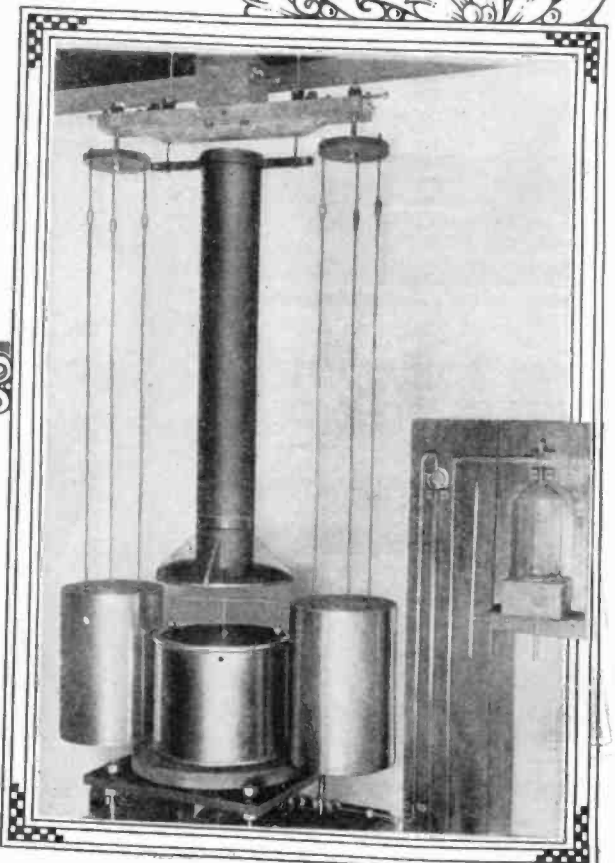

# Oenothera, the Evening Flowering Primrose

By DR. ERNEST BADE

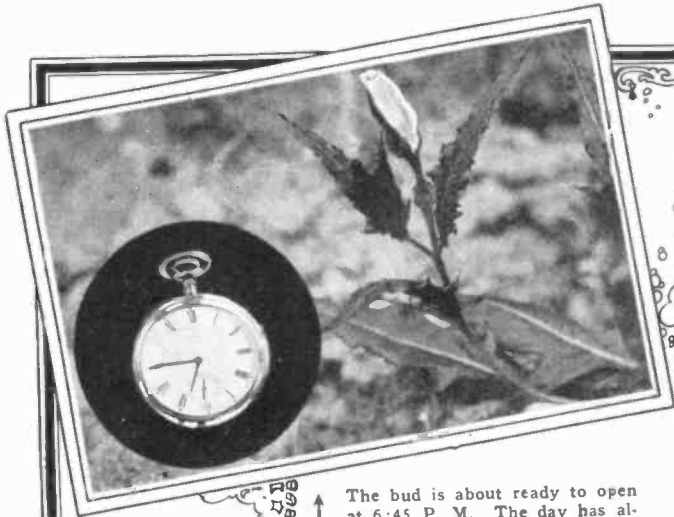

The bud is about ready to open at 6:45 P. M. The day has almost ended.

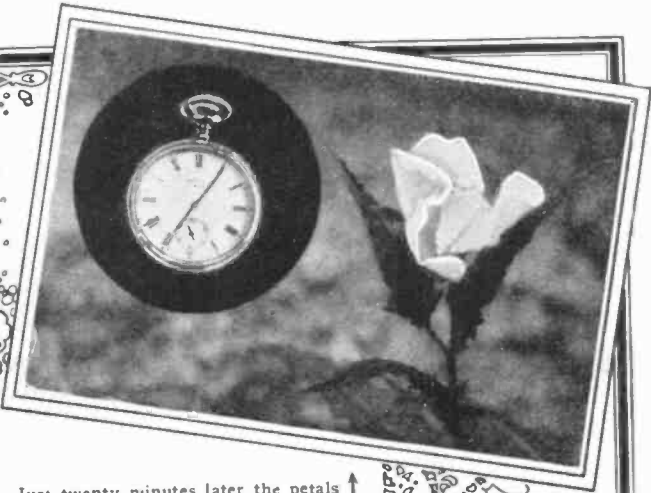

Just twenty minutes later the petals are partially unfolded

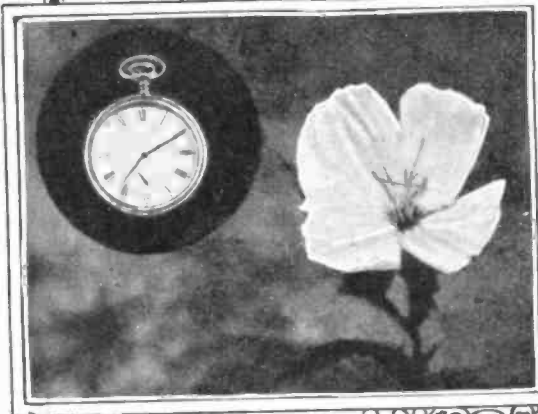

The flower is slightly more than half open five minutes later; the process of unfolding being so rapid that the motion of the petals can be seen when closely observed. The motion is not uniform, but consists of almost imperceptible little jerks.

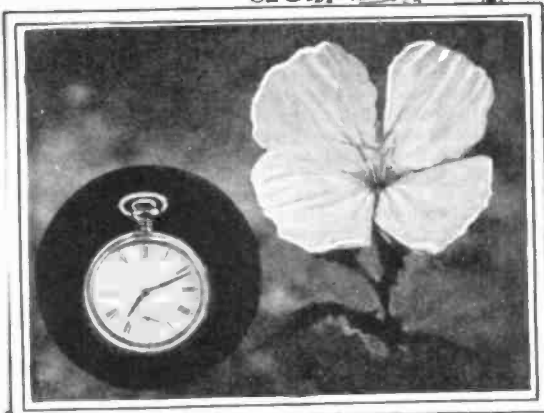

Now this flowering evening primrose is impatient, the flower begins to open fully its white and gleaming beauty. It is a flower built for the night, soft and fragile, its shining whiteness attracting the insects that fly by night.

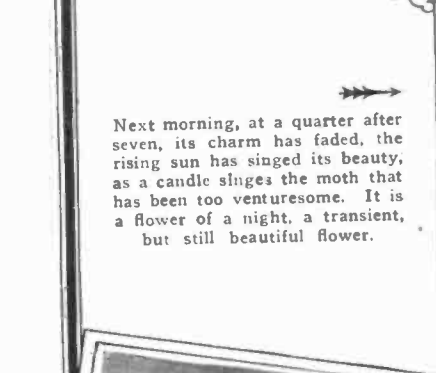

Next morning, at a quarter after seven, its charm has faded, the rising sun has singed its beauty, as a candle sings the moth that has been too venturesome. It is a flower of a night, a transient, but still beautiful flower.



At noon the flower of the night before cannot be recognized, it has become a shapeless discolored mass, curled around its support.

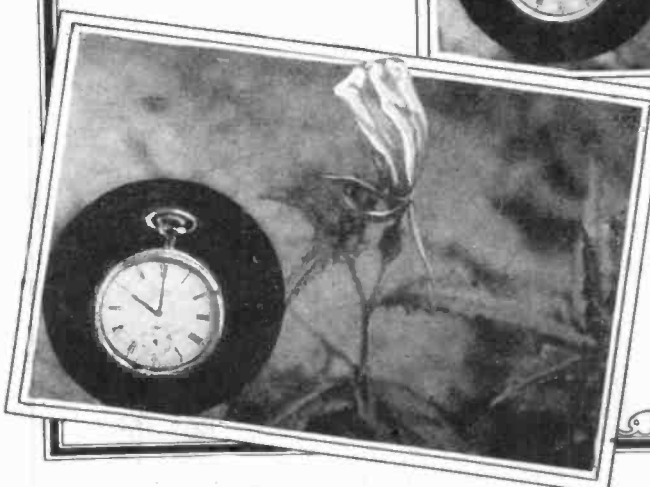

The decay is rapid. At 10 o'clock the next morning, the flower has wilted to the extent shown above. The sun has dried it up.

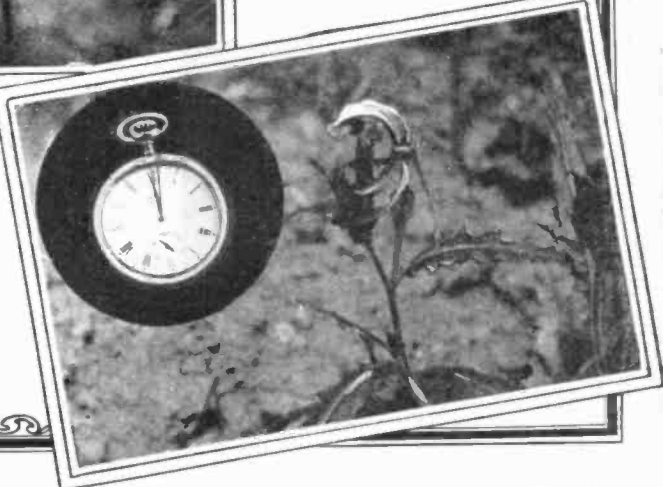

# Our Earth's Atmosphere

## A Few Interesting Facts Not Generally Known

By JOSEPH M. HOWARD

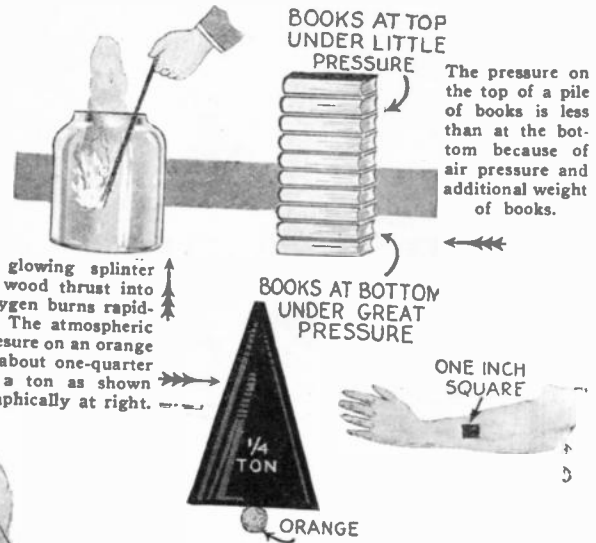
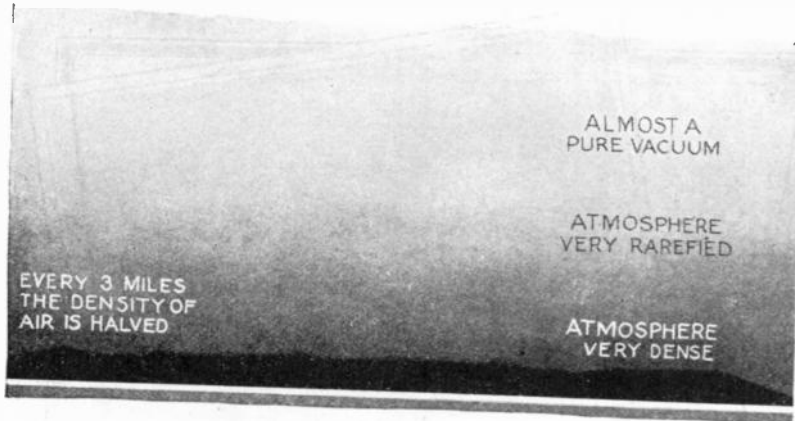

The air pressure at sea-level is greater than on the top of a high mountain. The reason is obvious. Recurring to our stack of books, the pressure on the lower book is much greater than the pressure on a book near the top because of the weight of the extra volumes. Furthermore, if the books were made of some elastic material, the books near the bottom would be compressed. Following the analogy, the air is very elastic and therefore greatly compressed due to the weight of the overlying layers. If one were to rise in a balloon he would find the pressure just halved every three miles. This greatly limits the heights to which balloons can ascend and therefore the heights to which we may explore the atmosphere by direct means. The effect of removing air pressure is shown at the right. An orange is placed in a chamber and the air removed by means of a pump. If sufficient air can be taken out, the orange will explode due to its internal pressure.

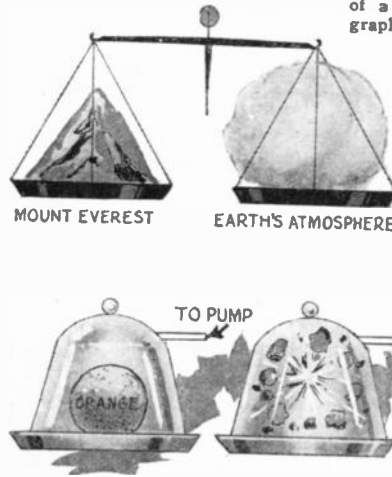

We live at the bottom of a sea of atmosphere just as fish live in a sea of water. The total weight of our atmosphere is five quadrillion (5 followed by 15 ciphers) tons or is equal in weight to Mount Everest. The air pressure is nearly 15 pounds to the square inch as above.

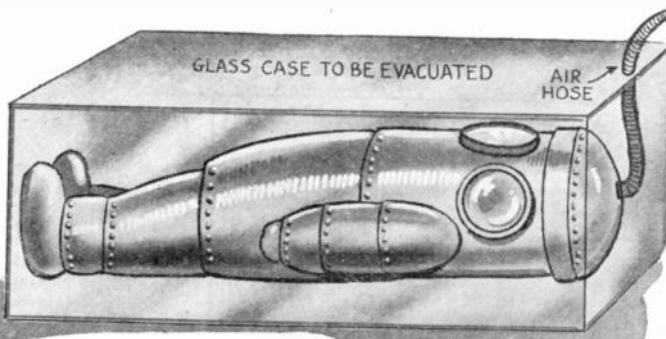
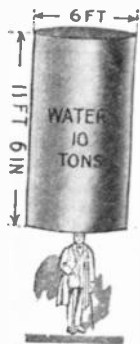

**SURROUNDING** the earth, which is about 8,000 miles in diameter, is a thin shell, known as the earth's atmosphere—or air. Near the surface it is composed almost entirely of oxygen and nitrogen, a very fortunate mixture. Oxygen, so necessary for the maintenance of human and animal life, would not suffice of itself. That gas is particularly active chemically, its presence being required for all processes of combustion. A glowing splinter thrust into the pure gas will burst into flame. If the earth's atmosphere were composed of this element alone, it would be impossible to stop fires.)

Meteors or shooting stars are small particles of iron or stone, which, heated by the friction of their passage through the atmosphere, are raised to a temperature where they shine brightly. These objects are seen as high as 120 miles, proving that the atmosphere extends to at least this height.

If the earth's atmosphere were instantaneously removed, everything including people would immediately explode, since the normal pressure on a person is 10 tons. In order to subject a man to a vacuum without this effect, he would have to be enclosed in a heavy armor and placed in an evacuated chamber. Air would have to be supplied by means of a pump and hose.

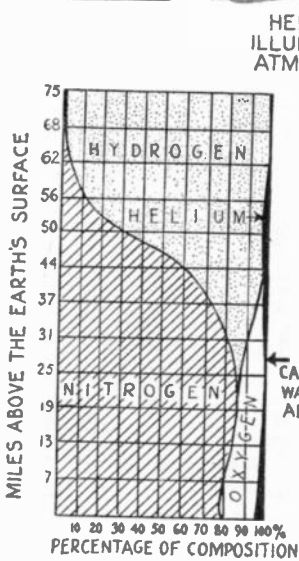

HEIGHT OF ILLUMINATED ATMOSPHERE

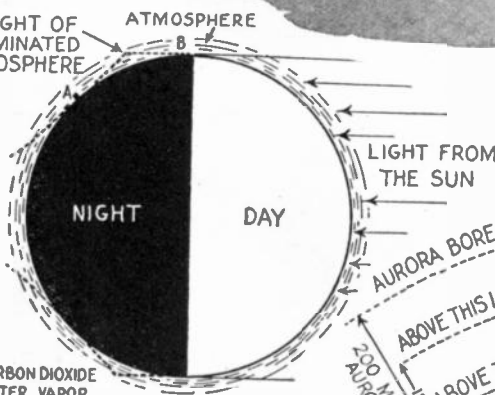

Twilight is caused by reflection from the atmosphere as above. Reflected rays of the sun are shown at A.

The mixture of gases in the atmosphere at different levels is graphically shown at the left.

ABOVE THIS LEVEL THE ATMOSPHERE IS INSUFFICIENT TO HEAT METEORS  
 ABOVE THIS LEVEL THE AMOUNT OF REFLECTED SUNLIGHT IS SLIGHT

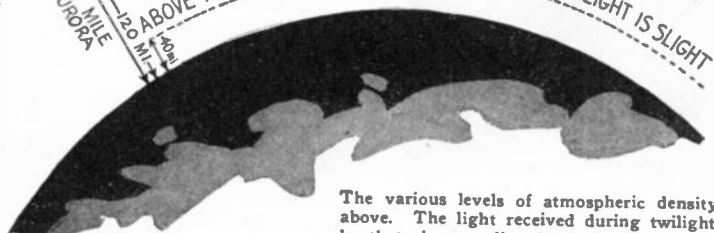

The various levels of atmospheric density are shown above. The light received during twilight is reflected by that air extending from the earth to a height of 40 miles above the surface.

# The Lime Rays of the Moon

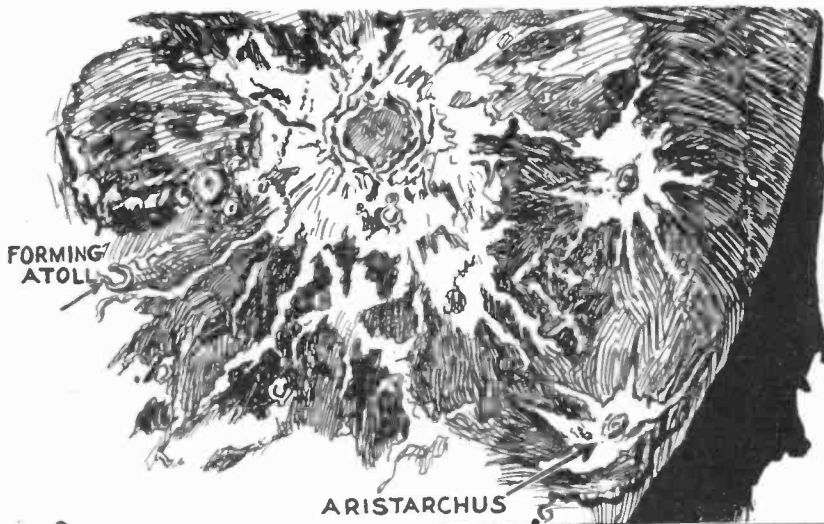

ARISTARCHUS

When one first views a photograph of our moon taken through a telescope, one of the most noticeable features is a series of rays emanating from the various craters. The largest ray system radiates from that crater known as Tycho. These rays have long been an object for theorizing by scientists. Various theories have been put forth such as one very old one; this explanation was that the rays were caused by a squeezing out of some highly reflecting material through long fissures in the sides of volcanoes during a remote volcanic period. Another theory by Prof. Pickering is that crystalline materials may have escaped from the interior or along radial cracks, in the form of vapor which condensed and precipitated, forming the rays which we illustrate here.

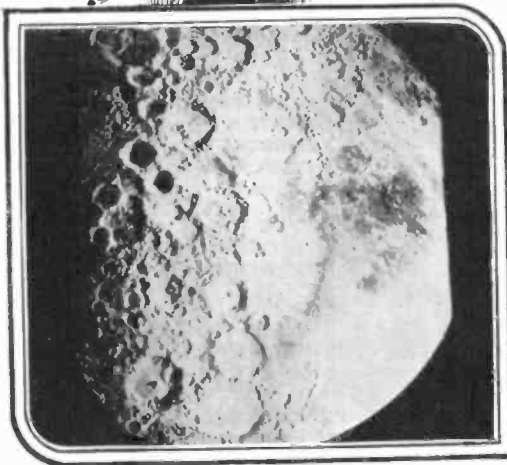

After the theory of Prof. Pickering, the discovery that coral types of the Actinozoa play a part in world formation is assumed to solve the mystery of the lunar ray systems. The very fact that outcroppings in India and Persia are of saline composition bespeaks for them an origin bound up with the early life generating forces of the planet earth. In their growth, coral forms consume quantities of water and carbon dioxide evolved by this form of life combined with or is dissolved in the water in the protoplasm of its cells. This coming in contact with the calcium in the cells formed calcium carbonate which was deposited in the form of the radial lines on the surface of the moon.

—Donald P. Beard.

## How To Photograph the Stars

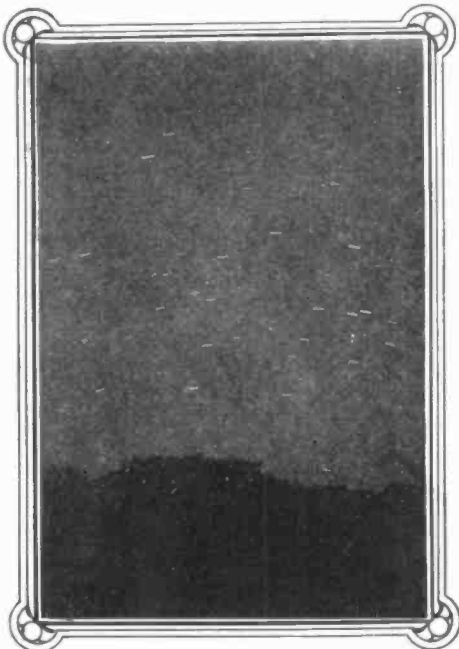

Above is shown a photograph of the stars taken on a clear moonless night without shifting the camera. An ordinary box camera was used and the stars appear as short traces of light across the sky. If the camera had been pointed toward the true north the stars would describe arcs of circles on the plate.

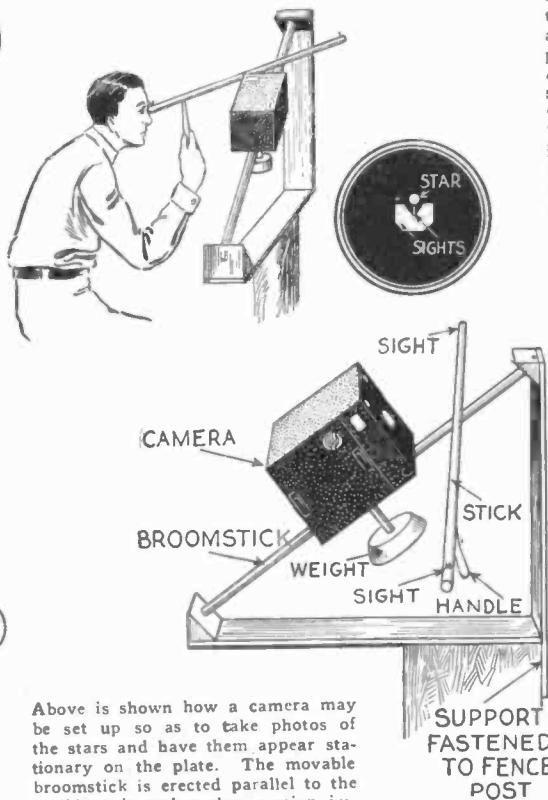

Above is shown how a camera may be set up so as to take photos of the stars and have them appear stationary on the plate. The movable broomstick is erected parallel to the earth's axis and a slow motion imparted thereto will give a photograph as at the right.

In order to use the apparatus illustrated at the left at its best, a sight should be taken along a stick, fastened to the camera support as shown, at any one of the stars. As the sight has to be shifted to keep the star in line with the sights, the camera will be shifted a corresponding distance. The operator should be comfortably seated in order to avoid jarring the camera. The photo below is a result of a 15-minute exposure with the camera pointed toward Orion.

—Don Home.

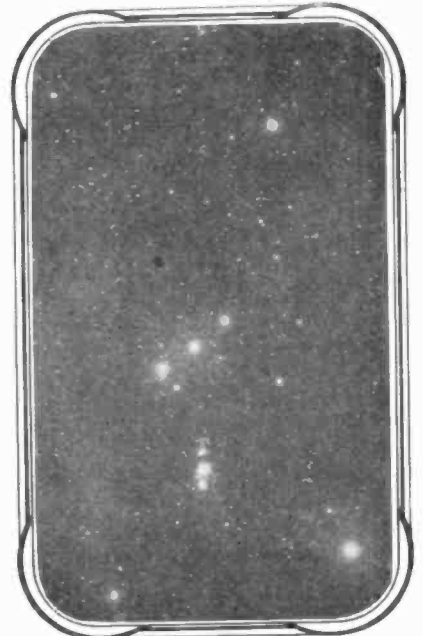

# Talking Movies In the Home

## Small Film Used But Perfect Results Obtained

By RUSSELL RAYMOND VORHEES



Above: Ferdinand Von Madaler, the inventor of this system.

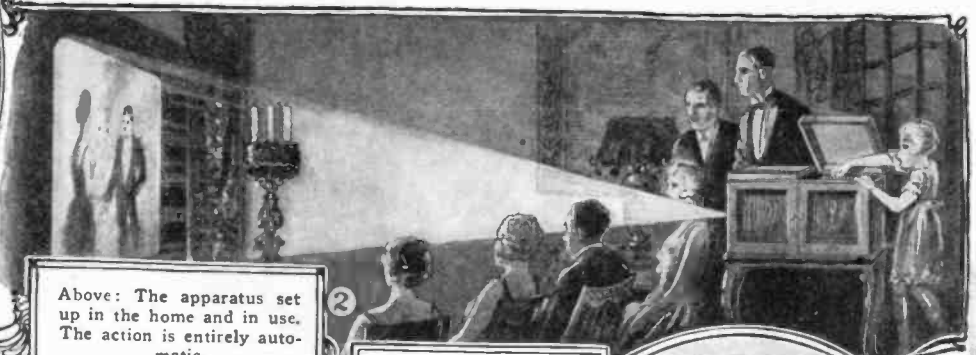

Above: The apparatus set up in the home and in use. The action is entirely automatic.

As at right, even a child can operate this talking movie machine.

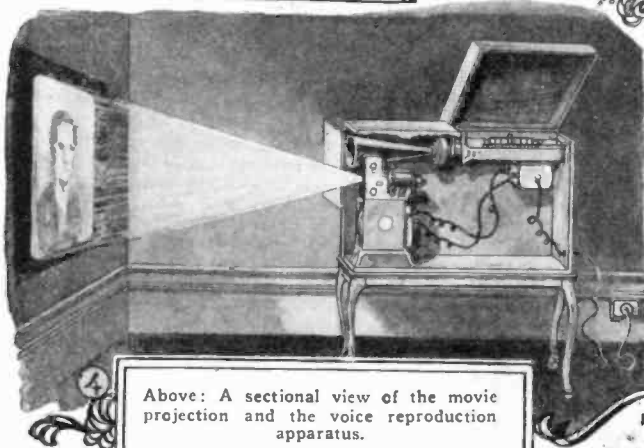

Above: A sectional view of the movie projection and the voice reproduction apparatus.



NOTE THE CENTER SPROCKET PERFORATIONS

VOICE RECORD FOR 1ST STORY

VOICE RECORD FOR 2ND STORY

PICTURES BELONG TO 1ST FILM STORY. (RUNNING DOWN)

PICTURES BELONG TO 2ND FILM STORY. (RUNNING IN OPPOSITE DIRECTION)

IN this new talking motion picture device, the action is first taken on a standard size film and the sounds recorded by either of the two methods shown here. One method records the sound on a disk record as at 6 and then records on the finished film as at 15. The second method is to record directly on the film in a new manner. Two stories occupy the space on each film, each narrative being continuous when each alternate frame is viewed. Thus no rewinding is necessary as the film is first run through to reproduce one story and then run through the opposite way in order to reproduce the other story. The sound records for the stories are on opposite sides of the film as at 5.

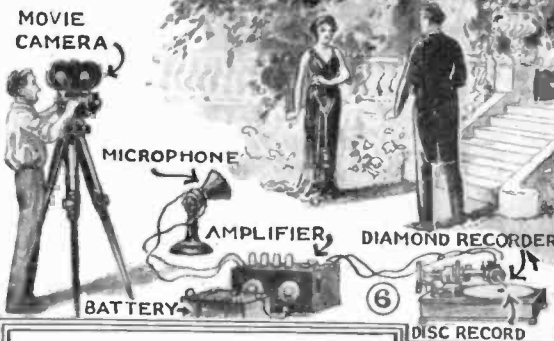

Above: Taking a picture and recording the sounds on a disk record, to be transferred later to the small film.

Right: Printing from a standard film upon alternate frames on small films.

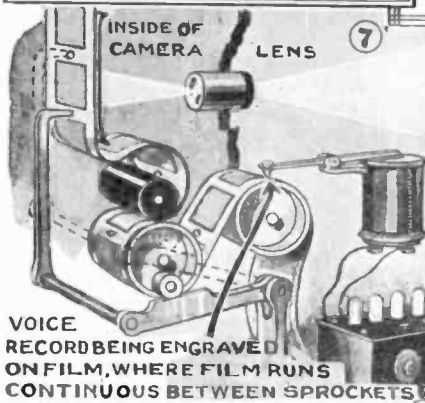

VOICE RECORD BEING ENGRAVED ON FILM, WHERE FILM RUNS CONTINUOUS BETWEEN SPROCKETS

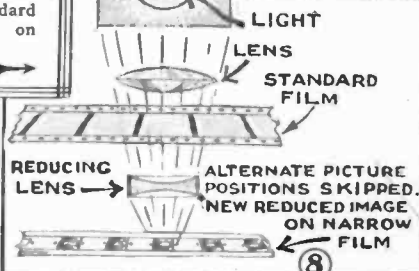

Left: An optional method of recording the picture and voice on the small film. Note the center perforation and the simple claw arrangement for moving the film past the lens. Right: The device that prints the pictures from an ordinary standard film upon the special film used in this new talking movie projector. The method used is shown above in 9.

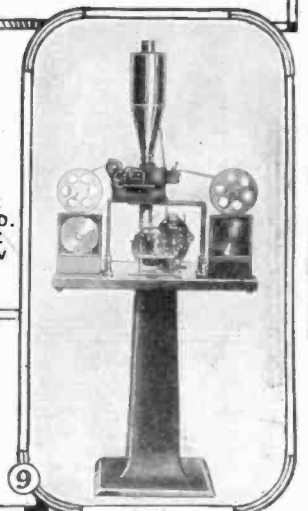

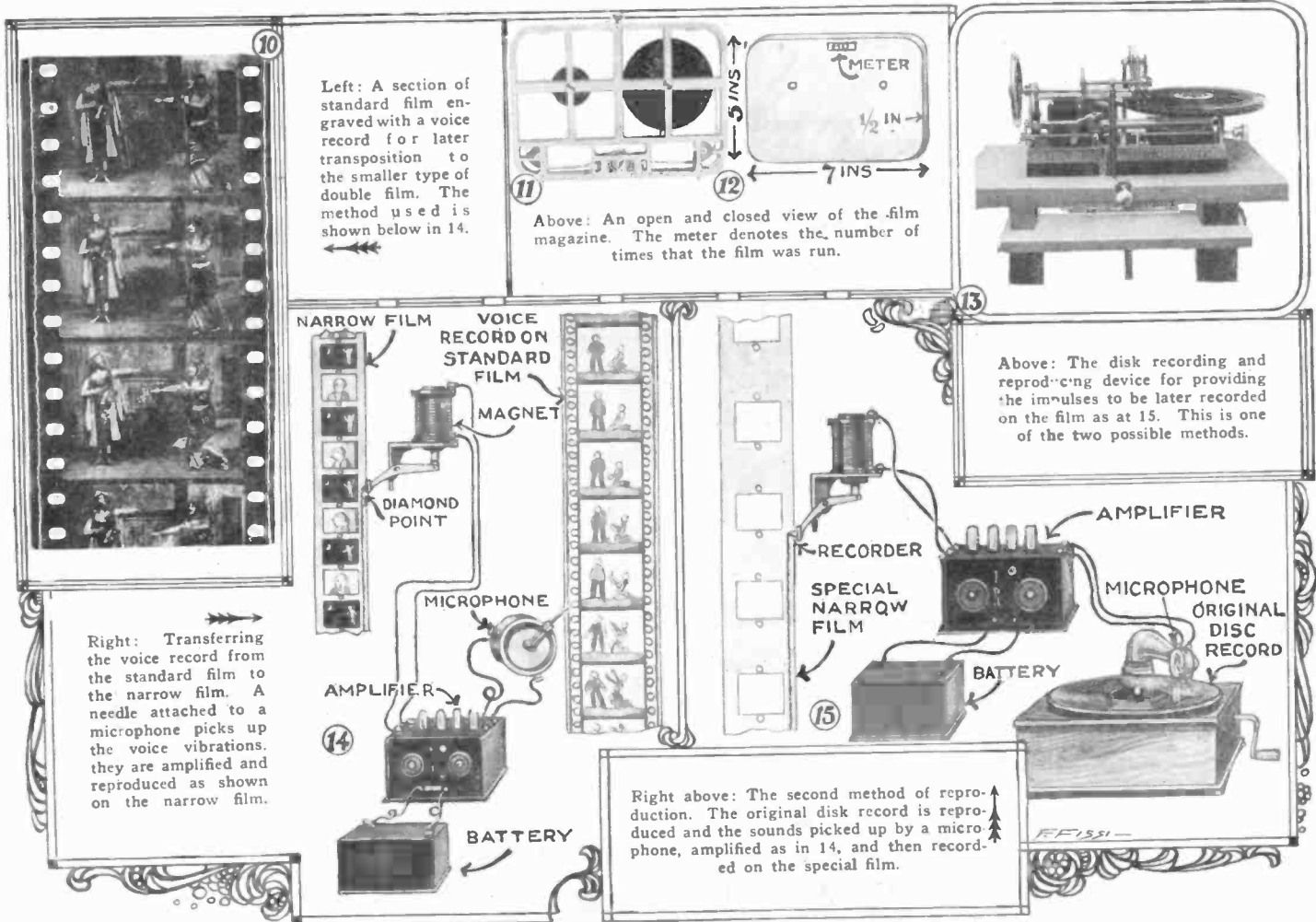

### Illuminated Step Plate

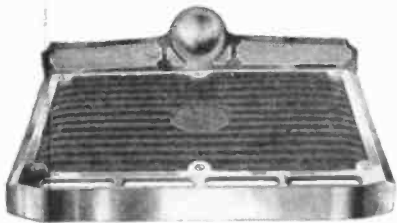

Above: An electrically illuminated step plate for use on the running board of an automobile.

Many accidents are caused by passengers getting in and out of an automobile and not being able to see the place to put their feet. The electrically illuminated step plate at the left eliminates this danger as it provides an electric light which gives ample illumination for passengers.

### Falling Plane Test

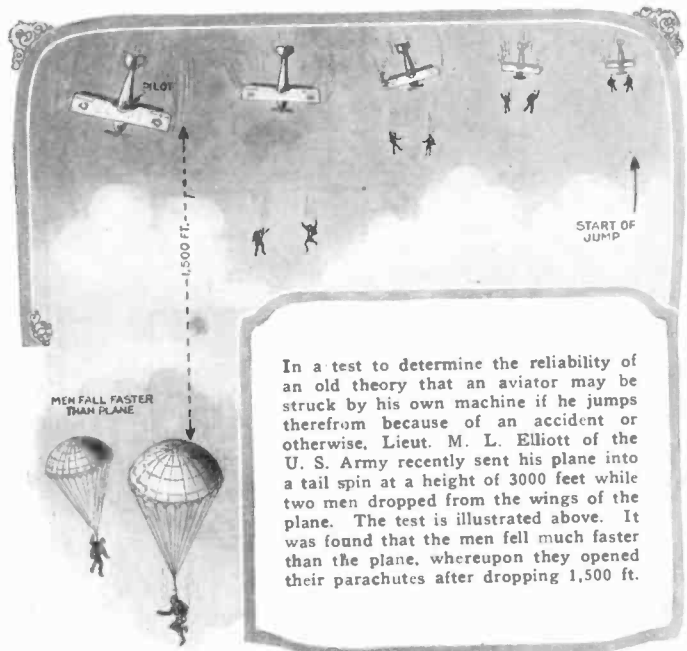

In a test to determine the reliability of an old theory that an aviator may be struck by his own machine if he jumps therefrom because of an accident or otherwise, Lieut. M. L. Elliott of the U. S. Army recently sent his plane into a tail spin at a height of 3000 feet while two men dropped from the wings of the plane. The test is illustrated above. It was found that the men fell much faster than the plane, whereupon they opened their parachutes after dropping 1,500 ft.

### Sanitary Bath Tub

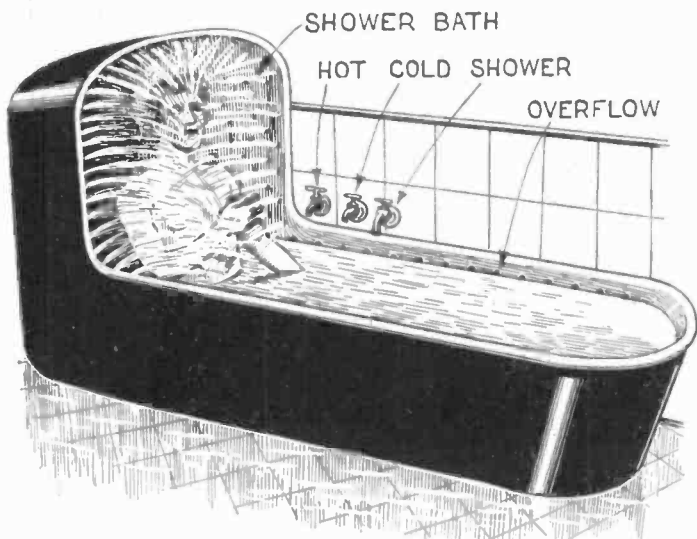

Mr. Mitchel I. Klein of Brooklyn, N. Y., has invented a new sanitary bath tube with a shower incorporated therein. This device of interest to all people is illustrated at the left. It has three improvements over the old type of bath tub and shower bath and they are first, a shower in the rear of the tub, eliminating the necessity of a curtain; second, no dirt can cling to the side of the tub as it is washed out of the overflow; and third, the tub cannot overflow as might be the case when a person goes to sleep in the bath tube with the water turned on. Furthermore, dirt, which naturally floats on the surface of the water, is washed out of the overflow as intimated above.

# How Gravity Acts

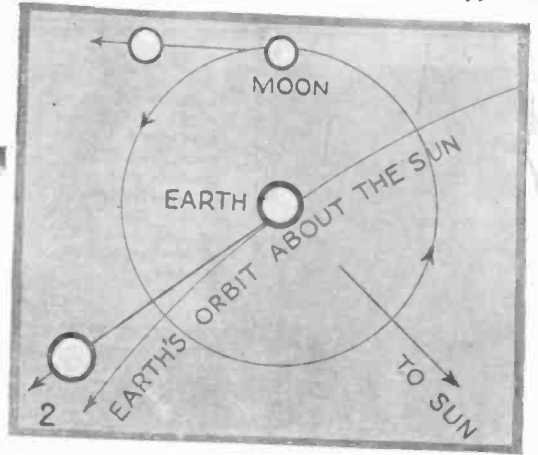
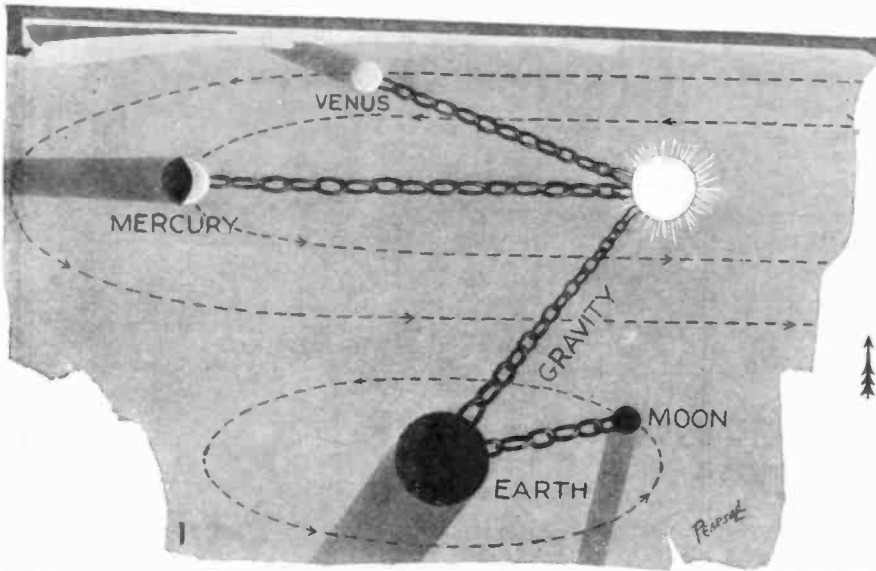
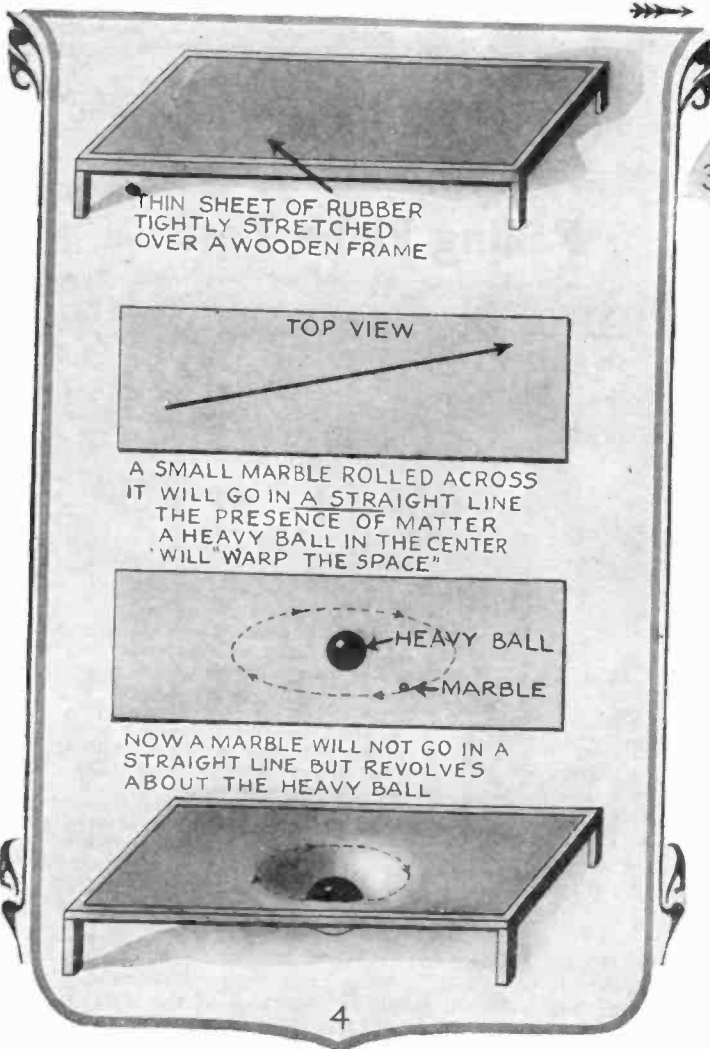
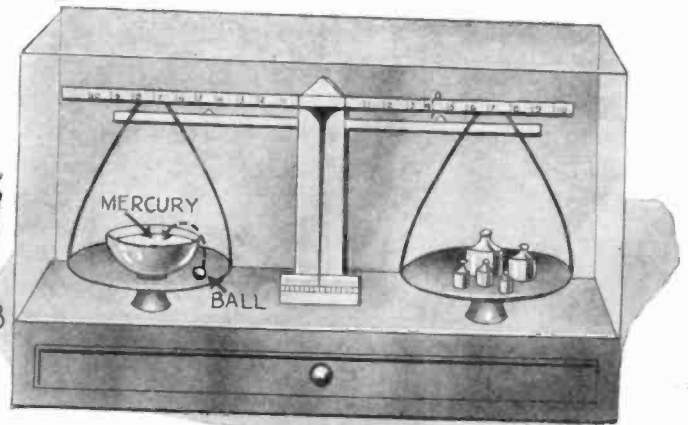
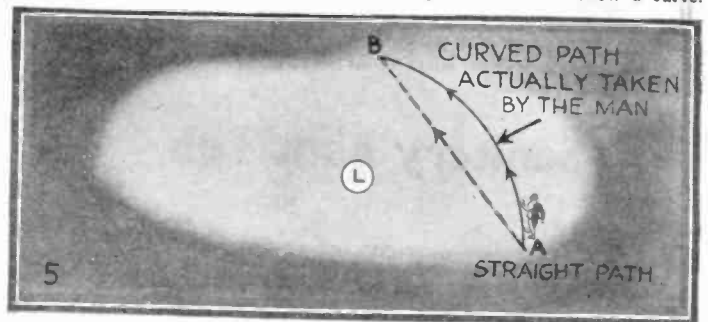

Fig. 2 above shows what would happen if the force of gravity suddenly refused to act. The earth and moon would fly off into space at a tangent to their orbits, as indicated by the straight arrows. The effect is the same as when a small boy is swinging a weight on the end of a string around his head and the string breaks. The weight, travels off in a straight line at a tangent to the path it traveled when confined by the string. Observations, however, show no weakening in the force of gravity.

Fig. 1 above shows how the force of gravity acts as chains between the sun and the planets. Fig. 3 at right, shows the famous Majorana experiment with a gravitational shield. His results were not accurate enough to confirm his opinion. This is explained on the opposite page.



Einstein explains gravitation by stating that matter causes gravitation merely by its presence and that the reason objects tend to move toward or around each other, the latter in the case of the planetary system, is because space is bent. Fig. 4 at the left gives an analogy of bent space. A sheet of tightly stretched rubber is employed and a marble rolled across this sheet will travel in a straight line. If, however, a comparatively heavy body, a ball for instance, is placed on the sheet it will cause a depression and the marble will no longer travel in a straight line when propelled, but will follow a curve.



Let us assume that we are up in an airplane as explained in the article on the opposite page. We watch a man traveling across an illuminated space from A to B. We see him travel in a curve instead of in a straight line. Just why this is so is explained in the article.

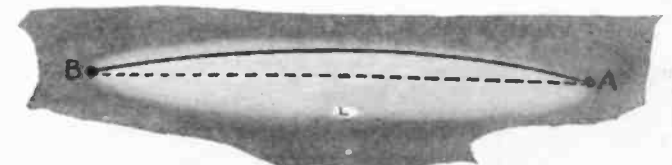

When we see the man in Fig. 5 pursue a curved path when in reality we would expect him to travel in a straight line, we are furnished with food for thought. Since this is an analogy, we will assume that the man in traveling from point A to point B across the illuminated area is traveling through space

and could not travel in a straight line because of the effect of the light L upon him. Another view of the curved path is shown in the lower right-hand illustration above. A study of the explanation of curved space on the opposite page will make this point clear.



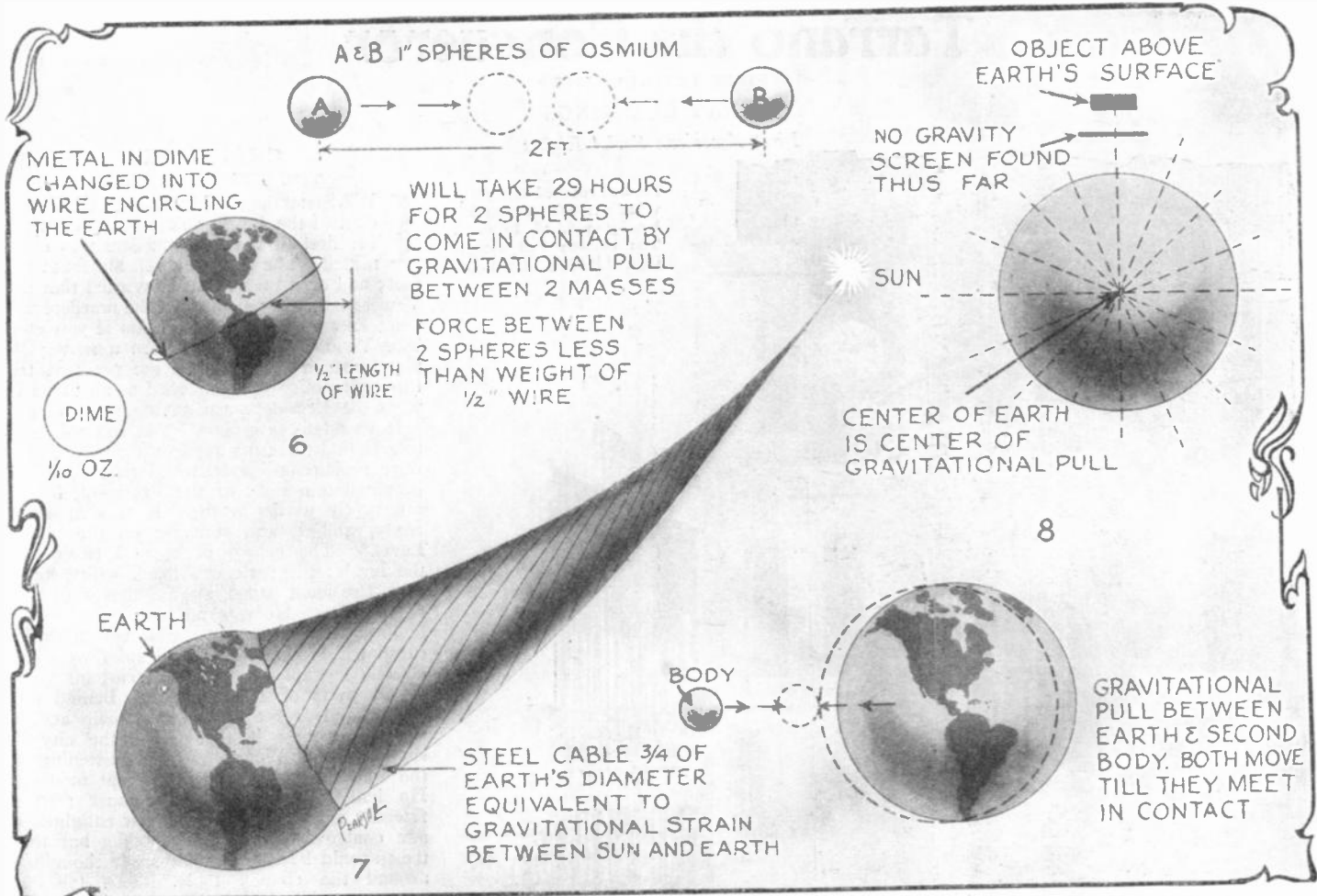

In the experiment with the spheres of Osmium, it is assumed that all friction or resistance to their motion is absent. The small force exerted between the two spheres is less than the weight of 1/2 inch of the wire formed from a dime, said wire being long enough to encircle the earth.

Fig. 7 illustrates the equivalent strain set up by the gravitational attraction between the sun and the earth. Fig. 8 shows that no screen found thus far can shield an object above the earth's surface from the gravitational pull of the earth and shows how two bodies move because of gravity.

# What Is Gravitation?

By Prof. Donald H. Menzel, Ph.D.

**T**WO HUNDRED AND FIFTY years have elapsed since the great scientist, Isaac Newton, put forth his theory of the law of gravitation. Before that time people thought objects fell to the ground merely because the air was too thin to support them. Sir Isaac suddenly had the brilliant idea that they fell because they were attracted to the earth, and that if such attraction existed near the earth, it might be strong enough to extend outward into space and hold the planets in their orbits. It would act as a strong chain which was bound to both the sun and planet, constraining the latter to move in a curved instead of a straight path (see Fig. 1).

If the force of gravity suddenly refused to act, the planets would fly off in tangents to their orbits, as illustrated in Fig. 2, the same effect as having the chains break. Fortunately, gravity shows no signs of weakening.

### WE KNOW LITTLE OF GRAVITY

In spite of the apparent universality of the law it extends as far as the distant stars, and since Sir Isaac Newton's discovery we have made very few advances in finding its origin. Electric and magnetic forces resemble it in many ways, but it can be neither of these.

Professor Majorana's research caused a lot of discussion a few years ago. He weighed a small steel ball first when it was by itself and again when floating on mercury.

The mean of a huge number of measures showed a small decrease in the weight of the object when it was floating in the mercury. Majorana then suggested that possibly the mercury had shielded it from the force of gravity (see Fig. 3).

A very important objection to this result has been raised, aside from the fact that the effect is so small that the errors possible in the weighings are several times larger than the observed difference. If matter shields another object from gravity, as Majorana would have us believe, then the earth quite effectively shields the moon from the sun every time there is a lunar eclipse. If the matter of the earth absorbs some of the force of the solar gravitation, the moon would show a slight deviation from its orbit as a result. It does not and quite refutes Majorana's experiment.

### EINSTEIN ON GRAVITY

Einstein seems to have solved the problem. To him matter causes gravitation merely by its presence. If no matter is present, all objects tend to move in straight lines. He proves that space near any quantity of matter is bent, and that any object approaching it will have to follow the bends in the space. The seemingly unintelligible statement that "space may be warped" is explained by an analogy. Euclid dealt with a space which was a plane and only with points and lines, which, having no thickness, had no weight and therefore did not distort his plane.

Let us make our plane out of tightly stretched rubber (see Fig. 4). A small virtually weightless marble will move across it in a straight line, the path of least resistance. If a heavy iron ball is now placed in the center, the plane will be "warped" and the path of least resistance will no longer be straight, but curved about the object, and if there were no friction, it would continue to revolve about it forever. This is a vivid picture of the case of the solar system. The planets do not revolve about the sun because its constraining force keeps them from flying away, but rather because space is bent and they follow their own inclination. Einstein called the natural path of any object a *geodesic*.

### A GRAVITATIONAL ANALOGY

One added analogy will clinch the argument. Imagine yourself in an airplane, directly over a certain part of the earth. You see a large bright area surrounded by darker ground. Near the center of the bright space is a light (see Fig. 5). There is a man at A who wishes to go across the bright area to B. You, in the airplane, expect him to follow the straight line, but are greatly puzzled when you find him taking the curved path indicated. Then suddenly an explanation occurs to you, "The light has repelled him, so that he could not go straight." Thus you have reasoned like Newton, who, to explain the curved paths

(Continued on page 280)

# Tarrano the Conqueror

FIRST INSTALLMENT

By RAY CUMMINGS

First American Serial Rights

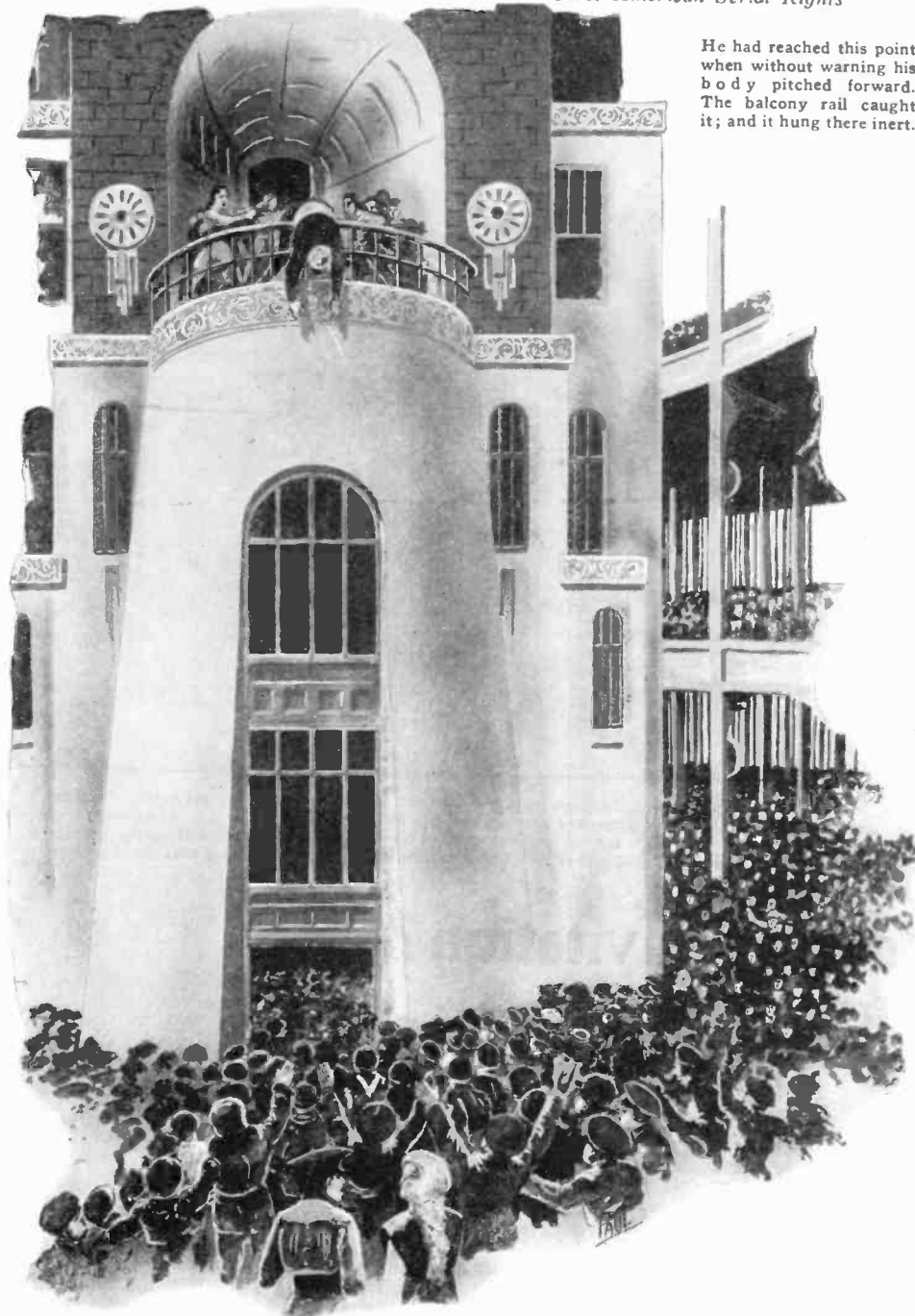

He had reached this point when without warning his body pitched forward. The balcony rail caught it; and it hung there inert.

## CHAPTER I

### THE NEW MURDERS

I WAS standing fairly close to the President of the Anglo-Saxon Republic when the first of the new murders was committed. The President fell almost at my feet; and even then I was convinced that the Venus-man at my elbow was the murderer. I don't know why; call it intuition if you will. The Venus-man did not make a move; he merely stood beside me in the press of the throng, seemingly as absorbed as all of us in what the President was saying.

It was late afternoon. The sun was setting behind the cliffs across the river. There were perhaps a hundred and fifty thousand people within sight of the President, listening raptly to his words. It was at Park Sixty, and I was standing on the Tenth Level.\* The crowd packed all twelve of the levels; the park was black with people. The President stood on a balcony of the park tower. He was no more than a few hundred feet above me, well within direct earshot. Around him on all sides were the electric megaphones which carried his voice to all parts of the audience. Behind me, a thousand feet overhead, the main aerials were scattering it throughout the city, I suppose five million people were listening to the voice of the President at that moment. He had just said that we must remain friendly with Venus; that in our enlightened age controversies were inevitable, but that they should be settled with sober thought—around the council table. This talk of war was ridiculous. He was denouncing the public news-broadcasters; moulders of public opinion, who every day—every hour—must offer a new sensation to their millions of subscribers.

He had reached this point when without warning his body pitched forward. The balcony rail caught it; and it hung there inert. The slanting rays of the sun fell full upon the ruffled white shirt; white, but turning pink, then red with the crimson stain welling out from beneath.

For an instant the crowd was stunned into silence. Then a murmur arose, and swelled into shouts of horror. A surge of people swept me forward. I could not see clearly

\*New York City, about where Yonkers now stands.

### FOREWORD

In "Tarrano the Conqueror" I present a tale of the year 2325 A.D.—a time almost as far beyond our present-day era as we are now beyond Columbus' discovery of America. My desire has been to create for you the impression that you have suddenly been plunged forward into that time—to give you the feeling Columbus might have had could he have read a novel of our present-day life.

To this end I have conceived myself a writer of that future time, addressing his contemporary public. You are to imagine yourself reading an Ancient-English translation of my original text—a translation so free that a thousand little colloquialisms will have crept into it that could not possibly have their counterparts in the year 2325. For these I ask your indulgence.

Apart from the text, you will occasionally find brief explanatory footnotes. Conceive them as having been put there by the translator.

If you find parts of this tale unusual or bizarre, please remember that we are living now in a comparatively ignorant day. The tale is not intended to be fantastic, scientific, or full of new and strange ideas. I have used nothing but those developments of our present-day civilization to which we are all looking forward as logical probabilities—woven them into a picture of what life in New York City very probably will be four hundred years from now. To that extent, the tale itself is intended to be only a love story of adventure and romance—written, not for you, but for that future audience.

RAY CUMMINGS.

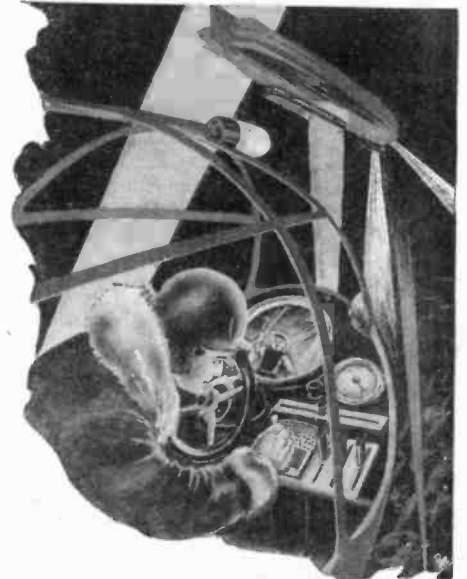

They were indeed; I could see them in all the towers underneath me. I was flying northeast; and at the moment, with a following wind, I was doing something over three-fifty.

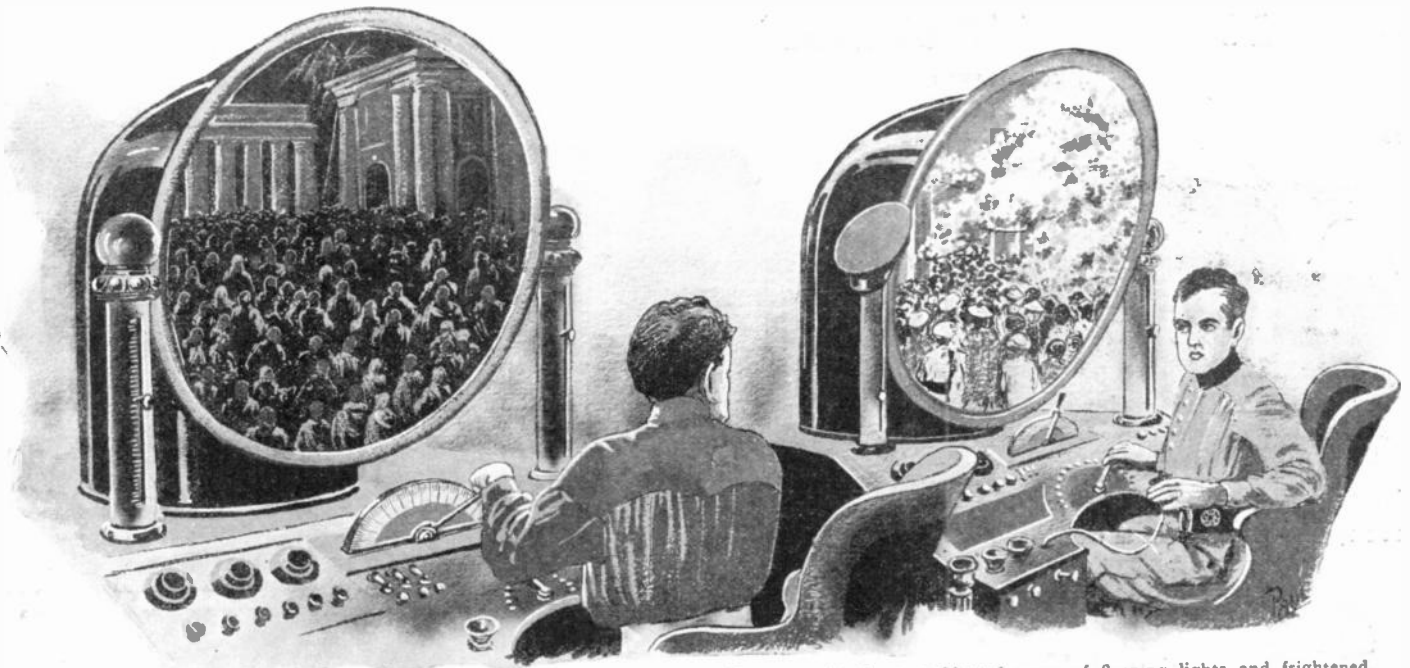

Above my desk, in a duplicating mirror from Headquarters, I could see that at the palace of Mombozo a throng of terrified blacks were gathered.

It was right there—a blurred scene of flashing lights and frightened, milling people.

what was happening on the balcony. The form of the murdered President was hanging there against the rail; a score of government officials were rushing toward it; but the body, toppling over the low support, came hurtling downward into the crowd, quite near me; but I could not reach it—the throng was too dense.

The shouts everywhere were deafening. I was shoved along the Tenth Level by the press of people coming up the stairway. Shouts, excited questions; the wail of children almost trampled under foot; the screams of women. And over it all, the electrically magnified voice of the traffic director-general in the peak of the main tower roaring his orders to the crowd.

It was panic; and then the traffic-directors descended upon us. We were pushed up on the moving sidewalks. North or south, whichever direction came handiest, we were herded upon the sidewalks and whirled away. With a hundred other spectators near me I was shoved to a sidewalk moving south along the Tenth Level. It was going some four miles an hour. But they would not let me stay there. From behind, the crowd was shoving; and from one parallel strip of moving pavement to the other I was pushed along—until at last I reached

the seats of the forty mile an hour inside section.

The scene at Park Sixty was far out of direct sight and hearing. The park there had already been cleared of spectators, I knew; and they were doubtless bearing the President's body away.

WE take great pleasure in presenting to our readers another story by Ray Cummings, well known to the followers of this magazine as the author of "The Man On The Meteor" and "Around The Universe." Many of our readers are also undoubtedly familiar with Mr. Cummings's book, "The Girl In The Golden Atom," which also appeared in magazine form. We are sure that all of our readers will be greatly pleased with this latest story from the versatile pen of Mr. Cummings.

"Murdered!" said a man beside me. "Murdered! Look there!"

We were across the river, into Manhattan. The Tenth Level here runs about four hundred feet above the ground-street of the city. The man beside me was pointing to a steel tower we were passing. It was several hundreds yards away; on its side abreast of us was a forty-foot square news-

mirror, brightly illumined. On all the stairways and balconies here a local crowd had gathered, watching the mirror. It was reporting the present scene at Park Sixty. As we sped past the tower I could see in the silver surface of the mirror the image of the now empty park from which we had been so summarily ejected. They were carrying off the President's body; a little group of officials bearing it away; red, broken, gruesome, with the dying rays of the sun still upon it. Carrying it slowly along to where a hastily called aero-car was waiting on the side landing stage.

We were past the mirror in a moment. "Murdered," the man next to me repeated. "The President murdered."

He seemed stunned, as indeed everyone was. Then he eyed me—my cap, which had on it the insignia of my calling.

"You are one of them," he said bitterly. "The last word," he said—"the lurid news-gatherers."

But I shook my head. "We are necessary. It was unfortunate that he should have said that."

I had no opportunity to talk further. The man moved away toward the foot of a landing stage near us. A south-bound flyer had overtaken us and was landing. I boarded it also, and ten minutes later was in my office in South-Manhattan.

I was at this time employed by one of the most enterprising news-organizations in Great New York. There was pandemonium in there that evening. My supper came up in the pneumatic tube from the public cookery nearby, but I had hardly time to taste it.

This, the evening of May 12, 2325, was for me—and for all the Earth—the most stirring evening of history. Events of inter-planetary importance tumbled over each other as they came to us through the air from the Official Information Stations. And we—myself and a thousand like me in our office—retold them for our twenty million subscribers throughout the Anglo-Saxon Nation.

The President of the Anglo-Saxon Republic was murdered at 5:10. It was the first of the new murders. I say new murders, for not in two hundred years had the life of so high an official been wilfully taken. But it was only the first. At 6:15 word came from Tokyohama,\* that the ruler of

\*Tokyo-Yokahama, Japan.

(Continued on page 268)



We watched the queer-looking characters printing on the tape. Very softly, in a voice hardly above a whisper, George de-coded it.

# Tricks of Mediums

By EDWARD MERLIN  
A Reformed Spiritualist.



When the seance begins, the spiritualist's right hand and left wrist are held by those closest to him in the circle of sitters.



The medium, going into a trance, jerks his right hand loose, but immediately calls attention to the fact that his hand is not being held. Seemingly both hands are again under control. Actually they are not.



A spirit hand pinches a sitter. Note the lazy tong grip.

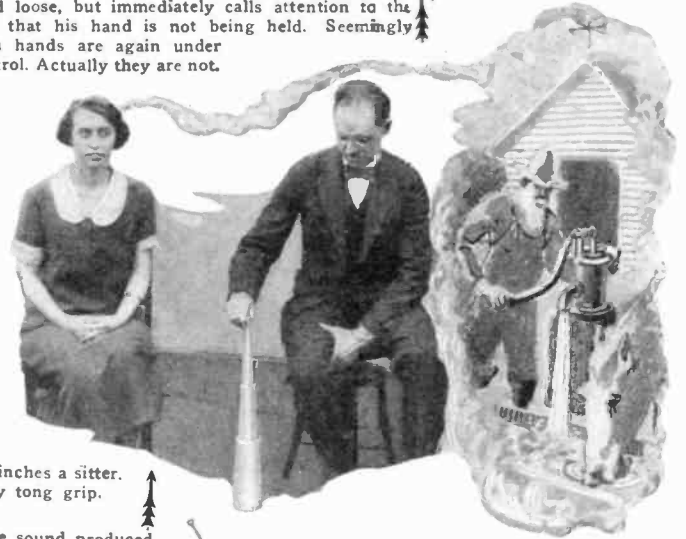

A remarkable similarity to the sound produced by a hand pump may be effected by collapsing and extending a spirit horn.

Sliding the horn across a carpeted floor produces a sound of wood being sawed.



A luminous button on the end of the collapsible rod produces "spirit lights."



The sound of a person drowning is produced by blowing into horn, as shown.

Daylight trumpet mediumship is effected as illustrated. Even those standing eight inches away cannot hear him whisper.



Diagram illustrating the apparatus used for moving luminous objects and a mandolin. The diagram includes:

- A **BUTTON COVERED WITH RADIUM LUMINOUS PAINT**.
- A **LUMINOUS PENDANT**.
- A **SMALL MUSIC BOX IN MANDOLIN**.
- A **HOLE FOR ROD**.
- RUBBER COVERED CURVED ENDS FOR LEVITATION-OF GLASS OF WATER AND "BABY" TOUCH, ETC.**

The luminous objects and the mandolin are moved about the room by a collapsible rod which the medium uses. Diagram of lazy tong also shown.

# Keeping a Kitchen Cool

By CHRISTINE FREDERICK

**W**OMEN have been called born martyrs. Certainly it would seem to be true when you think of the great numbers of women who endure the heat of the average kitchen, both winter and summer, and make no effort to ventilate or cool it.

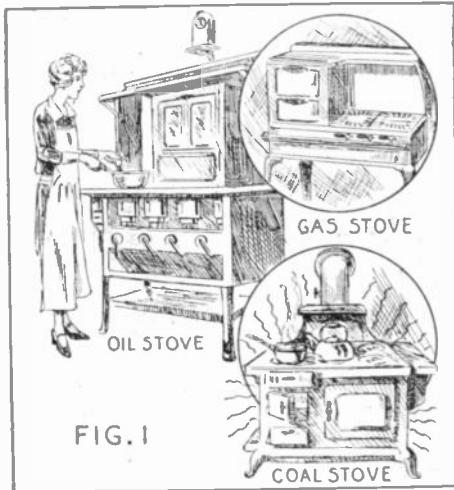

To help keep the kitchen cool in the summer-time do not use a coal stove or range if at all possible. Use instead either a gas stove, oil stove or if the rate for electric current is reasonable, an electric range.

Look, on the other hand, at men. Their offices, usually in tall buildings with many windows, have plenty of ventilation; yet in summer time what do you see? Electric fans galore! Window ventilating devices are used in winter, and even in some instances patented air purifiers, or automatic ventilators. Man, you see, believes in having science applied to his office, but women seem to putter along on kitchen equipment no different from that of their grandmothers.

But why not have a few up-to-date devices, at least? The summer is about here, and certainly the hours of labor that must be spent in mid-summer in the kitchen ought not to be passed with the heat of the stove, without some plan for relieving the worker. What can be done with kitchens to make them cooler?

### DON'T USE COAL STOVE

In the first place, cooking should not be permitted to heat the kitchen more than absolutely necessary. In these days of gas,

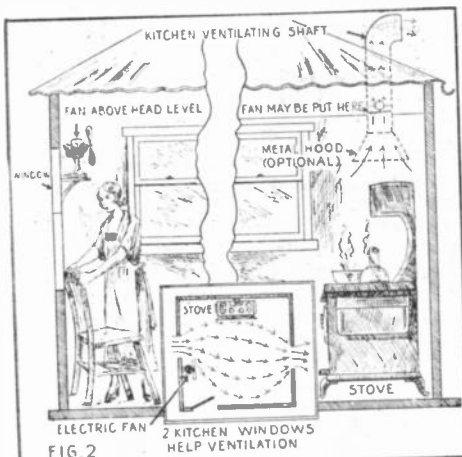

The illustration above shows several hints with regard to ventilating the average house kitchen. A ventilating shaft is a wonderful help.

gasoline, oil and electric stoves of proved high efficiency, no woman has much excuse except poverty for using a coal cooking stove in summer time. Yet millions of housewives do so, and not from poverty either. If possible, cooking should be done on an oil or gas stove in a semi-open air adjunct to the kitchen. But if this is not possible, by all means ventilate the kitchen. If the windows are not thoroughly adequate—usually they are not—then a ceiling ventilating shaft should be installed leading outdoors through a ventilating pipe. If it doesn't draw well, a small electric motor fan will help it. Don't grudge this expense—it will keep your kitchen not only cooler, but freer from odors. It will keep you fresher to enjoy other things.

### ELECTRIC FAN IN KITCHEN

If you have windows on two opposite sides of your kitchen—which is the best arrangement—then an electric fan will perform all

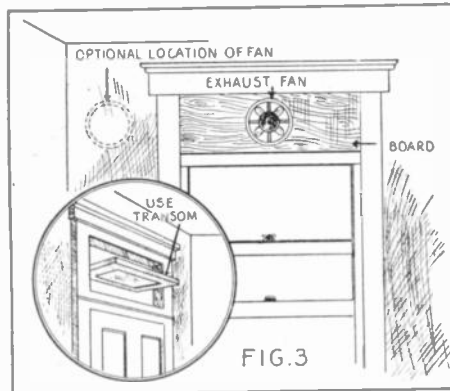

If you have a transom over the door, be sure to use it. Exhaust fans placed as shown help to circulate fresh air and carry off cooking odors.

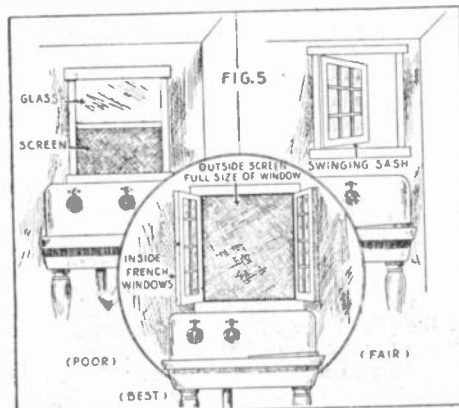

Even large windows do not give all the air possible when a screen the size of one sash only is permissible. The window shown at the right is excellent if large enough.

the ventilating and cooling you will likely need. You then get cross ventilation. It is surprising how few women seem even to think of using electric fans in the home, and how they consider them only devices to blow a cool breeze into your face. As a matter of fact this is just what they should not be used for, as it is likely to give you a summer cold to work with an electric fan draught on your hot face or neck. The best function of an electric fan—even a small one—is to circulate the air.

A fan should be placed, therefore, not so as to blow into your face, but where it will

best expel the hot air from the room. Even a small, hidden, slow-revolving fan is quite efficient. There is no need of whipping the air into your face; you will be cooler if currents of air are induced to go in and out of your window.



Don't drink several quarts of ice water every day in an effort to keep cool, says the author. Instead you will find much better results by simply allowing cold water to run over both wrists for a few minutes.

### STOVE HOODS AND TRANSOMS

A metal hood over a stove and of funnel-like shape, leading into a pipe that goes through a hole into the chimney, is a method you will see used in city restaurants, where much heat is often developed in close, unventilated quarters. This then is often very desirable for a hot, unventilated kitchen in which much cooking is done.

I am astonished at the number of women whose kitchen doors have transoms which are never opened. A transom in a door gives excellent ventilation, and provides frequently the cross-ventilation so effective.

### COOK EARLY IN MORNING

I am strong for still more thoroughgoing methods of having a cool kitchen by means of head work. Why not reduce to a minimum the heat making? Plan your meals for summer to reduce cookery. Some women never seem to spare themselves in summer time; they bake and boil and stew without any let-up from winter standards. Cut out as much cooking as you can. The family (Continued on page 285)

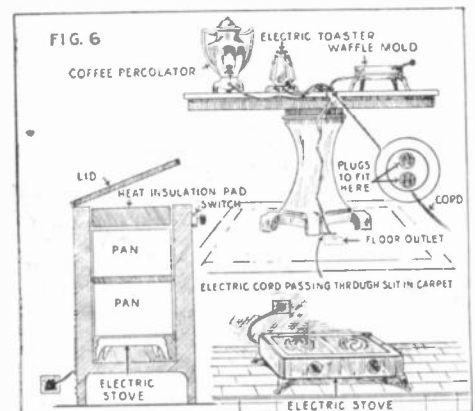

A meal can be placed in multi-compartment kettles, placed in the electric fireless cooker and economically cooked. Electric table cooking appliances are a Godsend in the Summer-time.

# Doctor Hackensaw's Secrets

By CLEMENT FEZANDIÉ

No. 41—A Journey to the Center of the Earth. (Part II.)

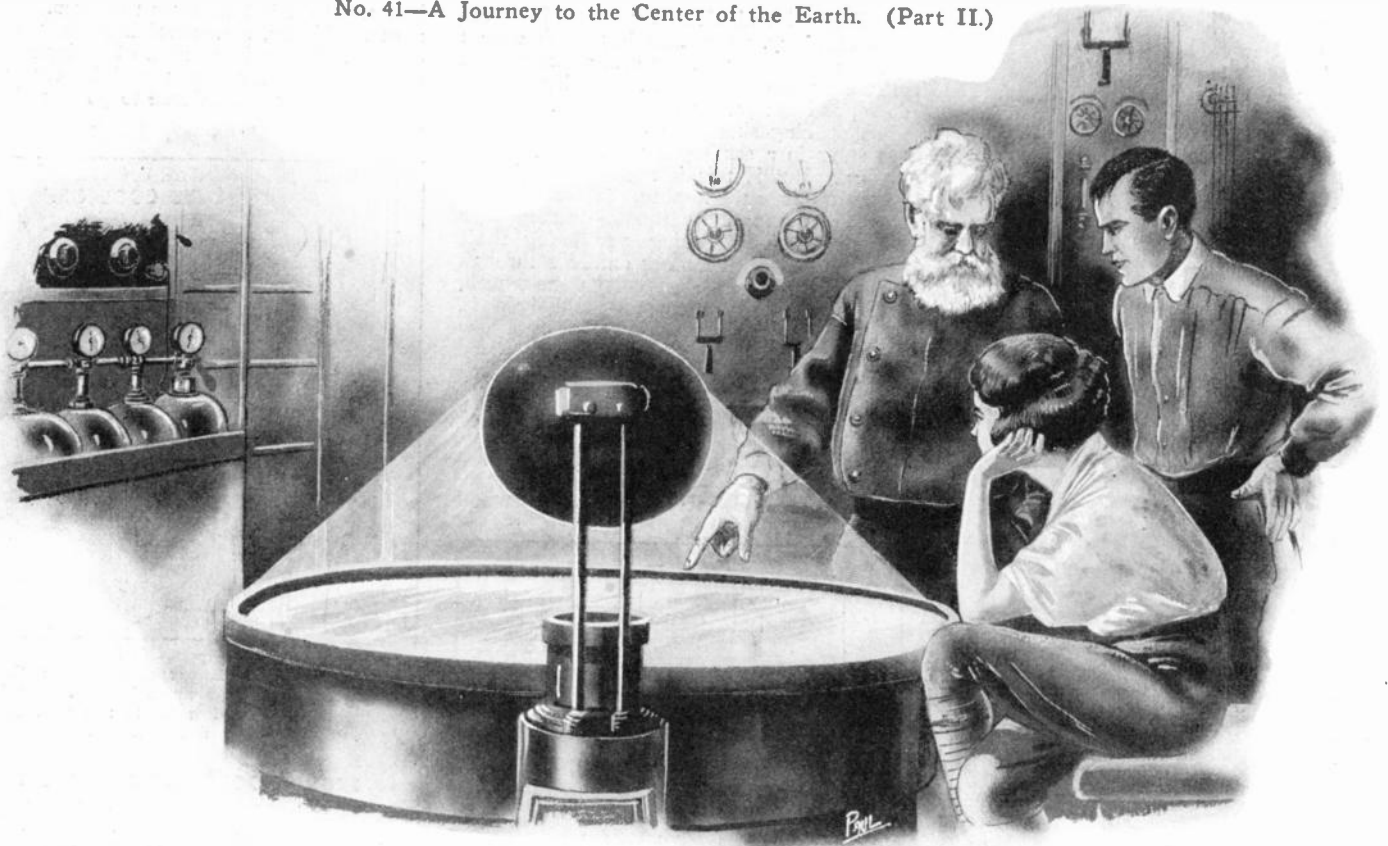

Dr. Hackensaw, Pep and Miggs seated within the reconstructed "Dart" on its journey to the center of the earth. Dr. Hackensaw is pointing

downward through the observation glass through which the progress of the car can be watched. The searchlight is directed downward.

## SYNOPSIS OF PART I.

DR. HACKENSAW after having determined to explore the center of the earth and having made preliminary observations, asks his very good friend Pepita Perkins, a newspaper reporter, to accompany him on a trip to the South Pole where the excavation was to be started for the trip to the center of the earth. They arrive at Dr. Hackensaw's village at the South Pole where a crevice in the earth five miles deep has been discovered. Working first with a diamond drill and then with an "atomic force drill," one of Dr. Hackensaw's inventions, they start work on the bottom of the pit. After some hours of drilling, observations made by means of a special microphone show that they are nearing another natural cavern in the interior of the earth. The diamond drill is once more brought into play and soon pierces the remaining shell of the rock into the lower cavity in which a partial vacuum is found to exist. A concussion bomb dropped into this cavity proves, by measuring the time it takes for the sound of explosion to reach the observers, that the cavern is over 100 miles deep.

## CHAPTER IV

"JERUSALEM!" exclaimed Doctor Hackensaw. "This hundred-mile pit will save us a lot of digging, but it forces us to change our plans immediately. Evidently a partial vacuum exists in this pit, and our first step must be to ascertain exactly what degree of vacuum exists. Luckily this will be easy, as I have a couple of special Geissler tubes with me, so constructed that air may be admitted or pumped out at will. One of these tubes I shall open and let down into the pit. The rarefied atmosphere of the pit and that in the tube will soon equalize. By passing an electric current through the tube and comparing the fluorescence with that of the second tube, into which I can admit more or less air until the two tubes emit an equal amount of light, I shall know that the vacuum in the pit is exactly equal to that in the second tube."

The experiment was tried, but when the result became known, Doctor Hackensaw shook his head.

"The air density in the pit is really very slight," he exclaimed. "In one way, of course, this is an advantage, for it will relieve us of the danger of encountering an enormous air pressure down below. But on the other hand it will make the start difficult."

"Couldn't you let in more air?" asked Pep.

"Certainly, and I should unhesitatingly do so if I were convinced the pit were only a hundred miles deep. I believe it to be much deeper, however."

"But you said the bomb exploded one hundred miles below the surface!"

"So it did, but it may have struck the side of the pit, or it may even have been set off by the compression of the air in front of it. However, to save time we'll do a little exploring. The electric aeroplane, "The Dart," is provisioned for six months and has an oxygen supply sufficient for three months. Accordingly, if we are prudent we have little to fear. What I shall do will be to provide some twenty-five or more miles of light but strong chain, fasten them to the rear of the aeroplane and let the car slowly down so we can examine the pit a little. To aid in this work I shall have some suits made in the style of light diving suits. These will be provided with suction-boots made on the principle of a fly's feet—the suction enabling me to walk down the sides of the pit without danger of falling, just as a fly walks head downwards on a ceiling."

"Gee!" cried Pep. "Make a pair of those boots for me, too! But won't it be tiresome to hold our bodies stiff?"

"No, I shall have a metal framework made to wear under our clothing. The

whole weight of our bodies will thus be borne by the metal frame and not by our muscles. Of course, we shall not be able to use these suction boots so long as the air in the pit is so rarefied. It requires normal atmospheric pressure to make sufficient suction. We can only use the boots in case the pressure is greater down below or in case I let air from above into the pit.

## CHAPTER V

Several weeks were required for the necessary preparations, and Pep was becoming very impatient when one fine day Doctor Hackensaw called to her:

"Pack your bag at once, Pep; we start at noon!"

An hour later, the two, accompanied by Miggs who was to act as pilot for the aeroplane, had descended into the closed chamber ready for the start down into the apparently bottomless pit.

At sight of "The Dart," however, both Miggs and Pep uttered a cry, for the compact spindle-shaped aeroplane they were familiar with now resembled one of the giant squids or octopuses familiar to all movie-fans.

Fastened to the rear of the aeroplane were several long tentacles or arms resembling huge metal springs, set in a circle. It was in fact an almost exact imitation of an octopus. Below was a second set resembling the first.

"What in the world are those arms for?" asked Pep, in surprise.

"Those are to serve as brakes," explained Doctor Hackensaw. "As there is practically no air in this portion of the pit, our car would fall down at a frightful speed if allowed to drop in."

"But I thought the car was to be held back by a chain?"

"So it is, for a short distance. But we cannot place much dependence on the chain, and must soon cast loose from it, anyway. Now I have ascertained that the pit is really a narrow well in the solid rock. As we descend I shall force these metal arms against the sides of the well and so be able to check our descent, or stop completely, at will. An electric equalizer will automatically keep the pressure equal in each arm so that our descent will be steady and uniform. Electric refrigerating devices will keep the ends of the arms from melting through the heat produced by friction against the rock. Should one of the arms become worn or injured, a new arm from below will automatically replace it. I can set the device so that the springs will press against the walls with any degree of pressure I desire.

"But we can't stand here talking. We must get inside the car, for we have a long way to travel and I don't dare to get up too much speed. This will not be a joy ride by any manner of means, for we shall be explorers. I have an excellent searchlight on the car which will reveal our path for a mile or more ahead of us, but it would not pay to be imprudent."

"One moment, doctor!" objected Miggs. "You say that these brakes are needed to hold us back. Couldn't you reverse the propeller and hold the car back that way?"

"Certainly I could if there were normal air at atmospheric pressure in the pit. But there is so little air here that the propeller would have nothing to work against. You cannot push the car backwards unless you've got air or something else to push against."

"All right!" said Miggs. "I understand that and I see that without the brakes we would just drop down into the pit. With the help of the brakes we shall get down all right, but if we can't use the propeller, how in the world are we ever going to get up again?"

#### CHAPTER VI

Doctor Hackensaw smiled at the boy's question: "Don't be afraid, Miggs," said he. "I ain't any more anxious than you are to be left down at the bottom of this hundred-mile hole, without any means of climbing up again. You know the old Latin proverb: '*Facilis descensus Avernii*'! It means that it's easy enough to go down, but not so easy to come up. I didn't find it so easy as all that to go down, but in our case it won't be very difficult to come up again."

"How will you manage it?"

"Simply enough. The cause of our trouble is that there is almost no air in this pit. The remedy is self-evident. We must let some air in from above, when we wish to return. I have arranged with Mr. Sam, the agent, to let in air by degrees on our return trip. If possible I shall signal to him by radio just when to send in the air. In case anything goes wrong with our radio apparatus, however, he is to let in air enough so that our car shall be always in an atmosphere of about fifteen pounds to the square inch when we return. In such an atmosphere our propeller can easily raise the car, and we can fly back without trouble. If he let in too much air, the pressure down below here would be too great and might cause trouble.

"How can Mr. Sam know where the car is and what pressure it exerts?"

"The car is itself a large permanent magnet, and by means of an ingenious amplifying device, its distance from the surface of the earth is indicated on an extra sensitive galvanometer in Mr. Sam's office. But to leave theory and come down to practical matters. There are only three of us in the car, so we must take turns as pilots. Each of

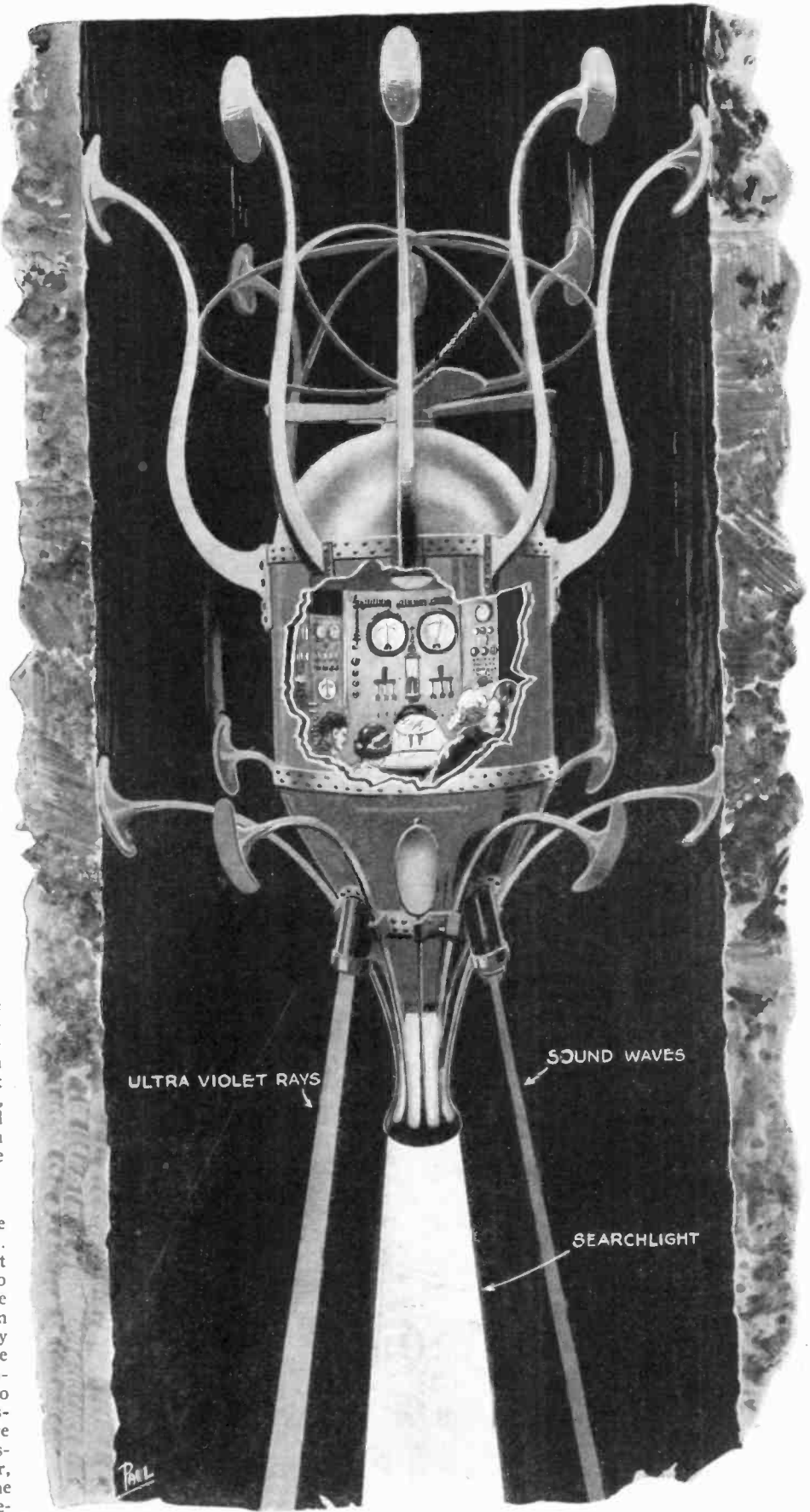

An external view of the "Dart" on its journey. Sound waves and ultra-violet rays act as warnings in case the car should approach too close to an obstruction. The side of the car is shown broken away revealing the complicated, yet commodious traveling compartment. The curved plates pressing against the sides of the shaft are brakes for regulating the speed.

us will take a trick of two hours at the controls and then have four hours' rest. There is very little for the pilot to do as everything is arranged to work automatically as much as possible. Yet it is only prudent to have someone constantly on guard. Our

searchlight shows the way for more than a mile ahead. There is a smoked glass window for the pilot to look through without being blinded by the rapid flashing by of the illuminated walls.

(Continued on page 278)

# Prize Awards In Our

## NAMES OF PRIZE WINNERS

1. Marion E. Parsons.
2. Louis Orlando.
3. S. J. Cinkus.
4. H. L. Mutispaugh.
5. L. J. Gauvin.
6. J. Leo Vanderheyden.
7. Benjamin Oremland.
8. Thomas H. Greene.
9. G. Vance Wardlaw.
10. O. J. Thielhart.
11. Miss Nellie Taylor.
12. Norman B. Krim.
13. Harold N. Whitmore.
14. P. C. v. Petegem.
15. R. B. Rinker.
16. Paul H. Yacoobian.
17. Wm. V. Gilpin.
18. Aurelia Beavers.
19. George Hama.
20. Mrs. Coletta Dengler.
21. John Odenbach.
22. Robert W. McCracken.
23. M. S. Compton.
24. Maurice Berger.
25. William M. Goldberg.
26. Carl William Fischer.
27. W. F. Payne.
28. Thomas McCartie.
29. Setrak Baker.
30. Earle S. Decker.
31. J. L. Moon.
32. Jas. C. Jones.
33. Miss Elsie J. Holly.
34. George H. Whitacre.
35. Ferdinand L. Holly.

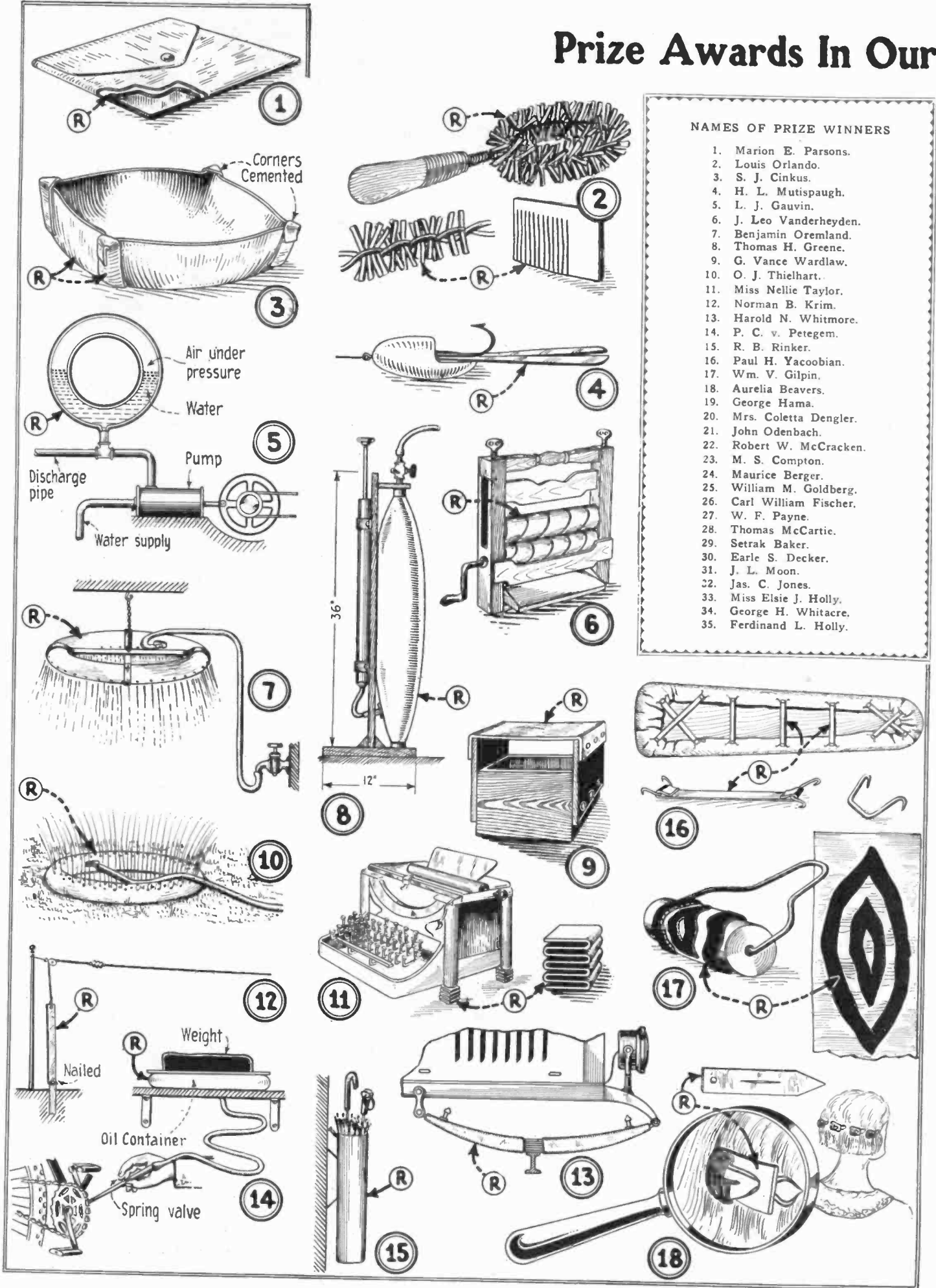



# Inner Tube Contest

## PRIZE WINNING ARTICLES

(R in illustrations denotes rubber or inner tubes.)

1. Case for damp wash cloth made of inner tube rubber covered with cloth. 2. Acid proof brush for laboratory use. 3. Photographic tray for tourists' use. 4. Fish bait. Rubber strip used in place of pork rind. 5. Pressure tank to keep water pressure constant. 6. Wringer roller renewer. 7. Shower bath. 8. Self-contained air reservoir for blow pipe. 9. Foot stool cover. 10. Garden or lawn sprinkler. 11. Type-writer shock absorber. 12. Device to keep aerial from breaking. The rubber tube absorbs shock by stretching. 13. Spring cover and oil retainer. Pour oil in valve stems. 14. Oil reservoir. 15. Wet umbrella receptacle. 16. Inner tubes keep ironing board cover under tension and smooth. 17. Wood graining tool. Roll in paint and then on wood. 18. Hair curler. 19. Rubber on draftsman's triangles preventing slipping. 20. Camper's bed spring. 21. Rubber over cardboard tube as winding base for bare wire. 22. Another radio item. Here the rubber tube is doubled back over the winding and cemented, protecting the wire. 23. Hot pot holder. 24. Anti-rattling chain cover. 25. Paste brush. 26. Mop. 27. Spreading gun for insect powder. 28. Bellows, cross-sectional view shown. 29. Hot and cold water mixer for sink. 30. Receptacle for fruit as it is picked with device shown. 31. Suspension for motor generator. 32. Squares of different colored rubber cemented to floor with water glass. 33. Floor brush. 34. "Non-tip" bottle holder for draftsman. 35. Bath brush.

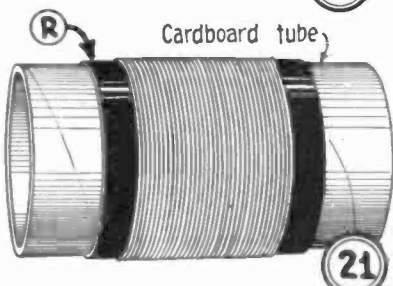
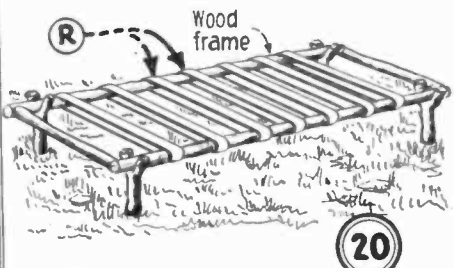
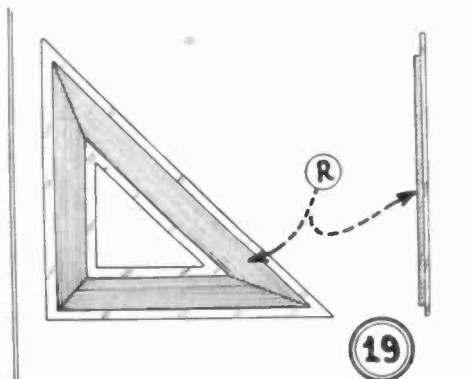
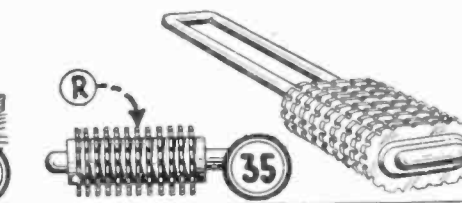
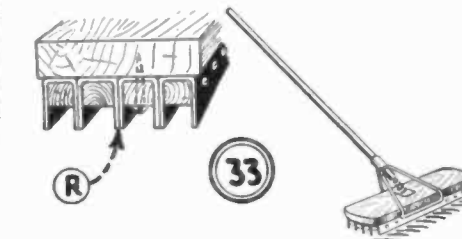
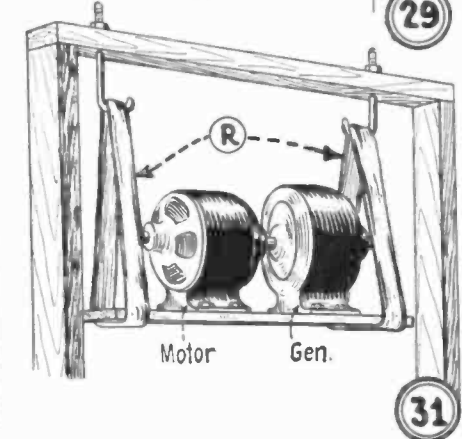
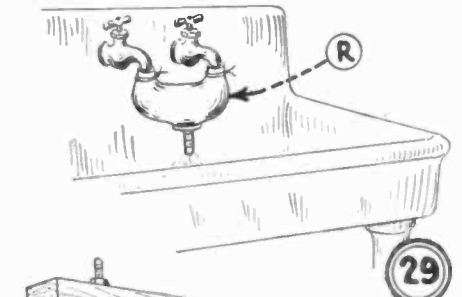
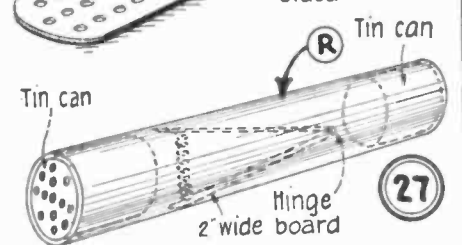
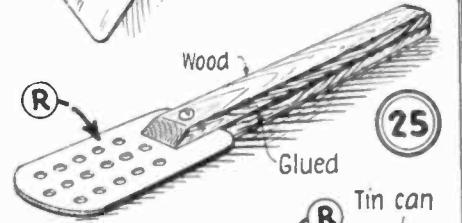
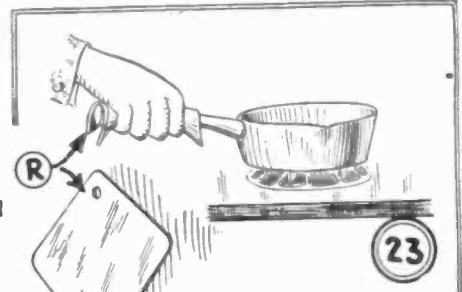
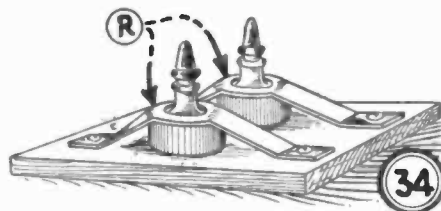
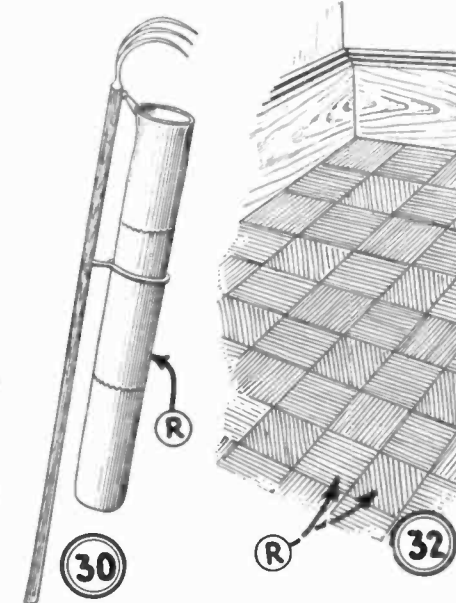
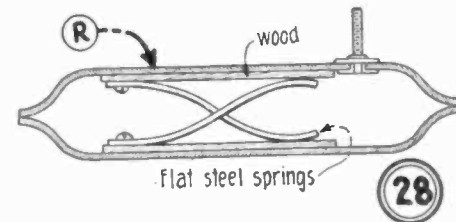
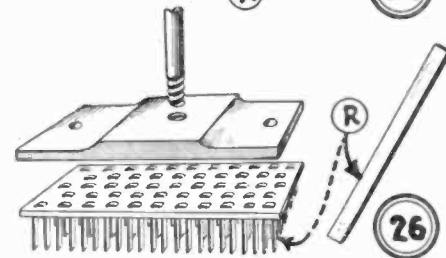
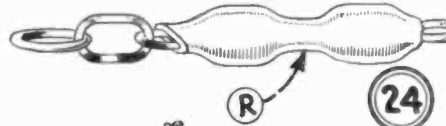
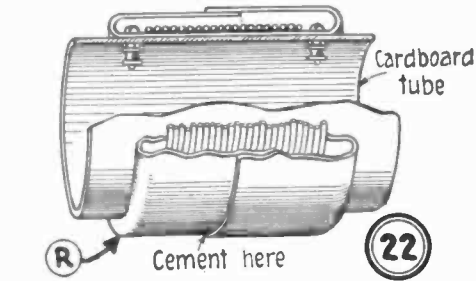

# Sound Waves Measure Ocean Depths

By S. R. WINTERS

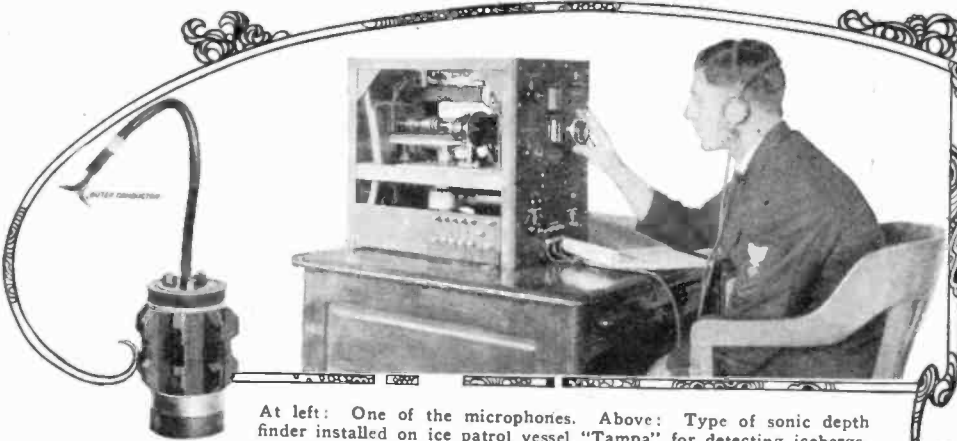

At left: One of the microphones. Above: Type of sonic depth finder installed on ice patrol vessel "Tampa" for detecting icebergs.

THE new sonic depth-finding apparatus determines ocean or river depths continuously at any moment desired. The device also lends itself to the detection of icebergs. The action of the sonic depth finder will be understood from the diagram below. If a sound pulse is projected from the transmitter in the hull of the boat, downward toward the ocean bottom, let us assume that the echo is picked up one second later as determined with a stop watch. The sound of the echo is received by a series of sensitive microphones placed below the water line as indicated below. The velocity of sound through water is 4,800 feet per second. Thus, if one second elapses before the echo is heard by the operator, he knows that the sound has been in transit over a distance of 4,800 feet in that time, and it is at once evident that the true depth of the water is one-half of 4,800 feet or 2,400 feet, since the sound must travel down and back. In using the apparatus shown at the left, the operator adjusts the handle calibrated in revolutions per second until the transmitter and echo sounds coincide in the two head phones. By referring the dial readings to a special conversion table, the depth of the water for this reading is at once obtained without any calculation on the part of the operator.

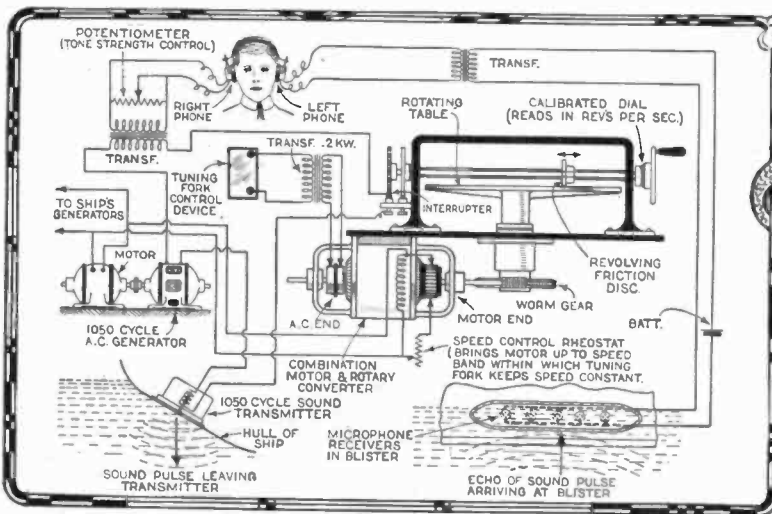

A schematic diagram of the sound wave depth finder. Sound waves strike ocean bottom and time taken for echo to be received is accurately measured.

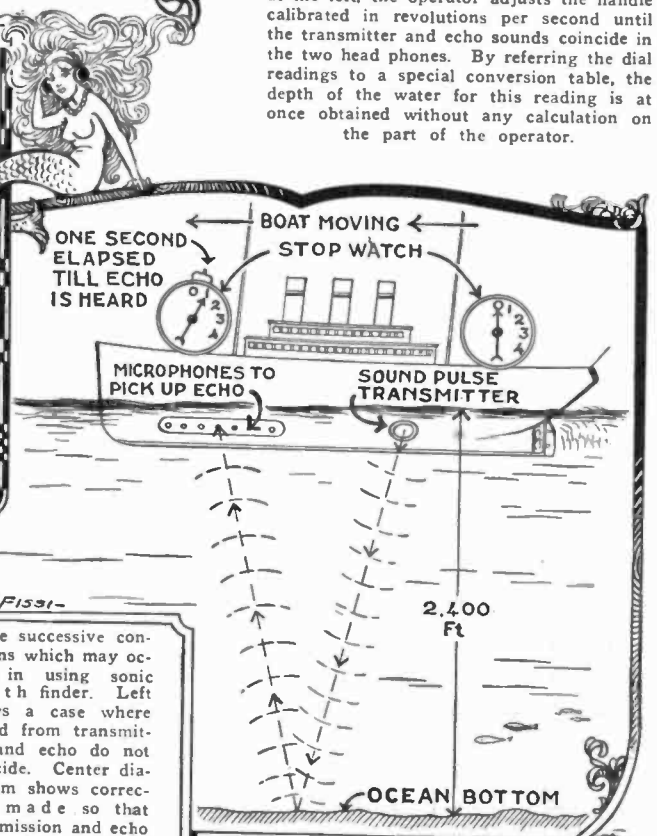

The diagram above shows how sound-wave echo is measured and ocean depth determined.

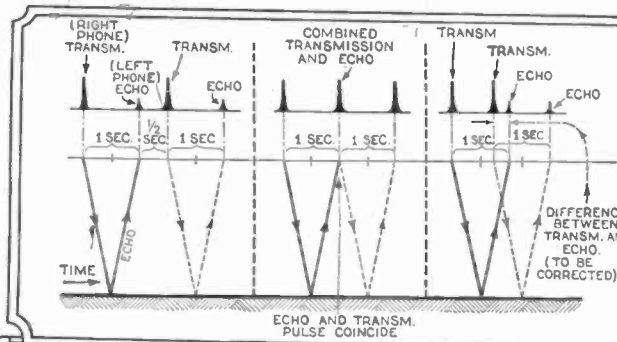

Three successive conditions which may occur in using sonic depth finder. Left shows a case where sound from transmitter and echo do not coincide. Center diagram shows correction made so that transmission and echo sounds synchronize. Right diagram shows transmitter and echo sounds out of phase and to be corrected.

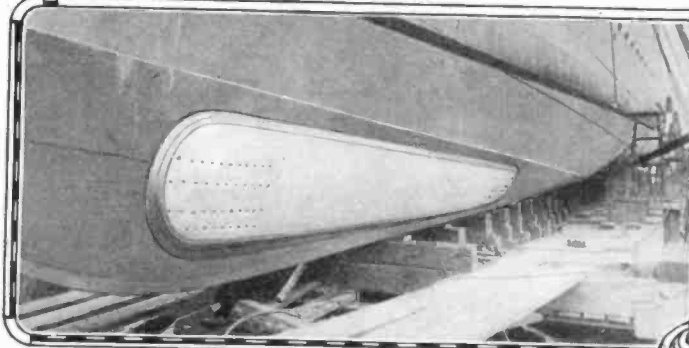

Steel "blister" on the S.S. Niagara placed below the water line, which houses the microphones.

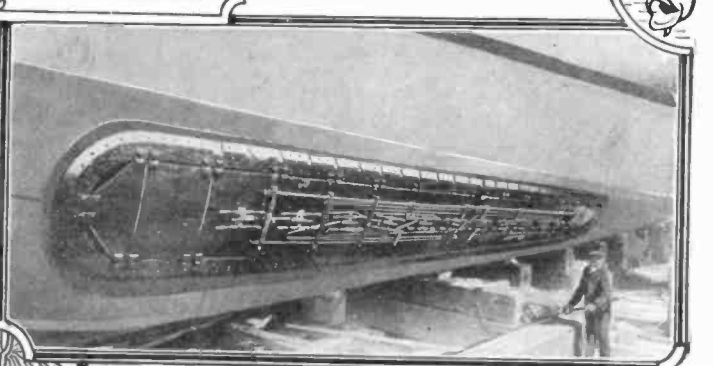

Above we see steel "blister" removed and battery of microphones and wiring in position.

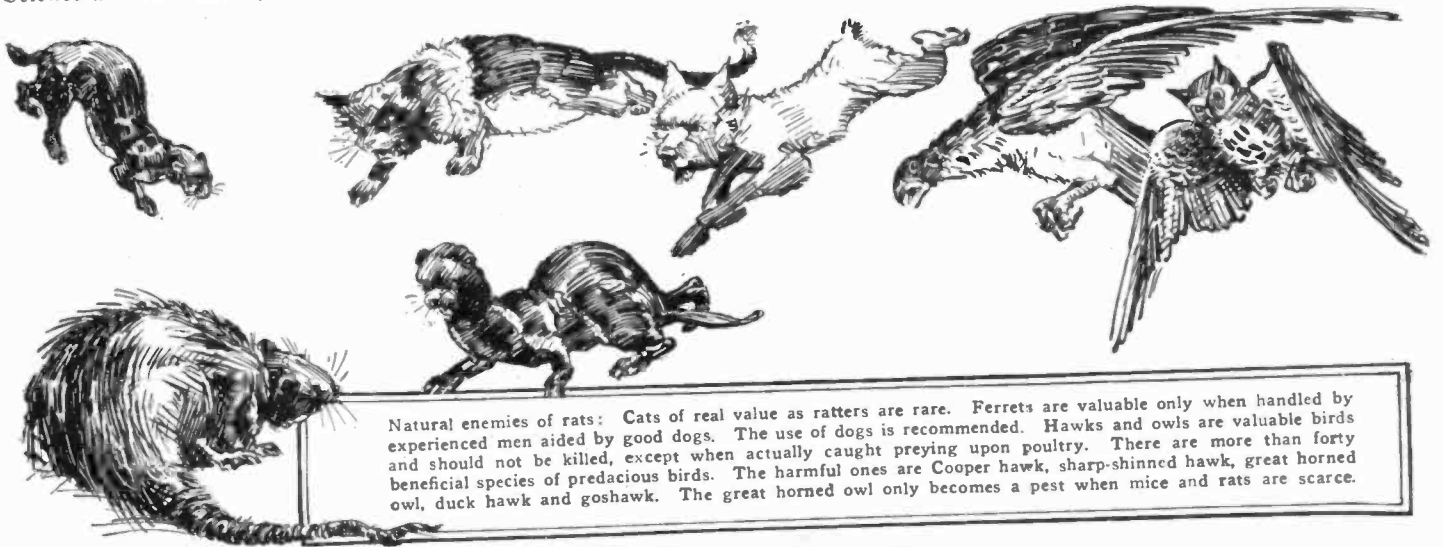

Natural enemies of rats: Cats of real value as ratters are rare. Ferrets are valuable only when handled by experienced men aided by good dogs. The use of dogs is recommended. Hawks and owls are valuable birds and should not be killed, except when actually caught preying upon poultry. There are more than forty beneficial species of predacious birds. The harmful ones are Cooper hawk, sharp-shinned hawk, great horned owl, duck hawk and goshawk. The great horned owl only becomes a pest when mice and rats are scarce.

# Death To the Rat

## \$250.00 Prize Contest for Rat Exterminating Means

By JOSEPH H. KRAUS

**R**ATS affect a larger percentage of population than any other pest in existence. Annually they damage property to the extent of \$200,000,000. Aside from this loss of property, rats often seriously bite infants in their cribs and are known to be carriers of fleas, which in turn transmit disease. Bubonic plagues are directly traceable to the rat flea.

The U. S. Department of Agriculture tells how to get rid of rats in Farmers' Bulletin No. 1302. This bulletin is furnished free to anyone who cares to write for it, and contains some most valuable information.

In an effort to discover new means for eliminating the rat pest, SCIENCE AND INVENTION Magazine is now conducting a prize contest for such methods.

Ideas will be judged by their efficiency, originality, lack of danger in using, a lack of danger to other animals liable to partake of rat meal if a meal is the suggestion submitted, ease of control, and the cost of operation.

### \$250.00 IN PRIZES

The Federal Government and State Departments are doing all they can to exterminate the rats. SCIENCE AND INVENTION MAGAZINE, now offers prizes for the best new methods for exterminating rats. The prizes to be awarded are as follows:

First Prize .....	\$100.00
Second Prize .....	50.00
Third Prize .....	30.00
Fourth Prize .....	25.00
Fifth Prize .....	20.00
Sixth Prize .....	15.00
Seventh Prize .....	10.00

Suggestions must be accompanied with photographs or affidavits sworn to before a Notary, or if a trap is entered, a model must be submitted.

Contest closes at noon in New York on October 15th. All suggestions must be in our hands at the time.

The number of entries per person is not limited.

In event of a tie for any of the awards, an identical prize will be paid to the contestants so tying.

Address entries to Editor, Rat Contest, c/o Science and Invention, 53 Park Place, New York City.



Above photo shows the dead rats in the hold of a vessel fumigated with carbon monoxide.



Photo shows hoses lowered into hold of ship through the ventilators. Hose delivers carbon monoxide which kills rats.

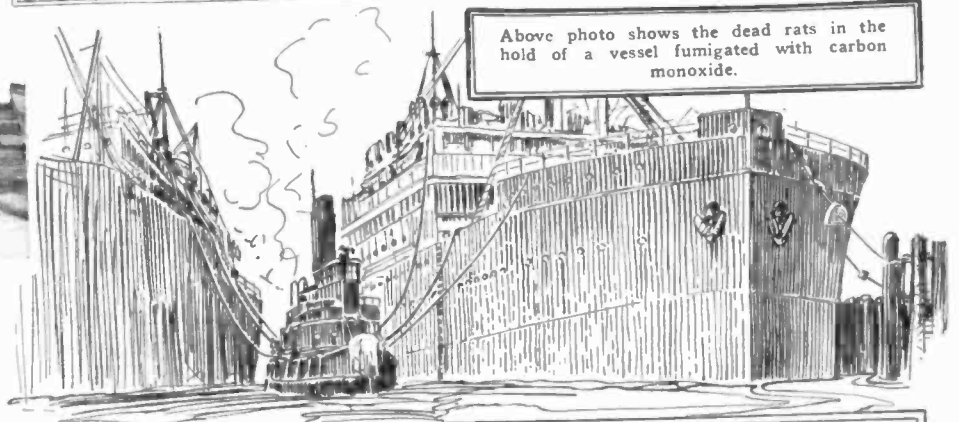

The diagram above shows how a steamer or tug-boat which generates carbon monoxide gas pumps this gas through hoses and sends it down into the holds of vessels. The poisonous gas permeates the holds and kills the rats without harming the cargo. Diagram at the right shows how rats have been eliminated around wharfs.

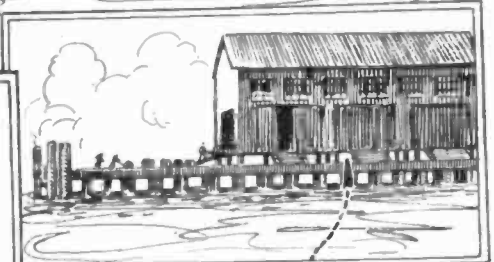

STORAGE ROOMS ON DOCKS RAISED TO LEAVE OPEN SPACES BENEATH

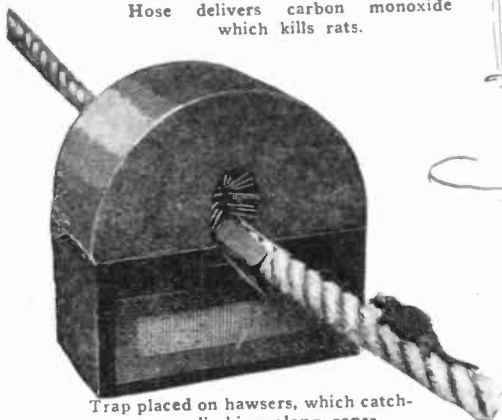

Trap placed on hawsers, which catches rats climbing along ropes.



MIX 4 PARTS FOOD WITH 1 PART BARIUM CARBONATE - MAKE SOFT AND MUSHY WITH WATER



OR SIFT BARIUM CARBONATE OVER SLICED BAITS AND RUB IN

DISTRIBUTE TEASPOONFUL OF EACH OF THREE TYPES ON PAPER - SEPARATE 10 TO 20 FEET

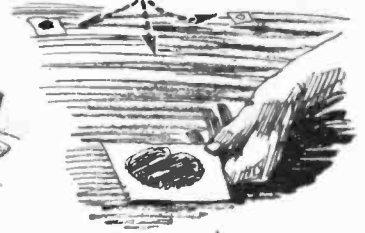

OR POISONED BAIT MAY BE DROPPED IN PAPER BAGS, THE TOPS OF WHICH ARE TWISTED TOGETHER

PICK UP UNEATEN BAITS AND DESTROY NEXT MORNING - FOOL FOXY RATS BY USING GOOD FOOD SEVERAL DAYS AND THEN SUBSTITUTE THE POISON

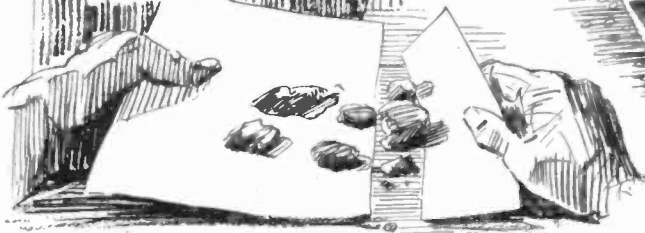

FOR TRAPS USE ROLLED OATS, FRIED BACON, BREAD, TOASTED CHEESE, RAW OR COOKED MEATS, FISH, NUT MEATS, CHEESE, APPLES OR CARROTS

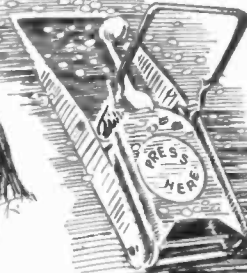

SPRINKLE ROLLED OATS OR CORN MEAL OVER TRAP

LEAN PLANK AGAINST WALL

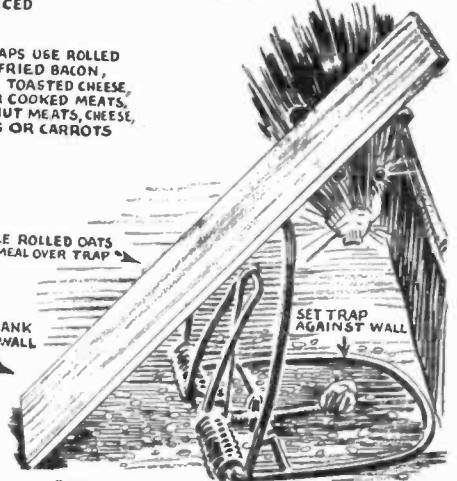

SET TRAP AGAINST WALL

RATS USUALLY TRAVEL ALONG WALLS



AS SOON AS POSSIBLE AFTER DEATH DIP RAT IN KEROSENE TO KILL FLEAS

CAMOUFLAGE TRAPS - SET IN PAN OF MEAL



©1925 BY SCIENCE AND INVENTION

Barium carbonate means death to rats, and is not harmful to household pets. The bait, such as meats, vegetables, fruits or cereals, may either be mixed with barium carbonate, or the barium carbonate may be sifted over the sliced baits and rubbed in. These baits are then distributed on sheets of paper or wrapped in paper bags. In the latter case the rats often take the paper bag into their burrows and feed on it there. The baits must be renewed daily. Immediately above, two rat traps are shown. These traps should be preferably mounted against the wall, as illustrated. Rats in their burrows may be killed by fumigating with carbon bisulphide or carbon monoxide. The former is a liquid obtainable in any drugstore, and the latter is found in gasoline engine exhausts.

DEPARTMENT OF HEALTH  
CITY OF NEW YORK  
305 PEARL STREET  
NEW YORK

OFFICE OF THE COMMISSIONER  
FRANK J. MONAGHAN, M. D.  
COMMISSIONER

Science & Invention,  
63 Park Place,  
New York City

Gentlemen:

KILLING RATS IN RAT BURROWS



SATURATE COTTON WITH CARBON BISULPHIDE AND PUSH WELL INTO BURROW

OR USE GASOLINE ENGINE EXHAUST

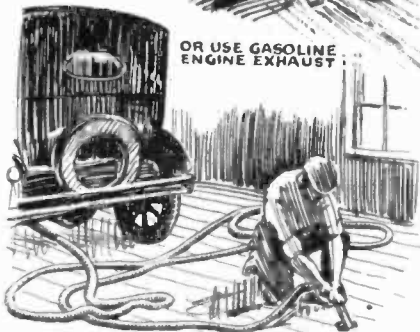

These are not all of the methods or materials used by this department in its war on the rat. They are, however, the general measures employed in the effort to "Rout the Rat". They contemplate starving, gassing, poisoning, trapping and building out this pest. The work in question was performed through a special squad directed by Supervisor W. E. Richards.

If your magazine sees fit to establish a prize for the discovery of other methods to fight the rat successfully and present those methods to us we shall be pleased to try them out if they should not be ridiculous, (as some of the suggestions made to us are) and have not already been used by us.

Very truly yours,

*Frank J. Monaghan*

FRANK J. MONAGHAN, M.D.  
Commissioner.

To the right is a portion of the letter sent to the writer from the U. S. Department of Agriculture. Notice that the Bureau is interested in keeping in touch with all new methods that possess value. We are sure that the readers of this publication will furnish the new methods, and consequently are requesting all who know of something not universally used for rat extermination, to submit those ideas to the editors of this publication.

FEEDING VIRUS TO RATS — DISEASE IS COMMUNICATED TO OTHER RATS

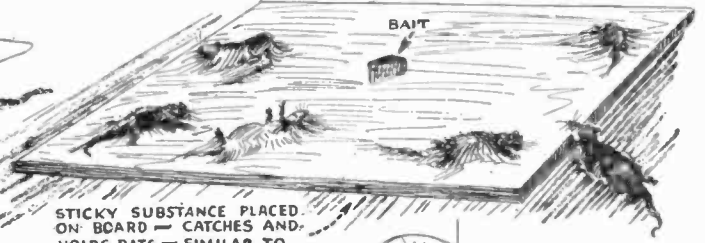

RATS IN CAGE TRAP ARE FIRST KILLED THEN SUSPENDED OVER TUB OF WATER — AS THEIR BODIES TURN COLD FLEAS LEAVE AND DROWN

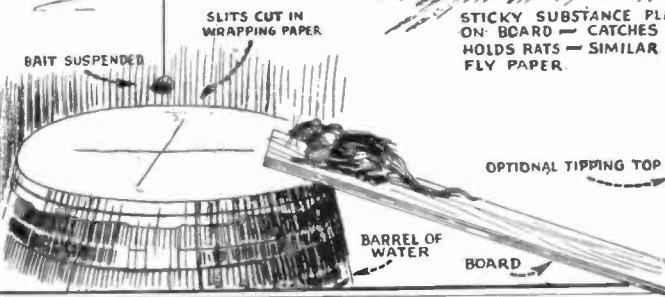

Feeding virus to rats is a more or less popular means for killing these pests, because the disease is communicated to other rats. After a time the virus loses its killing power, and consequently is not recommended to any great extent by the Bureau of Biological Survey. A sticky substance spread upon a board will hold the rats in their attempt to get at a piece of bait located at the center, and if the rats are well fed and will not go after bait, the sticky material can be placed on boards against the wall where rats might run. The tipping barrel top as well as the slits cut in wrapping paper stretched across the top of a barrel are very old systems, and are still in use. Experiments at electrocuting the rat have not met with very great success. Often a rat will get near the charged electrodes and on touching them will scamper away. At times the rat may leap into the air some six or eight feet. Unless the potential is quite high, electricity has little effect upon these pests.

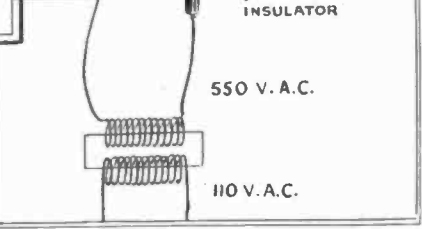
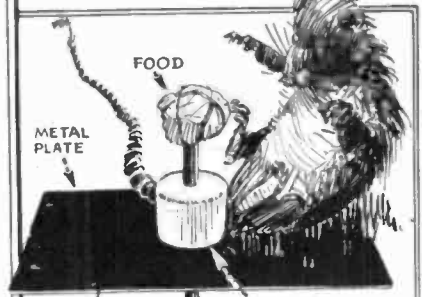
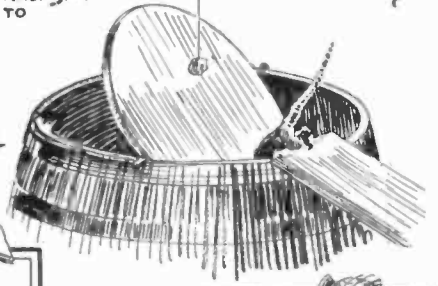

Ray (C) J. J. N.Y.

©1925 BY SCIENCE AND INVENTION

UNITED STATES DEPARTMENT OF AGRICULTURE  
BUREAU OF BIOLOGICAL SURVEY  
WASHINGTON, D. C.

ADDRESS REPLY TO  
CHIEF, BUREAU OF BIOLOGICAL SURVEY,  
AND REFER TO  
DI-R

Mr. Joseph H. Krebs,  
Field Editor, Science and Invention,  
53 Park Place,  
New York, N. Y.

Dear Mr. Krebs:

We are constantly receiving suggestions from sincere and well-meaning people, as well as from promoters of all shades of reliability. These suggestions vary from those having a practical basis to others that are utterly fantastic in character. Elimination of the latter type of proposals would probably be a large part of the work required in deciding upon the winning contestants.

This Bureau, however, is interested in keeping in touch with all methods that possess value and our representatives have had a wide range of experience with methods and plans of organization. We shall be glad, therefore, to counsel with you in selecting the methods that in our judgment possess the greatest merit, and to test out those that show genuine promise of value. If you decide to inaugurate such a contest, we shall be glad to be kept advised regarding the progress of your efforts and to be of any possible assistance in connection therewith.

Very truly yours,  
**W. C. Henderson**  
Acting Chief of Bureau.

Inc. 19636.

BAIT TO BE POISONED

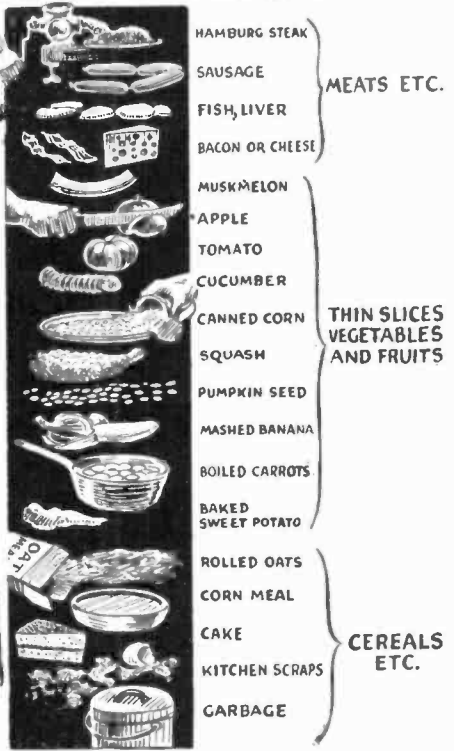

The portion of the letter above shows that the Department of Health of the City of New York is not by any means asleep. They realize that some methods might be discovered for eliminating the rat which would be better than those systems which are at present in use. We cannot help commending both the New York Department of Health and the U. S. Bureau of Biological Survey for their excellent work, and their very willing and hearty co-operation.

The above diagram shows what food products serve as bait for rats. These should be poisoned with barium carbonate for exterminating the animal.



# MAGIC "DUNNINGER" By

**THE MAN WHO MYSTIFIED**  
Prince of Wales, Ex-President Harding, Taft, Roosevelt, Pres. Coolidge and other celebrities  
Writes Exclusively for **SCIENCE AND INVENTION**



NO 28 OF A SERIES

The medium sits beside a spirit cabinet. Slowly the form of a spirit shapes itself in the cabinet. One of the spectators flashes a light upon the medium, but she is still occupying her previous position. She can well do this because an assistant had pushed the spirit out from beneath a bookcase, and the medium raised it as illustrated.

A billiard ball can be quickly converted into a handkerchief if the apparatus is set up as illustrated. A red shell pivotally mounted in a receptacle, rotates through 180 degrees when an assistant pulls the string. The silk handkerchief is inside.

An interesting gimmick for enabling a performer to produce a shower of silver from his fingertips is here illustrated. The holder made of brass and painted flesh color is passed from hand to hand. The coins are released at any desired moment.

The plate lifter comes into its own again in the stand, the design of which is here shown. By operating the plate lifter with the foot, it pushes the silver up. This piston in turn engages the bottom jaw bone of a skull placed upon the table, causing the teeth to click together and answering questions by clicking once for "no," and twice for "yes."

# Everyday Chemistry

By RAYMOND B. WAILES

EVER NOTICE THE BLACK CIRCLES AROUND NAIL HEADS ON OAK OR CHESTNUT WOODS?

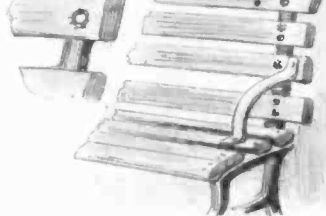

They are produced from the iron in the nail and the tannic acid in the wood. They are really ink spots.

WHAT IS THE "PHOS" IN A PHOSPHATE?



It is a dilute solution of Phosphoric acid, now thought to be very beneficial.

WHICH PRODUCES THE HOTTEST FLAME OXY-ACETYLENE OR OXY-HYDROGEN?

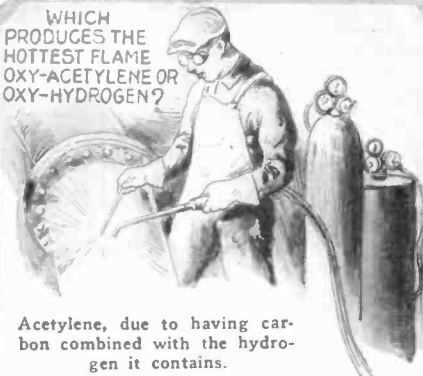

Acetylene, due to having carbon combined with the hydrogen it contains.

WHAT IS MILK OF MAGNESIA?

Add some household ammonia to Epsom salts dissolved in water. Watch the white precipitate form. This cloud is really solid magnesium hydroxide. Do not use it, however, as it is too impure.

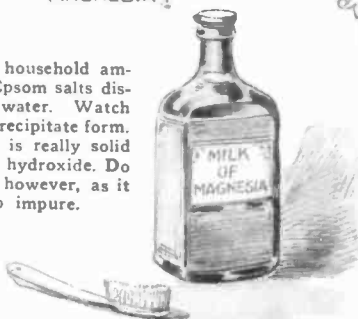

EVER NOTICE A PHOTOGRAPHERS FINGERS?

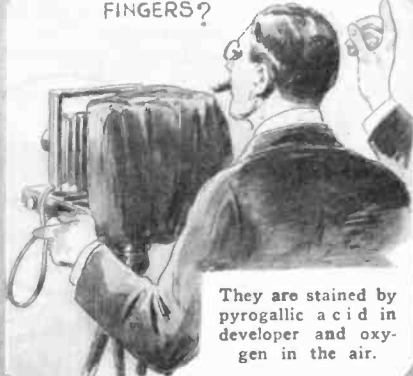

They are stained by pyrogallic acid in developer and oxygen in the air.

TEST YOUR SODA-POP FOR ARTIFICIAL COLOR!



Boil a strip of clean white cloth in the soda. Remove, boil in clean water. If artificial color was used, cloth will not become colorless.

WHY IS "AMMONIA" USED IN WINDOW WASHING?

Because ammonia forms soaps with grease. The soaps dissolve in water whereas greases will not. Therefore, windows can be cleaned easily with ammonia.



EVER BLOW YOUR BREATH THRU CLEAR LIME WATER?



If you do, a white cloud will be formed in the lime water due to the carbon dioxide in your breath. This same gas comes from burning processes.

EVER SEE A CHEMICAL MICROMETER?

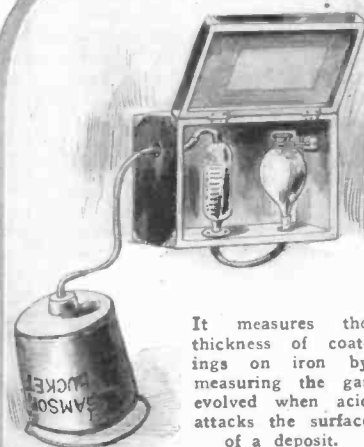

It measures the thickness of coatings on iron by measuring the gas evolved when acid attacks the surface of a deposit.

DOES ASPIRIN DISSOLVE WITH THE WATER WHICH WE DRINK WITH IT?



No. The acids of our stomach, however, break the substance down into ingredients which are then acted upon by the system.

Titanium oxide, a white metallic oxide, bids fair to outdo white lead as a pigment. Titanium is used as an alloy with steel.



WHAT SUBSTANCE MIGHT DO AWAY WITH WHITE LEAD?

(C)1925 BY SCIENCE & INVENTION

Yes, since lead oxide is undoubtedly thrown out from the exhaust. Poisonous effects of lead salts are known.

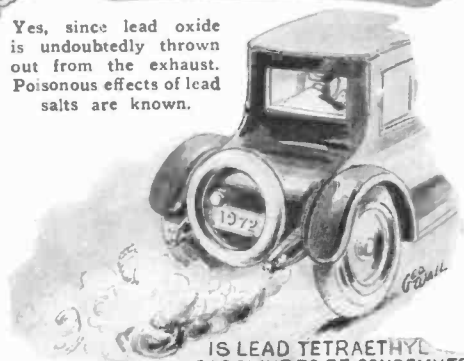

IS LEAD TETRAETHYL GASOLINE TO BE CONDEMNED?

# Progress in Medicine

Edited By JOSEPH H. KRAUS

## Successful Oxygen Tent

At the Presbyterian Hospital in New York City a portable oxygen tent devised by Dr. Allen L. Barach, of the hospital staff, and Dr. Carl A. L. Binger, of Rockefeller Institute, was recently demonstrated and pronounced a success. Pneumonia patients suffer from an insufficient amount of oxygen in the blood. Heretofore this oxygen was administered by means of a special type of mouth-piece which connected with the oxygen tank. In the oxygen tent a patient is as comfortable as he would be in an ordinary hospital bed. Oxygen, of course, does not cure the patient. It serves merely as a means for keeping them alive, nature taking care of the rest. The tent is made of a triple layer of fabric lined with rubber.

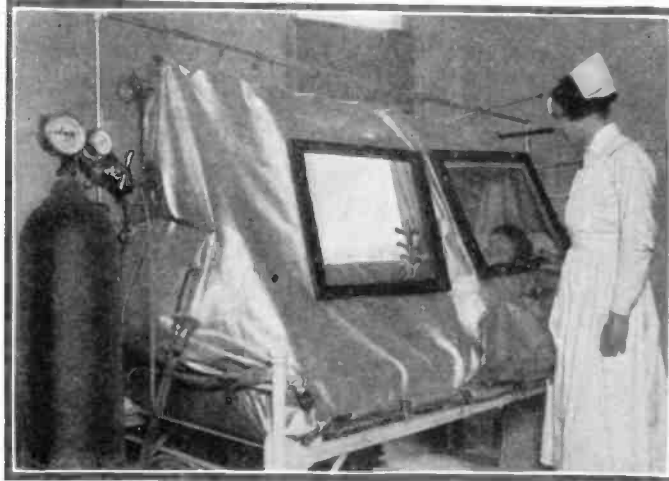

## Methanol is Deadly

Dr. Charles Norris, Chief Medical Examiner, warns that there is a great danger in drinking whiskey doctored with methanol. Methanol has been reported as being a "new" wood alcohol. As a matter of fact, the product itself is quite old. The greatest danger lies in the lack of odor or taste in methanol. Ordinary wood alcohol when added to a drink generally makes its presence known by its odor. This is usually enough to frighten off a drinker, provided that he is not too intoxicated in the first place to notice the characteristic smell. Methanol being non-odorless, and reported as being 100 per cent. pure wood alcohol, produces blindness and death as inevitably as the ordinary wood alcohol.

## Reported Cure for Radiodermatitis

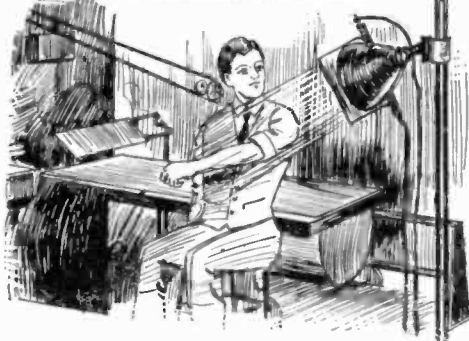

In order to obliterate the danger of radiations from an X-ray tube, Daniel Berthelot introduced J. Risler and P. Mondain to the French Academy of Sciences, who read a paper on the use of infra-red radiations for curing radiodermatitis, a malady produced by prolonged subjection to X-rays. The theory is based on the antagonism between infra-red or long radiations and X-rays.

## Simple Treatment for Vomiting

The Journal of the American Medical Association reports a very simple method of relieving vomiting by the administration of from fifty to two hundred cubic centimeters of a two per cent. sodium chloride solution by mouth. The water should be cold. Salt water as a household remedy to induce vomiting has been used for generations, but the



water is generally warmed. Drs. Edwin F. Lehman and Harry V. Gibson are the sponsors for this salt and cold water system.

## Deaf Hear Radio Programs

It has been definitely shown that deaf persons are capable of hearing programs coming through the air via radio. The reason for this is that the auditory nerve is seldom completely destroyed. There is more often some difficulty with the articula-



tions of the bones of the ear or with the ear drum itself. Due to the great amplification obtainable from two stages of audio frequency amplification, the deaf are frequently enabled to hear again. Diagram above is a cross-section through ear and bony canals.

## Drinking Sunlight



The photo herewith shows a new type of ultra-violet ray generator by means of which the rays can be administered to the mouth and throat. Ultra-violet rays, administered in this manner, have proven beneficial in cases of diseases of the mouth and throat. This machine is one of the number shown at a nursing exhibition in London.

as the ordinary wood alcohol.

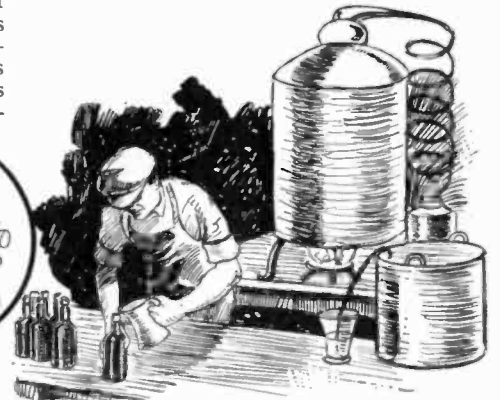

## Hay Fever

Dr. George Pines of Los Angeles describes in a very interesting manner the technique of collecting pollen and the preparation of pollen extracts for the treatment of hay fever in the Journal of the American Medical Association. In California alone, there are approximately 128 varieties of plants and grasses which pollenate. It is these pollens which cause the sufferers of hay fever so much distress. Flowering stalks of grasses or weeds are gathered, placed in a bucket of water and carried to the laboratory. Each day the flowers are shaken and the pollen is scraped up. The pollen is then placed in



ether and, after stirring, precipitates. From the precipitate, pollen extracts are made and injected for treatment of hay fever.



# Latest Devices



The life saver illustrated at the left has three swimming tubes each separately inflated. Each one is capable of supporting the swimmer, and a leak in one will not be disastrous. —H. S. Wood.

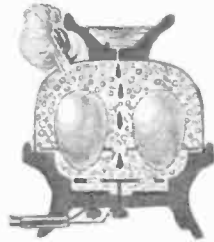

↑ The handle of the club above contains enough tear gas to foil any holdup.

↑ Eggs placed in the container are boiled by live steam. The water drips down to two metal plates at the bottom and boils immediately. —R. G. Thackwell.

↓ Below: An extension collar button which lengthens the neck bands. J. W. Von Stein.



← This device forces medicines through the skin by electricity. The medication is placed on a piece of gauze, one electrode is placed on top of the gauze, and the other electrode connected to the body.



↑ The two photos above show a new musical instrument made in the form of a walking stick. When the metal front is removed, a ukelele-like instrument is produced. The small insert above shows a picture hanger which will hold light pictures, and needs to be moistened before being stuck to the wall. It will not mar the walls or wall-paper. —J. W. Von Stein.

← On the automobile dashboard shown, there are two instruments; one indicating charge and discharge rates, gives the condition of the battery and when the button is pressed, it tells whether the battery is fully charged or weak. —J. W. Von Stein. The other tells whether the engine is cold or hot. The thermostat is clamped to the engine and the meter fastened to the dashboard. This is a better system than determining radiator temperature, because the latter does not give a true indication of motor heat. —Thomas W. Benson.

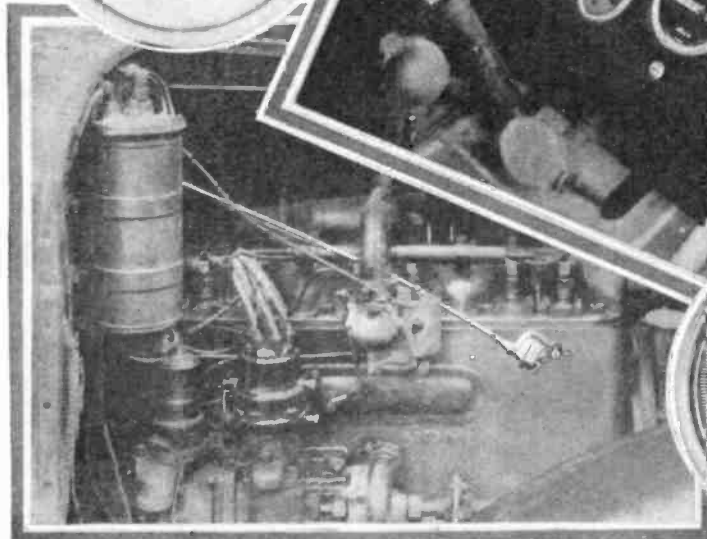
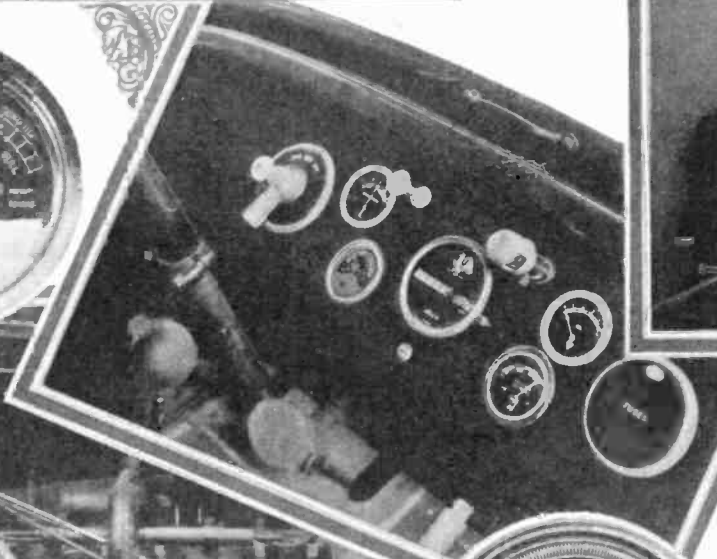



# THE CONSTRUCTOR

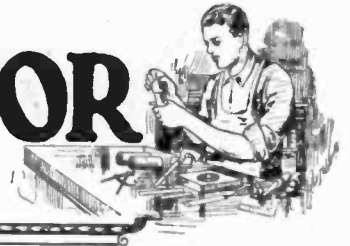

## Child's Auto Runs on Air



Above: Filling the compressed air tank by means of a hand pump. A pressure gauge on the dash board indicates the amount of power in reserve.



From England come the details of this novel automobile designed for the use of the small sportsman, which runs solely on air and requires no gasoline for its operation. Photo at immediate left shows the proud young owner ready to start for a trip. The machine will run for a quarter of a mile at a speed of five miles per hour and is equipped with a reverse and brake.

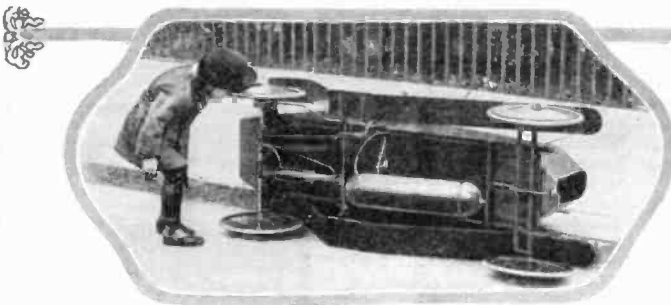

The mechanism of this small car is easily examined. It can be immediately tipped on its side for repairs as shown above. The operating mechanism of this car is shown at the right. A, B and C indicate various positions of the rotary air valve. At A, no air flows from the tank. At B, the air enters the rear end of the cylinder, while at C, it enters the front end. The valve housing is rotated by the handle marked reverse. A standard contracting brake is used.

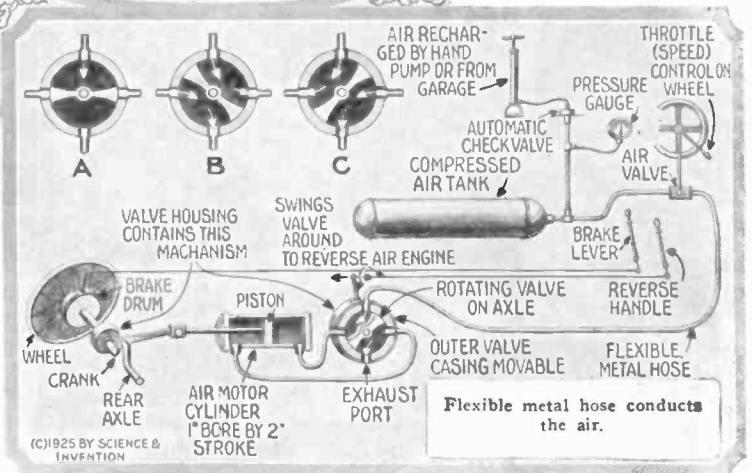

This device has been constructed with the fact in mind that it is to be operated by someone with no knowledge of machinery. There is a minimum number of parts and they are arranged in a simple manner.

## Toy Locomotive

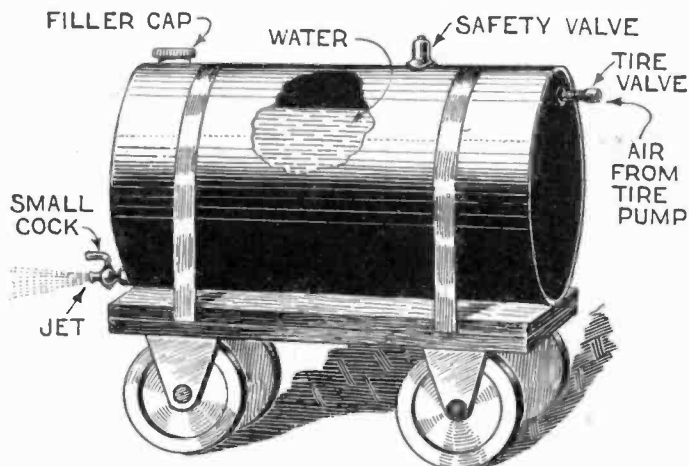

A toy reaction locomotive may be made from a small can strapped to a set of wheels and equipped as shown above. Fill about two-thirds full of water and compress air in the tank with a tire pump. Upon opening the small petcock, the jet of water will propel the device.

—C. A. Oldroyd.

## Shaving in Comfort

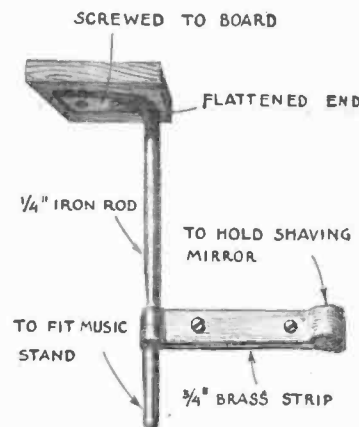

Where space is at a premium, a small bracket made as shown above hastens and makes more convenient the morning shave. A cup of water in a shaving mug is flushed with the shaving mirror as shown. A small electric light furnishes ample illumination and the entire support fits on a music stand.

—P. C. G.

# Make Your Own Fireworks

By RAYMOND B. WAILES

The joys of celebrating the Fourth of July can be greatly increased by making your own fireworks and noise makers. Those described on this page are safe and it is only necessary to use a few simple precautions where explosive materials are being used. Another advantage of these home-made fireworks is that by their use you can reduce your yearly expenditure for the celebration of Independence Day considerably.



Very fair imitation sparklers can be made as shown above. Affix a long mass of steel wool as at the left above to a bent iron rod. Light the end of the wool and twirl about in the air in order to produce sufficient air current to burn the steel. Do not use this indoors.



A safe and simple noise maker can be made from a key and nail as shown in the above illustration. Fill the hole in the end of the key with scrapings from the heads of matches. A wire frame should first be made to hold the nail and the key together as shown. Now with the material in the hole in the key, introduce the nail as shown, place on a hard surface and hit the end of the key a sharp blow with a hammer. A loud report will result.

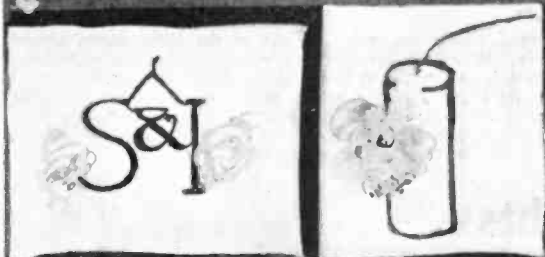

Invisible fire pictures afford much indoor fun. Draw a picture or design on white paper with a solution of saltpeter or potassium nitrate. When dry, nothing is visible, but the figure immediately comes to light when a glowing cigarette is touched to one of the lines.

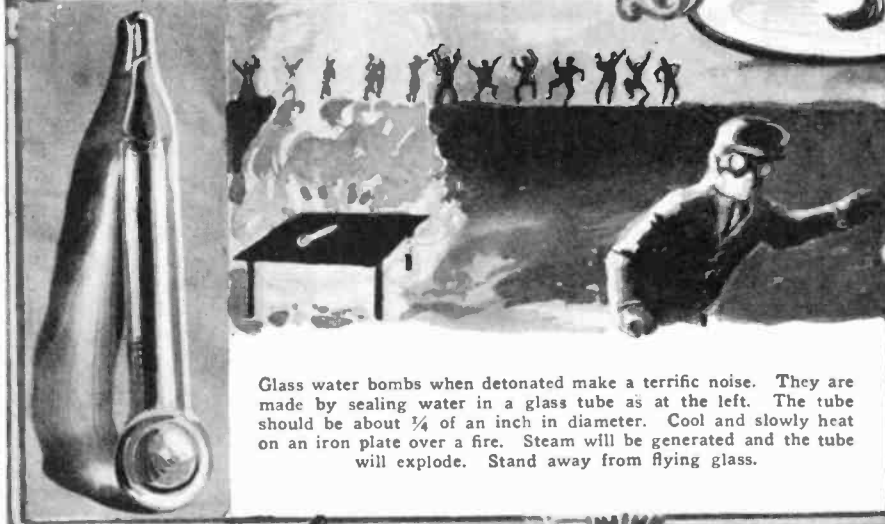

Glass water bombs when detonated make a terrific noise. They are made by sealing water in a glass tube as at the left. The tube should be about 1/4 of an inch in diameter. Cool and slowly heat on an iron plate over a fire. Steam will be generated and the tube will explode. Stand away from flying glass.



A fuse for igniting various fireworks can be made as shown above. Moisten five parts of saltpeter, 3 parts of charcoal and 1 part of sulphur with thin glue after having powdered the dry ingredients. Spread this mixture on a soft cotton string and allow the finished fuse to dry before use.



Caps for cap pistols and other noise making devices of a similar nature may be made as follows and as illustrated above. Powder together 7 parts of potassium chlorate, 3 parts of sulphur and 2 parts of black antimony sulphide. Moisten with thin glue and spot the solution on a glued paper strip as above. Cover with another strip of moistened glued paper and allow to dry.

To make various colored fires, use the chemicals mentioned below, mixing well together with a knife without rubbing. For green fire, use 90 parts by weight of barium chlorate and 10 parts of powdered dry orange shellac. For red fire, use 8 parts strontium nitrate, 3 parts potassium chlorate and 1 part powdered shellac. These may be made into colored fire candles by placing in a cardboard case as at left and inserting a fuse for igniting.

# Measuring Heights with Match Box

By C. A. OLDROYD

An ordinary small match box when properly manipulated makes an excellent device for measuring unknown heights.

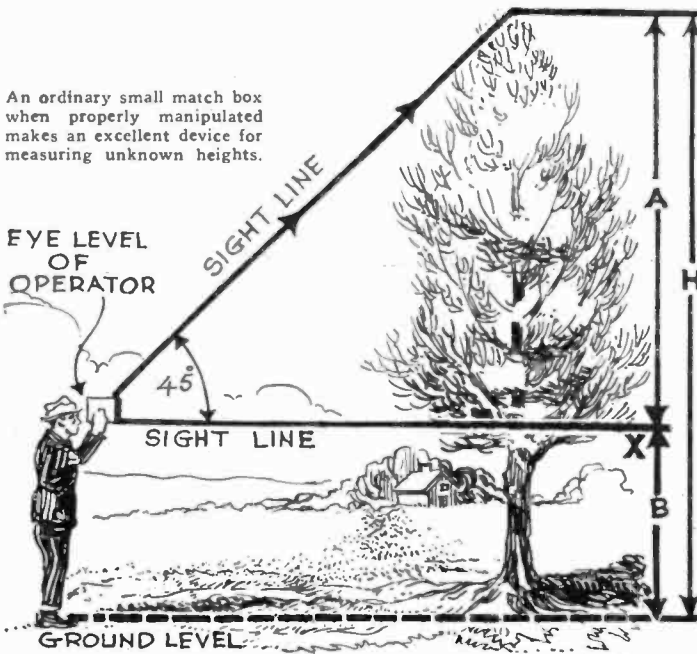

The match box, the dimensions of which are known, is held in the hands as shown above and sights taken along the two lines indicated.

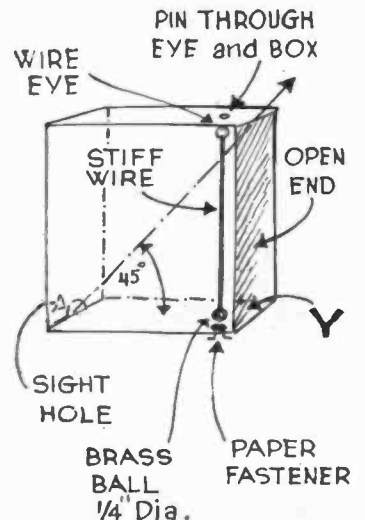
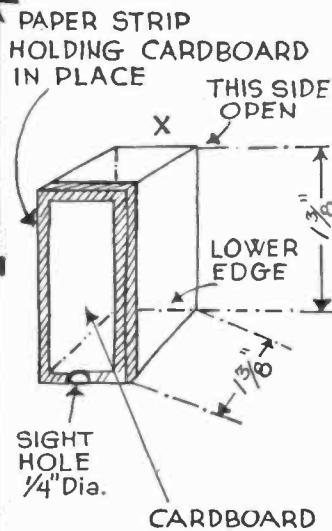

The match box used should preferably be cut to the sizes shown above, with the small hole. When the operator has moved so that the sight lines indicated are obtained, the height of the object is equal to the distance of the operator from the object plus the height of the operator's eye from the ground, or in the illustration at the left, H is equal to the distance from the tree to the operator, plus the distance B. A pendulum as shown above insures the box being level.

## Auto Hub Cap Lights

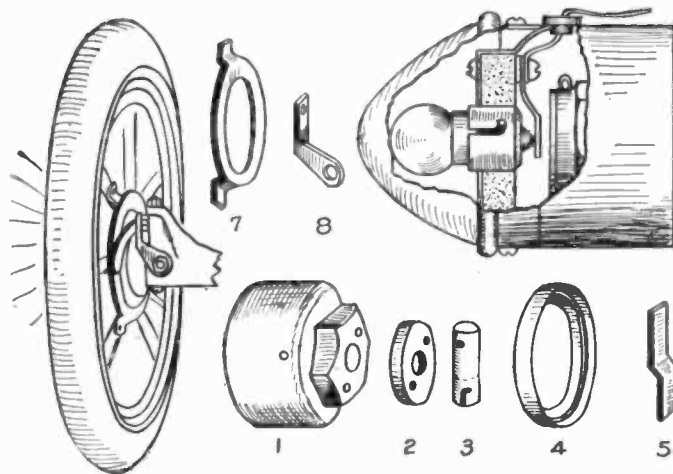

Lights on the front hub caps of automobiles make an interesting and distinctive novelty. They may be made as shown above. They may be controlled separately or together, as desired, by means of switches. A hole is drilled in the center of the hub cap to hold the socket and fiber ring. As the socket is soldered to the hub cap, it forms a ground return, necessitating

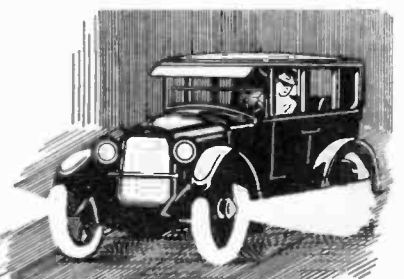
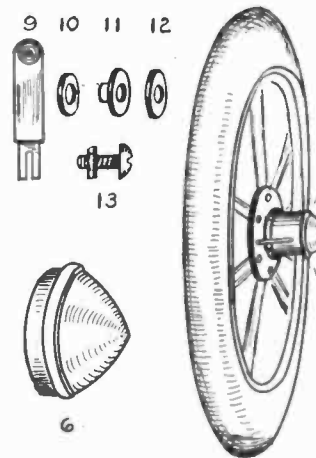

- 1-FORD HUB CAP
- 2-FIBRE RING
- 3-FORD HEADLIGHT SOCKET
- 4-BRASS RING
- 5-CONTACT PLATE
- 6-LAMP GLOBE
- 7-CONTACT RING
- 8-BRACKET FOR CONTACT BRUSH
- 9-CONTACT BRUSH
- 10-FIBRE WASHER
- 12-BRASS WASHER
- 13-BOLT

the use of only one wire. The latter is connected to a contact ring (7) to which contact is made by means of a brush. The electric light bulb is protected by means of a bullet shaped globe obtainable from any accessory dealer. This globe must be of quite thick glass although it is not supposed to hit anything. —L. O. Van Riper.

## Automatic Fisherman

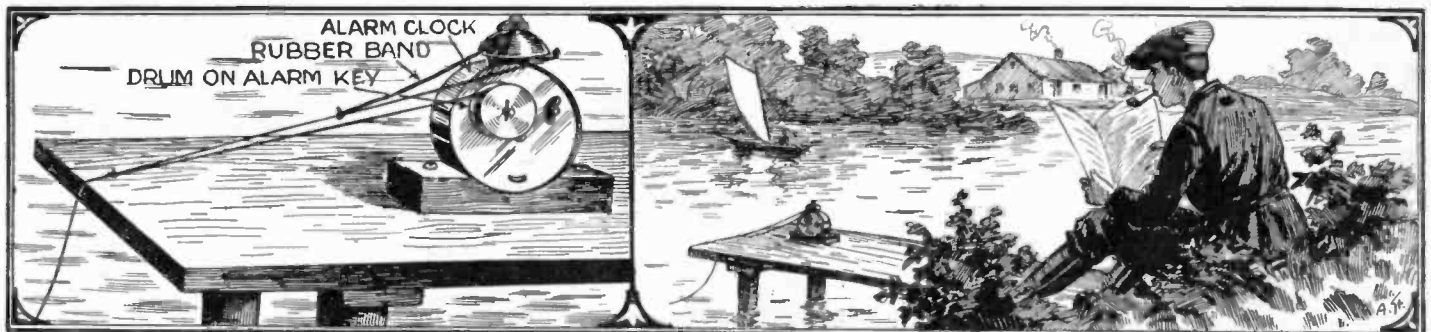

An alarm clock securely fastened to a base makes an automatic fisherman that will "play" a fish until the owner desires to pull it in. The clock is set to ring, but the stop is set so that it cannot do so. A small drum is placed on the alarm key and the fish line fastened to it. A second string

is knotted to the line and fastened to the alarm release. A rubber band helps to take up the shock when the fish bites. A fish pulling on the line releases the alarm and the spring "plays" the fish. Some fishermen would prefer to do the playing themselves. —Jacob Schmidt.

# Teaching Swimming on Land

A novel mechanical swimming instructor has recently been made by a Mr. Farmer of England and is illustrated in operation at the extreme right.

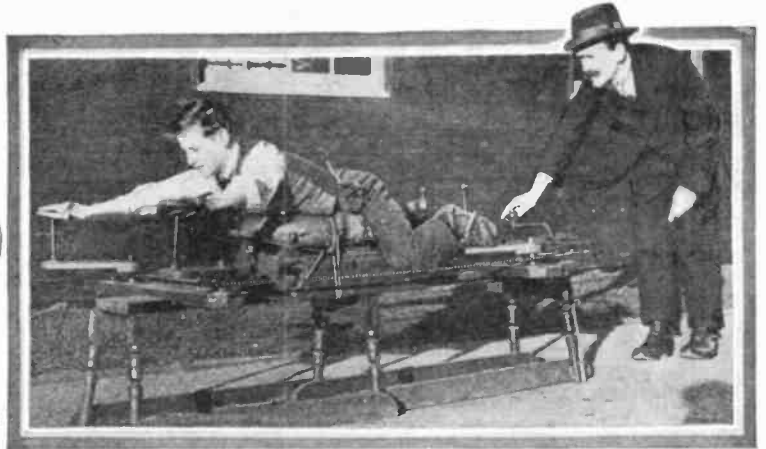
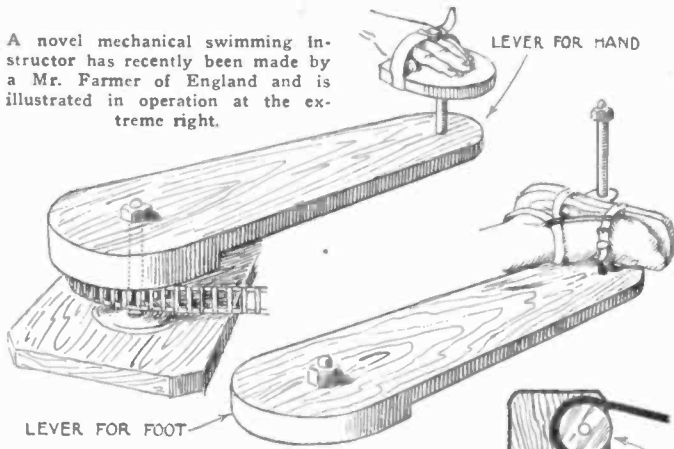

Mr. Farmer's device operates upon the following principle. The student lies prone on a cushion to which he is strapped as shown. The hands and feet are fastened in their respective positions whereupon the instructor turns the crank located at the rear of the machine causing the arms and legs of the pupil to go through the motions of swimming. These motions are produced as shown in our illustrations herewith. Bolted to each of the levers for the hands and feet is a gear around which passes an endless chain. This chain is moved by means of a gear attached to the handle. When the handle is rotated, the arms of the machine also rotate, causing the student's hands and feet to imitate the motions of swimming.

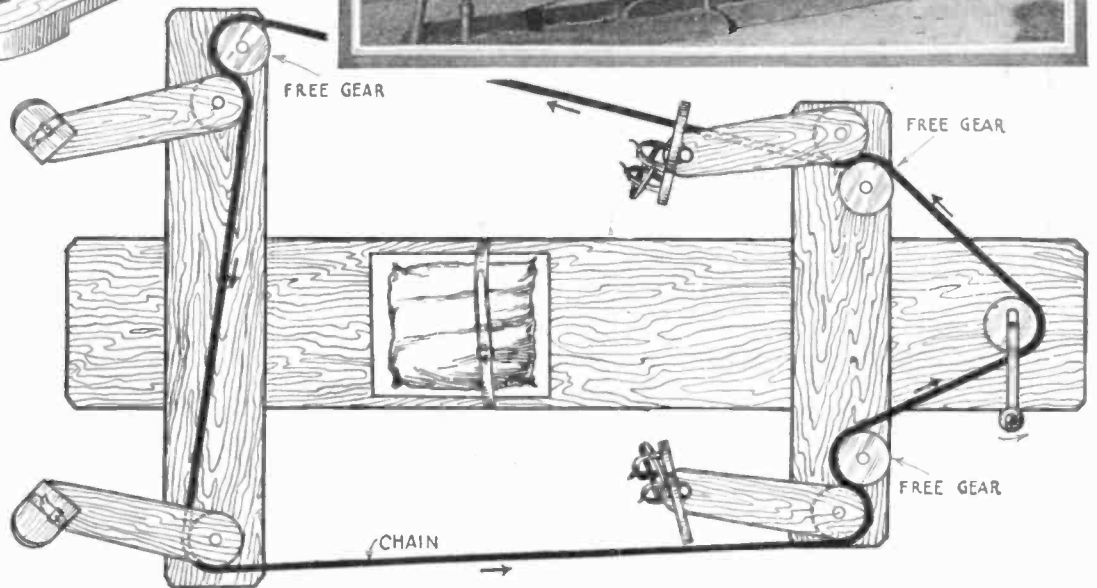

# Lights For the Photographer

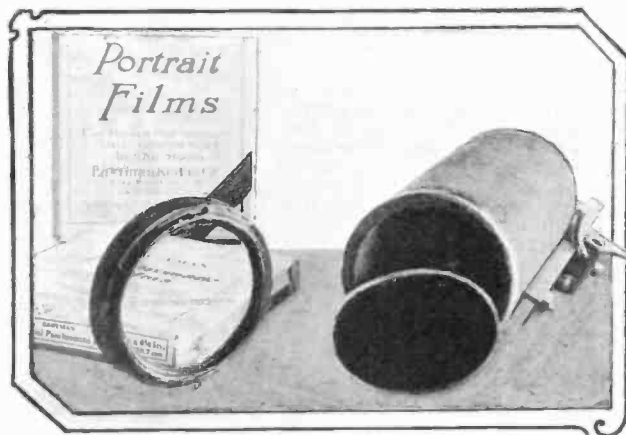
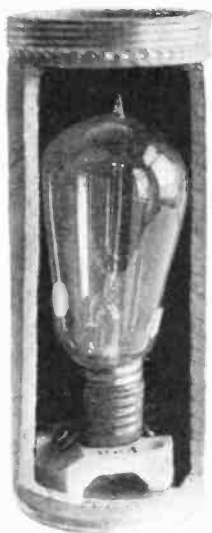

The materials needed for a dark-room safe light are an 8-ounce cardboard mailing tube, a socket, a 10-watt lamp and a standard "safe-light" glass such as may be purchased at any photographic supply store.

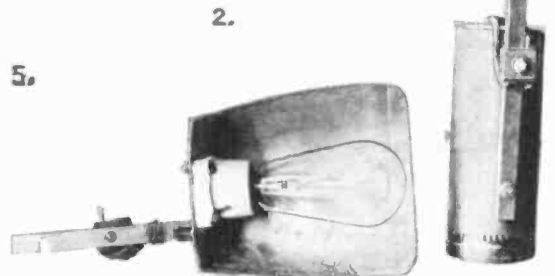

Above: Work lamp with half tin can as reflector.

A socket and lamp are mounted within the tube as shown above and a suitable clamp made such as the one shown at the right for holding the safe-light in position. The center is cut out of the tin cap of the mailing tube and a felt washer glued on the rim. Another felt washer is glued to the open end of the cardboard tube, the red glass disk placed thereon and the cover screwed into position.

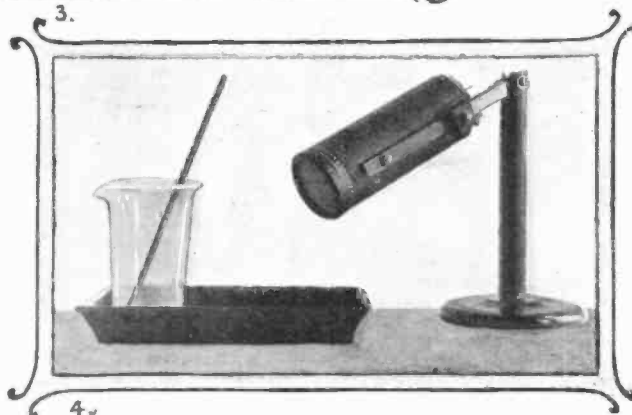

Above: A work lamp clamped to the same standard as used for the safe-light. — Herbert E. Hayden.



# HOW TO MAKE IT

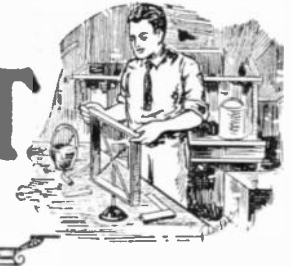

## Preventing Steaming



Roll a narrow strip of flannel into a ball, drop a few drops of glycerine thereon and apply to a glass surface. Spread the glycerine over the surface smoothly. This will prevent the steaming of windows or eye glasses in winter and also makes a good application to prevent water from collecting on the automobile windshield. —C. A. Oldroyd.

## Door Catch

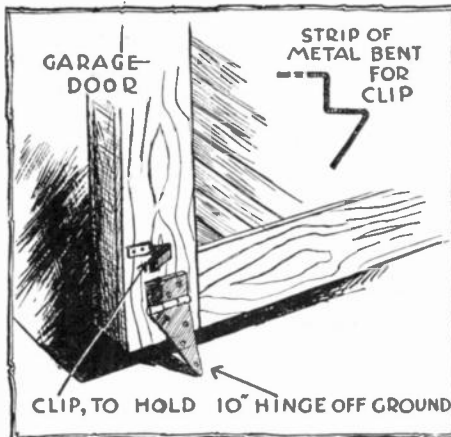

A 10-inch hinge screwed to the lower part of a garage door makes an excellent catch for holding that door open. The point of the hinge digs into the ground. It is of course placed on the inside surface of the door. A clip holds the hinge off the ground when not in use. —Robert J. Williams.

## Rubber Washers

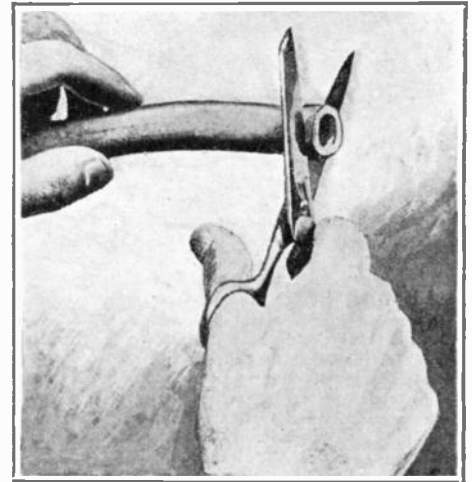

Small rubber washers for various purposes can be obtained by cutting pieces off the end of a rubber hose of the correct diameter. The process is illustrated above. These washers have various uses in the experimenter's laboratory and often are hard to obtain in the correct length and diameter. By this method the length can be any desired. (Author send address.)

## Auto Aid

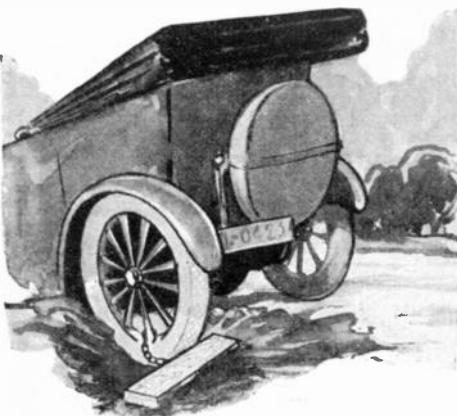

The device illustrated below is shown in use above. The hook engages with a spoke in the wheel and by putting the automobile gear in reverse and engaging the clutch slowly, a car can be pulled out of a bad mud hole.

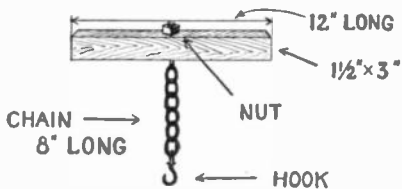

The details of this "mud hook" are shown directly above. Any block of wood may be used. A chain and hook are attached as shown. It is a wise precaution to carry a device of this nature in the car at all times as one never knows when it may come in handy. —George E. Griffin.

## Starting Switch

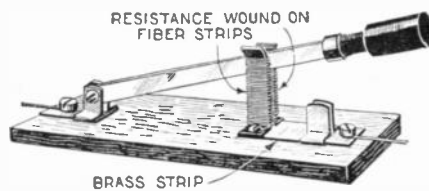

A starting switch for small motors may be easily made by winding a few feet of resistance wire on two fibre strips as shown. The lower ends of the windings are connected to the brass strip. As the switch is slowly closed, resistance is gradually cut out of the circuit until finally the blade touches the jaw and the motor attains full speed. —Thomas McCartie.

## Advertising Device

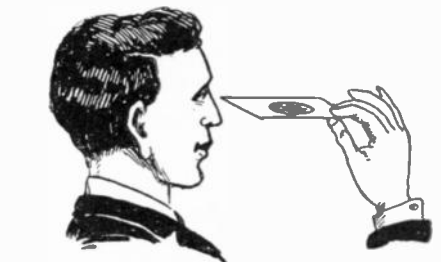
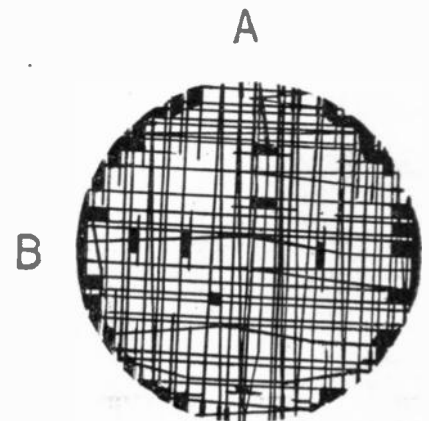

The above illustration shows a method of advertising. The lines on the circular figure are unintelligible when viewed in the ordinary manner, but if held in an edgewise position as shown, words become visible. By turning the top 90 degrees to the left, another phrase can be seen. By exercising a little ingenuity in the combination of words and phrases, other designs may be made. —J. E. Peterson.

## Stirring Rods

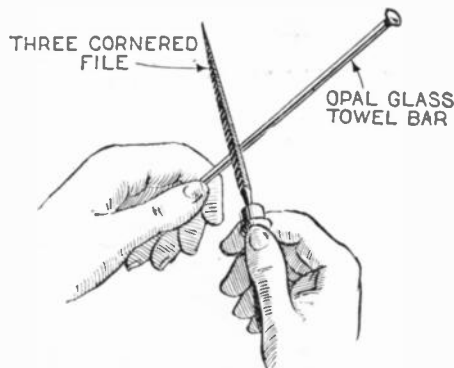

Stirring rods for photographic purposes may be made by cutting a glass towel rod in half. This may be quickly and easily accomplished by scratching the glass with a three-cornered file and then breaking at that point. Smooth the ends off with a file or emery paper. —L. M. Holden.

EVOLUTION AGAIN

Editor, SCIENCE AND INVENTION:

I am an old friend of your excellent magazine having read it from the time of the ELECTRICAL EXPERIMENTER. I especially approve of your "Readers Forum" and consider it one of the most commendable departments of your journal. I always keep SCIENCE AND INVENTION on file as it certainly does help me out of tight pinches quite frequently, for I am of argumentative temperament.

I read Mr. Riordan's opinion of evolution. I have always fostered Evolution and consider his attack very irrational.

"In the first place," as Mr. Meeker points out, "Mr. Riordan does not understand Evolution. That is obvious from the way he writes." Now, there is just a possibility that those who accuse others of having gone beyond reason may have done so themselves—or never have arrived at that place yet. If simple statements make truth, we ought to believe the "Arabian Nights," as all we see there are simple statements. Why, all we have there are magical words and Genii! When a man of that time wished to go anywhere, he need only jump on a carpet and mumble some incoherent, meaningless jargon and he will arrive at his wished-for destination almost instantaneously! Very simple statements! Amazingly simple! An "age of Miracles" undoubtedly!

Mr. Riordan would have us believe that the all-powerful fat went forth, "Abra-cadabra-dum(b)-dum(b)-dum(b)", which means in our English tongue "Let there be light!"

Mr. Riordan accuses Evolution of being "a far-fetched, unprovable theory." While, according to him, the Biblical "simple" story, "a perfectly simple and plausible explanation." I most heartily agree with him about the "simple" part of it. I maintain the Jews were at the childhood of the human race (so to speak) and their explanation accordingly child-like as well as possessing the merit (?) of "simplicity" combined with reason. As stated above, Mr. Riordan asserts that Evolution is unprovable. I wonder: has he ever read Darwin or Ernst Haeckel or both? Perhaps their writings are too complex to be reasonable, hence the theory put forth by one, and maintained by the other, is also unreasonable and "far-fetched." At any rate, I, for one, am ready to prove the truth of Evolution to him as soon as he will prove the truth of the Biblical tale which he considers so reasonable and simple. I believe the Biblical account is not half so probable or possible as the old Chaldean hypothesis if "simplicity" is to be considered the judge of reasonableness.

I would suggest it would be well for these Evolution-and-man-made hypotheses-knockers to read the writings of the above mentioned disciples of Evolution, then read somewhat of the Moulton-Chamberlin Planetesimal Hypothesis, compare it with the Biblical version and decide which are the more rational. And in the meantime, compare the two classes of people putting these theories forth (the present, exact age and the age when "Pi" was considered as ".3.")



SCIENCE AND INVENTION desires to hear from its readers. It solicits comments of general scientific interest, and will appreciate opinions on science subjects. The arguments pro and con will be aired on this page. This magazine also relishes criticisms, and will present them in both palatable and unpalatable forms. So if you have anything to say, this is the place to say it. Please limit your letters to 500 words and address your letters to Editor—The Readers Forum, c/o Science and Invention Magazine, 53 Park Place, New York City.

"Damnant quod non intelligunt."

GEORGE BRETT,  
Pullman, Wash.

(Now, maybe Mr. Riordan will have something to project into the controversy. Go to it boys!—EDITOR.)

CRIME, HEREDITY AND EXECUTIONS

Editor, SCIENCE AND INVENTION:

In reading over the different articles in your different magazines, I have come to the conclusion that you must have authorities on practically every subject at your service. Please refer this letter to the person who is best fitted to answer these questions: Is crime a disease? Is it inherited? Do you think that executions have any effect on the minds of those criminally inclined?

IVAN D. DAWSON,  
Brillion, Wis.

(Your first question as to whether or not crime is a disease cannot be answered as put. Crime itself is a specific act and may or may not be the effect of a diseased mind. More often the making of a criminal is due to environment and conditions. Most of those incarcerated in state institutions either accuse their companions, their parents, or temporary conditions for their predicaments. Occasionally we come across a kleptomaniac who will steal because he "simply cannot help it," or a pyromaniac will burn houses for the "pleasure" he derives from seeing buildings burn, watching the engines rush to the scenes of the fires and even listening to the cries for help from those trapped in the burning buildings. In these cases the tendency toward the criminal act can be attributed to faulty mentality or natural perversion. Even crimes of greater degree may be caused by perverted individuals, but such cases are relegated rather to the asylum than to the criminal courts for ultimate determination.

It may not seem to be true, but one frequently finds that the newspapers are largely responsible for crime waves by playing up the crime in scare heads. One reads of a bank robber who so easily broke into some bank and leisurely walked out with a million dollars. A few days later the action will be duplicated in another city in a slightly different manner and again played up by the papers. The desire for speedy money becomes great and some newspaper reader will take the chance and thus start on a criminal career. Association with characters having criminal tendencies invariably produces crime. Rarely a criminal will steal because he needs the money, and it is to be regretted that those who do this often get greater sentences than those who steal vast sums by bucket shop methods.

Tendency toward crime is not ordinarily hereditary; some of our lawyers attempt to show that mitigating circumstances are present in "wealthy" criminals, and expose the entire history of the lives of both parents, and lay particular stress on any perversity which may have been present in the lives of the parents and introduce this into the discussion. In this way the attorney may cause the jury to act more leniently toward the criminal. Insane parents may have children similarly afflicted, but this condition need not necessarily follow, although Dr. Kraft von Ebing reports in his book "Psychopathia Sexualis" thousands of cases in which heredity played an important part. Likewise in the very excellent work of Prof. Eugene Bleuler called "The Text Book of Psychiatry," heredity is considered as a germinal predisposition. This eminent authority states that, "it was always known that mental diseases converge in one family and lack in another, and that in the families with mental diseases the members that are not really diseased very frequently show certain deviations which often run in the direction of the disease. To be sure, those families are rare which on careful search prove entirely free, and the cases with only a few diseased members are always the more common."

The third question is difficult to answer, because it is not put clearly. If we execute a man with a criminal mind, then an execution cannot have any more effect on that individual, and neither can he use his mind. Whether such execution actually prevents any other criminals from performing similar acts is a question which must remain open for the time being. The percentage of crime per capita

is greater in America than in any other country. In some states where execution is not permitted, the crime wave is low and in others it is high. In some states where execution is required by law, there is a great deal of crime, and in adjoining states where execution is likewise required, it is low. Italy, for instance, does not execute her criminals; England does, and does so rapidly. The percentage of crime is low in both countries. It seems that the law here is too lenient and too slow.

All the questions which you have brought up, and particularly the last one, are interesting and may be made subjects of debates at high schools or colleges.—EDITOR.)

HATS OFF TO SCIENCE AND INVENTION

Editor, SCIENCE AND INVENTION:

I have read SCIENCE AND INVENTION since its infancy, when it started out as the original EXPERIMENTER, and I have a bound file up to three years ago and all the loose copies since, and I can always find "two bits" when the new one comes out. While at times the information is a trifle meagre on some one subject, I more than appreciate the boiling down policy of SCIENCE AND INVENTION of not having to wade through a whole page of endless, useless words to gain the meaning that can be put into a paragraph, and I think most of the readers do too.

As to contributions, I have sent in probably about a hundred, and have had about ten accepted, and while in one case I was inclined to think that my contribution was a good one, I knew that the bulk of them were wrong somewhere or they would have been accepted. "It's easy to win—it's losing that's hard."

And again as a side line and a hobby I'm a printer, that is, I pick up a small newspaper and build it up and then dispose of it, and I fully appreciate the SCIENCE AND INVENTION editors' job of turning out this publication in this form once a month. If you doubt my word go out in some small country town, buy a run-down weekly newspaper, and try to build up a circulation, and make a real publication of it. That's why the average typesetter grows bald-headed and stoop-shouldered.

Some time ago, probably six or eight months ago, you printed an article on making a lens out of two watch crystals. Our famous inventor, Jules Verne, inspired "Cyrus" and the reporter (in his sequel to 20,000 Leagues Under the Sea) in the Mysterious Island to use this means to produce fire.

"Hi-Tension Pete,"  
Minneapolis, Minn.

(If "Hi-Tension Pete" can win prizes in SCIENCE AND INVENTION's contest, there is no reason why any other individual could not win some of the awards which this publication is paying monthly. One must be patient and not become discouraged at the first or second failure. And above all, one must know and submit the proper material. Hi-Tension Pete did. So can you.)

The Experimenter

has come back! If you are one of the one hundred thousand readers of the old ELECTRICAL EXPERIMENTER, you will no doubt be glad to hear that the EXPERIMENTER is coming back BIGGER AND BETTER THAN EVER. PRACTICAL ELECTRICS has been changed into an entirely new kind of magazine entitled

The Experimenter

In this magazine which has been greatly enlarged in point of contents, illustrations and circulation, you will find the following new departments:

- Experimental Radio
- Experimental Chemistry

There is an entirely new treatment of radio containing experiments only. 90% of the magazine contains pure experiments written by the foremost authorities in their respective fields, also a monthly editorial by the writer.

A fine roto-gravure section is now added to brighten up the magazine. If you want experiments, this is your magazine.

Be sure to reserve a copy from your news-dealer before the issue is sold out. THE EXPERIMENTER will be on sale at all newsstands beginning June 20th, 1925.

Hugo Gernsback  
Editor

Hook-Ups  
via  
Radio

1 to 4; 14 to 16; 17 to 23. No, this is not a code message from a bootlegging story—it's just a part of a "circuitgram," invented by Hugo Gernsback, being broadcast by our new station

WRNY

Watch Newspapers for  
Program Announcements



# WRINKLES

## RECIPES & FORMULAS



Edited by S. Gernsback

### Artificial Frost

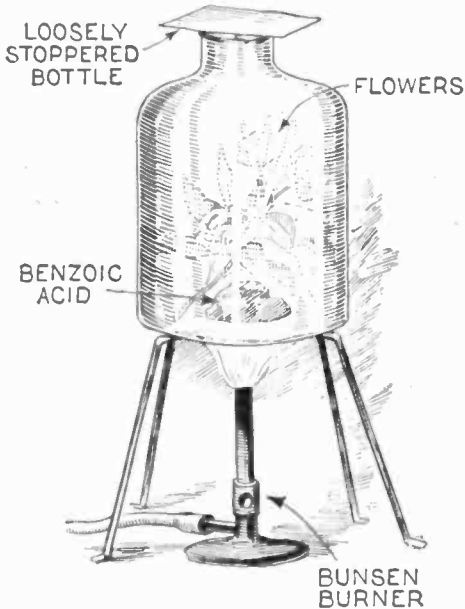

If a few grains of benzoic acid are placed in a loosely stoppered bottle along with some flowers and the container is carefully heated as illustrated, the benzoic acid will sublime and crystallize on the flowers, giving the appearance of hoar frost. Upon cooling, the bottle may be tightly stoppered and used as an ornament. The artificial frost will remain permanently on the flowers.

—Arthur A. Blumenfeld.

### An Ellipsograph

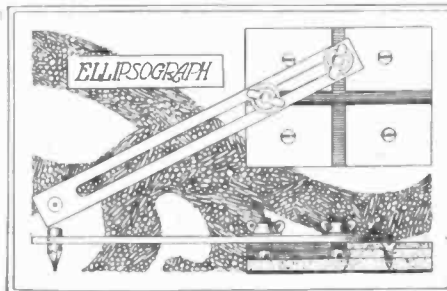

The base of the ellipsograph illustrated above is made of 9 strips of hard wood as shown. The Machine screw heads slide in the "T" slots. The arm is slotted to permit adjustment and carries a pen or pencil at its outer end.

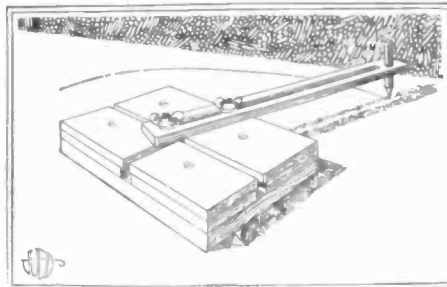

The ellipsograph is shown in action above. The base is covered with felt to prevent damage to drawings.

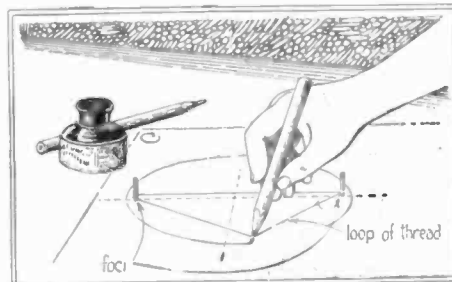

A simpler instrument for drawing ellipses is shown above. A phonograph needle is placed at each focus and a loop of thread placed around them so that it forms a triangle between the foci and a point on the periphery of the ellipse to be drawn. Move the pencil around as shown, keeping the loop taut.

—P. A. Judd.

### Draftsman's Aid

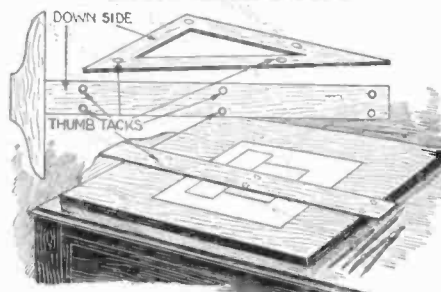

Thumb tacks placed in the sides of drawing instruments which make contact with the board aid them in sliding over the work. In the case of celluloid triangles, the thumb tack may extend through whereupon the point is riveted or clinched.

—G. A. Luers.

### Cell Protector

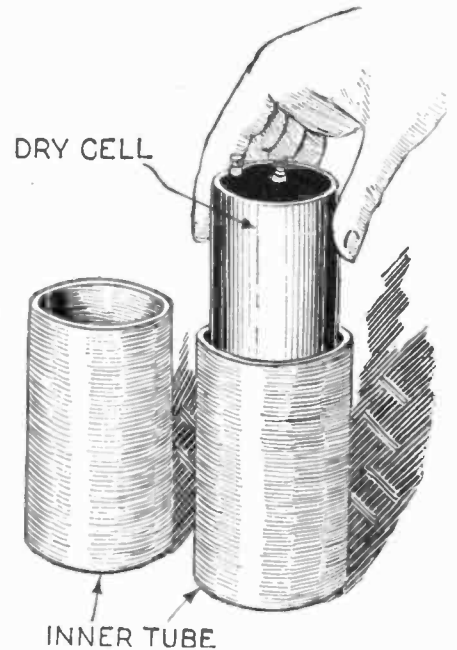

After a few weeks' use, the paper covers of dry cells are usually tattered and torn, exposing the zinc and sometimes causing short-circuits. A section of inner tube makes a good cover for dry cells. Remove all the paper or cardboard shell and slip the inner tube section over the cell as shown above.

—Arthur A. Blumenfeld.

### Emptying Bottles

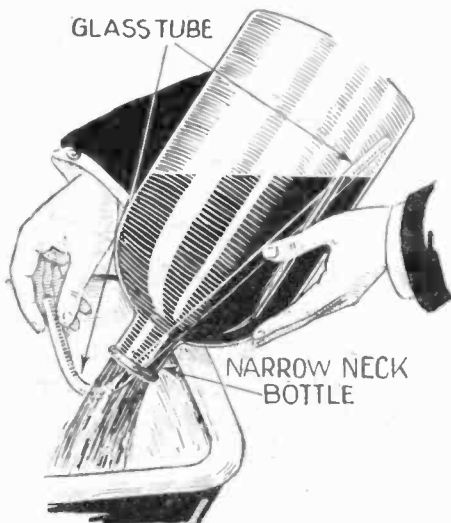

When cleaning narrow mouth bottles, they have to be filled and emptied several times and it is always noticed that emptying them is a lengthy process. This is because of the difficulty which the outside air finds in entering the bottle to replace the space from which the fluid is removed. The emptying process may be hastened considerably by making use of a glass tube as illustrated above. This tube allows air to enter the bottle quickly.

—C. A. Oldroyd.

### Preserving Stamp Pads



When your stamp pad dries out it does so because the liquid ingredient of the ink has evaporated and left only the basic material of the pad impregnated with the coloring matter. This, of course, is so hard that a rubber stamp cannot be coated with ink therefrom. As most rubber stamp ink pads have a large water content, the dried out pad may often be rejuvenated and brought back to its original usefulness by moistening the surface with a few drops of water.

—Philippe A. Judd.





# RADIO

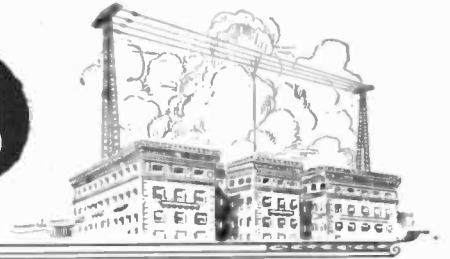

## Photos Sent 5,000 Miles

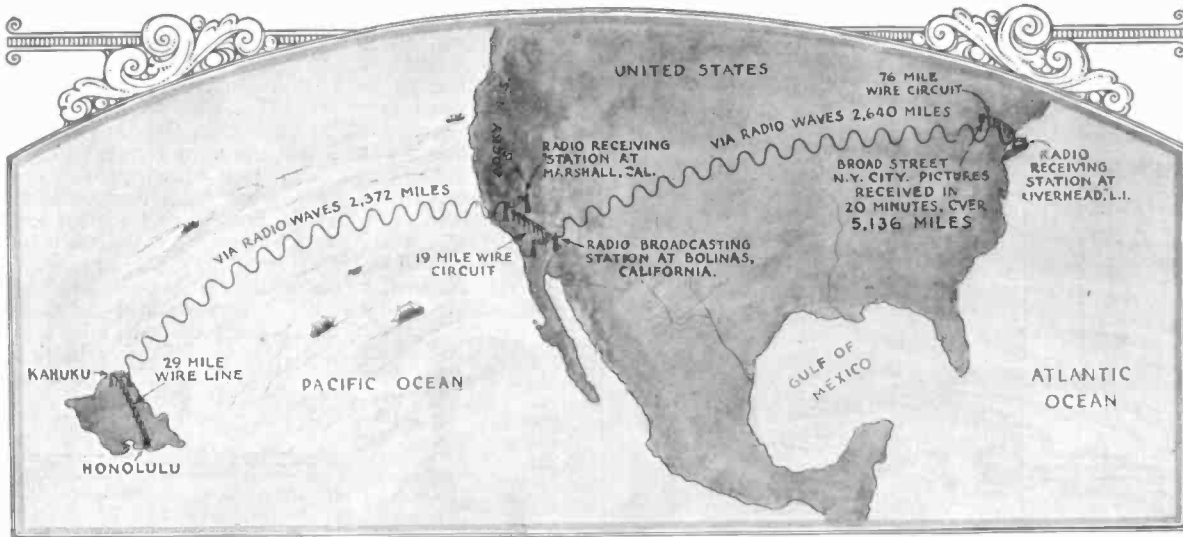

IN a recent most successful test which marks the passing of another milestone in radio history, several photos were transmitted from Honolulu, Hawaii, to New York City by radio with the aid of three short telegraph lines. The photos originating out in the far off Pacific Ocean were quite faithfully reproduced in New York City as is shown by their reproduction below. Our map at the right shows the distances over which the radio waves traveled and the chart directly below the map indicates the various changes that the photos or rather their equivalents in light, electricity and radio went through during the journey.

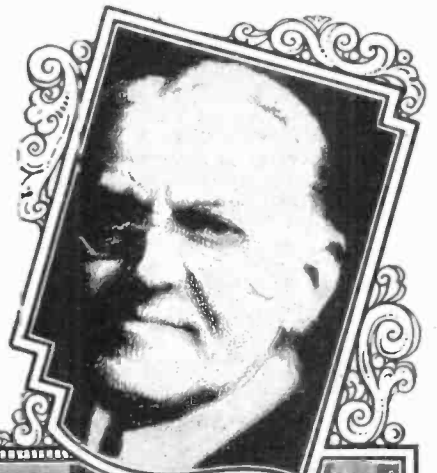
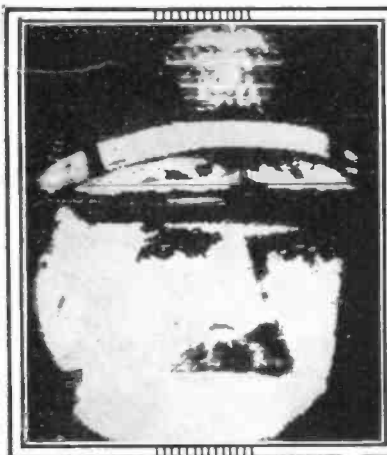
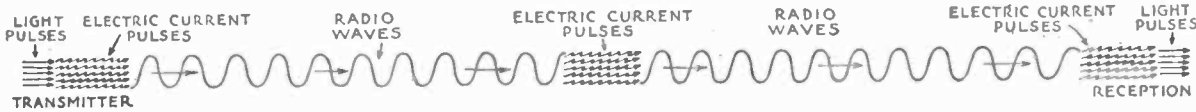

The photos at the left, right and lower left are faithful unretouched reproductions of those transmitted via radio and land line from Honolulu to New York. When the pictures are held at arm's length or a little further, they become very clear and distinct.

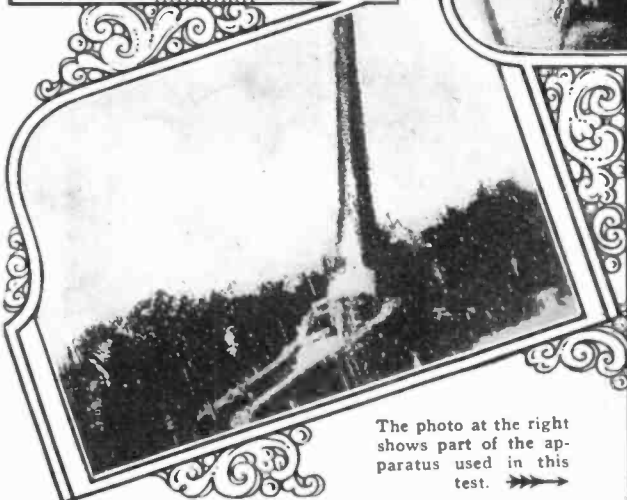

The photo at the right shows part of the apparatus used in this test.

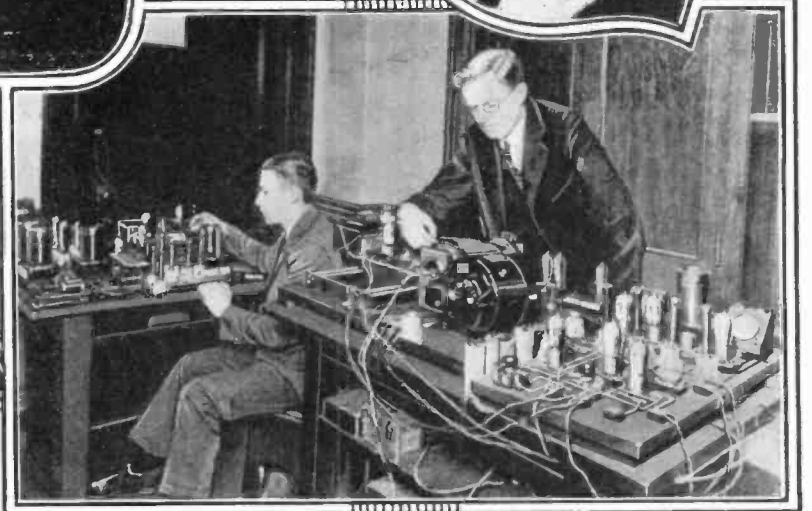

# WRNY—Radio

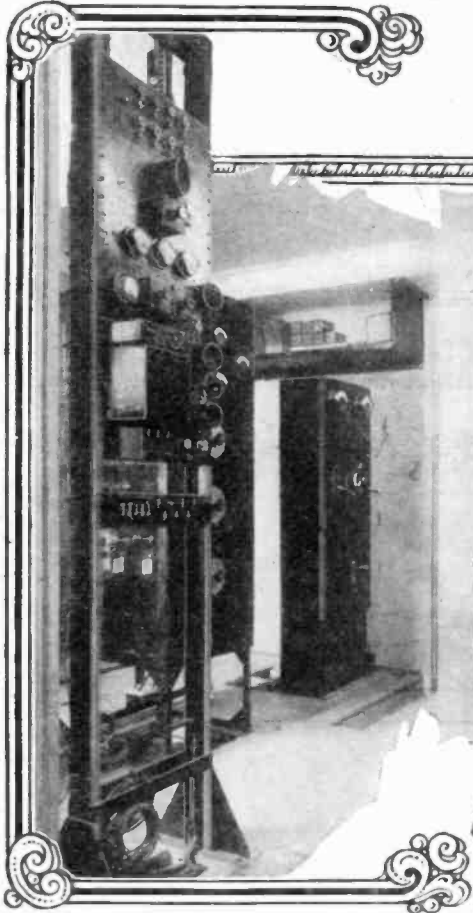

WRNY's control room under construction. In the foreground is the partially completed speech input system, in the middle the main transmitter panel, and on the right is the power control panel. Note the false flooring which covers all conduits inter-connecting the panels and the special grounding system used throughout the room. Upon completion of all wiring, this floor will be entirely finished and all wires hidden.



The foresight of Hugo Gernsback, editor-in-chief of this magazine and RADIO NEWS, is responsible for the short wave-length, 258.5 meters, which has been assigned to that station. In Mr. Gernsback's opinion, and that opinion is based on sound facts and reasoning, the short waves are the coming thing in radio broadcasting. As the wave-lengths become less, the frequency of the emitted wave increases and tuning becomes more selective. Therefore, even though a reduction in wave-length will mean certain changes in the present day standardized types of receiving sets, still when these changes have been made and the broadcasting stations are all operating on lower wave-lengths, the public will be far better off than they are today. As confirmation of these statements, one has only to listen in on some of the short broadcasting being carried on by station KDKA today. Tuning in this station on about 62 meters, one finds the tuning infinitely sharp.

The photographs on this and the opposite page show some of the constructional features of station WRNY. The station at the time of writing is not as yet in operation, and we therefore seized upon the chance to present to our readers some of the methods used in construction of a broadcasting station and also some of the new features incorporated in WRNY, which would not be so obvious after the station is completed, with most of these fine details hidden from sight. A noticeable feature is the absence of visible wiring between the panels of the transmitters. All this wiring is hidden under the floor. Another great feature and one which should interest every listener is the automatic control illustrated in the lower right-hand corner of this page. From this point, the announcer, shown testing the apparatus, can turn off the entire equipment from the air momentarily when necessary.

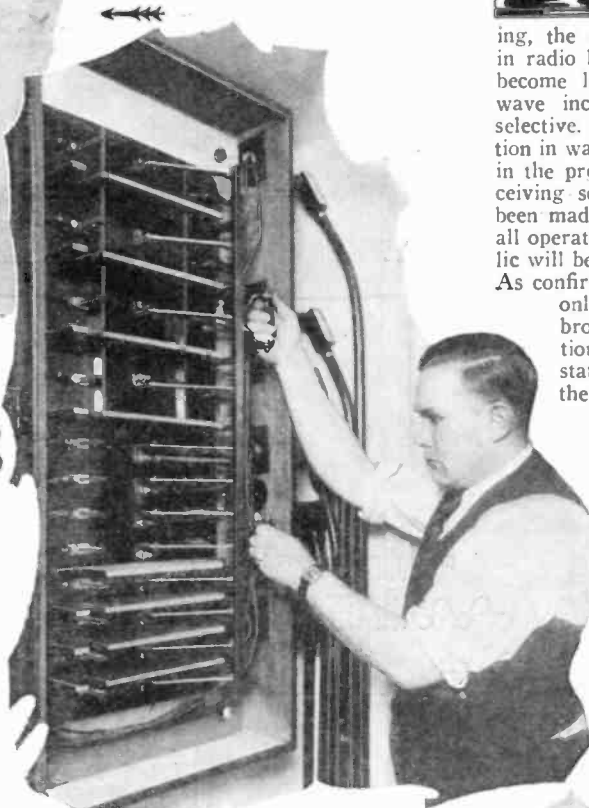

Below is shown the automatic control used by the announcer of WRNY, which enables him to cut the station off the air at any moment desired. Thus stage talk and other extraneous noises will not be transmitted. Note sound-proof door between studio and apparatus room.

WRNY is equipped with duplicate power plants supplying all the power for the transmitters. Continuity of service is assured for if one power plant goes wrong or is in need of repairs, the operator can immediately switch to the other plant by merely throwing the switch illustrated above. Chief Operator, Novy, is operating this switch.

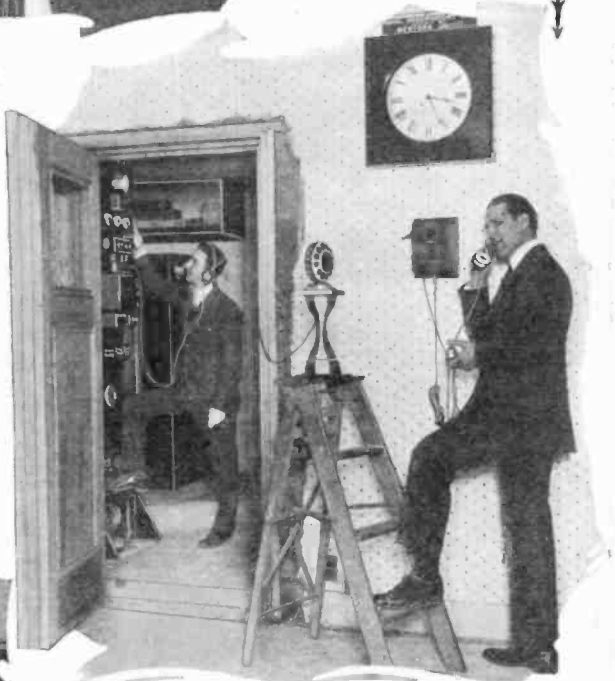

The heart of WRNY is shown at the left. Four large 250 watt vacuum tubes provide the power for putting this station over with a big "kick." Note the size of tubes as compared with the small receiving tube placed between them.

# News, N. Y.

A VIEW of WRNY in construction. At left of photo is shown the partially installed speech input equipment, while at the right appears a front view of the main transmitter panel. In the background Mr. E. W. Novy, chief operator, may be seen making some preliminary tests. Note the lightning switch overhead and the Western Union clock, which will insure the correct time being given at all times from WRNY. In this room there will be operators in constant attendance on the apparatus at all times during broadcasting. There will be men to watch the various instruments and see that everything is going along as it should. Then there will also be a relay of men listening in on the wave-lengths used by ships at sea, in order to intercept any SOS messages, calling for cessation of broadcasting.

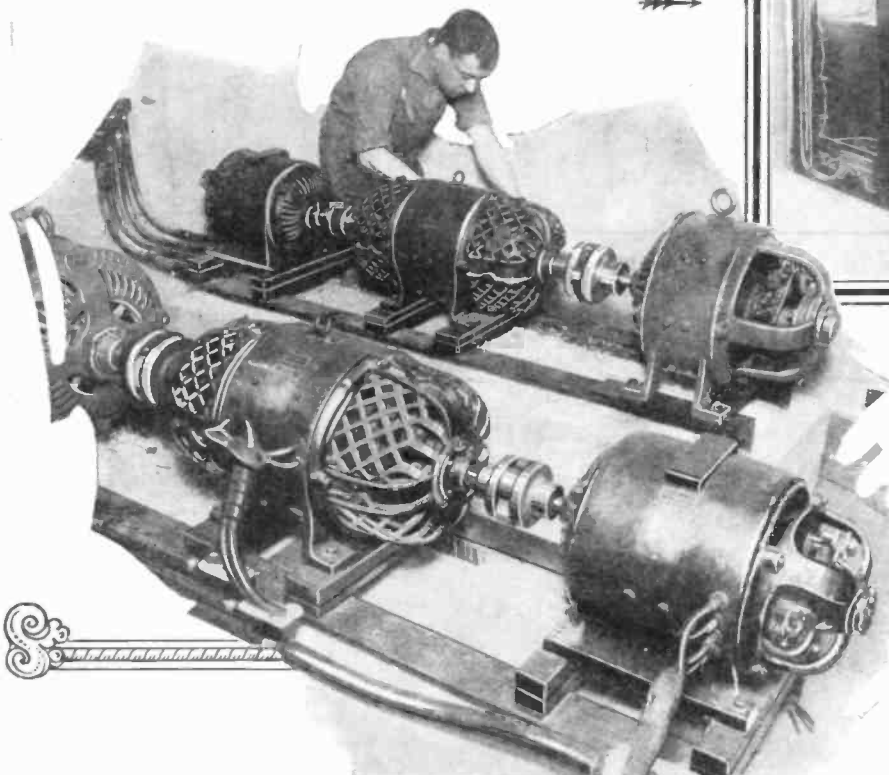

These two sets of motor-generators supply for WRNY 2,000 volts available for plate current, and 18 volts at 30 amperes for filament current for the operation of the powerful transmitter located two floors below. Note the rigid construction for the foundations of these units, which was made possible by their being in a specially constructed sound-proof room and remotely controlled from the main transmitter room. These two sets of motor-generators are connected to the large switch shown in the center of the opposite page, each unit being connected to one set of switch jaws. The blades of the switch are connected to the transmitting apparatus, and in this way the motor-generator to be used can be selected by the operator from the transmitter room.

Hail, Hail, the Gang's all here. This is the male population of WRNY celebrating the first successful test transmission from their station. Reading from right to left: Mr. David Reed, Director of Programs, and famed as the author of "Love Me and the World Is Mine"; E. W. Novy, chief operator and former chief operator of station WSUI, State University of Iowa, Iowa City, Iowa; Wm. DeMello, former chief operator at station WMAF, Round Hills Radio Corp., at South Dartmouth, Mass.; Gilson V. Willets, Manager, formerly director of station WOS, Jefferson City, Mo., and later operator and announcer at station WOC, Davenport, Iowa; James Maresca, former supervisor of the big trans-Atlantic station at Chatham, Mass. It is interesting to note that these four members of the engineering staff of WRNY have a total commercial radio experience of thirty-nine years, which is believed to be more than any other broadcasting station in the country can total for their operating staff. Every operator on the WRNY staff holds a first-class, first-grade, commercial radio license and these four licenses are shown on the wall above the boys. And so, when you listen in to station WRNY, you will know that station is being operated at top notch efficiency.



# "Circuitgrams" via Radio

By HUGO GERNSBACK

**T**HE writer presents herewith somewhat of a novelty, in connection with the broadcast station operated by the owners of this magazine. The new station WRNY, located at the Roosevelt Hotel, New York, and operating on a wavelength of 258.5 meters, will broadcast the new radio circuitgrams once a week, on Mondays at 9 P. M., commencing June 22. This will be a regular weekly feature, which should soon become popular in the radio fraternity.

The writer, who has originated the circuitgram, on which patents are pending, has kept in mind the fact that the radio fans are always on the look-out for the latest radio hook-up. New hook-ups are originated almost every week, and it is the purpose of WRNY to broadcast these the moment they make their appearance.

The method of broadcasting any and all circuitgram hook-ups is extremely simple. The WRNY announcer will first state what sort of hook-up it is, whether it is a regenerative, a reflex, a super-heterodyne circuit, or what not. He will then advise that you use circuitgram blank 1, 2, 3, 4 or 5—whichever is best suited for the occasion.

Suppose the hook-up of a single-tube, tuned radio frequency reflex circuit is to be broadcast. The announcer will then speak as follows:

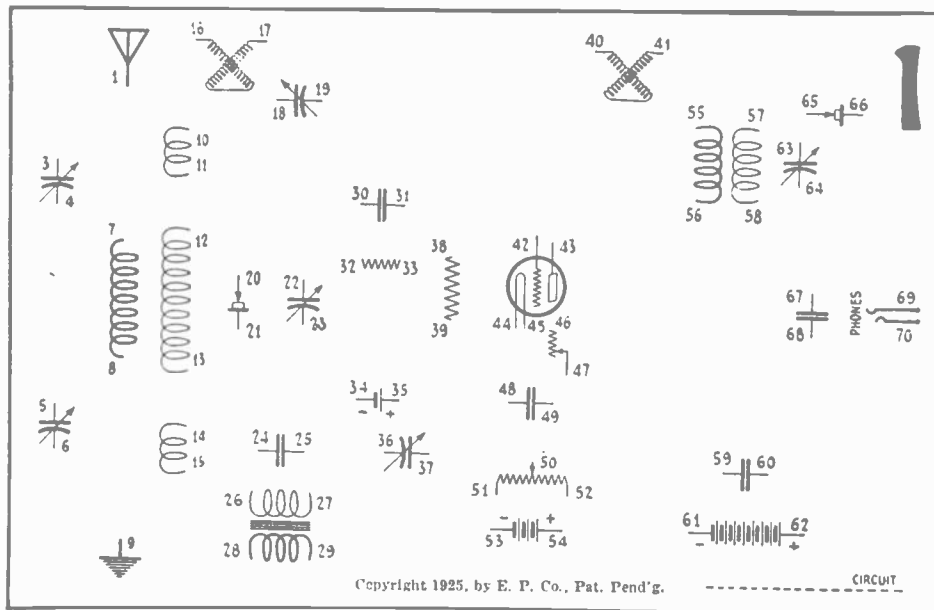

...tion numbers as follows: "Connect 1-7, 8-9, 12-42, 13-23, 22-12, 13-28, 9-29, 8-47, 44-54, 45-46, 47-53, 26-64, 27-66, 43-55, 56-69, 57-63, 63-65, 58-64, 70-62, 61-54."

and make sure that you have copied all numbers correctly.

If any special information is needed, as for instance, in the completed hook-up shown

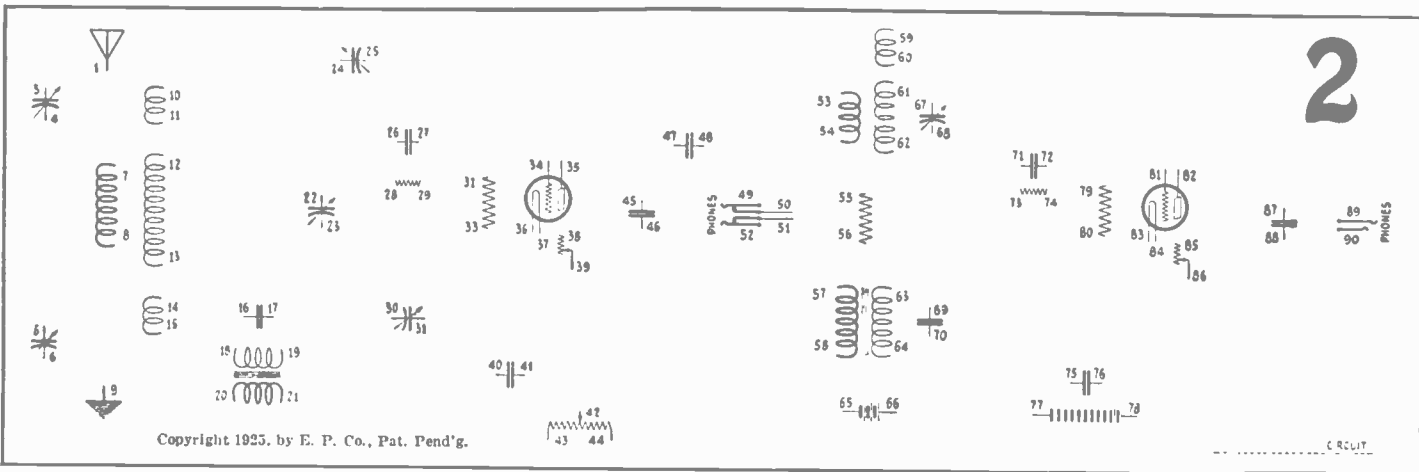

"We shall now broadcast a tuned radio frequency reflex hook-up. Please refer to circuitgram No. 1, single tube."

The announcer will then read off the con-

As he slowly reads these numbers, all you have to do is take them down. After reading off all numbers, the announcer will repeat them, so you can go over your record

in Fig. 6, the announcer will give such information immediately after the numbers have been read. Thus, for instance, he will give the number of turns and size of wire

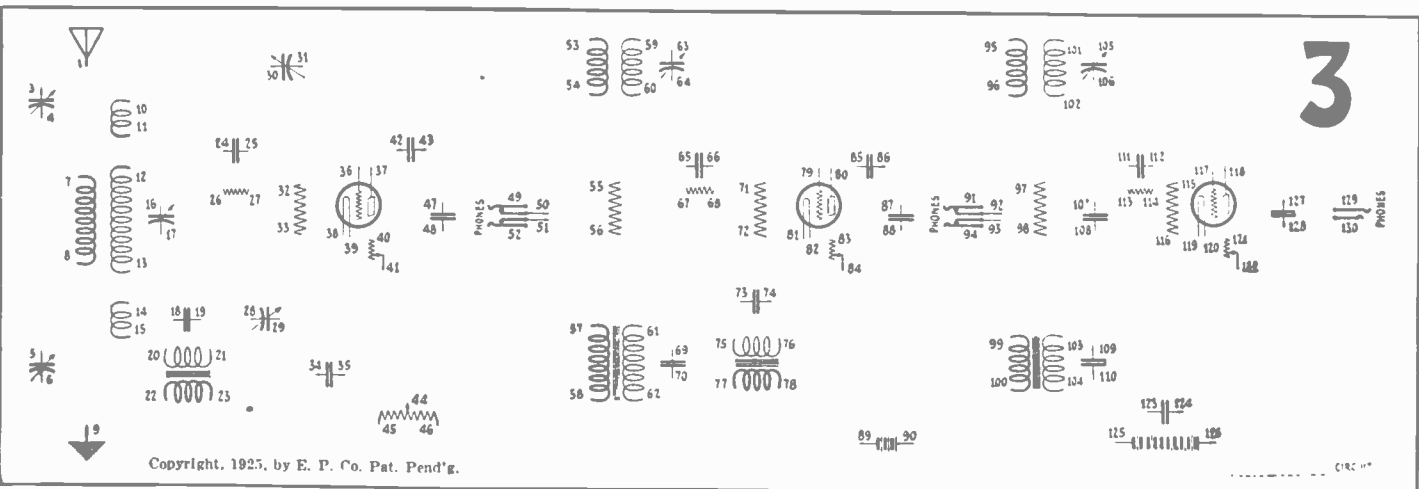

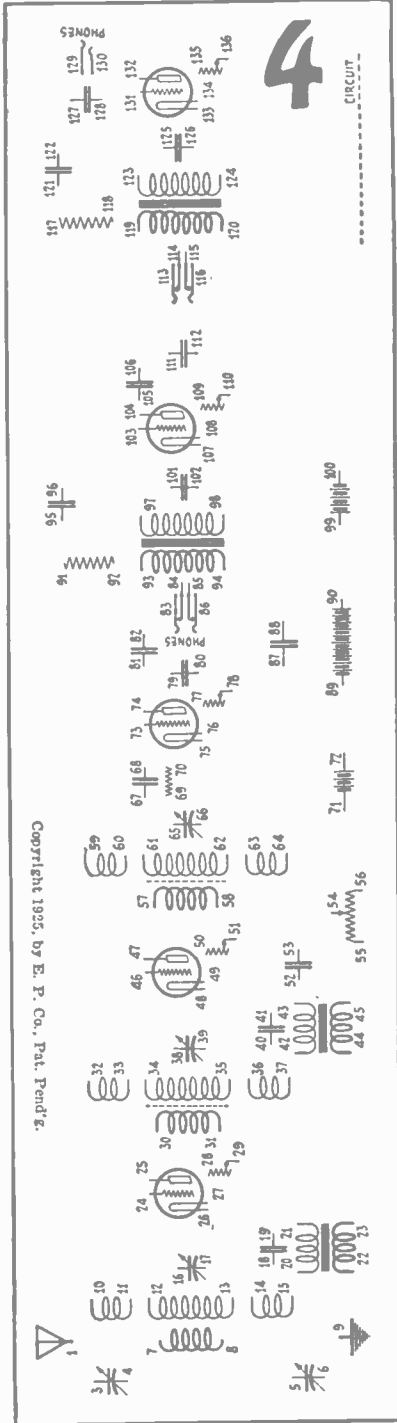

Copyright 1925, by E. P. Co., Pat. Pend'g.

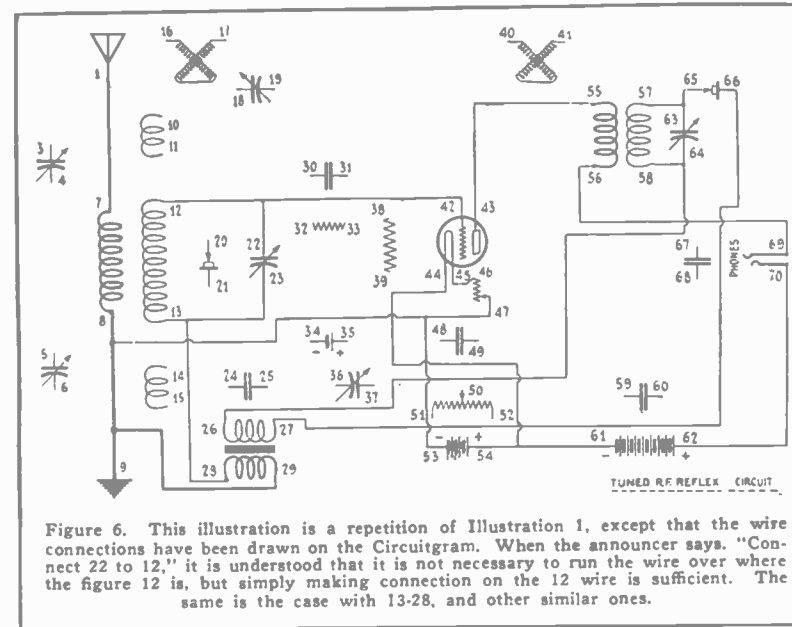

Figure 6. This illustration is a repetition of Illustration 1, except that the wire connections have been drawn on the Circuitgram. When the announcer says, "Connect 22 to 12," it is understood that it is not necessary to run the wire over where the figure 12 is, but simply making connection on the 12 wire is sufficient. The same is the case with 13-28, and other similar ones.

of coils 7-8 and 12-13; the ratio of transformer 26-27, 28-29; what crystal to use in 65-66; and all other necessary information.

And that is all there is to it. After the announcer has finished, all you have to do is take your record with the key numbers and fill in the lines on the circuitgram. You will then have a complete hook-up, as shown in Fig. 6. This is simplicity itself, and provides not only a lot of entertainment, but useful instruction as well.

It will be noted that the blank circuitgrams shown on these pages have been laid out in such a manner that it is possible to broadcast any modern hook-up, no matter what circuit is used.

Thus, for instance, it will be seen that the one-tube hook-up circuitgram provides for any possible circuit that could be used, such as detector, regeneration, reflex, radio frequency or for any combination of these employing a single tube.

As will be noted from illustration No. 6 the instruments that are not used in any particular hook-up are simply left unconnected. For this reason, even though the reader does not listen in to WRNY in order to take advantage of new hook-ups that are being broadcast, he can now draw his own hook-ups on the circuitgrams, without the necessity of first drawing the usual radio symbols.

It is interesting to note that it takes only two minutes to broadcast a hook-up of the type shown in Fig. 6.

The publishers of this magazine have prepared a tablet with blank circuitgram forms similar to those illustrated here, containing a goodly quantity of blanks. They will be furnished at 25c per tablet, sent postpaid.

The author would very much like to hear from our readers as to how they like this new feature, and any suggestions and improvements will be very gratefully received.

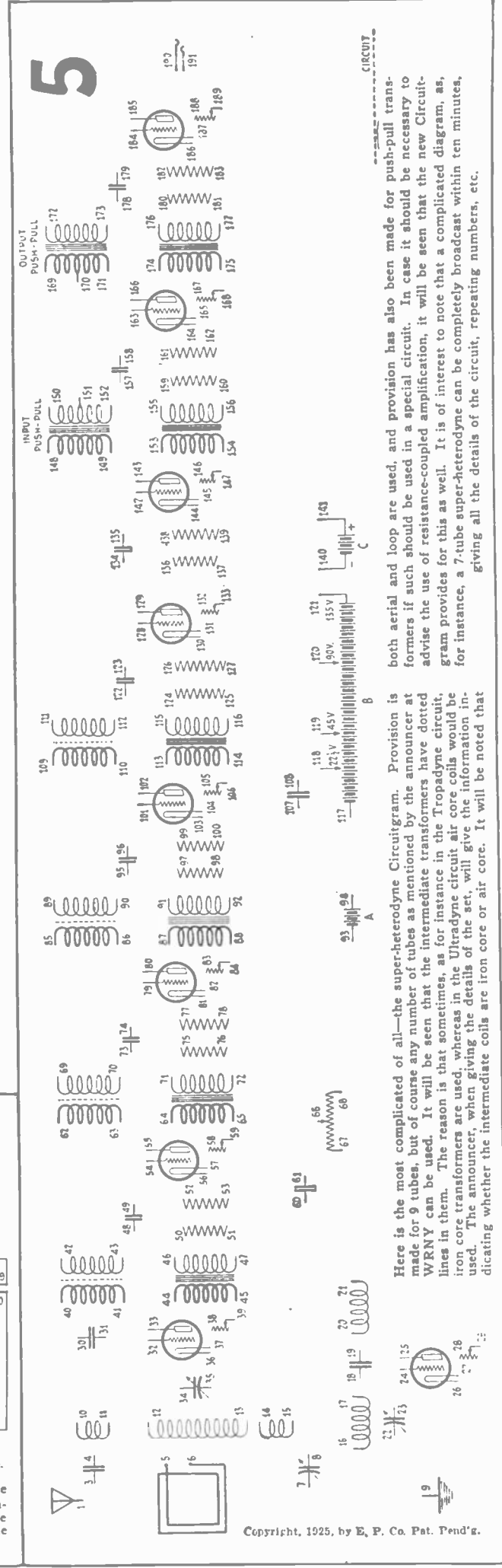

Copyright, 1925, by E. P. Co. Pat. Pend'g.

both aerial and loop are used, and provision has also been made for push-pull transformers if such should be used in a special circuit. In case it should be necessary to advise the use of resistance-coupled amplification, it will be seen that the new Circuitgram provides for this as well. It is of interest to note that a complicated diagram, as, for instance, a 7-tube super-heterodyne can be completely broadcast within ten minutes, giving all the details of the circuit, repeating numbers, etc.

Here is the most complicated of all—the super-heterodyne Circuitgram. Provision is made for 9 tubes, but of course any number of tubes as mentioned by the announcer at WRNY can be used. It will be seen that the intermediate transformers have dotted lines in them. The reason is that sometimes, as for instance in the Tropadyne circuit, iron core transformers are used, whereas in the Ultradyne circuit air core coils would be used. The announcer, when giving the details of the set, will give the information indicating whether the intermediate coils are iron core or air core. It will be noted that

# Three Circuit Tuner—Push-Pull Amplifier

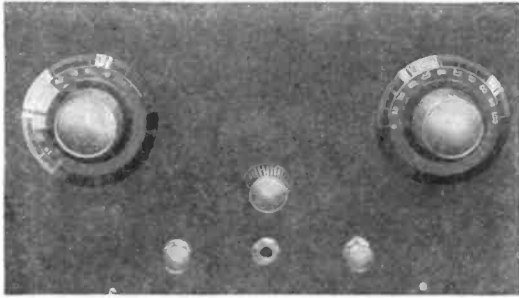

The neat panel layout of this receiving set is shown directly above. Only two controls are used, one for tuning and the other for regeneration. The carbon disk rheostat, the control knob of which is located in the center of the panel directly above the jack may be used to control all four tubes. The switch at the left of the jack controls the filaments and that at the right, the capacity of the two-section variable condenser.

The highly efficient, selective and simple set illustrated on this page can be built by anyone in a very short time. The well known three circuit tuner employing a standard coupler and a good make of low loss condenser is used. The results are all that can be asked for, both as to volume and clarity of the reproduced music and speech. The push-pull amplification feature assures all this. The push-pull transformers may be of any standard make such as those illustrated.

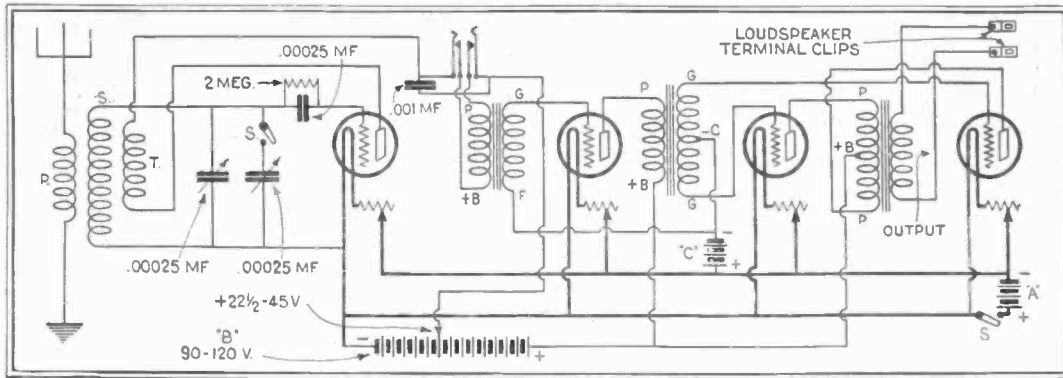
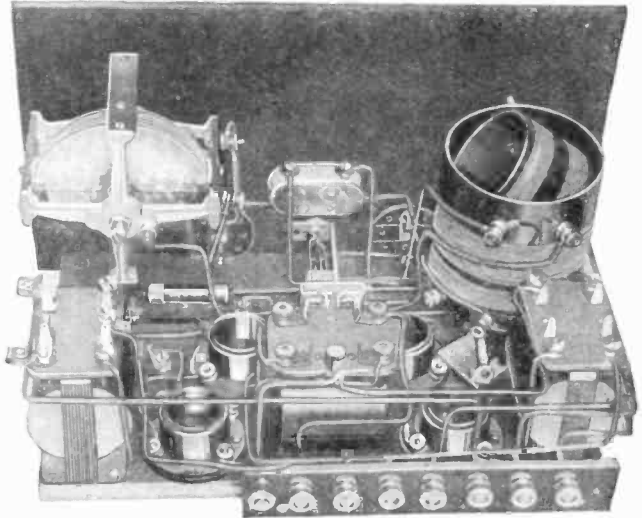

In the circuit diagram shown at the left, four separate rheostats are shown for the four tubes. This is not necessary as was demonstrated by the author in constructing this set, but is a desirable feature when unmatched tubes are employed. With standardized tubes, however, the one rheostat shown in the set above will give quite satisfactory control. For tuning and for "DX" work, the phones may be plugged in the jack and the loud speaker left connected to the clips provided. Removing the plug from the jack automatically connects the rest of the circuit and loud speaker. — Sidney E. Finkelstein, Assoc. I. R. E.

# A Miniature Phonograph Loudspeaker

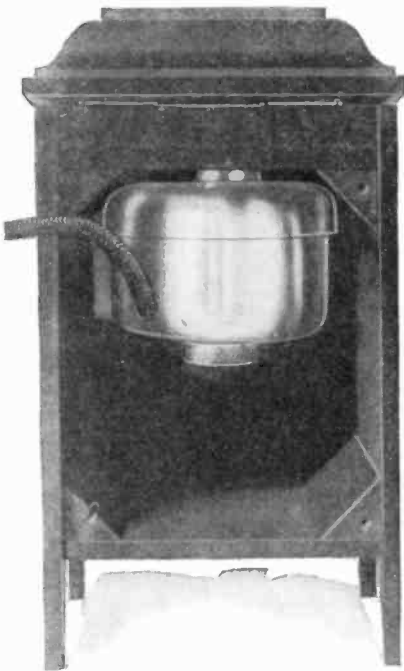

The cabinet is shown with the back panel off. It is seen that the loudspeaker unit is wedged in place and can easily be adjusted. When the loudspeaker is working the top cover is raised and it is surprising to note the quality of the music reproduced. The parts are glued together, after which two or three coats of stain are applied and carefully rubbed in. A wax polish gives the desired finishing touches.

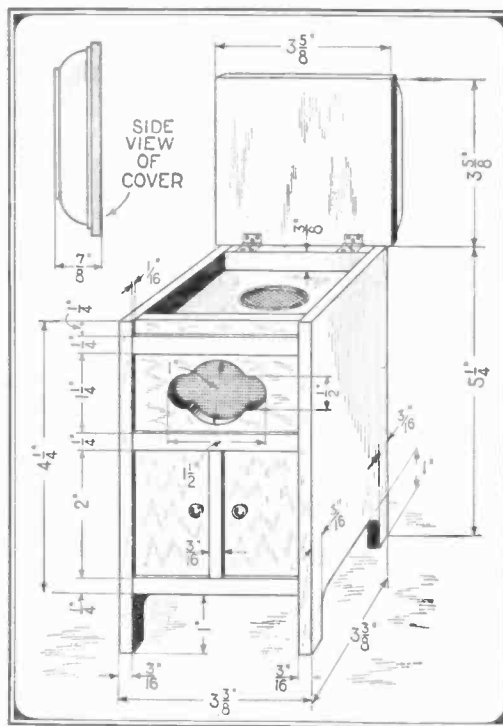

The dimensions of the various parts used in the construction of the speaker are given in the cut above. Note the circular aperture in the top of the cabinet through which the sound issues from the reproducer unit. The unit is simply wedged into place and can be readily adjusted from the rear of the cabinet. The opening in the front is made by drilling a series of holes and covering them with silk cloth.



How many of us have misgivings when we purchase a new loudspeaker and find that it does not present an entirely pleasing appearance in a room! The phonograph, in miniature, is reproduced and gives excellent results when fitted with an adjustable phone unit. Note the comparative size of the cabinet alongside the phone plug. Standing but a little more than six inches high and made in this instance of mahogany, the speaker is both novel and of pleasing appearance. —Leon Adelman.

# Four-Tube Portable

By SIDNEY E. FINKELSTEIN, A.M., I.R.E.

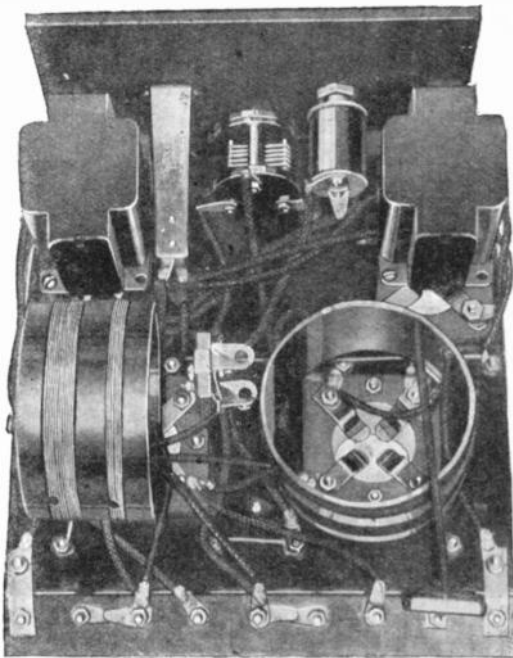

The above photo shows the bottom view of the assembled four-tube portable receiver. Note the compact arrangement of parts. The midget condenser in the center of the front panel serves to equalize the radio frequency and detector circuits. To the right of the condenser is the filament switch and to the left is the jack which is placed in the first stage of audio frequency amplification.

SUMMER is rapidly coming on and people will soon be going out into the open. Some may wish to take a radio set along with them. We have in this article, a fine four-tube receiver which takes up no more space than a hat box. You can use a single wire antenna about 100 feet long and get good ground connection by either driving a stake into the ground, or else a copper or galvanized iron nail into a tree. Fairly good reception may even be had without the use of an antenna. The front panel of the set measures 7½ inches square. This receiver consists of one stage of tuned radio frequency detector, and two stages of audio frequency amplification in a very compact arrangement. The receiver is controlled by a single dial which makes it highly desirable for outdoor use. This feature is made possible by the use of a special condenser of low-loss construction. The condenser tunes the first radio frequency stage and the detector at once. A midget condenser in series with the radio frequency circuit equalizes any change in it from the detector circuit.

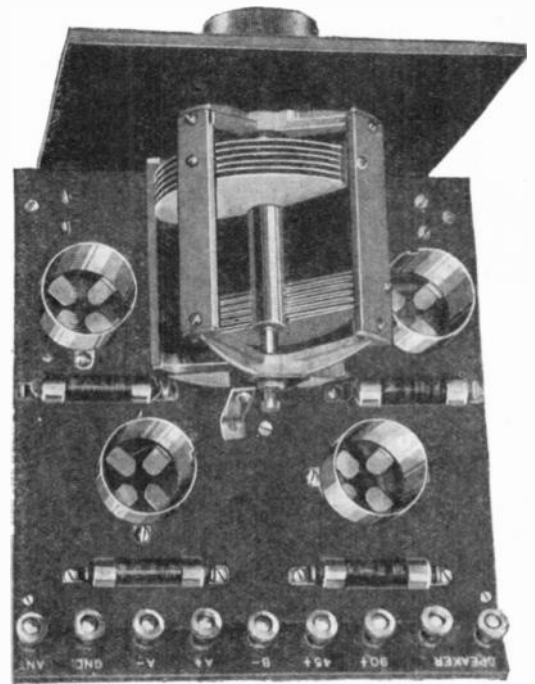

This photo shows the use of the ultra-vario condenser in the circuit. It consists of two rotor sections and two stator sections insulated from each other. In the back of the tube-sockets are seen the automatic filament control resistances, which do away with the use of filament rheostats, thereby simplifying the construction of the set.

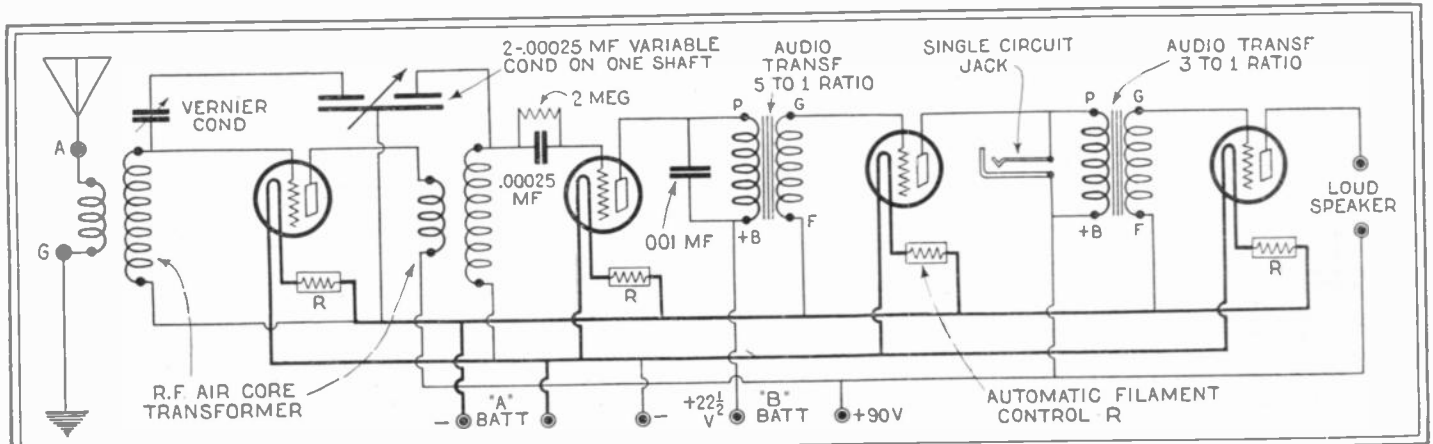

In the circuit used in this four-tube portable receiver, the coils are wound on three-inch diameter tubes. The secondary consists of 60 turns of No. 24 double cotton covered wire and the primary is wound directly over the secondary and consists of ten turns of the same wire.

High ratio transformers may be used because they help to pick up the weak output of the detector. The best of material should be used in the construction of this receiver because of the weakness of the signal. Small batteries can be used because the drain on them is not heavy.

## Latest Short-Wave Radio News

THIRTEEN years ago, when the first bill governing radio amateurs was passed, those wave-lengths below 200 meters were assigned to the amateurs, because at the time these waves were considered useless for wireless communication. The amateurs jumped in with a will and soon showed the Government that some wonderful work could be performed on these short waves, as 200 meters was considered at that time.

Then with the advent of the vacuum tube transmitter for general use, higher frequencies and lower wave-lengths could be employed. The Government thought that it would be a good idea to let the amateur experimenters work with some of the shorter waves and see what they could do.

Recent results on waves between 20 and 85 meters have been astounding. On 80 meters,

trans-continental transmission with the power input of 30 watts on a so-called 5-watt tube has become a nightly affair. On 20 and 40 meters, even greater distances during broad daylight have been covered. Heretofore, before the opening of the 20- and 40-meter bands, daylight was considered as a poor time for transmission. However, with these two bands, 4,000 and 5,000 mile transmission during broad daylight is an accomplished fact. John L. Reinartz, 1XAM, established contact with the west coast during daylight using very low power on 20 meters. Recently, April 19th, station 9XN, conducting experiments on apparatus to be used by the MacMillan Expedition to the North Pole, was heard by J. G. Ritchie, of Glasgow, Scotland, during broad daylight. Mr. Ritchie also stated that he had logged station 9ZT,

Minneapolis, Minn., seven days before.

We have undoubtedly only scratched the surface of the uses of short waves and we may soon expect to hear of even more phenomenal results obtained with these waves at an early future date. The latest short wave band in the neighborhood of three-quarters of a meter will undoubtedly open a vast field of experimental work in the way of directed radio. With this short wave-length the size of the reflector will not be prohibitive, and the ordinary radio room can contain one with ease. Some interesting experimental work along this line has been done by L. D. Grignon, S. M. Hyde and Frank C. Jones at station 6XM. Several extremely short wave oscillators of low power, using 5-watt tubes, have been built and tested with exceptional and most gratifying results.

# The Radio

Complete Directions for the Construction of an  
Given in the Most

By A. P. PECK,

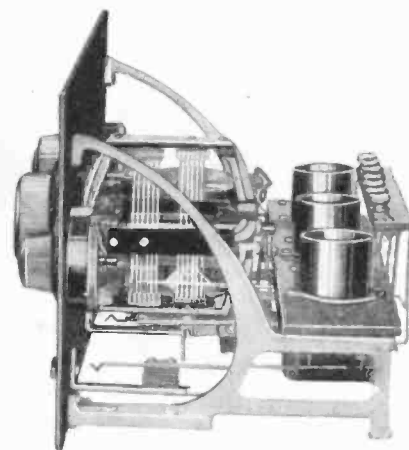
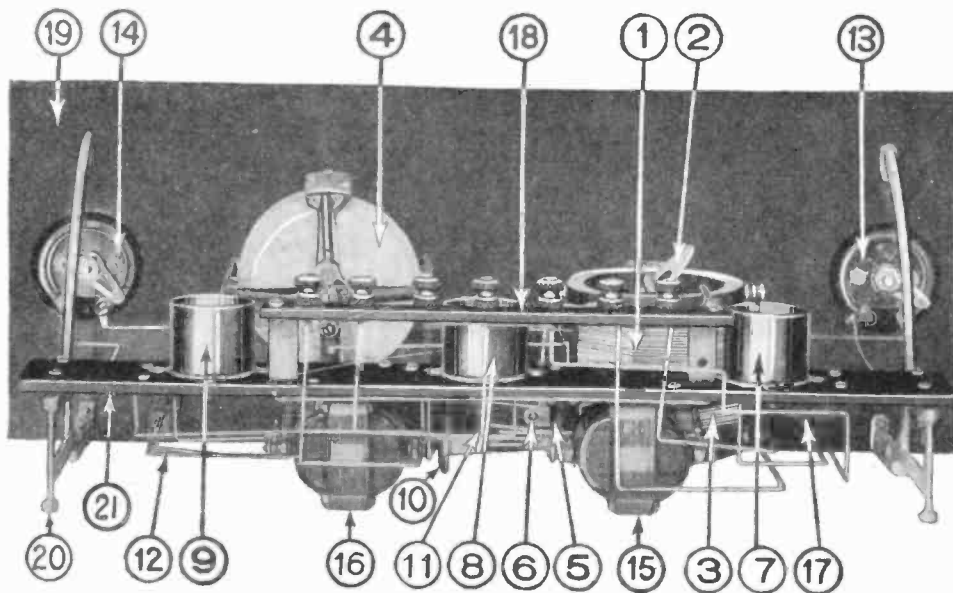

The efficient three-tube, three-circuit tuner detailed on this and the two succeeding pages is shown on the left and above. The numbers on the photographs at the left are carried through this entire article. The mounting brackets shown in the above photograph are a manufactured product.

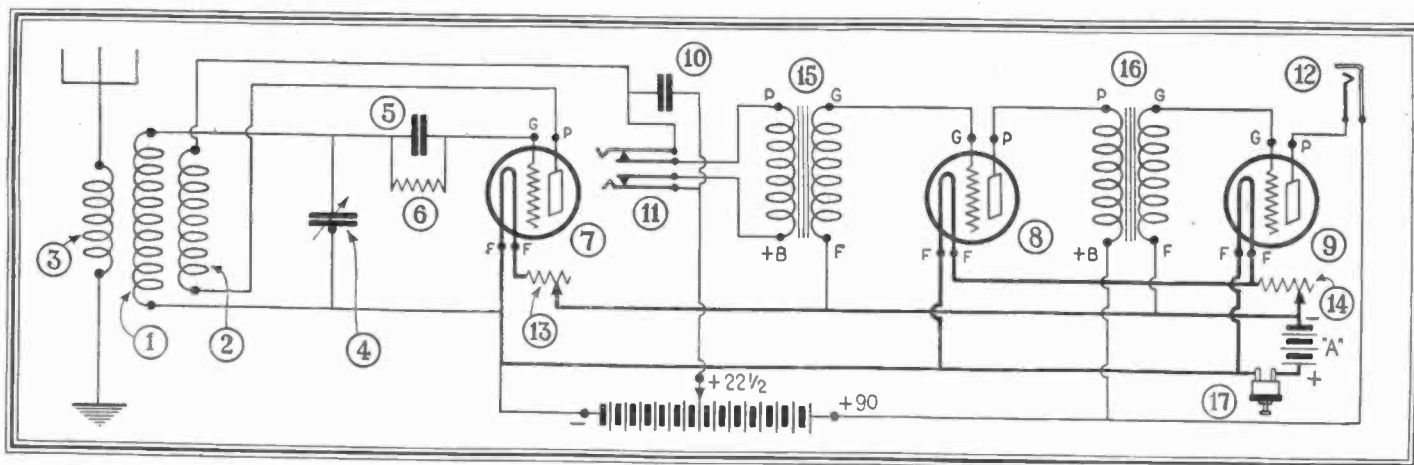

The complete schematic circuit diagram of the three-circuit tuner under discussion is given directly above. Note that here each instrument is assigned a specific number. By referring from this diagram to the photo-

graph above, it will be seen that the connections to each instrument can be carefully checked, and the wires leading from that instrument to the others can be followed out quickly and accurately.

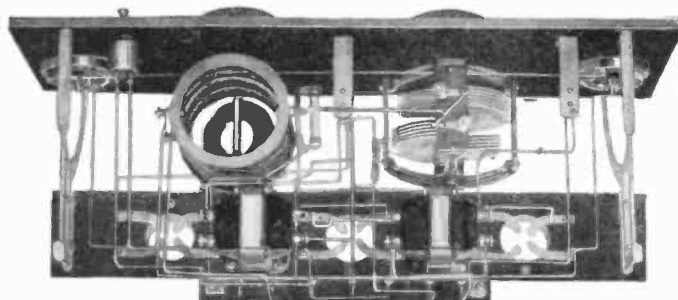
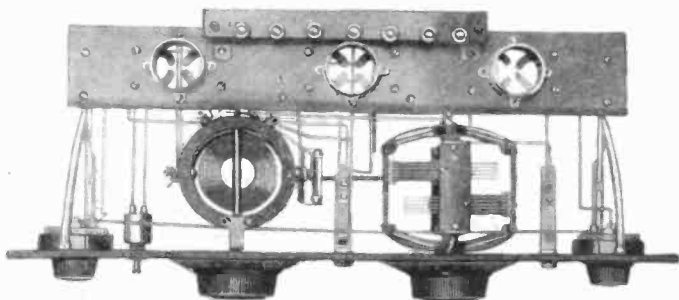

A top view of this receiving set is given directly above. Note the simple wiring and the neat arrangement of all of the parts. The long narrow strip supporting the sockets is in turn supported by the end brackets. The sockets shown are of the shell type without bases although of course standard sockets equipped with bases may be substituted. In such an event it will not be necessary to drill the large holes necessary when shell-type sockets are used.

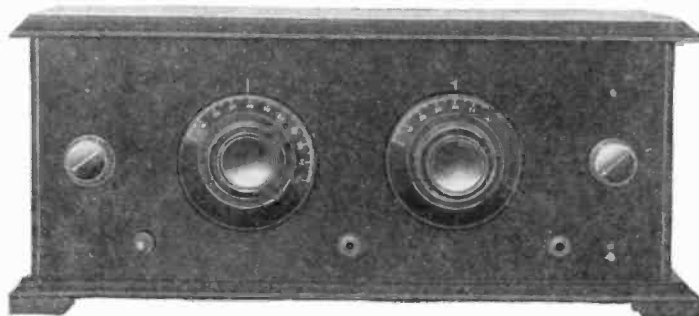

A bottom view of the tuner is given directly above, and a panel view of the entire unit placed in its cabinet at the left. In the above view, the placing of the audio frequency transformers and the springs of the sockets can be easily seen. The mounting of the grid leak and condenser on a binding post of the coupler or tuning coil can also be seen as may also the exact position of the phone or blocking condenser, 10 in the diagram above. The grid leak and condenser are numbers 6 and 5 respectively.



# Constructor

Exceedingly Efficient Three-Tube Three-Circuit Tuner  
Explicit Manner Possible

Assoc. I. R. E.

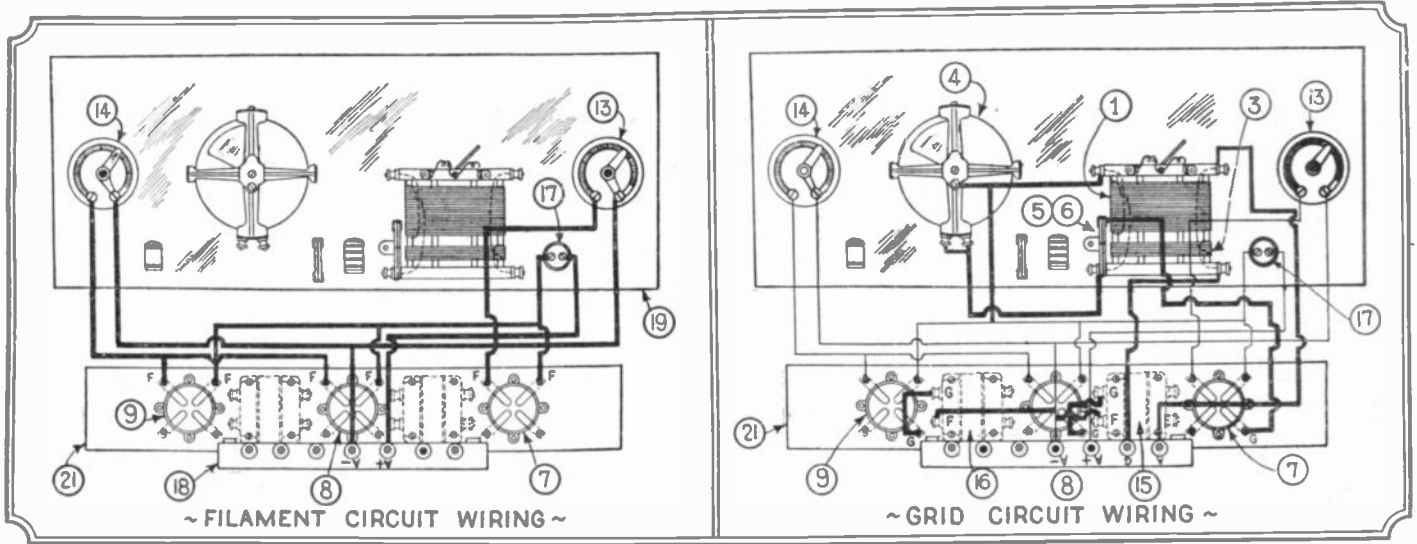

On this page, we introduce a radically new system of showing the various steps in the wiring of a radio set. We have divided the circuits into three distinct and separate groups and are showing them above and at the right in the order in which the wiring should be done. First, the filament circuit is to be wired. Begin at the A+ binding post, connect up the switch, 17, and then the three sockets. Then from the A- post connect the two rheostats 13 and 14 and the remaining filament springs on the sockets. By proceeding in this manner, the work of wiring the set is exceedingly simplified and the chances of making wrong connections reduced to a minimum. Stick to the specific section of the circuit that you are wiring at one time and you will find that the work will progress in a very satisfactory manner.

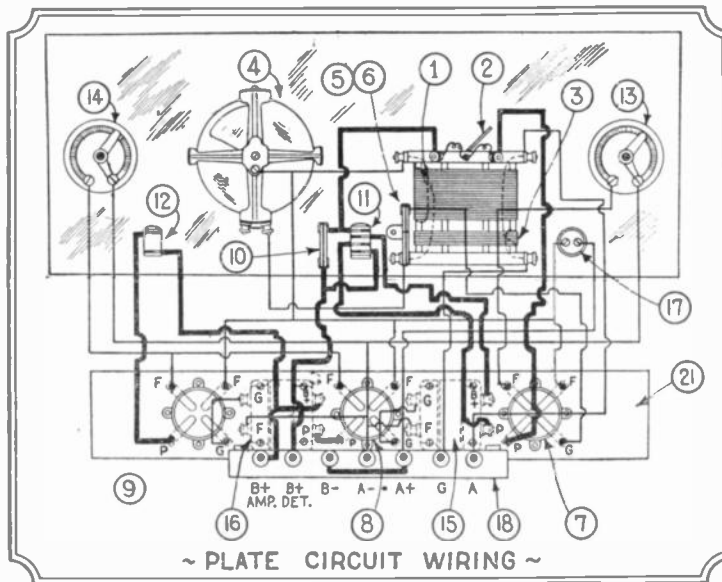

After the filament circuits are wired, the next step is the grid circuits. These are detailed above in heavy lines, the wires of the filament circuit which are already in place being shown in fine lines. In making these connections, one wire, that from the secondary of the coil to the grid leak and condenser is eliminated by mounting the grid condenser directly on the binding post of the coil as shown at 5 and 6 above. The grid leak and condenser used in this particular set are of the combined type, the clips for mounting the grid leak being fastened directly to the condenser. The plate circuit wiring is the next and final step and is illustrated at the left. Here again the connections already made, those of the filament and grid, are indicated in thin lines and those to be made, the plate circuit, in heavy lines.

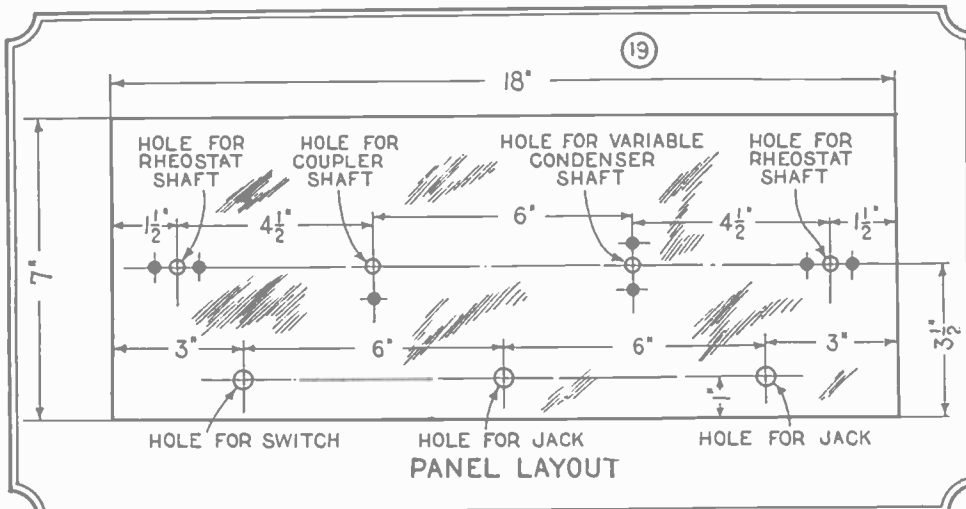

In laying out the panel of a new receiving set, the builder either mars or enhances the final appearance of the entire unit. If the holes are not properly centered and drilled, the dials will not line up and the result will be an unsymmetrical layout. To avoid this, use the panel layout given directly above. The distance between the holes in the panel and their positions thereon in relation to each other are shown. If a different type of condenser than that illustrated in the photos on the opposite page is used, the mounting holes for the same will have to be changed. However, keep the shaft holes in the same position.

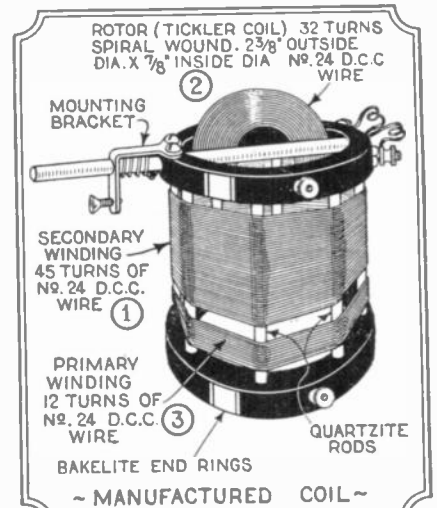

A highly efficient manufactured coil for use in this set is illustrated above. The numbers thereon indicate the windings and are for reference to the photo and diagram on the opposite page and the diagrams above. If you do not purchase a coil of this type, you can make one of your own.

# The Radio Constructor

(CONTINUED FROM PRECEDING PAGE)

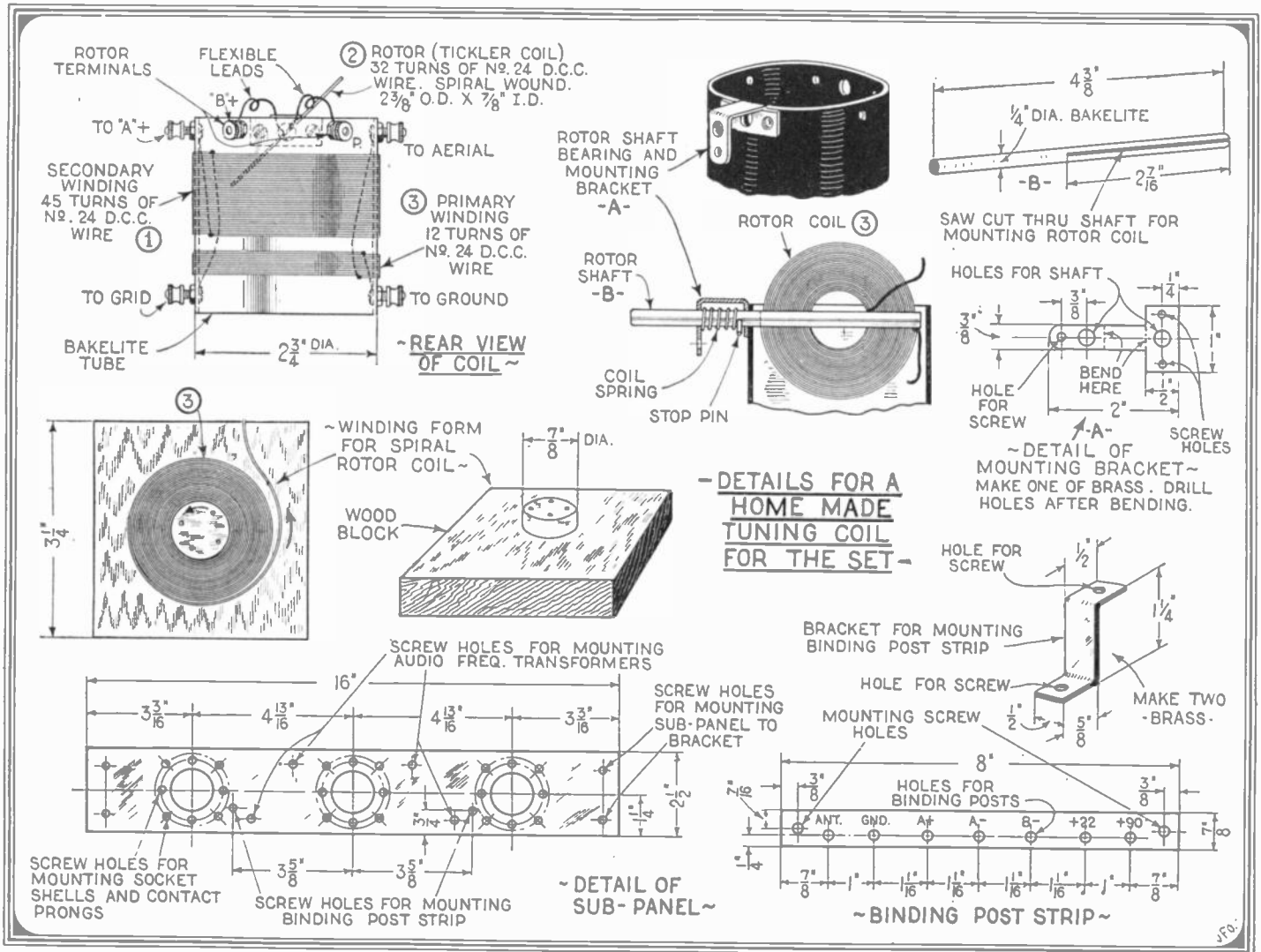

The details of the various home-made parts to be used in conjunction with the set described on the two succeeding pages are given above. A

home-made coil of exceedingly simple design, but one which will operate very efficiently is detailed as is also the sub-panel and binding post strip.

IN the presentation of this constructional article to the radio public, the writer has departed somewhat from the beaten track and instead of offering a circuit diagram, one or two photos of the set and letting the reader guess at the rest, he has, with the assistance of the artist, Joseph F. Odenbach, worked up what he considers to be one of the most complete radio articles ever published in any periodical.

Several photographs and a circuit diagram are published on page 254 and three progressive wiring diagrams, a panel layout, and a complete drawing of a manufactured coupler on page 255. The remaining constructional details are presented directly above.

Let us first assume that you have not bought one of the manufactured couplers and are desirous of making one yourself. A simple type is illustrated in detail above. The first requisite is a thin bakelite or paraffined cardboard tube  $2\frac{3}{4}$  inches in diameter by  $3\frac{3}{4}$  inches long. In one end of this tube drill two holes for the grid and ground binding posts and in the other end, four holes for the A+, B+, plate and aerial binding posts. At this end three other holes are to be drilled, one for the shaft and the other two for the small machine screws which hold the mounting bracket in place. After these holes are drilled and the posts mounted, wind the primary and secondary coils fol-

lowing the data given in the rear view of the coil above. Leave a space of about  $\frac{1}{4}$  of an inch between these two windings.

From fairly heavy strip brass, cut a piece, the details of which are shown at A above. Bend at the indicated points and drill the necessary holes. The two large ones will be of just sufficient size to allow the shaft to slip through and turn easily but must not be so large as to allow the shaft to wobble. The other holes are for fastening to the tube and panel. After you have assembled this mounting bracket on the stator, place a  $\frac{1}{4}$ -inch bakelite rod,  $4\frac{3}{8}$  inches long in a vise and very carefully cut along the length of the rod with a hacksaw for a distance of  $2\frac{7}{16}$  inches. This is shown at B above. The rotor coil which in this particular set is of the pancake type, as such a type has been found most efficient, is next to be wound and requires careful workmanship. It is not a hard proposition, however, and you only need be careful in order to insure good results. Provide a winding form as shown and after fastening one end of the No. 24 D.C.C. wire in a slot in the round center portion, start with the winding, proceeding a fraction of a turn at a time and holding that portion which has already been wound in place with the fingers of the left hand, guiding the wire with the right. After three or four turns have been wound, place a drop of collodion on the winding and let it

dry for a few seconds. It will hold the wire firmly in place. Do this every few turns, in order to keep the winding smooth and firm. When 32 turns have been wound, coat the whole upper surface of the winding with collodion and when dry, carefully remove from the block, using a thin bladed knife if necessary. Turn over and paint the untreated side with collodion. Solder the ends of the wire to two flexible leads, slip the coil into the slot in the bakelite rod and bind the rod in two or three places with strong wax thread. Apply a drop of collodion at the points where the coil and rod touch. Assemble the rotor in the stator, using a coil spring and stop pin as shown and the coupler will be complete. The stop pin may consist of a short thin machine screw passing through a hole in the shaft and fastened with a nut so that the end of the machine screw will strike the mounting bracket and prevent a complete rotation of the coil.

The details of the sub-panel are given, although they need not be followed if standard sockets are used. The latter can be mounted directly on the sub-panel by drilling only two holes for fastening. The binding post strip is also detailed.

The writer would deem it a favor if our radio readers would let him know how they like this type of constructional article and make suggestions for future articles of a similar nature.

(More Radio Articles on Page 289)

# Radio Broadcast

## REVISED AND CORRECTED TO DATE

First Group of Figures Indicate the Power in Watts in the Antenna of the Transmitting Station. The Second Group Gives the Wave-Length.

Call Letters	Location and Name	Power & Wave Length	Call Letters	Location and Name	Power & Wave Length	Call Letters	Location and Name	Power & Wave Length
KDKA	East Pittsburgh, Pa., Westinghouse Electric & Mfg. Co.	Variable—309.1	KFGQ	Boone, Iowa, Crary Hardware Co.	10—226	KFNG	Coldwater, Miss., Wooten's Radio and Electric Shop...	10—254
KDLR	Devils Lake, N. D., Radio Electric Co.	5—231	KFGX	Orange, Tex., First Presbyterian Church	500—250	KFNJ	Warrensburg, Mo., Central Missouri State Teachers' College	50—234
KDPM	Cleveland, Ohio, Westinghouse Electric & Mfg. Co.	500—250	KFHIA	Gunnison, Colo., Western State College of Colorado	50—252	KFNL	Paso Robles, Calif., Radio Broadcast Assn., Union High School	10—240
KDYL	Salt Lake City, Utah, Newhouse Hotel	500—333.1	KFHJ	Santa Barbara, Calif., Fallon & Co.	100—360	KFNV	Santa Rosa, Calif., L. A. Drake Battery and Radio Supply Shop	5—227
KDZB	Bakersfield, Calif., Frank E. Siefert	100—209.7	KFHL	Oskaloosa, Iowa, Penn College	10—240	KFNY	Helena, Mont., V. Kemp Roberts	50—248
KFAB	Lincoln, Neb., Nebraska Buick Auto Co.	200—240	KFIF	Portland, Ore., Benson Polytechnic Institute	100—248	KFOA	Seattle, Wash., Rhodes Dept. Store	500—454.3
KFAD	Phoenix, Ariz., McArthur Bros. Mercantile Co.	500—299.8	KFIO	Spokane, Wash., North Central High School	50—266	KFOC	Whittier, Calif., First Methodist Church	100—236
KFAE	Pullman, Wash., State College of Washington	500—348.6	KFIQ	Yakima, Wash., First Methodist Church	100—256	KFOJ	Moberly, Mo., Moberly High School	10—246
KFAF	Denver, Colo., Western Radio Corp.	500—278	KFIU	Juneau, Alaska, Alaska Electric Light & Power Co.	10—226	KFOL	Marengo, Iowa, Leslie M. Schafbuch	10—234
KFAJ	Boulder, Colo., University of Colorado	100—261	KFIZ	Fond du Lac, Wis., Daily Commonwealth & Seifert Radio Corp.	100—273	KFON	Long Beach, Calif., Echophone Radio Shop	100—234
KFAN	Moscow, Idaho, University of Idaho	50—231	KFJB	Marshalltown, Iowa, Marshall Electric Co.	10—248	KFOO	Salt Lake City, Utah, Latter Day Saints University	5—261
KFAR	Hollywood, Calif., Studio Lighting Service Co.	100—227	KJFF	Oklahoma, Okla., National Radio Mfg. Co.	225—261	KFOR	David City, Nebr., David City Tire & Electric Co. (Howard A. Shuman)	20—226
KFAU	Boise, Idaho, Boise High School	500—275	KJFI	Astoria, Ore., Liberty Theatre	10—246	KFOT	Wichita, Kans., College Hill Radio Club (College Hill Methodist Church)	50—231
KFAW	Santa Ana, Calif., The Radio Den	10—214.2	KFJM	Grand Forks, N. Dak., University of North Dakota	100—278	KFOX	Omaha, Nebr., Technical High School	100—248
KFBB	Havre, Mont., F. A. Buttrey & Co.	50—275	KFJR	Portland, Oregon, c/o Ralph Schneelock Co.	5—263	KFOY	St. Paul, Minn., Beacon Radio Service	50—252
KFBC	San Diego, Calif., W. K. Azhbil	5—278	KFJX	Ashley C. Dixon & Son	5—263	KFPG	Los Angeles, Calif., Oliver S. Garretson	10—238
KFBE	San Luis Obispo, Calif., Horn & Wilson	50—215.7	KFJY	Cedar Falls, Iowa, Iowa State Teachers' College	50—258	KFPH	Salt Lake City, Utah, Harold C. Mailander	50—242
KFBG	Tacoma, Wash., First Presbyterian Church	50—250	KFJZ	Fort Dodge, Iowa, Tunwall Radio Co.	50—246	KFPL	Dublin, Texas, C. C. Baxter	15—252
KFBK	Sacramento, Calif., Kimball-Upson Co.	100—248	KFKA	Fort Worth, Texas, W. E. Branch	50—254	KFPM	Greenville, Texas, New Furniture Co.	10—242
KFBL	Everett, Wash., Leese Bros.	20—224	KFKB	Greeley, Colo., Colorado State Teachers' College	50—273	KFPR	Los Angeles, Calif., Los Angeles County Forestry Department	500—231
KFBU	Laramie, Wyo., Bishop N. S. Thomas	50—270	KFKC	Milford, Kans., Brinkley-Jones Hospital Assn.	500—273	KFPV	San Francisco, Calif., Heintz & Kohlmoos	50—236
KFCB	Phoenix, Ariz., Nielson Radio Supply Co.	50—238	KFKQ	Conway, Ark., Conway Radio Laboratories	100—250	KFPW	Carterville, Mo., St. Johns Church	20—268
KFCC	Helena, Mont., First Congregational Church	10—248	KFKU	Lawrence, Kans., University of Kansas	500—275	KFPX	Pine Bluff, Ark., First Presbyterian Church	100—242
KFCF	Walla Walla, Wash., Frank A. Moore	100—256	KFKX	Hastings, Nebr., Westinghouse Electric & Mfg. Co.	1500—288.3	KFPY	Spokane, Wash., Symons Investment Co.	100—266
KFCL	Los Angeles, Calif., Leslie E. Rice, Los Angeles Union Stock Yards	500—236	KFLB	Menominee, Mich., Signal Electric Mfg. Co.	50—248	KFQA	St. Louis, Mo., The Principia	50—261
KFCY	Le Mars, Iowa, Western Union College	50—252	KFLP	Cedar Rapids, Iowa, Everette M. Foster	20—256	KFQB	Fort Worth, Texas, Searchlight Publishing Co.	100—254
KFCZ	Omaha, Nebr., Omaha Central High School	50—258	KFLR	Albuquerque, N. Mex., University of New Mexico	100—254	KFQC	Taft, Calif., Kidd Brothers Radio Shop	100—231
KFDD	Boise, Idaho, St. Michaels Cathedral	10—275	KFLU	San Benito, Tex., San Benito Radio Corp.	10—236	KFQG	Los Angeles, Calif., Armory Exposition Park, Southern California Radio Assn.	50—229
KFDH	Tucson, Ariz., University of Arizona	50—258	KFLV	Rockford, Ill., Swedish Evangelical Mission Church	100—229	KFQH	Burlingame, Calif., Radio Service Co. (Albert Sherman)	50—220
KFDJ	Corvallis, Ore., Oregon Agricultural College	50—254	KFLX	Galveston, Tex., George R. Clough	10—240	KFQM	Austin, Texas, Texas Highway Bulletin	100—268
KFDL	Denver, Colo., Knight-Campbell Music Co.	5—226	KFLZ	Atlantic, Iowa, Atlantic Automobile Co.	100—273	KFQP	Iowa City, Iowa, George S. Carson, Jr.	10—224
KFDM	Beaumont, Tex., Magnolia Petroleum Co.	500—315.6	KFMB	Little Rock, Ark., Christian Churches of Little Rock	—254	KFQR	Oklahoma, Okla., Walter L. Ellis	50—209.7
KFDX	Shreveport, La., First Baptist Church	100—250	KFMQ	Fayetteville, Ark., University of Arkansas	500—299.8	KFQT	Denison, Texas, Texas National Guard, 36th Signal Company	10—252
KFDY	Brookings, S. Dak., South Dakota State College of Agriculture and Mechanic Arts	100—273	KFMR	Sioux City, Iowa, Morningside College	100—261	KFQU	Holy City, Calif., W. Riker	100—234
KFDZ	Minneapolis, Minn., Harry O. Iverson	5—231	KFMT	Minneapolis, Minn., George W. Young	100—263	KFQW	North Bend, Wash., C. F. Knerim Photo Radio & Electric Shop	50—215.7
KFEC	Portland, Ore., Meier & Frank Co.	50—248	KFMW	Houghton, Mich., M. G. Saterren	50—266	KFQY	Belden, Nebr., Farmers State Bank	10—273
KFEL	Denver, Colo., Winner Radio Corp.	50—254	KFMX	Northfield, Minn., Carleton College	750—336.9	KFQZ	Hollywood, Calif., Taft Radio Co.	250—222
KFEQ	Oak, Nebr., Scroggin & Co. Bank	100—268	KFNF	Shenandoah, Iowa, Henry Field Seed Co.	500—266	KFRB	Beeville, Tex., Hall Brothers	250—248
KFER	Fort Dodge, Iowa, Auto Electric Service Co.	10—231				KFRC	San Francisco, Calif., City of Paris Dry Goods Co.	50—268
KFEY	Kellogg, Idaho, Bunker Hill & Sullivan Mining & Concentrating Co.	10—233				KFRF	Alexandria, La., W. R. Brown	10—242
KFFP	Moberly, Mo., First Baptist Church	50—266				KFRH	Grafton, N. D., The Radio Shop (Martin L. Monson)	10—268
KFFR	Sparks, Nev., Nevada State Journal	10—226				KFRI	Grand Forks, N. D., Men's Club of First Presbyterian Church	10—240
KFFV	Lamoni, Iowa, Graceland College	100—250				KFRM	Fort Sill, Okla., Lieut. James P. Boland, U. S. A.	50—263
KFFY	Alexandria, La., Louisiana College	50—275				KFRN	Hanford, Calif., M. Laurence Short	5—224
KFGC	Baton Rouge, La., Louisiana State University	100—268				KFRP	Redlands, Calif., Trinity Episcopal Church	10—211
KFGD	Chickasha, Okla., Oklahoma College for Women (J. A. Teeters)	100—252				KFRQ	Portland, Ore., Radio Market Service Co. (Harry M. Schultz)	5—213
KFGH	Stanford University, Calif., Leland Stanford Junior University	500—270				KFRU	Bristow, Okla., Etherical Radio Co.	500—394.5

### \$5,000.00 Cash

for

## A Successful PERPETUAL MOTION MACHINE

We don't want your patent rights. All we ask is a demonstration satisfactory to our committee of experts.

Contest closes March 1, 1926. Full details in March, 1925 issue of SCIENCE & INVENTION.

Call Letters	Location and Name	Power & Wave Length
KFRW	Olympia, Wash., United Churches of Olympia	100—220
KFRX	Pullman, Wash., J. Gordan Klemgard	10—217
KFRY	State College, N. Mex., New Mexico College of Agriculture and Mechanic Arts	50—266
KFRZ	Hartington, Neb., Electric Shop (P. M. Thies)	15—222
KFSG	Los Angeles, Calif., Echo Park Evangelistic Assn.	500—278
KFSY	Helena, Mont., Van Blaricom Co.	10—248
KFUJ	Breckenridge, Minn., Hoppert Plumbing & Heating Co.	50—242
KFUL	Galveston, Tex., Thomas Goggan & Bros. Music Co.	10—258
KFUM	Colorado Springs, Colo., W. D. Corley	100—242
KFUO	St. Louis, Mo., Concordia Seminary	500—545.1
KFUP	Denver, Colo., Fitzsimons General Hospital	50—234
KFUR	Ogden, Utah, H. W. Peery & C. Redfield	50—224
KFUS	Oakland, Calif., Louis L. Sherman	50—233
KFUT	Salt Lake City, Utah, University of Utah	100—261
KFUU	San Leandro, Calif., Colburn Radio Labs	100—224
KFUV	Springfield, Mo., G. Pearson Ward	10—252
KFUW	Moberly, Mo., Earl W. Lewis	10—233
KFUZ	Butte, Mont., Irving H. Bouchard	5—254
KFVC	Virginia, Minn., Young Men's Christian Assn.	10—248
KFVD	Camden, Ark., Bensberg's Music Co.	10—242
KFVF	San Pedro, Calif., McWhinnie Electric Co.	50—205.4
KFVH	Hollywood, Calif., Clarence B. Juneau	10—208.2
KFVI	Manhattan, Kansas, Whan Radio Shop	10—218.8
KFWA	Houston, Texas, Fifty-sixth Brigade, Headquarters Troop	10—248
KFWB	Ogden, Utah, Browing Bros. Co.	500—261
KFWC	Hollywood, Calif., Warner Bros. Pictures (Inc.)	500—252
KGB	Upland, Calif., L. E. Wall & C. S. Myers	10—211.1
KGO	Tacoma, Wash., Tacoma Daily Ledger	50—250
KGU	Oakland, Calif., General Electric Co.	2000—361.2
KGW	Honolulu, Hawaii, Marion A. Mulrony	500—360
KGY	Portland, Ore., Portland Morning Oregonian	500—491.5
KHJ	Lacey, Wash., St. Martins College	5—246
KHQ	Los Angeles, Calif., Times-Mirror Co.	500—405.2
KHQ	Seattle, Wash., Louis Wasmer (Excelsior Motorcycle & Bicycle Co.)	100—273
KJBS	San Francisco, Calif., Julius Brunton & Sons Co.	5—236
KIQ	Stockton, Calif., C. O. Gould	5—273
KJR	Seattle, Wash., Northwest Radio Service Co.	1000—384.4
KJS	Los Angeles, Calif., Bible Institute of Los Angeles	750—293.9
KLDS	Independence, Mo., Reorganized Church of Jesus Christ of Latter Day Saints	250—268
KLS	Oakland, Calif., Warner Bros. Radio Supplies Co.	250—242
KLX	Oakland, Calif., Tribune Publishing Co.	500—508.2
KLZ	Denver, Colo., Reynolds Radio Co.	250—266
KMJ	Fresno, Calif., San Joaquin Light and Power Corp.	50—234
KMO	Tacoma, Wash., Love Electric Co.	10—250
KNX	Los Angeles, Calif., Los Angeles Express	500—336.9
KOA	Denver, Colo., General Electric Co.	1000—322.4
KOB	State College, N. M., New Mexico College of Agriculture and Mechanic Arts	750—348.6
KOP	Detroit, Mich., Detroit Police Department	500—278
KPO	San Francisco, Calif., Hale Bros.	500—428.3
KPPC	Pasadena, Calif., Pasadena Presbyterian Church	50—229
KQV	Pittsburgh, Pa., Doubleday-Hill Electric Co.	500—275
KQW	San Jose, Calif., Charles D. Herrold	50—240
KRE	Berkeley, Calif., Berkeley Daily Gazette	50—258
KSAC	Manhattan, Kans., Kansas State Agricultural College	500—340.7
KSD	St. Louis, Mo., Post Dispatch	750—545.1
KSL	Salt Lake City, Utah, Radio Service Corp. of Utah	100—299.8
KTHS	Hot Springs, Ark., New Arlington Hotel Co.	500—374.8

## \$250.00 In Prizes

### How to Kill Rats

Do you know a good method for exterminating this pest, which annually cost the farmer hundreds of thousands of dollars. The rat is a disease carrier. Help to eliminate him. The prize-winning ideas must tell how to trap or destroy this undesirable rodent. See page 233 for complete details of the contest.

Call Letters	Location and Name	Power & Wave Length
KTW	Seattle, Wash., First Presbyterian Church	750—454.3
KUO	San Francisco, Calif., Examiner Printing Co.	150—246
KUOM	Missoula, Mont., University of Montana	500—244
KWG	Stockton, Calif., Portable Wireless Telephone Co.	50—360
KYQ	Honolulu, Hawaii, The Electric Shop	100—270
KYW	Chicago, Ill., Westinghouse Electric & Mfg. Co.	1500—535.4
KZKZ	Manila, P. I., Electrical Supply Co.	100—270
KZM	Oakland, Calif., Preston D. Allen	100—360
KZRQ	Manila, P. I., Manila Hotel, Far Eastern Radio (Inc.)	500—222
WAAB	New Orleans, La., Valdemar Jensen	100—273
WAAC	New Orleans, La., Tulane University	100—275
WAAD	Cincinnati, Ohio, Ohio Mechanics Institute	25—258
WAAP	Chicago, Ill., Chicago Daily Drivers Journal	200—278
WAAM	Newark, N. J., I. R. Nelson Co.	250—263
WAAP	Omaha, Neb., Omaha Grain Exchange	500—278
WABA	Lake Forest, Ill., Lake Forest University	100—227
WABB	Harrisburg, Pa., Harrisburg Sporting Goods Co.	10—266
WABI	Bangor, Me., Bangor Hydro-Electric Co.	100—240
WABL	Storrs, Conn., Connecticut Agricultural College	100—275
WABM	Saginaw, Mich., F. E. Doherty Automotive & Radio Co.	20—261
WABN	La Crosse, Wis., Ben A. Ott	500—244
WABO	Rochester, N. Y., Lake Avenue Baptist Church (Hickson Electric Co.)	100—278
WABQ	Haverford, Pa., Haverford College Radio Club	50—261
WABR	Toledo, Ohio, Scott High School	50—263
WABU	Camden, N. J., Victor Talking Machine Co.	50—226
WABW	Wooster, Ohio, College of Wooster	50—206.8
WABX	Mount Clemens, Mich. (near), Henry B. Joy	500—246
WABY	Philadelphia, Pa., John Magaldi, Jr.	50—242
WABZ	New Orleans, La., Coliseum Place Baptist Church	50—263
WADC	Akron, Ohio, Allen Theater	100—258
WAFD	Port Huron, Mich., Albert B. Parfet Co.	256—233
WAHG	Richmond Hill, N. Y., A. H. Grebe & Co.	500—315.6
WAIT	Taunton, Mass., A. H. Wait & Co.	10—229
WAMD	Minneapolis, Minn., Hubbard & Co.	100—244
WARC	Medford Hillside, Mass., American Radio Research Corp.	100—261
WBAA	West Lafayette, Ind., Purdue University	250—273
WBAN	Paterson, N. J., Wireless Phone Corp.	100—244
WBAO	Decatur, Ill., James Millikin University	100—275
WBAP	Fort Worth, Texas, Wortham-Carter Publishing Co. (Star Telegram)	1000—475.9
WBAV	Columbus, Ohio, Erner & Hopkins Co.	500—293.9
WBAX	Wilkes-Barre, Pa., John H. Stenger, Jr.	10—256
WBBA	Newark, Ohio, Plymouth Congregational Church	20—226
WBBG	Mattapoisett, Mass., Irving Vermilya	500—248
WBBH	Port Huron, Mich., J. Irving Bell	50—205.4

Call Letters	Location and Name	Power & Wave Length
WBBL	Richmond, Va., Grace Covenant Church	100—229
WBBM	Chicago, Ill., Atlas Investment Co.	200—226
WBBP	Petoskey, Mich., Petoskey High School	100—238
WBBR	Rossville, N. Y., Peoples Pulpit Assn.	500—273
WBBS	New Orleans, La., First Baptist Church	50—252
WBBU	Monmouth, Ill., Jenks Motor Sales Co.	10—224
WBBV	Johnstown, Pa., Johnstown Radio Co.	5—248
WBBW	Norfolk, Va., Ruffner Junior High School	50—222
WBBY	Charleston, S. C., Washington Light Infantry	10—268
WBBZ	Indianapolis, Ind., Noble B. Watson	50—238
WBCN	Chicago, Ill., Foster & McDonnell	500—266
WBDC	Grand Rapids, Mich., Baxter Laundry Co.	50—256
WBES	Tacoma Park, Md., Bliss Electrical School	100—222
WBOQ	Richmond Hill, N. Y., A. H. Grebe & Co.	100—236
WBRE	Wilkes-Barre, Pa., Baltimore Radio Exchange	10—231
WBS	Newark, N. J., D. W. May, Inc.	200—252
WBT	Charlotte, N. C., Southern Radio Corp.	250—275
WBZ	Springfield, Mass., Westinghouse Electric & Mfg. Co.	1500—331.1
WCAD	Canton, N. Y., St. Lawrence University	250—263
WCAE	Pittsburgh, Pa., Kaufmann & Baer Co.	500—461.3
WCAG	New Orleans, La., Clyde R. Randall	50—268
WCAH	Columbus, Ohio, Entekin Electric Co.	200—266
WCAJ	University Place, Neb., Nebraska Wesleyan University	500—275
WCAL	Northfield, Minn., St. Olaf College	500—336.9
WCAO	Baltimore, Md., Sanders & Stayman Co.	50—275
WCAP	Washington, D. C., Chesapeake & Potomac Telephone Co.	500—468.5
WCAR	San Antonio, Texas, Southern Radio Corporation of Texas	100—263
WCAT	Rapid City, S. D., South Dakota State School of Mines	50—240
WCAU	Philadelphia, Pa., Durham & Co.	500—278
WCAX	Burlington, Vt., University of Vermont	100—250
WCAY	Milwaukee, Wis., Hotel Antlers Broadcasting Assn.	250—266
WCAZ	Carthage, Ill., Carthage College	50—246
WCBA	Allentown, Pa., Queen City Radio Station	10—254
WCBC	Ann Arbor, Mich., University of Michigan	200—229
WCBD	Zion, Ill., Wilbur G. Voliva	1500—344.6
WCBE	New Orleans, La., Chalt Brothers Radio Co.	5—263
WCBG	Pascagoula, Miss. (portable), Howard S. Williams	10—268
WCBH	Oxford, Miss. (near), University of Mississippi	10—242
WCBJ	Bemis, Tenn., Nicoll, Duncan & Rush	150—240
WCBK	Jennings, La., J. C. Mans	10—244
WCBL	Houlton, Me., Northern Radio Mfg. Co.	50—266
WCBM	Baltimore, Md., Hotel Chateau (Charles Schwartz)	50—229
WCBQ	Nashville, Tenn., First Baptist Church	50—236
WCBR	Providence, R. I. (portable), Charles H. Messer	30—205.4
WCBU	Arnold, Pa., Arnold Wireless Supply Co. (F. J. Ambrose)	50—220
WCBY	Buck Hill Falls, Pa., Forks Electrical Shop	10—231
WCBZ	Chicago Heights, Ill., Coppotelli Bros. Music House	50—248
WCCO	Minneapolis, Minn., Washburn-Crosby Co.	1500—416.4
WCEE	Elgin, Ill., Charles E. Erbstein	500—275.1
WCK	St. Louis, Mo., Stix-Baer & Fuller Dry Goods Co.	100—273
WCM	Austin, Tex., Texas Markets and Warehouse Department	250—268
WCTS	Worcester, Mass., C. T. Scherer Co.	100—268
WCUW	Worcester, Mass., Clark University	238—250
WCX	Detroit, Mich., Detroit Free Press	500—516.9
WDAE	Tampa, Fla., Tampa Daily Times	250—273
WDAF	Kansas City, Mo., Kansas City Star	500—365.6

(Continued on page 282)

# RADIO ORACLE

In this Department we publish questions and answers which we feel are of interest to the novice and amateur. Letters addressed to this Department cannot be answered free. A charge of 50c. is made for all questions where a personal answer is desired.

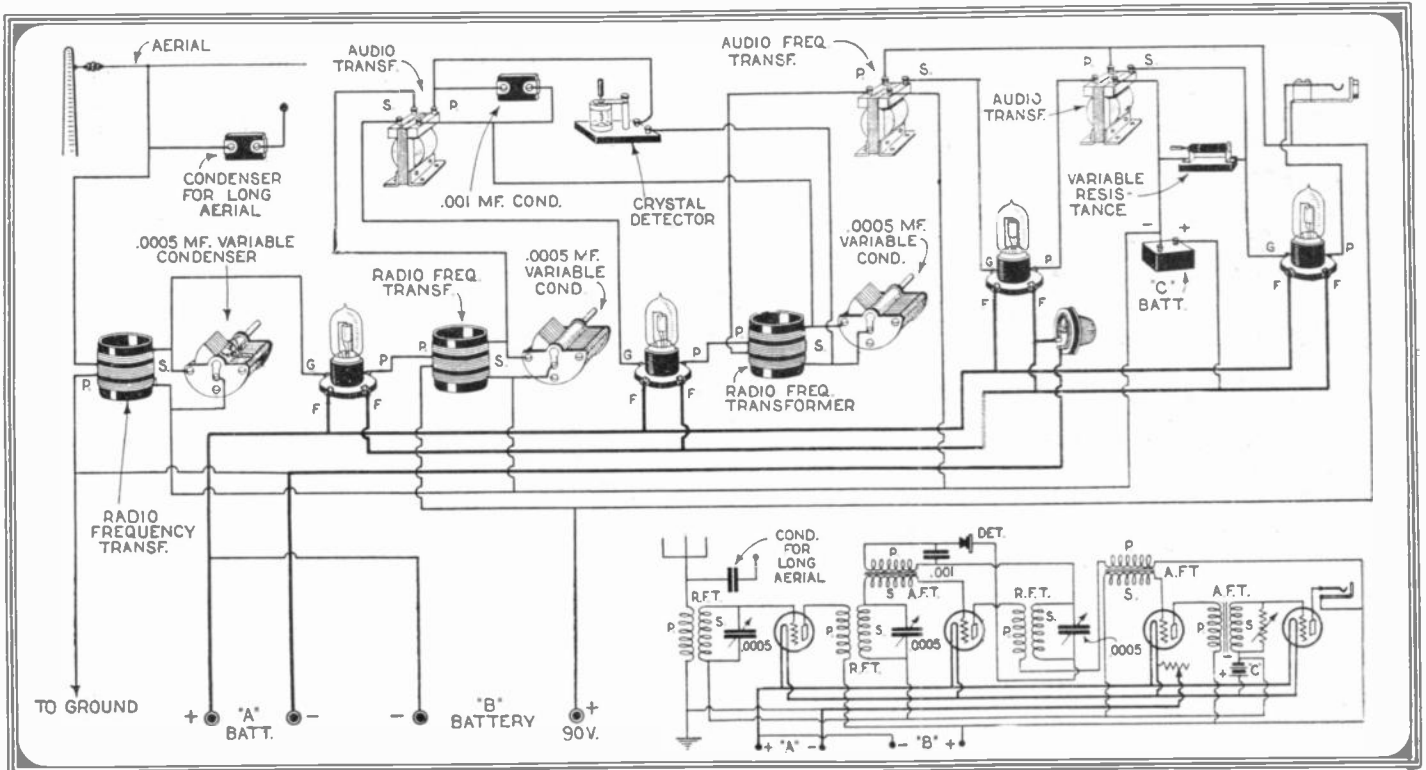

The well known and justly famous Tu-Ra-Flex circuit is shown in both picture and schematic form above with the addition of a single stage of audio frequency amplification giving the results of three stages total. The variable resistance shown is of assistance in controlling the circuit.

## TU-RA-FLEX CIRCUIT

(358) Q. 1. Walter Gray, Jr., Hamilton, Ohio, sends us a diagram of a Tu-Ra-Flex radio receiving set and requests us to show how one stage of audio frequency amplification could be added to it.

A. 1. We reproduce this highly efficient circuit herewith for the benefit of all of our readers and show the connections for a third stage of audio frequency amplification. Care should be taken in making this addition because of the fact that unless very good instruments and a low ratio transformer are used, howling in this third stage will result. A variable resistance placed in the third audio frequency transformer circuit as shown may be found of great assistance in controlling this stage.

## MORE DATA ON "B" BATTERY ELIMINATOR

(359) Q. 1. E. F. Morse, La Crosse, Wis., refers to the "B" battery eliminator described on page 66 of the May, 1925, issue of this magazine and asks for further information on the construction of the various parts illustrated therein.

A. 1. The following data is correct for the various instruments to be used in the construction of the "B" battery eliminator that you mention.

The core of the transformer is constructed of silicon steel strips .014 inches thick by 1½ inches wide. The outside dimensions of

the core are 5 inches square and the legs should be built up to 1½ inches high.

The 110-volt primary consists of 384 turns of No. 22 D.C.C. wire, wound 48 turns per layer in 8 layers. The secondary consists of 980 turns of No. 26 D.C.C. wire, wound

### Interesting Articles in July "Radio News"

Radio Goes to the North Pole.  
By John L. Reinartz.

The "Thermion" Vacuumless Tube.  
By H. G. Silberdorff.

New Uses for the Vacuum Tube.  
By C. B. Bazzoni.

The Augmentor Circuit.  
By Francis R. Hoyt.

All About Verniers.  
By Sylvan Harris.

What Is Low-Loss?  
By Sylvan Harris.

A Three-Range Receiver.  
By Laboratory Staff of Radio News.

65 turns per layer in 15 layers. A center tap is brought out at the 490th turn to be connected as shown in the diagram in this magazine. In the above data, space is allowed at the ends of the windings for supports for the same. Both coils should be

well insulated from the core and may be wound on opposite legs.

The electrodes of the rectifier are made of lead and aluminum plates as indicated in the article. They may be 1 inch wide by 3 inches long with an additional length allowed for projection above the surface of the liquid. The latter may consist of a saturated solution of ammonium phosphate or borax in water. The surface should be covered with a 1/8th-inch thick film of mineral or paraffin oil to prevent evaporation. The electrodes should be thoroughly sandpapered before being placed in the solution.

The 2mf. condensers may be purchased from any telephone equipment supply house.

The 30-henry choke may be wound as follows: Make up a core of a bundle of iron wires, 4 inches long by ½ inch in diameter. Provide suitable ends and a winding space 3½ inches long. Wind No. 38 enameled wire on the core until the outside diameter is 2½ inches. Provide suitable terminals.

Any adjustable resistance with a range of 10,000 to 100,000 ohms may be used for cutting down the voltage for the detector plate supply. The carbon pile type is suitable.

## LOSS OF VOLUME

(360) Q. 1. Edward Heron, Jr., Perote, Ala., sends a diagram of his receiving set which is a standard two-variometer and variocoupler type and says that after the

## WANTED!!! RADIO ARTICLES

WE want descriptions of new radio ideas which you have worked out in practice. Take photographs of the important parts and make pencil or pen and ink sketches of the hook-ups or mechanical details, et cetera. We are particularly

desirous of obtaining new hook-ups and descriptions of single tube sets, reflex and other types which have proven satisfactory. We like articles on new single tube receptors. We will pay good prices for your ideas.

—Editor.

set had been in use for some months, stations faded out and could not be brought up as loud as formerly. He asks our opinion as to the trouble.

A. 1. There are several possibilities here. First, your batteries may be worn out and this point should be investigated immediately.

### CHOKE COIL COUPLED AMPLIFIER

(361) Q. 1. Wm. Stone, Mansfield, Ohio, requests a circuit diagram of a three-stage, choke coil coupled amplifier to be added to standard one-tube circuit.

amplification, a detector and two stages of audio frequency amplification. The radio frequency amplification is transformer coupled. He asks: How can honeycomb coils be placed in this circuit to reach a wavelength of 1,600 meters?

A. 1. Such a procedure is not at all ad-

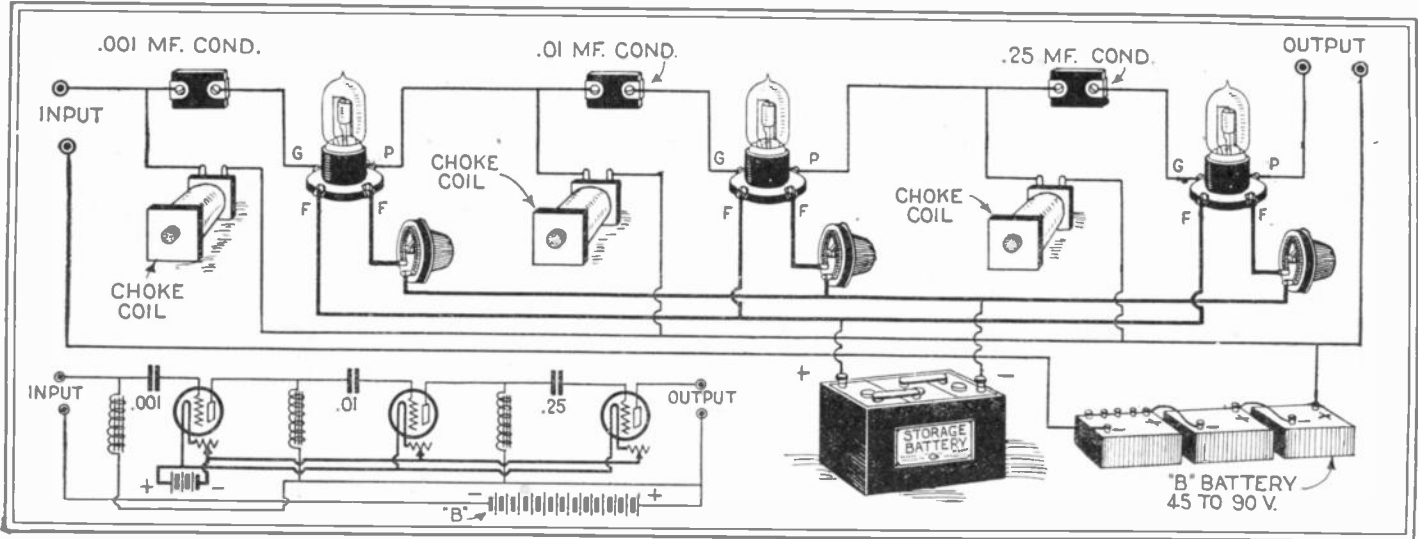

The choke coils in the above circuit may consist of approximately 10,000 turns of No. 36 enameled wire, wound on a 1/2-inch iron wire core 3 inches long. Suitable end plates should be provided. If desired, the secondaries of small spark coils may be used as the chokes.

ly. Then there is a further possibility that the electronic emission of your vacuum tube has decreased with a resulting decrease in efficiency of the set. This would account for the signals not coming in as loud as formerly. Furthermore, the resistance of your grid leak may have changed due to atmospheric conditions whereupon a change in signal strength would also be noticeable. We would advise you to look into these things carefully, checking the strength of your batteries first.

A. 1. We are giving in these columns the circuit of a three-stage choke coil amplifier which can be added to your particular type of set or any other standard receiving set. Be sure that your battery polarities are correct.

### LONG WAVE R.F. RECEIVER

(362) Q. 1. John Heap, Taylor, Texas, is at present employing a five-tube receiving set comprising two stages of radio frequency

visable with a set of the type you are using. In order to accomplish this work, you would not only have to load the primary and secondary circuits of the initial tuning element, but would also have to insert different radio frequency transformers to cover the higher band of wave-lengths. Such a procedure would necessitate your entirely rebuilding the set.

As the movement of the day is in the direction of short wave-lengths, why do you look for long wave reception?

## Guess this Circuit! \$100.00 in Prizes

SCIENCE AND INVENTION leads again, something entirely new!! The Mystery Set, a five-tube wonder. Submit its circuit and win a prize.

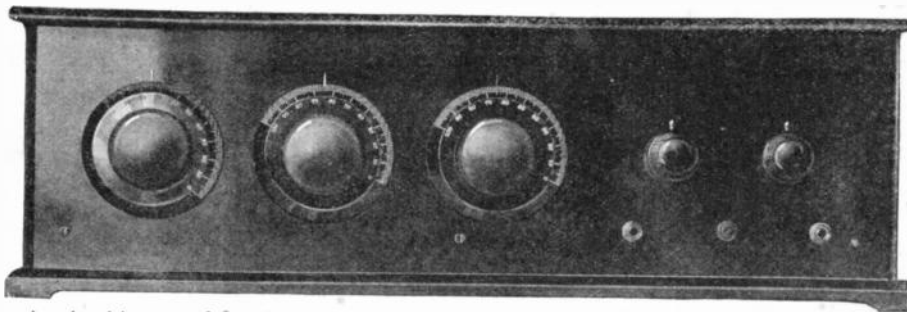

This is not a freak set. The circuit used is a standard one. A wonderful distance getter. Come on, Radio Fans, do your stuff. Better than a crossword puzzle and more interesting to solve.

FOR the first time in the history of the radio art, a very novel contest such as has never been held before, is being sponsored by SCIENCE AND INVENTION. Opportunity is given to the readers of SCIENCE AND INVENTION to exercise their mental powers in guessing the correct circuit used in the wiring of the above five-tube receiver. Look at it carefully, study minutely the front panel. Ponder a while, what may be behind the panel, the three large dials and the two smaller ones? The three large dials to the left operate—well, we will leave the guess-work up to you—may they operate condensers or variometers. Probably it is a—well, we will leave everything up to you. What are the two small dials for, can they be—? Or are they something else? The size of the panel is seven inches wide by twenty-six inches long. There is nothing hard about it. You may sub-

mit as many circuits as you desire. It is not necessary to state the constants of any of the parts, i. e., the capacities, inductances, resistances, etc. All that is essential is a carefully drawn diagram, which should represent your idea as to what circuit is employed in the receiver.

\$100.00 GOLD IN PRIZES	
1st Prize	\$50.00
2nd Prize	20.00
3rd Prize	15.00
4th Prize	10.00
5th Prize	5.00

### RULES

- 1—Contestants may submit as many entries as they desire.
- 2—Circuits must be carefully and clearly drawn in ink on one side of a sheet of white paper. All symbols should be marked as to what they are supposed to represent.
- 3—The contest closes at noon on Saturday, July 2, 1925.
- 4—In case of a tie, duplicate prizes will be awarded to each contestant so tying.
- 5—The correct circuit or the nearest to it will be awarded first prize.
- 6—All circuits must bear the contestant's name and address in the upper right hand corner. The date must also accompany the above.
- 7—The circuit and photo of the interior of the set will be published in the September or October issue.

# Scientific Humor

## AND HORSE SENSE

BILLY: "That woman reminds me of one of Dr. Hackensaw's creations."

WILLY: "How's that?"

BILLY: "Well, she has a deer face, bear knees, snaky eyes and pigeon toes."—*Philip L. Danzinger, Reporter No. 4,928.*

## ARITHMETIC IN THE GARDEN OF EDEN



How many apples did Adam and Eve eat?

Some say Eve 8 and Adam 2, a total of ten only.

Now we figure the thing out far differently; Eve 8 and Adam 8 also, total 16.

We think the above figures entirely wrong. If Eve 8 and Adam 8 2, certainly the total would be 90.

Scientific men, however, on the strength of the theory that the Antedeluvians were a race of Giants, reason something like this: Eve 8 1 and Adam 8 2, total 163.

Wrong again. What could be clearer than if Eve 8 1 4 Adam and Adam 8 1 2 4 Eve, total 9,938.

Still another calculation is as follows: If Eve 8 1 4 Adam, Adam 8 1 2 4 2 oblige Eve, total 82,056.—*J. H. Garlick.*

## SANITARY

DOCTOR: "Have you taken every precaution to prevent the spread of contagion in your family?"

RASTUS: "Absolutely, Doctor. We've done gone and bought a sanitary cup an' we all drink out of it."—*Charles A. N. Hall.*

## CONDENSING HIS LOSSES

1ST: "How can Bill make radio sets so cheap?"

2ND: "Oh using no-loss condensers I suppose."—*Derrick Rusden.*

## NOTHING SMALLER



PROFESSOR (to chemistry class): "I have explained to you that a molecule is the smallest part of a n y compound capable of existing in a separate form, while an atom is the smallest particle into

which a molecule can be divided. Now can any of you illustrate the difference between a molecule and an atom?"

STUDENT: "I think so, Professor. The bridegroom at a big church wedding looks like a molecule and feels like an atom."—*Smith O'Brien.*

## NON PLUSSED

PROFESSOR: "What are the plus members?"

MAZDA: "Negative."

PROFESSOR: "Are you sure?"

MAZDA: "Positive."—*Maurice Berger.*

## HOW ABOUT AN EGG-NOCK

"Say, Sam, what's the difference between opportunity and an automobile engine?"

"I dunno. What is it?"

"Opportunity only knocks once."—*J. Farrell.*

## First Prize \$3.00

### WE'LL NEVER BLUSH AGAIN

FRESHY: "What causes blushing?"

PROF: "A blush is a temporary erythema and calorific effulgence of the physiognomy, actologized by the perceptiveness of the sensorium, in a predicament of inequilibrium, from a sense of shame, anger or other cause, eventuating in a paresis of the vaso-motorial, muscular filaments of the facial divested of their elasticity, they become suffused with a radiance emanating from an intimidated praecordia."—*A. Schwartz, Reporter No. 19931.*



## THE LIGHT WEIGHT

The aspiring chemist, having finished the first chapter of the text-book, decided to equip his laboratory. So—"and now I'll want a balance," said he after a few minor purchases.

"English or Metric weights, sir?"

The embryo chemist after deep thought replied, "I guess I'd better take atomic weights."—*Keller.*

## BRICK-A-BRAG

A professor of gology had placed some specimens of rocks on his desk and was going to describe them to his students. While his back was turned for a moment, one of the students put among the rocks a piece of an old brick.



Then the professor went through the specimens, saying, as he picked up each, "This is a piece of sandstone"; "This is a piece of granite," and so on.

At last he came to the brick, and, holding it up said: "And this, gentlemen, is a piece of impudence."—*Mrs. Walter Wardle.*

## EVEN LIZZIES ARE

HISTORY TEACHER: "Yes, Johnny, and what age are we living in now?"

JOHNNY: "The Tin Age."

TEACHER: "What makes you think so?"

JOHNNY: "Because everything is canned, like fruit, music and vegetables. Even the other day I heard Dad say that someone was canned."—*Robert Grant.*

## A CUT-OUT

BOBBIE: "Jack built a radio set all by himself, but he couldn't work it on account of too much interference."

FREDDIE: "Interference is good. His mother objected to it and his father threw it out of the house."—*J. J. O'Connell.*

## BUT SUPPOSE IT WAS A "HEAVY" CIGAR?

PHYSICIST: "Suppose you had a box of cigars, but no matches, how could you light a cigar for a smoke?"

CHEMIST: "I'm sure I don't know."

PHYSICIST: "Why, simply take one cigar out of the box; the box will then be a cigar lighter."—*L. C. Cartwright, Reporter No. 9656.*



## 300 PEOPLE SEND THIS JOKE EVERY MONTH

Wise Guy: "I want some venerable condensers."

RADIO CLERK: "You mean variable condensers."

W. G.: "It does not meg any difference. That's what I camphor. What do they sulphur?"

R. C.: "Six dollars apiece. I never cinnamon with so much wit."

W. G.: "Well, I should myrrh myrrh. Yet I ammonia novice at it."—*Nicolas Close.*

## IF YOU LAUGH AT THIS IT IS ONE TOO

TWEET-TWEET!

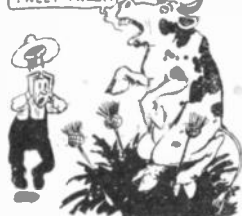

sitting on a thistle singing a phenomenon."—*William Francey.*

TEACHER: "What is a phenomenon?"

STUDENT: "I can't describe one; but if you see a cow; or hear a bird sing, those aren't phenomena; but if you see a cow, like a bird, that's a phenomenon."—*William Francey.*

## SETTLED IT

BILL: "Name some things that set."

JOHN: "The sun sets."

BILL: "Name another."

JOHN: "Radio sets."—*Rogério Quason.*

## CANNED SPEECH, OF COURSE!

WIFEY (reading radio page): "Isn't it just wonderful! Scientists can now multiply sound of the human voice 100,000 times."

HUBBY (thoughtlessly): "What have they done in the way of subtraction?"—*William Heitler, Reporter No. 11,783.*



# LATEST PATENTS

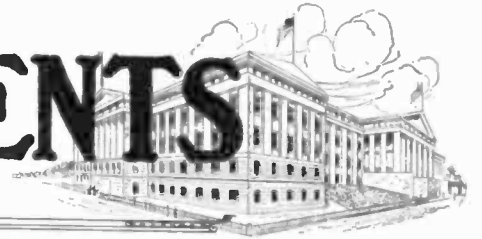

## Protective Device

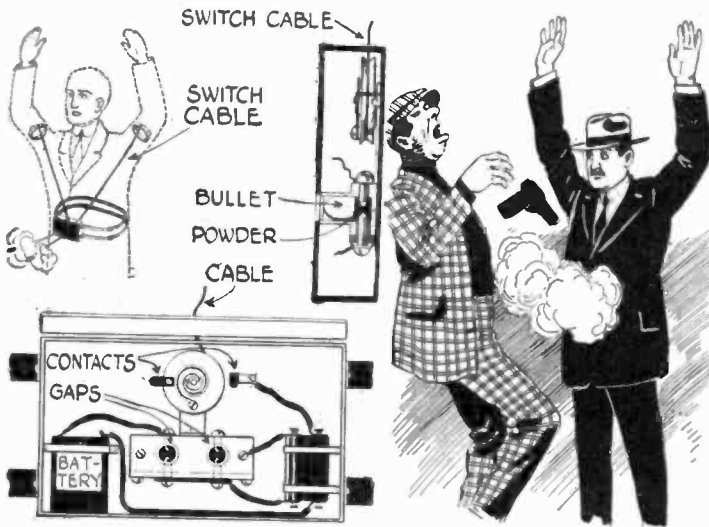

## Motorcycle Combination

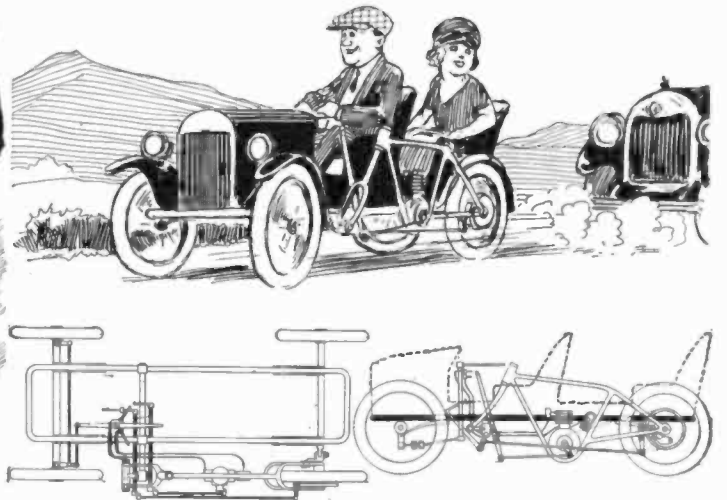

## Cigarette Ejector



No. 1,532,859, issued to William H. Balch, covers the device shown at left above. It is to be carried by those who have large quantities of money or valuable papers in their possession. By raising the arms at the command of a thug, two bullets are projected forward effectively eliminating the offender. The powder charge is fired by electricity.

No. 1,515,363, issued to K. P. Radovanovitch, covers the automotive vehicle shown in the upper right corner. This consists of a body to be attached to a standard motorcycle frame as shown. A steering lever and gas spark controls are provided in front of the driver.

No. 1,514,471, issued to A. A. Solberg, describes a combination cigarette or cigar holder and ejector shown at left center. By taking the holder apart, a sharp prong is revealed which may be used to remove the remains of a smoked cigarette or cigar from the holder.

No. 1,529,181, issued to Harry S. Holmes, embraces a system which hundreds of inventors have proposed in the past, but which, to our knowledge, no one has succeeded in perfecting. The device is a self-lighting cigar or cigarette illustrated in detail at right center. In order to avoid the noxious fumes of the ignition material, and prevent them from reaching the lungs of the smoker, Mr. Holmes has interposed a layer of charcoal composition which effectually filters these fumes.

## Self-Lighting Cigarette



COMPOSITION OF CHARCOAL IGNITION TIP

## Shoe Brush

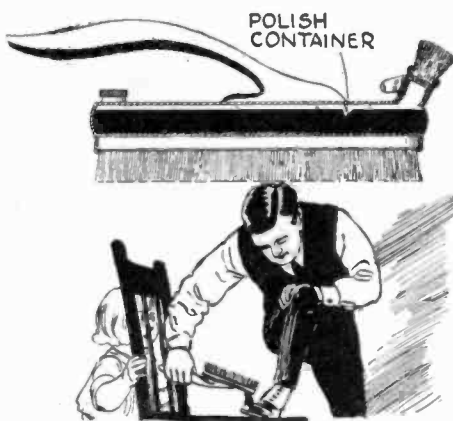

No. 1,532,804, issued to W. Garner, is for a combination shoe brush illustrated above. The polish container shown holds a liquid polish which is fed through the bristles of an applying brush to the shoe. The bristle retaining section is rotatable so that when a hole therein lines up with a hole in the cover of the polish container, the polish is free to flow through the bristles. When the holes are not in line, the polish container is sealed.

## Jar Cover



No. 1,529,521, issued to W. Westendorf, relates to a combination cover and handle for jars of the type ordinarily used by housewives for packing edibles and similar substances. The device is illustrated above and consists of a section into which screw-threads are pressed so as to catch the corresponding threads on a jar, a pouring spout, a cover and a handle, all contained in one integral unit.

## WANTED

ARTICLES pertaining to automobiles such as handy kinks, roadside repairs and anything of interest to the man who drives a car. \$50.00 in prizes every month are offered by MOTOR CAMPER AND TOURIST for such articles. Get a copy at your newsstand and see what is wanted. If your newsdealer cannot supply you send for free sample copy to:

MOTOR CAMPER & TOURIST  
53 Park Place,  
New York City.



# Non-Sc(i)ence

## I'M PERSONAL MAGNETISM

The March issue of *The Mancoil Educator* illustrates two compasses, one of which is being acted upon by a U-shaped magnet, and the by-line under the illustration reads:

"Overcoming natural magnetism by contact with a stronger magnet." This article should have been called, "What is wrong with this picture?" We will leave it to our readers.—*Martin D. Johnson.*



NOTE: The north seeking pole of a compass is attracted by the south pole of a permanent magnet and repelled by the north pole of the U-shaped magnet. Such a state of stable equilibrium, as illustrated in the diagram, cannot be produced. The point of the arrow will, therefore, point to the south pole of the permanent magnet. Simultaneously, the north pole of the compass to the left will swing around and be attracted by the south end of the compass needle at the right. Therefore, both arrows would be pointing nearly due east, assuming a position indicated by the dotted lines.

## A PERENNIAL AUTOMOBILE

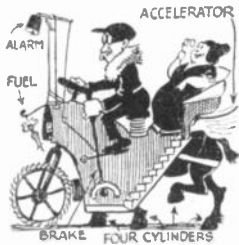

The E. Gray Smith Co. advertise in the *Nashville Tennessean* of May 11, 1925, as follows: "1823 four-cylinder Essex coach." Price .....\$? We never knew that they had autos in 1823. Perhaps Andrew Jackson had two or three such cars. They must improve with age. Aren't the cylinders "bored" after all these years? We would like to know in what museum they are being exhibited.—*Edward J. MacGavock.*

## A BASE BOSS

In the *Chicago Herald and Examiner* of March 8, 1925, we read the following: "No Sub-Boss Used." Looks as though the I. W. W. had not designed the set. Perhaps the tubes and sockets are screwed fast to the boss. He would be a pretty sight walking around town decorated a la five-tube Neutrodyne.—*Fred M. Cole.*



## (TRANS) MIGRATION VIA RADIO



objects through the air." Probably uses

## Money for Mistakes

The newspapers throughout the country, as well as the magazines, occasionally err. Sometimes these errors are misprints. At other times they are pure scientific misstatements. If you happen to see any of these humorous mistakes in the press, we will be glad to have you clip them out and send them to us. Give the name of the newspaper or magazine in which the error appeared and accompany the inclosure with a few humorous lines. The most humorous ones will be printed in this department, and for each one accepted and printed we will pay \$1.00. No NON-SC(i)ENCE entry will be accepted, unless the printed original accompanies the same. Address all NON-SC(i)ENCE entries to:

Editor, NON-SC(i)ENCE Dept.,  
c/o Science & Invention Magazine,  
53 Park Place, New York City.

ionic dissociation. Suppose some of the ions were lost in the transmission. We might out-Burbank Burbank with trunkless elephants and stripeless zebras. Pretty soon we will see elephants flying. What a wonderful sight it would be to see a bunch of rhinoceroses sitting on the telegraph poles, while taking a rest between flights.—*Maurice B. Cofer.*

## HAVE YOUR ABSCESS RENEWED



at a hospital here last night following an operation Monday for the renewal of an abscess of the brain."

Now all you people afflicted with abscesses of the brain, why not have that abscess renewed? After being with you for a while, it is undoubtedly no longer fashionable. Besides, who can tell, you might get a bigger abscess than the one which now serves as your pet.—*Randall K. Barrow.*

**\$11,000**  
for  
demonstration of  
**SPIRITUAL  
PHENOMENON**

This sum will be paid  
by  
**Science and Invention**  
and  
**JOSEPH F. RINN**

for authentic demonstrations of such manifestations as are listed in the full details of the contest, published on page 609 of the October issue of **SCIENCE AND INVENTION**. Contest closes May 1, 1926.

## RIPPING

The *New York Daily News* of May 12th contains the following item: "Katie Pullman, dancer, tore a ligament in her act at the 81st Street Theatre and will be out two weeks." We wonder which part of her anatomy her act is. Perhaps the ligament is one of those elastic things that stretch. A little more information, please. The less the better.—*Shirley Hecht.*



## BRITTLE MUSH

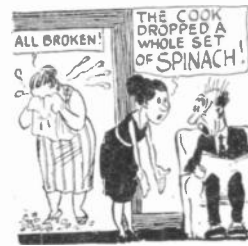

The *New York Daily News* of Wednesday, May 13th, advises in their "Good Cooking" that, "Because spinach is so fragile it is often sterilized over live steam and then rinsed in

cold water." We have heard of glassware being fragile, but never of spinach. Perhaps this is hit with a hammer to soften it, or some medicine may be administered to kind of "shake it down." Spinach is evidently not a hard(y) vegetable.—*Shirley Hecht.*

## HOW TO GROW THIN

The Metropolitan Life Insurance Company of New York has published a book called, "Overweight, Its Cause and Treatment." On the cover of this bulletin, which we reproduce below, is a drawing of a rather stout lady looking into a mirror and appearing thin. Some artists know more about art than about the principles of the reflection of light as obtained in a curved mirror. If this lady looked into a mirror of the curvature illustrated, she would appear to be three or four times as stout as she actually is. If a woman standing in front of this type of

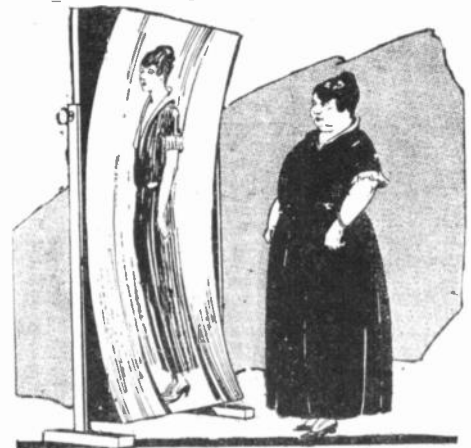
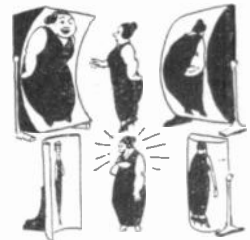

mirror was as stout as is shown by the reflection, an ordinary plain glass mirror would make her appear to be an exclamation mark. and if she stood in front of a mirror curved so as to produce an appearance of thinness, her image would vanish into nothingness. A geometrical line would have nothing on her when it comes to dimensions.—*L. O. Lofquist.*



# THE ORACLE



The "Oracle" is for the sole benefit of all scientific students. Questions will be answered here for the benefit of all but only matter of sufficient interest will be published. Rules under which questions will be answered:

1. Only three questions can be submitted to be answered.
2. Only one side of sheet to be written on; matter must be typewritten or else written in ink, no penciled matter considered.

3. Sketches, diagrams, etc., must be on separate sheets. Questions addressed to this department cannot be answered by mail free of charge.
4. If a quick answer is desired by mail, a nominal charge of 50 cents is made for each question. If the questions entail considerable research work or intricate calculations, a special rate will be charged. Correspondents will be informed as to the fee before such questions are answered.

## GROWING CRYSTALS

(1847) Q. 1. Raymond Hull, Savannah, Ga., asks the method of obtaining large crystals of alum.

A. 1. The simplest way of doing this is by growing the crystals. The apparatus necessary is illustrated herewith. The method is to dissolve as much common alum in hot water as is possible. Suspend a heavy string in this solu-

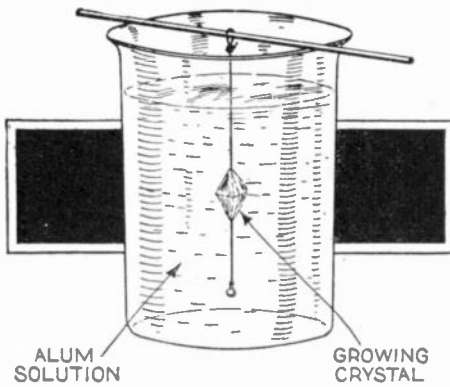

Showing how the simple apparatus is assembled for the growing of an alum crystal.

tion and place in some secluded spot where the solution will not be subjected to jars. In a few hours, crystals will start to form on the string and will grow to quite large sizes. To make them larger, place the string in a newly prepared solution, continuing the process until the desired result is obtained.

## COLD LIGHT

(1848) Q. 1. Harold Strickler, McPherson, Kansas, asks if literature on cold light substances is available and also for some general directions in the preparation of the same. He mentions several formulas that have been published in this magazine.

A. 1. The information available on cold light substances is very meager and in the preparation of them extreme care must be taken to have all of the materials used absolutely pure. Extreme cleanliness must be observed throughout the preparation. The several formulas that you mention have been tried and when the above precautions are followed, excellent results are obtained. If you will give us full information on the processes followed by you and exactly what results were obtained, we will be only too glad to assist you further.

## STATIC ELECTRICITY

(1849) Q. 1. Eugene Sullivan, Acton, Ont., Canada, asks if there is any connection between the charging of a piece of metal with static electricity and charging the same piece of metal with magnetism. He also wants to know how long a static charge will reside on the surface of a steel bar.

A. 1. Charging a piece of steel with static electricity is nothing like charging it with magnetism as the two are entirely distinct operations. The length of time which a static charge will reside on the surface of a steel bar depends on the size of the bar, the amount of charge and other factors such as atmospheric conditions and insulation from the ground.

## LIGHTNING ARRESTERS

(1850) Q. 1. V. S. Sterrett, Rockfield, Indiana, asks: What are the essential features of a lightning arrester system on outdoor electrical installations such as a telegraph and telephone lines? Is insulation provided, if so, why?

A. 1. The main necessity for a lightning arrester system is that it be capable of carrying static charges to the earth before they accumulate in sufficient quantity to cause a lightning discharge. Insulation is usually provided so that if the charges have become too strong, they will

not damage surrounding objects, but will be conducted directly to the ground.

## TELEPATHY

(1851) Q. 1. John T. Rowe, Milwaukee, Wis., says that a certain friend of his claims that someone is using some sort of a radio device for "listening in" on his friend's thoughts and that the friend hears voices asking questions by means of the same device. He asks if such a machine has ever been devised.

A. 1. No general radio telepathic machine has ever come to our attention and we believe that your friend is having hallucinations when he believes that he is hearing the voices of men asking questions in connection with the political case in which he is involved. Several instances of mild mental derangements of this kind have come to our attention and each and every one has proven to be on the lines suggested above.

## Important Articles to Appear In July Issue of "The Experimenter"

- Circuit Analysis. By Leon L. Adelman, Assoc. I. R. E.
- Short-Wave Amateur Receiver. By Alfred R. Marcy, Assoc. I. R. E.
- An Excellent Broadcast Receiver. By Joseph H. Kraus.
- The Pianor, An Electric Piano. Interesting Experiments in Organic Chemistry. By E. W. Blank.
- Home-Made Oscillating Rectifier. By Siegfried Langsdorff.
- Experiments With Tesla Resonator. By Kenneth M. Swezey.
- Iron Clad Lifting Magnet. By William J. Edmonds.

## MOTOR STARTER

(1852) Q. 1. Joseph J. Nachman, Rochester, New York, asks information on the principle of a motor starter.

A. 1. A motor starter is shown diagrammatically herewith. It merely consists of three or more resistance coils connected to switch points so that as a lever passes over the points, the coils will be successively cut in and out of the circuit.

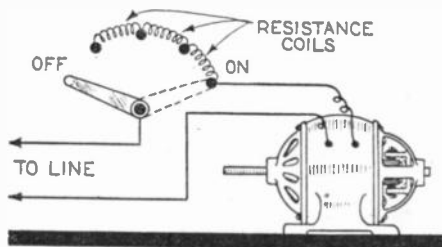

How the resistance coils in a small motor starting box are connected and used.

The reason for an instrument of this type on large motors is to prevent the burning out of the armature before the motor is well under way. Starting boxes for small motors may be simply and easily constructed by the amateur mechanic.

## CHEMICAL COMBUSTION

(1853) Q. 1. Wm. J. Osbahr, Weimar, Texas, asks how a fire may be started by chemical means.

A. 1. One method of doing this is to pulverize a small amount of potassium chlorate in a clean porcelain mortar. Reduce the chemical to a very fine powder, but make sure that the mortar is perfectly clean and that the chemical is free from dust. During the pulverizing, avoid violent percussion or heavy pressure. Place the powder on a sheet of paper and add a like volume of granu-

lated sugar which has also been reduced to powder and which is perfectly dry. Mix carefully, being sure not to rub the two materials. Put the mixture on a non-inflammable block in a strong draft of air. Place a drop of sulphuric acid on the mixture, though a thistle tube as shown, or by picking up the drop of acid on the end of a glass rod. A quick chemical action will follow and a violet colored flame will be seen.

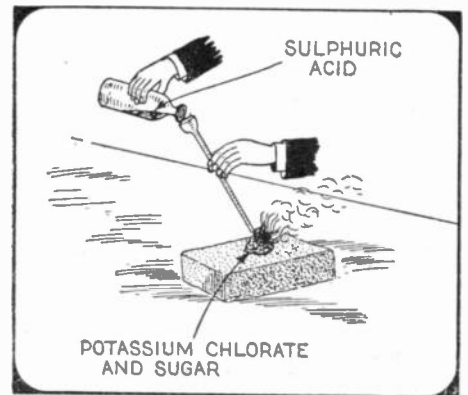

Sulphuric acid being added to a chemical mixture for demonstrating chemical combustion.

## RECTIFIER TROUBLE

(1854) Q. 1. Albert Schaefer, Buffalo, New York, says that he has built a small battery charger after directions published in this magazine and asks if he should use one 100-watt lamp in the circuit when charging a 12-volt, 60-ampere hour storage battery.

A. 1. The storage battery charger which you mention is not designed to charge a battery of the size you speak of. We would advise you to construct a charger along the same line, but using plates 4 x 5 inches in dimension. Four lead plates and four aluminum plates will be necessary and they should be connected up as shown in the magazine.

In connection with this charger, you should use five 100-watt lamps connected in parallel and in turn connected in series with the charger. The same will hold true for a 6- or 8-volt automobile battery.

## SPANGLES

(1855) Q. 1. Gustave Soeder, Brooklyn, New York, asks how the iridescent spangles used for decorating women's dresses are made.

A. 1. Usually some form of glass or quartz crystals are used for the work you mention. They are cut so that the resulting facets reflect light and give forth an iridescent effect. Various opalescent and colored glasses are also used and are usually cut in the same manner. The effect depends upon the reflection of light from the cut surfaces.

## MAGNETISM

(1856) Q. 1. A. Soskind, Bronx, New York, asks how much magnetic power would be needed to pull an ordinary sewing needle through a wooden board 1/8th of an inch thick.

A. 1. We doubt very much if it would be possible for you to draw a needle through a one-eighth inch wooden board by means of a magnet of any size whatsoever. Upon actuating the magnet you would find that the needle would be magnetically attracted, but would not be drawn through the board.

## SLANTING REFLECTION

(1857) Q. 1. Howard W. Smith, Grinnell, Iowa, says that he has noticed that as he is walking along a certain sidewalk towards a glass paneled door, that his reflection in that door appears to be slanting toward one side. He asks us to explain this phenomenon.

A. 1. Undoubtedly the slanting reflection which you have noticed is due to a slight inclination of the glass panels in the door or to some irregularity in the glass itself.

**HORSE-POWER OF WATER MOTOR**

(1858) Q. 1. Murray McDonnell, St. Charles, Ill., says that he has a standard type of water motor and desires to know a simple laboratory method of determining the horse-power of the same.

A. 1. Our diagram herewith shows the various apparatus necessary for this experiment. The pressure gauge may be used or not as desired, but it is of advantage in many experiments. Turn the water on full and increase the load by adding more weights at the point indicated, until the motor appears to be working very hard, while still running steadily at a fair rate of speed. Count the number of turns or revolutions per minute at the drive pulley or the pulley attached to the water motor. At the same time note the average reading of the balance in pounds and the amount of the suspended weights in pounds. Make several trials under widely varying loads, averaging the result. Measure the diameter of the bottom of the groove in the drive pulley. With the motor running steadily, the pull on the balance in pounds will be less than the weight. The difference represents the load carried by the motor. The load in pounds multiplied by the circumference of the drive pulley in feet gives the work done in foot pounds per revolution. The work done per revolution, multiplied by the number of R.P.M. equals work done in foot pounds per minute. This figure divided by 33,000 equals the number of horse-power developed by the water motor.

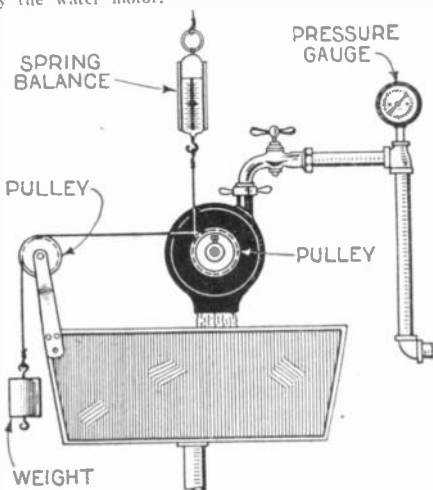

The set-up of the apparatus for determining the horse-power of a water motor.

**GRASSHOPPERS**

(1859) Q. 1. Henry Sendbeck, Bronx, New York, says that he has recently caught grasshopper, the color of the wings on the same being bright red underneath, but a dull green on top. He asks if this is some unusual type of insect.

A. 1. In the spring, young grasshoppers have the bright shiny red which you describe under their wings and when their wings are closed, a dull green on top. The red gradually disappears with the coming of summer and is practically entirely gone by the end of summer.

**TEST FOR DISTILLED WATER**

(1860) Q. 1. A. C. Singer, McKees Rocks, Penna., asks: What is a simple test for pure distilled water?

A. 1. The simplest test for pure distilled water is to place a small quantity of it in a glass evaporating dish, a so-called watch glass, and heat it over a Bunsen burner. After the material has completely evaporated, examine the dish and any foreign substances will be found therein.

Q. 2. What is a test for oil in water?  
A. 2. The same test is used for oil, but the heat is kept at a low point so that any oil which may be present will not be volatilized. Most oils will float on the surface of water and be visible.

**MOTORCYCLE ENGINE**

(1861) Q. 1. Lester Sinram, Clarksville, Iowa, asks whether or not we believe that a four-cylinder motorcycle engine will stand the same hard usage as a two-cylinder engine.

A. 1. Due to the fact that the vibration in a well balanced four-cylinder motorcycle engine will be less than in a two-cylinder, we believe that it will stand up much better under the same amount of usage.

Q. 2. What is your opinion on the relative values of aluminum pistons and light weight cast iron pistons?

A. 2. Although the aluminum pistons used in engines today are very good and will last for a considerable length of time, still in our opinion, cast iron pistons of the light weight type are the best. There are several reasons for this, among them being the fact that the cast iron piston is fitted closer to the cylinder as expansion does not have to be allowed for to such a great extent as in the aluminum piston.

**More Text!**

You will note that in this issue we have published several articles incorporating more text than usual. We are going to do this regularly, and thus combine picture and text make-up on a 50-50 basis, in an effort to make all our readers happy.

We find that the main objection to the aluminum piston is that since it is not fitted closely, the piston rings must be relied upon to keep up the compression, whereas in the cast iron piston, the compression is aided by the close fitting piston, and the engine is not so liable to "pump" oil from the crank case into the cylinders.

**TRANSFORMER POWER**

(1862) Q. 1. Miss Laura L. Smith, Pleasantville, N. J., says that she is unable to reconcile the fact that in a transformer, the amperage in the secondary decreases as the voltage increases. She asks us to explain.

A. 1. The decrease in amperage when the voltage increases in the secondary of a transformer can readily be understood by referring to the wattage. We know that a certain number of watts are being put into the primary and we know that there is a certain ratio of turns between the primary and secondary which governs the voltage of the latter, that in the primary being known. Theoretically there will be the same number of watts in the secondary circuit of a perfect transformer as in the primary, although in practice, there is quite a difference due to losses in transformation. Thus by dividing the voltage of the secondary circuit into the number of watts consumed by the primary, we obtain the number of amperes in the secondary circuit. You can therefore see that if the secondary voltage is higher than the primary, the amperage will be lower and as the voltage increases, the amperage will have to decrease.

**HECTOGRAPH**

(1863) Q. 1. E. M. Price, Somerville, Ohio, asks how to transfer pictures and printed matter by means of a hectograph.

A. 1. When items are printed with regular printer's ink, they cannot be reproduced on a hectograph as the latter requires an original copy made with a special ink. The only simple way to transfer fresh newsprint to plain paper is to rub over the surface of the same a piece of paraffin wax. Lay the newsprint face down on a clean sheet of paper and rub the back thoroughly with a hard smooth object. Upon removing the paper it will be found that the white sheet has thereon a copy of the newsprint. Of course, in using this method everything will be reversed.

**GASOLINE TURBINE**

(1864) Q. 1. A. Sanders, Petaluma, Calif., asks where complete details on the Tesla gasoline turbine may be obtained.

A. 1. A complete detailed description of the Tesla gasoline turbine appeared in the July, 1920, issue of SCIENCE AND INVENTION.

**IMPORTANT TO NEWSSTAND READERS**

IN order to eliminate all waste and unsold copies it has become necessary to supply newsstand dealers only with the actual number of copies for which they have orders. This makes it advisable to place an order with your newsdealer, asking him to reserve a copy for you every month. Otherwise he will not be able to supply your copy. For your convenience, we are appending herewith a blank which we ask you to be good enough to fill in and hand to your newsdealer. He will then be in a position to supply copies to you regularly every month. If you are interested in receiving your copy every month, do not fail to sign this blank. It costs you nothing to do so.

.....

To ..... Newsdealer

Address .....

Please reserve for me ..... copies of SCIENCE & INVENTION every month until I notify you otherwise, and greatly oblige.

Name .....

Address .....

**AUTOMOBILE STARTING MOTOR**

(1865) Q. 1. George A. Rogers, Memphis, Tenn., asks whether or not an automobile starting motor will run on A. C. Will a transformer in the A. C. line be of any assistance in this work?

A. 1. Your automobile starting motor might run on A. C. if it is series wound. We would suggest that you try it. In any event, it will probably require a slight start by hand before it will pick up speed. If the motor will not run in this manner, you cannot use any transformer to help it along, except to reduce the voltage applied to the proper value for the motor.

**LENZ' LAW**

(1866) Q. 1. Adolph Rothman, Cranford, N. J., asks: What is the law of electricity known as Lenz' law and how may it be demonstrated?

A. 1. The law may be stated as follows: "An induced current is always in such a direction as to resist, by its electromagnetic action, the motion by which it is produced." This law may be demonstrated by means of the laboratory apparatus illustrated herewith. A sheet of copper is hung in pendulum fashion so that it can swing edgewise between the poles of a powerful electro-magnet. As the current is turned on in the latter and the pendulum swung down swiftly, it will be instantly checked as it comes between the magnetic poles since there are currents induced in the copper which resist the motion, being governed by Lenz' law mentioned above. This current finally results in heat in the copper pendulum.

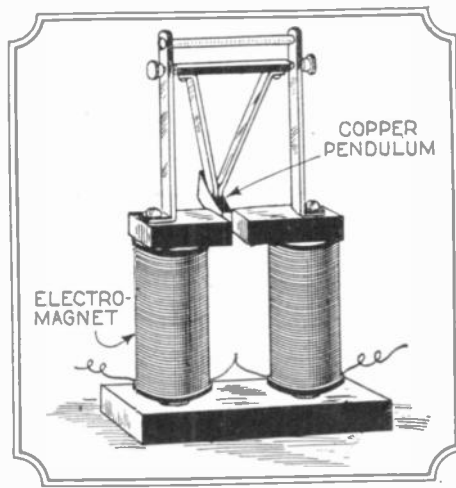

A laboratory model for demonstrating Lenz' law of induced currents.

**TELESCOPE**

(1867) Q. 1. Hazen Sorrell, Laredo, Texas, asks how to make a simple telescope.

A. 1. Several instruments of this nature have been described in past issues of this magazine. A very good telescope can be made of a two-inch diameter tube, 40 inches long, painted black inside and out. The object lens should be a double convex with a 30-inch focus placed in one end of the tube. The eye piece should consist of two plano-convex lenses with 1 1/2-inch focal lengths and about 3/8 of an inch in diameter, mounted in a tube about 3 inches long, capable of being slid back and forth in the other end of the long tube to secure a good focus.

**WATER-PROOF SOLUTION**

(1868) Q. 1. E. Runnebaum, Cartago, Costa Rica, asks how a water-proof solution for coating corks may be made from rubber. He states that he has made several solutions which have a disagreeable odor and desires one which will not have this drawback.

A. 1. We regret to say that we do not have any formulas on hand which would enable you to make the solutions you mention. As far as we have any record, all rubber solutions of the type you mention have a peculiar odor.

Why could you not use something similar to paraffin wax for covering your stoppers? We believe that this would be as efficient and much cheaper.

**STORAGE BATTERIES**

(1869) Q. 1. I. J. Rider, Portland, Ore., asks why Edison storage batteries are not normally used for automobile starting.

A. 1. Edison storage batteries can be used for automobile starting, but they are bulkier, for the reason that each cell gives about 1 volt. Six cells would have to be used instead of three, as in lead batteries.

Q. 2. How much of the energy used for charging a storage battery is returned in useful work?  
A. 2. From 70 to 75 per cent. of the energy is returned in useful work from both the types of batteries mentioned above.

# Prizes of More Than \$28,000.00 Offered by Science and Invention Magazine

## \$5,000.00 in Prizes For Perpetual Motion

**N**O—a perpetual motion machine has not yet been invented in spite of many reports to the contrary. SCIENCE AND INVENTION'S \$5,000.00 prize award still remains unclaimed. No one has as yet produced the model of a perpetual motion machine required by the contest rules.

This publication does not believe that perpetual motion is possible. It brands as imposters all who have claimed to have developed a working model of a perpetual motion machine. This statement applies also to those who have "destroyed the model because they feared that the idea would be stolen, and they would get nothing for their years of labor and suffering humanity would not be benefited."

The sum of \$5,000 is amply sufficient to protect any idea and will more than pay for a patent on the same. SCIENCE AND INVENTION does not desire the rights to the invention. They merely want to see the model in working condition. The conditions of the contest are that the device be brought or shipped to the offices of SCIENCE AND INVENTION MAGAZINE; that there is no trickery in making the mechanism work, and that the device work by gravity. Mechanism operating by atmospheric pressure changes, temperature changes, or humidity, are not considered perpetual motion devices. This contest is open to everyone. We suggest that our readers refer to the March, 1925, issue of this publication, and meanwhile also advise them not to invest in any machines being made to compete for this prize.

## \$11,000.00 in Prizes For Psychological Phenomena

**W**HAT has happened to all the mediums who received messages from the dead? What became of the mediums who were capable of producing actual manifestations and who gave wonderful daylight trumpet seances, and who on platforms and at their meetings openly invited investigation, but who, when they are called upon, did not respond or feigned that they were too busy, or made some other illogical excuses.

For more than two years SCIENCE AND INVENTION MAGAZINE and Mr. Joseph F. Rinn offered a total of \$11,000.00 in prizes for proof of spiritualism and psychological phenomena. The conditions of these offers were explained in the August, 1923, issue and again in the October, 1924, issue of this publication in the "Readers' Forum" Department. The conditions of this contest are briefly that the medium must produce some form of a psychological phenomenon which is not accomplished by the aid of trickery.

And it goes without saying that this contest is open to all mediums, regardless of where they may be. Up to the present time the editors of this publication have seen no genuine proof of spiritualism.

These statements naturally imply that spiritualism or psychological phenomena do not occur. The statements also imply that those who have "sitters" at their "circles" are evidently using trickery to hold their clients. All sorts of excuses may be offered by mediums as to why they do not care to enter their names in this contest, but an excuse at its best is merely a statement of inability to live up to the contest rules.

### Other Pending Contests

\$100.00 in Prizes For Circuit Diagram of the Mystery Set Announced in the May issue of this publication. Contest Closes July 2, 1925.  
Twenty Combination Pen-Pencils Awarded as Prizes in the Cut Flower Contest Announced in the June issue of this publication. Contest Closes July 30, 1925.

\$250.00 in Prizes Awarded for the Best Methods for Exterminating Rats. Contest Announced in This Issue and Closes Noon, October 15, 1925.

## \$1000.00 Monthly Contest Awards

<b>FIRST PRIZE \$100.00</b>	
25 New Flowers in 25 Years—Burbank, by H. H. Dunn.....	210-211
<b>SECOND PRIZE \$75.00</b>	
Exploring Sargasso Sea, by J. W. Von Stein.....	208-209
<b>TWO PRIZES OF \$50.00 EACH</b>	
What Is Gravitation? by Prof. Donald H. Menzel, Ph.D.....	222-223
Tricks of Mediums, by Edward Merlin.....	226
<b>THREE PRIZES OF \$35.00 EACH</b>	
Talking Movies in the Home, by Russell Raymond Voorhees.....	220-221
Keeping the Kitchen Cool, by Christine Frederick.....	227
Home-Made Fireworks, by Raymond B. Wailes.....	241
<b>FIVE PRIZES OF \$25.00 EACH</b>	
Oenothera, the Evening Flowering Primrose, by Dr. E. Bade.....	217
Our Earth's Atmosphere, by Joseph M. Howard.....	218
Three-Circuit Tuner—Push-Pull Amplifier, by Sidney E. Finkelstein.....	252
A Miniature Phonograph Loud Speaker, by Leon L. Adelman.....	252
Four-Tube Portable, by Sidney E. Finkelstein.....	253
<b>FIVE PRIZES OF \$20.00 EACH</b>	
A Movie Stadium, by Dr. Albert Neuburger.....	215
The Newspapers of the U. S., by Charles N. Holmes.....	215
The Lime Rays of the Moon, by Donald P. Beard.....	219
How to Photograph the Stars, by Don Home.....	219
Measuring Heights with a Match Box, by C. A. Oldroyd, Reporter No. 4433.....	242

<b>TEN PRIZES OF \$15.00 EACH</b>	
Life Saver, by H. S. Wood.....	239
Egg Cooker, by R. G. Thackwell.....	239
Battery Meter, by J. W. Von Stein.....	239
Engine Hear Indicator, by Thomas W. Benson.....	239
Musical Cane (author please send address).....	239
Toy Locomotive, by C. A. Oldroyd.....	240
Shaving in Comfort, by P. C. G.....	240
Auto Hub Cap Lights, by L. O. Van Riper.....	242
Automatic Fisherman, by Jacob Schmidt.....	242
Lights for the Photographer, by Herbert E. Hayden.....	243
<b>FIFTEEN PRIZES OF \$10.00 EACH</b>	
Collar Button, by J. W. Von Stein.....	239
Picture Hanger, by J. W. Von Stein.....	239
Phone Adaptor (author please send address).....	289
Pill Box Mike (author please send address).....	289
Polarity Indicator, by Jos. B. Miller.....	290
Switch Points, by Geo. Wendt, Reporter No. 15816.....	290
A Novel Tuner, by Arthur A. Blumenfeld.....	290
Low-Loss Coils, by Wilkes Dunhill.....	291
Rectifier Jar, by E. E. Laufer.....	291
Adjustable Switch, by Howard Allen Duncan.....	291
Binding Post, by G. H. Schmid.....	291

FOR INNER TUBE AWARDS SEE PAGES 230 AND 231  
No further entries.

## \$12,000.00 in Prizes for Articles

82 monthly prizes will be given as follows:

<b>FIRST PRIZE \$100.00</b>	
<b>SECOND PRIZE \$75.00</b>	
<b>2 PRIZES OF \$50.00 each</b>	
3	" " 35.00 "
5	" " 25.00 "
5	" " 20.00 "
10	" " 15.00 "
15	" " 10.00 "
10	" " 5.00 "
15	" " 2.00 "
15	" " 1.00 "

Last year SCIENCE AND INVENTION Magazine paid for articles \$13,320.00 to 1,112 prize winners. Hundreds of SCIENCE AND INVENTION reporters won prizes, and up to the time of going to press there were more than 21,000 reporters in the field.

Every month this publication pays \$1,000.00 or more in prizes, exclusive of money paid to those authors who are on contract, and who receive their own rates. At the left the list of prizes issued monthly is itemized, and above are the names of the prize winners for this issue. In order to assist our reporter correspondents in securing available material for publication, we issue without charge the reporter's card, a sample of which is illustrated at the right. Send a postal card for one. It will act as an open sesame in securing news. Address Field Editor, SCIENCE AND INVENTION, 53 Park Place, New York City.

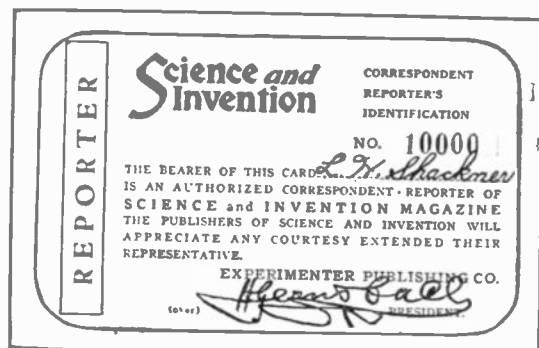

(Note—Unavailable material not accompanied by postage will not be returned.)

# How to Build The Ultradyne (Model L-2)

by R. E. Lacault, E.E., A.M.I.R.E.  
*formerly Associate Editor, Radio News*

How You Can Build This Remarkable Super-Heterodyne In Your Own Home



R. E. LACAULT

Designer of the Ultradyne Receivers and formerly Associate Editor of Radio News, is now Chief Engineer of the Phenix Radio Corporation.



A Home Built Ultradyne

THE Ultradyne Model L-2 is an improved Super - Heterodyne designed to so simplify its assembly that anyone can successfully build it at nominal cost and enjoy even greater performance than with any other type of Super-Heterodynes.

Every step is explained in an illustrated thirty-two page book, "How to Build and Operate the Model L-2 Ultradyne," in a non-technical way that one knowing nothing of radio finds easy to follow. Thousands have built the Ultradyne Model L-2 from instructions in this book, and thousands like Arthur Bender of 116 East Second Street, Covington, Ky., say it's the most wonderful receiver they have ever known.



The "Modulation System" of radio reception and the successful application of regeneration are vital features incorporated exclusively in the Model L-2 Ultradyne that give it greater sensitivity, greater range on the loud speaker and greater selectivity, than any other Super-Heterodyne. The Ultradyne Model L-2 detects the faintest broadcast signals—signals that other receivers fail to get, regenerates and makes them audible on the loud speaker. The Ultradyne easily tunes out

powerful local broadcasting completely and brings in distant stations clearly on the loud speaker. No other Super-Heterodyne can give you such performance.

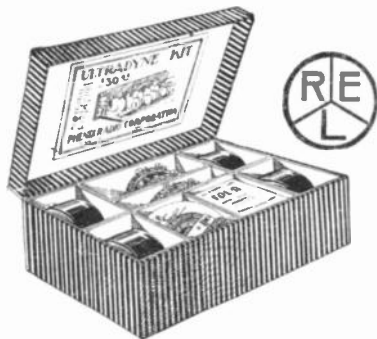

The Ultradyne Kit furnishes all special parts, required to build the Ultradyne, with these superior Super-Heterodyne features. The kit contains 1 low loss Tuning Coil, 1 low loss Oscillator Coil, 1 special Type A Ultraformer, 3 Type B Ultraformers, 4 matched fixed Condensers. The complete kit can be bought for \$30 from any reliable dealer. The Ultraformers are new, improved long wave radio frequency transformers, specially designed for the Ultradyne Model L-2 and are vital to the unusual efficiency of the receiver. To protect the public against imitation, every Ultraformer carries the

Lacault monogram seal (R. E. L.) and is guaranteed so long as this seal remains unbroken.

The Ultradyne Model L-2 has met with phenomenal success—success built purely on performance alone—its system of radio reception has been the envy of the largest radio manufacturers in the country. Now anyone who uses the Ultradyne Kit and follows instructions can build the Ultradyne Model L-2, the improved Super-Heterodyne, with positive assurance of getting better results than with any other super radio receiver.

## ULTRADYNE MODEL L-2

This trademark (Ultradyne) is a guarantee of perfection and satisfaction in a radio receiver, and applies to all receivers designed and built under the personal supervision of R. E. Lacault.

**25¢ This Coupon is Worth 25¢**

PHENIX RADIO CORPORATION, S&I  
114 East 25th St., New York City.

Gentlemen: Enclosed find 25c in stamps, together with coupon valued at 25c, for which please send me your regularly 50 cent priced Book of Instructions on "How to Build and Operate Ultradyne Model L-2."

Name .....

Address .....



## Beautifully Phrased, but—

\* \* \* \* \*

IT was an important letter. Neatly typed. Beautifully phrased. But it didn't get read!

*It was too formidable in appearance!*

That is the trouble with millions of letters today that are written on ordinary typewriters. But it can never be said about a Hammond-typed letter.

*For the New Hammond is different!*

### What It Does

It permits a variety of typographical effects that make things attractive and readable. It writes in any kind of type you want—large, medium or small; Roman, Italic, Bold, Script, etc.—or in any language desired. It spaces to fit the size. All in one machine. The change from one style or size to another style or size may be made instantly. You simply shift gears as in an automobile.

Writers, public men, business executives everywhere are turning to the New Hammond today as a means of gaining attention for what they have to say.

*Write for illustrated booklet explaining the hundreds of ways it can be made to serve you. Hammond Typewriter Corporation, 72 Brook Avenue, New York.*

Both Desk and Portable Models

THE NEW  
**Hammond**  
TYPEWRITER  
VARIABLE SPACING  
CHANGEABLE TYPE

“IT ALL BUT SPEAKS”

You can be quickly cured, if you

**STAMMER**

Send 10 cents for 288-page book on Stammering and Stuttering. "Its Cause and Cure." It tells how I cured myself after stammering 20 yrs. B. N. Bogue, 8118 Bogue Bldg., 1147 N. Ill. St., Indianapolis

## Tarrano the Conqueror

By RAY CUMMINGS

(Continued from page 225)

Allied Mongolia was dead—murdered under similar circumstances. And ten minutes later from Mombozo, Africa, the blacks reported their leader killed while asleep in his official residence.

The Earth momentarily was without leadership!

I was struggling to get accounts of these successive disasters out over our audiophones. Above my desk, in a duplicating mirror from Headquarters, I could see that at the palace of Mombozo a throng of terrified blacks were gathered. It was night there—a blurred scene of flashing lights and frightened, milling people.

Greys-son—next to me—had a mirror tuned to Tokyohama. The sun there was shining upon almost a similar scene of panic. Black and yellow men—on opposite sides of the Earth. And between them our white races in turmoil. Outside my own window I could hear the shouts of the crowd that jammed the Twentieth Level.

Greys leaned toward me. "Seven o'clock, Jac. You've got the arrival of the Venus mail. Don't overlook it. . . . By the code, man, your hands are shaking! You're white as a ghost!"

I grinned at him. The Venus mail; I had forgotten it completely.

"Greys, I wonder if it'll get in."

He stared at me strangely. "You're thinking that too. I told the British National Announcer it was a Venus plot. He laughed at me. Those Great Londoners can't see their fingers before them. He said, 'That's your lurid sense of newscasting. Keep it very well out of this.'"

Venus plot! I remembered my impressions of the Venus-man who was beside me when our President fell.

Greys was back at his work. I swept the south shore of Eastern Island\* with my finder, and picked up the image of the Inter-planetary landing stage, at which the Venus-mail was due to arrive. I could see the blaze of lights plainly; and with another, closer focus I caught the huge landing platform itself. It was empty.

The station-master there answered my call. He had no word of the mail.

"Try the lookout at Table Mountain," he advised me. "They may be coming down that way. . . . Sure I'll let you know. . . . What a night! They say that in Mediterranean!"

But I cut off; it was no time to chat with him. Table Mountain, Capetown, had no word of the mail. Then I caught the Yukon Station. The Mail flyer had come down on the North Polar side—was already crossing Hudson Bay.

At 8:26 it landed on Eastern Island. A deluge of Venus despatches overwhelmed me. But the mail news, before I could even begin to handle my section of it, was far overshadowed. Venus, now at 8:44 was calling us by helio. The message came in the Inter-planetary code, was decoded at National Headquarters, and from there flashed to us.

The Ruler of the Venus Central State was murdered! An almost incoherent message. The murder of the Ruler, at a time co-incidental with 6:30 in Great New York. Then the words:

*"City being attacked. . . . Tarrano, beware Tarrano. . . . You are in danger of*

*in danger of what? The message broke off. The observers, behind their huge tele-*

scopes at the Potomac Headquarters, saw the helio-lights of the Venus Central State go dark suddenly. Our own station flashed its call, but there was no answer. Venus—evening star on that date—was sinking to the horizon. But our Observatory in Texas could see the planet clearly; and gave the same report.

Communication was broken. The authorities of the Venus Central State—friendly to us in spite of the recent immigration controversy—had tried to warn us.

Of what?

### CHAPTER II

#### THE WARNING

It must have been nearly nine o'clock when a personal message came for me. Not through the ordinary open airways, but in the National Length, and coded. It came to my desk by official messenger, de-coded, printed and sealed.

*Jac II, Son of Jac Hallen, Inter-Allied news. Come to me, North-east Island at once, if they can spare you. Important. Answer.* Dr. Brende.

Our Division Manager scanned the message curiously and told me I could go. I got off my answer. I did not dare call Dr. Brende openly, since he had used the code, but sent it the same way. I would be up at once.

With a word of goodbye to Greys, I shoved aside my work, caught up a heavy jacket and cap and left the office. The levels outside our building were still jammed with an excited throng. I pushed my way through it, up to the entrance to the Staten Bridge. The waters of the harbor beneath me had a broad band of moonlight upon them, dim in the glare of the city lights. I glanced upward with satisfaction. A good night for air-traveling.

My small personal air-car was on the stage near the bridge entrance. The attendant was there, staring at me as I dashed up in such haste. He handed me my key from the rack.

"Going far, Jac? What a night! They'll be ordering them off if many more go up. . . . Going north?"

"No," I said shortly.

I was away, rising with my helicopters up till the city was a yellow haze beneath me. I was going north—to Dr. Brende's little private island off the coast of Maine. The lower lanes were pretty well crowded. I tried one of the north-bound at 8,000 feet; but the going was awkward. Then I went to 16,000.

But Grille, the attendant back at the bridge, evidently had his finder on me, out of plain curiosity. He called me.

"They'll chase you out of there," came his voice. "Nothing doing up there tonight. That's reserved. Didn't you know it?"

I grinned at him. In the glow of my pit-light I hoped he could see my face and the grin.

"They'll never catch me," I said. "I'm traveling fast tonight."

"Chase you out," he persisted. "The patrol's keeping them low. General Orders, an hour ago. Didn't you know it?"

"No."

"Well, you ought to. You ought to know everything in your business. Besides, the lights are up."

They were indeed; I could see them in all the towers underneath me. I was flying

(Continued on page 270)

\*Now Long Island.

# "BUILD YOUR OWN" WITH "RASCO" PARTS!

Buy from the Oldest and Original Exclusive Radio Parts House in the United States  
We pay ALL transportation charges in U. S. ALL GOODS SENT PREPAID IN 24 HOURS

Order direct from this page.

## SPECIAL PRICES FOR JULY

Money refunded if goods do not satisfy

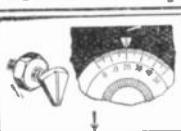

**Dial Marker**  
The big little thing you have been waiting for. Just drill a hole in the marker and mount the dial. Nickel plated and polished. L788 Dial Marker, three for .....\$1.10

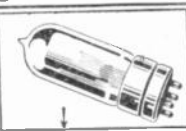

**Vacuum Tubes**  
Only best make tubes carried in stock. Any tube replaced if defective, providing filament lights.  
**SPECIAL PRICES**  
L701A 5 v., .25 amp. \$1.95  
L799 3 v., .06 amp. 1.95  
L72 1 1/2 v., .23 amp. 1.95

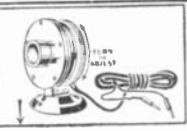

**Melotone Loud Speaker**  
The greatest and most powerful loud speaker phonograph attachment made. If, after five days trial, you do not proclaim it the best and most powerful speaker return it for refund.  
L6699 Melotone.....\$6.90

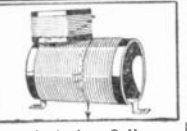

**Cockaday Coil**  
Guaranteed best make. Three windings of No. 18 Magnet wire. Has brass brackets for panel or base mounting. Satisfaction guaranteed or money back.  
L2750 Cockaday coil \$1.50

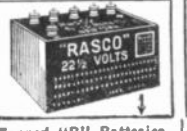

**Tapped "B" Batteries**  
We positively guarantee these batteries to be of long life. We carry only fresh stocks. All with tans.  
L2250 Sm. 2 1/2 v. ....\$.85  
L2251 Medium Navy size. 2 1/2 volt. ....1.20  
L4500 Medium large size. 45 volt .....2.30

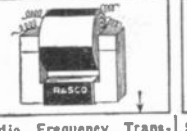

**Audio Frequency Transformer**  
No Better Transformer made. Highest class materials. Impregnated coils. Silicon steel stampings used. Save 50 per cent by assembling it yourself.  
L1100 Ratio 4:1-1. \$1.85  
L1150 Ratio 6 1/2-1. 1.85

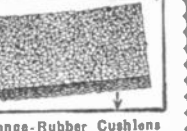

**Sponge-Rubber Cushions**  
Get rid of tube noises due to vibration. Softest sponge rubber made. Size 2 1/2"x3", 3/8" thick.  
L8989 Sponge-rubber cushions, each .....\$.12  
Six for .....\$.60

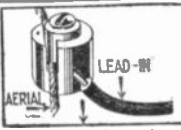

**Antenna Connector**  
At last the solderless antenna connector, made entirely of brass in three pieces; clamps aerial and lead-in with vise-like grip, keeping perfect contact at all times. Dia. 3/4", height 1/4".  
L9994 Connector.....\$0.20

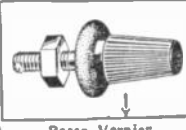

**Rasco Vernier**  
Why use a vernier condenser when a vernier attachment will do anything and everything a vernier condenser accomplishes? Cleverest vernier made. Can be used with any dial. Soft rubber ring engages dial. Nothing to come apart.  
L1450 Vernier .....\$.18

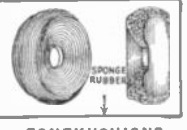

**FONEKUSHIONS**  
Made of sponge rubber. Make wearing your receiver a pleasure. Positively exclude all noises and make reception a pleasure. Sponge rubber will last for years. Light as a feather.  
L3550 Fonekushions, set of two .....\$.35



**Dial Button**  
Made in blue enamel and gold, to be worn in button hole. Every radio fan wants one. 3/8" diameter, best gold plate. Perfect reproduction of radio dial.  
L7799 Dial Button, each .....\$.25

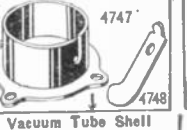

**Vacuum Tube Shell**  
Nickel plated shell for the man who builds his own. 4 holes to attach to sub-base. Each shell comes complete with 4 phosphor bronze socket contacts. See illus. 4748.  
L4747 Vacuum Tube Shell and Contacts .....\$0.10

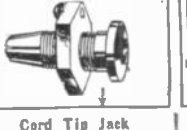

**Cord Tip Jack**  
Takes place of binding posts. Cord tip firmly gripped by jack. Made of brass, nickel plated. Screw to attach lead wire. No soldering necessary.  
L1500 Cord tip jack, Each .....\$.15

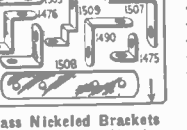

**Brass Nickeled Brackets**  
All illustrations 1/4" size.  
L1505 Bracket, each \$.05  
L1507 Bracket, each .05  
L1509 Bracket, each .04  
L1476 Bracket, each .05  
L1506 Bracket, each .05  
L1490 Bracket, each .04  
L1475 Bracket, each .03  
L1508 Bracket, each .05

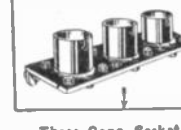

**Three-Gang Socket**  
Aluminum shells, genuine heavy bakelite base. 3 brackets for mounting. 12 nickel binding posts. Length 7/8".  
L5995 3 gang socket \$1.50



**Rasco 180° Variocoupler**  
Silk wire wound on bakelite tubes. Six taps. Wave length, 150 to 600 meters. For panel mounting. 3/4" shaft. Your money refunded if it is not all we claim.  
L3100 Variocoupler prepaid .....\$1.50

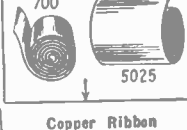

**Copper Ribbon**  
.005" thick.  
L700 3/4" wide; L701 1/2" wide; L702 3-16" wide. All sizes per foot. \$.01  
**Copper Foil**  
.001" thick. 4" wide.  
L5025 Copper Foil, per foot .....\$.10  
16-foot length .....\$.80



**Rasco Clip Leads**  
Invaluable for experimental work. Clip lead hooks in a jiffy onto any wire, binding post or conductor. Safest experimental connection. Brass clips. 1 foot silk wire, green or red.  
L7887 Clip Leads, ea. \$1.12  
Dozen lot .....1.35

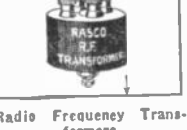

**Radio Frequency Transformers**  
Best Radio Frequency Transformer developed so far. Designed by R. E. Lacault, Inventor of Utradyna. Air core type. 200-600 meters.  
L2800 Transformer, size 1 1/2"x2 1/2" .....\$1.35

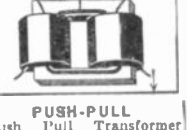

**PUSH-PULL Transformer**  
Push Pull Transformer for many new circuits. See any radio magazine of Standards. Beautiful high finish. Coils impregnated. Silicon steel laminations. Save 50 per cent by assembling yourself. Simple instructions furnished.  
L1459 Push-Pull Transformer, ratio 6 1/2 to 1 \$3.40



**Diestryto Panels**  
Highest dielectric strength as per Bureau of Standards. Beautiful high finish.  
L7100 7x10x3-16" .....\$.70  
L7120 7x12x3-16" .....\$.85  
L7140 7x14x3-16" .....\$.95  
L7180 7x18x3-16" .....1.25  
L7210 7x21x3-16" .....1.45  
L7240 7x24x3-16" .....1.65

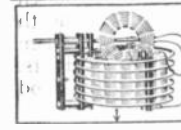

**Low Loss Tuner**  
Same type as used in our LOLOS EXPLORER. Tunes from 200 to 600 meters. Hard rubber insulation throughout. Silver plated primary. Secondary D. C. C. Ticker silk insulated wire.  
L2690 Tuner .....\$5.00



**"T" Wire Connectors**  
This big little article solves all troubles when making "T" wire connections. Made to take 1/16" square or round bus-bar wire. Can be attached with a pair of pliers.  
L2975 "T" Wire Connectors, 12 for.....\$0.05

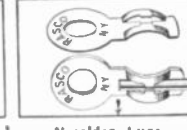

**Nosolder Lugs**  
Finally, a real solderless lug is here. Soldering positively done away with. Takes square or round bus-bar, which it holds with a vise-like grip. Perfect connection. Just slide bus bar into slip-grip.  
L3727 Lug, 25 for .....\$.15



**Low Loss Coil**  
Same type coil as used in Freshman and other Tuned Radio Frequency sets. D. C. wire, 200-550 wave length, 3" diameter, 1" wide, 5-16" thick. 4 connections, 2 primary, 2 secondary.  
L2629 Low Loss Coil 85



**Storage "B" Battery**  
18 volts, 4 1/2 amp. hours. Buy storage "B" batteries by capacity, not by looks. Charge lasts one month. Rubber tops and vents, wooden tray. Sent Express Collect.  
L4480 Storage "B" Battery, doz. ....\$14.00

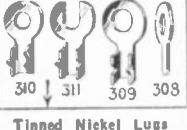

**Tinned Nickel Lugs**  
All our lugs are tinned.  
L316 Brass Lugs for No. 3 screw, doz. ....\$10  
L311 Copper Lugs for Nos. 6 and 8 screws, doz. \$10  
L309 Copper Lugs for Nos. 4, 6 and 8 screws, doz. \$10  
L308 Copper Lug for 6-32 screw, doz. ....\$10  
L357 6x1" each .....\$.45

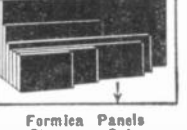

**Formica Panels**  
Clearance Sale  
As we are discontinuing these particular sizes, this material is now offered at cost. All 3-16" thick.  
L352 9x12" each .....\$1.25  
L354 8 1/2x9 1/2" ea. ....1.60  
L356 6x14" each .....1.20  
L357 6x1" each .....\$.45

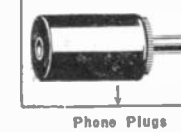

**Phone Plugs**  
Sold from 75c to \$1.00 everywhere. Hard rubber composition shell and patented cord tip holder. Finest workmanship throughout.  
L1030 Rasco Telephone Plug, Each .....\$.35



**Bakelite Socket**  
Octagon shape. Four nickel binding posts, phosphor bronze contact springs. Best brown bakelite.  
L6510 Bakelite socket \$4.40  
L6500 Tube Socket. Made entirely of composition. Best made. Each.....\$.35



**Blinding Post Name Plates**  
Dia. 3/4". These styles: Phones, Ground, —, Output, "A" Bat. —, "B" Bat., —, Loud Speaker, "C" Bat., Aerial, "D" Bat., —, Loop, "E" Bat., —, New "A" Bat., —, "F" Bat., —, "G" Bat., —, "H" Bat., —, "I" Bat., —, "J" Bat., —, "K" Bat., —, "L" Bat., —, "M" Bat., —, "N" Bat., —, "O" Bat., —, "P" Bat., —, "Q" Bat., —, "R" Bat., —, "S" Bat., —, "T" Bat., —, "U" Bat., —, "V" Bat., —, "W" Bat., —, "X" Bat., —, "Y" Bat., —, "Z" Bat., —, "AA" Bat., —, "AB" Bat., —, "AC" Bat., —, "AD" Bat., —, "AE" Bat., —, "AF" Bat., —, "AG" Bat., —, "AH" Bat., —, "AI" Bat., —, "AJ" Bat., —, "AK" Bat., —, "AL" Bat., —, "AM" Bat., —, "AN" Bat., —, "AO" Bat., —, "AP" Bat., —, "AQ" Bat., —, "AR" Bat., —, "AS" Bat., —, "AT" Bat., —, "AU" Bat., —, "AV" Bat., —, "AW" Bat., —, "AX" Bat., —, "AY" Bat., —, "AZ" Bat., —, "BA" Bat., —, "BB" Bat., —, "BC" Bat., —, "BD" Bat., —, "BE" Bat., —, "BF" Bat., —, "BG" Bat., —, "BH" Bat., —, "BI" Bat., —, "BJ" Bat., —, "BK" Bat., —, "BL" Bat., —, "BM" Bat., —, "BN" Bat., —, "BO" Bat., —, "BP" Bat., —, "BQ" Bat., —, "BR" Bat., —, "BS" Bat., —, "BT" Bat., —, "BU" Bat., —, "BV" Bat., —, "BW" Bat., —, "BX" Bat., —, "BY" Bat., —, "BZ" Bat., —, "CA" Bat., —, "CB" Bat., —, "CC" Bat., —, "CD" Bat., —, "CE" Bat., —, "CF" Bat., —, "CG" Bat., —, "CH" Bat., —, "CI" Bat., —, "CJ" Bat., —, "CK" Bat., —, "CL" Bat., —, "CM" Bat., —, "CN" Bat., —, "CO" Bat., —, "CP" Bat., —, "CQ" Bat., —, "CR" Bat., —, "CS" Bat., —, "CT" Bat., —, "CU" Bat., —, "CV" Bat., —, "CW" Bat., —, "CX" Bat., —, "CY" Bat., —, "CZ" Bat., —, "DA" Bat., —, "DB" Bat., —, "DC" Bat., —, "DD" Bat., —, "DE" Bat., —, "DF" Bat., —, "DG" Bat., —, "DH" Bat., —, "DI" Bat., —, "DJ" Bat., —, "DK" Bat., —, "DL" Bat., —, "DM" Bat., —, "DN" Bat., —, "DO" Bat., —, "DP" Bat., —, "DQ" Bat., —, "DR" Bat., —, "DS" Bat., —, "DT" Bat., —, "DU" Bat., —, "DV" Bat., —, "DW" Bat., —, "DX" Bat., —, "DY" Bat., —, "DZ" Bat., —, "EA" Bat., —, "EB" Bat., —, "EC" Bat., —, "ED" Bat., —, "EE" Bat., —, "EF" Bat., —, "EG" Bat., —, "EH" Bat., —, "EI" Bat., —, "EJ" Bat., —, "EK" Bat., —, "EL" Bat., —, "EM" Bat., —, "EN" Bat., —, "EO" Bat., —, "EP" Bat., —, "EQ" Bat., —, "ER" Bat., —, "ES" Bat., —, "ET" Bat., —, "EU" Bat., —, "EV" Bat., —, "EW" Bat., —, "EX" Bat., —, "EY" Bat., —, "EZ" Bat., —, "FA" Bat., —, "FB" Bat., —, "FC" Bat., —, "FD" Bat., —, "FE" Bat., —, "FF" Bat., —, "FG" Bat., —, "FH" Bat., —, "FI" Bat., —, "FJ" Bat., —, "FK" Bat., —, "FL" Bat., —, "FM" Bat., —, "FN" Bat., —, "FO" Bat., —, "FP" Bat., —, "FQ" Bat., —, "FR" Bat., —, "FS" Bat., —, "FT" Bat., —, "FU" Bat., —, "FV" Bat., —, "FW" Bat., —, "FX" Bat., —, "FY" Bat., —, "FZ" Bat., —, "GA" Bat., —, "GB" Bat., —, "GC" Bat., —, "GD" Bat., —, "GE" Bat., —, "GF" Bat., —, "GG" Bat., —, "GH" Bat., —, "GI" Bat., —, "GJ" Bat., —, "GK" Bat., —, "GL" Bat., —, "GM" Bat., —, "GN" Bat., —, "GO" Bat., —, "GP" Bat., —, "GQ" Bat., —, "GR" Bat., —, "GS" Bat., —, "GT" Bat., —, "GU" Bat., —, "GV" Bat., —, "GW" Bat., —, "GX" Bat., —, "GY" Bat., —, "GZ" Bat., —, "HA" Bat., —, "HB" Bat., —, "HC" Bat., —, "HD" Bat., —, "HE" Bat., —, "HF" Bat., —, "HG" Bat., —, "HH" Bat., —, "HI" Bat., —, "HJ" Bat., —, "HK" Bat., —, "HL" Bat., —, "HM" Bat., —, "HN" Bat., —, "HO" Bat., —, "HP" Bat., —, "HQ" Bat., —, "HR" Bat., —, "HS" Bat., —, "HT" Bat., —, "HU" Bat., —, "HV" Bat., —, "HW" Bat., —, "HX" Bat., —, "HY" Bat., —, "HZ" Bat., —, "IA" Bat., —, "IB" Bat., —, "IC" Bat., —, "ID" Bat., —, "IE" Bat., —, "IF" Bat., —, "IG" Bat., —, "IH" Bat., —, "II" Bat., —, "IJ" Bat., —, "IK" Bat., —, "IL" Bat., —, "IM" Bat., —, "IN" Bat., —, "IO" Bat., —, "IP" Bat., —, "IQ" Bat., —, "IR" Bat., —, "IS" Bat., —, "IT" Bat., —, "IU" Bat., —, "IV" Bat., —, "IW" Bat., —, "IX" Bat., —, "IY" Bat., —, "IZ" Bat., —, "JA" Bat., —, "JB" Bat., —, "JC" Bat., —, "JD" Bat., —, "JE" Bat., —, "JF" Bat., —, "JG" Bat., —, "JH" Bat., —, "JI" Bat., —, "JJ" Bat., —, "JK" Bat., —, "JL" Bat., —, "JM" Bat., —, "JN" Bat., —, "JO" Bat., —, "JP" Bat., —, "JQ" Bat., —, "JR" Bat., —, "JS" Bat., —, "JT" Bat., —, "JU" Bat., —, "JV" Bat., —, "JW" Bat., —, "JX" Bat., —, "JY" Bat., —, "JZ" Bat., —, "KA" Bat., —, "KB" Bat., —, "KC" Bat., —, "KD" Bat., —, "KE" Bat., —, "KF" Bat., —, "KG" Bat., —, "KH" Bat., —, "KI" Bat., —, "KJ" Bat., —, "KK" Bat., —, "KL" Bat., —, "KM" Bat., —, "KN" Bat., —, "KO" Bat., —, "KP" Bat., —, "KQ" Bat., —, "KR" Bat., —, "KS" Bat., —, "KT" Bat., —, "KU" Bat., —, "KV" Bat., —, "KW" Bat., —, "KX" Bat., —, "KY" Bat., —, "KZ" Bat., —, "LA" Bat., —, "LB" Bat., —, "LC" Bat., —, "LD" Bat., —, "LE" Bat., —, "LF" Bat., —, "LG" Bat., —, "LH" Bat., —, "LI" Bat., —, "LJ" Bat., —, "LK" Bat., —, "LL" Bat., —, "LM" Bat., —, "LN" Bat., —, "LO" Bat., —, "LP" Bat., —, "LQ" Bat., —, "LR" Bat., —, "LS" Bat., —, "LT" Bat., —, "LU" Bat., —, "LV" Bat., —, "LW" Bat., —, "LX" Bat., —, "LY" Bat., —, "LZ" Bat., —, "MA" Bat., —, "MB" Bat., —, "MC" Bat., —, "MD" Bat., —, "ME" Bat., —, "MF" Bat., —, "MG" Bat., —, "MH" Bat., —, "MI" Bat., —, "MJ" Bat., —, "MK" Bat., —, "ML" Bat., —, "MN" Bat., —, "MO" Bat., —, "MP" Bat., —, "MQ" Bat., —, "MR" Bat., —, "MS" Bat., —, "MT" Bat., —, "MU" Bat., —, "MV" Bat., —, "MW" Bat., —, "MX" Bat., —, "MY" Bat., —, "MZ" Bat., —, "NA" Bat., —, "NB" Bat., —, "NC" Bat., —, "ND" Bat., —, "NE" Bat., —, "NF" Bat., —, "NG" Bat., —, "NH" Bat., —, "NI" Bat., —, "NJ" Bat., —, "NK" Bat., —, "NL" Bat., —, "NM" Bat., —, "NO" Bat., —, "NP" Bat., —, "NQ" Bat., —, "NR" Bat., —, "NS" Bat., —, "NT" Bat., —, "NU" Bat., —, "NV" Bat., —, "NW" Bat., —, "NX" Bat., —, "NY" Bat., —, "NZ" Bat., —, "OA" Bat., —, "OB" Bat., —, "OC" Bat., —, "OD" Bat., —, "OE" Bat., —, "OF" Bat., —, "OG" Bat., —, "OH" Bat., —, "OI" Bat., —, "OJ" Bat., —, "OK" Bat., —, "OL" Bat., —, "OM" Bat., —, "ON" Bat., —, "OO" Bat., —, "OP" Bat., —, "OQ" Bat., —, "OR" Bat., —, "OS" Bat., —, "OT" Bat., —, "OU" Bat., —, "OV" Bat., —, "OW" Bat., —, "OX" Bat., —, "OY" Bat., —, "OZ" Bat., —, "PA" Bat., —, "PB" Bat., —, "PC" Bat., —, "PD" Bat., —, "PE" Bat., —, "PF" Bat., —, "PG" Bat., —, "PH" Bat., —, "PI" Bat., —, "PJ" Bat., —, "PK" Bat., —, "PL" Bat., —, "PM" Bat., —, "PN" Bat., —, "PO" Bat., —, "PP" Bat., —, "PQ" Bat., —, "PR" Bat., —, "PS" Bat., —, "PT" Bat., —, "PU" Bat., —, "PV" Bat., —, "PW" Bat., —, "PX" Bat., —, "PY" Bat., —, "PZ" Bat., —, "QA" Bat., —, "QB" Bat., —, "QC" Bat., —, "QD" Bat., —, "QE" Bat., —, "QF" Bat., —, "QG" Bat., —, "QH" Bat., —, "QI" Bat., —, "QJ" Bat., —, "QK" Bat., —, "QL" Bat., —, "QM" Bat., —, "QN" Bat., —, "QO" Bat., —, "QP" Bat., —, "QQ" Bat., —, "QR" Bat., —, "QS" Bat., —, "QT" Bat., —, "QU" Bat., —, "QV" Bat., —, "QW" Bat., —, "QX" Bat., —, "QY" Bat., —, "QZ" Bat., —, "RA" Bat., —, "RB" Bat., —, "RC" Bat., —, "RD" Bat., —, "RE" Bat., —, "RF" Bat., —, "RG" Bat., —, "RH" Bat., —, "RI" Bat., —, "RJ" Bat., —, "RK" Bat., —, "RL" Bat., —, "RM" Bat., —, "RN" Bat., —, "RO" Bat., —, "RP" Bat., —, "RQ" Bat., —, "RR" Bat., —, "RS" Bat., —, "RT" Bat., —, "RU" Bat., —, "RV" Bat., —, "RW" Bat., —, "RX" Bat., —, "RY" Bat., —, "RZ" Bat., —, "SA" Bat., —, "SB" Bat., —, "SC" Bat., —, "SD" Bat., —, "SE" Bat., —, "SF" Bat., —, "SG" Bat., —, "SH" Bat., —, "SI" Bat., —, "SJ" Bat., —, "SK" Bat., —, "SL" Bat., —, "SM" Bat., —, "SN" Bat., —, "SO" Bat., —, "SP" Bat., —, "SQ" Bat., —, "SR" Bat., —, "SS" Bat., —, "ST" Bat., —, "SU" Bat., —, "SV" Bat., —, "SW" Bat., —, "SX" Bat., —, "SY" Bat., —, "SZ" Bat., —, "TA" Bat., —, "TB" Bat., —, "TC" Bat., —, "TD" Bat., —, "TE" Bat., —, "TF" Bat., —, "TG" Bat., —, "TH" Bat., —, "TI" Bat., —, "TJ" Bat., —, "TK" Bat., —, "TL" Bat., —, "TM" Bat., —, "TN" Bat., —, "TO" Bat., —, "TP" Bat., —, "TQ" Bat., —, "TR" Bat., —, "TS" Bat., —, "TT" Bat., —, "TU" Bat., —, "TV" Bat., —, "TW" Bat., —, "TX" Bat., —, "TY" Bat., —, "TZ" Bat., —, "UA" Bat., —, "UB" Bat., —, "UC" Bat., —, "UD" Bat., —, "UE" Bat., —, "UF" Bat., —, "UG" Bat., —, "UH" Bat., —, "UI" Bat., —, "UJ" Bat., —, "UK" Bat., —, "UL" Bat., —, "UM" Bat., —, "UN" Bat., —, "UO" Bat., —, "UP" Bat., —, "UQ" Bat., —, "UR" Bat., —, "US" Bat., —, "UT" Bat., —, "UU" Bat., —, "UV" Bat., —, "UW" Bat., —, "UX" Bat., —, "UY" Bat., —, "UZ" Bat., —, "VA" Bat., —, "VB" Bat., —, "VC" Bat., —, "VD" Bat., —, "VE" Bat., —, "VF" Bat., —, "VG" Bat., —, "VH" Bat., —, "VI" Bat., —, "VJ" Bat., —, "VK" Bat., —, "VL" Bat., —, "VM" Bat., —, "VN" Bat., —, "VO" Bat., —, "VP" Bat., —, "VQ" Bat., —, "VR" Bat., —, "VS" Bat., —, "VT" Bat., —, "VU" Bat., —, "VV" Bat., —, "VW" Bat., —, "VX" Bat., —, "VY" Bat., —, "VZ" Bat., —, "WA" Bat., —, "WB" Bat., —, "WC" Bat., —, "WD" Bat., —, "WE" Bat., —, "WF" Bat., —, "WG" Bat., —, "WH" Bat., —, "WI" Bat., —, "WJ" Bat., —, "WK" Bat., —, "WL" Bat., —, "WM" Bat., —, "WN" Bat., —, "WO" Bat., —, "WP" Bat., —, "WQ" Bat., —, "WR" Bat., —, "WS" Bat., —, "WT" Bat., —, "WU" Bat., —, "WV" Bat., —, "WW" Bat., —, "WX" Bat., —, "WY" Bat., —, "WZ" Bat., —, "XA" Bat., —, "XB" Bat., —, "XC" Bat., —, "XD" Bat., —, "XE" Bat., —, "XF" Bat., —, "XG" Bat., —, "XH" Bat., —, "XI" Bat., —, "XJ" Bat., —, "XK" Bat., —, "XL" Bat., —, "XM" Bat., —, "XN" Bat., —, "XO" Bat., —, "XP" Bat., —, "XQ" Bat., —, "XR" Bat., —, "XS" Bat., —, "XT" Bat., —, "XU" Bat., —, "XV" Bat., —, "XW" Bat., —, "XX" Bat., —, "XY" Bat., —, "XZ" Bat., —, "YA" Bat., —, "YB" Bat., —, "YC" Bat., —, "YD" Bat., —, "YE" Bat., —, "YF" Bat., —, "YG" Bat., —, "YH" Bat., —, "YI" Bat., —, "YJ" Bat., —, "YK" Bat., —, "YL" Bat., —, "YM" Bat., —, "YN" Bat., —, "YO" Bat., —, "YP" Bat., —, "YQ" Bat., —, "YR" Bat., —, "YS" Bat., —, "YT" Bat., —, "YU" Bat., —, "YV" Bat., —, "YW" Bat., —, "YX" Bat., —, "YY" Bat., —, "YZ" Bat., —, "ZA" Bat., —, "ZB" Bat., —, "ZC" Bat., —, "ZD" Bat., —, "ZE" Bat., —, "ZF" Bat., —, "ZG" Bat., —, "ZH" Bat., —, "ZI" Bat., —, "ZJ" Bat., —, "ZK" Bat., —, "ZL" Bat., —, "ZM" Bat., —, "ZN" Bat., —, "ZO" Bat., —, "ZP" Bat., —, "ZQ" Bat., —, "ZR" Bat., —, "ZS" Bat., —, "ZT" Bat., —, "ZU" Bat., —, "ZV" Bat., —, "ZW" Bat., —, "ZX" Bat., —, "ZY" Bat., —, "ZZ" Bat., —



**"Rasco" Posts**  
Made of each composition.  
L650-51 Each .....\$.08  
L202 Has nickel-plated bottom, each .....\$.08  
Dozen, each style.....\$.90  
L122 Initialed Binding Posts. Six popular styles. Each .....\$.06

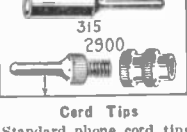

**Cord Tips**  
Standard phone cord tips, nickel plated.  
L315 Each .....\$.03  
**Separable Cord Tips**  
No solder required. Wire goes in ferrule. Shank holds it tight. Nickel plated.  
L2900 Each .....\$.06

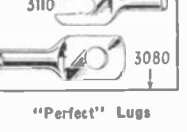

**"Perfect" Lugs**  
These new and improved lugs are brass, nickel plated, fattened on top as shown. Made of a single piece of metal. Lead wire goes into tube.  
L3110, L3080 "Perfect" Lugs, Each .....\$.02  
Dozen lots .....20

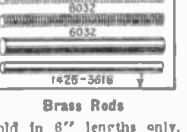

**Brass Rods**  
Sold in 6" lengths only.  
L8032 Rod 8-32" thread length .....\$.08  
L6032 Rod, 6-32" thread length .....\$.06  
L1425 Rod, plain, 3/4" round, length .....\$.10  
L3616 Rod, plain 3-16" round, length .....\$.08

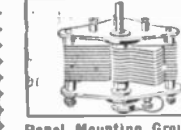

**Panel Mounting Grounded Rotor Condensers**  
Positively no better condenser made. Lowest losses, pictorial connection, binding posts, aluminum plates, rugged construction. Used by 9 big set manufacturers.  
L2113 15-plate ....\$1.50  
L2123 23-plate .....1.85  
L2143 43-plate .....2.85

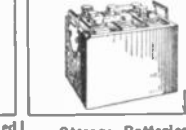

**Storage Batteries**  
Guaranteed for two years. Only NEW material used. Acid proof terminals. Patent vents.  
L2400 Two volt, 40 amp. hours .....\$3.90  
L640 Six volt, 40 amp. hours .....7.25  
L666 Six volt, 60 amp. hours .....9.50  
Shipped express collect.

**New 1925 "Rasco" Catalog No. 12**  
CONTAINS 75 VACUUM TUBE HOOK-UPS, 300 ILLUSTRATIONS, 500 ARTICLES, NOW 100 PAGES

All Armstrong Circuits are explained clearly, all values having been given, leaving out nothing that could puzzle you.

Just to name a few of the circuits: The V.T. as a detector and one-step amplifier; all Armstrong circuits; one-step radio frequency amplifier and detector; three stage audio frequency amplifier; short wave regenerative circuits; 4-stage radio frequency amplifiers; radio and audio frequency amplifier; inductively coupled amplifier; all Reflex Circuits.

**FREE**  
A POSTAL CARD BRINGS IT

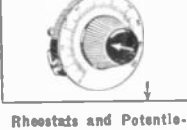

**Rheostats and Potentiometers**  
Come with metal dials and composition knob. Excellent merchandise despite low price.  
L4210 6 ohm Rheo. ....\$.27  
L4211 36 ohm Rheo. ....30  
L4212 240 ohm Potentiometer, 200 ohms .....45

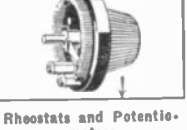

**Rheostats and Potentiometers**  
High heat dielectric base. Come with tapered, knurled knob, 2 1/2" dia. Complete with pointer.  
L4310 6 ohm .....\$.38  
L4311 30 ohm .....44  
L4312 Potentiometer, 200 ohms .....65

**RADIO SPECIALTY COMPANY, 100 Park Place, New York City**  
Factories: Brooklyn, N. Y. Elkridge, Md.

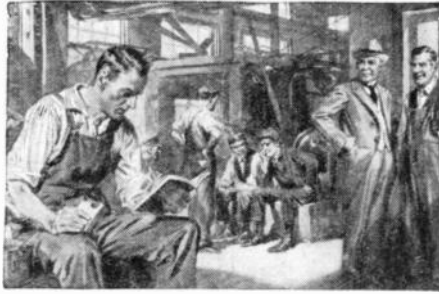

## “There’s One Man We’re Going to Keep”

“Ed Wilson, there, is one of the most ambitious men in the plant. I notice that he never fools away his spare time. He studies his International Correspondence Schools course every chance he gets.

“It’s been the making of him, too. He hasn’t been here nearly so long as Tom Downey, who was laid off yesterday, but he knows ten times as much about this business.

“I’m going to give him Tom’s job at a raise in salary. He’s the kind of man we want around here.”

**H**OW do you stand in your shop or office? Are you an Ed Wilson or a Tom Downey? Are you going up? Or down?

No matter where you live, the International Correspondence Schools will come to you. No matter what your handicaps or how small your means, we have a plan to meet your circumstances. No matter how limited your previous education, the simply-written, wonderfully-illustrated I. C. S. textbooks make it easy to learn.

This is all we ask: Without cost, without obligating yourself in any way, put it up to us to prove how we can help you. Just mark and mail this coupon.

### INTERNATIONAL CORRESPONDENCE SCHOOLS Box 5216-D Scranton, Penna.

Without cost or obligation on my part, please tell me how I can qualify for the position or in the subject before which I have marked an X:

- | BUSINESS TRAINING COURSES  |   |
|--|---|
| <input type="checkbox"/> Business Management                     | <input type="checkbox"/> Salesmanship           |
| <input type="checkbox"/> Industrial Management                   | <input type="checkbox"/> Advertising            |
| <input type="checkbox"/> Personnel Organization                  | <input type="checkbox"/> Better Letters         |
| <input type="checkbox"/> Traffic Management                      | <input type="checkbox"/> Show Card Lettering    |
| <input type="checkbox"/> Business Law                            | <input type="checkbox"/> Stenography and Typing |
| <input type="checkbox"/> Banking and Banking Law                 | <input type="checkbox"/> Business English       |
| <input type="checkbox"/> Accountancy (Including C.P.A.)          | <input type="checkbox"/> Civil Service          |
| <input type="checkbox"/> Nicholson Cost Accounting               | <input type="checkbox"/> Railway Mail Clerk     |
| <input type="checkbox"/> Bookkeeping                             | <input type="checkbox"/> Common School Subjects |
| <input type="checkbox"/> Private Secretary                       | <input type="checkbox"/> High School Subjects   |
| <input type="checkbox"/> Spanish <input type="checkbox"/> French | <input type="checkbox"/> Illustrating           |

- | TECHNICAL AND INDUSTRIAL COURSES  |  |
|---|--|
| <input type="checkbox"/> Electrical Engineering                           | <input type="checkbox"/> Architect                                   |
| <input type="checkbox"/> Electric Lighting                                | <input type="checkbox"/> Architects' Blue Prints                     |
| <input type="checkbox"/> Mechanical Engineer                              | <input type="checkbox"/> Contractor and Builder                      |
| <input type="checkbox"/> Mechanical Draftsman                             | <input type="checkbox"/> Architectural Draftsman                     |
| <input type="checkbox"/> Machine Shop Practice                            | <input type="checkbox"/> Concrete Builder                            |
| <input type="checkbox"/> Railroad Positions                               | <input type="checkbox"/> Structural Engineer                         |
| <input type="checkbox"/> Gas Engine Operating                             | <input type="checkbox"/> Chemistry <input type="checkbox"/> Pharmacy |
| <input type="checkbox"/> Civil Engineer                                   | <input type="checkbox"/> Automobile Work                             |
| <input type="checkbox"/> Surveying and Mapping                            | <input type="checkbox"/> Airplane Engines                            |
| <input type="checkbox"/> Metallurgy <input type="checkbox"/> Mining       | <input type="checkbox"/> Agriculture and Poultry                     |
| <input type="checkbox"/> Steam Engineering <input type="checkbox"/> Radio | <input type="checkbox"/> Mathematics                                 |

Name.....  
 Street..... 3-6-24  
 Address.....  
 City..... State.....

Occupation.....  
 Persons residing in Canada should send this coupon to the International Correspondence Schools Canadian, Limited, Montreal, Canada

# LEARN AVIATION

At Home in your spare time.  
 Be an expert Airplane Engineer.  
**Earn \$3,500 to \$10,000 a Year**

Practical course—takes only a few months. Write for special offer on free airplane parts and free catalog.

**WESTERN AIRPLANE CORPORATION**  
 Dept. S-7 Monadnock Block Chicago

Insure your copy reaching you each month. Subscribe to Science and Invention—\$2.50 a year. Experimenter Publishing Co., 53 Park Place, N. Y. C.

# Tarrano the Conqueror

(Continued from page 268)

north-east; and at the moment, with a following wind, I was doing something over three-fifty.

“But they’ll shut off your power,” Grille warned. “You’ll come down soon enough then.”

Which was also true enough. The evening local-express for Boston and beyond was overhauling me. And when the green beam of a traffic tower came up and picked me out, I decided I had better obey. Dutifully I descended until the beam, satisfied, swung away.

At 8,000 feet, I went on. There was too much traffic for decent speed and the directors in every pilot bag and tower I passed seemed watching me closely. At the latitude of Boston, I swung out to sea, off the main arteries of travel. The early night mail for Eurasia,\* with Great London its first stop, went by me far overhead. I could make out its green and purple lights, and the spreading silver beam that preceded it.

Alone in my pit, with the dull whir of my propellers alone breaking the silence of the night, I pondered the startling events of the past few hours. Above me the stars and planets gleamed in the deep purple of an almost cloudless sky. Venus had long since dropped below the horizon. But Mars was up there—approaching the zenith. I wondered what the Martian helio might be saying. I could have asked Greys back at the office. But Greys, I knew, would be too busy to bother with me.

What could Dr. Brende want of me? I was glad he had sent for me—there was nowhere I would rather have gone this particular evening. And it would give me a chance to see Elza again.

I could tell by the light-numerals below, that I was now over Maine. I did not need to consult my charts; I had been up this way many times, for, the Brendes—the doctor, his daughter Elza, and her twin brother Georg—I counted my best friends.

I was over the sea, with the coast of Maine to my left. The traffic, since I left the line of Boston, had been far less. The patrols flashed by me at intervals, but they did not molest me.

I descended presently, and located the small two-mile island off the coast which Dr. Brende owned and upon which he lived. It was 10:20 when I came down; to find them waiting for me on the runway.

The doctor held out both his hands. “Good enough, Jac. I got your code—we’ve been waiting for you.”

“It’s crowded,” I said. “Heavy up to Boston. And they wouldn’t let me go high.” He nodded. And then Elza put her cool little hand against mine.

“We’re glad to see you, Jac. Very glad.” They took me to the house. Dr. Brende was a small, dark man of sixty-odd, smooth-shaven, a thin face, with a mop of iron-grey hair above it, and keen dark eyes beneath bushy white brows. He was usually kindly and gentle of manner—at times a little abstracted; at other times he could be more forceful and direct than anyone with whom I had ever had contact.

At the house we were joined by the doctor’s son Georg. My best friend, I should say; certainly for my part, I treasured his friendship very highly. He and Elza were twins—twenty-three years old at this time. I am two years older; and I had been a room-mate with Georg at the Commons Educational Institution of the Potomac.

\*Now Europe and Asia.

Our friendship had, if anything, grown closer since my promotion into the business world. Yet we were as unlike as two individuals could possibly be. I am dark-haired, slim, and of comparatively slight muscular strength. Restless—full of nervous energy—and, they tell me, somewhat short of temper. Georg was a blond, powerful young giant. A head taller than I—blue-eyed, from his mother, now dead—square-jawed, and a complexion pink and white. He was slow to anger. He seldom spoke impulsively; and usually with a slow, quiet drawl. Always he seemed looking at life and people with a half-humorous smile,—looking at the human pageant with its foibles, follies and frailties—tolerantly. Yet there was nothing conceited about him. Quite the reverse. He was generally wholly deprecating in manner, as though he himself were of least importance. Until aroused. In our days of learning, I saw Georg once—just once—thoroughly angered.

“Come up promptly, didn’t you?” Georg was saying. He was leading me to the house doorway, but I stopped him.

“Let’s go to the grove,” I suggested. We turned down from the small viaduct, passed the house, and went into the heavy grove of trees nearby.

“He’s hungry,” Elza declared. “Jac, did you eat at the office tonight?”

“Yes,” I said. “Did you really?” “Some,” I admitted. In truth the run up here had brought me a thoroughly hearty appetite, which I just realized.

“I was pretty busy, you know,” I added. “Such a night—but don’t you bother.”

But she had already scurried away toward the house. Dear little Elza! I wished then, for the hundredth time, that I was a man of wealth—or at least, not as poor as a tower timekeeper. True, I made fair money—but the urge to spend it recklessly dominated me. I decided in that moment, to reform for good; and lay by enough to justify asking a woman to be my wife.

We reclined on a mossy bank in the grove of trees, so thick a grove that it hid the house from our sight. The doctor extinguished the glowing lights with which the tree-branches were dotted. We were in the semi-darkness of a beautiful, moonlit night.

“Don’t go to sleep, Jac!” I became aware that Georg and his father were smiling at me.

I sat up, snapping my wits into alertness. “No. Of course not. I guess I’m tired. You’ve no idea what the office was like tonight. Roaring.”

“I can imagine,” Georg said. “You were at Park Sixty when the President fell, weren’t you?”

“Yes. But I wasn’t supposed to be. I wasn’t assigned to that. How did you guess?”

“Elza saw you. She had our finder on you—I couldn’t push her away from it.” His slow smile was quizzical.

“On me? In all that crowd. She must have searched about very carefully to—”

I stopped; I could feel my cheeks burning, and was glad of the dimness there under the trees.

“She did,” said Georg. “I sent for you, Jac,” Dr. Brende interjected abstractedly, “because—”

But Georg checked him. “Not now, father. Someone—anyone—might pick you up. Your words—or read your lips—there’s light enough here to register on a finder.”

(Continued on page 276)





**The Simplest Practical Radio Set Made**  
**\$2.50**  
**A Complete Radio Receiver including Radiogem, Phone and Aerial**  
**The Complete Outfit Consists of Three Parts**

**(One)**  
**The RADIOGEM**

The simplest radio outfit made—yet as practical as the most expensive. A crystal receiving set that you can operate and enjoy even though you know absolutely nothing about radio. You receive the RADIOGEM unassembled, together with a clearly written instruction book, which shows you how to quickly and easily construct the set, using only your hands and a scissors. The outfit comprises all the necessary wire, contact points, detector mineral tube on which to wind the coil, etc., etc. The instruction book explains simply and completely the principles of radio and its graphic illustrations make the assembling of the RADIOGEM real fun.

**(Two)**  
**The GEMPHONE**

An adjustable, 1,000-ohm phone complete with 3-ft. cord—the first inexpensive adjustable receiver made. The Gemphone is of standard type and made of the very best grade of materials throughout. The case is made of turned wood, an exclusive feature with the "GEMPHONE." This is responsible for its exceptionally rich, and mellow tone. Like RADIOGEM, the GEMPHONE is sold unassembled. Our instruction pamphlet shows how to assemble it in two minutes, using only a screw driver.

**(Three)**  
**The AERIAL OUTFIT**

Consisting of 100 ft. of standard copper aerial wire and two porcelain insulators.

- Complete Radiogem Outfits - \$2.50**
- The Radiogem, only - 1.00**
- The Gemphone, only - 1.00**
- Aerial Outfit, only - .50**

# RAGEMCO

**Radio Headquarters for the Finest and BEST Radio Tools**



**RADIO TOOLSET**

This is the handiest set of tools ever made for Radio Work by the makers of the famous "YANKEE" Tools. It contains the following: 1 Ratchet Screw-driver, 6 1/4 in. long holding all attachments; 1 Blade, 5 1/4 x 3-18; 1 Blade, 3 1/2 x 7/8; 1 Blade 2 1/2 x 3/4; 1 Countersink; 2 Socket Wrenches for all small nuts; 1 Reamer to enlarge holes in panel from 1/8 x 1/4; 1 Wrench, one end 5-18" square or hex, for jack, other 1/4" hex, etc.  
**PRICE per set—No. 701.....\$3.00**



**HAND DRILL**

The hardwood handle is hollow to store drills. Iron frame, nickelled parts, ball bearing three jawed chuck holding and centering accurately round shank drills from 0 to 3-16. Length of drill, 12 inches.  
**PRICE—No. 303.....\$2.25**



**WIREBENDING TOOL**

For making eyes, loops, bends, and offsets on Bus Bar wire. With this device any Radio Constructor can wire his set to compare favorably with any factory made set. Easier to use and more accurate than pliers. Full directions in box. Made of heavy steel, blued and finished.  
**PRICE—No. 203.....\$1.00**

**CIRCLE CUTTER**



Especially designed for the Radio Constructor. Made of the finest material and equipped with the highest grade high steel cutting bits. It does three things at once. It drills its own pilot, cuts out plug and puts bead or scroll around the hole in one operation. Cuts holes 3/4 to 4 in. in diam.  
**PRICE—No. 402.....\$3.00**  
**401. Same tool but smaller and not fitted with bead or scroll in one operation.**  
**PRICE—No. 401.....\$2.00**



**HAND DRILL**

Especially designed for Radio Work by the makers of the famous "Yankee" Tools. A beautiful balanced, small, powerful drill with 4 to 1 ratio of gears for speed. Special chuck 9-32" capacity, to take largest drill, mostly furnished with drill or tool sets. Length over all, 9 1/4 in. Weight 1 1/4 lbs.  
**PRICE—No. 302.....\$2.75**



Three-in-One Nut Wrench. Consists of handle with hollow stem 6 inches in length and three interchangeable sockets fitting popular sizes of nuts. The hexagon sockets grip the nut solidly.  
**PRICE per set—No. 301.....65c**



Side Cutting Nipper, Lap Joint. For cutting all kinds of wire. Jaws hardened and oil tempered. Natural steel finish with polished jaws. Length 6 inches.  
**PRICE—No. 201.....75c**

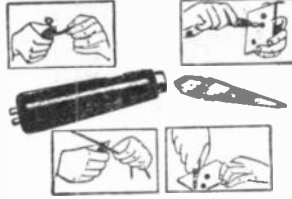

**RADIO HANDI-TOOL**

Bends Bus Bar or wire strips and scrapes wire, bores and reams holes, etc. Tool consists of 4 in. black japanned handle, to which is attached wire bending device, with nickelled ferrule and 3 in. long two sided reamer.  
**PRICE—No. 702.....50c**



**TOOL CHEST**

Set consists of "LOCK-GRIP" master handle, 5" long, black Rubberoid finish with steel chuck, nickel plated, buffed and with the following 9 tools: Saw, bradawl, large screwdriver, file, scratch awl, gimlet, reamer, chisel, small screwdriver. Each tool of fine steel, drop forged tempered, hardened, and nicely finished. Set comes in leatheroid box with tray.  
**PRICE—No. 703.....\$1.85**

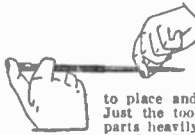

**SCREW STARTER and DRIVER**

Holds any screw by its slot with a firm grip, makes it easy to place and start screws in difficult places. Just the tool for the Radio Constructor. All parts heavily nickelled and polished.  
**PRICE—No. 304.....\$1.00**

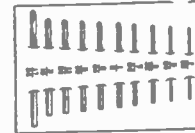

**RADIO DRILL SET**

Composed of 10 straight shank twist drills, fitting all hand and breast drills. The selection of these drills has been especially made for Radio Constructors and consists of the following sizes: 1-16, 5-64, 3-32, 7-64, 1/8, 9-64, 5-32, 11-64, 3-16, 17-64. Drills are mounted on white Holland Linen with sizes clearly marked.  
**PRICE—No. 305.....\$1.25**



**ELECTRIC SOLDERING IRON**

A perfect tool for Radio Work. Operates either on 110-volt A.C. or D.C. The heat element is of Nichrome, which prevents overheating and assures the desired even temperature. Size of Iron, 10 1/2 in. long. A 4-ft. cord and plug is furnished.  
**PRICE—No. 800.....\$2.00**

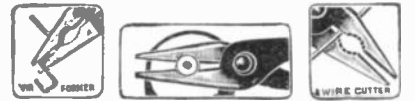

Combination Plier, Wire Cutter, Wire Former and Wrench. Drop forged, sturdier but exceptionally strong. 6 in. long.  
**PRICE—No. 202.....75c**



Long Sharp Nose, Side Cutting Pliers. Just the pliers for the radio constructor. Bends and cuts all kinds of soft wire. Nose 1 1/2 inches long, black body, polished jaws. Length 5 1/2 inches.  
**PRICE—No. 200.....75c**

Order all tools by order number. All goods are shipped free of transportation charges to all parts of the United States and possessions the same day as the order is received.

**MONEY REFUND GUARANTEE**

*If you are not satisfied money will be refunded on return of goods.*

**The RADIOGEM CORP., 66-S W. Broadway, New York**

# U.S. PATENTS



**SEND FOR THIS FORM**

## Don't Lose Your Rights

Before disclosing your invention to anyone send for blank form "Evidence of Conception" to be signed and witnessed. A sample form together with printed instructions will show you just how to work up your evidence and establish your rights before filing application for patent. As registered patent attorneys we represent hundreds of inventors all over the U. S. and Canada in the advancement of inventions. Our schedule of fees will be found reasonable. The form "Evidence of Conception" sample, instructions relating to obtaining of patent and schedule of fees sent upon request. Ask for them,—a post card will do.



Registered Patent Attorneys in U.S. and Canada  
255 Ouray Bldg., Washington, D. C.  
"Originators of form Evidence of Conception"

# PATENTS

TRADE MARKS · DESIGNS  
FOREIGN PATENTS

## MUNN & Co.

PATENT ATTORNEYS

Associated since 1846 with the Scientific American  
618 Woolworth Building, New York City  
325 Scientific American Bldg., Washington, D.C.  
414 Tower Building, Chicago, Ill.  
367 Hobart Building, San Francisco, Cal.  
222 Van Nuys Building, Los Angeles, Cal.  
Books and Information on Patents and Trade Marks by Request.

# INVENTORS!

Our facilities to assist you in securing patents, models, capital, etc., and our complete service to members will interest you. Dept. A.

**INVENTORS INTERNATIONAL INSTITUTE**  
15 Park Row, New York

## C. L. PARKER

Ex-Member Examining Corps, U. S. Patent Office

**Attorney-at-Law and Solicitor of Patents**

American and Foreign Patents secured. Searches made to determine patentability, validity and infringement.

Pamphlet of Instructions sent upon request

**MCGILL BUILDING WASHINGTON, D. C.**

# INVENTORS PROTECT YOUR IDEAS

Send for our Guide Book, HOW TO GET A PATENT, and Evidence of Invention Blank, sent Free on request. Tells our terms, methods, etc. Send model or sketch and description of your invention for INSPECTION and INSTRUCTIONS FREE. TERMS REASONABLE. BEST REFERENCES.

Name .....

Street .....

City .....

**RANDOLPH & CO.**  
Dept. 172, WASHINGTON, D. C.

# Patent Advice

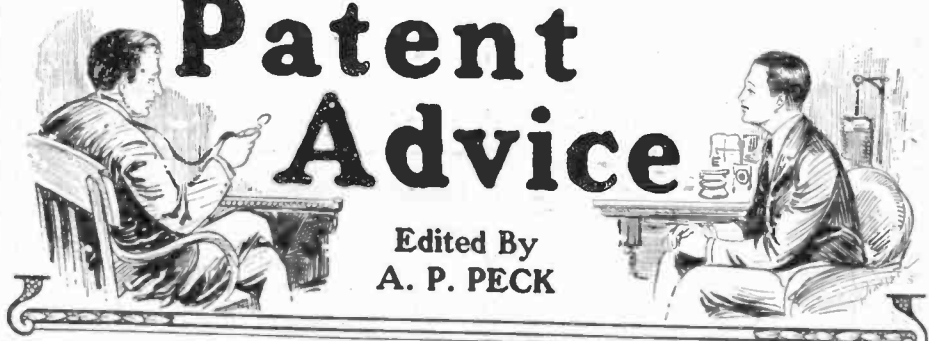

Edited By  
**A. P. PECK**

In this Department we publish such matter as is of interest to inventors and particularly to those who are in doubt as to certain patent phases. Regular inquiries addressed to "Patent Advice" cannot be answered by mail free of charge. Such inquiries are published here for the benefit of all readers. If the idea is thought to be of importance, we make it a rule not to divulge all details, in order to protect the inventor as far as it is possible to do so.

Should advice be desired by mail a nominal charge of \$1.00 is made for each question. Sketches and descriptions must be clear and explicit. Only one side of sheet should be written on.

**NOTE:**—Before mailing your letter to this department, see to it that your name and address are upon the letter and envelope as well. Many letters are returned to us because either the name of the inquirer or his address is incorrectly given.

### VARIABLE CAM MOVEMENT

(898) Mr. Henry Violetta, Indianapolis, Ind., writes that he needs a cam-movement for a certain piece of mechanism that he is building. The cam-movement, however, must be variable so that the cam itself can operate over a range from three inches to zero or no movement at all. The shift must be made while the mechanism is in operation.

A. In the figure herewith we show an improvised cam which will undoubtedly answer your purposes. The cam may be connected to any mechanism by means of a lever or by means of a gear rack or a slotted rod coupled directly to the mechanism which is to be moved. Further details from you concerning the mechanism will bring a more complete drawing showing attachment of the cam.

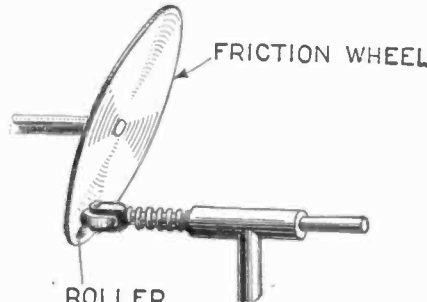

Simple form of variable cam.

### PUBLIC USE

(899) John Alberts, New York City, N. Y., asks us what is meant by the term "public use," particularly with reference to patents, and what these words imply, and also what is meant by "reducing an experiment to practice."

A. Let us assume that there are two original inventors who have worked upon the same idea at widely varying points in the United States. The first of these inventors applies for a patent. The second one does not apply for a patent, but has actually developed the invention and put it to use more than two years before the application for the patent was made by the first inventor. The second inventor, of course, can prove this by newspaper clippings and by many witnesses who have seen the device in operation. Legally, there-

fore, the first inventor is not entitled to the patent. (The Webster Loom Co., vs. Higgins.)

For your second question let us assume that the inventor has been experimenting upon a machine or an article of manufacture, and upon completion of the machine has actually used it either in public or in private. His invention becomes now a successful experiment and entitles him to a patent, but only if the machine has been used in public has he a right to defeat the claim of a subsequent inventor who may have applied first. In order to clarify this statement, let us assume that A and B were working upon an idea. A develops the idea, publicly demonstrates it and forgets about it entirely. The experiment being completely forgotten either before or after public use, can be reinvented and patented by B. If the invention is abandoned before public use, it indicates that the experiment was no more than an unsuccessful experiment and the idea may be patented again by B. If abandoned after public use, the invention becomes the property of the public. (Allis vs. Buckstall and Mallet vs. Cogger.)

### COMBINATION MATCH BOX AND CIGARETTE CASE

(900) John B. Souza, Honolulu, Hawaii, asks whether we advise him to try to patent the combination match box and cigarette case illustrated in the accompanying figure.

A. We cannot view your match-box-cigarette-case combination favorably in that it is neither ornamental nor very serviceable; particularly in view of the fact that the writer has recently seen a very compact cigarette case containing a match box and two individual ash trays. This latter design is not nearly as bulky as yours, and a good deal more ornamental and interesting from the purchaser's standpoint.

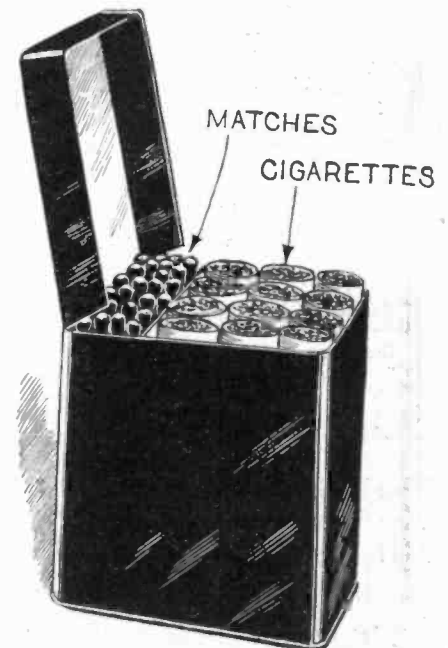

Patent advice is asked on this combination match box and cigarette case.

# PATENTS

## INVENTORS -write for these FREE BOOKS

MY  
PATENT  
LAW  
OFFICES



Just across  
street from  
U.S. PAT. OFF.

At the right is a view of my drafting and specification offices, where a large staff of experienced experts are in my constant employ. All drawings and specifications are prepared under my personal supervision.



If you have a useful, practical, novel idea for any new article or for an improvement on an old one, you should communicate with a competent Registered Patent Attorney AT ONCE.

Every year thousands of applications for patents are filed in the U. S. Patent Office. Frequently two or more applications are made for the same or substantially the same idea (even though the inventors may live in different sections of the country and be entirely unknown to one another). In such a case, the burden of proof rests upon the last application filed. Delays of even a few days in filing the application sometimes mean the loss of a patent. So lose no time. Get in touch with me at once by mailing the coupon below.

### Prompt, Careful Efficient Service

This large, experienced organization devotes its entire time and attention to patent and trademark cases. Our offices are directly across the street from the U. S. Patent Office. We understand the technicalities of patent law. We know the rules and requirements of the Patent Office. We can proceed in the quickest, safest and best ways in preparing an application for a patent covering your idea. Our success has been built on the strength of careful, efficient, satisfactory service to inventors and trademark owners located in every state in the Union.

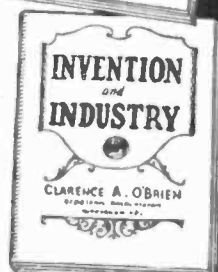
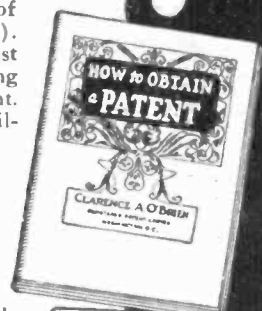

## No Charge for Information on How to Proceed

The books shown here contain valuable information relating to patent procedure that every inventor should have. And with them I will also send you my "Record of Invention" form, on which you can sketch your idea and establish its date before a witness. Such evidence may later prove valuable to you. Simply mail the coupon and I will send you the books, and the "Record of Invention" form, together with detailed information on how to proceed and the costs involved. Do this NOW. No need to lose a minute's time. The coupon will bring you complete information entirely without charge or obligation.

### Strict Secrecy Preserved

All communications, sketches, drawings, etc., are held in strictest confidence in strong, steel, fireproof files, which are accessible only to authorized members of my staff. Feel free to write me fully and frankly. Your case will have my personal attention. It is probable that I can help you. Highest references. But FIRST—clip the coupon and get my free books. Do THAT right now.

## Clarence A. O'Brien

Registered Patent Attorney

Member of Bar of Supreme Court of the United States; Court of Appeals, District of Columbia; Supreme Court, District of Columbia; United States Court of Claims.  
Practice confined exclusively to Patents, Trademarks and Copyrights.

## Mail this Coupon now!

CLARENCE A. O'BRIEN,  
Registered Patent Attorney,  
5393 Security Savings & Commercial Bank Bldg.,  
Washington, D. C.

Please send me your free books, "How to Obtain a Patent," and "Invention and Industry," together with your "Record of Invention" form, without any cost or obligation on my part.

Name .....

Address .....

(Important: Write or print name clearly)

# PATENTS

## TO THE MAN WITH AN IDEA

I offer a comprehensive, experienced, efficient service for his prompt, legal protection and the development of his proposition.

Send sketch, or model and description, for advice as to cost, search through prior United States patents, etc. Preliminary advice gladly furnished without charge.

My experience and familiarity with various arts, frequently enable me to accurately advise clients as to probable patentability before they go to any expense.

Booklet of valuable information and form for properly disclosing your idea, free on request. Write today.

**RICHARD B. OWEN, Patent Lawyer**  
164 Owa Building, Washington, D. C.  
41V Park Row Bldg., New York City

# PATENTS

BOOKLET FREE HIGHEST REFERENCES  
PROMPTNESS ASSURED BEST RESULTS

Send drawing or model for examination and report as to patentability

**WATSON E. COLEMAN, Patent Lawyer**  
644 G Street, N. W., Washington, D. C.

**FREE BOOKLET FOR INVENTORS**

If your invention is new and useful it is patentable—send me your sketch. Inventions developed, patented. Trade marks and copyrights obtained in the U. S. and Foreign countries.

**Z. H. POLACHEK**  
Reg. Patent Attorney  
Professional Engineer  
70 Wall Street New York

# INVENTIONS

Commercialized

ON A CASH OR ROYALTY BASIS

PATENTED OR UNPATENTED

In Business 25 Years - Complete Facilities - References.

Write **ADAM FISHER MFG. CO.**  
205D Enright Ave. St. Louis, Mo.

# PATENTS

As one of the oldest patent firms in America we give inventors at lowest consistent charge, a service noted for results, evidenced by many well known Patents of extraordinary value. Book, Patent-Sense, Free. Lacey & Lacey, 644 F St., Wash., D.C. Estab. 1860.

## INVENTORS

POWER—AUTOMOTIVE PATENTS

M. P. LAUGHLIN

47 West 42nd Street New York

## INVENTORS

Have your invention patented. Complete information in my booklet "Patents." Copy free.

**AMBROSE T. BUCKLEY — Patent Attorney**  
150 Nassau Street New York City

## "BECOME A LIGHTNING TRICK CARTOONIST"

Make money chalk talking. Send \$1 for snappy program of trick drawings, with instructions by a professional cartoonist. Satisfaction guaranteed. Circular free. Balda Art Service, Dept. 4, Oaksho, Wis.

**\$1 DOWN**  
**\$1 PER MONTH**

## ELECTRICAL EXPERT

Home Training

Now Manual Plan on one of oldest, best, courses. Easy, Practical, Thorough. Brings success and money. For beginners or experienced men. FREE 5 Days Trial. Send for Free Catalog. Burgess Electrical School, 524-127 N. Dearborn St. Chicago

## Book Review

**MAKING OF MAN.** By Sir Oliver Lodge, F.R.S. Stiff cloth covers. 170 pages. Published by George H. Doran Co., New York. Price \$2.00.

Sir Oliver edge at last comes into the field of evolution and with it we think, becomes somewhat of a Utopian. There must be something in the atmosphere of the "tight little island" which gives men a terrible penchant for idealism. It got Wells, and its fangs are out for Sir Oliver.

In the making of men, evolution itself, i.e., the history of the rise of man and all life from the original unicellular genus, is dealt with only in passing. That evolution is a reality is given elaborate proof, and proof in such a manner as only Sir Oliver can write it. When one finishes his first pages, one feels more proud of the human race in general.

Examining the history of this greatest of all romances, Sir Oliver brings out certain well defined ideas and postulates them into extremely interesting theses. Upon this he builds his view of the future, and explains man's present shortcoming by the fact that he still remains extremely young in his development. The future holds great promise. It is this view of the future, together with Sir Oliver's placing the present development of the human race at a comparatively low point, that leads to the belief that Sir Oliver may be becoming a bit touched with the Utopian idea.

**RELATIVITY AND GRAVITATION.** By T. Percy Nunn, M.A., D.Sc. Hard cloth covers. 162 pages. Published by E. P. Dutton & Co., New York. Price \$2.40.

Since the appearance of Einstein's original theory of relativity, there have been only two classes of books upon this subject, one for the man practically ignorant of science, and the other for the college professor of mathematics. This volume starts on a different level. The author selects as his readers, those people who are pretty generally acquainted with science and physics, and who have a workable knowledge of mathematics above the level of arithmetic. Upon this foundation, Mr. Nunn writes an extremely enlightened and understandable treatise of the subject. It is a hard nut to crack, this relativity, and takes no end of study. However, the industrious man, if he will apply himself without stint and develop a high disregard for the price of midnight oil, until he thoroughly masters this tone of Mr. Nunn's, will come out at least with knowledge enough of relativity to discuss the subject intelligently.

**LIGHT AND COLOUR.** By R. A. Houston. Stiff cloth covers. 179 pages. Published by Longmans, Green & Co., New York. Price \$2.50.

Mr. Houston is a lecturer on physical optics in the University of Glasgow. According to his own claim, the book is intended for the general reader and deals first with the spectrum, the nature of light, including details on color photography and allied subjects. Although the book is written in popular style, Mr. Houston takes particular pains to edit his work, so that all the most modern developments are included. He has chapters on the invisible rays lying above and below the ordinary belt, including X-rays following it with a chapter on atoms and stars. There is ample explanation of the wave thermometer in light. He closes the book with two very interesting chapters on photo-chemistry and photo-psychology. This latter subject is coming more and more into prominence and will be studied minutely as time goes on.

**THE STORY OF EARLY CHEMISTRY.** By John Maxson Stillman, late Prof. Emeritus of Chemistry, Stanford University. Hard covers. 5 $\frac{3}{4}$ " x 8 $\frac{3}{4}$ ". 560 pages. Published by D. Appleton & Co., New York. Price \$4.00.

Chemistry of late years has made most marvelous advances, and now that Chemistry and Physics are being brought so close together, the whole aspect of the natural sciences is changing greatly. Especially have recent studies on the colloidal state modified our conception of the relationship between Chemistry and Physics. The present book, by Professor Stillman, late Professor Emeritus of Chemistry of Stanford University, the famous California seat of learning, is of intense interest. It goes through the history of Chemistry from the earliest possible date down to what he very justly terms the Chemical Revolution. That transition he signalizes by the work of

Lavoisier, of whose life a very fascinating story is given in the last pages of the book, with extracts from the great master's writings and a vivid account of how he went to his death during the French Revolution. This reviewer has seen Lavoisier's beautiful apparatus, which is preserved in Paris as a true historical monument. The book in its middle sections treats "Chemistry by Centuries," an admirable method of presentation, and the rise and fall of the Phlogiston theory as well as the early ideas of chemical affinity are topics named in the contents which carry a strong appeal to the reader. Moreover, Prof. Stillman's painstaking and logical interpretation of the beliefs which actuated the alchemists throws a great deal of new light on this abstruse but fascinating chapter of Chemistry's development. It is impossible adequately to review so complete a treatment of historical Chemistry within the limits of our space. The subject throughout is dealt with in a warmly personal manner that makes delightful reading, the personal characteristics of many early investigators being exhumed as far as possible from the available records to bear their own messages. A brief foreword by Stewart Young pays tribute to Dr. Stillman's noteworthy career and an interesting bibliography of the books and manuscripts used by the author is appended.

**POWER PLANT MACHINERY.** By Walter H. James, S.B., and Myron W. Dole, S.B. Hard covers, 5 $\frac{3}{4}$ " x 9 $\frac{1}{4}$ ", 277 pages. Published by John Wiley & Sons, New York, \$3.00.

This book gives a good presentation of the modern reciprocating steam engine with numerous illustrations and diagrams. It is quite interesting to find in it that the Walschaert valve gear so often seen on locomotive engines, is given a very full description, and we note that the famous Corliss valve gear is also described. These are but two of a number treated. While the reciprocating engine forms the principal topic, turbine engines, governors and valve mechanism are treated in the three final chapters. Sixteen pages of problems are given, enough to keep the reader occupied with more useful work than cross-word puzzles, and a fairly good index closes the book.

**AN INTRODUCTION TO THE MATHEMATICAL ANALYSIS OF STATISTICS.** By C. H. Forsyth, Asst. Prof. of Mathematics, Dartmouth College. Hard covers, 5 $\frac{1}{4}$ " x 8 $\frac{1}{4}$ ". Published by John Wiley & Sons, New York. \$2.25.

It is very interesting to find the subject of elementary arithmetic so luminously treated as in the opening section of this book. As we go on, we find in it algebraic developments, which are supplemented by numerous exercises which are very largely numeral, for weak human nature is often convinced by plain numbers where higher algebra and calculus fail to appeal to the imagination. Interpolating receives adequate treatment, and through the book the human element peeps out so often as to give it a most interesting aspect. We presume that a couple of pages of logarithms followed by two antilogarithms will serve as mechanical help for the student, but we would certainly advise him to purchase a book of logarithmic tables.

**A SYSTEMATIC COURSE OF QUALITATIVE CHEMICAL ANALYSIS OF INORGANIC AND ORGANIC SUBSTANCES WITH EXPLANATORY NOTES.** By Henry W. Schimpf, Ph.G., M.D. Hard covers, 5 $\frac{1}{2}$ " x 9", 201 pages. Published by John Wiley & Sons, New York. \$1.75.

The name of this book might almost serve as its review. It is principally devoted to mineral qualitative analysis including, however, some leading organic acids in this portion. After some 140 pages, the analysis of inorganic substances, and the examination of organic substances is taken up, to which some 50 pages are devoted. The book is very nicely printed and gives a thoroughly good example of scientific book making by the numerous equations, giving a good example of how such a book should be compiled. In the earlier part of the work, a full treatment on the writing of equations is given, which is very interesting, and the definitions and divisions are well up to date.

(Continued on page 281)

# PATENTS TRADE-MARKS AND COPYRIGHTS

## OUR OFFER:

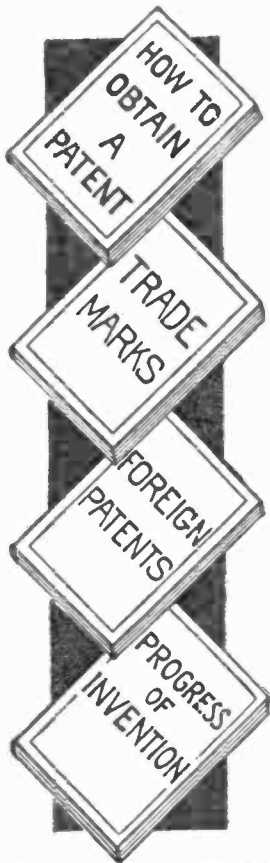

**Your first step**  
 Before disclosing an invention the inventor should write for our blank form "RECORD OF INVENTION." This should be signed, witnessed and returned to us together with model or sketch and description of the invention for INSPECTION and INSTRUCTIONS.

NO CHARGE FOR THE ABOVE INFORMATION  
**Our Four Books Mailed Free to Inventors**  
*Our Illustrated Guide Book*

### HOW TO OBTAIN A PATENT

Full instructions regarding U. S. Patents. Our Methods, Terms, and 100 Mechanical Movements illustrated and described.

### OUR TRADE MARK BOOK

Shows value and necessity of Trade Mark Protection. Information regarding Trade Marks and unfair competition in trade.

### OUR FOREIGN BOOK

We have Direct Agencies in Foreign Countries, and secure Foreign Patents in shortest time and at lowest cost.

### Progress of Invention

Description of World's Most Pressing Problems by Leading Scientists and Inventors

ALL COMMUNICATIONS AND DATA STRICTLY CONFIDENTIAL  
 INTERFERENCE AND INFRINGEMENT SUITS PROSECUTED

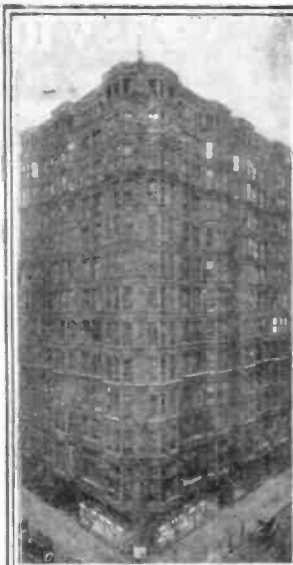

Chicago, Ill., Office  
 Suite 1114 Tacoma Bldg.



Pittsburgh, Pa., Office  
 Suite 514, Empire Bldg.

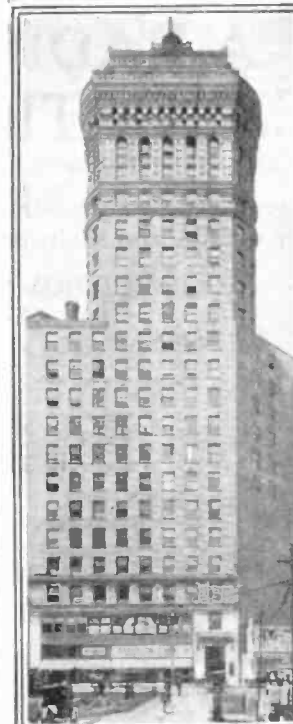

San Francisco, Cal., Office  
 Suite 1010 Hobart Bldg.

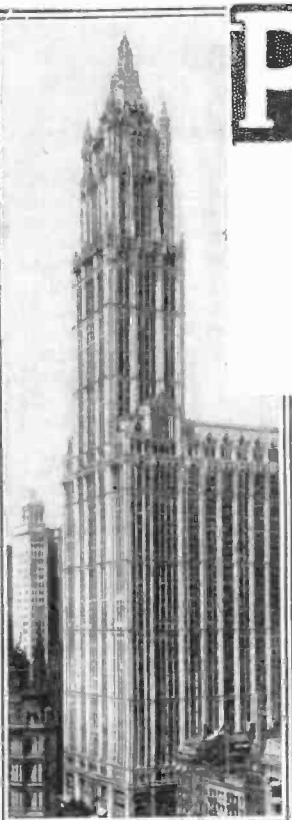

New York Office  
 Suite 1007 Woolworth Bldg.



Philadelphia, Pa., Office  
 Suite 714-715 Liberty Bldg.



Washington, D. C., Office  
 Victor Bldg.



Private Office, Victor J. Evans, with View of Patent Office Through Window

Highest References      Prompt Attention      Reasonable Terms  
**VICTOR J. EVANS & CO., Patent Attorneys**

Main Offices: 779-9th Street, N. W., Washington, D. C.  
 Gentlemen: Please send me FREE OF CHARGE your books as described above.

**FREE  
 COUPON**

Name.....  
 Address.....

**Easy to Play  
Easy to Pay**



**BUESCHER**  
True-Tone  
**Saxophone**

Easiest of all instruments to play and one of the most beautiful. Three first lessons sent free give you a quick easy start. In a few weeks you can be playing popular tunes. You can take your place in a band or orchestra in ninety days, if you so desire. Most popular instrument for dance orchestras, home entertainments, church, lodge and school. A Saxophone player is always popular socially and has many opportunities to earn money. Six Days' trial and easy payments arranged. (173)

**Free Saxophone Book** Shows all models and gives first lesson chart; also pictures of famous professionals and orchestras. Just send your name for a copy. Mention any other instrument in which you may be interested.

**BUESCHER BAND INSTRUMENT CO.**  
Everything in Band and Orchestra Instruments.  
723 BUESCHER BLOCK ELKHART, INDIANA

## Tarrano the Conqueror

(Continued from page 270)

The doctor nodded. "He's afraid—you see, Jac, it's these Venus—" "Father—please. It's a long chance—but why take any? We can insulate in the house."

The chance that someone who shouldn't be, was tuned to us as we sat there in that lonely grove! With the doctor's widespread reputation—his more than national prominence—it did not seem to me to be such a long chance either, on this, of all nights.

"As you say, no use in putting private things into the public air," I remarked; and I felt then as though a thousand hostile eyes and ears were watching and listening. "We can talk of what everybody knows," Georg commented. "The Martian Ruler of the Little People was assassinated an hour ago. You heard that coming up?"

"No," I said; but I had imagined as much. "Did they say—"

"They said nothing." Dr. Brende put in. "The flash of a dozen helioed words—no more."

"It went dark, like Venus?" "No. Just discontinued. I judge they're excited up there—the Bureau disorganized perhaps—I don't know. That was the last we got at the house, just before you came down. There may be something in there now—you Inter-Allied people are pretty reliable."

The Ruler of the Venus Central State, the leading Monarch of Mars, and our three chief executives of Earth—murdered almost simultaneously! It was incredible—any one of the murders would have been incredible—yet it was true.

There had been times—in the Inter-Allied Office, particularly—when I had been insulated from aerial eavesdropping. But never had I felt the need of it more than now. A constraint fell over me; I seemed afraid to say anything. I think we all three felt very much like that; and it was a relief when Elza arrived with my dainty little meal.

"Any word from Mars on the news-tape?" her father asked.

She sat down beside me, helping me to the food.

"I did not look," she answered.

She did not look, because she was busy preparing my meal! Dear little Elza! And because of my accursed extravagance—my poverty—no word of love had ever passed between us!

I thought I had never seen Elza so beautiful as this moment. A slim little thing, perfectly formed and matured, and inches shorter than I. Thick brown hair braided, and hanging below her waist. A face—pretty as her mother's must have been—yet intellectual as her father's.

I had taken Elza to the great music festivals of the city, and counted her the best dressed girl in all the vast throng. Tonight she was dressed simply. A grey-blue, tubular sort of skirt, clinging close to the lines of her figure and split at the side for walking; a tight-fitting bodice, light in color (a man knows little of the technicalities of such things); throat bare, with a flaring rolled collar behind—a throat like a rose-petal with the moonlight on it; arms bare, save for the upper, triangular sleeves.

It must suffice; I can only say she was adorable. Almost in silence I ate my meal, with her beside me.

Georg went into the house once, to consult the news-tape. It was crowded with Earth-events—excitement, confusion everywhere—inconsequential reports, they seemed, by comparison with what had gone before. But of helios from Mars, or Venus, there

were none reported. Of Venus, the tape said nothing save that each of our westward stations was vainly calling in turn, as the planet dropped toward its horizon.

I finished my meal—too leisurely for Georg and the doctor; and then we all went into the house, to the insulated room where at last we could talk openly.

As we entered the main corridor, we heard the low voice of the Inter-Allied news-announcer, coming from the disc in a room nearby.

"And I enus—"

The words caught our attention. We hurried in, and stood by the Inter-Allied equipment. Georg picked up the pile of tape whereon the announcer's words were being printed. He ran back over it.

"Another helio from Venus!" he exclaimed. "Ten minutes ago."

And then I saw his lips go tight together. He made no move to hide the tape from Elza, but she was beside him and already reading it. Her fingers switched off the announcer's droning voice—he was now saying something unimportant.

"Pacific Coastal Station," Elza read. In the sudden silence of the room her voice was low, clear, and steady, though her hands were trembling. "P.C.S. 10.42 Venus helio. 'Defeat! Beware Tarrano! Notify your Dr. Brende in Eurasia, danger.'"

We men stared at each other. But Elza went on reading.

"P.C.S. 10.44 Venus helio. 'Lost! No more! Smashing apparatus!' The Venus sending station went dark at 10.44.30. Hawaiian station will call later, but have little hope of re-establishing connection." "Tokyohama 10.46 Official, via Potomac National Headquarters Excitement here continues. Levels crowded—"

Elza dropped the tape. "That's all of importance. Venus Central Station warning you, father."

A buzz across the room called the doctor to his personal receiver. It was a message in code from Potomac National Headquarters. We watched the queer-looking characters printing on the tape. Very softly, in a voice hardly above a whisper, Georg de-coded it.

"Dr. Brende, see P.C.S. 10.42, warning you, probably of Venus immigrants now here. Do you need guard? Or will you come Washington at once for personal safety?"

"Father!" cried Elza.

Georg burst out. "Enough of this. We cannot—dare not talk in here. Father, come—"

We went out into the corridor again, across which was the small room insulated from all aerial vibrations. In the corridor a figure was standing—the one other member of the Brende household—the maid-servant, a girl about Elza's age. I knew her well, of course, but this evening I had forgotten her existence. She was standing in the corridor. Did I imagine it, or had she been gazing up at the mechanism ten feet above the floor—the mechanism controlling the insulated room?

"You wish me, Miss Elza? I thought I heard you call."

"No, Ahla, not 'til later."

With a gesture of respect, the girl withdrew, passing from our sight down the incline which led to the lower part of the house.

It was a very small incident, but in view of what was transpiring, it gave me a shock nevertheless.

For Elza's maid was a Venus-girl!

(End of first part)



**A RADIO EDUCATION**  
IN 5 VOLS.

**A COMPLETE RADIO LIBRARY**

Accurate and up-to-date data on the latest subject of Radio Science. Includes: History, Construction Principles, Circuit Diagrams, Commercial Radio, and the Story of the Development of Radio.

**PRICE \$1.97**

**A RADIO EDUCATION**  
IN 5 VOLUMES

**Theory, Design, Construction, Operation and Maintenance**

**LEARN AT HOME**

These five component parts of a complete Radio Instruction Course are outlined in five volumes that contain not merely the essentials as so many books do, but more, they contain all that any modern up-to-the-minute textbook on any subject would cover. They are in themselves a COMPLETE radio education teaching every possible portion of Radio science.

Size of each book 6 by 9 inches, handsomely bound and illustrated with charts, diagrams, descriptions of equipment, etc.

**SEND NO MONEY** for these books. Just forward your name and address. We send you the books at once. On receipt of same you pay the postman \$1.97 plus a few cents postage and then they are yours.

Distributed by  
**The Conrad Co.**  
233 Fulton St., New York, N. Y.

Insure your copy reaching you each month. Subscribe to SCIENCE & INVENTION—\$2.50 a year. Experimenter Publishing Co., 53 Park Pl.,

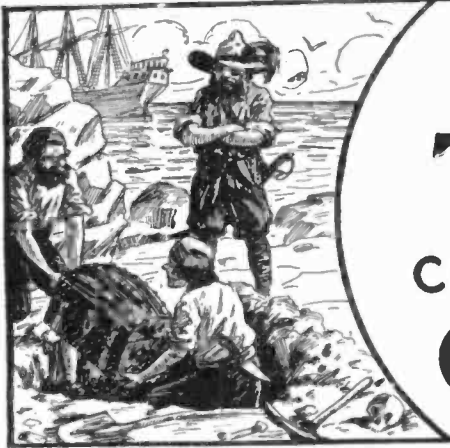

# BURIED TREASURE

can still be found in

# CHEMISTRY



## Good Chemists Command High Salaries

and you can make yourself independent for life by unearthing one of chemistry's yet undiscovered secrets.



T. O'CONOR SLOANE, A.B., A.M., LL.D., Ph.D.

Noted Instructor, Lecturer and Author. Formerly Treasurer American Chemical Society and a practical chemist with many well known achievements to his credit. Not only has Dr. Sloane taught chemistry for years but he was for many years engaged in commercial chemistry work.

Do you remember how the tales of pirate gold used to fire your imagination and make you want to sail the uncharted seas in search of treasure and adventure? And then you would regret that such things were no longer done. But that is a mistake. They are done—today and everyday—not on desert islands, but in the chemical laboratories throughout your own country. Quietly, systematically, the chemist works. His work is difficult, but more adventurous than the blood-curdling deeds of the Spanish Main. Instead of meeting an early and violent death on some forgotten shore, he gathers wealth and honor through his invaluable contributions to humanity. Alfred Nobel, the Swedish chemist who invented dynamite, made so many millions that the income alone from his bequests provides five \$40,000 prizes every year for the advancement of science and peace. C. M. Hall, the chemist who discovered how to manufacture aluminum made millions through this discovery. F. G. Cottrell, who devised a valuable process for recovering the waste from flue gases, James Gayley, who showed how to save enormous losses in steel manufacture, L. H. Baekeland, who invented Bakelite—these are only a few of the men to whom fortunes have come through their chemical achievements.

### What Some of Our Students Say of This Course:

I have not written since I received the big set. I can still say that it far exceeded my anticipations. Since I have been studying with your school I have been appointed chemist for the Seranton Coal Co. testing all the coal and ash by proximate analysis. The lessons are helping me wonderfully, and the interesting way in which they are written makes me wait patiently for each lesson.—MORLAIS COUZENS.

I wish to express my appreciation of your prompt reply to my letter and to the recommendation to the General Electric Co. I intend to start the student engineering course at the works. This is somewhat along electrical lines, but the fact that I had a recommendation from a reliable school no doubt had considerable influence in helping me to secure the job.—H. VAN BENTHUSEN.

So far I've been more than pleased with your course and am still doing nicely. I hope to be your honor graduate this year.—J. M. NORKUS, JR.

I find your course excellent and your instruction, truthfully, the clearest and best assembled I have ever taken, and yours is the fifth one I've studied.—JAMES J. KELLY.

From the time I was having Chemistry it has never been thus explained to me as it is now. I am recommending you highly to my friends, and urging them to become members of such an organization.—CHARLES BENJAMIN.

I shall always recommend your school to my friends and let them know how ample your lessons are.—C. J. AMDAHL.

I am more than pleased. You dig right in from the start. I am going to get somewhere with this course. I am so glad that I found you.—A. A. CAMERON.

I use your lessons constantly as I find it more thorough than most text books I can secure.—WM. H. TIBBS.

Thanking you for your lessons, which I find not only clear and concise, but wonderfully interesting, I am—ROBT. H. TRAYLOR.

I received employment in the Consolidated Gas Co. I appreciate very much the good service of the school when a recommendation was asked for.—JOS. DECKER.

## Now Is the Time to Study Chemistry

Not only are there boundless opportunities for amassing wealth in Chemistry, but the profession affords congenial employment at good salaries to hundreds of thousands who merely follow out its present applications. These applications are innumerable, touching intimately every business and every product in the world. The work of the chemist can hardly be called work at all. It is the keepest and most enjoyable kind of pleasure. The days in a chemical laboratory are filled with thrilling and delightful experimentation, with the alluring prospect of a discovery that may spell Fortune always at hand to spur your enthusiasm.

### You Can Learn at Home

To qualify for this remarkable calling requires elaborate specialized training. Formerly it was necessary to attend a university for several years to acquire that training, but thanks to our highly perfected and thorough system of instruction, you can now stay at home, keep your position, and let us educate you in Chemistry during your spare time. Even with only common schooling you can take our course and equip yourself for immediate practical work in a chemical laboratory. Dr. Sloane gives every one of his students the same careful, personal supervision that made him celebrated throughout his long career as a college professor. Your instruction from the very beginning is made interesting and practical, and we supply you with apparatus and chemicals for performing the fascinating analyses and experimental work that plays such a large part in our method of teaching, and you are awarded the Institute's official diploma after you have satisfactorily completed the course.

### Easy Monthly Payments

You don't have to have even the small price of the course to start. You can pay for it in small monthly amounts—so small that you won't feel them. The cost of our course is very low, and includes everything, even the chemistry outfit—there are no extras to buy with our course. Our plan of monthly payments places a chemical education within the reach of everyone. Write us and let us explain our plan in full—give us the opportunity of showing you how you can qualify for a highly trained technical position without even giving up your present employment.

### Special 30 Day Offer

Besides furnishing the student with his Experimental Equipment, we are making an additional special offer for a short while only. You owe it to yourself to find out about it. Write today for full information and free book "Opportunities for Chemists." Send the coupon right now while it is fresh in your mind. Or just write your name and address on a postal and mail it to us. But whatever you do, act today before this offer is withdrawn.

DON'T WAIT—MAIL COUPON NOW!

CHEMICAL INSTITUTE OF NEW YORK  
Home Extension Division 7  
66-S—West Broadway  
New York City



### Experimental Equipment Furnished to Every Student

We give to every student without additional charge this chemical equipment, including forty-nine pieces of laboratory apparatus and supplies, and forty different chemicals and reagents. These comprise the apparatus and chemicals used for the experimental work of the course. The fitted heavy wooden box serves not only as a case for the outfit but also as a useful laboratory accessory for performing countless experiments.

## CHEMICAL INSTITUTE OF NEW YORK, Inc.

Home Extension Division 7

66-S—WEST BROADWAY NEW YORK CITY

NAME .....

ADDRESS .....

CITY..... STATE.....  
S.I. July '25



## Men Needed in Electricity

**NO PROFESSION** offers greater opportunity to-day than Electricity. Salaries of \$12 to \$30 a day are not uncommon and the opportunity for advancement is unlimited.

As Forrest Crissey said recently in *The Saturday Evening Post*—"The demand for electrical work is increasing immensely and electrical contractors assert that the supply of electrical workers cannot overtake the demand for several years."

Now is the time to prepare for a good position in this profitable, interesting profession. You can study right at home in spare time through the International Correspondence Schools—just as so many other men have done. The I. C. S. Electrical Courses have been endorsed by Thomas A. Edison and Charles P. Steinmetz—the late electrical wizard of the General Electric Co.

Just mark and mail the coupon printed below and full information about Electrical Engineering, Electric Lighting, Electric Wiring, Electric Railways, Radio or any other work of your choice will come to you by return mail.

### Mail the Coupon for Free Booklet

INTERNATIONAL CORRESPONDENCE SCHOOLS  
Box 6215-D, Scranton, Penna.

Explain, without obligating me, how I can qualify for the position, or in the subject, before which I mark X.

<input type="checkbox"/> ELECTRICAL ENGINEER	<input type="checkbox"/> CHEMICAL ENGINEER
<input type="checkbox"/> Electrician	<input type="checkbox"/> Pharmacy
<input type="checkbox"/> Electric Wiring	<input type="checkbox"/> SALESMANSHIP
<input type="checkbox"/> Electric Lighting	<input type="checkbox"/> ADVERTISING MAN
<input type="checkbox"/> Electric Car Running	<input type="checkbox"/> Window Trimmer
<input type="checkbox"/> Heavy Electric Traction	<input type="checkbox"/> Show Card and Sign Paint'g
<input type="checkbox"/> Electrical Draftsman	<input type="checkbox"/> RAILROAD POSITIONS
<input type="checkbox"/> Electric Machine Designer	<input type="checkbox"/> ILLUSTRATOR
<input type="checkbox"/> Telegraph Expert	<input type="checkbox"/> DESIGNER
<input type="checkbox"/> Practical Telephone	<input type="checkbox"/> BUSINESS MANAGEMENT
<input type="checkbox"/> MECHANICAL ENGINEER	<input type="checkbox"/> Private Secretary
<input type="checkbox"/> Mechanical Draftsman	<input type="checkbox"/> Business Correspondent
<input type="checkbox"/> Machine Shop Practice	<input type="checkbox"/> BOOKKEEPER
<input type="checkbox"/> Toolmaker	<input type="checkbox"/> Stenographer and Typist
<input type="checkbox"/> Gas Engineer	<input type="checkbox"/> Cert. Pub. Accountant
<input type="checkbox"/> CIVIL ENGINEER	<input type="checkbox"/> Traffic Management
<input type="checkbox"/> Surveying and Mapping	<input type="checkbox"/> Commercial Law
<input type="checkbox"/> Mining Engineer	<input type="checkbox"/> GOOD ENGLISH
<input type="checkbox"/> ARCHITECT	<input type="checkbox"/> STATIONARY ENGINEER
<input type="checkbox"/> Architectural Draftsman	<input type="checkbox"/> CIVIL SERVICE
<input type="checkbox"/> Architects' Blue Prints	<input type="checkbox"/> Railway Mail Clerk
<input type="checkbox"/> PLUMBING AND HEATING	<input type="checkbox"/> Textile Drafter or Supt.
<input type="checkbox"/> Sheet Metal Worker	<input type="checkbox"/> AGRICULTURE
<input type="checkbox"/> Navigator	<input type="checkbox"/> Poultry Raising
	<input type="checkbox"/> Spanish Automobiles
	<input type="checkbox"/> RADIO

Name \_\_\_\_\_

Present Occupation \_\_\_\_\_ Business Address \_\_\_\_\_ 4-30-24

Street and No. \_\_\_\_\_

City \_\_\_\_\_ State \_\_\_\_\_

Canadians may send this coupon to International Correspondence Schools Canadian, Limited, Montreal, Canada

## Doctor Hackensaw's Secrets

By CLEMENT FEZANDIÉ

(Continued from page 229)

"My dependence, however, is not on the pilot. I have other devices to ensure our safety. In front of the car is an electric gong which will ring continuously during our descent. This will be a great protection."

"What in the world will be the use of a gong?" asked Miggs, puzzled. "You surely don't expect to meet another car coming up?"

"No, but I do fear to find some obstruction in the path, or to find a sudden turn in the pit, or even to find the pit completely closed."

"But what use will the gong be?"

"By means of a parabolic reflector I shoot the sound straight in front of the car. If there is no obstruction in front of us, there will be no echo. If, however, there is anything in the way, some of the sound waves will be reflected back to us and warn us of our danger. Not only will these waves sound an alarm, but they will automatically work a relay that will work the brakes and check the speed of the car. To make assurance doubly sure, I also shoot forth an ultra-violet ray in front of the car which acts in the same manner. When this ray strikes an obstruction, it is reflected back and acts on a photo-electric cell in the car, also sounding an alarm and putting on the brakes. This device is more delicate than the other, but it has the advantage of speed, for the light waves travel much faster than the sound waves. But we're wasting time. Everything is ready now for the start. I'll take the first trick at the wheel so you can watch me and see how things work. As you would feel a peculiar sensation when we acquire speed, a sensation similar to that experienced on a rapidly descending elevator, you will find it advisable to lie down on the adjustable couches. These couches are provided with a universal joint so they can be adjusted in any position desired. As you see there is a similar one provided for the pilot. Now then, are you all ready? Yes? Then I press the button and down we go!

### CHAPTER VII

The car trembled for an instant and then slowly began its descent into the bottomless pit, the chain that held it gradually unwinding as the car descended.

By slow degrees the doctor increased the speed. The brakes had already been tested out on several previous short trial trips, but so much depended on their proper working that the doctor now put them to a series of more strenuous tests. He would allow the car to drop suddenly a short distance and then apply the brakes with a jerk. He was overjoyed to find that they checked the descent of the car at once and without showing any signs of strain. The passengers suffered more than the brakes, and Pep, off her guard, was even once thrown off her berth to the ground. But she picked herself up, laughing, and accused the doctor of doing it on purpose.

Satisfied that everything was in perfect order, Doctor Hackensaw gradually increased speed and soon the car (or the "squad", as Miggs persisted in calling it), was falling downward at a uniform rate of forty miles an hour.

At the end of a couple of hours the instruments indicated that a depth of eighty miles had been reached and that the vacuum in the pit was not quite so great as at the start.

"You've got to look out now," said Miggs. "As the pit is only one hundred miles deep,

we'll strike the bottom in another half hour."

"No danger of that," replied the Doctor. "The pit must extend several hundred miles further."

"What makes you think that? Didn't you tell us that the bomb which dropped down exploded a hundred miles below the surface?"

"So it did; but the explosion was in all probability caused by the speed of its fall. It didn't go down quietly the way we did, at forty miles an hour, but fell at a constantly increasing speed. The compression of the air in front probably sufficed to force back the detonator that causes the explosion of the bomb."

"But what makes you think we are not near the bottom of the pit?"

"Because the air which is getting slightly denser, doesn't seem to be reflected back to us. If the bottom of the pit were a few miles away, we ought to feel a stronger back pressure or breeze than the instruments show. I am so sure of the fact that the bottom is a long way off that I am going to increase our speed to one hundred miles per hour."

"All right, but go slow!" said Pep, who didn't want another fall.

The speed was gradually increased and now our friends found that their bodies, as before, seemed a trifle lighter as the velocity increased. An acceleration of thirty-two feet per second would have caused them to lose all their weight and float in the air. Of course, their speed only increased a very small fraction of this, so the loss in weight, while perceptible, was perceived more as an uncomfortable feeling than as a sensation of lightness.

"Now Pep," said Doctor Hackensaw, "as we have a long and probably monotonous journey before us, suppose you hook up the radio set and see if you can catch some good music from one of the broadcast stations."

### CHAPTER VIII

The start had been made at eight o'clock in the morning in order to give a long day for the exploration, though of course there was no distinction between day and night in the pit, and the party could turn the electric lights in the car on and off at will.

The music broke up the monotony of the trip and cards and checkers and letter writing, the messages to be sent by radio, helped to pass the time. Pep had resolved to send to her special friends missives from the center of the earth if she should ever reach the spot.

As time passed the three friends found that their weight was becoming perceptibly lighter. Pep who weighed a hundred and twenty pounds normally, found when she suspended herself from a spring scale in the car that she now weighed only one hundred pounds and her lightness increased every hour.

Another sign that they were approaching the center of the earth was that the tension of the brakes against the walls of the pit, as indicated by a gauge in the car, became gradually less. Miggs inquired the cause of this from the doctor.

"You see, Miggs," explained Doctor Hackensaw, "I have set the speed of the car to remain automatically one hundred miles per hour, this being the highest speed at which it is prudent to travel. When we go faster than this, the brakes automatically press tighter against the walls of the pit, and so retard our speed. On the other hand, when

(Continued on page 280)

**CONN BAND INSTRUMENTS**  
WORLD'S LARGEST MANUFACTURERS

**EASIER** playing qualities of Conn instruments, the result of exclusive Conn processes, speed your progress, give you quickly the pleasure and profit of personally played music. Used and endorsed by the world's greatest artists.

**FREE TRIAL: Easy Payments** on any instrument for band or orchestra. Send today for catalogs and details; mention instrument.

**ROBERT E. CLARK**  
Trombone Soloist  
U. S. Marine Band  
uses a Conn.

**C. G. CONN, Ltd.**  
756 Conn Bldg., Elkhart, Ind.

Insure your copy reaching you each month. Subscribe to RADIO NEWS—\$2.50 a year. Experimenter Publishing Co., 53 Park Pl., N.Y.C.



# CHRISTIANITY ON BROADWAY

Excerpts from editorial in  
The Daily Reporter, White Plains, N. Y.  
By W. Livingston Larned

AN unusual project has been set in motion in New York. A "Business Building" is to rise on Broadway, at 173rd Street, dedicated to Christianity. To be known as the "Broadway Temple," it will contain a church, offices, auditoriums, schools, hotel accommodations, cafeterias, etc. And to a large extent, it will be erected by popular subscription. Individuals buy bonds, representing a 5 per cent investment and the total cost will be approximately \$4,000,000.

It is the first undertaking of its kind, and has so many amazing features that we will do well to observe some of these innovations. For this is a combination of church and skyscraper. Business and Christianity will be housed under one roof.

This Broadway Temple is, in a sense, a gigantic symbol of the uncontrovertible fact that Godliness can and should be continuous.

Broadway will be the better for a substantial reminder of this Holy Presence. From every vantage point, on sunny days, or nights filled with the sinister menace of storm, a high-flung cross of unquenchable light will be visible, glittering against the heavens. And he will murmur to himself reverently, "The Holy Spirit bids with me wherever I may be, walking or sleeping."

Broadway Temple will cover 26,000 square feet of foundation space, facing a whole block on Broadway. It will have a beautiful tower, 24 stories high; six million people will see a revolving cross of light, 34 feet high, on its topmost pinnacle. The church auditorium will seat 2200; there will be Sunday school rooms, a social hall and every modern convenience for religious and community work. An apartment hotel in the tower is to contain 644 rooms, public offices and dining halls. Apartments for housekeeping in the two wings will accommodate 500 persons. And there are stores fronting on Broadway.

In exploiting this magnificent and ambitious plan, its sponsors say: "A 5 per cent investment in your Fellow Man's Salvation, Broadway Temple is to be a combination of Church and Skyscraper, Religion and Revenue, Salvation and 5 per cent—and the 5 per cent is based on ethical Christian grounds."

Broadway Temple is more than a revolutionary idea, more than a sound investment, more than an architectural wonder of the age; it represents a spiritual stepping stone in man's climb upward to the Cross.

**"Buy These Bonds  
and Let God  
Come to Broadway"**

# Religion and Revenue Glorified by a Wonderful Ideal

The Directors who will conduct this business enterprise, the men with whom you, as an investor, will be associated, are some of the keenest and best-known business men in New York. They are

- President: Ellis L. Phillips,  
Pres. Long Island Lighting Co.
- Arthur J. Baldwin, Vice-President  
McGraw Hill Publishing Co.
- Carl H. Fowler, Vice-President,  
Fowler & Holloway
- Samuel McRoberts, Treasurer,  
Chatham & Phoenix Nat'l  
Bank & Trust Co.
- W. R. Comfort, President,  
Reid Ice Cream Co.
- Charles A. Frueauff,  
Frueauff, Robinson & Sloan
- Frank De K. Huyler,  
President of Huyler's
- E. V. P. Ritter,  
Formerly Pres. Grand Central  
Palace
- M. G. Collins, Vice-Pres., Broker
- Watson S. Moore, Vice-President,  
Formerly V.P.U.S. Grain Corp.
- Frederick Kraft, Secretary,  
Kraft Cheese Co.
- Hon. Royal S. Copeland,  
U. S. Senator
- Lamar Hardy,  
Former Corporation Counsel
- Robert H. Montgomery,  
Lybrand, Ross Bros. & Mont-  
gomery
- W. P. Tanner,  
W. P. Tanner-Gross Co.



**BROADWAY TEMPLE**  
A Twentieth Century Cathedral, Church,  
Hotel, Stores, Apartment House;  
Self-Supporting, Community-Serving

### Why this is a SAFE Investment

Merely as an investment the Bonds of the Broadway Temple are inviting as a business proposition. Ewing, Bacon & Henry, real estate experts, in a letter to Donn Barber, the architect, set forth the following conservative estimate of income:

Rental from stores . . . . .	\$27,500
Income from two apartment houses . . . . .	166,290
Income from apartment hotel . . . . .	402,300

Total annual income . . . \$596,090

Total expenses and interest and taxes . . . 470,500

Leaving a net surplus for the bond holders of \$125,590 annually

GEN. SAMUEL McROBERTS, *Trés.*  
Chatham & Phoenix National Bank & Trust Co.  
149 Broadway, New York City

I hereby subscribe to \$\_\_\_\_\_ in Broadway Temple Second Mortgage GOLD BONDS, income bearing at the rate of 5% per year. I agree to make payments as follows: 10% of total amount when my subscription is accepted, and 10% every sixty days thereafter until paid in full.

IF YOU WANT DETAILS ONLY, SEND COUPON BELOW

—Before I send in my subscription, please send complete details showing how I may make this investment with safety of principal and interest at 5%.

Name \_\_\_\_\_

Address \_\_\_\_\_

City \_\_\_\_\_ State \_\_\_\_\_

See Objects Miles Away!



**8-POWER WAR BINOCULARS**

**R**ECEIVED! Limited quantity GENUINE Imported French and German Army Officer's Binoculars. 8-Power Achromatic lenses; Premier Quality—Genuine Prisms; wide objective; same as used by famous European Army Commanders. We have supplied hundreds of them to U. S. Army and Navy Officers. Such powerful Binoculars usually sell for \$40 to \$50. Our price (while they last) complete with genuine leather case and carrying straps..... **\$21**

**10-DAYS' FREE TRIAL**

Send NO Money! NOTHING To Pay Postman! See them! Examine them! Try them! If satisfied, after 10 DAYS' TRIAL, you may pay at rate of

**\$4 A MONTH**

or, if you wish to pay cash, after 10 DAYS, take **\$19.50** Discount and send check or money order for

**B**ROADEN your field of vision! Don't live in a copped-up area! A new world will open up for YOU with a pair of these wonder Glasses. You'll see things others can't. People, Scenes, Views, Games of ACTION brought right to your feet! The joys of outdoors are not complete without them. The greatest pleasure giving INVESTMENT one can make. Indispensable for sports—baseball games, motoring, camping, yachting, hunting, hiking, races, bird and nature study, etc.

Sent on 10 Days' FREE TRIAL!

**ACT! QUANTITY IS LIMITED! ORDER TODAY! Send NO Money!**



2 Generations of Honorable Dealings  
**WASHINGTON JEWELRY CO.**  
Importers and National Mail Order House  
365 Washington Street, Boston, Mass.  
For prompt attention address DEPT. 8.

Gentlemen: Please send me 8-power Binoculars. I enclose NO money, and pay NOTHING to Postman. If I am satisfied after 10 DAYS' TRIAL, I have the privilege of paying for them at the rate of \$4.00 monthly—or of deducting \$1.50 and sending \$19.50 in FULL SETTLEMENT. Otherwise, I shall return them.

NAME \_\_\_\_\_  
ADDRESS \_\_\_\_\_  
Please write PLAINLY! Tear this coupon out NOW! If you wish to tell us something about yourself, it will be appreciated. SJS

**Doctor Hackensaw's Secrets**

(Continued from page 278)

we go less than a hundred miles per hour, the brakes automatically relax a trifle, allowing us to fall faster."

"But why should we slow up, as we near the center of the earth? I always thought the velocity would keep on increasing until the center of the earth was reached, and only begin decreasing after we had passed the center."

"So it would, Miggs, if our car were falling freely in a tube deprived of air. The acceleration of speed would each second become smaller and smaller, but would be added to the previous speed so that when we reached the center we should be traveling at a terrific rate. But as the brakes keep the car at a uniform speed of one hundred miles per hour, and the pull of gravitation becomes smaller each second, the car would gradually slow up and stop unless I eased up the brakes. Another thing that retards us is that the air is getting denser. It is now six o'clock—dinner time by the way—and we have been falling for ten hours. Of course, we went slowly at the start, but we have fallen nearly nine hundred miles now. If you look at the air gauge you will see that the air in the pit is perceptibly denser—not yet the normal atmospheric pressure of 15 pounds to the square inch, but approaching it.

Miggs looked at the simple gauge that indicated this pressure. It was nothing but a diaphragm. A valve allowed air from the pit to enter one side of the diaphragm and air from the car was admitted by another valve to the other side. A rod fastened to the diaphragm was thus pushed forward or back, indicating the pressure by pushing a needle pivoted on a dial.

The trio sat down to a hearty meal, taking short tricks of five minutes each on the pilot seat so that all might enjoy the meal together. Care had to be taken in moving around for their bodies had lost so much weight that a too brisk movement would cause them to jump high in the air. In fact, once poor Pep accidentally jumped so high that she kicked Doctor Hackensaw on the head, knocking him down. Luckily his light weight prevented him from hurting himself.

"If we were falling freely and there were

a perfect vacuum in the tube," explained the doctor, we should have had no weight at all during the entire trip, for we should ourselves have been attracted no faster than the car, even if we were in mid-air. As things are, however, we shall not lose our weight completely unless we stop at the center of the earth. At present our weight is governed by three factors: (1) the speed of the car; (2) the acceleration produced by gravitation at the spot we have reached; and (3) the density of the air in the pit."

"How does the density of the air in the pit affect our weight?" inquired Miggs.

"It retards the car, but does not retard our bodies. Hence, it increases our weight on the spring scale, or at least it would increase it, if the car were falling freely in the pit."

After dinner Doctor Hackensaw examined the instruments again and then started to make some calculations. The result seemed to puzzle him. Thinking he had made some error, he started all over again, but seemingly with no better result.

"What's the matter?" asked Pep.

"I don't know, but something's wrong. We are now twelve hundred miles below the surface of the earth, but our weights are much less than they ought to be at this spot. Something is wrong somewhere—unless—" he hesitated an instant, then a gleam of excitement came into his eyes:

"I have it!" he cried. "I understand everything now! I understand why our weight is almost nothing at present! I understand, too, what puzzled me so much in the radio observations we made before starting by sending directed waves through the center of the earth from surface to surface. But if my hypothesis is correct, the center of the earth must be an even more marvelous place than anyone had ever suspected it to be!"

(To be continued)

**What Is Gravitation?**

By PROF. DONALD H. MENZEL, Ph.D.

(Continued from page 223)

of the planets assumed, instead of a repellent, an attractive force. If you could minutely examine the conditions you would find your error. You have imagined the bright area to be flat. Actually it is within a pit, and the curved path is not only the natural, but the shortest one for the man to follow.

Einstein makes gravitation follow as a natural effect of the presence of matter. That is one of the reasons why his law seems simpler to the scientists than Newton's. If Einstein is right, as it appears, then it is probable that we shall never be able to annul gravitation, that is, without destroying matter—for they are one and the same thing. The present status of research indicates that the second is possible, though it should be hoped that it will not be accomplished within a short space of time.

**How Fast Can Airplanes Fly?**

By WILLIAM SULLIVAN  
Aeronautical Engineer

**Garden Arbors—How to Build Them.**

By WILLIAM BUTTERFIELD  
In the August issue.

**BLISS ELECTRICAL SCHOOL**



A special technical school with concise but comprehensive course in Electrical Engineering. Non-essentials eliminated. Thorough knowledge of underlying principles emphasized. Theory and practice are closely interwoven in class-room and laboratory.

**Electrical Engineering in One Year**

The course is designed for earnest, ambitious young men of limited time and means. Curriculum includes mathematics, mechanical drawing and intensive shop work. Students construct motors, install wiring, test electrical machines. Graduates are qualified to enter the electrical field at once.

Bliss men hold responsible positions throughout the world. Thoroughly equipped fire-proof dormitories, dining hall, laboratories and shops. Prepare for your profession in the most interesting city in the world. Established 1893. Send for catalog. Address  
**BLISS ELECTRICAL SCHOOL, 247 Takoma Avenue Washington, D. C.**

**ADULTS! SEX KNOWLEDGE BOOKS**

Instructive, authoritative, profusely illustrated in natural colors, etc. The worth-while sort. Contains everything one should know both before and after marriage to enjoy health and happiness. Large Catalog, 10c. F. SMETANA & CO. OWOSSO, MICH.

Insure your copy reaching you each month. Subscribe to **SCIENCE & INVENTION—\$2.50 a year.** Experimenter Publishing Co., 53 Park Pl, N. Y. C.

**The Isolator**  
By HUGO GERNSBACK  
(Continued from page 214)

shut out all the noises, it reached an efficiency of about 75 per cent. The reason was that solid wood was used.

In a subsequent helmet under construction, an air space is included, as per our line illustration, no wood entering into the construction at all. This feature should give almost 90 per cent. to 95 per cent. efficiency, thereby excluding practically all sounds.

It will be noted that the glass windows directly in front of the eyes are black. The construction involved the use of ordinary window glass, the outer glass being painted entirely black. Two small white lines were scratched into the paint, as shown. The idea of this is as follows:

The writer thought that shutting out the noises was not sufficient. The eye would still wander around, thereby distracting attention. By having the two white lines scratched on the glass, the field through which the eye can move is comparatively small. In illustration No. 1, it will be seen that it is almost impossible to see anything except a sheet of paper in front of the wearer. There is, therefore, no optical distraction here.

It was also found that if the helmet was used alone for more than fifteen minutes at a time, the wearer would become more or less drowsy. This is not conducive to hard thinking, and for that reason the writer introduced a small oxygen tank, attached to the helmet. This increases the respiration and livens the subject considerably.

With this arrangement it is found that an important task can be completed in short order and the construction of the Isolator will be found to be a great investment.

**Book Review**  
(Continued from page 274)

**THE PROBLEM OF THE OBELISKS.** By R. Engelbach. Hard covers, 5½" x 9", 134 pages. Published by George H. Doran Co., New York. \$4.00.

This very fully illustrated book devoted to the monoliths of Egypt is to be warmly commended to our readers. It certainly is most interesting reading giving all the particulars of the quarrying and probable methods of erecting obelisks. The application of the principle of the hour glass for gradually getting the obelisks into a vertical position, is illustrated by four views, which make a most interesting suggestion at least, of how the feat may have been done before, but this is not all, for an entire chapter is devoted to this subject of erection. The quarrying and transportation of obelisks comes next, and from ancient records it has been ascertained how many men were employed for some of the work.

(Continued on page 286)

**For Your Boat**



**Elto** Old Evinrude's New Quick Detachable ROWBOAT MOTOR

Easily carried. Quickly attached to any boat (without tools). Drives boat any speed, 2 to 10 miles per hour. No rowing, no work, no bother.

**Fast—Light—Powerful Easy to Carry**

Has 12 exclusive features, all described in our new Free Catalog. Write for it today. Elto Outboard Motor Co. Manufacturer's Home Bldg. Dept. 48 Milwaukee, Wis.

**The Motor that Starts with a Touch**



7c  
a  
day

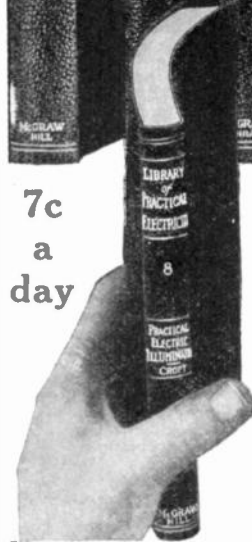

**Raise your pay with these books**

**B**IG salaries are paid in the electrical field for expert knowledge. The man who knows electricity in all its many phases—the man who has completely mastered the subject from A to Z—can pick his own job and name his own salary. The only way you can earn more is to learn more. Small knowledge means small pay. Learn the way to bigger pay. Become an expert. Croft will show you how.

**Croft Library of Practical Electricity**

8 volumes—3000 pages—2100 illustrations—flexible keratol—small monthly payments

Everywhere the Croft Library is acknowledged as the standard—the leader—in practical electrical training. In the Croft books you will find complete, detailed and up-to-the-minute information on all phases of electricity, motors, generators, armatures, commutators, transformers, circuits, currents, switchboards, distribution systems—electrical machinery of every type—wiring for light and power—how to do it mechanically perfect, in accordance with the National Electrical Code—wiring of finished buildings—underwriters' and municipal requirements—how to do a complete wiring job, from estimating it, to completion—illumination in its every phase—the latest and most improved methods of lighting—lamps and lighting effects, etc.

**Know electricity as experts know it and get an expert's pay**

Fit yourself for a bigger position by knowing electrical practice complete—inside and outside work—central stations and the whole subject. Croft will teach you. He will take you in quick, easy steps from the simplest principles to the complete and economical operation of a great central station. The Croft-trained man wins because he knows the "why" and the "how" of modern electrical practice. Croft has been through the mill. His knowledge has been gained by shirt-sleeves contact with electrical problems. He has worked his way up from the bottom to the top—from apprentice lineman to electrical engineer for one of the great electrical manufacturing companies. Now he heads his own consulting company, and his name is known in every corner of the electrical world. He is the one man above all others who can show you the way to permanent success.

**Examine these pay-raising books free**

We want you to test out statement—we want you to compare Croft books with others. Fill in and mail the coupon attached and we will send you the entire set of eight volumes for ten days' Free Examination. We take all the risk—pay all charges. You assume no obligation—you pay nothing unless you decide to keep the books. Then \$1.50 in ten days and the balance at the rate of \$2 a month. Send the coupon NOW and see the books for yourself. When your first payment of \$1.50 is received we will send you your free copy of Taylor's Transformer Practice.

**Send no money —just the coupon**

Name .....

Home Address .....

City and State .....

Employed by .....

Occupation .....

McGraw-Hill Book Co., Inc., 370 Seventh Avenue New York.

Gentlemen—Please send me the CROFT LIBRARY OF PRACTICAL ELECTRICITY (shipping charges prepaid), for 10 days' free examination. If satisfactory, I will send \$1.50 in ten days and \$2.00 per month until \$19.50 has been paid. If not wanted, I will write you for return shipping instructions. Upon receipt of my first payment of \$1.50 I am to receive a copy of Taylor's Transformer Practice without additional charge. (Write plainly and fill in all lines.)

**YOU TOO CAN PLAY THE HAWAIIAN GUITAR**  
 JUST AS THE HAWAIIANS DO  
 PLAY ALL THE LATEST HITS

**FREE! THIS \$15 HAWAIIAN GUITAR**

**ONLY 4 MOTIONS** used in playing the fascinating Hawaiian Guitar. Our native Hawaiian instructors teach you to master them quickly. Pictures show how. Everything explained clearly.

**PLAY IN HALF HOUR**  
 After you get the 4 easy motions, you can play harmonious chords with very little practice. 40,000 students have learned to play in this easy, pleasant way.

**EASY LESSONS**  
 The 52 printed lessons with a great many pictures make it easy to learn quickly. You don't have to know how to read notes. No previous musical knowledge necessary. You learn to play any kind of music, and play as you play.

**FREE GUITAR**  
 As a special offer to new students we give this full size, high grade instrument free of charge. It is sent at once without red tape or delay.

**WRITE AT ONCE**  
 Send your name at once and let us tell you all about the 52 easy lessons and the free guitar. You have everything to gain. Don't put it off. A post card will do. Ask for new special offer and easy terms.

First Hawaiian Conservatory of Music, Inc.  
 283 Broadway (Woolworth Bldg., Dept. 40, New York, N. Y.)

Special courses on Violin, Tenor-Banjo, Banjo-Ukulele and Ukulele



**\$3.25 (C.O.D.)**

**RADIO Storage "B" Battery**

**Lasts Indefinitely—Pays for Itself**

24 Cells Economy and performance unheard of before. Recharged at a negligible cost. Approved and listed as Standard by leading Radio Authorities, including Pop. Radio Laboratories, Pop. Sci. Inst. Standards, Radio News Lab., Lelex, Inc., and other important institutions. Equipped with Solid Rubber Caps, an insurance against acid and leakage.

**SEND NO MONEY** Just state number of batteries wanted and we will ship day order is received. Extra Offer: 4 batteries in series (96 volts), \$12.75. Pay expressman after examining batteries. 5 per cent discount for cash with order. Mail your order now.

**WORLD BATTERY COMPANY**  
 1219 So. Wabash Ave., Dept. 83, Chicago, Ill.  
 Makers of the Famous World Radio "A" Storage Battery  
 Prices: 6-v., 100 Amp. \$11.25; 120 Amp. \$13.25; 140 Amp. \$14.00. All equipped with Solid Rubber Case.

**World FOR RADIO STORAGE BATTERIES**

KOKA - WEA - WGN - WJS - KHJ - KGO - KFAC - WJY - KOP

**PIMPLES**

Your Skin Can Be Quickly Cleared of Pimples, Blackheads, Acne Eruptions on the face or body, Barbers Itch, Eczema, Enlarged Pores and Oily or Shiny Skin.

**FREE** Write today for my **FREE BOOKLET** "A Clear-Tone Skin," telling how I cured myself after being afflicted 15 years.

**E.S. GIVENS, 168 Central Bldg., Kansas City, Mo.**

**Fortune Telling Globe!**

THE GENUINE CRYSTAL ORACLE answers every question... Love, Marriage, Money, Luck! Mystifying, thrilling, fascinating game. Gift includes 6 inches round Crystal Globes 168-pg. Book on Divination by Crystal Dreams, etc., also Book "How to Converse with Spirits." Cat Price \$2.45

Send 20c for postage. Pay the balance (\$2.25) when delivered.

**PARK PUB. CO.**  
 Park Row Bldg., New York Dept. 5C

**Makes Autos Go 49 Miles On Gallon of Gasoline**

An amazing new device has been perfected by James A. May, of 803K Lacombe Bldg., Sioux Falls, So. Dak., that cuts down gas consumption, removes all carbon, prevents spark plug trouble and overheating. Many cars have made over 49 miles on a gallon. Any one can install it in five minutes. Mr. May wants agents and is offering to send one free to one auto owner in each locality. Write him today.

Insure your copy reaching you each month. Subscribe to **SCIENCE & INVENTION**—\$2.50 a year. Experimenter Publishing Co., 53 Park Pl., N. Y. C.

**Radio Broadcast Calls**  
 (Continued from page 258)

Call Letters	Location and Name	Power & Wave Length	Call Letters	Location and Name	Power & Wave Length
WDAG	Amarilla, Texas, J. Laurance Martin	100—263	WFBB	Eureka, Ill., Eureka College	100—240
WDAH	El Paso, Texas, Trinity Methodist Church (South)	50—268	WFBC	Knoxville, Tenn., First Baptist Church	50—250
WDAY	Fargo, N. D., Radio Equipment Corporation	50—244	WFBD	Philadelphia, Pa., Gethsemane Baptist Church	5—234
WDBC	Lancaster, Pa., Kirk, Johnson & Co.	50—258	WFBE	Seymour, Ind., John Van de Walle	10—226
WDBD	Martinsburg, W. Va., Herman E. Burns	5—254	WFBG	Altoona, Pa., William F. Gable Co.	100—278
WDBE	Atlanta, Ga., Gilham-Schoen Electric Co.	100—278	WFBH	New York, N. Y., Hotel Majestic (Concourse Radio Corp.)	500—273
WDBF	Youngstown, Ohio, Robert G. Phillips	50—222	WFBI	Camden, N. J., Galvin Radio Supply Co.	100—236
WDBJ	Roanoke, Va., Richardson-Wayland Electrical Corporation	50—229	WFBJ	Collegeville, Minn., St. John's University	50—236
WDBK	Cleveland, Ohio, M. & F. Broz Furniture, Hardware & Radio Store	100—227	WFBK	Hanover, N. H., Dartmouth College	100—256
WDBO	Winter Park, Fla., Rollins College	50—240	WFBM	Syracuse, N. Y., Onondaga Hotel	100—252
WDBP	Superior, Wis., Superior State Normal School	50—242	WFBN	Indianapolis, Ind., Merchants Heat & Light Co.	250—268
WDBQ	Salem, N. J., Morton Radio Supply Co.	10—234	WFBQ	Bridgewater, Mass., Radio Sales & Service Co.	10—226
WDBR	Boston, Mass., Tremont Temple Baptist Church	100—261	WFBQ	Raleigh, N. C., Wynne Radio Co.	50—252
WDBS	Dayton, Ohio, S. M. K. Radio Corp.	5—275	WFBR	Baltimore, Md., Fifth Infantry, Maryland, N. G.	100—254
WDBT	Hattiesburg, Miss., Taylor's Book Store	10—236	WFBT	Pitman, N. J., Gloucester County Civic Club	50—231
WDBW	Columbia, Tenn., The Radio Den	20—268	WFBY	Fort Benjamin Harrison, Ind., U. S. Army, Fifth Corps	100—258
WDBX	New York, N. Y., Otto Baur	50—233	WFBZ	Galesburg, Ill., Knox College	10—254
WDBY	Chicago, Ill., North Shore Congregational Church	500—258	WFI	Philadelphia, Pa., Strawbridge & Clothier	500—394.6
WDBZ	Kingston, N. Y., Boy Scouts of America (Ulster County Council)	5—233	WGAL	Lancaster, Pa., Lancaster Electric Supply & Construction Co.	10—248
WDM	Washington, D. C., Church of the Covenant	50—270	WGAQ	Shreveport, La., W. G. Patterson	150—263
WDWF	Cranston, R. I., Dutee W. Flint	500—440.9	WGAZ	South Bend, Ind., South Bend Tribune	250—275
WDZ	Tuscola, Ill., James L. Bush	10 and 100—278	WGBA	Baltimore, Md., Jones Electric & Radio Mfg. Co.	100—254
WEAA	Flint, Mich., Police Building, Frank D. Fallain	50—234	WGBB	Freeport, N. Y., Harry H. Carman	100—244
WEAF	New York, N. Y., American Telep. & Teleg. Co.	2000—491.5	WGBC	Memphis, Tenn., First Baptist Church	10—266
WEAH	Wichita, Kans., Wichita Board of Trade	100—268	WGBF	Evansville, Ind., Finke Furniture Co.	50—217.3
WEAI	Ithaca, N. Y., Cornell University	500—254	WGBG	Thrifton, Va., Breitenbach's Radio Shop	10—226
WEAJ	Vermilion, S. Dak., University of South Dakota	100—273	WGBH	Fall River, Mass., Fall River Herald Publishing Co.	10—209.7
WEAM	North Plainfield, N. J., Borough of North Plainfield	250—261	WGBI	Scranton, Pa., Frank S. Megargee	10—240
WEAN	Providence, R. I., Shepard Co.	100—270	WGBK	Johnstown, Pa., Lawrence W. Campbell (Fontaine Cha-teau)	5—248
WEAO	Columbus, Ohio, Ohio State University	500—293.9	WGBL	Elyria, Ohio, Elyria Radio Assoc.	10—227
WEAP	Mobile, Ala., Mobile Radio Co.	100—263	WGBM	Providence, R. I., Theodore N. Saaty	5—234
WEAR	Baltimore, Md., Goodyear Tire & Rubber Co.	1000—389.4	WGBN	La Salle, Ill., Iuh Radio Shop	10—256
WEAU	Sioux City, Iowa, Davidson Bros. Co.	100—275	WGBO	San Juan, Porto Rico, Dr. Roses Artan	10—275
WEAY	Houston, Tex., Iris Theatre	500—360	WGBQ	Menomonie, Wis., Stout Institute	20—234
WEBA	Highland Park, N. J., The Electric Shop	15—233	WGBR	Marshfield, Wis., Marshfield Broadcasting Assn.	10—229
WEBC	Superior, Wis., Walter C. Bridges	10—242	WGBS	New York, N. Y., Gimbel Brothers	1000—315.6
WERD	Anderson, Ind., Electrical Equipment & Service Co.	10—246	WGBT	Greenville, S. C., Furman University	15—236
WEBE	Cambridge, Ohio, Roy W. Waller	10—234	WGBW	Spring Valley, Ill., Valley Theater	20—212.6
WEBH	Chicago, Ill., Edgewater Beach Hotel Co.	1000—370.2	WGBX	Orono, Me., University of Maine	10—252
WEBJ	New York, N. Y., Third Avenue Ry. Co.	500—273	WGBY	New Lebanon, Ohio, Progress Sales Co.	30—218.8
WEBK	Grand Rapids, Mich., Grand Rapids Radio Co.	20—242	WGN	Chicago, Ill., The Tribune (Drake Hotel - Whitestone Co.)	100—370.2
WEBL	New York, N. Y., Woolworth Bldg., United States (portable), R. C. A.	100—226	WGR	Buffalo, N. Y., Federal Telep. Mfg. Co.	750—319
WEBM	United States (portable), Woolworth Bldg., N. Y.	100—226	WGST	Atlanta, Ga., Georgia School of Technology	500—270
WEBQ	Harrisburg, Ill., Tate Radio Co.	10—226	WGY	Schenectady, N. Y., General Electric Co.	1500—379.5
WEBR	Buffalo, N. Y., H. H. Howell	50—240	WHAB	Brooklyn, N. Y., Wm. H. Taylor Finance Corp.	50—240
WEBT	Dayton, Ohio, Dayton Cooperative Industrial High School	5—256	WHAD	Milwaukee, Wis., Marquette University	500—275
WEBW	Beloit, Wis., Beloit College	500—268	WHAG	Cincinnati, Ohio, University of Cincinnati	100—233
WEBY	Roslindale, Mass., Hobart Radio Co.	10—226	WHAM	Rochester, N. Y., University of Rochester (Eastman School of Music)	100—278
WEBZ	Savannah, Ga., Savannah Radio Corp.	50—234	WHAR	Atlantic City, N. J., Seaside House Hotel	100—275
WEEL	Boston, Mass., Edison Electric Illuminating Co. of Boston	500—475.9	WHAS	Louisville, Ky., Courier-Journal & Louisville Times	500—399.8
WEMC	Berrien Springs, Mich., Emmanuel Missionary College	500—285.5	WHAV	Wilmington, Del., Wilmington Electrical Specialty Co.	100—266
WENR	Chicago, Ill., All American Radio Corp.	100—266	WHAZ	Troy, N. Y., Rensselaer Polytechnic Institute	500—379.5
WEW	St. Louis, Mo., St. Louis University	100—248			
WFAA	Dallas, Tex., Dallas News & Dallas Journal	500—475.9			
WFAM	St. Cloud, Minn., Times Publishing Co.	10—273			
WFAV	Lincoln, Nebr., University of Nebraska	500—275			

Call Letters	Name	Location	Power & Wave Length
WHB	Kansas City, Mo., Sweeney School Co.		500-365.6
WHBA	Oil City, Pa., Shaffer Music House		20-250
WHBC	Canton, Ohio, Rev. E. P. Graham		10-254
WHBD	Bellevue, Ohio, Chas. W. Howard		20-222
WHBE	Sewickley, Pa., G. L. Trudel Taxicab Co. & Sewickley Auto Elec. Co.		50-205.4
WHBF	Rock Island, Ill., Beardley Specialty Co.		100-222
WHBG	Harrisburg, Pa., John S. Skane		20-231
WHBH	Culver, Ind., Cuver Military Academy		100-222
WHBI	Chesaning, Mich., Chesaning Electric Co.		50-227
WHBJ	Fort Wayne, Ind., Lane Auto Co.		10-234
WHBK	Ellsworth, Me., Franklin Street Garage		10-231
WHBL	Logansport, Ind., James H. Slusser		50-220
WHBM	Chicago, Ill., C. L. Carrell		20-233
WHBN	St. Petersburg, Fla., First Ave. Methodist Church		10-258
WHBO	Pawtucket, R. I., Young Men's Christian Assoc.		50-231
WHBP	Johnstown, Pa., Johnstown Automobile Co.		10-256
WHBQ	Memphis, Tenn., Men's Fellowship Class of St. John's M. E. Church South		10-233
WHBR	Cincinnati, Ohio, Scientific Electric & Mfg. Co.		20-215.7
WHBS	Mechanicsburg, Ohio, Edward W. Locke		10-208.2
WHBT	Downers Grove, Ill., Thomas W. Tizzard, Jr.		10-206.8
WHBU	Anderson, Ind., B. L. Bing's Sons		10-218.8
WHBV	Columbus, Ga., Fred Rays Radio Shop		20-244
WHBW	Philadelphia, Pa., D. R. Kienzle		100-215.7
WHBX	Punxsutawny, Pa., J. W. Bowser		50-212.6
WHBY	West De Pere, Wis., St. Norbert's College		50-250
WHDI	Minneapolis, Minn., William Hood Dunwoody Industrial Institute		500-278
WHEC	Rochester, N. Y., Hickson Electric Co.		100-258
WHH	Madison, Wis., University of Wisconsin		500-535.4
WHK	Cleveland, Ohio, Radiovox Co. (Warren R. Cox)		100-273
WHN	New York, N. Y., George Schubel		500-361.2
WHIO	Des Moines, Iowa, Bankers Life Co.		500-526
WIAD	Ocean City, N. J., Howard R. Miller		100-250
WIAK	Omaha, Nebr., Journal-Stockman Co.		250-278
WIAS	Burlington, Iowa, Home Electric Co.		100-254
WIBA	Madison, Wis., Capital Times Studio		100-236
WIBC	St. Petersburg, Fla., L. M. Tate Post No. 39, Veterans of Foreign Wars		100-222
WIL	St. Louis, Mo., St. Louis Star & Benson Radio Co.		250-273
WIP	Philadelphia, Pa., Gimbel Brothers		500-508.2
WJAD	Waco, Tex., Jackson's Radio Engineering Laboratories		500-352.7
WJAG	Norfolk, Nebr., Norfolk Daily News		250-270
WJAK	Greentown, Ind., Clifford L. White		20-254
WJAM	Cedar Rapids, Iowa, D. M. Perham		20-268
WJAR	Providence, R. I., The Outlet Co. (J. Samuels & Bro.)		500-305.9
WJAS	Pittsburgh, Pa., Pittsburgh Radio Supply House		500-275
WJAZ	Chicago, Ill., Zenith Radio Corp.		100-268
WJD	Granville, Ohio, Denison University		10-217.3
WJJD	Mooseheart, Ill., Supreme Lodge, Loyal Order of Moose		500-302.8
WJY	New York, N. Y., R. C. A.		1000-405.2
WJZ	New York, N. Y., R. C. A.		1000-454.3
WKAA	Cedar Rapids, Iowa, H. F. Paar		50-278
WKAD	East Providence, R. I., Charles Loeff (Crescent Park)		20-240
WKAP	Cranston, R. I., Dutee W. Flint		50-234
WKAQ	San Juan, P. R., Radio Corp. of Porto Rico		500-340.7
WKAR	East Lansing, Mich., Michigan Agricultural College		500-285.5
WKAV	Laconia, N. H., Laconia Radio Club		50-209.7
WKBE	Webster, Mass., K & B Electric Co.		10-231
WKRC	Cincinnati, Ohio, Kodel Radio Corp.		1000-325.9
WKY	Oklahoma, Okla., WKY Radio Shop		100-275



## Who owns the telephone?

For seven carefree years young John Graves worked in the car shops at Orenville, spending his dollars as fast as he earned them. Soon after his promotion to foreman, he was married and moved to a little white house on Orchard Avenue. Life was happier than ever, but spare dollars were not more plentiful, especially after a third member was added to the family.

Then came a day when the plant superintendent showed John the wisdom of saving a part of his earnings, for the satisfaction it would bring, and for protection against emergencies and old age. He and his young wife, for the first time, learned the difficult art of economy, and finally they came to know the joys of saving and of safe investment.

Today John Graves, and many thousands like him, own the stock of the American Telephone and Telegraph Company. This company is owned by more people than any other, and the great majority of its owners—laborers, clerks, housewives, business men and others—have bought it with their savings. As its business has grown, the number of its shareholders has increased until now one out of every 45 telephone subscribers is also a stockholder.



AMERICAN TELEPHONE AND TELEGRAPH COMPANY  
AND ASSOCIATED COMPANIES  
**BELL SYSTEM**  
*One Policy, One System, Universal Service*

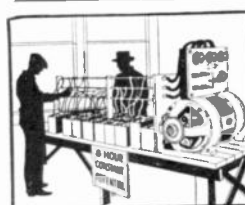

**HB ONE DAY BATTERY CHARGING** EARLY CLEARS \$150 to \$300 INSTANTLY PROFIT  
Start your own big moneymaking battery charging business. No experience is needed to make big monthly profits with HB One Day Battery Charging. Only \$35 puts an HB outfit in your shop complete with bench, bus-bars, connectors, cable, etc. Your big monthly profits easily carry the small monthly payments. 30 days' free trial on money-back guarantee. Write today for free bulletin 725.  
**HOBART BROS. CO.,** Box 87 Troy, Ohio  
LOWEST PRICES—EASIEST TERMS—YOUR BEST MONEY MARKET

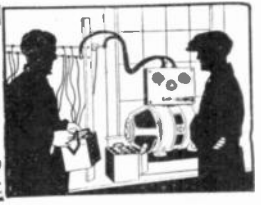

**Free Mailing Lists**  
Will help you increase sales  
Send for FREE catalog giving counts and prices on thousands of classified names of your best prospective customers—National, State and Local—Individuals, Professions, Business Concerns.  
**99% Guaranteed 5¢ each**  
**ROSS-Gould Co.,** 10th St. St. Louis

**Straightens Shoulders**  
—Increases Pep  
**THE NATURAL BODY BRACE**—Corrects stooping shoulders, straightens the back, gives the lungs chance for normal expansion, induces proper breathing. Brings restful relief, comfort, energy, and pep. For men and women.  
**Costs nothing to try it**  
Write for 30 days free trial offer and free book.  
**NATURAL BODY BRACE CO.**  
Howard C. Rash, Ft. 286 Rash Bldg., Selma, Kansas

# Any Lathe You Want On Easy Payment Terms

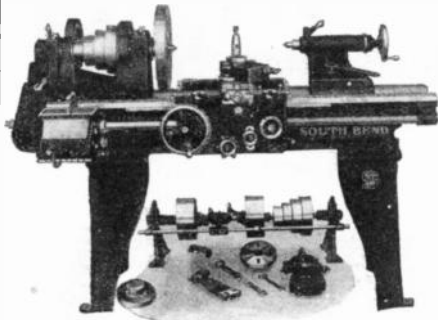

South Bend Screw Cutting Lathe,  
13" x 5' Price \$354

With a South Bend Lathe in your shop you can  
—Save money you now pay others for lathe work,  
—Make money on job work,  
—Get your work done when you want it,  
—Do better work just as you want it,  
—Prevent information of your plans getting into outside hands.  
—Become a skilled operator, always capable of earning good wages in any shop.

We make it easy for you to own one.  
32,000 in use in U. S. and 64 Foreign Countries.  
Write for Catalog.

**SOUTH BEND LATHE WORKS**  
501 E. Madison St., South Bend, Ind., U.S.A.

# Your Tires Free and \$300 a month



## Agent Users Wanted

SEE how easy it is with the **MASTER SALESMAN KIT**, which I send Free, to make \$10 to \$25 a day in your spare time showing **MELLINGER TIRES** at **BIG SAVING** to car owners. This powerful, hand-made, over-size, non-skid Cord is guaranteed by Bond for mileage half way around the world.

The Mellinger Plan starts you in business, all or part time; no capital or experience needed. Tires shipped prepaid on approval. Lowest wholesale prices in America.

**FREE** If you will boost **MELLINGER TIRES**, I have a surprising offer that will give you a set of sample sections. Be first to get my free offer, amazing confidential wholesale prices and big free book. Simply send name today to nearest address. **E. L. MELLINGER, Pres.**

**MELLINGER TIRE & RUBBER CO.**  
Philadelphia, Pa. Dept. 1931, Kansas City, Mo.



### ON ONE TUBE

**BIG FREE BOOKLET** tells the story. California users of **CROSS COUNTRY CIRCUIT** hear Atlantic Coast, Canada, Cuba, Mexico and Hawaii. Atlantic Coast users hear England to California. Our new plan makes this set easiest and cheapest to build. One hour puts in operation. One tuning control. No soldering. Any novice can do it. **BIG BOOKLET FREE** or complete instructions for 25c stamps or coin.  
**VESCO RADIO CO., Box 81-117 Oakland, Calif.**

The Famous **KON-VER-TER** Slide Rule Instantly adds, subtracts, divides, multiplies, converts fractions or decimals of an inch. Gives sines, co-sines, versed sines, co-versed sines, tangents, co-tangents, secants co-secants of angles directly. Gives square roots, squares, cube roots, cubes and fifth roots and powers of all numbers. Logarithms, co-logarithms, anti-logarithms. Instructions with rule. Deluxe Model \$3. Cash or C.O.D. New England Novelty Company Wakefield, Mass.

Call Letters	Location and Name	Power & Wave Length	Call Letters	Location and Name	Power & Wave Length
WLAL	Tulsa, Okla., First Christian Church	150—250	WRAN	Waterloo, Iowa, Black Hawk Electrical Co.	10—236
WLAP	Louisville, Ky., W. V. Jordan	20—275	WRAV	Yellow Springs, Ohio, Antioch College	100—263
WLAX	Greencastle, Ind., Greencastle Community Broadcasting Station	10—231	WRAW	Reading, Pa., Avenue Radio & Electric Shop	10—238
WLB	Minneapolis, Minn., University of Minnesota	5—278	WRAX	Gloucester City, N. J., Flexon's Garage	100—263
WLBL	Stevens Point, Wis., Wisconsin Department of Markets	500—278	WRBC	Valparaiso, Ind., Immanuel Lutheran Church	500—278
WLIT	Philadelphia, Pa., Lit Bros.	500—394.5	WRC	Washington, D. C., Radio Corp. of America	500—468.5
WLS	Chicago, Ill., Sears, Roebuck & Co.	500—344.6	WREO	Lansing, Mich., Reo Motor Car Co.	500—285
WLW	Harrison, Ohio, Crosley Radio Corp.	1500—422.3	WRIIF	Washington, D. C., Washington Radio Hospital Fund	50—256
WMAC	Cazenovia, N. Y., Clive B. Meredith	100—275	WRK	Hamilton, Ohio, Doron Bros. Electrical Co.	200—270
WMAF	Dartmouth, Mass., Round Hills Radio Corp.	100—500—360	WRM	Urbana, Ill., University of Illinois	500—273
WMAK	Lockport, N. Y., Norton Laboratories	500—466	WRR	Dallas, Tex., City of Dallas, Police and Fire Signal Department	350—261
WMAN	Columbus, Ohio, First Baptist Church (W. E. Heskett)	50—278	WRW	Tarrytown, N. Y., Tarrytown Radio Research Laboratory	500—273
WMAQ	Chicago, Ill., Chicago Daily News	500—447.5	WSAB	Cape Girardeau, Mo., Southeast Missouri State Teachers' College	100—275
WMAZ	St. Louis, Mo., Kingshighway Presbyterian Church	100—248	WSAC	Clemson College, S. C., Clemson Agricultural College	500—336.9
WMBF	Macon, Ga., Mercer University	100—261	WSAD	Providence, R. I., J. A. Foster Co.	100—256
WMC	Miami Beach, Fla., Fleetwood Hotel	500—384.4	WSAG	St. Petersburg, Fla., Gospel Tabernacle	500—266
WMC	Memphis, Tenn., "Commercial Appeal"	500—422.3	WSAI	Cincinnati, Ohio, United States Playing Card Co.	500—325.9
WMCA	New York, N. Y., Hotel McAlpin (Greeley Square Hotel Co.)	500—340.7	WSAJ	Grove City, Pa., Grove City College	250—229
WMU	Washington, D. C., Doubleday-Hill Electric Co.	50—261	WSAN	Allentown, Pa., Allentown Call Publishing Co.	50—229
WNAC	Boston, Mass., Shepard Stores	100—280.2	WSAP	New York, N. Y., City Temple, Adventist Church	250—263
WNAD	Norman, Okla., University of Oklahoma	250—254	WSAR	Fall River, Mass., Doughty & Welch Electrical Co.	100—254
WNAL	Omaha, Nebr., Omaha Central High School	20—258	WSAU	Chesham, N. H., Camp Marienfeld	10—229
WNAP	Springfield, Ohio, Wittenberg College	100—248	WSAX	Chicago, Ill., Chicago Radio Lab.	20—268
WNAR	Butler, Mo., First Christian Church	20—231	WSAZ	Pomeroy, Ohio, Chase Electric Shop	50—244
WNAT	Philadelphia, Pa., Lenning Brothers Co.	100—250	WSB	Atlanta, Ga., Atlanta Journal	750—428.3
WNAX	Yankton, S. Dak., Dakota Radio Apparatus Co.	100—241	WSL	Utica, N. Y., J. & M. Electric Co.	100—242
WNJ	Newark, N. J., Radio Shop of Newark	100—233	WSMH	Owosso, Mich., Shattuck Music House	10—240
WNYC	New York, N. Y., City of New York	1000—526	WSOE	Milwaukee, Wis., School of Engineering of Milwaukee	100—246
WOAC	Lima, Ohio, Page Organ Co.	50—261	WSRF	Broadlands, Ill., Harden Sales & Service	10—233
WOAF	Tyler, Tex., Tyler Commercial College	10—360	WSRO	Hamilton, Ohio, Radio Co. (Harry W. Fahlander)	100—252
WOAI	San Antonio, Tex., Southern Equipment Co.	500—394.5	WSUJ	Iowa City, Iowa, State University of Iowa	500—483.6
WOAN	Lawrenceburg, Tenn., James D. Vaughn	500—282.8	WSY	Auburn, Ala., Alabama Polytechnic Institute	500—250
WOAW	Omaha, Nebr., Woodmen of the World	100—526	WTAB	Fall River, Mass., Fall River Daily Herald Publishing Co.	100—266
WOAX	Trenton, N. J., Franklyn J. Wolf	50—240	WTAC	Johnstown, Pa., Penn. Traffic Co.	100—209.7
WOC	Davenport, Iowa, Palmer School of Chiropractic	500—483.6	WTAF	New Orleans, La., Louis J. Gallo	10—273
WOCL	Jamestown, N. Y., Hotel Jamestown	15—275	WTAL	Toledo, Ohio, Toledo Radio & Electric Co.	10—252
WOI	Ames, Iowa, Iowa State College	500—270	WTAM	Cleveland, Ohio, Willard Storage Battery Co.	1500—389.4
WOO	Philadelphia, Pa., John Wanamaker	500—409.2	WTAP	Cambridge, Ill., Cambridge Radio & Electric Co.	50—242
WOQ	Kansas City, Mo., Unity School of Christianity	500—278	WTAQ	Osseo, Wis., S. H. Van Gorden & Son	200—254
WOR	Newark, N. J., L. Banberger & Co.	500—405.2	WTAR	Norfolk, Va., Reliance Electric Co.	100—261
WORD	Batavia, Ill., Peoples Pulpit Association	500—278	WTAS	Elgin, Ill. (near), Charles E. Erbstein	1000—302.8
WOS	Jefferson City, Mo., Missouri State Marketing Bureau	500—440.9	WTAT	Boston, Mass. (portable), Edison Elec. Illuminating Co.	100—244
WPAJ	New Haven, Conn., Doolittle Radio Corp.	100—268	WTAU	Tecumseh, Nebr., Ruegg Battery & Electric Co.	10—242
WPAK	Agricultural College, N. Dak., North Dakota Agricultural College	50—275	WTAW	College Station, Tex., Agricultural & Mechanical College of Texas	250—270
WPAZ	Charleston, W. Va., John R. Koch (Dr.)	10—268	WTAX	Streator, Ill., Williams Hardware Co.	50—231
WPG	Atlantic City, N. J., Municipality of Atlantic City	500—299.8	WTAY	Oak Park, Ill., Oak Leaves Broadcasting Station	500—250
WPSC	State College, Penna., Pennsylvania State College	500—261	WTAZ	Lambertville, N. J., Thomas J. McGuire	15—261
WQAA	Parkersburg, Pa., Horace A. Beale, Jr.	500—220	WTG	Manhattan, Kans., Kansas State Agricultural College	50—273
WQAC	Amarillo, Tex., Gish Radio Service	100—234	WTHS	Flint, Mich., Flint Senior High School	250—218.8
WQAF	Springfield, Vt., Moore Radio News Station	50—246	WTIC	Hartford, Conn., Travelers Insurance Co.	500—348.6
WQAM	Miami, Fla., Electrical Equipment Co.	100—268	WWAD	Philadelphia, Pa., Wright & Wright, Inc.	100—250
WQAN	Scranton, Pa., Scranton Times	100—250	WWAE	Joliet, Ill., Lawrence J. Crowley (Alamo Ball Room)	500—242
WQAO	New York, N. Y., Calvary Baptist Church	100—360	WWAO	Houghton, Mich., Michigan College of Mines	250—244
WQAS	Lowell, Mass., Prince-Walter Co.	100—252	WWI	Dearborn, Mich., Ford Motor Co.	500—266
WQJ	Chicago, Ill., Calumet Rainbow Broadcasting Co.	500—447.5	WWJ	Detroit, Mich., Detroit News	500—352.7
WRAA	Houston, Tex., Rice Institute	100—256	WWL	New Orleans, La., Loyola University	100—275
WRAF	Laporte, Ind., The Radio Club	100—224			
WRAK	Escanaba, Mich., Economy Light Co.	100—256			
WRAL	St. Croix Falls, Wis., Northern States Power Co.	100—248			
WRAM	Galesburg, Ill., Lombard College	100—244			

**Keeping a Kitchen Cool**  
By CHRISTINE FREDERICK  
(Continued from page 227)

will very likely enjoy less cookery and more salads, cold cuts and other more easily prepared dishes. In really hot weather why not do cooking for two or three days ahead, and do it in early morning hours when the heat of the sun does not double the heat of the kitchen. By actually making up menus ahead for two or three or even four days in advance, you can at one cooking do all the hot work necessary.

**HOW TO COOL THE BODY**

Another matter about keeping cool in the kitchen: Keep yourself cool. Don't drink ice water during the hot part of the day in quantities; it doesn't cool you, it lowers your vitality and makes you more miserable. It is even dangerous. I'll tell you a plan I learned from a piano mover, and it was prescribed by his doctor, who had attended him after he'd been made seriously ill from drinking ice water after his heavy moving work. To really cool yourself: hold your wrists under the faucet and let the water run over them for a few minutes. It slowly and safely cools you, far more surely than the dumping of ice water into the stomach.

Another thing about keeping cool in your kitchen: reduce your steps around the kitchen to a minimum, for every time you move you use energy and feel the heat so much the more. And do not wear tight clothing in hot weather.

Guard against driving the heat of your kitchen into your dining room or elsewhere in the house. Keep out of the kitchen all superfluous things. In summer time trim down your equipment and use a few pots, pans, tools and dishes as possible.

Learn also to use one gas burner for a variety of purposes, remembering that two gas burners going doubles the heat produced in the kitchen. There are utensils, enabling you to cook three or more things at one time on one burner.

**FIRELESS COOKER A BOON**

The fireless cooker is naturally a heat saver of the finest variety, and if you haven't one, you should get one. It enables you to do the longest boiling or cooking job without using the burners. A pressure cooker is also a valuable aid. In fact, summer time brings out particularly the need for up-to-date equipment in the kitchen, for then your steps and labor are especially wearisome.

Set a simple table in summer and use fewer dishes, thus lightening the burden of dish washing, which is very especially a burden in hot weather. If you can do away with breakfast cookery, so much the better; and if you can stay out of the kitchen for lunch preparation, you have triumphed also over the heat demons.

**COOKING PLUS ELECTRICITY LESS HEAT**

Finally I recommend that if possible you substitute electric devices for the breakfast and lunch cookery and also to lighten cookery generally. I have a charming little electric device with which I can cook eggs, make toast and heat the coffee all at one operation, and I do it at the breakfast table, not in the kitchen. I can even grill some bacon at the same time. Why, then, go into the kitchen? Certainly electricity is a summer boon for the nimble housewife in other ways, why not in cookery?

**25 New Flowers In 25 Years—Burbank**  
(Continued from page 211)

transfer of pollen, and paused for an instant, his little brush raised like an orchestra leader's baton above the blossoming field. "There is no alchemy to the production of new and larger and better flowers and fruits and vegetables. I use only earth and sun and water and air, with careful selection of the parent plants, with patience and care in pollenization, and close observation. I merely aid nature to do in a few years what she alone and unaided would require centuries to accomplish. There is not a factor in my work which every plant-grower does not have at his disposal. My laboratory is the outdoors; I live close to the soil, and from it I receive new strength daily, and an ever increasing knowledge of the world of plants.

"The abandoned fruit tree in the corner of your garden was planted perhaps a generation ago. Yet a twig cut from it today may produce an abundant supply of fruit, or, by grafting and budding, you may transform it into a tree producing half a dozen varieties of fruits. There is nothing mysterious about it; you merely take a hand in helping nature produce the improved forms of fruits, vegetables and flowers that you desire. First of all, however, you must have a plan, a definite objective in your plant-breeding, and you must adhere to that plan until the objective is achieved. That is what Nature has been doing for uncounted centuries; it is what the plant-breeder must do for years. There is nothing which will take the place of care and time in this work. The first year that my experimental farm was in operation, half a century and more ago, my total returns were \$15.20, but I was not discouraged. A fruit grower wanted 20,000 prune trees, and wanted them for

planting that season. By planting almond seeds under gunny sacks and keeping the sacks wet, I forced their growth until, in three months, I had 25,000 almond roots, sufficiently strong to carry prune grafts. I then went into a prune orchard. From some fifty or sixty trees, I cut 20,000 buds, which I applied with my own hands to as many of the almond seedlings. They grew, I delivered the prune trees on time, and some of them are still growing."

At least two towns, one of them, Vacaville, quite a commercial center, owe their prosperity and growth to Burbank's development of the plum, now known by his name, of which thousands of carloads are shipped annually from the orchards surrounding these towns. A better apple, a larger prune, a disease-resisting pear, a finer-flavored peach—these are some of the contributions he has made to the fruit-grower. Among the flowers he promises, not yet so well developed as the roses mentioned, are a gladiolus with blossoms five inches in diameter, growing all around the stalk, instead of on one side as do present varieties of gladioli; a new lily of large size with several colors coming from the same bulb, developed from a wild lily sent to him by a correspondent in China; a giant zinnia, six inches in diameter; three close-growing shrubs whose entire tops burst into a solid mass of flame-colored blossoms; several flowering climbing vines, developed from wild vines received by Burbank some years ago from South American friends, and a leek which, though retaining its edible qualities, bears long stems of fragrant blossoms, not unlike hyacinths, making it suitable for the flower garden as well as for the vegetable patch.

**Learn Electricity by Actual Work**



Students Winding Huge Stator

*In the Great Shops of*  
**Coyne**

**Complete Training in 12 Weeks** Get into the BIG PAY FIELD. The whole world of Electricity is open to you as a COYNE-trained Electrical Expert. 12 weeks from now you can be an Electrical Expert no matter what you are doing today. Make this the most profitable and enjoyable summer of your life. Come to Chicago on beautiful Lake Michigan, the greatest Summer Resort City and the Electrical Center of the world, I'll pay your Railroad Fare from any place in the United States! Clip Coupon Now for Full particulars and for Big Free Book.  
**Earn \$60 to \$200 a Week**  
Coyne training is practical, money-making training—not correspondence. You work on the greatest outlay of Electrical Machinery in any school in the country, everything from Doorbells to Power Plants—everything to make you a thoroughly-trained BIG-PAY EXPERT.

**You Don't Need Education or Experience** It makes no difference how little education you have had, or what kind of work you are doing now, I'll make you an Electrical Expert through the COYNE LEARN-BY-DOING METHOD! I have done it for thousands—I will do it for you!

**Radio—Auto Electricity Course and Railroad Fare FREE!**  
I'll pay your Railroad Fare to Chicago, from any place in the United States if you act quick! And right now I am including absolutely free of extra charge, my complete Radio Course and Auto, Truck, and Tractor Electricity. CLIP COUPON NOW!

**Hear Coyne On the Air WCES 250 Meters** Be sure to listen in on the Coyne Radio Station, Tuesday, June 16 and June 23, 10:30 P. M., Day-light Saving Time. H. C. Lewis will speak.

**Earn While You Learn** My Employment Department helps you get a job to earn a good part of your expenses and assists you to a good job on graduation.

**Send Coupon NOW!** Don't delay a minute—get my big Free Book and full particulars of my special offer.

**COYNE ELECTRICAL SCHOOL**  
Dept. 533-B  
1300-10 W. Harrison St., CHICAGO, ILLINOIS

**FREE RAILROAD FARE!**  
MR. H. C. LEWIS, Pres. Coyne Electrical School, Dept. 533-B  
1300-10 W. Harrison St., Chicago  
Dear H. C.: I sure want one of those Big handsome 12 x 15 books, with 151 actual Photographs in two colors. Send it quick. I'll be looking for it on the next mail. I want the facts without placing me under any obligation. Be sure and tell me all about the Free Railroad Fare and Two Free Courses.

Name.....  
Address.....  
City..... State.....

# When Marriage is FATAL



Men who are serving prison terms for obtaining money or goods under false pretenses—men who have been hanged or electrocuted for killing other men, are no whit worse than many a man walking the streets today who has falsely gained the affections of a young girl, married her, and then, through his physical or mental rottenness, killed her every hope of future happiness.

Fatherhood should be a Felony, punished as a Capital Crime, when a man knowingly slaughters all that is most sacred in a woman's heart; her faith in the ability and character of her husband, her expectations of a happy home, her hopes of some day becoming the mother of healthy, strong, laughing little ones.

## Make Yourself Fit Before you Marry

Stop! Think! Don't take the fatal step. Fit Yourself for matrimony before you ask any woman to marry you. She can't know the things about you which YOU know and many of your men friends know. If you are weak, watery-blooded, bilious; with your tissues rotting away with constipation and your manhood lost through early excesses and dissipation, you are Unfit—Unclean—in no condition to marry her or any other girl.

### STRONGFORT The Perfect Man

Don't Do It! You will regret it all your life. And the girl who loves and trusts you now will despise and detest you when she learns the truth. Don't lead her to the altar until you are a real man in the fullest sense of the word. Get rid of the ailments which mean lifelong misery to you both. Put on flesh, if you are a walking skeleton; trim down, if you are grossly fat. Build yourself up until you are fine and fit again. You can do it—if only you will exert your Will Power and begin NOW!

### Restore Your Flagging Powers and Manhood

I will tell you what to do and how to do it. I have spent my life studying Nature's way of restoring health, strength and vigor to men and women who have lived too hard or too fast; who have, through ignorance or folly, violated Nature's Laws and are paying the penalty for it.

## STRONGFORTISM

The Modern Science of Health Promotion

Physicians and surgeons appreciate thoroughly the fact that—in a great number of cases—the rebuilding, revitalizing Forces of Nature alone (when the Cause of the trouble has been removed) Will Work the Cure.

**STRONGFORTISM** is a Science which I have developed out of and founded on those Forces. I have spent practically my whole life studying them, classifying them, learning how to apply them to individuals. By means of Strongfortism I built myself up and have won the World's Award as the Most Perfect Specimen of Physical and Health attainment. Through it I have helped bring happiness to my pupils in every part of the World. If YOU are weak, sickly, anemic, burned-out, Strongfortism will show you the one scientific certain road back to health, strength and virility. I guarantee it.

### SEND FOR FREE BOOK

"Promotion and Conservation of Health, Strength and Mental Energy." It contains the elements of Nature's most corrective and rebuilding forces. Every man and woman ought to read it. It will give you facts about the human organism which probably you have never known—facts that those who are married or about to be married cannot afford to be without. It will show you how you can be a real, red blooded virile man and yourself enjoy the joys of married life. It's absolutely free. Just mark the subjects on the consultation coupon on which you want special confidential information and send with it (one dime) to help pay postage, etc. Send for my free book Right Now. TODAY!

### LIONEL STRONGFORT

Physical and Health Specialist  
Dept. 1803 Founded 1895 Newark, N. J.

#### FREE CONSULTATION COUPON

Mr. Lionel Strongfort, Dept. 1803, Newark, N. J.—Please send me your book, "Promotion and Conservation of Health, Strength and Mental Energy," for postage on which I enclose a 10-cent piece (one dime). I have marked (X) before the subject in which I am interested.

- |               |              |                 |                 |
|---------------|--------------|-----------------|-----------------|
| .. Colds      | .. Female    | .. Constipation | .. Poor         |
| .. Catarrh    | .. Disorders | .. Nervousness  | .. Circulation  |
| .. Asthma     | .. Increased | .. Poor Memory  | .. Skin         |
| .. Hay Fever  | .. Height    | .. Rheumatism   | .. Disorders    |
| .. Obesity    | .. Pimples   | .. Diabetes     | .. Despondency  |
| .. Headache   | .. Insomnia  | .. Youthful     | .. Round        |
| .. Thinness   | .. Flat Feet | .. Errors       | .. Shoulders    |
| .. Rupture    | .. Stomach   | .. Vital Losses | .. Lung         |
| .. Lumbago    | .. Disorders | .. Impotency    | .. Troubles     |
| .. Neuritis   | .. Manhood   | .. Falling Hair | .. Stomach      |
| .. Neuralgia  | .. Restored  | .. Weak Eyes    | .. Shoulders    |
| .. Flat Chest | .. Gastritis | .. Prostate     | .. Muscular     |
| .. Deformity  | .. Heart     | .. Troubles     | .. Development  |
| .. (Describe) | .. Weakness  | .. Torrid Liver | .. Neurasthenia |
| .. Successful | .. Great     | .. Indigestion  | .. Short Wind   |
| .. Marriage   | .. Strength  | .. Biliousness  | .. Blackheads   |

Name .....

Age..... Occupation.....

Street..... City..... State.....

## Book Review

(Continued from page 281)

### A CENTURY OF EXCAVATION IN THE LAND OF THE PHAROHS.

By James Baikie, F.R.A.S. Hard covers, 5½" x 8¾". Published by Fleming H. Revell Co., New York. \$3.00.

This exhaustive treatise is most interesting. Mechanical readers will be attracted by the discovery of Flinders Petrie, the very eminent explorer, as to the working of stone by the very ancient Egyptian. Bronze saws with jewel cutting points like the modern diamond saw, were used in the remote centuries in Egypt, and the accuracy of the work on stone far surpasses modern practice. The diamond drill of today is used to extract a core from rock in many cases, but the modern drill core cannot hold a candle to those of the Egyptians. It is simply impossible to adequately review this book, and the statement of that impossibility is our best acknowledgement of its merit. Tutankhamen of course figures in the text, and the very numerous illustrations are so apposite and well done, that they add greatly to its value.

### THE NEW THEORIES OF MATTER AND THE ATOM.

By Alfred Berthoud, Prof. of Physical Chemistry at the Univ. of Neuchatel. Hard covers, 5½" x 8¾", 259 pages. Published by The Macmillan Co., New York. \$3.50.

The expression "New Theory" is one that excites a certain amount of resistance in the mind, it being far pleasanter to feel that the old theory, notably that of atomic chemistry, instead of being killed off and put into the discard, is being developed. But when we come up against relativity, there is no knowing what will happen, and so we find here Michelson's experiments given, but in rather too brief a form. Michelson's results that the earth is motionless in the ether certainly appears to puzzle, but its explanation by the still more puzzling Fitzgerald-Lorentz Contraction, which tells us that a brick moving with the velocity of light would be thinner than a playing card, does not give much comfort. Perhaps we can find some of that missing comfort in the fact that only a dozen men have been said to understand the Einstein Theory, that one of the U. S. astronomers in a casual way told the writer that it was not understood by the astronomer in question. The theory of Quanta and what has been picturesquely termed "the granular constitution of energy" are given adequate space. The book really is quite attractive.

(By an oversight in the proof reading, the name of Professor Michelson is wrongly spelled in text and index.)

### THE KINGDOM OF THE HEAVENS.

By Charles Nordmann, translated by E. E. Fournier D'Albe. Hard covers, 5½" x 8¾", 261 pages. Published by D. Appleton & Co., New York. \$3.50.

The treatment of astronomy in this work is certainly popularized, as all sorts of interesting and odd questions are taken up. Throughout the treatment is exceedingly popular. It is quite curious toward the end to find the fact brought out that it is well nigh impossible to really prove that the earth rotates on its axis. The author in bringing out this proposition of course refers to Einstein's theory of relativity, which he says has revived the old problem of whether the earth turns or not. There is lots of Einstein in the book, and Planck also appears. Some interesting figures are given; the greatest celestial velocity for instance, so far observed, is 4,000,000 miles per hour, but this is little more than 1/200th, the speed of light.

### ANALYTICAL CHEMISTRY, based on the text of F. P. Treadwell, late Prof. of Analytical Chemistry at the Polytechnic Institute of Zurich.

Hard covers, 6" x 9¼". 811 pages. Published by John Wiley & Sons, New York. \$5.00.

Gravimetric and up-to-date quantitative analysis, such as this one, is greatly to be welcomed. About 750 pages are devoted to the elaborate treatment of quantitative analysis, principally of inorganic substances, although it is impossible of course to give a sharp division between organic and inorganic analysis. For the old time chemists who have not been in active practice for some years, it makes absolutely good reading, as it gives the last methods of modern analysis. It is illustrative with very simple and nice illustrations, quite sufficient in number, and the treatise is warmly to be commended, and the reviewer only wishes if he can find the time, that he may read it as a complete book.

# FREE!

To Each Purchaser of a **WORLD 6 V. AUTO or RADIO BATTERY**

## 12-Cell — 24-Volt Storage 'B' Battery

Positively given free with each purchase of a WORLD "A" Storage Battery. You must send this ad with your order. WORLD Batteries are famous for their guaranteed quality and service. Backed by years of successful manufacture and thousands of satisfied users. Equipped with Solid Rubber Cases, an insurance against acid and leakage. You save 60 per cent and get a

### 2-Year Guarantee

**Bond in Writing** WORLD Batteries "tell their friends." That's our best proof of performance. Send your order in today.

<b>Solid Rubber Case Radio Batteries</b>	
6-Volt, 100-Amperes . . . . .	\$11.25
6-Volt, 120-Amperes . . . . .	\$13.25
6-Volt, 140-Amperes . . . . .	\$14.00
<b>Solid Rubber Case Auto Batteries</b>	
6-Volt, 11-Plate . . . . .	\$11.25
6-Volt, 13-Plate . . . . .	\$13.25
12-Volt, 7-Plate . . . . .	\$16.00

**Send No Money** Just state battery wanted and we will ship day order is received, by Express C. O. D. subject to your examination on arrival. **FREE!** 10¢ Battery included. **Extra Offer:** 5 per cent discount for cash in full with order. Buy now and get a guaranteed battery at 60 per cent saving to you.

**WORLD BATTERY COMPANY**  
1219 So. Wabash Ave., Dept. 19 CHICAGO, ILL.

# World

For **AUTO and STORAGE BATTERIES RADIO**

WMA • WFA • WGN • WJS • KLU • KGO • KFAP • WJY • KOP

# "I WANT YOU"

—Uncle Sam

## U. S. GOVERNMENT JOBS

**\$1140 TO \$3300 YEAR**  
ALL POSTAL SALARIES JUST RAISED

**MEN—WOMEN, 18 UP**

Steady Work	No Layoffs	Franklin Institute
Paid Vacations		Dept. E181
		Rochester, N. Y.

Common education sufficient

Gentlemen: Kindly send me, at once, and entirely without charge, list of U. S. Government big paid positions now obtainable. Advise me also regarding the salaries, hours, work, vacation and tell me how I can get a position, sending me also free sample coaching.

Name .....

Address .....

# WANTED-MEN TO LEARN RADIO

**\$75 to \$200 a Week**  
Right now, everywhere, big, easy money is being made in Radio. Field unlimited. You can master radio quickly at home in spare time. No previous experience necessary. Now is the time to enter this new, uncrowded field.

**1,000 Mile Receiving Set—FREE**  
Our new home-study methods make everything about radio amazingly simple. No other course like it. Makes you expert on radio operation, repairs and installations of all kinds. Send for literature telling all about opportunities and how we give 1,000 mile receiving set FREE. Don't miss this big offer—ACT. Write now for big free book.

**Radio Association of America**  
4513 Ravenswood Ave., Dept. G-7 Chicago



**WRITTEN 2-YEAR GUARANTEE**

**ARROW BATTERY**

**Battery Prices SMASHED!**

**To Consumers Only**

Here is a real battery quality, guaranteed to you at prices that will astound the entire battery-buying public. Order Direct From Factory. Put the Dealer's Profit in your pocket. You actually save much more than half, and so that you can be convinced of true quality and performance, we give a **Written 2-Year Guarantee**. Here is your protection! No need to take a chance. Our battery is right—and the price is lowest ever made. Convince yourself. Read the prices!

**Auto Batteries Radio Batteries**

6 Volt, 11 Plate, \$9.50    6 Volt, 100 Amp, \$9.50  
 6 Volt, 13 Plate, 11.50    6 Volt, 120 Amp, 11.50  
 12 Volt, 7 Plate, 13.00    6 Volt, 14 Amp, 13.00

**Buy Direct—Send No Money**

We ask no deposit. Simply send name and address and style wanted. Battery will be shipped same day we receive your order Express C.O.D. subject to your examination on arrival. Our guarantee accompanies each battery. We allow 6% discount for cash in full or by check. You cannot lose! Send your order today—NOW!

**ARROW BATTERY CO.**  
 Dept. 9    1215 So. Wabash Ave., Chicago

Get this great new  
**MAP of THE AIR**

A MARVELOUS new way to chart your radio exploits—a beautiful Air Map, printed in three colors, with every station clearly marked and Time zones outlined! Size 28 x 34 inches.

There's no limit to the useful and amusing ways you can use Collier's new Radio Map of the U. S. and Canada. With its help—

You can find out INSTANTLY how far any station is

If you use a directional aerial, you can point the loop exactly toward the station you want to get. The map also outlines the radio districts, and gives an alphabetical list of all stations and their operators.

Thousands have already been sold. Get yours today! At your news-stand or radio dealer's, only twenty-five cents — or just mail a quarter to us.

**P. F. COLLIER & SON COMPANY**  
 260 Park Avenue, New York City, RMB 3303

**Be a RADIO EXPERT**

**EARN \$50 to \$200 a Week**

**Free Book**

Send for my big FREE RADIO BOOK right now! See how many wonderful money making opportunities are waiting for you as a Trained Expert in the latest, fastest growing Big Pay field in the world—RADIO!

**Superdon Radio Set FREE**

Long distance super-powerful selective radio set FREE to every student who acts now! Not a cent extra charge.

Write Today for full particulars and proof that you can succeed quickly in the big pay business of Radio; also how to get the wonderful Twin Superdon set without cost. Write at once—Now! No obligation.

**P. J. Mandle, American Radio Engineers**  
 646 N. Michigan Ave., Dept. 79, Chicago

**BLANK CARTRIDGE PISTOL**

Protection Against Burglars, Tramps and Dogs

New Catalog Send 25c for new De Larko Catalog of Novelty, Toys, Tricks, Puzzles, Sporting Goods, etc. 120 pages. 10 and 10 c binding.

Well made and effective. Modelled on latest type of Revolver; appearance alone is enough to scare a burglar. When loaded it may be as effective as a real revolver—without danger to life. It takes standard .22 Caliber Blank Cartridges obtainable everywhere. Price \$1.00 postpaid. Blank Cartridges, by express, 50c per 100. Webster/Cowboy type for Blank Cartridge Pistol, 50c.

**JOHNSON, SMITH & CO., Dept. 393, RACINE, WIS.**

**FREE Electrical Training Book**

Mail postcard for amazing FREE book on electricity. Shows you how to earn \$10 to \$100 a month in this immense field. Famous S & H shop-type training fit you quick at home for big jobs. Exclusive system. Lack of experience or education no bar. Write.

**S & H ENGINEERING CO.**  
 1422 W. Monroe St., Dept. G-2, Chicago, Ill.

**WERDEN UND WESEN DER ASTROLOGIE.** By Robert Henfeling. Soft covers, 5 1/2" x 8 1/4", 94 pages. Published by Kosmos, Stuttgart, Germany.

For those who are interested in the history of what may be properly termed an almost extinct and a totally false pseudo-science, this book may be recommended as giving a very nice presentation of what the occult philosophy of the ancients was, how they endeavored to draw conclusions as to the future from the stars. It does seem as if it were a waste of time to resuscitate so false a bit of history.

**STANDARD ELECTRICAL DICTIONARY,** by T. O'Connor Sloane, A.M., E.M., Ph.D. Hard covers, 5" x 7 1/4", 790 pages. Published by The Norman W. Henley Publishing Co., New York. \$5.00.

The Standard Electrical Dictionary has been a popular work for many years, and has been constantly added to, so as to be up to date. In the present edition after the first and second parts, a third part has been added which is devoted to the definition of radio terms, but these terms have now become so numerous that we cannot but feel that this section might have been much longer. On turning back into the second part, we find many wireless definitions, so that the two sections put together give a pretty good presentation of the subject. The absence of an index is greatly to be regretted, because so many of the terms are two or more words in length, so that an index is really needed.

**ADVERTISING RESPONSE.** By H. M. Donovan. Hard covers, cloth bound, 5 1/2" x 8 1/2", 195 pages. Published by J. B. Lippincott Co., Philadelphia, Pa. \$2.00.

This interesting and valuable advertising textbook gives the results both in tabular and graphic form on researches made in seven Philadelphia high schools, where the response to different well-known grades of merchandise was tested with the aid of one thousand senior students, five hundred young men and five hundred young women.

These high schools were spread over the city of Philadelphia, so that each district in the city was represented, and the results, therefore, give a true cross-section of the city as a whole.

The manner of making the tests was by means of a questionnaire sheet, and this sheet included a list of the most common everyday commodities, such as bread, butter, cake, cigars, tooth paste, typewriters, pianos, razors, etc., and the manufacturer's name of each commodity which came to the mind first was to be put down under each item.

The analysis of the questionnaires proves very interesting reading to anyone interested, even slightly, in modern advertising. Store merchants would find this book of very practical value also, and among other things, which the reviewer read with great interest, was the section in which the advertising programs of some of the leading American manufacturers were given, these reports including the amount of advertising space given annually to newspapers, street car signs, store signs, etc. The value of these various forms of advertising as ascertained after the expenditure of huge sums of money by such manufacturers as the Gillette Safety Razor Co., Colgate and Co., etc., are of unestimable value to any student of advertising.

A very complete index of various brands and names is discussed in the book, as well as a separate index of advertising influences and the page references. There are forty-five graphic charts showing the influence of well advertised brands of goods, and the response of males and females on certain kinds of merchandise and foods, etc. All in all this is a book that should find a place on the desk of every advertising man.

**CIVIL ENGINEERING, Vol. 398 of International Library of Technology.** Hard covers, 5 1/2" x 9", 31 pages. Published by International Textbook Co., Scranton, Pa. \$3.00.

Covering mechanics, statics, hydrostatics and pneumatics, this volume, one of the large series comprising the International Library of Technology, starts with the fundamental principles of mechanics accompanied by simple mathematics, and this leads up to the study of analytical statics. This deals with such high sounding subjects as concurrent coplanar forces, but this is discussed in such clear style that any student in geometry can readily grasp the subject as here explained. Other subjects taken up in the work are kinematics and kinetics, hydrostatics and pneumatics. A closing chapter deals with the rudiments of analytic geometry. This is a well edited volume, and it should find a place on every engineering student's book shelf.

**Become a Commercial Electrical Engineer**  
**In One Year**  
**Or Learn an Electrical Trade In Three Months**  
**at this Famous School**

No calling offers such unbounded opportunities to the modern ambitious young man as that of Commercial Electrical Engineering. Within recent years the Electrical field has become so wide and diversified that there has sprung up a great demand for Electrically trained business men, consulting and efficiency engineers, men who can handle Commercial, Automotive and Engineering problems.



**Course Unexcelled**

It is for this reason that this recognized school has organized a special course in Commercial Electrical Engineering which may be completed in one year. This course is unexcelled and stands entirely alone. It is a combination of several standard courses which have been successfully taught for many years, but have been re-arranged and modified so that you can get a complete electrical education in one year of full-time instruction if you are qualified. Should you lack high school credits, you can make them up here in a comparatively short time. Ambitious young men with eighth grade schooling or some high school training and limited means can select any or all of the shorter courses, each three months complete in itself. Tuition reasonable.

1. LIGHT, HEAT and POWER WIRING and TESTING.
2. D.C. and A.C. MOTORS and GENERATORS, POWER TRANSMISSION, ARMATURE WINDING, MAINTENANCE and REPAIR, MOTOR GENERATOR WORK.
3. AUTOMOTIVE ELECTRICITY, including IGNITION, STARTING, LIGHTING and STORAGE BATTERIES FOR AUTOMOBILES, TRUCKS, TRACTORS, AEROPLANES, ETC.
4. RADIO SALES, SERVICE, BUILDING, and BROADCASTING.

IN ADDITION TO THESE FOUR SECTIONS, COMMERCIAL ELECTRICAL ENGINEERING STUDENTS WILL RECEIVE TRAINING IN COMMERCIAL AND ACADEMIC SUBJECTS, including Drafting, Physics, English, Business Law and Condensed Electrical Engineering.

**Special**

Those who cannot come to Milwaukee, write for information on Home-Laboratory Training.

**20th Anniversary Offer**

Save \$25.00 to \$100.00 on your training. Be a Man of Action and get full details TODAY. Mail the coupon.

**SCHOOL of ENGINEERING of Milwaukee**

Dept. 81-825, 415-417 Marshall Street, Milwaukee, Wis.

Please send me information on

..... Complete 1 Year Course.

..... 3 Months in .....

..... Home Laboratory Training.

Name .....

Address .....

City .....

Education .....

**ADDING MACHINE VEST POCKET SIZE**

**BABY CALCULATOR**  
 CHICAGO U.S.A.  
 PATENT APPLIED FOR

Does Work of \$100 Machine. Guaranteed for 5 yrs. Not a toy. Anyone can operate it. Will not make mistakes. Let this machine do your figuring. First cost in last cost. Everybody needs one for figuring.

ADD SUBTRACT MULTIPLY DIVIDE

**\$2.50** Total Cost

FREE TRIAL—Send No Money Just write "Send me a Baby Calculator" and give your name and address. We will ship it immediately, all charges prepaid. On delivery pay postman \$2.50. You can return it after 10-day trial for full refund if the Baby Calculator is not the greatest time and labor saver you ever used.

This is the lowest priced practical calculating machine made. Order today.

**BABY CALCULATOR SALES CO.**  
 P. O. Box 1118, Chicago, Ill., Dept. 64

**AGENTS** Every business firm, merchant or individual.

Buy the Baby Calculator on sight. BIG COMMISSION.

**Print Your Own**

Cards, Stationery, Circulars, Paper, etc. Save money. Print for others, big profit. Complete outfits \$8.85. Job press \$12.35. Rotary \$150. All easy, rules sent. Write for catalog please type etc. **THE PRESS CO., Y-47, Meriden, Conn.**

# The New Radio Stamp Fad

Here is the DX Radio Stamp Album just like the ones we owned in our youth, in which were placed the rare stamps of the countries of the world. Some were hard to get, some couldn't be purchased for love or money; but the fun of the hobby was the seeking of rare stamps and the eventual possession. So it will be with the DX Radio Stamp Album. There will probably be some stamps you will

never be able to own, but there will be many you will be proud to have and be able to show to other radio enthusiasts. It's an interesting game. Below the Album is shown the "Proof of Reception Cards" of which a generous supply is furnished with each Album. A dime placed in the hole in the card and sent to the station you heard brings back a stamp for your Album.

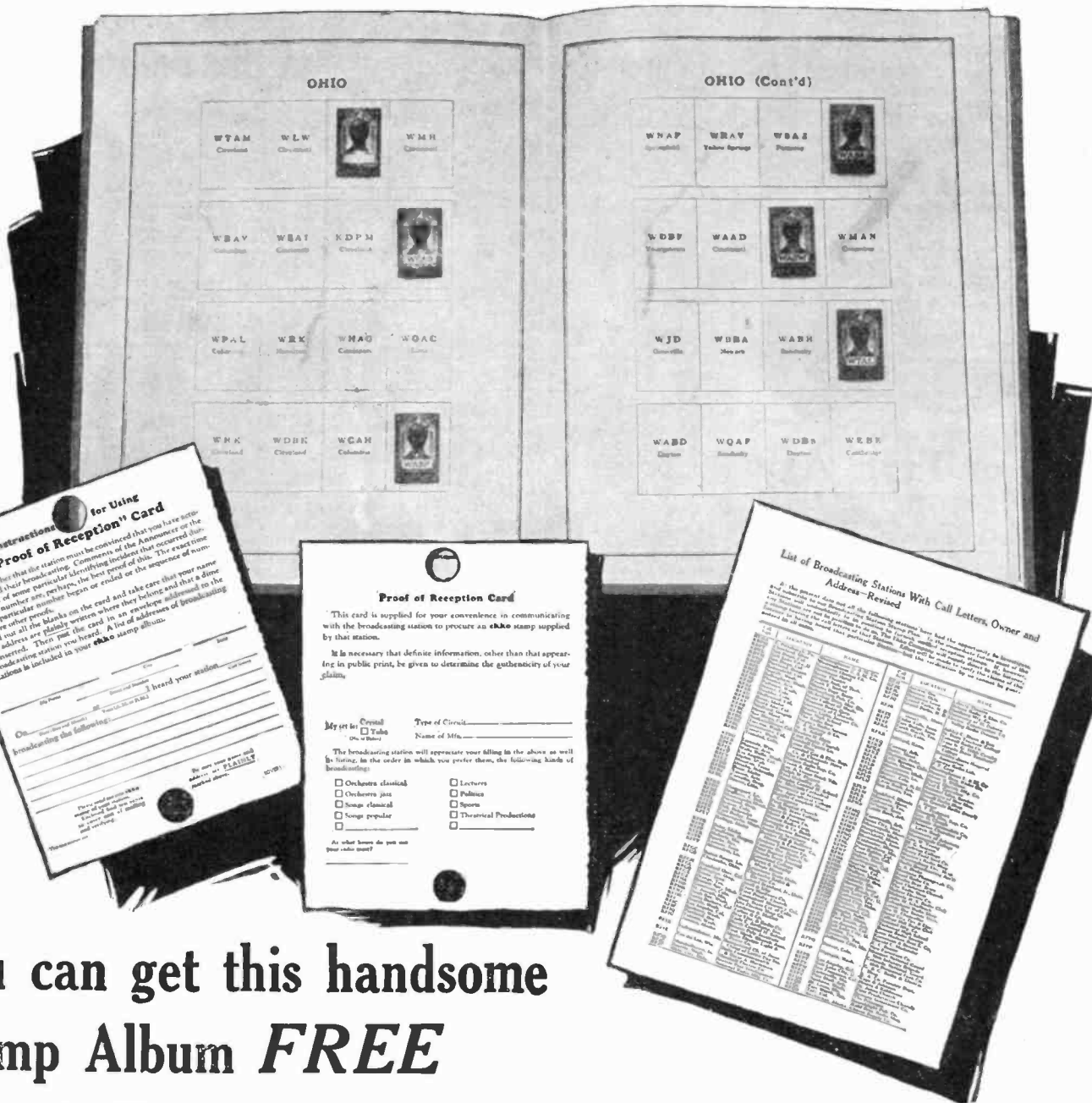

## You can get this handsome Stamp Album *FREE*

This beautiful EKKO Stamp Album, illustrated above, will be given away absolutely free with a subscription to any one of our four magazines: "Radio News," "Science and Invention," "The Experimenter," "Motor Camper and Tourist."

Don't pass up the opportunity to get this valuable premium. With this album, you can keep through the means of beautiful engraved stamps, a certified record of every broadcast station you have heard on your radio set. Your friends will enjoy seeing it.

The album consists of 96 pages, size 9 x 12 and is bound in extra heavy stiff cover.

With the Album is furnished a large Crams comprehensive radio map of the United States and Canada; a supply of "Proof of Reception Cards" and also some stickers. The Album contains a list of broadcast stations of the United States and Canada with wave-lengths and columns for recording dial setting, a table of stations arranged according to wave-lengths and a section for log records.

We have acquired 1,000 of these Albums especially for our subscribers. The coupon on this page filled out and mailed to us with \$2.50 will entitle you to a twelve months' subscription to any one of our four magazines and one of these EKKO Stamp Albums free.

EXPERIMENTER PUBLISHING CO., INC., 53 Park Place, New York, N. Y.

Gentlemen: I have decided to take advantage of your special offer. I am enclosing \$2.50 for 1 year's subscription to ( ) "Radio News," ( ) "Science and Invention," ( ) "The Experimenter," ( ) "Motor Camper and Tourist" and one EKKO Stamp Album which you will send me free. (Mark to which magazine you wish to subscribe)

NAME ..... CITY .....  
ADDRESS ..... STATE .....

**DON'T FAIL TO USE THIS COUPON**

# NEW YORK is NOT an EXPENSIVE CITY

FOR genuine comfort, unusual convenience and real economy, stop at the popular Hotel Martinique. The rates of \$2.50 per day and up—the special club breakfast at 45c and the table d'hôte dinner at \$1.25 are evidence of the consistent economy that makes this modern, progressive hotel one of the most popular in New York.

In the midst of the shopping, theatrical and business centres of uptown New York, the Hotel Martinique offers a convenience that is unusual.

Via enclosed subway, you can, without even stepping out-of-doors, go direct from the Martinique to any place in New York—or the United States for that matter—as you can quickly reach Grand Central or Pennsylvania Depot by subway.

On your next visit, stop in and ask us to show you how you can live right at the right price in New York.

A. E. SINGLETON, Res. Mgr.

*"The BEST without extravagance"*  
**Hotel  
Martinique**  
Affiliated with Hotel McAlpin  
Broadway-32<sup>nd</sup> to 33<sup>rd</sup> Sts.  
NEW YORK



## AUTO RUNS 57 MILES ON GAL. of "GAS"

A new automatic and self-regulating device has been invented by John A. Stransky, 471 Fourth St., Pukwana, South Dakota, with which automobiles have made from 35 to 57 miles on a gallon of gasoline. It removes carbon and reduces spark plug trouble and overheating. It can be installed by any one in five minutes. Mr. Stransky wants distributors and is willing to send a sample at his own risk. Write him today.

**RADIO** LOUD SPEAKING  
FACTORY GUARANTEED  
SET only **29<sup>50</sup>**

SEND FOR testimony of users and SPECIAL OFFER.  
MIDWEST RADIO CORP'N  
Pioneer Builders of Sets  
409-N E. 8th St., Cincinnati, O.

MIRACO GETS 'EM COAST TO COAST

AGENTS DEALERS WRITE

Insure your copy reaching you each month. Subscribe to SCIENCE & INVENTION—\$2.50 a year. Experimenter Publishing Co., 53 Park Pl., N. Y. C.

## RADIO WRINKLES

UNDER this heading we are going to publish items of interest to everyone who likes to build radio instruments. In order to continue this department it is necessary for our readers to tell us about their latest experiments. Write us a short description of some time- or money-saving kink you have discovered and send it to us along with a few sketches. Our regular prizes will be paid for this material. Be brief and try to put everything in the drawing. Don't be too elaborate. Address "RADIO WRINKLES" editor, care of Science and Invention.

### Phone Adaptor

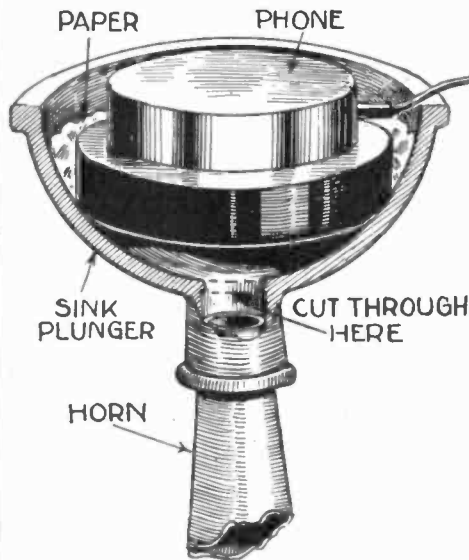

A simple phone adaptor may be made from a sink plunger. All that needs to be done is to cut through the partition separating the rod and the cup. Fasten the phone into the cup by stuffing with paper or cement the unit into the cup.

### Pill Box Mike

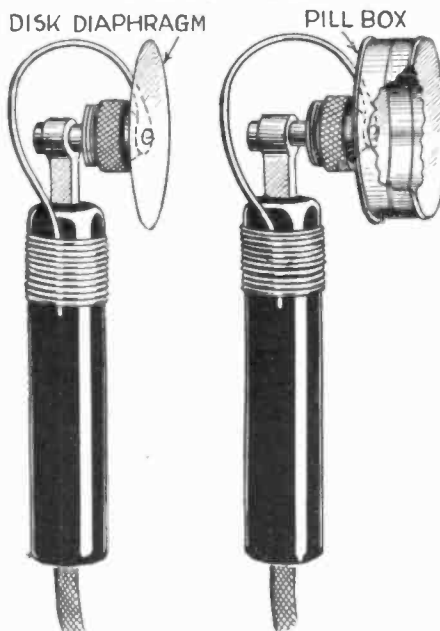

A simple radio phone mike may be easily made by making use of an old pill box. A hole is punched through one side and a microphone button is bolted onto it. One connection is taken from the diaphragm bolt and the other from the stationary part.

**ONLY \$3**

Brings You This  
Genuine Underwood  
Typewriter  
on 10 Days' FREE TRIAL

A perfect machine,  
complete in every  
detail. Read all  
about this great offer



Yes, We Will Positively  
Ship You

this splendid Underwood upon receipt of only \$3.00. This is by far the most liberal typewriter offer that has ever been made on so perfect a machine. Nearly two million Underwoods have been made and sold, proving conclusively that it is superior to all others in appearance, mechanical perfection and all-round excellence.

#### Ten Days' Free Trial

We want you to see for yourself that this is the typewriter you ought to have, and, therefore, we make our great free trial offer. You merely send us the three dollars deposit and we ship the machine for you to try for ten full days before you decide to keep it. If not satisfied, every penny of your money will be returned to you.

#### Rebuilt Like New

Every Underwood we sell is rebuilt just like new. It is dismantled right to the very bottom, and remanufactured to make it just like a new typewriter, with new enamel, new nickel, new platen, new key rings, new type; a complete, perfect typewriter, with two-color ribbon, back spacer, stencil device, automatic ribbon reverse, tabulator, key shift lock, etc. Impossible to tell it from a brand new Underwood, either in appearance, durability or quality of work.

#### Easy Monthly Payments

Our easy monthly payment plan makes it possible for YOU to own this splendid machine without having to pay out any big sum of money. You will hardly know you are paying for it. REMEMBER, you have the full use of the machine, just the same as though it was fully paid for.

#### Over 325,000 Sold

Over 325,000 people have purchased and been satisfied with our product. What better proof could anyone ask of the perfection of our typewriters and the integrity of this firm!

#### Your Money Back

Yes, you can have your money back if you want it. After you have examined the typewriter carefully, used it to write letters, if you decide for any reason whatever that you do not care for it, you may return it to us at our expense and every penny you have paid will be cheerfully and promptly refunded.

#### No Obligation on Your Part

When you send in the coupon for either further information about our great typewriter offer or for the typewriter itself on our free trial plan, you are under no obligation whatever until after you have tried it and have decided for yourself that you want to keep it.

#### Write Now for Our Big Typewriter Book

telling all about our great big typewriter factory. In this book we illustrate and describe all of the various processes of re-enameling, re-nickeling and assembling this splendid Underwood. It tells in an interesting way how each part is examined and tested carefully and thoroughly to insure the finished machine being one you will be proud to own.

Write Right Today  
Use Coupon Below

SHIPMAN-WARD MFG. CO.

B-216 Shipman Bldg., Chicago

Send me your big bargain catalog and complete details of your surprising offer, without obligation on my part.

NAME .....  
STREET .....  
CITY ..... STATE .....

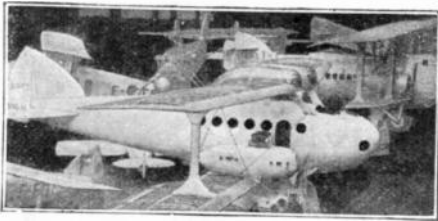

# Aviation Brings Quick Success

**T**O young men of daring no other field of work offers such a fascination, such high pay, nor such opportunities for quick success as the field of Aviation. As yet, aviation is practically in its infancy. But now is the time to get in.

## Amazing Opportunities in Airplane Industries

In the automobile industry and in the moving picture business hundreds of men got rich by getting in at the start. They made their success before others woke up. Today, these lines offer no greater opportunities than a hundred and one others. **BUT AVIATION IS NEW.** Get in while the opportunities are big. All over the country there will be a clamor for trained men. It will not be a question of pay but of getting capable men.

## Become an Aviation Expert \$50 to \$100 per Week

The study of aviation is almost as fascinating as the actual work. Every lesson is full of interest. That is why it is easy to learn aviation. You do not have to make yourself study—it is like reading an interesting book that tells you things you have always wanted to know. Only one hour each evening will give you the basic training in a surprisingly short time.

One student, S. F. McNaughton, Chicago, says: "Your lessons are like a romance, and what is more, after one reading, the student gets a thorough understanding. One never tires of reading them." James Powers, Pa., another student, says, "I am indeed surprised that such a valuable course can be had from such practical men for so little cost."

### Fascinating—Daring—Big Paying

- Prepare Now for One of These Positions
- Aeronautical Instructor \$60 to \$150 per week
  - Aeronautical Engineer \$100 to \$300 per week
  - Aeronautical Contractor Enormous profits
  - Aeroplane Repairman \$60 to \$75 per week
  - Aeroplane Mechanician \$40 to \$60 per week
  - Aeroplane Inspector \$50 to \$75 per week
  - Aeroplane Salesman \$5000 per year and up
  - Aeroplane Assembler \$40 to \$65 per week
  - Aeroplane Builder \$75 to \$200 per week

### Personal Instruction

by Experienced Men  
Men who have had actual experience give you personal attention. They select the lessons, lectures, blueprints and bulletins. They tell you things that are essential in everyday practice. Each lesson is easy to read and understand.

## Get Big FREE Book—Now

Send coupon below for New Book, just out, "Opportunities in the Airplane Industry." It is interesting and instructive. It will show you many things you never knew before about aviation. We have but a limited supply of these books—send the coupon before they are all gone.

**American School of Aviation**  
3601 Michigan Ave., Dept. F.F.7 Chicago, Ill.

**American School of Aviation**  
3601 Michigan Ave., Dept. F.F.7 Chicago, Ill.  
Without any obligation, send me your Free Book, "Opportunities in the Airplane Industry", also information about your course in Practical Aeronautics.

Name.....  
Street.....  
City..... State.....

## Polarity Indicator

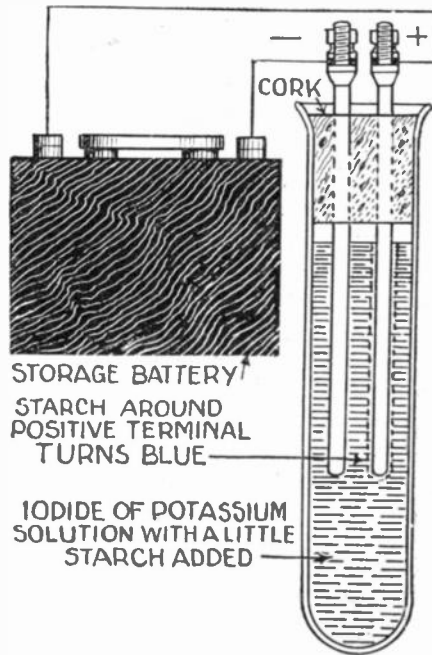

When the polarity indicator is connected to a storage battery, the solution around the wire connected to the positive terminal turns blue.  
—By Jos. B. Miller.

## Switch Points

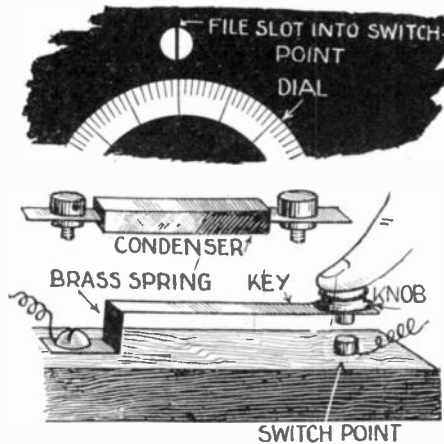

Old switch points may be utilized as dial indicators, connecting screws on condensers, or as contacts on a key.—By Geo. Wendt, Reporter 15816.

## A Novel Tuner

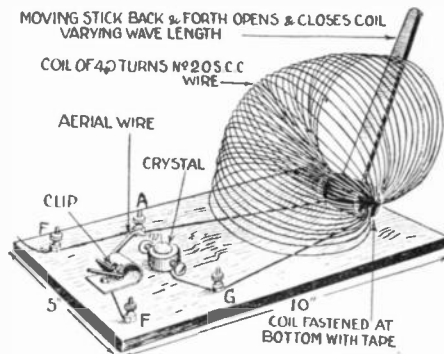

A novel crystal set is composed simply of a coil, a simple crystal detector, and a few binding posts. The set is tuned by opening and closing the coil. The high waves are reached by closing the coil, and the low waves by opening it.—By Arthur A. Blumenfeld.

# To Practical Men and Electrical Students:

Yorke Burgess, founder and head of the famous electrical school bearing his name, has prepared a pocket-size note book especially for the practical man and those who are taking up the study of electricity. It contains drawings and diagrams of electrical machinery and connections, over two hundred formulas for calculations, and problems worked out showing how the formulas are used. This data is taken from his personal note book, which was made while on different kinds of work, and it will be found of value to anyone engaged in the electrical business.

The drawings of connections for electrical apparatus include Motor Starters and Starting Boxes, Overload and Underload Release Boxes, Reversible Types, Elevator Controllers, Tank Controllers, Starters for Printing Press Motors, Automatic Controllers, Variable Field Type, Controllers for Mine Locomotives, Street Car Controllers, Connections for reversing Switches, Motor and Dynamo Rules and Rules for Speed Regulation. Also, Connections for Induction Motors and Starters, Delta and Star Connections for Auto Transformers, and Transformers for Lighting and Power Purposes. The drawings also show all kinds of lighting circuits, including special controls where Three and Four Way Switches are used.

The work on Calculations consists of Simple Electrical Mathematics, Electrical Units, Electrical Connections, Calculating Unknown Resistances, Calculation of Current in Branches of Parallel Circuits, How to Figure Weight of Wire, Wire Gauge Rules, Ohm's Law, Watt's Law, Information regarding Wire used for Electrical Purposes, Wire Calculations, Wiring Calculations, Illumination Calculations, Shunt Instruments and How to Calculate Resistance of Shunts, Power Calculations, Efficiency Calculations, Measuring Unknown Resistances, Dynamo and Dynamo Troubles, Motors and Motor Troubles, and Calculating Size of Pulleys.

Also Alternating Current Calculations in finding Impedance, Reactance, Inductance, Frequency, Alternations, Speed of Alternators and Motors, Number of Poles in Alternators or Motors, Conductance, Susceptance, Admittance, Angle of Lag and Power Factor, and formulas for use with Line Transformers.

The book, called the "Burgess Blue Book," is published and sold by us for one dollar (\$1.00) per copy, postpaid. If you wish one of the books, send us your order with a dollar bill, check or money order. We know the value of the book and can guarantee its satisfaction to you by returning your money if you decide not to keep it after having had it for five days.

THE  
**McCLURE PUBLISHING CO.**  
Dept. D.R.-720 Cass St. CHICAGO, ILL.

## Make Money Taking PICTURES



Tremendous, big-paying opportunities are open for ambitious men in Modern Photography. This is the picture age. Magazine and newspaper publishers buy thousands of photographs each year. Every manufacturer sends out high priced pictures of his products. Every home wants portraits. Photography is a business running into millions of dollars each year. And there is a great shortage of trained photographers.

### Earn \$3,000 to \$10,000 a Year

Hundreds of men are earning big money and establishing their own businesses. Even during spare time, while training, you can make \$75 a week easily—no matter where you live!

### Amazing New Easy Method

I show you at home, how to do the kind of work turned out by the big studios in New York and Chicago! I show you how to make big money within 30 days! C. M. Cole bought a home with money he had made when only half way through his training. So well do I know what I can do for you that I guarantee

Get \$100 for Flood Pictures  
"I took pictures of a flood and sold them for \$100. I have been able to buy my house and lot from the sale of pictures."  
C. M. Cole, Washington.

\$97 in 2 Days!  
"I made \$285 in December. Went out two days last week on home portrait work and made \$97."  
A. G. Hughes, Kentucky.

under bond to return every cent of your tuition if you are not thoroughly satisfied.

### Professional View Camera FREE!



Write at once for Free Camera Offer—I give you, free, a splendid professional view camera. You will be astonished and delighted. This offer open for short time only—so act quick! No obligation.

INTERNATIONAL STUDIOS, Inc.  
Dept. 142B  
3601 Michigan Ave., Chicago, U.S.A.

## Low-Loss Coils

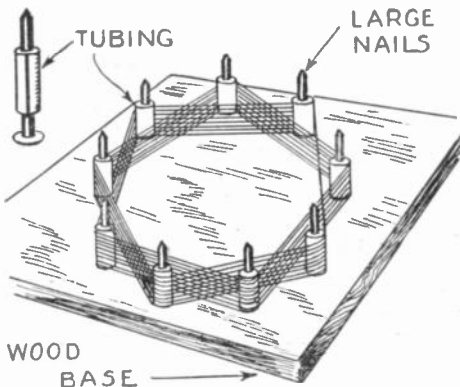

If a length of tubing is slipped over the nails on a coil form, it facilitates the removal of the coil without injury. Then again, much neater winding results, and due to the greater spacing of the wire that can be obtained, a smaller loss from distributed capacity is experienced.

—Wilkes Dunhill.

## Rectifier Jar

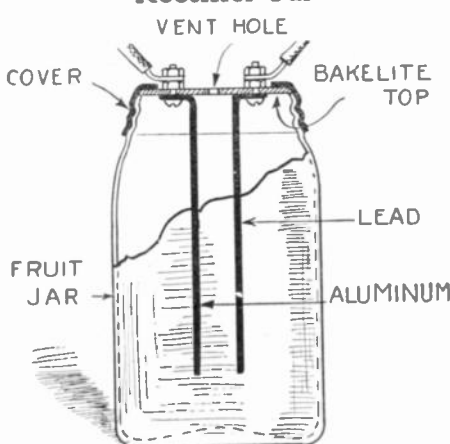

If you own a storage "B" battery, you will welcome this little device which is connected in series with the battery and a 75-watt lamp on the 110-volt A.C. line. An ordinary solution of commercial borax is used as the electrolyte and gives good service for charging.

—E. E. Laufer.

## Adjustable Switch

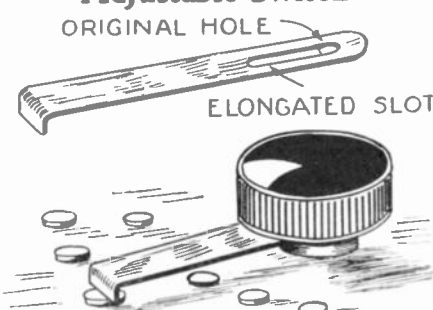

When it is desired to build a set requiring taps disposed along a circle of an odd diameter, it may be impossible to obtain a knob and switch of the desired size. By filing an elongated slot in the switch lever, you at once have the correct solution without much trouble.

—Howard Allen Duncan.

## Binding Post



To avoid the work of boring a multiplicity of holes for binding posts, a very convenient binding post can be made by filing to a point a length of threaded rod and pushing it in to the baseboard in the correct position.

—G. H. Schmid.

## High School Course in Two Years

Lack of High School training bars you from a successful business career. This simplified and complete High School Course—specially prepared for home study by leading professors—meets all requirements for entrance to college and the leading professions.

No matter what your business inclinations may be, you can't hope to succeed without specialized training. Let us give you the practical training you need. Check and mail Coupon for Free Bulletin.

American School  
Drexel Ave. and 58th St.  
Dept. HB-26, Chicago

### Money Back When You Finish If Not Satisfied

American School, Dept. HB-26 Drexel Ave. and 58th St., Chicago  
Send me full information on the subject checked and how you will help me win success.

- |                             |                            |
|-----------------------------|----------------------------|
| ..... Architect             | ..... Business Law         |
| ..... Building Contractor   | ..... Lawyer               |
| ..... Automobile Engineer   | ..... Mach. Shop Practice  |
| ..... Auto Repairman        | ..... Mechanical Engineer  |
| ..... Civil Engineer        | ..... Shop Superintendent  |
| ..... Structural Engineer   | ..... Employment Manager   |
| ..... Business Manager      | ..... Steam Engineer       |
| ..... Cert. Pub. Accountant | ..... Foremanship          |
| ..... Accountant & Auditor  | ..... Sanitary Engineer    |
| ..... Bookkeeper            | ..... Surveyor & Mapping   |
| ..... Draftsman & Designer  | ..... Tel. & Tel. Engineer |
| ..... Electrical Engineer   | ..... High School Graduate |
| ..... General Education     | ..... Wireless Radio       |
| ..... Personal Analysis     | ..... Undecided            |

Name.....  
Address.....

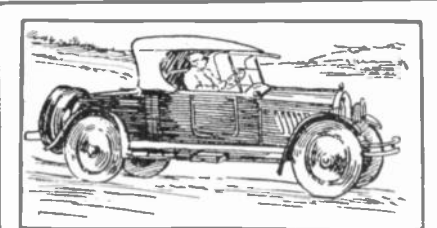

## Get Busy, Folks! Make money in your Auto or at Home

A real live proposition to those desiring to make money in their autos or at home. Neither capital or experience needed. Special inducement to those desiring to travel through United States and Canada (any size car). Send long self-addressed stamped envelope and two references.

STERLING SERVICE  
Wilmington, Delaware



Shapes while you sleep. Rapid, painless and safe. The ANITA is a Genuine and most Comfortable Nose Supporter. Absolutely GUARANTEED Highly recommended by Physicians.

Write for FREE booklet. "Nature's Way to Happiness"

The ANITA Co.  
Dept. 773 Anita Building.  
655 High St., NEWARK, N. J. BEFORE-AFTER

## PERSONAL STATIONERY 200 SHEETS and \$1.00 100 ENVELOPES

Printed with your Name and Address  
Clear, white bond paper, with envelopes to match. Your name and address printed in beautiful, rich blue ink, on both paper and envelopes, and sent to you postpaid for only \$1.00. (West of Mississippi river and outside of U. S. \$1.10.) If inconvenient to send the money, we will ship C.O.D. Money returned if you are not more than satisfied. Order today. Write name and address plainly.

AGENTS MAKE BIG MONEY taking orders for us. Write us today for our agent's proposition.

ELITE STATIONERY COMPANY  
5030 Main Street Smethport, Pa.

Have you read the article on page 40 in the May issue of Science and Invention, on Colored

## LUMINOUS PAINT?

One ounce assorted colors \$4.50  
Information and samples on request.

A. STROBL, 101 West 41st Street, New York



6-SHOT FINEST PERFECTED REVOLVER  
Sells elsewhere at \$12.00.  
Quick as a flash, safe, great penetrating power and true marksmanship.  
Blue steel or nickel, .38, .32 or 22 caliber all same price. Satisfaction or money back. SEND NO MONEY. Pay postman on arrival \$6.45 plus postage. Federal Mail Order Corp., 414 Broadway, New York, Dept. A-80

## Agents Wanted!

To take orders for the famous Blancke Thermostatic Automatic Carburetor Control. Makes Ford run on 5% air. Doubles mileage on gas and oil—easier starting—halves repair bills—eliminates carbon. Easily demonstrated. Sells on sight because saves \$100 every 10,000 miles. CADILLAC NOW USES THERMOSTATIC CONTROL UNDER BLANCKE LICENSE. Experience not necessary to sell this wonderful proven device. Get plan that starts you in your own business and make \$250 to \$2000 a month profit.

A. C. Blancke & Co. Dept. 602 W. Lake St., Chicago 863K

Insure your copy reaching you each month. Subscribe to SCIENCE & INVENTION—\$2.50 a year. Experimenter Publishing Co., 53 Park Pl., N. Y. C.

# Opportunity Ad-lets

**YOU** will find many remarkable opportunities and real bargains in these columns. It will pay you to read and investigate the offerings made every month by reliable firms, dealers and amateurs from all over the country. No matter what you may be seeking, whether supplies, automobile accessories, the opportunity to make money, or anything else, you will find listed here the best and most attractive specials of the month.

Advertisements in this section twelve cents a word for each insertion. Name and address must be included at the above rate. Cash should accompany all classified advertisements unless placed by an accredited advertising agency. No advertisement for less than 10 words accepted. Ten per cent. discount for 6 issues, 20 per cent. discount for 12 issues. Objectionable or misleading advertisements not accepted. Advertisements for the September issue must reach us not later than July 10th.

## The Circulation of Science and Invention is over 175,000 and climbing every month

EXPERIMENTER PUBLISHING CO., INC., 53 Park Place, New York City, N. Y.

### Agents Wanted

**Agents—Best seller; Jem Rubber Repair for tires and tubes; supersedes vulcanization at a saving of over 800 per cent; put it on cold. It vulcanizes itself in two minutes and is guaranteed to last the life of the tire or tube; sells to every auto owner and accessory dealer. For particulars how to make big money and free sample, address Amazon Rubber Co., Dept. 601, Philadelphia, Pa.**

**Agents—Write for Free Samples. Sell Madison "Better-Made" Shirts for large Manufacturer direct to wearer. No capital or experience required. Many earn \$100 weekly and bonus. Madison Mfgs., 511 Broadway, New York.**

**Big money and fast sales. Every owner buys gold initials for his auto. You charge \$1.50; make \$1.35. Ten orders daily easy. Write for particulars and free samples. American Monogram Co. Dept. 71, East Orange, N. J.**

**Only one sale a day means \$200 per month. Five sales, \$1,000 per month. Marvelous new adding machine. Retail \$15. Work equals \$350 machine. Adds, subtracts, multiplies, divides automatically. Speedy, accurate, durable, handsome. Five-year guarantee. Offices, stores, factories, garages buy one to dozen. A fortune for live agents. Write quick for protected territory and free trial offer. Lightning Calculator Co., Dept. W., Grand Rapids, Mich.**

**Earn big money fast applying gold initials to autos. Every owner buys—\$1.35 profit on \$1.50 sale—particulars and samples free. Write quick. Lithogram Co., Dept. 19, East Orange, N. J.**

**Earn \$10 daily silvering mirrors, plating and refinishing metalware, chandeliers, bedsteads, headlights. Outfits furnished. N. Deice Laboratories, 1133 Broadway, New York.**

**\$60—\$200 a week. Genuine Gold Letters for store windows. Easily applied. Free samples. Liberal offer to general agents. Metallic Letter Co., 411 B., North Clark, Chicago.**

**Write and learn how to start profitable business without capital or experience. Silvering mirrors, refinishing auto headlights, tableware plating. Outfit furnished. International Laboratories, Dept. 25, 309 Fifth Ave., New York.**

**\$10 daily silvering mirrors, plating and refinishing lamps, reflectors, autos, beds, chandeliers by new method. Outfits furnished. Write Gunmetal Co., Ave. D, Decatur, Ill.**

**Wonderful invention eliminates needles for phonographs. Preserves records. Abolishes scratching. Day's supply in pocket. \$20 daily. Sample on approval if requested. Everplay, Desk H7, McClurg Bldg., Chicago.**

**Agents Wanted Full or Part Time to Sell on liberal commission new Thermostatic Automatic Carburetor control Attachment for Ford cars. Increases mileage 100%. No holes to drill. Attached in 2 minutes. Does automatically exactly what Ford Manual instructs driver do by hand. Cadillac now using Thermostatic Carburetor Control under Hunkle license. Write at once. A. C. Blancko & Co., Dept. 863KX, 602 W. Lake St., Chicago.**

**Robt. H. Ingersoll of \$1 Watch fame wants good men to sell his Dollar Stropping outfit, an ingenious invention for sharpening all makes of safety razor blades. Great economic value. Meeting with nationwide approval. Easy to sell. Big repeat business. Agents having remarkable success. Full particulars. Robt. H. Ingersoll, 476H Broadway, New York City.**

**Rummage Sales Make \$50 Daily. Offer wonderful values. We start you. Wholesale Distributors, Dept. 171, 609 Division St., Chicago.**

**Big Money and fast sales; every owner buys gold initials for his auto. You charge \$1.50, make \$1.44 profit. 10 orders daily easy. Samples and information free. World Monogram Co., Dept. 32, Newark, N. J.**

**Make \$25 to \$50 week representing Clows' Famous Philadelphia Hosiery direct from mill—for men, women, children. Every pair guaranteed. Prices that win. Free book "How to Start" tells the story. George Clows Company, Desk 27, Philadelphia, Pa.**

**Sell Ford Owners Most efficient timer on market. Agents everywhere coining money—\$50 to \$75 weekly. Haines sold forty first week. Wonderful side line. Write Dept. 33, Auto Sun Products Co., 855 West 6th St., Cincinnati, Ohio.**

**Agents Monogram Automobiles. 15 million prospects. \$1.40 profit every \$1.50 sale. Withar made \$29.50 first day. Free samples. Worcester Monogram Co., M17, Worcester, Mass.**

**Salesmen—Make \$300 to \$500 monthly selling Morey Rim Tool to trade and car owners. Quick, easy sales. Best season just starting. Write for special offer. Morey Rim Tool Co., Sect. B, Blissfield, Mich.**

**Agents: Sell two shirts for price of one. Walton Duplex Shirts are reversible. Make \$15-\$25 daily. We deliver collect. Write for "Your Opportunity." Walton-Duplex Co., 501 Brooks Bldg., Chicago.**

### Agents Wanted (Continued)

**Make-Sell Your Own Goods—Formulas, Processes, Trademarks. Modern master methods. Catalog free. D. Thaxly Co., Washington, D. C.**

**For a worth while opportunity see our advertisement on Page 291 of this issue. Sterling System, Wilmington, Delaware.**

**Skat Sales Agents Wanted. All or Part Time for Skat Hand Soap, Metal Polish, etc. Strictly Commission. The Skat Company, Hartford, Conn.**

**New camera takes and finishes photos in one minute. Make money selling cameras or taking photos. Exclusive territory. Crown Co., Dept. 986, Norwalk, Conn.**

**Agents—Make \$75 to \$100 a week. "Fixit" Rubber Repair seals punctures and blowouts. Sample free. Marquette Rubber Company, 2325 N. Wolfram St., Chicago.**

**Easy Money Applying Gold Initials, Monograms on automobiles. Anyone can do it. Simply transferred from paper; takes 5 minutes. Make \$1.50, cost 5c. Samples free. "Italco," 325 Harrison, Boston, Mass.**

**Agents—Big Profit selling New Marvelous pocket cigar and gas lighters. Sample 25c. Radio Lighter Mfg. Co., 488 Rockaway Ave., Brooklyn, N. Y.**

**I need agents to handle an article that sells wherever a typewriter is used. A highly dignified class of trade to call upon. Exceptionally large percentage to agent. It costs nothing to investigate. The Office Specialties Mfg. Co., 7 Jacques St., Rochester, N. Y.**

**Earn big money selling a glued label representing a girl in a dancing pose, beautifully colored to stick on the windshields of automobiles. You will be surprised at the profit you will make. Samples and Instructions 15c in coin. R. Chaffoux, 959 Dorion St., Montreal, Canada.**

**More Agents Needed: Our famous Food Products, Soaps, Beauty Creams, now sold on Credit. Get new plan quick. Blair Laboratories, Dept. 56, Lynchburg, Va.**

**Make Money in Your Spare Time. Easy to make \$1 to \$2 an Hour by following our instructions. No Money or Experience Necessary. Write Today for particulars. Costs nothing to investigate. American Products Co., 2365 American Bldg., Cincinnati, O.**

### American Made Toys

**Opportunity to start Manufacturing Metal Toys and Novelties. No experience necessary. Enormous demand exceeds supply. We furnish, at cost, casting forms for production and buy entire output, also place yearly contract orders. Casting forms made to order. Catalog, advice and information free. Metal Cast Products Co., 1695 Boston Road, New York.**

### Battle Photos and War Relics

**For Dens: Relics Collected from Europe's Battlefields, Firearms, medals, helmets, etc. Illustrated catalogue and sample War photographs 25c. Lieut. Welch, 1889 Albany Ave., Brooklyn, N. Y.**

### Books

**Free—Upon request will send you my literature illustrating the following books. Astrology, Character, Clairvoyance, Concentration, Healing, Hypnotism, Magnetism, Mediumship, Personal Magnetism, Personality, Physiology, Salesmanship, Seership, Success, Sex, Will, Yoga Philosophy, Gazing Crystals, etc. A. W. Martens, E. E. 6, Burlington, Iowa.**

**Books Wanted: "Signalling Through Space Without Wires," by Lodge; and "Magic—Stage Illusions and Scientific Diversions," by Albert A. Hopkins. State price. Address H. W. Secor, c/o Science and Invention, 53 Park Place, New York City.**

### Business Opportunities

**Dollars yearly in your backyard. No mushroom dope. Particulars free. Metz, 313 East 89th, New York.**

**You can have a business-profession of your own and earn big income in service fees. A new system of foot correction; readily learned by anyone at home in a few weeks. Easy terms for training, openings everywhere with all the trade you can attend to. No capital required or goods to buy, no agency or soliciting. Address Stephenson Laboratory, 18 Rock Bay, Boston, Mass.**

**Stop Plodding! Be Successful. Operate a Tire Repair Shop. Make big profits in any locality. We teach you and furnish complete equipments \$100 up. Book of Opportunity free. Havwood's, 1312 South Oakley Avenue, Chicago.**

**Get Money in Your Mail. "Lambert's Mail Order Service" contains successful methods never before published. \$1.00 postpaid. Particulars free. Leon Lambert, Wichita, Kansas.**

### Chemistry

**Learn Chemistry at Home. Dr. T. O'Connor Sloane noted educator and scientific authority, will teach you. Our home study correspondence course fits you to take a position as chemist. See our ad on page 277 of this issue. Chemical Institute of New York, 66 W. Broadway, New York City.**

**Chemicals, Apparatus, Laboratory Outfits. Lowest prices. Prompt shipments. Write for Price list "A." Lions Scientific Institute, 338 Bausman St., Mt. Oliver, Pittsburgh, Pa.**

### Correspondence Courses

**Used correspondence courses of all schools sold, rented and exchanged. List free. (Courses bought.) Lee Mountain, East Chattanooga, Tenn.**

### Educational

**Correspondence Courses. All Schools. Lowest prices. Terms. Catalog free. Mention subject. Economy Educator Service, 440-H Sansome, San Francisco.**

### For Inventors

**We Develop Your Ideas into commercial shape for presentation to purchasers making working models, drawings, experiments or tests. Courtesy, efficiency, secrecy and ample equipment; 30 years' experience. Duccorron-Ritch Engineering Co., 504 Pacific Mutual Bldg., Los Angeles, Cal.**

**Unpatented Ideas Can Be Sold. I tell you how and help you make the sale. Free particulars (Copyrighted). Write W. T. Greene, 808 Jenifer Bldg., Washington, D. C.**

**Your Chemical problems solved and working process furnished for Five Dollars. Write me. W. Stedman Richards, Consulting Chemist, Box 2402, Boston, Mass.**

**Patents are expensive. Your ideas can be sold without this expense. Complete instructions. \$2. Box 61, Pontiac, Michigan.**

**Scientific information for inventors. Calculations, designing, scientific books. Commercial lists, patent advice. Write Scientific Information Bureau, Baltimore Bldg., Chicago.**

**Inventors. Get your goods on the market. Big opportunities. Information free. Service Bureau, 3703 North Whipple St., Chicago, Ill.**

**If you have a practical, useful invention to sell, write promptly. American Patents Corporation, Barrister Building, Washington, D. C.**

**New Ideas Wanted. Well known Radio Manufacturer whose products are nationally advertised and sold everywhere wants new Radio device to sell. Will pay outright or royalty for idea or invention which is really new and salable. Address: Mr. R. F. Devine, Room 1101, 116 West 32nd St., New York, N. Y.**

### For the Photographer

**Have you a Camera? Write for free sample of our big magazine, showing how to make better pictures and earn money. American Photography, 118 Camera House, Boston, 17, Mass.**

### Games and Entertainment

**Free with \$25 order our large die box. Send 20c for our large catalogue of tricks, puzzles, wigs, sensational escapes, Oaks Magical Co., Dept. 549, Oakshoh, Wis.**

**Magie Trick Cards that are absolutely guaranteed. Free samples. Write me today. C. D. Blankenship, Adrian, W. Va.**

### Health

**Free—Stop using tobacco. We will give free information how to conquer habit easily and permanently. Results guaranteed. Anti-Tobacco League Box M, Omaha, Neb.**

### Help Wanted

**Detectives Needed Everywhere. Work home or travel. Experience unnecessary. Write. George Wagner, former Government Detective, 1968 Broadway, N. Y.**

**Silvering Mirrors. French plate. Easily learned. Immense profits. Plans free. Wear Mirror Works, Excelsior Springs, Mo.**

**Help Wanted (Continued)**

All men-women, 18 to 65, wanting to qualify for Government Positions, \$140-\$300 monthly, home or traveling, write, Mr. Ozment, 293, St. Louis, Mo., quickly.

**Detectives Earn Big Money.** Travel. Excellent opportunity. Great demand everywhere. Experience unnecessary. Particulars free. Write, American Detective System, 1974 Broadway, N. Y.

**Men to Build Radio Sets** in spare time. Leon Lambert, 670-H Kaufman Bldg., Wichita, Kansas.

All men-women, 18 to 65, wanting to qualify for Government Positions, \$110-\$300 monthly, home or traveling, write, Mr. Ozment, 293, St. Louis, Mo., quickly.

**Men Wanted for Detective Work.** Experience unnecessary. Write J. Ganor, former Govt. Detective, 101, St. Louis, Mo.

**Men, 18 to 35.** Become Railway Mail Clerks. Commence \$1900 year. Common education sufficient. Sample examination coaching—free. Write today. Franklin Institute, Dept. E22, Rochester, N. Y.

**Firmen, Brakemen, Baggage-men.** Sleeping car. train porters (colored). \$140-\$200. Experience unnecessary. 897 Railway Bureau, East St. Louis, Ill.

**Insects Wanted**

**Why Not Spend Spring, Summer and Fall** gathering butterflies, insects? I buy hundreds of kinds for collections. Some worth \$1 to \$7 each. Simple outdoor work with my instructions, pictures, price-list. Send 10 cents (not stamps) for my illustrated prospectus before sending butterflies. Mr. Sinclair, Dealer in Insects, Box 1421, Dept. 41, Ocean Park, Calif.

**Instruction**

**Learn Chemistry at Home.** Dr. T. O'Connor Sloane, noted educator and scientific authority, will teach you. Our home study correspondence course fits you to take a position as chemist. See our ad on page 277 of this issue. Chemical Institute of New York, 66 W. Broadway, New York City.

**Correspondence Courses** sold complete; one-third usual prices because slightly used; easy terms; money back guarantee. All schools and subjects. Write for special free catalog. Courses bought for cash. Economy Educator Service, H202, West 49th St., New York.

**Machinery and Tools**

**Concrete Building Block Machines and Molds.** Catalogue free. Concrete Machine Co., 505 South Third St., St. Louis, Mo.

**Special machine builders, tool and die makers, inventors' models, production work** of all kinds. Dept. C, Quality Hardware & Machine Co., Ravenswood and Thorndate Avenues, Chicago, Ill.

**Manufacturing**

To order: Metal articles, simple, or complicated machinery. Models, tools, patterns. Experimenting. Parana Engineering Works, Brooklyn Station, Cleveland Ohio.

**Miscellaneous**

**Beautiful registered bull pups cheap.** Bulldogs, 501 Rockwood, Dallas, Texas.

**Your favorite Beverages, Syrups, Extracts and other Ferable Formulas.** Free information. The Formula Co., Dept. M, 122 West Howe, Seattle, Wash.

**Razor blade bargain.** Dozen, double, extra durable blades for Gillette razor 55c. Three dozen \$1.50 postpaid. Peter Wetterjulist, 1635-15th Ave., Rockford, Illinois.

**\$100 quickly developed \$2500 assets.** No canvassing. Legitimate. Kerr Company, Monadnock Bldg., San Francisco, California.

**Motorcycles—Bicycles**

**Don't buy a Bicycle Motor Attachment** until you get our catalogue and prices. Shaw Mfg. Co., Dept. 6, Galesburg, Kansas.

**Musical Instruments**

**Violins—Deep, Mellow, Soulful—on easy credit terms.** High grade, wonderful instruments of my own make. Development of many years' experience. Write for book. Gustav A. Henning, 2424 Gaylord St., Denver, Colo.

**Novelties**

**Magic goods.** Catalog free. Clifford Fenner, 2101 Jefferson, Louisville, Ky.

**Old Coins**

**10 different foreign coins 25c.** United States 2c. 10-cent and bargain price list 10c. Robert Cohen, Box 183, Muskegon, Okla.

**Old Money Wanted**

**\$2 to \$500 Each** paid for hundreds of Old or Odd Coins. Keep all old money. It may be very valuable. Send 10c for new illustrated Coin Value Book, 42c. Guaranteed Prices. Get Posted. We pay Cash. Clarke Coin Company, 11 Street, Lefroy, N. Y.

**Patent Attorneys**

**Patents.** Send for free booklet. Highest references. Best results. Promptness assured. Send model or drawing for examination and opinion. Watson E. Coleman, Patent Attorney, 614 G Street, N. W., Washington, D. C.

**Inventors write me about patents.** My fees payable monthly. Booklet free. Frank Fuller, Washington, D. C.

**Unpatented Ideas Can Be Sold.** I tell you how and help you make the sale. Free particulars (Copyrighted 1923). Write W. T. Greene, 869 Jenifer Bldg., Washington, D. C.

**Lacey Patent-Sense.** "The book the inventor keeps." Free. See page 271.

**"Inventors' Guide"** free on request; gives valuable information and advice for all who have original ideas or improvements. Frank Ledermann, Registered Attorney and Engineer, 17th Floor Woolworth Bldg., New York.

**Herbert Jenner, Patent Attorney and Mechanical Expert,** 606 F Street, Washington, D. C. I report if patent obtainable and exact cost. Send for circular.

**Millions spent annually for ideas!** Hundreds now wanted! Patent yours and profit! Write today for free book—tell how to protect yourself, how to invent, ideas wanted, how we help you sell, etc. American Industries, Inc., 212 Kresge Bldg., Washington, D. C.

**Inventors—Send for form "Evidence of Conception"** to be signed and witnessed. Form, fee schedule, information free. Lancaster and Allwine, Registered Patent Attorneys in United States and Canada, 212 Ouray Bldg., Washington, D. C.

**Monroe Miller, Ouray Bldg., Washington, D. C. Patent Attorney; Mechanical, Electrical Expert.** Free Blue Book gives candid advice.

**Patents Prepared; Trade Marks Registered—A comprehensive, experienced, prompt service** for the protection and development of your ideas. Preliminary advice gladly furnished without charge. Booklet of information and form for disclosing idea free on request. Richard B. Owen, 130 Owen Bldg., Washington, D. C., or 41-T Park Row, New York.

**Get your own patents.** Application blanks, complete instructions \$1. Cutting Bros., Campbell, Calif.

**Patents.** Time counts in applying for patents. Don't risk delay in protecting your ideas. Send sketch or model for instructions or write for free book, "How to Obtain a Patent" and "Record of Invention" form. No charge for information on how to proceed. Communications strictly confidential. Prompt, careful, efficient service. Clarence A. O'Brien, Registered Patent Attorney, 9293 Security Bank Building (directly across street from patent office), Washington, D. C. See page 273.

**Strong, protective, less expensive patents** secured through co-operation. Booklet free. Chartered Association of American Inventors, Barrister Building, Washington, D. C.

**Inventions patented or no attorney and filing fees to pay.** Patents sold or leased on commission basis. Address, Patent Service, Suite 800, 20 East Jackson Blvd., Dept. S.1., Chicago.

**Patents**

**Inventions commercialized.** Patented or unpatented. Write Adam Fisher Mfg. Co. 205 Enright, St. Louis, Mo.

**Personal**

**Lonely Hearts—Exchange letters; make interesting new friends** through our romantic club. Write Eva Moore, Box 908, Jacksonville, Florida.

**Get acquainted.** Make new friends. Exchange letters. Enclose stamped envelope for plan. The Lilly Club, Station H, Cleveland, Ohio.

**Lonesome! Make new friends.** Write Dolly Gray Club, Box 186K Denver, Colorado. Stamp appreciated.

**Exchange Cheery Letters** with new friends. Write Betty Lee, Inc., Box 820, City Hall Station, New York City. Stamp appreciated.

**Lonesome! Make friends everywhere** through our Club. Write Eva Burchard, Box 75, Portland, Oregon, for particulars.

**Lonely—Join our Club.** Make friends everywhere. Particulars free. Write Mrs. Matthews, Box 26, Oakland, Calif.

**Printing**

**Used Printing Presses, type, supplies, list free.** Norfolk Press Works, Drawer 1, Ballentine, Norfolk, Va.

**Printing Outfits and Supplies**

**Print your own cards, stationery, circulars, paper, etc.** Complete outfits \$8.85; Job Presses \$12, \$35; Rotary \$170. Print for others, high profit. All easy rules sent. Write for catalog presses, type, paper, etc. Press Company, A-8 Meriden, Conn.

**Radio**

**Attention! 50 Vacuum Tube Hook-Ups.** The greatest collection of Vacuum Tube Circuits ever brought under two covers at such insignificant cost. These diagrams will be found in the great "Rasco" catalogue which contains raw materials and parts in a greater profusion than any other catalogue. 15c in stamps or coin will bring the catalogue to you. Radio Specialty Company, 100 Park Place, New York City.

**Radio—(Continued)**

**Beys, don't overlook this!** The "Rasco" Baby Detector. Greatest detector ever brought out with molded base. Fully adjustable. See former advertisements in this publication or our catalogue. Detector with Galena Crystal complete, 50c; the same Detector with Radiolite Crystal, 75c. prepaid. Send for yours today. Radio Specialty Co., 100 Park Place, New York City.

**2650 Miles Distance with one tube.** Any Novice understands our Simplified instructions. Big Free booklet tells the story. Vesco Radio Co., Box 11781, Oakland, Calif.

**260,000 satisfied customers** hear distant stations on Lambert Crystal Sets. Copyrighted plans \$1.00. Complete kit and plans \$5.00. Leon Lambert, 670, Wichita, Kansas.

**Cabinet Radio Sets \$4.00.** Interesting Circulars sent on request. Nolte Mfg. Co., 61-H Gautier Ave., Jersey City, N. J.

**Elite Super Radio Receiver.** No Tubes, A or B Batteries. Operates Speaker, Clarify, Distance. Write Elite Radio Co., Box 193, Buffalo, New York.

**Salesmen Wanted**

**Can You Sell?** All-wool, union made, tailored-to-measure suits for \$39.75. Universal Tailors, J99 Bedford Street, Boston.

**A Salesman wanted** in every town or city within 25 miles of a broadcasting station to sell Radiogem, the complete radio receiving set that retails for \$2.50. With Radiogem there is nothing else to buy—the outfit includes the Radiogem receiving apparatus, 1,000-ohm phone, and aerial outfit. The cheapest radio outfit on the market—yet as practical as the most expensive. Big money to the right men. Send \$2.00 for sample outfit. The Radiogem Corp., 66R West Broadway, N. Y. City.

**Newest Invention!** Sells Every Office, Home and Store. Automatically takes slack and kinks out of cords on telephones, electric irons, Radio Receivers. \$25.00 daily. Sample on approval if requested. Neverkot, Dept. 77, McJurg Bldg., Chicago.

**Lightning strange battery compound.** Charges discharged batteries instantly. Eliminates old method entirely. Callon free to agents. Lightning Co., St. Paul, Minn.

**Song Poems**

**Song Poem Writers—Send for proposition.** Ray Hildeher, 121, 4010 Dickens Ave., Chicago.

**Stamps and Coins**

**Valuable information on Old Coins and stamps.** They are worth money. Order our book. Price 25c. H. Alexander Co., 59 Pearl St., New York.

**500 Mixed Stamps** from 10 different countries, Australia, North, Central, and South America, Russia, Africa, China, Japan, British, French, Colonies, War Issues, etc. Also 500 stamp hinges, pocket stock book, perforation gauge, and 3 United States stamps issued before 1872 all for 25c. Biggest bargain ever offered, satisfaction guaranteed or money back. Husman Stamp Co., Dept. S.1., St. Louis, Mo.

**California Gold,** quarter size, 27c; half-dollar size, 53c. Columbian nickel and catalogue, 10c. Norman Shultz, Box 116, Colorado Springs, Colo.

**Stamps 100 All Different 3 cents.** S. I. Quaker Stamp Company, Toledo, O.

**Technical School**

**Chicago Technical College** offers short, intensely practical courses in Drafting and Engineering—civil, mechanical, electrical, structural—Architecture, Building, Construction, Plan Reading, etc. Courses fitted to your needs. No time wasted. Instructors are experts. Graduates in demand at big salaries. Opportunities for part-time work while studying. Day and evening classes. 22nd year. Enter any time. No special preliminary training required. Low tuition—easy terms. Write for 52-page illustrated Blue Book, describing opportunities open to our graduates. Chicago Technical College, 24 Chicago Tech. Building, Chicago.

**Typewriters**

**Typewriters, all standard makes, \$10 up.** Fully guaranteed. Free trial. Write for complete illustrated lists. Northwestern Exchange, 121 N. Francisco Ave., Chicago.

**Ventriloquism**

**Ventriloquism taught almost anyone at home.** Small cost. Send 2c stamp today for particulars and proof. Geo. W. Smith, Room S-15, 125 N. Jefferson Ave., Peoria, Ill.

**Wanted**

**Detectives Earn Big Money.** Work home or travel. Experience unnecessary. Write, George Wagner former Government Detective, 1968 Broadway, N. Y.

**Wanted to Buy**

**Mail us your discarded Jewelry.** Gold, Crowns and Brides, Watches, Diamonds, Silver, Platinum, and old False Teeth. Money promptly mailed. Goods returned if offer refused. United States Smelting Works, (The Old Reliable), Dept. 73, Chicago

# LOFTIS

BROS. & CO. F&S

## DIAMONDS WATCHES

### CASH or CREDIT

#### SEND FOR CATALOG

Over 2,000 bargains in Diamond-set Jewelry, Watches, etc. Sent prepaid for your FREE Examination. Catalog explains everything. Money back if not satisfied.



No. 27 Dazzling Blue White perfect-cut Diamond. Solid 18-K White Gold. Price \$100. Pay \$10 down, then \$2.50 a week.

18-K Solid White Gold, 17 J. \$27.50  
14-K Solid White Gold, 16 J. \$22.50

#### High-Grade Railroad Watches

Guaranteed to Pass Inspection

HAMILTON No. 992, 21 Jewels, Adjusted to 5 Post-ions. Gold filled 25 Year Case \$55  
ELGIN'S LATEST RAYMOND, 21 Jewels, 8 Adjust-ments. Runs 40 hours one winding. Gold filled. Delivered on first pay-ment of \$5.50, then \$1.00 a week

**LOFTIS BROS. & CO. National Jewelers**  
Dept. B-22 108 N. State St., Chicago, Ill.  
Stores in Leading Cities

**RADIO FANS** -- Listen In on W. H. T. every Friday night from 9 to 10. Loftis Bros. & Co.'s hour of music



#### CALCULATIONS

In the Store, Office, Shop, Etc., can be instantly made with the Midget Slide Rule. If you have any figuring to do, order one on trial. It is the most versatile calculator ever invented.

The Engine-Divided Scales are on white celluloid, mounted on aluminum, grease and waterproof. Size 4".

Price, with Instruction Book, \$1.50. Leather Case \$5c extra.

Sent C. O. D., if desired. Catalog free. Your money back if you are not satisfied.

**GILSON SLIDE RULE CO., Niles, Mich.**



## SEXUAL KNOWLEDGE

320 Pages; Illustrated; Cloth  
By Winfield Scott Hall, M.D., Ph.D.  
SEX FACTS MADE PLAIN

What every young man and every young woman should know—What every young husband and every young wife should know—What every parent should know.

Table contents and commendations on request

AMERICAN PUB. CO., 745 Winston Bldg., Philadelphia

Postpaid \$1.00 Mailed in plain wrapper



## QUESTIONS and ANSWERS

Electricians' Examinations  
Diagrams, symbols, tables, notes and formulas for preparation for license.

READE PUB. CO.  
296 Broadway, N. Y. City

1.25¢ By MAIL



### Lamin Vite

Begin Today—Write for My FREE BOOK. I can make a good penman of you at home during spare time. Write for my FREE BOOK, "How To Become a Good Penman." It contains specimens and tells how others mastered penmanship by the Tamblin System. Your name will be elegantly written on a card if you enclose stamp to pay postage. Write today for book.

F. W. TAMBLIN, 424 Ridge Bldg., Kansas City, U. S. A.



SEND FOR THE INTERNATIONAL CATALOG Our net price list. Full line of auto bodies and accessories for Fords at Wholesale Prices. Save big money on bodies by buying Direct from Factory.

FOR FORD—Prices from \$27.85 up. Factory to consumer direct—Pay only One Profit

International Body Wks, 914 W. Ohio St., Dept. 4, Chicago, Ill.



### "BOW LEGS and KNOCK-KNEES" UNSIGHTLY

Send for Booklet showing photos of men with and without the Perfect Leg Forms.

PERFECT SALES CO., Dept. 50  
140 N. Mayfield Ave. Chicago, Ill.

Insure your copy reaching you each month. Subscribe to **SCIENCE & INVENTION**—\$2.50 a year. Experiment Publishing Co., 53 Park Pl., N. Y. C.

### Book Review

(Continued from page 287)

**TIERSEELE UND MENFCHENSEELE.** By Wilhelm Bolsche. Hard covers, 5 1/4" x 8", 76 pages. Published by Kosmos, Stuttgart, Germany.

This little book got up in the very attractive and familiar style of Kosmos' manuals, is really too short to adequately present the subject. Some very remarkable pictures of the ways and achievements of apes, showing most wonderful instances of equilibrium in their attempts to reach a distant article of food, as by climbing up a stick completely unsecured, are quite striking.

**MASTERS OF SCIENCE AND INVENTION.** By Floyd L. Darrow. Hard covers, 5" x 7 1/2", illustrated. Published by Harcourt, Brace & Co., New York City. \$2.25.

The portrait of Galileo very appropriately heads this book by Professor Darrow, well-known to our readers as one of our contributors in the line of chemistry. The first chapter is devoted to Galileo and his standing in the world of early scientists, and then we take a long step from Galileo to Newton and Einstein. Although Newton was born in the year of Galileo's death, his work certainly showed a great advance over Galileo's. So here we find the portraits of Newton with his majestic wig, and Einstein in twentieth century garb, side by side. Considerable space is devoted to Einstein and the meaning of the Michelson-Morley experiment is quite clearly put by the author. Prof. Darrow, however, does not mention that there are high authorities who do not accept all of Einstein's doctrines. With numerous portraits the book goes right through science in all its aspects. Naturally much space is given to chemistry. In physics and chemistry combined, he devotes a chapter to Sir Humphrey Davy and Michael Faraday, calling them two noblemen of science. Other chapters are on steam, glimpses of famous chemists and the work of the great Alvan G. Clark firm in telescoping. It is impossible to review this really exhaustive book, so numerous are the topics and so many are the individuals spoken of. Edison, Bell and Marconi are included, and the final chapter gives little notes on the biography of distinguished scientists, so that it might almost be said that it would be hard to find a name not mentioned in this book, if entitled to really eminent consideration.

**KEEPING UP WITH SCIENCE.** By Edwin E. Slosson, M.S., Ph.D. Hard covers, 5 1/2" x 8 1/4", illustrated, 355 pages. Published by Harcourt, Brace & Co., New York City. \$2.50.

This book by the well-known popular scientific writer, Dr. Slosson, is one that can be handed to anyone, even though they may be but slightly interested in scientific matters. The reviewer found this book very entertaining and enlightening, indeed, and among the everyday subjects which are seldom discussed, except in highbrow language in some dry science paper which the layman never would understand or take the trouble to read, we find such subjects as the smell of the bee hive and its effect on the bees; why a cat always lands on its feet when dropped; is lettuce rich in iron, etc., etc.? Among other interesting general subjects of up-to-the-minute scientific import, we find discussed such subjects as the discovery of insulin for the treatment of diabetes; sunshine cures rickets; balanced mountains; chemical warfare; glacial action, etc. This book makes a very fine gift.

**THE STARRETT BOOK FOR MOTOR MACHINISTS AND AUTO REPAIRMEN.** Vol. III of The Starrett Books. Hard covers, 4 1/2" x 7", 215 pages. Published by The L. S. Starrett Co., Athol, Mass. 75 cents.

This handbook will prove of great value to all workers around garages, and machinists in general. The various types of measuring instruments, how verniers and micrometers are read; measuring bore of worn cylinders, are well treated. Various drill and tap sizes are given in handy reference table form. Directions are given for adjusting valve tappets; fitting pistons and piston rings accurately; the grinding, lapping and honing of engine cylinders; also fitting crankshaft and connecting rod bearings. The latter sections of the book deals with welding, brazing and lead burning, as well as decarbonizing with oxygen. Some very useful information is given on lathes and lathe tools; how to cut threads on lathes, selecting change gears, taper turning, and among many other interesting things to the young machinist there is a section on taper turning without taper attachment.

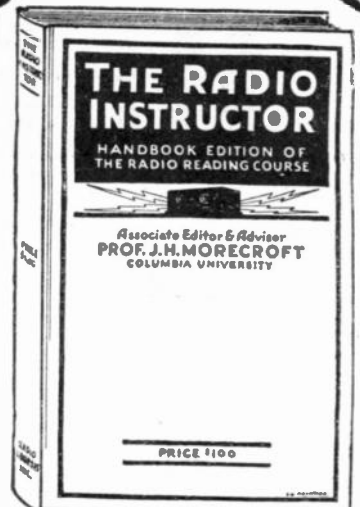

## A Solid Foundation for Your Radio Work

Here's a radio book that gives you the complete theory, design, construction, operation and maintenance of radio receiving apparatus. The book is divided into five sections each completing a separate division of radio receiving information so that the reader can more easily use the book for handy reference. It is a substantial foundation for anyone building or operating a radio receiver. Book contains 300 pages, size 5 1/2 by 8 1/2 inches, and is bound with standard, stiff cover.

Price \$1.00

# E.I. Company

Sole Distributors

**THE CONSRAD COMPANY**  
233 Fulton St. New York City



**"LIGHTING FIXTURES"**  
READY TO HANG  
Direct from the manufacturer. Completely wired including glass-ware. Send for new Catalogue No. 27 (Just reduced prices)

Special Proposition to Dealers  
ERIE FIXTURE SUPPLY CO.  
Desk B Erie, Pa.

## Young Men—Turn Your Spare Time Into Money!

Earn big profits, prizes, and awards selling **RADIO NEWS, SCIENCE & INVENTION, THE EXPERIMENTER, and MOTOR CAMPER & TOURIST** in your neighborhood. We train you as our salesman and pay you liberally for your time. Write at once and we will help you to get started.

M. BRIDWELL

**THE EXPERIMENTER PUBLISHING CO.**  
53 Park Place, New York, N. Y.



# Build your Own

Tropadyne!

Cockaday!

Neutrodyne!

Harkness!

Ultradyne!

Super-Heterodyne!

Autoplex!

Low-Loss

Reflex!

S.T. 100

Portable!

### USE THIS BLANK TO ORDER

Just clip out this coupon, check the patterns or books you want and mail it to us with full remittance.

The Conrad Co., Inc.  
233 Fulton St., New York, N. Y.

Gentlemen: I have checked below the patterns and books I desire. Enclosed find \$....., the full price. Kindly send me the items checked postpaid.

### Conrad Patterns—50c each

- ....No. 2. How to Make a Two-Stage Amplifier.
- ....No. 4. How to Make a Reinartz Receiver.
- ....No. 5. How to Make a Reflex Receiver.
- ....No. 6. How to Make a Cockaday Receiver.
- ....No. 7. How to Make a Neutrodyne Receiver.
- ....No. 8. How to Make the Autoplex Receiver.
- ....No. 9. How to Make the S. T. 100 Receiver.
- ....No. 10. How to Make the Ultradyne Receiver.
- ....No. 11. How to Make a Five Tube Cockaday Receiver.
- ....No. 12. How to Make a Portable Receiver.
- ....No. 13. How to Make a Harkness Receiver.
- ....No. 14. How to Make the Original Genuine Super-Heterodyne. List \$1.00.
- ....No. 15. How to Make a Low Loss Receiver.
- ....No. 16. How to Make a Tropadyne Superadio.
- ....A. Radio Map of the U. S. on Cloth.
- ....B. 20 Radio Diagrams and Hook-ups. New Edition.
- ....C. All About Aerials and Their Construction.
- ....D. Radio Amateurs Practical Design Data.

### Radio Books—25c each

- ....No. 1. Tips for the Radio Constructor.
- ....No. 2. How to Make Practical Radio Receivers.
- ....No. 3. Radio Questions Answered.
- ....No. 4. Radio Frequency Amplification.
- ....No. 5. Loud Talkers and How to Build Them.
- ....No. 6. How to Tune Your Radio Set.
- ....No. 7. One Hundred Radio Hook-ups. New Edition.
- ....No. 8. All About Radio Parts.
- ....No. 9. History and Operations of Vacuum Tubes.
- ....No. 10. The Neutrodyne and All About It.
- ....No. 11. How Radio is Received.
- ....No. 12. How to Locate Troubles in Your Radio Set.
- ....No. 13. Reflex Radio Receivers.
- ....No. 14. The Super-Heterodyne Theory and Construction.

### Special Books

- ....Radio News Amateurs' Handbook.....\$1.00
- ....Radio Log Book ..... .50
- ....Wireless Course in 20 Lessons—Leather Binding 2.00
- ....The Radio Instructor ..... 1.00
- ....The Radio Listeners' Guide & Call Book..... .35
- ....The Radio Review ..... .35

Name .....

Address .....

City ..... State.....

Conrad Books and Patterns Are Sold at All News-stand and Radio Stores

You have all the fun at half the cost and a pattern that's as easy to follow as a ladies' dress pattern

Everything Is Measured and Drawn Full Size

The CONSRAD COMPANY, Inc.  
233 Fulton Street New York, N. Y.

# The Great Hookup Magazine!

# RADIO REVIEW

Reg. U.S. Pat. Off.

## A Digest of the Latest Radio Hookups



IN EACH ISSUE AN INSTALLMENT OF  
**ILLUSTRATED**  
Radio Encyclopedia

The newest thing in radio publishing—A complete 100 page illustrated magazine containing hookups and constructional articles of every kind and description, gleaned from the entire radio press the world over.

No longer do you have to seek here or there for this or that hookup—Just refer to your file of the RADIO REVIEW. All the modern, useful circuits will be accumulated in this magazine and every hookup will be described in a constructional manner so as to aid the reader in the building of a complete receiver or transmitter.

RADIO REVIEW is absolutely impartial as it is published entirely in the interest of the reader. It is of the large magazine size, 9 by 12 inches, printed on fine magazine paper and profusely illustrated. It contains 100 pages of reading matter.

## In Every Issue is a Supplement of One Installment of S. Gernsbeck's Radio Encyclopedia

In every issue of RADIO REVIEW there will be a 16 page supplement of S. Gernsbeck's Radio Encyclopedia. This real encyclopedia of radio explains every word used in radio fully by means of photographs, drawings, charts or tables. The supplement is arranged in a convenient loose-leaf form so that it can be kept apart until you have accumulated all the installments.

Published by  
**The Consrad Co., Inc., 233 Fulton St., New York, N. Y.**

**35¢**

For Sale At All  
Newsstands  
and  
Radio Stores

THE CONSRAD CO.,  
233 Fulton Street, New York.

Enclosed find \$3.50, for which enter my subscription to RADIO REVIEW for 12 issues.

Name..... Town.....

Street..... State.....

# RADIO REVIEW—Greatest Hookup Magazine

Let These Guides

Solve Your Problems



# Electricity at your finger ends

**HAWKINS ELECTRICAL GUIDES** IN TEN VOLUMES

**3500 PAGES**  
**4700 PICTURES**

**\$1 A VOLUME**  
**\$1 A MONTH**

**SEND NO MONEY—SEND ONLY THIS COUPON**

Know the facts in Electricity. They mean more money and better position for you. Hawkins Guides tell you all you need to know about Electricity. Every important electrical subject covered so you can understand it. Easy to study and apply. A complete, practical working course, in 10 volumes. Books are pocket size; flexible covers. Order a set today to look over.

**LEARN ALL ABOUT**

Magnetism—Induction—Experiments—Dynamometers—Electric Machinery—Motors—Armatures—Armature Windings—Installing of Dynamometers—Electrical Instrument Testing—Practical Management of Dynamometers and Motors—Distribution Systems—Wiring—Wiring Diagrams—Sign Flashers—Storage Batteries—Principles of Alternating Currents and Alternators—Alternating Current Motors—Transformers—Converters—Rectifiers—Alternating Current Systems—Circuit Breakers—Measuring Instruments—Switchboards—Wiring—Power Stations—Installing—Telephone—Telegraph—Wireless—Bells—Lighting—Railways. Also many Modern Practical Applications of Electricity and Ready Reference Index of the ten numbers.

**SHIPPED FREE**

Not a cent to pay until you see the books. No obligation to buy unless you are satisfied. Send Coupon now—today—and get this great help library and see if it is not worth \$100 to you—you pay \$1.00 a month for ten months or return it.

**THEO. AUDEL & CO.,**

72 Fifth Ave., New York City

Please submit me for free examination, HAWKINS ELECTRICAL GUIDE (Price \$1 a number). Ship at once prepaid, the 10 numbers. If satisfactory, I agree to send you \$1 within seven days and to further mail you \$1 each month until paid.

Name .....

Occupation .....

Employed by .....

Home Address .....

Reference .....

S. I. July

**FREE!**

**How To Work  
Wonders with  
Words**

**Not Only Men Who Have Made Millions  
Send for this Astonishing Book  
~but Thousands of Others!**

**Y**OU can now get absolutely free the amazing book that some of America's most successful business men have praised and sent for—such men as Walter O. Ford, of the Ford Manufacturing Co., H. B. McNeal, President of Telephony Publishing Co., and C. F. Bourgeois, President of Robischon & Peckham Co. But don't think it is for big men only. Thousands of young men have found this book the key to advancement in salary and position. Write at once for *FREE* copy.

Today business demands for the big, important, high-salaried jobs men who can dominate others—men who can make others do as they wish. It is the power of forceful, convincing speech that causes men to jump from obscurity to the presi-

dency of a great corporation. Seven men out of nine have this knack, though they may not know it. Give me only 15 minutes of your time a day in the privacy of your home, and I'll show you how to bring out this powerful "knack," and use it to quickly gain advancement in position, salary, popularity, leadership, success.

I will show you how to conquer stage fright, self-consciousness, timidity, bashfulness and fear—those things which keep you silent when men of lesser ability get what they want by sheer power of effective and convincing speech. This simple, easy training is absolutely guaranteed to bring out your natural gifts or it costs you nothing.

**MAKE THIS FREE TEST**

Don't let 15 minutes a day stand between you and success. Mail this coupon today. It will bring you in this Free Book an amazing 5 minute test by which you can determine for yourself whether you are one of the seven men out of every nine that possess this "hidden knack." Thousands have found this to be the biggest forward step of their lives. Mail the coupon now.

**North American Institute**  
3601 Michigan Avenue

Dept. 124 B

Chicago, Ill.

**NORTH AMERICAN INSTITUTE,**  
Dept. 124B, 3601 S. Michigan Ave.,  
Chicago, Illinois.

Please send me at once your free book "How to Work Wonders with Words." It will enable me to decide for myself whether I am one of the seven men out of every nine who have the hidden knack of effective speech. I am not obligated.

Name .....

Address .....

City ..... State .....