

January

25 Cents

Science and Invention

IN PICTURES

THE SNOW BURNER

See Page 870

40
NON-TECHNICAL
RADIO
ARTICLES



EXPERIMENTER PUBLISHING COMPANY, NEW YORK, PUBLISHERS OF
RADIO NEWS - SCIENCE & INVENTION - THE EXPERIMENTER - MOTOR CAMPER & TOURIST

Unsurpassed selectivity, sensitivity, range, volume and tone combined

Looks like—and performs like—a \$200 radio set

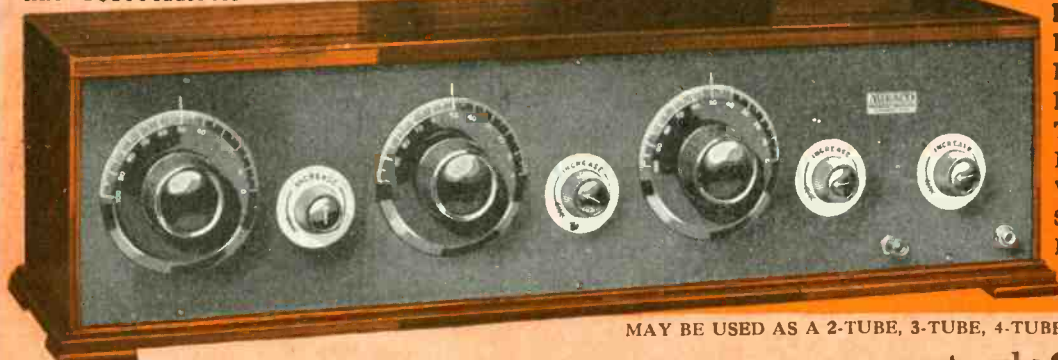

BUILT TO GIVE LOUD SPEAKER ENTERTAINMENT FROM STATIONS THOUSANDS OF MILES DISTANT WHILE LOCAL STATIONS ARE BROADCASTING

MAY BE USED AS A 2-TUBE, 3-TUBE, 4-TUBE OR 5-TUBE SET!

—costs only \$75

"Coast to Coast" reception verified by Miraco Users

NOTE! Do not judge Miraco sets by their prices. Enormous production makes them cost less. They are built by pioneer set makers—of highest grade parts. They embody improvements, refinements and features used in the most costly sets. Every Miraco user is an enthusiastic booster—these letters are typical of the many we receive.

Miraco "Shows" Missouri

I bought one of your radios last summer and like it fine. Have picked up stations from Coast to Coast and from Canada to Cuba. My Motto with the Miraco is: "What's the use to pay more when the Miraco will reach as far as you can understand the language!" —George V. Scott, Moberly, Mo.

Wisconsin Gets 'Em All Over U. S.

Am well pleased with my Miraco. Have listened to stations from the extreme eastern and western parts of the United States and as far south as Beaumont, Texas. It has come up to my expectations in every way. —J. H. Halbert, Augusta, Wisc.

New York Hears England And Brazil

Am very glad I bought a Miraco as it works the best of any I have heard. All the people who come to listen say that when they buy a set it will be a Miraco. Have heard London, England and Rio de Janeiro, Brazil, with my Miraco. It sure works fine. It is the best set on the market for the price. —Leo Link, Marcy, N. Y.

Pennsylvania Hears California

The Miraco is a real "Coast to Coast" set. Last night I tuned in on KGO, Oakland, Cal., WFAA, Dallas, Texas, KFXX, Hastings, Neb., besides 16 other stations. Have received 55 in all. It is a wonderful set for the price. —Earl O. Way, Coleman, Pa.

Iowa Hears N. Y. to Cal.

Have heard from New York to California on my Miraco. All who have heard it think it fine. —Chauncey Bailey, Stockport, Iowa.

Beats Some \$300 Sets

The Miraco that I bought last Fall is giving better satisfaction than some \$300 sets others have here. —Otis Morris, Warren, Idaho.

Indiana Gets Coast To Coast

Have received stations as far away as Oakland, Cal. and New York. I can get any station and am very pleased with my Miraco. —Eddie Smith, Meliott, Ind.

Nebraska Hears Cuba

Miraco sure is a go-getter. I get better reception than anyone in this neighborhood. Had WSAI, Cincinnati, on loud speaker in July—pretty good for warm weather. I tuned in KGO, Oakland, Cal. and WBZ, Springfield, Mass., and have heard PWX, Havana, Cuba, a number of times. —Verno J. Gustason, Blair, Neb.

"Hears The Scotch"

I am proud of my Miraco. Have had Cuba, Canada, Glasgow, Scotland—of which any one should be proud—with nearly every station in the U. S.—Purko A. Neet, Catlin, Ind.

The Marvelous MIRACO Ultra 5

[FIVE TUBE OUTFIT IN BEAUTIFUL SOLID MAHOGANY CASE]

Completely built, thoroughly tested and factory guaranteed by one of America's oldest and most reliable manufacturers of quality sets! Years of experience and quantity production explain its almost incredible price. Users, who have deluged us with commendations, say that friends who see and hear it are amazed that it sells for less than \$150 or \$200. Radio experts, who know good construction and quality parts, are equally astonished. You, too, will be delighted, thrilled, amazed with your big five-tube Miraco "Ultra 5" in its beautiful hand-rubbed solid mahogany cabinet! You'll be envied by radio friends who paid big prices for their outfits. Imagine getting all this for \$75—a beautiful sweet

toned "coast to coast loud speaker" set, composed of finest parts, housed in solid mahogany, equipped with the latest improvements, refinements and features found on costliest sets—and factory guaranteed! An instrument approved by radio's highest authorities! A set anyone can connect and operate. Even beginners learn quickly to cut through the "locals," get distant stations loud and clear, log stations and return to them at will. (Full directions with each set.) It is non-radiating, non-distorting, non-howling. Has cut-out switch—and a first stage phone jack for tuning—on Bakelite panel. All wiring concealed under Bakelite sub-base. Works on storage battery or dry cells. Literature describes other newest features.

Send coupon for SPECIAL OFFER

Other Miraco Long Distance Sets \$14³⁵ up



Users tell us that Miraco Model R justly deserves its title, "Radio's finest low priced quality receiver." One tube acts as a tuned radio frequency amplifier and detector combined. A great distance getter. Easy to operate and log. Covers all wave lengths 150 to 625 meters. Like all Miraco sets, it operates on a storage battery or dry cells. Never such value before at only \$14.35

MIRACO RADIO GETS 'EM COAST TO COAST



This wonderful new Miraco Model R-3 is the three-tube, long distance, loud speaker set that has created such a sensation. Easy to tune and log. Covers wave lengths 150 to 625 meters. Detector acts also as a tuned radio frequency amplifier. 2 stages audio frequency amplification. Has no equal for simplicity, volume, range or clearness at anywhere near its price

Miraco R-3 only \$29.50

The famous Miraco Model MW four tube "coast to coast loud speaker" outfit which users all over the country report outperforms and outdistances much costlier sets. Comes in a solid mahogany cabinet. The improved 1925 model is equipped with cut-out switch, first stage phone jack for tuning (removing plug automatically switches program to loud speaker) and other latest features. Employs one stage of radio frequency amplification, detector and two stages of audio frequency amplification. Another unmatched Miraco value, \$54.50.

These Miraco sets are as easy as a phonograph to operate. Built throughout of highest grade parts. Full directions for connecting and operating supplied with each set. No experience necessary. The three and four tube sets have cut-out switch and first stage phone jack. Each set completely built, thoroughly tested and factory guaranteed.



All the Proof you want is waiting for You!

Reports from the many users in every state prove Miraco Tuned Radio Frequency Receivers—at rock bottom prices—have efficiency of sets costing up to three times as much. Remember that Miraco Sets are the product of a long established, reputable manufacturer—pioneer builders of sets. Send for further evidence that they are Radio's finest moderately priced receivers. All Miraco sets bear the endorsement of radio's highest authorities. Mail coupon now for latest bulletins and plenty of additional testimony from users leaving no doubt that "Miraco Radio Gets 'em Coastal to Coast."

DEALERS! JOBBERS! Write for the new Miraco proposition. Nation-wide use and popularity of Miraco Sets, their amazing low prices and our extensive advertising, makes them wanted everywhere. Send coupon.

AGENTS! The wonderful tone, volume and distance-getting ability of Miraco Sets makes them easy to sell. Send coupon for proposition; good territory open.

Send coupon for free bulletins

or orders direct from this ad

MIDWEST RADIO CORPORATION Pioneer Builders of Sets

409 -K East Eighth Street Cincinnati, Ohio
Send free literature, your SPECIAL OFFER and all particulars regarding Miraco Sets. () Jobber. () Dealer. () Agent. () User.

Name
Address

Learn Electricity

in Great Shops!



Not by Correspondence
All PRACTICAL Work at

COYNE



IN 12 WEEKS

Earn \$60 to \$200 a Week

Why work at dull uninteresting work, at low pay, with no future? In 12 weeks I will train you for a big pay job where you can command \$60 to \$200 a week as a COYNE TRAINED MASTER ELECTRICAL EXPERT or you can go in business for yourself with very small capital and make up to \$15,000 a year. Men trained as I train them are in demand everywhere. The great development of the Electrical industry makes the demand for trained men tremendous. Big opportunities and advancement for those who prepare now. The Coyne school was founded 26 years ago and my thousands of SUCCESSFUL GRADUATES are living proofs of what my training can do for ANY AMBITIOUS man. Many of these fellows will tell you in my big free book what Coyne has done for them.

Complete Electrical Training in 12 Weeks

I train you thoroughly on the greatest outlay of ACTUAL ELECTRICAL machinery ever assembled in any school. You work with your hands on all kinds of Electrical apparatus, door bells, house wiring, armatures, switchboards, dynamos, everything to make you an all around ELECTRICAL EXPERT. This REAL WORK with REAL tools, on REAL machinery trains you many times FASTER, many times MORE THOROUGH than trying to learn in the field or by books or lessons.

**No Books—No Lessons—No Classes
—You Do Actual Work!**

I do not attempt to teach you by books or lessons. I train you to work with your head and hands on the same kind of Electrical Machinery used in power houses, industrial plants and on the outside, under actual working conditions, with instructors at your side. I have no classes, every student gets individual training.

Free Radio and Auto Course

For a short time only I am including ABSOLUTELY FREE my big new Radio Course and Auto, Truck and Tractor Electrical Course.

COYNE

Electrical School

1300-1310 W. Harrison St., Dept. 533-I CHICAGO, ILL.

You Don't Need Education or Experience

You don't need a lot of schooling to master my course. You don't have to be a high school graduate or even a grammar school graduate. My method of instruction is clear and plain, and yet thorough, and if you can understand plain English I will make you an electrical expert even though you haven't a lot of education or any previous electrical experience.

Coyne Trains You For Life

You can get a free life scholarship which enables you to stay longer than the required time if you care to, or you may return at any time to take up new work I'm constantly adding to my school to make it the most modern at all times.

Earn While You Learn

My employment department will assist you to a part time job where you can make a good part of your living expenses while training, and they will assist you to get a BIG PAY job on graduation.



H. C. LEWIS, President

Get My Free Book

This big, handsome new book just off the press—size 12x15 in.—shows actual photographs of my big shops. Cost me a dollar to print, but it's yours FREE if you mail coupon. You owe it to yourself to get the facts.

GET MY BIG FREE BOOK NOW!

H. C. LEWIS
President
COYNE
Electrical School
1300-10W. Harrison St.
Dept. 533-I
Chicago, Illinois

Dear Sir:—Please send me absolutely FREE your big new book and full particulars of your special offer and two courses FREE.

Name.....

Address.....

Town.....

State.....

MAIL THIS COUPON NOW!

Vol. XII.
Whole No. 141

Science and Invention

FORMERLY
ELECTRICAL EXPERIMENTER

January, 1925
No. 9

In Our Next Issue

Will the future doctor treat us from a distance?

A futuristic article dealing with the great possibilities of radio television and telautomatics is applied to the science of medicine and other subjects which make our daily life more enjoyable and safer. How doctors may be able to feel the pulse, take the blood pressure, percuss various portions of the body, and possibly operate on patients by radio.

A realistic shipwreck on the stage!

How "prop" ships are made to give a most realistic effect of burning on an ordinary theatre stage. You can hear the flames roar, see them creep inch by inch along the woodwork and even see a tremendous mast fall with a thunderous crash to the deck of the ship. All this and more has been reproduced on the stage.

Did you know that there was a relationship between hair and the detection of crime?

Hereafter criminals will do well to keep their heads shaven and do this work themselves, carefully destroying every particle of hair. If they do not do so, the long arm of the law may overtake them, due to clues furnished by small hairs.

Do you want a motor speedster?

An automotive engineer will tell you how to build an auto speedster that is practical and safe. The article will be accompanied by the detailed drawings and diagrams that have made the "Constructor" articles of this magazine justly famous.

The above are just a few of the treats in store for our readers in the next issue. Hundreds of photographs and illustrations will also be published, accompanied by short, to-the-point descriptions.

HOW TO SUBSCRIBE FOR "SCIENCE AND INVENTION." Send your name, address and remittance to Experimenter Publishing Co., 53 Park Place, New York. Mention the name of the magazine you are ordering. We also publish RADIO NEWS, THE EXPERIMENTER and MOTOR CAMPER & TOURIST. The subscription rate for SCIENCE AND INVENTION is \$2.50 per year (12 numbers). When remitting do so by check, money order or registered letter, if cash is enclosed. Avoid sending cash through the mail if

possible. Subscriptions for less than one year are not accepted. Subscriptions may be made in combination with RADIO NEWS, THE EXPERIMENTER or MOTOR CAMPER & TOURIST with considerable saving. Send postal for special rates. Subscriptions start with the current issue, unless otherwise ordered. POSTAGE. We prepay postage to all parts of the United States, Mexico and island possessions. For foreign or Canadian subscriptions we require 50 cents in addition to the subscription price for additional postage charges.

CHANGE OF ADDRESS. Notify us as far in advance as possible. It requires several weeks to make an address change on our records. Always write clearly, giving your old address as well as your new. ON EXPIRATION of your subscription we enclose a renewal blank in our last number to you and notify you otherwise. Unless we receive your order for a renewal, with your remittance, we stop our delivery to you on expiration. COMMUNICATION to us should always bear your full name, address and when possible the number which appears on your wrapper every month.

SCIENCE AND INVENTION is published on the 25th of each month. There are 12 numbers per year. Subscription price is \$2.50 a year in U. S. and possessions. Canada and foreign countries \$3.00 a year. U. S. coin as well as U. S. stamps accepted (no foreign coin or stamps). Single copies, 25 cents each. A sample copy will be sent gratis on request. Checks and money orders should be drawn to order of EXPERIMENTER PUBLISHING CO., Inc. If you change your address notify us promptly, in order that copies are not misrouted or lost.

New York City
General Advertising Dept.
53 Park Place

Western Advertising Representatives
Finucan & McClure
720 Cass St., Chicago, Ill.

Pacific Coast Advertising Representatives
A. J. Norris Hill Co.
Hearst Bldg., San Francisco, Calif.

Kansas City Advertising Representatives
George F. Dillon
Republic Building, Kansas City, Mo.

Member Audit Bureau of Circulations

EDITORIAL & GENERAL OFFICES: 53 Park Place, New York City

Published by Experimenter Publishing Company, Inc.

(H. Gernsback, Pres.; S. Gernsback, Treas.; R. W. DeMott, Sec'y).

Publishers of SCIENCE & INVENTION, RADIO NEWS, THE EXPERIMENTER and MOTOR CAMPER & TOURIST.

Contents for January

POPULAR ARTICLES

Editorial	869
By H. Gernsback.	
The Snow Burner	870
A Sailless, Engineless Ship	871
English Tidal Power Scheme	872
Dante's Inferno in the Movies	873
Little-Known Facts About Dirigibles	874
By W. P. Sullivan.	
The Dirigible of the Future	875
Movable Organ Keyboard	876
By A. P. Peck.	
Unique Clocks	877
Burning Oil Forms Defense	878
Building Bridges	879
Magic for Everybody	880
By Prof. Joseph Dunninger.	
Death Ray in Movies	881
The Living Death	882
By John Martin Leahy.	
Models of Famous Inventions	884
By Walter Sonneberg.	
Dr. Hackensaw's Secrets	886
By Clement Fzandic.	
Science Pictorial	888
The Path of the Solar Eclipse	889
By Isabel M. Lewis, M.A.	
How to View the Solar Eclipse	890
By Donald H. Menzel, Ph.D.	
Mystifying Jugglers' Tricks	892
The Radio Knife Explained	893
More Gambler's Tricks Exposed	894
Science Odds and Ends	895
By Dr. T. O'Connor Sloane.	
Science Problems and Puzzles	896
By Ernest K. Chapin.	
Breakfast Nook Furniture	897
By William Butterfield.	
Nature of Heat in Experiments	898
By Raymond B. Wailes.	

PRIZE CONTESTS

How-To-Make-It Department—\$30.00 in Prizes	903
Scientific Humor—Prizes for Best Jokes	917
Awards in \$1,000 Monthly Contest	920

AUTOMOBILES

Retort Cleans Engine Oil	878
Motor Hints	953

ELECTRICITY

Sailless, Engineless Ship	871
Movable Organ Keyboard	876
Models of Famous Inventions	884
The Radio Knife Explained	893
Latest Patents	916
The Oracle	918
Patent Advice	930

Edited by A. P. Peck

RADIO ARTICLES

Round the World Relay	906
Nauen Radio Station	907
Radio Pictorial	908
"An Ultra Super"	909
By R. W. DeMott.	
A New Distortionless Amplifier	910
A Remarkable Six Tube Receiver	911
By Grandon Lyons.	
An Improved Super-Het.	912
By H. Winfield Secor.	
A Page for the Novice	913
Radio Oracle	914
Radio Wrinkles	945

Edited by Leon L. Adelman.

CONSTRUCTOR ARTICLES

Steam Driven Model Boat	900
Cloud Filter	900
Amateur Surveyor's Transit	901
Tool Set From Old Files	902
Drill Press	902

CHEMISTRY ARTICLES

The Snow Burner	870
Nature of Heat in Experiments	898

ASTRONOMY ARTICLES

Path of the Solar Eclipse	889
How to View the Solar Eclipse	890

Send For This Sensational Radio Bargain Book-FREE



Big Radio Book

Send For it At Once

Order Direct From This Page! Save About One-half! Compare our prices with others. Only highest grade nationally known GUARANTEED parts. OUR GUARANTEE PROTECTS YOU. Money cheerfully refunded if you are not satisfied. Be sure to write your order and state prices plainly. Send post office or express money order or bank draft for total amount to insure prompt shipment. ALL PRICES ON THIS PAGE INCLUDE SHIPPING CHARGES RIGHT TO YOUR DOOR. Refer to any bank or commercial agency regarding our reliability. If your favorite circuit is shown here, order direct from this ad. No skill required to build your own radio with Randolph parts. Panels are all drilled. Instructions are simple and complete. Everything comes ready to assemble. Order direct! All ship'g charges prepaid.

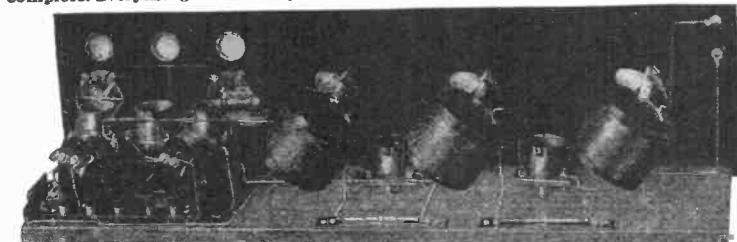

COMPLETE PARTS FOR
ACME 1-Tube REFLEX... \$17.45
ACME 4-Tube REFLEX... \$39.85

with Genuine Acme parts as specified, drilled bakelite panel and full wiring diagram.

COMPLETE PARTS FOR
2-Tube Harkness Set

including Licensed Harkness Coils, Drilled Panel and wiring diagram. Easy to build. Wonderful results. **\$17.95**

OUR GUARANTEE

Every article exactly as represented. Every article is tested before shipping. Complete satisfaction guaranteed or money will be cheerfully refunded.

COMPLETE PARTS FOR BREMER TULLY 5-Tube Nameless Circuit

With Genuine Bremer-Tully Parts, including Drilled Bakelite Panel and Instructions.

Specially priced at **\$39.25**

COMPLETE PARTS FOR 3 AND 5-TUBE NEUTRODYNE RECEIVING SET

Genuine Hazeltine Licensed Neutrodyne Parts Furnished.
COMPLETE PARTS FOR 5-TUBE SET
 1 7x24x³/₄ Drilled Panel
 2 Thordarson or Columbia Audio Transformers
 3 4" Bakelite Dials
 2 Precision Jacks
 1 Bakelite Rheostat, 30-ohm
 1 Bakelite Rheostat, 6-ohm
 1 Bakelite Binding Post Strip
 7 Marked Binding Posts
 1 Grid Leak and Condenser
 5 Bakelite Sockets
 1 .001 Condenser
 1 .006 Mica Condenser
 35 feet Hook-up Wire
 1 Kit consisting of 3 Hazeltine Licensed Neutroformers & 2 Neutrodons
 1 Baseboard
 2 Bezels **\$33.75**

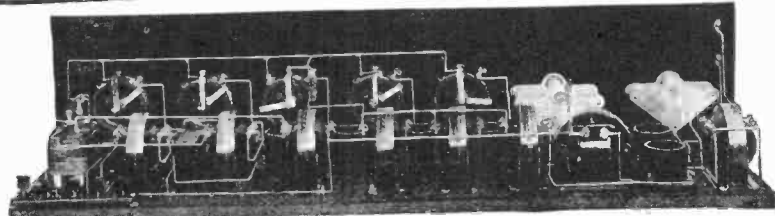

COMPLETE PARTS FOR 8-TUBE

2 23-Plate Bremer-Tully or Duplex Low Loss Condensers
 3 Remier or Columbia Intermediate Frequency Transformers
 1 Remier or Columbia Tuned Circuit Transformer
 1 Special Oscillator Coupler
 1 Nidget Condenser
 8 Bakelite Sockets
 2 Thordarson or Columbia A.F. Transformers
 1 Connecticut Filament Switch

SUPER-HETERODYNE

2 Bakelite 6-ohm Rheostats
 2 Bakelite 30-ohm
 1 Bakelite Potentiometer, 400 ohms
 1 Carter Double Circuit Jack
 1 Dupilier 1 mfd. Condenser
 1 .006 Mica Condenser
 1 .0005 Mica Condenser and 2 megohm Grid Leak
 3 .0025 Mica Condensers
 10 Binding Posts
 1 .00025 Mica Condenser
 1 Bakelite Terminal Strip for Binding Posts
 1 Multicoord cable for connecting Batteries
 1 7x30x³/₄ Drilled Bakelite Panel
 1 Baseboard
 35 ft. Hook-up Wire
 2 4-in. Bakelite Dials
 2 4 1/2 volt C Batteries **\$59.75**

Complete wiring diagrams, base board layout, blue-prints and instructions.

COMPLETE PARTS FOR Two Stage Amplifier
 with Thordarson or Columbia Transformers; with drilled panel & wiring diagram **\$10.90**

COMPLETE PARTS FOR Ultra Audion
 1000 Mille 1-Tube Set... **\$8.95**
 with drilled panel and wiring diagram.

COMPLETE PARTS FOR Reinartz
 1-Tube Reinartz Set... **\$10.45**
 3-Tube Reinartz Set... **17.55**

Randolph Special Headphones
 2200 Ohm **\$2.45**
 3000 Ohm **2.95**

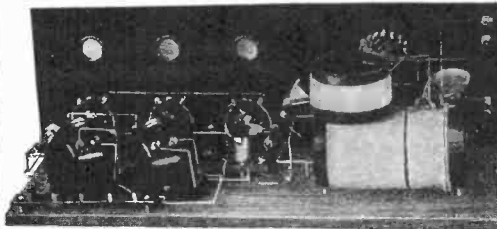

COMPLETE PARTS FOR 3-TUBE Cockaday Receiving Set

1 Cockaday Coil
 2 23-Plate Hy-Grade Cond.
 1 Bakelite Rheostat, 6 ohm.
 2 Bakelite Rheostat, 30 ohm.
 3 Bakelite Sockets
 1 high ratio Columbia or Thordarson Transformer
 1 Single Circuit Jack
 1 low ratio Columbia or Thordarson Transformer
 2 Double Circuit Jacks
 2 3 in. Bakelite Dials.
 1 Grid Leak and Mica Cond.
 7 Switch Points. 2 stops.
 1 Bakelite Binding Post Strip
 7 Binding Posts
 1 7x21x³/₄ in. Drilled Bakelite Panel
 3 Bezels
 1 Baseboard
 1 switch lever
 24 ft. Hook-up Wire **\$19.95**
 Complete blue-prints and wiring diagrams.
 1-Tube Set..... **\$10.45**

Easy to Build Your Own Radio Set

All complete parts for sets on this page consist of standard advertised guaranteed parts and include drilled bakelite panels and wiring diagrams for easy set construction. Everything guaranteed on money-back basis. All transportation charges paid. Don't forget! Only genuine guaranteed parts used. Lack of space does not permit us to itemize individual parts, but you are fully protected by our money-back guarantee. Our Service Division is behind you.

FREE BIG MONEY SAVING RADIO CATALOG

containing a thousand bargains of everything on radio—parts, supplies, complete parts for sets, complete sets, etc., also a mine of very latest information on all different circuits, complete list of broadcasting stations, and other valuable, up-to-the-minute radio data. Send your name and address on a card or letter. We will send catalog free.

Free Service Department

Our radio engineers will help you solve all your radio problems, and furnish up-to-date information on set construction, operation and improvement. This service is free to our customers.

COMPLETE PARTS FOR 5-Tube Improved Cockaday Receiving Set

With Resistance Coupled Amplification

As designed by L. M. Cockaday. Including drilled panel and wiring diagram complete, ready to wire.

\$39.65

RANDOLPH RADIO CORPORATION
 159 N. Union Ave. Dept. 276 Chicago, Illinois

SCIENCE and INVENTION READERS' BUREAU

Time and Postage Saver

IN every issue of SCIENCE and INVENTION you undoubtedly see numerous articles advertised about which you would like to have further information.

To sit down and write an individual letter to each of these respective concerns, regarding the article on which you desire information, would be quite a task.

As a special service to our readers, we will write the letters for you, thus saving your time and money.

Just write the names of the products about which you want information, and to avoid error the addresses of the manufacturers, on the coupon below and mail it to us.

If the advertiser requires any money or stamps to be sent to pay the mailing charges on his catalogue or descriptive literature, please be sure to enclose the correct amount with the coupon.

We will transmit to the various advertisers your request for information on their products.

This service will appear regularly every month on this same page in SCIENCE and INVENTION.

If there is any Manufacturer not advertising in this month's issue of SCIENCE and INVENTION from whom you would like to receive literature, write his name, address and the product in the special section of the coupon below.

TEAR ALONG THIS LINE

READERS' SERVICE BUREAU,

Experimenter Publishing Co., Inc., 53 Park Place, New York, N. Y.

1-25

Please advise the firms listed below that I would like to receive detailed information on their product as advertised in the issue of SCIENCE and INVENTION.

THIS FORM SHOULD NOT BE USED FOR TECHNICAL QUESTIONS

NAME	ADDRESS (Street—City—State)	List here specific article on which you wish literature.	If Catalogue of complete line is wanted, check in this column.
.....
.....
.....
.....
.....
.....
.....
.....
.....
.....

THIS FORM SHOULD NOT BE USED FOR TECHNICAL QUESTIONS

If you desire information from a manufacturer whose advertisement does not appear in this month's issue, use this space.

NAME	ADDRESS
.....
.....
.....

Your own name here.....

If you are a dealer check here.

Address.....
City..... State.....

ELECTRICITY



**I Will Qualify You
for an Important Job
Paying \$3000-\$5000^a year
Or I Don't Want a Penny**

No field in the world offers such wonderful opportunities to the trained man as does electrical work. I prepare you at home, in a few weeks, for one of these big, important, high-salaried jobs. No experience necessary. Continue your present work while training. I help you get a big-pay job and give you unlimited advisory service. Read about my new and improved method that is helping thousands of men out of the low wage class.

**Amazing New
"Shop-Type"
Home Training
Prepares You
Quickly for
Big Pay
Electrical Jobs**

Thousands of ambitious men are today qualifying themselves for Electrical jobs paying from \$65 to \$200 a week. By devoting some of your spare time for a few weeks to the new and improved S & H "Shop-Type" training you, too can be prepared to step into one of these important, high-salaried jobs. You at once step out of the wage earning class and up among the bosses—the important experts who direct the work of others.

No Experience Needed

By this new method of "Shop-Type" Electrical training, any man

of average intelligence can quickly and surely make himself ready to fill a big job in Electricity. You need not leave your own home nor give up your present work while training. This wonderful new method applies practical training with the theory of electricity so that even men who have never finished grammar school are graduating in jobs paying far more money than they have ever dreamed of making.

**Only 20 Weeks
Required**

Think of it. Only 20 short weeks stand between you and a big pay electrical job if you start my training at once. This training is so easy, so simple, that many of my students go into a c t i v e electrical work in that short time. Yet this training is so thorough and my graduates so successful, that S & H "Shop - Type" trained men are in big demand.

**Guarantee Your
Satisfaction**

Because my training has proved so successful and because my students are so enthusiastic over their rapid advancement in both money and position, I make a legal, binding guarantee to you that, if you are not completely satisfied with my training, it will not cost you a sin-

gle penny. I know what my training has done for others and know that it will do as much for you. The great Lincoln Institute of Technology stands behind this guarantee.

Electrical Outfit FREE

So that you can begin to earn money while training, I furnish you absolutely FREE, a big complete outfit of electrical apparatus, instruments and appliances. Many of my students earn enough to more than pay the cost of their training after the first few lessons. This equipment gives you actual "Shop-Type" training right from the start. In addition to all this, you have the advantage of the S & H Employment Service and Unlimited Advisory Service—these cost you nothing and you can use them as much as you wish.

Mail Coupon Today

To those who send the coupon now, I'll make another amazing offer, but you must hurry before this limited offer is withdrawn.

S. & H. Engineering Co.

Affiliated with Lincoln Institute of Technology

1422 W. Monroe St., Dept. A-2, Chicago, Ill.



Unholz and Farina were common laborers. They now own U. & F. Electric Co.



G. Melrose makes \$400 a month, the second year after S & H Training.



G. Fields jumped from \$35 a month to Superintendent of a big Electrical plant.

Chief Engineer Smith,
S & H Engineering Co.,
1422 W. Monroe St., Dept. A-2,
Chicago, Ill.

Please send me FREE and postpaid full particulars of your new and improved "Shop-Type" training in electricity and details of your remarkable free offer to those who enroll now.

Name

Address

City..... State.....

SPECIAL CHRISTMAS

MONEY-SAVING SUBSCRIPTION OFFER

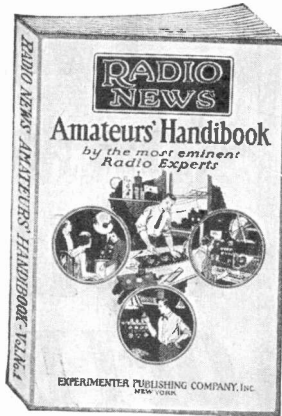

THIS BOOK FREE

To everyone of our readers, we are offering in the spirit of Christmas a very special opportunity. We are offering this 224 page, modern, complete and practical radio handibook, the most thorough book of its kind, FREE with every Christmas subscription to any one of our magazines. AND OUR OFFER IS A SUBSTANTIAL SAVINGS OVER THE REGULAR SUBSCRIPTION PRICE.

This is by far the most sensational opportunity we have ever made to our readers. We know that you will realize the saving and will want to get your subscription in at once.

BE SURE TO USE THE COUPON BELOW

HOW YOU SAVE MONEY ON THIS OFFER

REGULAR SUB. PRICE	- - -	\$3.00
HANDIBOOK (shown above)	-	\$1.00
		<hr/>
TOTAL		\$4.00
YOU PAY SUB PRICE	- - -	\$2.50
		<hr/>
YOU SAVE		\$1.50

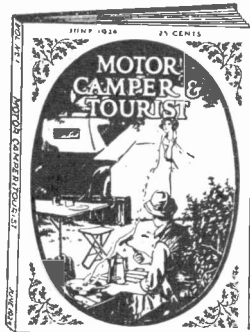
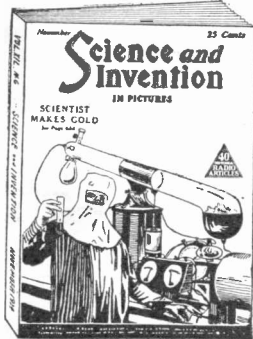

ALL YOU HAVE TO DO TO TAKE ADVANTAGE OF THIS OFFER IS TO CLIP THIS COUPON AND SEND WITH IT A CHECK OR MONEY ORDER

EXPERIMENTER PUBLISHING CO., INC.
53 Park Place, New York City.

Gentlemen:—

I am enclosing \$2.50 for a special Christmas subscription to RADIO

NEWS SCIENCE & INVENTION The EXPERIMENTER

MOTOR CAMPER & TOURIST *Check Magazine desired.*

NAME

ADDRESS

CITY STATE

Experimenter Pub. Co., Inc.
53 Park Pl., New York City

Get Into the BEST PAYING BUSINESS in America!



I Will Teach You to Earn \$3500 to \$10,000 a Year in the Auto Field

How much are you now making a week? Would you like to earn four times that much? Why not learn at home to boss the Big Pay jobs of the Automotive Industry? Thousands of positions paying from \$75 to \$200 a week are always open to trained men who know how to fill them.

I Train You at Your Home

I can teach you to become an Automotive Expert—can give you at home—in one year or less—what it took me many years to learn in English factories of Daimler and Rolls Royce and in American factories of Packard and Paige.

I Guarantee Your Success! Satisfaction—or Money Back!

Faith in yourself and ambition to learn is all you need. Are you willing to back yourself to win? All men are much alike from the head down. Invest a few dollars in your head and make it quadruple your pay, as it has done for thousands of my other students.

You Can Earn Big Money—Wherever You Live

Stay right at home—keep your present job—spend a few hours each week of your spare time—and I guarantee to make you an Auto Expert ready to go right into a Big Pay job. This trade knows no locality.

Earn as You Learn Age and Lack of Education No Drawback

You don't have to be a wonder—just an ordinary, everyday ambitious man. And you don't have to wait until you finish my course before you begin to earn. Earn as you learn. Almost from the start, you can begin to make good money on the side.

Practical Instruction—Oldest Auto School

Everything about my course is practical—easy to learn—and easy to apply. The lessons are intensely interesting—the practical tools and instrument supplied you insure your having the correct equipment for auto work. As soon as you become my student you will also be entitled to the life-long consulting service of the American School—the most successful and oldest Home Study Auto School in America.

Be a Big Paid Auto Expert

Start today to guarantee your future success. Send for my Big Free Book "The Easy Way to Bigger Pay." Actions count more than good intentions. Make the right move NOW. Fill out the Coupon! I'll show you how to make more money than you ever dreamed of earning.

Tom Plumridge, Chief Engineer
Automotive Division, American School

Dept. E-126 Drexel Ave. & 58th St., Chicago, Ill.

Do You Want More Money?

What are you doing to be a real success? Are you just thinking about it—just hoping that some day you'll be making lots of money? Day dreaming won't increase your earnings. The way to get ahead quickly and nicely is to act. If you have the ambition, I have the Training that will make you an Auto Expert. Get busy! Win success! Be a big man in this big pay field. The first step is to send me the coupon. Do it now!

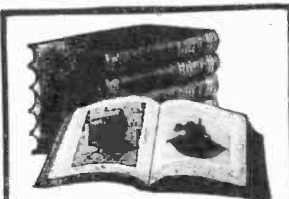

Free Auto Books

This big five-volume Auto Reference Library is FREE to you, 2200 pages, 2300 pictures, charts, photos, etc. Finest Auto Library in the world. Covers every subject. Alone worth the cost of the Course, but FREE with the course.

Free Tools and Instruments



Complete equipment for repair work—socket wrench set, special ratchet wrenches, extensions, adapters and universal joint, a valuable "Sonscope" for detecting engine irregularities, a volt-ammeter and a Willard Hydrometer for Battery work, and a set of high-grade feeler gauges.

Free Employment Service

I give you FREE a life-long help in getting you a big pay job. Use it before or after you graduate—any time you wish—as long as you wish. Through close touch with Manufacturers and Garages we are continually placing students and graduates in good pay jobs.

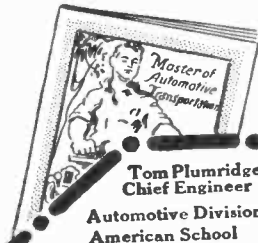

Tom Plumridge,
Chief Engineer

Automotive Division,
American School

Dept. E-126

Drexel Ave. & 58th St., Chicago

Send me your free book and other information on how I can best get into the Big Pay Field. This request is to put me under no obligation.

Name.....

Address.....

City..... State.....

EXPERIMENTAL RADIO

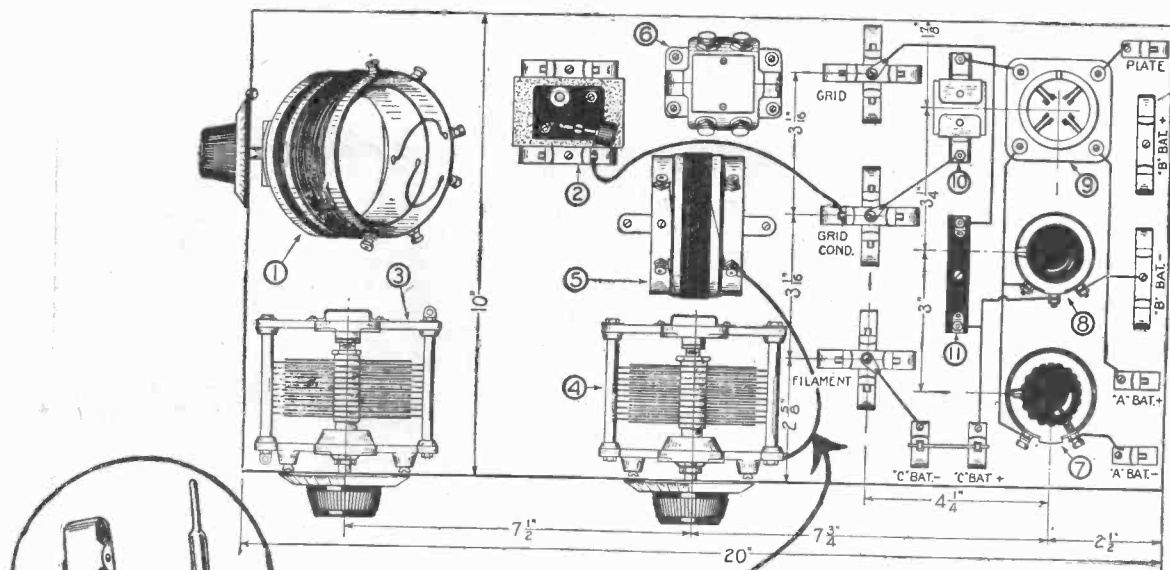

1000 Hookups

Meet the Hookup Board

Mr. Experimenter:

YOU who are experimenting with hook-ups know what it means to connect and disconnect loose wires from binding posts every time you try out a new hook-up. Sometimes it takes hours to do so and then it is a most tedious task. By means of the hook-up board which is now being demonstrated every month in **THE EXPERIMENTER** all this hard work has been done away with. Radio experimenting is now a positive pleasure and not tedious work.

You can now make hook-ups in 10 per cent. of the time that it took you previously. All this is accomplished by means of the clip-leads and tip-leads pictured at the left.

A new science,—**EXPERIMENTAL RADIO** has come into being. You will want to keep abreast with the myriad of hook-ups that are being published in all radio publications every month. Reading a hook-up does not give you any more satisfaction than smelling a steak. You want to experiment with the hook-up yourself. *The Experimenter* teaches you how to do it.

THE EXPERIMENTER now has twelve pages of experimental radio every month,—articles featuring radio from the experimental side only. Buy the January issue now on all newsstands. One copy will convince you that this is the one magazine you must have.

The EXPERIMENTER

25c The Copy—ON ALL NEWSSTANDS

SUBSCRIPTIONS—\$2.50 the Year

Published by

GERMOTT PUBLISHING CO., 53 Park Place, N. Y. City

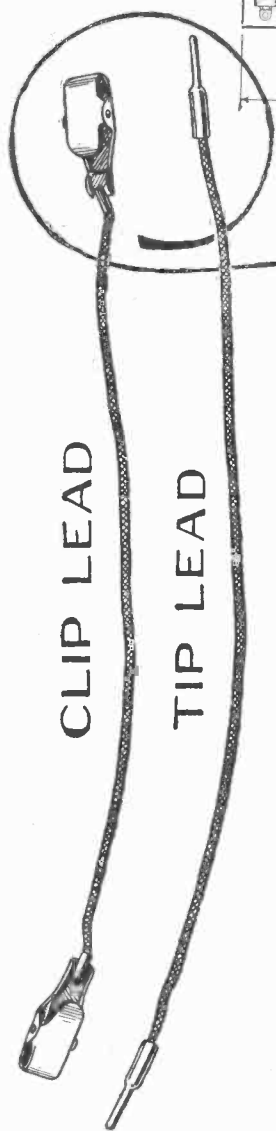

Electricity Pays Cooke Trained Men \$3500 to \$10,000 a Year

STEP out of your small-pay, no future job. Electricity wants you. The most interesting and best paying work in the world is calling you. Get ready now to earn \$70 to \$200 a week — you can do it in a few short months' time. I will train you at home and you can pay for your training with spare time work. My Course pays its own way. And Electricity Pays Cooke Trained Men \$3500 to \$10,000 a year.

Electrical Experts Needed Everywhere

Even common, ordinary electricians earn \$8 to \$10 a day. You know that yourself. They have short hours and pleasant work. But here is your opportunity for even a better job. Be an Electrical Expert and boss the big jobs—get the expert's pay—\$12 to \$30 a day—\$3500 to \$10,000 a year.

Why Salaries Are High in Electricity

The whole world is rapidly being electrified. In this country alone nearly a million and a quarter homes are being wired for electric light every year. Hundreds of the biggest power houses are being built. Entire railroad systems are replacing steam with electricity. Thousands of Factories—Hundreds of Mines—15 Million Automobiles—5 Million Radio Outfits—all depend on electricity, and men who are trained to handle it. Right now, there is a big shortage of trained men and more and more are needed every year. That's why salaries are high in electricity and why they will stay high and even go higher. Electricity is the ONE BIG PAY FIELD and it is open to you now.

Don't Let Lack of Experience Hold You Back

Don't rob yourself of the things you want—the joys and comforts of life—just because you may not know anything about electricity now. The thousands of big successful men I have already trained were clerks, mechanics, laborers, farm hands, etc., when they started—they knew nothing about Electricity either. But that doesn't keep them from making big money today. Don't let age or lack of education or experience hold you back. If you can read and write I can train you to earn \$70 to \$200 a week and I will *guarantee your satisfaction* with a signed *money back* guarantee bond.



Be an Electrical Expert

I will train you at home and help you make extra money while learning



L. L. COOKE,
Chief Engineer.
America's Most
Successful Teacher
of Electricity

YOU want to earn big money. You want to get into a line of work where there is a constant and increasing demand for men. You can do it—Easy. Electricity needs you and Cooke Trained Men easily earn \$3500 to \$10,000 a year.

Cooke Training gives you quick action. You start earning extra money at once, while you keep on with your present job. You don't wait 'til a year from now to cash in on what you learn. You get the extra money right after you start. I show you how to get and how to do spare-time electrical jobs right in your own neighborhood on which you get valuable practical experience. While you are learning to fill the expert's job which will pay \$3500 to \$10,000 a year, you earn many times more than the monthly payments on my Course. Send for my free book today and get the whole big story of your opportunities in Electricity—THE BIG PAY FIELD.

I Will Tell You More In My Big Free Book

Send the coupon for my free book "The Vital Facts About Electricity." In it are the fourteen big reasons why I can train you better than anyone else—Why "Cooke" Students' Service has revolutionized home-study training—The letters of over 100 men who earn up to \$12,000 a year—How you too, can get a big pay job in electricity in a few months' time—64 pages and over 150 pictures. Take your first step into the ranks of big-pay men today. Start succeeding this minute—Send for my free book, which tells you all about it—NOW.

L. L. COOKE, Chief Engineer
Chicago Engineering Works
Dept. 21 2150 Lawrence Avenue
CHICAGO, U. S. A.

Mail this Coupon for my FREE BOOK

L. L. COOKE, Chief Engineer, Chicago Engineering Works, Dept. 21, 2150 Lawrence Avenue, Chicago, U. S. A.

Send me your book "The Vital Facts About Electricity," full particulars of your Home Study Course, and your fourteen guarantees including your plan for helping me earn extra money while learning. This does not obligate me to enroll for your Course.

Name

Address

City.....State.....

The "COOKE" Trained Man is the "Big Pay" Man!

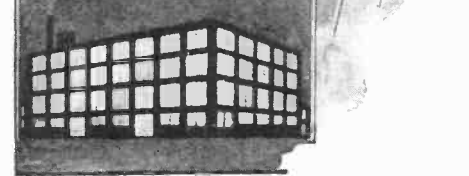
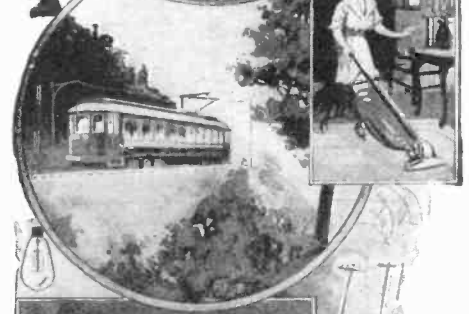
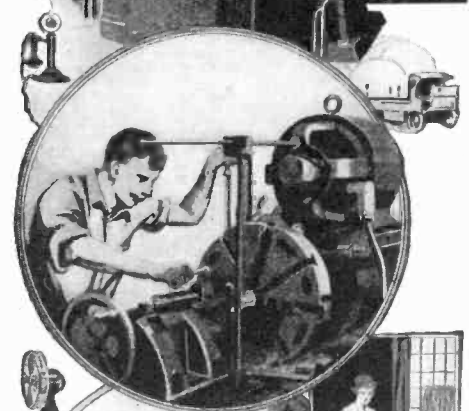
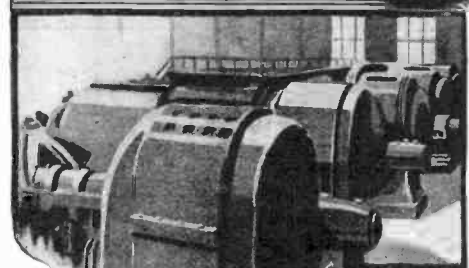

Master Electricity By Actual Practice

The only way you can become an expert is by doing the very work under competent instructors, which you will be called upon to do later on. In other words, *learn by doing*. That is the method of the New York Electrical School.

Five minutes of actual practice properly directed is worth more to a man than years and years of book study. Indeed, Actual Practice is the only training of value, and graduates of New York Electrical School have proved themselves to be the only men that are fully qualified to satisfy EVERY demand of the Electrical Profession.

The Only Institution of the Kind in America

At this "Learn by Doing" School a man acquires the art of Electrical Drafting; the best business methods and experience in Electrical Contracting, together with the skill to install, operate and maintain all systems for producing, transmitting and using electricity. A school for Old and Young. Individual instruction.

Over 9,000 Graduates are Successful Men in the Electrical World

No previous knowledge of electricity, mechanics or mathematics is necessary to take this electrical course. You can begin the course now and by steady application prepare yourself in a short time. You will be taught by practical electrical experts with actual apparatus, under actual conditions.

The N. Y. E. S. gives a special Automobile Ignition Course as an advanced training for Auto Mechanics, Garage Men and Car Owners. The course covers completely all Systems of Ignition, Starters, Lighting and other electrical equipment on automobiles, motor boats, airplanes, etc.

Let us explain our complete courses to you in person. If you can't call, send now for 64-page book—it's FREE to you.

New York Electrical School
29 W. 17th St., New York, N. Y.

Please send FREE and without obligation to me your 64-page book.

..... NAME
..... STREET
.....CITY STATE

New York Electrical School

29 West 17th Street, New York

Science and Invention

H. GERNSBACK, EDITOR AND PUBLISHER
H. WINFIELD SECOR, ASSOCIATE EDITOR
T. O'CONOR SLOANE, Ph.D., ASSOCIATE EDITOR

Editorial and General Offices, - - - 53 Park Place, New York

"Those Who Refuse to Go Beyond Fact Rarely Get As Far As Fact" . . . HUXLEY

The Dark Age of Science

By HUGO GERNSBACK

TOO many people nowadays are prone to settle themselves back in their chairs and congratulate themselves about the wonderful age in which we are living. With railroads, airships, radio and other "marvelous" activities abounding around us, it is easy to lull oneself into the belief that surely the millenium has arrived and that the world will never look rosier than it does now.

I BELIEVE THAT:
the wheel was one of the greatest inventions of all times.

As a matter of fact, 300 years hence this present age of ours will probably be termed the "dark age of science." This is not merely a catch phrase used by the writer, but he means it in all sincerity, and what is more, he can easily prove it.

Nowadays it makes us laugh when we think of how people in England and other parts of the world some five hundred years ago on top of coal mines and froze to death. They simply did not know that coal would burn and that it could be made to heat houses and otherwise perform tremendous work. While we laugh, you should soberly consider that we are doing the self same thing ourselves today. All about us there is untold quantities of energy, much cheaper, much better, more sanitary than coal, but we simply have not learned how to use it because we do not know. Every piece of rock, every car full of sand has a potential dormant power locked up within it. We may call this power atomic or by any other name, but the fact remains that we do not use it because we do not know how.

Take a great city like New York, which burns thousands of tons of coal whose products pollute the atmosphere every day, while right at its very feet two mighty rivers, the Hudson and the East Rivers flow by its shores, which rivers every day can actually furnish more power than all the coal burned in a year. Still, this mighty power goes to waste in this dark age of ours.

When you go to the butcher and order a 10-pound roast, you would become highly indignant if he handed you over $9\frac{3}{4}$ pounds of bones and less than $\frac{1}{4}$ pound of meat, but when you pay your electric light bill at the end of the month and you send the lighting company your check for \$10.00 you do this very thing. The reason is that exactly 98% of the electric power goes up in useless heat, which you do not need and which you do not want but which you must pay for. You actually get 2% of light, and in order to get this 2% you have

to pay 98% for something that is a total loss. Of course all this will make people laugh merrily 300 years hence, and they will not be able to understand how we could afford such frightful losses.

Then we go and invent the automobile, another monstrosity of the "dark age of science." In order to propel the same, we generate carbon-monoxide that pollutes the air in our streets, gives us headaches, and otherwise makes life unbearable for us. But this is far from being the worst. Here we go and create the automobile and then build so many of them that they become useless by their very numbers. Instead of transporting us quicker than the old horse-drawn vehicle, we actually find that the latter was much faster, in many instances. If you try, in any of our big city streets, to go about quickly, you will find that there is only one way of doing it and that is you must come right back to prehistoric times and *walk*. In cities like New York and Chicago, you can cover ground much quicker for reasonable distances on foot than by automobile.

Far from living in the millenium, we are living in an age of unspeakable waste. There is hardly anything that we can think of that is not wasted.

We know today the power of waterfalls, the inherent power of the tides, the inherent power of moving rivers, yet—99% of this goes entirely to waste. Wind power, another large source of energy, is hardly touched at all. This power alone is so vast that a small fraction of it, properly applied, would supply the world with sufficient energy to run all the machinery, all trains and all of our vehicles. Water power and wind power are well understood and can be exploited by us even today, but no real effort in this direction is to be discerned.

We do not wish even to speak of the power derived from the sun's heat, because we have as yet not found the key to unlock this tremendous energy, which is far, far greater than all the others combined.

At the present time we simply use sun power that has been stored up by nature millions of years ago. This is the case with coal, gasoline and practically every other fuel. All other forms of energy that are lying about us in every direction are not even touched. It is a comforting thought that our great-great-grandchildren will stand on their own legs, for they will know how to unlock a power universe, invisible to us.

I BELIEVE THAT:
sooner or later governments will subsidize all inventors of repute.

THE GOLDEN AGE OF SCIENCE
is now symbolized by the golden cover of **SCIENCE & INVENTION**, LOOK FOR THE GOLD COVER every month!

I BELIEVE THAT:
the human race has a lot to learn from the ants and the bees.

The Snow Burner

By JOSEPH H. KRAUS

A New Scheme for Clearing Snow from Sidewalks

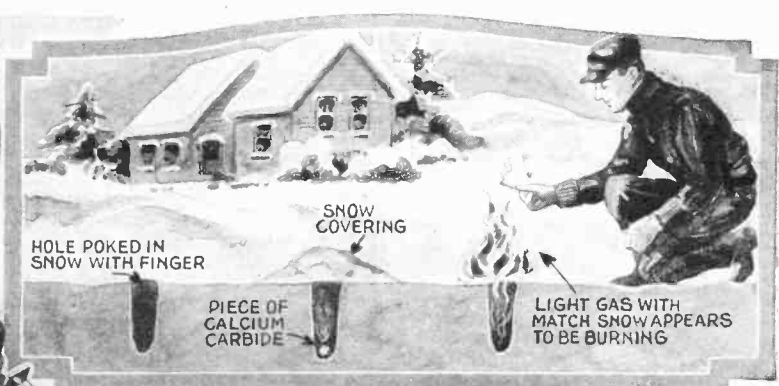

A simple experiment for seemingly burning snow is illustrated in the above drawing. A hole is first poked into the snow with the finger or with a stick. A piece of calcium carbide is then dropped into the hole and snow packed lightly on top of the calcium carbide. The moisture present in the snow causes the calcium carbide to go into chemical reaction with the water and evolve acetylene which burns on the surface of the snow when ignited. The heat formed will melt the snow, and the heat of reaction will further aid the melting of the snow.

Based on the principle of the experiment illustrated in the upper right hand corner of this page, the suggestion for the experiment having been made by Harry E. Hale, the snow burner illustrated above has been devised. Essentially this consists of a means of sprinkling calcium carbide upon snow, and as the gas is evolved, it is lit with a match. The sprinkler is then drawn over the walks, and the flames follow in its wake, melting the snow which runs off in the form of water.

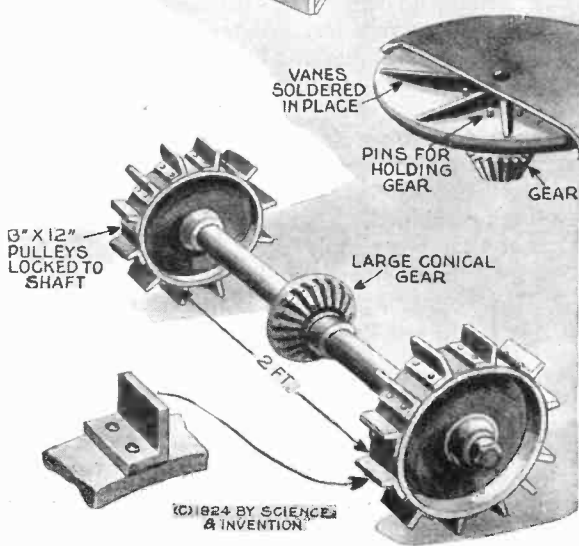
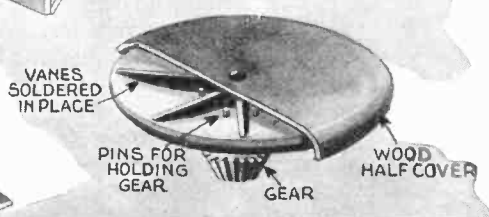
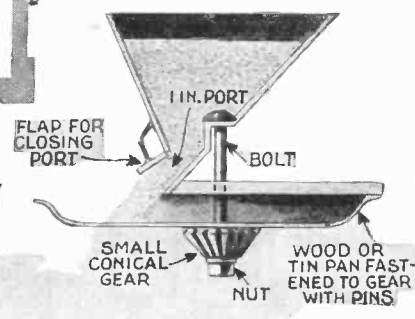

Great care must be exercised in sprinkling calcium carbide upon snow, so that when the gas is evolved and ignited, it will not set fire to shrubbery, trees or the house itself. Under no conditions should such a snow remover be used when a gale is blowing, and the individual drawing the mechanism over the road should always see to it that he heads into any slight breeze which may be blowing, so that his own clothes will not be ignited. A slow procedure is best because a large area of snow will not be heated at one time and the flame area is considerably confined. Above and to the left the principal parts of the mechanism are illustrated. It will be noted that a hopper containing calcium carbide slowly drops the carbide into a pan revolving at high speed. The pan is covered on the front half by a shield so that the carbide sprinkled out because of centrifugal force will only fall in back of the mechanism. For eliminating small patches of snow, the best system is to sprinkle the carbide out of a pan, as illustrated above.

Sail-less, Engine-less Ships

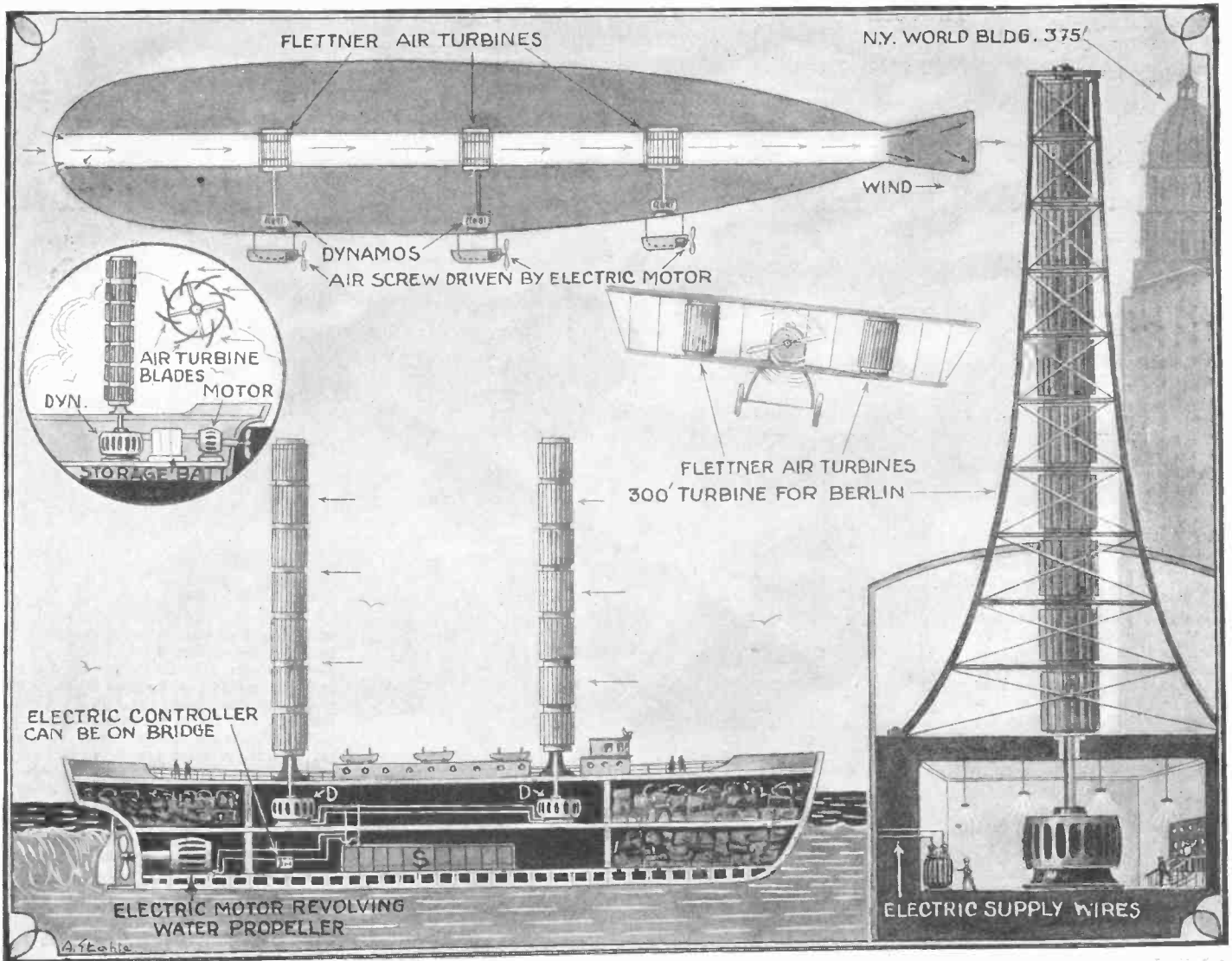

Announcement has just been made by Anton Flettner that he will attempt to sail a sail-less ship across the Atlantic. This ship is to be fitted with two revolving cylinders each sixty-five feet high, which are in reality highly efficient air turbines, connected to dynamos D, which in turn supply current to storage batteries, S, thence to electric motor coupled to the propeller. The illustration also shows the simplest view of the Flettner turbine coupled with the dynamo, storage battery and motor. The method is applicable not only to vessels, but also to airships and airplanes, where

the size of the Flettner turbines would be cut down considerably but a greater number would be used for turning dynamos which supply the motors coupled to the propellers with the necessary current. Strange as it may seem, it is absolutely possible to produce a ship of this nature which will sail faster than the wind. There is, however, no multiplication of power, but the wind power is utilized more efficiently and more flexibly in this wind turbine scheme. It is proposed to build a power plant in Berlin with tower 300 ft., high, comparable to the World Building in N.Y. City.

Building Houses While It Rains

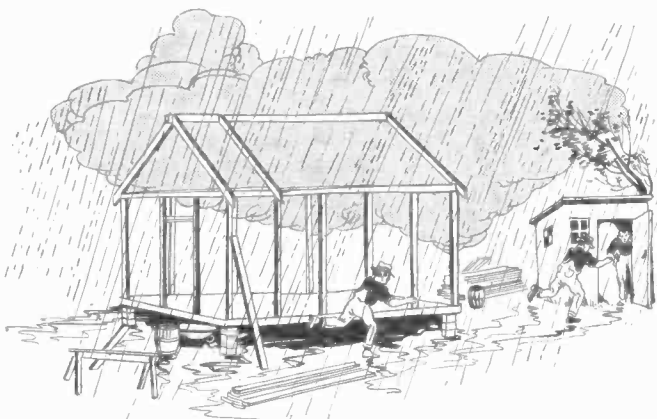

Why not erect a large tent big enough to house a building until completed so that work need not be interrupted during a rainy spell, suggests the author. Such a tent might cost \$500, but considering that labor cost \$9 a day, and it requires six men three months to build a \$10,000 bungalow, if but ten days were lost in the erection of the building, the cost of the tent would be saved on the first building and work expedited.

—K. G. Pratt, Reporter No. 7122.

Tidal Power Plant

PROPOSED TIDAL POWER PLANT FOR RIVER SEVERN, ENGLAND

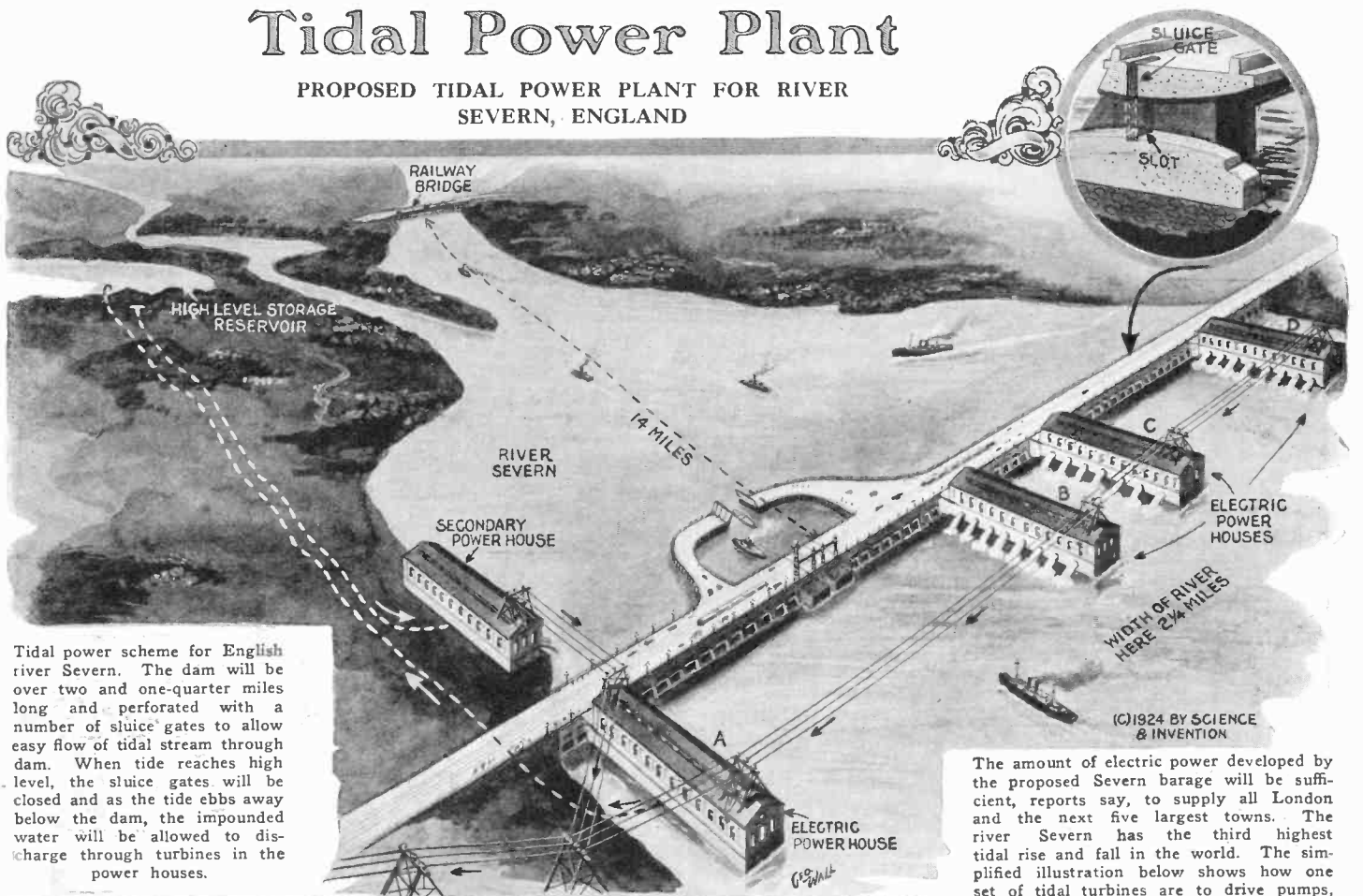

Tidal power scheme for English river Severn. The dam will be over two and one-quarter miles long and perforated with a number of sluice gates to allow easy flow of tidal stream through dam. When tide reaches high level, the sluice gates will be closed and as the tide ebbs away below the dam, the impounded water will be allowed to discharge through turbines in the power houses.

The amount of electric power developed by the proposed Severn barrage will be sufficient, reports say, to supply all London and the next five largest towns. The river Severn has the third highest tidal rise and fall in the world. The simplified illustration below shows how one set of tidal turbines are to drive pumps, storing water in a high level reservoir, water from this reservoir being used to operate dynamo turbines when there is no tidal power available from the main power houses situated along the dam. That is, when the tide is out and all of the impounded water above the dam has been passed through the turbines, the auxiliary high level storage reservoir will be utilized, through the intermediary of the secondary power house, to keep the supply of electric current continuous.

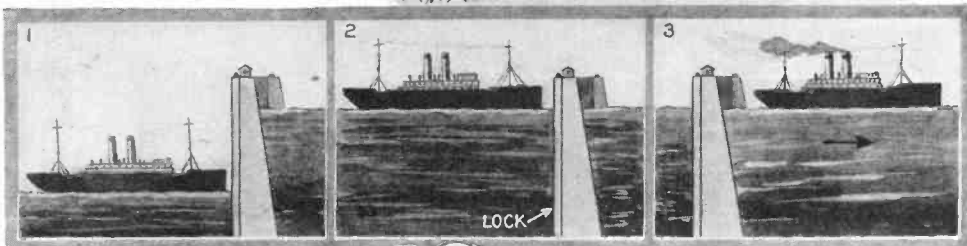

The three small drawings numbered one to three above show how ships will be locked through the Severn power dam. Fig. 1 shows a ship entering the opening through dam into lock, in which the water is at the same level as that on the down stream side of the dam. Fig. 2 shows water level in lock raised so that ship is at same level as impounded water above the dam. Fig. 3 shows ship passing out of lock gates into impounded or upstream waters.

The six numbered progressive views below shows in a clear manner how tidal turbines operate. On top of each tidal turbine there is a dynamo which spins with the turbine blades and develops electric power. Fig. 1 shows one of the turbines starting to work with tide falling below dam. Fig. 2 shows turbine working at full power, Figs. 3 and 4 showing the same operation, while Fig. 5 shows turbine preparing to stop. Fig. 6 shows turbine stopped while tide rises.

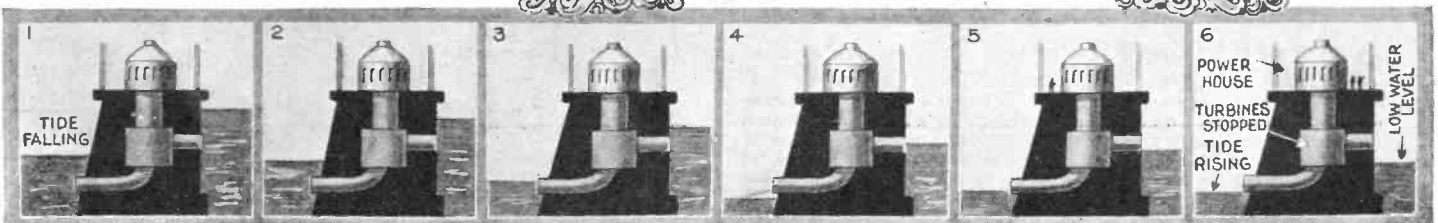
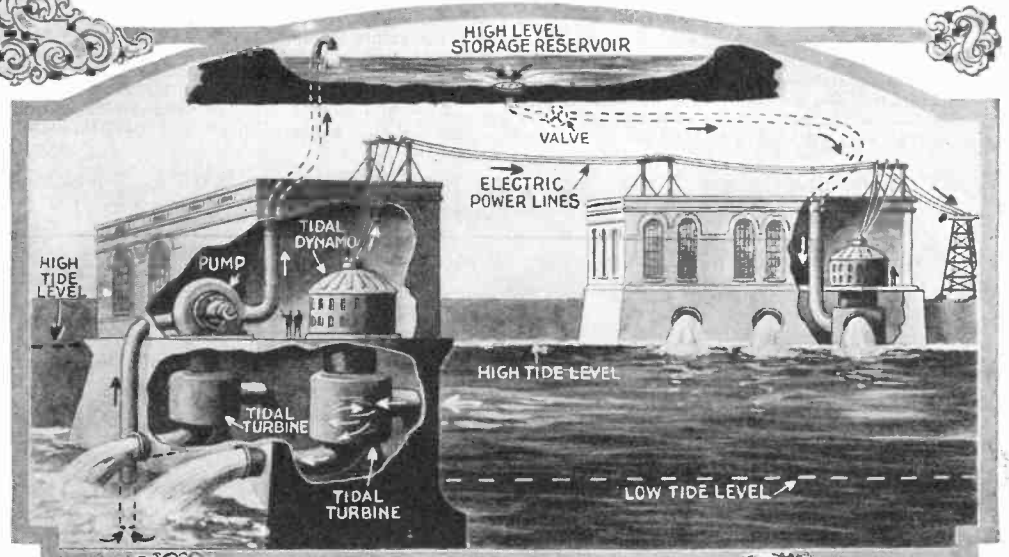

Dante's Hell Shown in Movies



One of the most unique characterizations in this William Fox super-picture is the imp shown above. An evil appearance was given to his skin by coating it with petroleum which caused it to shine.



The angel shown in the above photograph appeared out of the center of lightning flashes, which were produced by setting a plate of glass immediately in front of the camera, painting the lightning flashes on it with quick-firing composition and igniting with spark.



Here is detailed a next double exposure trick used.

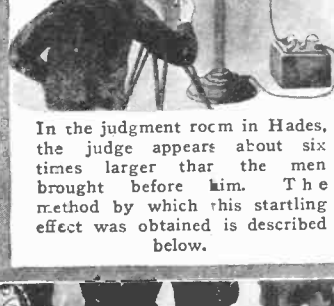

In the judgment room in Hades, the judge appears about six times larger than the men brought before him. The method by which this startling effect was obtained is described below.

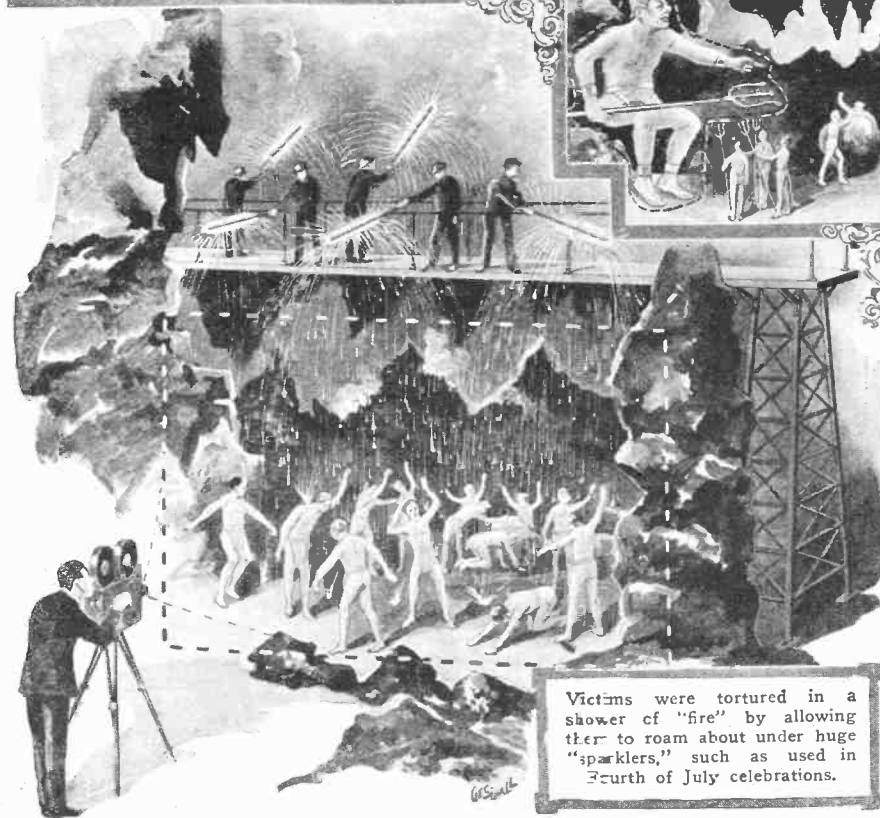
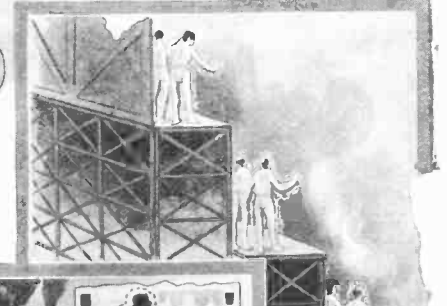

Victims were tortured in a shower of "fire" by allowing them to roam about under huge "sparklers," such as used in Fourth of July celebrations.

(C)1924 BY SCIENCE & INVENTION

The double exposure trick was done by photographing the figure of the judge in front of a dead black background, very near the camera. The film was then rewound with the portion covered by the judge blocked out with a template immediately in front of the film in the camera. The film was then run through again, exposing the remaining figures and the background at a much greater distance, the two perspectives giving the difference in size. Immediately above, to the left, is shown how the various tiers of the stairway of torture were caused to tremble. The papier maché rocks which composed the background were erected on wooden frames, which stage hands shook. The fire shower was accomplished by having stage hands shake huge sparklers down upon the players. The dotted line shows the range of the camera, which of course left out the men manipulating the sparklers.

Little-Known Dirigible Facts

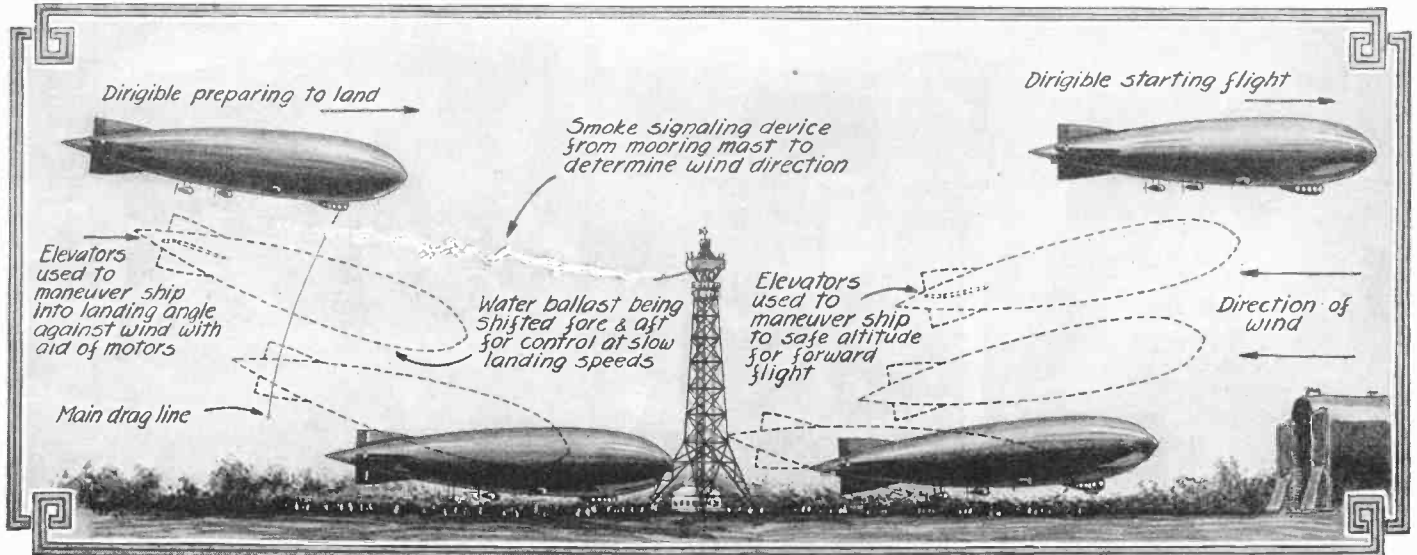

In landing a dirigible the ship does not ordinarily valve gas. The vessel is first maneuvered against the wind with the aid of her motors, a dragline dropped and eventually the ship is brought to its landing position.

In starting a flight, the propellers are permitted to turn over at a speed just sufficient to overcome the velocity of the wind, so that the vessel rises almost vertically.

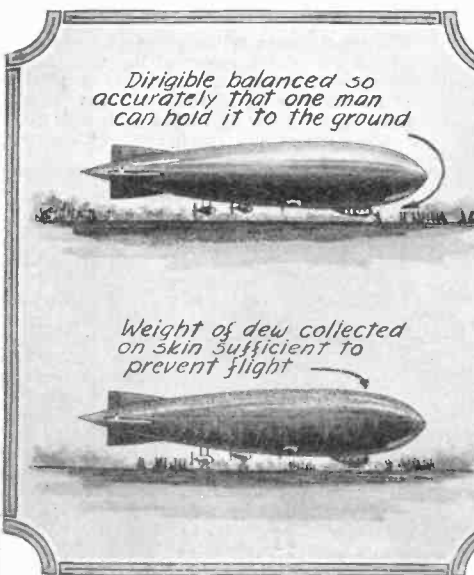

So well is a dirigible balanced that one man can hold it to the ground when it has its crew on board. It even becomes impossible to start a flight in the early morning after a heavy dew fall, as the weight of the

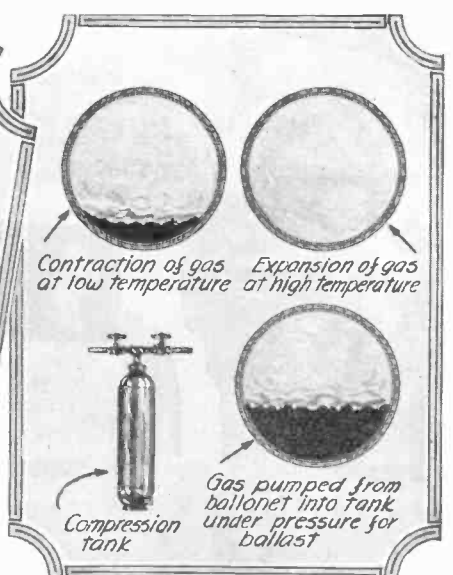

dew is too heavy to permit the ship to "take off." Illustrations at the right shows the effect on ballonets of the difference in temperature. Gas under compression is used as ballast.

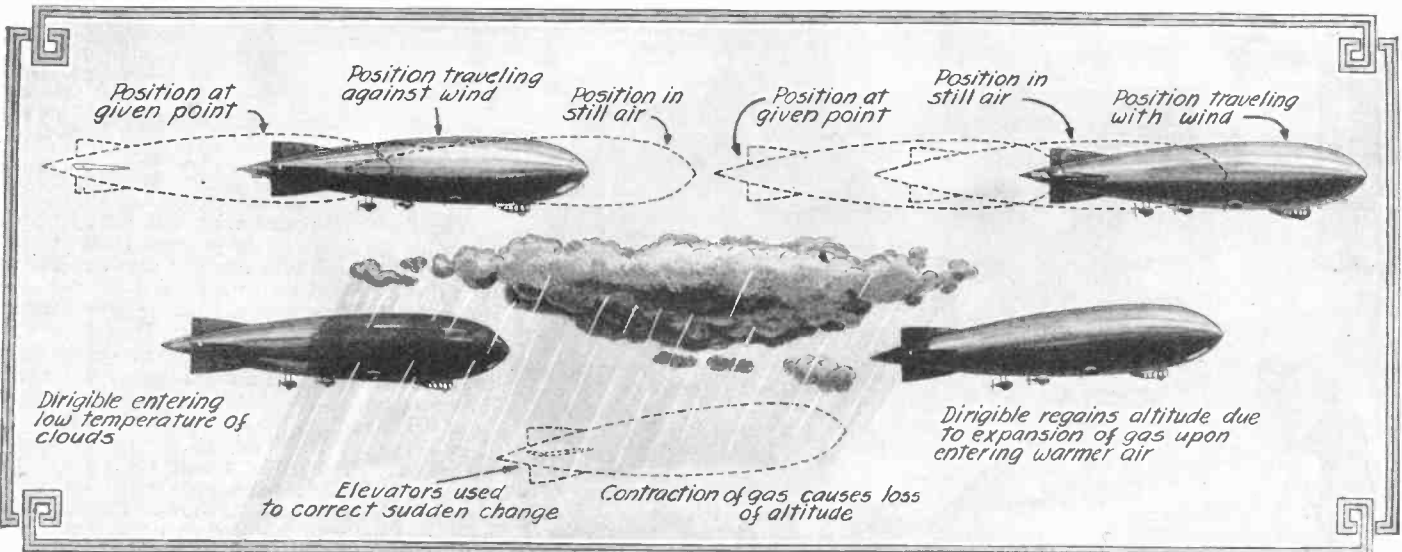

The above diagram illustrates how the wind affects the flight of a dirigible. The shaded illustration shows the position of the ship traveling with and against the wind. Notice how this varies with respect to the starting point. It is remarkable to see how rapidly a dirigible will sink

when it gets beneath a cloud. The heat from the sun is cut off, the gas contracts, and buoyancy is greatly lessened almost instantaneously. This drop is partially corrected by the elevating planes.

—William P. Sullivan, Aeronautical Engineer.

Safety Dirigible of the Future

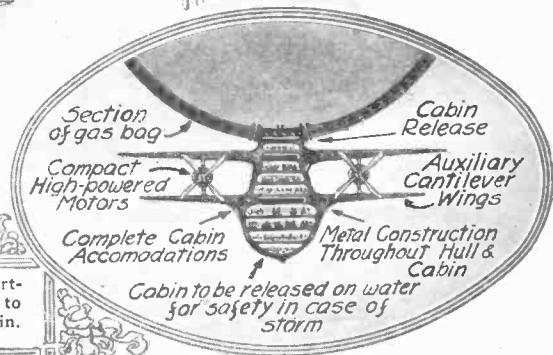
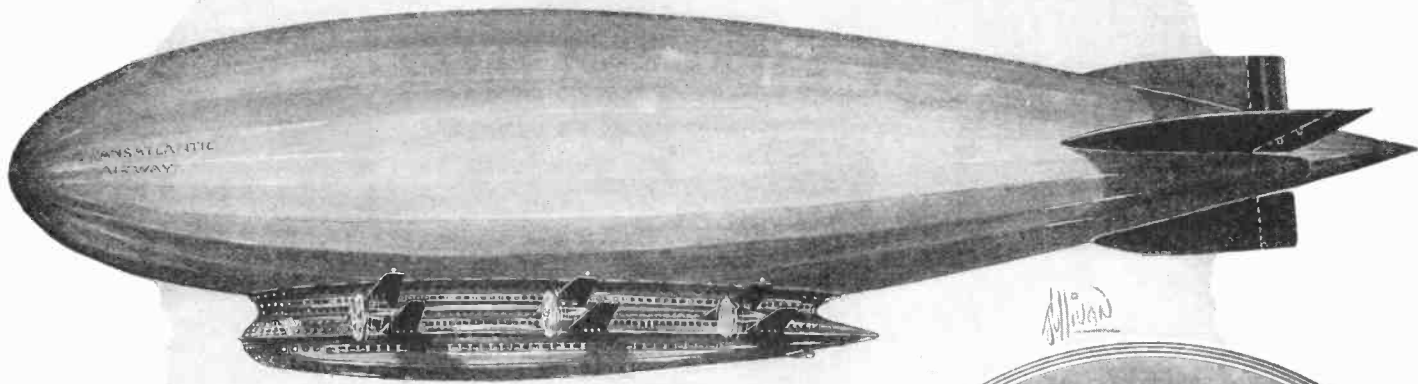

If trouble develops with the gas bag of the future dirigible, the passenger and engine compartment can be released therefrom and will volplane to earth. The wings may be flexible to assist with steering and rising and the compartment will float on water. —J. Von Stein.

Airship Moored to Boat

In the April, 1924, issue of SCIENCE AND INVENTION, we published what is known among artists as a "wash" drawing showing a large dirigible moored to a structural steel mast which was erected on an ocean going tank ship. This illustration was used in connection with an article by Graser Schornstheimer, our naval writer, dealing with the airship Shenandoah and is reproduced at the left. At that time, this mobile anchorage for a dirigible had never been built, but was merely in a theoretical stage. However, the tanker Patoka has recently been converted and its appearance differs very little from that set forth in our article many months ago. The photograph directly below is one taken at sea under actual working conditions and shows the Shenandoah moored at her ocean base. What's more, SCIENCE AND INVENTION was the first to publish such a picture.

Photo Times Wide World.

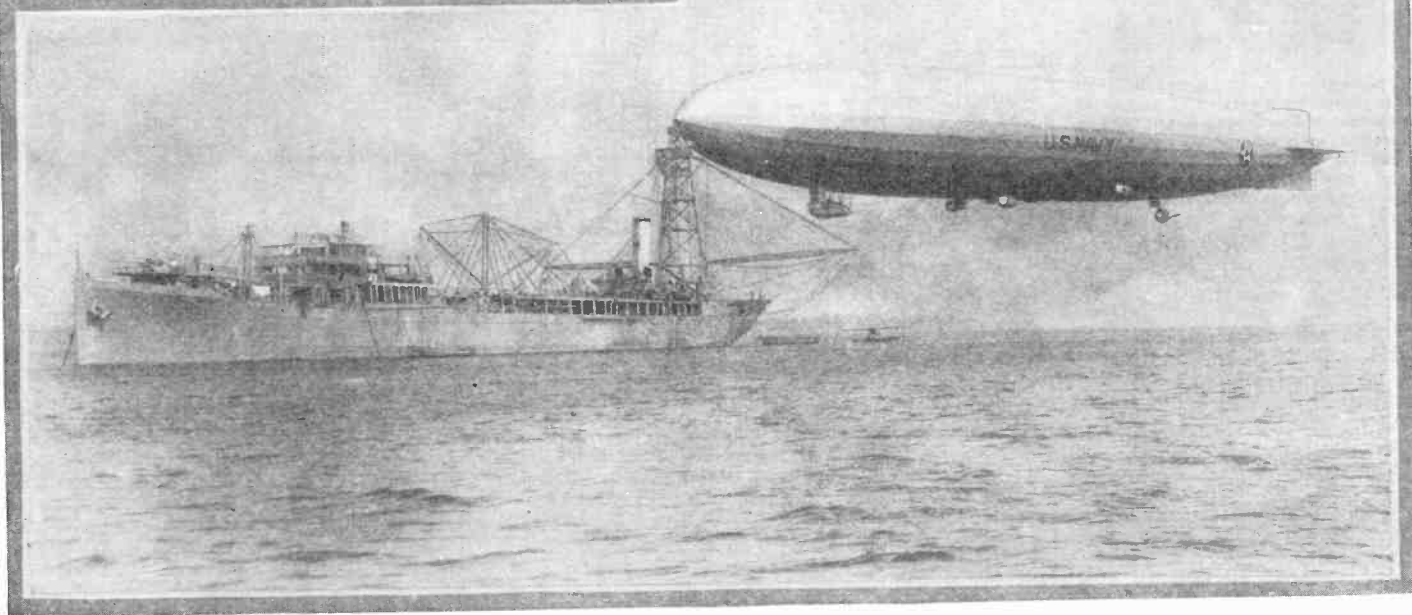
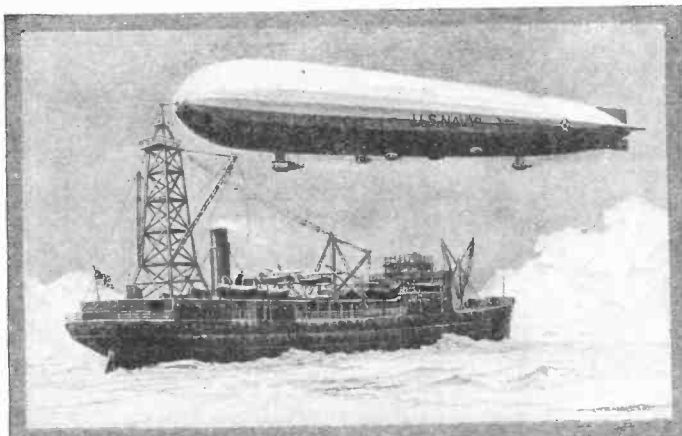

Movable Organ Keyboard

By A. P. PECK

At the left is shown new rising and falling organ console or keyboard as it appears at its greatest height.

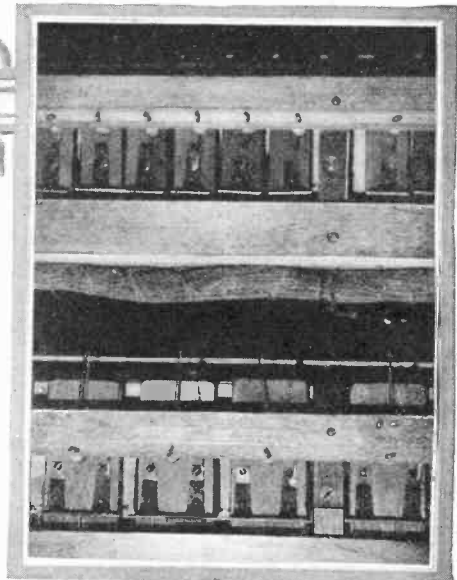
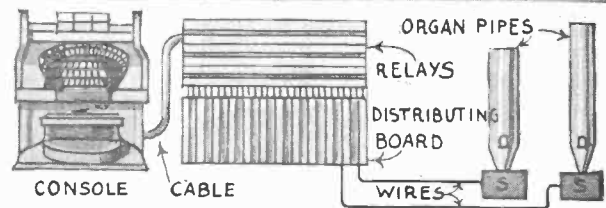
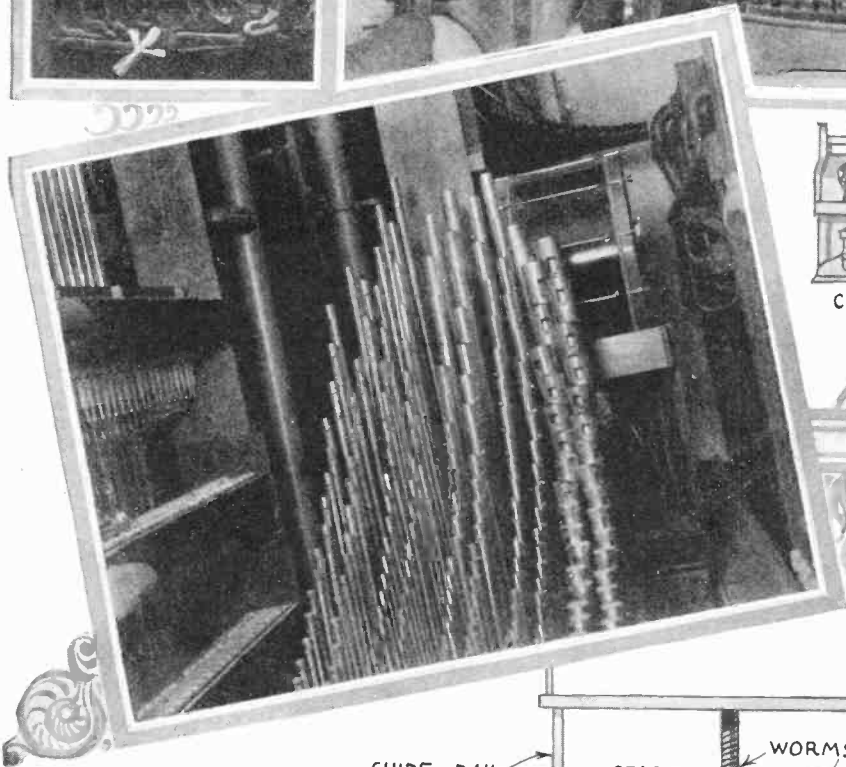
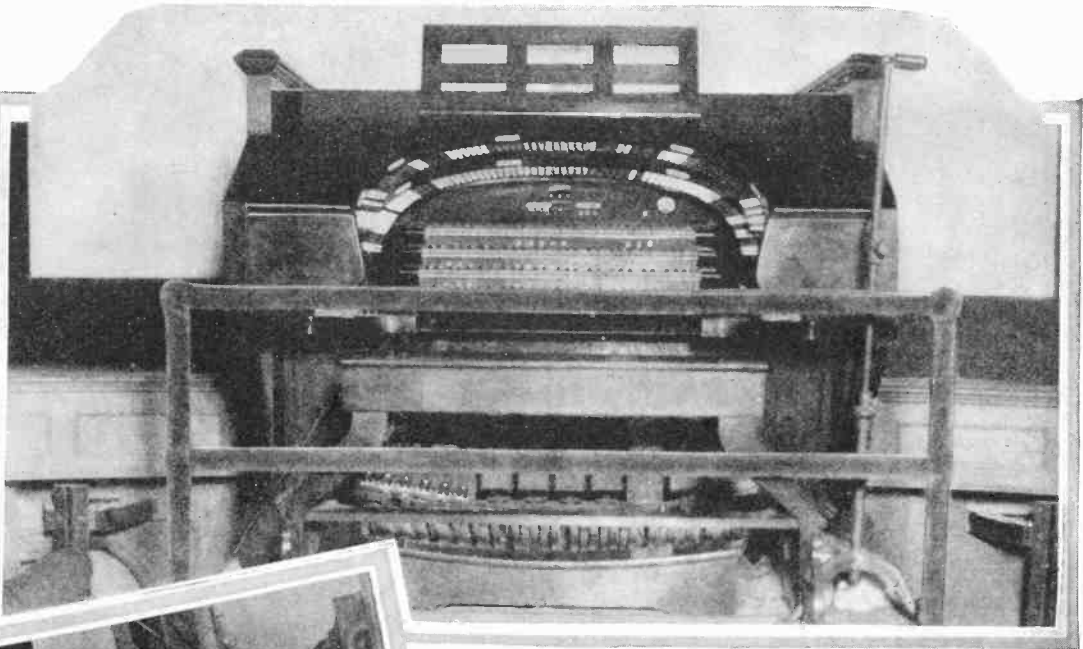

The photograph in the upper lefthand corner illustrates a very small section of the enormous distributing board used in connection with the electric organ described on this page. The photo directly above shows a part of the hundreds of pipes that are used as well as some of the traps.

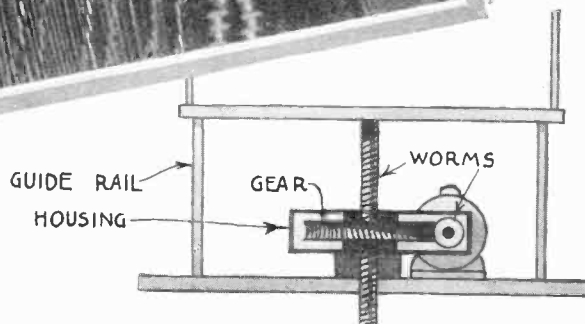

A powerful electric motor and a series of worm gears are used to raise and lower the organ console or keyboard as shown above.

Relays are used to close the main circuits of this electric organ. A section of the relay board is shown directly above.

ONE of the most novel and interesting organs ever constructed is the one which was recently installed in the Piccadilly Theatre, New York City. Several views of the console of this organ and of the various other parts are shown above.

The most interesting fact in connection with this musical instrument is that the console control or key board may be raised or lowered as desired. The purpose of this is to enable the organist to give solos in

full sight of the audience. To do this, the console is raised to its fullest height as shown at the top of this page, whereupon the organist is almost at a level with the stage floor. When motion pictures are being shown or the stage is occupied by other artists, the console is lowered. Flexible electric cables make it possible to keep the organ in operation at all times, whatever the position of the keyboard.

The simplified diagram shown at the cen-

ter right of the page gives an idea of how the circuits are wired. The cable from the console connects to a series of relays which make and break a circuit which carries the great amount of current necessary for operating the pipe mechanism. The relays are in turn wired to the distributing board from which connections extend to the pipes. The latter are supplied with air by means of an electrically driven pump, the flow of air being controlled by solenoids.

Unique Clocks

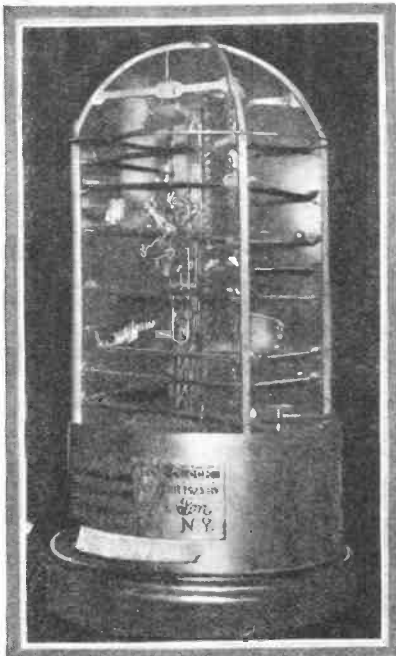

The Fred W. Jensen and Son perpetual motion clock (with a motor concealed in the base), is shown above.

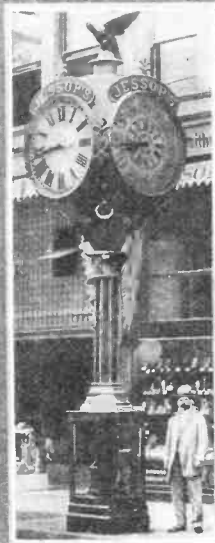

In San Diego there is a street clock with twenty dials which tell the time in the principal cities of the world simultaneously. It also gives the day of the week and the month. It was built entirely at a retail jewelry store.

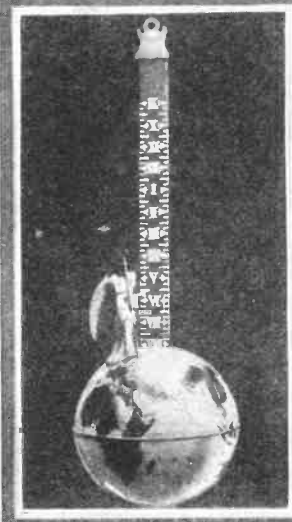
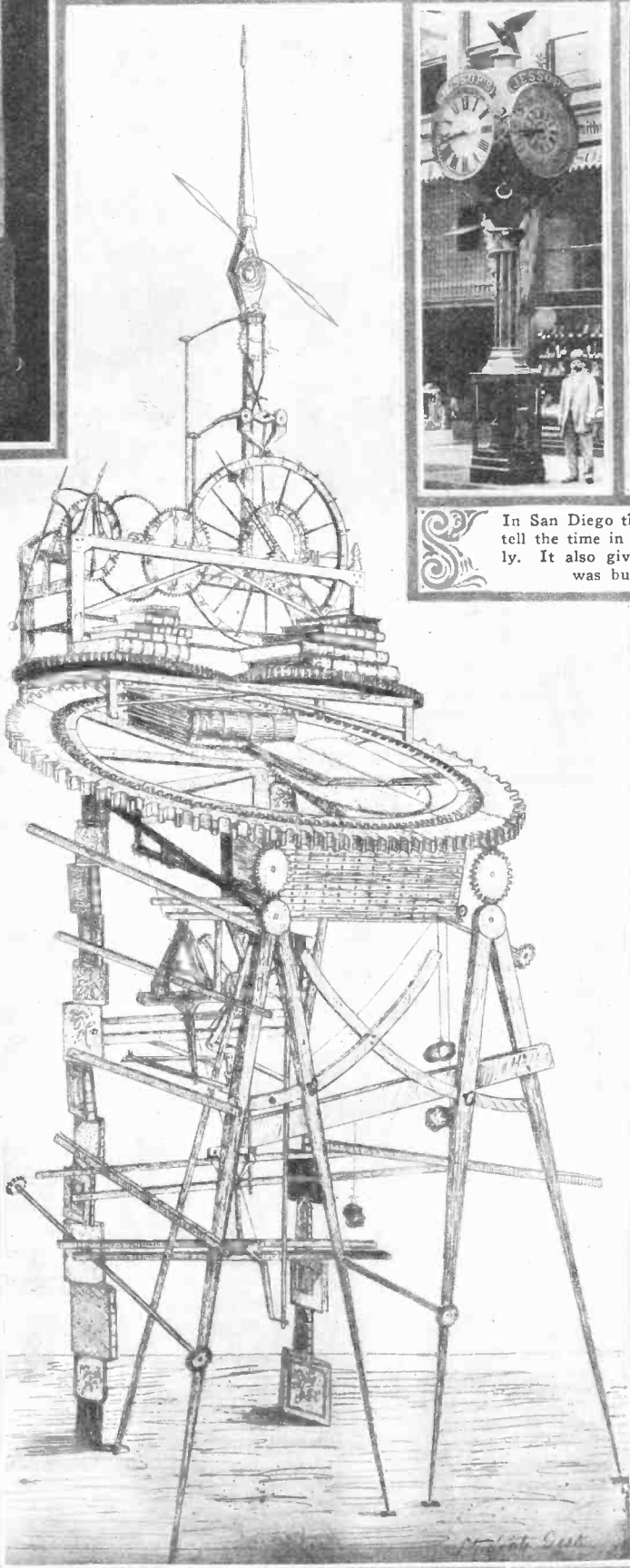
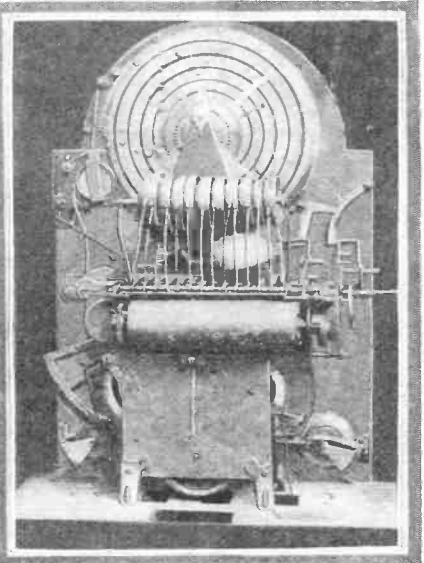

The ball clock above tells time by the pointing of the figure at the parchment strip. Gravity pulls the ball down.

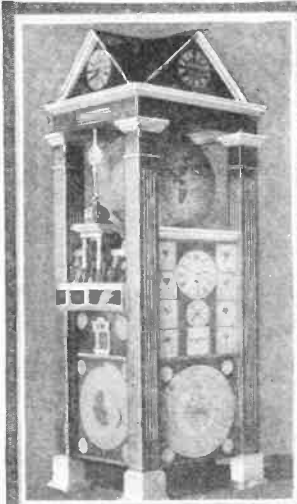

The above illustration gives a view of the famous John Muir clock, which the naturalist used to light his fires in the morning and to regulate his study periods at night by passing the various text-books he was using before him at the proper time. A large weight hung out the window actuated this device. At the left above is the clock of Frank Fried, which is a monument to five years of patient work. It is ten feet high and three feet square, and has 108 dials showing the time, size, flag, form of government, postage stamp and the lowest coin and the name of the capitol of every country in the world, as well as its language. The globe in the top representing the earth revolves every 24 hours. The moon is shown in comparative size and revolves once every 29 1/2 days. At the left is shown the famous straw clock built by a German, which contains nothing but straw. —H. E. Zimmerman.

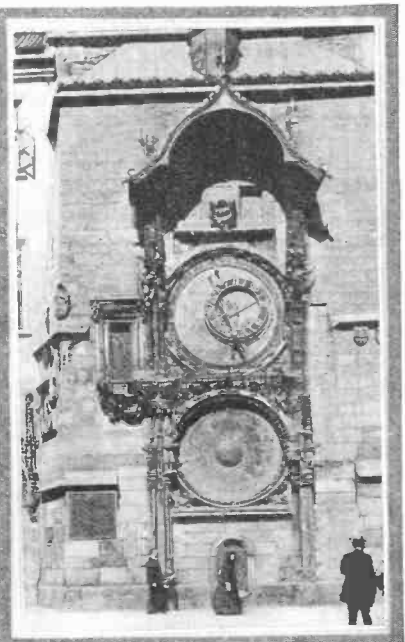

Town Hall clock at Prague, Czecho-Slovakia, was built in 1430. It shows mean time, Sideral time, and position of sun. —Siouka.

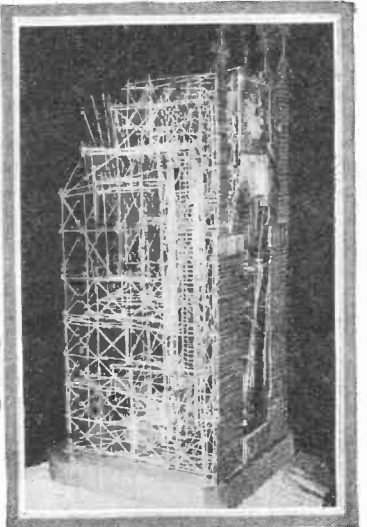

Burning Oil Forms Defense

RADIO EQUIPPED OBSERVATION BALLOON TO WARN OF ENEMY'S APPROACH AND IGNITE OIL

OIL SUPPLY STATION

CITY

ONE OF SEVERAL MAIN SUPPLY OIL PIPES

ENCIRCLING PIPE LINES

CUT OFF FROM EACH MAIN LINE

IGNITER POINT

HERMETICALLY SEALED CASE

RADIO LOOP

RADIO OPERATED RELEASE VALVES FOR OIL

COILS

OIL SEEPS OUT OF HOLES AND SATURATES TOP SOIL.

CONNECTION

PERFORATION

MAIN OIL LINE

SOLENOIDS

ELECTRICALLY OPERATED RELEASE VALVES FOR OIL

©1924 BY SCIENCE AND INVENTION

ONE of the most novel fortification ideas brought forward for some time, is shown in the above illustration. Circular pipes, suitably perforated, are laid in great circles around the city to be protected and oil is fed to them. Upon the approach of an enemy electrical or radio control is used to open the valves, thus soaking the surrounding territory. As the enemy starts to march over the soaked region, the oil is ignited. The arrangement is made in sections, so that only one segment may be used or a fiery circle may be created, entirely surrounding the city. The sketches at the right show the method of connecting the electrically operated valves. The sketch at the left shows how the pipes are laid around the town and how distribution is made to them.—L. B. Robbins.

Retort Cleans Engine Oil

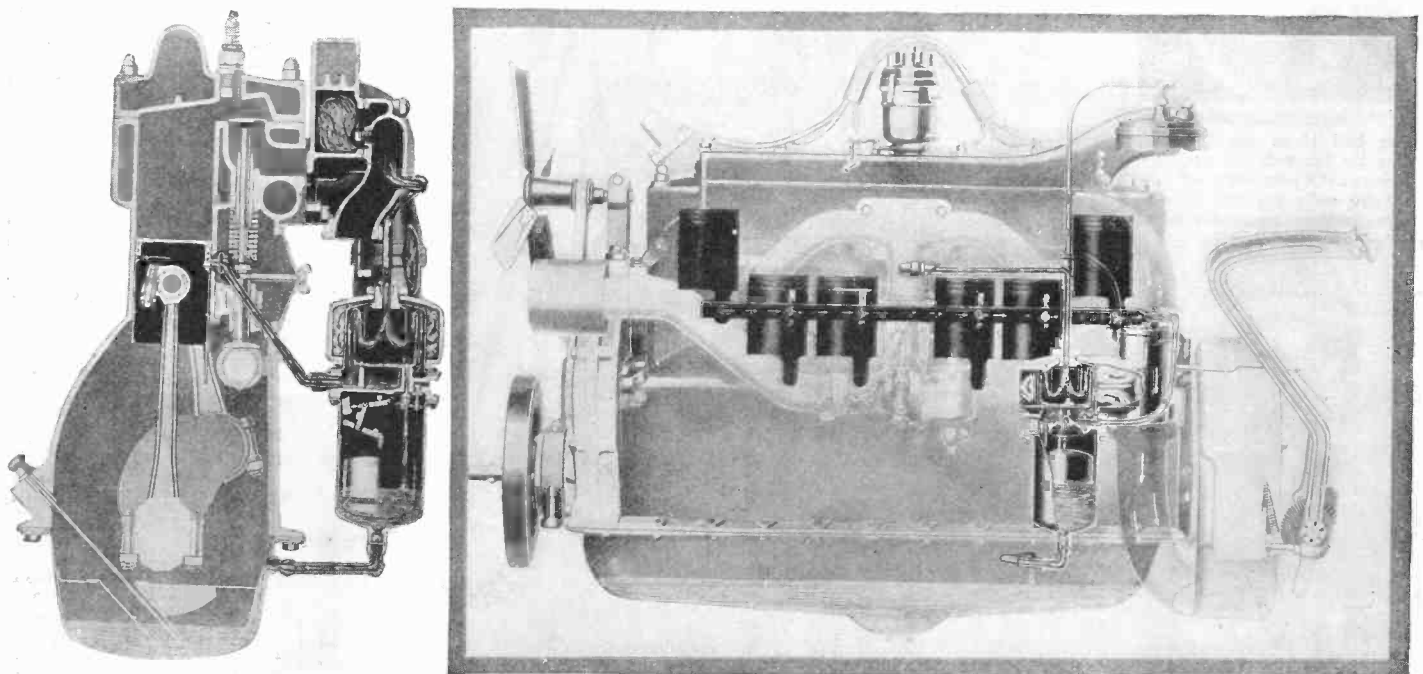

One of the most marvelous advances made in automobile engine construction during the past season, was the addition of an extremely complicated but practical oil filter system which cleans the cylinder oil and at the same time increases the efficiency of the engine. The sketch at the right above gives a cross-sectional view of the apparatus. As the oil is used it is sucked into the intake from the level of the bottom piston ring. It passes into the retort where the exhaust heat volatilizes water, kerosene and other light substances which may be in the oil. This retort is controlled by a rugged thermostat,

so that the oil is not liberated until the proper heat is reached. The volatilized gases pass out through the upper pipe and are fed into the intake manifold, while the clean oil drops into the bottom cylinder and is fed back into the crank case. Vacuum from the intake manifold operates the device. It is said that double the ordinary amount of oil may be put into the crank case, and this device will keep the engine from burning the oil and causing smoking. The left sketch shows side elevation.

Building Bridges

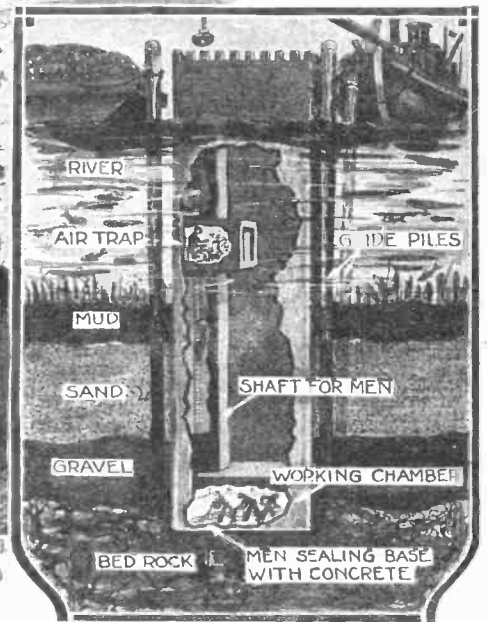
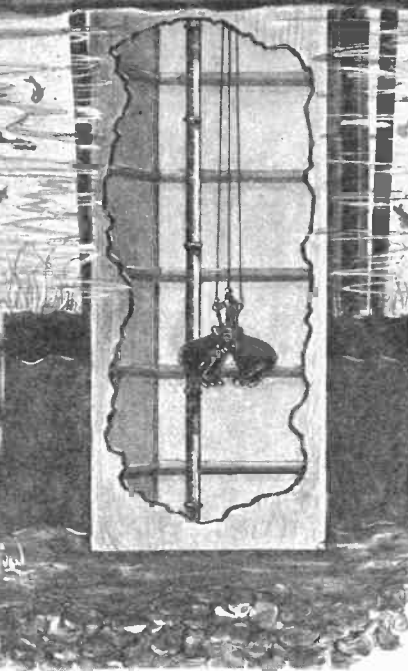
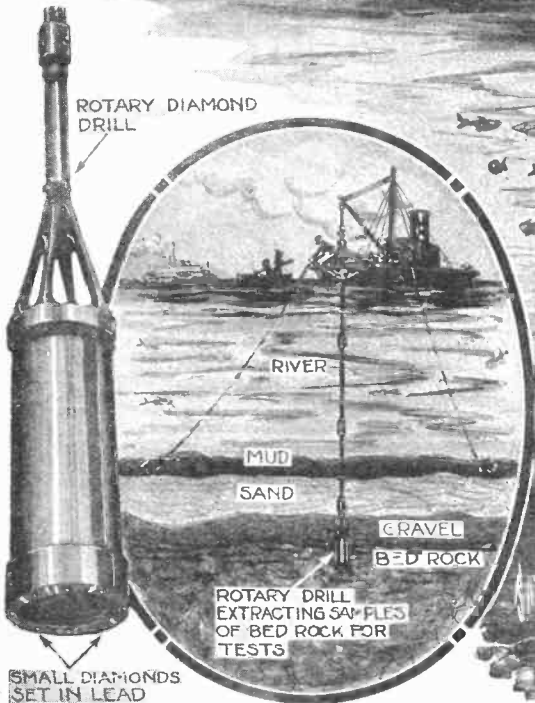
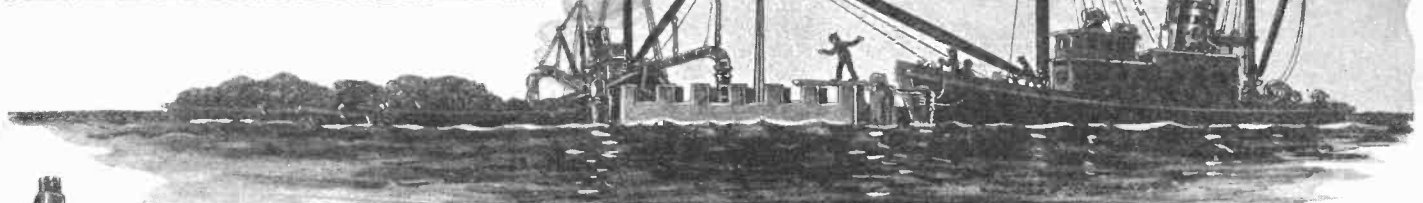
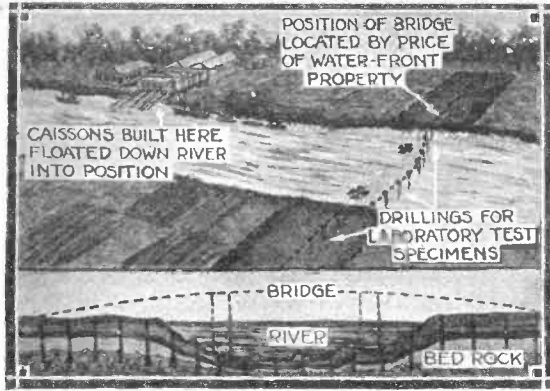

Some of the most interesting facts connected with bridge building are very little discussed. Preparation for the structure is as interesting as the structure itself. The inset at the top of the page shows how the engineers make a cross-section over which the bridge is to be run. The hollow cylindrical drill using diamonds for teeth shown at the left, cuts a core showing exactly the structure of the rock below. On this knowledge the location of the piers is decided.

A caisson is built above the location of the bridge and floated to position, where it is sunk. The sand and dirt is then hogged out of the inside of the caisson with dredge buckets, until the caisson sinks to solid rock. The sketch at the right shows the arrangement for men working at the bottom of the caisson under extra high air pressure. On reaching rock, the bottom of the caisson is sealed and then the whole filled with concrete. —W. B. A.

Compass

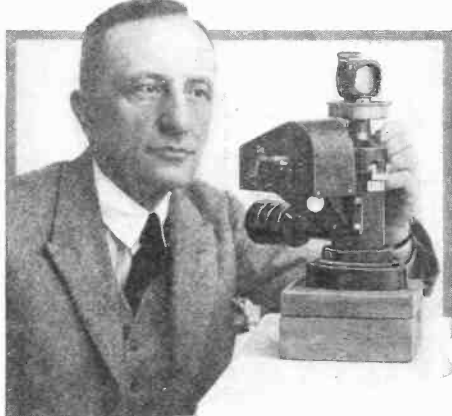

For northern cruises where the magnetic needle cannot be depended upon, the above compass which finds direction by pointing at the sun, is used. —Dr. Alfred Gradenwitz.

Rapidly Growing Plants

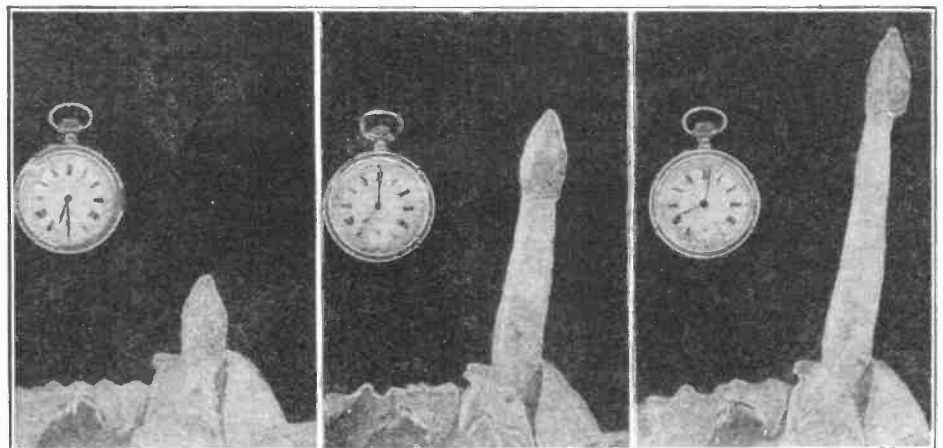

Possibly the most rapidly growing plant known to man is the fungus called Phallus. The above photographs show a sprout and the time taken for it to reach maturity. —S. Leonard Bastin.

Magic for Everybody

By PROF. JOSEPH DUNNINGER

NO. 22 OF A SERIES

A papier maché skull rests inside of a cabinet made of glass on three of its sides. Front and top are opened. The magician professes to be able to cause the skull to rise and fall at command, and the skull promptly obeys his orders. It can be made to answer questions by rising once for "no," twice for "yes." The secret lies in the fact that the skull is mounted upon a glass slab which is perfectly transparent. Attached to the bottom of the slab is a string passing over a pulley, and then to a system off stage. Naturally the bottom of the slab is concealed by the stand upon which the cabinet rests.

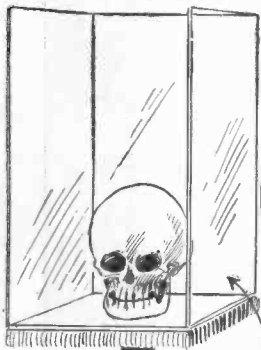
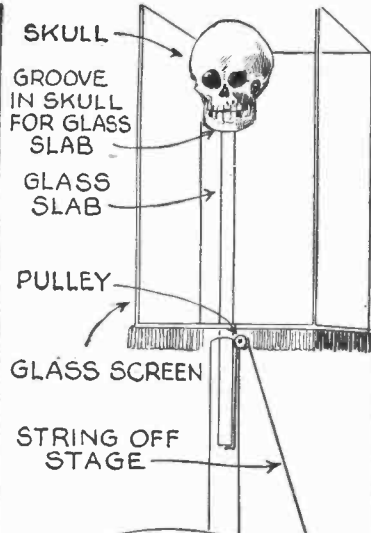

GLASS SCREEN



SOAP BUBBLE

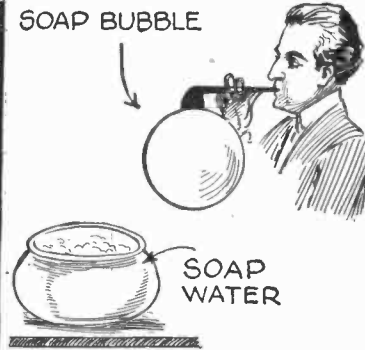

The magician now changes the type of his performance. He becomes a child again and blows soap bubbles, but the remarkable thing about these soap bubbles is the fact that when they are held near the flame of the candle, they explode. This may or may not be due to the gas in the magician's body; at least, that is the way he explains it. Actually the construction of the pipe has much to do with the exploding soap bubbles. Inside of the pipe one will find a small sponge soaked in gasoline. When the bubble is blown, gas fumes permeate its interior. Holding a candle near the bubble ignites the fumes as they are released, when the bubble bursts.

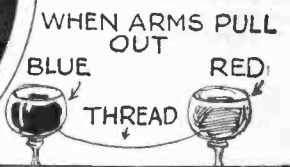
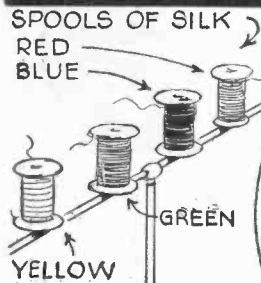
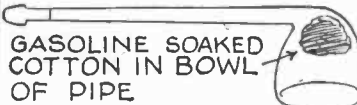

To demonstrate that the magician is likewise an expert weaver, he places several spools on a stand. There are varicolored threads on the spools one being red, another blue, a third green, etc. Picking up one of the spools, the magician proceeds to demonstrate how expertly he can weave the thread into a silk kerchief. He unwinds the thread from the spool slowly, curling it about his fingers, and finally withdraws a similarly colored kerchief. The secret lies in the construction of the spools, which contain the kerchiefs and which have a small lever and spring, permitting the kerchief to drop into the hand when it is released.

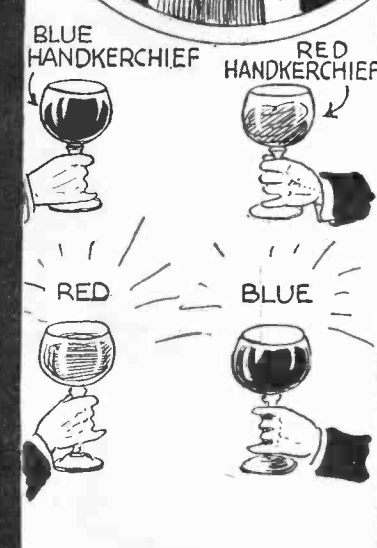

The magician holds two glasses in his hands. One of these glasses contains a red handkerchief and the other a blue one. He now causes the kerchiefs to visibly jump from one glass to the other, exchanging places. He merely raises his hands slightly and draws them apart, and presto! the exchange is made before the very eyes of the on-lookers. In preparation two holes are drilled in the bottoms of two tumblers, and a fine silk thread tied to the blue handkerchief is passed through the glass containing the red handkerchief, then through the glass containing the blue handkerchief, and finally tied to the red handkerchief, as illustrated.

Death Ray In Movies

By W. B. ARVIN

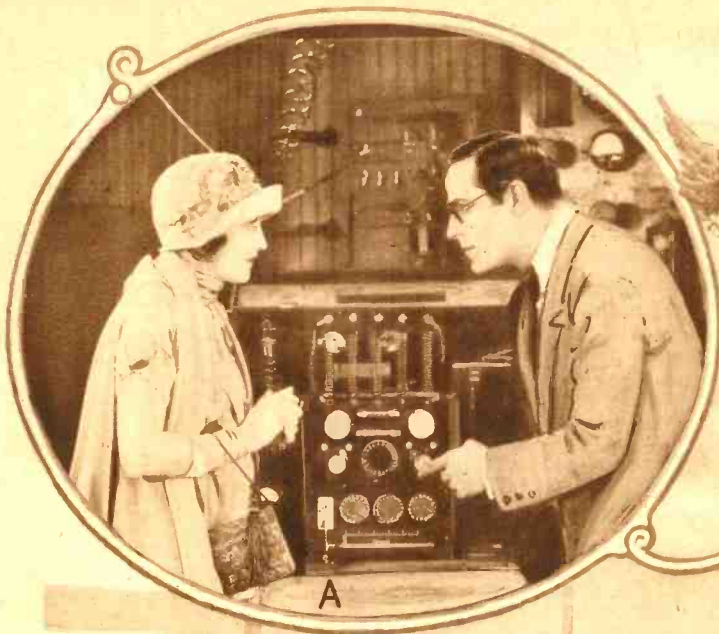

A

RAY PROJECTOR



B

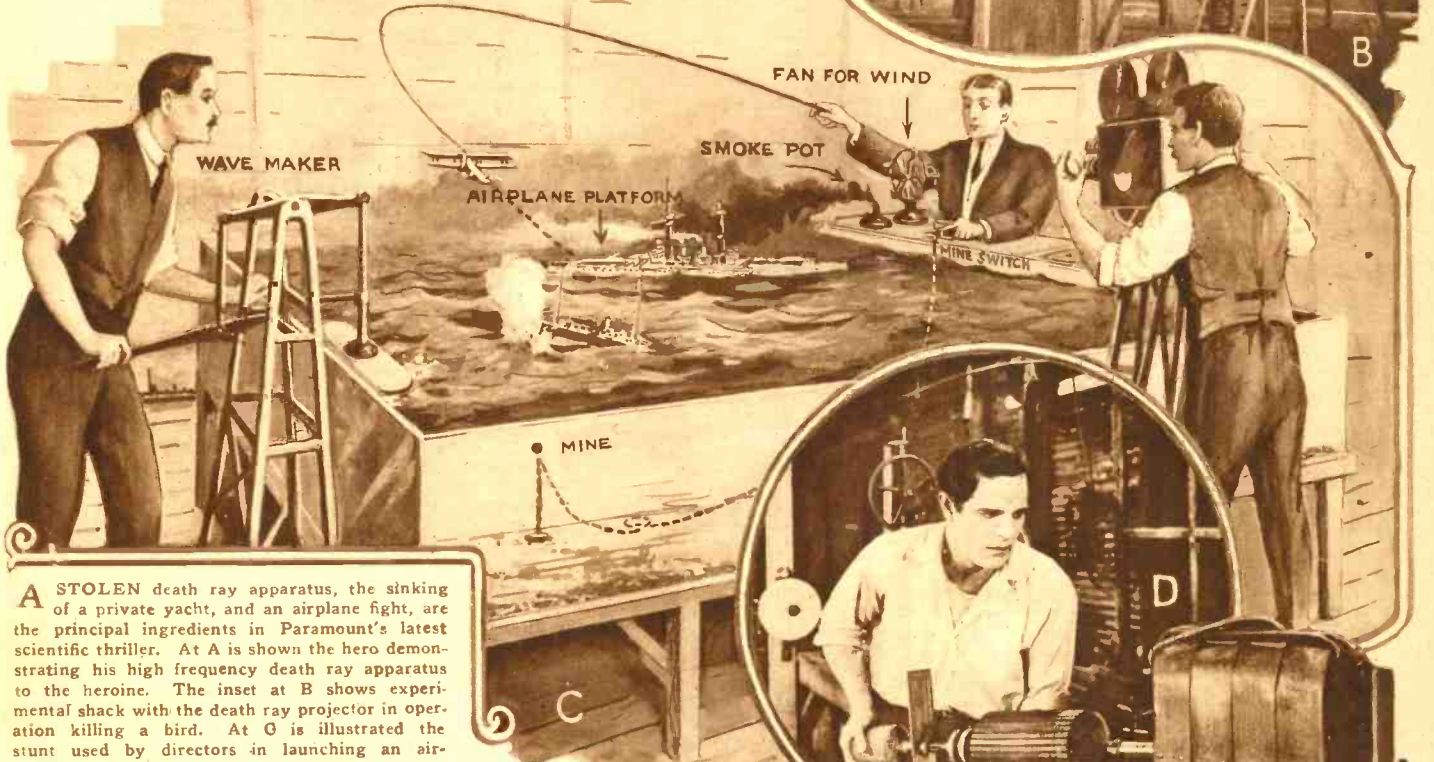

WAVE MAKER

FAN FOR WIND

SMOKE POT

AIRPLANE PLATFORM

MINE SWITCH

MINE



D

A STOLEN death ray apparatus, the sinking of a private yacht, and an airplane fight, are the principal ingredients in Paramount's latest scientific thriller. At A is shown the hero demonstrating his high frequency death ray apparatus to the heroine. The inset at B shows experimental shack with the death ray projector in operation killing a bird. At C is illustrated the stunt used by directors in launching an airplane from a battleship. A twenty foot tank in the studio was used as the sea, while one of the assistants wafted the airplane suspended from a string, back and forth by the side of the battleship. In the printing room, the back half of the cycle, that is, the part of the swing before the airplane reached a position just behind the platform of the battleship, was cut out and destroyed. Then another bit of film was exposed with the airplane standing on the landing provided for it on the deck of the battleship. The two films were then pasted together, so that one instant the audience sees the plane resting on the platform, and the next finds it gliding away into space. Then of course the view is changed and you see a bona fide airplane with pilots and everything. A novel airplane fight is staged by the method shown at E and the illustration opposite. The range of the camera is cut down by changing its focal length to take in only the section shown at E. The studio set-up employed for making the picture is clearly seen in the sketch. Of course, the private yacht which is wrecked, is another miniature reproduction blown up by exploding a small mine beneath it in the studio tank. A touch of realism was added by having the hero build a small generator and radio apparatus on a desert island. The photograph at D shows him in the act of completing the more or less primitive generator. By filming the scenes taken on the tank as though in nighttime, a multitude of projection sins were hidden.

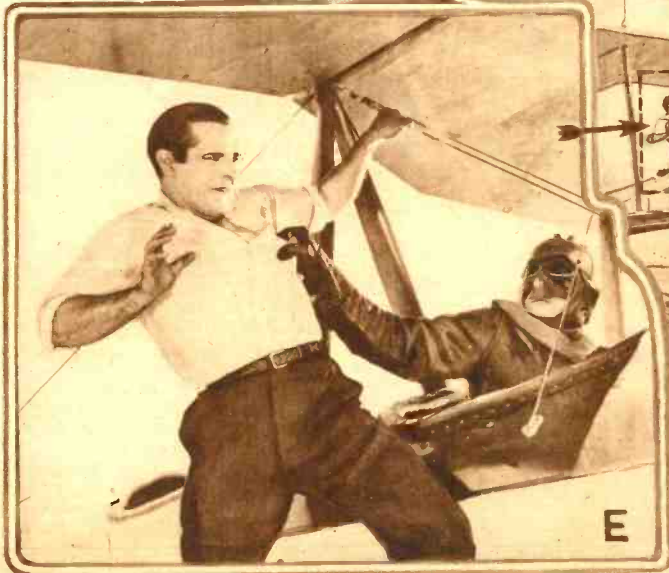

E

The Living Death

By JOHN MARTIN LEAHY

FOURTH INSTALLMENT



SYNOPSIS

The story opens with Captain Livingstone, exploring the aid of Darwin Frontenac, a famous scientist who has recently discovered methods of inducing hibernation in mammals. The Captain wants Frontenac's help in connection with a discovery he made during an exploration trip to the Antarctic. Before the Captain launches into his story leading up to the final details concerning the exact help he wishes, Frontenac revives a fish which has been frozen several days in a bucket of water, bringing the fish back to life. Several times in his plea the Captain has mentioned "her," also it is known that he wishes Frontenac's assistance in connection with his knowledge of the hibernation of mammals.

The Captain surprises Frontenac by making further statements relative to life in the Antarctic. The Captain says that certain discoveries that he made during his trip confirmed his beliefs that at one time the Antarctic was tropical and peopled by human beings.

The Captain goes on with his story of his trip. He tells Frontenac how his ship started toward the South Pole and how, far south of the Antarctic Circle they discovered land. Establishing a depot at latitude 85 degrees, they went inland. The air became warmer and to their great astonishment, they discovered a land surrounded by high mountains, the temperature of which was far above the freezing point and where palm trees and luxurious flowers grew. At this point the party divided, Hampden accompanying the Captain. After they explored for a while, they turned toward the direction taken by the other party. Suddenly lying in a pool of gore, they came upon a severed human head. It is that of one of their companions. Nearby they found a note telling how a thing came from above, instantly killed two of the party and badly wounded the third. The latter lived long enough to write the note, then his head, which was found by the Captain, was forcibly removed from his body and his body done away with. The survivors found the other heads but could get no trace of any of the bodies.

Leaving this Garden of Paradise, as they had at first named the spot, the Captain and Hampden journeyed on. Some distance further on they find a cave, which had been recently opened by a landslide. Entering the cave they found the floor to be of thick ice. Suddenly the Captain, with a start and cry, bent over and found embedded in the ice a beautiful young lady, perfectly preserved in every detail. After examination

"God in heaven," Hampden cried, "she isn't dead!"

CHAPTER XIII

"THAT YOU WILL AWAKE HER!"

"I MADE an exclamation and gazed at him in indescribable astonishment, wondering if I had heard him aright.

"Not dead?" I exclaimed.

"Not dead! Captain Livingstone—oh, the poor little kid!"

"Come, Hampden," said I. "What on earth are you talking about?"

"I know what I am talking about, Captain. I said what I believe, and I say it again: This poor girl isn't dead!"

"That's absurd!" I exclaimed. "There she is in solid ice! She can't breathe!"

"I stared at him in speechless amazement. I became suddenly alarmed. What had come over Hampden?"

"Breathe!" exclaimed Hampden. "If she could have breathed—or if the air had risen above the freezing point—then she would have died. The ice, the ice!"

cried Hampden, beating it with his hand. "That is what saved her!"

"Saved her? Yes, it has saved her body from decay, from returning to the elements whence it came. Anyone will grant you that. Saved her? Man, it was the ice that killed her."

"No! Saved her! Saved her body and soul! Yes, the soul—the soul too! Captain Livingstone, her soul is still there!"

"I was now really alarmed, but worse (so I thought it) was to follow.

"Come, come Hampden," I said, "let us consider this matter carefully, soberly. Here she is in solid ice; here she has been lying—just as we see her now—for thousands of years; and yet you say she is still alive!"

"Captain Livingstone," said he very earnestly, "I didn't say she is *alive*."

"Heaven help us! A moment ago you said that she isn't dead, and now you say that she isn't alive. I wish, Hampden, that you would tell me plainly what you really mean."

"I have told you. I said that this girl is not dead; that is what I meant. I said she isn't alive; that, too, is what I meant. In other words, she is *neither alive nor dead*—if you know what that means. That is why she doesn't have to breathe."

"If I know what that means. I'm afraid, Hampden, that I do know what that means. To be perfectly frank with you, I will say that I wish you would stop talking nonsense."

"You think then," he said, and he said it

Our boasted common sense often leads to near disaster. Tesla, Watt and Columbus are among those who succeeded only after fighting it.



Encrusted for ages in a solid cube of ice the Sleeping Beauty lay in state in her cave awaiting some one to awake her.

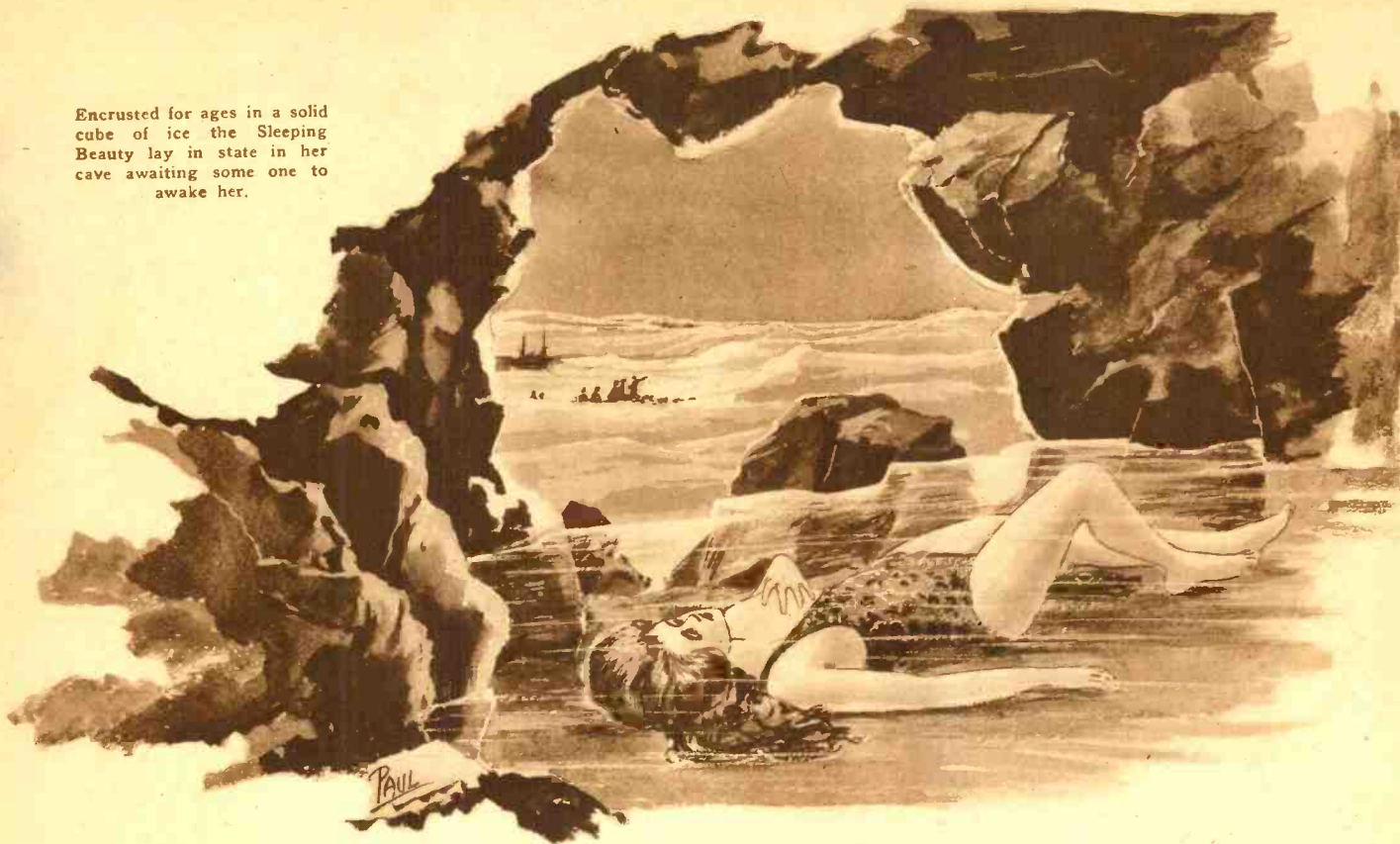

pretty testily, 'that I am touched in the head? Well, after all, the fault is largely my own. I should have explained, seeing that you are not aware of the scientific possibilities that one may—'

"There, there, Hampden,' I interrupted, 'we will just let those scientific possibilities be for the present, and we will concern ourselves with facts—plain, palpable facts.'

"He said nothing to this. 'In the first place,' I said, 'do you realize how old—how very old!—our Sleeping Beauty must be, how long she has been lying here in this ice?'

"I think I do. When she lived, this Antarctic land had a warm climate, perhaps even a tropical one, and then suddenly the Great Cold fell—suddenly, instantaneously, as the great Cuvier believed.'

"And she has been lying here through all the ages that have followed: you have not forgotten that?'

"Forgotten it? How could I have forgotten that she has been here for ages?'

"Thousands of years; probably a hundred thousand years. Hampden; and yet you say she is not dead!'

"Think of the time, Captain Livingstone? For time alone can never touch her, there in her bed of crystal. Ten million years, a hundred million, a thousand million years, and she would be even as we see her now—if this ice that holds her in were never disturbed. Age could follow age, eon follow eon, through all the eons of the coming eternity, and yet time alone could never lay its stain upon her or loose the soul from her body!'

"If the soul is still there? 'Yes; if the soul is still there—as I truly believe that it is.'

"I see, though,' he added, 'that I must explain.'

"And this he proceeded to do. I listened intently, doing my level best to understand, but I can see now that I understood but very imperfectly.

"He began with estivation and hibernation, taking great pains to show how they differed from the artificial suspension of vitality. Catalepsy came next, and of this mysterious condition he told me some very strange and terrible things. Then he went

on to describe the effects of certain drugs, of belladonna, mandragora, chloral hydrate and others—how they could produce the perfect semblance of death.

"And,' said Hampden, 'if the subject, while in that condition of seeming death, were frozen, he could be kept in that state for years, for hundreds of years—thousands. In fact, there is no limit to the time in which a body could be kept in that condition—of seeming death, remember.'

"And yet,' said I, 'not alive!'

"And yet not alive. That is the thing that must be firmly grasped and fully understood, that the body, whether that of a fish, a frog or a human being—it doesn't matter what—is neither alive nor dead.'

"I'm afraid,' I told him, 'that I can't see that.'

"And I'm afraid, Mr. Frontenac, that I don't see it now.

"It's just like that mathematical-point

business,' Hampden said: 'the mathematical point is nothing at all, and yet there it is. And so it is with the body when animation is completely suspended, as is the case with this poor girl here before us: the soul is not dead, neither is it alive, and yet it is there!'

"And other things he told me—of frogs and fishes, for instance, being frozen and restored to perfect life.

"I asked him if he had ever seen this thing done. No; he never had, but he had read about it.

"I'm afraid,' I told him, 'that I am something of a Doubting Thomas, after all. I would like to see that.'

"There can be no doubt about it, Hampden said.

"And yet there was doubt about it, for I—in my ignorance and cocksureness—doubted it, just as the world was to doubt me. So it goes, so it goes. And not only that, but I doubted, so to speak, Hampden himself. For I couldn't get the idea out of my thick skull that the sight of Sleeping Beauty had—why, how, I couldn't imagine—affected poor Hampden's head. God forgive me. I see now how wrong I was.

"But,' I objected, 'a human being is not a frog or a fish.'

"Don't you see, Captain Livingstone; don't you see?" said Hampden. 'The girl was drugged, and, while she lay here insensible, in that state of seeming death, the Great Cold fell and she was frozen, incased in ice. And so she has remained (not dead and yet not alive) through all the ages that have followed.'

(Continued on page 933)

How much, and how many, are paid \$1,800 for a dozen similar ones.

FINDS TROPICS IN FAR NORTH

Discoverer Reports a Sub-Yukon Valley Ringed With Hot Springs.

SEATTLE, Wash., Oct. 31.—A subtropical valley in northern British Columbia, just south of the Yukon Territory border, ringed in with glaciers and perpetual snows, is to be colonized next year by wealthy Vancouver (B. C.) sportsmen and mining men, according to S. C. Scott, the discoverer, who was in the city today after spending three years there.

"The valley is 480 miles inland, almost inaccessible, and contains abundant game," said Mr. Scott. "The temperature never gets below zero and freezing temperature is rare. Grass, hay, berries and wild fruits grow in profusion. It is about twenty miles long and two or three miles wide.

"I encountered several species of wild animals never seen before. The most curious was a large white deer weighing about 600 pounds. It had a horn on one side of the head. A series of hot springs on one side of the valley is responsible for the mild Winters and long, pleasant Summers. The soil is very fertile.

The Western Telegram in French

What one explorer recently found in the Arctic is depicted in the above excerpt from the New York Times.

"If change be essential to our idea of life, it may be asked what is the condition of a seed, which may remain unaltered during a period of many centuries; vegetating at last when placed in favorable circumstances, as if it had only ripened the year before. Such a seed is not alive: for it is not performing any vital operations. But it is not dead, for it has undergone no disintegration; and it is still capable of being aroused into active life, by the application of the appropriate stimuli. The most correct designation of its state seems to be dormant vitality. The condition of an animal reduced to a state of complete torpidity and inaction is precisely analogous; into such a condition, the frog may be brought by cold, and the wheel-animalcule by desiccation."—Dr. Carpenter.

Models of

Prepared by

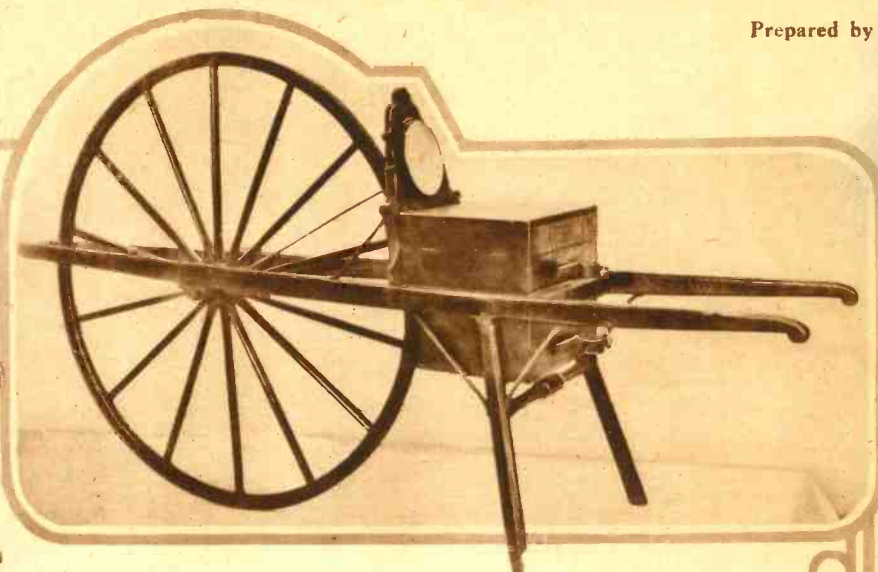
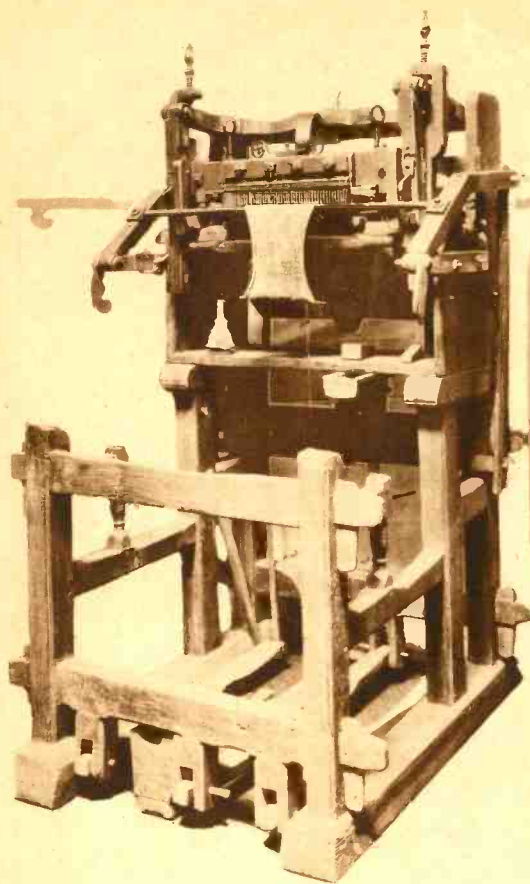

ONE of the most interesting collections of scientific models in the country is that of the Franklin Institute, at Philadelphia, Pa.; it gives a very accurate picturing of the history of mechanical progress. Immediately above is shown Lesley's Odometer which was used in connection with the second Geological Survey of Pennsylvania. The revolution of the large wheel was conveyed to a chain of gears in the box behind, moving an index, thus measuring the distance over which the machine travels. At the left is shown an ancient knitting machine constructed entirely of hard wood and using three foot pedals and a hand shuttle.

Many a tale of early electrical experimentation might be told by this model of Joseph Saxton's magneto electric machine. The construction is extremely simple, as shown by its photograph. The source of the potential changes was the pile of permanent horseshoe magnets constructed of five sections. A pair of wire wound armatures which cut the lines of force were rotated before the magnet pole-faces. Speed was obtained by the belted wheels.

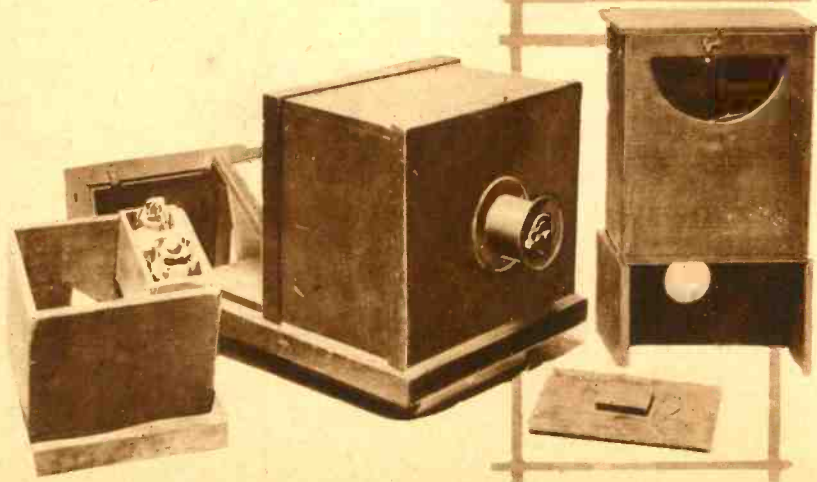
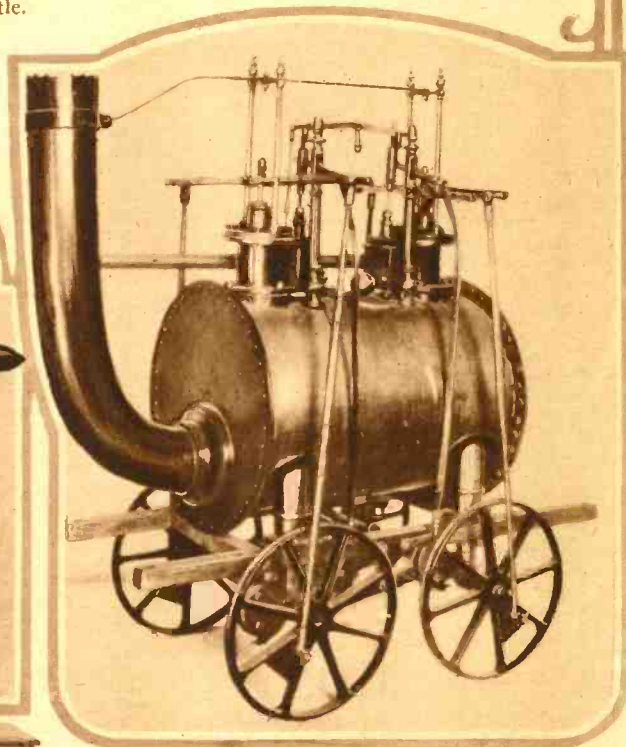
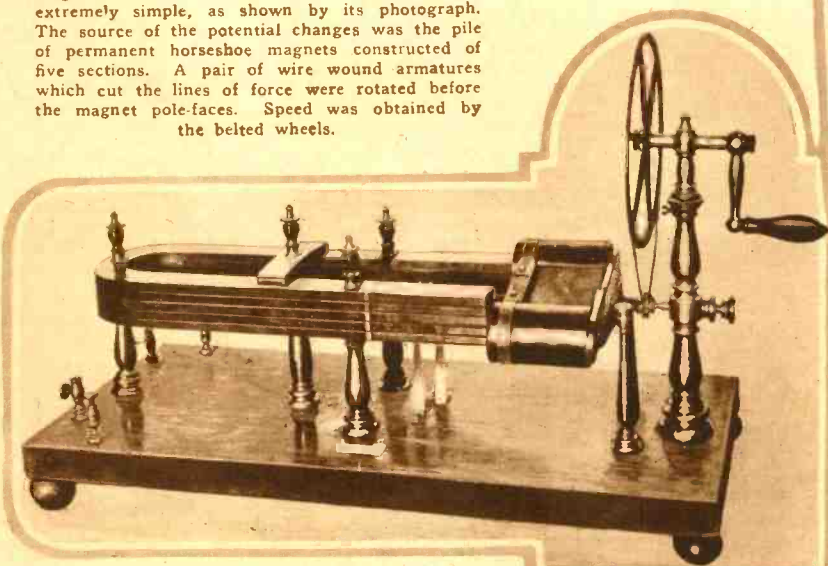

The whole system of modern transportation took on a new aspect when George Stephenson brought out his No. 1 locomotive in England, back in 1826. It incorporated several new features including the multitubular boiler and connection between the front and rear wheels. The model above shows exactly how the engine looked before its first run on the Stockton and Darlington Railroads. At the left is the forerunner of the modern movie camera. It is nothing less than the sensitizing outfit, developing box and camera, made by Joaquim Bishop, a chemical instrument maker. Aside from his regular work, he acted as assistant to Dr. Robert Hare, Professor of Chemistry in the University of Pennsylvania. It was one of the first daguerreotype outfits in this country.

Famous Inventions

WALTER SONNEBERG

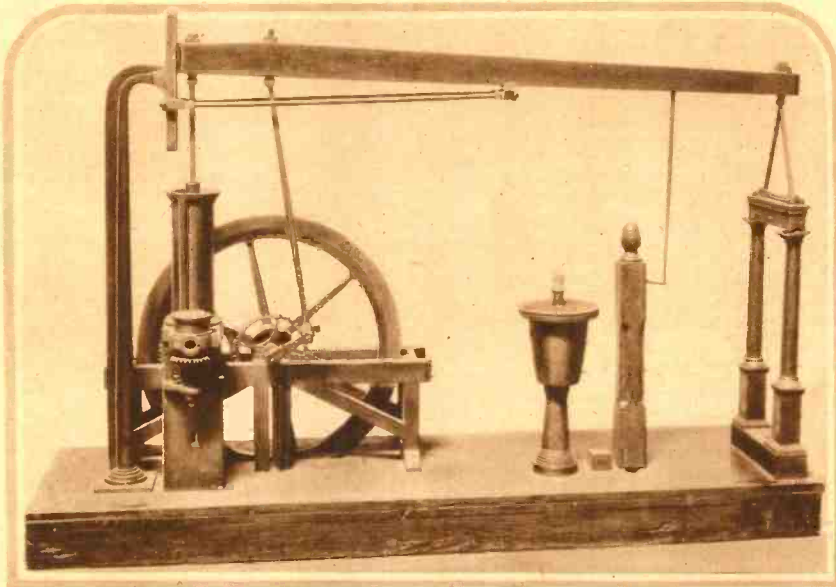

Almost all of the large trans-Atlantic liners owe their operating efficiency to the principle involved and first worked out in the above model. It shows Oliver Evans' original high pressure steam engine working on the compound principle. After the steam had exerted its force in the high pressure small cylinder, it passed over and expended some residual energy in the large low pressure cylinder. Both motions were communicated to the rocker arm which was connected to the pulley wheel.

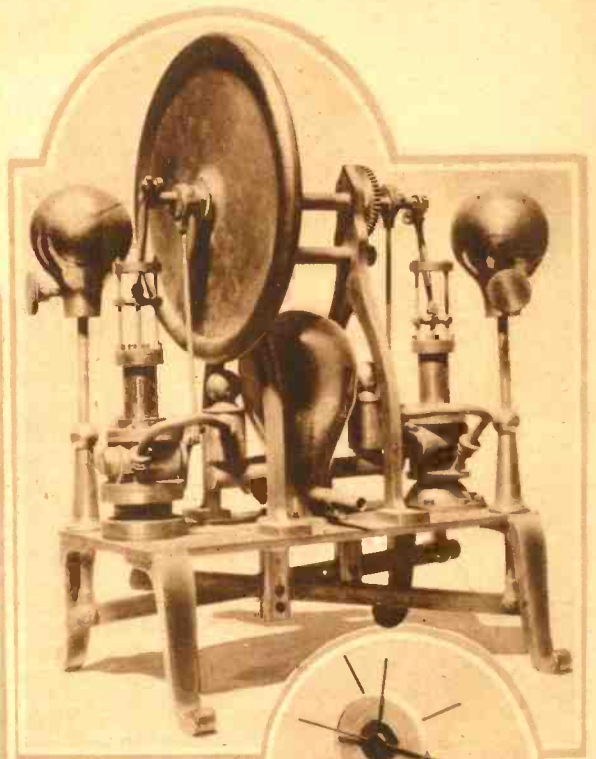

The model shown above represents the "hydro-vacu" motor invented by John W. Keeley to solve the problem of perpetual motion. Of course it did not.

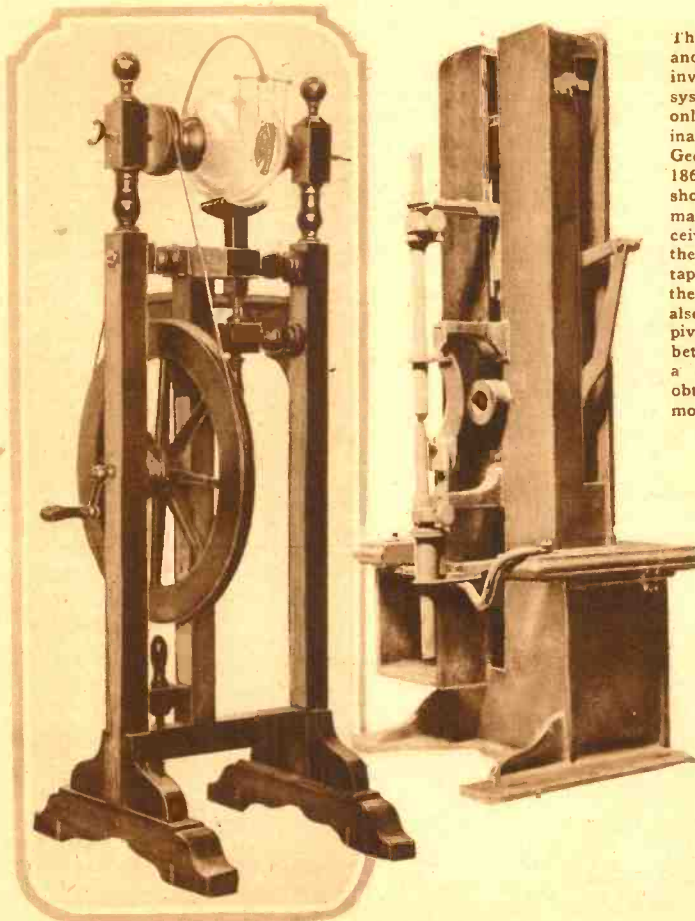

Dr. Franklin's original static machine using a whirling glass globe rotated by a wooden hand wheel, and incorporating a metallic ball to collect the charge is shown at the left above. At the right is a model of an early arc lamp using gravity with a ratchet control to feed the carbons.

The high speed radio and cable telegraphy involving the duplex systems are possible only through the original idea produced by George M. Phelps in 1869. At the right is shown his first automatic telegraph receiver, which inked the message on the tape as it came over the wire. To him is also due the idea of pivoting the needle between the poles of a magnet so as to obtain the rocking motion for recording messages.



The Yale lock is almost universally employed today, and the father of them all is shown in the photograph at the right. It was from this rather clumsy and crude affair that the fine instrument of precision found today on the door of almost every household was developed. The idea in this case simply reverts to ancient Egyptian locks, i.e., the idea of inserting a key, which must be of exactly the proper shape, before its motion can be imparted to the plungers of the lock, that is, the shape of the key and its insertion into the lock, actually opens the door. The identical idea is included in all our modern locks. The only difference is that the shape and relative positions of the plunger and barrel are slightly changed.

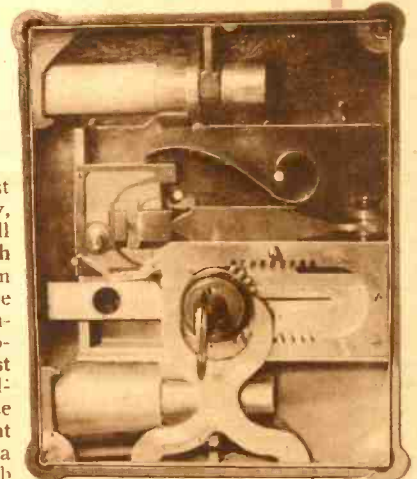

Doctor Hackensaw's Secrets

By CLEMENT FEZANDIÉ

NO. 35 A JOURNEY TO THE YEAR 3000

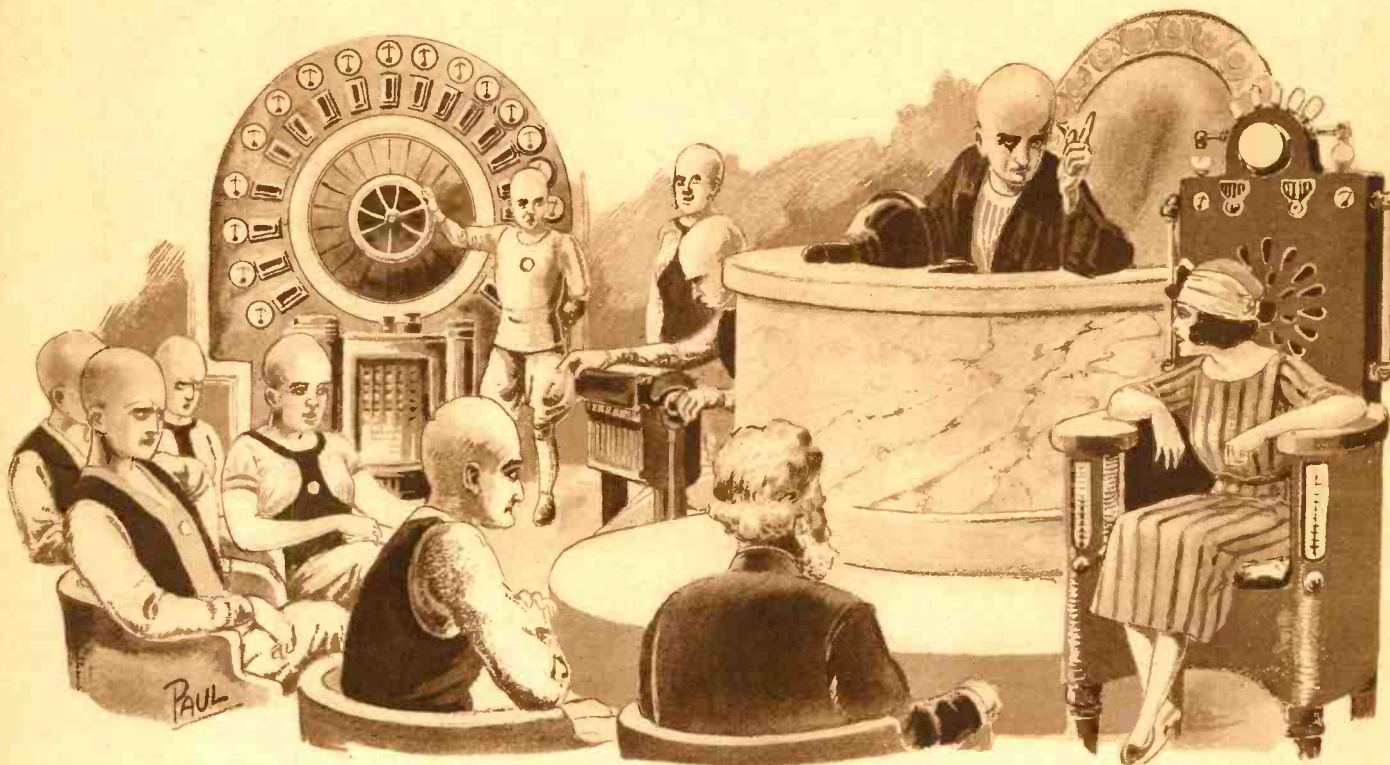

"Sit there," said the judge. "Now tell me how the accident happened. If you prevaricate, exaggerate, or hold anything back, I shall know it immediately, for along with the phonographic record of your statement

will be the 'graph' of your every heart-beat, and the dilation and contraction of your blood-vessels and the nervous twitches, induced by the various emotions of anger, fear, etc., that govern you while you speak."

(AUTHOR'S NOTE:—It would be a wise man who could tell in advance all that he will do in the next twenty-four hours. How much more difficult to predict the condition of the world a thousand years hence, except in broad general lines.)

"PEP," said Doctor Hackensaw, "Do you want to take a little trip with me?"

"Sure I do, Pop," replied Pep enthusiastically. "I'm always dying to be on the go. Where are you bound this time?"

"I'm going on a little journey to the year three thousand, and I thought you might like to come along."

"Quit your kidding, Pop, and tell me what you mean."

"I'm not joking, Pep. I'm in dead earnest. You know my dream machine?"

"Yep, your machine for making people dream whatever you want them to."

"Precisely. Well, you and I are going to visit the year 3000 in a dream."

Pep's face fell. "Aw, that won't be any fun!" she said.

"Won't it? Well, you just try it and see. The dream will only last an hour anyway, so you won't lose much. Besides, you'd be doing me a great favor. I've been experimenting lately in making two people dream the same thing at the same time, that is to say, combining both in the same dream. It is by no means an easy task, for our individual brains differ so much that the same word will suggest an entirely different train of thought to each. For example, I am experimenting now with two lovers who have been separated for the summer. I try to give them both the same dream every night by means of the same suggestive words on a phonograph record. For example, the words: 'Lake—Moonlight—Canoe—Upset—Save her,' will certainly make both the lovers dream at the same time of a canoe-ride end-

ing in an upset in which he saves her from drowning. The details may and certainly will differ, but I can elaborate these as far as I think desirable, so that when the pair write to each other they will be convinced they have indeed met in dreamland. The experiment has been so successful that now I wish to try to take you along with me in a dream."

"All right!" said Pep, resignedly. "If it

will give you any pleasure, I am willing to spare you an hour."

"Thank you—I don't think you'll regret it. I have the phonograph records all ready, so if you will step into the glass chamber I will set the temperature, air-blast and other attachments so they will work automatically by clock-work according to the graphs I have prepared; I shall then join you, and we can start at once. Please lie on the couch near the wall and I will lie on the other couch. That's right—are you ready? So am I. Then I'll press the button for the start. One, two, three—go!" and at the word the doctor pressed the button that was to hurl them one thousand years into the future.

As he did so, a soporific gas stole gradually into the closed glass chamber and soon caused the pair lying on the couches to fall into a deep slumber. Then an air-blast swept out these gases and nothing was heard but the phonograph, which had already begun and which kept on repeating in a mournful drone the words meant to reach the sleeping senses of the dreamers and make them dream of the year three thousand with all its inventions and improvements.

CHAPTER 2

"Here we are, Pep," cried Doctor Hackensaw. "We must be in the year 3000, and I suppose we are still in New York City, though I don't see any houses or any people. Ah, here comes someone!"

"I'm here with you, Pop," cried Pep, "but what a funny guy that is! Why, he hasn't got any hair on his head—he's as bald as a billiard-ball. Say, Rube," she called out tauntingly: "What made you shave your head? The cows won't know you when you get home!"

The person addressed turned around and looked at them in amazement, and with espe-

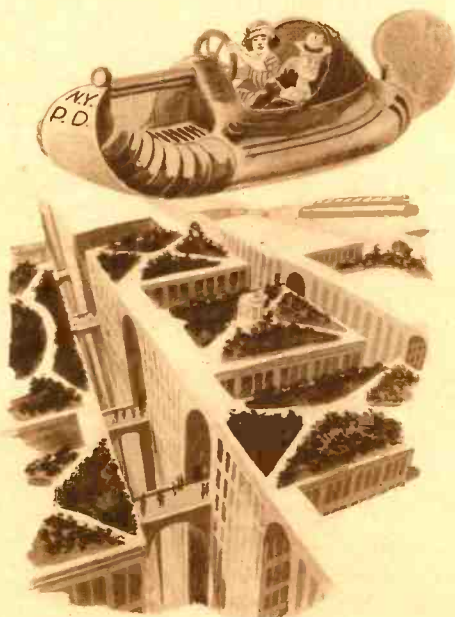

"Gee!" cried Pep. "This is fine! Since we've got to go to the police station, I'm going to have a little fun on the way, and learn to steer this machine. It looks easier to guide than any machine I ever piloted."

cial wonder at their hair and at Doctor Hackensaw's beard.

"Why who are you? What are you?" cried the newcomer in great surprise.

"We're strangers and we've come to visit you."

"What's your number? My number's 82Y325."

"What does that mean?" asked Pep.

"It means that I was born in the year 2892 in New York City and that my birth was the 325th recorded in New York that year. The odd number shows that I am a girl. The even numbers are given to boys. When we marry we add an 'M' to the number."

"You don't mean to say you are a girl!" cried Pep.

"A girl without any hair! That's terrible!"

"No one in New York has any hair. You two are the first people I ever saw with hair on the face or on the heads. But I've heard of the hairy savages that lived a thousand years ago!"

"Hairy savages!" cried Pep, drawing herself up proudly. "Are you speaking of us?"

"Certainly, but I'm forgetting that I ought to put you in touch with the newspaper. For an ordinary news item they only pay one hundred dollars, but you ought to be worth from five hundred to a thousand dollars. Wait till I see first if you've already been signalled." So saying, she took from her pocket a gold ring attached to the pocket by a long thread and slipped the ring on her finger.

"Hurrah!" she cried, after a moment of intent listening. "Your presence here isn't known to the paper yet. It's a scoop for me! Just listen and you can hear the account yourself. Here's a ring for each of you and a microphone to slip into your ear."

Doctor Hackensaw and Pep obediently placed the rings on their fingers and the microphones in their ears, and then waited to see what would happen. Nothing happened for a minute or two, and then suddenly they heard a shout:

"TWO HAIRY CREATURES OF ANCIENT TIMES VISIT NEW YORK—

one a man and one a woman. They wear outlandish garments and speak an almost unintelligible old English." This was followed by a picture of themselves which in some unaccountable manner they found in their mind's eye—evidently through vibrations of the microphone carried through the auditory nerve to some central ganglion and from there transmitted to the optic nerve. A pause ensued, and then came a different voice addressed directly to them: "The



"I'm here with you, Pop," cried Pep, "but what a funny guy that is! Why, he hasn't got any hair on his head—he's as bald as a billiard-ball. Say, Rube," she called out tauntingly: "What made you shave your head? The cows won't know you when you get home!"

New York Daily Broadcaster will pay you one hundred thousand dollars for a full account of yourselves. Start at once!"

Doctor Hackensaw hesitated, but Pep, to whom a hundred thousand dollars was a fortune, began at once giving a rapid summary of their lives. At the conclusion of her speech, the voice said:

"Thank you. The hundred thousand dollars has been placed to your credit at the store."

"You're in luck!" cried the thirtieth century maid. "One dollar means one day's food and lodging and clothing of the simplest sort, so one hundred thousand dollars means that you can live all your life long in luxury without doing any work. My name is Electra and I received a thousand dollars for reporting you, because you're a scoop."

"That's good, Miss Electra," said Doctor Hackensaw. "but I must ask for some explanations. In the first place where can I get a newspaper?"

"What do you mean? You just got the news—in fact you *were* the news!"

"But haven't you any printed newspaper?"

"Yes, a few thousand copies are printed to keep on file in the libraries and for the use of deaf people, but you'd have to order a copy in advance if you wanted one. But what use would it be to you?"

"I could read it."

"What's the use of that? That was all very well in the year 1900 when the Indian chief Tammany ruled New York, but nowadays."

"What!" cried Doctor Hackensaw, interrupting her. "Oh, I see! I'm afraid your historians have got their facts about old New York slightly twisted. However, it doesn't matter."

"But nowadays," continued Electra, "we carry our telephotophones with us in our pockets and get the latest news direct from the newspaper. When you listen in you hear all the important happenings since the last time you used the instrument. The newspaper will also furnish you old news if you ask for it. For books you would have to apply to the library. Tell them what you want and one of the readers will read you the most up-to-date facts on the subject and send on the illustrations as well. They will also read you a few chapters from any novel you choose."

"But haven't people any books at home?"

"Oh yes, there are the microscopic books, but they are not much used as you can hear from the library quicker than you can pick up your book."

"What are the microscopic books?"

"They are books photographed down to a very small size and can only be read by the use of a microscope. A thousand years ago people had enormous books four to six inches long and almost as wide. A small library of one hundred thousand volumes would fill a house. And the books were awkward to handle. A million of our books would not occupy more space than a thousand of the old ones. The pictures are in natural colors photographed from nature and the book can be either read or listened to on the phonograph—a great advantage when there is dialect or music mentioned in the book. Each page has the phonographic record as well as the print. The amplifier and microphotoscope for hearing and reading the book occupy small compass and are carried in the pocket."

"How is it you haven't any hair on your head?" asked Doctor Hackensaw.

"Hair is unsanitary. It is a breeding place for germs of all sorts. Besides, people were growing bald earlier and earlier in life. So the physicians finally decided to do away with hair altogether. It is no longer of any use to mankind, it is just a relic of the days when we were wild animals and required hair to protect us from

(Continued on page 922)

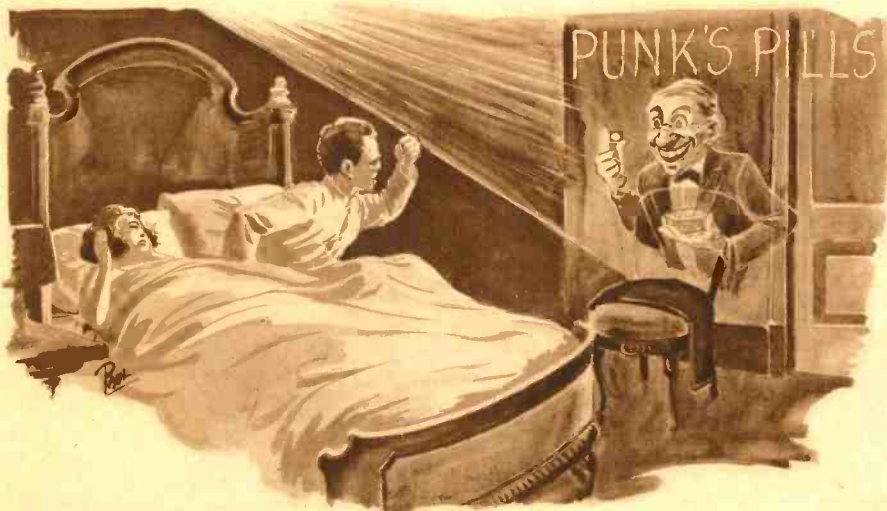

At one time, about the year 2000 advertising had become an unendurable nuisance. At night-time it was even worse than in the day-time, for the signs consisted of myriads of constantly changing electric lights of different colors. Even X-rays were used and advertisements projected through the walls of your house into your very bed-room.

Science PICTORIAL



BEFORE science finishes, the life of the crook will be a hard one. Vide the Epi-dactyloscope, the latest bit of engineering brought to the aid of the police; the machine in spite of its long name is comparatively simple. It is nothing more or less than a device for enlarging finger-prints, so that the identification of criminals can be made swift and easy.

At the right we have Dr. Charles Hunt, inventor of the "Whirling Dips." This machine is just another of those devices for installation in the amusement parks guaranteed to give the people their money's worth in thrills. It emulates the wobbly sea thrills of a liner.



The photograph above shows the light of an airplane flare for illuminating its landing.



Even the Bureau of Standards has taken up the very serious question as to just exactly what constitutes the qualifications of good automobile driving. In this particular instance they have developed a machine for testing automobile brakes. It is shown in the above photograph. The indicator is attached to the brakes and through a system of levers shows directly on the dial just the number of feet required to stop the car from twenty miles an hour speed. At the left is given the latest scientific lead to sufferers of indigestion. The apparatus was invented by Professor Bergonie, and consists of a system of electrodes and switches to contract and release abdominal muscles.

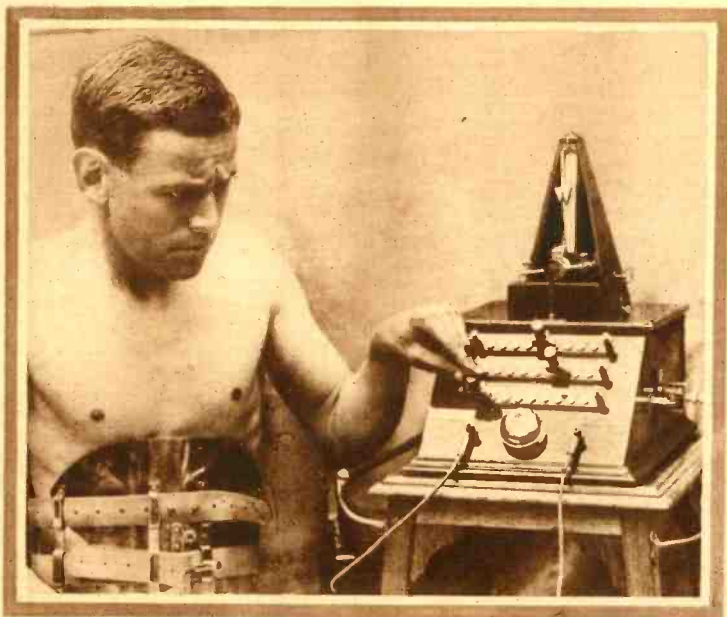

During his spare time Captain John T. Fehl, of the Jersey City, N. J., Fire Department, filed out of solid brass the exact replica shown at the right of his fire company's hook and ladder wagon No. 1. The details are perfect in every respect, and the apparatus is entirely workable, the only difference between the model and original being that the former works by electricity.

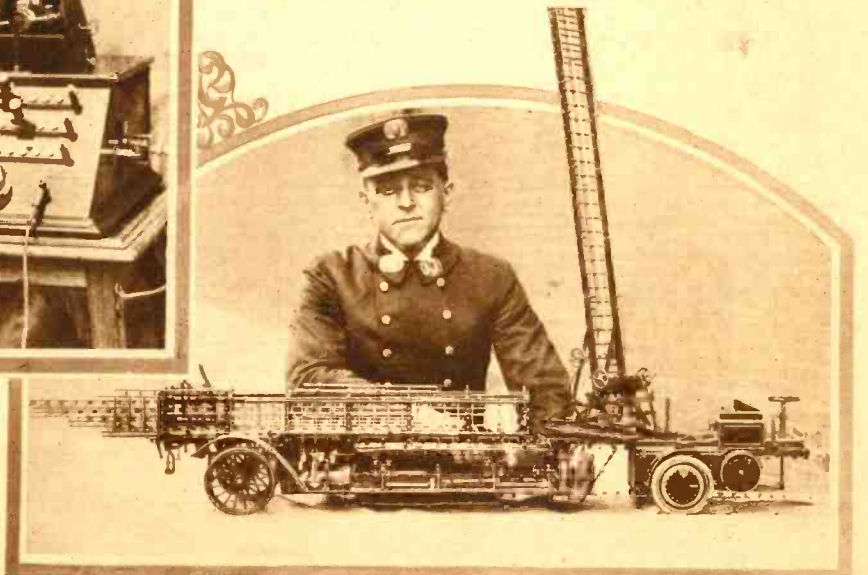

The Solar Eclipse of Jan. 24th, 1925

By ISABEL M. LEWIS, M.A.,
OF THE U. S. NAVAL OBSERVATORY

You can be of great help to science if you will make observations during the eclipse of Jan. 24, 1925. Observations of the shadow bands indicated on the right, and the directions in which they move, should also be made. They appear a few moments before and after totality. Astronomers are not entirely agreed as to the cause of the shadow bands, but they are generally conceded to be an atmospheric effect. A sheet should be stretched on the ground, and when the phenomenon first appears, a rod should be laid upon the sheet parallel to the direction in which the bands are moving. Note the width of the bands, their velocity, and whether they travel singly or in groups, when they first appear and disappear, and any other facts of interest.

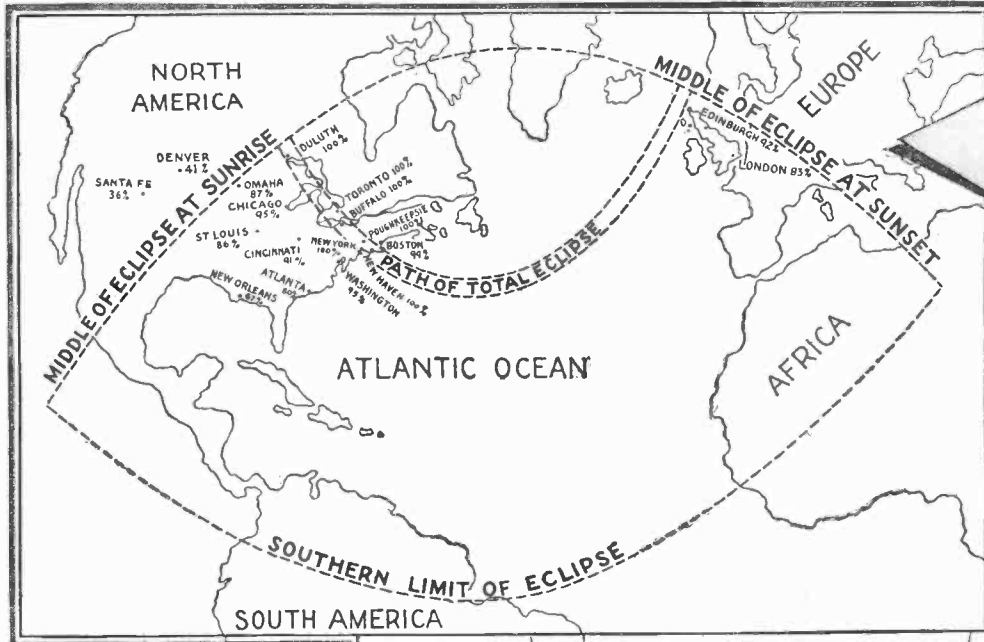
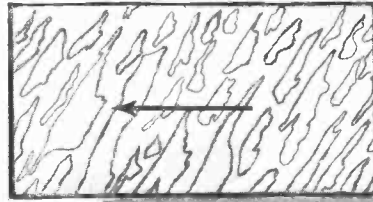

On Jan. 24th, 1925, there will be a total eclipse of the sun, which may be seen over area shown in diagram illustrated to left. Astronomers have asked all to cooperate with them in observing this eclipse. In the first place, the beginning and end of the total eclipse should be noted with the aid of binoculars or a small telescope, using the necessary protection for the eyes. An accurate chronometer should indicate the time to the nearest second or fraction thereof, when the last ray of sunlight disappears at the beginning of the total phase, and the first ray appears at the end of totality. One should also observe the form, brightness and general appearance of the solar corona which appears only during the total phase of the eclipse, and by all means make a sketch of it, noting whether it is evenly developed all around the sun or has extensions longer in some directions than others. Estimate its extent with the diameter of the moon as the unit of measurement. An example of the way this should be drawn is shown in the photo diagram to the left. Are the short bushy polar rays strongly in evidence? A sun spot minimum type of solar corona is indicated in the photo at the left. Long equatorial extensions of the coronal rays and short bushy rays divide sharply our solar poles like lines of force from a magnet. The sun spot maximum type is evenly developed in all directions. The long equatorial streamers have lacking and so are the short polar rays.

The diagram above indicates the path of the total eclipse and the southern limit of the eclipse, as well as the middle of eclipse, at sunset and sunrise. Probably ten million people will be within the limits of eclipse in New York, Connecticut and Long Island alone. The width of the path is approximately one hundred miles. The southern limit of total eclipse will pass directly through New York City in the vicinity of Central Park, where the duration of totality will be one-half minute. Here the fortunate will get a fleeting glimpse of the solar corona and prominences. This corona cannot be seen as long as the least percentage of sunlight remains, so it will pay you to get in the path limit.

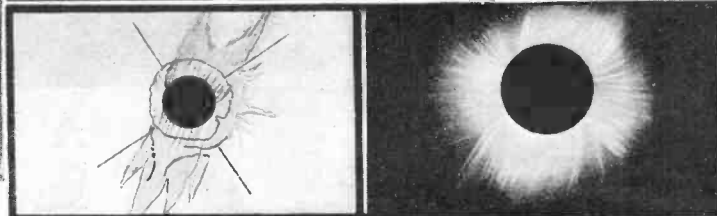
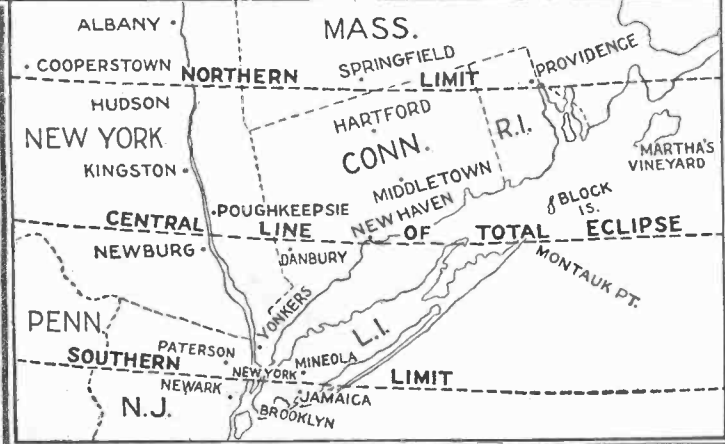

As the moon passes from west to east, the first contact or partial phase of the eclipse begins when the eastern edge of the moon seemingly touches the western edge of the sun. This is illustrated in Fig. 1 reproduced immediately above. In Fig. 2 we see a partial eclipse of the 50 per cent. variety. Here the solar diameter is half covered by the moon. The total eclipse begins when the eastern edge of the moon touches the eastern edge of the sun. This is the second contact, then

the third contact takes place, when the western edge of the moon separates from western edge of the sun. This is the ending of totality. The last contact occurs when the moon separates from the eastern edge of the sun. This latter illustrated in Fig. 5 is the ending of the partial eclipse. "Baily's Beads" are a peculiar phenomenon which appear just after the third contact or the end of totality, and may also be seen just before the second contact or beginning of totality.

Methods for Observing Eclipse

By DONALD H. MENZEL, Ph.D.

THERE are a number of simple methods which may be employed for observing this total eclipse. In this connection it might be noted that binoculars, opera glasses, telescopes of even a piece of cardboard with a pin hole may be worked into the business of observing an eclipse. For the half minute or more during totality, stars will be visible in the heavens. The sketch immediately below shows those which will be brightest. They will be plainly visible for twenty or thirty seconds. At the right is depicted a method for projecting a picture of the eclipse upon a piece of cardboard. This method will be found exceptionally useful where a large number of people are making an observance together. A small card is placed around the eye-piece of the telescope at right angles to it. Another card is held at the proper distance behind the telescope, so that the image of the sun is clearly projected upon it.

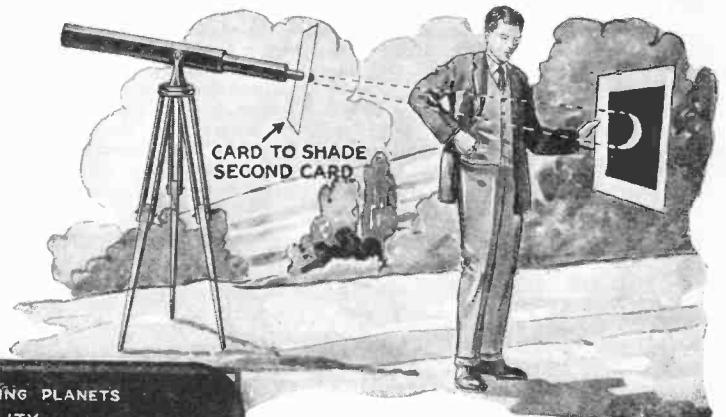

In using binoculars or other optical instruments for observing the eclipse, do not smoke the lenses themselves, but use a dark glass as shown below.



METHOD OF FIXING DARK GLASS ON FIELD GLASSES

In observing the eclipse, the best form of smoked glass to use is an overexposed photographic plate. A smoked glass may be made by smoking it with camphor or candle and binding a second sheet of glass over the smoked side to protect it.

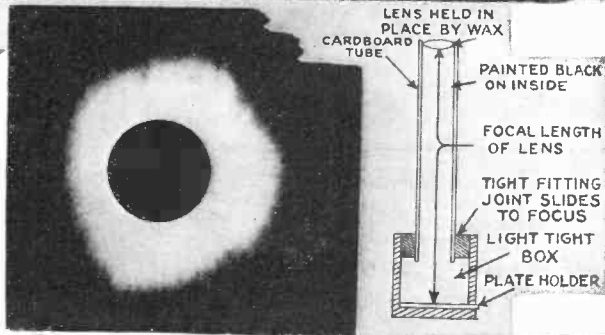
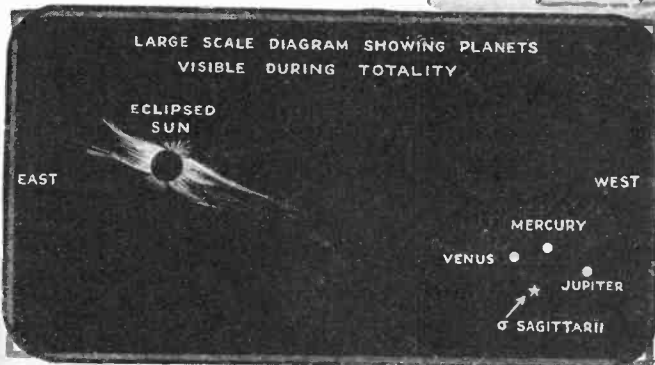

IF IT is desired to photograph the solar eclipse, a serviceable celestial camera may be constructed as shown in the small sketch at the left. A cardboard tube is painted black on the inside and attached to a light-tight box, in which the photographic plate is placed. The device must be experimentally focussed with a ground glass before time for the eclipse. Exposure may be controlled by placing a cap over the top of the lens. Another method for projecting the eclipse is shown in the lower left corner. A pin hole is placed in the center of a large cardboard sheet and the image so created, allowed to fall on a second cardboard sheet, as shown in the sketch. A little experimentation will show the proper distance at which the two cards must be separated in order to obtain a clear cut image. In making the lens camera, it will be necessary to have the distance from the lens to the photographic plate equal the focal length of the lens, and remember that the photographic focus is equal to the visual focus as measured on the ground glass, less the thickness of the ground glass.

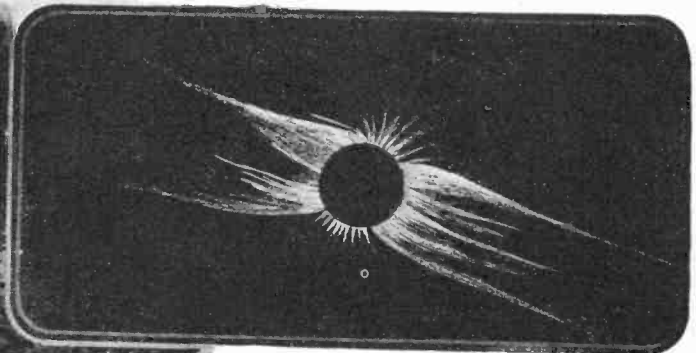
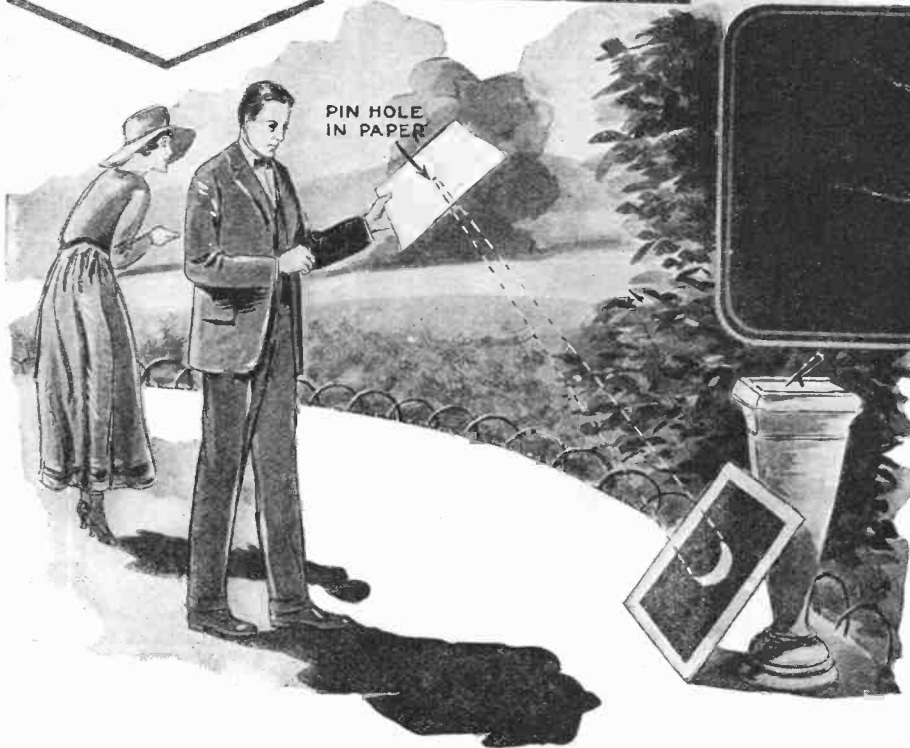

A CORONA will undoubtedly be visible at the instant of totality. No information will be available, however, as to what form it will take. The photograph above shows a corona which occurred at a sun spot minimum. The streamers may extend three million miles into space from the edge of the sun. No prediction has been made yet as to what may be expected during the forthcoming eclipse. In the center is shown another form of corona occurring when the sun spots were near the maximum. Note the complete absence of long streamers. When the sun spots are at a maximum, the corona is almost regular in shape. The exact connection between the sun spots and the corona is indicated, but the nature and reasons for the interaction are not explained.

Actual Path of Total Eclipse

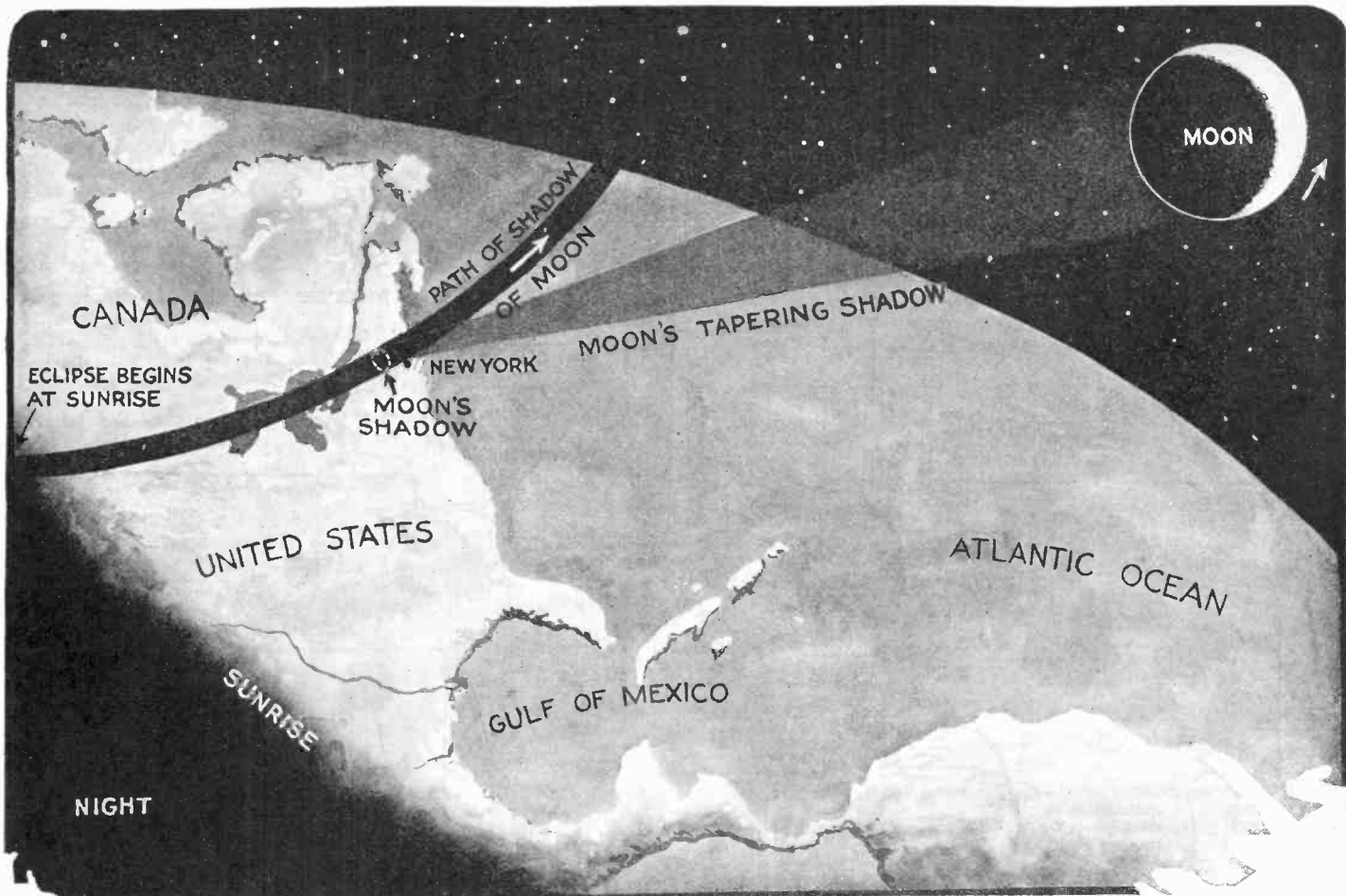

FOR the first time in a great many years, a total eclipse of the sun will be visible in the eastern part of the United States on January 24, 1925. In sketching the above illustration, our artist chose an imaginative point in space for his observation. Picture to yourself that you are situated in an airplane thousands of miles above the surface of the earth. Below, and to your left, will be the earth and if you have chosen your time correctly, North America will be in your center of vision. Suspended in space before you will be a large globe, a small portion of which will be illuminated by the

sun and the other part will be in shadow (night). This will be the aspect of the moon as viewed from space. As the moon moves on in its path, the tapering shadow which it throws on the earth will follow a narrow path across North America from West to East. At the time of this happening, the earth will be so situated in relation to the sun that the western half of the United States will be in darkness. Therefore, it will be possible to view the total eclipse only from a narrow band which crosses the Eastern United States in the path indicated. Other locations will see only a partial eclipse.

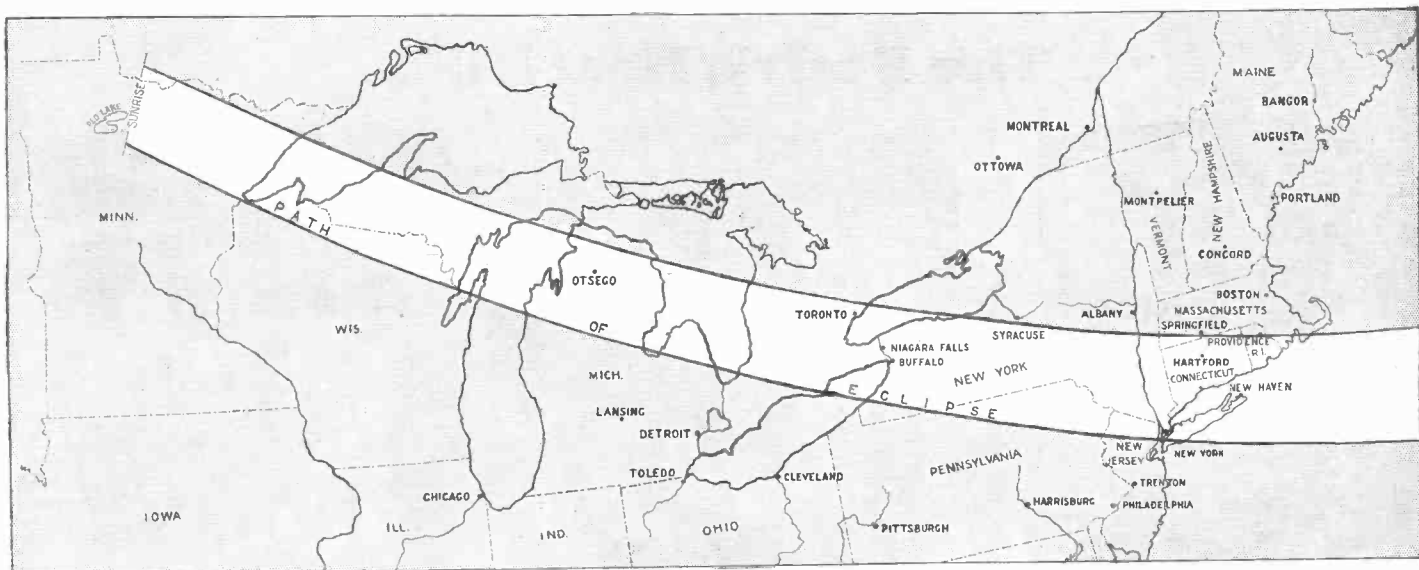

The above map illustrates graphically the path of the total eclipse of the sun from sunrise in the middle west of the United States until the path of totality passes the eastern coast and proceeds out across the Atlantic Ocean. Everyone situated within the above illustrated path will, if the day dawns clear and bright, be rewarded with a view of the total eclipse and for a period varying from .5 to 1.8 minutes, the observer will be in darkness as the eclipse becomes total. The following table gives the time of the beginning of the partial eclipse, the time of the beginning of the total eclipse (middle), and the end as well as the duration of totality.

Place	Start A. M.	Middle	End	Duration
Buffalo, N. Y.	7:59	9:07	10:22	1.8 min.
Geneva, N. Y.	8:00	9:10	10:26	1.5 "
Ithaca, N. Y.	8:00	9:10	10:26	1.8 "
New Haven, Conn.	8:01	9:13	10:32	2.0 "
New York City	8:00	9:11	10:29	0.5 "
Poughkeepsie, N. Y.	8:01	9:12	10:30	1.9 "

Mystifying Juggler Tricks

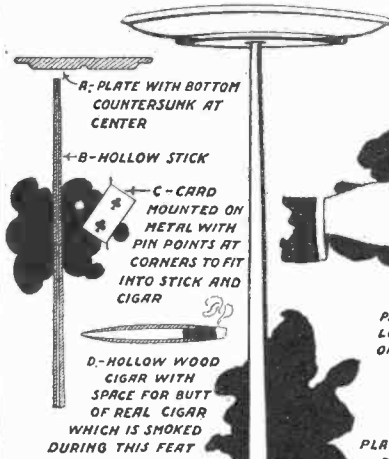
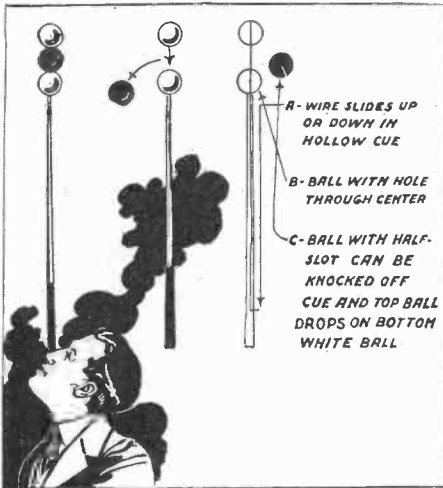

The papier mache hot dogs perform the most amazing feats in rolling down the board. They are loaded with small lead pellets or with mercury, so that they will end over like a roly-poly.



ROD SLIGHTLY HOLLOWED

The two cannon balls are juggled and the third hits the performer's head with a resounding whack. It is of rubber and the sound is caused by hitting the two real cannon balls together.

PLATE, CARD AND PARASOL SPIN

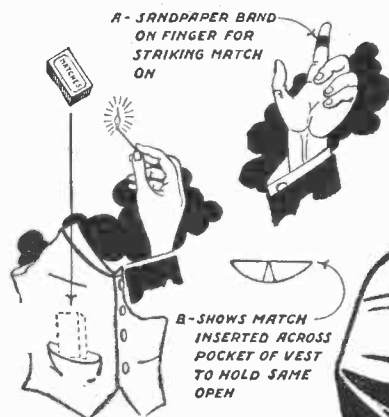

The performer tosses a box of matches into the air. It falls into his vest pocket and the match lights.

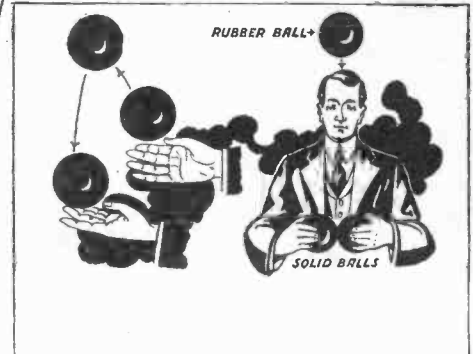

The stunts illustrated here are all performed with the aid of apparatus, and when worked before an audience will be surprisingly mystifying if done with some degree of perfection. In balancing the billiard balls on the cuestick the stiff wire holds the ball in place. The center ball is slotted so it can fall out. In the stunt illustrated at the center the cigar is a hollow wood cylinder

which takes a regular cigar stump. The card is backed with a piece of thin sheet iron and a pin extends from bottom and top. The stick upon which the plate spins is made of some tough light wood and the plate is countersunk at the bottom, to receive the stick. A little practice will be necessary before the three of them can be held perfectly straight. —L. J. Smith.

The Body's Heat Kills



In recent experiments the U. S. Bureau of Mines ascertained that if a man were permitted to breathe, and were so situated that his body could not radiate heat, in a very short time death would result. The above illustrations show graphically some of the results found. It was noted that with the wet and dry bulb thermometers, both reading 112.5° F., the individual could only live for thirty-five minutes. When work is performed, heat is

generated and dissipated into the atmosphere. When the surrounding air is too warm to take up the heat, the body perspires and the evaporation of the perspiration dissipates the heat. In the extreme the body cannot adjust itself to a temperature above ninety degrees wet bulb in still air, even though the body be in a state of perfect rest. It is better to work in dry air when the occupation necessitates working at temperature of more than 80° F.

Further Details of Radio Knife

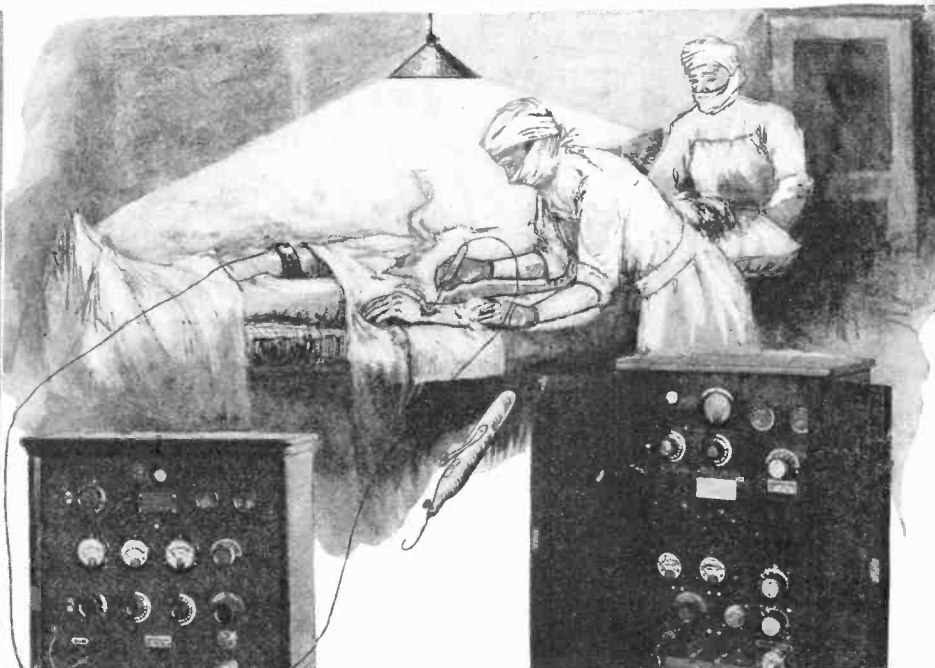
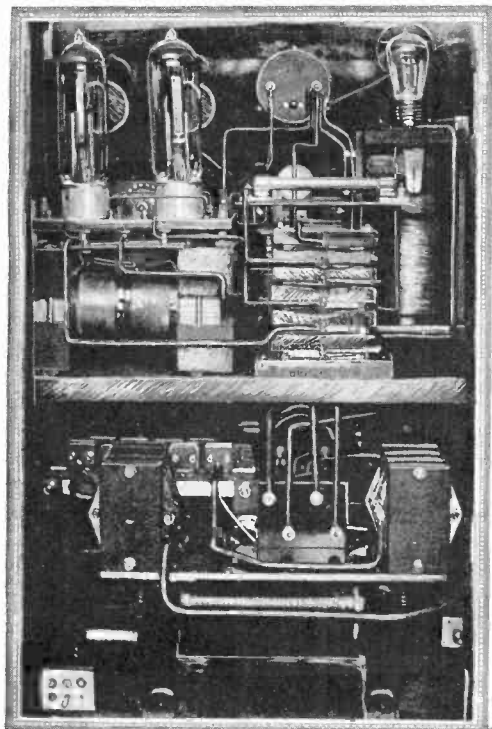

The photo immediately above shows the back view of the "radio knife," and the one at the right shows the front view of the same. Primarily the "radio knife" is an ordinary sewing needle, which by the use of the proper kinds of current, the first consisting of damped oscillations, causes coagulation of soluble protein substances in the blood, and consequently seals the blood vessels, preventing circulation. Cancer or other malignant cells cannot, therefore, find their way into the blood stream from the dangerous growth. In the second circuit the undamped oscillations are produced which also coagulate the blood proteins but to a lesser degree. The distinct property of this current is to cut through the tissues. This cut is absolutely sterile, being performed through the agency of heat, and consequently requires no mechanical effort. The heat produced is due to the resistance of the tissues to the current coming through the fine needle. Healing is rapid and scarless, and the work is done under local anesthesia without danger.

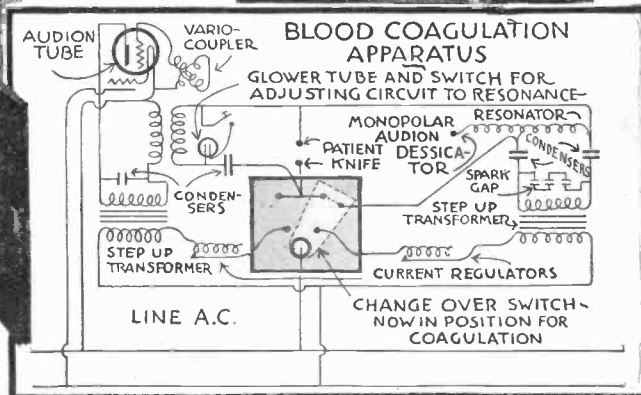

The above diagram shows the circuit of the "radio knife" apparatus. The instrument was developed by Dr. George A. Wyeth and is technically known as the Endotherm. Photos courtesy Wappler Electric Co.

Phonograph Resembles a Box Camera

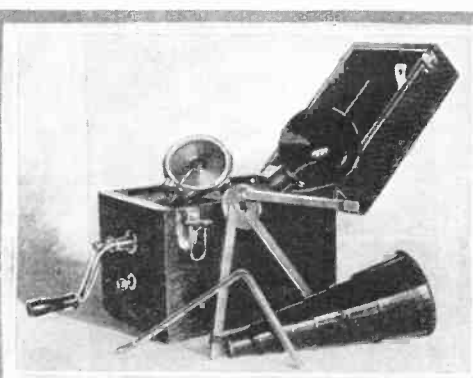

It looks like a camera but it isn't. The photo at the left shows what appears to be a small box camera. On opening the same, a handle, a collapsible turn-table, a reproducer, tone arm and horn, the latter made in either of two types, both shown above, come out of the box. The turn-table is then placed upon the phonograph, a record slipped upon the same, and the girls in camp have music with their meals, or for their dances.

More Gambler's Tricks Exposed

By MARK MELLEN

The Man Who Fooled P. T. Barnum

MANY gamblers who play for big stakes do not like to take chances on being caught with some mechanical device used for gambling. These sharks depend entirely upon their ability to manipulate the deck. They can reverse any man's cut without being noticed and so save their deal. Of course they are thoroughly acquainted with the best methods used to shuffle the cards, and if they can only counteract the cut, can deal themselves perfect hands. Another one of their favorite stunts is dealing from the bottom of the deck. It is very simple and depends principally on dexterity for successful completion. The sketches at the left show clearly how men employing this trick work their trade.

Employment of the methods shown on this page leave the sharp in a particularly good position. There is no absolute evidence of his cheating, except the witness who catches him at it, yet his bag of tricks gives him a sufficient percentage to play his game safely; yes, and to play it with the assurance of coming off with healthy profits in his pocket.



The three figures to the left expose palming. The top figure shows card shoved off deck by left thumb, right hand hiding movement. The second figure shows card retained in right palm, lifted in position by second finger of left hand.



To palm card on bottom of deck, grip corner of under card with left little finger at first joint. Then swing finger end of upper portion of deck out against left thumb. Shown below.

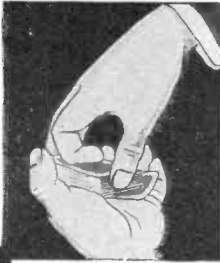

Left — Then release thumb of lower portion of deck, dropping down into left palm, releasing under packet, and slide deck out of left hand and drop it on the table to be cut, turning over left hand containing palmed card.



Maintaining the bottom palm while dealing, is done for one of several reasons, but mainly to avoid the risk of replacing the palm immediately after the cut; as a more favorable opportunity occurs just after the deal, when the remainder of the deck is placed on the table. This is of particular service in such games as poker and casino.

The cards are palmed in the left hand. The fingers of the left hand are kept close together, as at right.



The three figures to the right show how a card is dealt from the bottom of the deck. The second and third fingers of the left hand are spread far apart under the deck. The second finger of the right hand is used, as in second figure, to draw the bottom card off. The left thumb is used to push the top card partly off the deck, thereby camouflaging the real work, as shown in the third figure to the right. In the illustration the hands are held up to reveal the work.

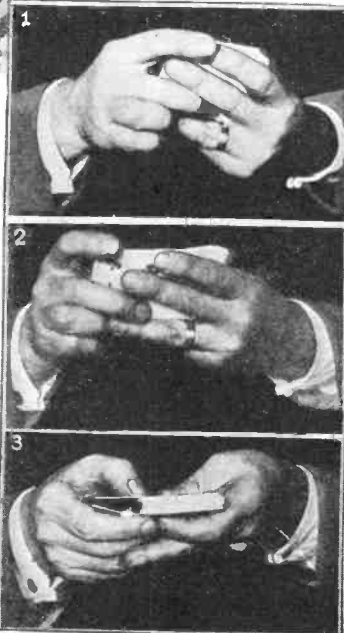

The top figure to the right shows how the sharp holds the location of the cut while dealing. The next figure shows the little finger at one end, the first or second fingers at the side and thumb diagonally across the top of the deck.

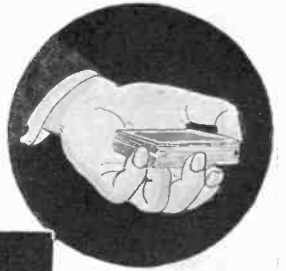
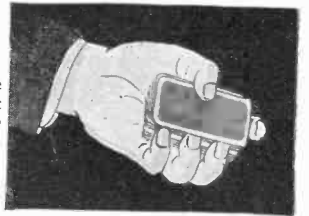

Next, to reverse the positions of the two parts of the deck, hold the upper packet firmly by pressing the thumb.

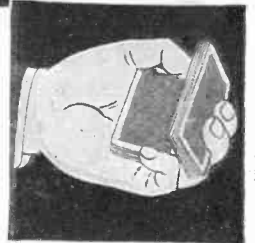
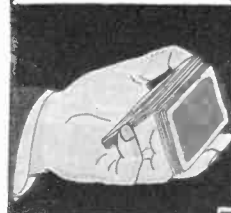

Then press lower packet up and over the top. The little finger aids in getting the under packet over by pulling down on the upper packet when lower one is lifted.

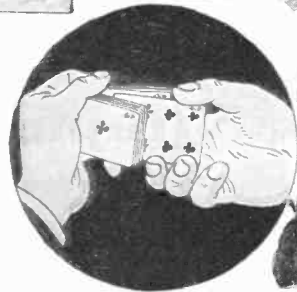

Figure above shows method for "skinning a hand." Separate the upper edges with both thumbs, bend slightly the card that is to be brought up. Then pull out the rest of the cards with the left hand by a backward and inward motion.



Science Odds and Ends

By T. O'CONOR SLOANE, PH. D., LL.D.

Second Installment

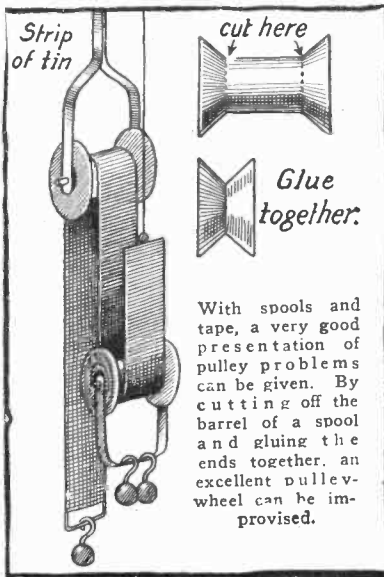

Strip of tin

cut here

Glue together.

With spools and tape, a very good presentation of pulley problems can be given. By cutting off the barrel of a spool and gluing the ends together, an excellent pulley-wheel can be improvised.

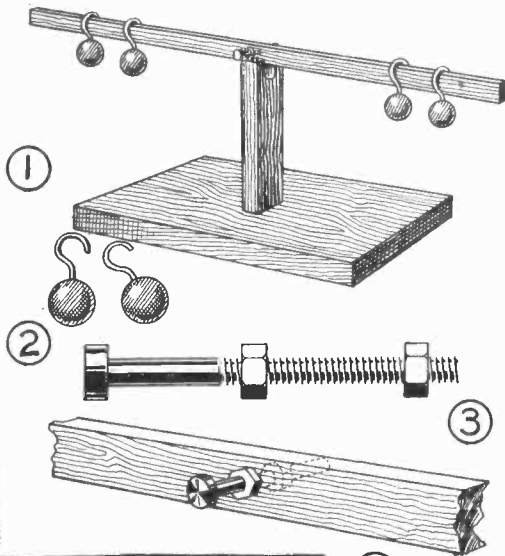

①

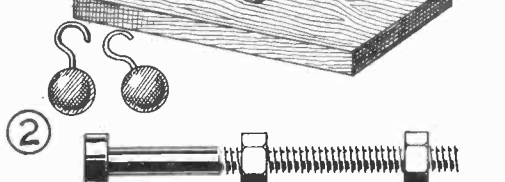

②

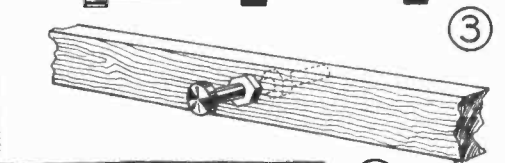

③

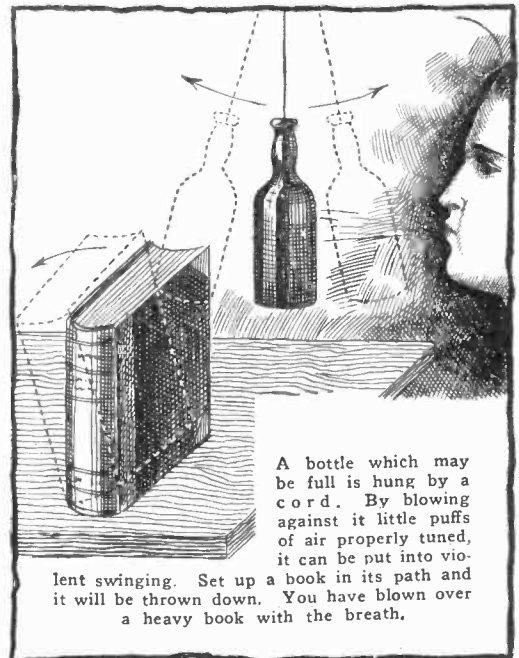

A bottle which may be full is hung by a cord. By blowing against it little puffs of air properly tuned, it can be put into violent swinging. Set up a book in its path and it will be thrown down. You have blown over a heavy book with the breath.

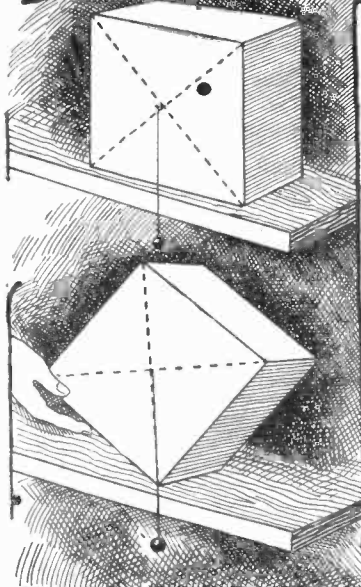

A plumb bob is hung from the line of center of gravity of the box. The latter is gently tipped, and as the cord passes outside the lower corner it falls over.

Lever have their pivots made from bolts with two nuts, as shown in 2 and 3. The lever or an easily made stand is shown in 1. For weights, lead bullets with hooks screwed into them are used.

Further lever experiments. By compounding levers a single bullet will support an astonishing weight.

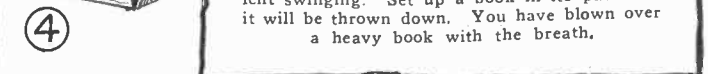

④

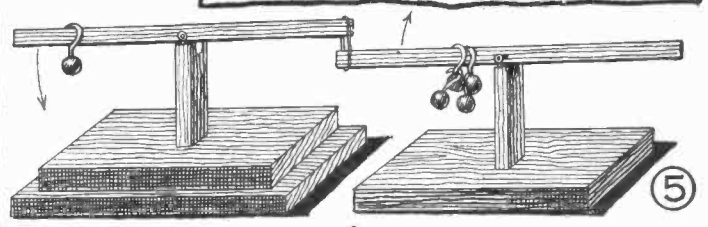

⑤

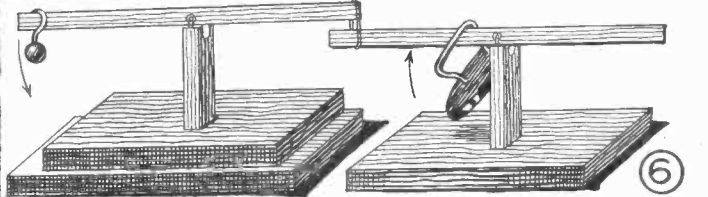

⑥

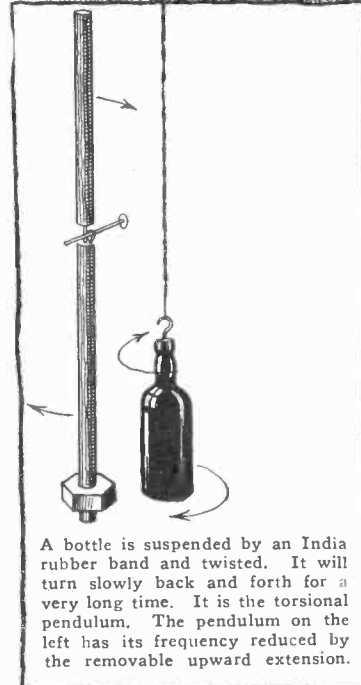

A bottle is suspended by an India rubber band and twisted. It will turn slowly back and forth for a very long time. It is the torsional pendulum. The pendulum on the left has its frequency reduced by the removable upward extension.

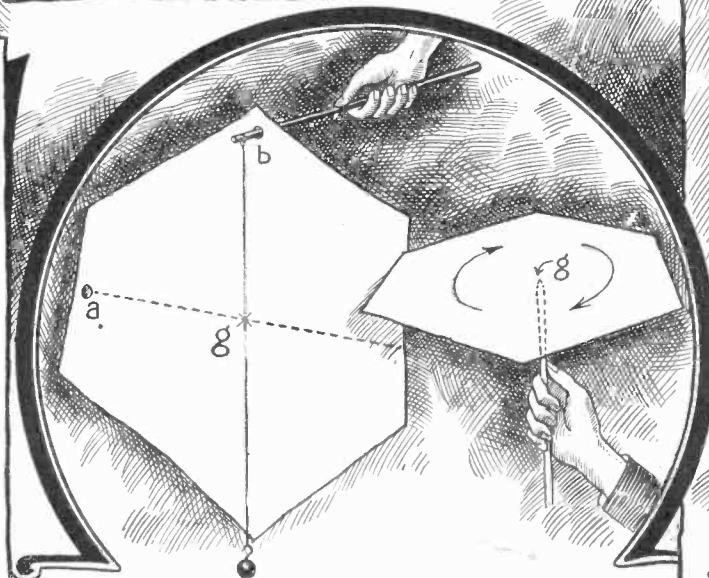

An irregularly shaped piece of pastebord is suspended by a rod passing through a hole (b). From the rod a plumb bob hangs. A pencil line is made to trace the line of the string. This is done in a second place (a). The intersection of the lines gives the center of gravity (g), and the pastebord can be spun on a pencil point.

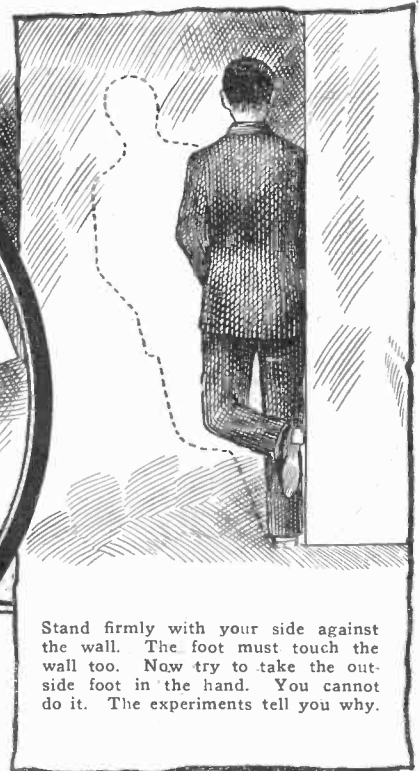

Stand firmly with your side against the wall. The foot must touch the wall too. Now try to take the outside foot in the hand. You cannot do it. The experiments tell you why.

Scientific Problems and Puzzles

By ERNEST K. CHAPIN

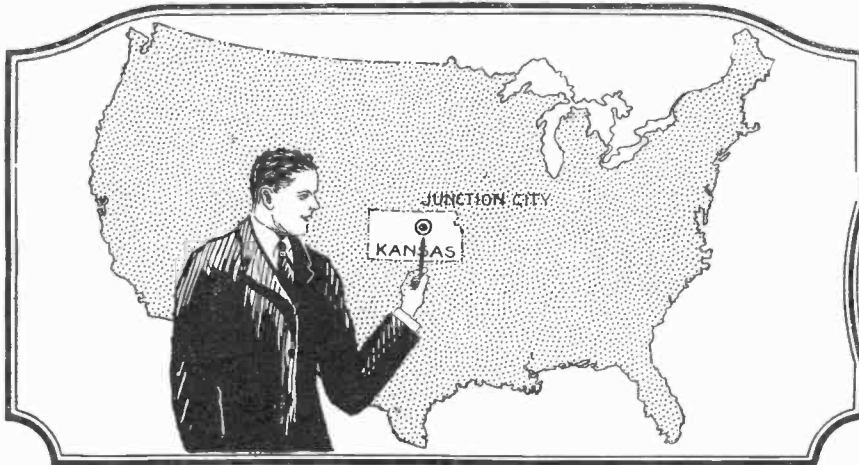

The geological center of the United States is supposed to lie at Junction City, Kansas. How could this be proven? Answer to this and remaining questions here appear on page 951.

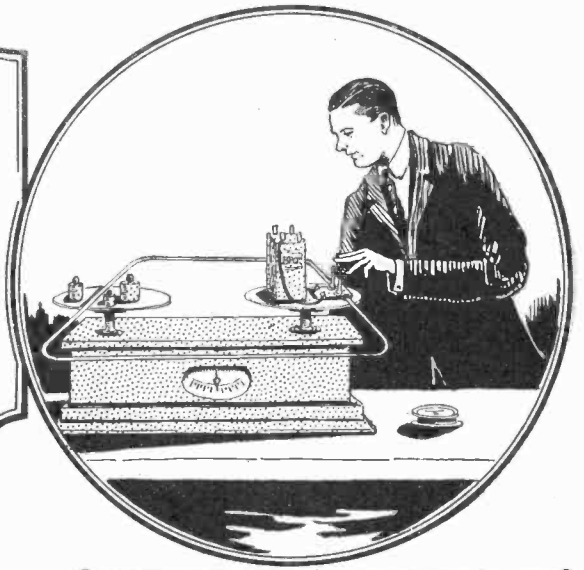

If a wire electrical circuit is balanced as shown above, with the current off on scales, will they be unbalanced when the current is on?

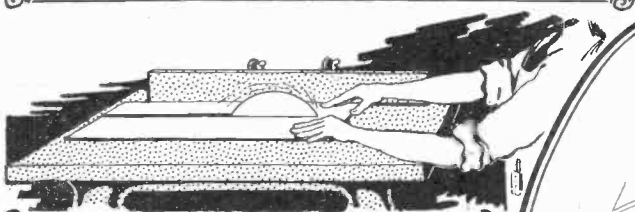

Circular saws made of paper used to cut pasteboard and cigar box wood are efficient only when rotating at high speeds. Why?

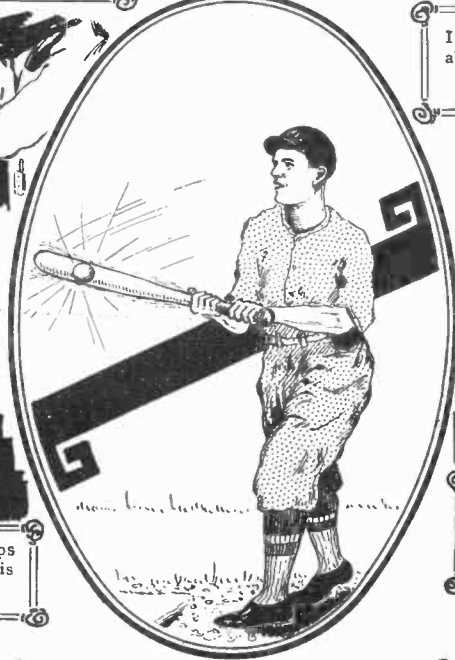

If a batter hits a ball too near the tip or the handle of his bat, a stinging sensation is felt in his hands. Why?

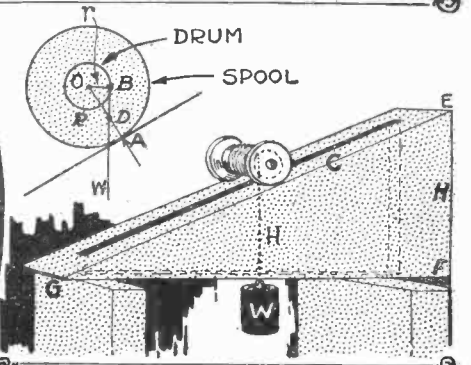

If the weight of a spool and cord is small in comparison with the weight W , will spool climb or descend plane? Slot C passes cord.

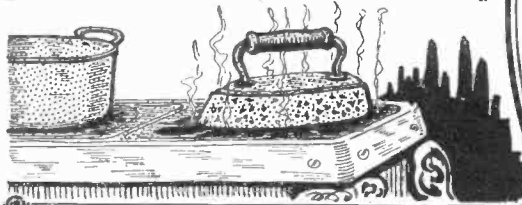

When flatirons are first placed over a gas flame, drops of water sometime appear on their sides. How is this explained?



If an aneroid and mercurial barometer are accurately checked at freezing temperature, will their readings always be the same?

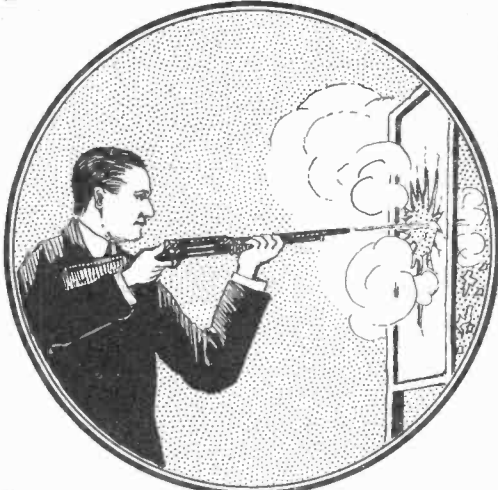

Which will shatter a pane of glass more badly, a swift bullet or a slow one, being fired directly at it?

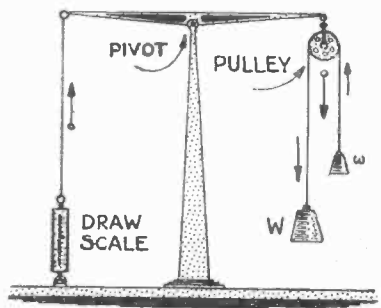

As large weight W , descends, drawing the smaller one upward, will the reading of the spring balance change, and if so how?

Breakfast Nook Furniture

By W. M. BUTTERFIELD

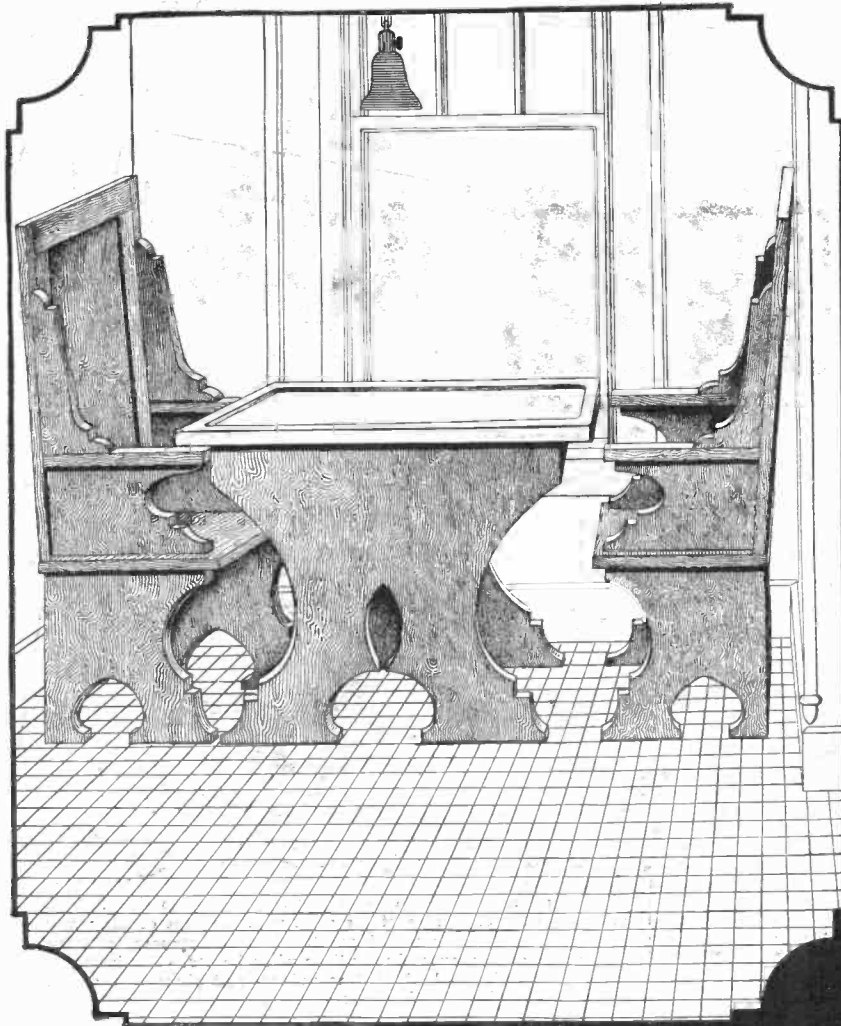

THE usual method when the home builder makes a mistake in his breakfast nook is to shove the furniture in the nook where it stands wedged, all three pieces, closely together. The only way to occupy the benches when sitting at the table is to step over the first one; this is being done in many cases by home builders who willingly put up with this inconvenience for the sake of the nook.

The things that a home mechanic will be interested most in are the things that some builders have done to make misfit furniture practical and useful. One of the first things attempted it seems is to remove the front arm and its supports, thus having two one-arm benches. One can slide on this bench by partly bending the legs as in a sitting posture. But the bench does not look finished so some have taken away the remaining arms with the result that the benches have very unstable backs, and look like poorly designed garden benches. The arms and supports have usually been put back, first having the arms and supports shortened to make these parts of the benches usable. The seat and ends are cut away in the same manner (see dotted lines on detail drawings). In other cases the table has been the only point of attack (the cut away methods are also represented in dotted line on a table drawing).

The result of all this wasted effort has shown builders that it does not pay, from a decorative sense anyhow, to alter the original lines of any piece of furniture. The drawings above show a mingling of the best styles of unmitigated nook furniture. The perspective view shows furniture wedged and having the proper distance between table and

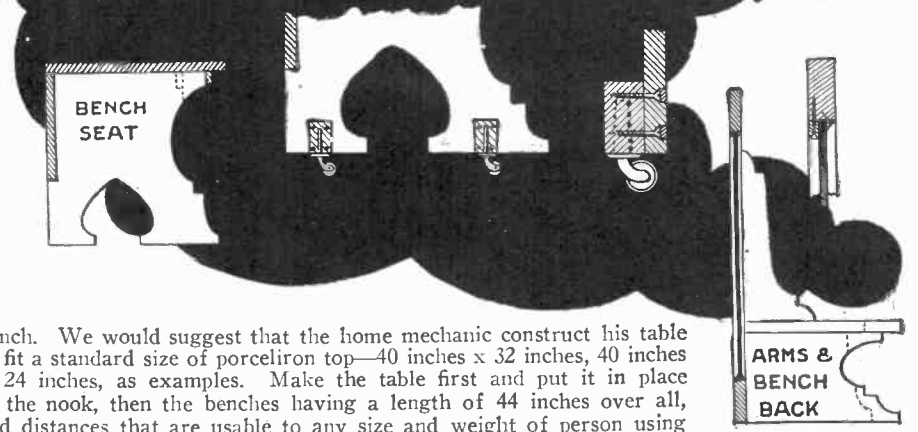
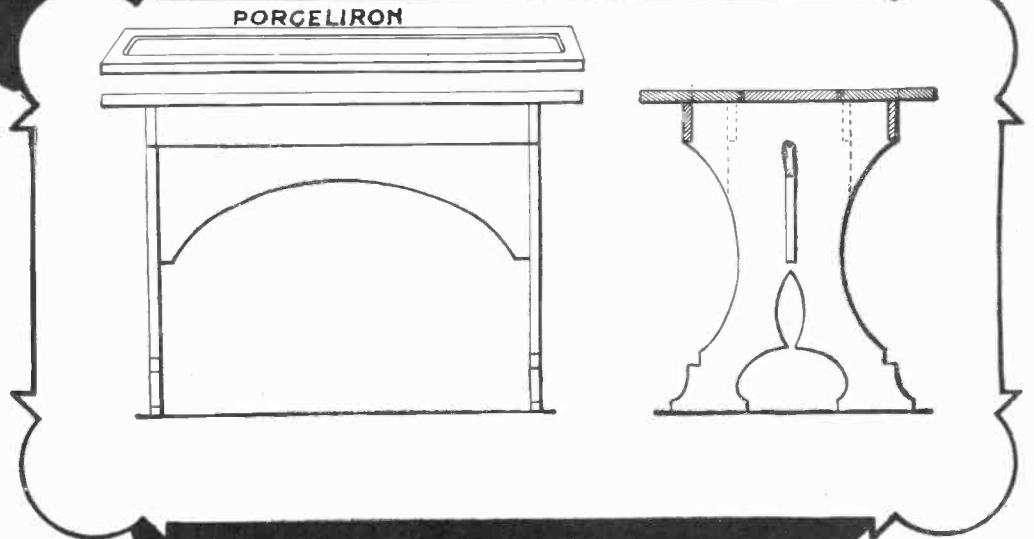

bench. We would suggest that the home mechanic construct his table to fit a standard size of porceliron top—40 inches x 32 inches, 40 inches x 24 inches, as examples. Make the table first and put it in place in the nook, then the benches having a length of 44 inches over all, and distances that are usable to any size and weight of person using this furniture. The furniture may be enameled either white or blue.

Nature of Heat

By RAYMOND

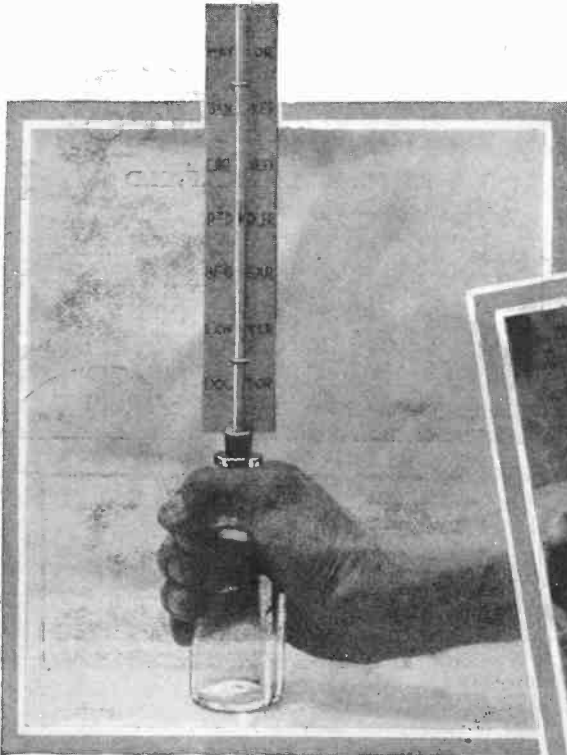

Drop of ink in straw shows expansion of gas when heated.



Glasses often break when hot water is poured into them. This is because the expansion of the glass with the heat of the water is so great that it is pulled apart. Some substances, such as pyrex, and quartz, expand very little when heated. For instance, a quartz vessel may be heated to redness and plunged into cold water without its breaking, because it expands very little with heat. The rate of expansion and contraction in a substance is known scientifically as its "coefficient of expansion."

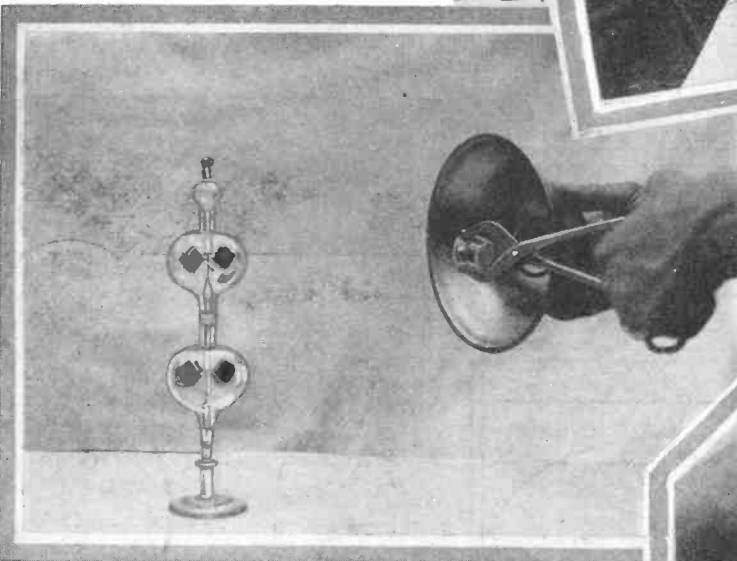

Heat is reflected in the same manner as light. The lamp shade above reflects the heat rays to the radiometer.

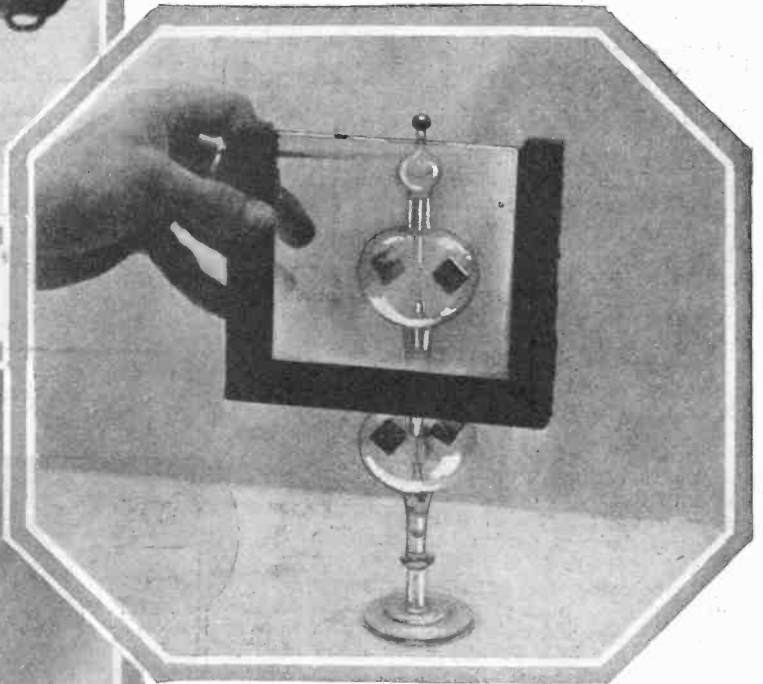

Different substances have a different conduction for heat. The radiometer often shown in the jeweler's window and illustrated in the above photograph can be used very vividly to show this principle. If a solution of alum and water is placed in the glass trough in front of the radiometer, the instrument will immediately slow down in its movements. Different conductivities of metal are shown at the left; wax balls are placed equidistant from the flame on wires of different metals which are heated. They will drop off at different times.

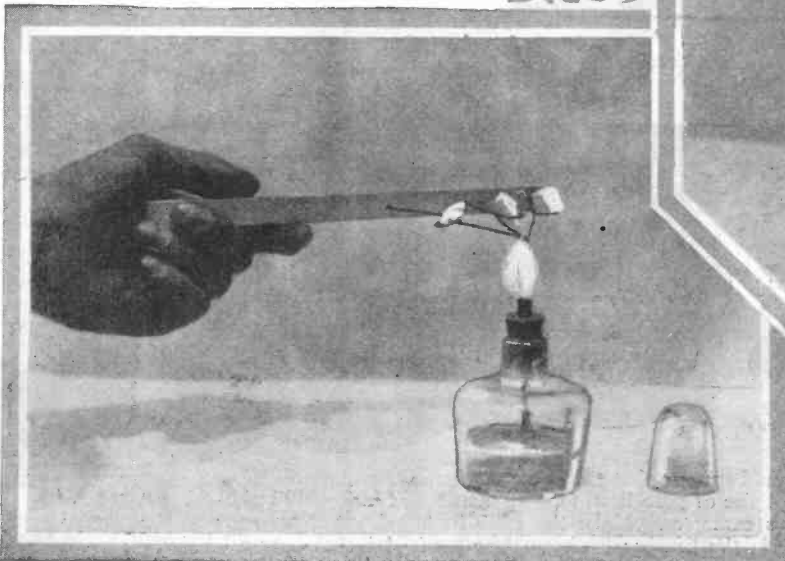

in Experiments

B. WAILES

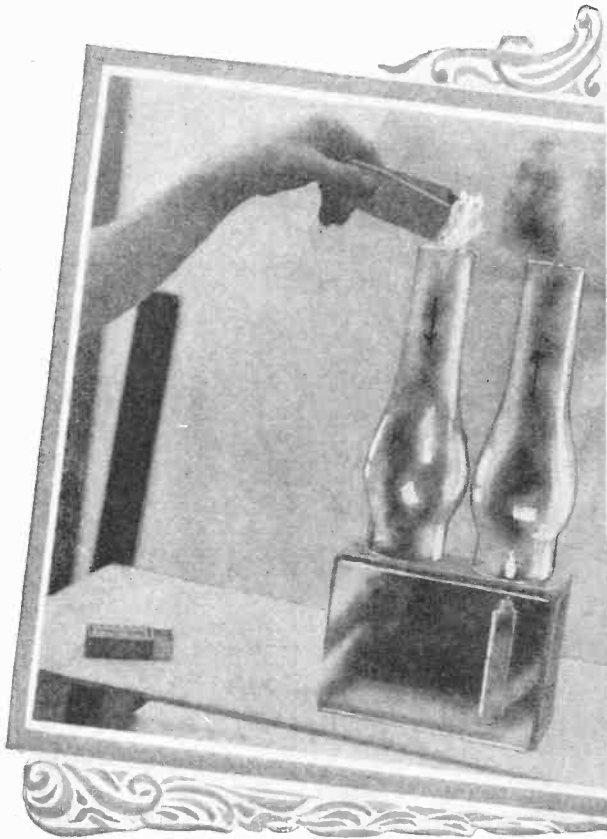

The convection of air currents is shown above. The candle is placed under one of the lamp chimneys and a piece of lighted paper held over the other. The hot air rises above the candle, pulling the smoke and flame of the paper down through the second chimney. Metal conducts heat better than wood. (See right.) Half a rolling pin is covered with metal foil and then with paper, and the paper lighted. The paper will burn while there is wood under it, but will go out over the metal because the metal dissipated the heat, preventing the paper burning.

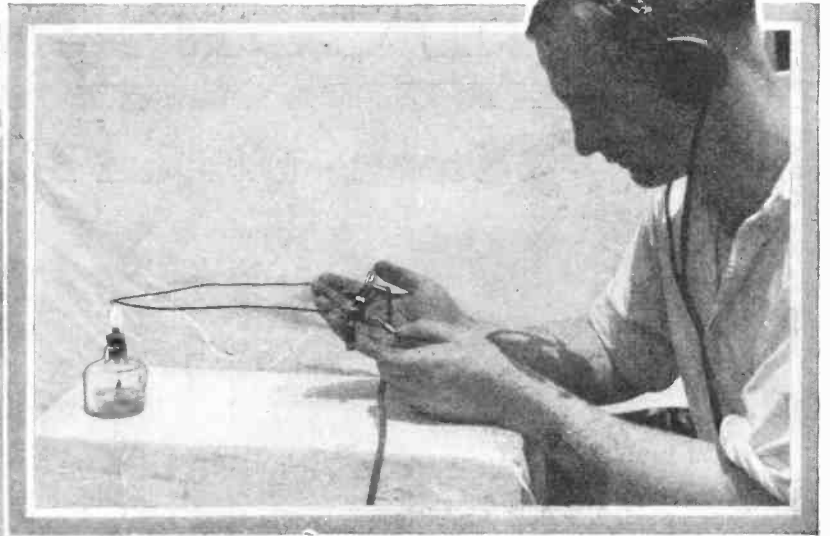

Electricity can be made directly from heat. To perform this experiment, twist the ends of an iron and a copper wire together, connecting the two wires to a pair of radio receivers. If the ends of the wires are heated and one of the phone tips is intermittently touched with one of the wires, thus opening and closing the circuit, a series of clicks will be heard in the telephone. This is the principle of the thermo-couple.

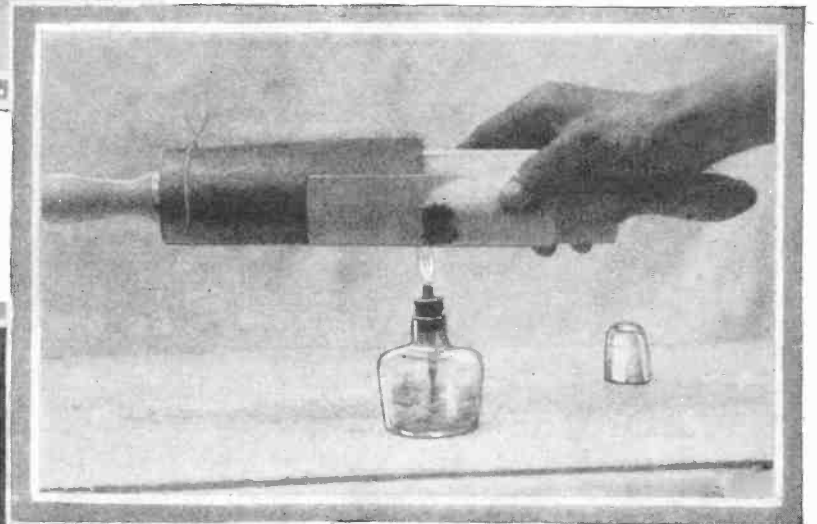

That water is a very poor conductor of heat is shown plainly in the experiment at the left. A thermometer is held just under the surface of a bowl of water and gasoline or some other substance is lighted on top of the water. As the fire blazes merrily on, very little rise will be noted in the temperature registered by the thermometer under the water.

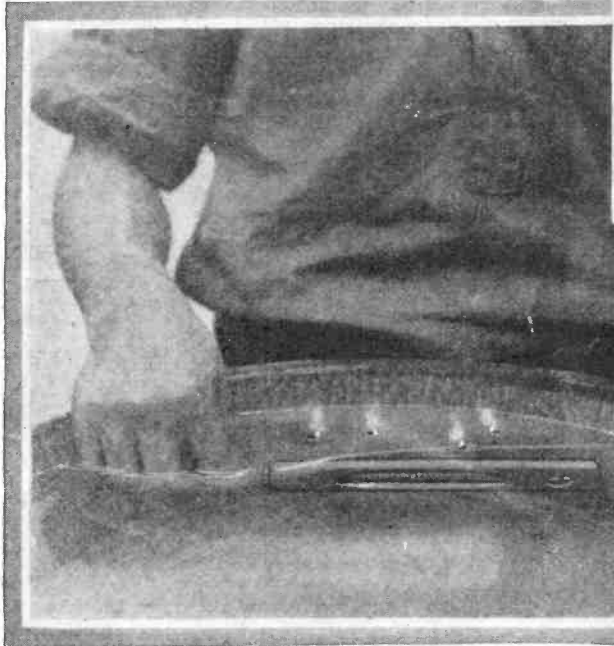

The expansion of a rod when heated can plainly be made visible with a few simple bits of apparatus, as shown at the right. One end of the rod is placed in a book, and the other end is allowed to roll over the top of a pencil which has a pointer attached, as shown. A scale on a piece of white paper is placed behind the pointer, so that direct readings of the rod's movements may be made. Any suitable means may be used to supply heat to the length of rod between the book and pencil. As this heat increases, the rod will grow longer and longer and thus roll the pencil, the pointer of which will magnify the movement enough so that it may be plainly seen.

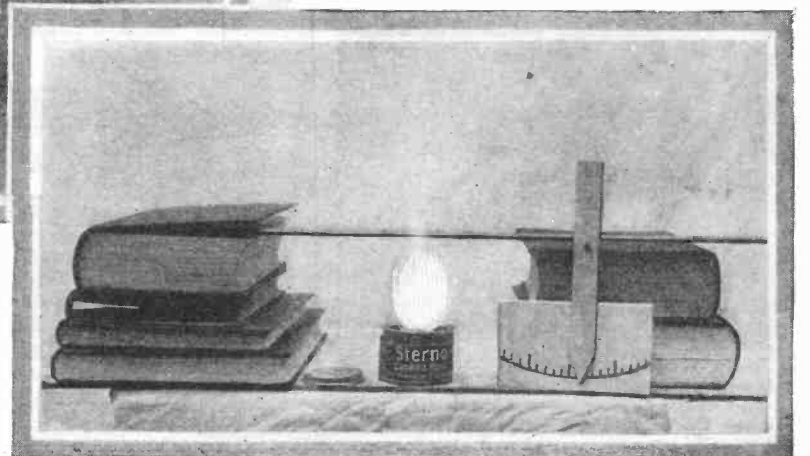

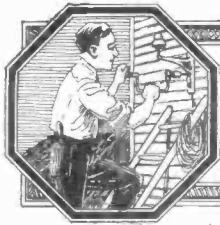

THE CONSTRUCTOR

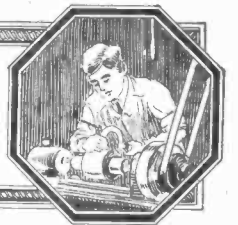

Steam-Driven Model Boat

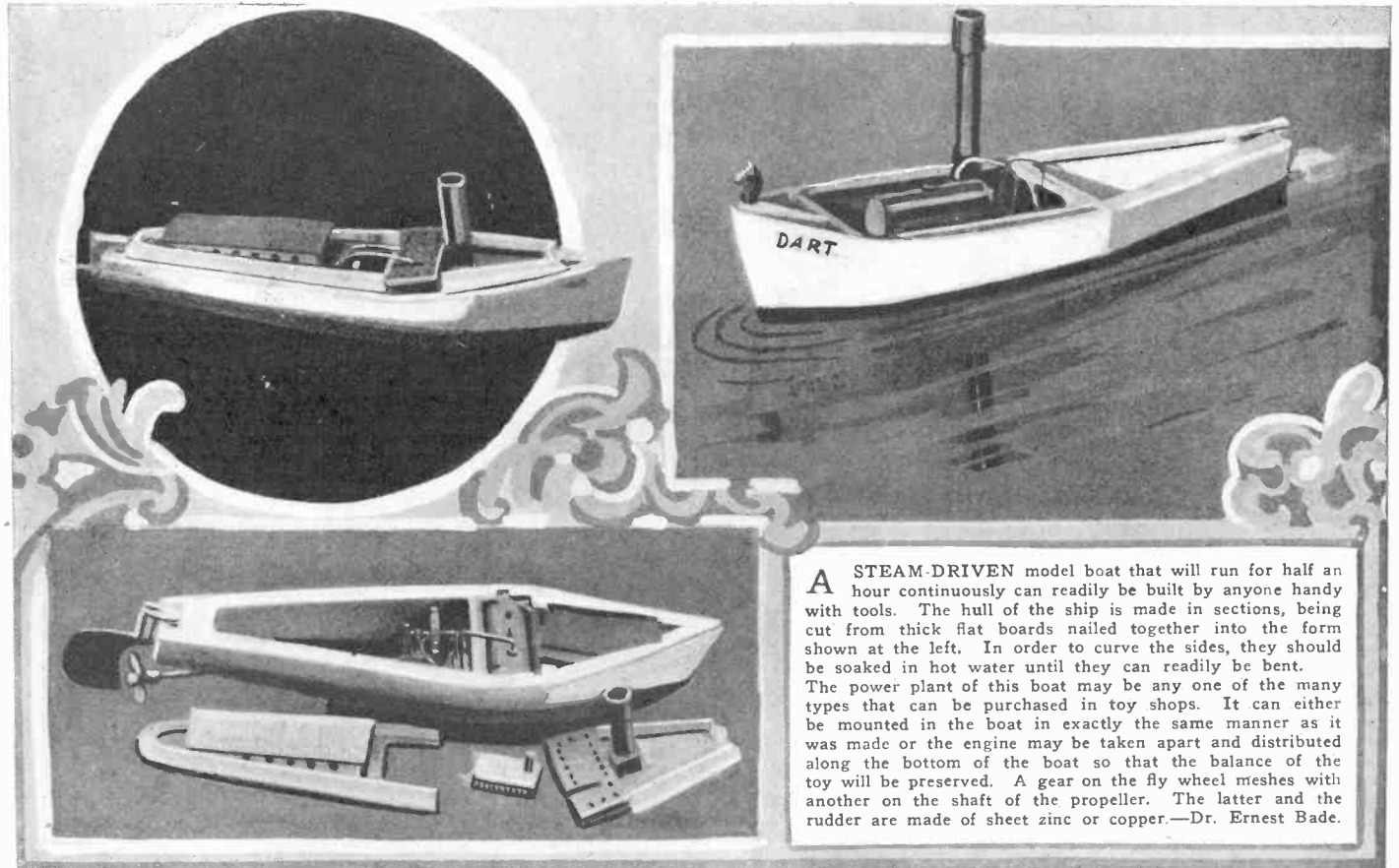

A STEAM-DRIVEN model boat that will run for half an hour continuously can readily be built by anyone handy with tools. The hull of the ship is made in sections, being cut from thick flat boards nailed together into the form shown at the left. In order to curve the sides, they should be soaked in hot water until they can readily be bent. The power plant of this boat may be any one of the many types that can be purchased in toy shops. It can either be mounted in the boat in exactly the same manner as it was made or the engine may be taken apart and distributed along the bottom of the boat so that the balance of the toy will be preserved. A gear on the fly wheel meshes with another on the shaft of the propeller. The latter and the rudder are made of sheet zinc or copper.—Dr. Ernest Bade.

Watch Compass



To use a watch as a compass, place it on a flat surface, point the hour hand at the sun, and south will be found to be half way between the hour hand and the figure 12.
—Dr. A. Neuburger.

Cloud Filter



Often times when taking outdoor scenes with small hand cameras, the resulting photograph disappoints one. Where a standard cloud filter is not available, ordinary sun glasses may be used, hold'ng one of the yellow glasses in front of the lens. The sun glasses should be plain glass or celluloid. Using this idea, length of exposure must be increased.—Charles T. Belden.

Amateur Surveyor's Transit

COMPASS BOX POSITION WHEN IN USE

BRASS LOCATING PINS

CIGAR BOX

BLOCK OF WOOD

MIRROR

VERT. WIRE

HORIZ. WIRE

INDEX LINE

SMALL LEVEL TUBE

PLASTER OF PARIS

WOOD

CELLULOID PROTRACTOR

TRIPOD SOCKET

KNOB

SECTION "AA"

REFLECTION OF BUBBLE

HORIZONTAL WIRE

VERTICAL WIRE

LINE OF SIGHT WHEN LEVELLING

LINE OF SIGHT

ANGLE MEASURED

SAME AS ANGLE MEASURED

SLOPE OF HILL

EXAMPLE "A"

LINE OF SIGHT

EXAMPLE "B"

— TO ADJUST INSTRUMENT —

OPERATION I - DRIVE 1ST NAIL ON LEVEL WITH HORIZ. WIRE - SIGHT 2ND NAIL.

OPERATION II - 2ND POSITION SIGHT BACK TO 1ST NAIL AND PLACE 3RD NAIL.

OPERATION III - DRIVE NAIL 4 HALF WAY BETWEEN NAILS 1 AND 3 - TILT INSTRUMENT UNTIL SIGHTED - AND LEVEL PROTRACTOR - MARK INDEX

THESE HEIGHTS SHOULD BE EQUAL

1ST. POSITION

2ND. POSITION

EXAMPLE "C"

CABIN

"B" LINE

STREAM

EXAMPLE "D"

"A" LINE

RED CREEK

For making the above combined transit and level, procure a perfect cigar box, cut the vertical slot in one end as shown. Then drill a $\frac{3}{8}$ " hole through the opposite end, and cover it with a piece of brass containing a $\frac{1}{16}$ inch peep hole. Measure the height carefully of this hole above the box bottom. At exactly the same height, pass the horizontal cross-hair which can be made of a fine wire well across the slot. Place the vertical cross-hair over the slot in the center and exactly parallel to the side of the box. The vertical wire is placed exactly the same distance from the side of the box as the center of the brass peep hole. The compass is placed on the top of the box with the north and south line of its dial passing directly through a line drawn through

the vertical cross-hair and the center of the peep hole. Two pins in the compass bottom fitting in holes in the top of the box serve to keep it in place. To the inside of the box a piece of good white drawing paper is glued. A protractor is pinned to a small strip of hardwood, and the level is held to the protractor with plaster of Paris. This level must be exactly parallel to the flat side of the protractor. A screw is run through the exact center of the protractor and fastened to the back of the box. The mirror on the block of wood is placed as shown. The method of using the transit for measuring angles, leveling, and running straight lines is explained in the sketches. Adjustment is also explained.

—H. E. Balfour.

Heater

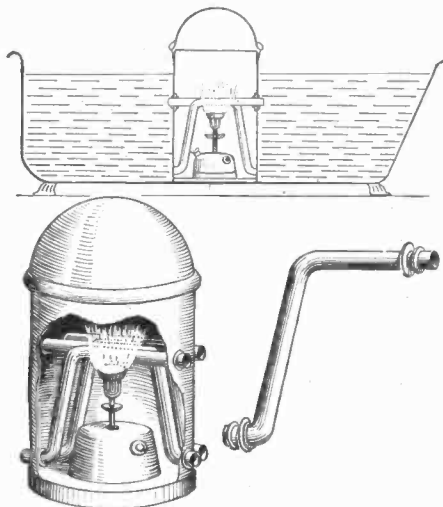

The device for heating the bath water with a gasoline heater sits into the bath tub. The water circulates through the pipes by convection.

—John P. Stoddart.

Housewife's Sink Kink

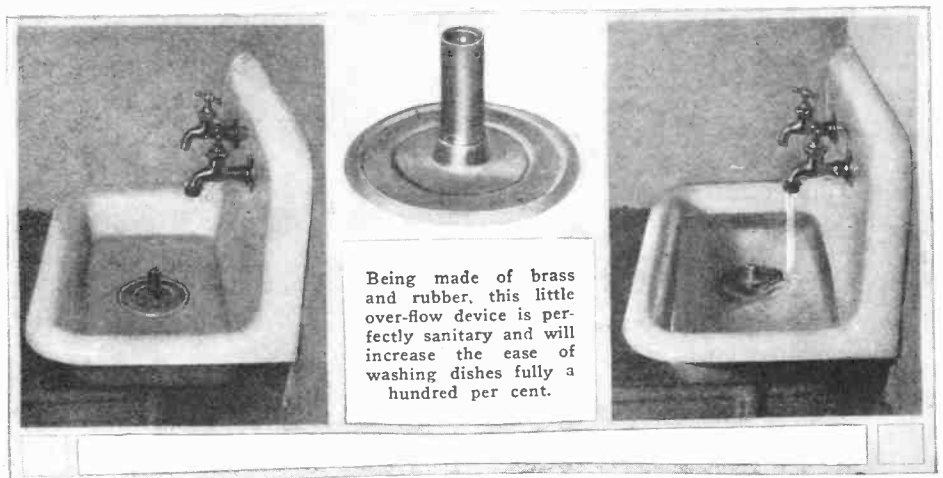

Being made of brass and rubber, this little over-flow device is perfectly sanitary and will increase the ease of washing dishes fully a hundred per cent.

For washing dishes with constantly clean water, the little device shown above, recently brought out, will find a hearty reception among the housewives. It is set over the sink outlet and the surface water passes over the top over-flow.

—Author?

Tool Set from Old Files



SCRAPERS

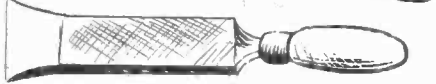

NAIL AND COTTER ROLLER

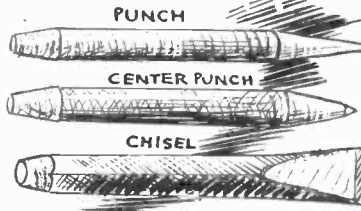
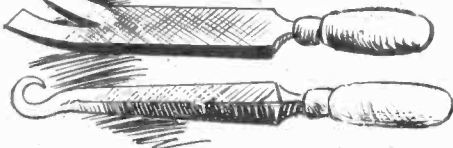

EXTRACTORS

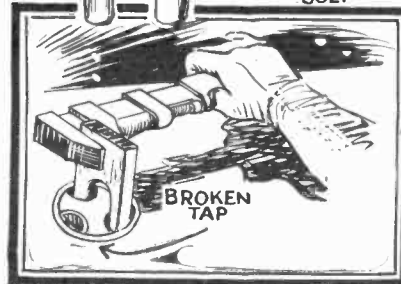
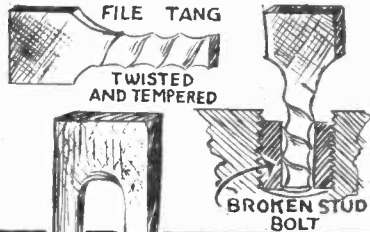

DRILL FOR GLASS



DRILL FROM ROUND FILE



LARGE-FLAT DRILL



DRAWING KNIFE

The system of using the metal of old files for the construction of tools has long been known to mechanics. However, a few adaptations are shown in this article which have not before been generally known. In all

cases above the temper is drawn from the file, then it is ground into shape and retempered. For all the instruments except the glass drills use a light straw temper; for the latter, use a deep purple.—G. A. Luers

Drill Press

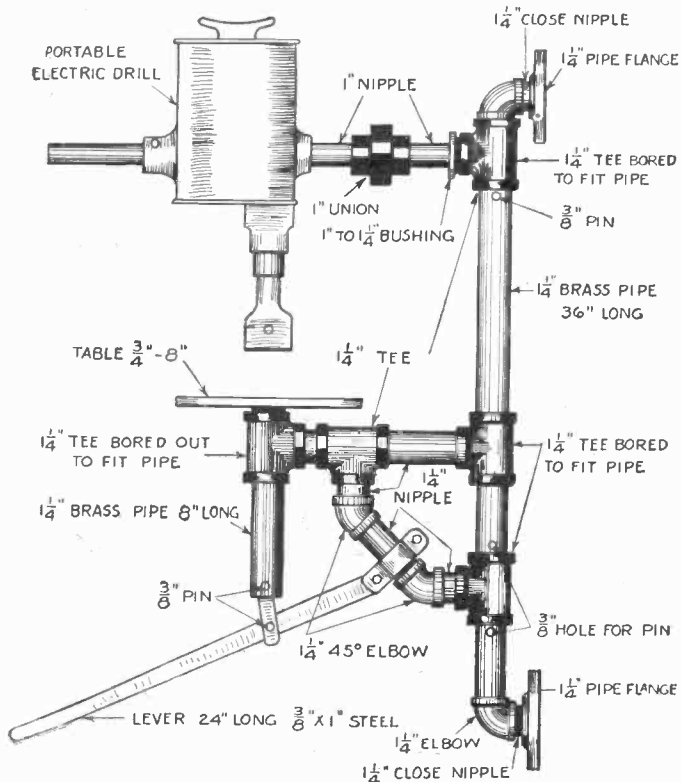

The drill shown above was made of standard 1/4-inch brass pipe fittings equipped with a standard electric drill as the power unit. The work is adjusted by raising the table with the aid of the lever. The pins in the main frame adjust the height roughly. Brass pipe will be found best.—Harry B. Luessen.

Sugar Motor

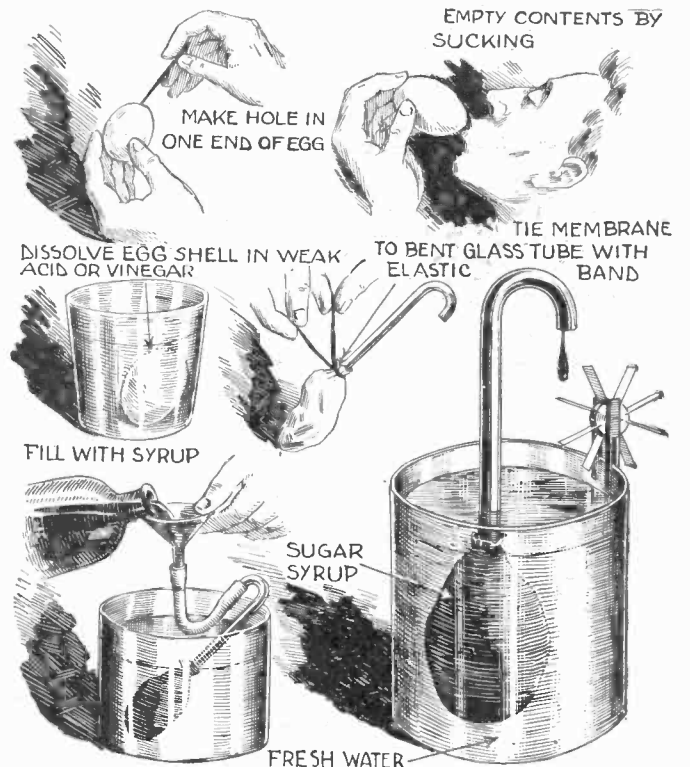

Osmosis is responsible for the operation of this motor. A small hole is made in one end of an egg and the contents sucked out. The shell is dissolved away with vinegar or weak acid, and the membrane sack attached to a hooked tube. If the sack is filled with sugar syrup, osmosis will cause the liquid to rise through tube running wheel.—Dr. R. G. Harris.



HOW-TO-MAKE-IT

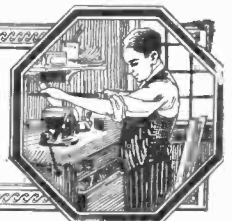

This department will award the following monthly prizes: First prize, \$15.00; second prize, \$10.00; third prize, \$5.00. The purpose of this department is to stimulate experimenters toward accomplishing new things with old apparatus or old material, and for the most useful, practical and original idea submitted to the Editors of this department a monthly series of prizes will be awarded. For the best idea submitted a prize of \$15.00 is awarded; for the second best idea a \$10.00 prize, and for the third best a prize of \$5.00. The article need not be very elaborate, and rough sketches are sufficient. We will make the mechanical drawings. Use only one side of sheet. Make sketches on separate sheets.

Window Cleaner FIRST PRIZE \$15.

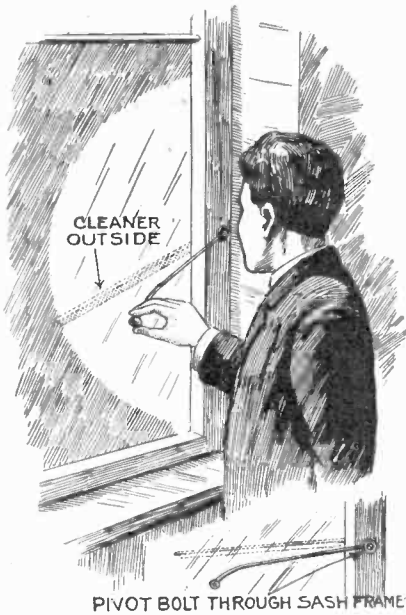

A discarded automobile windshield cleaner comes in handy when attached to a window frame as shown above. During storms, it permits those inside the house to obtain a clear view outside. —L. B. Robbins.

Burning Steel



A piece of steel wool, if placed in the flame of a Bunsen burner for a second and removed, will emit bright flashes for about ten seconds. —Arthur A. Blumenfeld.

Overflow Alarm SECOND PRIZE \$10

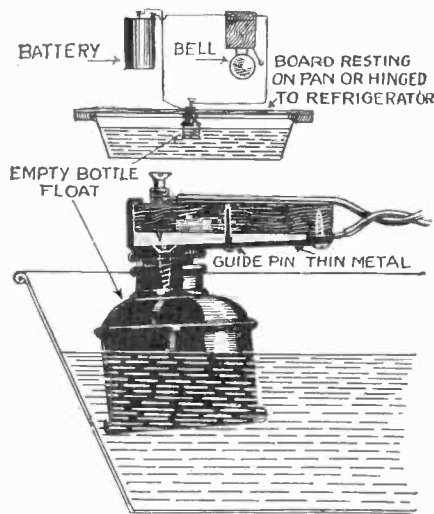

An alarm to be placed in the drip pan of a refrigerator to sound when the pan is full, may be made as shown above. —G. W. Beerbwer.

Camera Shield THIRD PRIZE \$5

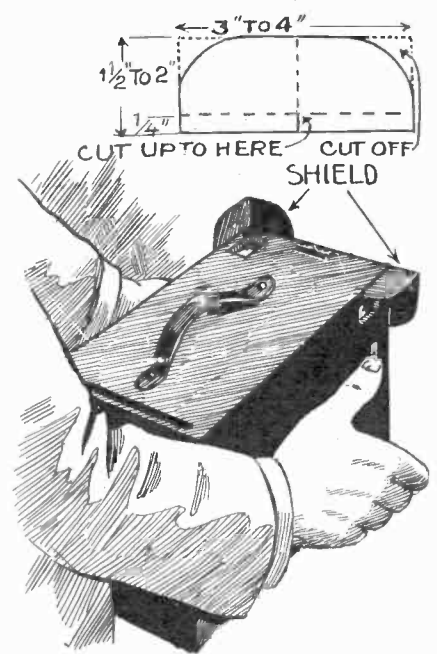

When using large hand cameras, it is often difficult to properly shield the finder with the hand so as to obtain a clear view. This difficulty can be overcome by cutting two shields from sheet tin in the shape shown above and attaching to the camera. —Andrew Chlpka, Sr., Reporter No. 8081.

Trap Drums

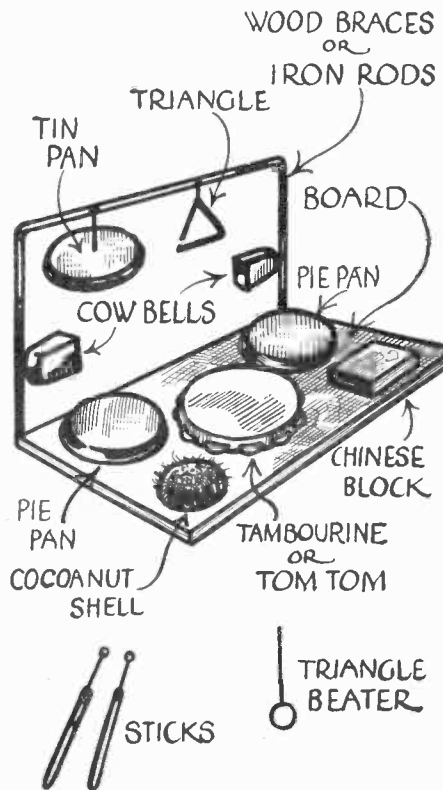

The various instruments shown above when mounted as indicated make quite a respectable set of trap drums. Two drum sticks and a triangle beater are also necessary. —John W. Reed.

Vanishing Smoke

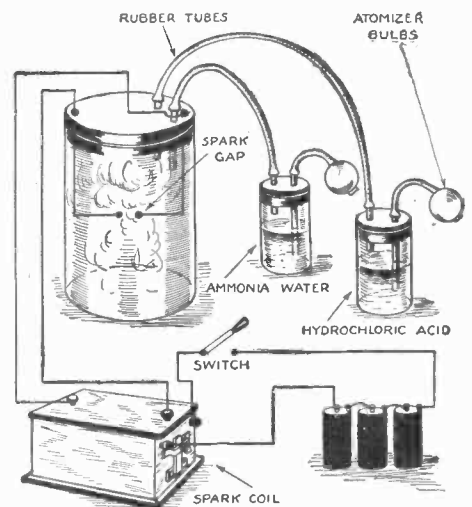

A demonstration of the Cottrell system for precipitation of smoke may be made as shown above. The two gases mingling form smoke. Passing a spark through the smoke precipitates the particles. —Francis D. Whittemore, B. S.

WRINKLES RECIPES & FORMULAS

Edited by S. GERNSBACK

Savings Bank

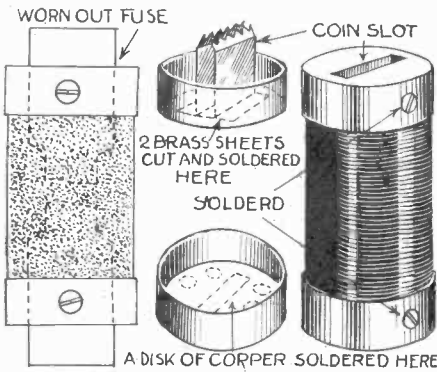

A burned out tubular fuse makes a good savings bank when arranged as shown above. —E. Corral.

Hygrometer

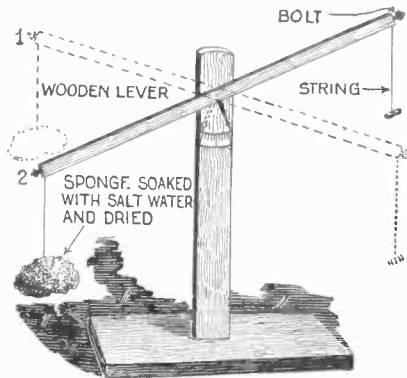

A hygrometer may be made by suspending a sponge as shown. It rises in dry and falls in wet weather. —L. M. Bingaman.

Top Remover



When the screw top on a jar sticks, use the kink that is illustrated above. Pull the string to the right. —Ingolf Kvamme.

Screen Stretcher

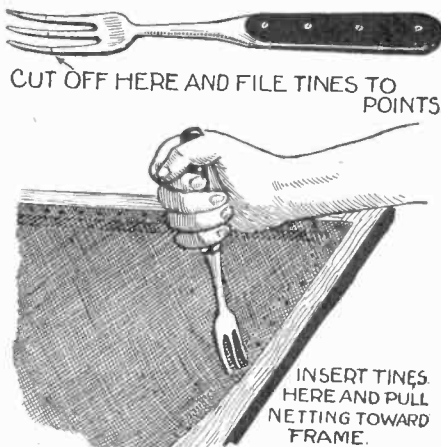

When tacking netting on a frame, use a fork cut as shown above to stretch the material. —Edward Evers.

Can Opener



Another use for a fork is illustrated above. The tines are completely cut off. —Edward Evers.

Simplified Spirals

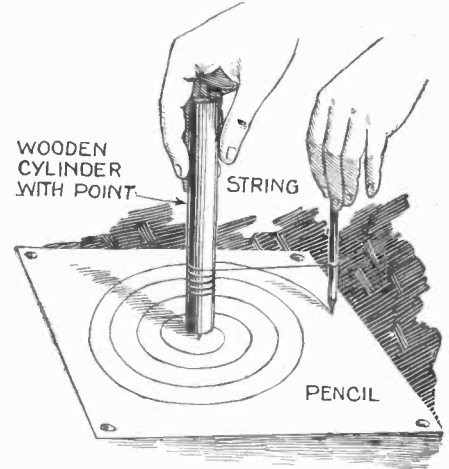

Use this kink for drawing spirals. The string is lengthened or shortened, according to the motion of the pencil. —J. Mursand.

Removing Stains

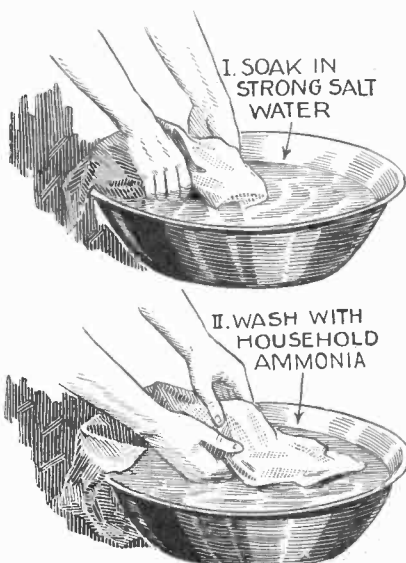

Left: Indelible ink stains are usually very hard to remove. Soak the stained portion in strong salt water. Then remove and wash the material thoroughly with household ammonia. —Howard C. Kramer.

Right: Thermit is composed of three parts of powdered aluminum, mixed with five parts of iron oxide. It is ignited by means of magnesium. A welding crucible may be made as shown. When welding two nails together, proceed as shown. To melt a hole in sheet iron, mount at a 45° angle. Allow the thermit to fall upon it. For welding a boss to a steel plate, see lower right. The thermit forms the boss. —Charles D. Tenney.

Thermit Welding Simplified

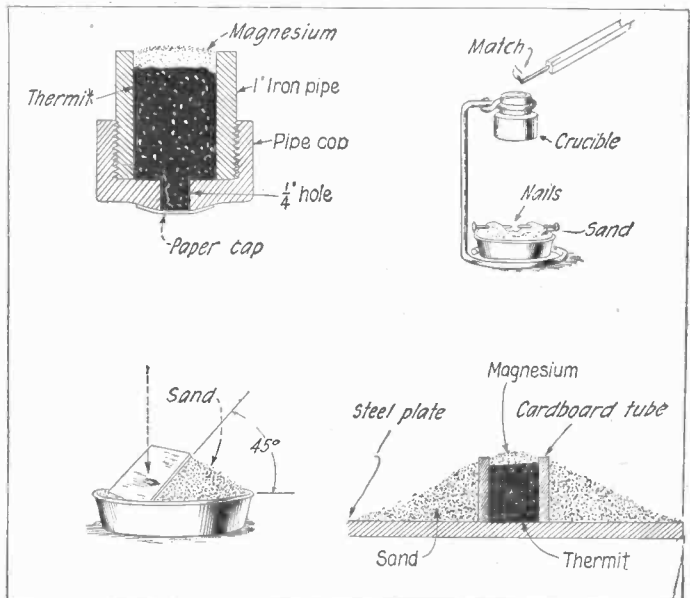

Readers Forum

A SUGGESTED DEBATE

Editor, *Science and Invention*:

As a reader of your magazine might I be a man so small, with a mind perhaps too narrow to ask for a debate entitled, "The possibilities, or rather the impossibilities of perpetual motion, VS., the impossibilities of creation of life."

Your articles on perpetual motion are usually headed "an attempt at the impossible." While an article on "creation of life" was made so flowery as to make the old maid or bachelor hope that in a few years if nature does not produce the mate they desire they may send to Sear's Gormy Ward Roe Buck & Co. and get just what they want.

Believe me to be an interested reader of your excellent magazine.

G. V. TIMBLIN,
Indiana, Pa.

(Whether creation of cells that live, reproduce and die has anything to do with the creation of man, or not, is a question which we do not care to enter upon. Nevertheless, Mr. Mazur in the article "Artificial Creation of Life" appearing in the July issue of this publication, page 261, gave complete instructions on how to duplicate the effects he obtained, so that anyone unskilled in the art could duplicate the result. Not only did Mr. Mazur tell how to produce the effects but he also produced them.)

All the perpetual motion enthusiasts we have met tell how to obtain power from the machines of their brain, but do not produce the effect themselves.

This leads us to the inevitable conclusion that the designers of perpetual motion machines do not know what they are designing, otherwise they would have developed cons ago a machine that will work by gravity alone.—Editor.)

GRAVITATION LACKING

Editor, *Science and Invention*:

At last with the opening of the Readers' Forum, I can ask a question that has been bothering me for some time. Why is it that when Dr. Hackensaw and Pep are flying around so calmly in the story, "Dr. Hackensaw's Trip to the Moon," there are articles on the table and cot which, though not fastened, do not move? In such case why would not a tea pot take to the air as did Dr. Hackensaw and Pep? Of course, if you say it wouldn't, I'll believe it, but why wouldn't it?

When articles are rejected, do you always return them to the writer? May I say that Ben-Zyl's paper ladder should have won first prize—in the joke contest? I do not wish to offend anyone by this statement.

JAMES W. ROGERS,
Jackson, Tenn.

(The reason that the tea pot does not leave the table when Dr. Hackensaw's car is flying to the moon is because of the fact that the gravitational attraction at the particular spot described in the story is practically nil, consequently, the result is that the tea pot and the table attract each other in direct proportion to their mass and inversely as the square of the distance between them. The tea pot resting on the table in the first place will not tend to draw the table away from its position in the car, there being no distance between the two objects. The attraction of the table for the tea pot is considerably greater than that of the tea pot for the table because the mass of the table is greater than that of the tea pot. The table on the other hand is attracted by the car following the same rules and consequently remains practically in its original position. On the other hand Dr. Hackensaw and Pep float around in the car, which position they attain by the use of muscular effort. You will recall that they practically pushed themselves upwardly into the air and then found that they were floating around.)

Rejected articles are returned whenever stamps are enclosed with the manuscripts. Very often, the manuscripts are of considerable value to the writer and the writer neglects to enclose the necessary transportation charges for the return of his papers. In these cases the manuscripts are returned by us. Those articles that are considered of no practical value and which we believe have no value to the writer are thrown into the waste paper basket. If, therefore, you want to be assured that your manuscripts will be returned you should enclose stamps to defray mailing charges.

With regard to Ben-Zyl's Paper Ladder, we would suggest that said individual received no prize for his contribution. As an experiment, the article is interesting. A prominent lecturer used this paper ladder for years in his demonstrations of paper magic. There is no practical use for such a ladder.

The editor would further advise that it is not necessary to apologize for any statements that you may make. The Readers' Forum is for our readers and we will air their views and comment upon the same, should we deem comments advisable.—Editor.)

THE SHOWER OF FISH

Editor, *Science and Invention*:

When T. A. T.'s fingers were badly burned through the handling of radium at the Memorial

SCIENCE AND INVENTION desires to hear from its readers. It solicits comments of general scientific interest, and will appreciate opinions on science subjects. The arguments pro and con will be aired on this page. This magazine also relishes criticisms, and will present them in both palatable and unpalatable forms. So if you have anything to say, this is the place to say it in. Please limit your letters to 500 words and address your letters to Editor—The Readers Forum, c/o Science and Invention Magazine, 53 Park Place, New York City.

Hospital, he was advised to go on a long vacation, far away from those benevolent-malignant radium emanations if he desired to preserve his fingers and hands.

Alaska, and the North in general, held no charm, for bitter memories remained of cold, and snow, and perpetual ice, so it was decided to prospect our Southern Neighbors, searching for Carnotite, Pitchblende or other radium active mineral. Carnotite Ore, valued at times because of the radium content at hundreds of thousands of dollars per ton, like gold, is found according to the old prospectors' theory—"where you find it."

While in Spanish Honduras, during one of our periodical visits to "town"—or should a half dozen adobe huts with a score of Indians be called a metropolis,—we learned of a phenomenon said to occur yearly on the outskirts of the capital city of the State of Yore, Honduras.

The natives swore that between the thirteenth and eighteenth of each June a heavy storm comes up and when the violence of the storm has subsided the people emerge from their homes and gather up fish which have descended from the clouds.

Being so close we decided to investigate the phenomenon, for besides being of great scientific interest the biblical societies would probably welcome our return to the states with wreaths of glory—for if it rained fish why not Biblical loaves of bread. So over steep mountains covered with moss bearded verdure, slashing trails through fetid mats of jungle, passing old towns

unlike any he had ever seen in the local streams.

The twentieth of June dawned, several days past the date that the wonderful "Iluvia del pescades" was supposed to fall and we decided to continue our search for ores. The story of the "rain of fish" is well known to tropical travelers, to the men of the fruit plantations, prospectors and timber men and it is the younger of them that scoff at the mention of the rain of fish, but the older men, who have fought their way through the jungle and swamp, over rugged mountains, shake their heads and refuse to commit themselves.

Another legend of Honduras, in the Department of Gracias, near the frontier of Salvador, is that of a spring of blood, which when tested with tincture of iron will clot. Various attempts have been made to bring a sample of the liquid out, but upon arriving in the lowlands the substance seems to ferment and burst the containers. The story also goes that if left the substance will separate into white and red corpuscles.

L. K. WRIGHT,
Astoria, L. I.

(Although the rain of fish is a possibility the legend of the stream of blood is highly improbable. There are many substances in water which will produce a marked color change when a drop or two of iron chloride is added to the water. A small quantity of tannin in water produces with iron chloride a jet-black solution which to the superstitiously inclined may appear to be a clot. The bursting of containers can be due only to fermentation. This does not seem very plausible and sounds more like fiction. The precipitation of red and white corpuscles from water is absurd. There is a possibility that the blood of some animal may be washed away in the water on some occasions, but that would not be a constant factor and hence the story must be listened to with more than a passing doubt in mind.—Editor.)

SPEED BOAT

Editor, *Science and Invention*:

In the October issue of SCIENCE AND INVENTION there is an article on a Simple and Efficient Motor Launch. Can you tell me the size of this boat?

C. B. TOWERS,
New York City, N. Y.

(Let us read what Mr. P. G. Howes, Assistant Curator of the Bruce Museum at Greenwich, Connecticut, has to write:

"The boat, which by the way I built myself, is eighteen feet over all by four feet six beam. In the tests that I gave it, it carried three passengers sitting on the decks and cabin and towed a fourteen foot skiff containing four more. All of these were full grown people.

"The entire cabin inside is taken up with engine, bilge-pump, etc.

"I should add that since writing the article I have had to cut down the power of the engine so that the boat makes about ten miles an hour, as the higher speed started to tear things up. The boat is now over the experimental stage, and I use it every day. It causes endless interest and there are often many cars stopped along by my house to watch proceedings.

"I have also found the addition of paddle covers necessary, as the wheels throw considerable water."

This gives you the information you requested.—Editor.)

SPIRIT SEEKER

Editor, *Science and Invention*:

I saw an article in the June 16th, 1923, "Pathfinder" entitled, "Proof of Spirits Will Win \$6,000." To settle this baffling controversy whether spirits exist I wrote to them and they referred me to you. For five years at different times I have heard and seen over two hundred spirits; in other words, people that have passed from the Earth to the Life Beyond. In the last two years people from the other world have bothered me a great deal; more so than they did before that. Some seem very glad to see me and they express it that way. Some talked of music and of school and others of interests here below. They seem to think that the time passes very slowly over there. Some spoke of things that had happened that we both know of. Their appearance was the same as when I last saw them and they talked as naturally. Some of them told me what spirit was. They said that spirit was mind and that only. They can think, talk and remember and that is all. They say that mind or spirit is very insufficient and they find it very monotonous over there. They all appear in their physical form that they had here on earth because mere mind was so inadequate to express themselves if they do not. I do not know but do not think it ever possible for anyone to take a psychic photograph of a spirit for spirit is mind. One can only photograph material subjects. Spirit or mind has no substance. Hence people that have passed from earth to the Life Beyond or spirit life, cannot make themselves physical or material because they have no substance. Mind is not

(Continued on page 940)

The Experimenter

has come back! If you are one of the one hundred thousand readers of the old ELECTRICAL EXPERIMENTER, you will no doubt be glad to hear that the EXPERIMENTER is coming back BIGGER AND BETTER THAN EVER. PRACTICAL ELECTRICS has been changed into an entirely new kind of magazine entitled

The Experimenter

In this magazine which has been greatly enlarged in point of contents, illustrations and circulation, you will find the following new departments:

Experimental Radio
Experimental Chemistry

There is an entirely new treatment of radio containing experiments only. 90% of the magazine contains pure experiments written by the foremost authorities in their respective fields, also a monthly editorial by the writer.

A fine roto-gravure section is now added to brighten up the magazine. If you want experiments, this is your magazine.

Be sure to reserve a copy from your news-dealer before the issue is sold out. THE EXPERIMENTER will be on sale at all newsstands beginning December 20th, 1924.

Hugo Gernsback
Editor

peopled with Indians, with here and there an ancient Spanish Church smouldering to ruin, we eventually arrived in the city of Yore, which is situated in a great broad valley.

In Yore, we quartered with the mayor, an affable man who scouted the legend but admitted that the year previous he had seen some tiny sardine like fish fall upon the ground after a great storm.

In the morning we walked out to the ground known as "El Pantano" where the fish were supposed to fall. There were no lakes, streams or volcanoes nearby and it appeared as though it would be a strange phenomenon. The tiny mountain streams were not very prolific with fish, while the mayor said those which he saw were

Radio Pictorial

At the right is shown what French claimants say is the original transmitter. It was built in 1889 by Dr. Edouard Branly, whose researches are said to ante-date those of Marconi. The apparatus was placed on exhibition at a French Radio Show.

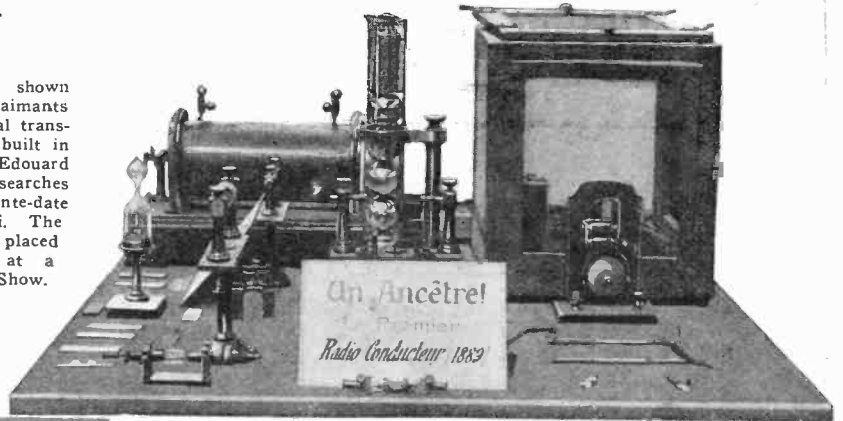

The miniature farm shown above is not a plaything but a complete radio receiving set. This is another of the entries in the Radio World's Fair home built receiver contest. The animals control the rheostats. The loud speaker is seen in well at extreme right of photo.

The prize contest at the New York "Radio World's Fair" brought forth many marvels in radio construction. One of the most interesting of the entries is that shown below. Following the regular lines of radio set construction Fred C. Mathews of North Bergen, N. J., built one of the world's smallest regenerators. Low loss apparatus was used throughout.

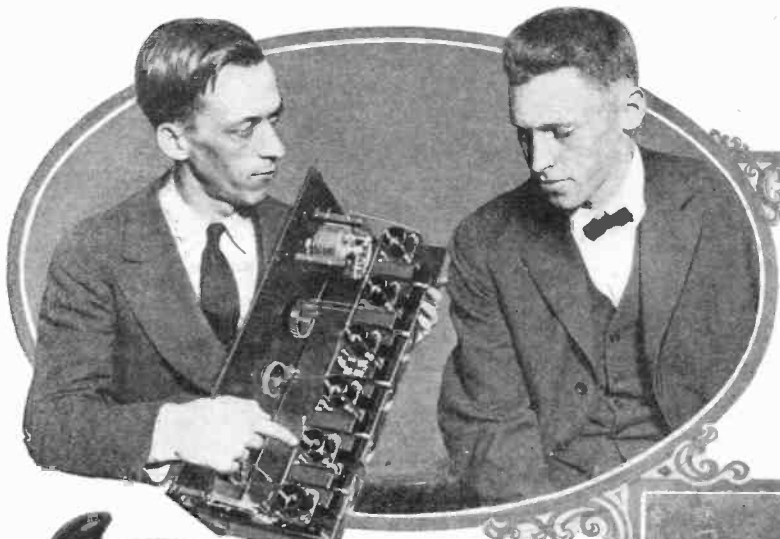
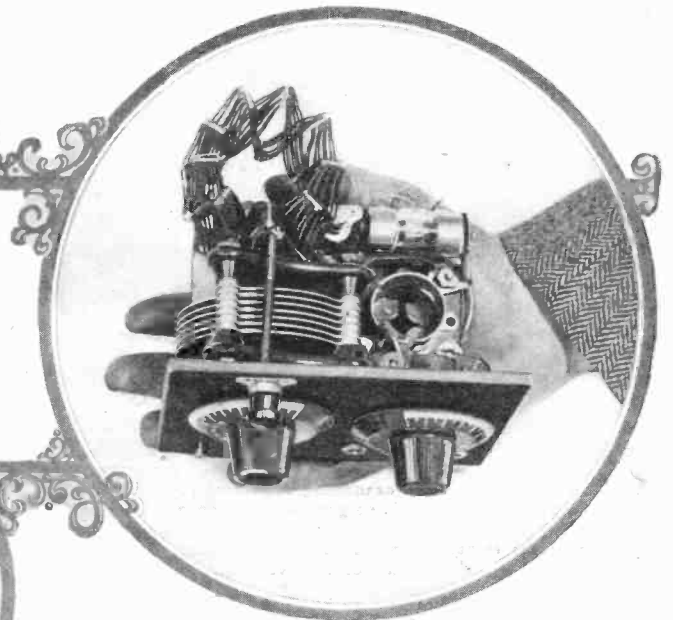

E. T. Flewelling, famous radio designer, has brought forth another radio set. It is a six tube outfit and it proved at a demonstration held recently to be a wonder for DX reception.

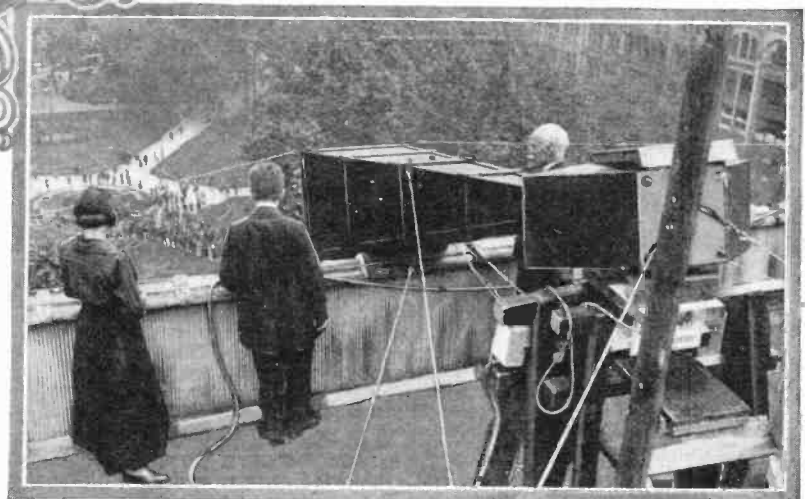
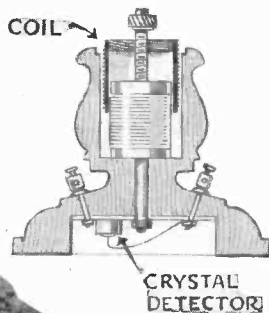

One of the prettiest as well as one of the most novel designs in radio receivers which has come to our notice recently is that shown above. Made in the form of a small urn, it is turned from two kinds of wood. The crystal detector is in the base.

The purveyor of entertainment through the loud speaker shown above was careful of getting his license, for it certainly makes a lot of noise. It is installed a-top a high Berlin building, in which the firm manufacturing the unit has its quarters. It is an excellent advertisement.

A New Distortionless Amplifier

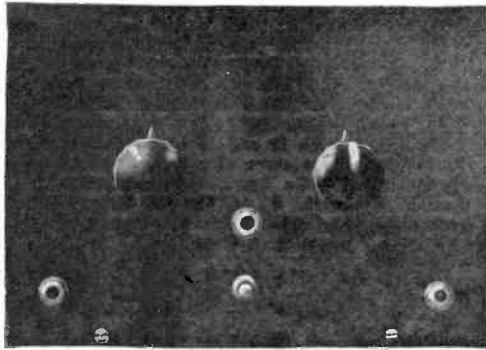

Much has been said in favor of resistance coupled amplifiers. Here is one that surpasses them all. It employs the well known diode tubes.

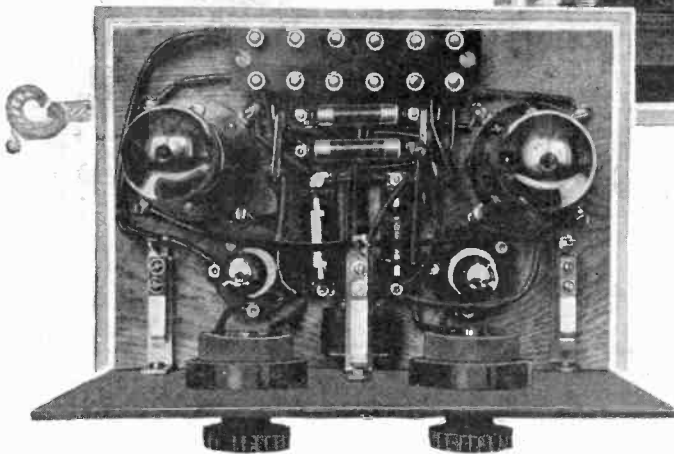

The above photo shows a view of the two step audio frequency amplifier employing the new method of coupling. In the upper right-hand corner is shown a group of New York newspaper men listening attentively to Mr. J. W. Marshall, a Philadelphian, the inventor of the system. Tests show no distortion whatsoever, both on local and distant stations, and with no apparent diminution in volume.

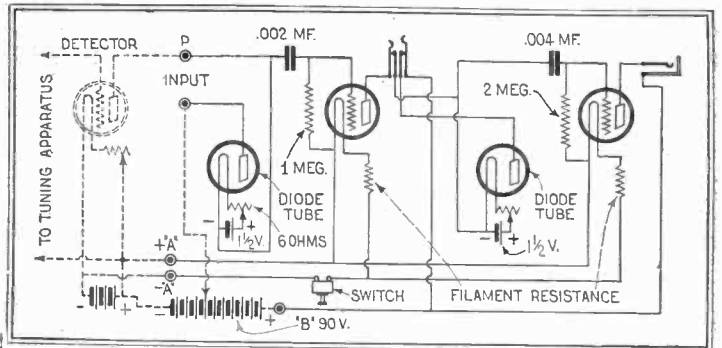

The diode tubes employ a single dry cell to light their filaments. Not only does the tube function as a plain resistance coupled amplifier, but its use allows of a lower "B" battery voltage being employed. The above diagram shows how the amplifier may be connected.

Novel Miniature Crystal Set

By W. J. RITTALL



The owner is shown with his complete crystal set which is smaller than the ordinary earphone and fits easily within the palm of his hand. The set is unique in that it has three very small switch levers which tune both primary and secondary circuits.

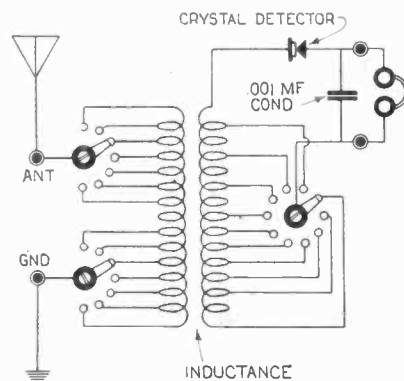

The primary consists of 300 feet of No. 38 S. C. C. wire, tapped at every 20 feet and is wound in a compact coil, 2 inches in diameter. The secondary contains 400 feet of the same wire, tapped at every 40 feet.

Here is a real honest-to-goodness crystal set that gives splendid results when used in conjunction with a single wire aerial, 100 to 200 feet long. An ordinary pill box is used, though a circular bakelite "panel" contains the necessary contacts, switch levers, and crystal detector. Stations several hundred miles distant have been heard, though it must be remembered that a sensitive crystal must be employed. A fixed condenser is incorporated.

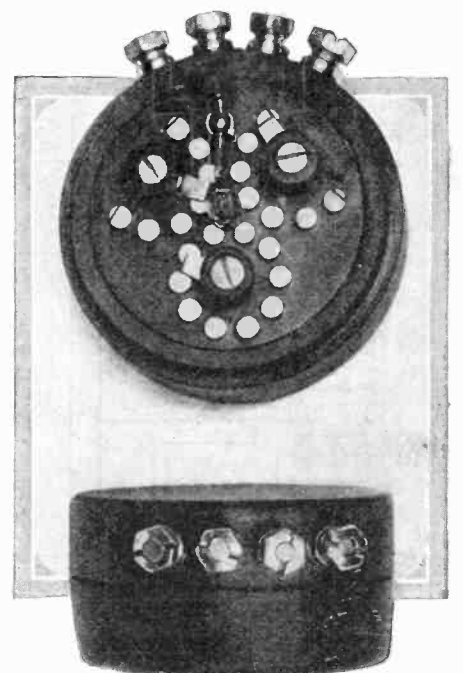

Note the neat and careful workmanship. Four handy binding posts afford easy connections for the aerial, ground and phones.

A Remarkable Six Tube Receiver

By GRANDON LYONS

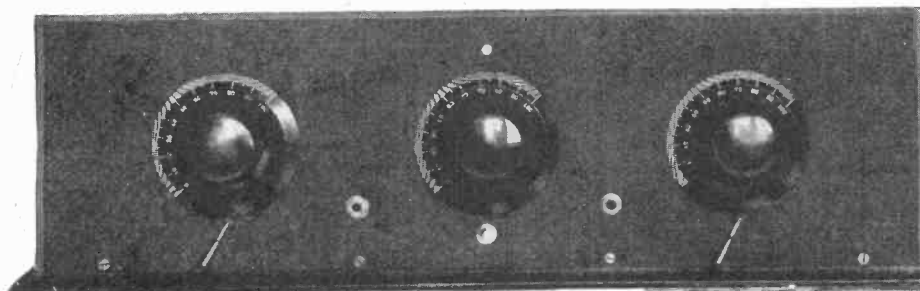

With a view towards getting ease of control, selectivity, quality of reproduction and good volume, this receiver was built and fulfills every condition. Its one stage of radio frequency amplification acts as a distance getter and radiation preventer. The detector to which is added regeneration, in conjunction with one stage of transformer and resistance coupled audio frequency amplification gives unexcelled clarity. Again, the well balanced push-pull amplifier affords sufficient volume to amplify without distortion.

THE foremost consideration in the construction of a multi-tube set is perhaps that of ease of control. After this primary consideration, should come clarity of reproduction, while, thirdly, distance getting ability. Exhaustive tests made with this set have proved that stations but five meters apart can be heard without the semblance of interference. With but two main tuning controls, and an optional control for regeneration, the set is practically well adapted for ease in tuning. Augmenting this feature is its pleasing appearance. Covering a wave-length range of from 200 to 580 meters, stations within a 1,500-mile radius are received on the loud speaker, nightly. One outstanding feature is the elimination entirely of all filament rheostats. In their stead are used filament resistances which allow sufficient current to operate the 201A tubes, which are employed. The primary of the radio frequency transformer which can be an ordinary neutroformer coil, contains 10 turns of wire, thus making it of the shock excited type. This type of tuning makes selectivity a much simpler task, for as it were, the antenna circuit is semi-a-periodic and therefore, non-partial to frequencies of its fundamental wave-length. It is advisable to use a single wire antenna about 100 feet long. Note the well-proportioned layout.

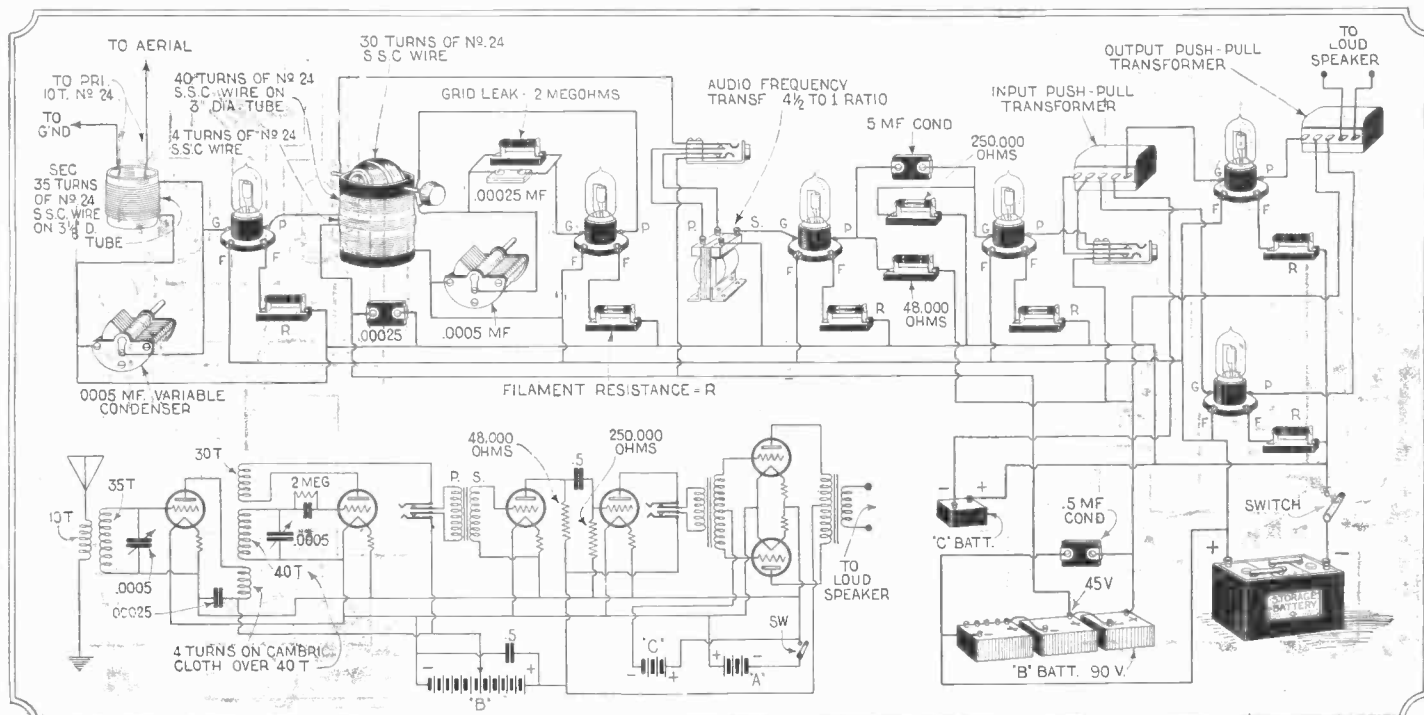
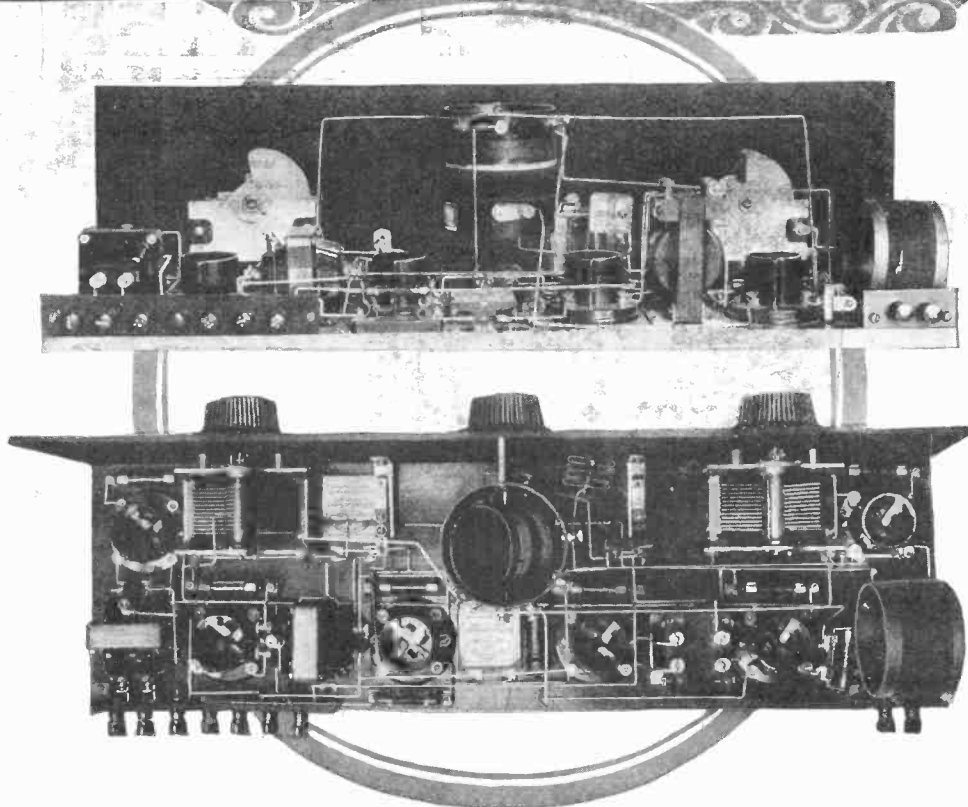

Following the above circuit diagram through, we find that it incorporates every essential for the production of superior results. The variocoupler employed uses no smaller than No. 24 wire since unnecessary resistance

with its deleterious effect would be manifest. In the plate circuit or on the tickler, a smaller wire can be used, since it aids in controlling regeneration and minimizes oscillations.

An Improved Super-Het

By H. WINFIELD SECOR

Modifications Which Give Better Results

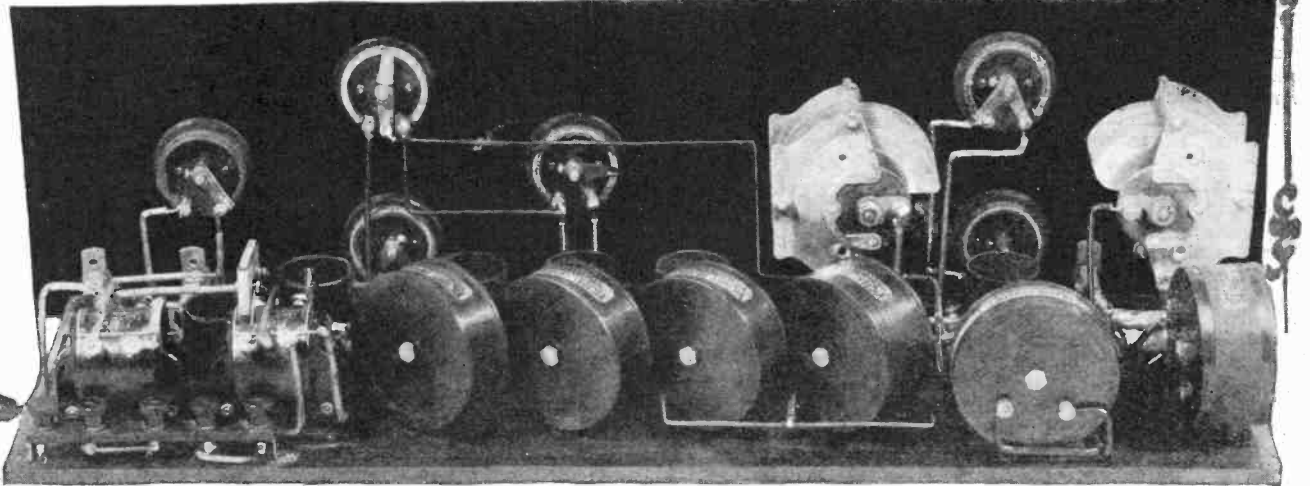
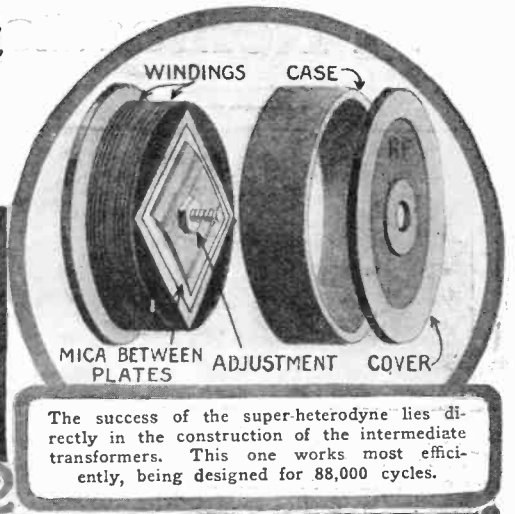
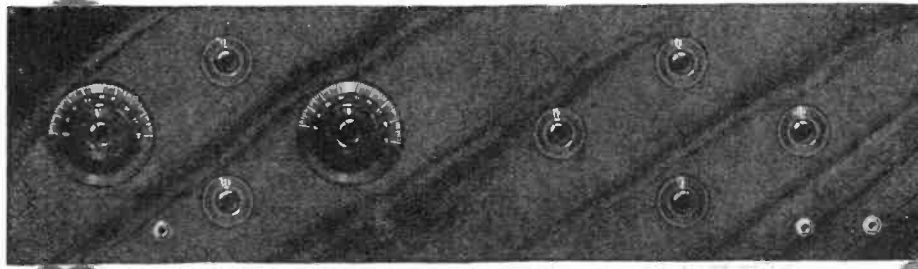

FOR maximum performance, the necessity for eliminating inter-coupling between the radio frequency stages, the desirability of using transformers designed to have a very sharp tuning curve, and the very essential need of having the transformers as much alike as possible, are the main problems which have been successfully overcome with this circuit. Due to the fact

that an aperiodic or untuned primary is used, the need for "matching" tubes is obviated. Again, the secondary being shunted by a .00025 fixed condenser, lowers its radio frequency resistance and results in sharper "peak" resonance. The transformers are individually tuned with a standard oscillator. The transformers are said to be accurate to within 1/2 of 1 per cent.

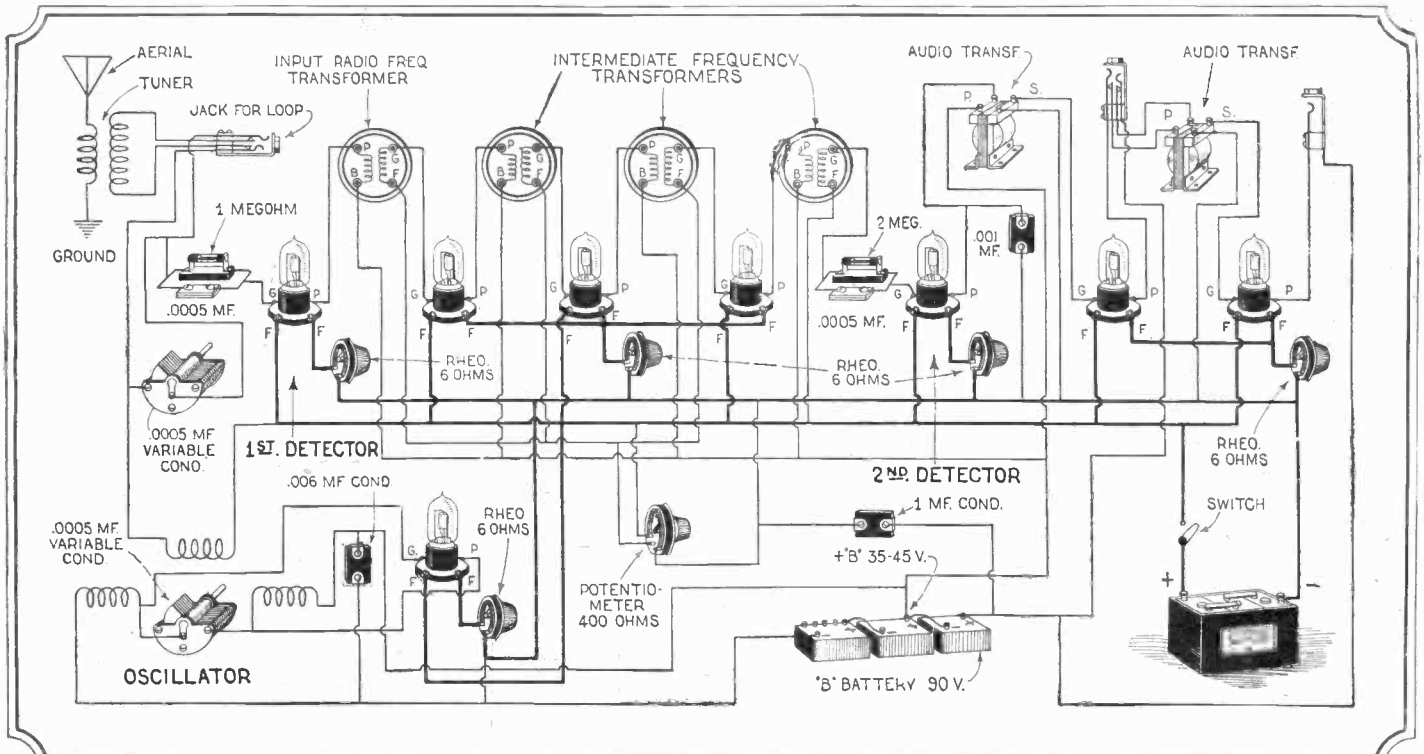

The wiring employed in the average super-heterodyne is not as difficult to understand as some would believe. The filament circuit is shown in heavy contrast with the rest of the circuit, thus allowing very slight chances for making errors. A double-circuit jack is very handy for

connecting a loop antenna in the place of the aerial and ground and is incorporated. A potentiometer materially aids in controlling the intermediate amplifier circuit and affords a ready control for volume. This results in a saving of "B" battery current and prevents oscillations.

A Page for the Novice

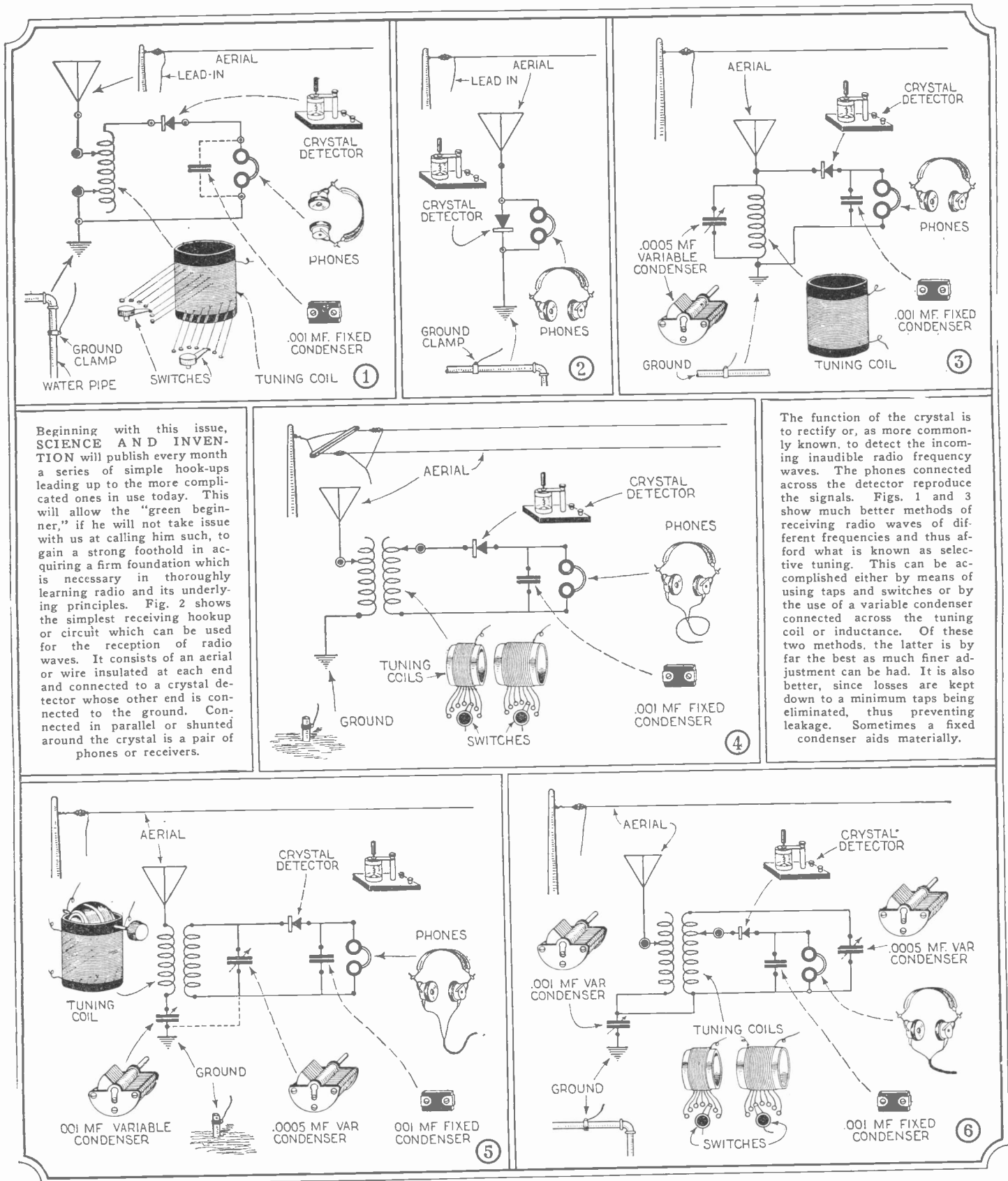

Beginning with this issue, **SCIENCE AND INVENTION** will publish every month a series of simple hook-ups leading up to the more complicated ones in use today. This will allow the "green beginner," if he will not take issue with us at calling him such, to gain a strong foothold in acquiring a firm foundation which is necessary in thoroughly learning radio and its underlying principles. Fig. 2 shows the simplest receiving hookup or circuit which can be used for the reception of radio waves. It consists of an aerial or wire insulated at each end and connected to a crystal detector whose other end is connected to the ground. Connected in parallel or shunted around the crystal is a pair of phones or receivers.

The function of the crystal is to rectify or, as more commonly known, to detect the incoming inaudible radio frequency waves. The phones connected across the detector reproduce the signals. Figs. 1 and 3 show much better methods of receiving radio waves of different frequencies and thus afford what is known as selective tuning. This can be accomplished either by means of using taps and switches or by the use of a variable condenser connected across the tuning coil or inductance. Of these two methods, the latter is by far the best as much finer adjustment can be had. It is also better, since losses are kept down to a minimum taps being eliminated, thus preventing leakage. Sometimes a fixed condenser aids materially.

Fig. 4 shows an arrangement whereby much finer tuning can be accomplished and what is known as "interference" obviated to a great extent. It is known as an "inductively coupled" circuit. The radio wave is picked up by the antenna and then traverses the primary circuit, where tuning is accomplished by means of a switch and the necessary taps. By means of the phenomena of induction, the radio frequency currents are induced into the secondary circuit through the inductance. The rest of the circuit, as can be seen, is similar to the single circuit receiver as shown in Figs. 1, 2 and 3. The space between the primary and secondary inductances is what is known as the degree of coupling between the primary and secondary

circuits. By varying this distance, in conjunction with the other necessary tuning devices, extreme selectivity can be obtained. The more accurate the tuning, which is attributable to the degree of sharpness which can be obtained, the less interference from undesirable stations will be experienced. The best conditions for distant reception and maximum volume lies in the use of carefully soldered joints and well designed layouts. Figs. 5 and 6 are simply modifications of Fig. 4 and are much superior in that extremely fine tuning can be obtained by the use of variable condensers in both primary and secondary circuits. Sometimes a wire connecting the primary and secondary circuits as shown in Fig. 5 is very helpful.

Radio Oracle

In this Department we publish questions and answers which we feel are of interest to the novice and amateur. Letters addressed to this Department cannot be answered free. A charge of 25c. is made for all questions where a personal answer is desired.

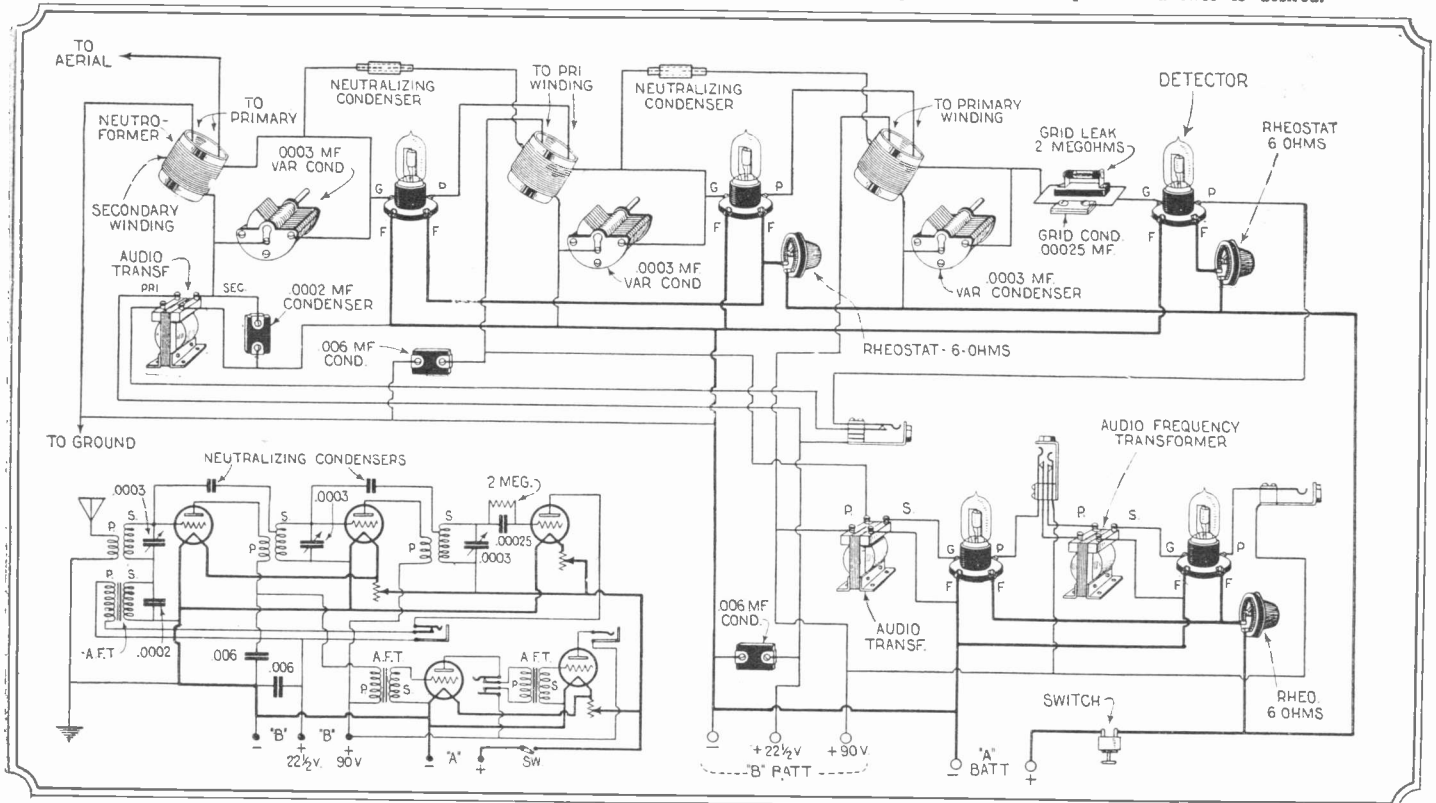

Those who have a four tube reflexed neutrodyne will find that an added stage of audio frequency amplification will vastly improve the volume on distant stations. The diagram shows explicitly how this can best be done. It is best, perhaps, to rewire the set completely for superior results.

REFLEX NEUTRODYNE

(323) James J. Ashton, Pensacola, Fla., asks:

Q. 1. Can you give me a diagram for adding one stage of audio frequency amplification to my four tube reflex Neutrodyne receiver?

A. 1. The above diagram gives in full detail the exact wiring that is employed to add one additional stage of audio frequency. It is best to rewire your set completely, so the diagram shows the circuit as one complete set. The only additional parts you will need will be a double circuit and single circuit jack, a four to one audio frequency transformer, a six ohm rheostat and a standard socket.

THERMAL AMMETER

(324) Stuart Thompson, Jersey City, N. J., asks:

Q. 1. What is the basic principle of operation of the thermal ammeter and how does it differ from the ordinary types of ammeters?

A. 1. The formula $P = RI^2$ represents the basic principle of the thermal ammeter where P is the power consumed as heat in the instrument. The deflection of the pointer of the instrument depends directly upon the heating effect of the current. In order that the relationship of P to I, the current, should remain constant so that a given deflection will always correspond to the same amount of current, it is necessary that R, the resistance of the instrument should not

change with the frequency. To accomplish this, the conductor must have a very small cross-section and the working element of a thermal ammeter must be a fine wire or a very thin strip of metal. An error of not more than 1% is allowed in instruments used in most ordinary radio work over any range of frequency employed. Thus for the ordinary instrument, a copper wire of 0.08 millimeters in diameter is used. As can readily be seen, a single wire of this size can carry at best, only a few amperes, because larger currents would overheat the wire and perhaps burn it up. Contrary to general opinion, the length of the wire is not important. It is only long enough so that the current distribution within it is not appreciably altered by the terminals to which it is connected. Such instruments when properly constructed may be calibrated with direct current or low frequency alternating current and the calibration assumed to be correct at high frequency. Of course, if possible, it is always best to calibrate the ammeter by comparison with some recognized standard at the frequencies at which it will be used. At the high frequencies, it must be remembered that errors in the readings are liable to occur. Thus, not all the current traverses the wire element, but some of it is shunted through the dielectric or the material of which the case of the meter is made. However, the hot wire ammeter of the ordinary design will give fairly accurate readings. For measuring radio currents of about 0.003 to 3 amperes it must be borne in mind that it is the cheapest meter obtainable.

INTERFERENCE BY RADIATION

(325) William Shaw, Meadville, Pa., asks:

Q. 1. Kindly publish information as to which of the following sets cause interference by radiation.

- *Autoplex
 - Neutrodyne
 - Ultradyne
 - *Single Circuit Regenerative
 - *Three Circuit Regenerative
 - *Cockaday Four Circuit
 - *Reinartz
 - Reflex
 - *Ultra Audion
 - Radio Frequency Tuned Receiver
- Note—Those marked with an asterisk, *, radiate.

The only way to know best when a receiver is radiating is by actual test for it is not always radiating when a squeal is heard in the phones. This can best be done by arranging with a neighbor to listen in. In any case, the listener must have his set oscillating.

CORRECT PHRASEOLOGY

(326) Richard Coleman, Sioux City, Iowa, wants to know:

Q. 1. Will you kindly decide for us which is the correct phrasing for a 201A, UV-199 or other receiving tube?

A. 1. While audions are often called tubes, lamps, valves, electron relays and bulbs, the proper phraseology would be to call them by their correct trademarked name such as UV-201A, UV-199, C-300, etc.

WANTED!!! RADIO ARTICLES

WE want descriptions of new radio ideas which you have worked out in practice. Take photographs of the important parts and make pencil or pen and ink sketches of the hook-ups or mechanical details, et cetera. We are particularly

desirous of obtaining new hook-ups and descriptions of single tube sets, reflex and other types which have proven satisfactory. We like articles on new single tube receptors. We will pay good prices for your ideas.

—Editor.

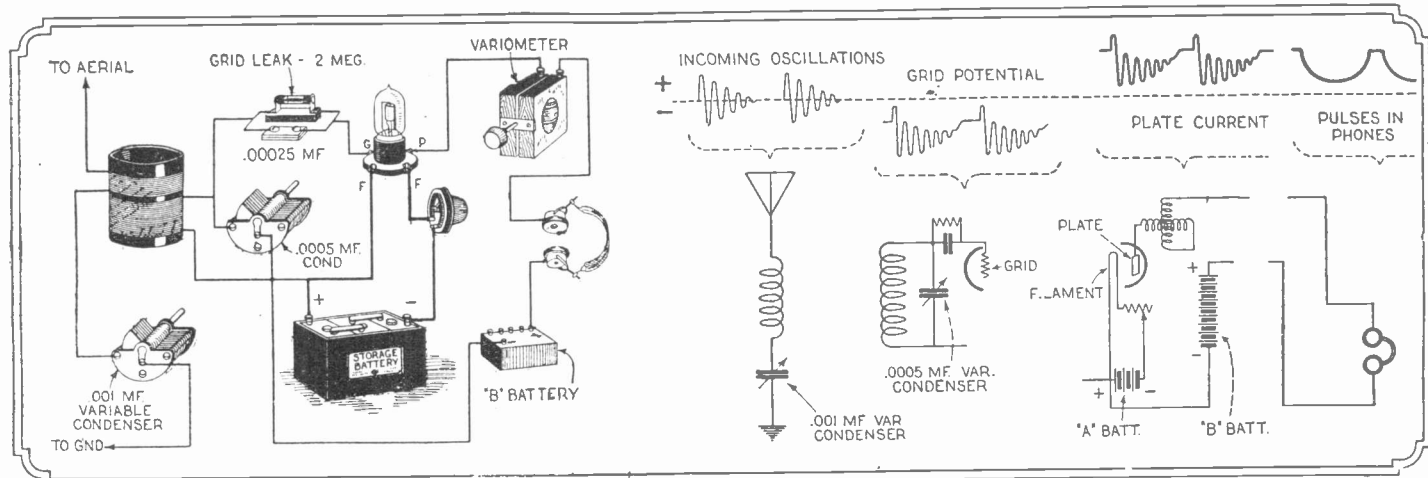

Just what happens in the different parts of a simple regenerative circuit is depicted here. Memorize the diagrams. They will help you in solving and understanding more complicated hook-ups.

FUNDAMENTALS

(327) George Davis, West New York, New Jersey, asks:

Q. 1. Kindly show and explain the various wave forms and transformations in a simple regenerative circuit?

A. 1. In the antenna circuit (Fig. 1), the incoming oscillations are absorbed to a maximum degree if the circuit is in resonance with the wave. From the primary inductance, the energy is transferred to the secondary circuit (Fig. 3), in which it assumes the wave form as shown in the accompanying sketch. This is due to the rectifying action of the detector. As the current in the plate circuit is always direct and varies at radio frequency, its wave form is shown depicted in No. 3. Due to the responsive action of the diaphragm in the phones, what is known as the actual value of the current fluctuations in the plate circuit are reproduced, assuming the variations as shown in 4.

PHASE ANGLE

(328) George F. Dowell, Chatham, N. J., asks:

Q. 1. Kindly explain in full what is meant by phase angle?

A. 1. Ordinarily in taking up the study of electro-motive force and current, the element of time is not always taken into account. It is only done so when we speak of electricity in terms of energy, kilowatt hour, horse power hour, etc. In direct current, phase angle does not exist, since the current and voltage generated rise and fall together. In alternating current circuits, both the current and the voltage are alternating, that is, each rises from zero to a maximum value in one direction and back to zero and maximum in the other direction. These two alternations are what is known as a complete cycle. When the current and voltage start from zero and reach a maximum at the same instant and return to zero and reach a maximum in the opposite direction at the same time, they are said to be in phase. Whatever their positive or negative values may be, whether one is larger than the other, the voltage must

????????????????????????????????

**What Is It?
\$20.00 Prize
By HUGO GERNSBACK**

HERE is a puzzle that may well tax your ingenuity. SCIENCE & INVENTION offers \$20.00 for the best solution of the puzzle. This puzzle will be known as the "Five Sense Mystery". The subject under consideration is an inanimate thing—meaning that it is not living.

- You can taste it;
- you can smell it;
- you can hear it;
- you can see it and,
- you can feel it,—

in other words you use all of your five senses. Yet, and most important, you must never touch the particular thing.

Although this may seem impossible, it not only can be readily done, but you probably have done it many times yourself.

The particular thing is found in almost every household. It is not, for instance the wind, the ocean, etc.

There will be one prize of \$20.00 for the best answer to the correct solution. The prize will go to the person who not only gives the correct solution, but gives the solution in the shortest amount of space in the simplest language.

Should two contestants submit the same answer, the same prize will go to both. This contest closes Feb. 15, 1925.

Address all replies to Editor, Five Sense Mystery, c/o this Publication, 53 Park Place, N. Y. C.

reach its maximum or minimum at the same time the current does, if both are in phase.

However, if the voltage reaches a maximum before the current does, the voltage is

said to be leading the current and the current is said to be lagging. Usually, it is spoken of as either lead or lag of the current referred to the voltage where circuits comprise inductance or capacity. Even in our receiving sets such conditions exist and there is always a phase difference between the current and voltage. It is customary to measure this difference in degrees. Thus, when the phase angle difference is known to be 90°, the current is either leading or lagging the voltage; when one is maximum, the other is zero. The radian, an arc whose length is equal to that of the radius of its circle (5 F. 296°) is often used.

Where a circuit comprises resistance only, the voltage and current are always in phase. If it were possible to eliminate the resistance from a circuit leaving inductance only, the current would lag the voltage by 90°; also, if the resistance were removed from a circuit leaving capacity only, the current would lead the voltage by 90°. However, since resistance is always present in any circuit, the 90° phase angle is never obtained. Whether the current lags or leads, the predominant value of inductance or capacity determines this.

The action of a current affected by inductance may be compared to inertia in mechanics. When near the end of a single alternation, with the resultant decrease in current value, the inductive effect tends to oppose this diminution and continue the flow. This effect can be readily observed by breaking the circuit composed of a large inductance in series with an alternating current source. Promiscuous arcing across the key contacts will also show the great tendency of the current to continue its flow. The same applies when the current is reaching its maximum value. It is choked down or opposed by the inductance and at any one instant the momentary value of the current is less than the momentary value of the voltage divided by the resistance. Thus either capacity or inductance tends to smooth out an alternating current and the difference between the instantaneous values of current and the voltage is what is known as the phase angle between them.

DeForest and Fessenden—Read Their Biographies

In the October issue of *Radio News*, there started a biography of Dr. Lee DeForest, inventor of the Audion. This biography will run for 12 months in *Radio News* and we hope all SCIENCE

AND INVENTION readers will read this important work by the famous inventor. In the January number Prof. Reginald A. Fessenden's biography will start.

INTERESTING ARTICLES TO APPEAR IN THE JANUARY ISSUE OF RADIO NEWS

- The Radio on the ZR-3. By Captain H. C. Flemming.
- A Zero Carrier-Wave Broadcast Transmitter. By G. H. Dacy.
- Super-Power Broadcasting. By Louis Frank.

- Beginning: The Inventions of Reginald A. Fessenden
- The Discovery of the Oscillating Crystal. By Dr. Greenleaf W. Pickard.

- Modern Radio Storage Batteries. By James M. Skinner.
- Analyzing High Frequency Resistance of Single Layer Coils. By Sylvan Harris.



LATEST PATENTS

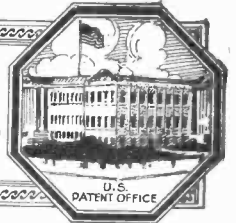

Captivating Automobile Bumper

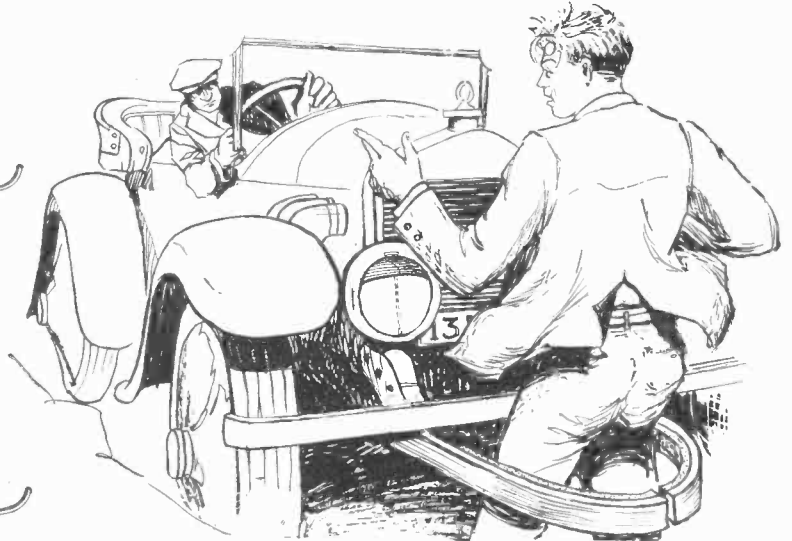
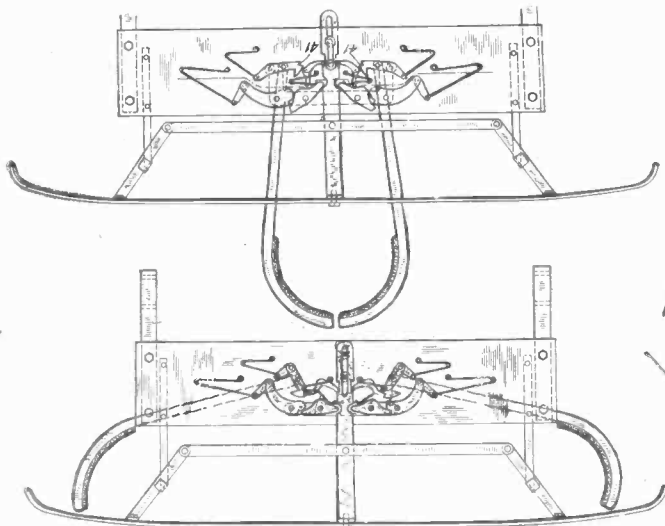

No. 1,509,991. Issued to S. Advent. This latest attachment for the front of an automobile is designed to prevent a person from being thrown aside when struck by a car. We wonder what will happen when a car,

going into a small parking space strikes the spare tire of the car in front of it and the curved arms are released. The operating mechanism of the bumper is shown at the left above.

Traffic Sign

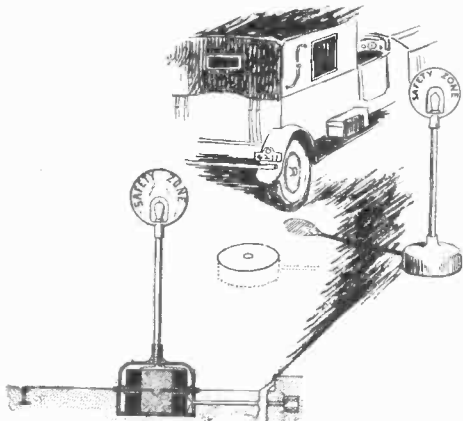

The traffic sign illustrated above can be removed from its position without necessitating the removal of any wires whatsoever. The current is supplied to the light by means of a transformer. The primary coil is set into the street at a point where the light is to be located. The secondary coil is in the base of the sign.

Ornamental Fan

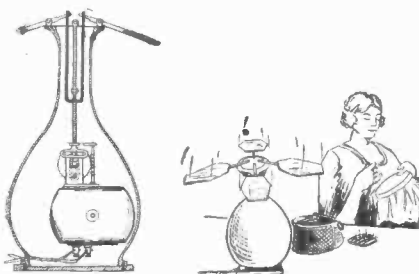

Instead of the usual circular type of fan, an ingenious inventor has patented the one shown above. An electric motor actuates a set of arms which are in turn fastened to other arms, on the ends of which are located flat surfaces as shown. These oscillate up and down, producing a breeze.

WANTED

ARTICLES pertaining to automobiles such as handy kinks, roadside repairs and anything of interest to the man who drives a car. \$50.00 in prizes every month are offered by MOTOR CAMPER AND TOURIST for such articles. Get a copy at your newsstand and see what is wanted. If your newsdealer cannot supply you send for free sample copy to:

MOTOR CAMPER & TOURIST
53 Park Place,
New York City.

Mirror Holder



No. 1,509,746. Issued to George A. Zeidler. And now, gentlemen, when we get up in the morning and proceed with our shaving, we can gird on our armor as illustrated above. This mirror is designed to be held in the desired position as shown. Here is a caution, however. Do not do your deep-breathing exercises while using this attachment.

Crocheting Ring

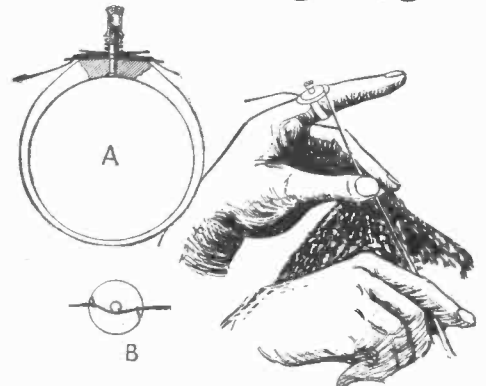

This latest patent should be of interest to all the ladies. It pertains to a ring that is of great assistance when crocheting. A cross-section of the ring is shown at A. The crocheting thread is drawn through one of the disks as shown at B and is held taut, by means of the friction between the two disks caused by the action of the small spiral spring upon the upper disk.

Engine Tell-Tale



No. 1,510,601. Issued to John H. Mount. This spark plug attachment allows anyone testing an engine to determine which cylinders are firing without recourse to a screw driver for short-circuiting the plugs. Merely pushing the handle to an upright position and listening to the sound of the motor tells whether or not that cylinder is firing.

Scientific Humor

THE SCIENTIFIC MIND

They led him out of his cell early that morning and down the short corridor to the little room. It was the first time he had ever been in the death chamber. He looked about and noted its appurtenances, the small barred window and finally the chair. As they strapped him in it he turned curiously to one of the guards.

"Does the prison generate its own electricity?" he asked.—*Louis Ginsbury.*

WU'D A PIG GO ALONG WITH IT?



CHORUS GIRL: "I bought a Super - Heterodyne receiving set for a song."

DISGUSTED RADIO FAN: "That's nothing. I bought mine for a squeal."—*N. Compton.*

WE'D STEP ON THE GAS

CHEMISTRY TEACHER: "This gas is deadly poison, what steps would you take if it should escape?"

CHARLTON: "Long ones."—*Roger M. Johnston, Reporter No. 13294.*

THE LIE DETECTOR

"A Familiar Instrument."

DINTY: "Do you believe that there is really something which can invariably tell when a man is lying?"

JIGGS: "I know it."

DINTY: "Ah! Perhaps you have seen one of the instruments?"

JIGGS: "Seen one? I married one!"—*Alexander Lozouski.*

AND A RAT IN THE HAIR

SMITH: "That woman reminds me of one of Doctor Hackensaw's creations."

JONES: "How's that?"

SMITH: "Well she has a deer face, bear knees, snakey eyes and pigeon toes."—*J. Ilivich.*



JOHN, BRING THE OTHER SIFTER

PROF.: "How long is a short circuit?"

STUDENT: "As long as it lasts."—*Harry J. Walters.*

SHOULD BE INDUCTED

PROF. OF CHEM. (eyeing empty seat): "Where's Henry?"

STUDENT: "Gone."

PROF.: "Where did he go?"

STUDENT: "Straight up."—*Richard Barrett.*

THEY ARE BOTH DISCUSSED

1ST NUT: "How does a psychic differ from a radio fan?"

2ND NUT: "I give up."

1ST NUT: "The psychic gazes at a crystal and the radio fan cusses at it."—*Charles Carter.*

FRIGID SILENCE REIGNED

PROF. TO ZOOLOGY CLASS: "And where do animals grow the most fat, around the North Pole or the equator?"

STUDENT: "Around the equator, of course."—*Robert L. Fuller.*

First Prize \$3.00

HARD ON THE HEN



PAT: "So you have a new invention. What is it?"

MIKE: "It is a revolving nest. When the hen lays an egg, the nest turns and the egg falls on some straw under the floor. When the hen turns around and sees no egg, she will think she has not laid one, and will go right back and lay another."—*Chas. Grill.*

COMING DOWN TO EARTH

FRED: "She appears planetary to me."

ED: "Has she the figure of Venus?"

FRED: "No, but she has Mars on her face."—*A. Daansen.*

WE receive daily from one to two hundred contributions to this department. Of these only one or two are available. We desire to publish only scientific humor and all contributions should be original if possible. Do not copy jokes from old books or other publications as they have little or no chance here. By scientific humor we mean only such jokes as contain something of a scientific nature. Note our prize winners. Write each joke on a separate sheet and sign your name and address to it. Write only on one side of sheet. We cannot return unaccepted jokes. Please do not enclose return postage.

All jokes published here are paid for at the rate of one dollar each, beside the first prize of three dollars for the best jokes submitted each month. In the event that two people send in the same joke so as to tie for the prize, then the sum of three dollars in cash will be paid to each one.

HE GOT THE GATE THEN!

Three boys were discussing radio distances they had reached.

1—"I got Chicago last night."

2—"Well, I stuck my set outdoors and got Chile."

3—"That's nothing, I put my set in the sink and got Grease."—*Everett Shepard.*

THE ANNOUNCER WAS NO CAKE EATER

WIFE: "How do you like my cake? I got the recipe over the radio."

HUSBAND (trying to bite into the cake): "That recipe must have been broadcast through the Rocky Mountains."—*Ralph Womer.*

HE TIRES OUR READERS

This month's strychnine sundae goes to the new mechanic who thought balloon tires were first designed for the Shenandoah.—*C. E. Weinland.*

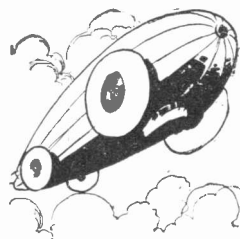

DISTANCE DOESN'T LEND ENCHANTMENT THIS TIME

The most recent law discovered in physics is:

The amount of talking done in a classroom is directly proportional to the distance from the teacher.—*G. Fashena.*

ONE EXACT ANSWER

"If your father heard your stupid answers, it would make him turn over in his grave."

"It couldn't. He was cremated."—*Charles A. Hall.*

THIS WAS A KNOCKER

AVIATOR (after doing a tail spin): "What's that peculiar knock I hear?"

PASSENGER: "Oh, that's just my heart!"—*Clifton Ask.*



LOCAL INTERFERENCE

BASHFUL MAID TO SUITOR: "Don't you think you had better go now?"

ABSENT-MINDED RADIO ANNOUNCER: "Er—a—yes, good-night. W-S-O-S signing off at 11:45 Eastern Standard Time."—*H. Edw. Bennett, Reporter No. 13,211.*

A LABORIOUS LOCHINVAR

HE: "When I first saw you, your beauty electrified me."

SHE: "When I first saw you your dumbness shocked me and your sparking disgusted father, while your gassing asphyxiated mother."—*Richard Barrett.*

COLD FEET, NO DOUBT

Student coming from laboratory after examination. "Congratulate me old top, at last I have made a scientific achievement."

SECOND STUDENT: "What is it?"

FIRST STUDENT: "I have obtained absolute zero."—*Olin T. Mathews.*

AND THAT AIN'T ALL

PROF.: "What did Archimedes discover when he was taking his bath?"

BRIGHT BOY: "Dirt."—*Marshall Smith.*



HE'S QUICK

The man next door describes electricity as being the soonest stuff he ever knew of.—*Les Van Every.*

SOCIAL PARADOX

"Ho, hum!" yawned the electric fan, "I give a lot of people a cool reception, but they like me for it."—*Les Van Every.*

A SHOCKING ANSWER

LITTLE BOY TO FATHER: "Papa, why do people call an old horse a 'plug'?"

BOY'S FATHER: "'Cause they only have a spark of life left in them, son."—*Harry Walters, Reporter No. 13,835.*

A HANDSOME DEFINITION

"What is the difference between a radio bug and a bankrupt business?"

"One takes receivers in hand—receivers take the other in hand."—*Sam Y. Caldwell.*



THE ORACLE



The "Oracle" is for the sole benefit of all scientific students. Questions will be answered here for the benefit of all but only matter of sufficient interest will be published. Rules under which questions will be answered:

1. Only three questions can be submitted to be answered.
2. Only one side of sheet to be written on; matter must be typewritten or else written in ink, no penciled matter considered.

3. Sketches, diagrams, etc., must be on separate sheets. Questions addressed to this department cannot be answered by mail free of charge.

4. If a quick answer is desired by mail, a nominal charge of 25 cents is made for each question. If the questions entail considerable research work or intricate calculations a special rate will be charged. Correspondents will be informed as to the fee before such questions are answered.

PICTURE ENLARGER

(1783) Jack Kunz, Guttenberg, New Jersey, says he has a 3A Kodak and desires to magnify small insects such as flies ten or fifteen diameters. He asks:

Q. 1. Will you kindly describe the process of doing this?

A. 1. In order to take enlarged pictures such as you desire with your 3A Kodak, it will be necessary to add an extension in the form of a large rectangular frustum such as shown in the picture herewith. You can, however, instead of using this, obtain a double convex lens, placing it at the focal distance from the object and viewing it with your camera, take the desired picture.

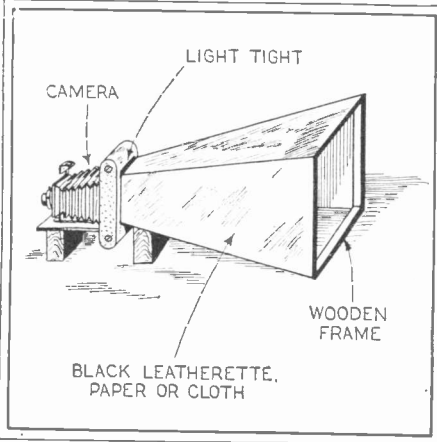

By constructing a rectangular frustum from narrow strips of wood and covering the whole with black leatherette paper, a handy picture enlarger is obtained.

THE EYE

(1784) Robert Hayes, Baltimore, Md., asks:

Q. 1. Is it true that the image on the retina of the eye is inverted and that the brain rectifies it?

A. 1. Every object seen, no matter at what distance, always gives an inverted image on the retina.

Q. 2. Can you give me more information about the eye?

A. 2. The human eye resembles a camera in many respects. It has a series of convex lenses, a cornea, aqueous humor, vitreous humor and crystalline lens in order to form a clear

image of a near or distant object on the retina, the screen at the back of the eye. A shutter, the eye lid, excludes the light when the optic is not in use and an iris diaphragm, the iris, regulates the amount of light entering. A great variety of marvelous intricate bits of mechanism, tiny muscles, move the orb about and point it toward the object to be seen. In its normal state, the eye is a far more wonderful instrument than the camera. In the first place, it is automatically focused both for near and distant objects, although not by a to and fro movement of the lens as in the camera, but by a change in the focal length of the crystalline lens

Nearsightedness or myopia is usually due to the fact that the retina is too far from the cornea so that the rays of light from a distant object are brought to a focus in front of the retina. That is, a person suffering from this defect of the eye can see clearly only those objects which are close to him. To correct this fault, a concave lens is fitted to the eye and has the effect of pushing the image back to the retina.

Farsightedness or hypermetropia is usually due to the fact that the retina is too close to the cornea so that the rays of light from an object not very distant, are brought to a focus behind the retina. Thus a person suffering from this defect of the eye can see clearly only those objects which are further distant. To correct this fault, a convex lens is used to bring the image back to the retina.

Interesting Articles to Appear In January Issue of "The Experimenter"

How to Make the New Mercury Electro-Generator, By C. A. Oldroyd.

Simple Experiments in Chemistry, By Raymond B. Wailes.

Striking Experiments in Diffusion, By Earle R. Caley.

Single Tube Reflex Experiments with the Hook-Up Board, By Clyde J. Fitch.

How Much Does Your Amplifier Amplify? By William Grunstein.

A Detector and Two-Stage Amplifier Unit, By Leon L. Adelman.

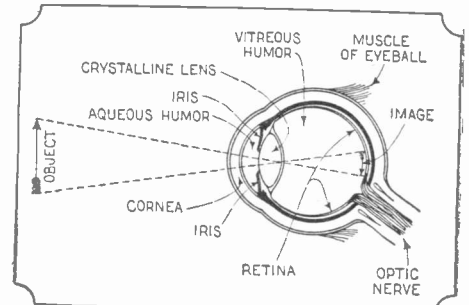

What a wonderful and intricate piece of mechanism is the human eye! Note how every object seen is inverted on the retina and conveyed to the brain which rectifies it.

Astigmatism is due to a defect in the curvature of the cornea and of the crystalline lens so that the rays of light from an object are not all brought to the same focus and the image is not, therefore, sharply defined. A person suffering from this defect of the eye cannot see anything distinctly, though in many cases he is not aware of this fact until his eyes have been tested by an oculist and the proper lens adjusted to them.

It is a well known fact that defects of vision place a serious strain upon the nervous system and are often the unsuspected cause of headaches, indigestion, dizziness and even of apparent dullness. It must be remembered that the eyes are our most wonderful organs and that we should be very careful of our vision.

OUR \$12,000 PRIZE CONTEST

IT will be noted from recent issues and the present one that our prize contest has been a whale of a success. Over \$1,500 has been paid out this month for worth while contributions to SCIENCE AND INVENTION, either in pictures, suggestions, ideas or articles. We now have on our staff, close to 16,000 correspondent reporters who are scouting the world for

new material that can be written up for SCIENCE AND INVENTION. And the formula is simple—just keep your eyes open. Even if you were totally deaf or blind, you could still win a prize by simply using your head and sending us ideas of a scientific nature, or of a nature directly or indirectly attached to new inventions.

FURTHER ARTICLES FOR FEBRUARY SCIENCE AND INVENTION

Cold Light Substitute for X-Rays

How to Etch Metal

Gas Warfare and Methods of Combatting It

Our Digestive System,

By Ismar Ginsberg, B. Soc., Chem. Eng.

Latest Movie Exposés

Hot Air Versus Steam and Hot Water Heat, By H. Winfield Secor

Animals That Make Themselves Invisible, By Dr. Ernest Bade.

How to Make Rubber Balloons

Useful Cements—How to Make Them

A New American Helicopter—How It Flies Everyday Chemistry,

By Raymond B. Wailes.

Vacuum Tube Testers,

By Leon L. Adelman.

FREE INFORMATION

IF you want additional information concerning any of the subjects illustrated and described in this number of SCIENCE AND INVENTION we shall be glad to give you other data we have at our command. To make this work as easy as possible for our editors, please be brief. Write only on one side of the paper and state exactly in a few words just what it is you desire further information on. We have the original manuscripts and drawings of many of these articles in our files and can furnish much additional data in most cases. Please do not fail to send stamped and self-addressed envelope. Make all questions concise and specific.

Address all inquiries of this nature to INFORMATION EDITOR c/o Science and Invention, 53 Park Place, New York City.

RANGE BOILER CONNECTIONS

(1785) James R. Lunday, Jacksonville, Fla., says he has recently purchased a boiler for installation in his country bungalow and would like to install it himself. He asks:

Q. 1. Can you kindly give me piping connections for use with and without the use of gas or kerosene heater?

A. 1. As clearly shown in the drawing, the connections to the waterback of the stove and those to the boiler are depicted. It has been found that if pipe connections are made six inches from each end of the boiler, the best arrangement is obtained. The standard boiler

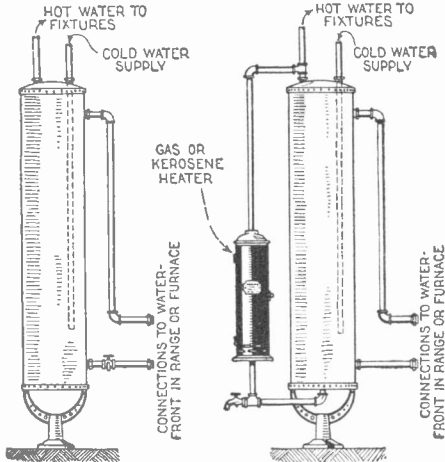

Range boilers can readily be installed by the average layman. The above diagram shows how to do it properly so as to pass the fire underwriters' rules.

sizes and tappings make it entirely possible for you to do the entire job yourself, thus effecting a great saving. For quickly heating the water in the boiler, both the water front and the gas heater connections can be used. At any rate, care must be taken to insure watertight connections and that the boiler is fastened in such a way as to entirely meet the requirements of the underwriters.

LIQUID AIR

(1786) Albert Gec, Milwaukee, Wis., asks: Q. 1. Who first liquified air and how? A. 1. About 1878 Cailliet in Paris and Pictet in Geneva, both liquified air. The method used was to subject the gases to great pressure and cool them to the lowest point attainable, by evaporating liquid sulphur dioxide under diminished pressure.

The compressed gases were then allowed to suddenly escape and the cooling resulting from the expansion was sufficient to cause condensation.

The present day methods of obtaining liquid air on a large scale were devised by Dr. Linde in 1895, and by others, and are based on the progressive cooling of a stream of escaping gas, by its own expansion. The French scientist, Georges Claude is one of the highest authorities on the subject.

HELIUM

(1787) Charles Marcos, Bridgeport, Conn., wants to know:

Q. 1. What is the density and boiling point of helium?

A. 1. Helium boils at minus 268.5° C. and has a density of 0.15.

ELECTRO-PLATING FISH

(1788) Kary Canatsey, Idola, Kansas, wants to know:

Q. 1. Kindly give me complete information as to how the fish was electro-plated as described in the July issue.

A. 1. The process for electroplating the fish is as follows:—

Use an ordinary plating solution of the same strength as is used in small metal work. The current strength is two amperes at 4 to 6 volts. The fish is first thoroughly cleaned on the inside, it being cut open by a long slit in one side. It is then filled with molten wax or other plastic material.

The fish when prepared is fresh from the water, having just been caught. It is given a coat of shellac and then coated with graphite. It is then placed in the plating solution. Care must be taken in handling as the fish will collapse if not properly stuffed and if the plating solution and current density are too strong.

WEATHER FORECASTER

(1789) A. E. Serviss, Baltimore, Maryland, asks:

Q. 1. How is a storm glass made and how is it read?

A. 1. The method of making a storm glass is as follows: Two and one-half drachms of camphor are dissolved in 11 drachms of alcohol, while 38 grains each of saltpeter and sal ammoniac are dissolved in 9 drachms of water and the two

solutions are mixed. The mixture is then poured into a test tube which is carefully corked and sealed. A pin hole is made in the cork by forcing a red hot needle through it. Fine weather is indicated by the presence only of the clear liquid with a sediment (somewhat like a precipitate) on the bottom of the tube. Rain is indicated by a steady rise of the sedimentary deposit, the liquid being very clear. An approaching storm is indicated by the appearance of the substance at the top of the tube in a leaf-like form, the liquid being in a turbid and fermented state. In winter the substance is generally whiter and nearer the top than in summer. If a portion of the substance crystallizes on one side of the tube, winds may be expected from that direction.

Q. 2. What is the weight of the earth and what is the density upon which it is computed?

A. 2. The weight of the earth is six sextillion tons. The result is based on using an average density of 5.52.

EFFICIENCY OF BOILERS

(1790) Maxwell J. Fine, Oklahoma City, Oklahoma, asks:

Q. 1. What is the efficiency of up-to-date large steam boilers?

A. 1. According to exhaustive tests conducted by the Babcock & Wilcox Co. the average efficiency of steam boilers lies between 50% and 60%.

Using a good grade of anthracite whose heat value approximates 14,800 B. T. U. per pound, equal to the heat required to evaporate 15.26 lbs. of water from 212° F., with an efficiency of 60%, only about 9.15 lbs. of water will be evaporated by one pound of coal. There are several important questions to be taken into account; the quality of the coal, the purity of the water, the thickness of the scale in the boiler and the care in firing. All are important in determining the practical efficiency.

IMPORTANT

TO NEWSSTAND READERS

IN order to eliminate all waste and unsold copies it has become necessary to supply newsstand dealers only with the actual number of copies for which they have orders. This makes it advisable to place an order with your newsdealer, asking him to reserve a copy for you every month. Otherwise he will not be able to supply your copy. For your convenience, we are appending herewith a blank which we ask you to be good enough to fill in and hand to your newsdealer. He will then be in a position to supply copies to you regularly every month. If you are interested in receiving your copy every month, do not fail to sign this blank. It costs you nothing to do so.

To Newsdealer

Address

Please reserve for me.....copies of SCIENCE & INVENTION every month until I notify you otherwise, and greatly oblige,

Name

Address

PRESSED FUEL

(1791) Henry Miller, Washington, D. C., asks: Q. 1. How is pressed fuel made?

A. 1. Anthracite dust is mixed with 10% of its bulk of dry pitch. The pitch is obtained by the fractional distillation of tar, at a temperature of 572° F. The mixture is heated by steam to 212° F., at which temperature the pitch acquires its cementing properties. It is then passed between two rollers on the periphery of which are a series of semi-oval cavities, thus pressing the mass into about the shape of an egg. The globules are then cooled for several minutes and are ready for shipment. Sometimes sawdust is mixed with it. Thus ordinary waste coal dust is converted into a valuable product.

BEAUFORT WIND SCALE

(1792) James V. Grant, Poughkeepsie, N. Y., asks:

Q. 1. Kindly publish the Beaufort wind scale.

A. 1. The scale you desire is given below:

	Miles per hr.
0	Calm 0-3
1	Light air 3-8
2	Light breeze 8-13
3	Gentle breeze 13-18
4	Moderate breeze 18-23
5	Fresh breeze 23-28
6	Strong breeze 28-34
7	Moderate gale 34-40
8	Fresh gale 40-48
9	Strong gale 48-56
10	Whole gale 56-65
11	Storm gale 65-75
12	Hurricane 75-

THERMO-COUPLES

(1793) John Larimer, Staten Island, New York, wants to know:

Q. 1. What metals are used in sensitive thermo-couples?

A. 1. Thermoelectric pyrometers employ platinum against platinum-iridium or platinum-rhodium alloys for high precision work. The alloys contain 10% of iridium or rhodium. The cost of these thermo-couples, however, is very high, so for industrial purposes, cheaper metals and alloys are used, such as copper, nickel and iron.

The melting point of pure tungsten is 2900° C or 5252° F.

WOOD

(1794) Richard Langley, Philadelphia, Penna., asks:

Q. 1. Will you kindly publish a list of the various useful woods?

A. 1. We are giving you the list you desire below:

Alder	Apple	Ash
Box	Cedar	Cherry
Dogwood	Ebony	Elm
Hemlock	Hickory	Holly
Ligun vitae	Linden	Locust
Oak, Live	Oak, White	Oak, Red
Spruce	Sycamore	Teak
Balsa	Bamboo	Beech
Chestnut	Cork	Cypress
Fir	Gum	Hackmatack
Juniper	Hornbeam	Larch
Mahogany	Maple	Mulberry
Pine, White	Pine, Yellow	Poplar
Walnut	Willow	

Balsa wood is the lightest, weighing only 10 lbs. per cubic foot, ebony being the heaviest, weighing 76 lbs. per cubic foot.

FALLING HAIR

(1795) Joseph H. Krantz, Woodridge, New York, asks:

Q. 1. Is there anything that I can do to prevent the continual loss of hair?

A. 1. The head must be thoroughly cleaned; first by washing and then by shampooing.

A preparation of salicylic acid 1 part, precipitate of sulphur 3 parts and rose water 25 parts are rubbed into the scalp in a most thorough fashion. This will stimulate the hair follicles and sebaceous glands to activity.

The treatment is continued for five nights, when on the sixth and seventh, shampoos are in order. By steady application and perseverance over a period of from four to eight weeks, the hair becomes more lifelike and in most cases will begin to take a firmer hold with a luxurious growth resulting.

Q. 2. What is Pinaud's Eau de Quinine composed of?

A. 1. The composition of this hair tonic is as follows:

Quinine Sulphate, 2 parts.
Tincture of Krameria, 2 parts.
Spirit of lavender, 10 parts.
Glycerine, 15 parts.
Alcohol, 100 parts.

DICYANIN GLASSES

(1796) Milton Brady, Philadelphia, Pa., asks: Q. 1. How can I make a pair of dicyanin glasses so as to enable me to view the human aura?

A. 1. Very little success as yet has been accomplished by the means of using dicyanin glasses to view the human aura. You can readily make a pair of such glasses by getting two pairs of cheap glasses and fastening them together about

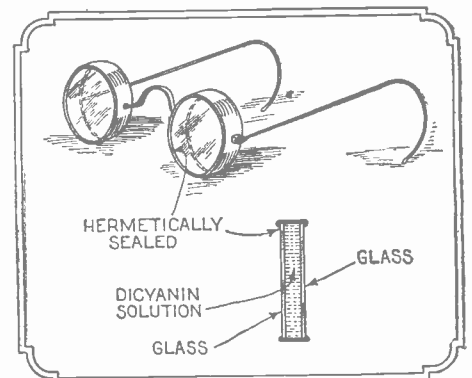

By using a small metal band to fasten two pair of glasses together with the aid of a bit of sealing wax, so-called "dicyanin glasses" for viewing human aura are readily made.

1/4th of an inch apart after having filled the space between them with an alcoholic solution of dicyanin. A very dark room and a solution of the correct strength, which can be obtained only through experimentation, may enable one, with a vivid imagination, to view the human aura.

Awards in \$1000 Monthly Contest

The Regular Departments Pay Prizes of Their Own. Authors on Contract Receive Their Own Rates; this, With Other Special Payments Makes the Total Paid for Articles in Excess of \$1500.00 Monthly.

FIRST PRIZE \$100.00

Models of Famous Inventions, by Walter Sonneberg..... 884 and 885

SECOND PRIZE \$75.00

Solar Eclipse, by Donald H. Menzel, Ph.D. 890 and 891

TWO PRIZES OF \$50.00 EACH

Solar Eclipse of Jan. 24, 1925, by Isabel M. Lewis, M.A. 889

Nature of Heat in Experiments, by Raymond B. Wailes 898 and 899

THREE PRIZES OF \$35.00 EACH

Unique Clocks, by H. E. Zimmerman 877

Burning Oil Forms Defense, by L. B. Robbins 878

A Remarkable Six Tube Receiver, by Grandon Lyons 911

FIVE PRIZES OF \$25.00 EACH

The Snow Burner, experiment suggested by Harry E. Hale. 870

Little Known Dirigible Facts, by Wm. P. Sullivan, M.E. 874

Mystifying Juggler Tricks, by L. J. Smith 892

Amateur Surveyor's Transit, by H. E. Balfour 901

Tool Set from Old Files, by G. A. Luers 902

FIVE PRIZES OF \$20.00 EACH

Building Houses While It Rains, by J. G. Pratt 871

Future Zeppelin Design, suggested by J. Von Stein 875

Steam-Driven Model Boat, by Dr. Ernest Bade 900

Drill Press, by Harry B. Luessen 902

A Miniature Crystal Set, by W. J. Rittall 910

TEN PRIZES OF \$15.00 EACH

Swiftly Growing Plants, by S. Leonard Bastin 879

Cloud Filter, by Charles T. Belden 900

Housewife's Sink Kink (author please send address) 901

Sugar Motor, by Dr. Russell G. Harris 902

Thermit Welding Simplified, by Chas. D. Tenney 904

Battery Control Panel, by Evermont Fiesel 945

Crystal Standby, by Samuel M. Malkin 947

Unique Vernier, by Irving Mower 947

Radio Chandelier, by Donald Crow 949

Duplex Tuning Unit, by George E. Johnson..... 950

FIFTEEN PRIZES OF \$10.00 EACH

Jensen Clock, by Joseph Lukacs 877

Prague Clock, by Herbert Slouka 877

Compass, by Dr. Alfred Gradenwitz 879

Heater, by John P. Stoddard 901

Trap Drums, by John W. Reed 903

Vanishing Smoke, by Francis D. Wittemore 903

Hygrometer, by L. M. Bingham 904

Screen Stretcher, by Edward Evers 907

Loud Speaker, by L. I. Dupuy 946

Battery Switch, by L. Ringer 946

Tin Can Cover Dial, by E. R. Gilmore 948

Multiple Detector, by F. J. Bruno 948

Panel Detector, by Samuel M. Malkin 949

Jack Switch, by Halbert H. Clark 950

Tangential Control, by E. M. Abbott 950

TEN PRIZES OF \$5.00 EACH

Watch Compass, by Dr. Albert Neuburger 900

Burning Steel, by A. A. Blumenfeld 903

Savings Bank, by E. Corral 904

Top Remover, by Ingolf Kvamme 904

Can Opener, by Edward Evers 904

Simplified Spirals by J. Mursand 904

Removing Stains, by Howard C. Kramer 904

Simple Switch, by A. Horsfall 945

Rheostat Dial, by George Vatcher, Rep. No. 9608 946

Socket Suspension, by J. Futterman 948

FIFTEEN PRIZES OF \$2.00 EACH

Vernier Dial, by R. H. Watkins 948

Location Finder, by K. Liu 949

(No further Entries)

\$13,320.00 in Prizes Paid Last Year

WITH the December issue our \$12,000 a year prize contest came to a happy conclusion. Not only did we pay out \$12,000 in prizes as announced in our November, 1923 issue, but we did actually pay out in prizes alone, not less than \$13,320.00 to 1,112 winners. These prizes every month ranged from the first prize of \$100.00 down to the smallest prize winner of \$1.00 each.

Up to the time of going to press, SCIENCE & INVENTION had no less than 18,590 reporters scattered over every section of the globe. These reporter-contributors have sent in an avalanche of material, and their efforts have been fruitful in that they have won prizes.

SCIENCE & INVENTION aims to print the news first, if it is inter-

esting and to otherwise excel in the reporting of science and invention. Small wonder then that with the enthusiastic co-operation of our thousands of Reporter-Correspondents, SCIENCE & INVENTION today occupies an enviable position in the scientific press.

The \$12,000.00 prize arrangement has worked out so satisfactorily during the year just closed that we have decided to extend it for another year and we hope that our correspondents will be as successful in winning prizes for the coming year as they have been during the past one. We wish to thank all of our friends for their co-operation and wish them the best of luck for the coming year.

Note New Prize Schedule.

Here Is How You Can Get in the Contest:

\$12,000 or More in Gold

EVERY month SCIENCE AND INVENTION pays \$1,000 or more in gold in prizes. Every text article published will receive a prize—(most of the departments have awards of their own which they give every month). Ideas are what the Editors want. The ideas must be told simply, so that your mother or your sister can understand them—in pictures or sketches or both. But the idea must be new and must have something to do with science or invention.

The Editors want pictures and sketches—must have them—but what they want most

82 monthly prizes will be given as follows:

	FIRST PRIZE \$100.00
	SECOND PRIZE \$75.00
	2 PRIZES OF \$50.00 each
3	" " 35.00 "
5	" " 25.00 "
5	" " 20.00 "
10	" " 15.00 "
15	" " 10.00 "
10	" " 5.00 "
15	" " 2.00 "
15	" " 1.00 "

\$12,000 or More in Gold

is IDEAS. These ideas will be handsomely paid for. We have published a pamphlet showing the rules of the contest which we shall be glad to send to anyone free on receipt of a postal card with your name and address. The pamphlet gives full details, the rules and how to submit articles. The magazine itself shows you what is wanted. Study it closely and submit your ideas.

The closing date for all prize contributions is the 15th of the month preceding date of issue, i.e., the 15th of Jan. for the March issue, the 15th of Feb. for the April issue, etc.

WILL YOU BE OUR REPORTER?

IN connection with our \$12,000 prize contest announced herewith, it goes without saying that you will have to do a little work in order to win a prize. The Editors do not wish to make it hard for you, quite the contrary. We want pictures and ideas and we cannot have too many of them.

Herewith is reproduced our reporter's card. Up to now we have issued over 18,000 of these. Note in our awards how our reporters are winning prizes right along. We shall be glad to send the reporter's card free to anyone who makes an application for it. By means of this card you will be able to secure entry into industrial plants, business houses, motion picture studios, steamships, docks, public buildings, etc. This reporter's card will prove an open sesame to you in many instances. Every card is numbered and only one is given to a correspondent. A postal card from you and a request for this reporter's card is all that is necessary to obtain one. It will be sent to you by return mail. With it we will send you a pamphlet giving rules of the contest and how to proceed in order to get photographs, to send in sketches, and other information in order to obtain a valuable prize. Not only will this card help you to obtain material for this magazine, but it will train you to become a news gatherer, and will be the means of helping you to earn a good deal of money during your spare hours.

Address Field Editor, SCIENCE AND INVENTION, 53 Park Place, New York

REPORTER



SCIENCE and INVENTION

CORRESPONDENT
REPORTER'S
IDENTIFICATION

NO. 10000

L. H. Shackner

THE BEARER OF THIS CARD IS AN AUTHORIZED CORRESPONDENT-REPORTER OF SCIENCE AND INVENTION MAGAZINE. THE PUBLISHERS OF SCIENCE AND INVENTION WILL APPRECIATE ANY COURTESY EXTENDED THEIR REPRESENTATIVE.

EXPERIMENTER PUBLISHING CO.
Herbert Ball
PRESIDENT

FREE--25c Book on Wood Finishing



Tells You How To Finish Radio Cabinets



If you have a hobby for making radio cabinets, furniture, work benches, etc., you will find our Book invaluable for, naturally, you want to give your handiwork as beautiful a finish as possible.

This Book gives complete instructions for finishing all wood—hard or soft—old or new. It is the work of experts—beautifully illustrated. Gives covering capacities—includes color charts, etc. Use coupon below.

JOHNSON'S WOOD DYE (Penetrating)

Johnson's Wood Dye is very easy to apply. It dries in four hours and will not rub off or smudge—penetrates deeply, bringing out the beauty of the grain. Johnson's Wood Dye is made in 17 popular shades as follows:

- | | |
|------------------------|-----------------------|
| No. 128 Light Mahogany | No. 125 Mission Oak |
| No. 129 Dark Mahogany | No. 130 Weathered Oak |
| No. 127 Brown Mahogany | No. 110 Bog Oak |
| No. 329 Red Mahogany | No. 172 Flemish Oak |
| No. 120 Fumed Oak | No. 178 Brown Flemish |
| No. 123 Dark Oak | No. 131 Walnut |
| No. 126 Light Oak | No. 140 Early English |
| No. 124 Golden Oak | No. 180 Gray |
| No. 160 Brown Oak | |

All shades may be easily lightened, darkened or intermixed. Full directions on every label. Select the shade of Dye you want from the list above and order it from your dealer by name and number.

S. C. JOHNSON & SON, Racine, Wis., U. S. A.
"The Wood Finishing Authorities"

Johnson's Wood Dye is a dye in every sense of the word. It contains no finish whatsoever. Like most first class products it answers one purpose only—it dyes the wood—the finish must be applied over it. We recommend Johnson's Varnishes or Johnson's Polishing Wax.

Ask for a FREE copy of the Johnson Book at the best Paint or Hardware Store in your locality. Stores displaying the Johnson Service Department Sign shown below can furnish the Book and full information on how to finish wood the proper way.



S. C. JOHNSON & SON, Dept. S. I. 1, RACINE, WIS.
"The Wood Finishing Authorities"
(Canadian Factory—Brantford)

Please send me free your Instruction Book on Home Beautifying and Wood Finishing. I enclose 10c to cover postage and wrapping.

MY DEALER IS.....

My Name

Address

City and State.....

MEN WANTED

for highly-paid repair work on 16,000,000 Autos

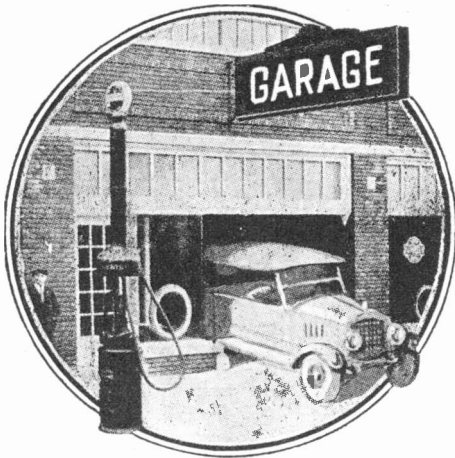

We Want Men

WE WANT MEN to learn the Auto and Garage Business. Right now there are more calls for Greer Trained Automobile men than we can supply. In 8 weeks we will make YOU an Auto or Garage expert and get you a job. You can be either an expert Auto, Truck or Tractor Repairman—Shop or Garage Manager—Salesman—Machine Shop Man—Battery Man—Tire Vulcanizer and Repair Man—Welder—Chauffeur—Electrician—anything you want to be in the Automobile, Garage or Accessory business. We train you and start you earning. Mail the coupon today for Free Book and Special Offer.

WE HELP YOU

Go In Business For Yourself

18 months ago one of our graduates started in business for himself with a capital of \$400. Today his business is worth \$30,000. Another graduate now averages \$400 to \$500 per month profit after 8 months in business. Another has retired—dependent at 40—his 8th year out of our shops. Out of more than 40,000 men we have trained, over 30,000 are now in business for themselves. You, too, can do what these men have done. Let us train you and help you get started in business for yourself. You can at least double your present earnings.

EARN WHILE YOU LEARN

We offer you a chance to earn while you learn. Our FREE EMPLOYMENT DEPARTMENT has secured thousands of part time jobs for men who have learned the auto Business in the big Greer Shops. This is a wonderful opportunity for you. See it and seize it. Mail the coupon to me today for complete offer.

FREE

This big AUTO BOOK is FREE to those who mail the coupon below. Many pages and pictures on Automobiles and Shop Training. Get it to-day—and study my Big Special Offer that comes with it.

MAIL THIS TODAY

ERWIN GREER, President,
Greer College of Automotive Engineering,
2024 S. Wabash Ave., Dept. 2903, Chicago, Ill.
Please send me FREE Book "How to Succeed in the Auto & Tractor Business" and Special Training Offer. This request does not obligate me in any way.

Name
Address

Doctor Hackensaw's Secrets

By CLEMENT FEZANDIÉ

(Continued from page 887)

the weather. So nowadays, whenever a child is born, all the hairs are destroyed at the roots and we therefore no longer have hair of any kind—neither hair nor beards. Our teeth, too, are destroyed at birth, in the bud, before they begin to plague us. You cannot imagine how strange it seemed to me to see both of you with teeth."

"Not stranger than it did to us to see that you had no teeth. The lack of teeth makes a person look awful!" cried Pep.

"Does it? Well, if you listen to the newspaper account, you will see that the thing that struck the public as most frightful about you, was not your hairiness, but your ferocious-looking teeth that make you look like cannibals. We destroy them,—not only to avoid future pain, but because teeth furnish breeding places for microbes. Our gums become somewhat hardened, and as we use only soft food, and it is predigested, we no longer need teeth. Only animals that tear or chew their food require teeth. But excuse me a minute, there's a man I should like to meet."

She left then, but returned a couple of minutes later. "It's all right," she said. "I've invited him to take an air-ride with me this afternoon."

"He's a friend of yours?" asked Pep.

"No, I never met him before. But I liked his appearance, so I looked at his identification button to see his number, and I telephoned to the newspaper and got full particulars about him. As they were satisfactory I went up to him and invited him. He telephoned to the paper for particulars about me, and they must have been O. K. or he wouldn't have accepted my invitation."

"Gee!" cried Pep, "I wish I had the nerve to go up to every handsome man I see and ask him to take me on a joy-ride!"

"I knew there was no fear of his refusing. My father is head of the Microbe Factory."

"What!"

"Yes, he manufactures microbes by the ton and ships them to every part of the world. Of course only a small proportion of these are health microbes for fighting disease. Most of them are for industrial purposes—agricultural microbes for securing the proper fertilization of the soil, chemical microbes for aiding the different chemical processes, dairy microbes for butter and cheese-making, fermentation microbes for producing alcohol, etc., etc. He manufactures thousands of varieties and immense quantities of each. His factory is on Manhattan Isle—all that is left of what once was the whole of New York City."

"Why, what happened to Manhattan Island?"

"It has gradually sunk and been covered by the sea. It is now a part of New York Bay."

"Excuse me for changing the subject," said Pep, "but what must we do to get the hundred thousand dollars the Daily Broadcaster promised us?"

"It has already been placed to your credit at the store. We don't use money any more. Everything is done by credit. Money was filthy and served to carry around disease germs. Besides, money led to theft. Credit is much safer. If a store has reason to doubt your solvency it telephones to the central store to know if your credit is good for the amount. Your thumb-print is your signature. It cannot be counterfeited for it is made in the presence of the clerk. Nor can your credit be counterfeited."

"One thing that strikes me as peculiar,"

said Doctor Hackensaw, "is that I see no advertisements. I expected to see advertisements everywhere, recommending 'Pitt's Pills,' or Susy's Soap."

"Advertising isn't allowed," replied Electra, "or, at least, it is restricted within certain very narrow limits. At one time, about the year 2000 advertising had become an unendurable nuisance. The walls of the houses, the streets, the pavements, the vehicles and even the sky were covered at all times with glaring and changeable advertisements. At night-time it was even worse than in the day-time, for the signs consisted of myriads of constantly changing electric lights of different colors. Even the X-rays were used and advertisements projected through the walls of your house into your very bed-room. As if that were not enough, loud speakers constantly dinned into your ears the merits of 'Birch's Buttons' or 'Peter's Pants' till people were driven wild, and stringent laws were passed to regulate advertising, confining it to books and periodicals. All publications were given away free to the public, the advertisers paying all expenses. You could choose a library of whatever books you wanted and they would be sent you free, with thanks for accepting them. And the publishers were very particular about the advertising they accepted, for they found that the more particular they were to publish only advertising of the first class, the more eager the advertisers were in applying for space, even though they paid all the expenses of publication. And then the end of all advertising came about in the very simplest way by the formation of the 'General Purchasing Agency,' which does all our buying for us. If you want anything from a pin to a house, from a rhinoceros to a wife, a postage stamp or a theatre ticket, you stop in at the company's nearest office—they have one on every block—and place your orders. You are sure of getting the object best suited for your purpose that can be obtained anywhere for the price you are willing to pay. They sell cheap qualities but no 'shoddy,' and they even deal in second-hand goods, taking any objects you wish to get rid of at fair valuation."

"That killed advertising. It was no longer necessary for men to persuade you that Pinch's Pills were the best by dinning it into your ears or flashing it into your eyes by brilliant lights or moving pictures thrown on the clouds. In the year 1900 advertising was a highly useful form of education, for it was necessary to hypnotize the people by constant reiteration to impress a fact on their minds and teach them about new products. But it was most expensive and annoying, and was getting so bad something had to be done to stop it. A man would have to pay nearly double the price for goods if we had to go back to the old system. The agency will hunt up for us any article we wish, or will manufacture one for us if unable to find it. If you let them know what things you are interested in—what kind of plays or books you like, they will send you full information about anything new that comes up in that line. They make a specialty of preparing individual programs of entertainments for home enjoyment—sending you by telephoto portions of the best acts on the boards at the time, selecting them to suit your taste, which they soon learn to know. You thus see the very best of the novelties and don't have to sit through any 'chasers.'"

(Continued on page 924)

No. 772
45-volt
large
vertical
Price
\$3.75



No. 766
22½-volt
large
horizontal
Price
\$2.00

*Dry "B" Batteries
are more economical
and more dependable
than any other
source of plate
current!*

Cut your operating cost

THIRTY years' experience in the manufacture of dry batteries has enabled us within the past two years to steadily and greatly improve dry "B" Battery quality. Eveready "B" Batteries are now from two to three times better than ever before.

Eveready "B" Batteries will long outlast any others, and are the most economical and dependable source of plate current. These are strong statements, but they have been proved by tests in our own and in independent laboratories. Check them for yourself on your own radio set. Get Eveready "B" Batteries.

There is an Eveready Radio Battery for every radio use.

Manufactured and guaranteed by
NATIONAL CARBON COMPANY, INC.
Headquarters for Radio Battery Information
New York San Francisco
Canadian National Carbon Co., Limited, Toronto, Ontario

EVEREADY Radio Batteries

—they last longer



Everybody likes good music. Nearly everybody would like to play a musical instrument. And very soon everybody will be playing one, for anybody can play a Hohner Harmonica.

Twelve million music lovers, young and old, have learned to call the Hohner Harmonica "That Musical Pal of Mine." They know that there's nothing like good music for happiness, and nothing like a Hohner for good music.

Don't hum—play it on a Hohner. Get one today—50¢ up—and ask for the Free Instruction Book. If your dealer is out of copies, write M. Hohner, Inc., Dept. 197, New York City.

If you want a musical treat ask to hear Victor Record 19421, by Borrah Minevitch.



Send For **FREE RADIO** 100 Pages **CATALOG** YOU Need it!
 Full of information about Radio and reduced-price offers on all kinds of Sets, Parts and Accessories
 Get this book NOW, before buying anything
LIBERTY M.O. HOUSE
 Dept. A-199 106 Liberty St. New York N.Y.

\$3 Brings you a Genuine **UNDERWOOD** TYPEWRITER
10 DAYS FREE TRIAL Your \$3.00 unconditionally returned if at end of 10 days you are not satisfied with this latest model UNDERWOOD typewriter rebuilt by the famous Shipman Ward process.
GREAT PRICE SAVING Direct to you from the largest typewriter factory in the world by our money saving methods.
EASY MONTHLY PAYMENTS So small that you will not notice it while you enjoy the use of this wonderful machine.
FREE BOOK OF FACTS Explaining Shipman Ward's wonderful system of rebuilding typewriters and also valuable information about the typewriter industry both instructive and entertaining.
 Act Today! Mail Coupon **5 Year Guarantee**
 Shipman Ward Mfg. Company
 2181 Shipman Building
 Montrose & Ravenswood Aves., Chicago
 Name.....
 St. and No.....
 City..... State.....

Dr. Hackensaw's Secrets

(Continued from page 922)

How long Electra would have continued in this strain, it is difficult to say, but she suddenly interrupted herself with a cry. "Good gracious!" she cried. "There's the police-plane coming for us."

"The police-plane?" cried Pep. "What do they want with us?"
 "I suppose they only want to disinfect you, nothing more. You are almost certain to carry microbes in that long hair of yours and you might easily start an epidemic in the city."

As she spoke, a small aeroplane with no one on board, descended gracefully out of the heavens, and alighted at their feet with scarcely a flutter.

"You must get on board," said Electra, "and the plane will automatically take you to the police station. There is really very little danger of an epidemic because in entering or leaving a house we have to pass through a disinfecting chamber that squirts gaseous ozonol into our clothing and kills all the germs we may have about us, but you will have to see the health officer."

"Won't you come with us?" asked Pep.
 "I can't. I have to go and get my stomach that I left last week to be repaired and overhauled."

"What!"
 "Yes. My stomach pained me and didn't work well, so I had it cut out and sent to the hospital to be cleaned up and fixed, and I had another stomach put in to use in the meantime. But I prefer my own. I'm used to it, so I'm going to get it today. My liver too needs attention, but I'll wait till next month before I leave that to be cleaned."

Thanking Electra for her kindness, the pair stepped into the police-plane and pressed the starting button. Instantly the machine rose from the ground and soon they were flying over the roofs of the beautiful city that looked like a fairy-garden beneath them, for the roofs were all on the same level and covered with growing flowers and shrubs.

"Gee!" cried Pep. "This is fine! Since we've got to go to the police-station, I'm going to have a little fun on the way, and learn to steer this machine. It looks easier to guide than any machine I ever piloted."

In vain Doctor Hackensaw begged her not to meddle with the levers. The wilful girl who had chosen the pilot-seat seized the steering lever and was delighted to find that the machine obeyed her slightest motion. It was both wonderful and exhilarating.

And the inevitable happened. Not knowing the laws of the road, Pep got into the wrong lane and when a squadron of a hundred aeroplanes suddenly crossed her path, she lost her head, swerved her machine quickly and ran headlong into one of the planes whose presence she hadn't noticed. Both planes were badly disabled and fell to the ground. Fortunately neither the doctor nor Pep were injured, but the occupant of the other plane was not so fortunate, for his arm was broken by the fall.

Doctor Hackensaw was examining the poor fellow when a boy scout came up to him and said:

"You are wanted at once at police headquarters, sir," and stepping into the police-plane he motioned them to follow.

Doctor Hackensaw hesitated, but he saw the boy was evidently an official, so he and Pep took their places, and a few minutes later the pair were ushered into the

(Continued on page 926)

Make \$100 Weekly—sell RADIO

Demonstrate Once—Results Mean Sure Sale
 Coast to coast, lowest prices, attractive four-tube instrument \$39.50. Big commission to you. Exclusive territory to proven salesmen. Territory going fast, write today for large illustrated book No. 100. Don't fail to name your county.



OZARKA, Inc.
 818 Washington Blvd., Chicago, Ill.

13 WEEKS FOR 15 CENTS
The Pathfinder
 SHOWS THE WAY THROUGH THE JUNGLE OF EVENTS
 You've heard your neighbor praise this wonderful weekly magazine that 3 million people read. Unbiased digest of national and world affairs. Check full of the kind of reading you want. Science, politics, travel, fun, question box, books, health, home, radio—entertainment and instruction for all. Send 15c (coin or stamps) today for this big paper on trial 13 weeks, or \$1 for 1 year (32 issues).
PATHFINDER, 566 Langdon Sta., Washington, D. C.

The Famous KON-VER-TER Slide Rule
 This rule instantly adds, subtracts, divides, multiplies, converts fractions or decimals of an inch. Gives sines, Co-sines, versed sines, co-versed sines, tangents, co-tangents, secants, co-secants of angles directly. Gives square roots, squares, cube roots, cubes and fifth roots and powers of all numbers. Logarithms, co-logarithms, anti-logarithms. Is in use throughout the world. About 6 inches in diameter. Is most complete rule of its kind ever made to sell at a popular price and box for each rule. **DELUXE MODEL White Ivory Celluloid, \$3.00 postpaid.** We also handle other types of slide rules, engineering handbooks and equipment.
J. C. Hamilton, 7 Water St. Boston, Mass. Dept. B.

MAKE MONEY SELL MADISON SHIRTS
 Direct from our factory to wearer. Easily sold. Over one million satisfied wearers. No capital or experience required. Large steady income. Many earn \$100. to \$150. weekly. Territory now being allotted. **Write For Free Samples.**
MADISON MILLS MFRS., 562 B'way, New York

STUDY AT HOME
 Directed by **The University of Chicago**
 Courses in English, History, Chemistry, Business, Mathematics, Education, Psychology, and 35 other subjects command credit toward a Bachelor degree. Begin any time. Address 27 Ellis Hall, University of Chicago, Chicago, Ill.

RADIO SETS — — AUTO BODIES
 SEND FOR THE INTERNATIONAL CATALOG
 Our net price list. Full line of Radio Sets; and auto bodies for Ford's Wholesale Prices. Save big money by buying Direct from Factory
International Body Works, 914 W. Ohio St., Dept. 4, Chicago, Ill.

The Midget
"Five-in-One" Slide Rule is a combination Mannheim, Polymetric, Log-Log, Binary, Add and Subtract Slide Rule. It will instantly add, subtract, multiply and divide any combination of whole numbers, fractions, mixed numbers and decimals. Gives every root and power, also Logs, Sines and Tangents. Made of aluminum with scales on white celluloid. Size 4 in. Approved and adopted by colleges. Price with instructions, \$1.50. Leather Case 50c extra. Sent C. O. D. if desired. Catalogue Free. **GILSON SLIDE RULE CO., Niles, Mich.**

Wrestling Book FREE
 Tells how to be a great athlete and scientific wrestler—how to WIN. Startling secrets taught in wonderful lessons by world champions Farmer Burns and Frank Gotch. Be strong, healthy, athletic. Handle big men with ease. Learn self-defense. Be a leader. Men and boys, write for Free Book today. State your age.
Farmer Burns School 1251 Railway Bldg., Omaha, Neb.

Insure your copy reaching you each month. Subscribe to Science & Invention—\$2.50 a year. Experimenters Publishing Co., 58 Park Pl., N. Y. C.

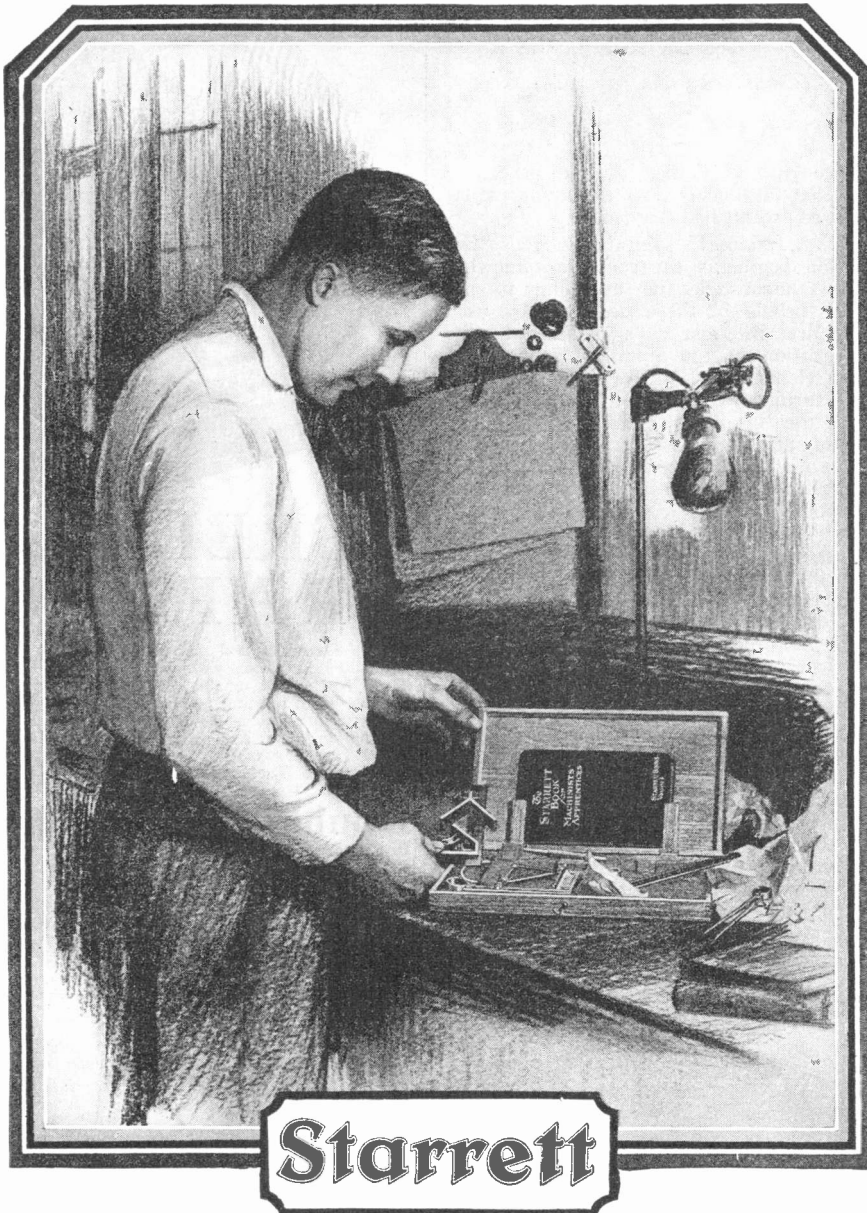

Starrett

Are
The Best Tools
Too Good
For The
Beginner



Apprentice Set No. 901

When you learned to ride a bike you begged or borrowed from one of the kids an old wheel to practice on. That is, you did if you were wise.

But you can't learn a trade that way. You must have *accurate* tools to do accurate work and any mechanic will tell you so. That's why crack machinists advise the youngster to start with his own kit of

Starrett Tools—the same fine tools they use themselves. In the No. 901 Apprentice Set you get the start of a kit of well-made, accurate tools that you'll use the rest of your life. The Set is contained in a handsome nicely finished wood case and is sold by good hardware stores everywhere. At a price which is not the least attractive feature of this splendid kit.

Write for Starrett Catalog No. 23 describing the uses of 2200 Fine Precision Tools. Free.

THE L. S. STARRETT CO.

*World's Greatest Toolmakers
Manufacturers of Hacksaws Unexcelled
ATHOL, MASS.*

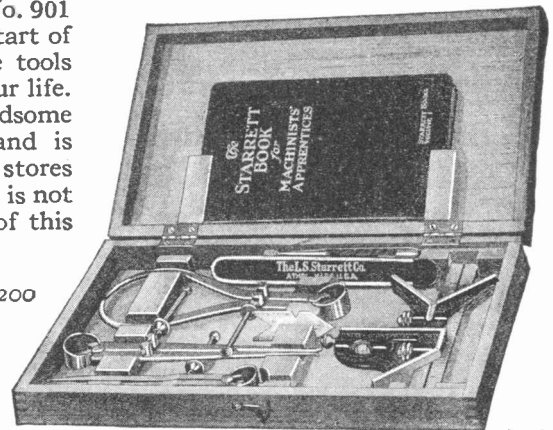

7426

Set No. 901 consists of: No. 11, 6-inch Combination Square complete with Sliding Head and Center Head, No. 117 B, Center Punch, No. 320, 6-inch Flexible Steel Rule in Pocket Case; No. 390, Center Gage; No. 79, 6-inch Outside Caliper with Solid Nut; No. 73, 6 inch Inside Caliper with Solid Nut; No. 77, 5-inch Divider with Spring Nut, and the Starrett Book for Machinists' Apprentices, Vol. I.

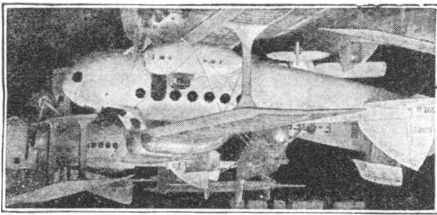

Aviation Brings Quick Success

TO young men of daring no other field of work offers such a fascination, such high pay, nor such opportunities for quick success as the field of Aviation. As yet, aviation is practically in its infancy. But now is the time to get in.

Amazing Opportunities in Airplane Industries

In the automobile industry and in the moving picture business hundreds of men got rich by getting in at the start. They made their success before others woke up. Today, these lines offer no greater opportunities than a hundred and one others. **BUT AVIATION IS NEW.** Get in while the opportunities are big. All over the country there will be a clamor for trained men. It will not be a question of pay but of getting capable men.

Become an Aviation Expert \$50 to \$100 per Week

The study of aviation is almost as fascinating as the actual work. Every lesson is full of interest. That is why it is easy to learn aviation. You do not have to make yourself study—it is like reading an interesting book that tells you things you have always wanted to know. Only one hour each evening will give you the basic training in a surprisingly short time.

One student, S. F. McNaughton, Chicago, says: "Your lessons are like a romance, and what is more, after one reading, the student gets a thorough understanding. One never tires of reading them." James Powers, Pa., "another student, says, "I am indeed surprised that such a valuable course can be had from such practical men for so little cost."

Fascinating—Daring—Big Paying

- Prepare Now for One of These Positions
- Aeronautical Instructor \$60 to \$150 per week
 - Aeronautical Engineer \$100 to \$300 per week
 - Aeronautical Contractor Enormous profits
 - Aeroplane Repairman \$60 to \$75 per week
 - Aeroplane Mechanician \$40 to \$60 per week
 - Aeroplane Inspector \$50 to \$75 per week
 - Aeroplane Salesman \$5000 per year and up
 - Aeroplane Assembler \$40 to \$65 per week
 - Aeroplane Builder \$75 to \$200 per week

Personal Instruction

by Experienced Men
Men who have had actual experience give you personal attention. They select the lessons, lectures, blueprints and bulletins. They tell you things that are essential in everyday practice. Each lesson is easy to read and understand.

Get Big FREE Book—Now

Send coupon below for New Book, just out, "Opportunities in the Airplane Industry." It is interesting and instructive. It will show you many things you never knew before about aviation. We have but a limited supply of these books—send the coupon before they are all gone.

American School of Aviation
3601 Michigan Ave., Dept. 14-21 Chicago, Ill.

American School of Aviation
3601 Michigan Ave., Dept. 14-21 Chicago, Ill.
Without any obligation, send me your Free Book, "Opportunities in the Airplane Industry," also information about your course in Practical Aeronautics.

Name.....
Street.....
City..... State.....

Doctor Hackensaw's Secrets

(Continued from page 924)

presence of the justice of the peace, to whom Pep at once began a voluble explanation of what had happened.

"Wait a minute!" said the judge. "Before you begin, as the room is somewhat chilly, I must ask the attendant to put another pebble in the crucible (they used atomic heat in those days, obtained by the disintegration of the atoms of stones, into lighter elements). As for you," he continued, turning to Pep, "you must take your seat in the 'Chair of Truth.'"

So saying, he pressed a button, and as he did so, a peculiar looking arm-chair came walking into the room on its own four legs, automatically moved by some invisible mechanism. All kinds of thermometers, dials and instruments of every sort were attached to the chair.

"Sit there," said the judge. "Let your hands rest on the arms of the chair and tell me how the accident happened. If you prevaricate, exaggerate, or hold anything back, or tell an untruth, I shall know it immediately, for along with the phonographic record of your statement will be the 'graph' of your every heart-beat and the dilation and contraction of your blood-vessels and the nervous twitches induced in you by the various emotions of anger, fear, etc., that govern you while you speak. In a word I shall read your mind and know exactly how much confidence I can place in your statements."

Pep, somewhat frightened, sat down as she was bid and began her story again. But she had not spoken a dozen sentences before the magistrate interrupted her.

"It's no use going on," said he. "The electric light has turned green, and the heart-dial marks 33 degrees by Chubb's gauge. You may not think you are lying, but you are prevaricating at a great rate. Now begin over again and tell the full truth or I shall have to hypnotize you and get the full confession while you are in the hypnotic trance."

Thus admonished, Pep began over again, and this time she gave the exact facts. When she had finished the judge merely remarked:

"Guilty! And sentenced to pay the penalty!"

"But," sobbed poor Pep, "I didn't mean to do any harm."

"No, but you were reckless, and your recklessness caused the damage. You must make it good."

Here Doctor Hackensaw interposed. "I will pay for the broken arm," he said. "We have a credit of one hundred thousand dollars here."

"Money cannot pay for the suffering of a broken arm," returned the judge. "If the girl had been a thief and had merely stolen money, we should allow her to make restitution with an added fine to pay police expenses and to add to the fund from which restitution is made to robbed persons when the thief cannot be caught. In the present case the girl must make restitution."

"How can we make restitution for a broken arm?" asked Doctor Hackensaw, puzzled. "You don't mean that Miss Pepita's arm must be broken because she was unfortunate enough to break this man's arm?"

"No indeed! That would be as foolish as to condemn a murderer to death because he has killed a man. We force the murderer to make restitution to society for the life he has taken, and as he cannot re-

(Continued on page 928)

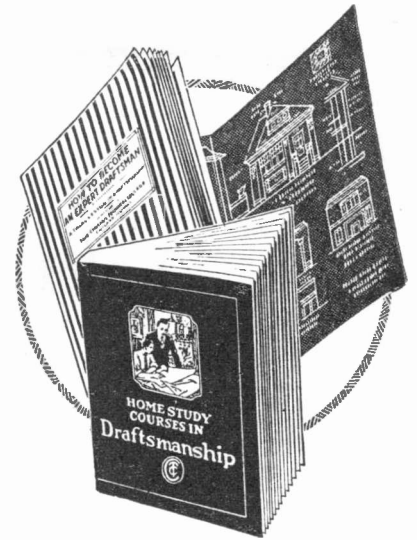

FREE Trial Lesson DRAFTING

Mail the coupon and we will send you this Free Trial Lesson which will show you how well prepared you are to master Drafting. No obligation on your part, nothing to pay. While other schools ask you to enroll and pay a fee at once, we send this lesson first. Before you pay a cent or decide about enrolling test your ability and learn about the Chicago Tech. Method of teaching Drafting by mail.

Double your Earnings

Big concerns everywhere are seeking expert Draftsmen at top notch salaries. This is your chance to step ahead just as R. L. Cary did who reports 300% salary increase since training with Chicago Tech.; or as J. A. Da Costa did who was doing manual labor and rose to an executive position.

Train by Mail

By the Chicago Tech. Method you can become an expert Draftsman by home study. Practical men will give you the training that brings highest pay. No use less theories—you learn how to handle actual problems. Direct personal instruction. **FREE** Drawing. We furnish full size professional Drawing Outfit (retail price \$25) free or credit you on fees if you have one.

Send the Coupon

Ask now for the Trial Lesson. We will also send catalogs and full information about the Chicago Tech. Method. No obligation—no promise on your part. Send today.

CHICAGO TECHNICAL COLLEGE,
Dept. 145, Chicago Tech. Bldg.
118 East 26th Street, Chicago, Ill.

Without cost or obligation to me please send **Free Trial Lesson in Drafting** and other instructive matter about opportunities open for me in this line.

Write or Print Name Plainly

Name

Address

City

State

Ford Runs 57 Miles On Gallon of Gasoline

A new automatic and self-regulating device has been invented by John A. Stransky, 4349 Fourth St., Pukwana, South Dakota, with which automobiles have made from 35 to 57 miles on a gallon of gasoline. It removes carbon and reduces spark plug trouble and overheating. It can be installed by any one in five minutes. Mr. Stransky wants distributors and is willing to send a sample at his own risk. Write him today.—Adv.

Write today for your free copy of

Ward's New Radio Catalogue



WARD'S Radio Catalogue is a big 68-page book—a real reference volume on quality Radio Equipment. In addition to descriptions of sets, parts and hook-ups, much matter of general interest to every radio fan is included. The book will prove fascinating to the confirmed radio enthusiast as well as to the beginner.

Tested and guaranteed
Radio equipment sold without the usual Radio profits

WARD'S Radio Department is headed by experts who know and test everything new. Who know by experience what is best—what gives the best service.

Our catalogue is prepared under their supervision. It shows all the best hook-ups, everything in parts and complete sets—so simple that you yourself can install them in a short time.

Headquarters for Radio

Today Ward's is serving thousands upon thousands of Radio fans who have written for our catalogue, who have been surprised to see how low in price the standard Radio equipment can be sold without the usual "Radio Profits."

You, too, can profit by writing for a free copy of Ward's Radio Catalogue. If interested at all in Radio, you should write for this book. See for yourself the savings.

Our 53-Year-Old Policy

For 53 years we have sold quality merchandise. We never sacrifice quality to make a low price. In buying Radio Equipment at Ward's, you are buying from a house of proven dependability. Address our house nearest you: Dept. 40-R

ESTABLISHED 1872
Montgomery Ward & Co.

The Oldest Mail Order House is Today the Most Progressive

Chicago

Kansas City

St. Paul

Portland, Ore.

Oakland, Calif.

Ft. Worth

Popularity Plus!



Yours-with this most winning of all musical Instruments
 You can be popular - you can be in demand socially - you can be welcome everywhere - with an irresistible

BUESCHER True Tone Saxophone



Don't be a wall-flower. Don't be a dawdler. Step out of the crowd and into the picture. Be able to do something to earn your welcome. Learn to play a Buescher Saxophone.

**Easy to Play
 Easy to Pay**

You'll be astonished how quick you master this beautiful instrument. It's not necessary to be talented - to be musically inclined. The Buescher Saxophone is so perfected and simplified that practically anyone can learn to play. The scale can be mastered in an hour; in a few weeks you will be playing popular airs. Practice is pleasure, because you learn so quickly. 6 days trial and easy payments.

Free

Send coupon or postal for a free copy of our latest Saxophone Book. Tells all about the various Buescher Saxophones, with pictures of the famous professionals and orchestras. Mention any other instrument in which you may be interested. 167

BUESCHER BAND INSTRUMENT CO.
 Everything in Band and Orchestra Instruments
 389 Buescher Block Elkhart, Ind.

Buescher Band Instrument Co.
 389 Buescher Block, Elkhart, Ind.
 Gentlemen:
 I am interested in the instrument checked below:
 Saxophone... Cornet... Trombone... Trumpet...
 (Mention any other instrument interested in)
 Name
 Street Address.....
 Town..... State.....

Doctor Hackensaw's Secrets

(Continued from page 926)

suscitate his victim we condemn him to save one hundred lives in place of the one he has taken."

"You mean you make him a life-saver on the coast?" asked Doctor Hackensaw, more and more puzzled.

"No, there is no trouble in hiring all the life-savers we want. Besides, few of them can hope to save one hundred persons from drowning. No, the murderer must not only risk his life, but risk suffering and disease as well. In a word we require him to submit to undergo experiments by competent medical men who are studying cures for various diseases. He must allow himself to be inoculated with disease germs or in some such manner aid in the progress of science. In this way and in this way only can he pay his debt to society. For while he saves only one hundred lives of the present generation, the experiment may be the means of saving countless lives in future generations. Of course, it is impossible to evaluate how many lives are saved by any one experiment, but our physicians are generous in making the estimate, especially when the experiment entails considerable suffering. The patient, as a rule, is glad to feel that he is making a real restitution that will rehabilitate him. We always give him the option of being put to sleep for fifty or one hundred years, instead of submitting to the operation, but only in one or two cases has the alternative been accepted.

"Now this young lady, through her recklessness, has broken a man's arm. She must pay him money damages, but at the same time she must submit to have some mild pathological experiments tried upon her by our physicians."

"But Judge—" began Pep.

"There is no appeal from the sentence. The operating room adjoins this one, and your sentence can be carried out at once."

And the terrified girl was pushed into the next room, where half a dozen physicians and nurses were waiting for her. She was forced into a chair, and was held down while one of the men sterilized a lancet and proceeded to make an incision in her arm. And then—

And then she awoke.

"Gee!" she cried, "I woke up just in time. Another minute and they would have shot me full of germs! Wake up, Pop," she called out, shaking Doctor Hackensaw by the arm.

The doctor slowly opened his eyes. "Pep," said he, "you had a narrow escape. But let this be a lesson to you. Whenever you are tempted to drive recklessly in your auto, think what it would mean if you had to make good whatever damage you caused—to give a leg for one of your victim's legs, an arm for an arm, or your life for his!"

CORRECTION NOTICE

In the Radio Oracle for November, 1924, the circuit showing how to charge a storage "B" battery directly from the 110 volt A.C. lines was slightly incorrect. The polarities of the battery should have been reversed.

"MOVIE" CREDIT

In the December issue of SCIENCE AND INVENTION we featured the movie comedy entitled, "Hold Your Breath", and this was erroneously attributed to Universal, but should have been credited instead to Christie Comedies.

LOFTIS BROS. & CO. 1115

Diamonds Watches

Cash or Credit
Genuine Diamonds Guar.

Send for Catalog

Over 2,000 bargains in Diamond-set Jewelry, Watches, Wrist Watches, Pearls, Silverware, etc. Sent prepaid for your Free Examination. Satisfaction Guaranteed or money back.

The Diamonds in these Rings are brilliant. Blue White, high-grade Quality Gems. The mountings are Solid 18-k White Gold, except No. 20, which is Platinum.

No. 30 \$100 \$750 A Week

No. 67 \$125 \$325 A Week

No. 35 \$37.50 \$100 A Week

No. 12 \$50 \$125 A Week

No. 20 \$200 \$500 A Week

TERMS: Goods delivered on first payment of one-tenth of purchase price; balance in equal amounts, payable weekly, semi-monthly or monthly, at your convenience.

17 Jewel Elgin
No. 15 - Green Gold Watch, 25-Year Case; 17 Jewels; 12 Size, Gilt Dial, \$30; \$3 \$100 A Week

No. 49 - Wrist Watch, Solid 18-k White Gold - 17 Jewels, \$40. Delivered on first payment of \$4.00, then \$100 A Week

LOFTIS BROS. & CO. ESTD. 1858

THE OLD RELIABLE CREDIT JEWELERS
DEPT. H-22
108 N. State St., Chicago, Ill.
Stores in Leading Cities

YOU TOO CAN PLAY THE HAWAIIAN GUITAR

JUST AS THE HAWAIIANS DO
 PLAY ALL THE LATEST HITS

FREE! THIS \$15.

HAWAIIAN GUITAR.

Special courses on Violin, Tenor-Banjo, Banjo-Ukuleles and Ukulele

ONLY 4 MOTIONS used in playing the fascinating Hawaiian Guitar. Our native Hawaiian instructors teach you to master them quickly. Pictures show how. Everything explained clearly.

PLAY IN HALF HOUR
After you get the 4 easy motions, you can play harmonious chords with very little practice. 40,000 students have learned to play in this easy, pleasant way.

EASY LESSONS
The 52 printed lessons with a great many pictures make it easy to learn quickly. You don't have to know how to read notes. No previous musical knowledge necessary. You learn to play any kind of music, and pay as you play.

FREE GUITAR
As a special offer to new students we give this full size, high grade instrument free of charge. It is sent at once without red tape or delay.

WRITE AT ONCE
Send your name at once and let us tell you all about the 52 easy lessons and the free guitar. You have everything to gain. Don't put it off. A post card will do. Ask for new special offer and easy terms.

First Hawaiian Conservatory of Music, Inc.
233 Broadway (Woolworth Bldg. Dept. 40) New York, N. Y.

MAKE MONEY AT HOME

YOU CAN earn money at home in your spare time making show cards. No canvassing or soliciting. We show you how, supply you work at home no matter where you live and pay you cash for all work done. Full particulars and booklet free. Write to-day.

AMERICAN SHOW CARD SYSTEM, LTD.
110 Adams Building Toronto, Canada

A FINE MECHANIC APPRECIATES A FINE TOOL
 The Johnson Folding Pocket Rule is made of Spring Nickel Silver, accurately and distinctly graduated. It can be used as a Square, Hook-rule, Calliper gauge, Protractor, Triangle or Tri-square, and can be applied to practically all classes of mechanical work. Vernier reads to one-half degree. Center Joint has fibre bearings which will not become loose and will remain firmly at any angle.

No. 46-6" Rule \$2.50; No. 45-12" \$3.50. Including chamois cases. Money refunded if not satisfied. Catalog on request.

E. P. JOHNSON RULE MFG. CO., Dept. A.
565 W. Washington Blvd., Chicago



A book the whole family will enjoy—sent free on request

THE new Magnavox Receiver has assumed a place of acknowledged leadership among the enduring radio achievements of the year.

The Magnavox one dial Station Selector means that anyone can now command a degree of selectivity previously limited to the expert. You probably have your own ideal of what a radio receiver should accomplish. Investigate the Magnavox and find that your ideal has come true.

Reliable dealers everywhere carry Magnavox Radio Products in stock. If unacquainted with the Magnavox store in your vicinity, write us for information and literature.

ILLUSTRATED above is the Magnavox Radio Receiver TRF-5, a 5-tube tuned radio frequency circuit encased in handsomely carved mahogany cabinet. This set, without tubes or batteries, represents remarkable value

An accessory for the TRF-5 is the M4 Reproducer (also illustrated)

Magnavox Radio Receiver TRF-50 has the same circuit and panel enclosed in carved period cabinet with built-in Reproducer,



THE MAGNAVOX COMPANY
OAKLAND, CALIFORNIA

New York: 350 West 31st St. Chicago: 162 N. State St. San Francisco: 274 Brannan St.
Canadian Distributors Perkins Electric Limited, Toronto, Montreal, Winnipeg

The Magnavox Co.
350 West 31st St., New York
Send me a complimentary copy of Radiotikes, the "funny people" of radio.

Name.....
Address.....

U.S. PATENTS



SEND FOR THIS FORM

Don't Lose Your Rights

Before disclosing your invention to anyone send for blank form "Evidence of Conception" to be signed and witnessed. A sample form together with printed instructions will show you just how to work up your evidence and establish your rights before filing application for patent. As registered patent attorneys we represent hundreds of inventors all over the U. S. and Canada in the advancement of inventions. Our schedule of fees will be found reasonable. The form "Evidence of Conception" sample, instructions relating to obtaining of patent and schedule of fees sent upon request. Ask for them,—a post card will do.



Registered Patent Attorneys in U.S. and Canada
255 Ouray Bldg., Washington, D. C.
"Originators of form Evidence of Conception"

PATENTS

TO THE MAN WITH AN IDEA

I offer a comprehensive, experienced, efficient service for his prompt, legal protection and the development of his proposition.

Send sketch, or model and description, for advice as to cost, search through prior United States patents, etc. Preliminary advice gladly furnished without charge.

My experience and familiarity with various arts, frequently enable me to accurately advise clients as to probable patentability before they go to any expense.

Booklet of valuable information and form for properly disclosing your idea, free on request. Write today.

RICHARD B. OWEN, Patent Lawyer
164 Owen Building, Washington, D. C.
2276-8 Woolworth Bldg., New York City

PATENTS

Hand books on Patents, Trade Marks, etc., sent free. Our 78 years of experience, efficient service, and fair dealing assure fullest value and protection to the applicant. The Scientific American should be read by all inventors.

MUNN & CO.

618 Woolworth Building, New York

Scientific American Building, Washington, D. C.

Tower Bldg., Chicago, Ill.

Hobart Bldg., 582 Market St., San Francisco, Cal.

Van Nuys Building, Los Angeles, Cal.

C. L. PARKER

Ex-Member Examining Corps, U. S. Patent Office
Attorney-at-Law and
Solicitor of Patents

American and Foreign Patents secured. Searches made to determine patentability, validity and infringement.

Pamphlet of Instructions sent upon request

McGILL BUILDING WASHINGTON, D. C.



PATENT ADVICE

Edited by
A. P. Peck

In this Department we publish such matter as is of interest to inventors and particularly to those who are in doubt as to certain patent phases. Regular inquiries addressed to "Patent Advice" cannot be answered by mail free of charge. Such inquiries are published here for the benefit of all readers. If the idea is thought to be of importance, we make it a rule not to divulge all details, in order to protect the inventor as far as it is possible to do so.

Should advice be desired by mail a nominal charge of \$1.00 is made for each question. Sketches and descriptions must be clear and explicit. Only one side of sheet should be written on.

NOTE:—Before mailing your letter to this department, see to it that your name and address are upon the letter and envelope as well. Many letters are returned to us because either the name of the inquirer or his address is incorrectly given.

COLLAR BUTTONS

(862) N. S. Bogdon, Warren, Ohio, has designed some unique collar button ideas and wants our opinion on the idea.

A. 1. We do not believe that you can possibly secure a patent upon your collar stud and button improvement. Ideas very similar to these have already been protected and have been found on the market.

The main difficulty with a patent of this nature

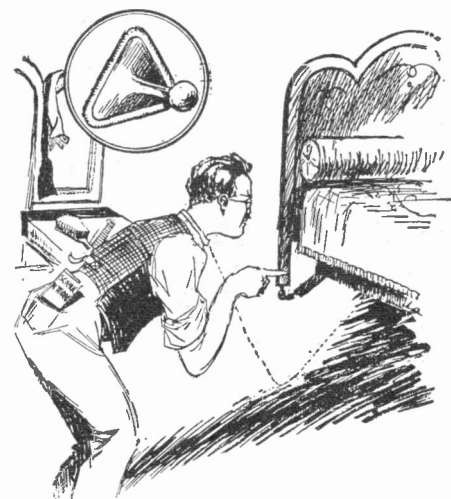

Triangular shaped bases on collar buttons will not prevent their loss.

is that it loosens on one or the other side of the collar and then is lost very easily. This suggestion is likewise true of the clip device.

With regard to the button improvement, we would suggest that it is not so much the round end of the button which causes it to roll as relatively light construction. We are confident that a button as designed by you will on identically the same conditions roll or rather bounce just as far as the button with a round Shank. If you place a button on the table and attempt to roll it, you will find that it describes but a small circle.

CROSSING GATE

(863) Sam Davies, Newton, New Jersey, submits plans for a gate to be used at railroad crossings and asks our advice as to patenting and marketing it.

A. 1. Unless your system of automatic crossing gate is very ingenious and infallible in operation, working in both winter and summer months, we would strongly advise against patenting the same. There is little likelihood of its being accepted.

BOTTLE CAP

(864) Frank Bedich, Binghamton, New York, says he has a novel bottle cap which should be useful and asks our advice as to manufacturing the article before obtaining a patent upon it.

A. 1. It will be impossible to do anything with your bottle cap unless you patent the same, but we are of the opinion that you should have no difficulty in securing the necessary finances among your friends in order to obtain a patent.

We cannot give you any advice upon this bottle cap unless we have information concerning its construction.

SANITARY POWDER PUFF

(865) C. M. Woodward, Pasadena, Calif., submits a model of an individual sanitary powder puff. He asks our opinion on the proposition, stating that the idea is in the line of individual drinking cups, and is intended to eliminate the necessity of using a powder puff over and over again.

A. In our opinion your powder puff would find quite a ready market if the same were sold at 1c or 2c. We doubt very much if you can manufacture these to sell at this cost, as the device seems to be entirely too expensive. It would be advisable to decrease the size of the whole, which will incidentally cut down manufacturing costs. As a matter of fact, a small tuft of cotton with a gauze surrounding the same, containing the powder on the inside, and then faced with a sheet of paper, would serve the purpose just as well.

We would suggest that you have a patent-search made upon the idea, and if you find the device seems to be patentable, work along this line. We do not look upon your design with favor, and would suggest marked improvements in the same, to reduce not only manufacturing costs, but also the method of holding the powder, and the way of disposing of the puff after it has been used.

With your device there is a possibility of spilling the contents of the powder puff box, which was proved when the writer attempted to examine the model you sent.

ASHLESS CIGARETTE HOLDER

(866) H. P. Maher, Seattle, Wash., submits sketches of an ashless cigarette holder which he devised and on which he desires advice. A sketch of the holder is given herewith.

A. We are of the opinion that a device of this nature is not patentable, as hundreds of similar ones have been proposed from time to time. Furthermore, we do not believe that such a cigarette holder would be looked upon with favor by the smoking public. The inside of the holder would soon become soiled because of the action of the smoke and ashes and furthermore, the holes in the sides of the cigarette container would allow ashes to sift through. We would most certainly advise you not to invest any money in promoting this idea.

(Continued on page 932)

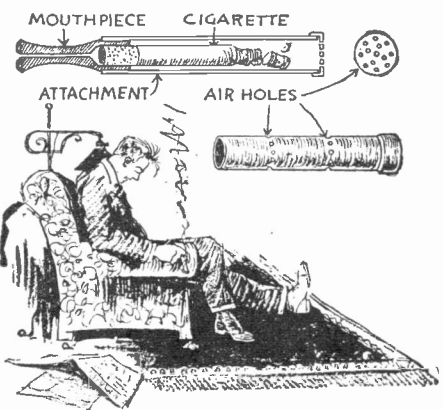

A cigarette holder such as shown above, is not patentable for the reasons given in the text.

PATENTS

INVENTORS: PROTECT YOUR IDEAS-WRITE FOR THESE FREE BOOKS: DO IT NOW

TRADE MARKS-COPYRIGHTS

ANY NEW article, machine, design or improvement thereof, or any combination of parts or improvements in any known article which increases its efficiency or usefulness, may be patented, if it involves invention.

IF YOU HAVE ANY NEW IDEAS

which you feel are useful, practical and novel, take prompt action to protect your rights. If you have invented any new machine or new combination of parts or improvement, or any new design or process, SEND DRAWING, MODEL OR DESCRIPTION of it for information as to procedure to secure protection.



Drafting and Specification Room of Clarence A. O'Brien, Registered Patent Lawyer, Washington, D. C.

ALL COMMUNICATIONS are held in strict confidence. My personal, careful and thorough attention is given to each case. I offer you efficient, reliable and prompt service—based upon practical experience. Highest references. NO CHARGE FOR ABOVE INFORMATION.

WRITE TODAY FOR FREE BOOKS, "HOW TO OBTAIN A PATENT" and "INVENTION AND INDUSTRY" and blank form "RECORD OF INVENTION."

These books will give you valuable information, and they may save you much time and effort. Send for them, NOW. My practice is devoted exclusively to United States and Foreign Patents and Trade Marks. Write me freely, frankly and with full confidence; it is very probable that I can help you.

USE THE COUPON attached, and immediately upon its receipt I shall send you the form Record of Invention to be returned to me with drawing, description or model of your idea; promptly upon receiving your idea I shall write you as to procedure and costs.

CLARENCE A. O'BRIEN

REGISTERED PATENT LAWYER

Member of (COURT OF APPEALS, DISTRICT OF COLUMBIA, UNITED STATES COURT OF CLAIMS;
Bar of (SUPREME COURT OF UNITED STATES, SUPREME COURT, DISTRICT OF COLUMBIA
Practice Confined to Patents, Trade Marks and Copyrights

FREE COUPON

CLARENCE A. O'BRIEN, Registered Patent Lawyer

539 Security Savings and Commercial Bank Building Directly Across Street from Patent Office WASHINGTON, D. C.

Please send me your free books, "HOW TO OBTAIN A PATENT" and "INVENTION AND INDUSTRY" and blank form, "RECORD OF INVENTION," without any obligation on my part.

Name

Address

IMPORTANT—WRITE OR PRINT NAME CLEARLY.

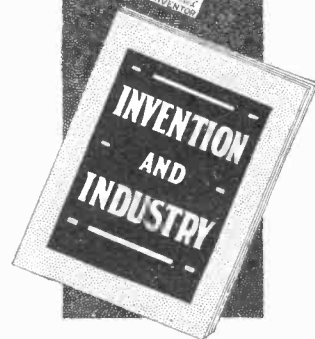
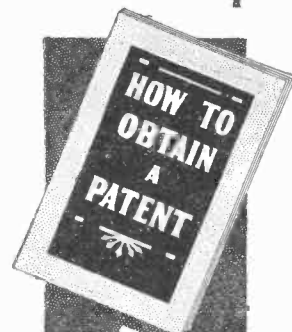

Mechanical Engineering

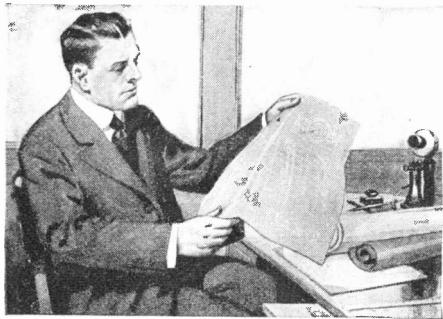

Learn at Home!

Employers are looking for men with mechanical ability.

There is an easy, delightful way in which you can learn right at home in spare time. For 33 years the International Correspondence Schools have been giving men and women just the training they need for success in mechanical engineering and more than 300 other subjects. Hundreds of thousands have stepped into good positions through I. C. S. help.

Let the I. C. S. help you. Choose the work you like best in the coupon below, then mark and mail it today. This doesn't obligate you in the least but it will bring you information that will start you on a successful career. This is your chance. Mark and mail the coupon now.

INTERNATIONAL CORRESPONDENCE SCHOOLS

Box 6187-D, Scranton, Penna.

Without cost or obligation on my part, please tell me how I can qualify for the position or in the subject before which I have marked an X:

BUSINESS TRAINING COURSES

- | | |
|--|---|
| <input type="checkbox"/> Business Management | <input type="checkbox"/> Salesmanship |
| <input type="checkbox"/> Industrial Management | <input type="checkbox"/> Advertising |
| <input type="checkbox"/> Personnel Organization | <input type="checkbox"/> Better Letters |
| <input type="checkbox"/> Traffic Management | <input type="checkbox"/> Show Card Lettering |
| <input type="checkbox"/> Business Law | <input type="checkbox"/> Stenography and Typing |
| <input type="checkbox"/> Banking and Banking Law | <input type="checkbox"/> Business English |
| <input type="checkbox"/> Accountancy (including C.P.A.) | <input type="checkbox"/> Civil Service |
| <input type="checkbox"/> Nicholson Cost Accounting | <input type="checkbox"/> Railway Mail Clerk |
| <input type="checkbox"/> Bookkeeping | <input type="checkbox"/> Common School Subjects |
| <input type="checkbox"/> Private Secretary | <input type="checkbox"/> High School Subjects |
| <input type="checkbox"/> Spanish <input type="checkbox"/> French | <input type="checkbox"/> Illustrating |

TECHNICAL AND INDUSTRIAL COURSES

- | | |
|---|--|
| <input type="checkbox"/> Electrical Engineering | <input type="checkbox"/> Architect |
| <input type="checkbox"/> Electric Lighting | <input type="checkbox"/> Architects' Blue Prints |
| <input type="checkbox"/> Mechanical Engineer | <input type="checkbox"/> Contractor and Builder |
| <input type="checkbox"/> Mechanical Draftsman | <input type="checkbox"/> Architectural Draftsman |
| <input type="checkbox"/> Machine Shop Practice | <input type="checkbox"/> Concrete Builder |
| <input type="checkbox"/> Railroad Practices | <input type="checkbox"/> Structural Engineer |
| <input type="checkbox"/> Gas Engine Operating | <input type="checkbox"/> Chemistry <input type="checkbox"/> Pharmacy |
| <input type="checkbox"/> Civil Engineer | <input type="checkbox"/> Automobile Work |
| <input type="checkbox"/> Surveying and Mapping | <input type="checkbox"/> Airplane Engines |
| <input type="checkbox"/> Metallurgy <input type="checkbox"/> Mining | <input type="checkbox"/> Agriculture and Poultry |
| <input type="checkbox"/> Steam Engineering <input type="checkbox"/> Radio | <input type="checkbox"/> Mathematics |

Name.....
 Street..... 3-6-24
 Address.....
 City..... State.....

Occupation.....
 Persons residing in Canada should send this coupon to the International Correspondence Schools Canadian, Limited, Montreal, Canada

Insure your copy reaching you each month. Subscribe to Science and Invention—\$2.50 a year. Experimenter Publishing Co., 53 Park Place, N. Y. C.

HANDY COMBINATION

(867) J. S. Wilder, St. Petersburg, Florida, submits a model of a combination blotter, straight edge and scratch pad, the construction of which is outlined herewith. He asks our opinion on the patentability of the combination as well as advice on the best way to promote the idea.

A. Selling the device which you have designed is more or less of a gambling proposition. You may find that the device will sell. On the other hand, it may turn out to be a complete fizzle.

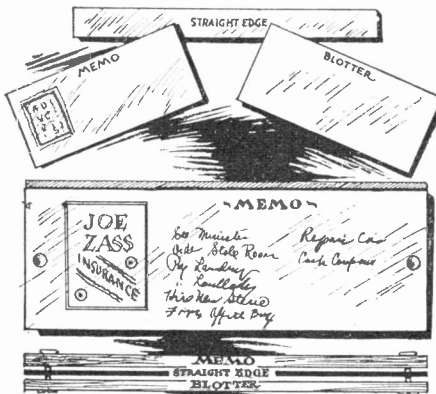

A combination such as shown above might possibly be of advertising value.

We would suggest that you have a search made and if you find it patentable, that you cautiously proceed to locate a firm willing to undertake the manufacture of the same. The possibility of the proposition from an advertising viewpoint is greatest. Large sums of money are spent yearly on publicity, and this method should present a fairly good means of advertising, and at the same time establish a sale for your device. The cost of the system is rather expensive, but it is not prohibitive.

We would suggest that you weigh all the details regarding the sale of this system, do not jump at conclusions too rapidly, and do not form the idea that you have a wonderful money-making proposition. You may be able to make a success of the device, but the chances are against you, and unless you can reasonably spare the money which a patent will cost, that is, about \$120.00 or perhaps even more, we would not suggest applying for a patent. Be positive that after the search is made your claims will be broad. Some attorneys may notify you that you can secure a patent on the device, and they will probably be able to do this on some long involved claims of many elements. This being the case, the patent would be practically worthless. Broad claims would be absolutely necessary.

We do not suggest clipping the bottom of the scratch pads to the blotter, as it is too difficult to remove the scratch pads. We would suggest that an ordinary pad glued at the top be substituted, so that the papers after they are used, can be torn off easily and destroyed.

SELF-CLINCHING COTTER PIN

(868) A. F. Wood, Tulsa, Okla., says that he has invented a self-clinching cotter pin which he deems to be much better than anything on the market. He asks our opinion as to whether it would be worth while to try to patent such a device from the standpoint of making a commercial success of it.

A. If you are in a position to manufacture your self-clinching cotter pins, at the same cost price as other cotter pins now found upon the market, we are of the opinion that the same would sell.

It may be easy enough to patent a device; it may be difficult to place it upon the market. Consequently, we would advise that you establish commercial relations at first.

Painting Paper Hanging and Decorating

Marbling and Graining—Auto Painting—Show Card Writing

Learn any of these big paying trades in a few weeks by practical work under competent instructors. No books—no classes—start any time. No previous experience or education necessary. Working conditions exactly the same as "out on a job." Largest and best equipped painting shops in America—the only industry endorsed school.

Make \$10 to \$20 a Day

Or, go in business for yourself and make \$5,000 to \$13,000 a year. We train you to become an EXPERT, not an ordinary "brush hand." There are not enough trained men to go around. Be an EXPERT and get the big money.

Send Coupon for Free Book

Take the first step today and send for Free Book and Special Offer. No obligation. A few weeks' practical training will fit you for this big paying trade.

CHICAGO PAINTING SCHOOL
 150 W. Austin Ave. Dept. 1431 CHICAGO, ILL.

INVENTORS! Your Success

depends upon truthful and proper advice at the right time. Our facilities to assist you in securing patents, models, capital, etc., and our complete service to inventors will interest you.

Information upon request.
INVENTORS INTERNATIONAL INSTITUTE
 15 Park Row, New York

PATENTS

BOOKLET FREE HIGHEST REFERENCES PROMPTNESS ASSURED BEST RESULTS Send drawing or model for examination and report as to patentability

WATSON E. COLEMAN, Patent Lawyer
 644 G Street, N. W., Washington, D. C.

Inventions Developed

If you have an undeveloped invention, consult us. We will prepare practical designs for you, also procure your patent rights. Write for FREE BOOKLET.

Manufacturers Patent Co., Inc.
 70 Wall St., New York

PATENTS

Trade-Marks, Copyrights and Patent Litigation Write for advice and instructions how to proceed, costs, etc. Hand Book with illustrations of 100 Mechanical Movements sent free on request.

ALBERT E. DIETERICH
 Patent Lawyer and Solicitor
 Successor to Fred G. Dieterich & Co.
 602 OURAY BLDG. WASHINGTON, D. C.

INVENTORS who derive largest profits know and heed certain simple but vital facts before applying for Patents. Our book Patent-Sense gives those facts sent free. Write **LACEY & LACEY**, 644 F St., Washington, D. C. Established 1869.

PATENTS Patent Litigation Trade Marks Copyrights

Handbook of Instructions, "How to Protect Inventions" Free on Request

R. H. FRAVEL, Patent Attorney
 Formerly of the U. S. Patent Office Examining Corps
 3503 McLachlen Bldg. Washington, D. C.

Inventors Protect your rights! Recording Blank Free. Consult me if you have an undeveloped invention or idea. Do not delay! **O. S. Leszay** Registered Attorney and Engineer 15 Park Row, New York, N. Y.

INVENTORS PROTECT YOUR IDEAS

Send for our Guide Book, HOW TO GET A PATENT, and Evidence of Invention Blank, sent Free on request. Tells our terms, methods, etc. Send model or sketch and description of your invention and we will give our opinion as to its patentable nature.

Name.....
 Street.....
 City.....

RANDOLPH & CO.
 Dept. 172, WASHINGTON, D. C.

The Living Death

By JOHN MARTIN LEAHY

(Continued from page 883)

"Suppose," I queried, "that she had not been drugged? Would the cold alone, in that case, have produced this condition of suspended vitality, as you declare it to be?"

"I don't know," said Hampden, "but I am afraid that, if she had not been drugged, the cold would have killed her.*"

"And how do you know that the cold didn't kill her, anyway—even though she lay here drugged?"

"Of course. I don't know; I can only say what I believe."

"And not only that, but how do you know that the belladonna, or whatever it was that they gave her, didn't kill her before ever her body was frozen?"

"I don't know that, either," Hampden returned. "I can only base my belief upon appearances and on what I think very possible and even probable. That is the foundation for my belief that she was not dead then—that she is not dead now."

"Well," I said, "let us say that this poor girl isn't dead—mind you, I don't say that I believe it; but let us say that it is so. Let us say that she is only sleeping. Heaven knows, she looks like one only asleep. There is nothing, I mean, corpse-like in the appearance of the body. But what then? She is only sleeping; but death itself could be no more terrible than this sleep of hers. Your boasted science is helpless here. Science can never awake her."

"No," Hampden answered. "This is a sleeper that no man on earth can ever awake. If she was a cold-blooded creature, it could be done. But as it is, she is doomed to the ice—to everlasting sleep (so we may call it because we have no better word) or a death foul and terrible, terrible, above all, because the very act of restoring her to life would, after all these thousands of years, mean her death."

"Now, however, we know that Hampden was wrong! Your wonderful discovery, Mr. Frontenac, has shown that there is hope—granting always, that is, that she was not dead when the body was frozen, incased in ice. That, so I believe now, we may easily regard as possible."

"And so now you see why I have come to you, Mr. Frontenac, and why I have told you my story."

"And something tells me that I have not come in vain, that you will go and find her, that—great Heaven, the terrible wonder, the awful thoughts it gives a man—that you will awake her!"

CHAPTER XIV

FRONTENAC ANSWERS

I know that it gave me a terrible wonder—awful thoughts. To awake her! Her sleep had lasted for thousands of years, perhaps three hundred thousand, and now to awake her! What strange things (when she had learned our language) she could tell! What a story to listen to! Three hundred thousand years! What was the slumber of Rip Van Winkle, Epimenides or the Seven Sleepers to that? And, besides, all that was fiction, whilst this—but was it real?

Here suddenly came other thoughts—thoughts the very antipodes of those others.

Real? What on earth had come over me? Shades of the great Munchausen, come and listen and turn green with envy! What a weaver of spells was this Captain Stanley Livingstone, with his tales of palm-trees

*"It may be doubted whether a healthy warm-blooded animal suddenly and equally frozen through all its parts is dead, although it is not recoverable."—Dr. Richardson.

PATENTS TRADE-MARKS AND COPYRIGHTS

OUR OFFER: No Charge for Examination and Instructions

YOUR FIRST STEP before disclosing an invention. The inventor should write for our blank form—

"Record of Invention"

This should be signed and witnessed and returned to us together with model or sketch and description of the invention for examination and instructions. *No charge for the above information.*

Our Four Books Mailed Free to Inventors

How to Obtain a Patent

Our Illustrated Guide Book contains full instructions regarding U. S. Patents. Our Methods, Terms, and 100 Mechanical Movements illustrated and described, Articles on Assignment or SALE OF PATENTS, Patent Practice and Procedure, and Law Points for inventors.

Our Trade Mark Book

Shows the value and necessity of Trade-Mark Protection and gives information regarding Trade-Marks and unfair competition in trade.

Our Foreign Book

We have Direct Agencies in all Foreign Countries. We secure Foreign Patents in shortest time and lowest cost.

Progress of Invention

Description of World's Most Pressing Problems by Leading Scientists and Inventors.



VICTOR J. EVANS & Co.

VICTOR BUILDING · 779 - 9TH ST., N.W.

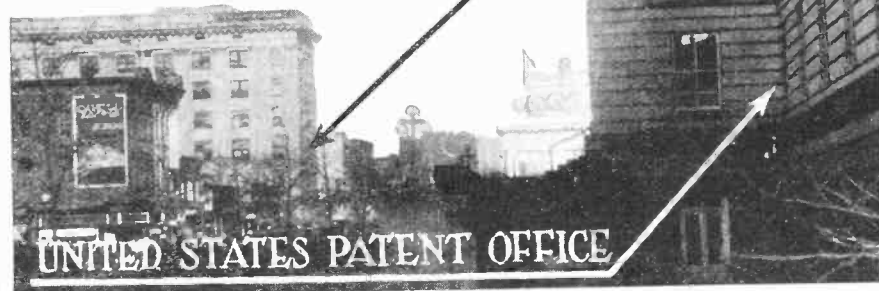

UNITED STATES PATENT OFFICE

WE REGARD A SATISFIED CLIENT

As our best advertisement, and will furnish to anyone upon request, lists of clients in any state for whom we have secured patents. All communications strictly confidential.

Highest References—Prompt Attention—Reasonable Terms

WRITE TODAY

FREE COUPON

VICTOR J. EVANS & CO., Patent Attorneys

New York Offices Philadelphia Offices Pittsburgh Offices
1007 Woolworth Bldg. 714-715 Liberty Bldg. 514 Empire Bldg.
Chicago Offices, 1114 Tacoma Bldg. San Francisco Offices, Hobart Bldg.

Main Offices, 779 Ninth Street, Washington, D. C.

Gentlemen: Please send me FREE OF CHARGE your books as described above.

Name Address

Dealers

Get this Free Book



RADIO TIPS for DEALERS

The Guide of the Radio Industry for Dealers only

Dealers Wanted

We want dealers in every locality to handle our line of goods

Our Proposition Means Money to You
Our prices save you money. The quality of our goods insures satisfied customers. Our fast service will help you do a large business on a small investment.

Send For Our Free Catalog
We supply you the finest line of merchandise—both sets and parts for building sets. Our dealers' information service will help you quickly build up a successful profitable business. Tell us what business you are doing and can do. We will help you. Act quick.

W. C. Braun Co.
32 So. Clinton St. Chicago, Ill.



RADIO EXPERTS EARN BIG MONEY

Thousands of big pay opportunities open to the radio trained man. Success easily won in the fastest growing industry of all time. From land and sea comes the urgent call for men who can construct, install, operate, repair, maintain and sell radio equipment.

CASH for Your Spare Time!

Take orders from your neighbors for radio sets. Get big fees for your services and advice. Home study qualifies you—short course, low cost, easy terms, money back guarantee.

Wonderful tube receiving set of latest design. Range over 1000 miles. Write today for FREE copy of "Radio Facts."

A. G. MOHAUPT, Radio Engineer
RADIO ASSOCIATION OF AMERICA
4513 Ravenswood Ave., Dept. 61 Chicago



\$1 Postpaid with Instructions

SEND FOR YOUR FREE COPY

TESTED HOOK-UPS

SUBMITTED BY USERS OF OUR WONDERFUL TRANSMITTER BUTTON FOR LOUD SPEAKERS AMPLIFICATION EXPERIMENTS

K. ELECTRIC CO.
15 PARK ROW NEW YORK

near the Southern Pole—palm-trees, forsooth, and in a land where the temperature in December and January, in the very midst of the Antarctic summer, is below freezing. And butterflies and birds and flowers, and a monster that cut off men's heads and left the mark of an enormous claw!

A sensible man, when he had done as well as that in the line of fiction and fairytales, ought, in common reason, to use a little restraint and rest there on his laurels. But not so our worthy Captain. He must needs cap it all with a real marvel. And so this Sleeping Beauty. Sleeping Beauty! That was wonderful enough, but to be sleeping in a bed of solid ice! Hocus-pocus, abracadabra, hokum and bunk! Whoever heard of a girl sleeping in a bed of ice? And only for a quarter of a million years or so!

Heavens, what a necromancer was our worthy Captain when he could bring me—yes, even me—under his spell, when he could make me believe (as I certainly had done) this wild story of his—a yarn that no man could believe in for a moment without a total abnegation of common-sense.

But, at this very moment, still other thoughts came. Was I not a little precipitate here, just a little bit too cocksure? Who was I to say what could or could not be? The Gardens of Paradise, and within the Antarctic circle! A strange place truly. Why, the thing was repugnant to common-sense. But hold on a minute. What, after all, was this boasted common-sense of ours? Was it a counselor to be implicitly trusted—a psychic queen, as it were, who could do no wrong? It certainly was not, as easily could be shown by a thousand instances.

The discoverer of the Yellowstone Wonderland, for example, had been branded as a liar by this wonderful common-sense.

"After his return to St. Louis," Chittenden tells us, "Colter evidently talked a great deal about his adventures, and in spite of the fact that such men as General Clark and the others we have mentioned (James, Brackenridge and Bradbury) esteemed his accounts worthy of record, he succeeded in making himself rated by the general public as an unmitigated prevaricator. His stories were generally discredited; their author became a subject of jest and ridicule, and the region of his reputed discoveries was long derisively known as 'Colter's Hell.'"

Well, as the discoverer of the Yellowstone Wonderland had been treated, so had the man who sat before us.

"James Bridger," to quote Chittenden again, "celebrated hunter, trader, and guide, whose name and career are part of the pioneer history of the West, was thoroughly familiar with the region now comprised in the Yellowstone Park. His personal knowledge of it dates back as far as 1830. He often visited it, not like Ferris in a single locality, but in all its parts, and was well acquainted with its wonderful features. In his efforts to disseminate the knowledge he had acquired, he was as persistent as Colter had been before him, and with little better success. He tried to get his descriptions before the public, but no periodical or newspaper would lend itself to his service. The editor of a leading western paper stated in 1879 that Bridger had told him of the Yellowstone wonders fully thirty years before. He prepared an article from his descriptions and then suppressed it, 'because a man who claimed to know Bridger told him he would be laughed out of town if he printed any of 'old Jim Bridger's lies.' In later years this editor publicly apologized to Bridger for having doubted his statements."

At the present day one is totally at a loss to account for incredulity like this—for the ridicule that was heaped upon a man simply because he said he had gone to the headwaters of the Yellowstone and there he had seen a gevser!

(Continued on page 936)

FREE



To Each Purchaser of a World Battery

A 24-Volt "B" Storage Battery positively given FREE with each purchase of a WORLD "A" Storage Battery. The WORLD Battery is famous for its guaranteed quality and service. Backed by years of Successful Manufacture and Thousands of Satisfied Users. You save 50%.

Prices That Save and Satisfy

Auto Batteries		Radio Batteries	
6-Volt, 11 Plate	\$12.25	6-Volt, 100 Amps.	12.50
6-Volt, 13 Plate	14.25	6-Volt, 120 Amps.	14.50
12-Volt, 7 Plate	17.00	6-Volt, 140 Amps.	16.00

Shipment Express C. O. D. subject to examination. 2 per cent discount for cash in full with order.

2-Yr. Guarantee Bond in Writing With Each World Storage Battery

proves satisfactory World performance. Mail this ad with your name and address—we will ship battery day order is received; and give you your choice of "B" Storage Battery or a handsome nickel finish Auto Spottie, FREE. Write TODAY.

WORLD BATTERY COMPANY
1219 So. Wabash Ave. Dept. 19, CHICAGO, ILL.

This FREE "B" Storage Battery takes the place of dry cell "B" batteries. Can be recharged and will last indefinitely. To be sold retail for \$6.00. It is the only battery of its kind equipped with solid rubber case—and insurance against acid and leakage. Take advantage of this remarkable introductory offer NOW. (To those who prefer it, we will send FREE a handsome nickel finish Auto Spottie, instead of the "B" Battery. Be sure to specify which is wanted.)

GIVEN FREE
To introduce this new and superior World "B" Storage Battery to the Public.



VESCO SMILES AT MILES



ON ONE TUBE

BIG FREE BOOKLET tells the story. California users of CROSS COUNTRY CIRCUIT near Atlantic Coast, Canada, Cuba, Mexico and Hawaii. Atlantic Coast users near England to California. Our new plan makes this set easiest and cheapest to build. One hour puts in operation. One tuning control. No soldering. Any novice can do it. BIG BOOKLET FREE or complete instructions for 25c stamps or coin.

VESCO RADIO CO Box St-117 Oakland, Calif.

FARAWAY RADIO



\$29.50

Gets stations Far and near Loud and Clear

FARAWAY Radio Sets are amazing values at bargain prices. Operate with either dry cells or storage batteries. Beautiful cabinet finished in mahogany with new platinum-finished panel. SATISFACTION GUARANTEED. Don't pay \$100 to \$150. Write for our money-saving plan and literature.

2-Tube Set - \$29.50
4-Tube Set - \$59.50

Dealers - Agents: Biggest possibilities you ever heard of. Write for plan and territory quickly.

THE FARAWAY RADIO CO., 657 W. THIRD ST., CINCINNATI, O.

DEALERS SAVE MONEY

By Ordering from Our Bargain Catalog of Nationally Advertised Radio Goods. Write for It Today!

AMERICAN RADIO MFG CO.
Dept. 7 6 WEST 14th ST. KANSAS CITY, MO.

ADULTS! SEX KNOWLEDGE BOOKS

instructive, authoritative, profusely illustrated in natural colors, etc. The worth-while sort. Contains everything one should know both before and after marriage to enjoy health and happiness. Large Catalog, 10c.

F. SMETANA & CO. OWOSSO, MICH.

"BUILD YOUR OWN" WITH "RASCO" PARTS!

Buy from the Oldest and Original Exclusive Radio Parts House in the United States

We pay ALL transportation charges in U. S. ALL GOODS SENT PREPAID IN 24 HOURS

Order direct from this page.

NEW AND EXCLUSIVE "RASCO" GOODS

Money refunded if goods do not satisfy

HERE it is! The radio tool that will bring happiness to all radio experimenters and constructors. Here is a tool that does 16 different things and does them well. A tool that does practically everything required in building your radio set. The tool is built of hardened steel, size exactly as per illustration, highly finished. Here are some of the uses: 1. Screwdriver. 2. Center punch. 3. Countersink and reamer. 4. Bus bar wire bender. 5. Bus bar and wire bender for 8-32 screw. 6. Bus bar and wire bender for 6-32 screw. 7. Socket wrench for jacks & 6-32 nuts. 8. Socket wrench for 6-32 nuts. 9. Socket wrench for 8-32 nuts. 10. Socket wrench for 8-32 nuts. 11. Wrench for knurled nuts. 12. Screw gauge for 4-32 screw. 13. Screw gauge for 6-32 screw. 14. Screw gauge for 8-32 screw. 15. Screw gauge for 10-32 screw. 16. Knife for wire skinning. These are only the important uses of the tool, but many other uses will readily suggest themselves to every radio experimenter. You will wonder how you have gotten along before without the 16 in 1 radio tool. Get one of these happiness tools. You will never again be without it. 14800 RASCO 16 in 1 Radio Tool, each \$0.35

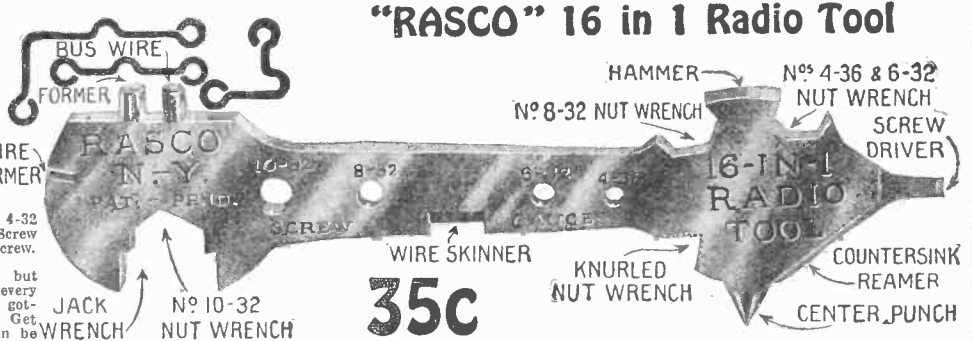

"RASCO" 16 in 1 Radio Tool

Crystodyne Detector. For All New Oscillating Crystal Circuits

(PATENTS PENDING)

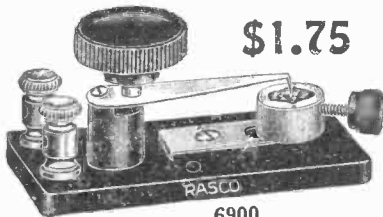

\$1.75

Here is a detector which has been especially developed by us for the new Crystodyne circuits. This detector while using the natural mineral zincite can be used with any other crystal as well. Several unique features are embodied in this detector. To begin with it is the only detector that has a sliding crystal cup with perfect contact arrangement and which cup not only slides but rotates with an eccentric motion. (Note slot A.) By means of the small knob the cup slides easily so that any point of the crystal can be brought into contact. A new crystal can be inserted immediately by unscrewing the catwhisker that contact plate which at the same time forms the catwhisker is made of spring steel. The combination of steel-zincite is the only one that was found practical for the Crystodyne oscillating crystal. Note the micrometric adjustment that can be made by means of the large knob bearing that can be made by means of the finest possible degree. The base is of

against the steel spring. This raises and lowers the steel point to the finest possible degree. The base is of bakelite, all parts nickel plated and polished. 16900—Crystodyne Zincite Detector with Crystal.....\$1.75
16900—Natural Zincite Mounted Crystal especially tested for Crystodyne work, fits any crystal cup..... .60

"RASCO" Snap Switch

This switch is intended as a battery switch to disconnect your "A" batteries. Only one hole to drill. No tools required to mount, use your finger and thumb. Also this switch takes up a minimum of room, much less than other switches, the base of the switch measuring only 1 1/4 x 1/2". All metal parts nickel plated. A switch you will be proud to possess. 14850—RASCO Snap Switch. Each 25c

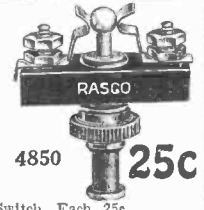

14850 25c

RADIO DIAL BUTTON

You are interested in radio—you have a radio set, or you are a radio experimenter. You know it and your friends know it; but suppose you casually meet another radio man. He will not know that you are interested in radio, nor will you know that he is. For you and every radio enthusiast the new radio dial button has been created. It identifies you immediately and will help you and everyone else to break the ice when "Greek meets Greek."

The new emblem is a small button measuring 3/8 in. in diam. It is an exact replica of a standard modern radio dial. It has a raised knob and the dial graduations are exactly like the best radio dial. Along the lower circumference the word "RADIO" is set in gold. The entire dial is made in best black enamel. All lettering, figures and gradations are inlaid gold on enamel. The knob part is also in gold. Best gold plate is used. The button is equipped with a screw back so that the emblem can be attached to your button hole in a few seconds. The most beautiful radio emblem ever made. Thousands are worn it. Get one or more of these buttons today. Made of best materials. It will positively not tarnish and it lasts for years. J7799—"RASCO" Radio Dial Button, each.....\$0.25



RASCO NAME PLATE ASSORTMENT
No. 4994

This Name Plate Assortment Packet contains Nine Binding Post Name Plates as follows: one Aerial; one Ground; two Phones; one "A" Bat. +; one "A" Bat. +; one "A" Bat. +; one "A" Bat. +; one "C" Bat. +; one "C" Bat. +. 14994 Nine Name Plate Assortment.....\$0.20

RASCO LUG ASSORTMENT
50 LUGS
5 DIFFERENT STYLES
No. 4995

This Lug Assortment Packet contains fifty of the most important lugs for the man who "Builds His Own" as follows: 10 lugs for 8/32; 10 for 6/32; 10 prong lugs (solderless) 6/32; 10 ditto 8/32; 10 flat type 6/32. All lugs are tinned. 14995 Lug Assortment.....\$0.22

RASCO RADIO NEEDS ASSORTMENT
108 PIECES
No. 4996

This assortment contains 108 pieces as follows: 36 "T" Wire Bus-Bar Connectors; 4 Adapter Bushings (to fit 1/4" dial to 3/16" shaft); 4 Separable Phone Tips; 4 Angle Brackets; 24 Lock Washers; 36 Assorted Lugs, already tinned for easy soldering. 14996 "RADIO NEEDS" Assortment.....\$0.48

RASCO RADIO HELPS ASSORTMENT
No. 4997

Here is an assortment that everyone building a radio set needs. Contains the following: 12 Assorted "Perfect" Lugs; 6 Grid Leak Mountings; 4 Dial Markers; 8-1475; 6-1476; 8-1492; 2-1505 Brackets. List Price of all parts, \$1.32. 14997 Radio Helps Assortment.....\$0.98

"RASCO" Clip Leads

Here is something that every experimenter has been waiting for impatiently. This is a flexible silk-covered conductor to the ends of which are soldered strong brass spring clips. Instead of using wires to make your connections—screwing and unscrewing binding posts



—a clip lead hooks in a jiffy onto any wire, any binding post or other conductor in order to make a safe experimental connection. "RASCO" CLIP LEADS come in two colors, green and red, to distinguish connections. Brass clips have powerful grip. Length of clip lead, one foot. 17887 RASCO CLIP LEADS, Each.....\$0.12
Dozen lots..... 1.35

"RASCO" Brackets

Here is a line of small brackets evolved especially for the man who "Builds His Own." They can be used in a number of different ways—to hold tuning coil wires; inductances; spider webs, etc.; to hold up panels; to attach various instruments to baseboards, etc. "RASCO" brass brackets are stamped from heavy metal and have been designed to do the work right. They are nickel-plated and carefully finished. All illustrations are exactly half-size. Every builder needs at least a dozen of these. Order them now and save money and effort. 11475 Brass Angle Piece, 5/16" wide x 7/16" high. Each.....\$0.03
11476 Brass Bracket, 3/4" high x 2 lugs 1/4" long. Each..... .05
11490 Brass Angle Piece, size 3/4" x 3/4". Each..... .04
11505 Brass Angle Piece, size 1 1/2" high x 3/4" long..... .05
Dozen lots, each style 15 percent discount.

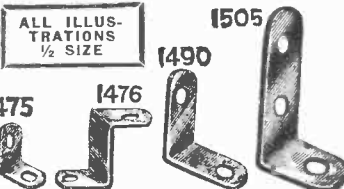

SEE OUR 2-PAGE AD ON PAGES 1130 and 1131 RADIO NEWS

Dealers and Jobbers

Write or wire for territory that is still open on the specialties described on this page. These articles are widely advertised and you will have a demand for them almost immediately. We shall be glad to send samples to responsible and rated concerns. Address all wholesale inquiries to RADIO SPECIALTY COMPANY Wholesale Department 25A West Broadway, New York City

RADIO SPECIALTY CO., 100 Park Place, New York City
Factories: Brooklyn, N. Y. Elkridge, Md.

Now you can understand RADIO



**JUST OUT
514 PAGES**

Compiled by
**HARRY F. DART,
E.E.**

Formerly with the
Western Electric Co.,
and U. S. Army In-
structor of Radio.

Technically edited by
F. H. Doane

NO MORE need you turn from book to book, hoping to find what you want. It is all here, in 514 pages crammed full of every possible radio detail. Written in plain language, by engineers for laymen. More than 100,000 sold.

IT EXPLAINS: Electrical terms and circuits, antennas, batteries, generators and motors, electron (vacuum) tubes, every receiving hook-up, radio and audio frequency amplification, broadcast and commercial transmitters and receivers, super-regeneration, codes, etc.

Send \$1 to-day and get this 514-page I. C. S. Radio Handbook—the biggest value in radio to-day.

International Correspondence Schools
Box 6191-D, Scranton, Penna.

I enclose One Dollar. Please send me—post-paid—the 514-page I. C. S. Radio Handbook. It is understood that if I am not entirely satisfied I may return this book within five days and you will refund my money.

Name.....

Address.....

Check here and enclose \$1.50 if you wish the de luxe edition, bound in Leatheroid.

BARGAIN CATALOG Yours FREE! 100 Pages!



Get it now!

Crammed full of information and offers of all kinds of complete RADIO SETS, Parts and Accessories

Only \$21.95 for 1-tube outfit, receiver parts unassembled; often receives over 1,000 miles. Only \$33.78 for 2-tube outfit, receiver assembled; often receives over 1,000 miles on loud speaker. Only \$85.09 for 6-tube Neutrodyne outfit, receiver parts unassembled; has received England. These prices include all accessories, aerial, etc.—everything needed for receiving on head phones. Also, Crosley receivers, 10% off 25 other popular sets away down. It's easy to do business with us, for this is "The Radio House of Friendly Service." All goods offered subject to examination and approval. No money in advance. Quick shipment. We pay transportation anywhere in U. S. Satisfaction or money back. Your questions answered free. Get this wonderful catalog—you need it—write today! (And will you be so kind as to add the names of several friends you believe will soon want radio goods? Thank you!)

Liberty Mail Order House
Dept. A202 106 Liberty St., N.Y. C.

LATEST WHOLESALE RADIO CATALOG

FREE Simply send name TODAY for big 48-page catalog of latest radio goods at Wholesale. Live dealers and agents wanted. STANDARD RADIO CO., 112 East 13th, Kansas City, Mo.



FREE
This \$12.00 DARCHE Call-Me

Electric Alarm CLOCK Free. Operated by battery in clock case. No home complete without one. Write for particulars.

DARCHE MFG. CO.
641 Washington Blvd., Chicago

The Living Death

(Continued from page 934)

Well, hadn't it always been so? Men like Colter and Bridger have always been branded as fakers; but your Sir Kenelm Digbys—ah, what wonderful men are your Sir Kenelm Digbys!

"Even as late as 1623," says Dr. Cheadle, "Sir Kenelm Digby, the Admirable Crichton of his time, produced a sympathetic powder which was to cure wounds even when the patient was out of sight. This powder had extraordinary success, and its efficacy was almost universally acknowledged."

There is common-sense for you! And it is a great consolation to know that there is little likelihood the supply will ever fail us.

This celebrated powder, by the way, was simply pulverized ferric sulphate.

I remembered, too, that, when the first Ornithorhynchus was brought to Europe, those wise fellows the naturalists sat up and stared and then turned to common-sense for an explanation of the outré phenomenon before them, with this result: those wise old owls solemnly came to the conclusion that it was nothing but a clever hoax, that some joker had taken a duck's bill and stuck it onto the animal! Very clever, but he couldn't fool them!

Also, when they heard that someone somewhere in Africa had seen some kind of creature with a neck tremendously long, those same wise naturalists said they knew that *ex Africa semper aliquid novi*, for the ancients had so written, but—well—ahum, nothing so strange as often was to be found in the human encephalon, these strange things being known as illusions, hallucinations and delusions.

Not so very long ago common-sense prescribed the heart of the poor nightingale for those suffering from loss of memory, and for thousands of years, convinced mankind that the earth was flat as a pancake.

When Scheiner (to whom some attribute the discovery of the spots on the sun) informed the provincial of his order that the great luminary, the Eye of the Universe, was suffering from ophthalmia, this was the answer he received, dictated, of course, by our old friend common-sense:

"I have several times read my Aristotle all through from beginning to end, and I can assure you that he mentions not a syllable about it. Go, my son, tranquilize yourself, and be assured that what you suppose to be spots on the sun are nothing but specks in your eyes or flaws in your glasses."

It is easy enough to smile at this, at such blind submission to the authority of the great Stagirite—just as easy, in fact, as it is to forget that most of us, after all, are pretty good Aristotelians in more ways than one.

Your scientist is a great admirer of common-sense. Indeed, Huxley says somewhere that science is nothing but organized common-sense. Ahum, let us see what this common-sense really is. In former times, when a man spoke of stones falling down out of the sky, your scientist, this votary of common-sense, gave a smile of pity and said something about superstition and old wives' tales. It was not until the shower of meteoric stone at L'Aigle in Normandy, in 1803, that scientists realized that stones actually do fall from heaven. The French government sent Biot to investigate this old wives' tale that had come out of Normandy, and his report made it impossible for even the most devout worshiper of common-sense to doubt any longer.

And there you have it: up to the year 1803, common-sense declared the thing ab-

(Continued on page 938)

One Radio Book Everyone Reads

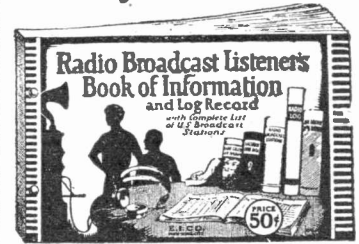

The Radio Broadcast Listener's Book of Information and Log Record

is not only a complete, practical book of those essential Radio facts that everyone who owns a radio should know, but it is also a handy log record for those who want to keep a record of the stations they receive.

The book is enclosed in a handsome two-color cover, bound in Loose-leaf fashion, so that new pages can be inserted if necessary. It contains 80 pages, each one containing information more valuable than the last.

The following is a brief summary of the information contained in this book:

Information for the Broadcast Listener: Vacuum Tube Table: Meter wave lengths: Radio Batteries: Wireless code chart: Station log chart:

Complete list of Broadcast Stations of the United States, giving Power, wave length, and Time of Operation each day of the week.

Log Sheets for tabulating the dial settings of the stations you receive on your radio. Size of Book, 6 in. by 9 in., with handsome 2-color cover

Postage **PRICE 50¢** Paid

CONSRAD CO., Selling Agents
233 FULTON STREET
NEW YORK CITY

E.I. Company

Build Your Own-At 1/2 the Price!
Guaranteed Nation Wide Reception

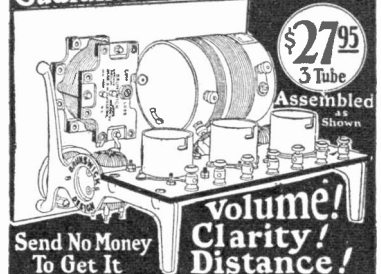

Send No Money To Get It
Volume! Clarity! Distance!

THE NEW DE LUXE AMBASSADOR
With Special Features--Can Be Wired Easily--Quickly

- THIS kit enables you to build a set that will compare with any factory built set. Will bring in all the distance you want—loud, clear, distinctive. Wiring and assembling chart that comes with kit, makes building simple, easy. Plug in ear phones or loud speaker and get Frisco or New York. By building it yourself you save 60%.
- KIT CONSISTS OF**
- 1 Drilled 7 x 10 Ration Mahogany Panel, Engraved in Gold.
 - 1 Genuine Ambassador Master 3-Circuit Litzendracht Tuning Coil.
 - 1 Genuine Brunswick Low Loss Condenser.
 - 1 Triplod Mounting Socket.
 - 2 Premier Heshog Audio Transformers.
 - 4 Brunswick Underslung Foundation Brackets.
 - 2 Brunswick Jacks with Gold-Plated Fronts; 1 for phones; 1 for loud speaker.
 - 1 Freshman Mica Grid Condenser.
 - 1 Standard Glass-Enclosed Grid Leak.
 - 2 30-Ohm Shackton Bakelite Rheostats.
 - 2 Moulded Mahogany Dials grained to match panel.
 - 5 Lengths Professional Round Bus Bar.
 - 1 Set of 7 Instrument Finish Binding Posts completely mounted.
 - 1 Special Blue Print for this circuit. Not an ordinary hook-up, but in clear picture form any child can understand and make.
- All packed in handsome box. Complete \$27.95 c.o.d. Only \$27.95 c.o.d. Send no money—just mail postal or letter today. Written money back guarantee with every order. **RADIO SHACK**, America's Largest Radio Dealers, 65 Vesey St., Dept. M19, New York.

Insure your copy reaching you each month. Subscribe to **SCIENCE & INVENTION**—\$2.50 a year. Experimenter Publishing Co., 53 Park Pl, N. Y. C.

NO MORE BATTERIES

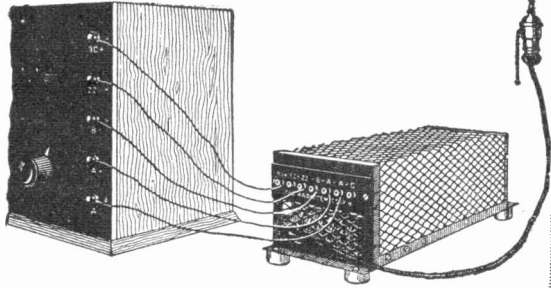

A-B POWER UNIT

The New Radio Unit That attaches to any Radio Set replacing both A and B Batteries.

Read These Facts

- 1—Absolutely eliminates all batteries.
- 2—NOISELESS at all times.
- 3—Will operate any set—no change whatsoever necessary in your set.
- 4—Steady current at full voltage always—a feature not found in batteries.
- 5—Will not overheat.
- 6—All connections identical to battery posts.
- 7—Will operate efficiently up to 10 tubes (1/4 Amp. each).
- 8—Eliminates danger of burning out tubes.
- 9—Attaches to any Light Socket 110 Volt D. C.

PRICE

\$30.⁰⁰

Sent Express Collect

Better order to-day. In two weeks' time we will be so swamped with orders that they will have to wait their turn. Orders sent now can be filled immediately.

RADIOGEM CORP.,
66-S—West Broadway, New York City.
Gentlemen:—I enclose \$25.00. Kindly ship me express collect one A-B Power Unit (for 110 volt Direct Current only).

Name

Address

City and State.....

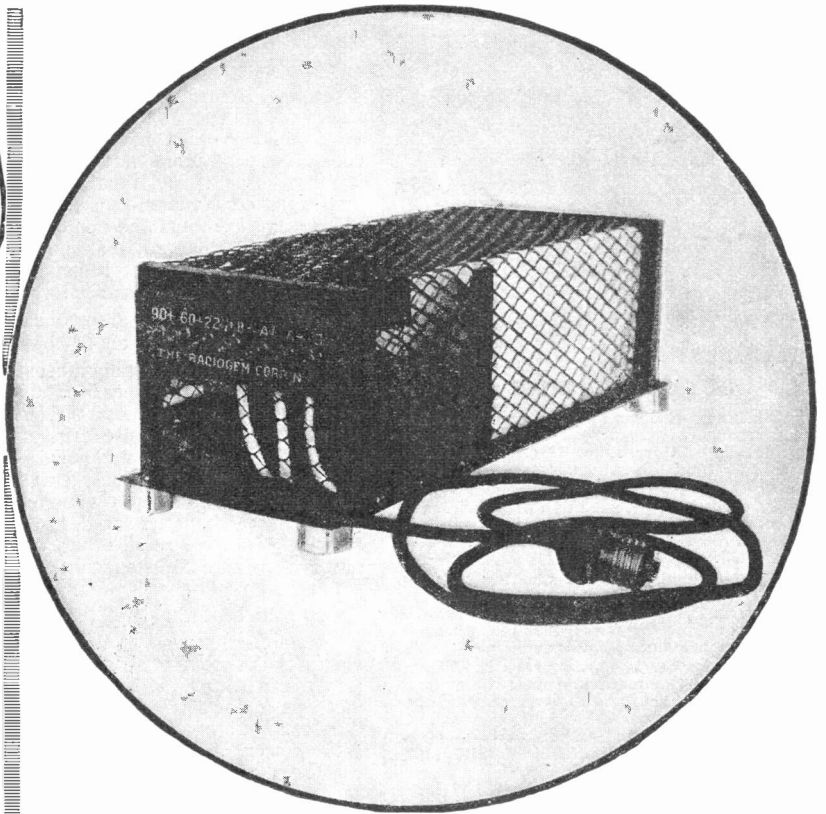

Patent

Pending

AT LAST

The Logical Unit for Operating the Radio Set—Cleaner, Steadier, More Compact and More Economical than Batteries

You can dispose of your batteries. Both A and B types. You can use the large space they occupied for other and more valuable material. You can rid your radio set of the unsightliness of the A and B batteries.

We have just perfected this logical ideal unit for the operation of the modern radio receiving outfit, a unit that takes the place of your batteries and operates direct from 110 Volt D. C. house current from the nearest socket.

The unit is small, neat, compact, not messy. It is silent in operation, does not overheat and IT DELIVERS A STEADY CURRENT AT ALL TIMES FOR BOTH FILAMENT AND PLATE, THEREBY INCREASING THE SIMPLICITY OF OPERATION OF THE MULTI-TUBE SET.

It is easier to hook up than batteries, absolutely no change necessary in your set. All connections are identical to battery posts, and are so marked. Has taps for the following voltages: 6, 22, 60, 90.

Entire unit is only 14 inches long by 6 inches wide by 5 inches high. Construction is of the finest materials for dependable long life. The unit is beautifully finished and will not detract from the appearance of the most ornate receiving set.

This Unit for Direct Current Only

AC Unit Under Constuction

Use the Coupon on the Left

The Radiogem Corporation

66-S-West Broadway New York City

BUILDING TRADES NEED MEN!

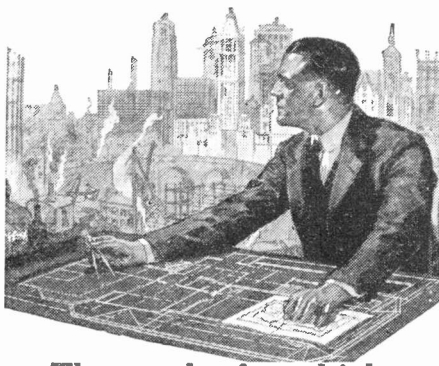

Thousands of good jobs at good salaries

THE business tide has turned! And the building trades are leading the way back to prosperity! Government experts estimate that two to four billion dollars will be spent for building construction this year.

To-day the most vital need of this great building program is men—trained men—men who can step right in and do the skilled work that building construction requires.

There is a simple, easy, fascinating way by which you can prepare for a good position, at a good salary. You can do it right at home, in spare time, no matter where you live, through the International Correspondence Schools.

All we ask is the chance to prove it. That's fair, isn't it? Then mark and mail the coupon printed below and get the full story of what the I. C. S. can do for you.

TEAR OUT HERE
INTERNATIONAL CORRESPONDENCE SCHOOLS
Box 6186-D, Scranton, Penna.

Without cost or obligation, please tell me how I can qualify for the position or the subject before which I have marked an X in the list below:

- | TECHNICAL AND INDUSTRIAL COURSES | |
|--|---|
| <input type="checkbox"/> Architect | <input type="checkbox"/> Surveying and Mapping |
| <input type="checkbox"/> Architectural Draftsman | <input type="checkbox"/> Gas Engine Operating |
| <input type="checkbox"/> Architects' Blue Prints | <input type="checkbox"/> Automobile Work |
| <input type="checkbox"/> Building Foreman | <input type="checkbox"/> Airplane Engines |
| <input type="checkbox"/> Concrete Builder | <input type="checkbox"/> Plumber and Steam Fitter |
| <input type="checkbox"/> Contractor and Builder | <input type="checkbox"/> Plumbing Inspector |
| <input type="checkbox"/> Structural Draftsman | <input type="checkbox"/> Foreman Plumber |
| <input type="checkbox"/> Structural Engineer | <input type="checkbox"/> Heating and Ventilation |
| <input type="checkbox"/> Electrician | <input type="checkbox"/> Sheet Metal Worker |
| <input type="checkbox"/> Electrical Engineer | <input type="checkbox"/> Steam Engineer |
| <input type="checkbox"/> Electrical Contractor | <input type="checkbox"/> Railroad Positions |
| <input type="checkbox"/> Electric Wiring | <input type="checkbox"/> Chemistry |
| <input type="checkbox"/> Mechanical Engineer | <input type="checkbox"/> Pharmacy |
| <input type="checkbox"/> Mechanical Draftsman | <input type="checkbox"/> Metallurgy |
| <input type="checkbox"/> Machine Shop Practice | <input type="checkbox"/> Mining Engineer |
| <input type="checkbox"/> Toolmaker | <input type="checkbox"/> Navigation |
| <input type="checkbox"/> Civil Engineering | <input type="checkbox"/> Mathematics <input type="checkbox"/> Radio |

- | BUSINESS TRAINING COURSES | |
|--|---|
| <input type="checkbox"/> Business Management | <input type="checkbox"/> Salesmanship |
| <input type="checkbox"/> Industrial Management | <input type="checkbox"/> Advertising |
| <input type="checkbox"/> Personnel Organization | <input type="checkbox"/> Better Letters |
| <input type="checkbox"/> Traffic Management | <input type="checkbox"/> Foreign Trade |
| <input type="checkbox"/> Business Law | <input type="checkbox"/> Show Card Lettering |
| <input type="checkbox"/> Banking and Banking Law | <input type="checkbox"/> Stenography and Typing |
| <input type="checkbox"/> Accountancy | <input type="checkbox"/> Teacher |
| (Including C.P.A.) | <input type="checkbox"/> Civil Service |
| <input type="checkbox"/> Nicholson Cost Accounting | <input type="checkbox"/> Railway Mail Clerk |
| <input type="checkbox"/> Bookkeeping | <input type="checkbox"/> Common School Subjects |
| <input type="checkbox"/> Business English | <input type="checkbox"/> High School Subjects |
| <input type="checkbox"/> Private Secretary | <input type="checkbox"/> Illustrating |
| <input type="checkbox"/> Business Spanish | <input type="checkbox"/> Cartooning |
| | <input type="checkbox"/> French |

Name.....
Street.....
Address.....
City..... State.....

Occupation.....
Persons residing in Canada should send this coupon to the International Correspondence Schools Canadian, Limited, Montreal, Canada.

"LEARN AVIATION"
OPPORTUNITY is at your door. Learn Airplane Engineering Now. Earn \$2,000.00 to \$10,000.00 a year. Write for free catalog.
WESTERN AIRPLANE CORP.,
Dept. S, Monardnock Block, Chicago

Insure you copy reaching you each month. Subscribe to Science and Invention—\$2.50 a year. Experimenter Publishing Co., 53 Park Place, N. Y. C.

The Living Death

(Continued from page 936)

surd and, ever since, that it is absurd to suppose it absurd. Can you beat it?

Well, I can.

Common-sense used to tell the scientist that, as a spherical body of incandescent gas loses heat, it must needs grow cooler and cooler, that the more heat it loses, the colder it must become; and then along came Lane and (quoting common-sense, who a moment before had said just the opposite) proved to that scientist that such a body, instead of growing cooler, in fact becomes hotter and hotter—that the more heat it loses, the hotter it gets!

What do you think about that?

We are told (by common-sense) that resistance retards the speed of a body. Of course. For once common-sense, we say, is right. But common-sense hasn't finished yet. For right around common-sense turns and informs us that, if a body traveling round the sun—a planet or a comet—encounters a resisting medium, its speed, instead of being retarded, is accelerated—that the more resistance such a body encounters, the faster it must go!

Can you beat that? I can.

Common-sense tells us that molten metal is very hot and that it will burn a man. Yet a man can thrust his hand into a stream of metal as it flows from the furnace and draw the hand out again without even a blister. I have seen it done. All that man did—it was Darwin Frontenac—before thrusting his hand into that molten stream, was to dip it into a pail of water.

So what, after all, is common-sense but a sort of psychic Great Mogul? And, like all moguls, great or small, he sometimes cuts some mighty queer capers. For instance, sometimes at midday he gravely remarks that it is midnight. And what do we do then? Do we try to show his majesty that, instead of being midnight, it is in reality noonday? Not we. For he is the Great Mogul—and we? We are worshiping subjects (alias Aristotelians) and we all exclaim, our voices raised to accents ecstatic: "Behold the moon and the star!"

I thought of these things and of many more, and then the Captain broke the silence and my train (or jumble) of thought—for which, I have little doubt, you will be rather thankful.

"Yes," said he, "to awake her!"

He was gazing earnestly, wistfully at Darwin Frontenac. Frontenac's eyes were fixed on the other, the expression in them keen and yet strangely vacuous, but he did not break the silence.

"To awake her!" murmured Captain Stanley Livingstone. "Once I would have thought such an idea wild as the wildest fancy of poet or romancer; but now I believe that it is a sober possibility."

"It is," Frontenac nodded, a glitter in his gray eyes, "if the girl's condition be indeed one of suspended animation, if life had not quitted the body before it was frozen."

"I believe, Mr. Frontenac, that it had not, that Hampden was right, that my poor Sleeping Beauty is in that strange state which is neither life nor death."

"It is very possible," Frontenac said. "But one can't be sure of that until—"

"Until?" queried the Captain, leaning forward.

"One can't be sure, Captain. Remember, the girl had been drugged."

"I remember that, Mr. Frontenac. But she isn't dead; she can't be dead! A dead body could never be so lifelike in appearance."

Frontenac made no response.

"There is one thing, though," said the discoverer: "suppose that the drug they gave

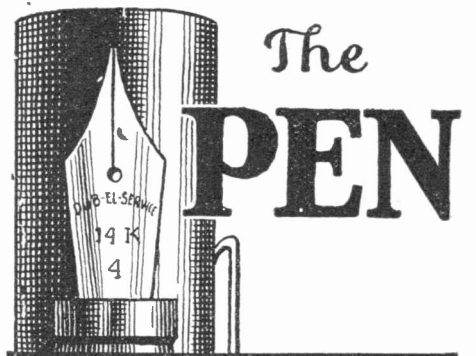

The PEN

The PEN-PENCIL

An essential necessity on the road to success

More so than the most valuable textbook, a faithful PEN-PENCIL always by your side and at your command aids you in your struggle for success and power.

The PEN-PENCIL is the modern, improved combination of the old-fashioned fountain pen and automatic pencil. It is a fountain pen and automatic pencil in ONE.

When it is in your pocket you have always at your command not only a fine, accurate, free-flowing fountain pen, but also a reliable smooth writing pencil, the most essential weapons in your struggle for success and happiness.

You will never regret the day you make yourself a gift of a Dub-el Servis Pen-Pencil. It's a lifetime friend, both in times of distress and prosperity.

Large standard variety of sizes, all styles. Prices from \$2.75, \$3.00, \$3.50, \$5.00 and up.

Write today for our Free Catalogue of styles and prices.

Dub-El Servis Corp.

130 W. 42nd St. NEW YORK CITY

ACTUAL \$5.00 SIZE

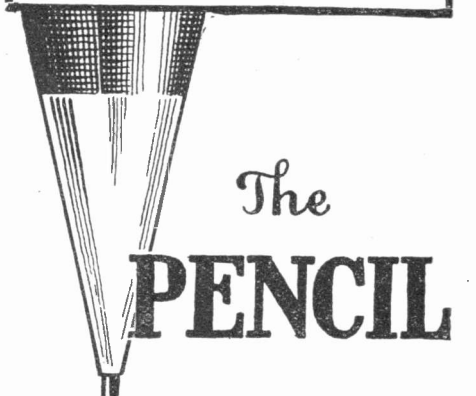

The PENCIL

her would have proved fatal if the cold had not fallen; in that case, if you awake her, will the poison continue its work and kill her, kill her after all these thousands of years?"

"No," Frontenac answered: "my antidote will neutralize the belladonna, mandragora or whatever it was they gave her—if I can awake her!"

"Then, Mr. Frontenac," the other exclaimed, "you are going to go down there and get her?"

Frontenac smiled a little.

"Exploring, Captain, is rather out of my line."

The other waved a hand airily.

"Don't hesitate a moment because of that. Did you learn to swim before ever you went into the water? Never fear, Mr. Frontenac, you will be an explorer before you get back."

"If I ever do!"

"You will get back to the world. You'll go down there better prepared than I was. You'll know what you are going to meet."

"I'm afraid that I don't. All I know is that it is a thing with an enormous claw."

"Oh, well," said the Captain, "you know that it is there, which is more than I did."

"And," he added, "as for experience, I understand that you have been in the Arctic."

Frontenac waved a hand deprecatingly.

"I was never very far from the ship. I was only a scientist, not an explorer, though I may truly say that it would have been the other way around if my own wishes could have been followed."

"And I," said the Captain, "am only an explorer, not a scientist. Experience, Mr. Frontenac, is, of course, a great thing, but not so great as it is often held up to be. It isn't everything, by any means. And, besides, experience is very apt to put a man into a rut. He is often sure, certain, absolutely positive that this thing can be done and that that thing can't when, as a matter of fact, he doesn't know anything about it at all. That's the one bad thing about experience. It is the new men, as a rule, who do the new things."

"I have long believed that. But here is another thing: I have my work here to do; nothing has been farther from my mind than that I should ever go forth as an explorer. And another thing, Captain: I am no longer young."

The Captain stared, then a smile moved those weather-beaten features.

"You are not yet old, by a good many years."

"Alas, I am; I'll soon be forty."

"Forty!"

Captain Livingstone laughed.

"Now," said Frontenac, "if I were as young as my friend McQuestion here, if I were (as he is) a regular, genuine, dyed-in-the-wool, blown-in-the-glass sourdough, a member of the great Order of Icicle Muckymucks as well as that of the Muckluck Tillicums, if I could live for a whole week on a snowflake and simply feast upon a rabbit-track—if all that were only so, I wouldn't hesitate for a single moment. But, as it is—"

"As it is?" the Captain suggested.

"As it is, not being qualified to become an Icicle Muckymuck, to say nothing of a Muckluck Tillicum, what can I do?"

"Well, Mr. Frontenac," the explorer smiled, "your moment is up."

He turned his look to me.

"Are you going to go with him, Mr. McQuestion?"

"Is he going?"

The Captain turned his look back to Darwin Frontenac.

For some moments there was a deep silence, then Frontenac spoke:

"Yes, I will go, Captain Livingstone; I will get your Sleeping Beauty and awake her if I can—if that thing there in the Gardens of Paradise doesn't get me within the reach of its claws."

(To be continued.)



Go After the Big-pay Job!

"Know electricity as experts know it and get an expert's pay"

DON'T be satisfied to worry along in little jobs with little pay. Master the finer points of electrical practice and bring the big pay job within your reach. Croft will show you how. Through his famous books he will teach you electricity as experts know it and put you in line for an expert's pay. Forty thousand men are using these books to step ahead—WHY NOT YOU?

A great book on transformer practice—free if you order now!

The Croft Library of Practical Electricity

A Combined Home Study Course and Reference Library
8 volumes—3000 pages—2100 illustrations—flexible Keratol binding
Was \$27.00—Now \$19.50

FREE
with the
LIBRARY
Taylor's
Transformer

Practice

IF YOU ORDER NOW!

YOU SAVE

\$10.50

AND HAVE

10

MONTHS TO PAY

FREE EXAMINATION

NO MONEY IN ADVANCE

SEND YOUR COUPON NOW

McGraw-Hill Book Company, INC.

370 Seventh Avenue New York

No method of teaching electricity offers a quicker, surer way to success than the Croft books.

Starting right in with the ABC's of modern electrical practice, Croft takes you through his books in easy steps. He gives you the secrets of success in electricity in plain words, figures and illustrations.

Croft teaches you electrical practice complete—inside and outside work—central stations and the whole subject. He takes you in quick, easy steps from the simplest principles to the complete and economical operation of a great central station.

He tells you things you need to know about motors, generators, armatures, commutators, transformers, circuits, currents, switchboards, distribution systems—electrical machinery of every type, installation, operation and repair—wiring for light and power—how to do it mechanically perfect, in accordance with the National Electrical Code—wiring of finished buildings—Underwriters' and municipal requirements—how to do a complete job, from estimating it, to completion—illumination in its every phase—the latest and most improved methods of lighting—lamps and lighting effects, etc.

The Sure Way to Bigger Pay

Big salaries are paid in the electrical field for expert knowledge. The man who knows electricity in all its many phases—the man who has completely mastered the subject from A to Z—can pick his own job and name his own salary. The only way you can earn more is to learn more. Small knowledge means small pay. Learn the way to bigger pay. Become an expert.

FREE TRIAL

The proof of all we have said is in the books themselves, and it costs you N-O-T-H-I-N-G to examine them. There are no charges of any kind to pay. We pay everything. We send the books to you for 10 days' examination and let you be the sole judge as to their value.

EASY PAYMENTS

If you decide to take this sure road to promotion, you need send only \$1.50 in ten days and pay the balance at the rate of \$2.00 a month. You do not have to send any money to see the books. On receipt of your first payment of \$1.50 we will send you your free copy of Taylor's Transformer Practice.



FREE Examination Coupon

McGraw-Hill Book Co., Inc.,
370 Seventh Ave.,
New York

Gentlemen:—Send me the LIBRARY OF PRACTICAL ELECTRICITY (shipping charges prepaid), for 10 days' free examination. If satisfactory, I will send \$1.50 in ten days and \$2 per month until the special price of \$19.50 has been paid. If not wanted, I will write you for return shipping instructions. Upon receipt of my first payment of \$1.50 I am to receive a free copy of Taylor's Transformer Practice.

Name

Home Address

City and State

Employed by

Occupation S.&I. 1-1-25

WURLITZER

Couldn't Play a Note—
Now Makes \$100⁰⁰
a week



"Bill Carola"
Landau's
Serenaders

Read Bill Carola's story in his own words—
"When I sent for your catalog, I wanted a Tenor Banjo, but I hesitated a long time as I didn't know a note of music. I finally decided to try it a week, as you offered, and at the end of that time I found I could pick a few notes. Then I started the correspondence course you furnished, and in seven months, even before the final payments on the Banjo were due, I had taken my place in a professional orchestra. Now I am making \$100 a week, three times what I made as a clerk. Two of my friends made money with their instruments after five months practice, one a drummer and the other a saxophonist, and neither could play a note when he started. I wish everybody knew how easy it is—anyone who can whistle a tune can learn to play a musical instrument."
Bill Carola

New Offer

Learning to Play
Made Easy

FREE We now furnish with every instrument a Free Scholarship Certificate. This scholarship entitles you to free tuition in one of the foremost correspondence schools of music in the country. Whether you want to learn to play for profit or only for pleasure, this Free Scholarship will make it surprisingly easy for you.

**Free Trial
Easy Payments**

You may have any Wurlitzer instrument for a week's free trial in your own home. No obligation to buy. Payments are arranged in small monthly sums, a few cents a day will pay for your instrument. Wurlitzer instruments are the result of 200 year's experience in musical instrument building. Famous for artistic quality, rich tone value and fine workmanship. Used in the finest bands and orchestras throughout the world.

Free Book

Illustrates and describes every known musical instrument—over 3000 articles. Special offers on complete outfits. Special prices direct to you. We also give you our Free Trial, Easy Payment plan and special Free Scholarship offer. No obligation.

Send Coupon Today



The Rudolph Wurlitzer Co., Dept. 1251
117 E. 4th St., Cincinnati 329 So. Wabash Ave., Chicago
120 W. 42nd St. New York 250 Stockton St., San Francisco

Name.....
Address.....
City.....State.....
Instrument.....
(State instrument in which you are interested)

Copyright 1924, The Rudolph Wurlitzer Co.

Reader's Forum

(Continued from page 905)

the brain for that is flesh or physical and mind is not physical but spiritual. Mind has the power of memory, to think, speak and send orders through the body. But when mind is separate from the body then it just has memory, thought and speech, which is spirit. I am told of things that are to happen and they have happened or taken place just as they were told to me. (Italics ours.—Ed.) I can relate a good many things at different times that actually happened and that were told me beforehand. The above statements are all true.

Mrs. EDYTH BISHOP,
Grizzly Flats, Calif.

(SCIENCE AND INVENTION Magazine does not believe in Spiritualism and one of the awards in the \$11,000.00 contest for the production of Spiritual phenomena is:

\$1,000.00 will be paid to any person who will accurately describe something definite going on at a distance in a place selected by Mr. Joseph F. Rinn, or who will predict in advance an event or calamity of such a definite nature that it would be impossible for such person to have any controlling power over or previous knowledge of the same.

If, therefore, you are positive that you are capable of foretelling an event which will come under the above prize heading, the editors would suggest that you enter the Spiritualistic contest. It may be mentioned in passing that not one worth-while phenomenon, not one Spiritual manifestation has been produced which was not obviously on its very face fraudulent and which the perpetrators did not admit when they were cross examined. Each and every one of those who attempted to demonstrate Spiritual phenomenon, therefore, have admitted that they were practicing deceit and fraud in an attempt to recover all or part of the \$11,000.00 offered by SCIENCE AND INVENTION Magazine. We dare to say without fear of contradiction that there is no one capable of producing genuine Spiritual phenomena. In New York City Spiritualists must practice under cover if at all. In California, on the other hand, palmists, clairvoyants and Spiritual advisers of all kinds fill the columns of the newspapers with their advertisements.

We often wonder why the response to this contest is no greater than it has been and why we are not overwhelmed with applicants for the awards. Can it be that all professional Spiritualists know that they are practicing deceit? This same question does not apply to private parties who became so enthused with Spiritualism that they permit their subconscious mind to dictate messages seemingly from the dead.—Editor.)

A BOOST FOR RAY CUMMINGS

Editor, Science and Invention:
I am writing at this time to inform you of the great interest I took in reading the serial story, "The Man on the Meteor." I waited for each issue of the magazine wondering what would happen next. Every part of the story was very vivid and full of action. Could you inform me as to who "Nemo" is? I would very much like to get the story in book form. Do you think it will be printed this way soon?

HARRY PROSS,
Bristol, Conn.

(Nemo—the "Man on the Meteor," is purely a fictitious character. We understand that this story is to be published in book form at an early future date.—Editor.)

PERPETUAL MOTION

Editor, Science and Invention:
Your letter in regard to perpetual motion machine just received. I note you ask for working model to be submitted in your perpetual motion contest.

When I wrote you I had been assured by my attorney at Washington that he had looked over the records and found nothing to conflict with my claim and that I had a wonderful proposition. But since he has made further examination of records and informs me that some person has been granted two patents covering every claim I had put forth. Now that being the case I see no incentive in getting out a model unless it would be to get your \$1,000.00 prize.

I feel confident that the machine will work, because the operation of the 24 pumps in no way retards the operating of the wheel or it requires no more power to revolve the wheel when pumping than when pumps are not pumping.

I got my idea from an exhibit of frictionless ball-bearing on exhibition at the Gottenberg, Sweden, Exposition. They run a 10-ton flywheel mounted on these bearings, using a No. 10 snool cotton thread for belt and small sewing machine electric motor for power, that being the case I feel confident that a one horsepower motor would operate my 30-ton wheel and compress about 8 cu. ft. of air per minute, which is a record I believe.

The Greatest Radio Pattern Ever Made



The Entire New Standard Super-Heterodyne

With the new Consrad Pattern, the giant Super-Heterodyne is as easily built as any one tube radio set.

You have blueprints, full size, 19½ in. by 44 in. of not only the complete circuit but also of the complete panel with every measurement plainly marked so that all you have to do is follow the blueprints accurately.

Then you have the large 16 page instruction book the most complete of its kind ever printed. The beginner in radio set building will have no trouble in following this instruction book.

NOW IS THE TIME TO BUILD YOUR POWER SET AND MAKE A REAL TRY FOR THE DISTANCE YOU HAVE ALWAYS WANTED TO GET.

Complete pattern is enclosed in a handsome two color stiff cardboard folder size 9 x 12.

Price \$1.00 Prepaid
AT ALL RADIO and NEWS DEALERS

Published by
The Consrad Company
233 Fulton St., New York, N. Y.

PERSONAL STATIONERY 200 SHEETS and 100 ENVELOPES \$1.00

Printed with your Name and Address

Clear, white bond paper, with envelopes to match. Your name and address printed in beautiful, rich blue ink, on both paper and envelopes, and sent to you postpaid for only \$1.00. (West of Mississippi river and outside of U. S. \$1.10.) If inconvenient to send the money, we will ship C.O.D. Money returned if you are not more than satisfied. Order today. Write name and address plainly.

AGENTS MAKE BIG MONEY taking orders for us. Write us today for our agent's proposition.

ELITE STATIONERY COMPANY
5030 Main Street Smethport, Pa.

DON'T WEAR A TRUSS

BE COMFORTABLE—

Wear the Brooks Appliance, the modern scientific invention which gives rupture sufferers immediate relief. It has no obnoxious springs or pads. Automatic Air Cushions bind and draw together the broken parts. No salves or plasters. Durable. Cheap. Sent on trial to prove its worth. Beware of imitations. Look for trade-mark bearing portrait and signature of C. E. Brooks which appears on every Appliance. None other genuine. Full information and booklet sent free in plain, sealed envelope.



BROOKS APPLIANCE CO., 172A State St., Marshall, Mich.

And since the Patent Office has granted two patents on this same machine, without model, then I should think that your publication would be glad to accept my drawings for competition for your prizes, especially since I never really claimed perpetual motion for my machine.

LOUIS H. CORDIS,
Astoria, Oregon.

(Unfortunately the editors cannot consider drawings as perpetual motion prize entries. SCIENCE AND INVENTION holds that a perpetual motion machine was never made. Many inventors are equally positive that they have invented the system and can demonstrate it.

SCIENCE AND INVENTION says, "Show Me." And for being shown we offer \$1,000.00 to anyone who will but merely demonstrate a working model. No patent for a perpetual motion machine, as such, has been granted by the Patent Office during recent years. Several patents for perpetual motion have been granted by the Patent Office under the heading of "Energy Transmitting Devices" and as "Toys." All of them mention a motor "in order to start the device." This gets by at the U. S. Patent Office if the above quoted statement is made and perpetual motion is not claimed.—Editor.)

SUN POWER

Editor, *Science and Invention*:

I read and enjoy your magazine quite often, and have just read the September issue. The *Readers' Forum* interested me very much, especially the letters relative to heat and electricity from our sun. Mr. Templin's article was enough to make one sit up and take notice.

Since you invite letters along this line, and while my Genius calls me (as my favorite author, Emerson, puts it) I will write.

This talk about heat, etc., from the sun, brings to me an idea which like Banquo's ghost will not stay down. I often think about it, but that is as far as it has ever gone except an occasional discussion with some semi-amateur astronomer friend. The idea is to store up in some manner the heat we are always trying to get rid of in summer and use it in winter.

To my mind this would be the greatest boon science could bestow on man, as he is at present constituted, provided, of course, that some moneyed shark did not get hold of it and tie it up so that he, his heirs, assigns and legal representatives would have a perpetual monopoly, and then breed parasites for the rest of mankind to support.

The idea does not fall in the same category (at least to my mind) with perpetual motion, for it would not be a case of trying to get something for nothing as in perpetual motion, but simply "holding fast to what is good," i.e., something we already have.

The idea of course could not be new, but I would like to know what others and better minds have thought of it, and what if anything has been done, or is being done towards the solution of the problem. What is your idea?

A. E. STEWART,
Charlotte, N. C.

(Attempts have been made to store only a slight part of the energy of the sun in several ways. Water power is one of them and production of electricity by means of two copper sheets, one of which is oxidized and the other polished, immersed in an electrolyte, is another method.

In California and in Africa power plants in the form of steam engines are in operation. Here the energy for the heat of the engine is developed by the sun and is concentrated by reflectors.

All of this does not even scrape the surface of the field and we may look forward to even greater systems of utilizing this power of the ages.—Editor.)

A SPIRITUALIST

Editor, *Science and Invention*:

Some time ago I witnessed one McAlbert read some 200 names and questions from a large crystal. Of course, he called it "spiritualism."

Has there ever been an explanation given for this stunt? If so, where was it printed?

He had a confederate. Questions and names were placed on small slips of paper. Then he would lecture for an hour, go into a room where his confederate had been, get a large crystal, place it on a handkerchief, and read names, questions and answers (?) with startling rapidity. Approximately 200 questions were answered. Could globes be so constructed to expose to his view all this information or was this information held in his hand?

J. R. PELSMA,
Pittsburg, Kansas.

(McAlbert is a legitimate performer and consequently we will not expose his system. If he claims that his trick was spiritualism we should expose him. Nevertheless, he does not attempt to defraud the public and is acting, purely for entertainment. For that reason, we will say that what he does is not spiritualism, it is just a plain trick known to every magician. An improvement of this trick was described by Professor Dunninger in the columns of this magazine in one of his early articles.—Editor.)

I Guarantee

To Make You A Public Speaker or I Won't Take A Penny



Give Me 15 Minutes a Day

I'll Show You How to Control One Man or a Big Audience—
How to Conquer Stage Fright—How to Increase Your Earn-
ings—All by the Power of Effective Speech.

THAT'S all I want, 15 minutes a day, to prove to you beyond a shadow of a doubt that I can do for you what I have done for other men— increase your income, make you a leader, make you successful.

C. F. Bourgeois, President of Robischon & Peckham, says: "The lesson on 'How to Develop Personality' is alone worth the entire cost of the course. It has been of real practical help to me." Walter O. Ford of the Ford Manufacturing Company writes, "Was always considerably flustered when called upon to speak. Now, thanks to your course, I feel perfectly at home and confident. Every man who wants a strong personality and the power of effective speech should take your course." H. B. McNeal, President of the Telephony Publishing Company, says: "It should appeal to every man and especially to young men who are ambitious for rapid promotion."

Increase Your Salary

These men write as do hundreds of other successful men concerning this amazing new method of making you a forceful, fluent, convincing speaker. Why do salary increases and the big-pay jobs seem to just come naturally to one man when all about him are men of equal ability in other respects? I'll tell you. The successful man has the knack of making every word he says or writes count in his favor. He is never at a loss for the right word and he presents his proposition or views in clear, logical and forceful language. He gets what he goes after.

Sway Others at Will

How many men can address a dignified board of directors and have his plans and ideas instantly approved? How many men can appear at a moment's notice before an audience and create enthusiastic notice? Not many. And yet there is no reason why any man should not be able to do those things.

I don't care what line of business you are in. I don't care how embarrassed you now are when you are required to speak. I don't care what you think now. I can show you how to rise quickly

above the mass in business, how to step to promotion, how to be a leader with poise and the assurance to plunge right into any subject and convince your hearers of your point of view. By this amazing new method, made possible by Professor R. E. Pattison Kline, formerly dean of the Public Speaking Department of the Columbia College of Expression, being a powerful speaker is easy and simple.

Make This Free Test

To convince you fully that you can become a powerful and convincing speaker by giving me only fifteen minutes a day right in the privacy of your own home, I will send you a remarkable FREE self-test, and then you can judge for yourself. I want you to determine whether or not you wish to have this power of speech that men envy and women applaud. Also, because I know that you will be so delighted that you will tell others of this amazing method, I am making a special offer for a short time only.

Send No Money

Fill in the coupon and mail at once. You, like thousands of others, can quickly and easily learn the secret of achievement both in position and salary and all this without leaving your present position and by devoting only a few minutes a day to the fascinating material I will send you. Just give me your name and address on the coupon.

NORTH AMERICAN INSTITUTE
Dept. 1421 3601 Michigan Ave., Chicago

NORTH AMERICAN INSTITUTE,
Dept. 1421, 3601 Michigan Ave., Chicago, Ill.

I am interested in your coupon in Effective Speaking and your Free self-test and special offer. Please send me full particulars. This request places me under no obligation of any kind.

Name

Address

City State

(In Box)

What This Amazing Course Teaches You

- How to make after-dinner speeches.
- How to write better letters.
- How to sell more goods.
- How to have a good memory.
- How to enlarge your vocabulary.
- How to make political speeches.
- How to develop self-confidence.
- How to have a winning personality.
- How to be master of any situation.

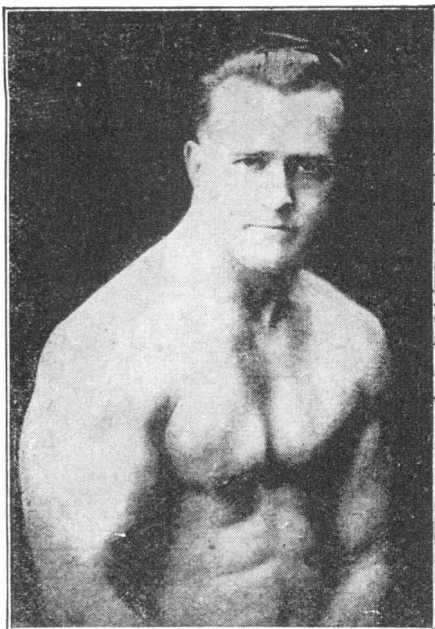

EARLE E. LIEDERMAN
The Muscle Builder

"THOU SHALT NOT KILL"

is the most gruesome commandment handed down to mankind. A man may lie, steal or break any other law and the public will eventually forgive and forget. But let him commit murder and the cry of everybody is to give him the full penalty—*Death!* And what is the common excuse of the murderer? *INSANITY!* Sure, he's crazy. Any man must be crazy to commit murder.

But how about the fellow who slowly but surely kills his own body by neglect? He's the craziest one of all.

Stop! Think this over! What are you doing with your own body? Surely you don't want to be put in this class. But if you are not doing everything possible to prolong your life and keep your body just as clean and healthy as your Maker intended, you are inviting death. You are slowly but surely killing yourself.

A NEW LIFE

Have you ever enjoyed the pleasures of perfect health? Have you ever felt the thrills which accompany a strong robust body? If not, you have nature's biggest gift awaiting you. That is what I have to offer you. I don't promise to feed this to you in pill form. No, you have to work for it. You can't get anything in this life without effort. Don't let anyone fool you by telling you different. I'm going to make you work, but oh boy! how you'll like it. After a few days you will feel the old pep shooting through your veins and you will crave your exercise like a kid wants his bread and sugar.

TODAY IS YOUR DAY

This is your birthday. Today you start a new life. I'm going to make a real live, "rip-snortin'", go-getter out of you. I'm going to expand that chest so it will give your lungs a treat with life-giving oxygen. This will put real vim into your blood and shoot it throughout your entire system. I'm going to broaden your shoulders and strengthen your back. I'm going to put a ripple of muscle up and down your body that will make a big powerful he-man out of you. You will have the arms and legs of a modern Hercules. I'll clear your brain and pep up your entire system. You will be just bubbling over with vitality. You will stretch out your powerful body and shout for bigger and greater things to accomplish. Nothing will be too difficult for you to tackle.

Sounds good, doesn't it? You can bet your Sunday hat it's good. It's wonderful. And it's no idle prattle either. I'm not promising these things. I guarantee them. Do you doubt me? Make me prove it. Come on. Atta boy. Let's go.

Send for my new 64-page book

"Muscular Development"

IT IS FREE!

It contains forty-three full-page photographs of myself and some of the many prize-winning pupils I have trained. Some of these came to me as pitiful weaklings, imploring me to help them. Look them over now, and you will marvel at their present physiques. This book will prove an impetus and a real inspiration to you. It will thrill you thru and thru. All I ask is 10 cents to cover the cost of wrapping and mailing and it is yours to keep. This will not obligate you at all, but for the sake of your future health and happiness do not put it off. Send today, right now, before you turn this page.

EARLE E. LIEDERMAN

Dept. 201, 305 BROADWAY, NEW YORK CITY

EARLE E. LIEDERMAN

Dept. 201, 305 Broadway, New York City

Dear Sir:—I enclose herewith 10 cents for which you are to send me without obligation on my part whatever, a copy of your latest book, "Muscular Development." (Please write or print plainly.)

Name

Address

City..... State.....

Book Review

THE PEOPLE'S INSTITUTE EXTENSION COURSES. PSYCHOLOGY.

We have received from The People's Institute Publishing Company, a series of pamphlets, six in number, on Psychology. It seems that Dr. Charles Beard once said to a friend, "If I can only gear my lectures to a battery of linotype machines." With all due regard to the Doctor's mechanical abilities, we would observe that one linotype machine might answer every purpose. The People's Institute Publishing Co. has now undertaken to issue in pamphlet form stenographic transcriptions of the lectures of prominent scholars, which before publication are edited by the lecturer. Week by week they are published, and they establish a correspondence course, in the sense that a person receiving these lectures can ask questions regarding the lecture by mail, and will receive replies from the lecturer. Lesson sheets are also given to direct the student in his work. We are glad to see that the managers of this interesting course in psychology emphasize the existence of quacks and sensation-alists who disseminate pseudo-psychology. The idea of the Company is to give prominent lecturers very wide publicity by printing their lectures.

THE MECHANICAL PROPERTIES OF FLUIDS. A Collective Work. Hard covers, 6" x 8 3/4", profusely illustrated. Published by D. Van Nostrand Co., New York City. Price \$6.00.

The D. Van Nostrand Company are the American publishers of this collection of essays on the mechanics of fluids. The book is largely mathematical, but brings in enough literature to make it really good reading. It is made quite practical too by the treatment of such subjects as submarine signaling, the reaction of air on artillery projectiles, the use of soap films for determination of liquid stress, directional listening, so as to determine the locality of a steam whistle or cannon shots, and lubrication even is brought in. The reviewer has turned with some fear to the end of the work to see if it is indexed, and is gratified to find two indexes there, one of the subjects and one of the names. As an instance of the practical aspect of the book, we would cite the short description of illustrations of the Venturi Meter, and Pitot Tube. There are nine authors.

THE EINSTEIN THEORY OF RELATIVITY. By Garrett P. Serviss. Hard covers, 5" x 7 1/2", profusely illustrated, 96 pages. Published by Edwin Miles Fadman, Inc., New York City.

The preface of this book states that the Einstein theory has reached a celebrity which makes it essential for everybody to know something about it. One of the blessings of humanity is that nobody has to know all about it, and the illustrious twelve who are supposed to be the only ones who do understand it are certainly to be congratulated upon the depths of their intellectual powers. Up to a certain point, relativity is absolutely simple, but when we come to what we may term the "Einstein Relativity," it certainly is a test of the understanding. This book is based largely on the Einstein film, prepared for moving picture projection, and the illustrations are naturally very attractive and Mr. Serviss seems to have done very well in making an agreeable text on so obscure a theory. As an instance of relativity, some pictures are given to show that one rock may be large or small in relativity to the other. It certainly does not need the Einstein Theory to tell us that.

THE MATHEMATICAL THEORY OF RELATIVITY. By A. Konff. Hard covers 5" x 7 3/4", 214 pages. Published by E. P. Dutton & Co., New York City. Price \$3.20.

From far off Heidelberg comes this mathematical treatise and the book is absolutely beyond review. The formulas are simply blinding in their extent. It would be quite interesting to know whether Prof. Konff is one of the great twelve. It is often a subject of surmise how far a difficult differential equation or formula operates to convince the mind, even of the mathematical reader. The Einstein theory is peculiar in one respect. It has the good fortune to be eagerly accepted by many, who cannot follow its mathematical developments.

The publishers call this work "an elementary introduction" to the theory. If this book is elementary what must the full treatises be? These last words of the book may be a comfort to the layman, "It still lies with the future to bring about full and complete agreement between theory and experience."

100 Radio Hook-Ups

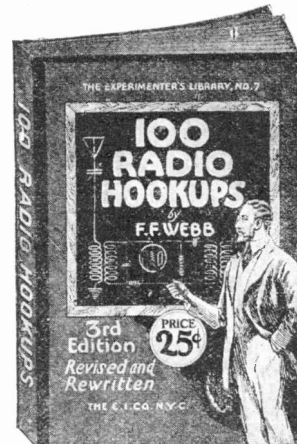

Revised Edition

16 PAGES ADDED

The most complete, practical and up-to-date radio hook-ups book obtainable. Just revised and brought up to the minute by one of the foremost radio engineers in the industry.

Contains only practical, efficient hook-ups, Crystal sets, one tube sets, reflex, regenerative, radio frequency, and super circuits.

Gives all important details of each circuit so that the constructor can build the set he desires.

All Orders Filled Within 24 Hours. You Can Obtain a Copy at All Reliable Radio and News Dealers.

PRICE 25¢ Prepaid

THE E. I. COMPANY
Sole Distributors
THE CONSRAD COMPANY
233 Fulton St. New York City

Consrad

"RADIO'S FOREMOST PUBLISHERS"

RADIO OUTFIT Complete

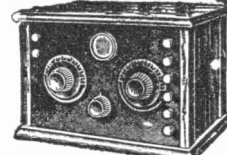

\$21.95

Long Distance 1-Tube D. K. SUPERIOR Set Complete. Nothing Else to Buy.

Produces astonishing results. Receives music, speeches, information, instruction, acrobats, etc., free to you, from broadcasting stations hundreds of miles away, often more than 1000. Easy to operate. Cheapest means of entertainment ever devised. No knowledge of radio required. No electricity except supplied by dry battery included in offer. Satisfaction guaranteed. Big bargain—only \$21.95 for all parts assembled and accessories complete. No money advance. SEND FOR RADIO BOOK FREE

100 pages crammed full of interesting information and offers of radio sets and parts at cut prices. Large variety of complete sets, assembled, ready for use. Write today. NOW!

Liberty M. O. House, Dpt. A165, 106 Liberty St. N.Y.C.

LAW STUDY AT HOME

Become a lawyer. Legally trained men win the highest positions and biggest success in business and public life. Be independent. Greater opportunities now than ever before. Big corporations are headed by men with legal training. Earn \$5,000 to \$10,000 Annually

We guide you step by step. You can train at home during spare time. Degree of LL. B. conferred. LaSalle students practicing law in every state. We furnish all text material, including fourteen-volume Law Library. Low cost, easy terms. Get our valuable 106-page "Law Guide" and "Evidence" books free. Send for them NOW

LaSalle Extension University, Dept. 1384-L Chicago
The World's Largest Business Training Institution

MAKERS OF SCIENCE. By Ivor B. Hart. Cloth, 320 pages. Published by the Oxford University Press, London.

Very few histories of science are written in such a manner as to maintain a connected thread of narrative throughout the book. A great many others lack a sufficient amount of detail on the author's life which in many cases throws important sidelights on the discoveries of the scientists, aside from adding greatly to the romance of the complete work.

This little volume deals rather completely—at least as concerns all the major discoveries in the realm of science—with the constant growth of scientific knowledge, from the time of the early Greek philosophers and mathematicians down to the present. Science as used here, of course, means exact science.

Along with the thread of a narrative showing the constant additions to the sum of our scientific facts, there is the life story of the various men whose minds gave these facts to the world. Most of the discoveries are given simply with the laws and axioms which were postulated by their discovery. Not the least interesting feature of this little volume is, as has been said before, the biographical details of the life of the discoverer of the various facts. Although the name of the volume would seem to indicate that it was merely a collection of disconnected papers upon important scientists, quite the contrary is true, since the whole thing contains a more or less continuous narrative.

It is one of the most interesting scientific volumes dealing primarily with the more theoretical side of the question that has come to this department's view in some time. It is most interesting.

A THOUSAND AND ONE FORMULAS.

By S. Gernsback. Cloth, 160 pages. Published by Experimenter Publishing Co., New York. Price \$1.75.

How many times has the experimenter been confronted with the problem of finishing a metal cabinet, needing some particular kind of glue or being in a hole for lack of some peculiar cement? This little volume is designed primarily to take just such causes of grief from the life of the experimenter. It is divided into a number of main divisions each of which contain subject matter dealing with a certain sub-division of the experimenter's work. Suggestive headings are: Cements, glass and glass working, inks, metal-craft, photography, electroplating, pyrotechny, varnishes and paints, and even perfumery and soaps.

One of the most interesting divisions of this volume is that which is placed at the conclusion of the formulas, and which deals with laboratory hints, designed also to elucidate a number of points usually found baffling to the laboratory operator. The method used in writing this book makes it extremely valuable as a reference work. Values and compositions are set out in the simplest possible terms, while at the same time, due importance is given to the method in which the substances given in formulas must be prepared. This latter point is one which is frequently overlooked in such works. The book is extremely well indexed.

THE CONCRETE ENGINEER'S HANDBOOK. Edited by the staff of the International Correspondence Schools. Cloth covered 3½" x 5½", profusely illustrated. 368 pages. Published by the International Textbook Co., Scranton, Pa. Price \$1.00.

This extremely valuable little pocket reference manual on concrete engineering contains a valuable set of weight and measure tables in the forepart, and describes clearly and simply how to measure various surfaces of triangular and other shapes; this is followed by a concise and easily understood section covering the calculations for various loads on structures. This section contains several extensive tables containing the weight of various materials, including farm products, coal and wood. Some necessary laws of mechanics are then discussed with simple formulas, and this is followed by several pages on stresses and strains. A valuable treatment with elaborate tables is then given on homogeneous beams. This is followed by a chapter on sand and cement; tests of cement; mixing and working of concrete with a handy table giving the proportion of ingredients and quantities to be mixed for various concretes.

A clear and very well illustrated section deals with steel reinforcements of concrete structures, and then we come to a chapter on concrete design. One of the closing sections takes up the design of foundations, including cantilever foundations, and the final chapters deal with building details, form work, water-proofing and building laws.

PLUMBERS AND FITTERS HANDBOOK. By the staff of the International Correspondence Schools. Cloth covers. 3½" x 5½", profusely illustrated, 376 pages. Published by the International Textbook Co., Scranton, Pa. Price \$1.00.

This excellent little handbook will find wide use in the hands of plumbers, heating and ventilating experts, and all those who are interested in this

Will you give me 6 Months to Increase YOUR PAY?

Your name on the coupon means "Yes"



No, I am not a wizard. I don't claim to have a "corner" on success, but here's a fact.

For fourteen years I have been helping men just like you to make more money, not just a few men here and there, but thousands of men.

Think these facts over—in just a few months time I boosted one man's pay from \$2.00 a day to over \$300 a month—another now makes as high as \$27.00 a day—another man, after securing my help went into business for himself and, while he now hires his drafting done, he makes over \$50,000 a year.

\$275 Extra in Three Days

One man saw an ad like this—Sent in the coupon—Enrolled for the Columbia Course—and shortly after he received \$275 for one drawing that he made in his spare time in three days.

Do you make money like these men do? Does the money in your pay envelope get you the things you really want or just enough to make you wish you, too, could have the good things of life that other men have—money, independence, success, happiness?

MAKE \$50 TO \$100 A WEEK

Columbia will train you to be an expert Draftsman in your spare time at home by mail. There's a lot of room for you if you act now. This doesn't mean that you will be just an ordinary Draftsman, but a finished, Professional Draftsman, able to hold your place among the highest paid Draftsmen in the land.

PROMOTION IS QUICK

We'll qualify you for a high salaried position in the Drafting field and keep you in touch with openings for Draftsmen in the big machine shops, industrial plants and United States Government departments. Men who start as Draftsmen are often advanced to Chief Draftsmen, Chief Engineers, Production Managers, and so on. Many of my graduates are today holding such positions as a result of my help. These positions pay big money and lead on to executive positions of the highest type. Thousands of men have found Drafting to be the stepping stone to some of the biggest positions in American industry.

GET THE RIGHT TRAINING

I started this school years ago. Today it is a solidly established nationally known institution, with graduates all over the world. I stand personally in back of the Columbia School of Drafting and back of every promise, every statement we make.

You get the right training when you enroll at Columbia. You spend no time on long winded theories. You start on actual drawing work the day you receive your first lesson. You get right down to brass tacks and there is no lost motion, no waste time or effort at any stage of the course. From the very beginning you can feel yourself making progress, the kind of progress that makes you confident of yourself and sure of your success.

YOU NEED NO PREVIOUS TRAINING

This course of mine is easy to understand and easy to follow. It is designed for men who must have the best and who must get the right training quickly, so as to be able to make more money as soon as possible. Many of my students are qualified, even before they complete the course. Many a man has increased his pay so soon after enrolling that his course has actually cost him nothing.

SUCCESS CALLS MEN OF ACTION ONLY

If you are a man of action—if you want success bad enough to reach out and grab it, clip the coupon now and show me that you are a man of action. Keep right on top of this opportunity to make real money. Don't go looking for a pair of scissors, tear the coupon off and mail it right away. Get started now.

What I Give You

Free Book. Send in the coupon today. I will immediately send you our book "Drafting—Your Success" which tells about Drafting and its opportunities and contains proof that I can raise your pay.

Free Subscription to Drafting Publication, "The Compass." I will give you free a subscription to our helpful, inspiring publication, "The Compass."

Practical Problems. You will be carefully coached in practical Drafting work.

I Help You Get A Job. I will help you get a position as a practical Draftsman and will give you real, personal help, such as I have given to thousands of others.

Personal Instruction and Supervision, throughout the Course. You will receive the personal instruction and help of Roy C. Clafin, President of the Columbia School of Drafting and a practical Draftsman of many years' experience.

Draftsman's Equipment. I will furnish you with a full set of first class drawing equipment and Drafting instruments, as shown in the picture below, when you enroll. You keep both sets on completing the course.

Consultation Privileges. You are free to write me at any time for personal advice and suggestions regarding your progress.

Diploma. The diploma I will give you on completing the course attests to your proficiency as a Draftsman. It is an entering wedge to success.

Advice Regarding Government Positions. The following are a few of the many positions open in the Government Departments from time to time. The salaries are starting salaries, subject to increase:

- Architectural Designer — \$4,000 a year.
- Chief Draftsman, Naval Aircraft Factory — \$15.04 a day.
- Aeronautical Draftsman, Field Service Navy Department — \$5.20 to \$12.50 a day.

We will advise you as to other government openings from time to time.



FREE DRAFTING OUTFIT
We give you free with our course this professional Drafting outfit. It is yours to keep when you complete the course.

COLUMBIA SCHOOL OF DRAFTING
Roy C. Clafin, President
Dept. G-114, 14th and T Sts., N.W., Washington, D.C.

FREE BOOK COUPON

COLUMBIA SCHOOL OF DRAFTING
Dept. G-114, 14th and T Sts., N. W., Washington, D. C.

Please send me without charge your free illustrated book on Drafting, telling me how I can secure your help in securing a position as Draftsman. Also enter my name for free subscription to "The Compass."

Name

Address

City State

WANTED

RAILWAY POSTAL CLERKS

\$1600 to \$2300 Year

TRAVEL—See your country
MEN—BOYS, 18 UP
SHOULD MAIL COUPON IMMEDIATELY
Steady work. No layoffs. Paid Vacations
Common Education Sufficient

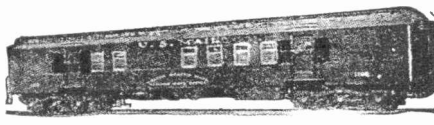

FRANKLIN INSTITUTE,
Dept. T181, Rochester, N. Y.

Strs. Send me without charge: (1) Sample Railway Postal Clerk Examination coaching lessons; (2) Schedule showing places of coming U. S. Government examinations; (3) List of many Government jobs now obtainable.

COUPON

Name

Address

Insure your copy reaching you each month. Subscribe to Science and Invention—\$2.50 a year. Experimenter Publishing Co., 53 Park Place, N. Y. C.



The Hour That Counts!

When you see a man putting in his noon hour learning more about his work, you see a man who won't stay down. He'll never be satisfied until he hits the top. And he'll get there!

In shops, factories, offices, stores, in every line of industry, men are holding splendid positions won through spare-time study with the International Correspondence Schools. To-day they are earning four or five times—yes, some of them ten times as much money as when they started. Employers everywhere are looking for men who really want to get ahead. If you want to make more money, show your employer that you're trying to be worth more money.

For 33 years the International Correspondence Schools have been training men and women right in their own homes.

Thousands upon thousands of men have stepped up in just this way. More than 180,000 are studying now. Can you afford to let another hour pass without making your start toward something better? Here is all we ask—without cost, without obligation, just mark and mail this coupon!

INTERNATIONAL CORRESPONDENCE SCHOOLS Box 6188-D, Scranton, Penna.

Without cost or obligation on my part, please tell me how I can qualify for the position or in the subject before which I have marked an X.

BUSINESS TRAINING COURSES

- | | |
|--|---|
| <input type="checkbox"/> Business Management | <input type="checkbox"/> Salesmanship |
| <input type="checkbox"/> Industrial Management | <input type="checkbox"/> Advertising |
| <input type="checkbox"/> Personnel Organization | <input type="checkbox"/> Better Letters |
| <input type="checkbox"/> Traffic Management | <input type="checkbox"/> Show Card Lettering |
| <input type="checkbox"/> Business Law | <input type="checkbox"/> Stenography and Typing |
| <input type="checkbox"/> Banking and Banking Law | <input type="checkbox"/> Business English |
| <input type="checkbox"/> Accounting (including C.P.A.) | <input type="checkbox"/> Civil Service |
| <input type="checkbox"/> Nicholson Cost Accounting | <input type="checkbox"/> Railway Mail Clerk |
| <input type="checkbox"/> Bookkeeping | <input type="checkbox"/> Common School Subjects |
| <input type="checkbox"/> Private Secretary | <input type="checkbox"/> High School Subjects |
| <input type="checkbox"/> Spanish | <input type="checkbox"/> Illustrating |
| <input type="checkbox"/> French | |

TECHNICAL AND INDUSTRIAL COURSES

- | | |
|---|--|
| <input type="checkbox"/> Electrical Engineering | <input type="checkbox"/> Architect |
| <input type="checkbox"/> Electric Lighting | <input type="checkbox"/> Architects' Blue Prints |
| <input type="checkbox"/> Mechanical Engineer | <input type="checkbox"/> Contractor and Builder |
| <input type="checkbox"/> Mechanical Draftsman | <input type="checkbox"/> Architectural Draftsman |
| <input type="checkbox"/> Machine Shop Practice | <input type="checkbox"/> Concrete Builder |
| <input type="checkbox"/> Railroad Positions | <input type="checkbox"/> Structural Engineer |
| <input type="checkbox"/> Gas Engine Operating | <input type="checkbox"/> Chemistry <input type="checkbox"/> Pharmacy |
| <input type="checkbox"/> Civil Engineer | <input type="checkbox"/> Automobile Work |
| <input type="checkbox"/> Surveying and Mapping | <input type="checkbox"/> Airplane Engines |
| <input type="checkbox"/> Metallurgy <input type="checkbox"/> Mining | <input type="checkbox"/> Agriculture and Poultry |
| <input type="checkbox"/> Steam Engineering <input type="checkbox"/> Radio | <input type="checkbox"/> Mathematics |

Name.....
Street..... 3-6-24
Address.....
City..... State.....

Occupation.....
Persons residing in Canada should send this coupon to the International Correspondence Schools Canadian, Limited, Montreal, Canada

Agents Wanted!

Salesmen—Distributors

to use and introduce attachment that makes Fords run on 94% air. THERMOSTAT on exhaust automatically turns down needle valve as engine warms exactly as Ford Manual says do by hand.

Blancke Auto Thermo

An Automatic Carburetor Control Makes Fords start easier winter or summer—saves half gas and oil—cuts repair bills one-half—reduces carbon formation one-half. Sells on sight to every Ford owner as easily as giving him a \$100 bill, because it saves \$100 every 10,000 miles. Cadillac now uses as standard equipment thermostatic carburetor control under Blancke license. You can make Big Money selling this wonderful proven device. Experience not necessary. Blancke plan will start you without capital in a business of your own that makes you from \$250 to \$2,000 a month profit.

Write for free circulars Now!

A. C. Blancke & Co. 602 W. Lake Street
Dept. 721 Chicago

Insure your copy reaching you each month. Subscribe to SCIENCE & INVENTION—\$2.50 a year. Experimenter Publishing Co., 53 Park Pl., N. Y. C.

class of work. The book has a very thorough index like others of the handbooks put out by the above institution. The forepart deals with weights and measures, and the calculation of areas, together with tables of the circumferences and areas of various sized circles. Among the subjects covered in this well edited treatise are tin roofing; properties of air and steam; ventilation; loss of heat from buildings; fuels; chimneys; size of hot air pipes and stacks as well as registers, etc. Another section takes up heating by steam, and the mechanical details connected therewith. This is followed by a chapter on hot water heating, a system which is now so much in vogue in private homes and other buildings, and we then read about blower systems of heating. The air supply of public buildings, heating and ventilation is well discussed, with valuable tables and formulae. Gas and gas fitting is then treated on, and the book ends with a well illustrated and clearly discussed section on plumbing, including bathrooms, kitchen boilers, sprinkler systems, etc.

RADIO FOR EVERYBODY. By Austin C. Lescarboursa, 361 pages, cloth covers, 7 1/2 x 5 1/4", illustrated, price \$1.50. published by the Scientific American Publishing Co., New York City.

The author of this work has taken a preceding book of the same title as given above and rewritten it, enlarging and revising many portions of it, so that it is thoroughly up-to-date. Even with the many radio books that we find on the market today, this one has its place. It is in itself a complete text book on radio reception and covers practically every phase of the subject in a clear and concise manner. All of the latest improvements in radio frequency transformers are discussed and illustrated in detail. Even the sodion tube, a comparatively recent addition to the radio family, is described and discussed.

A complete chapter is devoted to the discussion of many different types of standard radio receivers, ranging from the simple single tube sets to the second harmonic six tube super-heterodyne receivers and the popular combinations of a radio set and phonograph.

One of the last chapters in the book is devoted to circuits and their explanation. Not many circuits are given, but each and every one is of a fundamental type and tends to keep confusion at a minimum. The book is at least on a par with any of the radio books found on the market today, and far better than many of them.

AUTOMOBILE IDENTIFICATION. By Sergt. John F. Brennan, 176 pages, hard covers, illustrated, 7 1/2 x 5", price \$2.50, published by Scientific American Publishing Co., New York City.

The identification of automobiles by sight is an extremely important subject to the police and makes an interesting study for the civilian. The author of this book is an instructor in automobile identification in the police department of the city of New York and therefore is well qualified to speak on the subject. By means of a system of key numbers, the various different types of automobiles are classified. First, styles of bodies are illustrated and then particular makes of cars. Each one of the latter is shown in a clear half-tone cut which depicts the appearance of the car very clearly. In each case, some particular feature of the car, a feature which stands out above all others, is noted. Therefore, identification becomes easy, comparatively, after a study of the illustrations. Then follow a series of illustrations of radiators of different kinds.

Bumpers and hub caps come in for their share in the identification process and many different styles are shown. Brakes are discussed and a few pages are devoted to safety measures.

This book is one which should be of interest to every automobile owner as it gives the police viewpoint of the automobile situation. It shows how the police are attempting to co-operate for the prevention of theft and accidents and gives several striking examples of ingenious detective work on their part. The book is one which makes interesting and instructive reading to any one connected in any way with automobiling.

INVENTOR'S MANUAL. By George M. Hopkins, 128 pages, 7 1/2 x 5", cloth covers, price \$1.50. published by the Norman W. Henley Publishing Co., New York City.

Although a small book in size this manual for inventors contains a wealth of information which is of great value to those to whom it is addressed. The book is designed principally to give a few hints toward the patenting of original devices and other hints which will enable an inventor to steer clear of the many swindlers who may try to cheat him out of his invention or who may try to separate him from some of his money by many different methods. The various money-making schemes are outlined and the inventor amply warned. The method of obtaining a patent is clearly outlined. The author then goes on to tell how newly invented devices can be placed on the market and deals with the obstacles that are to be met in trying to market any device.

A knowledge of occupations is of great benefit to inventors who desire to market their own product and a tabulated list is given in this book.

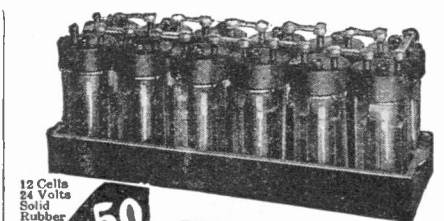

12 Cells
24 Volts
Solid Rubber Case

\$3.50 COD SPECIAL

INTRODUCTORY PRICE
For a limited time only, and to introduce this new and superior Storage "B" Radio Battery to the Public, we are selling it for \$3.50. Regular Retail Price is \$5.50. You save \$2.00 by ordering NOW. A finer battery cannot be built than the

World Storage "B" Battery

(12 CELLS—24 VOLTS)
To ten million homes with Radio Sets—and to countless millions of prospective buyers—this WORLD Storage "B" Battery brings a new conception of battery economy and performance. Here is a battery that pays for itself in a few weeks—will last five years and can be recharged at a negligible cost. And you save \$2.00 by ordering now.

A Superior Battery Equipped With Has heavy duty 21-8 in. x 1 in. x 1.4 in. plates and plenty of acid circulation. Extra heavy glass jars allow ready observation of charge and prevent leakage and escape of current. It holds its charge, while idle, at constant voltage. You will find this battery a boon to long distance reception. It does away with a great many noises so often blamed on static. Mail your order today.

SEND NO MONEY

Just state number of batteries wanted and we will ship day order is received. EXTRA OFFER: 4 batteries in series (96 volts), \$12.00. Pay Expressman after examining batteries, 5 per cent discount for cash in full with order. Send your order NOW and save \$2.00.

WORLD BATTERY COMPANY
Makers of the famous World Radio "A" Storage Battery
1219 S. Wabash Ave., Dept. 83 Chicago, Ill.

SAVE \$2.00 BY ORDERING NOW!

Music Lessons
WITH AN ACCREDITED SCHOOL
At Home

A Complete Conservatory Course
By Mail Wonderful home study music lessons under care of great American and European teachers. Endorsed by Paderewski. Master teachers guide and coach you. Lessons a marvel of simplicity and completeness.

Any Instrument Write telling us course you are interested in—Piano, Harmony, Voice, Public School Music, Violin, Cornet, Mandolin, Guitar, Banjo, or Reed Organ—and we will send our Free Catalog with details of course you want. Send now. UNIVERSITY EXTENSION CONSERVATORY
67 Siegel-Myers Bldg. Chicago, Illinois

I Guarantee You Can Play Any String Instrument in 1 Minute

Most remarkable music invention of the century. Any novice can now play any string instrument—INSTANTLY! A child can play without hesitation. No notes to learn—no ear for music needed. The only color system on the market, full protection by U.S. patents. Pronounced marvelous by nationally known musicians.

\$20.00 VALUE FREE!

Beautiful instrument given on with each color number course. Rich, mellow tone. Money Back Guarantee. Your money back if it fails. Get full details and Free instrument offer. Write Today! Schneider School of Music 238 Vermont St., Dept. U-1 Blue Island, Ill.

Carrying Case **FREE** with 3 ft. Telescope
See people and objects miles away just like they were close; see Moon and Stars as never before. Opens over 3 ft., long, 5 sections, brass bound, powerful lenses. Useful and entertaining. Color of objects could be seen miles away. Mrs. Yarbrough. Watch my boy arrive at school 2 miles away. Mrs. Horn. Read numbers on freight cars mile away, see mountains on moon. A. G. Palmer. Thousands pleased.

Send No Money today; on arrival of Big 3 ft. Wonders Telescope with FREE Carrying Case and Money Back Guarantee only \$1.35 plus a few pennies postage. Satisfaction Guaranteed.

FERRY & CO., 3222 N. Halsted St., Dept. 9251, CHICAGO

Straightens Shoulders
—Increases Pep
THE NATURAL BODY BRACE—Corrects stooping shoulders, straightens the back, gives the lungs chance for normal expansion, induces proper breathing. Brings restful relief, comfort, energy, and pep. For men and women.

Costs nothing to try it
Write for 30 days free trial offer and free book.
NATURAL BODY BRACE CO.
Howard C. Rash, Pt. 286 Rash Bldg., Salina, Kansas

RADIO WRINKLES

UNDER this heading we are going to publish items of interest to everyone who likes to build radio instruments. In order to continue this department it is necessary for our readers to tell us about their latest experiments. Write us a short description of some time- or money-saving kink you have discovered and send it to us along with a few sketches. Our regular prizes will be paid for this material. Be brief and try to put everything in the drawing. Don't be too elaborate. Address "RADIO WRINKLES" editor, care of Science and Invention.

BATTERY CONTROL PANEL

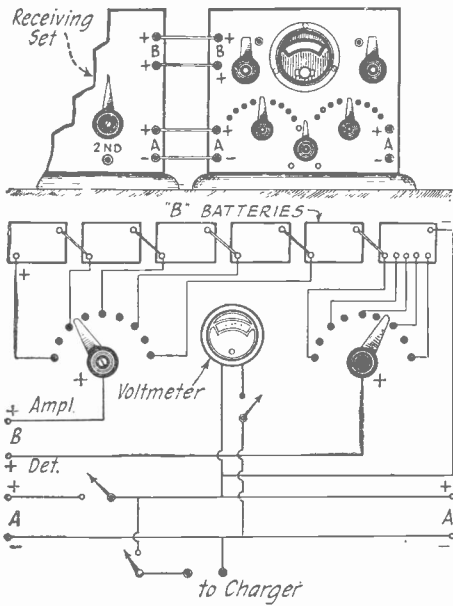

By placing the "B" batteries within a cabinet and employing the circuit given herewith, a very handy and helpful arrangement is provided, which protects them from dust, short-circuit and breakage. The "A" battery connections are also incorporated on the panel and thus lends itself to ready recharge. A 0-10-voltmeter presents an attractive appearance and is very useful in testing the "A" battery. —Evermont Fisel.

SIMPLE SWITCH

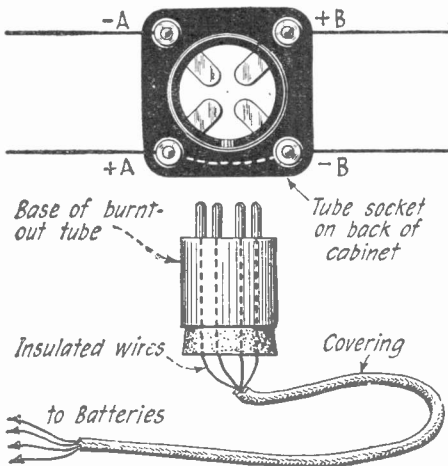

The obvious advantages of using the above switch speaks well for it. The base of a broken tube is employed and fitted with a large cork. Both "A" and "B" battery connections are made and insured against accidental run-downs, shorts, etc. —Alexander Horsfall.

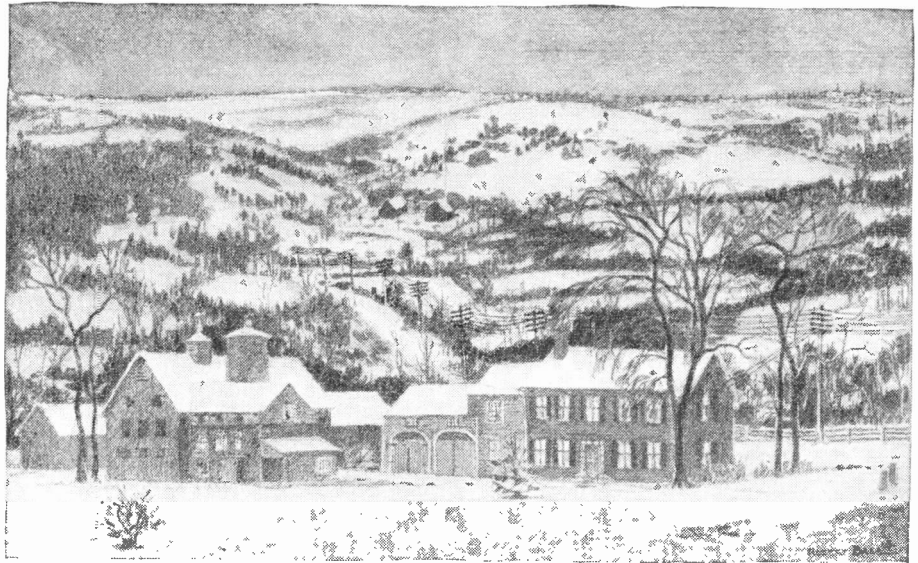

NEIGHBORS

When Ephraim Crosby made a clearing far out on Valley Road and built his house, he had no neighbors. He lived an independent life, producing on the farm practically all that his family ate and wore. Emergencies—sickness and fire and protection of his homestead from prowlers—he met for himself. Later he had neighbors, one five and another eight miles away. Sometimes he helped them with their planting and harvesting, and they helped him in turn. Produce was marketed in the town, twenty miles along the cart-road.

Today Ephraim Crosby's grandchildren still live in the homestead, farming its many acres. The next house is a good mile away. But the Crosbys of today are not isolated. They neighbor with a nation. They buy and sell in the far city as well as in the county-seat. They have at their call the assistance and services of men in Chicago or New York, as well as men on the next farm.

Stretching from the Crosbys' farm living-room are telephone wires that lead to every part of the nation. Though they live in the distant countryside, the Crosbys enjoy the benefits of national telephone service as wholly as does the city dweller. The plan and organization of the Bell System has extended the facilities of the telephone to all types of people. By producing a telephone service superior to any in the world at a cost within the reach of all to pay, the Bell System has made America a nation of neighbors.



AMERICAN TELEPHONE AND TELEGRAPH COMPANY
AND ASSOCIATED COMPANIES
BELL SYSTEM
One Policy, One System, Universal Service

"THERE'S MONEY IN IT"

AT HOME LEARN TELEGRAPHY AT HOME

MORSE AND WIRELESS

TEACH YOURSELF in half usual time, at trifling cost, with the wonderful Automatic Transmitter THE OMNIGRAPH. Sends unlimited Morse or Continental messages, at any speed, just as an expert operator would. Adopted by U. S. Government and leading Universities, Colleges and Telegraph Schools. 3 styles. Catalog free.

If you own a Radio Phone Set and don't know the Code, you are missing most of the fun.

OMNIGRAPH MFG., CO. 22 Hudson St., NEW YORK

Print Your Own

Cards, stationery, circulars, labels. Presses \$12 up. Paper Cutters \$3 up. Save money. Print for others, big profit. All easy, rules sent. Write for catalog presses, type, paper etc. THE PRESS CO., N-27, Moridon, Conn.

"BECOME A LIGHTNING TRICK CARTOONIST"

Make money chalk talking. Send \$1 for snappy program of trick drawings, with instructions by a professional cartoonist. Satisfaction guaranteed. Circular free. Balda Art Service, Dept. 4, Oshkosh, Wis.

25¢

Book No. 13

Reflex Radio Receivers

This is the reflex book of the E. I. Co. library. Contains 64 pages. Size 5 x 8 inches. Handsomely bound with a stiff cardboard cover printed in two colors. Tells all about the Reflex circuits of all makes and kinds and gives all important details of each individual circuit with data of how to construct same.

Book No. 11

How Radio Is Received

By R. S. OULD of the Bureau of Standards of the U. S. Government.

This is one of the handiest of the E. I. Co. books for the amateur radio listener. It explains in a very clear way how Radio is transmitted and received. It contains 64 pages, size is 5 x 8 inches and is bound with a stiff cardboard cover and printed in two colors. Price 25c.

On Sale at All Radio and News Dealers



REFLEX The Economy Circuit

The Reflex is the startling circuit. The results from the Reflex are sometimes more than startling. Every amateur radio set builder will want this handy book that tells you everything about the various reflex circuits and how they are constructed.



How Radio Is Received

This new book of the E. I. Co. tells thoroughly and completely just how radio is received. How the radio waves originate, are sent out into space and finally received on the antenna and telephones. It enables you to understand the principles of the reception of the voices and music you receive daily out of the air.

The E. I. Company
SOLE DISTRIBUTORS
The Consrad Co., 233 Fulton St.
New York City

Consrad

"RADIO'S FOREMOST PUBLISHERS"

RHEOSTAT DIAL DIAL GLUED TO PANEL

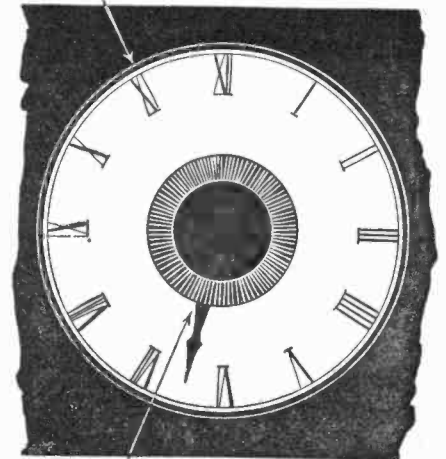

KNOB AND POINTER

An old watch dial, especially one of the radium variety, makes a fine stationary dial for use in rheostats and other radio controls. A generous amount of glue smeared on the back of it readily attaches to the panel.
—George Vatcher, Reporter No. 9608.

LOUD SPEAKER

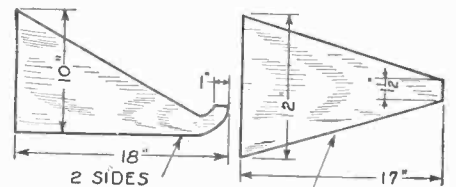

ONE EACH FOR TOP AND BOTTOM

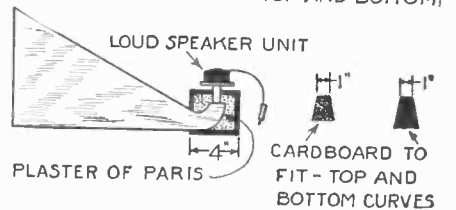

A good loud speaker giving plenty of volume and a mellow tone is made from three ply wood that can be obtained from an old phonograph box or any thin wood. The illustrations show how the horn is cast in a plaster-of-Paris base. After completion it is given a coat of light varnish.
—L. I. Dupuy.

BATTERY SWITCH

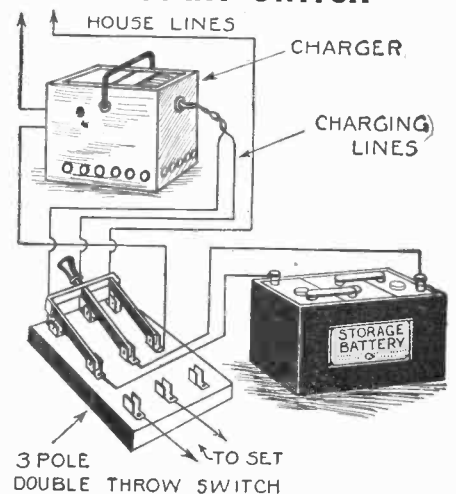

3 POLE DOUBLE THROW SWITCH

By wiring up a three-pole double-throw switch in the manner shown in the diagram, a convenient method for connecting the battery either to the charger or the set is realized. When so connected, there will be absolutely no danger of burning out tubes of a receiving set through accidental short circuits. This arrangement also avoids dangerous loose wires, fooling with clips, etc.
—L. Ringer.

CRYSTAL STAND BY

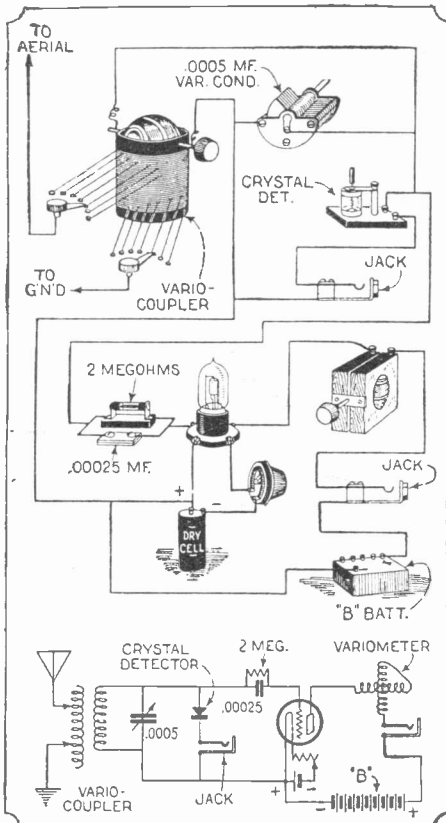

When one of several things happens, such as the burning out of a tube, or a dropping off in voltage of the "A" or "B" battery, the crystal finds itself readily available. By connecting one in series with a single circuit jack across the secondary circuit, as is shown, it merely necessitates the plugging in of the phones to continue an interrupted concert.

—Samuel M. Malkin.

UNIQUE VERNIER

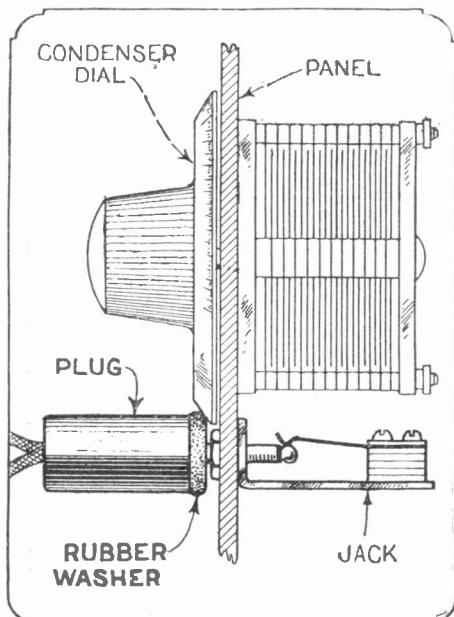

When designing the layout of a panel, if the output jack is placed underneath a variable condenser or variometer, the phone plug, when fitted with a rubber washer, acts as a practical vernier control. A circular piece of gum rubber is slipped over the end of the plug and cemented on, after which plug may be inserted into the jack and be used without danger of breaking the circuit. Care must be taken in making the measurements exact, else one will run into difficulties.

—Irving Mower.



This vivid demonstration of all modern street lighting methods is set up and maintained by the General Electric Company, the Cleveland Illuminating Company, and the city authorities of Cleveland.

Forty Streets in One

This is a section of East 152d Street, Cleveland. Forty electric switches control as many different circuits. By turning one switch after another, every method of street lighting by electricity is demonstrated.

City engineers are invited to witness this experiment, and others of equal interest at Schenectady, N. Y., Harrison, N. J., and Lynn, Mass.



Co-operation between city authorities and large designers and builders of electric lighting systems makes for progress, for safety, and for municipal advancement. The services of G-E electric lighting engineers are always at the disposal of forward-looking communities.

GENERAL ELECTRIC

Send Now For—

Art and Life Magazine

Deals with Art, Nature, Physical and Mental Culture. For Artists, Students, THINKERS. Stands for The BODY BEAUTIFUL, Mind intellectual, Soul intuitional. Prints drawings and paintings showing Ideal Human Proportions, life photos, illustrations, designs, cartoons, comics, etc. Inspiring articles, poems, art lessons, assignments, criticisms, etc. Invaluable to all seeking POWER of Body, Mind, Soul. Nothing like it. Can't be described. Money refund if not satisfactory. YOU WILL LOSE unless you

CUT THIS OUT and send with \$1 NOW
for 5 Mo. Trial Sub. (No free samples)
ART AND LIFE, Dept. 252, KALAMAZOO, MICH.

STAMMER NO MORE

Kill the fear of stammering. Re-education the key. The widely famed Hatfield Method fully outlined in an accurate, dependable, worthwhile book—"HOW TO STOP STAMMERING." It has inspired thousands. Free copy today.

THE HATFIELD INSTITUTE, 109 N. Dearborn, Chicago, Ill.

Write Like This

Wonderful, new device, guides your hand; corrects your writing in few days. Big improvement in three hours. No failures. Complete outline FREE. Write C. J. Ozment, Dept. 44 St. Louis, Mo.



How This Man Won Success As an Electrical Expert

General Manager of his company at 28 years of age! His own boss—owns his home—married and happy and prosperous—that's the remarkable success achieved by Wallace H. Rohrschneider, now General Manager, Secretary and Treasurer of the Hustisford Light, Power and Manufacturing Company of Hustisford, Wisconsin.

Mr. Rohrschneider got his start toward his quick and brilliant success at School of Engineering of Milwaukee. There he received the practical, intensive and specialized training that enabled him to make good in a big way.

Why Don't You Get Into This Big Pay Field?

The same kind of training that put Mr. Rohrschneider into the ranks of the highly-paid Electrical Specialists will qualify you for brilliant success in this fascinating field of unlimited opportunities. Come to America's Greatest Institution of Electrical Education. Learn by actual practice in our big laboratories with their magnificent equipment, including motors, dynamos, switchboards, ignition and lighting systems, etc. Recognized experts give you personal instruction every step of the way.

Earn Your Way Through This Great College

You can earn money to help defray your expenses while you are learning. Our wonderful co-operative plan brings an Electrical Career within the reach of every ambitious man. Our Free Employment Department secures positions for those students who wish to earn part of their expenses. In addition, the Department will help you get a good position in the Electrical Industry when your training is completed.

BIG BOOK FREE—Mail the coupon today for our big new illustrated catalog. Check the course that interests you most and we will send you special information. Read about the School that trains men for practical and quick success. See how easy it is for you to get the training that will enable you to step to a splendid position and a handsome income. Mail the coupon right NOW. No cost or obligation.

Next Term Opens January 5th.

SCHOOL OF ENGINEERING of Milwaukee

Dept. S.&I.-125B, 415 Marshall St., Milwaukee, Wis.

MAIL COUPON NOW

SCHOOL OF ENGINEERING OF MILWAUKEE

Dept. S.&I.-125B, 415 Marshall St., Milwaukee, Wis.

Please send me without any cost or obligation, full particulars of the electrical course I have checked and your big Free Book telling about your Institution and how it will fit me for a big position in the electrical field. Also tell me about your Earn-While-You-Learn plan.

(Check courses interested in, and be sure to give your education.)

—School of Practical Electricity—6 months or 1 year course. Complete general course, covering entire electrical field.

—Institute of Electrotechnics—12 to 30 months' course. Practical electrical training combined with thorough Academic education.

—College of Electrical Engineering—3 years' course. Regular collegiate work granting B. S. Degree. 14 High School units or diploma from our Institute of Electrotechnics required for entrance.

—Commercial Electrical Engineering—1 year course. Thousands of Trained Men wanted in this new profession. 14 High School units or diploma from our Institute of Electrotechnics required for entrance.

—School of Automotive Electricity—3 to 6 months. Covers all systems of starting, lighting, ignition, and storage batteries for automobiles, tractors, air-craft, etc. Intensive practical course.

—One year Auto Electrical Engineering Course.

—Armature Winding and Motor Generator Repair Course—3 to 6 months' course. Brief, but intensely practical, leading to well-paying positions.

—Electrical Home-Service Training with laboratory facilities, for those who cannot come to Milwaukee.

Name

Street

City..... State.....

Age..... Education.....

TIN CAN COVER DIAL

TIN CAN COVER, KNOB, RUBBER ERASER.

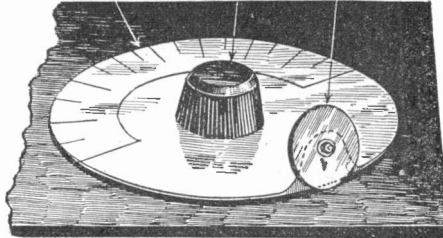

The cover of a tin can be salvaged and utilized as a handy dial. It is fitted with a rotary eraser which acts as a vernier, and is calibrated in the usual manner.

—E. R. Gilmore.

MULTIPLE DETECTOR

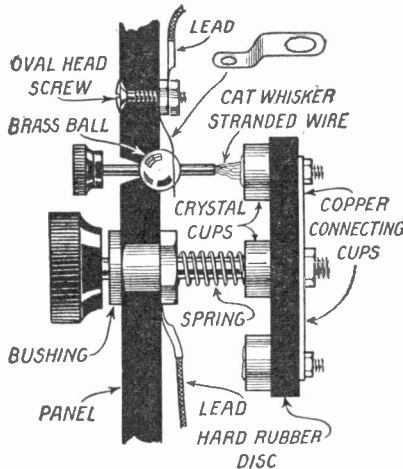

Very often the sensitive spots on a crystal are lost and when in necessity, it is usual that they cannot be found. By building one of these multiple crystal holders, it is possible to revert instantaneously to a sensitive crystal. The drawing clearly shows its construction, four cups being mounted on a circular bakelite or hard rubber disk.

—F. J. Bruno.

SOCKET SUSPENSION

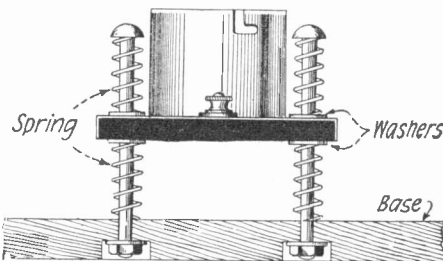

A non-microphonic socket mounting is made simply by following the above suggestion. Four short brass wire springs are placed as is shown and alleviate noise to a great extent.

—J. Futterman.

VERNIER DIAL

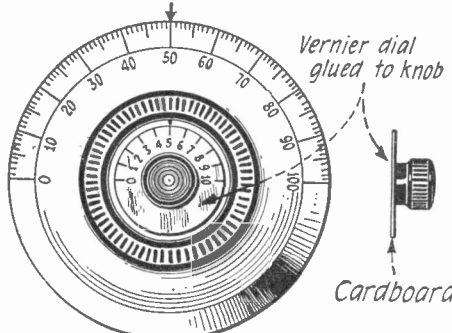

If a small cardboard dial is glued to the vernier knob of a condenser, accurate calibration of wave-length can be obtained. A white marker is scratched on the knob of the large dial.

—R. H. Watkins.

On Credit!

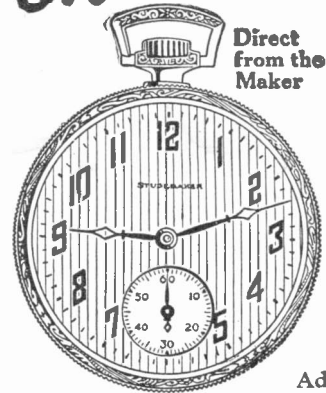

8 Adjustments

\$1 down!

—and direct from factory

Only \$1.00 down buys the famous Studebaker Insured Watch direct from the factory at the low factory price. Choice of 54 newest Art Beauty Cases, in white gold, green gold or yellow gold effects; 8 handsome dial designs. Mail coupon for beautiful Style Book in colors—Sent Free!

21 Jewel ~ Extra thin STUDEBAKER The Insured Watch

Has 21 Jewels—8 adjustments—and is insured for the lifetime of the owner. The masterpiece of timepieces at an amazingly low price.

Watch Chain FREE!

For a limited time we are offering a beautiful Watch Chain FREE. Write while offer lasts.

Mail Coupon for FREE Book

Mail coupon today for magnificent Studebaker Book of Advance Watch Styles. Find out how you can buy direct from the factory—save money and own one of the finest watches made. The Book shows 54 newest thin-model designs in Art Beauty Cases. Sent FREE!

STUDEBAKER WATCH CO.

Dept. E-97 South Bend, Indiana

Canadian Address: Windsor, Ontario

Ask for Ladies' Bracelet Watch Folder

Ask for Jewelry Folder

STUDEBAKER WATCH CO.

Dept. E-97 South Bend, Indiana

Please send me your Free Book of Advance Watch Styles and particulars of your \$1.00 down offer.

If you live in Canada send your inquiry to our Canadian office: Windsor, Ontario.

Name

Address

City..... State.....

Check here for Ladies Watch Folder Check here for Jewelry Folder



FREE \$20 Fine Tone Musical Instruments

We have a wonderful new copyrighted system of teaching note music by mail. To first pupils in each locality we will give free a \$20 superb Violin, Tenor Banjo, Ukulele, Hawaiian-Guitar, Banjo, Mandolin, Banjo-Ukulele, Banjo-Mandolin, Cornet or Banjo-Guitar absolutely free. Also teach Piano and Organ. Very small charge for lessons only. Four lessons will teach you several pieces. Over 100,000 successful players. We guarantee success or no charge. Complete outfit free. Write today, Dept. 149. No obligation. Slingerland School of Music, 1815 Orchard St., Chicago, Ill.

MORE PROFITS

To Dealers Who Buy Nationally Advertised Radio Goods from Our Bargain Catalog! Write for It Today!

AMERICAN RADIO CO.

Dept. 7 6 WEST 14th ST. KANSAS CITY, MO.

LOCATION FINDER

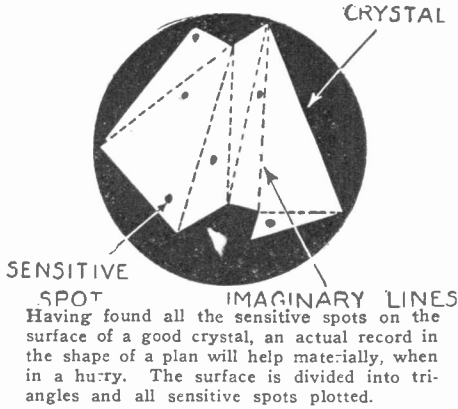

—K. Liu.

RADIO CHANDELIER

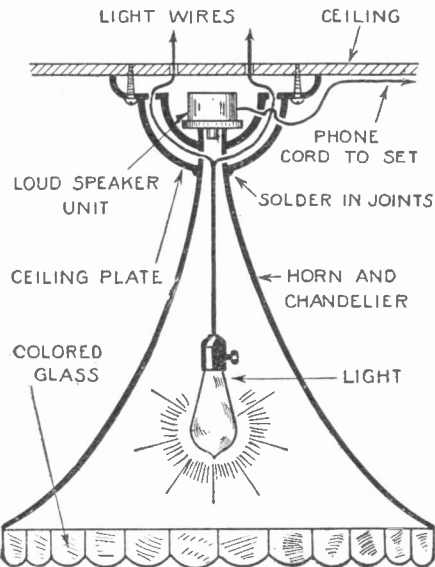

By placing the reproducer unit in the canopy of a fixture of the type shown, an exceptionally good loud speaker arrangement is had. Else, the horn of the loud speaker is adorned with a few embellishments and fastened as is depicted. This presents a very pleasing appearance, besides being practical.

—Donald Crow.

PANEL DETECTOR

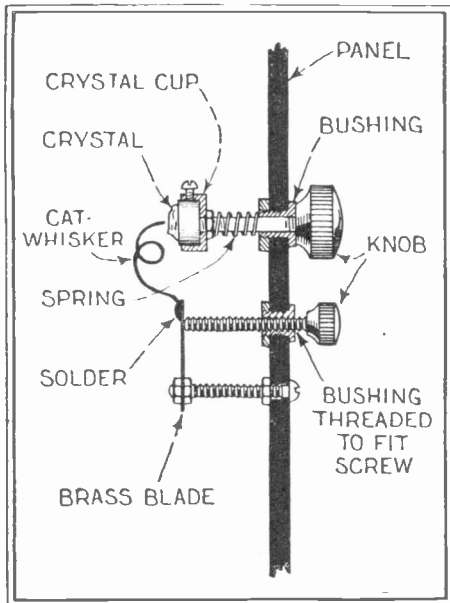

A crystal detector capable of very delicate adjustment is constructed as shown and affords neatness in appearance. The crystal cup is soldered to a short length of brass bar to which a knob is attached at the other end. A spring placed on this keeps the crystal rigid, while a vernier arrangement allows extremely fine adjustment.

—Samuel M. Malkin.

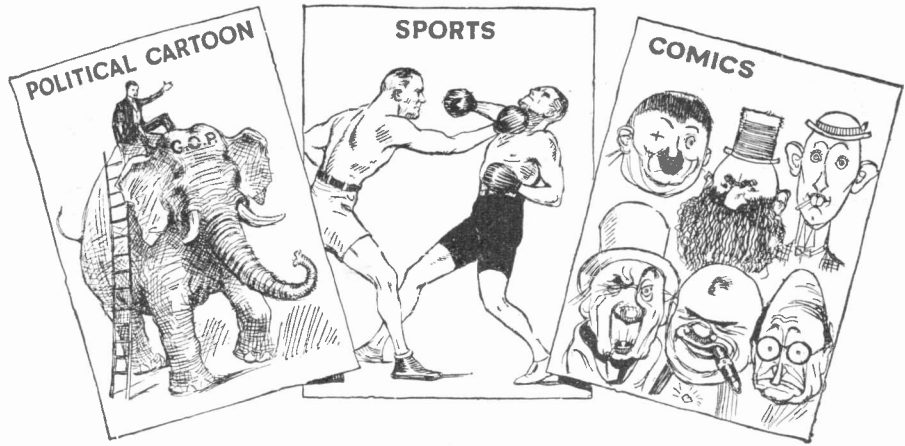

Thousands Can Draw
CARTOONS
Who Have Never Even Tried

Cartoonists earn from \$50 to far over \$300 a week. Why tie yourself to work that is drudgery when through a remarkable new method you can easily learn at home in spare time to draw cartoons that **SELL?**

THOUSANDS of men today are working at routine, uninteresting jobs who could be successful cartoonists. Many are earning pitiful salaries who could make wonderful salaries in cartooning. Briggs, Fox, Fisher, Goldberg and other leading cartoonists are credited with earning *more than the President*. Yet a few years ago many of our most successful cartoonists never dreamed they could draw a good cartoon!

from one of America's most prominent cartoonists! With his help you can, in an *amazingly short time*, learn to draw the comic strips, humorous, political, and animated cartoons which are in such big demand.

Learn More About Cartooning
Send for **FREE BOOK**

Never have cartoons been so popular. Millions of dollars were spent last year on cartoons of all kinds—and every week newspapers increase the amount of cartoons used. Get full details on the amazing opportunities in this fast growing field of cartooning and full information on this remarkable home-study method. Mail coupon for **FREE BOOKLET today**.

The World's Easiest, Pleasantest and Best Paying Profession

Just watch a cartoonist work. A few little lines—a couple of simple curves—a splash of black here and there—and then you see a splendid cartoon before you. With a few strokes of his pen he has taken some little incident of his day's experience—some humorous or sad scene he has witnessed—and produced a cartoon which tells the entire story to thousands of newspaper readers.

New Easy Way to Learn Cartooning

This fascinating ability to draw cartoons can now easily be *yours*—this ability which can mean so much real pleasure and profit to you. Through a wonderful new method you receive right at home through the mail a complete training in cartoon making, and *personal corrections* on all of your work

Washington School of Cartooning
Room 261C, 1113-15th St., N. W. Washington, D. C.

Washington School of Cartooning
Room 261C, 1113-15th Street, N. W.,
Washington, D. C.

Please send me without obligation, your illustrated **FREE BOOKLET** on Cartooning.

Name
(Write name plainly)

Address

City State

If under 16 years, please state age.....

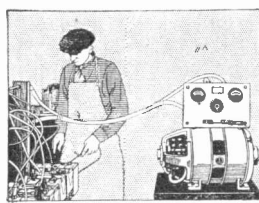

\$300 PROFIT Monthly from HB 8 Hr. Battery Charging
Add big battery charging profits to your income. Just \$35 cash puts this HB 8-Hour Constant Potential Battery Charging outfit in your shop—complete—all ready to set up and operate. Easy terms on balance. This HB is the lowest-priced complete outfit on the market. 30 days' trial on money-back guarantee. Ideal equipment for the small battery shop. No experience needed to install or operate. HB Users clear \$150 to \$300 monthly profits. Write for free bulletin No. 452.
HOBART BROS. COMPANY Box S-1 Troy, Ohio
Pays For Itself ~ Earns Big Profits

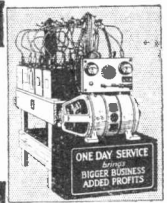

Shot Guns Breech Loading \$4.50 Like Cut

It is the U. S. Cal. 45B. L. Rifle. Barrels cut to 22 inch length. Rehored smooth for Bird shot. Rifle Barrels interchangeable, same length \$2.00 extra. Bird shot Cartridges for these guns, \$3.00 hundred; Ball cartridges, \$3.00 hundred. Send for Catalog, W. Stokes Kirk, 1627 FK, North 10th St., Phila., Pa.

RADIO Buyers' GUIDE

For Consumers **FREE** 100 Pages
Get it now—before you buy any set or parts to build one. Just send your name.
Shipping in all kinds of complete sets, Parts and Accessories.
(Will you be so kind as to add the name of one or more friends you believe will soon want radio goods? Thank you!)
Liberty M. O. House, Dept. A260 106 Liberty St. N.Y.

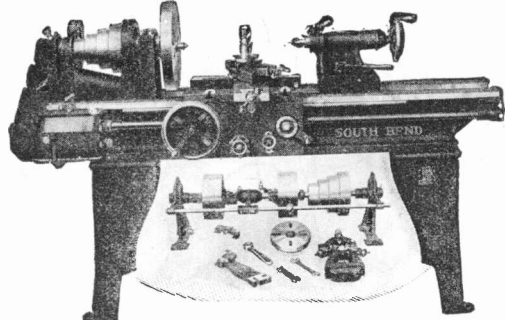

PRICE LIST OF POPULAR SIZES

Size of Lathe	Standard Change Gear	Quick Change Gear
9" x 3'	\$211.00	\$241.00
11" x 3 1/2'	244.00	284.00
13" x 6'	316.00	366.00
15" x 6'	376.00	431.00
16" x 8'	438.00	498.00
18" x 10'	656.00	721.00

13" x 5' South Bend Quick Change Gear Lathe Price \$354.00

EASY PAYMENT PLAN
 THE EASY PAYMENT PLAN allows you to install a SOUTH BEND LATHE in your shop, by making one payment with the order; the balance to be paid month by month, the amount depending upon the size of the Lathe.
 Catalog No. 82 gives complete information on SOUTH BEND LATHES and the EASY PAYMENT PLAN. SEND FOR IT TO-DAY.
SOUTH BEND LATHE WORKS
 390 E. MADISON STREET SOUTH BEND, INDIANA, U. S. A.

SOUTH BEND LATHES

GEORGE FULWELL'S HOTELS

Hotels for Wife—Daughter—
 Mother or Sister—and Dad
 Central—Comfortable—Homelike
 MODERN CONVENIENCES

DETROIT, MICH.
 Hotel Normandie
 \$1.50 to \$3.50

CLEVELAND, OHIO
 Colonial Hotel
 \$2.00 to \$4.50

R. C. PINKERTON, Res. Mgr.

WM. E. GAMBLE, Res. Mgr.



Hotels Start You With Salaries up to \$3500 a Year — with your living

Hotels, restaurants, clubs, apartments, everywhere need trained men and women—salaries to start up to \$3,500 a year with your living. Over 70,000 high-class positions paying up to \$10,000 a year are open every year in the hotels of the United States. Today this is the **FIRST INDUSTRY IN AMERICA** with over \$992,394,968 in new hotels being built in 1924—exceeding by \$200,000,000 the next largest industry. These new hotels, restaurants, etc., will need over 60,000 trained men and women.

You can have one of these high-class big-pay positions, with luxurious meals and apartment and fascinating work. No previous experience necessary. The Lewis Schools guarantee to give you the valuable knowledge that it has taken some of the most successful hotel men years to obtain—men who are now making \$5,000 to \$30,000 a year. We train you by mail in your spare time at home with the Lewis Simplified Study Plan, and we put you in touch with big opportunities. Our students employed, our methods endorsed by leading hotel men everywhere. Send today for Free Book, "YOUR BIG OPPORTUNITY," showing how we can train you for one of these splendid positions in 20 weeks or less, and explaining our Money-Back Guarantee.

LEWIS HOTEL TRAINING SCHOOL
 Room O-3488 Washington, D. C.

FREE BOOK COUPON
LEWIS HOTEL TRAINING SCHOOLS,
 Room O-3488, Washington, D. C.
 Send me without obligation the Free Book, "YOUR BIG OPPORTUNITY."
 Name.....
 Address.....
 City..... State.....

How to Get a Position with the U. S. Government

Thousands of appointments are made yearly. Good salaries—short hours—liberal vacations (as much as 30 days in some branches of the service). Positions open now in Washington and in other cities.

"Pull" and influence unnecessary. Common school education sufficient as groundwork for most positions. The International Correspondence Schools will prepare you right at home to pass your Civil Service examination with a high mark.

Mail the coupon today for 48-page Free Civil Service booklet.

INTERNATIONAL CORRESPONDENCE SCHOOLS
 Box 6190-D, Scranton, Penna.

Without cost or obligation, please send me a copy of your 48-page CIVIL SERVICE BOOKLET, which tells how I can secure a good-paying position with the U. S. Government.

Name.....

Address.....

JACK SWITCH

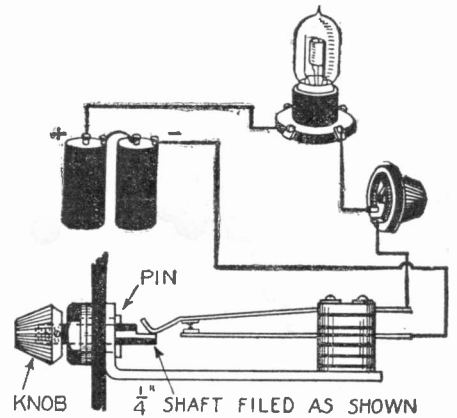

A cheap as well as efficient filament switch can be made by utilizing an ordinary single circuit jack which is fitted with a short length of brass rod filed at one end and fitted with a small knob at the other. Two small pins running through it prevent it from working loose. In this way the different functions of a more complicated circuit may be readily controlled, positive contact being established at all times.
 —Halbert H. Clark.

DUPLEX TUNING UNIT

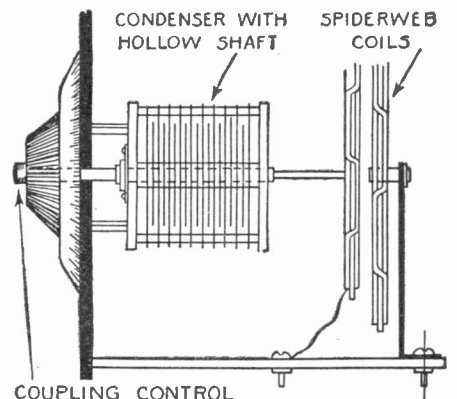

For those building a portable set, this idea will go very well. The vernier plate from a condenser is removed and in its stead is attached a spider-web coil. The inner rod is thus made to vary the coupling between the coils of the receiving set. As can be understood, this arrangement allows of compactness to a greater extent than can be achieved by any other means. Flexible leads are connected to the movable part and terminate in binding posts on the base.

—George E. Johnson.

TANGENTIAL CONTROL

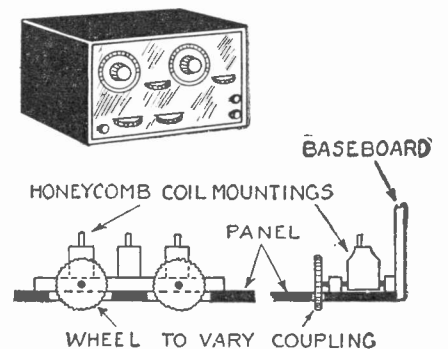

By attaching a honeycomb coil mounting on the back of a panel and equipping it with small wheels such as of bakelite or the ordinary typewriter eraser, a method for varying the coupling between the honeycomb coils is the result. Rheostats can be equipped in a similar manner and present a very pleasing appearance. The slots in the panel to accompany these controls are best cut by drilling a series of holes of the required diameter and using a file to finish up.

—E. M. Abbott.

Answers to Scientific Problems

(Continued from page 896)

THE SPOOL AND PLANE

The spool will evidently roll uphill or downhill depending upon which motion tends to lower the weight W . Suppose the spool drops (or rises) a vertical distance H while rolling a distance C equal to the circumference of the rim. In so moving it will roll up (or unroll) a length of cord equal to the circumference c of the drum. If the height H of the plane is less than the circumference c of the drum it is evident that the spool will roll uphill since in only that event would the weight descend. But if the height H is greater than the circumference c the spool will move down hill. On considering the similar triangles OBD and EFG it can be seen that $H/ = OB/OD$, and OB/OD is greater than r/R and therefore greater than c/C . Hence H/C is greater than c/C and H is greater than c . Therefore the spool will roll down hill.

Perhaps a simpler way to arrive at the same conclusion is to consider the action of the force W with reference to the pivotal point A where the spool comes in contact with the plane. The line of action of this force BDC passes the plane somewhat below A . Hence it will tend to turn the spool downward. If the line BDH passed through the plane above A it would tend to turn the spool upward while if it passed through A itself the weight would have no tendency to turn the spool either way.

THE GEOGRAPHICAL CENTER

The geographical center of a country may be determined by pasting a map of the country on a piece of pasteboard and cutting around the border. Then suspend it from a pin thrust through one corner into a wall. If the map hangs freely the geographical center will lie along a line drawn vertically downward from the pin. By changing the point of suspension to another corner a second line can be determined which passes through the geographical center. Then since the geographical center lies along both lines it must lie at their intersection. For the United States this point is not far from Junction City, Kansas, but probably somewhat further west.

THE ELECTRICAL CIRCUIT AND THE PLATFORM BALANCE

By means of a compass needle it can be readily shown that a magnetic field surrounds a wire carrying an electric current. The reaction of this field with that of the earth tends to make a wire move at right angles to the earth's field. It can also be shown that if the thumb, forefinger, and middle finger of the left hand be extended at right angles to each other with the forefinger in the direction of the magnetic field (earth's), middle finger in the direction of the current the thumb will point in the direction in which the conductor will tend to move. Applying this rule it will be seen that the force is downward on the platform B and upward on the wire on platform A . Hence weights would have to be applied to platform A to secure an exact balance. The unbalancing force would be slight in the problem here given—about half a gram for most places in the United States, depending upon the strength of the horizontal component of the earth's magnetic field.

MOISTURE ON A FLAT-IRON

Water is one of the combustion products of illuminating gas. Ordinarily the water passes away unnoticed in the form of vapor, but when a cold surface such as that of a flatiron is present some of the moisture may condense in small droplets.



The Kit Contains

the six essential SUPER HILCO-DYNE instruments, together with the required number of HILCO Precision Fixed Condensers and a 20-page book thoroughly describing and illustrating by text and blueprints all details of the SUPER HILCO-DYNE RECEIVER.

Price of book separate from the kit—\$1.00.

Different

-and superior to any other circuit!

The SUPER-HILCO-DYNE RECEIVER—a seven tube set superior in every way and different from the conventional super heterodyne (note wiring diagram below) is made from the \$30 SUPER HILCO-DYNE KIT and about \$45 worth of standard radio parts sold by any dealer. It operates

either on storage battery or dry cell tubes.

SELECTIVITY—A fan receiving in New York next to the high voltage elevated railway tunes in or out all the nearby high powered broadcasting stations and gets what he wants when he wants it.

DISTANCE—A fan receiving in a large metropolitan hotel uses the steam radiator as his antenna and gets coast to coast reception.

TUNING—Only two dials. Stations can be located today, tomorrow, or next month by turning back the dials to the place where those stations came in before.

CONSTRUCTION—Inexperienced fans all over this continent have built these sets without trouble.

RADIATION—Not a squeak, squawk or squeal comes from the SUPER HILCO-DYNE to bother your nearest neighbor. It does not radiate.

DISTORTION—Absolutely true tone qualities from the lowest note of a base horn to the highest note of a coloratura soprano.

VOLUME—You can dance any night with a SUPER HILCO-DYNE RECEIVER. Loud speaker reception on all stations.

WAVE RANGE—90 to 600 meters.

SIZE OF RECEIVER—Only 7" x 28" panel.

Each SUPER HILCO-DYNE KIT is thoroughly tested and the air core transformers are matched and balanced in our own laboratories.

Here is selectivity, great distance, volume, clarity, easy tuning, simple construction. It is your set, custom built to YOUR requirements. It is the ONE you want; the ONE you have been hoping for. Order from your dealer or send for descriptive literature on the SUPER HILCO-DYNE KIT and other famous Hilco radio apparatus. Address Dept. 16.

Scientific Radio apparatus that is distinctively different and superior in efficiency and appearance.

SUPER-HILCO-DYNE BOOK

Free with kit

A. E. HILL MFG. CO. Atlanta, Ga.

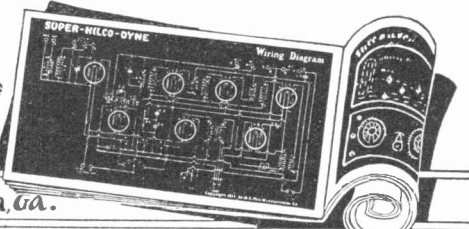

FREE VACUUM TUBE Radio Set

The Set you always Wanted—FREE!

A real RADIO SET—Listen in on Concerts, Lectures, Singing, etc. Can receive 75 to 100 miles and more.

RUSH your name and address and we will tell you HOW you can get a VACUUM TUBE RADIO SET

ABSOLUTELY FREE

Don't delay. Write today for FREE RADIO PLAN.

Home Supply Co., 131 Duane St., N.Y., Dept. 139

BLANK CARTRIDGE PISTOL

Protection against Burglars, Tramps, & Dogs

PRICES 50c. \$1.00!

POST-PAID

Well made and effective. Modeled on latest type of Revolver; appearance alone is enough to scare a burglar. When loaded it may be as effective as a real revolver without danger to life. It takes standard .22 Cal. Blank Cartridges obtainable everywhere. Price 50c., superior quality \$1.00 post-paid. Blank Cartridges by express, 50c per 100.

JOHNSON SMITH & CO., Dept. 182 Racine, Wis.

"LIGHTING FIXTURES"

READY TO HANG

Direct from manufacturer. Completely wired including glassware. Send for Catalogue No. 26 (Just off the Press)

Special Proposition to Dealers

ERIE FIXTURE SUPPLY CO.

Desk B Erie, Pa.

MODEL SLIDE VALVE MARINE ENGINE

1/2" bore, \$12.75. or 3/8" bore, \$15.75

You will probably wish to make your own model boat hull, but what about your power unit? We are builders of working model engines and boilers of many types. We can supply you with a power unit that will meet the requirements of your particular model boat. Boiler, Ship and Naval fittings. Special work. Large illustrated catalogue, 20c.

BATHE MFG. CO.

Dept. 2, 5214 Woodland Ave., Phila., Pa.



A thoughtful, helpful, useful gift

THE Remington Portable is truly a universal gift—welcomed by people who write, much or little, the world over. It is saving the time of countless women. It is greatly assisting children in their school work, and properly training them for the future. It is indispensable to the college student of today. And men find in the Remington Portable a little helper always ready to lighten every writing task. It is the modern way to write.

The Remington Portable, complete with case, and in a beautiful Christmas container, \$60. Easy payment terms if desired. For sale by all Remington branches and over 5000 dealers.

Remington Portable DeLuxe

A distinctive model in ivory tone finish and handsome brown leather case. A limited number available at \$75.00 each.

Write for illustrated "For You—For Everybody"

REMINGTON TYPEWRITER COMPANY

Dept. 14, 374 Broadway, New York

Remington Portable

THE RECOGNIZED
LEADER—IN SALES
AND POPULARITY



THE STINGING OF A BALL BAT

If in swinging an athlete's hammer preparatory to a throw the wire should strike some obstacle it is very evident that the inertia of the hammer would cause it to give a violent jerk to the hands. Similarly in swinging a ball bat the behavior is much the same as if its entire mass were concentrated in one spot (the center of percussion) and whirled about a pivotal point like a hammer about the hands of the thrower. If a ball strikes squarely on the center of percussion the bat is merely retarded in its swing and scarcely any force is applied to the hands. But if it strikes at any other spot the reaction tends to turn the bat about some point other than its normal pivot and hence jars the hands more or less painfully.

THE PAPER SAW

Centrifugal force tends to keep the paper stiff and straight, and if the disk is whirled rapidly it becomes virtually quite rigid.

ACCELERATION AND WEIGHT

As the weight W descends it will move faster and faster, *i.e.*, accelerate, because of the constant net force equal to $W-w$ acting upon the system. The effect is just the same then as if one were pulling up a small weight w and dropping a large weight W . Pulling up a mass with acceleration would increase the force on the arm of the lever, while dropping a mass would tend to decrease the force. But since the decrease is more than the increase it is apparent that the drawscales supporting the system will show a force, which will be less when the weights are moving than when they are stationary.

THE BULLET AND THE PANE OF GLASS

A fast moving bullet may pierce a sheet of glass so quickly that it actually doesn't have time to shatter before the bullet is through and on its way again. Such a bullet will leave a hole nearly as smooth as if it had been drilled. A slow moving bullet or a stone is retarded more by the pane and so contributes more of its energy.

THE BAROMETERS

A mercurial barometer will read accurately only for the particular altitude and latitude for which it was calibrated. At other altitudes and latitudes the changes in the earth's gravitation force are often sufficient to make slight although noticeable changes in the reading even for the same atmospheric pressure. Corrections for latitude are only necessary when precision readings are required as they are too small to be important in ordinary cases.

6 TO 120 VOLT CHARGER



A distinctive advantage of this new vibrating rectifier is its ability to charge at varying rates as desired, up to 120 volts of "B" batteries *in series*. This eliminates the necessity of rewiring 24 volt sections in parallel in order to charge them. Two, 4, 6 or 8 volt "A" batteries may also be charged at a 5 to 7 ampere rate. The charger is furnished with meter, fuse plug, socket for lamp to vary "B" charging rate, 6 feet of lamp cord, and two charging wires, 4½ feet long.

\$17.45 **AMAZINGLY LOW PRICED 1925 MODEL GOVERNMENT TESTED SIDE WHEELER**

JUST received. Limited quantity of brand new 1925 famous "TROOPER" Side Swing revolvers. Specially built of the finest tool steel and Government tested. Not to be compared with ordinary guns. Shoots any standard American cartridge. Special introductory price for short time. Only one gun to a customer.

32 cal. 6-shot : \$17.45
32, 20 or 38 cal. 6-shot : \$18.45

PAY POSTMAN ON DELIVERY plus postage. Money back promptly if not satisfied.

William Ward Co., Dept. HA1W
1269 Broadway, New York

Makes Autos Go 49 Miles On One Gallon of Gas

Sioux Falls, S. Dak.—James A. May of this city announces the perfection of an amazing device that is enabling car owners to more than double their mileage from gasoline used and at the same time remove every particle of carbon from their motors. Many cars with this device attached have made over 49 miles on a gallon. It is automatic and self-regulating and can be attached by anyone to any car in a few minutes.

Mr. May wants agents and is willing to send a sample at his own risk to anyone who will write him. Just send your name and address to James A. May, 1920 Lacotah Bldg., Sioux Falls, S. Dak.

Electrical Engineering

Course for men of ambition and limited time. Over 4000 men trained. Condensed course in Theoretical and Practical Electrical Engineering including the closely related subjects of Mathematics and Mechanical Drawing taught by experts. Students construct motors. Install wiring, test electrical machinery. Course complete

In One Year

Established in 1893. Prepare for your profession in the most interesting city in the world. Free catalog.

BLISS ELECTRICAL SCHOOL
106 Takoma Ave., Washington, D. C.

A Wonderful Book on Finger Prints FREE to YOU!

FULL of Thrilling, True Stories of crime mysteries solved through Finger Print Evidence by some of America's greatest Finger Print Experts. Gripping illustrations. Greatest book ever published on the subject. Send for your FREE copy TODAY.

UNIVERSITY OF APPLIED SCIENCE
Dept. 14-21 1920 Sunnyside Ave. Chicago, Ill.

RADIO CATALOG

Crammed full of Biggest Bargains in Sets, Parts and Accessories—**FREE**

Contains interesting explanation of marvelous benefits of Radio which you may enjoy—told in language anyone can understand. You should get it before buying.

Liberty M. O. House, Dept. A201, 106 Liberty St., N. Y. C.

FREE Your Name As \$175 VALUE Inlaid in Gold NEVER SOLD FOR LESS

THE PERFECT WRITING INSTRUMENT
The New Improved **INKOGRAPH** Writes like pencil with ink better than good fountain pens. Won't skip, blot, scratch, leak, clog or soil hands. Makes 3 or 4 carbons. 14 kt. gold point, shaped like fine lead pencil point. Guaranteed. **SEND NO MONEY.** Pay postman \$1 plus postage. Agents wanted.

INKOGRAPH CO., Inc., 195 U Centre St., New York

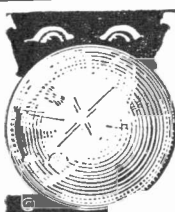

Fortune Telling Globe! THE GENUINE CRYSTAL ORACLE answers every question... Love, Marriage, Money, Luck! Mystifying, thrilling, fascinating game. \$4 Outfit includes 6 inches round Crystal Globe; 168-pg. Book on Divination by Crystal Dreams, etc.; also Book "How to Converse with Spirits." Cat Price \$2.45. Send 20c for postage. Pay the balance (\$2.25) when delivered.

PARK PUB. CO.
Park Row Bldg., New York
Dept. 5U

Motor Hints

By **TOM C. PLUMRIDGE**
Rear Axles and Their Adjustments

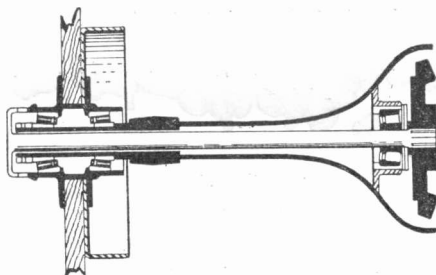

The first type of axle to be considered is known as the full floating type and is illustrated above. The entire weight of the body rests on the axle housing and the axle shafts themselves only serve to transmit the power from the drive shaft to the wheels. The axle may be removed without taking off the wheel.

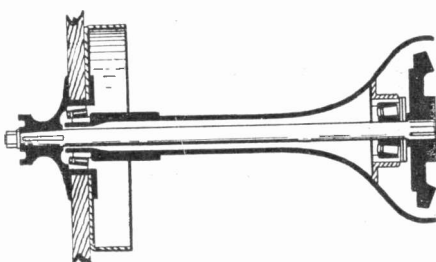

In the three-quarter floating type of axle illustrated above, the axle takes part of the load of the body and also serves to drive the wheel. The axle housing takes the rest of the load that is not supported by the axle. In this type, the axle can also be removed without removing the wheel.

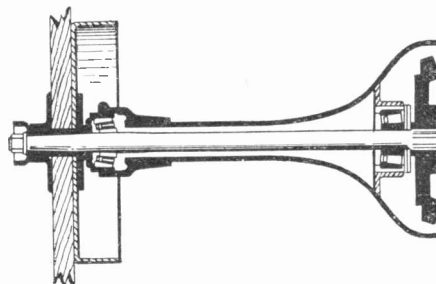

In the semi-floating type, illustrated above, the axle not only takes all the load but does the driving at the same time. This is a cheaper form of construction, but it necessitates taking the housing apart before the differential can be reached.

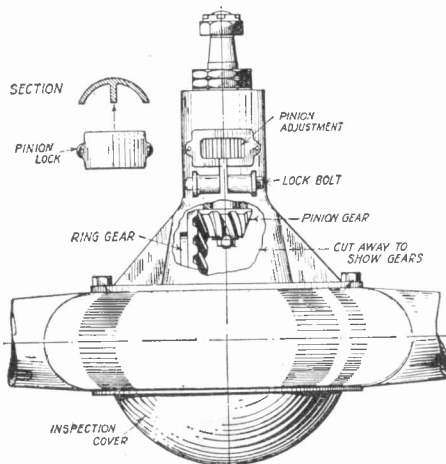

"D" Above illustration shows the location of the pinion adjustment which may be reached by removing the cover directly over the adjustment. The projection on the cap locks the adjustment in position.

Do You Know Why Men Succeed?

It is true that some men succeed by Luck.

It is likewise true that some succeed by Pull.

But don't let that beguile you.

For every one hundred men who succeed by Luck or Pull, there are ten thousand who succeed because *they deserve to!*

Yes, deserve to!

Ability counts.

Executives are continually looking for good men.

Nothing in the world can keep you down if you make up your mind to go up.

You can wait if you want to, but five years from To-day you will still be waiting—the shadow of the man you might have been.

The time to send in this I. C. S. coupon is—*now!*

INTERNATIONAL CORRESPONDENCE SCHOOLS
Box 6189-D, Scranton, Penna.

Without cost or obligation on my part, please tell me how I can qualify for the position or in the subject before which I have marked an X:

BUSINESS TRAINING COURSES

- Business Management
- Industrial Management
- Personnel Organization
- Traffic Management
- Business Law
- Banking and Banking Law
- Accountancy (including C. P. A.)
- Nicholson Cost Accounting
- Bookkeeping
- Private Secretary
- Spanish
- French
- Salesmanship
- Better Letters
- Show Card Lettering
- Stenography and Typing
- Business English
- Civil Service
- Railway Mail Clerk
- Common School Subjects
- High School Subjects
- Illustrating

TECHNICAL AND INDUSTRIAL COURSES

- Electrical Engineering
- Electric Lighting
- Mechanical Engineer
- Mechanical Draftsman
- Machine Shop Practice
- Railroad Positions
- Gas Engine Operating
- Civil Engineer
- Surveying and Mapping
- Metallurgy
- Mining
- Steam Engineering
- Radio
- Architect
- Architects' Blue Prints
- Contractor and Builder
- Architectural Draftsman
- Concrete Builder
- Structural Engineer
- Chemistry
- Pharmacy
- Automobile Work
- Airplane Engines
- Agriculture and Poultry
- Mathematics

Name.....
Street..... 3-6-24
Address.....
City.....State.....

Occupation.....
Persons residing in Canada should send this coupon to the International Correspondence Schools Canadian, Limited, Montreal, Canada

DeFonse License **HONEYCOMB COILS**

The Universal all-wave inductance. Back and front panel mountings. Send 25c for Super Het., R. F. and Honeycomb Coil Circuits and Complete Catalog.

Chas. A. Branston, Inc.
Dept. 4, 815 Main St. Buffalo, N. Y.

PLAY A TUNE IN 10 MINUTES!

On Ukulele, Banjo, Ukulele, Mandolin, Tenor Banjo or Guitar. Amazing new invention. No knowledge of music necessary; no practice—you can play tunes right away. Easily attached to any instrument. Simply press numbered keys. Finest tone than when played the old way. Send for FREE BOOK and bargain catalog of musical instruments. No obligations. Have fun, money, popularity. Write today.

Free Book

FERRY & CO., 3222 N. Halsted St., Dept. 1251, Chicago, Ill.

IN EVERY HOME

A Radio Well Understood

Complete satisfaction from any radio outfit is usually based on the operator's knowledge of the fundamentals of operation.

The E. I. Co. books, as shown here, are expressly written, by radio experts, for the man who wants to understand his radio receiving set. The important points are all covered and fully explained in simple, everyday language.

Each book consists of 54 pages bound with stiff board covers and handsomely printed in colors. Their handy pocket size enables you to keep them ready at all times.

READ THE DESCRIPTIONS OF THE BOOKS SHOWN HERE. PICK OUT THE BOOKS YOU NEED OR IF YOU DO NOT SEE JUST WHAT YOU WANT WRITE FOR OUR FREE LIST OF PUBLICATIONS.

ON SALE
AT ALL RADIO STORES
AND NEWSSTANDS

Each  Prepaid

The E. I. Company
Sales Agents

The Consrad Company
233 Fulton Street New York City



Book No. 1

Many men fail in building their Radio sets because of some trivial error that could easily have been corrected before it was too late. The E. I. Company has compiled a book that will help you avoid all the common pitfalls while building your Radio sets.

PRICE 25c



Book No. 2

The man who wants to build only those PRACTICAL Radio Sets that are guaranteed to give good results when properly constructed will need this book. Gives the principal successful hookups of practical Radio Construction.

PRICE 25c



Book No. 3

Question No. 1—What is Radio? This is the nature of the questions that this book answers. Then it answers questions on all the principal parts of a Radio Receiver. It is a handy book to keep in your Radio File.

PRICE 25c

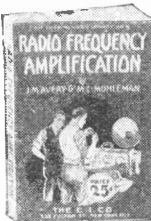

Book No. 4

Distance lends enchantment — and its the Radio Frequency Amplification that brings in the distance on your Radio Receiver. If you contemplate adding any Radio Frequency to your set you'll want this book at your side.

PRICE 25c



Book No. 6

Don't struggle in the dark, looking for stations—here is an inexpensive book that gives you detailed instructions on just how to handle your Radio set. You will be surprised at the increased results that can be obtained through proper tuning.

PRICE 25c



Book No. 7

No better book for your work bench. Gives diagrams, hookups and details on Radio Hookups galore. One of the most complete hookup books published. Authentic and up-to-date in every respect. Third edition now ready.

PRICE 25c

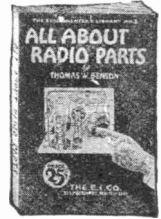

Book No. 8

Everyone who constructs a radio set should know the simple fundamentals of the various parts of his set. The E. I. Company has set these forth in a compact little book that is valuable at all times.

PRICE 25c

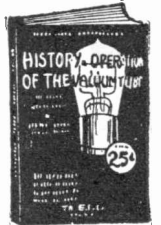

Book No. 9

The Vacuum Tube is a marvelous piece of apparatus. A short study of it as given in this book gives you the principle on which every Vacuum Tube Radio Receiver operates.

PRICE 25c

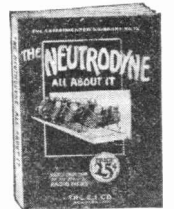

Book No. 10

Everybody knows the famous Neutrodyne hookup. One of the finest Radio Receivers in use today. This 51-page E. I. Company book gives an explanation of every detail of the Neutrodyne and how it all works.

PRICE 25c



Book No. 11

The simplest and yet most complete Radio Guide Book for any amateur broadcast listener. In print only two weeks, fresh from the press.

PRICE 25c



Book No. 12

Anyone with this handy book as a guide can repair and keep in order his own radio set. Covers every detail of the modern radio sets and tells how to locate and repair any trouble.

PRICE 25c

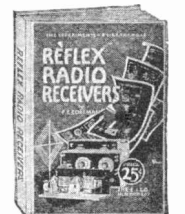

Book No. 13

Just off the press. Hookups galore on the finest and most up-to-date reflex circuits in use today. Diagrams and descriptions on every modern reflex.

PRICE 25c

Consrad

RADIO'S FOREMOST PUBLISHERS—Everything in Books, Patterns and Diagrams

CANADIANS WANTED

To Learn Electricity This Wonderful New Quick Way

Greatest System of Training Ever Devised

Combination Home Study and Residence Course

Just like going to school and working in a Power Plant at the same time.

Lack of Education No Drawback

Regardless of how little education you have had we can by this wonderful system make you a Master of Electricity capable of earning from \$2,500 to \$10,000 a year.

You will be trained through the use of your hands and eyes as well as your brain.

You Will Learn Electricity By Actual Laboratory Practice

DON'T get this method confused with a correspondence course.

Enter this highly paid field through our EASY TO MASTER, SHOP-LABORATORY SYSTEM OF TRAINING.

America's Greatest Electrical School Brought To Your Home

Write today for our Big Free Book fully describing this astonishing new plan. Tells also about Consultation privileges with our Staff of Experts, Free Employment Bureau and other Special Service. MAIL COUPON TODAY.

Canadian School of Electricity

Associated with

SCHOOL of ENGINEERING of Milwaukee

CLIP THE COUPON

Canadian School of Electricity,
263 St. James Street
Montreal, Que., Canada.

Please send me without charge or obligation on my part full details of your NEW SHOP-LABORATORY SYSTEM of home training in Practical Electricity.

Name

Address

City

Age.....

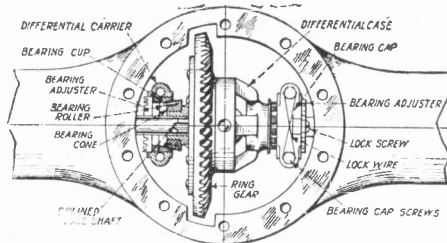

"E" The above illustration shows the remaining adjustments on a differential that are to be reached by removing the rear inspection cover.

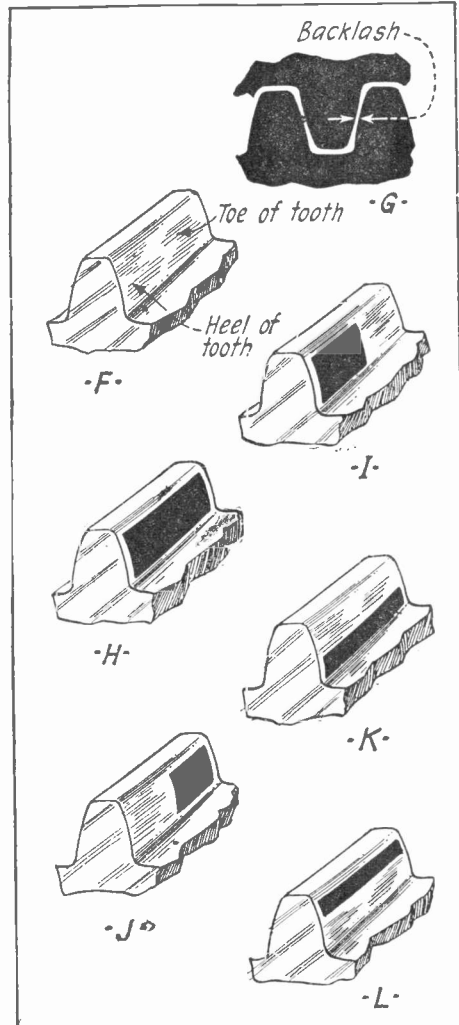

In adjusting gears, the object is to keep the gears quiet in operation and have the greatest amount of tooth contact. F illustrates the two parts of a gear tooth known as the toe and heel. G above, shows where backlash takes place. The illustration at H shows how gears will wear if correctly meshed. If the gears mesh so that only the blackened portion of the tooth illustrated at I are wearing, the ring gear must be moved nearer to the drive pinion. To do this, loosen the bearing adjuster shown in E above, on the right side, and tighten the one on the left side. If the contact is as in J, the condition is to be corrected by loosening the left-hand adjuster shown in E and tightening the right-hand one. The condition shown in K is remedied by turning the pinion adjustment shown in D, to the left. Wear as illustrated in L is compensated for by turning the pinion adjustment to the right.

Invisible ray insures secret directive radio communication. Invented by General Gustave Ferrié of the French Army in collaboration with Mons. R. Vouaust.

A new Italian torpedo is guided by radio. Under actual test, the mechanism used by the inventor performed perfectly. Only one wave-length is used and the inventor claims it is interference proof.

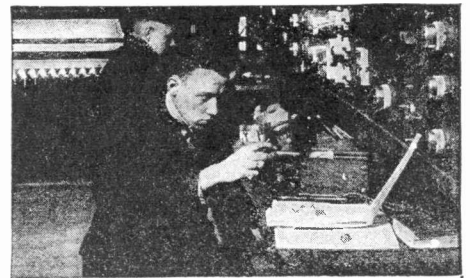

Corner of One of the Seven S. of E. Laboratories

Take This Short Cut to Accomplish Your Ambition

The field of electrical engineering offers wonderful opportunities for trained men to direct and carry out great industrial and commercial projects. Get a thorough and practical training here in our course of

ELECTRICAL ENGINEERING with B. S. Degree in 3 Years

A faculty of specialists is leading hundreds of ambitious young men to sure success. Why not you?

If you are lacking some preparatory studies you can make them up here as you go along. This is an exceptional opportunity to become an electrical engineer in the shortest possible time.

ELECTROTECHNICS

From 1 to 2 years in this course makes you a completely trained electrotechnician—prepared to fill such positions as general plant superintendent, director of construction, superintendent of maintenance, chief draftsman, etc. The Electrotechnician is the man between the Electrical Engineer and the Electrician—a well paid position and a stepping stone to higher executive work. A grade school diploma or equivalent admits you without examination. New term opens every 6 weeks.

COMMERCIAL ELECTRICAL ENGINEERING In 1 Year

Unparalleled opportunities for brilliant, successful careers in the new field of Commercial Electrical Engineering. To meet the extraordinary present-day demands for trained electrical business men, consulting and efficiency engineers, we offer this thorough, condensed and very practical training, especially adapted to high school graduates.

PRACTICAL ELECTRICITY

In this complete 6 months' Electrical Course—8 hours daily—you can learn house, factory and theatre wiring, testing and meter work, A.C. and D.C. Armature Winding and all necessary mathematics.

A 3 months' course in A.C. and D.C. Armature Winding, or a 3 months' Course in Light and Motor Wiring and Testing is offered to those with limited time and means.

AUTO ELECTRICAL SERVICE ENGINEERING AUTOMOTIVE ELECTRICITY

Electrical specialists who instinctively diagnose and locate automotive electrical troubles command high positions and are well paid. Specialize in starting, lighting, ignition and storage batteries and command a big job at a big salary.

"EARN WHILE YOU LEARN"

We agree to provide, for a limited number of worthy young men, half-time jobs at good wages, and permanent positions with unlimited prospects to all duly qualified graduates. Here is the opportunity of your life to acquire a thorough, practical training for big-paying profession that is in urgent need for trained men.

ESTABLISHED 20 YEARS AGO

The S. of E. stands absolutely alone in the field of thorough, practical electrical education and in commercial and electrical engineering.

NO NEED OF YOUR BEING WITHOUT AN S. OF E. TRAINING

It does not matter how old you are or what schooling you have had. Students from 16 years up to 60 are in attendance here.

Fill out the following coupon and mail it to-day.
New Term Opens January 5th.

SCHOOL of ENGINEERING of Milwaukee

Founded 1905

SCHOOL OF ENGINEERING OF MILWAUKEE
S.I.-125A, 415-17 Marshall Street,
Milwaukee, Wis.

Without obligating me in any way, please mail free 72-page illustrated book "Electricity and the One Best Way to Learn It" and particulars regarding the course I have marked with an X.

- Electrical Engineering.
- Electrotechnics.
- Commercial Electrical Engineering.
- Automotive Electricity.
- Auto Electrical Engineering.
- Armature Winding.
- Light, Motor Wiring and Testing.
- Practical Electricity.
- am interested in your "Earn While You Learn" Plan.

Name Age.....

Address

City State.....

Education

A COURSE IN INVENTING

by

Radio's Most Prolific Inventors

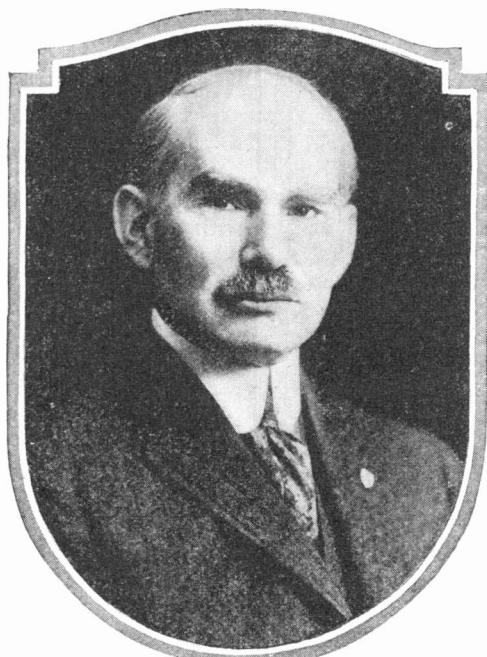

DR. LEE DeFOREST, B.S., D.Sc.

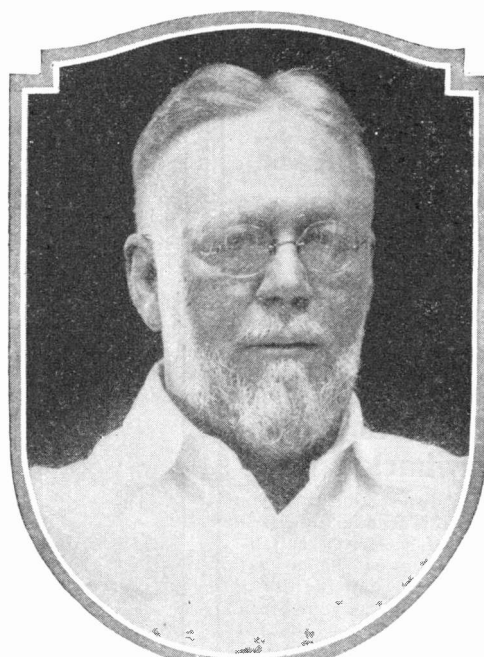

PROFESSOR REGINALD A. FESSENDEN

LEARN HOW THESE GREAT INVENTORS DEVELOPED THEIR FAMOUS SUCCESSES

TWO OF RADIO'S MASTER ENGINEERS

There is only one way in which you can learn how to go about inventing. There is only one path to follow, one method that brings success.

The lives of the greatest, most prolific, master inventors are a sure, safe guide to your realization of success in this great field.

The lives of Radio's two greatest men, Dr. Lee DeForest and Professor Reginald A. Fessenden, constitute a complete course in practical inventing for anyone. The complete stories of these men now running in RADIO NEWS tells just how they struggled, how they worked in developing their great inventions.

Dr. Lee DeForest invented the modern vacuum tube, that marvelous instrument that makes powerful radio reception and transmission possible. He is also the inventor of the radio receiving system of regeneration that is used in thousands of radio receiving sets today.

Professor Reginald A. Fessenden is that great inventor who developed the modern radio telephone. His early experiments in the sending of the human voice without the aid of wires are an inspiration to every inventor young or old.

HERE IS YOUR OPPORTUNITY TO FIND OUT HOW OTHERS HAVE SUCCEEDED IN THE FIELDS OF INVENTING.

THE COMPLETE STORIES OF THESE TWO GREAT INVENTORS ARE NOW RUNNING MONTHLY IN "RADIO NEWS."

JANUARY ISSUE IS NOW ON SALE ON ALL NEWSSTANDS AT 25 CENTS THE COPY.

Published by

The Experimenter Publishing Co., Inc., 53 Park Place, New York

Opportunity Ad-lets

YOU will find many remarkable opportunities and real bargains in these columns. It will pay you to read and investigate the offerings made every month by reliable firms, dealers and amateurs from all over the country. No matter what you may be seeking, whether supplies, automobile accessories, the opportunity to make money, or anything else, you will find listed here the best and most attractive specials of the month.

Advertisements in this section twelve cents a word for each insertion. Name and address must be included at the above rate. Cash should accompany all classified advertisements unless placed by an accredited advertising agency. No advertisement for less than 10 words accepted. Ten per cent. discount for 6 issues, 20 per cent. discount for 12 issues. Objectionable or misleading advertisements not accepted. Advertisements for the March issue must reach us not later than January 10th.

The Circulation of Science and Invention is over 150,000 and climbing every month

EXPERIMENTER PUBLISHING CO., INC., 53 Park Place, New York City, N. Y.

Agents Wanted

Agents—Best seller; Jem Rubber Repair for tires and tubes; supersedes vulcanization at a saving of over 300 per cent; put it on cold. It vulcanizes itself in two minutes and is guaranteed to last the life of the tire or tube; sells to every auto owner and accessory dealer. For particulars how to make big money and free sample, address Amazon Rubber Co., Dept. 601, Philadelphia, Pa.

Agents—Write for Free Samples. Sell Madison "Better-Made" Shirts for large Manufacturer direct to wearer. No capital or experience required. Many earn \$100 weekly and bonus. Madison Mills, 561 Broadway, New York.

Big money and fast sales. Every owner buys gold initials for his auto. You charge \$1.50; make \$1.35. Ten orders daily easy. Write for particulars and free samples. American Monogram Co. Dept. 71, East Orange, N. J.

We start you without a dollar. Soaps, Extracts, Perfumes, Toilet Goods. Experience unnecessary. Carnation Co., Dept. 232, St. Louis.

Make \$25 to \$50 week representing Clows' Famous Philadelphia Hosiery, direct from mill—for men, women, children. Every pair guaranteed. Prices that win. Free book "How to Start" tells the story. George Clows Company, Desk 27, Philadelphia, Pa.

Only one sale a day means \$200 per month. Five sales, \$1,000 per month. Marvelous new adding machine. Retail \$15. Work equals \$50 machine. Adds, subtracts, multiplies, divides automatically. Speedy, accurate, durable, handsome. Five-year guarantee. Offices, stores, factories, garages buy one to dozen. A fortune for live agents. Write quick for protected territory and free trial offer. Lightning Calculator Co., Dept. W., Grand Rapids, Mich.

Earn big money fast applying gold initials to autos. Every owner buys—\$1.35 profit on \$1.50 sale—particulars and samples free. Write quick. Lithogram Co., Dept. 19, East Orange, N. J.

We want Salesmen and Agents, either whole or side line, to sell our low priced radio books to the trade. Excellent proposition for live wires. The E. I. Company, Publishers, 233 Fulton Street, New York City.

Earn \$10 daily silvering mirrors, plating and refinishing metalware, chandeliers, bedsteads, headlights; Outfit furnished. N. Dele Laboratories, 1133 Broadway, New York.

\$60—\$200 a week. Genuine Gold Letters for store windows. Easily applied. Free samples. Liberal offer to general agents. Metallic Letter Co., 411 E., North Clark, Chicago.

Agents—Make \$25.00-\$100.00 weekly selling Comet Sprayers and Autowashers to farmers and Autoists. All brass. Thru continuous stream. Established 30 years. Particulars free. Rusler Co., Johnstown, Ohio, Box C17.

\$25.00 a day easy! Best line of brushes on the market. 90 varieties, including famous Auto Fountain Washer. Excellent territory available. Write immediately. Philadelphia Brush Co., Dept. 26, Vineland, N. J.

District Managers Wanted—Appoint Local Agents for us in your locality. No canvassing or delivering. \$100.00 weekly easily made. Commissions advanced. Bob Russell, Z 2307 Archer, Chicago, Ill.

Write and learn how to start profitable business without capital or experience. Silvering mirrors, refinishing auto headlights, tableware plating. Outfit furnished. International Laboratories, Dept. 25, 309 Fifth Ave., New York.

Agents—Be independent, make big profit with our soap, toilet articles and household necessities. Get free sample case offer. Ho-Ro Co., 2719 Dodder St., St. Louis, Mo.

Make \$17 Day.—Finest extracts, food products, toilet preparations, household necessities. Credit; sample case free. Write for amazing offer. Perkins Products, B-30, Hastings, Nebr.

At Last! Diamond Rival Discovered! Amazing blue white Rajah Gem astounds jewelry world and deceives experts! Beautiful Sample Case Free! \$100 weekly! Write Quick! Rajah Diamond Co., Dept. F45, Salisbury, N. C.

Wonderful Invention eliminates needles for phonographs. Preserves records. Abolishes scratching. Day's supply in pocket. \$20 daily. Sample on approval if requested. Everplay, Desk H1, McCurg Bldg., Chicago.

Agents—Something New—Wonderful Invention. Ford Owners will order it—Distributors profit 300%—thirty day trial offer. Write A. Z. Super, 1204—Fondulac, Milwaukee, Wis.

Agents—Pick up \$5.40 for few minutes' work. Then, if you like, become "regular" representative making \$10-\$15 daily. Write quick for particulars. Pitkin Company, 694 Pitkin Building, Newark, New York.

Agents Wanted (Continued)

Agents—\$15 a day. Easy, Quick sales. Free auto. Big weekly bonus. \$1.50 premium free to every customer. Simply show our beautiful, 7-piece, solid aluminum handle cutlery set. Appeals instantly. We deliver and collect. Pay daily. New Era Mfg Co., 803 Madison St., Dept. 88C, Chicago.

\$300.00 a month to distribute everyday household necessity in rural and small town districts. No money needed. Million dollar firm behind it. Write for particulars and state territory desired. B. U. Johnson, 611 W. Lake, Chicago.

Clean Up \$100.00 Weekly with our marvelous Christmas packages, selling from 50c to \$3. Great crew manager's proposition. Postal brings unique plans. Davis Products Co., Dept. 67, 1311 Carroll, Chicago.

Big Money selling New Household cleaner. Washes and dries windows. Sweeps, scrubs, mops. Complete outfit less than brooms. Over 100 per cent profit. Harper Brush Works, 152—3rd St., Fairfield, Iowa.

Formulas, Processes, Trade-Secrets. Different, dependable, guaranteed. Catalog free. D. Thaxly Co., Washington, D.C.

Want Money? Lots of it? Sell Perry Photo Medallions and Lykoll Paintings of loved ones. Novel, Appealing. Easy to sell. \$15 to \$10 a day. Advance commissions. Write Perry Photo Novelty Corp., 1791 Jerome Ave., New York.

Can you sell to colored people? Write Eston Co., Dept. 130, 2500 Second Ave., Birmingham, Alabama.

Darn E-Z Big Money Now. Sells faster than ever. Hard times improve sales. This universal Hosiery and fabric cement finds eager buyers in every home, office, store, and factory after two minute demonstration. New uses command instant attention. Special selling system assures generous income. Darn E-Z Laboratories, Dept. 30, Dayton, Ohio.

Distributors—Screw-Holding Screw Driver. Handiest Tool ever invented. Unlimited Market. Tremendous demand! Big repeat earnings! Write Cohn Tool, 739 S. Boylston, Boston, Mass.

Agents wanted. Men and women. Exclusive territory. Marvelous new camera takes and finishes pictures inside camera in one minute. Wonderful opportunity. Crown Co., 908 Romax Bldg., New York.

Clothing Sensation! New line of men's clothing. Allwool suits, all at one low price of \$23.50. Nothing higher. We pay biggest commissions cash with order, supply finest selling outfit and give powerful co-operation. 3 to 6 orders a day gives you income of \$60.00 to \$125.00 a week. Experience isn't necessary. If you're honest, earnest and willing to work we'll train you. Address Dept. 213, William C. Bartlett, Inc., 850 W. Adams St., Chicago.

Agents wanted to advertise our goods and distribute free samples to consumers; 90c an hour. Write for full particulars. American Products Co., 2359 American Bldg., Cincinnati, Ohio.

American Made Toys

Opportunity to start Manufacturing Metal Toys and Novelties. No experience necessary. Enormous demand exceeds supply. We furnish, at cost, casting forms for production and buy entire output, also place yearly contract orders. Casting forms made to order. Catalog, advice and information free. Metal Cast Products Co., 1696 Boston Road, New York.

Automobiles and Accessories

Ford Owners—Start your car instantly in coldest weather with illuminating gas. Complete copyrighted instructions for cheaply and easily constructing illuminating gas primer attachment, and for removing carbon with water, mailed for one dollar. Primer attachment saves ten to twenty per cent in gasoline after engine warms. Money Back Guarantee. C. J. Menasco, 1428—11th St., N.W., Washington, D.C.

Battle Photos and War Relics

For Dens: Relics Collected from Europe's Battlefields. Firearms, medals, helmets, etc. Illustrated catalogue and sample War photographs 25c. Lieut. Welsh, 2117 Regent Place, Brooklyn, N. Y.

Books

Hypnotism. Astounds, controls. Wants gratified. Disease eliminated. 25 Easy Lessons \$1.00 "Mindreading" (Any distance) wonderful. Success guaranteed. 60c "How to Win in Business, Love and Society" 400 pages \$3.00. Catalog free. Science Institute, SE 1014 Belmont, Chicago.

Harnessing the Sun for Power. \$1.00 Postpaid. Your money returned if you are not satisfied. W. A. Buchhelm, Bookseller, 1455 Race Street, Denver, Colorado.

Business Opportunities

Dollars yearly in your backyard. No mushroom dope. Particulars free. Metz, 313 East 89th, New York.

You can have a business-profession of your own and earn big income in service fees. A new system of foot correction; readily learned by anyone at home in a few weeks. Easy terms for training, openings everywhere with all the trade you can attend to. No capital required or goods to buy, no agency or soliciting. Address Stephenson Laboratory, 18 Back Bay, Boston, Mass.

Stop Plodding! Be Successful. Operate a Tire Repair Shop. Make big profits in any locality. We teach you and furnish complete equipment \$100 up. Book of Opportunity free. Haywood's, 1312 South Oakley Avenue, Chicago.

Get Money in your mail. "Lambert's Mail Order Secrets" contains successful methods never before published. Particulars free. Leon Lambert, 670-D Kaufman Bldg., Wichita, Kansas.

Will finance patent (good invention) for interest. V. A., c/o Patent News, Washington, D.C.

Free Book. Operate little mail order business home evenings. Book free. Pier, 859 Cortland St., N. Y.

Money making books, formulas, plans, etc. Write for circulars. Morris Specialty Co., 2007 Park Ave., St. Louis, Mo.

164 ways to make money. Free. Morton 1122 E. 31st, Kansas City, Mo.

Formulas. New, Different. Make your own extracts, flavors, syrups, beverages, etc. Name-address brings valuable information free. Meriden Co., 3322 M. White Bldg., Seattle, Wash.

Special Free Offer. 100,000,000,000 German Marks, 5,000 Polish Marks, and 10 Russian Czar Pre-war Roubles Absolutely free with every 25c order for 100 Kromen Hungarian Government 5 1/2 per cent. Bonds, interest coupons attached. Send 25c order today and receive latest Quotations. Public State Bank, Dept. 615, Chicago.

Earn \$25 weekly. spare time. writing for newspapers, magazines. Experience unnecessary. Copyright book free. Press Syndicate, 987, St. Louis, Mo.

Make big money. Safe & Lock Expert. Wayne Strong, 3800 Lan Franco St., Los Angeles, Cal.

Chemistry

Learn Chemistry at Home. Dr. T. O'Connor Sloane noted educator and scientific authority, will teach you. Our home study correspondence course fits you to take a position as chemist. See our ad on page 867 of this issue. Chemical Institute of New York, 66 W. Broadway, New York City.

Correspondence Courses

Used correspondence courses of all schools sold, rented and exchanged. List free. (Courses bought.) Leo Mountain, East Chattanooga, Tenn.

District Representatives

Money-making opportunity selling Radiolite system of charging batteries. Sells to battery stations, garages, auto-owners. White for information and free demonstration offer. Radiolite Co., Dept. N, St. Paul, Minn.

For Advertisers

24 words—\$55 Rural Weeklies \$14.20. Ad-Meyer, 6119 St. Louis, Mo.

For Inventors

We Develop Your Ideas into commercial shape for presentation to purchasers making working models, drawings, experiments or tests. Courtesy, efficiency, secrecy and ample equipment; 30 years' experience. Ducoron-Rich Engineering Co., 504 Pacific Mutual Bldg., Los Angeles, Cal.

Unpatented Ideas Can Be Sold. I tell you how and help you make the sale. Free particulars (Copyrighted). Write W. T. Greene, 808 Jenifer Bldg., Washington, D. C.

Your Chemical problems solved and working process furnished for Five Dollars. Write me. W. Stedman Richards, Consulting Chemist, Box 2102, Boston, Mass.

Have you an invention or patent for sale on cash or royalty basis? Do you wish to buy a practical money making invention? Write us definitely what you have or want. We bring seller and buyer together. Address. Western Security Co., 303 Hannibal, Mo.

If you have a Patent for Sale I have some information of interest to you. Particulars Free. Am no broker. W. H. Colby, Room 15, 461 Charlotte Avenue, Detroit, Michigan.

Formulas

Money-making Books, Plans, Formulas. Catalogue Free. Ideal Book Shop, 5501-E, North Robey, Chicago.

For the Photographer

Have you a Camera? Write for free sample of our big magazine, showing how to make better pictures and earn money. American Photography, 118 Camera House, Boston, 17, Mass.

For Sale

For Sale. Magazines of all kinds, 1887-1924 at 5 and 10c each. Richard Zorn, North Baltimore, Ohio.

Games and Entertainment

Tricks, Puzzles, Jokes, Magical Apparatus, Plays, Stage Supplies. Mind-Reading Acts and Sensational Escapes. Send 10c for 160-page illustrated 1922 professional catalogue. Oaks Magical Co., Dept. 519, Oshkosh, Wis.

Health

Free—Stop using tobacco. We will give free information how to conquer habit easily and permanently. Results guaranteed. Anti-Tobacco League Box M, Omaha, Neb.

Help Wanted

We want Salesmen and Agents, either whole or side line to sell our low priced radio books to the trade. Excellent proposition for live wires. The E. J. Company, Publishers, 233 Fulton Street, New York City.

Detectives Needed Everywhere. Work home or travel. Experience unnecessary. Write: George Wagner, former Government Detective, 1968 Broadway, N. Y.

Silvering Mirrors, French plate. Easily learned, immense profits. Plans free. Wear Mirror Works, Excelsior Springs, Mo.

All men, women, boys, girls, 17 to 65, willing to accept Government positions, \$117-\$250, traveling or stationary. Write Mr. Ozment, 293 St. Louis, Mo., immediately.

Detectives Earn Big Money. Travel. Excellent opportunity. Great demand everywhere. Experience unnecessary. Particulars free. Write, American Detective System, 1974 Broadway, N. Y.

Earn \$1.20 an hour cutting blanks at home; anywhere; spare time. Men only. Send addressed reply envelope. Goodyear Ex., 117 W. 23d St., New York.

Men to Build Radio Sets for me in spare time. Leon Lambert, 670-H Kaufman Bldg., Wichita, Kansas.

Become a Landscape Architect. Uncrowded profession of wonderful opportunity for money-making. Easily mastered by mail. Earn while you learn. Write for book. American Landscape School, 65-E, Newark, New York.

Be a Detective—Exceptional opportunity; earn big money. Travel. 111g rewards. Established 1909. Particulars free. Write C. T. Ludwig, 1417 Westover Bldg., Kansas City, Mo.

Firemen, Brakemen, Baggage-men, Sleeping Car, Train Porters (colored) \$140-\$200. Experience unnecessary. 897 Railway Bureau, East St. Louis, Ill.

Earn \$25 weekly, spare time, writing for newspapers, magazines. Experience unnecessary. Copyright book free. Press Syndicate, 986, St. Louis, Mo.

Make money at home writing showcards. We instruct and provide work. Kwik Showcard, 61 Bond J, Toronto, Can.

Men 18-35. Become Railway Mail Clerks. Commence \$1600 year. Common education sufficient with our coaching. Particulars free. Write immediately. Franklin Institute, Dept. J23, Rochester, N. Y.

Information

Detailed, expert information, advice promptly. Any subject. \$1.00. International Information Institute, 15H Moore Street, New York.

Instruction

Learn Chemistry at Home. Dr. T. O'Connor Sloane, noted educator and scientific authority, will teach you. Our home study correspondence course fits you to take a position as chemist. See our ad on page 867 of this issue. Chemical Institute of New York, 66 W. Broadway, New York City.

Correspondence Courses sold complete; one-third usual prices because slightly used; easy terms; money back guarantee. All schools and subjects. Write for special Free catalog. Courses bought for cash. Economy Educator Service, H202, West 49th St., New York.

Machinery and Tools

Concrete Building Block Machines and Molds. Catalogue free. Concrete Machine Co., 305 South Third St., St. Louis, Mo.

Manufacturing

To order: Metal articles, simple, or complicated machinery. Models, tools, patterns. Experimenting. Parma Engineering Works, Brooklyn Station, Cleveland, Ohio.

Miscellaneous

Hindu Psychology, Yogi, Personal Magnetism. The Secret Sciences, Books and Courses. Large illustrated Private Catalogue, with "How Realize Any Desire," 25c. Adaros, 116 South Michigan, Chicago.

Beautiful registered bull pups cheap. Bulldogs, 501 Rockwood, Dallas, Texas.

Cigar Smokers! Factory to Smoker System Saves you half; write for particulars and special offer. Montrose Cigar Factory, 4004 Montrose Ave., Chicago, Ill., Dept. B.

Manufacture new, fast selling articles. Free list of plans, patterns, molds, processes. F. Barter, 3937 Tracy, Kansas City, Mo.

Build a Ford Racer. Book with complete plans of world's record holder. Postpaid \$2.00. P. W. Cornelius, 325 N. Capitol Ave, Indianapolis, Ind.

Pocket Guide to 2000 tourists' camps; auto trails; airplane landings together with two 40 in. maps. One Dollar. 550 Fisk Bldg., 250 West 97th, New York City.

Repair your own clock, and make money repairing others. It's easy. You can do it. Send 25c and I will send you the Jewelers' Secret of cleaning clocks. W. L. Hamilton, Tupelo, Miss.

Motion Pictures

Films rented and sold. Moving Picture Projectors sold at lowest prices. Movie Cameras \$40.00. Tripod \$20.00. Movie Projector \$25.00. New Motor Driven Suit Case Projector \$75.00. Write for Bargain Price-List. C. Ray, 324 Fifth Ave., New York.

Motorcycles—Bicycles

Don't buy a Bicycle Motor Attachment until you get our catalogue and prices. Shaw Mfg. Co., Dept. 6, Galesburg, Kansas.

Musical Instruments

Violins—Deep, Mellow, Soulful—on easy credit terms. High grade, wonderful instruments of my own make. Development of many years' experience. Write for book. Gustav A. Henning, 2124 Gaylord St., Denver, Colo.

Novelties

Magic goods, cards, books, novelties, tricks, catalogue free. Clifford Fenner, 2101 Jefferson, Louisville, Ky.

Patent Attorneys

Patents. Send for free booklet. Highest references. Best results. Promptness assured. Send model or drawing for examination and opinion. Watson E. Coleman, Patent Attorney, 614 G Street, N. W., Washington, D. C.

Get your own patents. Application blanks, complete instructions \$1. Cutting Bros., Campbell, Calif.

Inventors write me about patents. My fees payable monthly. Booklet free. Frank Fuller, Washington, D. C.

Unpatented Ideas Can Be Sold. I tell you how and help you make the sale. Free particulars (Copyrighted 1923). Write W. T. Greene, 808 Jenifer Bldg., Washington, D. C.

"Inventor's Advisor," the valuable Patentbook with 139 Mechanical movements and illustrations, sent free upon request. M. I. Labiner, Patent Attorney, 3 Park Row, New York.

M. P. Laughlin, Patents. Engineer-Attorney, 47 West 42nd Street, New York.

Patents—Write for our Guide Books and "Record of Invention Blank" before disclosing inventions. Send model or sketch of your invention for Examination and Instructions. No charge for the above information. See advertisement on page 819. Victor J. Evans & Co., 191 Ninth, Washington, D. C.

Inventors: Send sketch or model for free opinion concerning patentable nature and exact cost of patent. Book "How to Obtain a Patent," sent free. Tells what every inventor should know. Established twenty-eight years. Highest references. Prompt service. Reasonable charges. Chandless & Chandless, 476 Seventh, Washington, D. C.

Patents. Write for my free Guide Books "How to Obtain a Patent" and "Invention and Industry" and "Record of Invention" blank before disclosing inventions. Send model or sketch of your invention for Instructions. Promptness assured. No charge for above information. Clarence A. O'Brien, Registered Patent Lawyer, 929 Security Bank Building, directly across street from Patent Office, Washington, D. C. See page 931.

Patents Procured; Trade Marks Registered—A comprehensive, experienced, prompt service for the protection and development of your ideas. Preliminary advice gladly furnished without charge. Booklet of information and form for disclosing idea free on request. Richard B. Owen, 130 Owen Bldg., Washington, D. C., or 2278-T Woolworth Bldg., New York.

Monroe Miller, Ouray Bldg., Washington, D. C. Patent Attorney; Mechanical, Electrical Expert. Free Blue Book gives candid advice.

Inventors—Send for form "Evidence of Conception" to be signed and witnessed. Form, fee schedule, information free. Lancaster and Allwine, Registered Patent Attorneys in United States and Canada, 242 Ouray Bldg., Washington, D. C.

The Patentome. Impartial advice to Inventors and Manufacturers. Mailed on request. Anderson & Son, Patent and Trade Mark Lawyers, Established 1865. 637 F St., Washington, D. C.

Millions spent annually for ideas. Hundreds now wanted! Patent yours and profit. Write today for free book—tells how to protect yourself, how to invent, ideas wanted, how we help you sell, etc. American Industries, Inc., 212 Kresge Bldg., Washington, D. C.

Study Patent Solicitation. Income Patent Attorney. Full Particulars. Patent Law, Jordan, Minn.

Patents

M. P. Laughlin, Patents. Engineer-Attorney, 47 West 42nd Street, New York.

Inventions commercialized. Patented or unpatented. Write Adam Fisher Mfg. Co., 205, St. Louis, Mo.

Patents For Sale

1,433,832. Riding clown with clappers movable in hands. Alfred Lynch, 938 Lambertson St., Trenton, N. J.

Personal

Exchange Cheery Letters with new friends. Write Betty Lee, Inc., Box 820, City Hall Station, New York City. Stamp appreciated.

Lonely—Join our Club. Make friends everywhere. Particulars free. Write Mrs. Mathews, Box 26, Oakland, Calif.

Free to Men or Women—Information of a scientific nature that has brought physical vigor and happiness to thousands. No charge; no obligation. Write Fair Sales Co., Dept. 246-1, Colorado Springs, Colo.

Lonely Hearts—Exchange letters; make interesting new friends through our romantic club. Write Eva Moore, Box 908, Jacksonville, Florida.

Ladies' beauty cream. Rolling massage cream. Orange vanishing cream. Theatrical cold creams. All four 10c. Wm. Rodgers 839 Oak, Cincinnati.

Phonographic Supplies

Build Your Phonograph. Spring Motors, Electric Motors, Tonearms, Amplifiers, Accessories. Latest Equipment also in Radio Mechanism and Cabinets. Catalog mailed for ten cents.

Photoplays, Stories, Etc.

\$\$\$ For Ideas. Photoplay Plots Accepted any form; revised, criticized, copyrighted, marketed. Advice free. Universal Scenario Corporation, 223 Security Bldg., Santa Monica & Western, Hollywood, California.

Photoplay Idea—Original, for sale. Lucrecia Asencio, P. O. Box 3814, Station D, Philadelphia, Pa.

LIMITED OFFER FIELD AND OPERA GLASS

A magnificent instrument, daintily designed and finished. Equipped with POWERFUL lenses that will enable you to see people and objects miles away. Exceptionally useful when out in the open, also for the movies or theatre. Glasses are 3 1/2 inches high extended, 2 1/2 inches closed. All metal parts beautifully nickel plated covered with fine quality imitation leather. Sent in plush-lined case. A fortunate purchase enables us to sell these WONDER glasses at this bargain price.



\$1.75
Value \$5.00

ORDER TODAY, LIMITED SUPPLY
Send cash with order, or we will send C. O. D.
AMERICAN PURCHASING SYNDICATE
164 Market Street, Newark, N. J., Dept. 208
Send for binocular and fire arm lists

Deafness



Perfect hearing is now being restored in every condition of deafness or defective hearing from causes such as Catarrhal Deafness, Relaxed or Sunken Drums, Thickened Drums, Roaring and Hissing Sounds, Perforated, Wholly or Partially Destroyed Drums, Discharge from Ears, etc.

Wilson Common-Sense Ear Drums
"Little Wireless Phones for the Ears" require no medicine but effectively replace what is lacking or defective in the natural ear drums. They are simple devices, which the wearer easily fits into the ears where they are invisible. Soft, safe and comfortable. Write today for our 168 page FREE book on DEAFNESS, giving you full particulars and testimonials.
WILSON EAR DRUM CO., Incorporated
525 Inter-Southern Bldg. LOUISVILLE, KY.

PIMPLES

Your Skin Can Be Quickly Cleared of Pimples, Blackheads, Acne Eruptions on the face or body, Barbers Itch, Eczema, Enlarged Pores and Oily or Shiny Skin. Write today for my FREE BOOKLET, "A CLEAR-TONE SKIN,"—telling how I cured myself after being afflicted 15 years.
E.S. GIVENS, 168 Chemical Bldg., Kansas City, Mo.

A PERFECT NOSE



shaped at home while you sleep. Rapid, painless and safe. The ANITA is the genuine, unique and most comfortable NOSE ADJUSTER absolutely guaranteed. Highly recommended by physicians. Winner Gold Medal Feb. 1923. Write for FREE booklet, The ANITA CO., Dept. 173 Anita Bldg., Newark, N. J.

DEAFNESS IS MISERY
I know because I was Deaf and had Head Noises for over 30 years. My invisible Antiseptic Ear Drums restored my hearing and stopped Head Noises, and will do it for you. They are Tiny Megaphones. Cannot be seen when worn. Effective when Deafness is caused by Catarrh or by Perforated, Partially or Wholly Destroyed Natural Drums. Easy to put in, easy to take out. Are "Unseen Comforts." Inexpensive. Write for Booklet and my sworn statement of how I recovered my hearing.
A. O. LEONARD
Suite 369, 70 5th Avenue -- New York City

WRITE JOKES

EARN FROM \$50 TO \$150 PER WEEK writing jokes, epigrams and humorous stories for publications. Tremendous demand for material. Our short course in Humor Writing teaches you to write humorous material that sells. Learn in your spare time—earn in your spare time. Complete marketing plan and markets furnished. Write today for full particulars.
AMERICAN INSTITUTE OF HUMOR
Office E, 319 Marion Bldg., Cleveland, O.



You can be quickly cured, if you STAMMER

Send 10 cents for 288-page book on Stammering and Stuttering, "Its Cause and Cure." It tells how I cured myself after stammering 20 yrs. B. N. Bogue, 8112 Bogue Bldg., 1147 N. III. St., Indianapolis.

"BOW LEGS and KNOCK-KNEES" UNSIGHTLY
Send for Booklet showing photos of men with and without the Perfect Leg Form
PERFECT SALES CO., Dept. 50
140 N. Mayfield Ave. Chicago, Ill.

Insure your copy reaching you each month. Subscribe to **SCIENCE & INVENTION**—\$2.50 a year. Experimenter Publishing Co., 53 Park Pl., N. Y. C.

Radio

Build Your Radio. Complete line of radio equipment. Money saving prices. Complete sets or units ready for assembly. Send ten cents for catalog. Hoosier Manufacturing & Supply Co., 310 Baldwin Block, Indianapolis, Indiana.

Attention! 50 Vacuum Tube Hook-Ups. The greatest collection of Vacuum Tube Circuits ever brought under two covers at such insignificant cost. These diagrams will be found in the great "Rasco" catalogue which contains raw materials and parts in a greater profusion than any other catalogue. 15c in stamps or coin will bring the catalogue to you. Radio Specialty Company, 100 Park Place, New York City.

Boys, don't overlook this! The "Rasco" Baby Detector. Greatest detector ever brought out with molded base. Fully adjustable. See former advertisements in this publication or our catalogue. Detector with Galena Crystal complete, 50c; the same Detector with Radiolite Crystal, 75c, prepaid. Send for yours today. Radio Specialty Co., 100 Park Place, New York City.

Send me your burned out or broken Power tubes—50 watts or over. Will pay liberally. W. Baker, 36 W. 20th St., New York City.

Have your broken and burned out power tubes repaired. 50 watts or over. Send them to us for Repair. Charges reasonable. Wm. Baker, 36 W. 20th St., New York City.

Dealers—Write for our illustrated catalog of reliable radio merchandise. Rossiter-Manning Corporation, Dept. G, 1830 Wilson Ave., Chicago, Ill.

Radio Generators: 500V 100 watt, \$28.50. Battery Charging Generators, \$8.50. High Speed Motors—Motor Generator Sets. All sizes. Motor Specialties Co., Crafton, Penna.

Motors—Manufacturer's surplus sale. 1/4 H.P., \$8.50; 1/2 H.P., \$12.50; 1 H.P., \$21.50; 8 Volt Charging Generators, \$8.50. Complete Lighting Plants—Generators. Light Machinery. Write for Catalog Motor Specialties Co., Crafton, Penna.

Wanted: Light Machinery—Lathes—Drill Presses—Model High Speed Gasoline and Steam Motors. Best Cash Prices Paid. Motor Specialties Co., Crafton, Penna.

Genuine "Radiotron" Tubes \$3.40 postpaid. Dept. SI-1, MacClaren, Onset, Mass.

Salesmen Wanted

Take orders for shoes direct from manufacturer to wearer. Experience unnecessary. Pull or part time. Mason Shoe Mfg. Co., 3rd Avenue, Chippewa Falls, Wis.

Stamps and Coins

California Gold, quarter size, 27c; half-dollar size, 53c. Columbian nickel and catalogue, 10c. Norman Shultz, Box 146, Colorado Spring, Colo.

Stamps 100 All Different 3 cents. S. I. Quaker Stamp Company, Toledo, O.

158 Genuine Foreign Stamps. Mexico War Issues. Venezuela, Salvador and India Service, Guatemala, China, etc., only 5c. Finest approval sheets 50 to 60%. Agents Wanted. Big 72-p. Lists Free. We buy stamps. Established 20 years. Hussman Stamp Co., Dept. 156, St. Louis, Mo.

You'll get profit and pleasure collecting old coins. Send 10c for genuine old coin and large coin catalog. This is just a get-acquainted offer. Send today. You'll be delighted with it. H. Max Mehl, Numismatist, Dept. N, Mehl Building, Fort Worth, Texas. Largest Coin Firm in U. S.

Typewriters

Typewriters, all standard makes, \$10 up. Fully guaranteed. Free trial. Write for complete illustrated lists. Northwestern Exchange, 121 N. Francisco Ave., Chicago.

Wanted

Detectives Earn Big Money. Work home or travel. Experience unnecessary. Write, George Wagner former Government Detective, 1968 Broadway, N. Y.

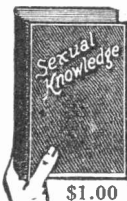

SEXUAL KNOWLEDGE
320 Pages ILLUSTRATED Cloth
By Winfield Scott Hall, M.D., Ph.D.

SEX FACTS MADE PLAIN
What every young man and
Every young woman should know
What every young husband and
Every young wife should know
What every parent should know

Postpaid. Mailed in plain wrapper. \$1.00
Table contents and commendations on request.
AMERICAN PUB. CO., 1145 Winston Bldg., Philadelphia

PIMPLES

CAN BE CURED. If you suffer from pimples, acne, blackheads, brown spots or eruptions I want to send you my simple home treatment under plain wrapper. It gave me a soft, velvety, smooth and radiant complexion, and cured thousands of men and women after everything else failed. Simply send name for generous 10 day free trial offer of my secret home treatment.
W. H. WARREN, 563 Gateway Sta., Kansas City, Mo.

Take Pictures



\$3000 to \$10000 A YEAR

We train you quickly right in your own home. Tremendous field in Modern Photography. Newspapers, magazines, advertisers, etc., need thousands of high-class photos. 35,000 splendid locations open now. My amazing new method equips you to earn \$50 to \$100 a week while learning. Shows you how to do the kind of work turned out in Chicago and New York studios. Also how to start big money business of your own.

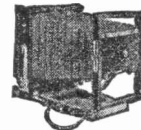

FREE Write at once for FREE camera offer. I give you high grade professional Camera free. Offer open only short time—act at once. I guarantee my training.
INTERNATIONAL STUDIOS, Inc.
1421 Michigan Ave. Dept. Chicago, U. S. A.

Dope and Drugs Bring Disaster

When you lack pep, when you feel despondent, when you seem to grow stale—don't depend upon dope and drugs to bring you back. That way lies disaster. The more dope you take the worse off you'll be. Nothing is so certain.



STRONGFORTISM

Rescues Men. Hopeless of ever being himself again, the man addicted to the use of artificial stimulants sinks into utter despair. But Strongfort brings such men a message of hope—lifts them from the lowest depths up into the sunshine of health. No drugs or dope to add to your misery, but scientific methods of restoring by which, in the privacy of your bedroom, you rebuild yourself and again become a new, full-powered man with a new outlook on life; another chance to walk upright, to look men in the face, to win social, business and financial success.

Get My Free Book. Mention the ailments on which you want special information and send it to me with a 10c piece to help pay postage, etc., on my free book—"Promotion and Conservation of Health, Strength and Mental Energy." It's a man-builder and a The Perfect Man life-saver. Send for it Right Now.

LIONEL STRONGFORT
Physical and Health Specialist over 25 years
Dept. 1691 Newark, New Jersey, U. S. A.

Agents Wanted



You can build a big money-making business of your own selling Anti-Mist. Sells to Auto owners, Garage and Auto Supply stores, Opticians, Dentists, Railroads and Street car Companies. Anti-Mist makes glass frost-proof, steam-proof, water-proof. Clear vision guarantee in all weather; money back guarantee if it fails. Every Demonstration Sells It. Aggressive, hustling agents can make \$50 to \$100 a week with this fast selling product, big commissions paid. Write today for full particulars. Retail at 35c for 3/4 oz. can, 8 oz. can for \$1.50.
ANTI-MIST CHEMICAL CO.
Dent. 5, 201 E. Ontario St. Chicago



Learn to Sell
Begin Today—Write for My FREE BOOK. I can make a good penman of you at home during spare time. Write for my FREE BOOK, "How To Become a Good Penman." It contains specimens and tells how others mastered penmanship by the Tamblin System. Your name will be elegantly written on a card if you enclose stamp to pay postage. Write today for book.
F.W. TAMBLIN, 424 Ridge Bldg., Kansas City, U.S.A.

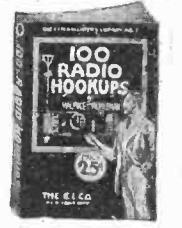
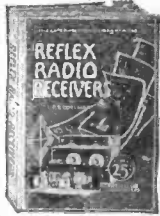

Consrad Covers Radio

With over 14 complete patterns on the standard radio circuits and more than 25 separate books on every phase of radio receiving and transmitting, Consrad covers every question that the amateur radio set builder might ask.

Each Consrad publication is extremely thorough, being written by a selection of radio's foremost engineers. The user of a Consrad book or pattern can always be sure he is correct and that the results of his work will be satisfactory.

Consrad Publications are sold on all newsstands and at all radio dealers. Buy the book or pattern you need today.

The Consrad Company,
233 Fulton Street,
New York City

Sole Distributors for
The E. I. Company



CONSRAD PATTERNS

- Radio Map of the U. S. on Cloth.
- How to Make the S. T. 100 Receiver.
- How to Make a Neutrodyne Receiver.
- How to Make a Reinartz Receiver.
- How to Make a Reflex Receiver.
- How to Make a Cockaday Receiver.
- How to Make a Short Wave Regenerative Receiver.
- How to Make a Radio-Phone Crystal Set.
- How to Make One or Two Stage Amplifiers.
- All About Aerials and Their Construction.
- 20 Radio Diagrams and Hook-ups.
- Radio Amateurs' Practical Design Data.
- How to Make the Ultradyne Receiver.
- How to Make a Five Tube Cockaday Receiver.
- How to Make a Portable Receiver.
- How to Make a Super-Heterodyne Receiver.
- How to Make a Low Loss Receiver.

50c Each

E. I. Co. BOOKS

- Tips for the Radio Amateur Constructor.
- How to Make a Radio-Phone Receiving Set.
- Radio Questions Answered.
- Radio Frequency Amplification.
- Loud Talkers and How to Build Them.
- How to Tune Your Radio Set.
- One Hundred Radio Hook-ups.
- All About Radio Parts. History and Operation of Vacuum Tubes.
- The Neutrodyne and All About It.
- How Radio is Received.
- How to Locate Trouble in Your Radio Set.
- Reflex Radio Receivers.

25c Each

OTHER BOOKS

- Radio News Amateur Handbook . . . \$1.00
- Radio For All . . . 2.00
- The How and Why of Radio Apparatus .75
- Wireless Course in 20 Lessons . . . 2.00
- Experimental Electricity Course in 20 Lessons . . . 1.25
- A Thousand and One Formulas . . . 1.50
- Radio Reading Course in 5 Volumes.. 1.25
- The Beginners' Radio Guide . . . ea. .10
- Building an Inexpensive Radio Crystal Set . . . ea. .10
- Radio Log Book . . .50
- Radio March35
- Radio Jazz35
- Listen In35

Consrad

RADIO'S FOREMOST PUBLISHERS—Everything in Books, Patterns and Diagrams

Let These Guides

Solve Your Problems



Electricity at your finger ends

HAWKINS ELECTRICAL GUIDES IN TEN VOLUMES

3500 PAGES
4700 PICTURES

\$1 A VOLUME
\$1 A MONTH

SEND NO MONEY—SEND ONLY THIS COUPON

Know the facts in Electricity. They mean more money and better position for you. Hawkins Guides tell you all you need to know about Electricity. Every important electrical subject covered so you can understand it. Easy to study and apply. A complete, practical working course, in 10 volumes. Books are pocket size; flexible covers. Order a set today to look over.

LEARN ALL ABOUT

Magnetism—Induction—Experiments—Dynamos—Electric Machinery—Motors—Armatures—Armature Windings—Installing of Dynamos—Electrical Instrument Testing—Practical Management of Dynamos and Motors—Distribution Systems—Wiring—Wiring Diagrams—Sign Flashers—Storage Batteries—Principles of Alternating Currents and Alternators—Alternating Current Motors—Transformers—Converters—Rectifiers—Alternating Current Systems—Circuit Breakers—Measuring Instruments—Switchboards—Wiring—Power Stations—Installing—Telephone—Telegraph—Wireless—Bells—Lighting—Railways. Also many Modern Practical Applications of Electricity and Ready Reference Index of the ten numbers.

SHIPPED FREE

Not a cent to pay until you see the books. No obligation to buy unless you are satisfied. Send Coupon now—today—and get this great help library and see if it is not worth \$100 to you—you pay \$1.00 a month for ten months or return it.

THEO. AUDEL & CO.,

72 Fifth Ave., New York City

Please submit me for free examination, HAWKINS ELECTRICAL GUIDE (Price \$1 a number). Ship at once prepaid, the 10 numbers. If satisfactory, I agree to send you \$1 within seven days and to further mail you \$1 each month until paid.

Name

Occupation

Employed by

Home Address

Reference

S. I. Jan.

How inventive ability is now being developed

Develop your inventive ability. A single idea, which solves one of the millions of the world's daily problems, can make you independent for life. Fifteen famous inventors now make every step in invention as simple as A B C. Spare time at home quickly develops your native instinct for inventions.

FOR a long time it was commonly believed that every invention was a matter of luck—the result of some happy inspiration that suddenly flashed through a man's brain, and which made him fabulously rich without the slightest effort or thought. But you can prove for yourself that this is not so. You can prove for yourself that invention is the result of thinking and acting along definitely exact, scientific lines.

Suppose, when you went home tonight, you found a window rattling. Through your mind would flash, almost instinctively, a regular order of thoughts which characterize the conception and completion of every invention the world has ever known. First, you would recognize a problem to be solved—the rattling of the window. Then you would think of several principles of science or mechanics which would solve your problem. You might think of the scientific fact that if you poured water on the frame the wood would swell and tighten the window. You might think of using a nail. But what you most probably would do, would be to use the oldest mechanical principle known to man, the wedge.

One Little Idea May Bring You a Fortune

With every new advance, with every new discovery that the world experiences more problems are coming up—and more inventions are needed to solve these problems. Now, as never before are new inventions wanted, and the world will pay a fortune to the man or woman who gives it just one of the inventions it needs now. Little ideas have won fortunes for their originators. Eberhard, who invented the rubber on the end of a pencil, has been paid hundreds of thousands of dollars for his simple idea. The man who invented the metal tip for shoelaces, the man who conceived the idea of the "humped" hairpin, the man who developed the metal tape measure; all have achieved enormous wealth from their "little" ideas.

Can You Solve this Problem?

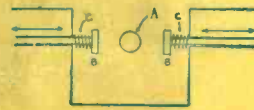

"A" is the end of a shaft. The two members "B B" are free to move in either direction indicated by the arrows. If they are pushed back, the springs "C C" will immediately pull them forward again. Our problem is to put some kind of an attachment on the revolving shaft "A" so that the members "B B" will be pushed back both at the same instant every time the shaft "A" makes a single revolution. The device on shaft "A" must also allow the two members "B B" to come forward once in every revolution. What would you suggest putting on the shaft "A"?

Edison Says: "Invention Should Be Taught as a Science!"

Although the fact has been universally recognized, that invention is governed by a few simple, easily acquired, fundamental principles, no one ever before thought of putting these principles in black and white so that everybody interested in invention could know them. But now it has been done. Fifteen famous inventors have at last given to the world the laws and principles of Inventive Science. They have shown every ambitious man and woman how to invent. They are teaching Invention, exactly as other people are teaching law, medicine, bookkeeping. Instead of spending years groping blindly, instead of wasting your time in useless, heartbreaking drudgery, you learn how to complete your ideas quickly; you learn how to think so you are sure to succeed. In simple, easy-to-understand language you are told how successful inventors work; you learn how to think along inventive lines, you learn the short-cuts to successful invention; you learn how to use the secrets of invention that convert a simple little idea into money.

But you learn more than just how to invent in this fascinating course. Thousands of inventors have lost the profits of their invention simply because they didn't know how to patent and sell their ideas. This complete course shows you just how to apply for a patent, how to protect your rights when your patent is granted, and how to dispose of your invention so you will get the greatest returns possible.

Not one step in invention has been omitted. Everything you want to know about invention—developing your ideas, securing information you need, how to apply for patents, how to protect your rights, how to sell your invention—are taken up, step by step, so that when you have completed the course you have a wealth of information worth thousands upon thousands of dollars.



RAYMOND F. YATES

FREE—New Book on Inventive Science

A wonderful new book has just come from the press that tells you all about the Science of Invention. It tells you how to avoid the pitfalls that have brought failure to thousands of would-be inventors. It tells you how to learn the secrets of practical invention, which famous inventors discovered only after years of heart-breaking effort, and discouraging mistakes, and it tells you how to do this in only fifteen minutes of your spare time each day. This fascinating book will be sent to all those who are genuinely interested. Get the advice of these fifteen famous inventors. Let them tell you how you can easily learn the secrets of successful invention. Send for this Book today, as only a limited number are available for free distribution. Send the coupon NOW, or a letter or postal card will do. There is no cost or obligation. This bureau is not connected in any way with patent attorneys or manufacturers. Our only work is to help ambitious men and women to develop their inventive ability—to become successful inventors.

BUREAU OF INVENTIVE SCIENCE
Dept. 71, Wisner Bldg., ROCHESTER, N. Y.

BUREAU OF INVENTIVE SCIENCE

Dept. 71, Wisner Building, Rochester, N. Y.

Please send me your free book, "The Science of Invention."

Name

Address

City State