

October

THE NEW

25 Cents

# Science and Invention

IN PICTURES

\$12,000

IN PRIZES

FOR PICTURES

SEE PAGE 534



ELECTRIC FLAMING LOGS

See Page 546



# ELECTRICITY

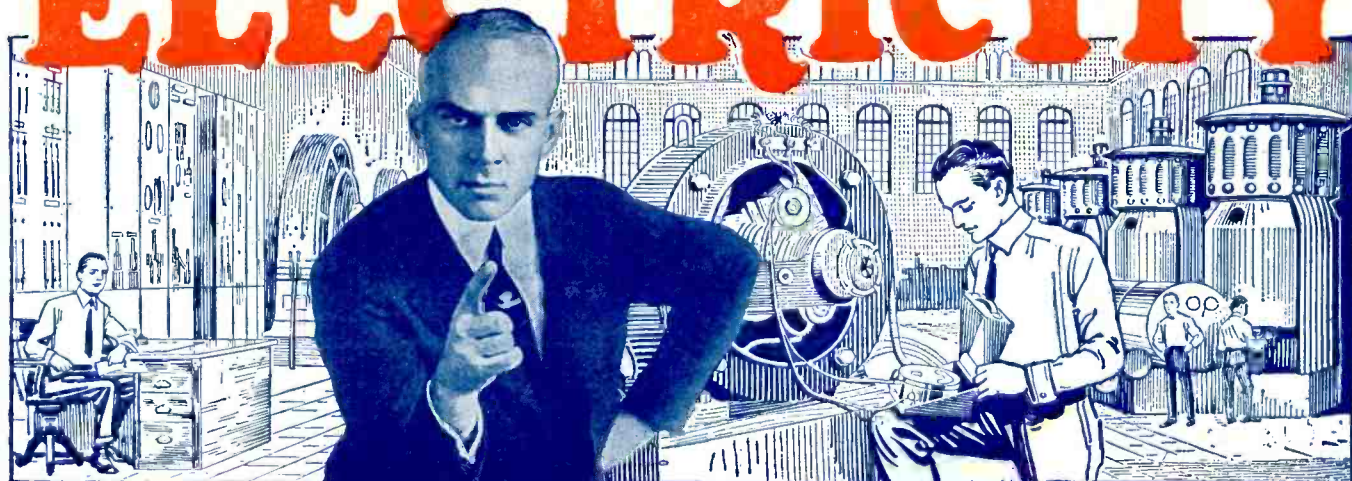

## Let Me Show You How to Make It Bring You \$9000 a Year

You men who are slaving away in small-pay jobs, hoping and striving for better things, I wish you could be with me here for just a few moments. I would show you how thousands of men just like yourself have quickly stepped into high-salaried positions and brilliant success in this fascinating field of electricity. In each and every case, their first step toward this cherished goal was to write

to me for the same *free proof* I want to send to you. They followed my advice and today are leading happy, prosperous lives—many drive their own cars, own their own homes and have plenty of money to spend for the other good things in life! They are Electrical Experts—"Cooke Trained"—earning \$3500 to \$10,000 a year!

### Be an Electrical Expert Learn at Home

Get into this great field of Electricity! Know this magic force, the ways and means it is harnessed for use in industry, and a thousand jobs will be opened to you at salaries far beyond your fondest dreams. Read Pence's story at the left! Let it be your guide post to success! Hundreds of other Cooke-Trained men have done as well, and many better! And how? Simply by taking this specialized training that quickly fits any man, no matter what his age or previous education, to take his place with the big-pay men of the country. You needn't give up your present job or go away to school, by this amazing method you may learn right at home in your spare time.

### \$3500 to \$10,000 a Year

Twenty years of actual work all over the world in the electrical field gave me a grasp of just what a man must learn to fill an important position. My experience taught me that a man must know first the principles involved and then the *best methods* to apply and regulate those principles. Why make a man wade thru a lot of useless study, wasting months of precious time? And so, at enormous expense and years of effort, I evolved a system of training that is stripped of every useless step. I will make the student a practical worker! I will place in his head and hands the means to make big money as a skilled Electrical Expert! I will fit him in a *short time* to earn a princely salary, \$3500 to \$10,000 a year for his skill!

### Thousands of Happy Men Say "There Is No Other Training Like This"

"You have given me a most wonderful training, a training no other school can, I feel sure, approach, much less duplicate," says F. E. Radcliffe, one of my boys who is making good in Ohio. I wish you could see the thousands of letters I get like this! John Burke of Baltimore made \$750 in spare time before he finished his training! Think what this means to you! No frittering away time serving a costly apprenticeship! Every step in this fascinating training adds earning power. You quickly become a practical man, ready to fill a big-pay job.

Many of my boys set up in the Electrical Contracting business, wiring houses, repairing motors, generators, electrical appliances, installing farm lighting systems, etc. Others set up shops and spaces in garages for repairing electrical systems on

automobiles, trucks, motorcycles etc. They are fitted at once to start in business for themselves, with practically no investment. And with the big plants, even the ordinary electrician makes good money. But the Trained Expert is the man who is *Boss*—he is the big-pay man. With this training behind you, you can claim such an enviable place for yourself.

### You Cannot Lose—I Guarantee Your Complete Satisfaction

You don't have to take my word for one thing. So sure am I that after taking this training you can step right into a high-salaried position, and you will thrill with the newly found power that is yours, that I guarantee under bond to return every cent of tuition you pay me, if you are not absolutely satisfied that it is the best investment you ever made. Electricity needs you—it offers you boundless opportunity for a brilliant career. I have tried to remove every stumbling block toward accomplishing your ambition. I will help you win, if you will let me!

### FREE—If You Act Now—FREE Big Electrical Outfit

I know that it is only by practice with actual instruments and materials that a man can become a *practical electrical expert*. For that reason I give you without charge or stipulation a Complete Outfit of Electrical Tools, Materials, and Measuring Instruments. I also furnish you with supplies, examination paper and many other things that other schools don't furnish. You actually start early in the course to work at your profession, rapidly becoming proficient, ready to do any electrical job.

### EXTRA—A Course in RADIO Given FREE for a Short Time

The up-to-date Electrical Expert must know radio or wireless work, how to make and repair the various equipment. This is a mighty profitable field today, and many men are making big money in it. Because I want to make this my banner year, I am now giving this \$45.00 Course in Radio *absolutely Free* to new students. Don't miss this remarkable offer which might be withdrawn at any time.

Make up your mind now to get into this great profession quick. Every day lost keeps you away that much longer from prosperity and happiness! Mail the coupon today for my big free book, "How to Become an Electrical Expert." And other free proof that I can put you into the class with Pence and thousands of other Cooke-Trained men who are making princely incomes!

L. L. Cooke, Chief Engineer,  
Chicago Engineering Works,  
Dept. 27, 2150 Lawrence Ave., Chicago, Ill.



### \$9000 A Year

The picture above shows Mr. W. E. Pence of Chehalis, Washington, in his working togs. Pence is a "Cooke-Trained" man, and his letter below shows what he thinks of my course.

Dear Mr. Cooke:

Thought you would be interested in a hand-bill I have just gotten out regarding my new shop. Business is going strong, paying me now some thing over \$750 a month above my expenses.

And I must thank you again for my success, because it was your wonderful Course and method of instruction that put me where I am.

Your true friend,  
W. E. PENCE.

### YOUR PASSPORT TO SUCCESS

L. L. Cooke, Chief Engineer, Chicago Engineering Works, Dept. 27, 2150 Lawrence Ave., Chicago, Ill.

Send me at once "How to Become an Electrical Expert" with other proof that I can become a big-pay Electrical Expert through your Training. Register me for your Special Free Offers. You send this FREE without any obligation on my part.

Name .....  
Address .....  
City ..... State .....

MAIL  
COUPON  
TO-DAY

**The "Cooke" Trained Man is the "Big Pay" Man**



# If New Hair Doesn't Grow After Using My Method — I Don't Want a Penny!

I mean just exactly what I say! I don't care how thin your hair may be—I don't care how many treatments you have taken without results. If my new discovery won't restore your hair, I don't want to keep a cent of your money! Furthermore I'll send you the proof of what I have done for others entirely FREE! Just mail the coupon below.

By ALOIS MERKE

Founder of Famous Merke Institute, Fifth Ave., New York

**A**FTER 17 years' experience in treating baldness—which included long years of experimentation in Heidelberg, Paris, Berlin, Geneva, Cairo and other centers of scientific research—I have discovered a startling new way to promote hair growth.

At the Merke Institute, Fifth Avenue, New York—which I founded—I have treated scores of prominent stage and social celebrities. People are coming to me from all parts of the country to gain the benefits of my discovery. Many pay as high as \$500 for the results I have brought them.

Yet now, through a series of ingenious inventions, I have made it possible for every one to avail themselves of my discovery—right in their own homes, and at a cost of only a few cents a day!

### My Unusual Guarantee!

I know you are skeptical. I know that you have tried perhaps dozens of different remedies and treatments without results. I know that you have wasted time and money on treatments which by their very nature could NEVER restore your hair. All right. Perhaps my treatment cannot help you, either. I don't know. But I do know that it has banished falling hair and dandruff for hundreds of others—often with the first few treatments. I do know that it has already given thick, luxuriant hair to people who long ago had despaired of regaining their hair. And I am so downright positive that it will do the same for you that I am entirely willing to let you try it at my risk—and if it fails to restore your hair, then I'll instantly—and gladly—mail you a check, refunding every cent you have paid me. In other words, I absolutely GUARANTEE to grow new hair on your head—and if I fail, then the test is free.

### Entirely New Method

What is my method? It is entirely new. It is entirely different from anything you ever heard of. No massaging—no singeing—no "mange" cures—no unnecessary fuss or bother of any kind. Yet results are usually noticeable even after the very first few treatments.

Many people have the idea that when the hair falls out and no new hair appears, that the hair roots are always dead.

I have disproved this. For I have found in many cases which have come under my observation that the hair roots were NOT dead, but merely dormant! Through undernourishment, dandruff and other causes, these starving, shrunken roots had literally gone into a state of "suspended animation." Yet even if the scalp is completely bare, it is now possible in the majority of cases to awaken these dormant roots, and stimulate an entirely new growth of healthy hair! I KNOW this to be true—because I do it every day.

Ordinary measures failed to grow hair because they did not



penetrate to these dormant roots. To make a tree grow, you would not think of rubbing "growing fluid" on the bark. Instead, you would get right to the roots. And so it is with the hair.

In all the world there is only one method I know about of penetrating direct to the roots and getting nourishment to them. And this method is embodied in the treatment that I now offer you on my positive guarantee of satisfactory results, or the trial costs you nothing. The treatment can be used in any home in which there is electricity.

Already hundreds of men and women who only recently were bald or troubled with thin falling hair, have through this method, acquired hair so thick that it is the envy and admiration of their friends. As for dandruff and similar scalp disorders, these usually disappear after the first few applications.

Remember—I do not ask you to risk "one penny" in trying this treatment. I am perfectly will-

ing to let you try it on my absolute GUARANTEE—and if after 30 days you are not more than delighted with the growth of hair produced, then I'll gladly return every cent you have paid me. I don't want your money unless I grow hair on your head.

### Free Booklet Explains Treatment

If you will merely fill in and mail the coupon below I will gladly send you—without cost or obligation—an interesting 32-page booklet, describing my treatment in detail.

This booklet contains much helpful information on the care of the hair—and in addition shows by actual photographs what my treatment is doing for others.

No matter how bald you are—no matter if you are completely bald, this booklet will prove of deepest interest to you. So mail the coupon now—and it will be sent you by return mail.

**ALLIED MERKE INSTITUTES, Inc.,**  
512 Fifth Avenue., New York City, Dept. 4610

### Actual Results

(Dozens of letters like the following are received every day by the Merke Institute.)

"In the short time I have used your treatment I have gained remarkable results. Dandruff has disappeared entirely. My scalp is now all full of fine new hair. Would not part with my treatment for 10 times its cost." A. W. B.

"The top of my head is now almost covered with new hair about one-half inch long. I have been trying five years, but could never find anything to make my hair grow until your treatment." T. C.

"Ten years ago my hair started falling. I used hair tonics constantly, but four years ago I displayed a perfect full moon. I tried everything—but without results. Today, however, thanks to your treatment, I am pleased to inform you that I have quite a new crop of hair one inch long. My friends are astonished at the result." P. H. B.

ALLIED MERKE INSTITUTES, Inc., Dept. 4610,  
512 Fifth Avenue, New York

Please send me, without cost or obligation on my part, a copy of the new booklet describing in detail the Merke Institute Home Treatment.

Name .....

Address .....

City ..... State .....



# Science and Invention

FORMERLY

## ELECTRICAL EXPERIMENTER

PUBLICATION OFFICE: 542 Jamaica Ave., Jamaica, N. Y.  
EDITORIAL & GENERAL OFFICES: 53 Park Place, New York City  
Published by Experimenter Publishing Company, Inc. (H. Gernsback, Pres.; S. Gernsback, Treas.; R. W. DeMott, Sec'y).  
Publishers of SCIENCE AND INVENTION, RADIO NEWS, and PRACTICAL ELECTRICS

### Table of Contents for October

#### POPULAR SCIENTIFIC ARTICLES

EDITORIAL	527
A WHIRL OF MERRIMENT	528
TRICK MOVIE SETS FOOL US	529
MOVIES EXPOSE FAKE SPIRITUALISTS	530
A MODERN CHARLATAN—The Unscientific Work of Dr. Albert Abrams	532
SOUND OF PLANE ATTRACTS AERIAL TORPEDO	533
By Raymond F. Yates	
\$12,000 OR MORE IN PRIZES FOR PICTURES	534
LARGEST FALLS IN THE WORLD	535
By Fred W. Horton	
HOW TO AVOID AUTO ACCIDENTS	536
By H. Winfield Secor, E.E.	
OUR CITIES OF THE FUTURE	537
By H. Gernsback, Member of the American Physical Society	
DR. HACKENSAW'S SECRETS—No. 21—Dr. Hackensaw's Trip to the Moon	538
By Clement Fezandie	
AROUND THE UNIVERSE—Fourth Installment	540
By Ray Cummings	
SKY-SCRAPER TO TOWER 80 STORIES	542
SMOKE TO HIDE BOMBING PLANES	543
MT. ETNA DESTROYER OF CITIES	544
JOHN DOE—HIS FINGERPRINT	545
By Fairfax Proudhit Walkup	
WILL YOU BE OUR REPORTER?	545
A FLAMING LOG SIGN	546
MAGNET HOLDS AUTO WHILE GLOBE SPINS	546
WEIRD SHENANDOAH CAVERNS	547
ODDITIES OF OUR BODY	548
PAPER "FILM" MOVIES A SUCCESS	549
By Eric A. Dime	
THE POWER OF SAP	549
ELECTRICITY FROM THE SUN	550
By Dr. H. Becher	
NEW SUSPENDED ELECTRIC RAILWAY	550
MAKING SHOT	552
By Robert H. Moulton	
COMBINATION AUTO AND BOAT	553
By Joseph H. Kraus	
TWO VALUABLE MOTOR HINTS	554
IF A "FORD" USED ALL ACCESSORIES!	554
By A. P. Peck	
MAGIC FOR EVERYBODY	555
By Prof. Joseph Dunninger	
POPULAR ASTRONOMY—STAR MAP FOR OCTOBER AND THE COMPARATIVE DENSITY OF THE VARIOUS STARS AND PLANETS	556
By Isabel M. Lewis, M.A., of the U. S. Naval Observatory	
HOME MECHANICS	558
By William M. Butterfield	
EVERYDAY CHEMISTRY	560
By Raymond B. Wailes	

#### PRIZE CONTESTS

\$12,000 OR MORE IN PRIZES FOR PICTURES	534
TOY CONTEST—\$100.00 IN PRIZES	551
OPTICAL ILLUSION CONTEST "AWARDS"	559
HOW-TO-MAKE-IT DEPARTMENT—\$30.00 IN MONTHLY PRIZES	564
WRINKLES, RECIPES AND FORMULAS—\$5.00 MONTHLY PRIZE	565
\$200.00 SINGLE TUBE RADIO CONTEST, EXTENDED TO NOVEMBER 15th	574
SCIENTIFIC HUMOR—PRIZES FOR BEST JOKES	578

#### AUTOMOBILES

HOW TO AVOID AUTO ACCIDENTS	536
By H. Winfield Secor, E.E.	
COMBINATION AUTO AND BOAT	553
By Joseph H. Kraus	
AUTO SAFETY LIGHT	553
TWO VALUABLE MOTOR HINTS	554
IF A "FORD" USED ALL ACCESSORIES!	554
By A. P. Peck	

#### ELECTRICITY

A WHIRL OF MERRIMENT	528
A MODERN CHARLATAN	532
SOUND OF PLANE ATTRACTS AERIAL TORPEDO	533
By Raymond F. Yates	
A FLAMING LOG SIGN	546
MAGNET HOLDS AUTO WHILE GLOBE SPINS	546
ELECTRICITY FROM THE SUN	550
By Dr. H. Becher	
NEW SUSPENDED ELECTRIC RAILWAY	550
THE ORACLE	579
PATENT ADVICE	601

#### RADIO ARTICLES

RADIO TO AID IN MINE RESCUE	566
By W. B. Arvin	
BALLOONS TO SUPPORT ANTENNAE	567
RADIO-DIRECTED TORPEDO OF TOMORROW	568
By Graser Schornstheimer	
BROADCAST STATION PHOTOS	569
RECEIVING THE NEW WAVE LENGTHS	570
By Marius Logan	
RADIO FOR THE BEGINNER—RHEOSTATS	572
By Armstrong Perry	
FOUR GOOD SINGLE TUBE HOOK-UPS	573
By Marius Logan	
\$200.00 SINGLE TUBE RADIO CONTEST, EXTENDED TO NOVEMBER 15th	574
A SPECIAL "REFLEX" AMPLIFIER	575
By R. B. Hall	
RADIO ORACLE	576
LATEST PATENTS	577
REVISED BROADCAST CALLS TO DATE	586

#### CONSTRUCTOR ARTICLES

DECORATIVE EFFECTS FROM OIL	561
By Dr. Ernest Bade	
MISCELLANEOUS CONSTRUCTOR ARTICLES	562
HOW TO MAKE MICRO-PHOTOGRAPHS	563

#### CHEMISTRY ARTICLES

EVERYDAY CHEMISTRY	560
By Raymond B. Wailes	
DECORATIVE EFFECTS FROM OIL	561
By Dr. Ernest Bade	
WRINKLES, RECIPES AND FORMULAS—\$5.00 MONTHLY PRIZE	565

#### ASTRONOMY ARTICLES

POPULAR ASTRONOMY—STAR MAP FOR OCTOBER AND COMPARATIVE DENSITY OF THE VARIOUS STARS AND PLANETS	556
By Isabel M. Lewis, M.A.	

SCIENCE AND INVENTION is published on the 25th of each month. There are 12 numbers per year. Subscription price is \$2.50 a year in U. S. and possessions. Canada and foreign countries \$3.00 a year. U. S. coin as well as U. S. Stamps accepted (no foreign coin or stamps). Single copies, 25 cents each. A sample copy will be sent gratis on request. Checks and money orders should be drawn to order of EXPERIMENTER PUBLISHING CO., Inc. If you change your address notify us promptly, in order that copies are not misdirected or lost.

All communications and contributions to this journal should be addressed to Editor, SCIENCE AND INVENTION, 542 Jamaica Avenue, Jamaica, New York, or 53 Park Place, New York City, N. Y. Unaccepted contributions

cannot be returned unless full postage has been included. ALL accepted contributions are paid for on publication. A special rate is paid for novel experiments; good photographs accompanying them are highly desirable.

SCIENCE AND INVENTION: Monthly. Entered as second-class matter at Jamaica, N. Y., Post Office, under act of Congress of March 3, 1879. Title Registered at the Patent Office. Copyright, 1923, by E. P. Co., Inc., New York. The Contents of this Magazine are copyrighted and must not be reproduced without giving full credit to the publication.

SCIENCE AND INVENTION is for sale at all newsstands in the United States and Canada; also at Brentano's, 37 Avenue de l'Opera, Paris. Member of the Audit Bureau of Circulation.

New York City.  
General Advertising Dept.,  
53 Park Place.

Western Advertising Representatives,  
Fineman & McClure,  
720 Cass St., Chicago, Ill.

Pacific Coast Advertising Representatives,  
A. J. Norris Hill Co.,  
Hearst Bldg., San Francisco, Calif.

Kansas City Advertising Representative,  
George F. Dillon,  
Republic Building, Kansas City, Mo.



# Great Inventors now teach you secrets of practical invention

How would you like to be the inventor of the tin cap that now corks millions of bottles—and who gets a royalty on every one? How much money would you have now if you had invented the simple idea of putting a rubber tip on pencils? The inventor of the Gillette Safety Razor is said to have made as high as \$2,500,000 a year! The inventor of the tiny snap fastener last year paid an income tax of \$29,000. The man who invented the Autographic Kodak sold his patent rights for \$300,000!

**J**UST one single idea can make you independently wealthy in a short time. Little things—like the crimped hairpin, the paper safety-match, the metal-tip shoelace—brought their inventors hundreds of thousands of dollars. Only recently "Success Magazine" told how one woman built up a splendid business from an invention based on a little wedge-shaped piece of wood!

Couldn't you develop an invention as simple as these? Haven't you some ideas—even now—for one of these little inventions which can pay you so much money? Just one little idea can bring you fame and fortune. The world is waiting for new inventions and it will pay handsomely for even the simplest idea.

## What Invention Is

After all, invention is nothing more than the science of "fixing things." And how many times a day you do "fix things". A leaky faucet, a rattling window, a broken strap—you fix hundreds of things just like these almost every day. You may not know it, but when you "fix things" you are actually using the laws and principles upon which every invention is made.

Prove it. Here is shown a very simple problem in invention. See how easily and quickly you can solve it. What would you put on shaft "A" to force members "B B" to move back? Think of something you know now which can give you the answer. If you have an ordinary electric light switch you will find it in a few minutes.

This proves that invention is not guesswork or blind luck—that it is not a God-given faculty possessed by a few favored mortals. The truth is that invention is based upon exact laws which anybody can learn. It is merely a matter of first seeing a problem to be fixed and then of thinking of something which solves the problem. That's all. The problem shown here proves that when you think inventively, invention becomes as easy to learn as reading or writing.

## Why More Inventions are Needed Now

Hundreds of years ago, the world didn't need many new things. That is why few inventions were made. But now the world has more needs, more things to be "fixed." And that is why, in the United States alone, over 50,000 inventions are patented every year!

The world wants better and cheaper light and power. It wants an electric light that will be heatless. It wants new motors that will weigh less and produce more power. It wants faster and less costly aeroplanes, motor cars, steam engines. It wants new inventions which will make cooking and housework easier. It wants new inventions that will save time and labor in the home, the



Raymond F. Yates, who with fourteen other famous inventors, now makes it easy for you to learn how to invent in your spare time at home.

farm, the factory and the office. It wants new ideas for toys and other amusements. It wants its present inventions to be developed so that they will work better and more economically.

Surely you have at least one idea which can be harnessed to a natural law for the solution of some problem. It can be a new kind of mechanical toy or some device which will make your wife's housework easier. It can even be something as simple as the common nutcracker. The man who invented the Kiddie-Kar, it is reported, made over \$5,000,000!

But whatever your invention may be, if it fills a real need the world will pay you well for it. Every day you see things which can be improved or "fixed". Every day you can get ideas for new inventions. You have the ability to invent—NOW! All you need is the training to develop your ideas methodically, to think inventively.

## What Edison Says

Could you ask the advice of any greater authority than Thomas A. Edison? Listen to what he says: "INVENTION IS A SCIENCE AND SHOULD BE TAUGHT AS A PROFESSION."

And now, for the first time, you can profit by Edison's advice. You can actually learn invention as a profession—exactly as other people are learning electricity, automobile mechanics, law, medicine, as a profession. Never before were the easy-to-learn principles of Inventive Science written down so everybody could read them, and learn to use them. But now the Bureau of Inventive Science offers you the first course in practical invention ever devised.

## Learn Invention by Actual Practice at Home

Hitherto every inventor had to work out the principles of invention for himself. But at what a terrific price in long years of discouragement, lost time, wasted money! Now you can quickly learn the secrets of invention which brought wealth and fame to Edison, Marconi and other great inventors, in your spare time at home.

Fifteen famous inventors tell you WHAT

TO INVENT and HOW TO INVENT. They tell you the secrets of invention which every successful inventor must know. They explain how to originate ideas, how to develop and perfect them, how to patent your inventions. But this course tells you more than how to invent. Thousands of inexperienced inventors have been defrauded out of their rewards because they did not know how to protect their patent rights, or how to sell their inventions. This great course tells you everything you want to know—how to sell your invention, how to get royalties, how to organize a company, how to get the most money for your ideas.

## As Fascinating as a Game

The most fascinating part of this great new course is that it teaches you by actual practice, right in your own home. With each lesson you are sent some problem in invention—just like the one you worked out here.

This fascinating exercise in solving actual problems sharpens your instinct to fix things. Better than anything else, it gives you an unforgettable, instinctive habit of thinking inventively which is worth more than you realize. In fact, the lessons and exercises are so simple, so easy to understand, so interesting, that they seem more like a pleasant game than like instruction which can make you a successful inventor.

## Everything Explained in New FREE Book

A wonderful new book, just printed, tells you more about the Bureau of Inventive Science and its simple new course in invention. It explains in detail just how this course develops your ability to invent. It tells you how great inventors work, how little ideas have made fortunes, how you, too, can learn the secrets of invention, in your spare time at home.

Send today for this fascinating book and find out how to develop your ideas, how to get a patent, how to protect your invention, the best way to sell your invention, how to convert a simple little idea into big money. It costs you nothing, so if you are genuinely interested send the coupon at once. This Bureau is not connected with patent attorneys or manufacturers. Its only purpose is to teach you the secrets of successful invention. Write for the FREE BOOK now.

BUREAU OF INVENTIVE SCIENCE  
Dept. 710, Wisner Building, Rochester, New York

Bureau of Inventive Science  
Dept. 710, Wisner Building, Rochester, N. Y.

Please send me your free book, "The Science of Invention."

Name ..... Age .....

Address .....

City ..... State .....

## This test shows how easily you can develop your ability to invent

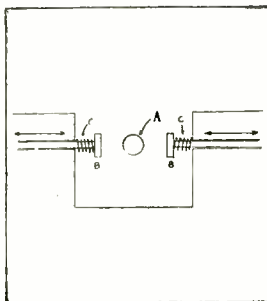

Here is an interesting little problem and its solution will be found very simple, if we really think hard.

"A" is the end of a shaft. The two members "B B" are free to move in either direction indicated by the arrows. If they are pushed back, the springs "C C" will immediately pull them forward again. Our problem is to put some kind of an attachment on the revolving shaft "A" so that the members "B B" will be pushed back both at the same instant every time the shaft "A" makes a single revolution. The device on shaft "A" must also allow the two members "B B" to come forward once in every revolution. What would you suggest putting on the shaft "A"?



# BUILD YOUR SET BETTER -- AT LOWER COST

BUILD YOUR SET WITH BARAWIK STANDARD RADIO GOODS

**EXCEL 180° VARIOCOUPLER**  
**B522** Each .....\$1.75  
 Properly designed and well made. Green silk windings over natural uncolored genuine bakelite tubes. Primary has tabs every 7 turns and last 4 turns tapped every turn. Cast aluminum support with panel mounting screw. 1/4 inch shaft. Produces best results in any type circuit for 175 to 225 meters.



**SUPER 180° VARIOCOUPLER**  
**B521** Each .....\$.96  
 A wonderful value, produces excellent results. Green silk windings on black fibre tubes. Rigid mounting support for table or panel mounting. Primary tapped for fine tuning circuit 200 to 600 meters.  
**B522** Variometer—same style. Each.....\$.96c



**SUPERIOR VARIOCOUPLER**  
**B523** Each .....\$3.15  
 A handsome instrument of superior design and construction. Stator tube and rotor ball of moulded red brown bakelite. Large size green silk windings insure highest efficiency. Table or panel mounting. 1/2 inch shaft. Superior results in circuits for 180 to 650 meters. Tapped primary for finest tuning. Noiseless contacts.



**SUPER MOULDED VARIOMETER**  
**B412** Each .....\$2.60  
 Polished black moulded rotor and stator forms. Maximum inductances with greatest efficiency and minimum distributed capacity. A high grade durable instrument that will make up into a set that will get the best results. Wave length 180 to 600 meters.



**EXCEL MOULDED VARIOMETER**  
**B524** Each .....\$3.68  
 A wonderful value at our price. Properly designed and constructed. Polished black bakelite rotor and stator forms. Large size. Green silk wire insures greatest efficiency. 1/2 inch shaft. Noiseless pigtail connection. Table or panel mounting.



**SUPERIOR VARIOMETER**  
**B525** Each .....\$4.45  
 Forms moulded of red brown bakelite. A neat handsome instrument. Green silk windings calculated for highest efficiency. 1/2 inch shaft. Noiseless pigtail connections. Table or panel mounting. Produces superior results in any type circuit 180 to 650 meters.



**RADIO INDUCTANCE COILS**  
 Carefully made—fine looking coils. Highest efficiency. Low distributed capacity effect, low resistance—high self inductance. Very firm impregnation. Range given in meters when varied with .001 variable condenser. Mounted coils have standard plug mountings.

Turns	Range	Art No.	Not Mtd.	Art No.	Price
25	120-250	B301	\$0.39	B320	\$0.85
35	175-450	B302	.42	B322	.95
50	240-720	B303	.49	B323	1.02
75	390-910	B304	.54	B324	1.08
100	500-1450	B305	.58	B325	1.13
150	600-2000	B306	.63	B326	1.17
200	900-2500	B307	.72	B327	1.26
250	1200-3500	B308	.78	B328	1.35
300	1500-4500	B309	.82	B329	1.36
400	2000-6000	B310	.97	B330	1.57
500	2800-8100	B311	1.12	B331	1.63
600	4000-10000	B312	1.27	B332	1.78
750	5000-12000	B313	1.43	B333	1.93
1000	7000-15000	B314	1.70	B334	2.25
1250	9750-18500	B315	1.92	B335	2.45
1500	14500-26500	B316	2.18	B336	2.60

**INDUCTANCE COIL MOUNTINGS**  
**B340**—3 Coil. Ea. \$3.40  
**B341**—2 Coil. Ea. 2.75  
 Sturdy, rigid durable construction. Made of polished black bakelite.



**COIL MOUNTING PLUGS**  
 Made of moulded bakelite.  
**B344** Plug for mounting "honey-comb" inductance coils .....48c  
**B345** Stationary plug to fasten mounted coil stationary to panel 89c  
**B346** Movable plug to fasten mounted coil to panel so it can be rotated \$1.10



**HIGH-GRADE LIGHTNING ARRESTER**  
**B981** Each .....75c  
 A dependable protector, all ways on guard. Small and compact. Weatherproof porcelain case. Easily fastened and connected.



**OUR SPECIAL VARIOMETER AND VARIOCOUPLER**



Build into your set reliable instruments. You can depend on this variometer and variocoupler to give you the best results in any circuit working from 180 to 650 meters. In design and construction they are the best. Only the highest grade materials are used. The prices quoted save you 30 to 40 percent. Why pay more?

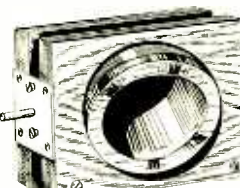

**MAGNET WIRE**  
 Insulated copper wire. Best quality even drawn wire, one piece to a spool. Prices quoted are for 8 oz. spools unless otherwise stated.

Double Cotton Covered		Enameled Insulation		Double Green Silk Covered	
Number	B990	Number	B992	Number	B991
Gauge	Price	Gauge	Price	Gauge	Price
18	.....43c	20	.....39c	20	.....\$0.75
20	.....55c	22	.....50c	22	......85
22	.....70c	24	.....55c	24	.....1.10
24	.....80c	26	.....60c	26	.....1.38
26	.....90c	30	.....65c	30	.....1.25
28	.....1.05	32	.....70c	32 (4 oz.)	1.65
30	.....1.45	36	.....90c	36 (4 oz.)	2.20

**SOLID BARE COPPER WIRE**  
 Solid bare copper wire for aeriads, leads or wiring instruments.  
**B240**—100 ft. coil 40c **B242**—500 ft. coil \$1.95  
**B244**—100 ft. coil 67c **B245**—500 ft. coil \$3.05

**BRASS ROD**  
 Supplied only in 8 inch lengths.  
**B961** Threaded 6-32, per 8 inch length... 6c  
**B963** Threaded 8-32, per 8 inch length... 8c  
**B965** Solid 3-16 inch, per 8 inch length... 6c  
**B967** Solid 1/4 inch, per 8 inch length... 9c

**SPAGHETTI**  
 For covering connecting wires in sets. For size 12 and 14 wires.  
**B955** Finest quality braided and saturated with best baked lustrous transparent insulating varnish, 3 feet for .....19c  
**B956** Best quality braid and covered with black insulating compound, 3 feet for..... 9c

**TINNED COPPER "BUS BAR" WIRE**  
 Size 14 tinned copper wire. For wiring sets. Best size for neat job and easy soldering.  
**B969** Round. Ten feet for.....12c  
**B970** Square. Ten feet for.....14c

**RADIO SOLDERING IRON**  
**B540** Each .....\$1.50  
 Soldered connections in radio sets produce better results. This guaranteed iron is exactly right for radio work. A neat solid connection quickly and easily made. Operates on any lighting current 100 to 120 volts. 6 ft. cord with attaching plug. Length 13 inches. Heats quickly will not overheat.



**TINOL**  
**B969** Per tube .....19c  
 A combined solder and flux in handy form. Put a little on the connection heat with a match, torch or solder iron and you have a neat electrically and mechanically perfect joint.  
**B541** Medium size .....\$3.48  
**B542** Larger size .....4.25

**AUTOMATIC BLOW TORCH**  
**B543** Each .....\$1.19  
 Burns denatured alcohol. Automatically generates pointed flame in a few seconds. Easy to solder joints in hard places. Lights with a match. Burns 20 minutes on one filling. 5 1/2 inches high, 7/8 inch cylinders. Works fine with Tinol listed above.



**SUPER BLOW TORCH**  
**B544** Each .....39c  
 Burns denatured alcohol. Vest pocket size. Blowing on tube produces a hot pointed flame. Lights with a match. Works fast. Burns 10 minutes on one filling. Easy to solder joints in hard places. 3 inches high. 7/8 inch cylinder. Long rubber tube. Produces fine joints with Tinol listed above.



**ANTENNA INSULATORS**  
**B260** Size 1x3/4. Two for .....17c  
**B234** Size 1 1/2x1. Two for .....69c  
**B266** Size 1 1/2x10 1/2. Two for .....\$1.28

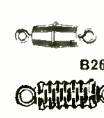

**LEAD-IN INSULATORS**  
**B270** For 4 inch walls or less .....42c  
**B271** For 9 inch walls or less .....69c



**OUTDOOR LIGHTNING ARRESTER**  
**B980** Price .....\$1.55  
 Protect your instruments with this lightning arrester. You cannot afford not to. Weatherproof porcelain case. Air gap type. Permanent. Durable. The most practical quality arrester obtainable. Underwriters approved.



**SPIDER WEB COILS**  
**B290**—25 turn. Each .....35c  
**B291**—35 turn. Each .....47c  
**B292**—50 turn. Each .....43c  
**B293**—75 turn. Each .....48c  
**B294**—100 turn. Each .....52c  
 A new popular type of inductance of highest efficiency. Lowest distributed capacity and high frequency resistance. Firm green silk windings with fibre mounting strips.





**REINARTZ INDUCTANCE**  
**B296** Each .....\$1.10  
 Made of green silk covered wire, spiderweb wound to produce greatest efficiency and lowest losses. 21 taps so arranged that crossing is avoided. Two fibre strips and wooden rod furnished permit various styles of mounting. With this coil a high grade set can be built at a low cost. Directions included.



**ULTRA AUDION COIL**  
**B296** Each .....78c  
 Spider web wound of green silk covered wire. Four taps. Produces wonderful results. Fibre strips and wooden rod for mounting included. Directions furnished.

**PANEL MOUNTING VARIABLE CONDENSERS**

These are especially high grade condensers and we guarantee them to be mechanically and electrically perfect. Fine polished end plates of heavy bakelite. Shafts 3/4 inch diameter. Sturdy, heavy aluminum alloy plates perfectly spaced to insure smooth, even, reliable capacity. Our low prices save you money. These condensers are of the very best make and are not to be compared with many inferior, cheap condensers offered. We guarantee them to please you or your money back. The vernier style has one separately controlled plate which permits of the finest tuning.

REGULAR STYLE		VERNIER STYLE	
B815	—11 plate ..... 79c	Including Dial and Knobs	
B816	—11 plate ..... 97c	B825	—11 plate .00025 mfd. ....\$2.45
B814	—11 plate .00025 mfd. ....\$1.32	B824	—26 plate .0005 mfd. .... 2.85
B813	—11 plate .0005 mfd. .... 1.43	B826	—16 plate .001 mfd. .... 3.15
B812	—13 plate .001 mfd. .... 1.73		

**STRANDED ANTENNA WIRE**  
 Cabled of fine copper strands. Very flexible. High tensile strength. Best for aeriads.  
**B248**—100 ft. coil 58c **B249**—500 ft. coil \$2.75

**OUR SPECIAL AUDIO FREQUENCY AMPLIFYING TRANSFORMERS**  
**B550** Each .....\$2.25  
 The result of years of research work and experienced engineering. In quality of work and volume of sound, the things a transformer is built for, we guarantee it to equal or surpass any other transformer. Neat in appearance. Carefully made. Fully mounted with plainly marked binding post connections. 5 to 1 Ratio. Wonderful results on one, two or three steps without distortion or howling. A quality item in every respect. Not to be compared with articles built for price only.



**OUR SPECIAL SHIELDED TRANSFORMER**  
**B551**—3 1/2 to 1 Ratio. Each .....\$2.75  
**B552**—6 to 1 Ratio. Each .....\$2.75  
 The same high grade style of transformer as above, enclosed in a metal case which completely shields it from any outside magnetic influences. Very attractive appearance and sturdy construction. Free from howling and local disturbances.



**THORDARSON AUDIO FREQUENCY AMPLIFYING TRANSFORMERS.**  
**B232** Ratio 3 1/2 to 1. Each .....\$3.40  
**B233** Ratio 6 to 1. Each .....\$3.80  
 Recognized by leading radio engineers as the best balanced and most efficient transformer. Correct characteristics for any standard tube. Wonderful results without distortion on one, two or three steps. Plainly marked binding post connections on bakelite panel.



**OTHER STANDARD BRANDS AUDIO FREQUENCY TRANSFORMERS**  
 Fresh, clean stock in original containers.  
**B553** Acme. Each .....\$4.45  
**B554** Coto. Each ..... 4.45  
**B555** Federal. Each ..... 4.45  
**B712** Radio Corp. Each ..... 6.40

**RADIO FREQUENCY AMPLIFYING TRANSFORMER**  
**B560** For 201A or 301A Tubes. .....\$1.70  
**B561** For 199 or 11 or 12 Tubes For 199 or 11 or 12  
 Due to its special design this transformer will produce wonderful results in any type of regular or reflex radio frequency circuit. While low in price we believe it equal or superior to higher priced transformers. Perfect for one, two or three stages. Compact, convenient form, easily mounted. Range 175 to 600 meters. Try it. If you are not satisfied return it and get your money back.



**OTHER STANDARD BRANDS RADIO FREQUENCY TRANSFORMERS**  
**B562** Dubilier. Each .....\$4.45  
**B563** Coto. Each ..... 4.45  
**B564** Basila. Each ..... 4.45  
**B565** Acme. First stage. Each ..... 4.45  
**B566** Acme. Second stage. Each ..... 4.45  
**B567** Acme. Third stage. Each ..... 4.45  
**B714** Radio Corp. Each ..... 5.95  
**B995** All American. Each ..... 3.75

**LONG NOSE PLIERS**  
**B970** Price .....95c  
 The handiest pliers for radio work. Made of fine hardened steel. Length, 5 inches.



**DIAGONAL JAW NIPPERS**  
**B972** Price .....\$1.05  
 For fine electrical work. Made of hardened steel. Length 5 inches.



**FOUR-IN-ONE SCREW-DRIVER**  
**B974** Each .....55c  
 Especially suitable for radio work. Will handle any size screw used. Smaller drivers nest inside larger one and are held in place with screw cap. Made of steel, nickel finished.



**NEUTRODYNE TRANSFORMERS**  
**B571** Per set of three .....\$4.95  
 An air core transformer for use in neutrodyne method of reception. Can also be used for tuned radio frequency or as a fixed coupler with condenser across secondary. Proper design for results and efficiency. Green silk windings on bakelite tubes with adjustable mounting brackets to fit most any condenser.

**NEUTRALIZING CONDENSERS**  
**B572** Per set of two .....40c  
 Simple, inexpensive, effective precision type. Micrometer adjustment is attainable. Easily mounted in circuit.

**ENCLOSED VARIABLE CONDENSERS**  
 One of the best made condensers. Rigid, accurately spaced aluminum plates. For-transparent case. Knob and pointer. Clear transparent case.  
**B808** 43 plate .001 Mfd. \$2.80  
**B808** 21 plate .005 Mfd. 2.47





# WITH BARAWIK STANDARD RADIO GOODS

## VACUUM TUBES

Standard Brands—Cunningham Radionotron. Every one guaranteed new and perfect. We will ship brand in stock unless you specify otherwise.

B105 Detector, UV200 C300 Ea. \$4.30  
 B112 Amplifier, UV201A C501A 5.95  
 B118 5 Watt Transmitter ..... 7.70  
 B107 WD11 C11, Each..... 5.95  
 B101 WD12 C12, Each..... 5.95  
 B102 UV199 C299, Each..... 5.95  
 B104 UV199 Adapter fits 199 tube to standard socket ..... 42c  
 B108 WD11 Socket, Each..... 35c  
 B109 WD11 Adapter, Each..... 48c

## STANDARD TUBE SOCKET

B140 Each ..... 39c  
 Moulded of genuine red brown bakelite. Binding post connectors. For table or panel mounting. Neat and strong.

## METAL TUBE SOCKET

B146 Each ..... 42c  
 A strong durable socket for panel or table mounting. Metal tube and base. Plainly marked binding post connections well insulated.

## TWO AND THREE GANG SOCKETS

These sockets make it easy to build a detector and amplifier units and make a neat, compact workmanlike job. Perfectly made of high grade materials. Quickly mounted on panel or base.

B147 Two-gang socket ..... 95c  
 B149 Three-gang socket ..... 1.30

## 199 SOCKET

B145 Each ..... 49c  
 Moulded of high insulating material. Sponge rubber base prevents ringing in tube. Plainly marked binding post connections. Neat and compact.

## FILAMENT CONTROL RHEOSTATS

B132 6 ohm. Each..... 45c  
 B129 20 ohm. Each..... 52c  
 B131 30 ohm. Each..... 59c  
 B135 6 ohm Vernier ..... 95c  
 Best grade. Will give real service. Durable and lasting. High heat resisting base, diam. 2 1/2 in. Tapered polished black knob 1 1/4 in. diam.

## POTENTIOMETERS. Match above rheostats.

B151 200 ohm ..... 79c  
 B152 400 ohm ..... 79c

## SUPERIOR RHEOSTATS

B153—6 ohm. Each..... 69c  
 B154—20 ohm. Each..... 76c  
 B155—30 ohm. Each..... 83c  
 The finest rheostat. Smooth, even action. Best design, best workmanship. Supplied with attractive dial and knob. A rheostat for high grade sets.

## POTENTIOMETERS to match above rheostats, with dial and knob.

B156—275 ohm ..... 98c

## QUICK ACTING VERNIER RHEOSTAT

B124—6 ohm ..... 79c  
 B125—15 ohm ..... 88c  
 B126—30 ohm ..... 99c  
 Vernier adjustment at every degree of resistance. Pushing knob in turns off the filament.

## THREE INCH DIAL

B923 For 3-16 inch shaft. Each ..... 19c  
 B924 For 1/4 inch shaft. Each ..... 19c  
 A handsome neat looking dial moulded in one piece of polished black composition. 180° scale marked 0 to 100 finely engraved in contrasting white enamel. Diameter 3 inches.

## TWO INCH DIAL

B921 For 3-16 inch shaft. Each 16c  
 B922 For 1/4 inch shaft. Each 16c  
 A handsome dial moulded in one piece of polished black composition. 270° scale marked 0 to 100 finely engraved in contrasting white enamel. Fine for rheostat or switch control. Diameter 2 inches.

## BAKELITE DIALS

B931—2 in. Diam. for 3-16 inch shaft. Each ..... 32c  
 B932—2 in. Diam. for 1/4 inch shaft. Each ..... 32c  
 B933—3 in. Diam. for 3-16 inch shaft. Each ..... 33c  
 B934—3 in. Diam. for 1/4 inch shaft. Each ..... 33c  
 B935—4 in. Diam. for 1/4 inch shaft. Each ..... 40c  
 Moulded in one piece of genuine bakelite in polished black finish. Finely engraved scale in contrasting white enamel. Sure grip knob that fits the fingers. Higher grade dials for good sets. Sizes match perfectly.

## COMPETITOR JACKS

B387 Open circuit. Each..... 27c  
 B388 Two circuit. Each..... 35c  
 Well made, durable smooth working, nickel finished frame. Well insulated.

## WE PAY TRANSPORTATION CHARGES EAST OF THE ROCKIES

PRESERVE THESE PAGES—ORDER FROM THEM AND SAVE MONEY  
 FAST SERVICE—TRY US AND BE CONVINCED

THE PRICES QUOTED DELIVER THE GOODS TO YOUR DOOR  
 OUR GUARANTEE PROTECTS YOU—We handle only the best goods carefully tested and checked by expert radio engineers. You are assured of getting guaranteed apparatus that will give superior results. And while our goods are best, our prices are lowest. Our goods equal or surpass the claims we make for them. We do not attempt to deceive or mislead. Our reputation for fair dealing is our most valued asset.

HOW TO ORDER—Write your Order plainly, state Article Number, Description and Price of items wanted, Send Postoffice or Express Money Order, Certified Check or Bank Draft for Total of Order. Prompt Shipment is assured when these directions are followed.

## VERNIER DIAL ADJUSTER

B941 Each ..... 19c  
 Easily installed at edge of dial, gives finest vernier adjustment of condenser or inductance. A great value. Polished black knob.

## ENCLOSED DETECTOR

One of the finest crystal detectors on the market. Supersensitive galena crystal enclosed in heavy glass shield. Quick, positive adjustment. Brass parts polished nickel finish.

B730 Each ..... 89c

## GALENA DETECTOR

Easy fine adjustment. Crystal mounted in cup. Moulded base and knob. Brass parts polished nickel finish. An unequaled value.

B732 Each ..... 59c

## DETECTOR PARTS

B725 Price set..... 23c  
 All metal parts for crystal detector. No base included. Easily assembled. Polished nickel finish.

## SUPERIOR RADIO JACKS

Finest grade jacks. Improved design. Best materials. Phosphor bronze springs. Silver contact points. Nickel finish. Mount on panels 1/8 to 3/8 in. thick.

B390 Open circuit. Each..... 38c  
 B391 Closed circuit. Each..... 46c  
 B392 Two circuit. Each..... 55c  
 B393 Single circuit filament cont. .... 59c  
 B394 Two circuit filament cont. .... 76c

## SUPERIOR VARIABLE GRID RESISTANCE

B167 Each ..... 80c  
 B168 With .00025 Condenser ..... 95c  
 Eliminates hissing, clarifies signals. Capacity smoothly varied from 0 to 6 megohms by half turn of knob. Easily mounted on any panel.

## TUBULAR GRID LEAKS AND CONDENSERS

Very convenient. Permit of quick change of leaks or condensers of varying capacity. Cut shows leak mounted. Leaks and condensers have same appearance. Each part priced separately.

B849 Grid Leaks. Each..... 18c  
 Resistances—1/2, 1, 1 1/2, 2, 3, 5, 7 and 10 megohms. Specify which size is wanted.

B831 Grid and Plate Condensers. Each..... 39c  
 Capacities—.00025, .0001, .00025, .0005 mfd. Specify which size is wanted.

## MOUNTINGS

B840 Single mounting. Each..... 29c  
 B842 Double mounting. Each..... 49c  
 B844 Triple mounting. Each..... 69c

## HYDROMETER

B190 Each ..... 48c  
 Accurately tells you the condition of your storage battery. Helps you keep your battery in better condition.

## SWITCH LEVERS

Very neat polished black composition knob. Exposed metal parts polished nickel finish. Fitted with panel bushing, spring and two set nuts. A high grade switch.

B381 1 1/2 in. Radius. Each 15c

## SWITCH LEVER STOP

Brass polished nickel finish.  
 B386—Dozen 18c Hundred \$1.05

## CABINETS

Fine looking cabinets solidly built. Elegant hand rubbed finish. You will be proud of your set mounted in one of these cabinets. Hinged tops. Front rabbeted to take panels. Panels not included. Prices are transportation paid.

Panel Size	Inside Dimensions			Art. No.	Price Each
	High	Wide	Deep		
6x7"	5 1/2"	6 1/2"	7"	B420	\$2.35
6x10 1/2"	5 1/2"	10"	7"	B422	2.75
7x14"	6 1/2"	13 1/2"	7"	B423	3.35
7x18"	6 1/2"	17 1/2"	7"	B426	3.75
7x21"	6 1/2"	20 1/2"	7"	B425	3.85
8x24"	8 1/2"	23 1/2"	10"	B429	4.65
9x14"	8 1/2"	13 1/2"	10"	B430	4.65
12x14"	11 1/2"	13 1/2"	10"	B430	4.65
12x21"	11 1/2"	20 1/2"	10"	B432	5.45

## RADIO "BAKELITE" PANELS

Notice our very low prices on this fine quality material. We supply genuine Bakelite, Condensite Ceteron or Formica, all of which are materials with practically identical mechanical, chemical and electrical properties. Machines well without chipping. Won't warp. Waterproof. Highest mechanical and dielectric strength. Attractive natural polished black finish which can be sanded and oiled.

Panel Size Inches	1/8" thick		3/16" thick		1/4" thick	
	Art. No.	Price	Art. No.	Price	Art. No.	Price
6x7	B450	\$0.50	B460	\$0.75	B470	\$0.98
6x10 1/2	B451	.75	B461	1.11	B471	1.47
7x14	B458	1.20	B468	1.80	B478	2.40
7x18	B453	1.55	B463	2.30	B473	3.10
7x21	B457	1.78	B467	2.65	B477	3.60
7x24	B459	2.10	B469	3.10	B479	4.15
9x11	B454	1.60	B464	2.30	B474	3.10
12x14	B455	2.10	B465	3.10	B475	4.15
12x21	B456	3.15	B466	4.65	B476	6.20

## INDUCTANCE SWI

B385 Price including knob and dial ..... \$1.29  
 Mounts switch points and contact lever behind panel. Only one hole needed to mount. 15 switch points, any number of which may be used. Smooth wiping contacts. Attractive tapered knob.

## SUPERIOR INDUCTANCE SWITCH

B386 Each ..... 79c  
 Quickly and securely mounted by drilling one hole. Only knob and pointer show in front of panel. Connections can be soldered before fastening switch, making assembly much easier. Metal parts nicked. Bakelite knob and supporting base.

## BARAWIK QUALITY HEADSETS

B770 Per Set, 2000 ohms..... \$3.25  
 These headsets have proven on rigid tests to be one of the very best on the market. The tone quality is excellent with an unusual volume. Skilled workmen make them from only the best selected materials. The receiver cables are fine polished finish with polished black ear pieces. Fabric covered head band comfortable and quickly fitted to the head. Supplied with 5-foot cord. These sets were designed to sell for much higher prices than we ask, and at our price are a wonderful bargain. We guarantee that you will be pleased with them and agree that they are the best value by far yet offered. If they don't suit you we will cheerfully return your money.

## STANDARD BRAND HEADSETS

B754 Baldwin Type C with universal jack plug..... \$1.75  
 B756 Red-head, 3000 ohm 5.78  
 B768 Brandes, 2000 ohm 5.35  
 B769 Brandes, 3000 ohm 6.95  
 B751 Murdock 56, 2000 ohm 4.20  
 B752 Murdock 56, 3000 ohm 4.95  
 B764 Frost, 2000 ohm 4.20  
 B766 Frost, 3000 ohm 4.85  
 B758 Western Electric .. 9.50

## PLATE CIRCUIT "B" BATTERIES

You can make real savings on these batteries. Don't pay more. We guarantee them to equal any on the market regardless of price. Absolutely uniform. Extra long life.

B180 Signal Corps type, small size. 15 cells, 22 1/2 volts. Each... \$1.05  
 B184 Variable Large Navy size, 6 1/2 x 4 x 3 inches 5 tabs, giving range from 16 1/2 to 22 1/2 volts in 1 1/2 volt steps. Each..... \$1.95  
 B188 Combination Tapped 15 volts, 30 cell, 13x4x3 battery. Tapped to give 45, 22 1/2, 21, 19 1/2, 18 and 16 1/2 volts. Handles both detector and amplifier tubes. Each..... \$3.75

## "B" BATTERY METER

B169 Each ..... 98c  
 Reads 0 to 50 volts. Accurately tells you the exact condition of your B Battery. Convenient watch size. Polished nickel case with wire lead.

## STORAGE "A" BATTERY

A very high grade battery made especially for radio service. Guaranteed for three years. Properly cared for will give many more years of service for filament lighting. Made of best new materials. Full capacity. The best battery buy on the market. Try one of these batteries on your set for 10 days. If at the end of that time you are not fully satisfied with the battery return it and we will refund the purchase price.

B194 6 volt, 40 ampere size. Each..... \$10.75  
 B196 6 volt, 80 ampere size. Each..... 13.25

## HOMFCHARGER BATTERY CHARGING RECTIFIER

Charge your battery at home over night for a few cents. Simply connect to any 110 volt 60 cycle light socket, turn on current and rectifier does the rest automatically. Will work for years without attention. Simple connections. Gives a tapering charge rate by which the batteries should have. You can make it pay a profit charging your friends' auto batteries. Long connecting cords with pair of battery clips.

Prices are Transportation Paid.  
 B201 For 6 volt battery ..... \$12.95  
 B203 For 12 volt battery ..... 12.95

## BATTERY CLIPS

B198 Two for ..... 28c  
 Clip onto storage battery terminals, lead coated. Make positive non-corrosive contact at all times.

## WIRE CONNECTING CLIPS

B199 Per dozen ..... 30c  
 Small connecting clips for quick fastening leads onto binding posts, etc. Handy and useful. Every radioist should have at least a dozen.

## SWITCH CONTACT POINTS

Brass polished nickel finish. All have 1/2 in. long size 6-32 screws and two nuts. All prices the same.  
 Dozen 18c Hundred \$1.05  
 Order by Article Number.  
 B360 Head, 1/4 in.; Diam. 1/4 in. High  
 B362 Head, 3-16 in.; Diam. 1/4 in. High  
 B363 Head, 3-16 in.; Diam. 1-16 in. High  
 Solder Lugs to Fit Contact Points  
 Also for connecting wires to binding posts, etc.

B365 Dozen 8c Hundred 30c

## BINDING POSTS

Brass, polished nickel finish. Washer and 6-32 in. screw extending 1/2 in.  
 B370 Large size—barrel and knob 3/4 in. long. dozen ..... 85c  
 B372 Smaller size—barrel and knob 9-16 in. long. dozen ..... 70c

## VARIABLE GRID LEAKS

B160 Standard style ..... 16c  
 B161 De Luxe style with extra heavy screw top finely finished ..... 32c  
 Pencil mark type for panel mounting. Resistance may be varied exactly as needed.

## GRID CONDENSERS

B162 Well insulated. Paper covering. Each ..... 8c  
 B163 Highest grade. Mica insulated. Polished nickel case. Each ..... 23c  
 Fit over posts of above leaks. The combination makes an efficient unit. Cap. .00025 mfd.

## SUPERIOR RADIO PLUGS

B395 With set screws for fastening cord. Each ..... 35c  
 B397 Two-way—takes two pair any style cords. Each ..... 59c  
 Highest grade plugs. Fit any standard jacks. Polished round barrels.

BUILD YOUR SET WITH BARAWIK STANDARD RADIO GOODS

THE BARAWIK CO.

Chicago's Original Radio Supply House Beware of Imitators

102 South Canal Street

CHICAGO, ILL.



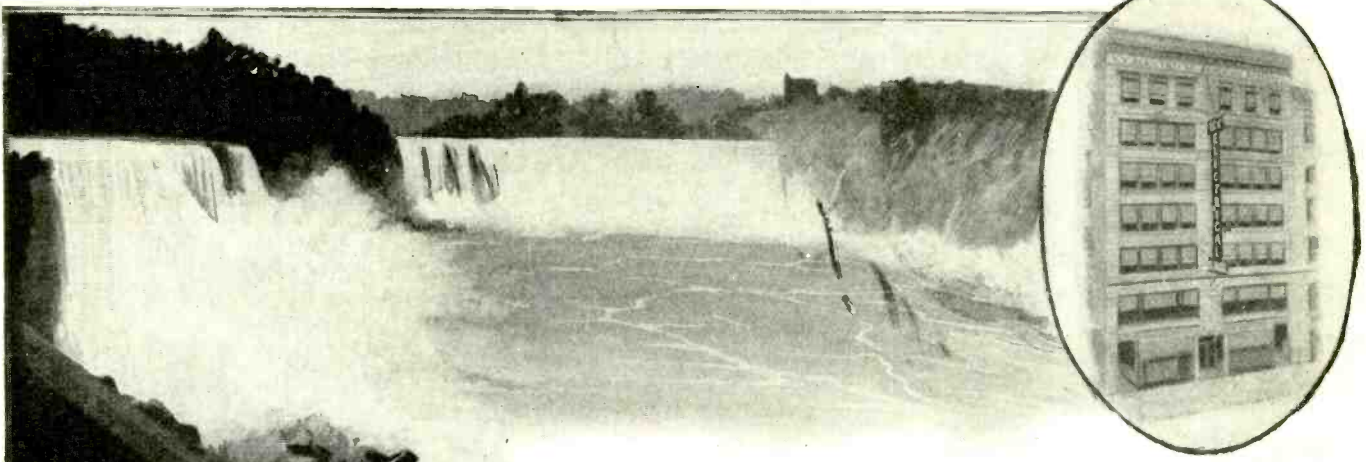

# Master Electricity By Actual Practice

The only way you can become an expert is by doing the very work under competent instructors, which you will be called upon to do later on. In other words, *learn by doing*. That is the method of the New York Electrical School.

Five minutes of actual practice properly directed is worth more to a man than years and years of book study. Indeed, Actual Practice is the only training of value, and graduates of New York Electrical School have proved themselves to be the only men that are fully qualified to satisfy EVERY demand of the Electrical Profession.

## The Only Institution of the Kind in America

At this "Learn by Doing" School a man acquires the art of Electrical Drafting; the best business methods and experience in Electrical Contracting, together with the skill to install, operate and maintain all systems for producing, transmitting and using electricity. A school for Old and Young. Individual instruction.

### Over 8,000 Graduates are Successful Men in the Electrical World

No previous knowledge of electricity, mechanics or mathematics is necessary to take this electrical course. You can begin the course now and by steady application prepare yourself in a short time. You will be taught by practical electrical experts with actual apparatus, under actual conditions.

The N. Y. E. S. gives a special Automobile Ignition Course as an advanced training for Auto Mechanics, Garage Men and Car Owners. The course covers completely all Systems of Ignition, Starters, Lighting and other electrical equipment on automobiles, motor boats, airplanes, etc.

*Let us explain our complete courses to you in person. If you can't call, send now for 64-page book—it's FREE to you.*

# New York Electrical School

29 West 17th Street, New York

New York Electrical School  
29 W. 17th St., New York, N. Y.

Please send FREE and without obligation to me your 64-page book.

..... NAME  
 ..... STREET  
 ..... CITY ..... STATE



Volume XI  
Whole No. 126

# Science and Invention

H. GERNSBACK, EDITOR AND PUBLISHER  
H. WINFIELD SECOR, ASSOCIATE EDITOR  
T. O'CONNOR SLOANE, Ph.D., ASSOCIATE EDITOR

OCTOBER  
1923  
No. 6

Editorial and General Offices, - - 53 Park Place, New York

**"Those Who Refuse to Go Beyond Fact Rarely Get As Far As Fact" -- HUXLEY**

## The "New" Science and Invention

By H. GERNSBACK

**T**HIS issue of SCIENCE AND INVENTION witnesses an important and far reaching innovation, not only in the magazine field, but in the technical press as well. For some time we have felt that SCIENCE AND INVENTION was not fulfilling its mission as it should. When this magazine was first established in 1913, as the ELECTRICAL EXPERIMENTER, it was a highly technical magazine and its circulation reached a figure of not more than 100,000. The reason for this was that there are only a limited number of technical-scientific readers in the country who can support such a magazine. Consequently in 1920 the magazine broadened its scope and changed its name to SCIENCE AND INVENTION. Sometime previous to the change of name, the magazine had not been strictly electrical nor strictly experimental. It had been found necessary to embrace other scientific lines in order to satisfy the demands of its readers. Then when the magazine became known as SCIENCE AND INVENTION, the circulation quickly jumped up close to 200,000 copies in 1921. The reason, of course, was that more readers were interested in the sort of material we published at that time and the material we have been publishing ever since.

But recently we have been aware that we could give our readers more for their money. Along the old and established line of publishing, we printed illustrations and lengthy articles. Often it was necessary to reduce illustrations to such an extent that they did not show up very well. This was necessitated by the fact that we had to run so much text.

A diligent canvas among many readers of SCIENCE AND INVENTION tended to show that few people actually read the articles. Most of them studied the illustrations and read the captions. We point with pride to our illustrations and particularly to the technical ones. We have been fortunate to secure artists who know how to illustrate difficult subjects in such a way that words really become superfluous.

Moreover, in these days, people do not wish to read if they can help it. A picture or illustration correctly made can tell a story more eloquently than 5,000 words. That is one of the reasons why motion pictures have been so eminently successful; pictures, a few titles, and the story is told far better than any book could do it.

Bearing these things in mind, we have come to the conclusion that the world really needs an entirely new sort of

magazine. The answer is simple. *Nothing but pictures, with captions, to explain the story.* The result is the new SCIENCE AND INVENTION now in your hands. The editorial policy remains exactly the same as before. No changes have been made as you will notice. *Instead, we are offering three to four times as much material as we have ever offered before.* All of our departments, as you will note, have been reduced to pictures and captions, with the exception of our scientific fiction stories which for the time being will run on as usual. The reason is that the average man or woman does not wish to laboriously wander through miles of text of scientific facts, which means concentration and study. With fiction, however, this does not hold true because fiction is an entertainment; it does not require study. On the other hand, *we have tried to reduce all scientific matter to entertainment instead of study.* As to how successful we will be in this issue and subsequent ones, you are the sole judge. At any rate, we believe there is a very large public interested in scientific matters and if such matter can be presented in an easily digestible form, it will, we hope, be welcomed by the multitude.

If we make it possible for the man in the street to absorb scientific knowledge without headaches and without trepidation, we believe we shall have accomplished a distinct service to humanity. To the average man, Science means a musty book, sealed with 7 seals. The average man will have none of it. If on the other hand we can show your mother, your wife, or your child

that Science is a most interesting subject of which every one in all walks of life should know more, then we believe we shall have achieved our goal.

Science in all its phases, is the most wonderful thing that the world has ever known and it is just beginning to come into its own. Not so very many years ago, men were burned at stakes and murdered for inventing or thinking up something new. Today the scientist is glorified. Science touches every one of us in one way or another, and is regulating and running our very lives. Science and invention are the direct causes of our huge fortunes, our great industries and the greater part of our national wealth. It will be our purpose to disseminate such scientific knowledge, not only in a palatable manner, but in a way that "he who runs may read."

In conclusion, may we ask a personal favor of you? Please write and tell us frankly how this first issue of the new SCIENCE AND INVENTION strikes you.

### THE GOLDEN AGE OF SCIENCE

is now symbolized by the golden cover of SCIENCE & INVENTION. Beginning with this issue, SCIENCE & INVENTION will have a golden cover every month. LOOK FOR THE GOLD COVER!



# A Whirl of Merriment

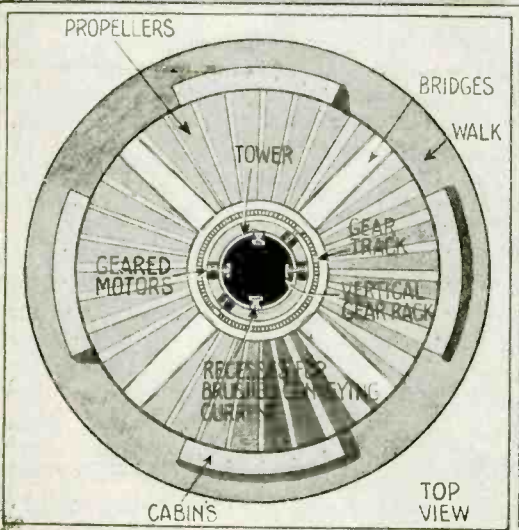
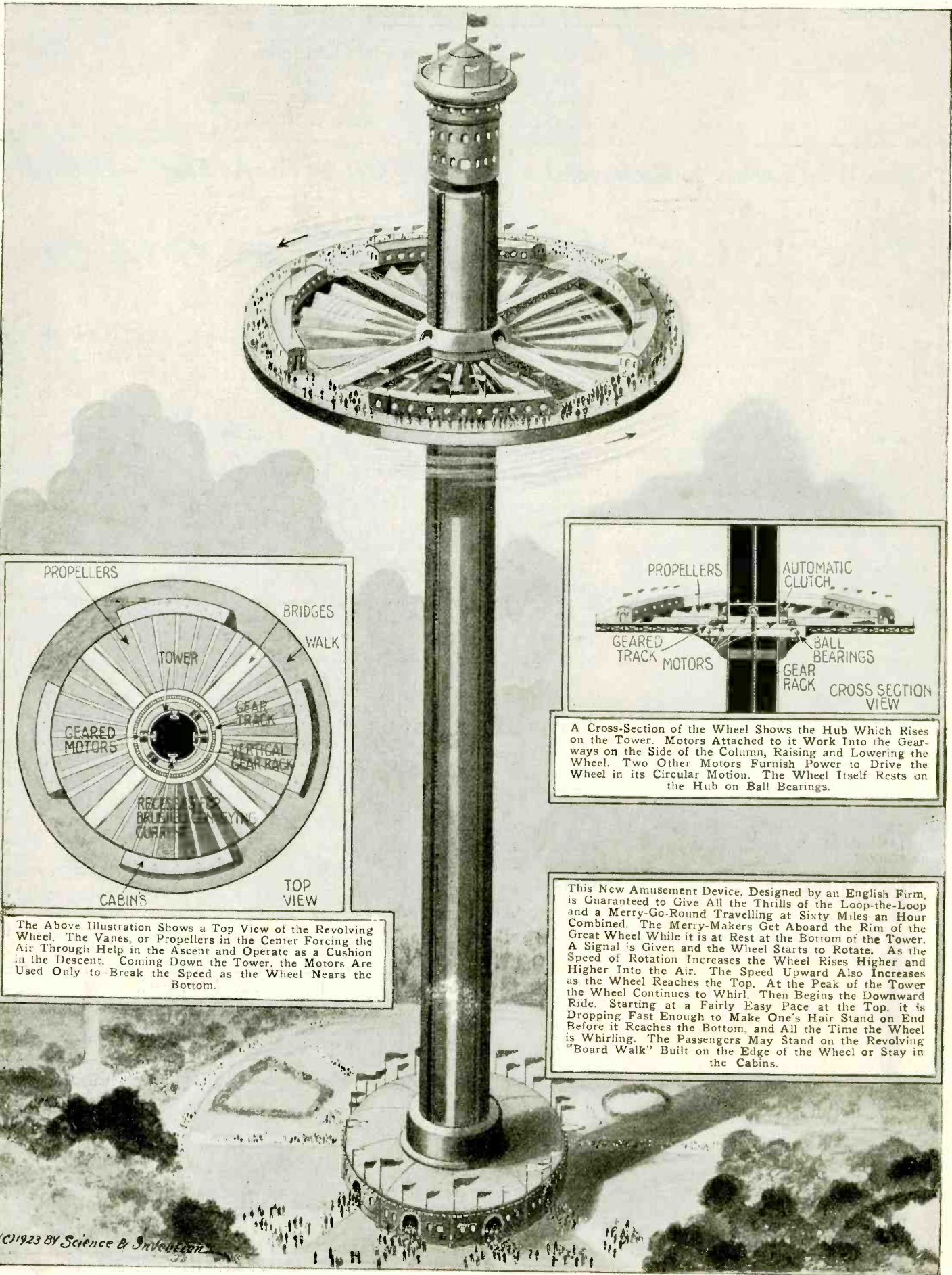

The Above Illustration Shows a Top View of the Revolving Wheel. The Vanes, or Propellers in the Center Forcing the Air Through Help in the Ascent and Operate as a Cushion in the Descent. Coming Down the Tower, the Motors Are Used Only to Break the Speed as the Wheel Nears the Bottom.

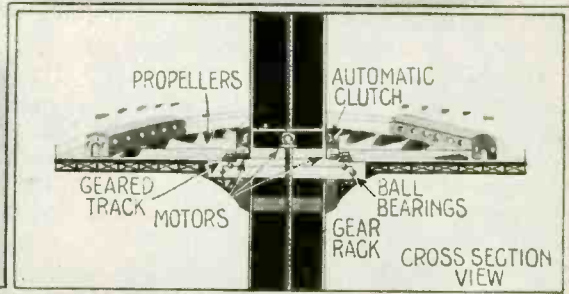

A Cross-Section of the Wheel Shows the Hub Which Rises on the Tower. Motors Attached to it Work Into the Gearways on the Side of the Column, Raising and Lowering the Wheel. Two Other Motors Furnish Power to Drive the Wheel in its Circular Motion. The Wheel Itself Rests on the Hub on Ball Bearings.

This New Amusement Device, Designed by an English Firm, is Guaranteed to Give All the Thrills of the Loop-the-Loop and a Merry-Go-Round Travelling at Sixty Miles an Hour Combined. The Merry-Makers Get Aboard the Rim of the Great Wheel While it is at Rest at the Bottom of the Tower. A Signal is Given and the Wheel Starts to Rotate. As the Speed of Rotation Increases the Wheel Rises Higher and Higher Into the Air. The Speed Upward Also Increases as the Wheel Reaches the Top. At the Peak of the Tower the Wheel Continues to Whirl. Then Begins the Downward Ride. Starting at a Fairly Easy Pace at the Top, it is Dropping Fast Enough to Make One's Hair Stand on End Before it Reaches the Bottom, and All the Time the Wheel is Whirling. The Passengers May Stand on the Revolving "Board Walk" Built on the Edge of the Wheel or Stay in the Cabins.

(C) 1923 BY Science & Invention



# How Trick Movie Sets Fool Us

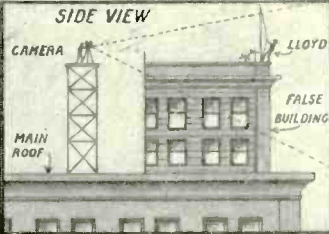
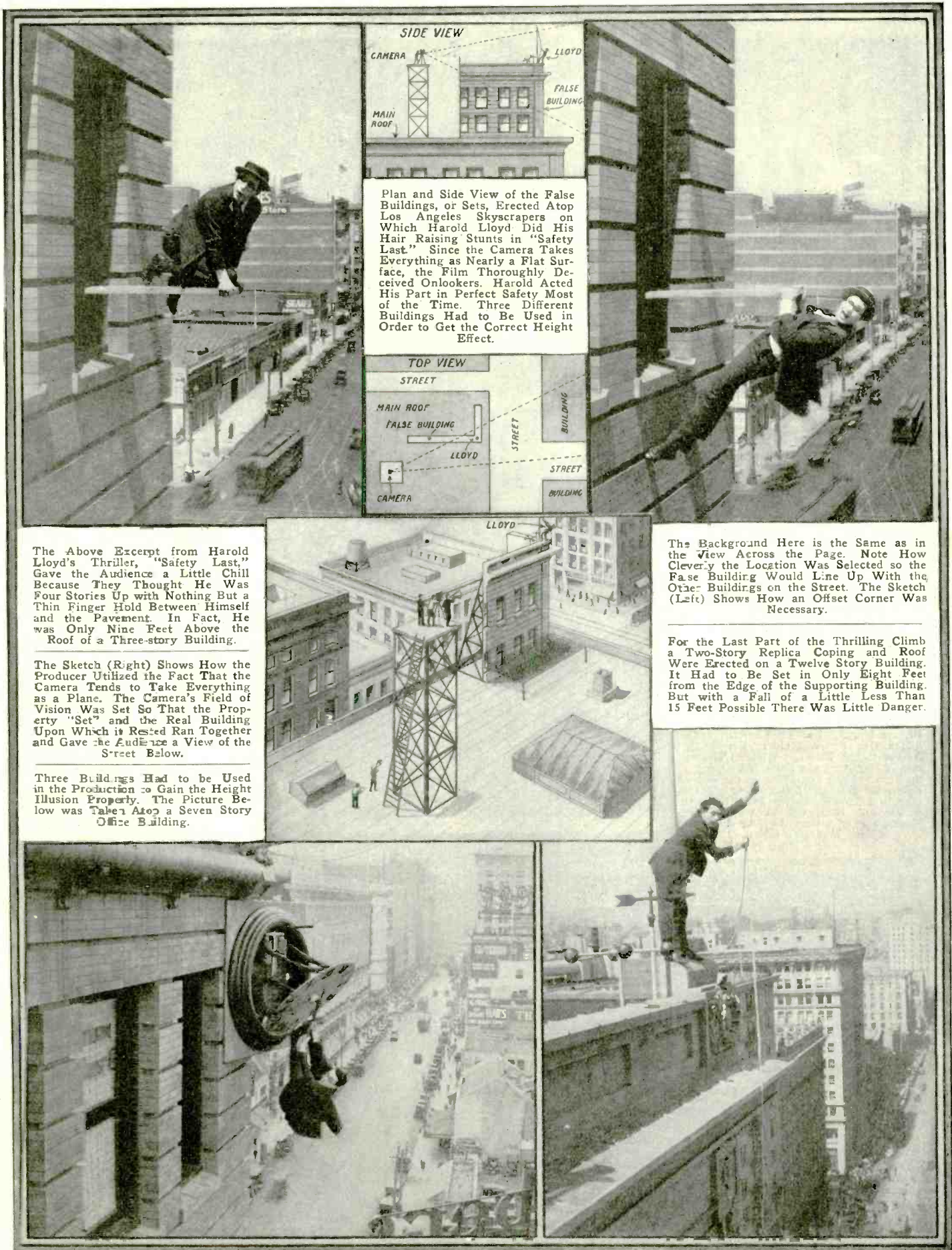

Plan and Side View of the False Buildings, or Sets, Erected Atop Los Angeles Skyscrapers on Which Harold Lloyd Did His Hair Raising Stunts in "Safety Last." Since the Camera Takes Everything as Nearly a Flat Surface, the Film Thoroughly Deceived Onlookers. Harold Acted His Part in Perfect Safety Most of the Time. Three Different Buildings Had to Be Used in Order to Get the Correct Height Effect.

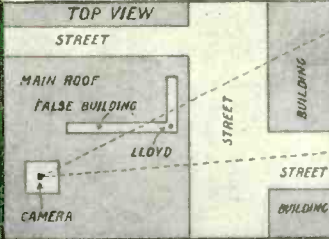

The Above Excerpt from Harold Lloyd's Thriller, "Safety Last," Gave the Audience a Little Chill Because They Thought He Was Four Stories Up with Nothing But a Thin Finger Hold Between Himself and the Pavement. In Fact, He was Only Nine Feet Above the Roof of a Three-story Building.

The Sketch (Right) Shows How the Producer Utilized the Fact That the Camera Tends to Take Everything as a Plane. The Camera's Field of Vision Was Set So That the Property "Set" and the Real Building Upon Which it Rested Ran Together and Gave the Audience a View of the Street Below.

Three Buildings Had to be Used in the Production to Gain the Height Illusion Properly. The Picture Below was Taken Atop a Seven Story Office Building.



The Background Here is the Same as in the View Across the Page. Note How Cleverly the Location Was Selected so the False Building Would Line Up With the Other Buildings on the Street. The Sketch (Left) Shows How an Offset Corner Was Necessary.

For the Last Part of the Thrilling Climb a Two-Story Replica Coping and Roof Were Erected on a Twelve Story Building. It Had to Be Set in Only Eight Feet from the Edge of the Supporting Building. But with a Fall of a Little Less Than 15 Feet Possible There Was Little Danger.

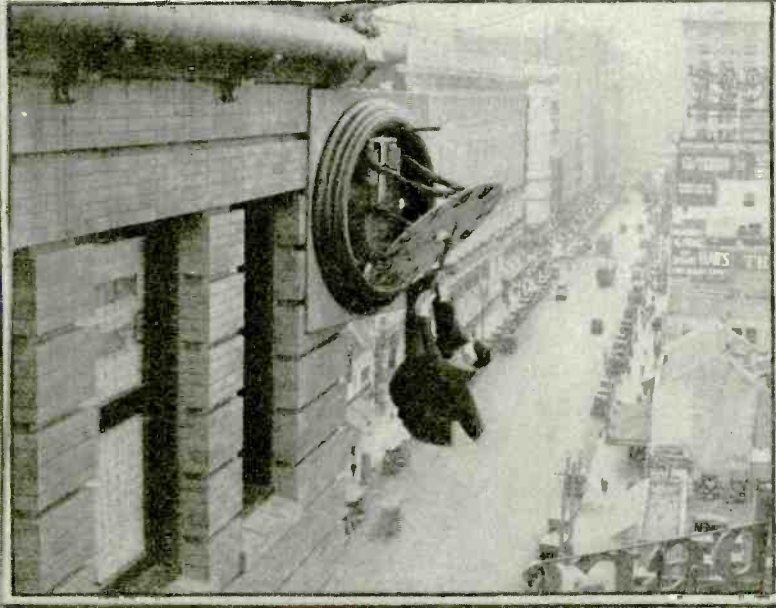



# Movies Expose

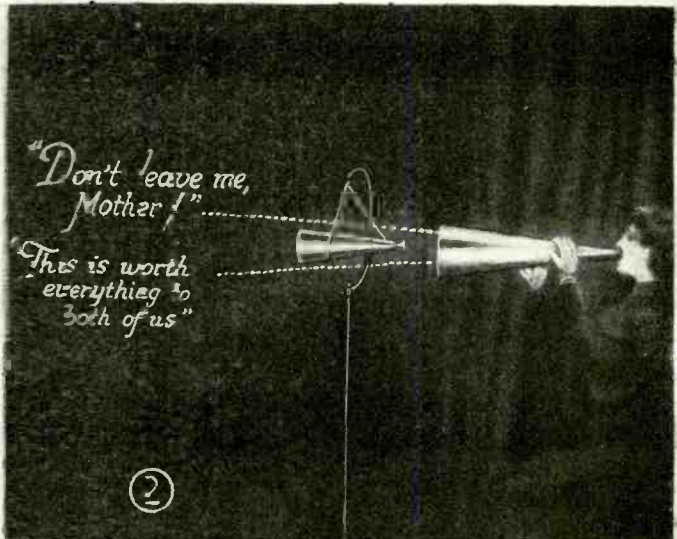

In the Motion Picture "The Satan's Paradise" a Complete Expose of Tricks Practised by Mediums is Given. This Picture Was Made in Accordance with the Dictates of a Detective from Scotland Yard, Who Was Active in the Investigation of Spirit Mediums in England.

In Picture Shown Above the Medium is Outside of Her Dark Cabinet and is Just About to Suspend a Horn from the Stand Shown on the Table. The Anxious Mother is Expecting News from Her Son Reported Missing at the Front During the World War. In Her Quest for Knowledge Regarding Her Son, She Meets Many of the Imposters Who Are Caught in the Acts Illustrated Here. For Instance, a Message is Written Upon a Sheet of Paper and Placed Between Two Slates Which Are Bolted Together.

The Detective Shown at the Right in Picture No. 3 Discovers That the Slate Slides Out of its Holder, Permitting Access to the Message Without Necessity of Removing the Bolts, Which Hold the Two Frames Together. In the Photo Below the Method of Delivering a Message to a Medium in the Dark Cabinet is Shown. Note the Stick with the Message at the End, Passing Beneath the Medium's Skirt.



In Photo 2 Shown Above, What Appears to be a Sound Coming from the Horn on the Stand is in Reality a Deception. The Medium Having Read the Message Delivered to Her, as Per Pictures 5 and 6, Answers by Talking Through the Megaphone Held by Her Within the Cabinet. This Horn is in Line with the Horn Outside of the Cabinet.

And Yet People Would Have Us Believe that Communication with the Spirit World is a Possibility. There Are Many Amongst Us Now Who Are Thoroughly Convinced That Communication with the Dead is Possible, and Tell us Stories of Remarkable Effects Which a Medium Has Produced. We Have Openly Challenged Each and Every Medium in the United States and in Other Countries to Come Forward and Give Us One Authenticated Phenomenon, One Instance Wherein a Disinterested Committee Will State that Communication is Established Beyond Doubt, While Our Investigators Are Present. The Number of Mediums Willing to Accept Our Challenge (Which, if Conditions Are Lived Up to, Would Mean \$11,000 to the Medium, Who May, However, Compete for Any of the \$1,000 or \$5,000 Prizes), Were Conspicuous by Their Absence. So If You Have Any Friends Who Claim the Powers of a Spiritist, Just Inform Them That We Are Willing to Pay a Good Price for an Authentic Manifestation.

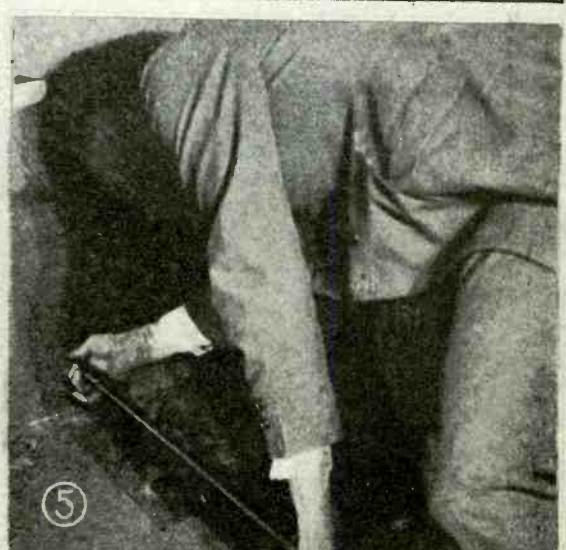
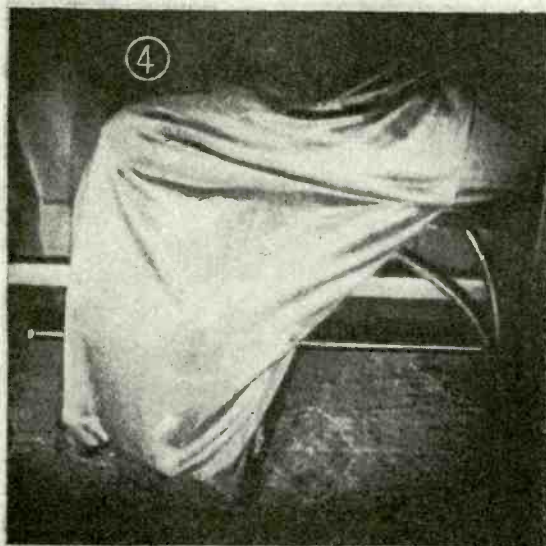



# Fake Spiritualists



A Detective Investigating Spiritual Mediums Concealed Himself Behind the Trap Door, Which the Would-be Spirit is Opening in Photo No. 6 Above. Here He Saw How the Famous Medium Managed to Materialize the Spirit of a Departed Relative. The Human Spirit Walking Very Quietly on the Thickly Carpeted Floor Entered the Spirit Cabinet by Sliding Beneath the Curtains.

In the Photo Below the Medium Has Taken Advantage of a Very Clever Deceptive Means. Having First Secured a Picture of the Beloved and Departed Son, He Takes a Photograph of This Picture Producing a Negative, and Makes a Glass Positive from It. This Positive He Places Under a Glass Sheet in the Developing Table. When the Mother Visits One of the Seances She is Told to Bring Her Own Plate Packed in Her Own Plate Holder With Her. A Picture of Her is Taken with Her Own Camera Placed in the Medium's Studio. The Mother Then Takes the Exposed Plate in its Holder into the Dark Room, and She Herself Places it into the Developing Bath. On a Pretext That One of the Chemical Bottles Have Been Displaced, the Medium Covers the Glass Developing Tray with a Sheet of Black Cardboard, and Turns on the Light in the Room. At the Same Time He Causes a Lamp Beneath the Developing Table to Light and Produces an Effect Exactly Similar to Contact



Printing. Needless to Say the Image is Reproduced on the Plate. This is Further Shown in Fig. 10.

The Spirit Form (a Draped Assistant Covered with White Gauze Previously Dipped in Phosphorescent Paint). Having Entered the Dark Cabinet Where the Medium is Bound Both Hand and Foot, Takes Its Place Behind the Medium, and After the Curtains Have Been Opened, the Spirit Form Glides Softly Out of the Cabinet Almost Within Grasp of the Spectators.

In Photo 8 Shown at the Left, the Mother in Search of Information Regarding Her Son Has Written a Question on a Slate. This Slate is Covered with Another. The Medium Then Takes it from the Victim's Hand, Raises it High Above Her Head, and Tells Her to Stretch Her Hands Up for it. In Doing So an Assistant in Back of a Would-Be Picture, Makes a Rapid Exchange of Slates, and the Poor Self-Deluded Individual Receives Her Answer to the Question, Not Knowing That There Has Been an Exchange Made. Because She Does Not Believe That Deception Can Be Practised in Such a Short Space of Time.

In the Photo Below, Fig. 10, is the Finished Plate Produced by the Method Outlined in Photo 9.

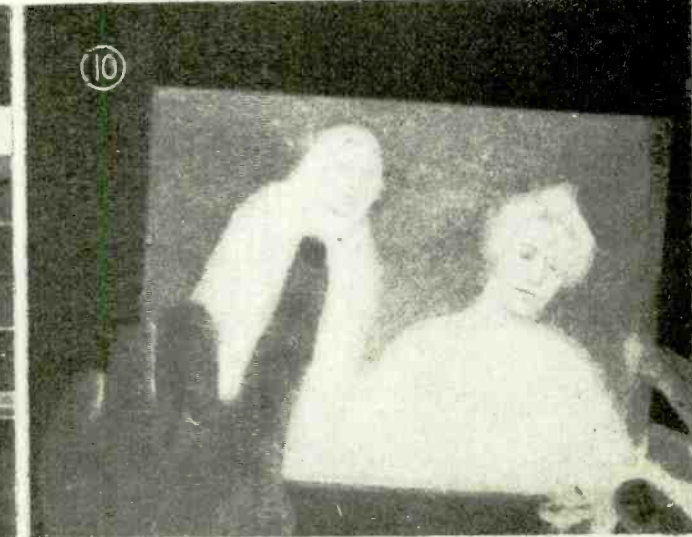
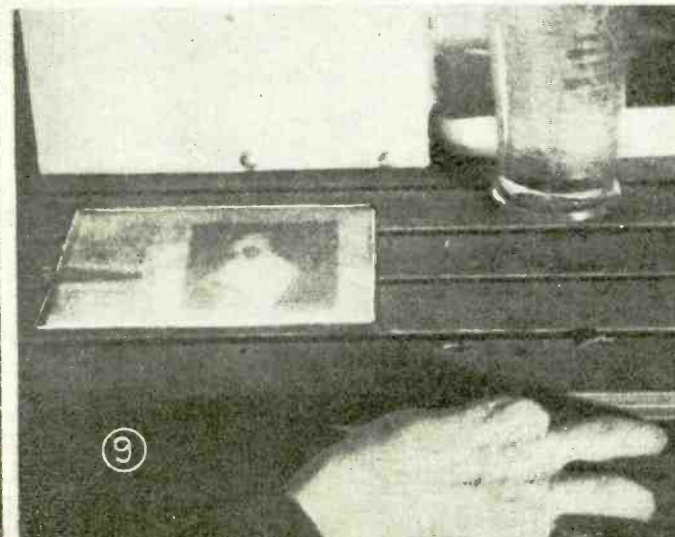



# A Modern Charlatan

By A. B. TRIPP

WE HAVE HAD MANY LETTERS FROM OUR READERS REGARDING DR. ABRAM'S SUPPOSED ELECTRONIC CURES. WE GIVE OUR OPINION BELOW.

An Abrams "Electronic Diagnosis" is Here Pictured in Detail. The Round Box on the Desk is the Dynamizer, Into Which Specimens of the Handwriting or of the Dried Blood of Patients Are Put. "Electromagnetic Earth Currents" Are Supposed to Enter This So-Called "Condenser" from the Water Pipe, and to Pick Up the "Radioactivity" of the Test Specimen, Conveying the "effects of This Radioactivity" to the Little Square Box, the Rheostatic Dynamizer. The Latter is Officially Described as "an Amplifier, Which Greatly Intensifies the Energy." A Strange Amplifier, This!—Having But Two Terminals, and Connected Into the Circuit in Series. The Other Two Instruments on the Desk Are Rheostatic Ohmmeters, Which Record the Strength of the Energy in Ohms! The Examining Doctor is Shown Tapping the Abdomen of the "Reagent" for "Areas of Dullness," Miraculously Produced by the Energy Passing Through the Wire and Electrode Which the Reagent Holds Near His Forehead. Note the Astonishing Fact that the Reagent is Grounded by Two Footplates, Which Lead Right Back to the Water Pipe. Perhaps Dr. Albert Abrams Can Explain How He Gets a Flow of Current in a Circuit Whose Resistance is Enormous.

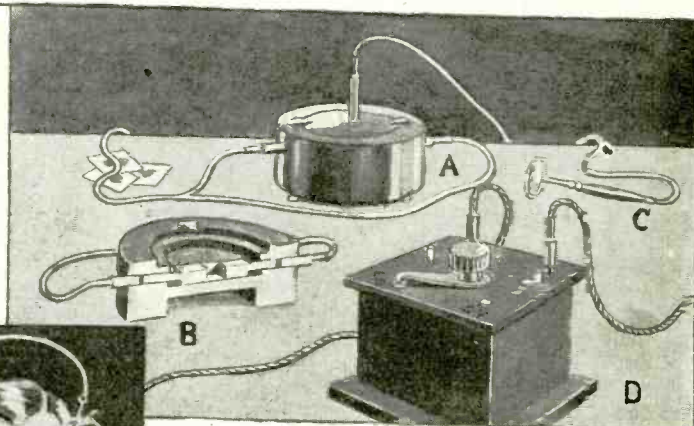
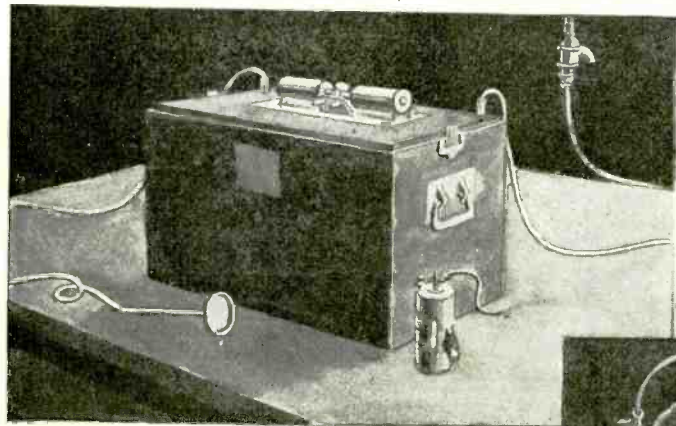
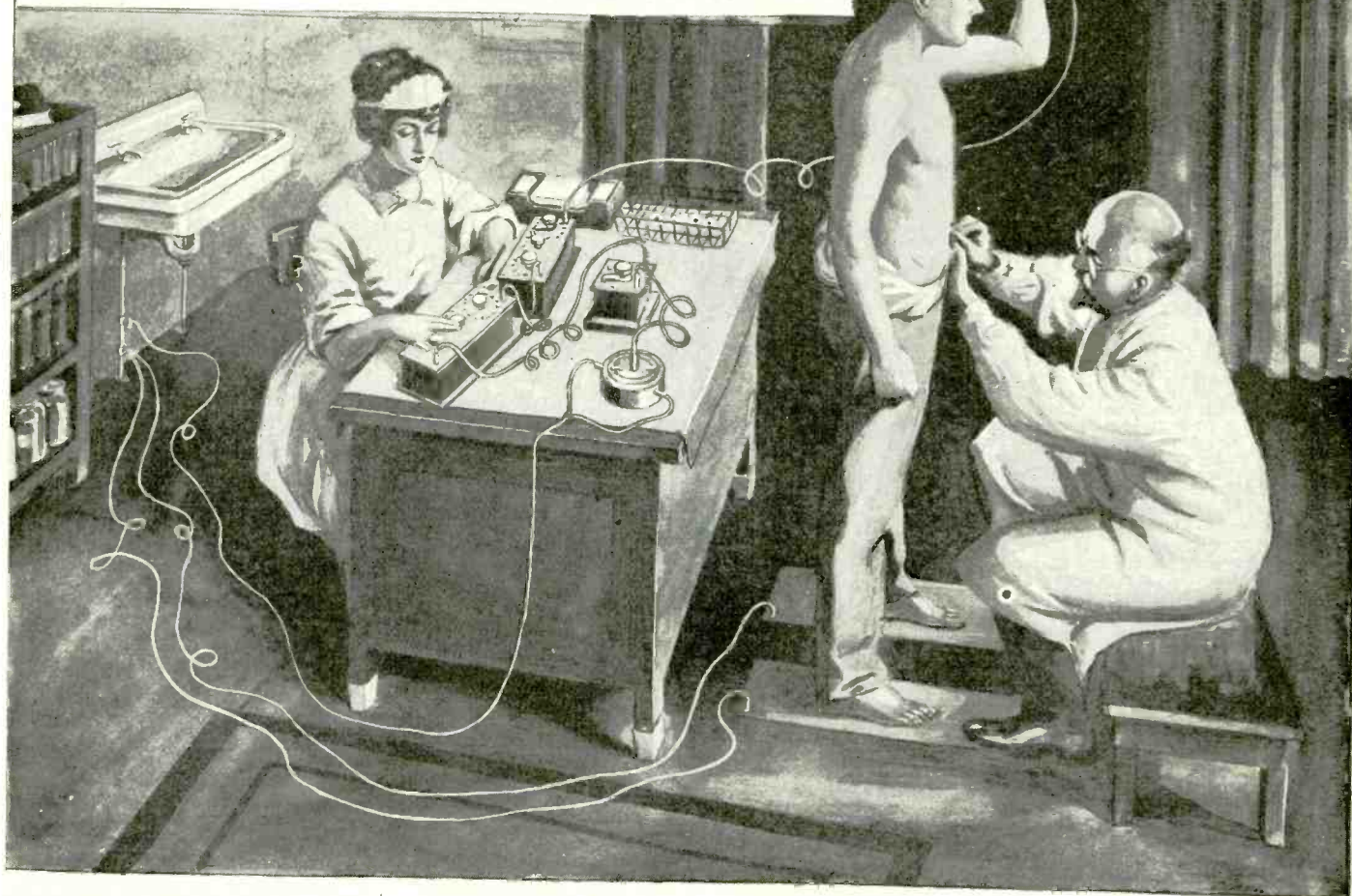

The "Oscilloclast." Above—Abrams' Cure-all Treating Machine, Pictured Beside a Worn-out Dry Cell. The Cell, Picked Up from an Ash Heap, Was So Feeble That it Would Scarcely Run a Doorbell for More Than Two or Three Seconds. Yet This Old, Burst Cell Running Its Doorbell Was a Very Hercules of Power as a Generator of Electronic Oscillations When Compared with the Glorified Electric Buzzer Towering Impressively Above It. The Only Energy That the Oscilloclast Generates is Sound, Noise. Small Center Picture Shows How Abrams "Short-circuits" the Brain. "Brain Waves May Be Conducted Through Wires," Says Dr. Abrams.

An Ordinary Piece of Wire Clipped to Hair on Opposite Sides of the Head Will "Short-circuit" These Brain Waves. (Page 103 New Concepts of Diagnosis and Treatment by Dr. Albert Abrams). Above a Close-up View of the "Diagnostic Instruments." A—"The Wonderful Little Dynamizer," Which Abrams Pretends is a "Condenser." B—The Dynamizer Cut in Two, After the Cover-Electrode Has Been Removed. Note the Two Aluminum Electrodes Inside, Upon Which the Wrapped-up Blood Specimen is Placed. C—A Brow Electrode, with Rubber Rim to Prevent Metallic Contact with the "Reagent's" Skin. D—The Abrams Rheostatic Dynamizer.



# Sound Of 'Plane Attracts Aerial Torpedo

By RAYMOND F. YATES

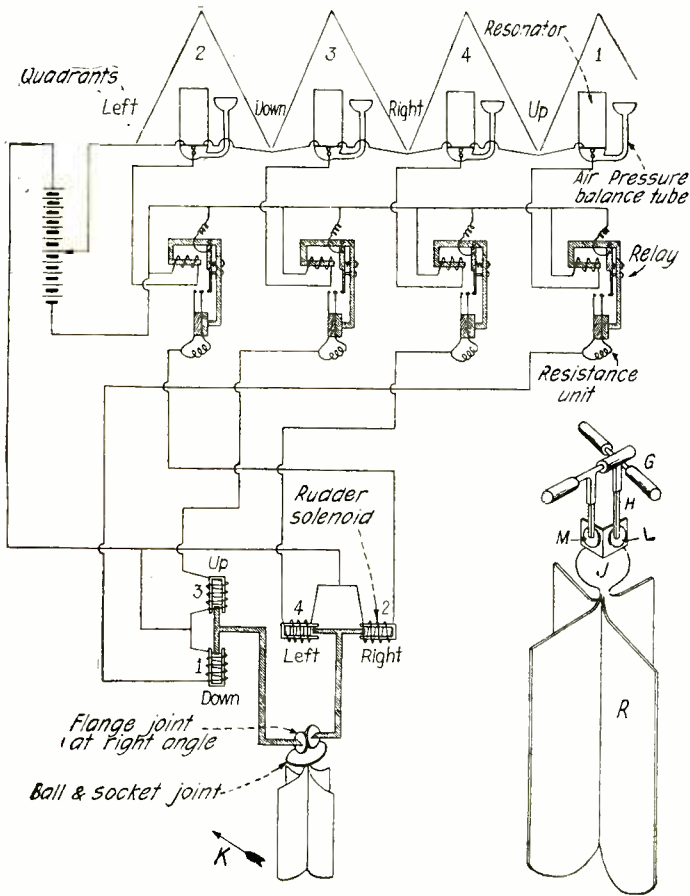

This New Aerial Torpedo Which Follows the Trail of An Airplane As Tenaciously As Does the Proverbial Bull Dog On the Trail of the Unhappy Tramp, Is the Invention of Dr. Sidney Morton Baruch. The Electrical Circuits Shown in Schematic Form at the Left Serve to Show How the Various Resonators or Sound Detectors, Mounted in the Nose of the Aerial Torpedo, Act On Magnetic Relays Which Open and Close the Circuits to the Magnetic Solenoids Controlling the Steering Rudders of the Device.

The Aerial Battle Scene Shown Below in Full Activity Makes Clear Just How the Sound-Attracted Aerial Torpedoes, Once They Have Been Shot From the Earth, Follow the Plane With Deadly Accuracy. The Large Horns Shown in the Lower Right-Hand Corner Serve to Collect the Sound From An Airplane Toward Which They Are Trained, and the Pitch of This Sound Is Accurately and Quickly Measured. The Sound Resonators in the Aerial Torpedo to Be Fired at the Plane Are Then Tuned to the Particular Sound of the Craft to be Attacked—and Away It Goes On Its Winged Mission of Destruction. Every Airplane Has a Different Sound so That the Feasibility of this Scheme Seems Well Substantiated.

The Detailed Drawing (Lower Left-Hand Drawing) of the Baruch "Blood-Hound of the Air" Shows the Liquid Air Storage Tanks and Super-Heater, Together With Liquid Air Turbine for Propelling the Torpedo, as Well as the Electro-Magnetically Controlled Rudders Actuated by Microphones Attached to the Sound Resonators. If the Sound is Strongest from Below Then the Rudders Are Turned so as to Cause the Torpedo to Go in That Direction, and Vice Versa.

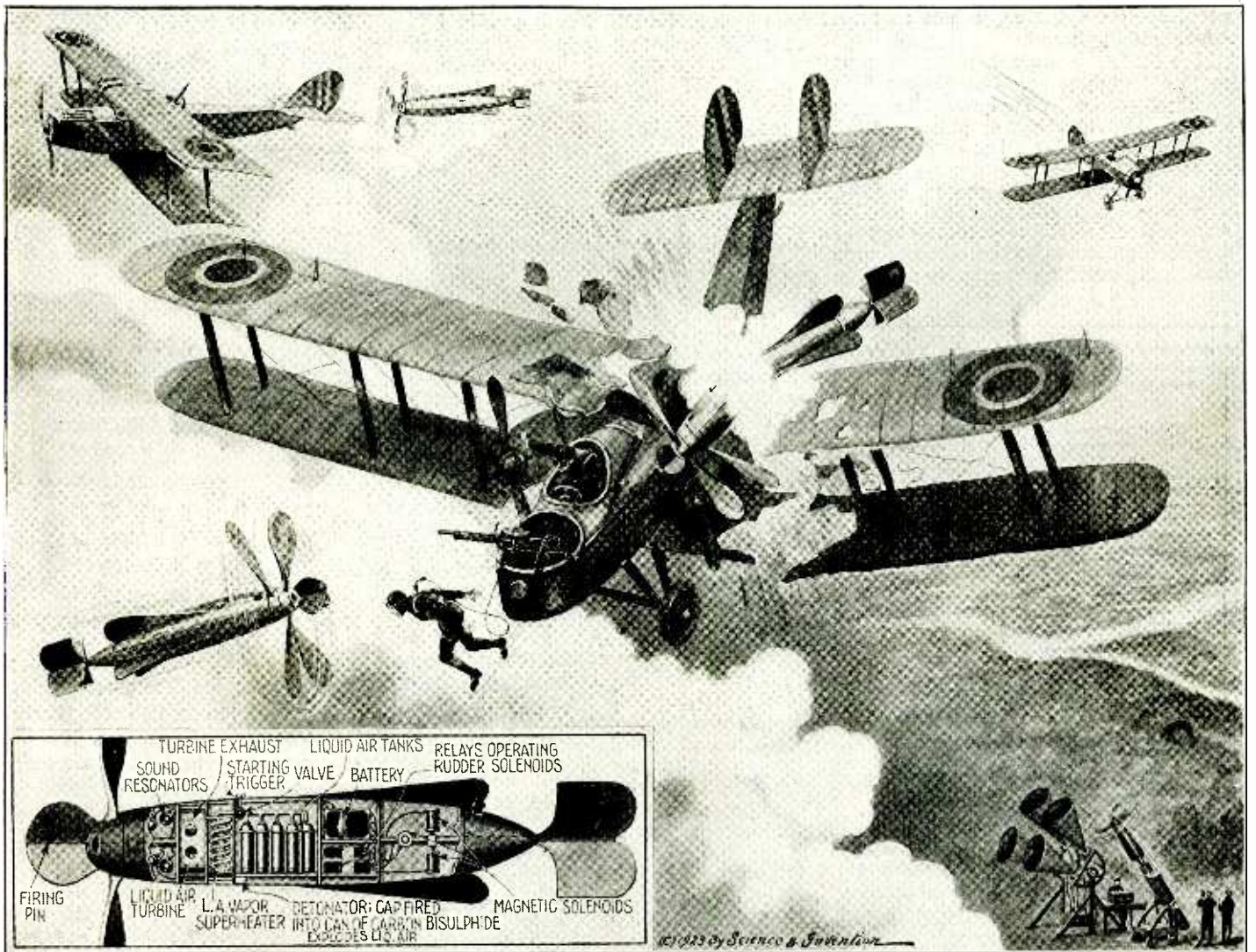



# \$12,000 or More in Prizes

LOOK over this issue of SCIENCE AND INVENTION and get acquainted with its new make-up and new ideas expressed therein. Note particularly that hereafter SCIENCE AND INVENTION will tell its scientific news primarily in pictures. In order to do so, the Editors must have the pictures in the first place. It being impossible for us to collect all the material personally, we have to rely upon our readers, not only for pictures, but for suggestions as to articles to illustrate, hence the prize contest.

Beginning with the January issue, SCIENCE AND INVENTION will pay the sum of \$1,000 or more per month to its readers for one year or longer, for pictures and ideas for illustrations.

A study of this issue will show you what we are aiming to do. You will note that we are trying to make difficult scientific subjects intelligible to the layman. In other words, we claim that any scientific subject can be told in pictures.

If in the future you walk along the street and see something new that has not been described previously, send that idea to us with a sketch, drawing, or photograph, or if you cannot do either, just an explanation of the idea written in intelligible English. We will then make our own illustrations. For every such idea accepted, whether accompanied by a picture or not, we will pay a prize. BUT ALWAYS REMEMBER THAT THE IDEA MUST HAVE SOMETHING TO DO WITH

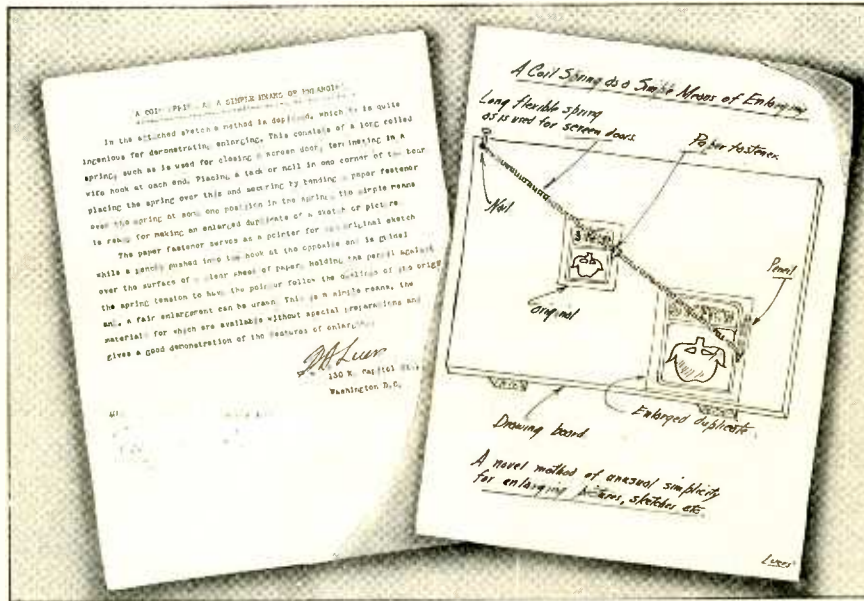

This is an Example of the Way Articles Should Be Submitted. They Need Not Be Typewritten, However.

SCIENCE OR INVENTION. Otherwise it cannot be accepted.

The highest prizes will be awarded for the best suggestions considered from an editorial viewpoint. Second best, third best, et cetera, will be judged in a like manner. A long article is not necessary, nor desired. Illustrations should be accompanied by not more than 500 words, less if possible. If a good picture is to be had, and if you have no camera, it will pay you to borrow one or have a friend or professional take the picture.

What we do not want are ideas that have been published before, either by us or by some other periodical. We must have original matter.

If you know any new experiment; a new wrinkle; a new formulae; write it up with a small sketch, and send it in to us.

All such contributions sent to this Magazine, will be paid for in the form of prizes. Note particularly that every Department will pay a series of prizes for articles accepted for that department. Make a start now—perhaps you will win one of next month's awards.

Some illustrations will require full pages; others will require only one column space 2" high. But so far as the prizes are concerned, it makes no difference if the illustration which represents the idea is printed by us in large or small space. It is the idea that counts in all cases. In the event of a tie for any of the prizes the identical prize will be awarded to each contestant so tying.

A small illustration has just as good a chance to win a prize as a large one. Every illustration will be accompanied by the name of the author. Prizes will be published every month in SCIENCE AND INVENTION. We have so many and varied departments in SCIENCE AND INVENTION that it will be very easy to win.

A few good examples of "How to do it" are shown on this page. Of course, we do not publish the illustrations or the entire text as submitted. Illustrations are redrawn by our artist and the text "boiled down" into a caption.

When submitting an idea, be just as brief

as possible. A few little free hand sketches are often better than 500 words.

Rules of the Contest:

- 1: No article must be any longer than 500 words.
- 2: Contestants may send in more than one contributions there is no restriction as to number.
- 3: All entries must be executed in type or ink; no penciled matter is eligible. Always make sketches on a separate sheet of paper.
- 4: All entries on which no prizes have been awarded, will be returned to contestants, providing return postage is attached.
- 5: All prizes are paid monthly, upon publication.

6: Address all entries to Editor, SCIENCE AND INVENTION, 53 Park Place, N. Y. City.

## \$12,000 or More in Gold!

SCIENCE AND INVENTION magazine, beginning with the JANUARY issue, will pay prizes of \$1,000 or more a month, or \$12,000 for the year.

88 monthly prizes will be given as follows:

FIRST PRIZE		\$100.00
2 PRIZES of \$50.00 each		
10	"	25.00
5	"	20.00
10	"	15.00
20	"	10.00
10	"	5.00
20	"	2.00
10	"	1.00

The closing date for all prize contributions will be the 15th of the month preceding date of issue, i.e., 15th of November for the January number; the 15th of December for the February number, etc. All manuscripts must reach us by this time of the month for the respective issue.

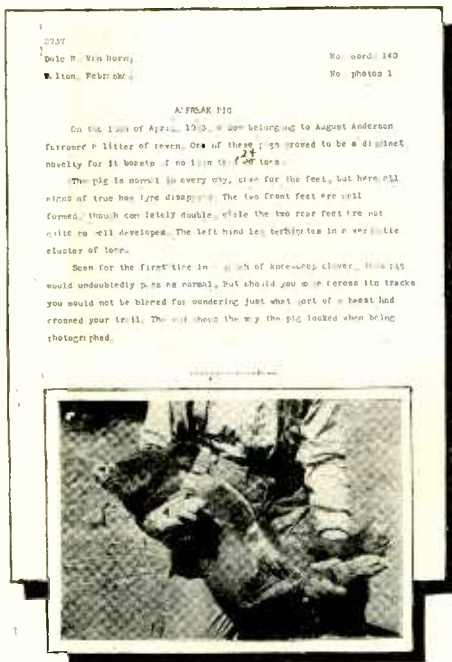

If Submitting Photographs—the Above Illustration Will Show How to Do It.



# World's Largest Falls

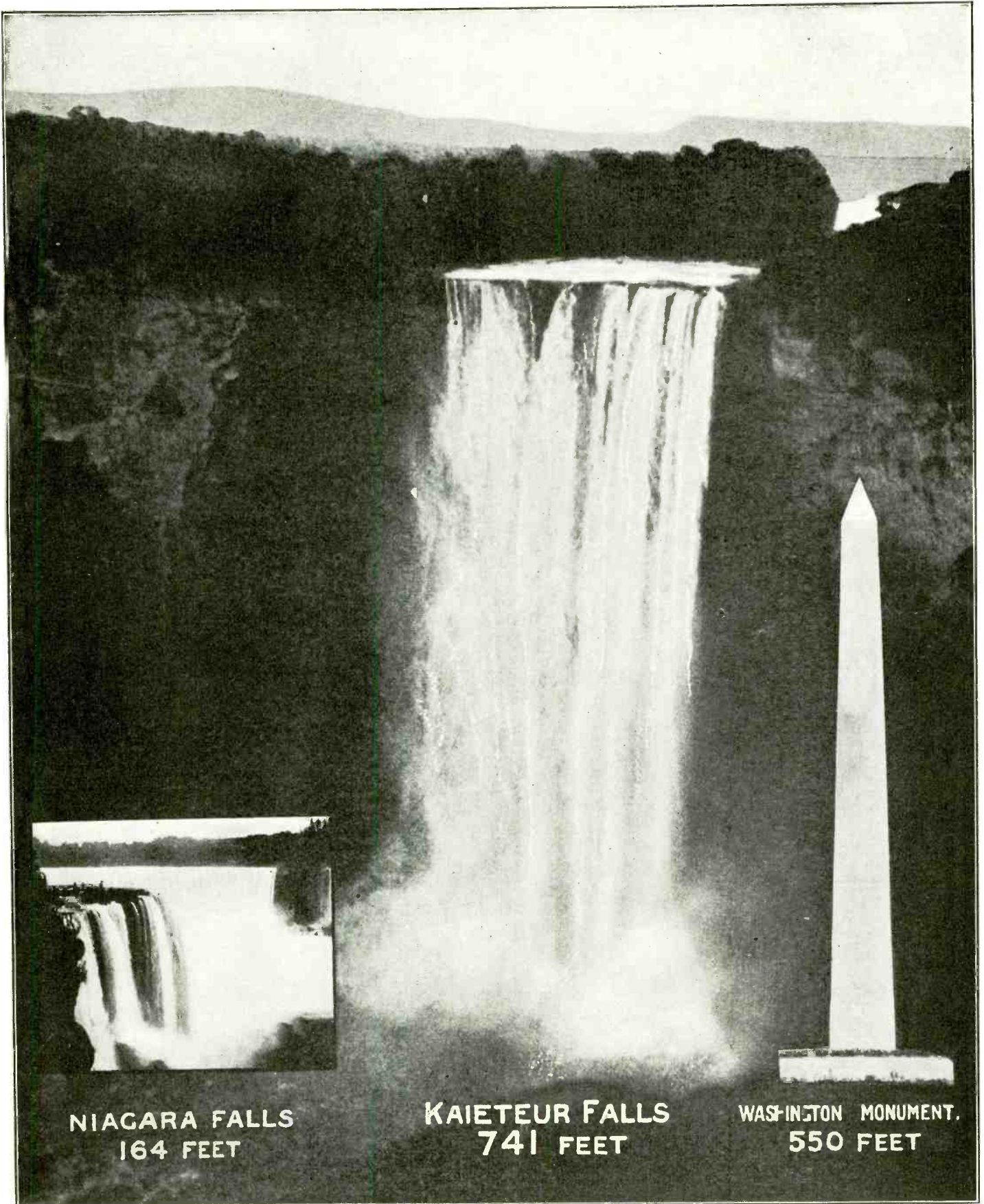

**NIAGARA FALLS**  
164 FEET

**KAIETEUR FALLS**  
741 FEET

**WASHINGTON MONUMENT.**  
550 FEET

Kaieteur Falls, a Great Unharnessed Giant to Engineers and a God to Poets. Lies in the Heart of British Guiana and in the Superb Beauty Becoming the Greatest Waterfall in the World, Serenely Rolls Its Millions of Horse-power Into Nothingness. Towering 741 Feet from Brink to Kettle, it is Taller Than Niagara Put Atop the Washington Monument. If That Isn't Fall Enough;

the River Slopes Off 81 Feet More in the Thousand Feet Below Kaieteur. The Potaro River, Which Tumbles Over This Drop, is 369 Feet Wide, and in Flood Time, the Sheet of Water at the Brink is Fifteen Feet Deep. The Potaro is a Tributary of the Essequibo. Hidden Deep in the Heart of the Jungle, Few White Men Have Seen the Falls, a Sight for the Gods.



# How To Avoid Auto Accidents

By H. WINFIELD SECOR, E. E.

Watch Block Signals. Look and Listen, Signal Bells Do Not Always Work. This Illustration, as Well as the Others Shown Here All Resulted in Fatalities, and All Could Have Been Avoided.

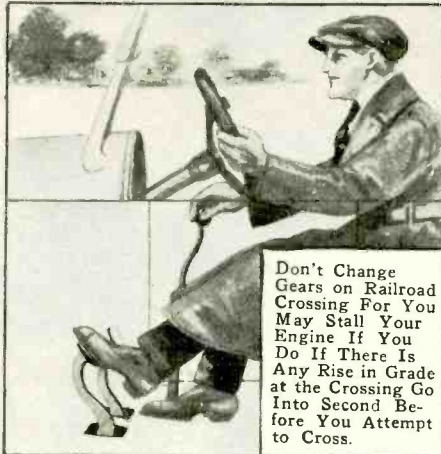
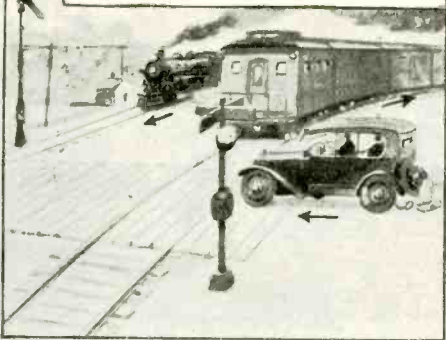

Don't Change Gears on Railroad Crossing For You May Stall Your Engine If You Do If There Is Any Rise in Grade at the Crossing Go Into Second Gear Before You Attempt to Cross.

If Trapped on a Crossing, Which is Sometimes the Case Where the Gates Work Automatically, Don't Be Afraid to Crash Through the Gates. Timber is Cheaper Than a New Car and a Big Doctor's Bill.

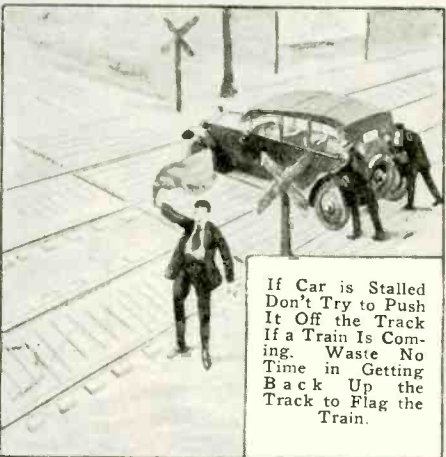

If Car is Stalled Don't Try to Push It Off the Track If a Train Is Coming. Waste No Time in Getting Back Up the Track to Flag the Train.



When Stalled on Hill, If the Brakes Show Signs of Slipping Turn the Steering Wheel So the Car Will Back Into a Ditch or Against a Tree. Don't Attempt to Climb a Hill Without Power.

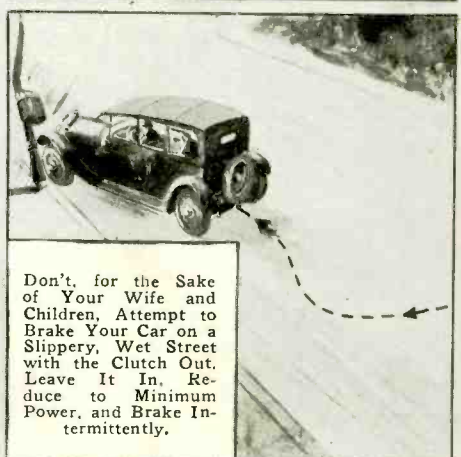

Don't, for the Sake of Your Wife and Children, Attempt to Brake Your Car on a Slippery, Wet Street with the Clutch Out. Leave It In. Reduce to Minimum Power, and Brake Intermittently.



Don't Pass Cars on Hills. If You Do You May Find Out a Lot of Things About the Speed of Cars Coming Down. If You Have a Periscope to See Over the Top, Alright; But if You Haven't, Remember That the Driver Coming in the Other Direction Expects Half the Road to be Clear.



Don't Pass the Car Ahead on a Blind Curve and Not on Any Curve if You Haven't Insurance on Your Life and Car.

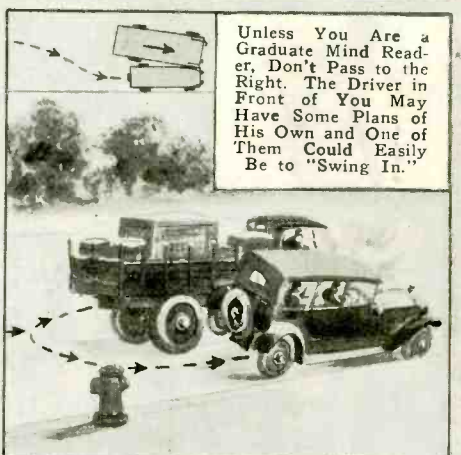

Unless You Are a Graduate Mind Reader, Don't Pass to the Right. The Driver in Front of You May Have Some Plans of His Own and One of Them Could Easily Be to "Swing In."

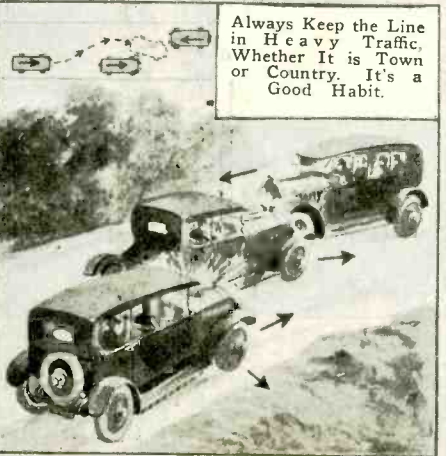

Always Keep the Line in Heavy Traffic, Whether It is Town or Country. It's a Good Habit.



Always Have a Driver in Seat of a Car in Tow. Case Illustrated Here Cost Two Lives When a Tow Line Gave Way and the Dead Car Backed Down the Hill Into the Following Car.



If You Respect Your Radiator You Must Also Respect Trucks. Give Them Plenty of Leeway. Remember, Too, That Buses Take on Passengers at Most Any Corner and That They Pull Up to the Curb for Embarkation.

(c)1923 By Science & Invention



# Our Cities of The Future

By H. GERNSBACK

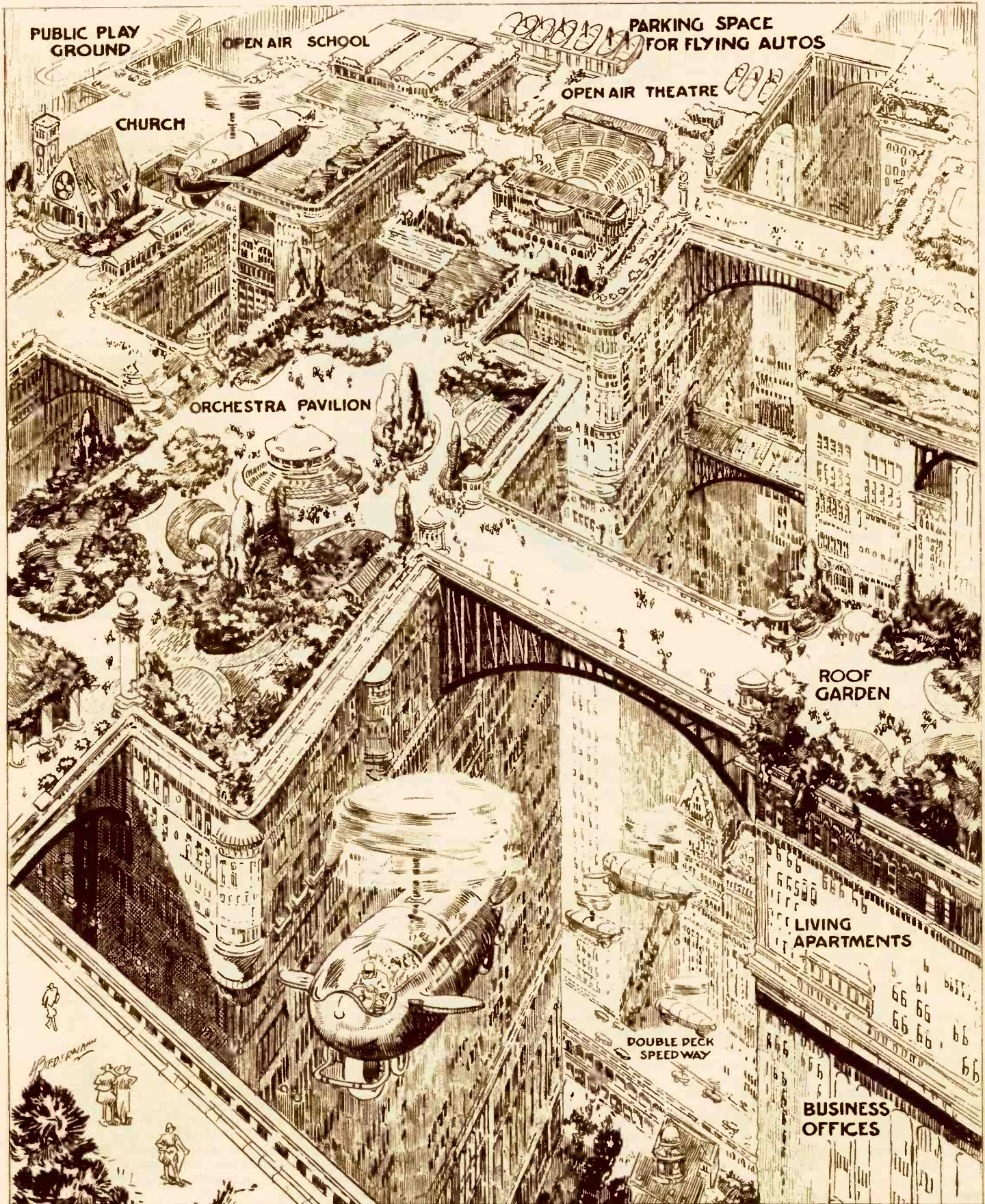

In Europe, as a Rule, People Do Not Travel To and From Business, Taking from 15 Minutes to an Hour on an Average in Doing So. Usually They Live Near Their Place of Business, and Often Just Over Them. The Illustration Shows an American City of the Future Which Will Do Away with the Useless Traveling Which Nearly All of Us Do To-day. At Present, This Travel Means a Huge Loss of Time. It Means Car Fare and Inconvenience. In the Future, the Cities Will Be Laid Out with Business Buildings Covering

Entire Blocks as Seen Above. Atop These Will Be Apartments Where People Will Live. The Parks, Restaurants and Landing Places for Airplanes, Will Be on Top of the Apartments. The Top Levels Will Be Connected by Bridges. The Advantages of This Plan Are so Huge it is Surprising the Idea Has Not Been Tried, as Yet, on a Large Scale. To Be Sure, in New York, There Exists To-day Many Roof Gardens Upon Which Even Large Trees Grow.

©—1923—By Science and Invention.



# Doctor Hackensaw's Secrets

By CLEMENT FEZANDIÉ

No. 21

## Dr. Hackensaw's Trip To the Moon

"How do you do, doctor?" said she. "I'm glad to meet a fellow-passenger."

"My dear young lady," cried the startled doctor. "Who are you, and what in the

Doctor Hackensaw perceived that it would be useless to reason with this obstinate young girl. Pep Perkins was evidently determined to go along with him, and he must make the best of the matter.

The car by this time was revolving with some speed, as the Ferris wheel to which it was attached, was gaining velocity at each revolution. Both parties were obliged to hold tight to special handles arranged along the car.

"Miss Pepita. . . ." began the doctor.

"Call me Pep, please," interrupted the young lady.

"Well, Miss Pep. You don't seem to realize that we shall soon be whirling around in a circle at the rate of seven miles per second, and barely time to secure ourselves in our couches. It would be utterly impossible to hold on to these straps. Besides, in order to avoid the bad effects of the dizziness, I am going to take ether and you must take some, too. We shall thus be asleep when the car is rotating at its greatest speed."

"Then you consent to take me along with you?" cried the young girl, overjoyed, and she impulsively threw both arms around the doctor's neck and kissed him enthusiastically.

Doctor Hackensaw's face softened, and he looked at her with a fatherly gaze, as he muttered to himself:

"Poor girl! She is only a child yet! If we ever get back from this trip. . . ."

But he didn't finish his sentence. Time was too precious.

"Get into your couch, quick!"

said he, "and I'll turn your ether supply on for you. There is just the right amount to keep you asleep until we are shot off."

The young girl obeyed. A moment later the doctor locked himself in his own couch and turned on his personal supply of ether. Then he lost consciousness.

Meanwhile the speed of the wheel, to which the car was fastened, had been gradually increased until it had attained its maximum. And now the chain, which held the car to the wheel, was gradually allowed to unwind from its windlass, so that the car gradually ascended beyond the circumference of the wheel, thus revolving in ever increasing circles. You have seen a boy whirling a weight around at the end of a string, and gradually letting out the string so that the weight turns in larger and larger circles. This was precisely the same thing, but on a greater scale.

Finally, the car had attained the requisite velocity of seven miles per second, and made two or three revolutions at this frightful speed. Then came the decisive moment for which the alarm was set. At the very instant when the chronometer indicated the seventy-third hundredth of the second for which the start was scheduled, the car was automatically released from the chain that held it to the earth, and went shooting off into space!

The spectators who watched it gave an "ah!" of astonishment and dismay as they saw the metal of the external shell become red-hot, owing to the friction of the air as the car passed through the earth's atmosphere, for the car was traveling so fast, that, although the start was made in the

(Author's Note. In my story last month I called attention to a fact which seems to have been overlooked by all previous chroniclers of interplanetary trips,—namely that the direction and velocity of the projectile depend more upon the rotation of the earth on its axis, and the speed and position of the earth in its revolution around the sun, than it does upon the initial force of seven miles per second, with which the car is shot off into space. In the present story I call attention to another overlooked fact, namely that the passenger in the car, during the entire trip, would be apparently freed from the attraction of gravitation.)

(Beg Pardon, Mr. Fezandié as to the latter statement. See "Baron Münchhausen's Scientific Adventures" by H. Gernsback, July, 1915 issue "Electrical Experimenter."—Editor.)

"Is everything ready for the start?"

"Yes, doctor. The last touches have been given and I'll take my oath that everything is in apple-pie order. The wheel will start turning in ten minutes, and the car will be released for its flight to the moon at precisely 27 minutes 31 73/100 seconds past three o'clock. The release will be made automatically when the chronometer reaches this point."

"That's good. An error of a small fraction of a second would mean that my car would miss the moon, and go wandering off into space. But what in the world can be delaying Silas Rockett. He was to have come with me. Ah, here he is!"

As Doctor Hackensaw said these words, the reporter came up breathlessly.

"Doctor," said he, "I'm awfully sorry, but I can't go with you as I expected. My fiancée, Gloria Mundy won't let me! She's afraid to let a handsome man, like me, run loose among the lunar beauties. Besides, she doesn't believe I'd ever get back, and she has no use for a sweetheart two-hundred-and-forty thousand miles away."

Doctor Hackensaw's face fell, for the idea of making the trip alone was by no means a pleasant one.

"Never mind, Silas," said he genially. "It's too bad you can't come, because if the inhabitants of the moon chance to be cannibals, I'm afraid there won't be enough of me alone to make a meal for the royal palace or palates. But never mind. I'll do the best I can without you."

He spoke cheerfully, but it was with a heavy heart that he entered the car that was to bear him on his strange journey. Everything seemed in order, oxygen tanks, provisions, and an ample water supply. Each article was securely fastened, although the internal car was pivoted in an external shell, so as to always remain upright while the car was whirled around at the frightful speed necessary for the start.

Two beds, or rather, two couches had been prepared for the passengers. These were designed for the comfort of the travelers in starting. Doctor Hackensaw absent-mindedly opened the wrong couch—the one intended for the reporter. Imagine his amazement when out jumped a young girl of about twenty, who laughingly held out a hand to him.



Doctor Hackensaw Hesitated a Moment, Then Said: 'Very Well, I'll Open the Window for Just a Second, So as Not to Allow Too Much Air to Escape; be Ready, and Throw the Bag Out Quickly.' Suiting the Action to the Word, He Opened the Casement and the Young Girl Hurlled the Paper Package Forth with All Her Might. Away It Sped as if Shot from a Cannon, and, Lighted Up by the Sun's Rays, it Looked for all the World Like a Shooting-Star.

world are you doing here? Quick, you must get out of this, for the car will start immediately."

"My name is Pepita Perkins," replied the young girl, "but of course all my friends call me 'Pep.' I'm a reporter for the New York Daily Growl. I heard that Silas Rockett wasn't coming with you, so I thought I'd take his place."

"But I can't possibly allow you to come to the moon with me," cried the doctor, aghast. "Quick, let me open the door, or better still, I'll sound the alarm to warn my foreman not to start the car!"

"No you don't!" cried the young lady, throwing herself between him and the door. I'm stronger than you are, doc, so force would be useless. I'm here, and here I'm going to stay. Ah! Here we're starting. It's too late now! You know yourself that if there's the slightest delay now, all your work will be wasted, for your Ferris wheel would no longer be aimed in the right direction, and a new one would have to be built."

It was but too true, as Doctor Hackensaw well knew. Still he tried one more appeal.

"My dear young lady," he pleaded. "Don't you realize the danger? The chances are that we won't reach the moon alive, and even if we do reach it, we shall probably never come back. And think of your reputation. Think of the scandal that will be attached to your name for having come alone with me on this wild trip!"

"It will make a dandy sensational story for the Daily Growl," replied the young lady, with a toss of her pretty head. "Gee! It'll be the scoop of the season!"



rarefied air of a high mountain, the resistance of this air was enormous during the first second of flight, and not only retarded the velocity of the car considerably, but produced an intense heat. Luckily the doctor had provided for this by means of refrigerating agents in the walls, and by others that played on the outer shell. Otherwise serious damage would have been done, both to the car and its occupants. After the first few seconds of flight, however, the air became so rarefied as to be negligible.

In a very short time the car itself was out of sight, but astronomers followed the new meteorite with their telescopes, for even after it lost its heat, it still shone in the heavens, as a planet shines, by reflecting the light of the sun. The newspapers reported its progress hour by hour, and that night the *New York Daily Grawl* issued an extra with a wireless message from the occupants of the car. The article was headed: "Lady Passenger in the Car for the Moon"—It was the scoop of the season, and the circulation of the paper rose to an unprecedented height.

Meanwhile, what was happening in the car? "Pep" was the first of the two passengers to awaken. She opened the top of her couch and looked out. In spite of the doctor's precautions she felt dizzy and nauseated from the rapid spinning she had undergone. After a few moments, however, she felt a little better, and grasped a handle

to pull herself to a sitting position. Luckily she held fast to the handle, for, to her surprise, her body kept rising, and soon her feet were in the air and her head downward, while she clung frantically to the berth. It was not difficult, however, to pull herself down again.

"Gee!" she cried, "that's funny! I must have slept two or three days, and we're now at the spot between the earth and the moon where there's no gravitation. I must wake up the doctor."

As she said the words, the cover of the doctor's couch slowly opened, and that worthy looked out. He, being older, had suffered even more from the dizziness than the young lady. It took him some minutes to recover from his daze. Then he attempted to rise from his couch. But he neglected to hold on to the handle, and up he shot to the top of the car, spinning around in a circle as he rose.

For the life of her, Pep could not help laughing as she watched these strange antics and saw the poor doctor strike the top of the car, and then bounce down again like a rubber ball. Twice up and twice down he went before Pep was able to catch hold of him to stop his flight, and then, inadvertently relaxing her own grip on the handle, she was carried up with him on the rebound. Round and round went the pair, clinging to each other, and revolving as they rose. These acrobatics would have con-

tinued for quite a while, had not Pep been dexterous enough to catch hold of a handle at the third trip, and thus brought them both to a stop.

"Gee!" said she, "that's queer! I had no idea things would act like this when they had no weight! Where are we now, doc?"

Doctor Hackensaw had finally managed to gather his wits together, and, replied: "I can't see the telemeter from here. This is the instrument that tells our distance from the earth. But I think, if you move carefully, you can swim up slowly through the air and take a look at the dial. I'm too giddy to try it myself."

Pep tried the experiment, and found that by relying only upon the movements of her hands, without any initial push, it was easy to swim through the air in any direction, though her arms at first went like windmills, for the speed of each motion, now that her body had no weight, was about sixteen times as great as it would have been under normal conditions. However by slowing down her efforts, she avoided this, and reported that the dial indicated 5987 miles from the earth.

"How does this instrument work?" she asked.

"I had my choice of several methods," replied the doctor, "but selected this as the simplest. An automatic wireless signal is sent me from my laboratory every second. (Continued on page 597)



© 1923, By Science and Invention.

Twice up and Twice Down He Went Before Pep Was Able to Catch Hold of Him to Stop His Flight, and Then, Inadvertently relaxing Her Own Grip on the Handle, She Was Carried Up with Him on the Re-

bound. Round and Round Went the Pair, Clinging to Each Other, and Revolving as They Rose. These Acrobatics Would Have Continued for Quite a While, Had Not Pep Caught Hold of a Handle at the Third Trip.



# Around the Universe

By RAY CUMMINGS

4TH INSTALLMENT

## CHAPTER VI (Concluded)

THE audience was held in front of the vehicle, with Tubby, Sir Isaac and Ameena sitting on the floor in its doorway while a circle of guards kept back the crowd of giants that had collected. Within this circle the Great Mogul and his four Wisest Men stood.

Tubby felt as though he weighed over four hundred pounds—which indeed was the case; and his companions in proportion.

"It's just like being a Lilliputian in Gulliver's Travels," he whispered to Sir Isaac as the Great Mogul knelt down to see him more closely. Tubby was struggling for breath; a great

weight seemed compressing his chest his head was ringing his eardrums felt as though something

were pushing them inward—all, as Sir Isaac had explained an hour before, because of the excessive pressure of the Jovian atmosphere. It was most disagreeable. And especially it was unpleasant to be nailed down by one's own weight—to be forced to interview the greatest monarch of the Solar System in an undignified sitting posture on one's own doorstep!

"Saturn, a Globe Almost as Large as Jupiter and with its Marvelous System of Rings Very Much Larger, at This Proximity Was a Magnificent Sight. As Viewed from the Vehicle's Present Position, the Concentric Rings—the Inner One Somewhat Darker — Were Opened Up to an Angle of Nearly Thirty Degrees—a Glistening, Gleaming Silver Band, Like the Broad Brim of a Crownless Hat Encircling the Planet. It Was a Most Glorious Sight."





Sir Isaac beamed when Tubby made his remark about the Lilliputians. "Ah, so you have read my 'Gulliver's Travels?'" There was a book! If I do say it myself, my scientific conceptions in that were—" "Sh!" Tubby whispered. "He's talkin' to us!"

Tubby noticed suddenly that the Great Mogul and all his followers had very big, flat feet—shaped like snow-shoes—as though they were meant for walking on very soft surfaces. They—

The Great Mogul was talking in a huge, roaring voice. The words were strange, unintelligible.

Sir Isaac smiled with embarrassment; and shook his head. "Too bad," he whispered to Tubby. "I ought to know their language—but I don't. You see I've never written much about Jupiter. I—"

A little Jovian stepped forward—a stoop-shouldered, weazened individual no more than nine or ten feet tall. By his face he might have been two or three hundred years old. He looked more like a giant mummy than a man.

"I speak your Earth-language," he said. "All of them—the languages of the Solar System are my study."

Tubby felt impressed. He whispered to Sir Isaac:

"Looks like he'd been studyin' too much, don't he? Mean lookin' guy, huh perfessor?"

The Interpreter added: "His Supreme Highness demands that you explain your mission."

Sir Isaac did so, respectfully but eloquently outlining the nature of the disaster that threatened the Earth from Mars and Mercury, and ending by pleading most

SYNOPSIS OF THREE PRECEDING INSTALLMENTS OF "AROUND THE UNIVERSE."

WHILE watching a game of cards "Tubby" suddenly finds himself out in the open under the stars. He also finds that he has been endowed with a power of wishing and having his wishes come true. He wishes that he could know all about the stars and astronomy and there appears before him a man who introduces himself as Professor Isaac Swift DeFoe Wells-Verne. The Professor tells "Tubby" that he will teach him all about astronomy. Tubby then wishes that he could travel everywhere in the universe and before them appears a space flyer which Sir Isaac says is his invention. They start for Venus.

Landing on Venus, they meet a young lady whose name is Ameena. She tells them that the earth is in danger. Her people have found out that the Martians are about to descend upon the Earth and conquer it. Emissaries from both Mars and the Twilight People of Mercury, as the latter are going to assist the Martians, have been to Venus and tried unsuccessfully to enlist the aid of the Venusians. She says that the armies of Mars and Mercury have already conquered the Moon and placed outposts there.

The Professor decides that they must go for help to the Light Country located on Mercury, as its inhabitants are not going to enter into the war.

The people inhabiting the Light Country of Mercury refuse to assist the people of the Earth in the threatening War. After an altercation with the King of the Light Country, the space Travelers go back into their machine and launch forth into space.

The voyagers decide to travel to Jupiter and solicit aid of the inhabitants. They head toward Jupiter and come upon it on the hot side which is still in a molten state. However, they circle around the planet and land upon the solid side. Upon landing they are granted an audience with the Great Mogul of Jupiter at 12 o'clock noon, Earth Eastern time.

earnestly that the great Jovians lend their aid to the Earth to prevent so murderous an attack.

The Interpreter turned to his master and translated. When he had finished, the Great Mogul laughed!

The three voyagers knew then, before an answering word was spoken, that their mission to Jupiter was a failure. They had made their plea—the lives of all the teeming millions of people of the Earth were at stake—and the Great Mogul laughed!

"That dirty, mean—" Tubby would have broken into open villification, but Sir Isaac stopped him.

The Great Mogul was now speaking to his Interpreter.

"His Supreme Highness the Great Mogul is extremely sorry," said the Interpreter a moment later.

"Yes, he looks it," This from Tubby.

The Interpreter's face darkened as he repeated this sarcasm to his master. A torrent of passionate anger swept over the Great Mogul's face. The Interpreter listened to his words a moment; then, in translating them his anger made him lapse into an Earth-colloquialism more expressive than elegant.

"His Supreme Highness says all you little worlds can shoot yourselves to Hell for all *He* cares," said the Interpreter.

Tubby tried belligerently to rise to his feet, but his weight made the effort a lamentable failure.

"We're sorry," Sir Isaac shouted at once. "Tell His Highness we meant no offense. . . . These Jovians are most hot-tempered people it would seem." He added this last to Ameena in an undertone.

(Continued on page 604)

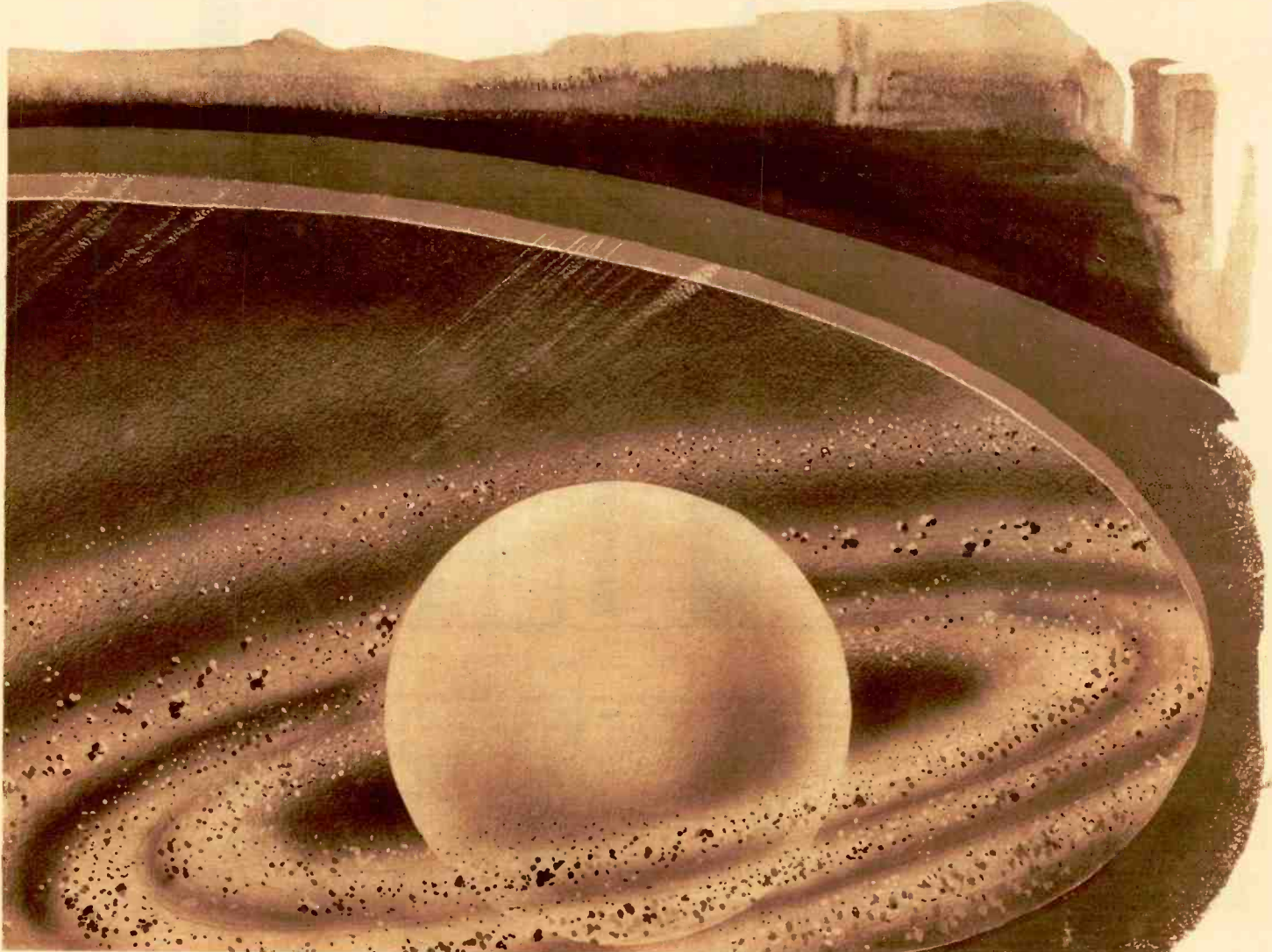



# Sky-Scraper To Tower 80 Stories

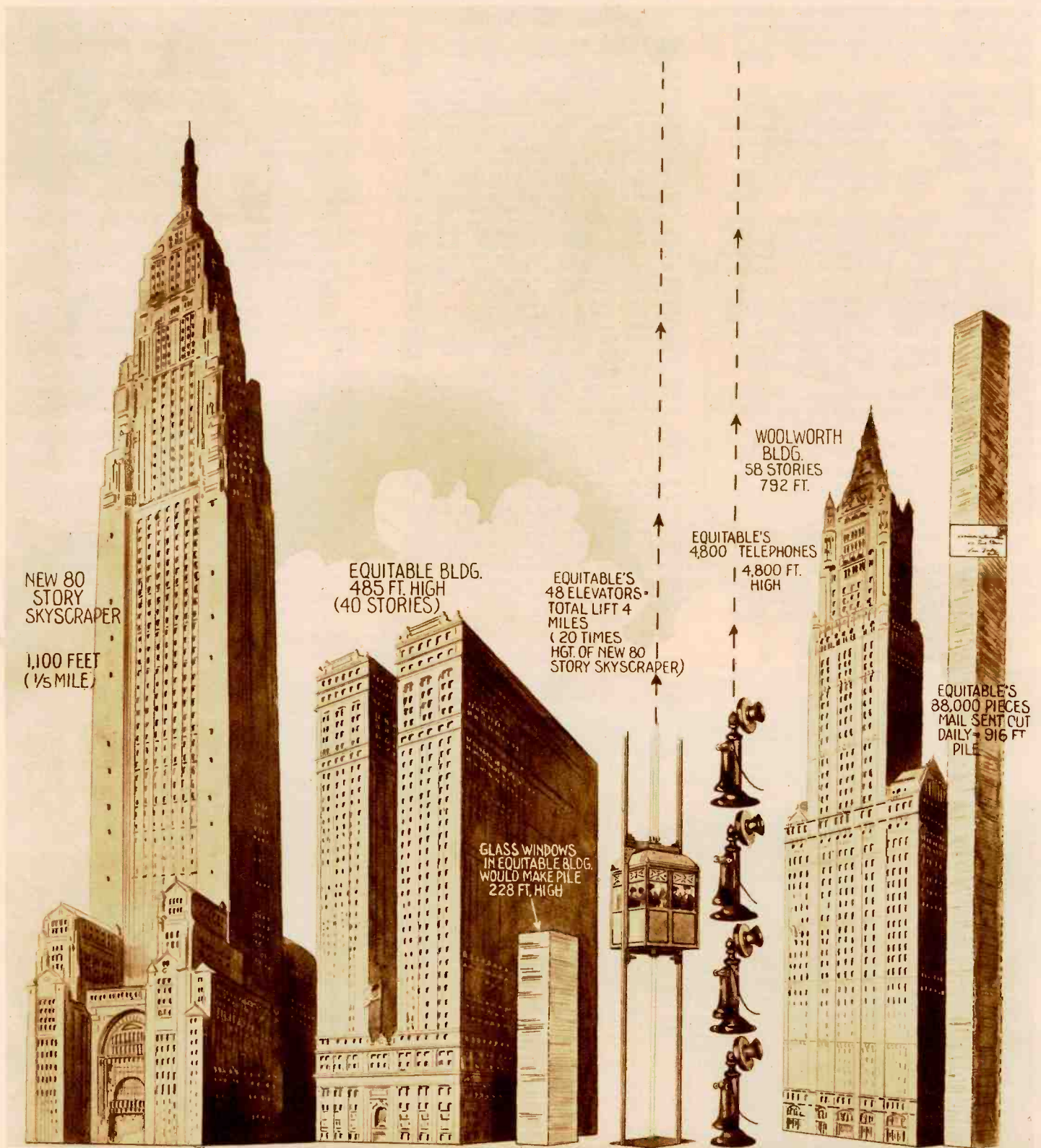

With the Announcement of Plans, Drawn by Bertram Grosvenor Goodhue, for the Erection of an Eighty-Story Office Building to be Built on the Site of Madison Square Garden, New York, Some of the Problems of Caring for Such a Building After Construction Are Illustrated Here. When Built, the Tall Central Tower Will Reach 1,100 Feet Into the Air, Nearly a Fifth of a Mile Above the Street Level. It Will, of Course, be the Largest Office Building in the World.

The Illustration Shows It Compared with the Two Other Large Buildings, The Woolworth and the Equitable. Each Day, 88,000 Pieces of Mail Fall Through the Chutes That Run From the Top to the Bottom Floors of the Equitable Building. Were They Stacked in One Huge Pile, the Resulting Stack Would Tower 916 Feet Into the Air, or 124 Feet Higher Than the Woolworth Tower. The 14,000 People Who Daily Earn Their Bread in the Equitable Building Talk Over 4,800 Feet of Telephones—That is, They Would if the Telephones Were Stacked.

The Ordinary Desk Instrument is just a Foot Tall. There Will Have to be Quite a Few Elevators in the New Skyscraper, Too. Every Time the Forty-eight Elevators of the Equitable Building Make a Complete Trip They Rise a Total Distance of Four Miles. More than 90,000 People Use These Cars Every Day.

The Equitable Still Remains the Largest Office Building in That It Houses the Greatest Number of Persons. The Glass in Its Windows, if Stacked, Would Reach a Height of 228 Feet. Ten Men Wash Them But They Never Get Through. Before They Get Clear Around the First Ones Are Ready for Another Bath. The Foundations Upon Which the New Building Must Rest Will Need a Great Deal of Attention. The Equitable Foundations Go Ninety Feet Below the Surface of the Street and the Piles That Hold the Woolworth Tower Are Sunk 110 Feet Into the Ground.



# Smoke to Hide Bombing Planes

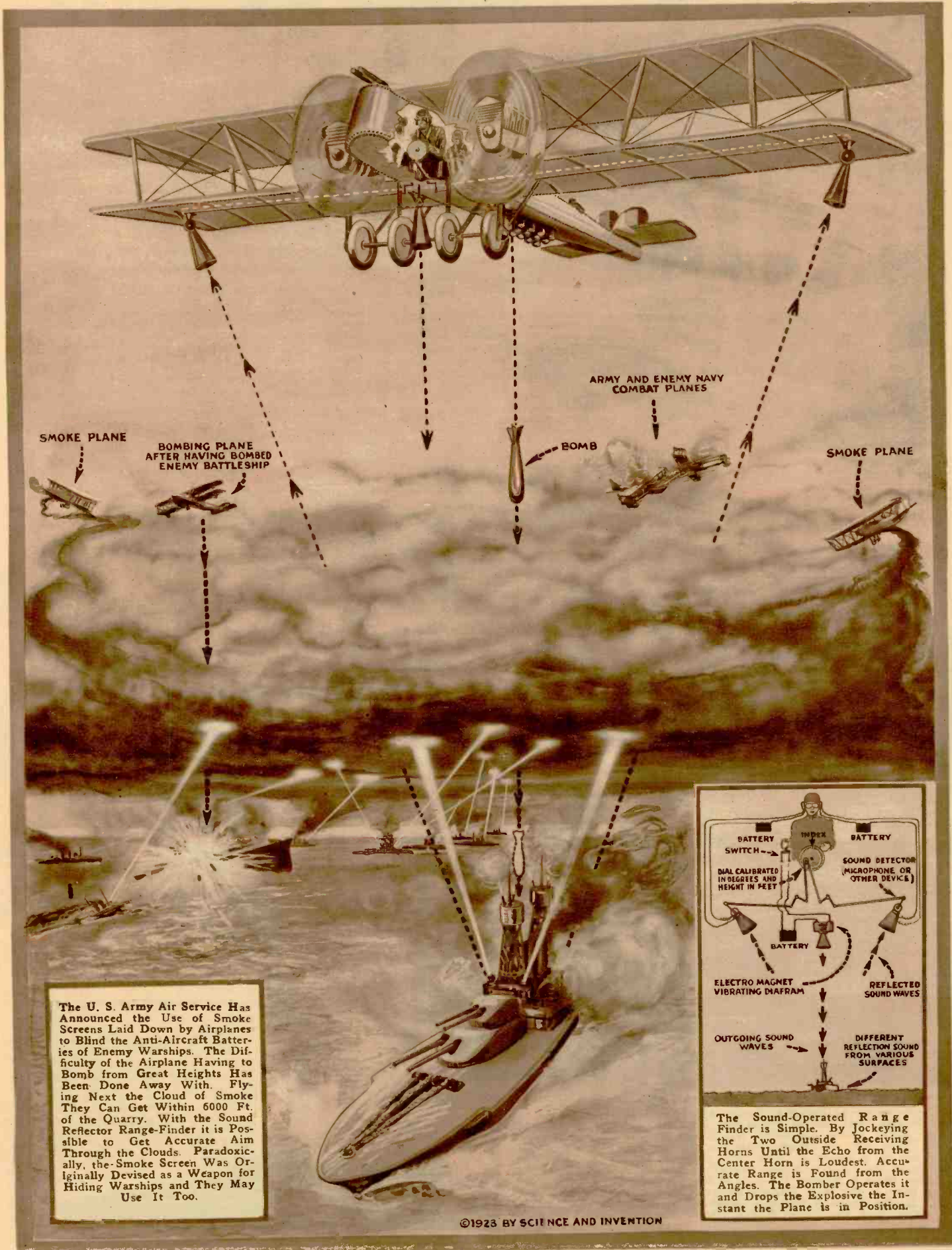

SMOKE PLANE

BOMBING PLANE AFTER HAVING BOMBED ENEMY BATTLESHIP

ARMY AND ENEMY NAVY COMBAT PLANES

BOMB

SMOKE PLANE

The U. S. Army Air Service Has Announced the Use of Smoke Screens Laid Down by Airplanes to Blind the Anti-Aircraft Batteries of Enemy Warships. The Difficulty of the Airplane Having to Bomb from Great Heights Has Been Done Away With. Flying Next the Cloud of Smoke They Can Get Within 6000 Ft. of the Quarry. With the Sound Reflector Range-Finder it is Possible to Get Accurate Aim Through the Clouds. Paradoxically, the Smoke Screen Was Originally Devised as a Weapon for Hiding Warships and They May Use It Too.

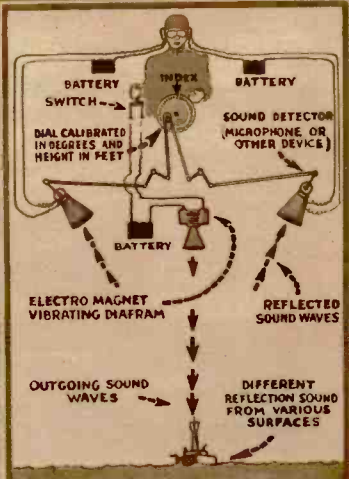

The Sound-Operated Range Finder is Simple. By Jockeying the Two Outside Receiving Horns Until the Echo from the Center Horn is Loudest, Accurate Range is Found from the Angles. The Bomber Operates it and Drops the Explosive the Instant the Plane is in Position.

©1923 BY SCIENCE AND INVENTION



# Mt. Etna, Destroyer of Cities

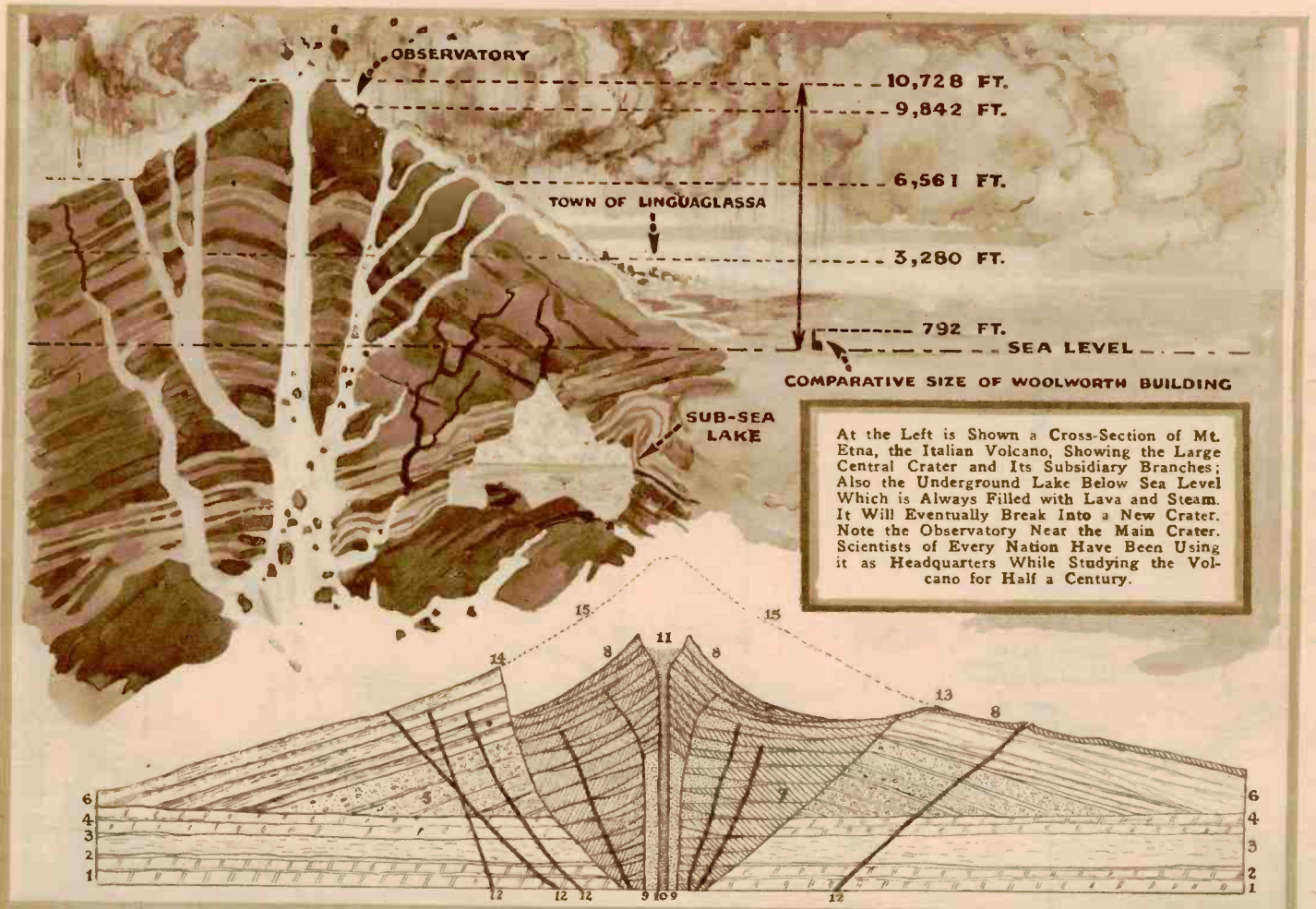

At the Left is Shown a Cross-Section of Mt. Etna, the Italian Volcano, Showing the Large Central Crater and Its Subsidiary Branches; Also the Underground Lake Below Sea Level Which is Always Filled with Lava and Steam. It Will Eventually Break Into a New Crater. Note the Observatory Near the Main Crater. Scientists of Every Nation Have Been Using it as Headquarters While Studying the Volcano for Half a Century.



In this Diagrammatic Cross-Section of Vesuvius the Strata (1) to (6) Are Prehistoric and at One Time Submarine, (7), the Great Crater of A. D. 79, (8) to (11), Modern

Lava Beds and Craters, (12) Fissures and "Blowholes," (15), the Original Mountain. The Crater (10) is Always Open, While (9) Opens Only in Great Eruptions.

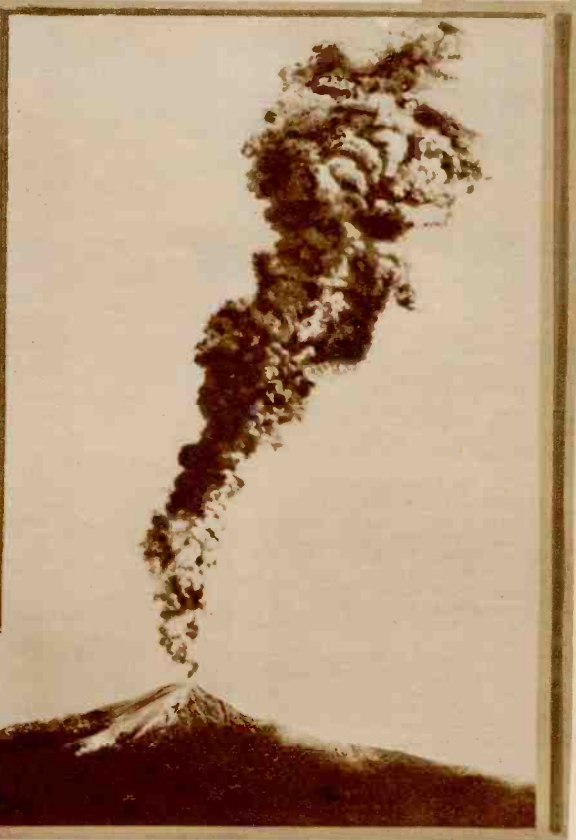

Etna is Shown in Full War Glory (Above) as He Was Last Spring When His Few Days of Playfulness Destroyed a Dozen Towns and Left 50,000 People Homeless. The Clouds Are Composed of Steam and White Ash. For Weeks After the Eruption This Fine Ash Filled the Air for a Radius of Fifty Miles or More Around the Mountain. Although the Lava is Molten and White Hot as it Comes from the Crater, When it Reaches the Foot of the Mountain it is Like a Moving Bank of Hot Mud Pushing Everything, Including Towns, Before it. At the Right is Shown a Smoke Column Several Miles High Floating from the Crater During One of the Less Active Periods.



# John Doe--His Fingerprint

By FAIRFAX PROUDFIT WALKUP

NAME Albert Holland,	CLASSIFICATION 1 - U - 00 --- 16			
ALIAS	FORMULA 3 - - - 00 --- 14			
NO. 3064	COLOR White.			
1. RIGHT THUMB	2. R. FORE FINGER	3. R. MIDDLE FINGER	4. R. RING FINGER	5. R. LITTLE FINGER
6. L. THUMB	7. L. FORE FINGER	8. L. MIDDLE FINGER	9. L. RING FINGER	10. L. LITTLE FINGER
Plate Impressions of the Four Fingers Taken Simultaneously Plate Impressions of the Four Fingers Taken Separately				
LEFT HAND				
RIGHT HAND				
Taken by Paul N. Waggener,	Date Dec. 21, 1918.	Prisoner's Signature		
Classified by Paul N. Waggener,	Date Dec. 21, 1918.	<i>Albert Holland</i>		
Revised by Paul N. Waggener,	Date May 28th, 1920			

NAME Abner Holland,	CLASSIFICATION 1 - U - 00 --- 16			
ALIAS	FORMULA 3 - - - 0 --- 17.			
NO. 3346.	COLOR White.			
1. RIGHT THUMB	2. R. FORE FINGER	3. R. MIDDLE FINGER	4. R. RING FINGER	5. R. LITTLE FINGER
6. L. THUMB	7. L. FORE FINGER	8. L. MIDDLE FINGER	9. L. RING FINGER	10. L. LITTLE FINGER
Plate Impressions of the Four Fingers Taken Simultaneously Plate Impressions of the Four Fingers Taken Separately				
LEFT HAND				
RIGHT HAND				
Taken by Paul N. Waggener,	Date January 8, 1920	Prisoner's Signature		
Classified by Paul N. Waggener,	Date January 8, 1920	<i>Abner Holland</i>		
Revised by Paul N. Waggener,	Date May 28th, 1920			

Above Are the Finger Prints of Albert Holland, Twin Brother of Abner Holland, of Memphis, Tennessee. Compare His Finger Prints with Those of Abner on the Left.

Above We Have the Finger Prints of Abner Holland and While There is a Difference in Them the Primary Classification is the Same, a Thing Never Recorded for Twins Before.



Look Sharply at the Picture of Albert Holland and See What Kind of a Detective—or Rather "Character Reader"—You Are. Compare This Photograph with That on the Right of Albert Holland.

Well, Folks, We Have to Tell You the Sad Story that Abner Holland Above is the "good boy" of the Twins. They Have a Most Striking Resemblance in Both Facial Appearance and Contour.

## WILL YOU BE OUR REPORTER?

IN connection with our \$12,000.00 prize contest announced elsewhere, it goes without saying that you will have to hustle to win a prize. The Editors do not wish to make it hard for you; quite the contrary. We want the pictures and want them badly. Herewith is reproduced our reporter's card. We shall be glad to send it to anyone who makes an application. By means of this card, you will be able to secure entré into industrial plants, business houses, motion picture studios, steamships, mines, etc. This card will prove an open sesame to you in many instances. Each card is numbered and only one is given to a correspondent. A postal card from you and a request for this reporter's card is all that is necessary for obtaining one. It will be sent you by return mail. Address Field Editor, SCIENCE AND INVENTION, 53 Park Place, New York City.

REPORTER

### Science and Invention

CORRESPONDENT  
REPORTER'S  
IDENTIFICATION

NO. 999

*John Doe*

THE BEARER OF THIS CARD IS AN AUTHORIZED CORRESPONDENT-REPORTER OF SCIENCE and INVENTION MAGAZINE THE PUBLISHERS OF SCIENCE AND INVENTION WILL APPRECIATE ANY COURTESY EXTENDED THEIR REPRESENTATIVE.

EXPERIMENTER PUBLISHING CO.  
*H. G. Falk*  
PRESIDENT

(over)



# A Flaming Log Sign

By JAMES E. ATHERTON

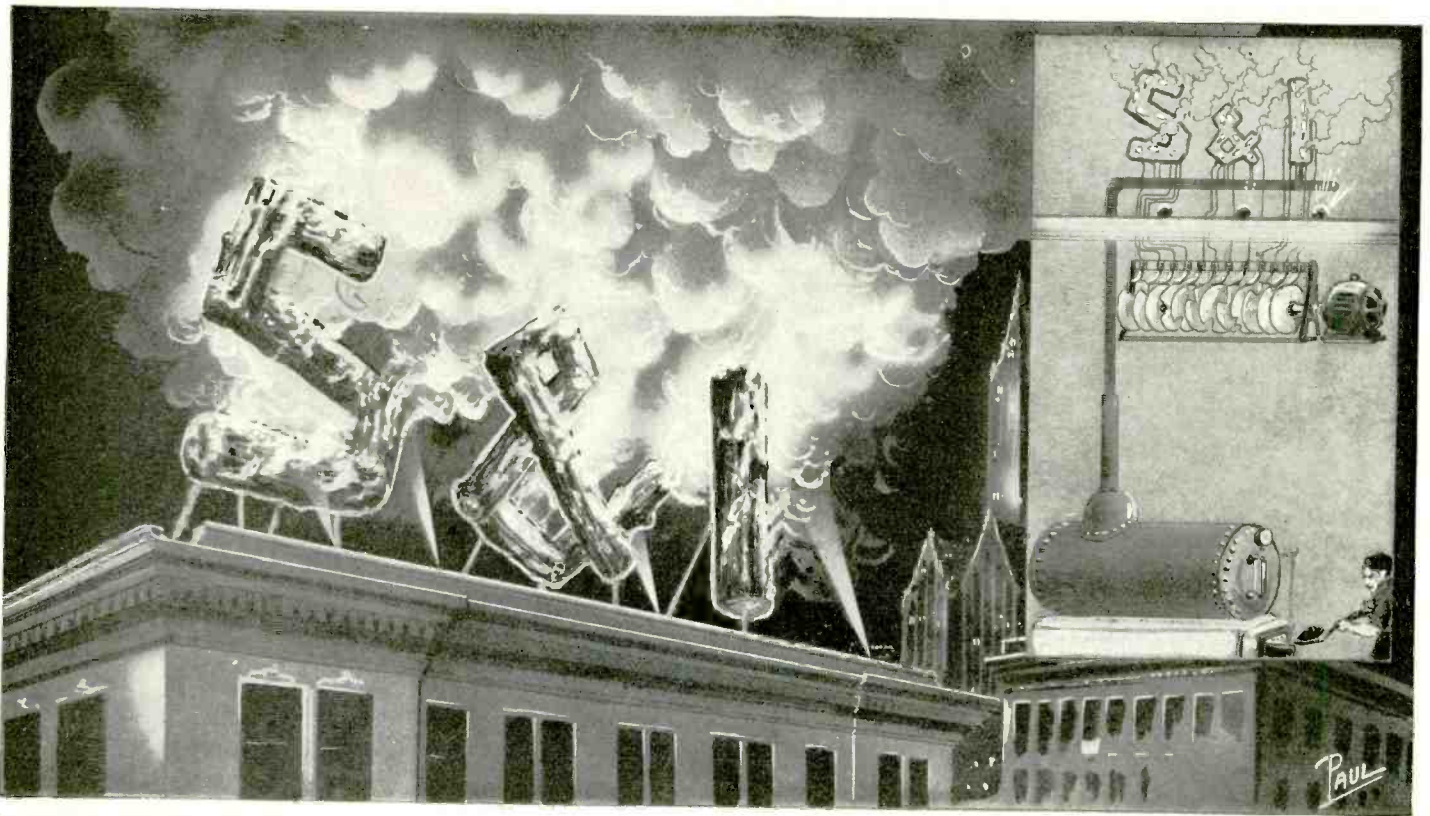

Flaming Advertisement Shown Above and Likewise Illustrated on the Cover of This Magazine, is One of the Cleverest Advertising Signs Patented. It Consists of Logs Made of an Amber-Colored Glass, in Which Incandescent

Lamps Are Located. Slits in the Glass Permit Steam to Pass Out Through the Logs, Which Steam is Illuminated by Colored Floodlights. The Lamps Within the Sign are Flashed on and Off by a Regular Flasher. This is the Invention of Jose De Elorza, of Madrid, Spain.

# Magnet Holds Auto While Globe Spins

By MARGARET REISS

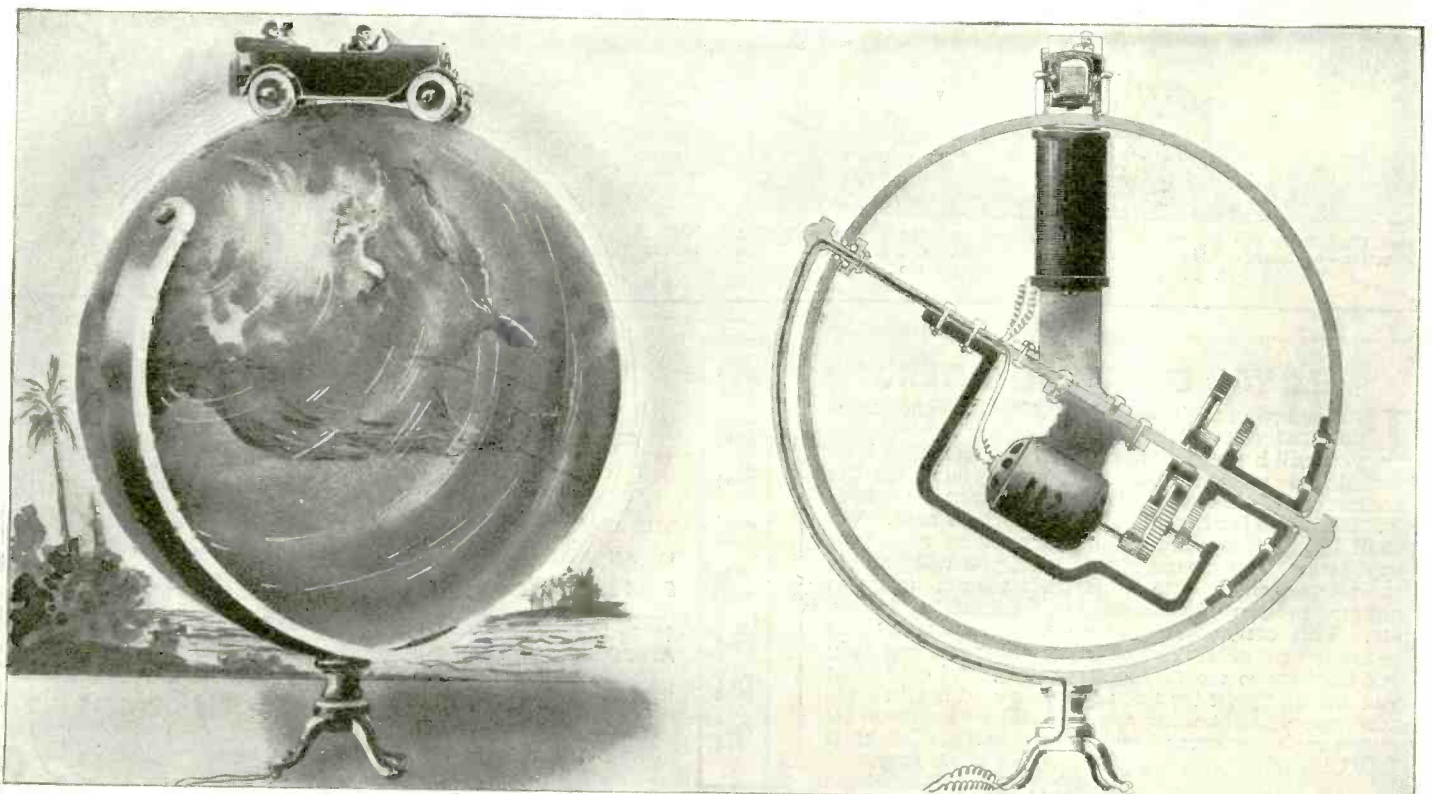

The Advertising Novelty Illustrated Above, is Bound to Attract Attention in Any Store Window, For Regardless How Rapidly the Earth Moves Beneath the Car, the Automobile Maintains its Position on the Surface. Looking

Into the Earth, We Find the Reason. A Large Magnet, Constantly Stationary, Holds the Miniature Machine Against the Surface of the Globe Rotated by a Concealed Electric Motor. Patented by Thomas G. Craver.



# Weird Shenandoah Caverns

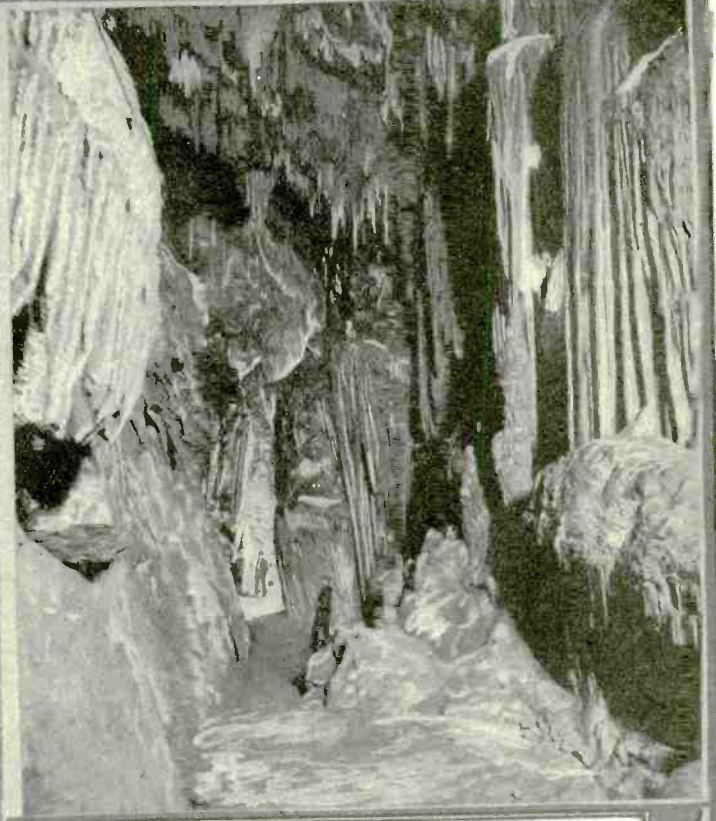
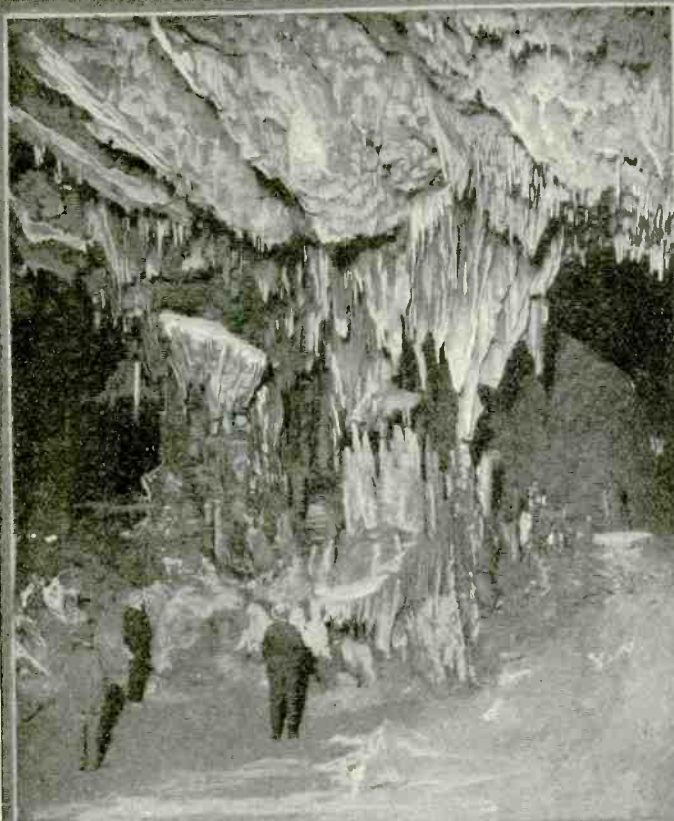

This Flashlight Was Taken In the Persian Palace, of the Caverns of Shenandoah, Virginia. Note the weird Formations.—Photo By Hiserman.

The Tower of Babel, (Grottoes of Shenandoah, Virginia), in the Background is Three Times the Size of Any Known Stalactite Formation in the World.

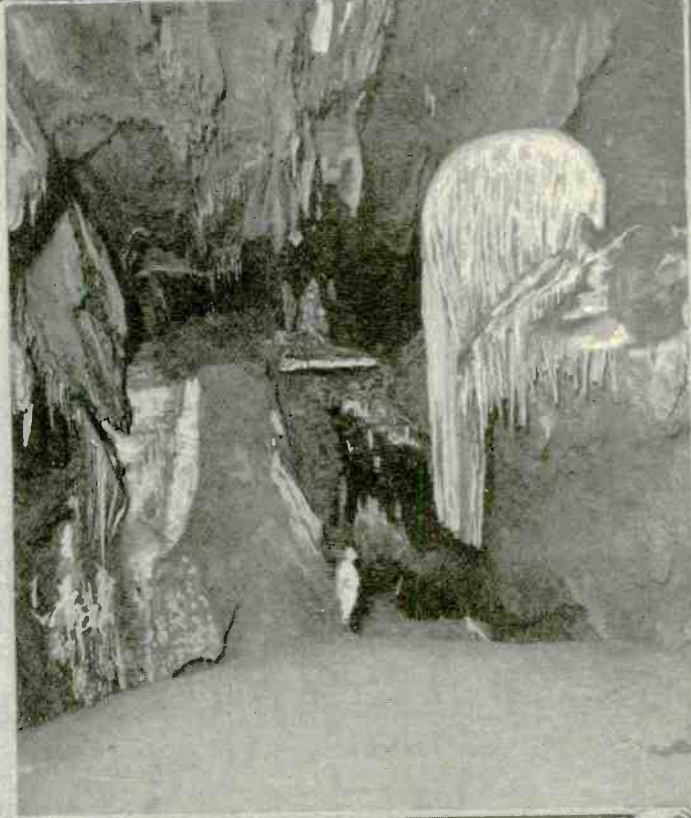

The Luray Caverns in Virginia Have Been Estimated to be Over 2,000,000 Years Old. It required 120 years to Form One Cubic Inch of This Stalactite Formation — Photo © D. Strickler.

Grottoes of Shenandoah, Virginia. The Lime Water Has Dropped From the Top of the Cave Onto This Point Forming a Perfect Oval and Then Running Down the Side Making a Veil.



# Oddities Of Our Body

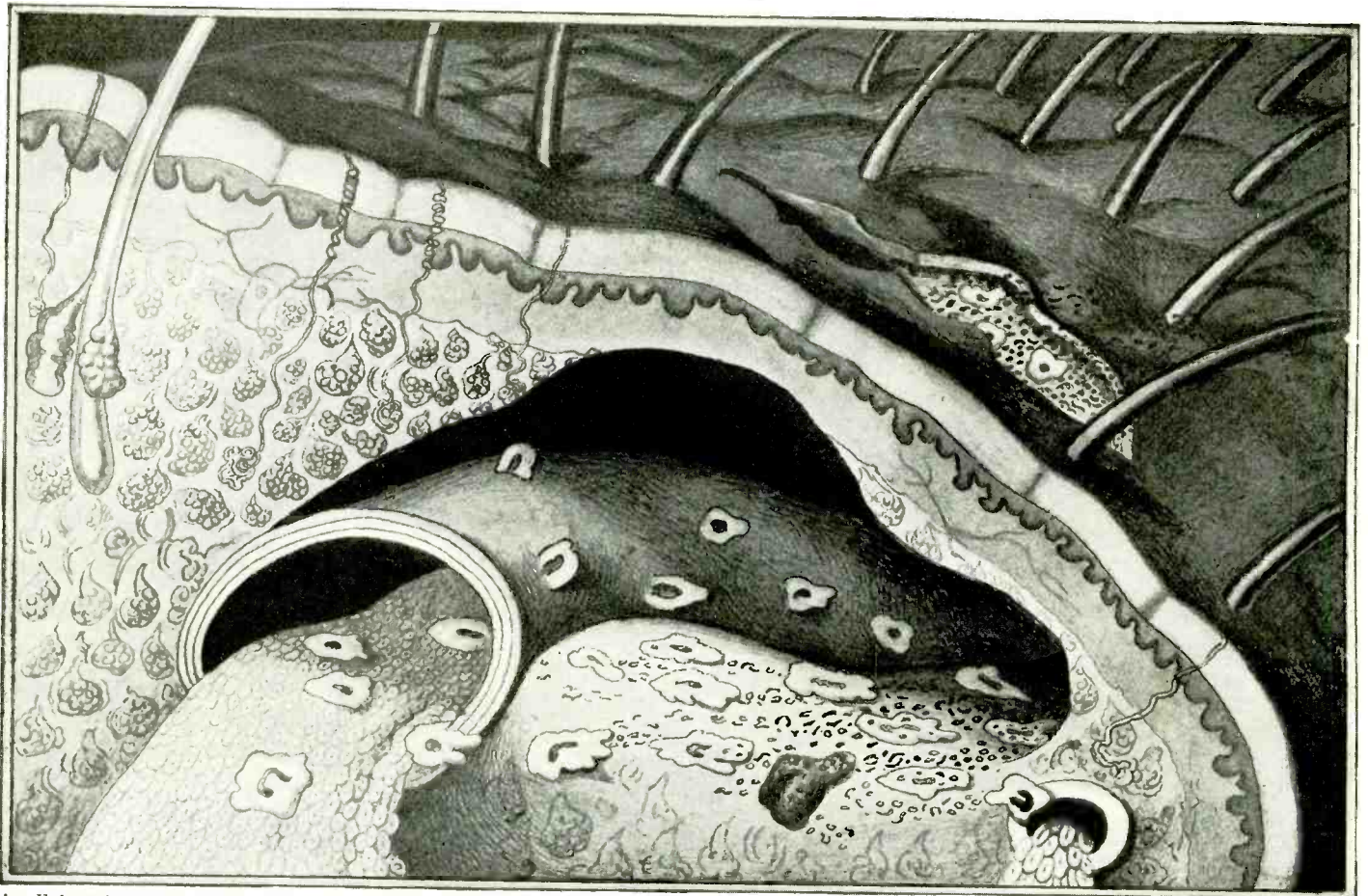

An Enlarged Vertical Section Through the Skin Made Near a Cut Would Show Us What is Pictured Above. Here a Large Tortuous Pipe-Like Structure is a Blood Vessel. Through Its Walls White Blood Cells Are

Passing Toward the Cut to Devour Germs as They Enter. Notice the Hair on the Surface of the Skin and the Canals of the Sweat Glands. Near the Upper Left Hand Corner the Section Has Just Grazed a Hair and Its Follicle.

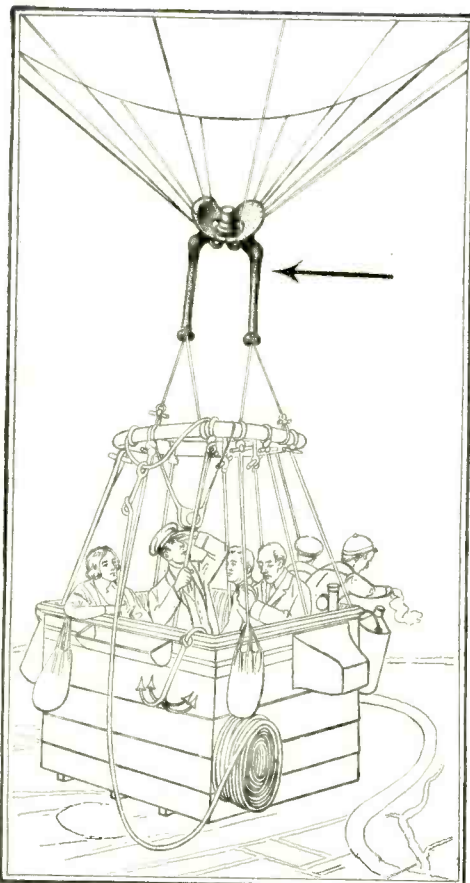

At the Left is Strikingly Illustrated the Great Strength of the Ligaments, Those Tendons Which Hold the Bones in Their Joints. Here the Pelvis Has Been Secured to a Balloon and the Basket of the Balloon is Seen Hanging from the Thigh Bones. The Total Weight Supported is Over 850 Pounds. The Picture Although Seemingly Fantastic is Perfectly Justified by Measurements Made Upon the Body.

It is Not Generally Known That the Compression Strength of the Thigh Bone Exceeds That of Granite Fully Two-Fold, and is Three Times as Strong as Brick. Cast Iron Succumbs to Pressure at 103,806 Pounds. Bone at 21,333 Pounds. Granite at 8,532 Pounds, Good Wood, 7,110 Pounds and Brick at 711 Pounds. Fully 20 Men Could Stand on the Thigh Bone Without Crushing It, As Shown at the Right.

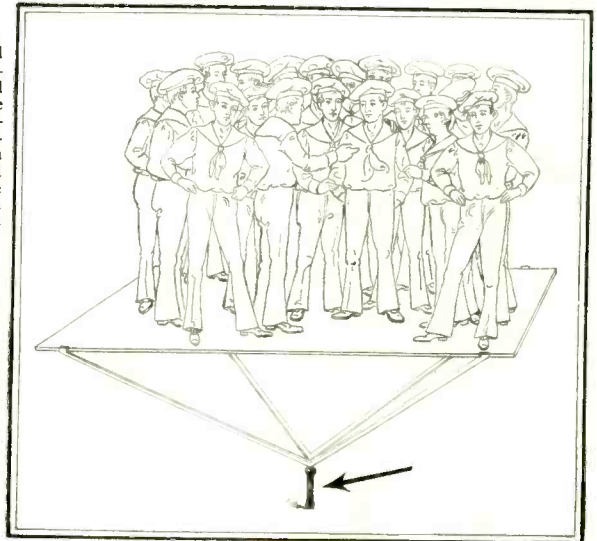

## Want More Information?

**I**F you want additional information concerning any of the subjects illustrated and described in this number of **SCIENCE AND INVENTION**, we shall be glad to give you other data we have at our command if you will send 50c for such special data. To make this work as easy as possible for our editors, please be brief. Write only on one side of the paper and state exactly in a few words just what it is you desire further information on. We have the original manuscripts and drawings of many of these articles in our files and can furnish much additional data in most cases. Send stamped and self-addressed envelope, together with 50c. remittance in stamps, money order or certified check.

Address all inquiries of this nature to **INFORMATION EDITOR**, c/o Science and Invention, 53 Park Place, New York City.



# Paper "Film" Movies a Success

By ERIC A. DIME

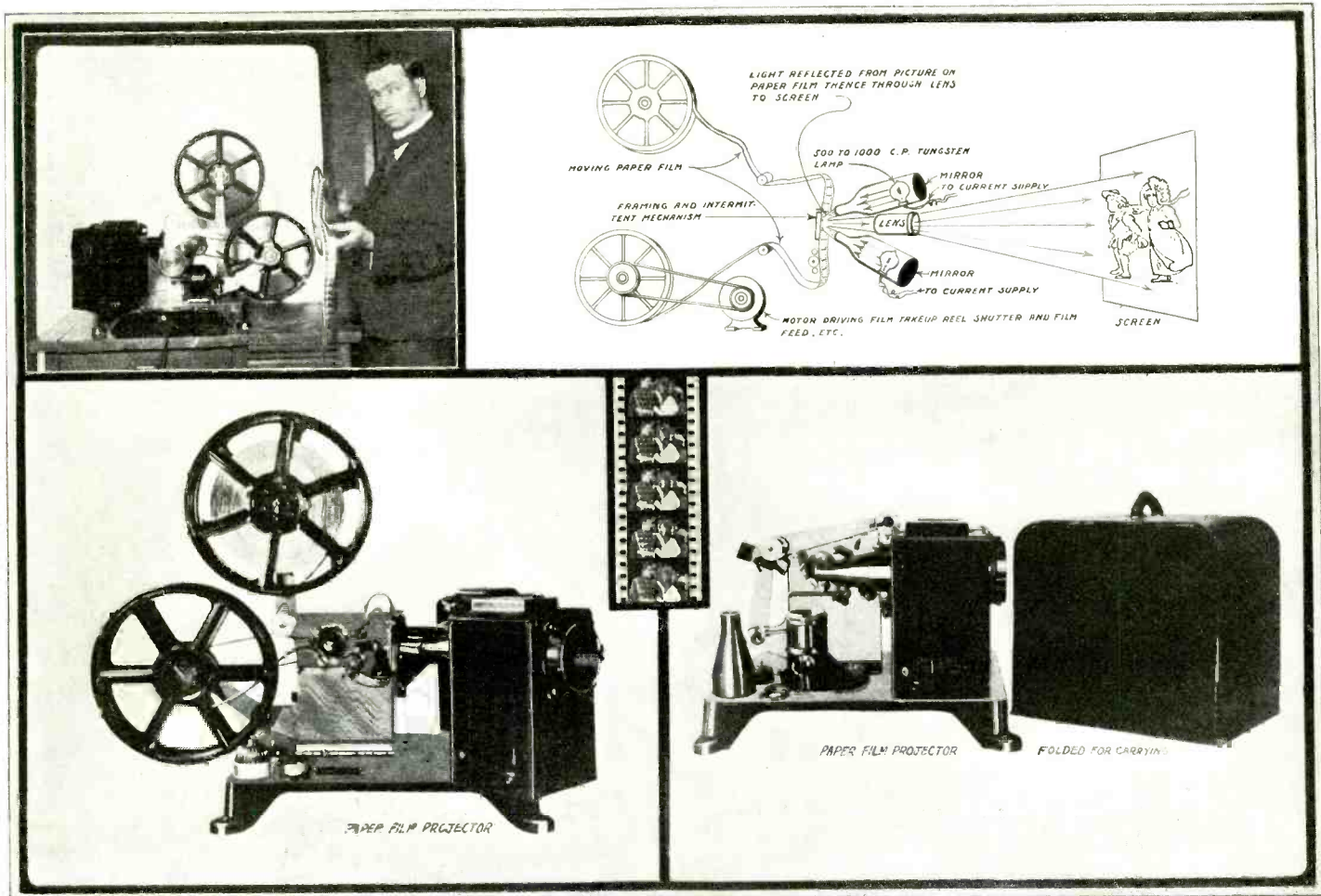

Paper Movie "Films" Are the Latest. The Upper Left-Hand Photograph Shows the Inventor With One of His Projecting Machines Employing Paper "Film" Movies. The Diagram at the Top Shows How Powerful Incandescent

Lamps Supply the Light for the Projector. Light is Reflected From the Opaque Paper "Film" and Then Passes Through a Powerful Lens Onto the Screen. A Specimen From One of the Paper Movies is Shown in the Center.

## The Power of Sap

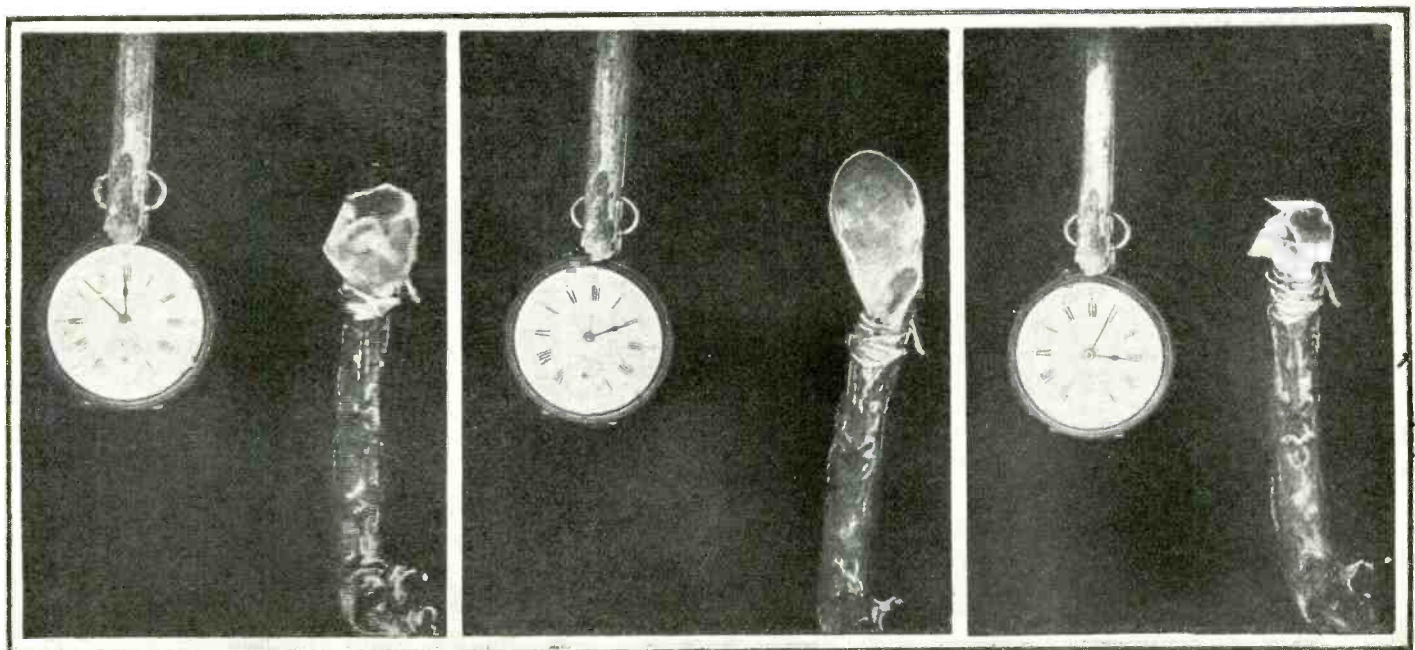

The Power of Sap is Vividly Demonstrated by the Three Photos Above Which Were Taken By S. L. Bastin of England. A Piece of Cloth Was Tied

Over the End of the Cut Stalk of a Growing Plant. The Watch Shows Time Required, Three Hours and Twelve Minutes, For the Sap to Burst the Bag.



# Electricity From the Sun

By Dr. H. BECHER

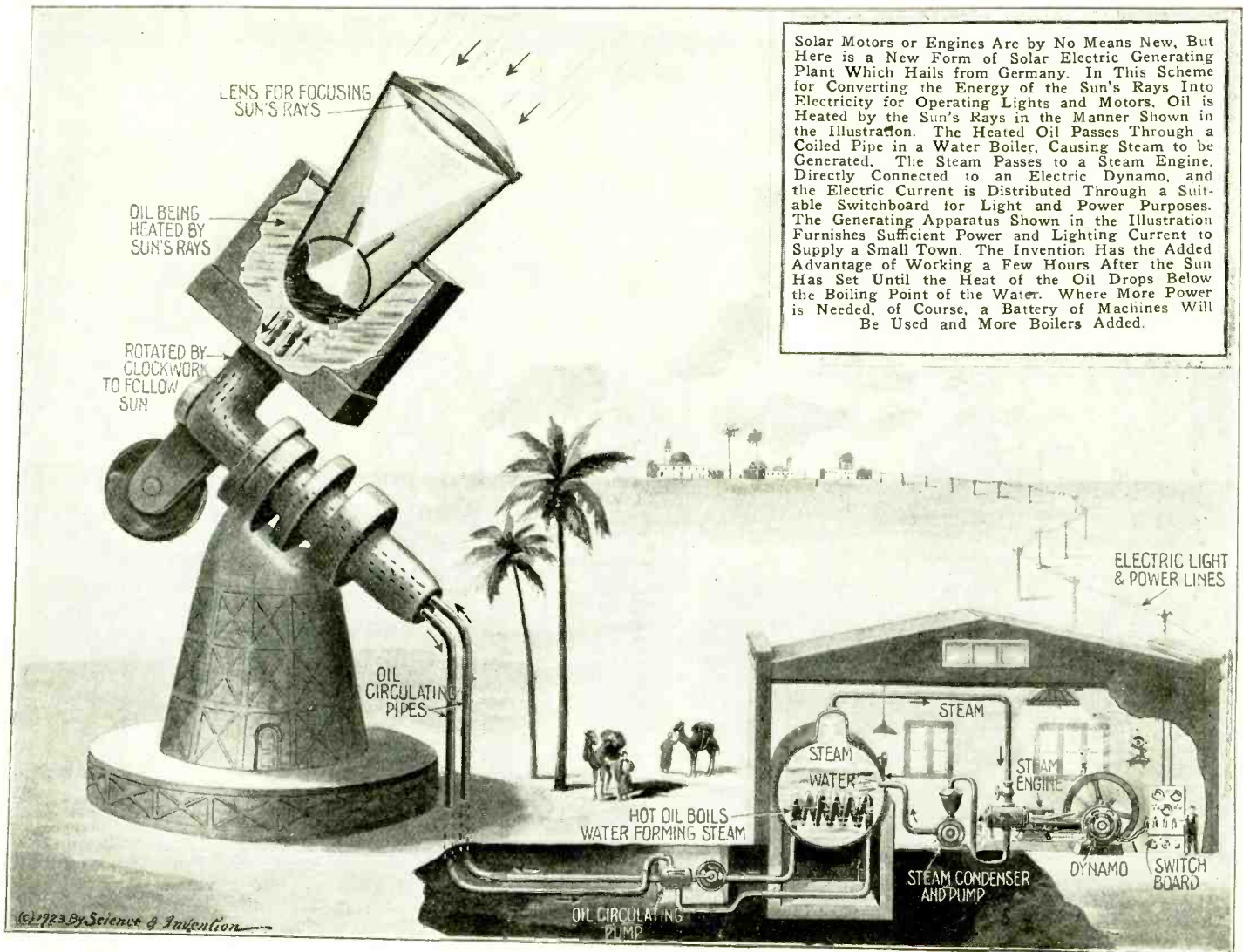

Solar Motors or Engines Are by No Means New, But Here is a New Form of Solar Electric Generating Plant Which Hails from Germany. In This Scheme for Converting the Energy of the Sun's Rays Into Electricity for Operating Lights and Motors. Oil is Heated by the Sun's Rays in the Manner Shown in the Illustration. The Heated Oil Passes Through a Coiled Pipe in a Water Boiler, Causing Steam to be Generated. The Steam Passes to a Steam Engine. Directly Connected to an Electric Dynamo, and the Electric Current is Distributed Through a Suitable Switchboard for Light and Power Purposes. The Generating Apparatus Shown in the Illustration Furnishes Sufficient Power and Lighting Current to Supply a Small Town. The Invention Has the Added Advantage of Working a Few Hours After the Sun Has Set Until the Heat of the Oil Drops Below the Boiling Point of the Water. Where More Power is Needed, of Course, a Battery of Machines Will Be Used and More Boilers Added.

## New Suspended Electric Railway

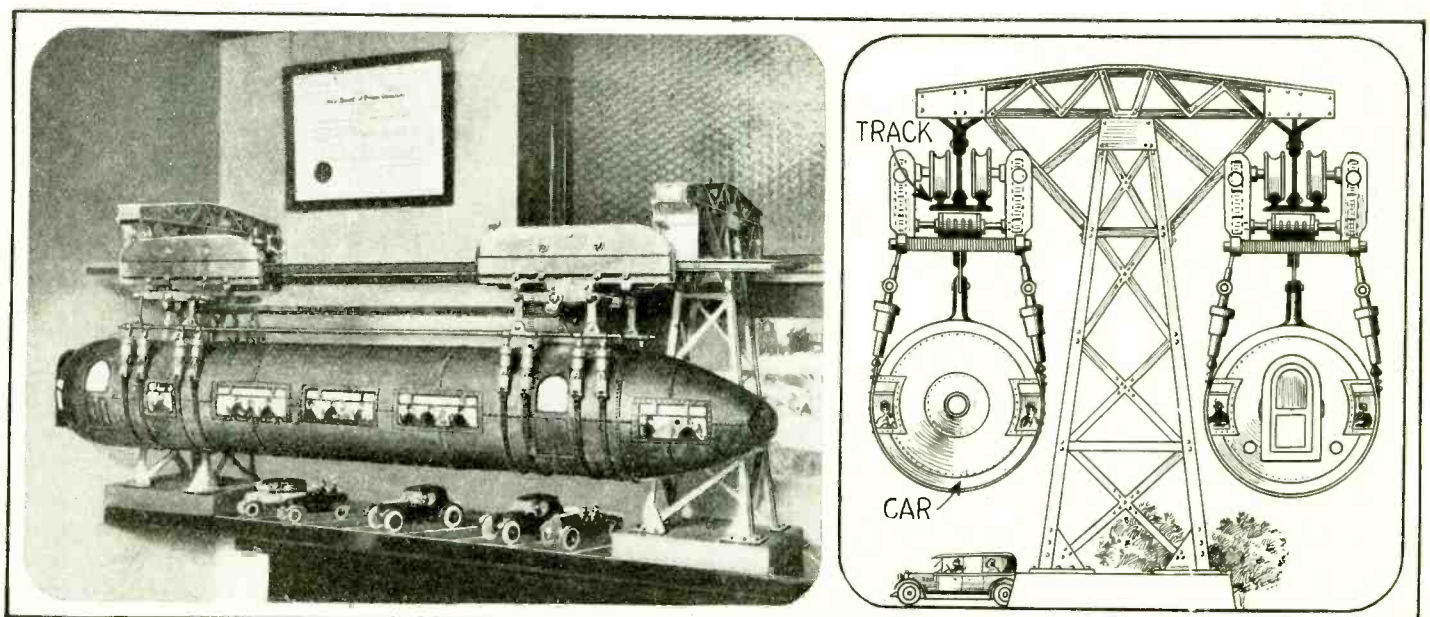

This Model of a Suspended Overhead Street Railway with Torpedo Shaped Cars Was Constructed by Its Inventor, Fletcher E. Felts, of Los Angeles, Calif., and It Has Been Approved and Recommended by the Police Department of That City, Reports State. The Cross-Sectional View of the Sus-

pension Railway Shown at the Right Indicates How the Electric Motors Drive the Propelling Wheels Through Gears, the Suspension Wheels Being Also the Driving Wheels. The Main Idea is to Give Greater Street Space for Motor Cars.



# Toy Contest—\$100.00 in Prizes

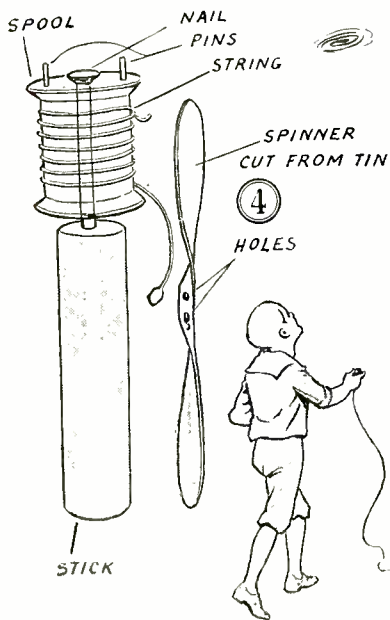
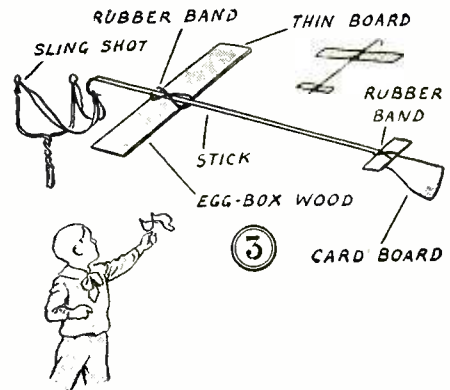
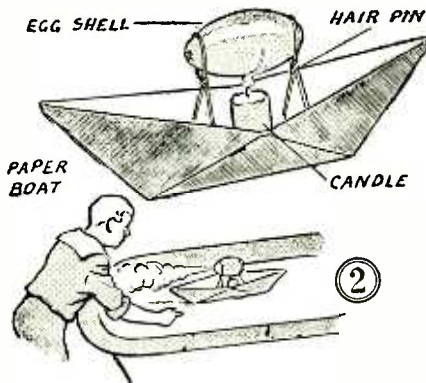
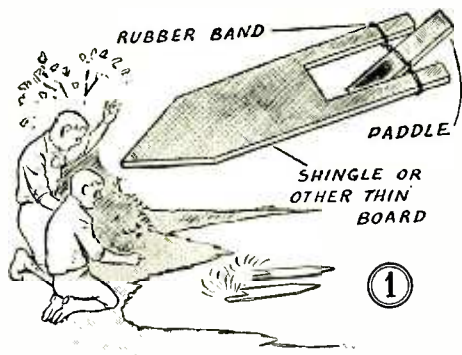

## \$100.00 IN PRIZES

**I**n an effort to help young Americans build their own toys, we are offering \$100.00 in prizes for the most instructive toys submitted to this contest. Toys on the style of those indicated on this page are acceptable, but those which require expensive machines and unusual figures, will not be considered. We desire simple toys made of wood, paper, strings, magnets, glass, rubber bands, bent wire, clockworks and toy electric motors—yet toys which have some educative value.

As shown on this page 1 is a toy boat, made of two pieces of wood and a rubber band. 2—Is an egg shell boat. The steam generated causes the paper boat to move forward. 3—Is a small glider propelled by a rubber band. 4—Is an aerial spinner. 5—is a radio elephant propelled out of the box by clapping the hands. The circuit to the electro-magnets is maintained by a small weight which bridges two contacts. Current passing through the coils of the electro-magnets holds a sheet iron plate against them. A sound vibration causes the side of the box to tremble, breaks the contact and propels the elephant out of the box. 6—Are toy dolls containing iron filings in their legs and a cork head. Magnets beneath the base cause them to bob up and down. 7—Is a top with a magnetic spindle. 8—Are pith ball figures mounted in a box beneath a glass plate. Rubbing the glass plate causes them to bounce up and down. In event of ties for any of the awards, participants so tying will be given prizes tied for. Participants are not limited as to the number of entries. A sketch and a 100-word article describing the device are all that is necessary. Models should preferably be submitted. This contest closes in New York, midnight, November 10th., and all articles, manuscripts, and models should be in our hands by that time.

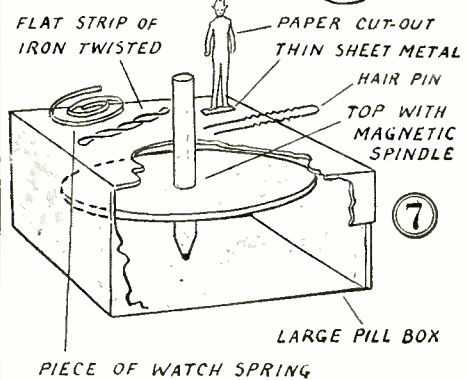
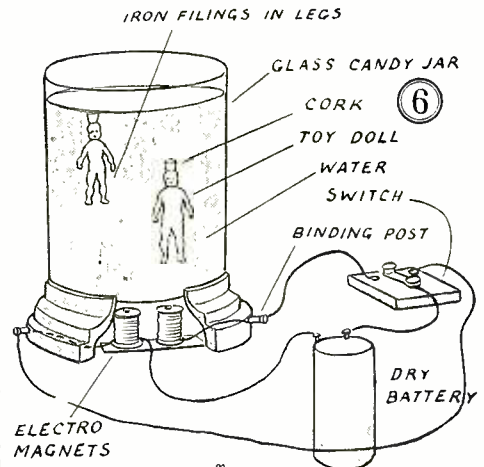

### \$100.00 IN PRIZES WILL BE AWARDED AS FOLLOWS:

First prize	\$25.00
Second prize	20.00
Third prize	15.00
Fourth prize	10.00
Four prizes, each of	5.00
Five prizes, each of	2.00

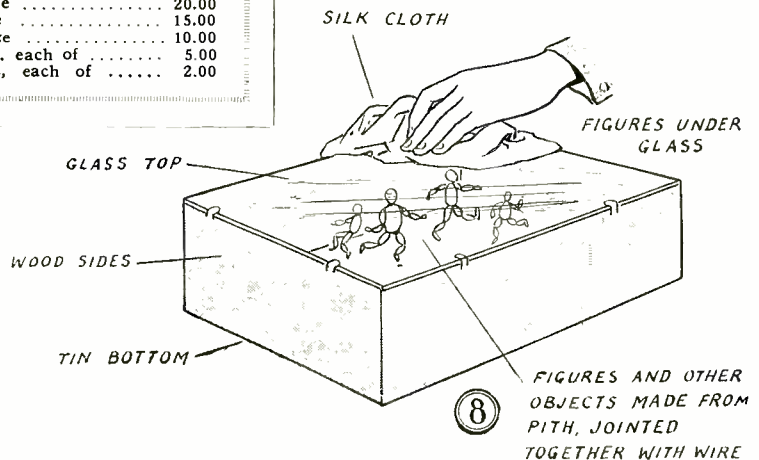
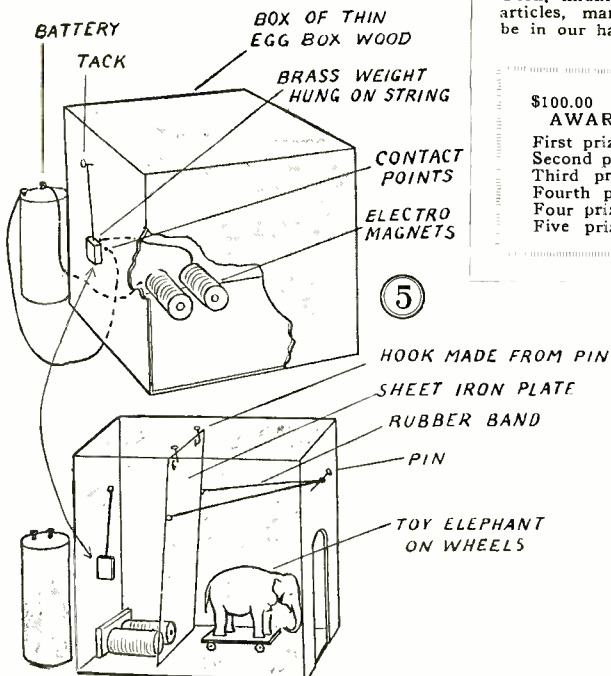



# Making Shot

By ROBERT H. MOULTON

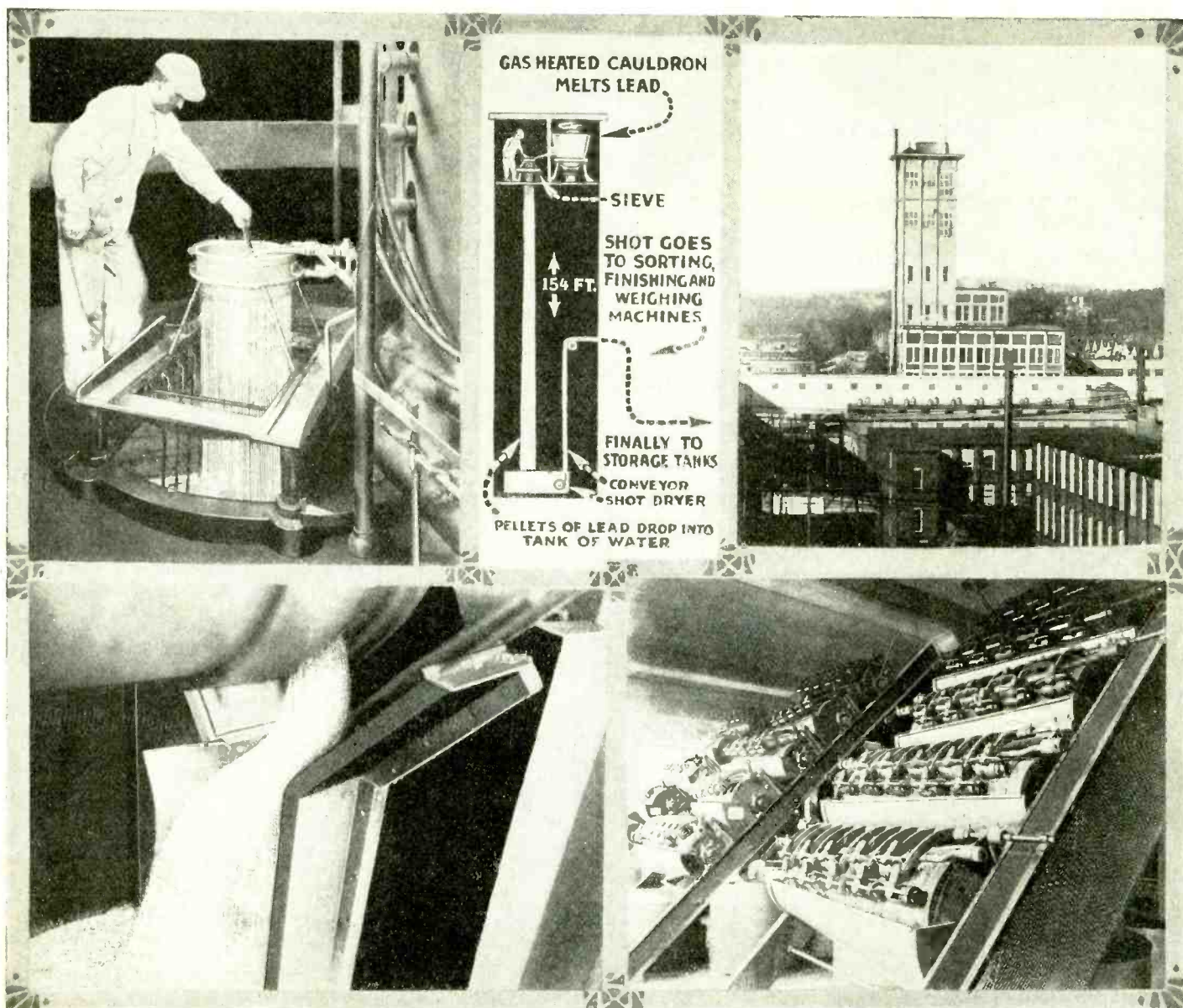

Upper Left: The Sieve From Which a Shower of Lead Drops 154 Feet Into the Water. Upper Center: A Cross-Section View of the Shot Tower. Upper Right: An Exterior View of the Shot Tower. Lower Left: Stream of Shot

Going To the First Polisher. Lower Right: Series of Revolving Drums With Screens, Through Which the Perfect Shot Pass To Be Sorted Into Their Various Sizes. Conveyers Then Carry Them to the Shipping Room.

## Organ Music

HAS charmed myriads of people in every generation. One of the earliest known musical instruments of any consequence from an engineering point of view, was the organ. Its music has exercised a powerful influence down through the ages, and it is with great pleasure we present an article on the first organ in the November number. Superb illustrations by the author will accompany it. Mr. C. B. Bunnell, the author, is a keen student of early historical subjects and his pen and ink study of the first organ, described by Hero of Alexandria 280 B. C., is one of the finest pieces of work we have had in many months.

## Several of the Other Feature Articles In the November SCIENCE and INVENTION

RAISING BUTTERFLIES AS A BUSINESS, By Dr. Ernest Bade.

THE FIRST ORGAN—AS DESCRIBED BY HERO OF ALEXANDRIA 280 B. C., By Charles Beecher Bunnell.

THE FIRST ELECTRIC FERRY BOAT.

HEARING THROUGH THE TEETH — AN INVENTION WHICH BIDS FAIR

TO MAKE THE DEAF HEAR. By H. Gernsback.

WHAT IS A PEARL?

By Ismar Ginsberg, B.Sc.Chem.

FORECASTING THE WEATHER, BY THE DIRECTION OF THE WIND.

By E. B. "Farmer" Dunn.

HOW TO BUILD A RECTIFIER FOR CHARGING STORAGE BATTERIES.

By Dr. Ernest Bade.

EXPERIMENTS WITH ICELAND SPAR CRYSTALS.

By O. Ivan Lee.

THE ROGER'S LOOP AERIAL—FULL DETAILS OF THE NEWEST INVENTION IN RADIO.

AROUND THE UNIVERSE — FIFTH INSTALLMENT. By Ray Cummings.



# Combination Auto and Boat

By JOSEPH H. KRAUS

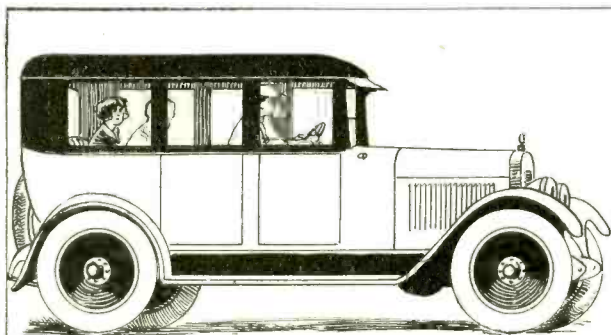

LOOKS LIKE AN ORDINARY AUTO



BUT THE TOP COMES OFF

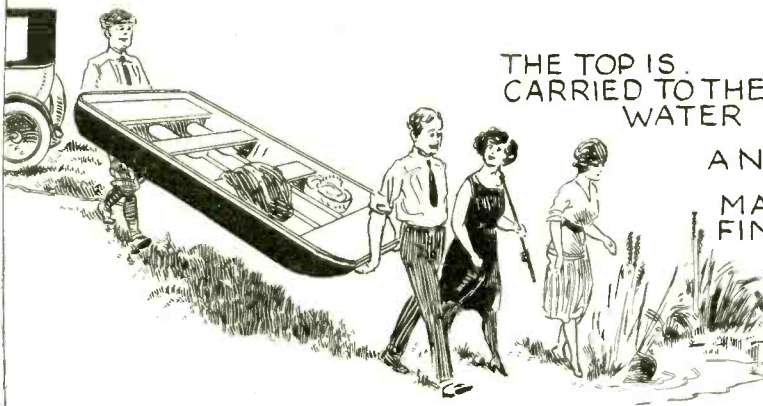

THE TOP IS CARRIED TO THE WATER

AND MAKES A FINE BOAT

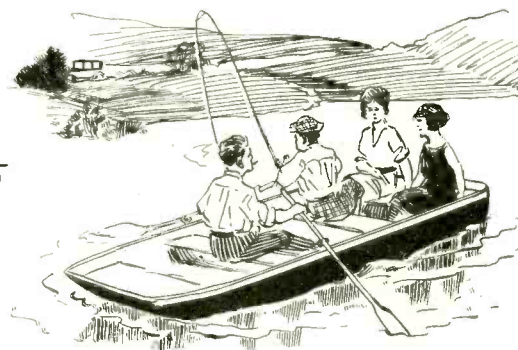

Why Go to the Trouble of Hiring a Boat When Out on a Fishing Trip When the Top of Your Automobile Makes a Very Serviceable Skiff? As a Matter of Fact, John A. Cowan of Kansas City, Mo., Has Patented an Automobile of just Such a Type in Which the Top Comes Off. It May Then Be Carried

Down to the Water, the Oars Removed and a Pleasurable Boat Ride May Be Experienced. Of Course if it Should Rain While the Rowers Are on the Lake, the Interior of the Automobile Would Get Wet, But Who Wants to Be in an Open Boat While it is Raining. So the Cover Goes Back in Place.

## Air for Swimmers

## Auto Safety Light

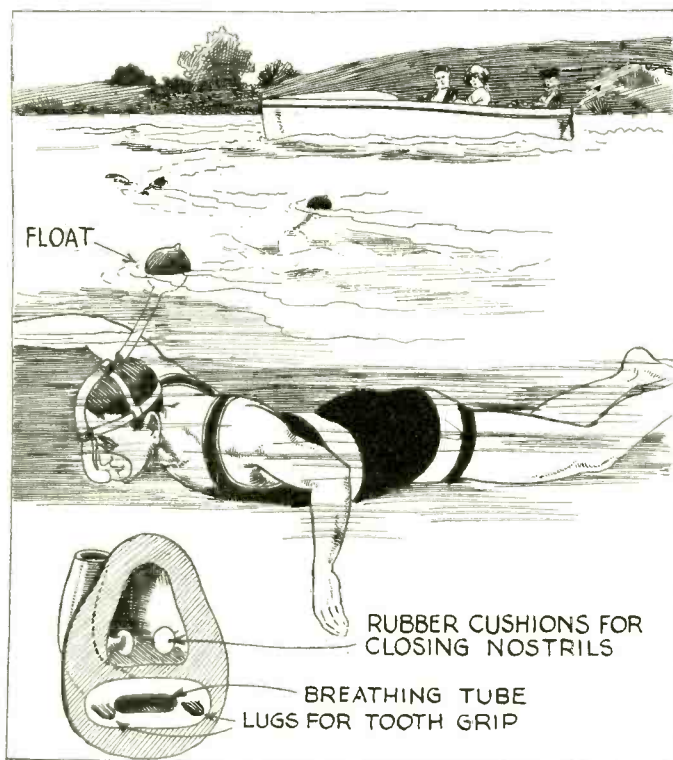

For Teaching Swimmers the Crawl Stroke and Insuring Correct Breathing, the Floating Air Buoys Shown Above. Communicating With the Swimmer's Mouth and Nose By Means of a Rubber Hose, Are Found Very Serviceable. The Swimmer Need Not Raise His Head Above the Surface of the Water at Any Time During a Race. The System is Patented by William S. Feinberg, of Chicago, Ill.



An Ingenious American Inventor, George C. Strong, of Norfolk, Va., Has Patented An Automobile Safety Light Which Attaches Beneath the Left Hand Front Mudguard of An Automobile. This Prevents a Driver Traveling in the Opposite Direction from Mistaking the Position of the Forward Wheel, Thus Preventing Many Accidents.



# Two Valuable Motor Hints

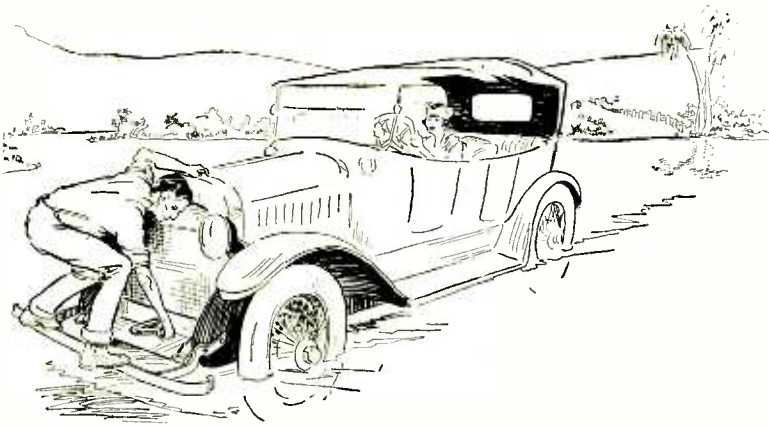

By Removing All the Spark Plugs from the Engine, Which Was Rendered Inoperative by the Flooding of the Carburetor While Crossing a Stream in Porto Rico, Dr. T. O'Connor Sloane Was Enabled to Turn the Crank and Propel the Car Out of the Stream; the Gear Shift Was Placed in "High." After the Car Had Been "Cranked" Out of the River, the Spark Plugs Were Replaced, the Water Removed from the Carburetor, and the Journey Resumed.



Here is Another Trick Once Used by Dr. T. O'Connor Sloane to Start an Engine Which is Worth Knowing. Place the Gear Shift in "High" and Jack Up One Rear Wheel; Place the Second Jack Under One of the Tire Rim Bolts Which Gives Enough Pressure for Turning the Wheel.

## If A "Ford" Used All Accessories!

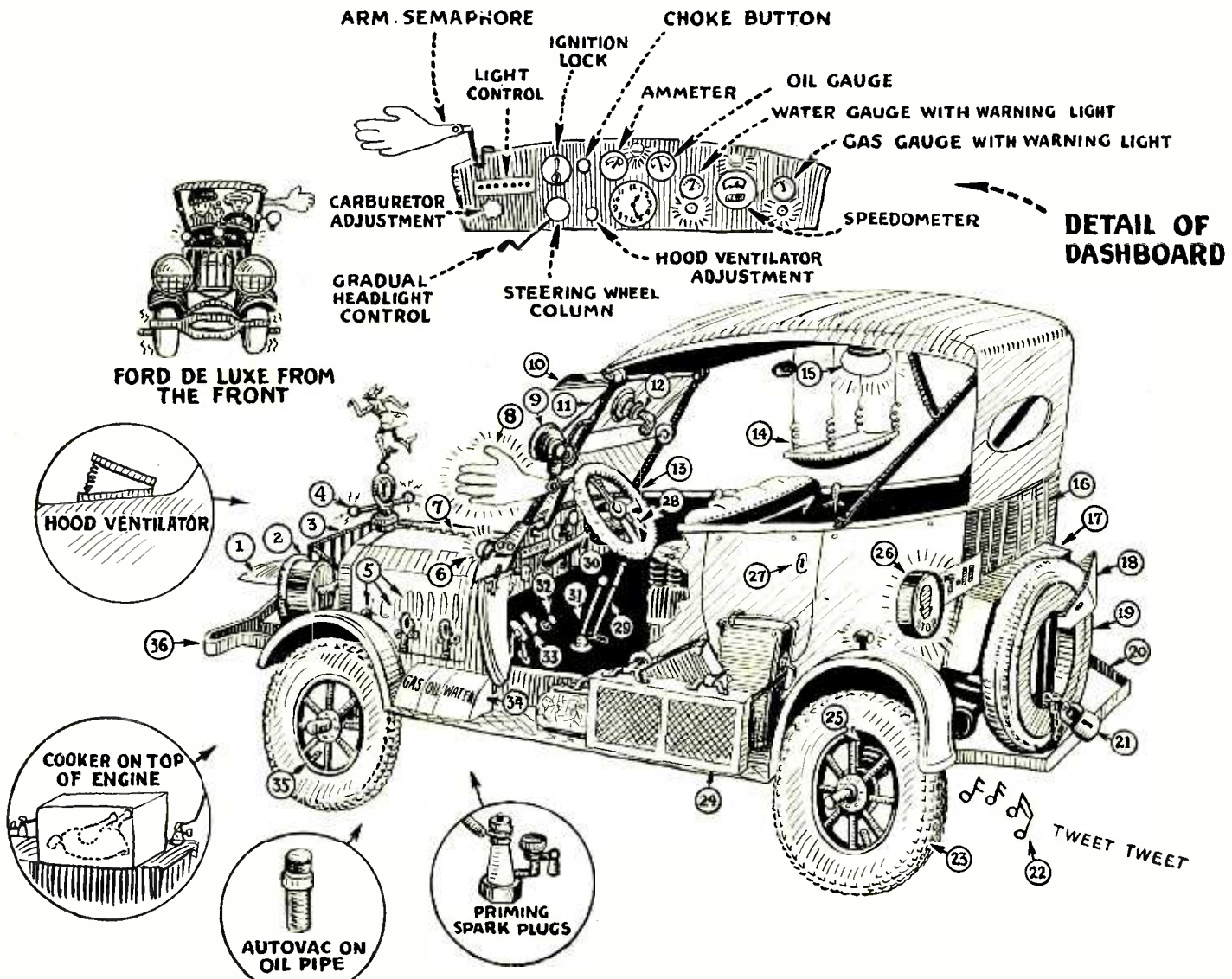

1 Visor for Headlights; 2 Barrel Headlights; 3 Radiator Shield; 4 Motor, Electrically Lighted, Surmounted by Figure of Mercury; 5 Spring Hood Clamps; 6 Hood Lights; 7 Special Carburetor; 8 Arm Semaphore; 9 Combination Spot and Trouble Light with Mirror Back; 10 Sun Visor; 11 Slanted Windshield; 12 Spot Light, Trained from Behind Windshield; 13 Electrically Heated Steering Wheel; 14 Baby Carrier; 15 Dome Light in Tonneau;

16 Brass Strips to Protect Paint; 17 Trunk; 18 Spike Theft Preventer. 19 Spare Tire Carrier; 20 Rear Bumper Attached to Mud Guards; 21 Spare Tire Lock; 22 Exhaust Whistle; 23 Oversize Tires; 24 Luggage Carrier; 25 Shock Absorbers; 26 Wright Stop Signal; 27 Door Locks; 28 Watch on Steering Wheel; 29 Brake; 30 Steering Column Lock; 31 Gear Shift Lever; 32 Accelerator; 33 Non-Slip Pedals; 34 Emergency Gas, Water and Oil; 35 Visible Tire Gauge; 36 Front Bumper—and They Sell 'Em.



# Magic For Everybody

By PROF. JOSEPH DUNNINGER.

NO. 7 OF A SERIES

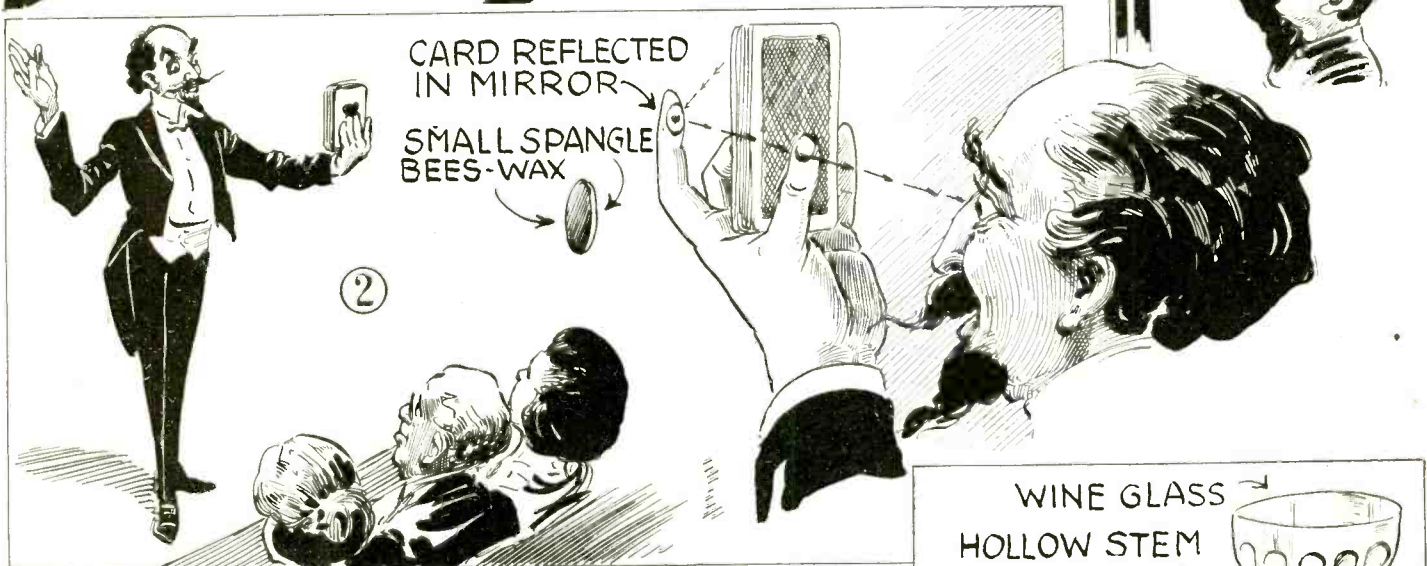
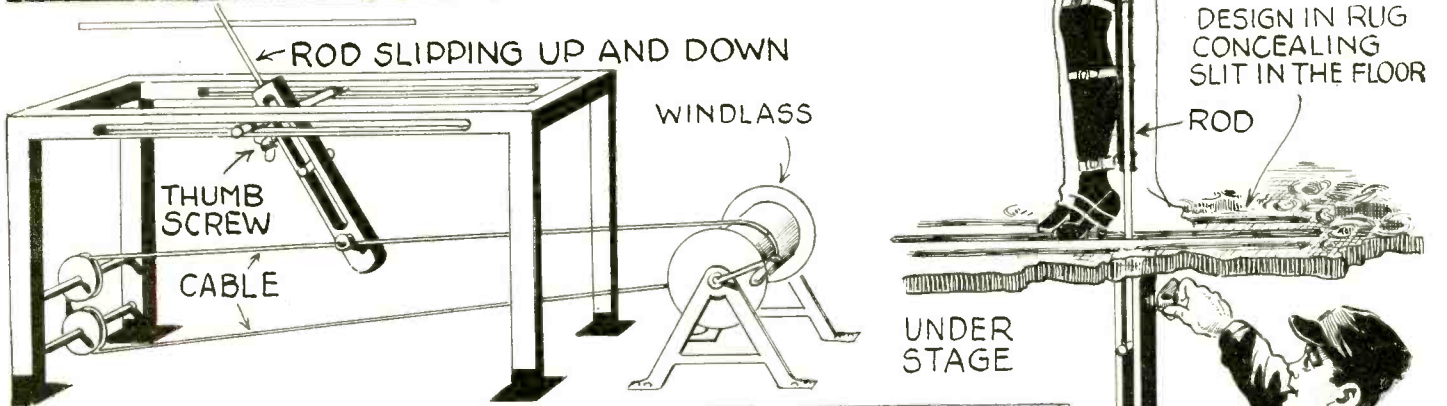
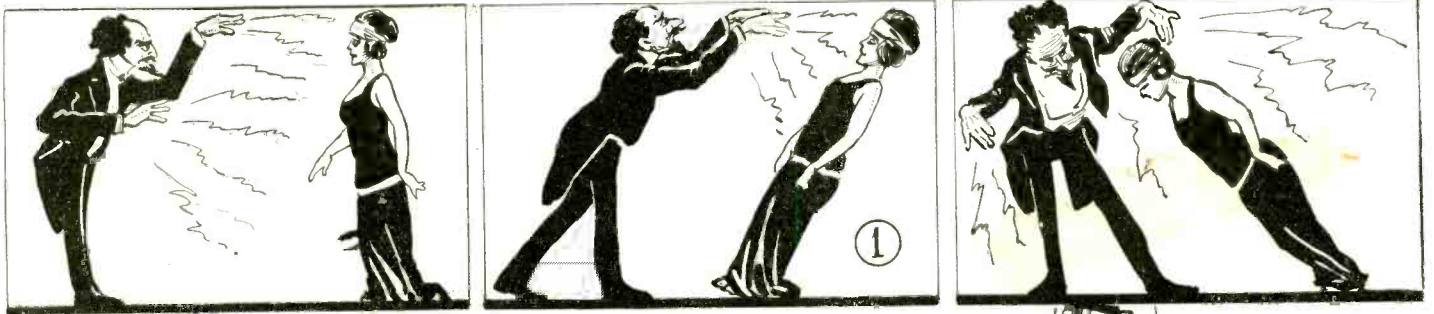

The Hypnotic Stunt (1) is Performed with Apparatus Shown. The Rod Slipped Through Tube, Operated by Windlass Beneath Stage, is Attached to the Lady's Legs. (2) To Read the Deck from the Back Use Small Mirror

and Wax. (3) The Mystic Wineglass Fills as Soon as Emptied if Bulb is Pressed. (4) The Handkerchiefs Knot When Thrown, with the Aid of a Rubber Band. Operator Snaps Band Over Corners When He Drops Them.



# Popular Astronomy

By ISABEL M. LEWIS, M.A.

Of the U. S. Naval Observatory

THE constellations most favorably located for observation in October, are:

Cassiopeia and Cepheus near the meridian due north.

Pisces, Andromeda and Pegasus in the east.

Cygnus and Lyra in the west.

Delphinus and Aquila in the southwest.

Capricornus and Aquarius on the meridian due south.

The far southern constellation of Piscis Australis is visible near the southern horizon and contains the brilliant, first-magnitude star Fomalhaut.

## NOW SETTING WEST

Ophiuchus and Serpens, Boötes, Corona Borealis and Hercules are now setting in the west, they will not be visible in the evening again until spring or early summer.

Constellations now rising are:

Perseus, the Pleiades, and Auriga in the northeast; Cetus in the east. These groups will be better placed for observation next month.

## THE MILKY WAY

The Milky Way is now magnificently in view on clear, dark nights when the moon is absent. It stretches across the heavens in an irregular belt from the northeastern to the western horizon passing through the constellations of Auriga, Perseus, Cassiopeia and Cephus to Cygnus, where it divides into two streams, one passing through Serpens and Ophiuchus to the horizon, and the other through the small constellation of Sagitta. The Arrow, and Aquila. The Eagle.

The Milky Way is particularly rich in stars and nebulae in Perseus and Cygnus. Even a field glass will reveal some of the wonderful richness of the star fields in these regions.

## FIRST MAGNITUDE STARS

Among the stars of the first magnitude visible in October are: Deneb, or Alpha Cygni, a white star in Cygnus now near the zenith in our latitude (40° North). Also Fomalhaut, far south, east of the meridian, a beautiful white star. One of the nearer stars, about twenty-five light years from the earth, is Altair, in Aquila, in the southwest. Alpha Centauri, Sirius and Procyon are nearer. They are about 16 light years dis-

tant. Vega, in Lyra, now west of the meridian near the zenith is a magnificent blue-white star easily identified by its two faint, attendant stars that form a small triangle with it. Vega shares with Capella the honor of being the brightest star north of the celestial equator. It is about 40 light years from the earth.

Capella in Auriga, a yellow star now rising in the northeast, is equal in brightness to Vega. It is of the same type as our own sun and about 33 light years distant.

No planets are visible this month at this time.

## OF SPECIAL INTEREST

Among the objects of special interest visible at this time is the Great Square in Pegasus. This huge square is formed by three bright stars in Pegasus and a fourth in Andromeda. It is one of the best-known con-

figurations in the heavens, as distinctive in form and as easily recognized as the Big Dipper. We associate it always with the first clear, frosty evenings of early fall.

The Northern Cross in Cygnus, with Deneb, the first-magnitude star at the head of the cross, with Albireo—visible as a beautiful blue and gold double star in small telescopes—at its foot is visible this month. It is a beautiful configuration considered by some to be equal in splendor to the far-famed Southern Cross.

## MOST DISTANT STAR

"Job's Coffin" is a very distinctive little diamond-shaped group of stars in Delphinus. In this constellation is located the most distant known object in the heavens, a faint globular star cluster distant 220,000 light years from the earth.

Alpha in the constellation of Capricornus, The Sea-Goat, is one of the few stars in the heavens that appears double to the naked eye. It can be separated even though it is somewhat unfavorably placed for observation in our latitudes. The star Beta which is a little brighter than Alpha lies just to the south of it.

The Great Nebula in Andromeda is to be found in the position indicated on the chart. Faintly visible to the naked eye as a small, hazy patch of

light, it is a magnificent object as shown on photographs taken with the aid of powerful telescopes. Its distance is not definitely known but it is one of the nearer spiral nebulas.

## METHODS OF STUDY

In studying the constellations with the aid of the chart shown on this page, do not pick those configurations lying close to the horizon. If trees and buildings do not obstruct the view of them, the haze and fog that always fill the lower part of the atmosphere around the horizon will prohibit a clear view. None of the planets are to be seen to advantage this month at the hours mentioned in the chart. When they do appear, however, they will be seen somewhere near the path of the ecliptic. They never get more than a few degrees away from it to one side or the other. When seen they will be in one of the zodiac constellations.

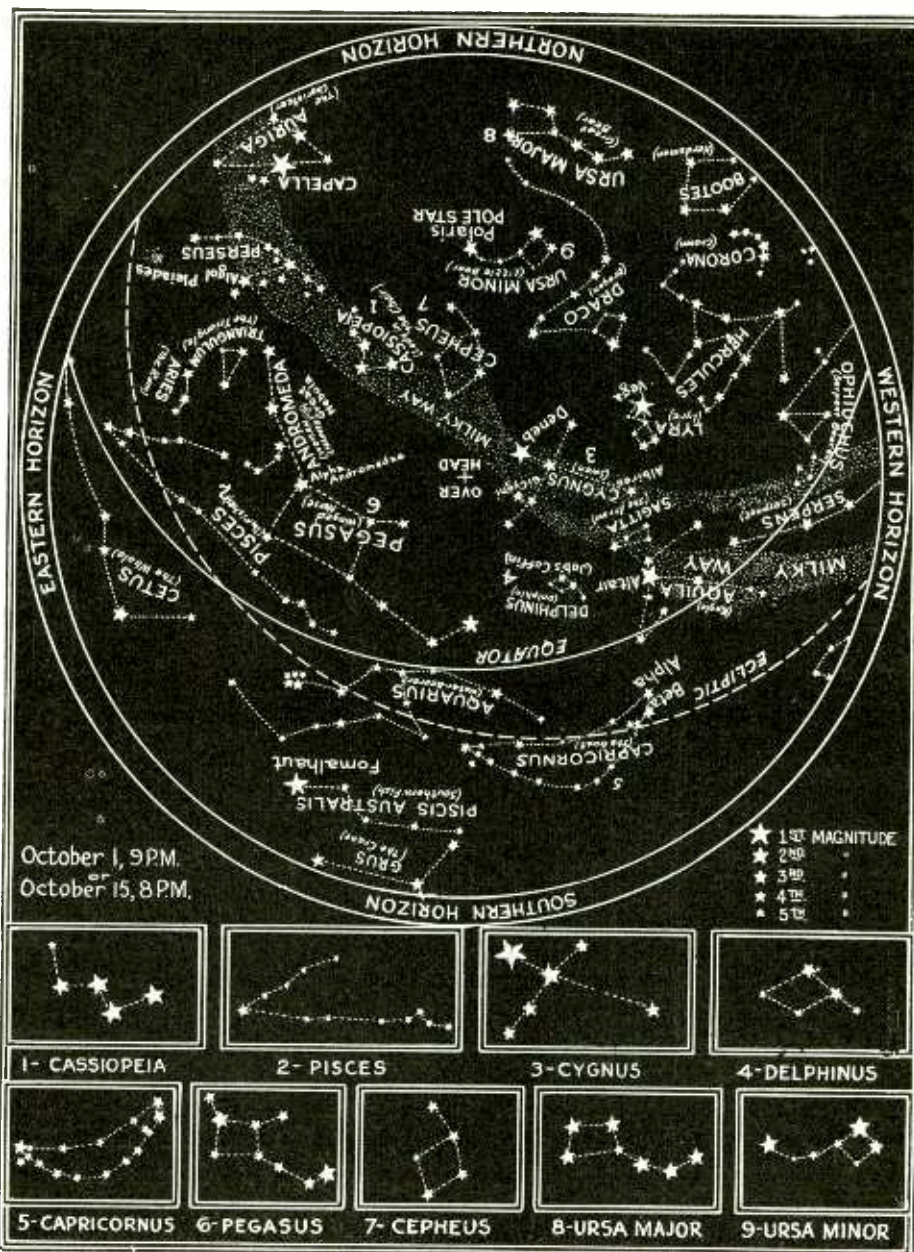



Above is Shown a Map of the Heavens for October. The Constellations Will Have the Exact Locations in the Sky as Shown on the Map at 9 P. M., October 1, or 8 P. M., October 15. To Use the Map, Hold It in an Inverted Position Over the Head with the Direction Indicated on the Map Coinciding with the Real Direction; That is, with the Top of the Map Toward the North. The Zenith is the Point Directly Overhead and the Meridian is a Line Running North and South, Passing Through the Zenith and Polaris. Close-up Views of Each of the Larger Constellations Are Reproduced in the Lower Half of the Illustration.

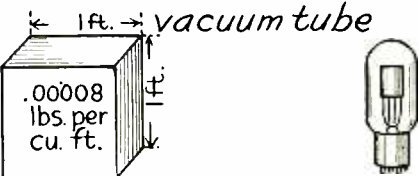
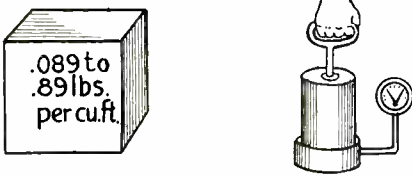
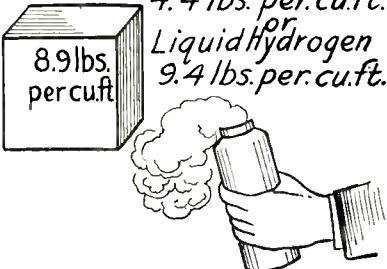

# Comparison of Density of Celestial Bodies with Familiar Substances

<p><b>RED GIANTS. (SUCH AS BETELGEUZE)</b></p> <p><i>Lighter than the contents of a vacuum tube</i></p>  <p>Weight of 1 cu.ft. of star's material</p> <p>Helium Gas = .011 lbs. per cu.ft. Hydrogen = .006 lbs. per cu.ft.</p>	<p><b>ORANGE COLORED OR YELLOW GIANTS. (SUCH AS ARCTURUS OR CAP-ELLA)</b></p> <p><i>Compare with air = .081 lbs. per cu.ft.</i></p>  <p>Air compressed to ten times its normal density = .81 lbs. per cu.ft.</p>	<p><b>BLUE-WHITE HELIUM AND WHITE HYDROGEN STARS. (SUCH AS RIGEL AND VEGA)</b></p> <p><i>Compare with Liquid Helium = 4.4 lbs. per cu.ft. or Liquid Hydrogen 9.4 lbs. per cu.ft.</i></p> 
---	--	--

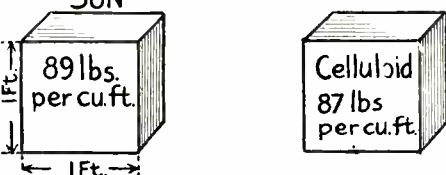
## THE LIGHTEST STARS

<p><b>STARS IN YELLOW DWARF CLASS, (WHICH INCLUDES SUN) THAT ARE HEAVY BUT ARE BELIEVED TO BE IN COMPRESSED GASEOUS STATE</b></p>  <p>SUN</p> <p>89 lbs. per cu.ft.</p> <p>Celluloid 87 lbs. per cu.ft.</p>	<p><b>RED DWARF STARS - HEAVIEST STARS KNOWN NEARING EXTINCTION, LUMINOUS BUT WITH CONSISTENCY OF ROCKS</b></p> <p><i>How these stars can continue to shine as luminous bodies is a puzzle to scientists</i></p>  <p>160 lbs. per sq.ft.</p> <p>Marble 160-177 lbs. per cu.ft.</p> <p>W. URSAE MAJORIS</p>	<p><b>HEAVIEST STAR KNOWN VARIABLE STAR IN COMA BERENICES</b></p>  <p>193-300 lbs. per cu. ft.</p> <p>Flint Glass 180-370 lbs. per cu. ft.</p>
--	--	---

METEORITES ARE EITHER COMPOUNDS OF NICKEL AND IRON OR IGNEOUS ROCKS. DENSITY 200-500 LBS. PER CU. FT.

## THE HEAVIEST STARS

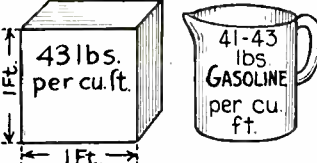
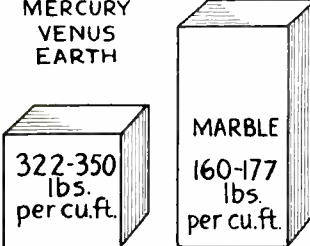
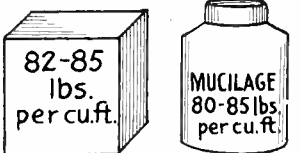
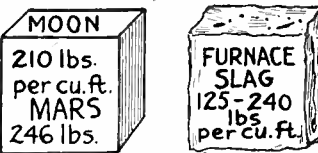
<p><b>SATURN</b></p>  <p>43 lbs. per cu.ft.</p> <p>41-43 lbs. GASOLINE per cu. ft.</p> <p><b>LIGHTEST PLANETS</b></p>	<p>MERCURY VENUS EARTH</p>  <p>322-350 lbs. per cu.ft.</p> <p>MARBLE 160-177 lbs. per cu.ft.</p> <p><i>Much heavier than rocks of the Earth's surface</i></p> <p><b>HEAVIEST PLANETS</b></p>	<p>JUPITER } DENSITY ABOUT THAT OF THE SUN URANUS } NEPTUNE }</p>  <p>82-85 lbs. per cu.ft.</p> <p>MUCILAGE 80-85 lbs. per cu.ft.</p> <p>Gaseous but highly compressed</p>	<p><b>MOON</b></p>  <p>210 lbs. per cu.ft.</p> <p>MARS 246 lbs.</p> <p>FURNACE SLAG 125-240 lbs. per cu.ft.</p> <p><i>Note - These two bodies are about equal in density to the heaviest star known</i></p>
--	---	--	--

## DENSITY OF THE PLANETS AND THE MOON

The Density of the Heavenly Bodies Can Be Easily Visualized by the Diagrams Shown Above. In Regard to the Heavier Bodies, Whose Density is Indicated in the Center Cut on the Page, It May Be Said That Many

Scientists Hold the Theory That the Luminous Stars Generate the Heat Necessary to Keep Them Incandescent by Constant Contraction. These Red Dwarf Stars Have Almost Ceased to Contract, Some Experts Say.



# Home Mechanics

By WILLIAM M. BUTTERFIELD

FOOT STOOL AND LEG REST

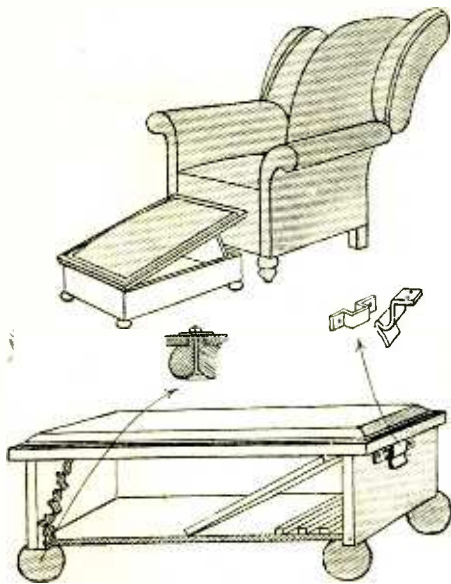

A Welcome Addition to Any Easy Chair in the Form of a Foot Stool May be Very Readily Made as Shown Above and Placed on Rollers or Casters so as to be Easily Moved From Place to Place.

SHAVING CABINET

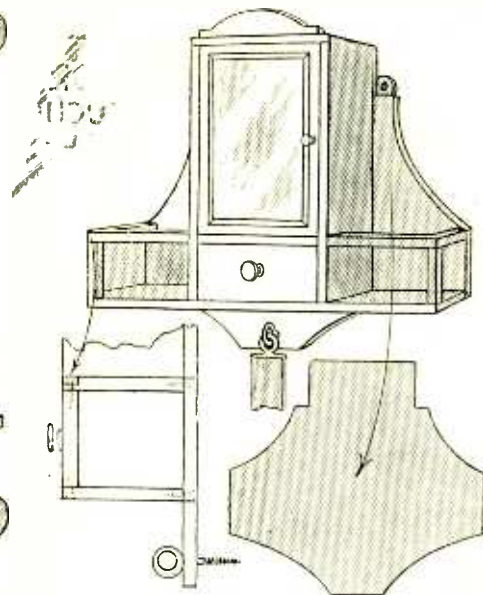

The Handy Shaving Cabinet Which May Be Seen Above Will Hold All the Materials Necessary for a Comfortable Shave. The Mirror in the Door Makes it Unnecessary to Have a Separate Mirror.

PRESS YOUR NECKTIE

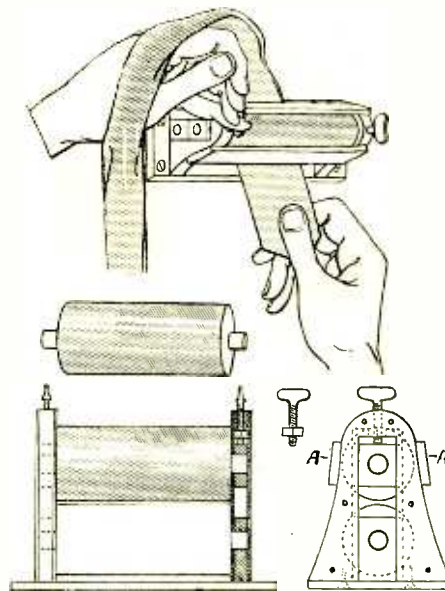

Neckties Which Simply Will Not Stay Pressed Can be Smoothed Out in a Jiffy by Using the Mangle Type Presser Shown Above. The Parts Are Simple, Two Rollers and a Compression Screw.

CLOSET SHOE RACK

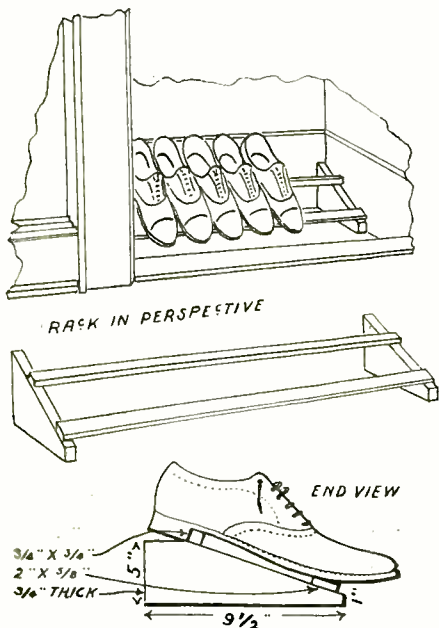

Is Your Domestic Life Ruined Because Your Wife or Sister Can Never Remember Where You Threw Your Shoes? Then Try This Little Rack in Your Closet. It Will Remove the Temptation to Throw Them Behind the Trunk.

ATTRACTIVE FENCE

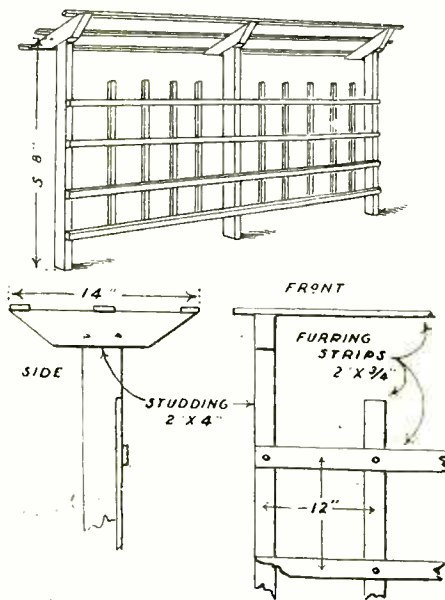

The Pergola and Lattice Work Fence Shown Above Will Add Greatly to the Value of Your Property. The Plan Gives Structural Details. The Average Cost of the Fence per Eight Foot Section is only \$1.25.

YOUR OWN SHINE PARLOR

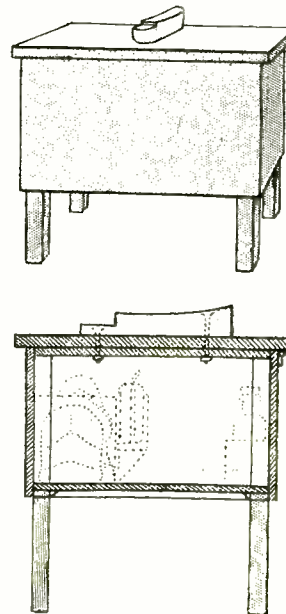

The Little Stand Shown Above Will Beat Tony, the Bootblack, Out of Many a Dime. With the Convenient Footrest on Top and All the Necessary Materials Gathered Below, Most of the Unpleasantness of the Homemade Shine is Extracted.

## Single Tube Radio Contest

**W**E wish to call attention to the special \$200.00 prize contest for the best single tube receiving sets, described in detail on page 574. We announced this contest originally in the July number, but owing to the usual summer vacations coupled with the warm weather, our readers apparently have not been very industrious in turning out anything new in radio receiving hook-ups.

We advise all radio fans to read the rules of this contest carefully; and in order to give everyone a chance to win one of the ten prizes in gold, there being two first prizes of \$50.00, each in gold, we have extended the closing date of this contest to November 15th. The instrument submitted for test need not be an elaborate one at all so long as it works properly.—THE EDITORS.



# Optical Illusion Contest Awards

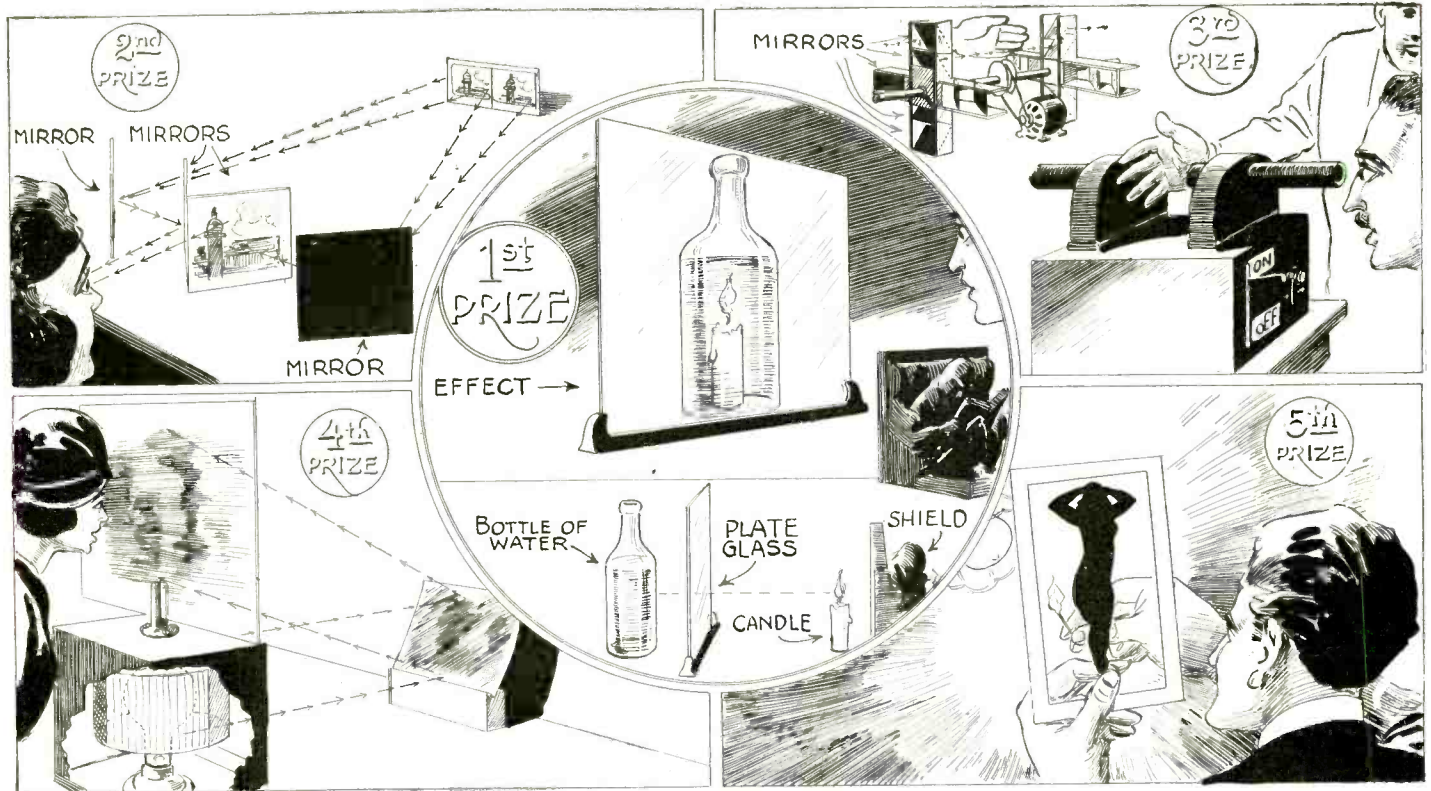

The First Prize Illusion, for which \$50.00 was paid to Leroy Western, is made by placing a bottle nearly filled with water behind a small piece of plate glass. In front of the glass a lighted candle is placed behind the screen so that when the observer looks at the glass the reflection of the candle makes it seem to be burning in the water.

The Second Prize of \$20.00 won by Brent McRae, is a mirror stereoscope. The two mirrors in the center are at an angle of 45°. The outside mirrors are 3 inches from the inner ones. Regular stereoscope pictures may be used. Others, two and one-half inches square, will also work. The mirrors and pictures must be vertical. The exact distances and angles may be found by experimenting.

The Third Prize, of \$15.00, which went to Esten Moen, is an "X-Ray" machine. The mirrors placed on the moving axle, revolved at about 200 R.P.M. through the phenomenon of "retention of vision," the observer sees

the object and also through it at the same time. All apparatus is placed in the case shown.

The Fourth Prize of \$10, which was won by G. H. Getz, consists of a sheet of glass supported on a box containing a regular light bulb which is fitted with a rotating screen colored so the colors fade into each other. The shade is constructed on a light cardboard frame with a top which is fluted with vanes so the hot air will rotate the shade. The light is reflected through a hole in the back of the box to the mirror and onto the glass. The screen is supported on a metal bearing resting on the tip of the bulb.

In the fifth prize illustration, for which \$5.00 was paid to John Stoneham, the cardboard figure, glued to thin gauze which is held on a cardboard frame, will seem to move if a light is swayed from side to side behind it.

## How The Water Lily Greet The Sun

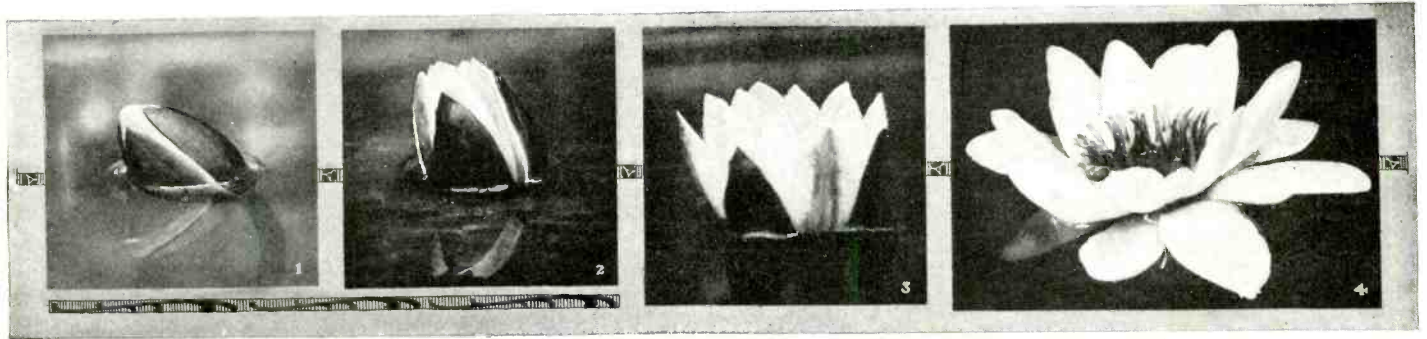

The pictures above, covering thirty-five minutes, show graphically how the water lily opens to the sun in the morning. The second picture

(reading L. to R.) was taken fifteen minutes after the first. The third and fourth each at ten-minute intervals follow the second picture.

## A Lock For Coats

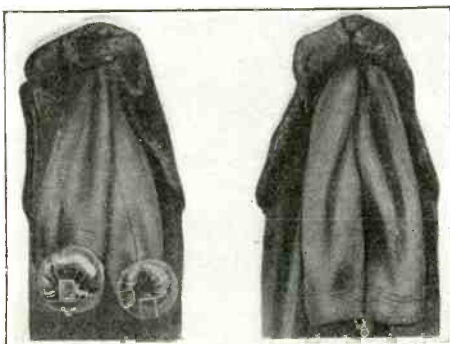

This coat lock consists of a small chain run under the lining of each sleeve and padlocked.

### THE EDITORS ASK A FAVOR

To our readers:

This is the first issue of the NEW SCIENCE AND INVENTION. It has been created at a cost three times as great as any previous number. In order to put it out the editors have expended a vastly greater effort than ever before.

May we then ask you to voice your approval or disapproval of the NEW SCIENCE AND INVENTION. It is not necessary to sign your name. Just cut this out paste on back of a postal card and mail to the Editor.

I approve your new policy .....

Why I do .....

I do not approve your new policy .....

Why I do not .....

Name .....

Address .....



# Everyday Chemistry

By RAYMOND B. WAILES

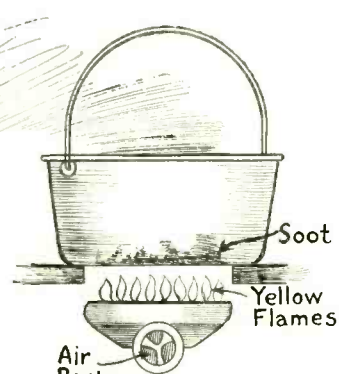

**Sooty Pots?**  
Give the burner more air

1

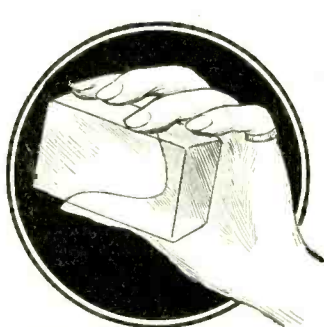

**What are Transparent Soaps?**

2

**Why does Salt cake?**

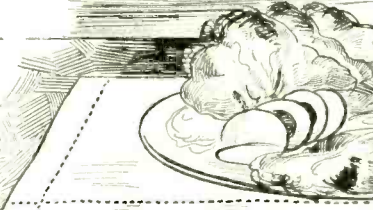
3

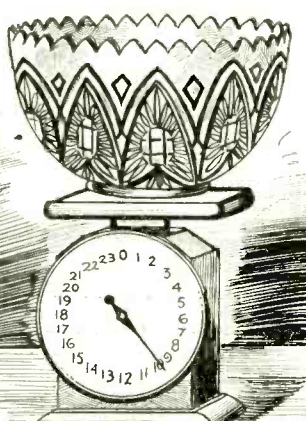

**Why is Cut Glass very heavy?**

4

**Why do Egg Spoons turn black?**

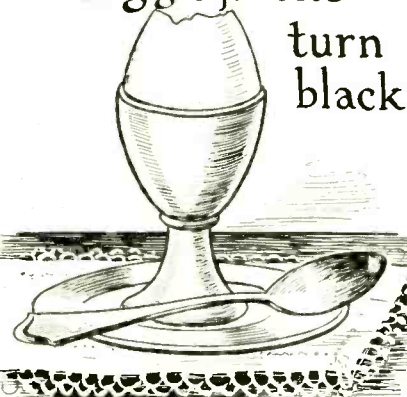

5

**Is this Point really Lead?**

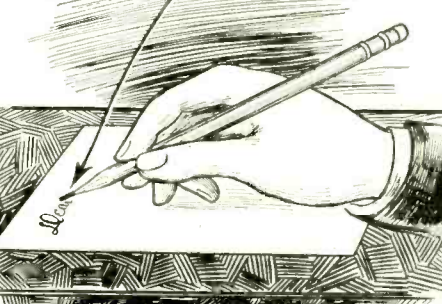

6

**Certain "Cleaners" will not explode Why?**

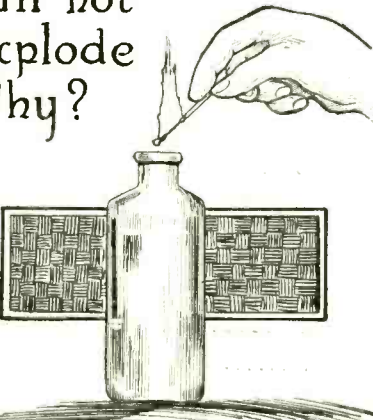

7

**How does the White Cloud form in Electric Light Bulbs?**

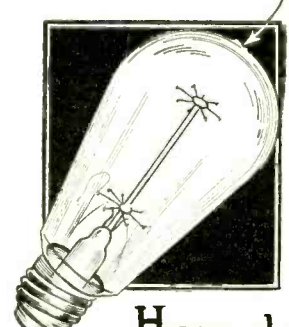

8

**Two Disinfectants make a Radio Panel**

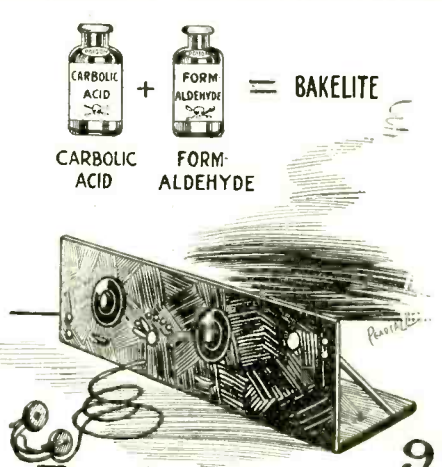

9

The Answers are: (2) Alcohol in Regular Soap Dissolves the Color. (3) Silicate. (5) Due to the Sulphur in the Egg. (6) No. Graphite. (7) Carbon Impurities in the Salt Cause It to Cake. (4) Cut Glass Contains Lead. (8) Tungsten Oxide, Formed by Action of Oxygen on Tungsten is White. (9) Carbon Tetrachloride is Non-Combustible.



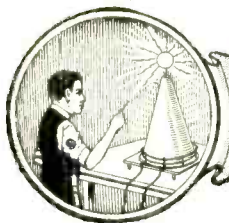

# THE CONSTRUCTOR

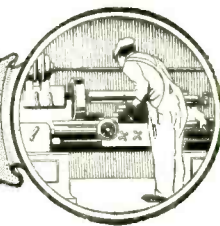

## Decorative Effects From Oil

By DR. ERNEST BADE

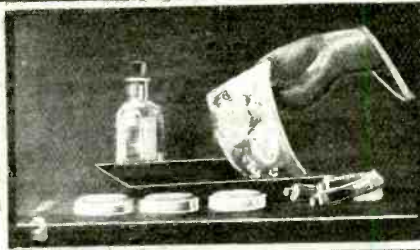
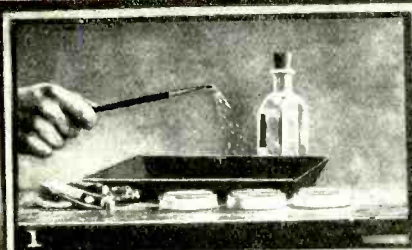

Surface Tension is Responsible for Dr. E. Bade's Method of Making Decorative Papers Used for Making Photograph Mountings, Lamp Shades, Box Covers, or Other Paper Novelties. Photo Shows Method Used for Spattering the Colors on the Treated Water from Which the Print is Taken. Each Tint Must Have a Separate Container. The Pigment Used is Regular Tube Oil Color Diluted with Turpentine. A Marbling Effect is Obtained by Drawing a Match Through the Surface.

Any Kind of Paper May Be Used to Take the Print. The Water Solution is Made of Gum Tragacanth (Powdered) Which is Dissolved in a Little Water and Made Into a Paste. The Paste is Then Diluted to the Consistency of Milk. After the Different Colors Have Been Spattered on the Surface the Paper is Lightly Placed in a Floating Position Where It is Left for Ten Seconds. It Is Then Lifted from the Tray by Grasping One of the Floating Ends.

Starch Paper is Made Much More Simply. The Process is to Dissolve Half a Teaspoonful of Starch in Half a Glass of Water. Then Dilute Into Half a Pint of Boiling Water. If Necessary, Boil Till Clear and Glassy. Then Add Water Color Tints. Brush on the Paper with Stiff Bristles. For Designs, Draw a Comb or Other Toothed Instrument Over the Surface of the Coated Paper as Shown in the Above Photo. By Drawing a Feather Over the Paper a Marbling Effect is Obtained.

Below is Shown a Specimen of the Decorative Work Done in Blue and Red. The Two Colors Were Spattered on the Water Where They Formed Small Circles. Then a Match Was Drawn Laterally Through the Surface of the Pan and the Design Below Resulted. A Little Experimentation with the Tints and Mixing Will Produce Many Novel Effects.

The Design Shown Below is in Plain Black and White. The Colors were Applied in Two Large Splotches at Each End of the Pan. As the Colors Will Not Mix on the Surface of the Water There is Little Danger in the Spattering Process. The Design Below Was Obtained by Drawing a Match Slowly from the Upper to Lower Corner.

All Sorts of Weird Designs Can Be Obtained in the Starched Tinted Papers. There Is a Great Deal of Pleasure in Making Them on Account of the Ease of Preparing the Mixture. Designs or Crests May Be Worked Into This Medium with a Very Good Effect. The Illustration Below Shows a Two-Color Design on Paper Coated By Dr. Bade.

BLUE

RED



BLACK & WHITE



RED

WHITE

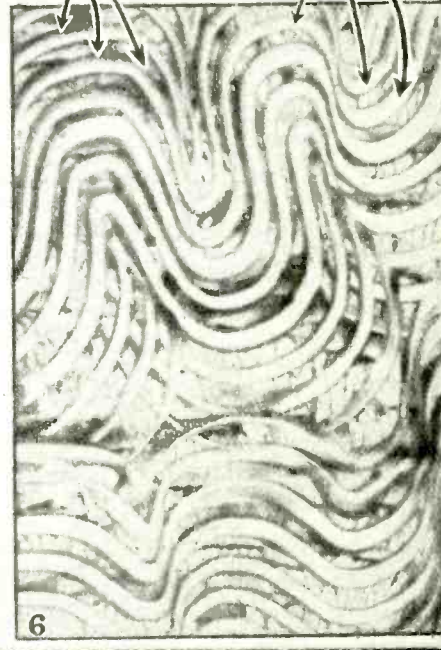



# Simply Built Hand Drill

# Torch Stove

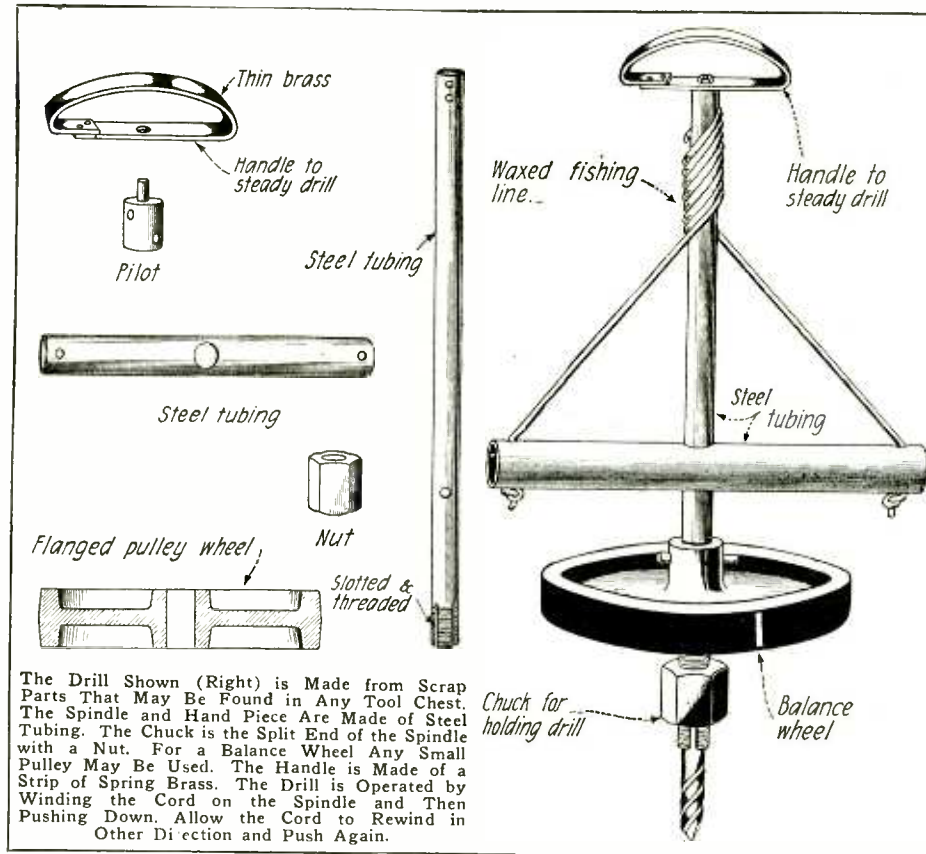

The Drill Shown (Right) is Made from Scrap Parts That May Be Found in Any Tool Chest. The Spindle and Hand Piece Are Made of Steel Tubing. The Chuck is the Split End of the Spindle with a Nut. For a Balance Wheel Any Small Pulley May Be Used. The Handle is Made of a Strip of Spring Brass. The Drill is Operated by Winding the Cord on the Spindle and Then Pushing Down. Allow the Cord to Rewind in Other Direction and Push Again.

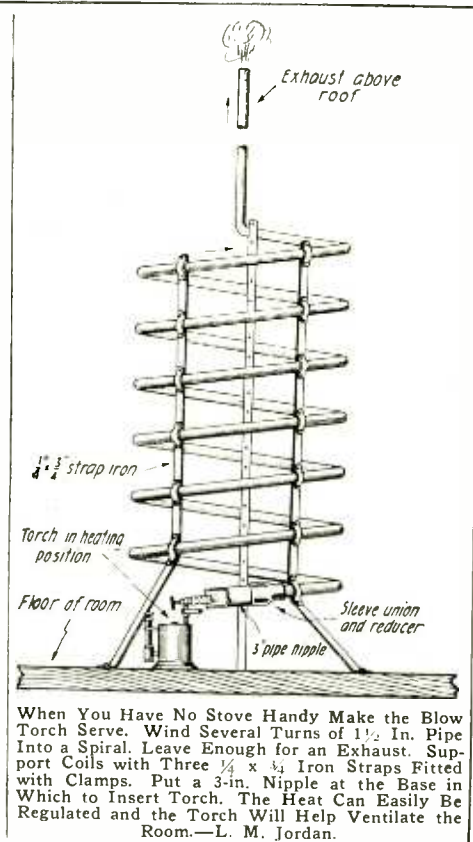

When You Have No Stove Handy Make the Blow Torch Serve. Wind Several Turns of 1 1/2 In. Pipe Into a Spiral. Leave Enough for an Exhaust. Support Coils with Three 3/4 x 3/4 Iron Straps Fitted with Clamps. Put a 3-in. Nipple at the Base in Which to Insert Torch. The Heat Can Easily Be Regulated and the Torch Will Help Ventilate the Room.—L. M. Jordan.

## Moon's Age Chart

## Extension Phone From Extra Parts

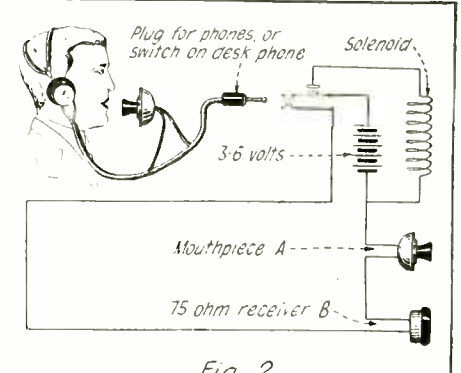
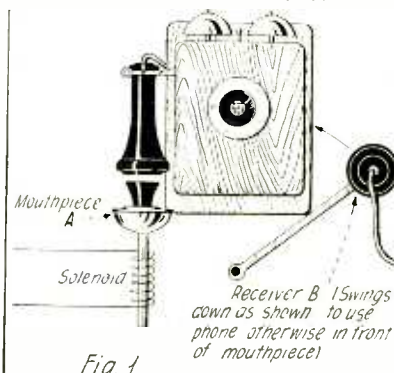
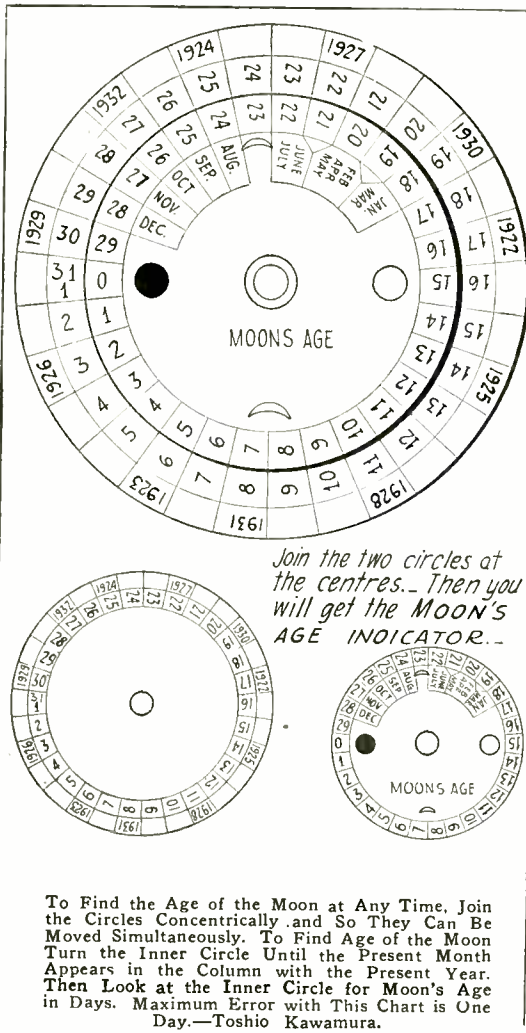

This Telephone Extension is Easily Made and as Many as Are Wanted Can Be Used. Once the Transmitter and Receiver Have Been Fixed to the Outside Instrument. A Regular Transmitter is Used and is Fastened so That it is about an Inch from the Receiver, as Shown in the Cut When the Receiver is at Its Highest Position on the Hook. A 75-Ohm Receiver is Braced so it Stands About a Quarter of an Inch from the Transmitter. The Hook-up is Shown to the Left. Thousand-Ohm Radio Receivers May Be Used at the Receiving End. A 3 to 6 Volt Battery is Used.—Richard Ballou.

## Method to Increase Range of Scales

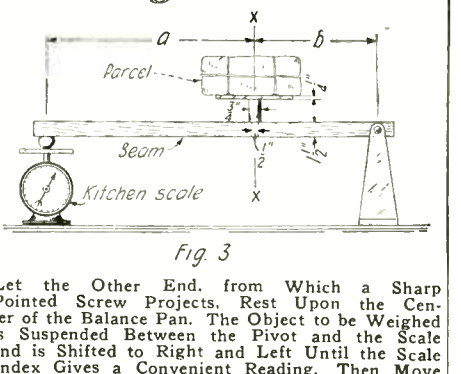
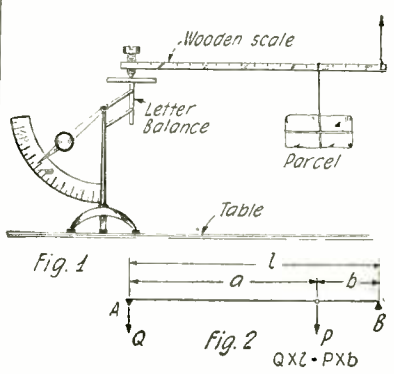

Let the Other End, from Which a Sharp Pointed Screw Projects, Rest Upon the Center of the Balance Pan. The Object to be Weighed is Suspended Between the Pivot and the Scale and is Shifted to Right and Left Until the Scale Index Gives a Convenient Reading. Then Move the Object to the Nearest Division of the Lever and Read the Scale. Unknown Weight Equals Length of Lever, Divided by Distance from Pivot to Weight Multiplied by Index Reading of the Scale or Unknown Weight.—C. A. Oldroyd.



# Camera For Use With Microscope

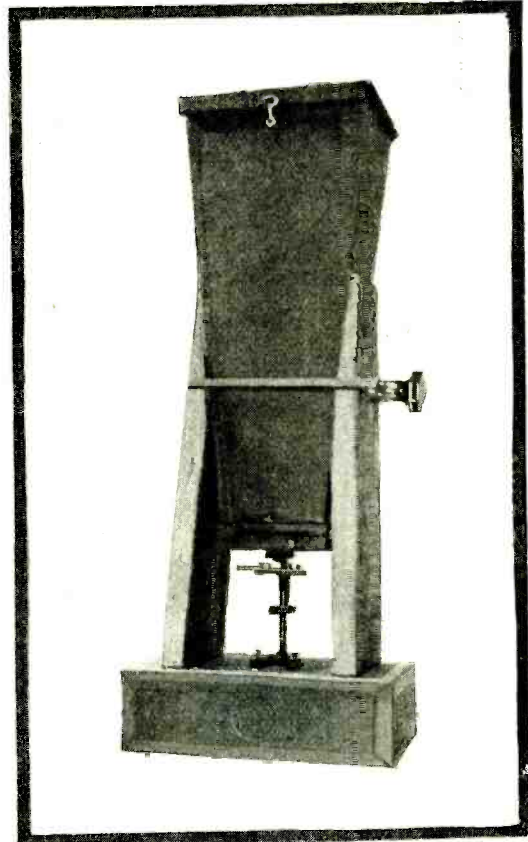
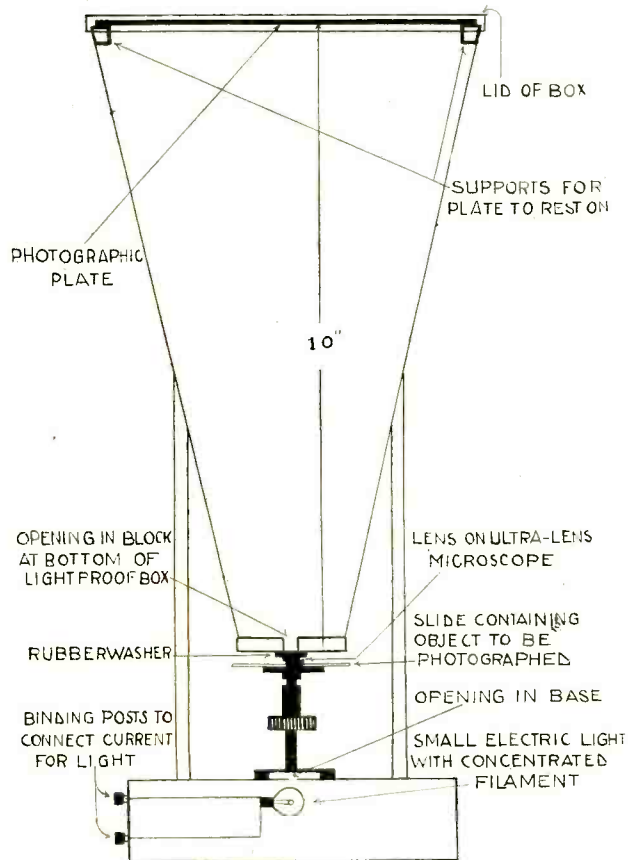

Cross-Section Shows Lightproof Box Taken from Old Enlarging Camera or Constructed by Amateur Supported Over Microscope. Top Must Fit Light-Tight. Microscope and Camera Are Supported on Cigar Box.

In Picture of Apparatus (Above) Brass Strip Movable Support for Camera is Shown. Light for Illuminating Subject Must Be Directly Under Slide, in Cigar Box. Use a Flat Black Paint Only, on Apparatus.

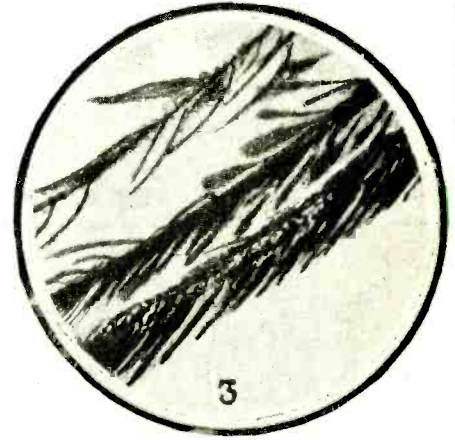
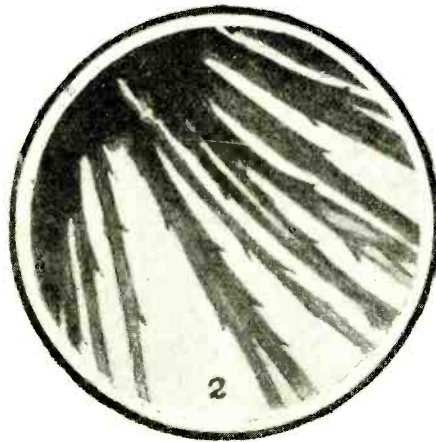

Number 1 Shows a Section of the Feelers from the Foot of an Ordinary Moth. Specimens for Photographing Are Mounted in the Same Manner as They Are for Microscopic Examination: on Slides, in Balsam. 4—Hook on Bumble-Bee's Foot.

In 2 is Shown Dandelion Seed. No. 3 is Section from Mosquito's Wing. No. 5 Wing of Ordinary House Fly. No. 6 Plant Pollen. All These Photos Were Made with the Above Apparatus, Including 125 Diameter Microscope of the Ultra-Lens Type.

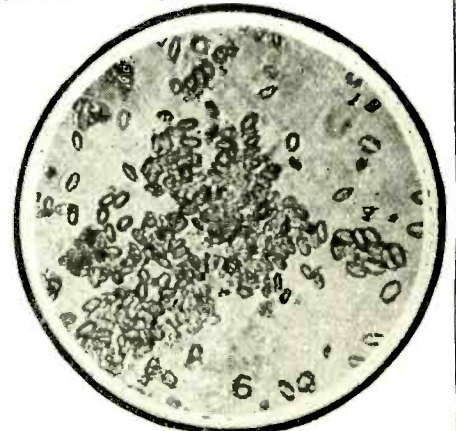
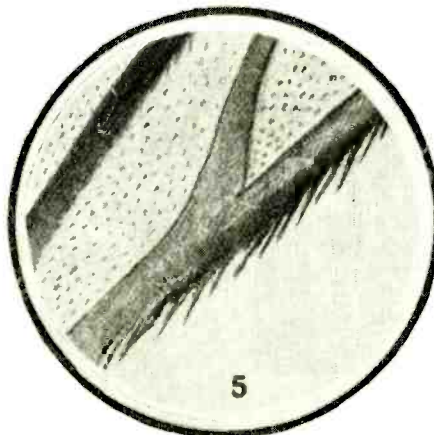
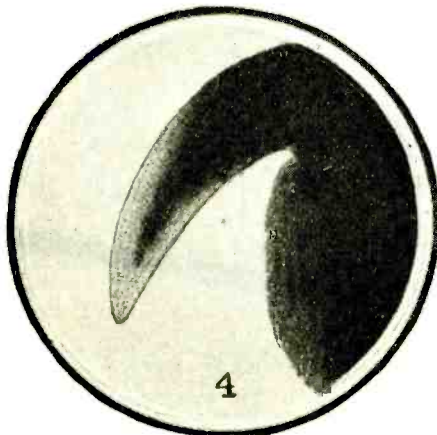



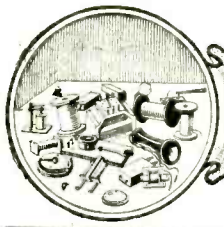

# HOW-TO-MAKE-IT



This department will award the following monthly prizes: First prize, \$15.00; second prize, \$10.00; third prize, \$5.00. The purpose of this department is to stimulate experimenters toward accomplishing new things with old apparatus or old material, and for the most useful, practical and original idea submitted to the Editors of this department a monthly series of prizes will be awarded. For the best idea submitted a prize of \$15.00 is awarded; for the second best idea a \$10.00 prize, and for the third best a prize of \$5.00. The article need not be very elaborate, and rough sketches are sufficient. We will make the mechanical drawings. Use only one side of sheet. Make sketches on separate sheets.

FIRST PRIZE \$15.00

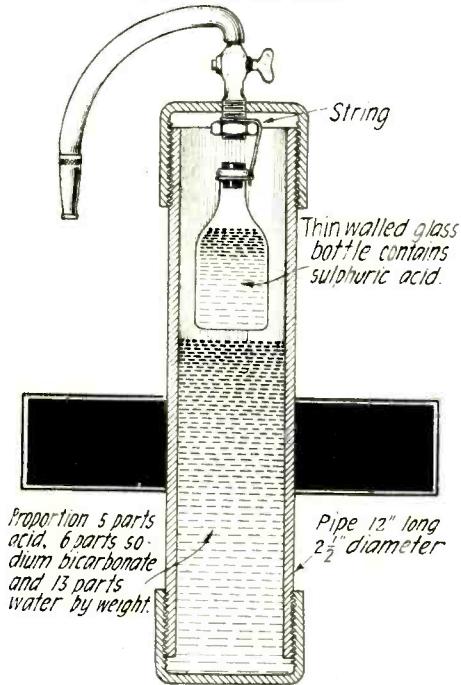

The Fire Extinguisher Shown Above Contains a Bottle of Sulphuric Acid Suspended from a Nut Screwed on the Cock. The Pipe is Filled Three-Fourths Full of Water Saturated with Bicarbonate of Soda. To Operate, Shake Tank to Break Bottle, Open Cock and Spray on Base of Fire.—H. P. Clay.

SECOND PRIZE \$10.00

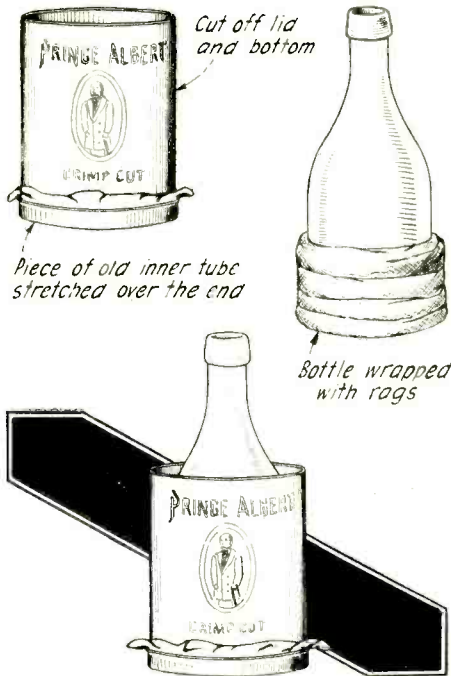

A Force Pump Handy for Cleaning Sink Pipes Can Be Made from a Circular Can and Bottle. Wrap the Bottle with Rags So It Fits Snugly. Place a Piece of Inner Tube Over the Bottom of the Can in Order to Get Tight Contact Over the Sink Strainer and Then Work the Bottle Up and Down Vigorously.—Thos. Barta.

THIRD PRIZE \$5.00

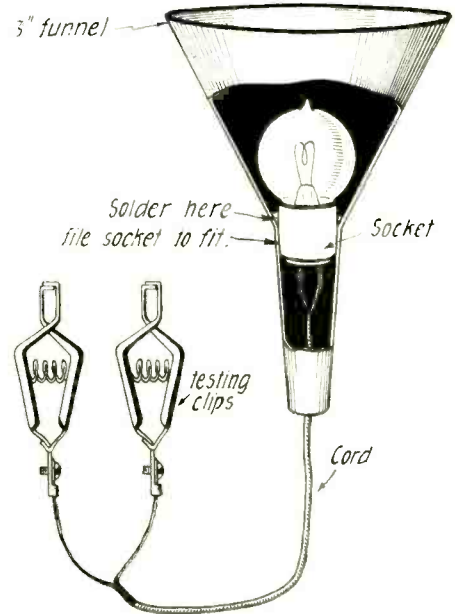

A Trouble Light Can Be Made from a Funnel and Headlight Socket. Solder Socket in After Cord Has Been Drawn Through the Neck of the Funnel. Attach Battery Clips to the Ends of the Cord. A 3-Inch Funnel Will Serve the Purpose Best. It's Not Necessary to Fasten the Cord In.—Stanley Fitch.

## For A Kinkless Phone Cord

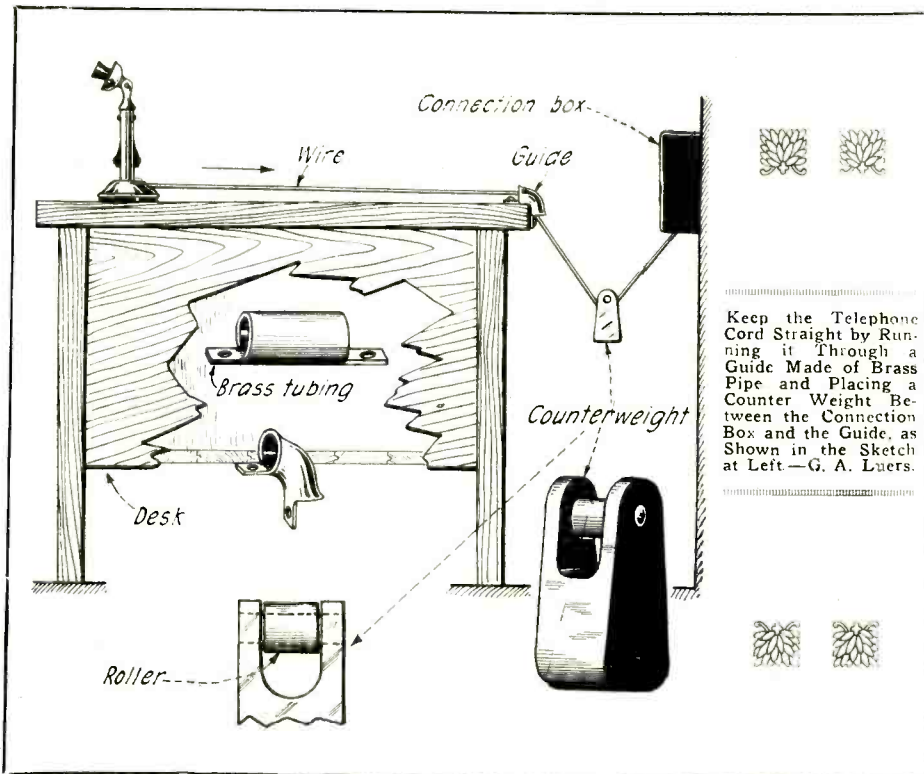

## Rawhide Barometer

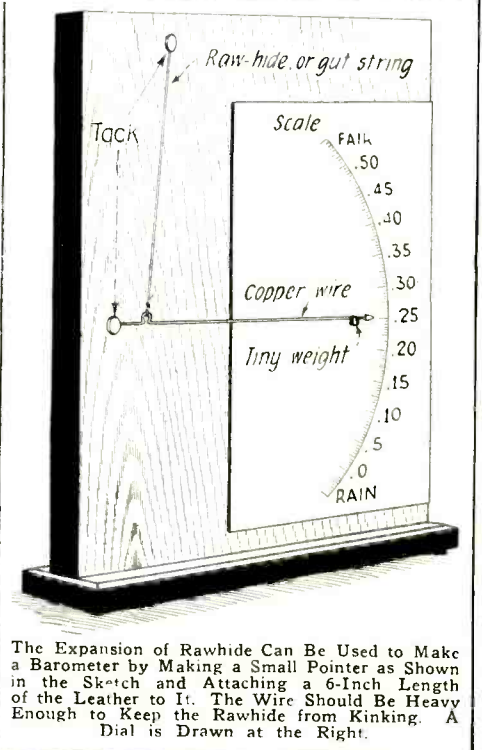



# Wrinkles, Recipes Formulas

EDITED BY S. GERNSBACK

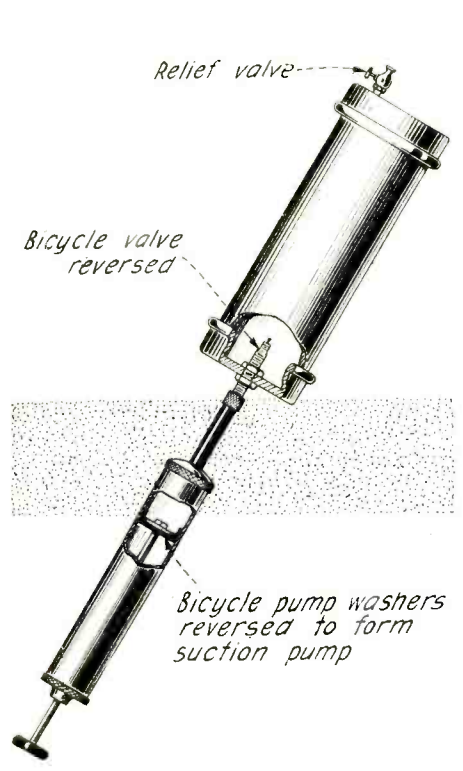

The Best Method of Popping Corn is in a Vacuum. The Device Illustrated Here is Made of a Short Length of Large Pipe. The Corn is Inserted and the Cylinder Heated and the Air Exhausted.—W. E. Dodge.

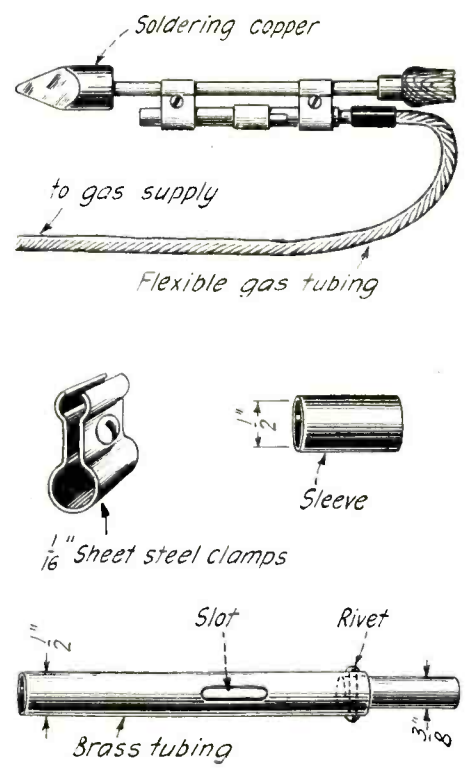

The Burner Used in the Above Heater is of the Bunsen Type. The Sleeve is Placed Over the Slot in the Tube and the Gas Line Attached to the Shank. The Whole is Attached to the Iron with the Clips.—G. A. Luers.

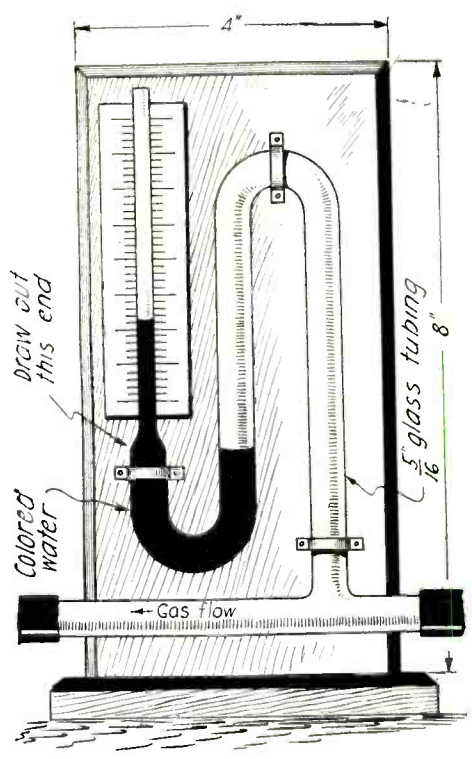

The Above Illustrated Gas Gauge is Simple in Construction. The Bend is Made and the End Drawn Out. The Tee is Then Made. If the Bends are Made While the Glass Rests on a Flat Surface a Neat Product Will Result.—Carlyle Weiss.

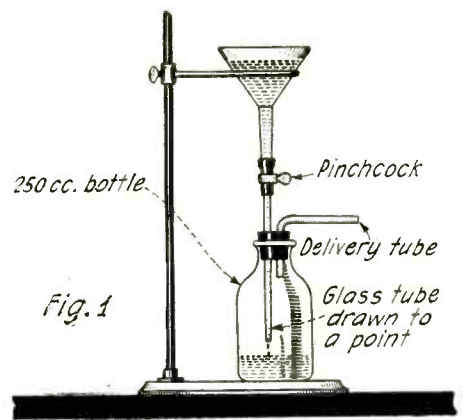
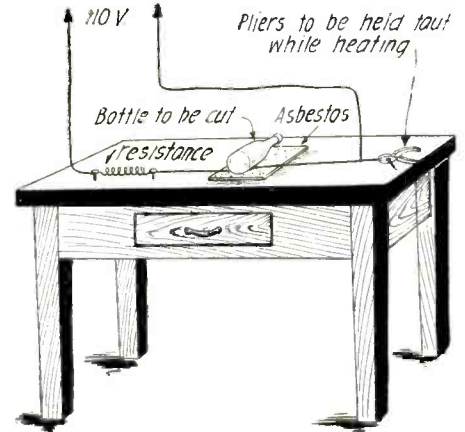
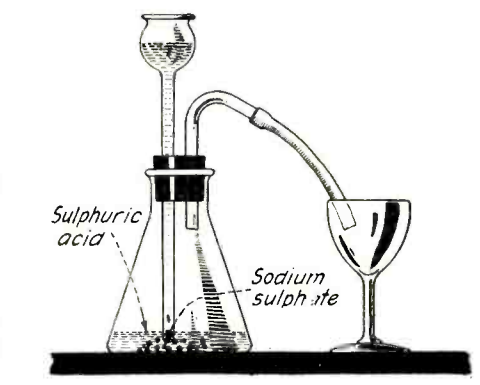
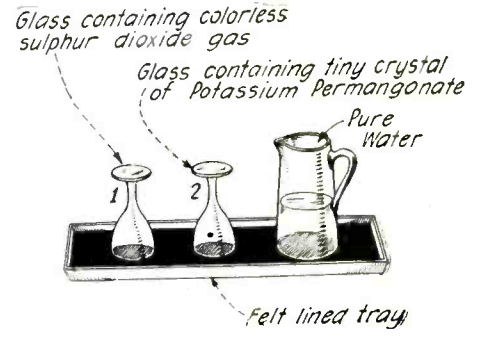

Fig. 1



The Heat Through the Resistance Wire (Nichrome or German Silver) Quickly Cuts the Bottle in a Clean Line Where the Wire is Wrapped Around it.—Frank Lindstaedt.



When Water is Poured into Tumbler 1 It Remains Clear. When Poured into Tumbler 2 It Turns Wine-red. When Returned to the Pitcher the Solutions React. Water is All Clear Again. Gas Made from Sulphuric Acid on Sodium Sulphite as Shown in Boycott Cut.—Chas. Tenney.

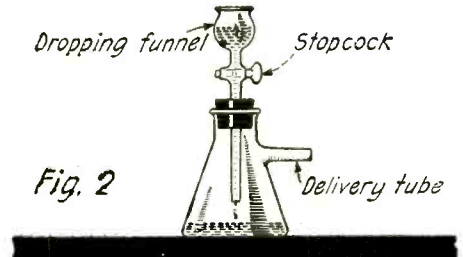

Fig. 2

Much Broken Apparatus and Ruined Experiments Result from Making Gas by the Heat Method. With the Apparatus and Formulas Given This Can Be Dispensed With.



**RADIO DEPARTMENT**

# How Radio Will Aid Mine Rescue

By W. B. ARVIN

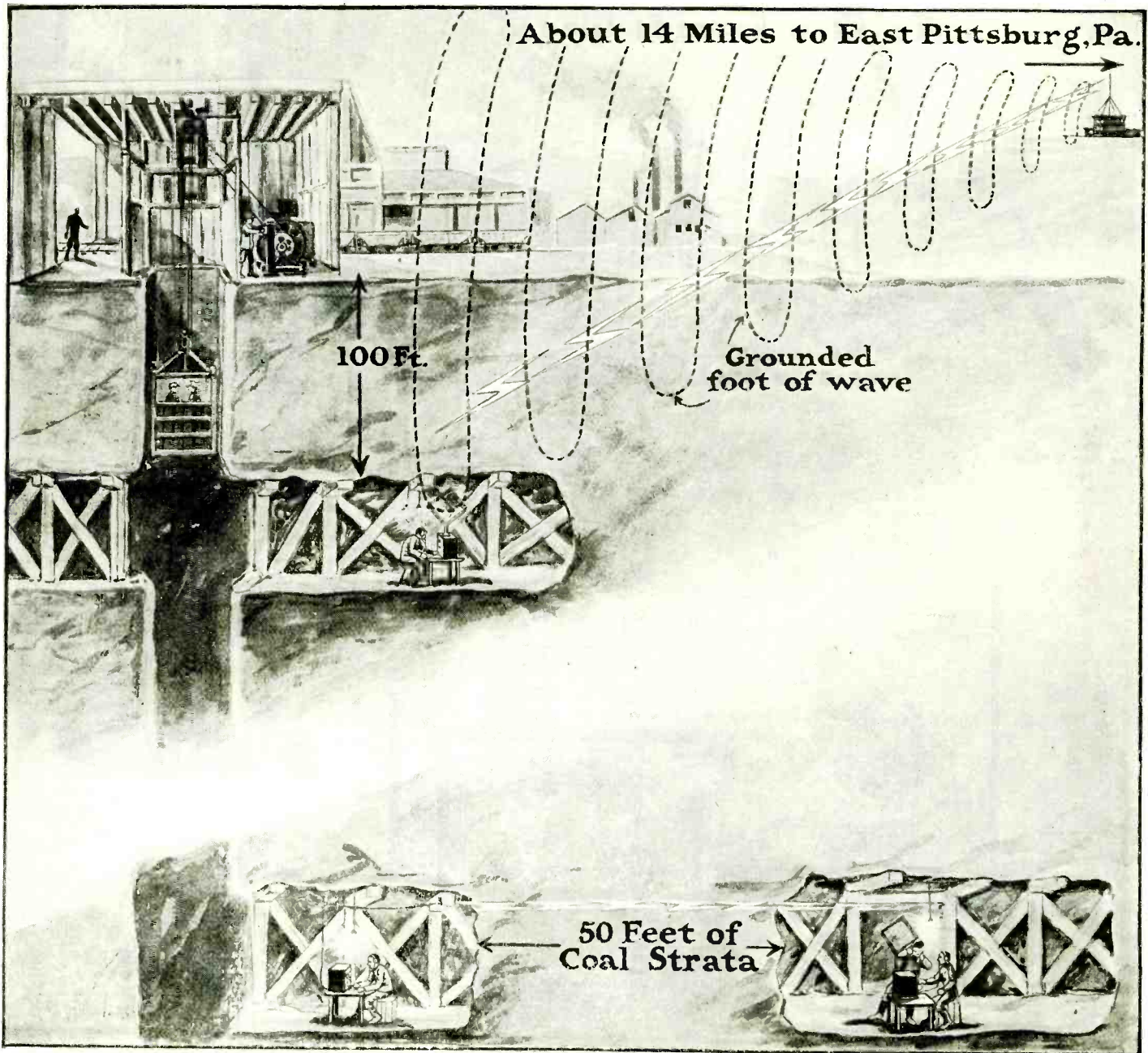

That Future Mine Disasters May Be Averted to a Great Extent Through the Use of Radio Communication is a New Theory on Which the United States Bureau of Mines is Constantly Making Experiments Through Which They Hope to Remove a Great Deal of Danger Encountered in Mine Accidents. In the Illustration Above is Shown the Results as Set Out in the Latest Report Made to the Bureau on Investigations Carried Out at the Government's Experiment Mine Near Bruceton, Penn. The Experiments, Made Under the Supervision of Mr. J. J. Jakowsky, Showed That Reception from an East Pittsburg Station, Fourteen Miles Away, Was Possible with the Receiving Set 100 Feet Underground. Transmission

Was on 360 Meters. The Most Promising Results Were Obtained in Experiments Where Both Transmission and Reception Were Carried on Underground. Waves Were Broadcast Through a Fifty-Foot Strata of Coal, as Shown in the Lower Part of the Drawing. Reception Was Clear and Distinct Though the Strength of the Signals Decreased in Direct Ratio to the Thickness of the Strata. A Horizontal Antenna Was Found to be Practically Useless While a Vertical Loop of One Turn Worked Admirably. The Theory Held by the Experts is That the Direction of the Strata Has Little Effect on Reception But That Its Density May Cause Slight Variations in the Strength of the Signals.



# Balloons to Support Antennae

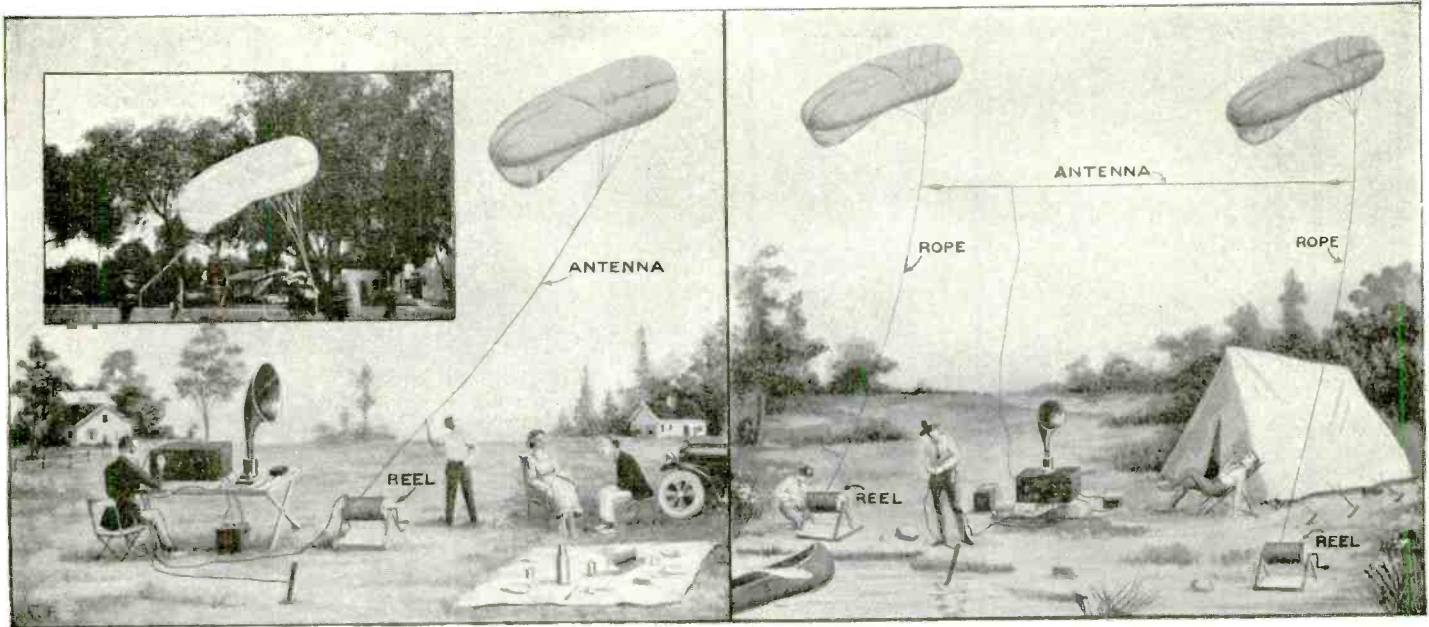

A Kite Balloon Has Been Designed by Mr. Roy Knabenshue of Burbank, California, for Supporting a Radio Antenna. It is Shown in the Photograph in the Upper Left-Hand Corner and Two of Its Uses Are Illustrated Above. Ex-

cellent Results Were Obtained With the Vertical Antenna Used As Shown at the Left. The Illustration at the Right Shows the Manner in Which Balloons Were Used in the Late World War, as Then Described in This Magazine.

## Leviathan's Radio Transmitter

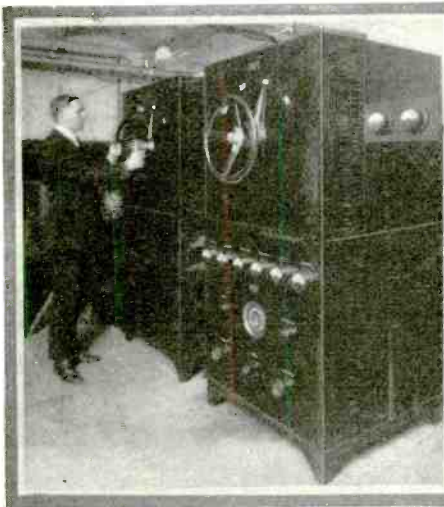

Testing and Tuning the Radio Telegraph Transmitter on Board the Leviathan is Shown Above. This Set Has Been a Great Success for Long Distance Transmission.

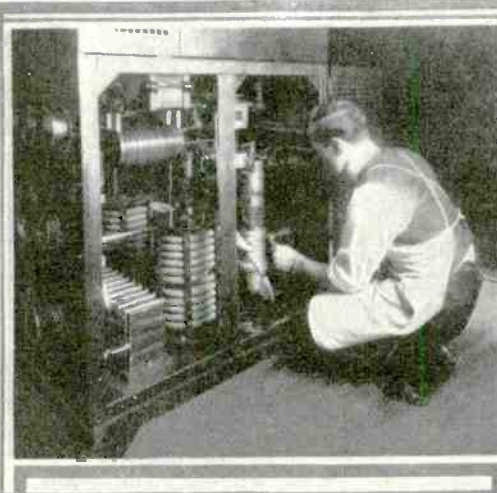

The Inside of the Vacuum Tube Unit is Illustrated, Showing the Water-Cooled Tubes Designed to Operate With a Plate Voltage of 6000 Volts Great Success Has Been Achieved With This Arrangement.

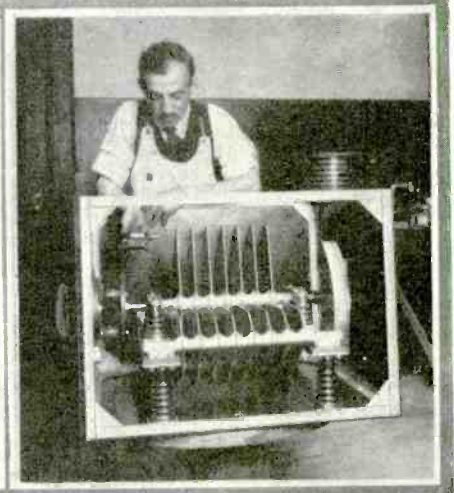

One of the Variable Condensers on the Leviathan's Transmitter, Compared With a Standard Variable Condenser Held by the Gentleman.—Photos, C. W. Tucker.

### Variable Condenser

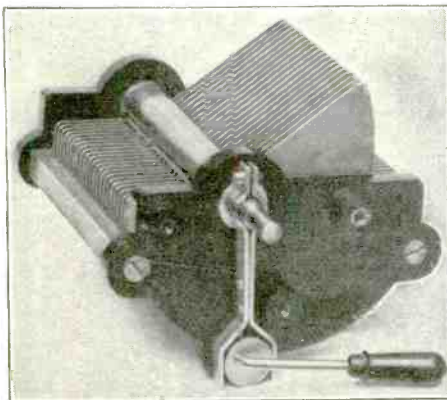

A New Type of Variable Condenser Giving a Straight Line Curve and Equipped With an Exceedingly Accurate Vernier. This Instrument is Made in Standard Sizes, of Brass or Aluminum.

### 30-Ohm Resistance

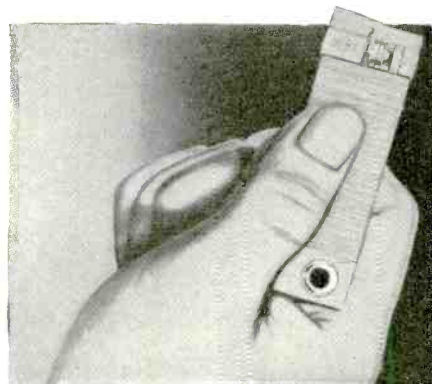

A Resistance Unit of 30 Ohms, To Be Added To a Standard Vacuum Tube Rheostat For Use With Vacuum Tubes Consuming Only One-Quarter of an Ampere or Less is Shown Here.

### The Radio Doll

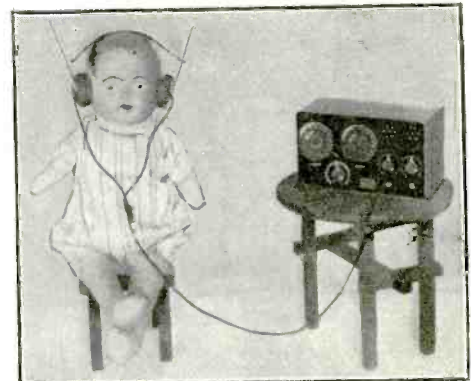

Radio Has Invaded Toy-Land and Small Imitation Receiving Sets With Dolls Are Being Shown in the Up-To-Date Toy Departments. — Photo by J. E. Dadswell.



# Radio-Directed Torpedo of To-morrow

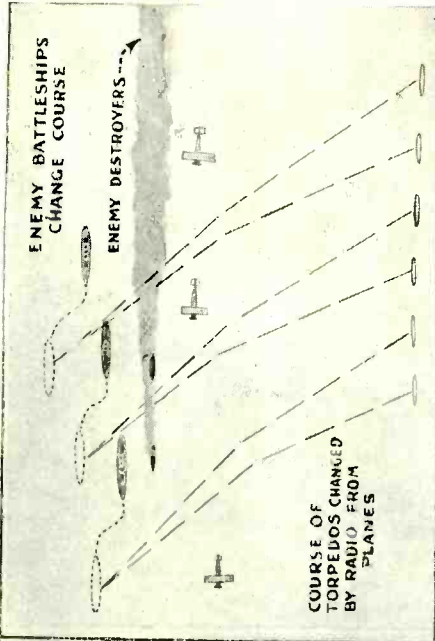
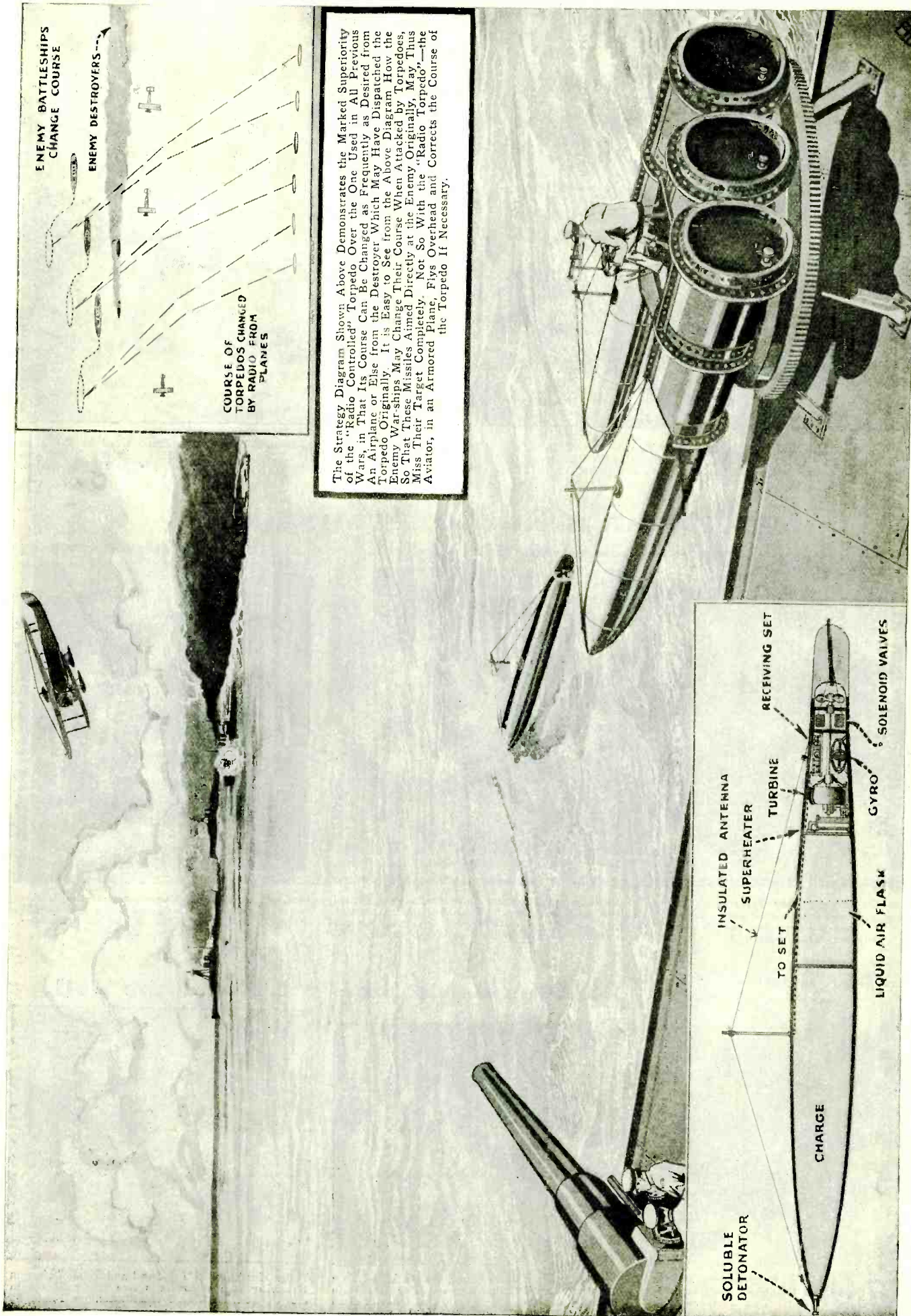

The Strategy Diagram Shown Above Demonstrates the Marked Superiority of the "Radio Controlled" Torpedo. Over the One Used in All Previous Wars, in That Its Course Can Be Changed as Frequently as Desired from An Airplane or Else from the Destroyer Which May Have Dispatched the Torpedo Originally. It is Easy to See from the Above Diagram How the Enemy War-ships May Change Their Course When Attacked by Torpedoes, So That These Missiles Aimed Directly at the Enemy Originally, May Thus Miss Their Target Completely. Not So With the "Radio Torpedo"—the Aviator, in an Armored Plane, Flies Overhead and Corrects the Course of the Torpedo If Necessary.

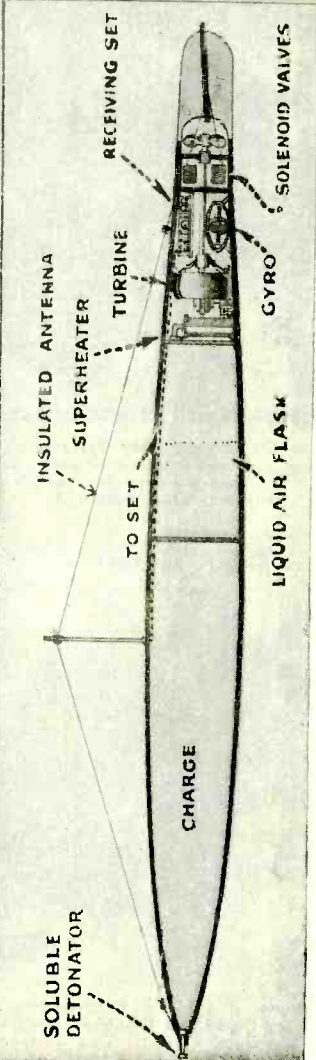

The Large Illustration Above Shows the Triple Torpedo Tube Mounted on the Deck of a Destroyer With the Center Radio-Controlled Torpedo Being Discharged Into the Water Toward the Enemy Vessels. The Airplane Is Seen Flying Above Ready to Keep An Eagle Eye On It So As to Send Out Any Correcting Radio-Control Impulses That May Be Necessary. The Detailed View in the Lower Left-Hand Corner of the Illustration Shows the Interior Arrangement of the Radio-Controlled Torpedo. Details by Graessner Schornstheimer, Special Naval Writer for Science & Invention.

© 1923 BY SCIENCE & INVENTION



# BROADCAST STATIONS

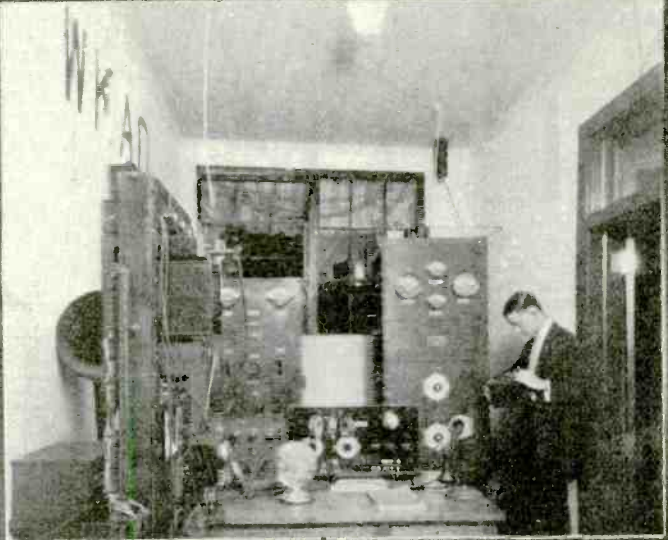
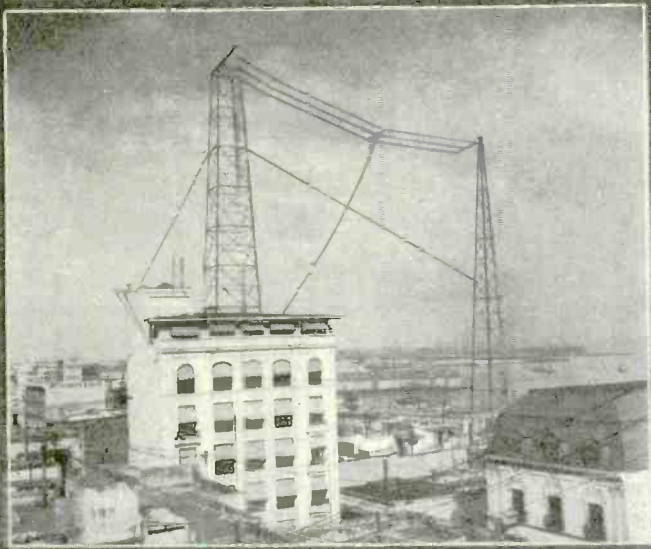

Upper Left: The Antenna System of Station WKAQ, Porto Rico. Above: The Operating Room of WKAQ Showing One of the Operators Checking Up the Wave-Length With a Wave-Meter. Left Center: The Studio of the Same Station.

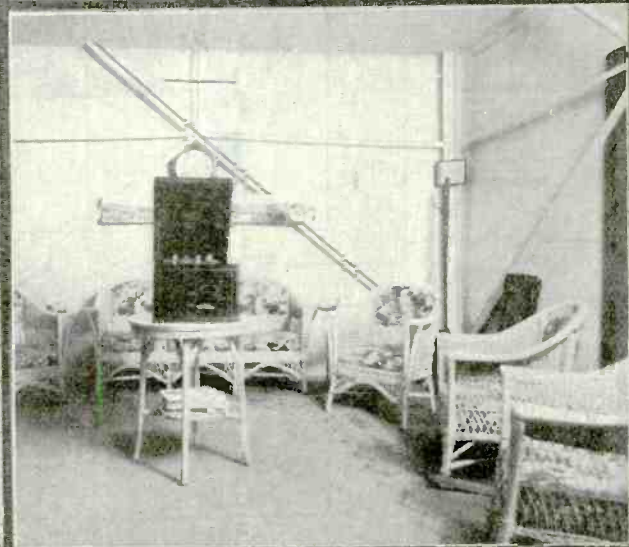

Above: The Artists' Rest Room at WKAQ. A Radio Receiving Set is Provided for Their Entertainment Between Selections.

Below: A View of the Extremely Neat Power Room of WKAQ. The Motor-Generators Appear on the Right and the Various Instruments and Apparatus Necessary for the Operation of the Station May Be Seen Around the Wall. This Station Has Been Heard in New England, Nova Scotia, and Many Cities Throughout the United States. The Station Proves to Be An Important Link Between the Island and Distant Places. Lower Right: The Monitoring Set of WKAQ on the Desk, and the Voice Amplifier on the Wall. The Operator Can Check Up On the Outgoing Programs by Means of His Receiving Set.

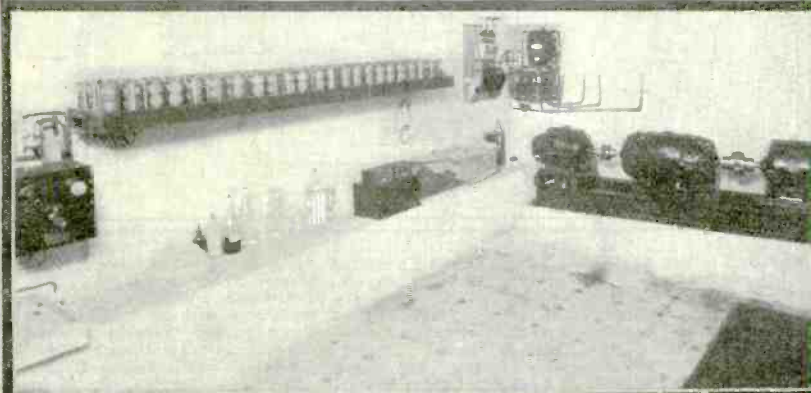



# Receiving the New Wave-Lengths

By MARIUS LOGAN

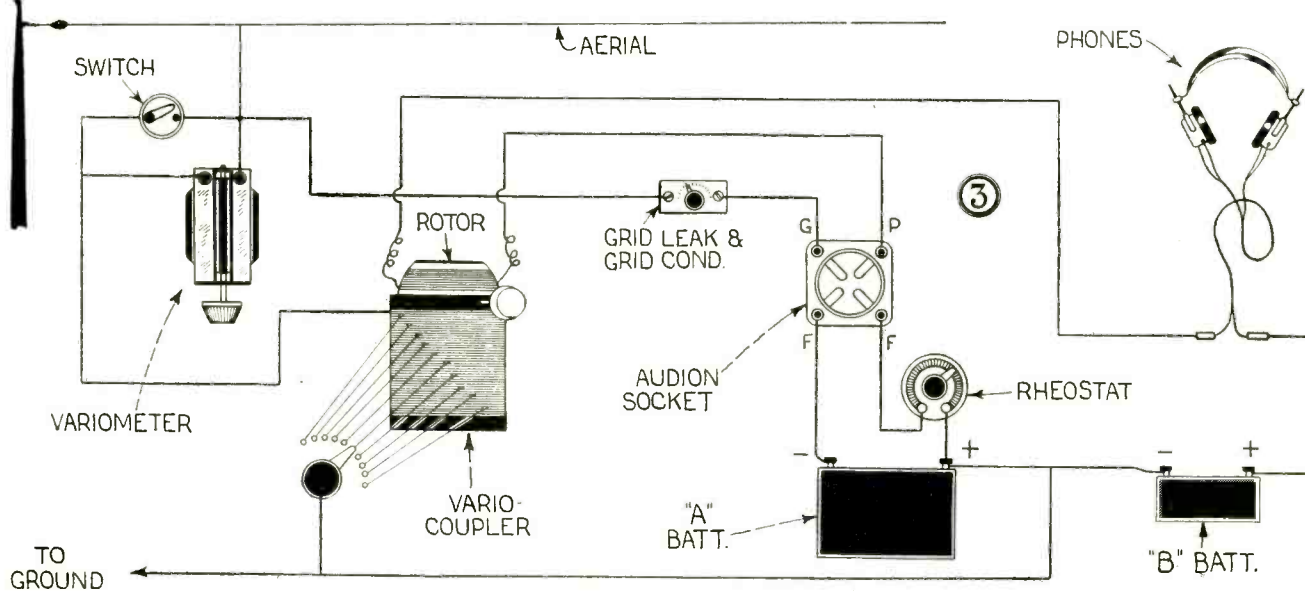
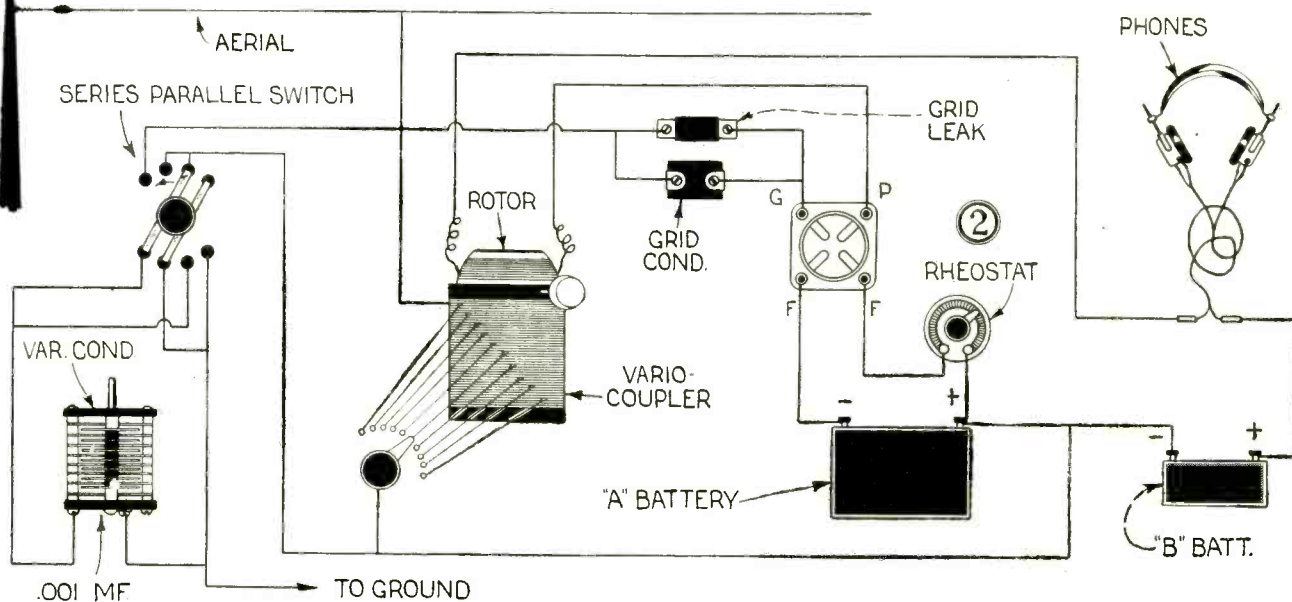
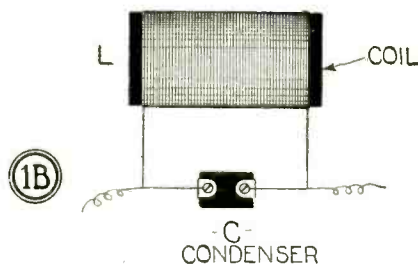
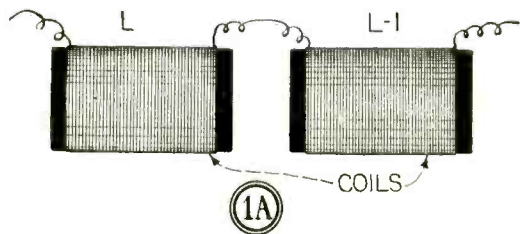

In Fig 1 Are Shown Two of the Methods of Loading an Inductance. If L has a Natural Wave-Length of 300 Meters and L 1 is of the Same Construction Then the Total Wave-Length to Which the Two Coils, Connected as Shown, Will Tune, Will Be 600 Meters.

In Fig. 1 B, Coil L May Be Loaded to Respond to a Wave-Length Higher Than Its Natural Period, by Connecting Across Its Terminals a Small Fixed Condenser as Indicated at C. This Particular Connection is Usually Termed a Shunt or Parallel Connection.

The Single Circuit Tuner Illustrated in Fig. 2 May Be Made to Receive on Higher Wave-Lengths Than Ordinarily, by Placing a Variable Condenser, with a Series-Parallel Switch, in the Circuit as Shown. Connect Condenser in Parallel for Long Waves; in Series for Short Waves.

Another Method of Loading a Single Circuit Tuner is Shown in Fig. 3. It Consists of Placing a Variometer in Series with the Stator of the Vario-coupler, Thereby Increasing the Natural Wave-Length of the Set. By Means of the Switch Illustrated, the Variometer May Be Shorted.



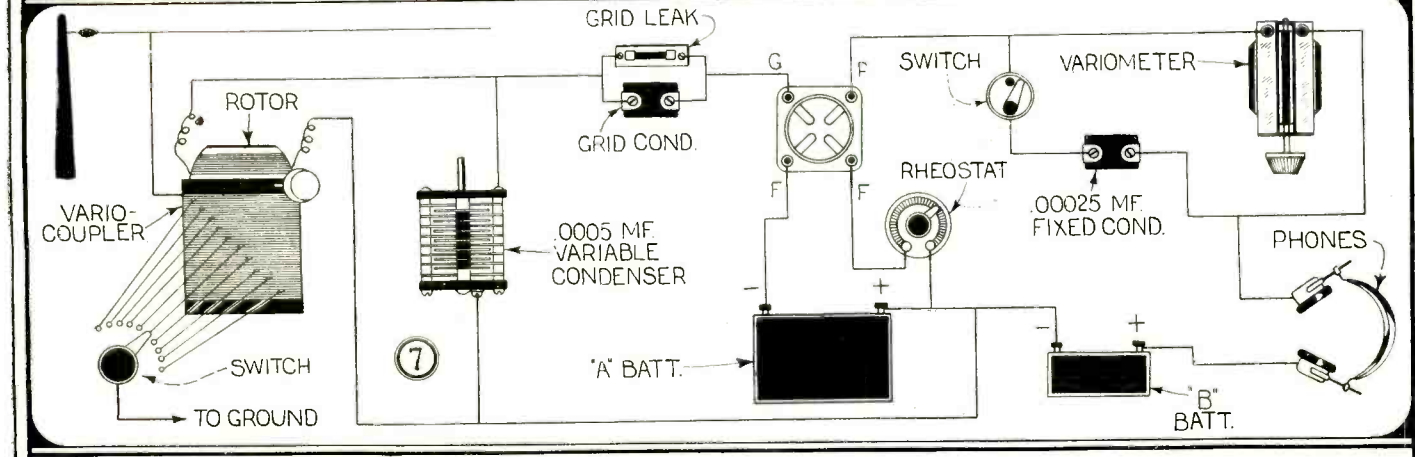
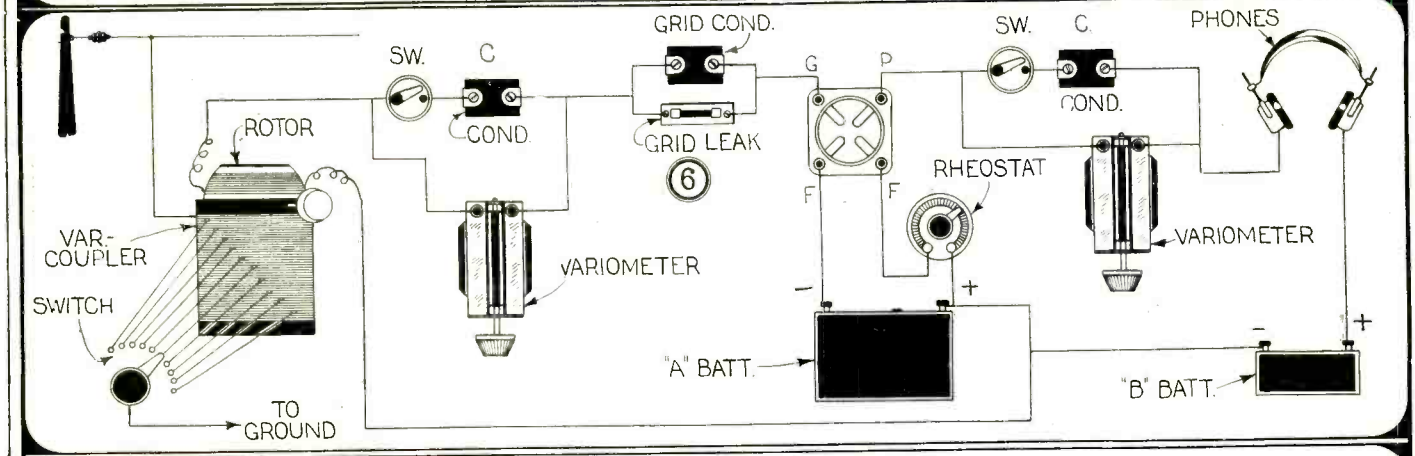
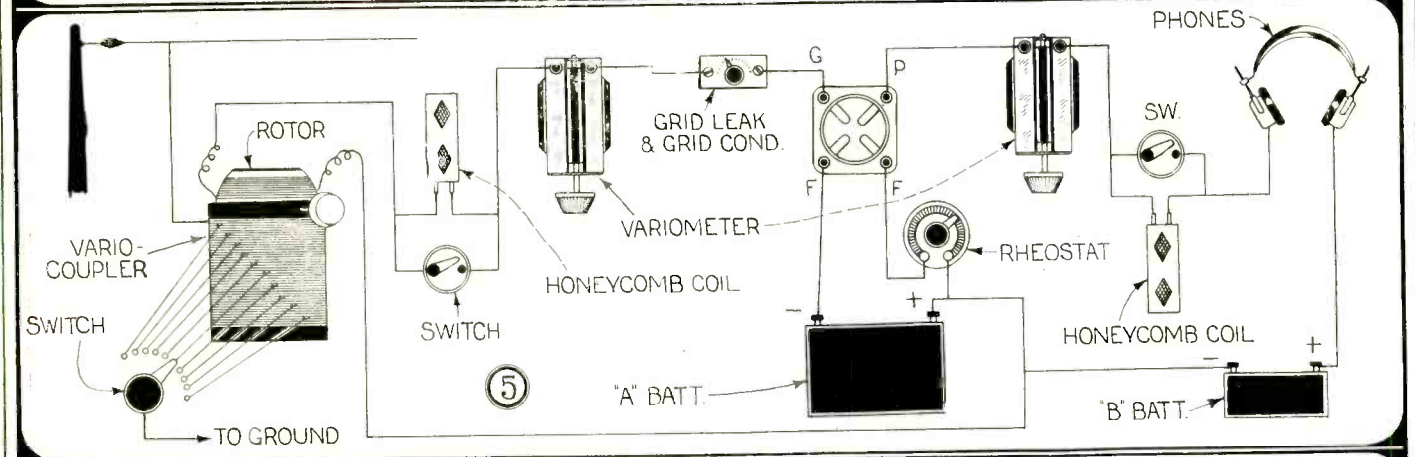
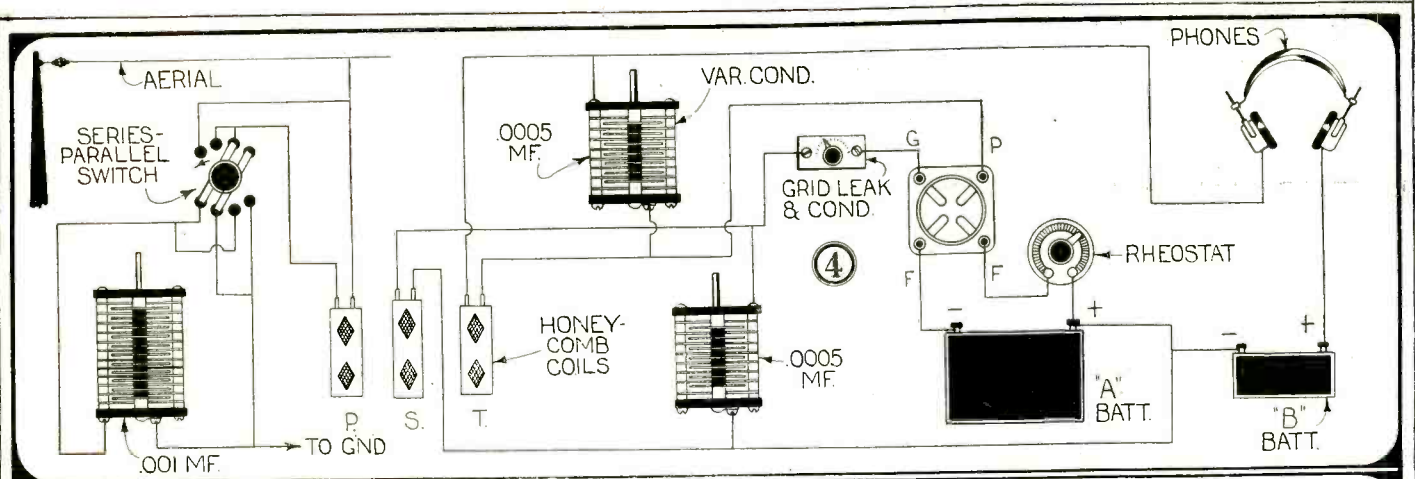

A Standard Three Honey-comb Coil receiving Set May Be Loaded to Respond to Higher Wave-Lengths as Shown in Fig. 4. Here a Variable Condenser and Series-Parallel Switch is Used in the Primary as in Fig. 2, and the Secondary and Tickler Coils Are Loaded by Placing a .0005 mf. Variable Condenser Across Them.

With the Ordinary Vario-Coupler and Two Variometer Short Wave Regenerative Circuit, the Grid and Plate Circuits Must Be Changed so as to Respond to the Higher Waves. This May Be Accomplished as Shown in Fig. 5 by Using Two Honey-comb Coils with Two Small Switches for Short-Circuiting Them.

Another Method of Loading a Standard Three-Circuit Receiving Set by Means of Two Small Fixed Condensers as Shown in Fig. 6 at Points Marked C. The Exact Size of These Condensers Should Be Determined by Experiment; Those with a Capacity of .00025 Mf. Will Give Good Results. Cut-out Switches Are Used.

Another Form of Three-Circuit Tuner Employing a Variable Condenser to Tune the Grid Circuit is Shown in Fig. 7. A Small Fixed Condenser with a Capacity of .00025 Mf. is Shunted Across the Variometer in the Plate Circuit. It May Be That the Rotor of the Vario-Coupler Will Require a .001 M.F. Cond.



# Radio for the Beginner

By ARMSTRONG PERRY

NO. 20 RHEOSTATS

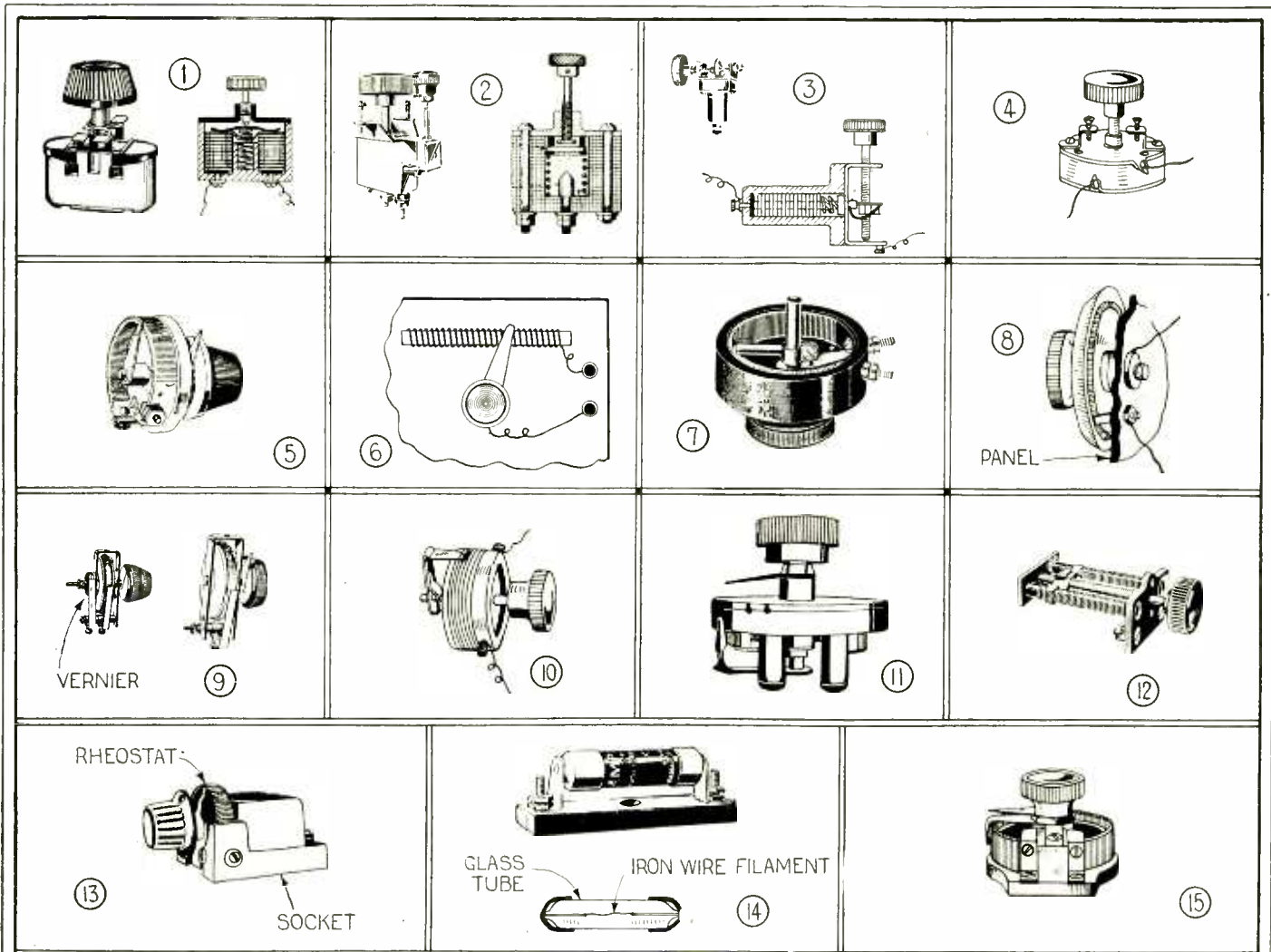

In This Article the Various Styles and Types of Rheostats and Resistances Used in Radio Construction Are Shown. Figs. (1) and (2) Show Popular Types in Which the Resistance is Varied by Compression of Carbon in the Form of Discs in 1 and Granular Particles in 2. In the Following Illustration the Resistance is of Carbon Disks. Fig. 4 Works on a Similar Principle. In Numbers (5), (7) and (8) Are Shown Styles of V.T. Filament Rheostats. In (6) We Have the

Simplest Home-made Variety. In Figs. (9) and (10) the Resistance Units Are Capable of Very Fine Adjustment. (In 9) the Vernier Gives the Fine Adjustment and in (10) All Parts of the Wire Are Available. The Types Shown at (11) and (12) Differ from the Other V.T. Types Only in Mounting and Adjustment Method. At (13) the Rheostat and the Tube Socket Are Combined. In (14) We Have an Automatic Iron Wire Ballast Resistance Unit.

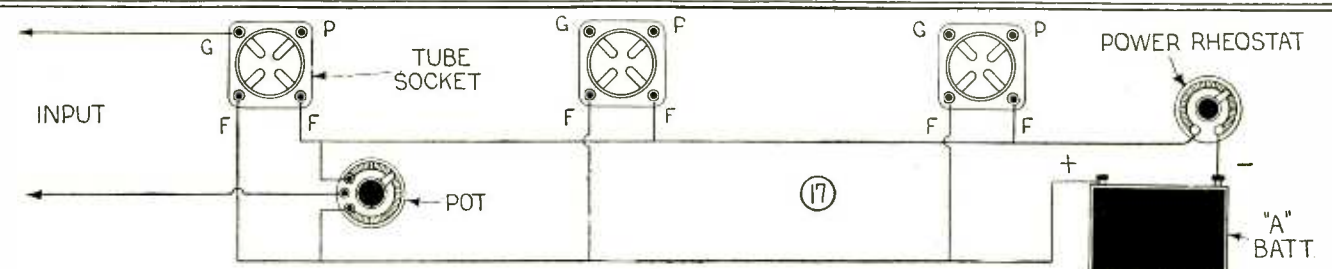
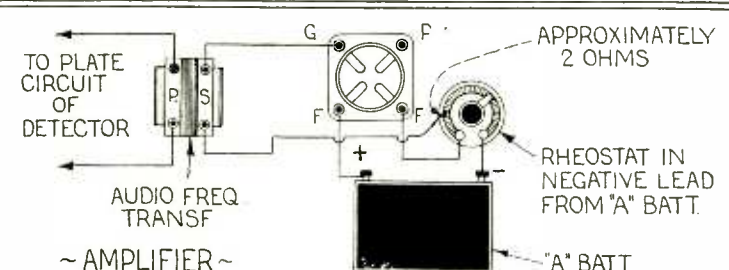
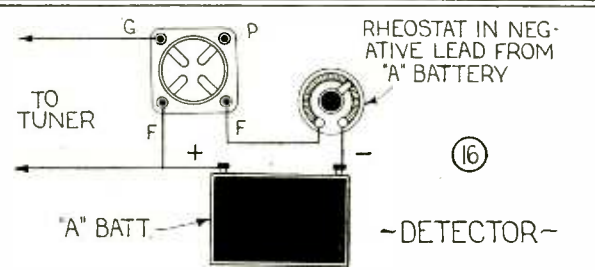

Fig. (16) Shows Preferred Location of Rheostat in Filament Circuit of a V.T. Detector. The Wiring Diagram at Right Shows a Trick Used by Several Manufacturers and by the Navy. The Grid Lead in the Amplifier Circuit is Connected to a Point Part Way Around the Rheostat Resistance Unit So That Approximately 2 Ohms Will be in the Circuit.

In the Lower Diagram (17) is Shown the Method Used to Control Three Filaments with One Knob. It Also Shows the Connections of a 300-Ohm Potentiometer, a Good Style of Which is Shown in Fig. 15. This Latter Instrument Affords a Ready Control of the Grid Bias Voltage. It is Particularly Useful in Radio Frequency Amplifying Circuits.



# Four Good Single Tube Hook-Ups

By MARIUS LOGAN

<p>10 TURNS ON 3/2 FT FRAME 0.005 MF VARIABLE COND.</p>	<p>GRID LEAK GRID COND TUBE SOCKET VARIOMETER .00025 MF. FIXED COND. RHEOSTAT SWITCH "A" BATT. "B" BATT. PHONES</p>	<p>For Those Who Are Content to Listen to the Programs Rendered by the Local Broadcast Stations, and Who Are Unable to Erect an Outdoor Aerial, the Circuit of Fig. 1 is Well Suited. This Set Has Only Two Controls. The 23-Plate Variable Condenser Connected Across the Loop Aerial is the One and Only Tuning Control. Regeneration or Signal Strength is Controlled by the Variometer. The Fixed Condenser C is Used for Receiving on the Higher Waves, by Closing the Switch.</p>
<p>The Circuit in Fig. 2 is Known as a Single-Circuit Regenerative Receiver. It Consists Mainly of a Vario-coupler, the Rotor of Which is Employed as a "Tickler Coil," Controlling the Regeneration. A Series-Parallel Switch is Employed. So That the Variable Condenser Can Be Connected in Series with the Tuning Coil for Short Waves, in Parallel with the Coil for Long Waves, or Out of the Circuit for Reception on Intermediate Waves. The Variable Condenser "C" is Optional.</p>	<p>SERIES-PARALLEL SWITCH GRID LEAK GRID COND. VARIOMETER RHEO. SWITCH "A" BATT. "B" BATT. PHONES TO GND 0.001 MF VAR. COND. VARIO-COUPLER 0.005 MF. VAR. COND. C</p>	<p>The Circuit of Fig. 3 Will Not Give Quite the Same Amount of Signal Strength as That of Fig. 2. However, it is Much More Selective. It Employs a Standard Honeycomb Coil Mounting and Three Honeycomb Coils. Tuning is Accomplished by Varying Condensers C1 and C2, and Adjusting the Coupling Between the Primary and Secondary Coils. Regeneration is Controlled by Adjusting the Coupling Between the Tickler and Secondary Coil. Again, a Series Parallel Switch is Employed so That All of the Broadcast Wave-lengths Can Be Covered.</p>
<p>SERIES-PARALLEL SWITCH 0.001 MF VARIABLE COND.</p>	<p>GRID LEAK &amp; COND. TUBE SOCKET RHEOSTAT PHONES "A" BATT. "B" BATT. TO GROUND HONEYCOMB COILS DL. 35 DL. 50 DL. 75 0.001 MF VAR. COND. C2 C1</p>	<p>The Circuit of Fig. 3 Will Not Give Quite the Same Amount of Signal Strength as That of Fig. 2. However, it is Much More Selective. It Employs a Standard Honeycomb Coil Mounting and Three Honeycomb Coils. Tuning is Accomplished by Varying Condensers C1 and C2, and Adjusting the Coupling Between the Primary and Secondary Coils. Regeneration is Controlled by Adjusting the Coupling Between the Tickler and Secondary Coil. Again, a Series Parallel Switch is Employed so That All of the Broadcast Wave-lengths Can Be Covered.</p>
<p>The Circuit of Fig. 4 Combines Selectivity and Sensitivity. Tuning is Accomplished by Varying the Amount of Wire in Use on the Primary Coil of the Vario-coupler. Adjustment of the Variable Condenser across the Secondary Coil and the Coupling Between These Two Coils. Regeneration is Controlled by the Variometer in the Plate Circuit of the Vacuum Tube. The Fixed Condenser "C" May Be Placed in the Circuit by Closing the Switch, for Reception on the Higher Wave-lengths. The Switch Should Be Opened When Receiving on the Lower Wave-lengths.</p>	<p>GRID LEAK GRID COND. VARIOMETER RHEOSTAT SWITCH "A" BATT. "B" BATT. PHONES TO GROUND 0.005 OR 0.01 MF. VAR. COND. VARIO-COUPLER ROTOR 0.0025 MF CONDENSER C</p>	<p>The Circuit of Fig. 4 Combines Selectivity and Sensitivity. Tuning is Accomplished by Varying the Amount of Wire in Use on the Primary Coil of the Vario-coupler. Adjustment of the Variable Condenser across the Secondary Coil and the Coupling Between These Two Coils. Regeneration is Controlled by the Variometer in the Plate Circuit of the Vacuum Tube. The Fixed Condenser "C" May Be Placed in the Circuit by Closing the Switch, for Reception on the Higher Wave-lengths. The Switch Should Be Opened When Receiving on the Lower Wave-lengths.</p>



# \$200.00 Single Tube Radio Contest

**DATE OF CLOSING EXTENDED TO NOVEMBER 15th, DUE TO LACK OF RESPONSE BY OUR READERS. DO YOU OR DO YOU NOT WANT REAL MONEY FOR YOUR EXPERIMENTS? BETTER GET BUSY—THERE ARE 10 PRIZES IN GOLD.—EXTENSION OF TIME AGREED TO BY CONTESTANTS ENTERED TO DATE.**

**S**IMPLICITY in radio is becoming more and more the goal of all radio experimenters. There is no doubt that in radio the vacuum tube rules the land at the present time. There have been described many hundreds of different single tube hook-ups, but we believe that somewhere one will be found superior to what has appeared so far.

In order to locate it, we are willing to pay prizes to the ones who can show us the best "single tube" hook-ups. It makes no difference whether the hook-up submitted to us is of the regenerative type, a reflex, radio frequency, and detector or any combination of the three—or, for that matter, something entirely new.

With a single tube hook-up, as, for instance, a super-regenerative, it is possible to pick up radio concerts from over 1,000 miles and more—and concerts have been reported as coming in on a loud talker from such a distance.

Then there are other hook-ups which do not reach so far, that are better for local work, and bring in the sounds with a great volume, on a loud talker.

It seems that at the present time the public really wants something that is simple and that brings in the sounds loudly from local stations, rather than covering great distances with a pair of head receivers.

The judges, therefore, will have their eyes open for long distance hook-ups, or short distance hook-ups that can be used best with loud talkers.

As will be seen in our list of prizes, there are two series—one for the long distance "DX" types, and for the short distance "loud talker" types. The best of each group will get similar prizes.

The sets that the prizes go to should be easily tuned, and there should be a minimum of interference for the sets of each group.

Furthermore, the judges will look out for the set of the greatest simplicity. Naturally the more apparatus employed and the more complicated the set is, the smaller will be the chances for a high prize. The high prizes will therefore probably go to those sets having the simplest circuits, with a minimum of apparatus contained therein.

The following rules must be observed:

## RULES FOR SINGLE TUBE CONTESTS

Not more than one vacuum tube can be used.

### FIRST PRIZE

"DX" Set, \$50.00 in gold.  
"Loud-Talker" Set, \$50.00 in gold.

### SECOND PRIZE

"DX" Set, \$20.00 in gold.  
"Loud-Talker" Set, \$20.00 in gold.

### THIRD PRIZE

"DX" Set, \$15.00 in gold.  
"Loud-Talker" Set, \$15.00 in gold.

### FOURTH PRIZE

"DX" Set, \$10.00 in gold.

### FIFTH PRIZE

"DX" Set, \$5.00 in gold.  
"Loud-Talker" Set \$5.00 in gold.

Total, \$200.

Any vacuum tube may be used, whether using two or three elements or more. Dry battery tubes, or storage battery tubes, can be used at the designer's option.

The circuit (the arrangement and layout of the parts) should be different from anything that has appeared in print heretofore or else some new feature should be embodied in the outfit, that has not been used or published previously.

It is absolutely necessary that the circuit or hook-up has been actually used in

practice, as mere ideas are not eligible in this contest.

As a proof of this, all contributors must submit their outfits to the editors, who will test the outfits themselves, under the usual conditions, and will be guided by the performance of the outfit in awarding the prizes.

A manuscript of not more than 750 words should accompany the outfit.

Where standard instruments, such as condensers, tubes, etc., are used in assembling the circuit, they should be individually named in the manuscript.

A good diagram of the connections, well executed in ink, must be furnished.

A photograph of the builder is also required.

All outfits, photographs, diagrams and other data, sent in by contestants, which have not been used by the publishers, may be returned at the publishers' own expense.

Outfits are to be sent by Parcel Post or Express, Prepaid. Expenses for such transportation both ways will be refunded by the publishers.

All models or outfits will be promptly returned to the builders.

More than one outfit may be entered by contestants.

The contest is open to every one, radio club members included, except manufacturers of radio apparatus.

All prizes will be paid upon publication.

Where two contestants submit the same prize-winning idea (constituting a tie), the full prize will be paid to each.

This contest closes in New York on November 15th, midnight, and the first prize-winning article will appear in the February, 1924 issue.

Address all outfits and all correspondence pertaining to this prize offer to *Editor, Single Tube Prize Contest*, in care of this publication.

## Loud Speaker Horn Vernier Adjustment for Condensers

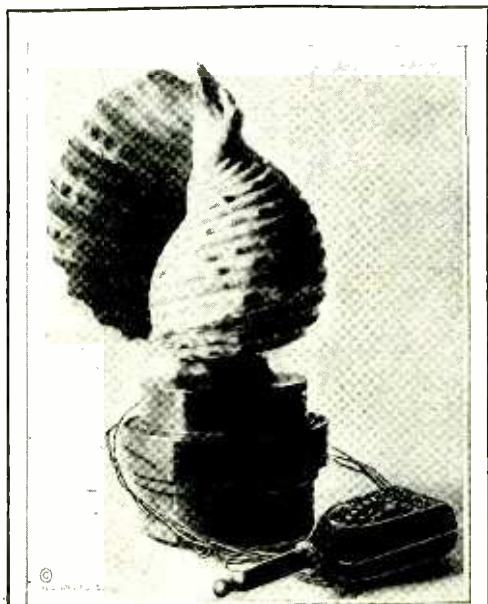

The Natural Acoustics of This Sea Shell Combined with Its Small Size Make It a Wonderful Loud Speaker Horn. The Tone Is Clear and Loud and the Volume Big, According to the Atlantic City Amateur Who Uses It.



Tune for DX and CW Stations on the Same Condenser! A New Adjusting Knob, Known as the Univernier, Has Just Been Brought Out with Which It is Possible to Make a Closer Selection with a Regular .001 or .0005 Variable Than with the Use of a Vernier. By Means of Gears Inside the Knob Its Movement is Reduced Eight Times Making the Fine Tuning Possible. For CW Stations Slip the Knob in and It Works Directly to the Condenser Shaft Giving Broad Tuning and Quick Adjustment. Photo (Above) Shows Special Dial Graduated to Single Degrees for Use With the Fine Tuning.

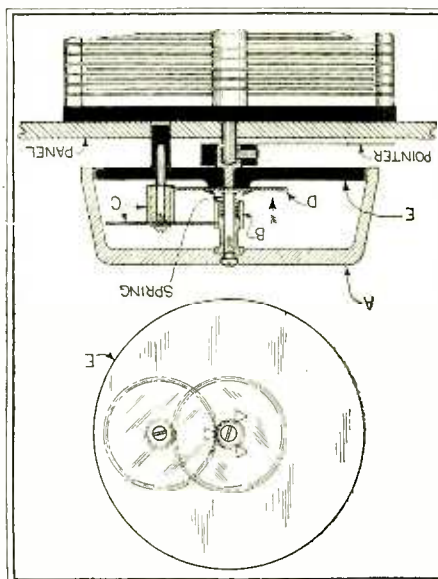

Shell (A in Sketch Above) is Attached to Small Gear (B) Which Turns Reducer (C) Attached to Base (E) Which in Turn Works Second Reducer (D). A Spring Holds Shell Gear in Mesh. When It is Slipped in Gears Are Disengaged and It Works Shaft by Meshing Prongs on (D).



# A Special "Reflex" Amplifier

By R. B. HALL

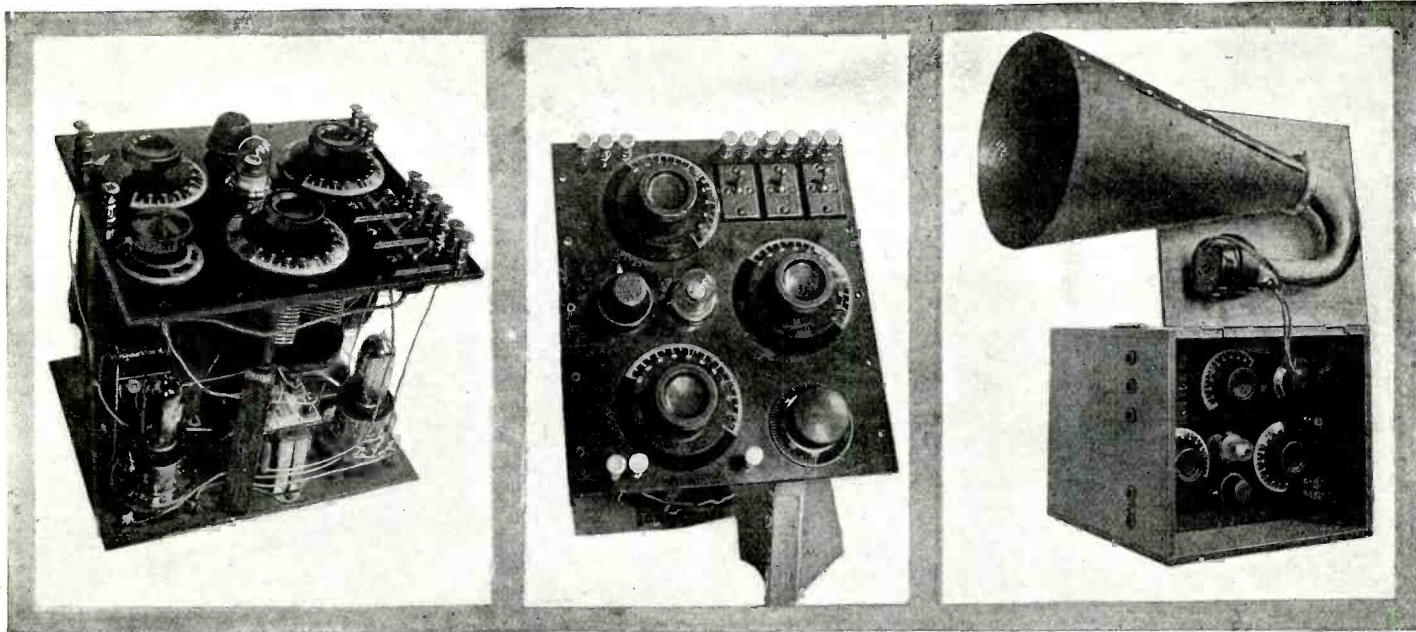

A Top and Side View of the Compact Reflex and Straight Amplification Radio Receiving Set, As it Appears Without the Cabinet.

A Front View of the Same Set, Showing the Relative Positions of the Controls and the Crystal Detector.

The Combination Receiving Set Placed in Its Cabinet, Showing Its Size in Comparison with a Standard Type of Loud Speaker.

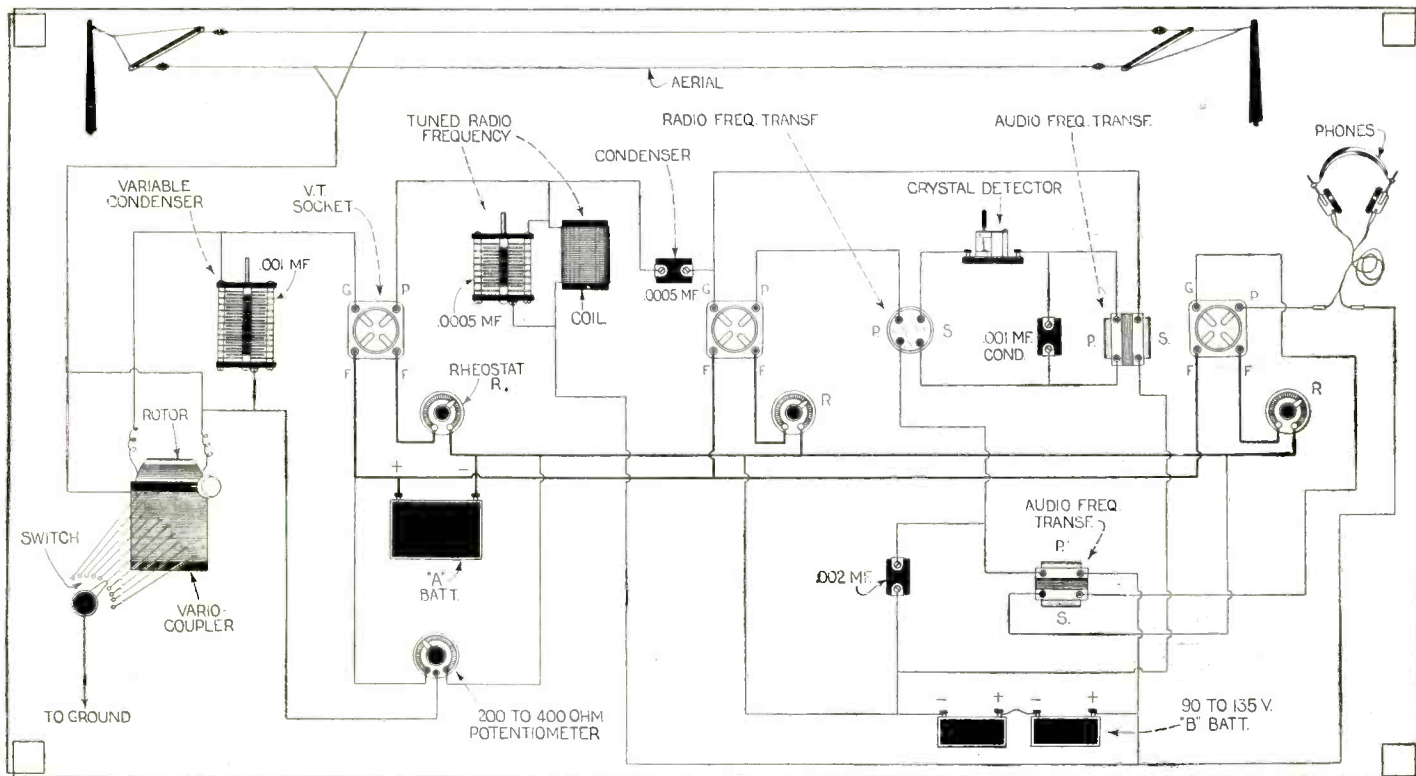

The Circuit Diagram of the Combination Radio Receiving Set is Shown Above. This Circuit Gives Excellent Results on Both Long Distance and Local Reception and is Comparatively Easy to Control. The Tuned Radio Frequency Choke Coil is Made by Winding Approximately 45 Turns of No. 20 D. C. C.

Wire on a 3/8-Inch Diameter Insulating Tube. The Crystal Detector May be of Any Type Desired. Although it Should Be Rather Rugged in Construction and Should Use a Crystal Capable of Passing Quite a Large Current. An Erla Radio Frequency Transformer is Recommended by Mr. Hall.

## 250,000 COPIES

is a tremendous figure for a radio publication. Nevertheless, just this many copies have been printed of the October issue of RADIO NEWS, America's greatest radio magazine. Month after month some of the foremost radio men throughout the world contribute to the columns of RADIO NEWS. ARTICLES by well-known Scientists such as Sir Oliver Lodge, Dr. J. A. Fleming, Dr. Lee de Forest, Eugene Nesper (Berlin), and John Scott Taggart (London), will be found regularly in RADIO NEWS.

### SOME OF THE INTERESTING ARTICLES APPEARING IN THE OCTOBER ISSUE OF RADIO NEWS

Pioneer Work in Ether Waves,  
By Sir Oliver Lodge.

Experiments with the ST-100 Circuit,  
By John Scott-Taggart.

Radio Frequency Amplifiers,  
By Louis Frank.

Electrons, Electric Waves and Wireless  
Telephony,

By Dr. J. A. Fleming.

The Galena Amplifier,  
By Clyde J. Fitch.

A Capacity-Coupled Receiver,  
By Paul G. Watson.

Construction of Push-Pull Transformers,  
By H. N. Bliss.



# Radio Oracle

In this Department we publish questions and answers which we feel are of interest to the novice and amateur. Letters addressed to this Department cannot be answered free. A charge of 25c is made for all questions where a personal answer is desired.

## INDOOR AERIAL

(186) Jack J. Jones, Summit, New Jersey, asks:

Q. 1. Should an indoor aerial, which is run around a room and suspended from the picture moulding be insulated?

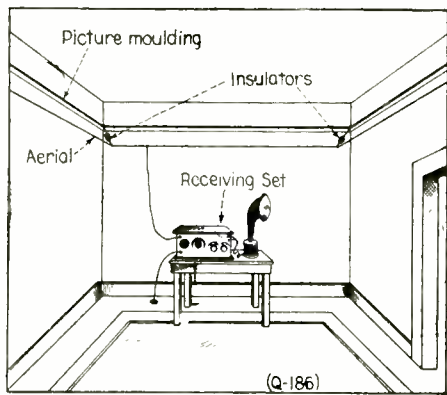

One of the Best Locations for an Indoor Antenna is Illustrated Above. The Insulators Are Not Necessary, but Will Give Somewhat Better Results in Damp Weather.

A. 1. It would be best to suspend such an aerial as illustrated in these columns.

## THE BEST ANTENNA

(187) Philip T. Brown, Portland, Maine, wants to know:

Q. 1. How can I construct the most efficient aerial, regardless of cost, for receiving on wave-lengths of 600 meters and up?

A. 1. The illustration in these columns shows the best possible type of antenna for such work.

## PHONE TRANSMITTER

(188) Walter Baumgartner, Manchester, Iowa, says that he has a single tube C. W. transmitter, with an inductively coupled tuner, and asks:

Q. 1. How can I convert this into a radiophone transmitter?

A. 1. The circuit diagram in these columns shows the method of connecting the microphone. The transmitting key must be closed when the set is used for radiophone transmission.

## CRYSTAL HOOK-UP

(189) Walter Biehl, Porterfield, Wisconsin, asks:

Q. 1. How can I hook up a variometer, a two slide tuning coil, and a crystal detector?

A. 1. The diagram given herewith shows the necessary connections.

Q. 2. How can I use a lightning switch on this set?

A. 2. This is also indicated in the diagram.

## RADIO FREQUENCY SWITCHING ARRANGEMENT

(190) H. C. Fulson, Memphis, Tennessee asks:

Q. 1. How may two stages of radio frequency amplification be connected with

an audion detector, and switches used to eliminate the first two tubes when desired? Two variocouplers are to be used.

A. 1. The necessary connections are shown at the bottom of this page.

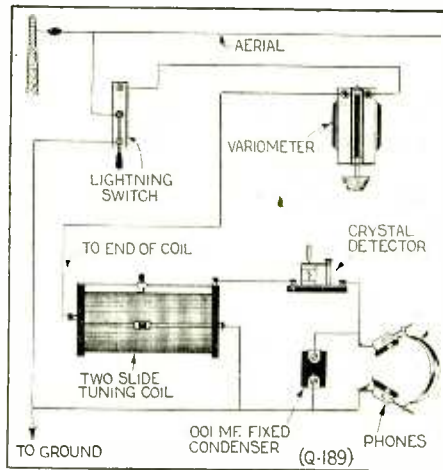

The Necessary Connections for a Lightning Switch Used with a Crystal Receiving Set Are Shown Above. The Variometer Will Allow Reception on Higher Wave-Lengths.

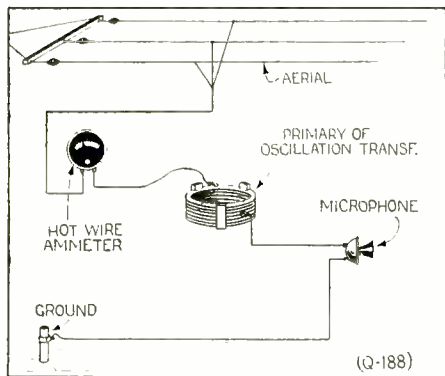

A Microphone Inserted in the Ground Lead of a Loose-Coupled C.W. Transmitter, Will Allow the Transmission of Radiophone Messages. This Method is Satisfactory Only Over Short Distances.

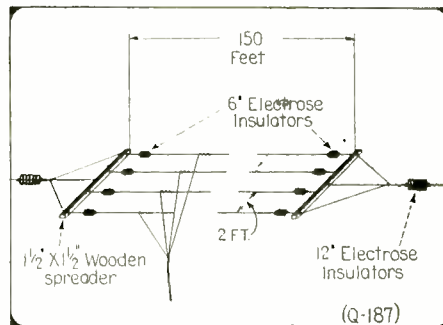

For All Around Use, Where Expense is Not to be Spared, an Aerial Built as Illustrated Above Will Give Excellent Results for Reception. It Should Be Located as High as Possible.

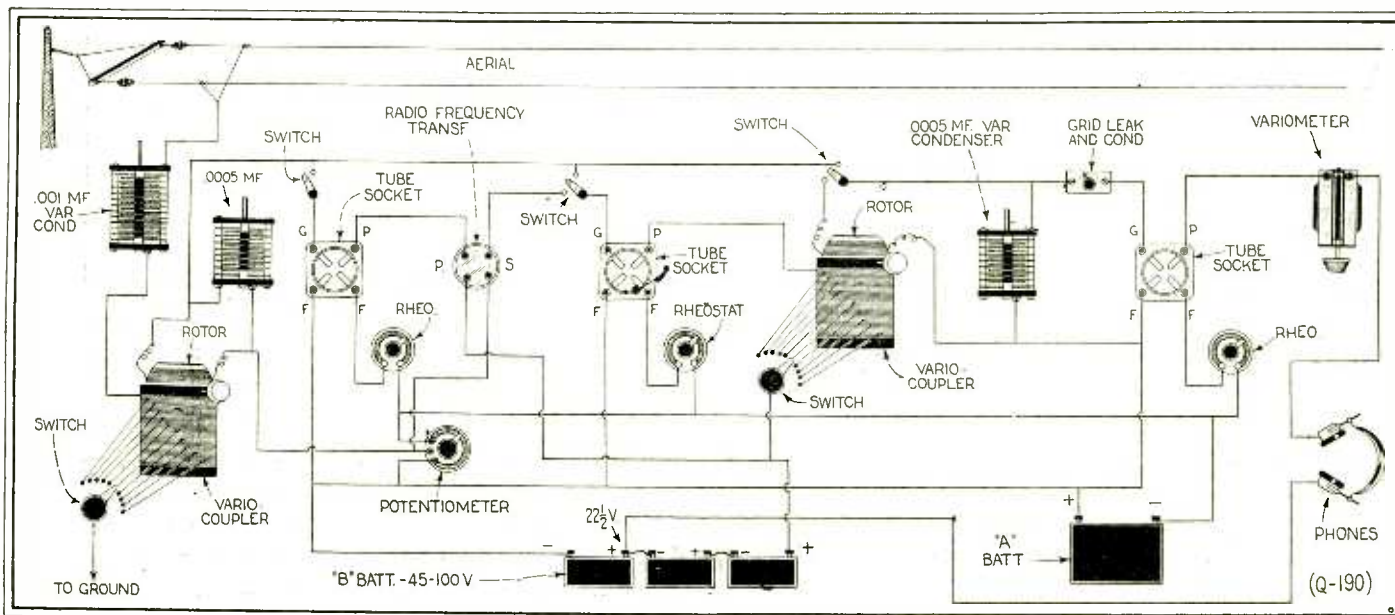

An Excellent Circuit for Tuned Radio Frequency Amplification is Given Above. By Means of the Two 2-Point Switches and the Single-Point Switch, it is Possible to Use One or Two Stages of Radio Frequency Amplification or Both May Be Eliminated and the Detector Used Alone. The First Stage

of Amplification is Through a Transformer While the Second is Tuned with a Vario-Coupler. Regeneration is Accomplished in the Detector Only by Use of the Tuned Grid and Plate Circuits. The Potentiometer is Essential in This Circuit for Best Results. Standard Instruments Should Be Used.



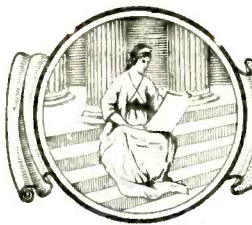

# LATEST PATENTS

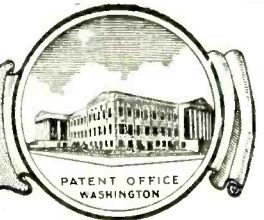

## Animated Picture

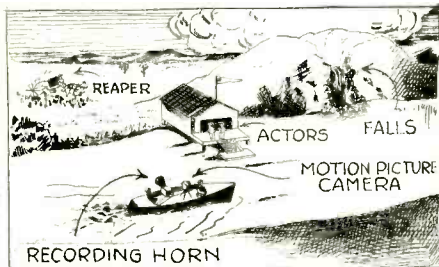
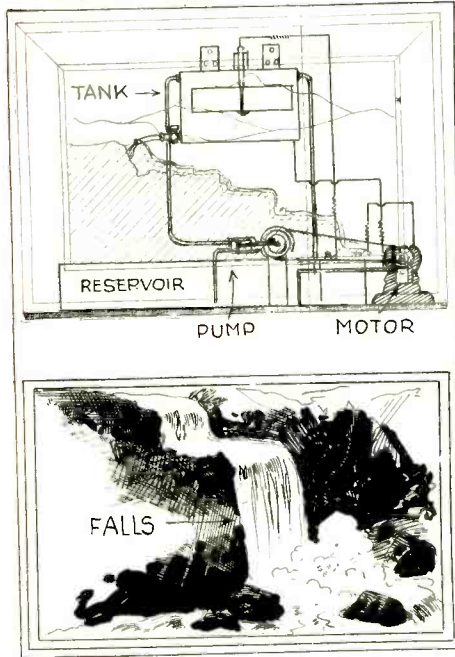

The Usual Deadness of Pictures is Obviated Here by Use of Bas-relief Around the Waterfall, a Tank Above and Below Allowing the Pictured Fall to Become a Real One. A Motor-pump Raises the Water From the Bottom to the Top Tank, Where it is Used Again.

## MASSAGING DEVICE



Take Your Morning Massage on the Way to Work! With this Little Vacuum Massaging Device That can be Carried in a Hand Bag the Need of Waiting in the Beauty Parlor is Obviated. Just Press the Handle and You Have a Perfect Vacuum Massage.

## Hydraulic Brake

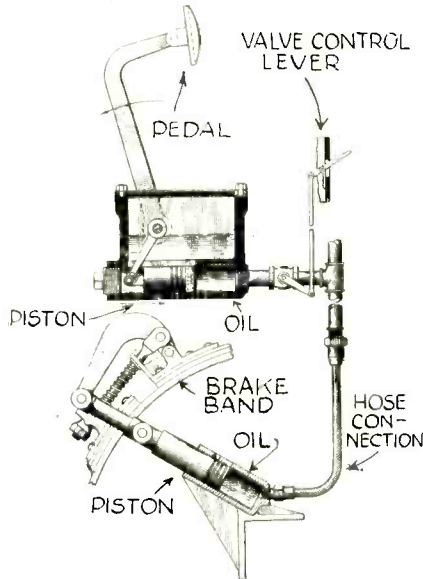

Above is Shown a Hydraulic Brake for Automobiles. In Operation it is Actuated by a Foot Pedal. The Whole System is Automatically Vented So That Air That Might Collect in the Cylinders is Released and its Cushioning Effect Destroyed.

## CLOTHES-LINE KNOTTER

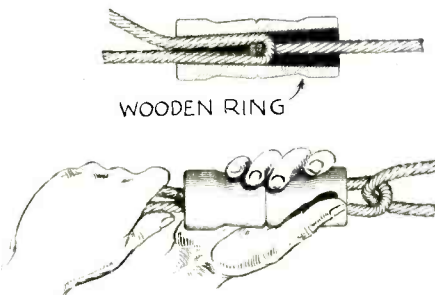

There is no Longer any Necessity for Doing Acrobatic Stunts Out the Window in Order to Fasten the Clothes Line. Note the Idea in the Patent Shown Above. Just Slip the "Handle" on the Line, Make a Loop, Pass the Other Loose End Through and Loop, and Pull the Handle Up.

## FISH-POND GAME

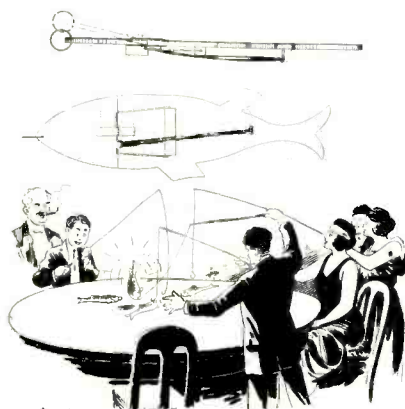

This Game Gives, Almost, the Real Thrill of Fishing. With the Aid of the Rubber Band, When the Fish is Hooked, Taking the Curve Out of its Spine, it Flies High into the Air, Eluding the Fisherman's Hook. Score by the Fishes Successfully Caught.

## Piano Self-Taught

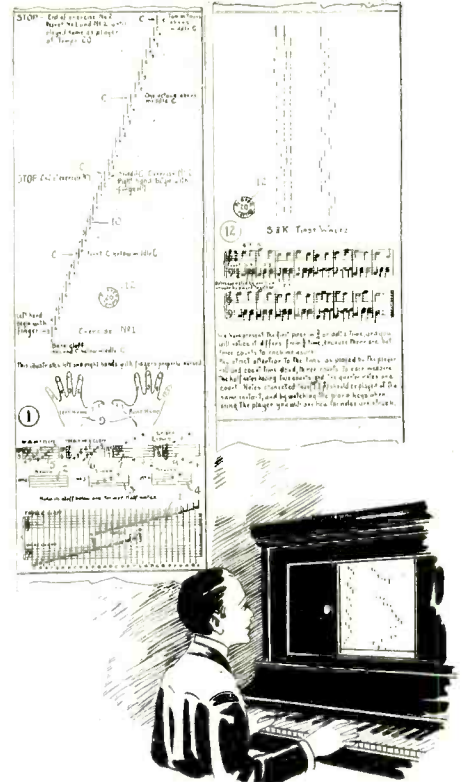

Here is Shown a Simplified Method of Teaching Piano With the Aid of a Player-piano. All Connotations are Written on the Roll. It is Only Necessary for the Student to Give the Written Lesson His Attention and Place His Fingers on the Keys Depressed.

## CHAIN FIRE ESCAPE

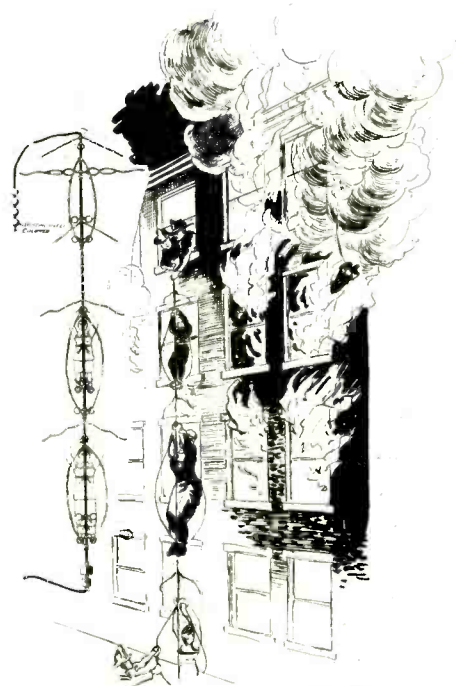

This Novel Fire Escape, Constructed of Cable and Chains Has the Advantage of Allowing a Large Number of Persons to be Rescued from a Burning Building at One Operation, With the Minimum of Danger to Both Firemen and Victims.



# Scientific Humor

**Blood Curdling**—During a lecture at Yale, Professor AUGUST KROGH, of Copenhagen, announced that if the blood-vessels of the average man were placed in a straight line they would encircle the globe two-and-a-half times. The chief drawback, it seems, is the great difficulty of getting them back into their proper position again.—*Punch*, (London).

**They Affect OUR Pocketbook**—"Do wireless waves in any way affect living creatures?" asks a correspondent in a contemporary. A henpecked husband writes to say that since he bought a listening-in set he has at last found peace.—*Humorist*, (London).



**Clever Animals**—At a table in a certain boarding-house a student boarder, who had been reading the scientific notes in a publication on a side table, remarked:—

"More than five thousand elephants a year go to make our piano keys." "My land!" exclaimed the landlady. "Isn't it wonderful what some animals can be trained to do!"—*MacLean's Magazine*.

**Stung!**—In a scientific article it is stated that only two colors, blue and yellow, are visible to bees. This is contrary to the popular belief that, on occasion, they see red.—*Punch* (London).

**My Stars!**—"My dear," said the newly married man to his wife, "where did all these books on astronomy come from? They are not ours."

"A pleasant little surprise for you," remarked his wife. "You know, my dear, you said this morning that we ought to study astronomy; and so I went to the bookseller's and bought everything I could on the subject."

It was some minutes before he spoke. "My dear," he said then, his voice husky with emotion, "I never said we must study astronomy; I said we must study *London*."—*Tit Bits* (London).

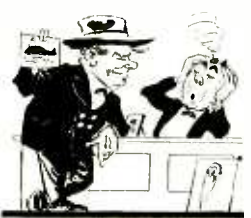

**A Large Order**—CUSTOMER—"Do you make life-size enlargements from photographs?"

PHOTOGRAPHER—"Yes, sir; that's one of our special lines."

CUSTOMER—"Well, do one of

this for me. It's a snap I took of a whale."—*Bulletin* (Sydney).

**A Light (English) Joke**—During a recent thunderstorm the lightning is said to have caused the signal lights on telephone switchboards to glow as if subscribers were calling. We are "sorry" the operators were disturbed.

**Some Speed!**—An airplane from London to Hythe (60 miles) reached its destination several minutes before the telephone message announcing its departure was received at Hythe. Perhaps the aeroplane was delayed by engine trouble.—*Humorist* (London).



**Why the Editor Fled**—The bolt of lightning came down between Mrs. Carney and her sister, and ripped off a good deal of plaster.—*From an account of a storm in the Hudson*, New York, *Evening Star*.

**Or Go To The Movies**—"Who is Thomas A. Edison?"

"He's the man that invented the phonograph to keep us awake, so we would stay up all night using his electric lights."—*Judge*.

**Sure—No Ash Sifter Journals!**—"Your husband is handy with tools, isn't he?"

"Well, he can fix a stubborn radio apparatus," said Mrs. Wijit, "but he can't repair an ash sifter."—*New York Sun*.

"SCIENTIFIC HUMOR," which for several years ran successfully in SCIENCE AND INVENTION, is beginning anew in this issue.

We have compiled on this page a number of jokes in which the scientific element is present. Look these over carefully before you send in your contributions. We have shown on this page scientific humor from all parts of the world, but we believe our readers will have no trouble in matching these humorous outbursts, and in many cases "outburst" them!

All contributions must be scientific in order to get attention. Do not copy jokes from old books or other publications as they will not be accepted. Write each joke on a separate sheet of paper and sign your name and address to it. Write only on one side of the sheet. Letters cannot be acknowledged unless return postage is attached. For each joke published, the contributor will receive \$1; there is also a first prize of \$3 for the best one submitted each month. In the event two people send in the same joke trying for the prize, each will receive the amount of the prize.

**S-TUT-TUT**—She had sent off a telegram and was waiting for an answer. Suddenly the halting click of the receiving machine sounded in the office, and she said to her companion:—

"That's from Harry; I can tell his stutter."—*Tit Bits* (London).

**When the Lightning Struck**—"Ever get shocked talking over the telephone during a storm?"

"Yes, once. I called up my wife while she was housecleaning to say that I'd bring a friend home to dinner."—*Boston Transcript*.

**A Loose Connection**—"Great Scot, Harris, how did you get down here?"

"By wireless, you idiot. Can't you see?"—*Passing Show* (London).



**Should Have Sold 'Em For Ground Rods!**—"I suppose you cleared a fortune peddling lightning rods around the country this summer?"

"Couldn't interest a single farmer. They all had their roofs covered with radio aerials."—*Judge*.

**Why They Flunked**—Among recent schoolboy examination "howlers" we choose the following:

"Parallel lines are the same distance all the way and do not meet unless you bend them."

"Gravitation is that which if there were none we should all fly away."

"Horse power is the distance one horse can carry a pound of water in an hour."—*The Christian Evangelist* (St. Louis).

**She Took To Him**—"Who is the girl you just greeted?"

"I made her acquaintance during my last air voyage—air ship fell down—so I offered her the use of my parachute."



—*Fliegende Blätter* (Munich).

**Righto!**—Engel much interested in science, returns home after attending lecture on radio telephony.

"Just think Fischel that it is possible to speak from America to Europe by Radio"

"Well that is nothing extra!"

"What! Talking across the ocean without wires and poles is nothing extra!"

"Sure not. If they could put telegraph poles with wires across the ocean, that would be something to crow about."

—*Lustige Blätter* (Berlin).

**Nosed Out**—TEACHER TO THE CLASS—"Does any one know how iron was discovered?"

PUPIL—"Yes, sir."

TEACHER—"Well, tell this class your information."

PUPIL—"Please, sir, they smelt it."—*Hollywood High School News*.

**We Want One**

—*Optimistic Inventor*

(Soliloquizing after

smash) — Still,

that gives me a

splendid idea—a

folding car!

—*Passing Show*

(London).



**Solid Ivory**—PROFESSOR: "What is a transparent body?"

"A transparent body is—is—is—"

PROFESSOR: "Is a body thru which one sees light."

"Thank you professor."

PROFESSOR: "Since you have not been able to give me a definition, give me an example."

"A key hole."

PROFESSOR: "Key hole! How so?"

"Because you can see the light through a key hole."—*Le Petit Journal* (Garden City).

**An Eye Full**—"What are you studying now?" asked Mrs. Johnson.

"We have taken up the subject of molecules," answered the son.

"I hope you will be very attentive and practice constantly," said the mother. "I tried to get your father to wear one, but he could not keep it in his eye."—*Columbia Jester*.



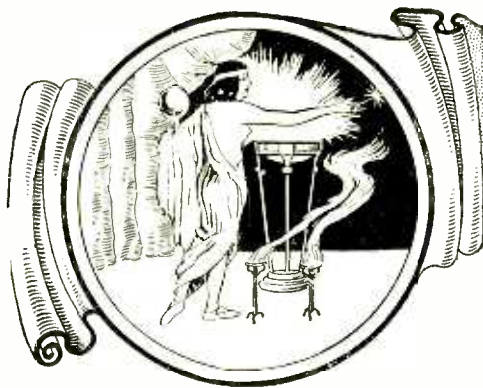

# THE ORACLE

The "Oracle" is for the sole benefit of all scientific experimenters. Questions will be answered here for the benefit of all, but only matter of sufficient interest will be published. Rules under which questions will be answered:

1. Only three questions can be submitted to be answered.
2. Only one side of sheet to be written on; matter must be typewritten or else written in ink, no penciled matter considered.
3. Sketches, diagrams, etc., must be on separate sheets. Questions addressed to the department cannot be answered by mail free of charge.
4. If a quick answer is desired by mail, a nominal charge of 25 cents is made for each question. If the questions entail considerable research work or intricate calculations a special rate will be charged. Correspondents will be informed as to the fee before such questions are answered.

## PIN HOLE CAMERA

(1540) J. B. Pinkos, Pittsburgh, Penna., asks:  
Q. 1. How may a pin hole camera be made?  
A. 1. The construction of a pin hole camera is extremely simple and its finished appearance is shown herewith. The construction is as follows.

Make a box of either cardboard or light wood,

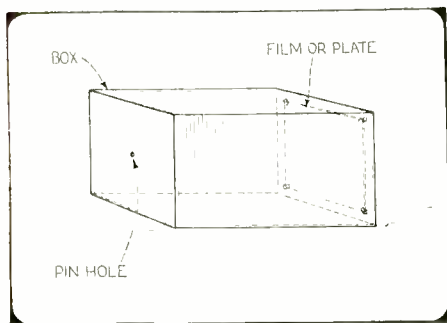

In the Pin-hole Camera Shown Above the Size of the Exposing Opening Will Have to be Determined by Experiment, Also Exposure Time.

of about the shape shown, and with ends slightly larger than the film which is to be used. One side of the box should be on hinges so that the film can be readily placed within or removed. Next paint the inside of the box black and in one end, punch a hole with a thin needle. The size of this hole will have to be determined by experiment.

Now in a dark room, place a film in the end of the box opposite the pin hole and hold it in place by means of any type of wire or spring clips which may be desired. Close up the box so that all light will be excluded therefrom and cover up the pin hole. Take the camera into a good strong light and make the exposure. The length of this exposure will have to be determined by experiment and is controlled by uncovering the pin hole for the desired length of time and then covering it up again. Be careful not to shake the camera while the exposure is being made.

## ARTICLES ON ELECTRICITY FROM THE AIR.

(1541) O. Godrich, Jacksonville, Fla., asks:  
Q. 1. What material have you ever published on the extraction of electricity from the atmosphere and from natural forces, also on work done in overcoming gravitation.

A. 1. Many issues of this magazine have contained some form or other of articles dealing with one or the other subjects you mention.

However, we are giving you below a list of feature articles on these subjects.

Power From the Air.....	Mar., 1922
Electric Power From the Sun.....	Apr., 1922
Electricity From The Wind.....	Jan., 1922
Overcoming Gravitation.....	Mar., 1920
New Researches in Gravitation.....	Mar., 1920
Gravity Defied.....	Jan., 1922

All these issues may be obtained from our Subscription Department at 25 cents each.

## PHOSPHORESCENT LAMP

(1542) Robert S. Graham, Beaver Falls, Penna., says that he has several times seen mention of a lamp which glows continuously consisting of a small pill bottle with chemicals inside. He asks:

Q. 1. Can you tell me where any such lamp has been described and if possible tell how to make one?

A. 1. The lamp you mention has been described once or twice in the pages of this magazine, but it does not seem to give very good satisfaction. The writer constructed one, but it did no more than glow, giving forth practically no light whatsoever.

The method was as follows. Obtain a small pill bottle, and enough olive oil to fill the same about two-thirds full. Heat the olive oil almost to its boiling point, and pour into the pill bottle. Drop therein a small piece of phosphorus about the size of a pea, allow the oil to cool, and cork the bottle. It will be found necessary to uncork the bottle at various intervals in order to re-establish the glow. Care must be taken in handling the phosphorus to see that it is kept under water at all times up to the point when it is transferred to the oil.

## FIRE EXTINGUISHERS

(1543) J. H. Gechnyden, Lynchburg, Va., asks:

Q. 1. Is carbon tetrachloride a good fire extinguisher and in what way may it be used for this work?

A. 1. Carbon tetrachloride is an excellent fire extinguisher, which work it does by virtue of the gas given off which extinguishes the flames. This material is used in a well known make of fire extinguisher, and the resulting gas is by no means harmful to human beings. If the carbon

## IMPORTANT

### TO NEWSSTAND READERS

IN order to eliminate all waste and unsold copies it has become necessary to supply newsstand dealers only with the actual number of copies for which they have orders. This makes it advisable to place an order with your newsdealer, asking him to reserve a copy for you every month. Otherwise he will not be able to supply your copy. For your convenience, we are appending herewith a blank which we ask you to be good enough to fill in and hand to your newsdealer. He will then be in a position to supply copies to you regularly every month. If you are interested in receiving your copy every month, do not fail to sign this blank. It costs you nothing to do so.

To ..... Newsdealer

Address .....

Please reserve for me ..... copies of SCIENCE & INVENTION every month until I notify you otherwise, and greatly oblige.

Name .....

Address .....

tetrachloride is contained in sealed glass containers, they should be thrown at the worst part of the fire with a force sufficient to break the glass. Carbona is practically the same thing and makes a good fire extinguisher.

## TRANSLUCENT METAL

(1544) Felix Grandich, Bronx, N. Y., asks:  
Q. 1. Is there any metal which can be made translucent and if so, how?

A. 1. The only way to obtain a translucent metal, is to heat or press the same into very thin sheets. Gold, silver and platinum are the only metals which lend themselves to this process. Gold leaf is a very good example of translucent metal. Some of the rarer metals can also be beaten thin enough to become translucent.

## WIND-DRIVEN ELECTRIC LIGHT SYSTEM

(1545) Oscar Peterson, Worthing, So. Dak., refers to an article in the February issue of SCIENCE AND INVENTION on how to make a wind-driven electric lighting system and asks:

Q. 1. Can this lighting system be used to charge a six volt storage battery?

A. 1. You may very easily utilize the wind-driven power plant you mention for the charging of a storage battery, in fact, such a use was suggested in the article. An automobile generator is particularly adapted to such use.

## SPARK COILS IN SERIES

(1546) C. P. Sullivan, Johnsonburg, Penna., wants to know:

Q. 1. How can I procure a longer spark from a spark coil, by connecting to it another spark coil of the same size?

A. 1. You may procure the spark length of both of your spark coils, by connecting the

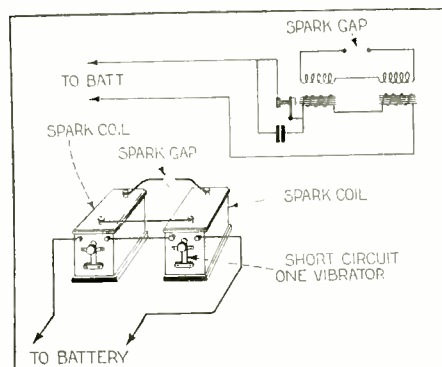

In Connecting the Spark Coils in Series For a Fatter and Longer Spark, as Shown Above, Short-Circuit One of the Vibrators, as Shown.

primaries in series with each other and in series with the battery, also connect the secondaries in series as illustrated herewith. Use but one vibrator.

## REMOVAL OF HAIR ELECTRICALLY

(1547) J. F. Price, El Paso, Texas, asks:  
Q. 1. How is hair removed from any part of the body by electrolysis?

A. 1. In the electrolysis method of removing hair, one electrode, connected to a six volt storage battery, is held in the hand, and the other is connected to a sterilized needle. The latter is inserted into the skin at the root of the hair, until a small white drop of fluid exudes from the base of the hair.

At this time it will be found that the hair can be easily removed and will never return. This method is very slow as it is necessary to remove one hair at a time, and is, unless practiced by a competent operator, rather dangerous.

## CALCULATING TRANSFORMER DESIGNS

(1548) Fred S. Orpen, Toronto, Canada, requests:

Q. 1. What is the formula for obtaining the number of turns in the coils of a step-down transformer? For example, if the primary were designed for 110 volts with 500 turns wound thereon, and you required a 12 volt secondary, how would you calculate the number of turns in the latter?

A. 1. When the number of turns in the primary of a step-down or step-up transformer has been determined, the number of secondary turns for a particular voltage is very easily found. This equation is used. The number of turns on the primary is to the primary voltage as the number of turns on the secondary is to the secondary voltage. Three of these are known and by simple mathematics the fourth one may be found.

## THE THALOFIDE CELL.

(1549) T. K. Peters, Los Angeles, Calif., asks:  
Q. 1. How may I make a sensitive photoelectric cell such as that known as the Thalofide cell?

A. 1. We will send upon receipt of a stamped addressed envelope the name of the manufacturer of the Thalofide cell. However, you will not be able to purchase any of the material used in the cell as it is manufactured under a secret process and must be made as it is to be used and placed immediately in a vacuum as otherwise its photoelectric properties will be destroyed.



**PHOTO ELECTRIC CELLS**

(1550) Vernon F. Bradley, Decatur, Ill., says that he has seen mention in this magazine of a photo electric cell much more sensitive than a selenium cell. He asks:

Q. 1. Can you tell me where I can purchase a book dealing with the construction of these cells or give me this information through your Oracle Department?

A. 1. All cells which depend for their action upon light, are called photo-electric cells, therefore, selenium comes under this head, as does the Kuntz and the Thalofide cell. We do not believe that you can obtain a book giving instructions for the making of these very sensitive cells as it requires a full laboratory equipment including a vacuum pump. If you wish to get a further insight into the manufacture of these cells, you should write to the Patent Office at Washington, D. C., and request a copy of patent No. 1,316,350, enclosing 10c. in cash.

**ELECTRICALLY OPERATED WHISTLE**

(1551) Wilbur E. Allen, Monticello, Ill., asks:

Q. 1. How may I operate a steam whistle by means of a solenoid from a point remote to the whistle?

A. 1. You may obtain the result you desire by constructing a lay-out similar to the one illustrated herewith. This consists of a solenoid which pulls a bar fastened to a lever, which in turn operates the whistle. The solenoid is connected through a switch to the 100-volt line. Not knowing the force required to operate the whistle, nor any other definite data, we are unable to tell you what size solenoid to use, but would advise you to experiment until you find the best size.

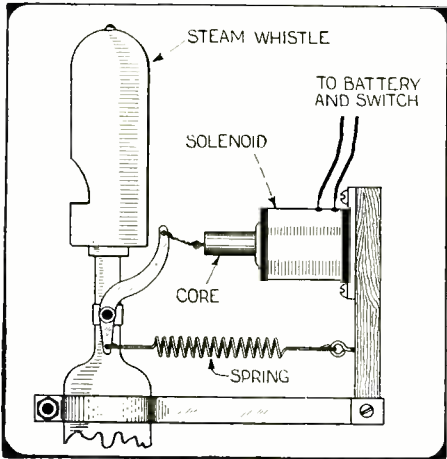

How to Rig Up a Solenoid Magnet to Operate a Steam or Compressed Air Whistle.

**HECTOGRAPH COMPOSITION**

(1552) Anthony Azzopardi, New York City, asks:

Q. 1. How is the composition used in a hectograph or duplicating pad made?

A. 1. We are giving you the desired information herewith. Add 3 ounces of water to 1 1/2 ounces of white glue. Heat in a double boiler until the glue is melted, then add 6 ounces of glycerin and pour into a shallow pan. If the resulting composition upon solidifying is too hard, add more glycerin, and if it is too soft, add more glue. It will be necessary to remelt the composition in the double boiler before making any such additions.

Q. 2. What kind of ink is used in connection with this device?

A. 2. The ink to be used with this composition may be made by dissolving one dram of purple aniline in 1 ounce of water.

**ROMAN VITRIOL AND LIQUID NITROUS OXIDE**

(1553) Mr. J. S. Bahin, North Adams, Mass., wants to know:

Q. 1. What is roman vitriol?  
A. 1. Roman vitriol is nothing more than copper sulphate, (CuSO4).

Q. 2. Can nitrous oxide be liquified?  
A. 2. It is entirely possible to liquify nitrous oxide, by applying a heavy pressure.

**HEATING BATHS FOR CHEMICAL EXPERIMENTS**

(1554) Mr. Robert Beidle, Barberton, Ohio, mentions a certain experiment in which a water bath is used for heating a particular substance whose boiling point is 248° F. He asks if it is possible to use a water bath in this particular case.

A. 1. We would advise you to either substitute a sand bath for the water bath in the experiment you mention, or else add a quantity of calcium chloride to the water, in which case the boiling point will be raised considerably. Either of these methods will give the results you desire.

**MOTOR TROUBLE**

(1555) Albert Barker, Goderich, Ont., Canada, says that he has a one-quarter horse-power motor designed to run on 110 volts A.C., which motor

runs on the brushes until it gets up speed, whereupon the brushes are disconnected from the circuit. He says that this motor ran very well until recently, but now when the current is turned on a hum is produced, but the armature does not rotate. He asks:

Q. 1. Can you tell me what is wrong with this motor and give a few suggestions regarding the same?

A. 1. It may be that either your brushes are damaged or striking, or else some of your armature coils are burned out. We suggest that you dismantle the motor, and by inspection you can tell whether or not the trouble is with the brushes. This is the most likely place. We would suggest, however, that, unless you are well versed in such work, you send the motor back to the firm from whom it was purchased and have them do the repair work, as one uninitiated in this line might cause damage which would be expensive to rectify.

**BATTERY CHARGING**

(1556) Albert Barker, Goderich, Ont., Canada, asks the Oracle:

Q. 1. How many six volt storage batteries can be charged from an ordinary type of four-jar rectifier?

A. 1. Any one of the ordinary types of the four-jar-rectifiers will charge as many as ten storage batteries, which should be connected in series. This applies to 6-volt batteries. The charging rate of the batteries will depend upon the batteries themselves. The charging rate should be about 1 1/2 times the normal discharge rate, and the amount of current which passes through the rectifier, is determined by a bank of lamps used in series with the A.C. side of the same.

- NEW STUNTS ELECTRICAL
- NEW APPLIANCES FOR THE HOME
- NEW EXPERIMENTS BY THE DOZEN
- And Innumerable Other

**Interesting Articles in October Issue of "Practical Electrics"**

including

- FOUR-WAY SWITCHES By O. E. Bricker
- STORAGE BATTERY FOR DEMONSTRATIONS By Francis G. Le Mercier
- NEW YORK'S ELECTRIC MAP.
- HIGH VOLTAGE LABORATORY BATTERY By Harry R. Lubcke
- THERMIC TELEPHONES.
- LIVING ELECTRIC BATTERIES By Harry Van Demark

**INCANDESCENT GAS MANTLES**

(1557) Louis Garna, New York City, requests:

Q. 1. Can you tell me how the materials applied to gas mantles are made?

A. 1. We are giving you the formula for the making of the treating mixture used in the manufacture of incandescent gas mantles.

Lanthanum oxide	.....	3 parts
Yttrium oxide	.....	2 "
Burnt magnesia	.....	5 "
Acetic acid	.....	5 "
Water, distilled	.....	10 "

The oxides are dissolved in the acetic acid and water, and to the solution another 15 parts of distilled water are added and the whole filtered. The vegetable fibre (in its knitted or woven form) is impregnated with this solution, dried, and arranged on its support. In the formula the acetic acid may be replaced with dilute nitric acid. The latter seems to have some advantages over the former, among which is the fact that the residual ash, which is the working part, where acetic acid is used has a tendency to ball up and make a vitreous residue, while that of the nitric acid remains in powdery form.

**ETCHING**

(1558) Francis Gates, Healdsburg, Calif., asks: Q. 1. How may materials such as brass, copper, iron and hard rubber be etched?

A. 1. Etching can be done on various kinds of metals by means of any acid which will attack that metal. This work has been discussed at various times in past issues of SCIENCE AND INVENTION.

For best results hard rubber should be engraved rather than etched, as it is by far the simplest way of obtaining any such results.

**COPPER WIRE AS FUSE**

(1559) Edward Ayers, Deer Park, Wash., wants to know:

Q. 1. Can I use fine copper wire in place of fuses?

A. 1. Any size of copper wire will act as a good fuse; No. 34 wire answering the purpose you mention. It is necessary however, that the wire be rather short; otherwise, it takes too long for the current to heat the same to the melting point. That is the reason why fusible links are used in place of copper wire, because they will heat much more rapidly on an overload, and melt at a much lower temperature.

Q. 2. How can I make a galvanometer, using a magnetic compass in its construction?

A. 2. Winding a dozen turns of wire around your compass will make a very good galvanometer. A coil 5" in diameter with the compass placed on a shelf in the center, will answer your purpose admirably. No. 18 is a good size wire to employ.

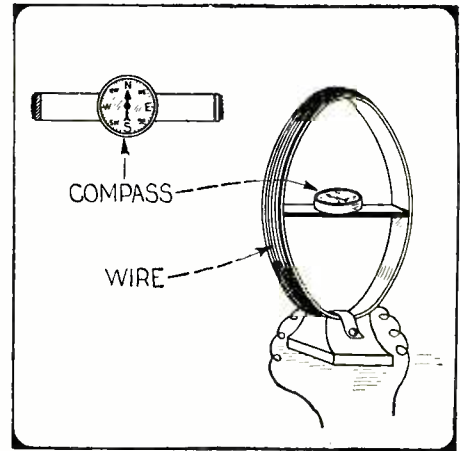

Simple Way in Which to Construct a Galvanometer For Home Laboratory Use.

**TRICK MIND READING**

(1560) Alston Maxwell, Tuscaloosa, Ala., says that he has recently viewed a performance in a theater in which a lady sat at a piano on the stage and her assistant went among the audience. Spectators whispered to the assistant the name of the selection that they wished the lady to play as he leaned over toward them, and immediately the pianist would play the selection desired. Our correspondent believes that the actor who passed among the audience had a sensitive microphone concealed under his clothes, but is not sure as to how the connections were made to the lady on the stage. He asks:

Q. 1. Am I right in my assumption as to the microphone, and how can the circuit be completed?

A. 1. We believe that you are quite correct in assuming that the microphone was concealed beneath the actor's clothing. The matter of making the circuit from the actor in the audience to the actor on the stage was fully described in the December, 1921 issue of Practical Electrics, under the head of "The Haunted Violin."

In this method two metal strips were placed under the carpet and contact was made by sharp metal points, fastened to the heels of the actress' shoes.

**ILLUMINATING ROTARY SIGN**

(1561) J. K. Johnson, Corpus Christi, Texas, says that he has seen a rotating electric sign which appears stationary when illuminated by a peculiar type of bulb. He asks:

Q. 1. What are these bulbs and how is the effect produced?

A. 1. The bulbs you mention are those known as Geissler tubes, and the sign must be rotated at a speed equivalent to the frequency of the sparks passing through the Geissler tube.

**EXPERIMENTAL ELECTRO-MAGNET**

(1562) W. E. Allen, Monticello, Ill., asks:

Q. 1. How may I make an electro-magnet so that it will operate on 110 volts A. C.?

A. 1. The size of the wire used on your magnet will depend upon the size of the core and the amount of current you wish to draw. An experimental magnet may be constructed by winding 500 turns of No. 18 D. C. wire on a 1 inch iron core, 4 or 5 inches long. The core should be composed of a bundle of iron wires.

**SOLDERING STEEL**

(1563) A. J. Gibson, Philadelphia, Penna., requests:

Q. 1. How can I solder steel and what solution should be used?

A. 1. In soldering, it is necessary to heat both of the parts to be joined, thoroughly, to the melting point of the solder being used. A solution of zinc chloride in water may be used for soldering steel. Killed muriatic acid is used by plumbers and tinsmiths for all such soldering.



# Radio Catalogue Free—

**Write us  
a post card—  
Address Dept. 40-R**

and we will send you free this 52 page catalogue of radio sets and parts. It also contains explanation of radio terms, map and list of broadcasting stations and much radio information, including an explanation of successful hook-ups and circuits.

You will be amazed at the low prices Ward's quote. A complete tube set having a range of 500 miles and more, including tubes, head set, batteries, and antenna equipment, as low as \$23.50.

This catalogue contains everything for the expert and amateur. Complete sets and every improved part for building sets, all the most up-to-date devices—at the lowest possible prices.

## Headquarters for Radio

Montgomery Ward & Co. is headquarters for Radio, selling everything direct by mail without the usual "Radio-profits." Why pay higher prices? Ward quality is the best and the prices will often save you one-third. Everything sold under our Fifty Year Old Guarantee,—Your Money Back if You Are Not Satisfied. Write today for your copy of this complete 52-page Radio Book.

**Write to our house nearest you. Address Dept. 40-R**  
**Chicago Kansas City St. Paul Portland, Ore. Ft. Worth**

# Montgomery Ward & Co.

**The Oldest Mail Order House is Today the Most Progressive**





# Let an Experienced Newspaper Man Show You How to Break Into the Newspaper Field



NEWSPAPER work offers countless opportunities for the young man or the young woman who really wants to amount to something. The history of Journalism shows innumerable instances where bright young Reporters have been graduated from newspaper staffs to high places in the industrial and political world. Ex-President Harding was an old newspaper man. Thomas W. Lamont, one of the senior partners of J. P. Morgan & Company, was a reporter on the New York Tribune. Senator Walter E. Edge of New Jersey was, and is, an editor; so is ex-Senator James K. Vardaman of Mississippi. Augustus Thomas, America's foremost playwright, was a reporter on the St. Louis Post Dispatch. Arthur Hookins and Brock Pemberton, theatrical producers, were newspapermen. Arthur Woods, executive commissioner of New York, was a reporter. Newspaper work, in itself, is a field that offers unlimited opportunity—and it often leads to better things.

### FASCINATING WORK

#### Salaries of \$40 to \$125 a week

There isn't any profession that offers the thrill that Journalism does and there is always room for a life, wide awake young fellow in this exciting field. Regular Reporters earn from \$10 to \$125 a week. Good deskmen on a daily paper are paid from \$60 to \$100 a week. A "Star" Reporter can command his own salary.

### Part Time If You Prefer

Hundreds of ambitious men and women make extra money by corresponding for newspapers or writing for magazines in their spare time. Many of the most successful reporters of today started in this way. If you have the ability to write, there is always a market for your efforts.

### We Will Teach You Journalism At Home

Henry J. Brockmeyer, Assistant City Editor of the New York Evening Post, will give you a thorough training in Journalism in six short easy lessons. Mr. Brockmeyer is well qualified to teach you. He has trained hundreds of men and women, many of whom have, under his guidance, developed into front rank reporters or feature writers.

Mr. Brockmeyer's course in Practical Journalism will teach you what it would take months of actual newspaper work to learn. The course is complete, authoritative, easy to understand. In it Mr. Brockmeyer has incorporated everything that his long experience of over thirty years in the newspaper field has taught him. It shows not only the way a newspaper is run, giving a detailed explanation of the editorial and administrative staffs, with the duties of each, but it trains the student in every phase of Journalism, instructing him how to develop a "nose for news", how to write, how to prepare his copy and edit it for publication and drills him into the development of style, with countless references and actual examples.

The complete course comprises six comprehensive lessons just bristling with everything a reporter or correspondent must learn. And it's all interesting reading—more fascinating than any novel. You won't want to stop studying once you start.

### Five Days Trial

To actually prove to you the merits of the course we will send it to you on five days' trial. If at the end of that time you do not feel that you have received more than your ten dollars' worth (the price of the complete course is only \$10) you may return it to us at our expense and your money will be immediately refunded. We won't even ask you for an explanation—we guarantee to refund your money in full within twenty-four hours after receiving the lessons back.

Just fill a check, money order or ten dollar bill to the coupon below and mail it to us. Then take five days after the course arrives to decide whether you want to keep it or not. You, alone, will be the judge. We know that you will find the course worth many times its price.

THE PRESS GUILD, Inc., 66-D-W. B'way, N. Y.

THE PRESS GUILD, Inc., 66-D-West Broadway, New York City.

Enclosed find \$10 for which you are to ship me at once, prepaid, Henry J. Brockmeyer's complete course in Practical Journalism with the distinct understanding that if I return the course in five days my full \$10 will be refunded and no questions asked.

(Name) .....  
(Address) .....  
(City) ..... (State) .....

# Pitfalls of the Radio Inventor

By EVERETT N. CURTIS.

(Concluded from Sept. Number)

Where the inventor is well acquainted with the art, he could very well in many cases dispense with such examination, and rely upon the Examiner after the case gets into the office to discover and cite adverse references if there are any. Even after the usual preliminary examination is made, it is quite

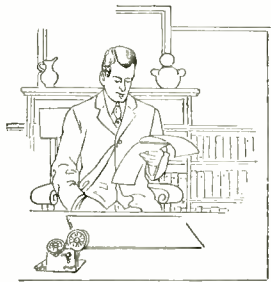

Be Sure to Read Carefully the Specifications Listed in Your Patent. If You Don't You May Be Granted a Patent on a Thing Entirely Different from the One You Invented. This Very Often Happens.

likely that the Examiner will in due course cite references not disclosed by it.

Such preliminary examination is, however, a safeguard, and in case the inventor is ignorant of the prior art, it is to be recommended as being of some value.

### DATES ARE IMPORTANT

Another matter to be considered by the inventor is the importance of preserving the dates of his invention. If he obtains a patent and thereafter brings a suit, it may be advisable to show that he conceived his invention and reduced it to practice before the person who is claimed to be a prior inventor, or prior user, or author of a prior publication. Such proof may also be important should he be thrown into interference in the Patent Office during the prosecution of his application. No inventor's mere say-so, uncorroborated by other evidence, will be sufficient to establish the date of invention. There must be evidence of disclosures to others, drawings or writings, or the embodiment of the invention in some perceptible form. Memorandum books with dated and witnessed sketches and descriptions properly signed are often used to prove the date of conception. All inventors should have such books or memorandum sheets, and should carefully preserve them. As soon as the creative thought occurs to the inventor, he should record it in his memorandum book, and if possible should fully illustrate the same with sketches. When he has done this, he should sign his name, together with the date and place, and should have the same witnessed and signed by one or more witnesses. Letters written to some member of the inventor's family or to a friend, making the same disclosure, are also good evidence, particularly where the envelope showing the cancellation date of the post office is preserved. Probably the best evidence, next of a reduction to practice, is an affidavit with attached sketches certified to by a notary public, with his seal attached. But even the establishment of the first date of invention may come to naught unless the inventor is shown thereafter to

have been diligent in reducing his invention to practice. The inventor should, therefore, be prompt in trying out his invention in some practicable form; his work must be promptly finished physically as well as mentally. If he waits too long between conception and reduction to practice, some other inventor who may independently conceive the invention subsequent to his date of invention may first reduce it to practice, and may be held to be entitled to the patent because of the want of diligence of the earlier inventor. Reduction to practice may be accomplished in two ways. First, by carrying out a process on a commercial or practicable scale, by constructing and operating a practicable machine, or by producing an article of manufacture, or composition of matter, or, second, by filing an application for patent, which operates as a constructive reduction to practice. In any event the inventor should take care, in so far as possible, to make his disclosures to persons of intelligence, since otherwise he may jeopardize his rights if he depends upon the evidence of witnesses who do not rightly comprehend the invention or its purposes, and cannot therefore clearly testify as to what the disclosure really was. Memoranda, sketches and letters if once established speak for themselves, it is true, but corroborating witnesses if not intelligent may make difficult even the establishment of such written evidence.

Don't Try to Keep the Idea Secret. If a Patent is Not Applied for Within Two Years After Its Evolution the Patent Office Will Honor a Claim of Another Person Made More Quickly.



### FULL DISCLOSURE IS NECESSARY

Another matter sometimes overlooked by the inventor is the necessity of making a full disclosure in his application for patent. If the patent attorney who draws the application has not all of the facts as the inventor knows them, such inventor should not complain if he finds his invention is not fully covered and protected. If possible, the inventor should supply his attorney with the fullest possible written description of his invention, together with working or intelligible drawings. If the inventor must supply his description verbally, let it be very full and complete. Furthermore, the inventor should insist that he be permitted to take home and consider the specification and claim after the same have been prepared by his attorney, and after he receives such specification he should read the same with the utmost care to be sure that nothing has been left out. After the application has once been filed, while the full opportunity is otherwise afforded for amendment, the examiner will not permit *new matter* to be added. The inventor should also study the claims, which are the measure of the patent, and carefully bear in mind that everything which is *not* claimed is *dedicated to the public*. He should also consider that the more carefully prepared the specification and claims of the application, the more valuable will be the patent when issued. If he hurries his patent attorney, or in his anxiety to get a patent at the least possible expense, employs inferior talent, he must not be surprised if his patent

It Is Always Well to be Sure Your Idea "Works" Before You Give Your Patent Attorney His Certified Check. "Reduction to Practice" is Required by the Patent Office.



(Continued on page 584)



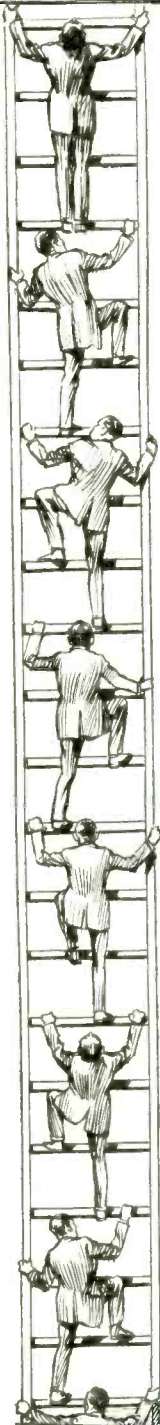

\$200  
per week

\$150  
per week

\$100  
per week

\$75<sup>00</sup>  
per week

\$50<sup>00</sup>  
per week

\$25<sup>00</sup>  
per week

\$20<sup>00</sup>  
per week

\$18<sup>00</sup>  
per week

# Get The Pay of the Man Higher Up!

You are not the kind of man who is always going to take orders from others. What you want is to **give**—not **take** orders. You want the bigger pay that goes with that kind of work; and here in this great Library of Practical Books for Self-training, you are offered the sure way of getting what you want.

In these books you will find a wealth of the very information you need to **GET MORE MONEY** in the trade you are following. There are thirteen sets, each set devoted to one particular line of work. Each set is written by a group of highly trained practical experts who cover the entire subject from a technical standpoint yet do it so clearly and illustrate everything so plainly with diagrams and blue prints that you can't fail to understand every word.

Thousands of men who have read and studied these books have gained by it. If you were to get only one idea that helped you prove an **UNUSUAL** knowledge of your work, that one idea would be worth what a dozen sets would cost you. Every book is simply packed with such ideas and helpful information.

### Reference Books That Make Happy Days of Pay Days Select Your Own Line From This List for Week's Free Use

5 vols. Carpentry and Contracting— was \$37.50 now.....	\$19.80	8 vols. Business Management—was \$52.50 now.....	29.80
12 vols. American Law and Practice (including free reading course and 250 page book of standard legal forms)—was \$97.50 now.....	49.80	7 vols. Steam and Gas Engineering— was \$52.50 now.....	24.80
8 vols. Applied Electricity—was \$60.00 now.....	29.80	4 vols. Sanitation, Heating and Ven- tilating—was \$30.00 now.....	14.80
6 vols. Auto Engineering—was \$45.00 now.....	21.80	4 vols. Fire Prevention and Insurance— was \$30.00 now.....	14.80
9 vols. Civil Engineering—was \$67.50 now.....	34.80	6 vols. Modern Machine Shop Practice —was \$45.00 now.....	21.80
		4 vols. Telephony and Telegraphy— was \$30.00 now.....	14.80
		4 vols. Drawing—was \$30.00 now.....	14.80

### Free Consulting Membership

A resident consulting staff of from 15 to 20 practical experts is waiting to solve for you any difficulty that you may have. A letter or a wire to American Technical Society will bring you an immediate answer and the solution to your problems. This advisory staff of practical men plus your working and reference library will enable you to handle successfully any job in your line. These men know all the latest methods and the newest and best ways of doing things. Let this pay-raising consulting staff be **YOUR SILENT PARTNER**. Use this service daily if necessary.

**This free consulting membership offer is good for a limited time only and can be withdrawn without notice.**

### Use Books FREE For One Week—Send No Money

—just fill out the coupon. After you receive the full set of books, express collect, read them over and test them out for seven days. If you don't want them, send them back at our expense. If you decide they will do for you what they have done for more than 200,000 others, pay \$2.80 within one week and \$3.00 each month thereafter until the special price is paid. **This amounts to only ten cents a day.** Mail coupon NOW if you want a bigger, better job at higher wages.

Here's your opportunity, if you want to **EARN MORE MONEY**. Remember, we are taking all the chances—you pay **NOTHING** unless you are absolutely satisfied after seeing the books. Isn't this about the fairest proposition that was ever put up to you?

**American Technical Society**  
Dept. X-725 Chicago, U. S. A.

© A.T.S. 1923

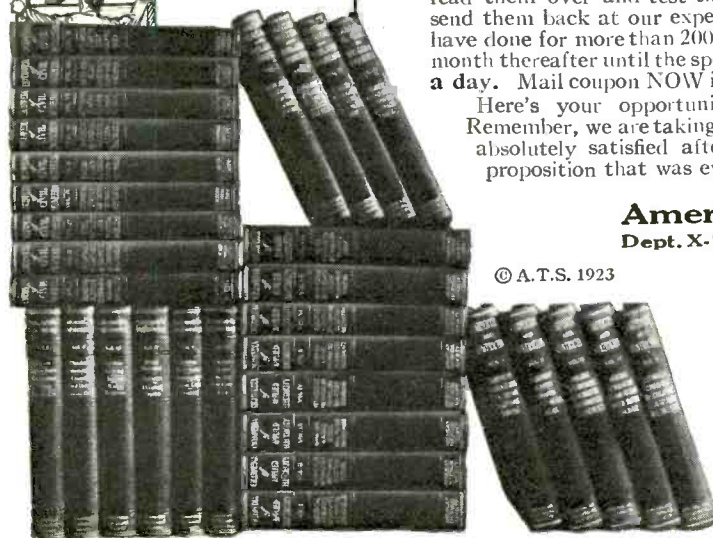

AMERICAN TECHNICAL SOCIETY, Dept. X-725 Chicago.

Please send me a set of \_\_\_\_\_ for seven days' **FREE EXAMINATION**, shipping charges collect. I will examine these books thoroughly, and if satisfied, will send \$2.80 within seven days and \$3.00 a month until I have paid the special price of \$..... If I decide not to keep the books, I will return them within one week at your expense. It is understood that if I keep the books I am entitled to a **FREE Consulting Membership** in the Society.

Name .....

Address .....

Reference.....  
(Please fill out all lines, give local merchant, banker or employer as reference.)



# BLUE PRINT READING



## Learn at Home!

THE building trades are booming. Employers everywhere are looking for men who can read blue prints. Splendid salaries and rapid advancement are offered men who have this special training.

There is an easy, delightful way to learn. The International Correspondence Schools will teach you right at home in an hour a day of the spare time that now goes to waste.

You will like the course because it is so PRACTICAL. You work on actual blue prints—the same blue prints a contractor would use if asked for an estimate, or a foreman would receive from a contractor.

In a surprisingly short time you can acquire a knowledge of blue prints that will be of great value to you in a salary way the rest of your life.

Mail this coupon to-day!

INTERNATIONAL CORRESPONDENCE SCHOOLS  
Box 6207-C, Scranton, Penna.

Without cost or obligation on my part, please tell me how I can qualify for the position or in the subject before which I have marked an X:

### TECHNICAL AND INDUSTRIAL COURSES

- |  |   |
|--|---|
| <input type="checkbox"/> Blue Print Reading                          | <input type="checkbox"/> Electrical Engineering                           |
| <input type="checkbox"/> Architect                                   | <input type="checkbox"/> Electric Lighting                                |
| <input type="checkbox"/> Contractor and Builder                      | <input type="checkbox"/> Mechanical Engineer                              |
| <input type="checkbox"/> Architectural Draftsman                     | <input type="checkbox"/> Mechanical Draftsman                             |
| <input type="checkbox"/> Concrete Builder                            | <input type="checkbox"/> Machine Shop Practice                            |
| <input type="checkbox"/> Structural Engineer                         | <input type="checkbox"/> Railroad Positions                               |
| <input type="checkbox"/> Chemistry <input type="checkbox"/> Pharmacy | <input type="checkbox"/> Gas Engine Operating                             |
| <input type="checkbox"/> Automobile Work                             | <input type="checkbox"/> Civil Engineer                                   |
| <input type="checkbox"/> Airplane Engines                            | <input type="checkbox"/> Surveying and Mapping                            |
| <input type="checkbox"/> Agriculture and Poultry                     | <input type="checkbox"/> Metallurgy <input type="checkbox"/> Mining       |
| <input type="checkbox"/> Mathematics                                 | <input type="checkbox"/> Steam Engineering <input type="checkbox"/> Radio |

### BUSINESS TRAINING COURSES

- |   |   |
|---|---|
| <input type="checkbox"/> Salesmanship           | <input type="checkbox"/> Business Management                              |
| <input type="checkbox"/> Advertising            | <input type="checkbox"/> Industrial Management                            |
| <input type="checkbox"/> Better Letters         | <input type="checkbox"/> Personnel Organization                           |
| <input type="checkbox"/> Foreign Trade          | <input type="checkbox"/> Traffic Management                               |
| <input type="checkbox"/> Stenography and Typing | <input type="checkbox"/> Business Law                                     |
| <input type="checkbox"/> Business English       | <input type="checkbox"/> Banking and Banking Law                          |
| <input type="checkbox"/> Civil Service          | <input type="checkbox"/> Accountancy (including C.P.A.)                   |
| <input type="checkbox"/> Railway Mail Clerk     | <input type="checkbox"/> Nicholson Cost Accounting                        |
| <input type="checkbox"/> Common School Subjects | <input type="checkbox"/> Bookkeeping                                      |
| <input type="checkbox"/> High School Subjects   | <input type="checkbox"/> Private Secretary                                |
| <input type="checkbox"/> Illustrating           | <input type="checkbox"/> Business Spanish <input type="checkbox"/> French |

Name.....  
Street..... 3-27-23  
Address.....  
City..... State.....

Occupation.....  
Persons residing in Canada should send this coupon to the International Correspondence Schools Canadian, Limited, Montreal, Canada.

## EARN MONEY AT HOME

YOU can make \$15 to \$60 weekly in your spare time writing show cards. No canvassing or soliciting. We instruct you by our new simple Directograph system, pay you cash each week and guarantee you steady work. Write for full particulars and free booklet.

WEST-ANGUS SHOW CARD SERVICE LIMITED  
Authorized Capital \$1,250,000.00  
67 Colborne Building Toronto, Can.

## 5 Master Keys

Work like magic in emergencies or prove whether your door or padlocks are burglar-proof. Open and test thousands of different locks. Recommended by users in ten different nations. Most wonderful and only keys of their kind. Send \$1 today. Novel key chain FREE with set.

MASTER KEY CO., 8 Manhattan Block, Milwaukee, Wis.

## Pitfalls of the Radio Inventor

(Continued from page 582)

when issued is of such narrow scope as to be of little or no value. If, therefore, the inventor finds himself in a position where by reason of lack of means he is unable to employ a solicitor of standing and experience, he should endeavor to seek out and interest some person with capital in his invention. It is better by far to have a half interest in a valuable patent with broad claims, than the whole interest in a patent with claims so narrow that they are limited to the precise device shown and can be easily avoided by others without penalty.

The inventor should also consider the two years statutory bars of the statute, and take care not to use his invention commercially or publicly for two years before applying for a patent. A publication or use two years prior to an application completely bars an inventor from the right to a patent. If, therefore, any person, including the inventor, has described such invention in a printed publication or has used the invention for more than the two years prior to his application, the inventor forfeits his rights, unless he can show such public use was entirely his own and was experimental in character. An example of such experimental use is that of an invention for a city pavement, where it might be necessary in order to test the same experimentally to employ more than the two years public use. Courts, however, are prone to look askance at the suggestion of experimental use in reply to the defense of public use, so that it is wise to avoid public experimental use by the inventor if possible.

### EMPLOYEE'S INVENTIONS

Where an employee invents, even though the invention is made during hours of employment, and the employer pays for the prosecution of the application, all that the employer will obtain in the absence of any express agreement is a shop-right or at the most an implied license. The right to the patent still remains in the employee. Where there is an express agreement that the employee will assign to his employer all his inventions relating to the employer's business during the period of his employment, the courts will enforce such agreement and compel the inventor to assign. Agreements, however, of this character are strictly construed, and unless the word assign or the equivalent is used, the tendency of the courts is to give the employer only a shop-right in the invention. If the agreement were not restricted to a particular class of inventions, or to the business of the employer, and required the inventor to assign to his employer all his inventions of any nature whatsoever, the court would hold such an agreement to be in restraint of trade and would refuse to enforce it.

The patent law requires all assignments of patents, as against a subsequent purchaser or mortgagee for a valuable consideration without notice, to be recorded at the Patent Office within three months from the date of the assignment or prior to such subsequent purchase or mortgage. Except, however, as against such purchaser or mortgagee, recording is not necessary to the validity of the assignment or chain of title. This clause is not very important as to the inventor, except as he may desire to protect the interests of assignees, or except perhaps as he himself may acquire patent interests. Any person purchasing a patent should cause a search of the title to be made at the Patent Office at Washington in order to make sure that such title is clear, and should in general take the same precautions as if he were taking title to a parcel of real estate.

### JOINT INVENTORS

By joint inventors is meant those inventors who together create a single invention. They

are entitled to a joint patent, but neither of them can obtain a separate patent for the invention. If they desire they may file separate or joint applications, but only one patent will issue. The fact that one person furnishes the capital and another makes the invention does not entitle them to make an application as joint inventors, but in such case they may become joint patentees upon the inventor assigning an undivided interest to his colleague. Independent inventors of distinct and independent improvements on the same machine cannot obtain a joint patent for their separate inventions. In such case a separate application should be filed for each inventor. Since it can rarely be shown that two or more persons have joined in the creation of the invention, very few applications for a joint invention are filed. Great care should be exercised by the inventor where he supposes he is a joint inventor. In many cases it will be found after carefully sifting the facts that there is in reality but one inventor, and if such inventor is so careless as to permit another person to be joined with him as joint inventor, the results may be very serious in case of litigation. After the patent for a joint invention has been issued, if it develops that the invention is not in fact joint, the patent will be declared to be void.

### SECRET PROCESSES

In some instances it may be determined particularly where a process is concerned that such process will be held secret. In case the inventor determines upon such course, he should carefully bear in mind that once he has determined to keep his invention secret, while availing himself of the results commercially, he may, if such secret use is long continued, lose his rights to a patent. Yet in some cases it has happened that the inventor after using his secret process for a number of years has become alarmed lest such process through the unfaithfulness of an employee might be divulged to the public, and has made application for and has received a patent for such process.

Where such facts, however, have appeared to the court, it has been held, in the case of a concealment for the purpose of profit over a long period of years, that the patent will be held to be void because of constructive abandonment or forfeiture of the right of an inventor to a patent.

### FOREIGN PATENTS

So far as concerns foreign countries, the inventor should bear in mind that once the invention is divulged to the public, either in the form of a patent or other printed publication, such publication will become a bar to the issuance of a patent. This applies particularly to foreign countries, there being an exception relative to U. S. patents in the case of the inventor himself, who is not debarred from receiving a patent for his invention in this country by reason of its having been first patented by him abroad, unless the application for the said patent was filed more than twelve months prior to the filing of the application in this country. The proper course to pursue in the ordinary case is after notice of allowance is received by the inventor in this country, to utilize the six months in which he is to pay his final fee for the filing of such application in foreign countries as he may desire. In this country a patent does not go to issue, that is become published, until the final fee has been paid, and since the inventor has six months for such payment he has ample time before paying such fee to file his applications abroad.

(Continued on page 586)



# NATIONAL Apparatus of Simplicity and Perfection

For Reflex and Crystal Sets

The Monodyne circuit is one of the most radical advances in Radio engineering. Parts heretofore considered essential are omitted. One simple tuning control gives selectivity, equal if not superior to sets costing hundreds of dollars.

All Wave Lengths

2 coils are furnished with each set.

## NATIONAL "GOLD-GRAIN" DETECTOR

Entirely New Circuit  
No Storage Batteries

\$1.00



Actual Size FOR PANEL MOUNTING

## NATIONAL MONODYNE

PAT. TRADE MARK PDG.

### TUBE SET MODEL GT-1

\$10.00

Including Two Inductance Coils Without Tube



Amplifies As It Detects  
ONLY ONE CONTROL

## NATIONAL INTERFERENCE ELIMINATOR

The National Interference Eliminator can be used with any and all radio outfits no matter what make, tube or crystal sets. Will bring in stations you never heard before. Nothing else required with set as illustrated. Just connect it with two short wires to your outfit.

\$7.50

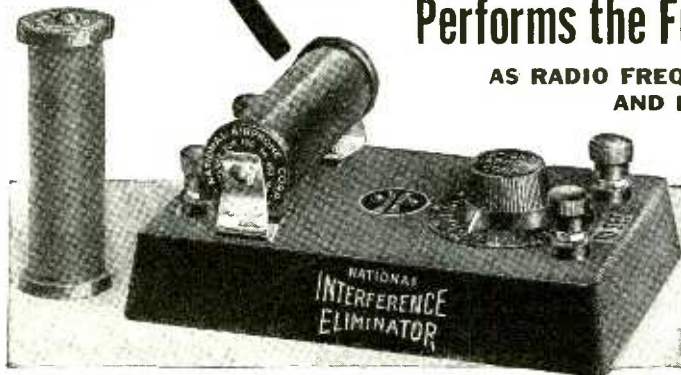

THE SINGLE TUBE Performs the Function of 2-Tubes AS RADIO FREQUENCY AMPLIFIER AND DETECTOR

OVER 1000 Miles

Dear Sirs:—When your Monodyne sample arrived, to be entirely frank, we did not believe it capable of doing very much on long distance work. After carefully testing the set we feel that we owe you an apology.

The National Monodyne naturally percolated all over the place; we heard Davenport, Chicago, Dallas, Texas and Atlanta, Ga. The next night we took it to the home of Mr. McCreary, President of the Western Radio Company here, and we heard another string of stations, using the WD-12 tube with two 22½ "B" batteries.

Your Monodyne is certainly a wonder and we should be very glad to stock and advertise it locally.

We are enclosing our initial order, which kindly rush.

Yours very truly,

The Radio-Electric Shop, Inc.  
225 East Tenth St., Kansas City, Mo.

**An Absolute Necessity to Clear Reception**  
Eliminates broadcasting and code-signal interference  
Can be used to increase or shorten wave lengths

Dealers, Jobbers and Distributors—Send for Samples and Prices

**NATIONAL AIRPHONE CORPORATION**  
20 HUDSON ST. NEW YORK

**SEND NO MONEY**

National Airphone Corporation  
20 Hudson Street, New York City, N. Y.

S. I. 10-23

Gentlemen:

Please send me prepaid the articles crossed, for which I will pay postman upon delivery the advertised price.

- One  National Monodyne
- One  Interference Eliminator
- One  Panel Detector

NAME .....

STREET .....

CITY ..... STATE .....



**\$1.00 DELIVERS to Your Home**



**Complete Outfit**

# Violet Ray

ONLY \$1.00 brings this complete, scientific Violet Rays outfit to you. Treat yourself and family at home, save delay, costly doctors and medicines. Thousands use Violet Rays at home to relieve pain and sickness. The identical outfits doctors have bought from us for years and with which they successfully treat many ailments, including those listed below.

## QUICK RESULTS —No Medicine

Violet Rays work quickly, it's scientific, goes after the cause. That's why results are quick, permanent. Dr. Duncan, Kewanee, Ill. writes, "Violet Rays is the finest thing I ever used to relieve pain, treatments are so pleasant all my patients like it." Use it yourself at home, you save Doctor's bills.

**Beauty Aid** Brings natural, magnetic beauty of health, no dieting, exercise or drugs. FREE book tells in detail how high priced beauty specialists use it to improve scalp and skin.

## EARN CASH

Men, women, without experience earn liberal profits in spare time showing Violet Rays to neighbors. Proves results first demonstration, sells on sight. Get attractive offer and wholesale prices now.

## Send FREE Book For

Explains how Nikola Tesla discovered Violet Rays, how it works, why it heals. Tells what doctors and plain folks accomplish in conquering pain, disease and nervous trouble with Violet Rays.

**Reveals Marvelous Scientific Discovery** Shows charts of human body, explains where pains start, how to banish them. Offered FREE for a limited time only, to introduce Violet Rays. Send for FREE copy.

## Check Your Ailment Below for Free Advice

Here is a partial list of ailments successfully treated with Violet Ray:

- |              |             |                |
|--------------|-------------|----------------|
| Catarrh      | Hay Fever   | Piles          |
| Chilblains   | Headache    | Rheumatism     |
| Colds        | Gout        | Skin Diseases  |
| Constipation | Insomnia    | Sore Throat    |
| Ears-Itches  | Lumbago     | Sprains        |
| Eczema       | Nervousness | Tonsillitis    |
| Eye Diseases | Neuritis    | Whooping Cough |
| Falling Hair | Paralysis   | Asthma         |

## Mail coupon—Send no money

**VI-REX ELECTRIC COMPANY,**  
326 W. Madison Street, Dept. 410 Chicago

Please send me without cost or obligation your free book describing your VI-REX Violet Ray outfits, and details of your \$1.00 offer.

Name \_\_\_\_\_

Address \_\_\_\_\_

City \_\_\_\_\_ State \_\_\_\_\_

## Pitfalls of the Radio Inventor

(Continued from page 584)

Another important matter to be considered is that of constructive abandonment of an invention. This occurs where the inventor by reason of indifference or otherwise permits others to use his invention without objection over a substantial period. Where the invention has been thus abandoned the right of a patent is gone, on the theory that where a gift is once made to the public it can never be taken back. Sometimes where an inventor has ceased experimenting upon a particular device which has proved defective for the purposes for which it was designed, such situation gives rise to the presumption of an abandoned experiment. Once the inventor has exercised his creative faculty and has conceived an invention it is accordingly incumbent upon him to proceed diligently in effecting his invention and applying for a patent, since otherwise, his lack of diligence or his slothfulness may be construed as an abandonment, in which case his right to a patent is entirely gone.

Such are the main pitfalls to be encountered by the ordinary inventor in this country, most of which may be avoided through the use of ordinary care on the part of the inventor. At all times he should bear in mind the maximum of the equity courts, in which most patent cases for infringement are tried, which is, that equity aids the vigilant, not those who slumber upon their rights.

## Radio Broadcast

Complete List of Broadcast Stations in United States

(Revised to date)

Call	Name	City and State	Lengths
KDKA	Westinghouse Electric & Manufacturing Co.	East Pittsburgh, Pa.	326
KDPM	Westinghouse Electric & Manufacturing Co.	Cleveland, Ohio	270
KDPT	Southern Electric Co.	San Diego, Cal.	
KDYI	Telegram Publishing Co.	Salt Lake City, Utah	360
KDYM	Savoy Theatre	San Diego, Cal.	252
KDYQ	Oregon Institute of Technology	Portland, Ore.	
KDYS	The Tribune	Great Falls, Mont.	360
KDYW	Smith Hughes & Co.	Phoenix, Ariz.	
KDYN	Star Bulletin	Honolulu, Hawaii	
KDZB	Frank E. Siefert	Bakersfield, Cal.	
KDZE	The Rhodes Co.	Seattle, Wash.	
KDZF	Auto Club of Southern California	Los Angeles, Cal.	278
KDZI	Electric Supply Co.	Wenatchee, Wash.	
KDZK	Nevada Machinery & Electric Co.	Reno, Nev.	
KDZQ	Nichols Academy of Music	Denver, Colo.	
KDZR	Bellingham Publishing Co.	Bellingham, Wash.	261
KDZT	Seattle Radio Association	Seattle, Wash.	
KEAD	McArthur Bros.	Mercantile Co., Phoenix, Ariz.	
KEAE	State College of Washington	Pullman, Wash.	
KEAF	Western Radio Corp.	Denver, Colo.	
KEAJ	University of Colorado	Boulder, Colo.	
KEAN	The Electric Shop	Moscow, Idaho	
KEAP	Standard Publishing Co.	Butte, Mont.	
KEAQ	City of San Jose	San Jose, Cal.	
KEAR	Studio Lighting Service Co.	Hollywood, Cal.	280
KEAT	S. T. Donohue	Eugene, Ore.	275
KEAU	Independent School District of Boise City	Boise High School, Boise, Idaho	270
KEAV	Abbot Kinney Co.	Venice, Cal.	258
KEAW	The Radio Den (W. B. Ashford and T. White)	Santa Ana, Cal.	
KEAY	Virgin's Radio Service	Medford, Ore.	360
KFBB	F. A. Buttrey & Co.	Havre, Mont.	360

(Continued on page 588)

Play a **CONN** for Pleasure and Profit



Isham Jones and his famous orchestra are among the great popular stars who use and endorse Conn instruments.

Conn instruments are easiest to play because of the exclusive way they are made and many improvements, refinements, and features developed in the great Conn laboratories. You can play a tune in a few hours on the Conn saxophone—take your place in orchestra or band in a short time. Conn cost no more.

**Free Trial; Easy Payments.** Write now for Free Book and details, mentioning instrument which interests you.

C.G. Conn Ltd., Elkhart, Ind.  
1056 Conn Bldg.



**CONN**  
WORLD'S LARGEST MANUFACTURERS OF HIGH GRADE BAND AND ORCHESTRA INSTRUMENTS

CULTIVATE YOUR MUSICAL BUMP

## NEW-TREAD TIRES AT 40¢ ON THE DOLLAR

Send No Money!

Here is a real opportunity to cut your season's tire bill notwithstanding advances in prices. For a limited period only we offer our famous New-Tread Tires—as illustrated—at less than 40¢. Made of NEW LIVE RUBBER and built on the best carcasses money can buy.

**Special Sale Prices**

Size	Tire	Tube	Size	Tire	Tube
28x3	\$4.95	\$1.25	36x4	\$8.65	\$2.35
30x3	4.95	1.35	32x4	9.35	2.40
30x3½	5.85	1.40	33x4½	9.00	2.45
32x3½	6.50	1.50	31x4½	9.15	2.50
31x4	7.00	1.60	35x4½	9.25	2.60
32x4	7.50	1.85	36x4½	9.45	2.70
33x4	7.85	2.15	35x5	9.75	2.80
34x4	8.10	2.25	37x5	9.85	2.90

ALL OUR TUBES ARE NEW FRESH STOCK and Guaranteed for One Year. Shipment made same day order is received. Pay on arrival and if not satisfied, return AT OUR EXPENSE. Specify whether straight, silt or clincher wanted. FIVE PER CENT DISCOUNT when cash accompanies order. DEALER AGENTS WANTED IN EVERY LOCALITY.

**STANDARD TIRE & RUBBER CO.**  
3280 S. Morgan St., Chicago, Illinois

## FINE OLD VIOLINS On Easy Payments 30 Days Free Trial

allowed, no matter where you live. If not more than pleased with our values return violin AT OUR EXPENSE—and no harm done. Ability to play the violin brings social and financial success. Get a violin with a rich, mellow tone and it will create in you a desire to master it.

## Free! Magnificent Album-Catalog

containing portraits of the world's greatest violinists since Paganini's time, a half-tone of "Stradivarius in his Workshop" and the romantic story of The King of Musical Instruments. A postal brings all to you FREE—no obligations.

## Old Violins Bought, Sold, Exchanged and Repaired

Send in your old violin by insured parcel post for examination. We may be able to make a very valuable instrument out of it at small cost. Many violins that were considered worthless brought high prices after they left our repair shop. No charge for estimates.

**CREMONA VIOLIN SHOP, CHICAGO**  
FORTY-THIRD & SHIELDS AVE., DEPT. K-51

## FREE a wonderful Book on Finger Prints

Full of thrilling crime mysteries solved through finger print evidence by America's greatest experts. Gripping illustrations. True stories. You can learn the Fingerprint profession at home in spare time. Write today. Get full details. Big surprise in store for you. Book and offer free. Write now.

**UNIVERSITY OF APPLIED SCIENCE**  
1920 Sunnyside Avenue, Dept. 53-37 Chicago, Ill.



# "BUILD YOUR OWN" WITH "RASCO" PARTS!

THE Radio Specialty Company—"RASCO" for short—now in its third year, is unquestionably the oldest and most unique radio parts supply house in the United States, if not in the whole world. This Company makes a specialty of small orders. No order is too small to get immediate and prompt attention. The reason is simple: 80% of our orders are small. The reputation of this house was built upon service. Ask any of your radio acquaintances what they think of "RASCO" service. "RASCO" promptness. Thousands of unsolicited testimonials are in our files, to prove that we serve the public as it has never been served in radio merchandise before. Be sure to get our great 84-page catalog, containing over 500 different parts. Catalog contains over 300 illustrations. "WE CAN ONLY DISAPPOINT YOU ONCE." Try us with a 50c. order and make us prove what we say. Prices include delivery to your door.

**Order direct from this page. We pay all transportation charges. All goods sent prepaid in 24 hours.**

**NOTE BIG PRICE REDUCTIONS THIS MONTH Money refunded if goods do not satisfy**

**LOOP AERIAL**  
The loop aerial you have been waiting for. Made entirely of well seasoned hard wood. Complete with all parts and base; No. 22 enameled wire used. Total height of loop 36", 2 feet on the side; loop is in 100 divisions. Can be put together by anyone in less than 5 minutes. Satisfaction guaranteed.

R-2300 Two loop aerial, complete... \$1.15

**STORAGE BATTERIES**  
New! New! New!  
Two volt, 10 ampere hour storage battery for use with WD11, 12, and U.V. 119 tubes. Don't keep on buying dry cells continuously. This storage battery will pay for itself in two months. Only best materials used. Guaranteed for 2 years. You can connect up to 6 dry cell tubes on a single one of these batteries. Can be recharged for a few cents. Hard rubber container encased in impregnated wool case. Due to low price and large weight of batteries, shipped express collect.

R-2400. Two volt, 10 ampere hour storage battery, size 2 1/2 x 8 x 9" ..... \$4.25  
R-640. Six volt, 40 ampere hour storage battery, size 4 3/4 x 7 1/2 x 9" ..... 8.75  
R-660. Six volt, 60 ampere hour storage battery, size 6 1/2 x 9 1/2" ..... 11.00

**WOOD CABINETS**  
Highest grade mahogany cabinets made. Best hand rubbed finish. Top finished. Front of cabinet rabbetted to fit panel. Price delivered to your door; no panel included in these prices. Entire cabinet made of 1/2" well seasoned stock.

R-714. Wood cabinets, panel size 7"x11"..... \$3.35  
R-718. Wood cabinets, panel size 7"x18"..... 3.60  
R-724. Wood cabinets, panel size 7"x24"..... 4.40  
R-710. Wood cabinets, panel size 7"x10"..... 2.60  
R-712. Wood cabinets, panel size 7"x12"..... 3.00  
R-721. Wood cabinets, panel size 7"x21"..... 3.90

**CARDBOARD TUBING**  
Only seamless tubing made in United States. Perfectly seasoned. Heavy wall. (I.D.—Inside Diameter. O.D.—Outside Diameter. L.—Length.)

R-6600. 3" I.D., 3 1/2" O.D. x 7' L..... \$3.00  
R-6601. 3 1/4" I.D., 3 3/4" O.D. x 7' L..... 3.25  
R-6602. 3 1/2" I.D., 3 1/2" O.D. x 7' L..... 3.50  
R-6603. 3 3/4" I.D., 4" O.D. x 5' L..... 2.75  
R-6604. 4" I.D., 4 1/2" O.D. x 5' L..... 3.50  
R-6605. 2 3/4" I.D., 3" O.D. x 2 1/2' L..... 1.15

**"RASCO" BEZELS**  
The finest bezel on the market. Best brass mesh used. The bezel comes entirely nickel plated. Will improve looks of your panel 100 per cent. Outside diameter 1". Can be used on 1/2" or 3/16" panel.

R-1700. Rasco bezel..... \$1.15  
R-1701. Rasco bezel 1 1/2" diam..... .20

**FORMICA PANELS**  
Clearance Sale.  
This sheeting is positively the best grade on the market. High finish on both sides. Too well known to require much explanation. Due to the fact that we are discontinuing these particular sizes, this material is now offered practically at cost. Prices are about 40 per cent lower than our catalogue list. Note also that we ship these panels prepaid. This alone amounts to a considerable saving.

R-350. 6"x12"x1/8" thick, each..... \$1.50  
R-351. 6"x18"x3/16" thick, each..... 1.50  
R-352. 9"x12"x3/16" thick, each..... 1.75  
R-353. 12"x18"x3/16" thick, each..... 4.00  
R-354. 6"x18"x3/16" thick, each..... 1.90  
R-355. 6"x12"x3/16" thick, each..... .85  
R-356. 6"x11"x3/16" thick, each..... 1.60  
R-357. 6"x13"x3/16" thick, each..... .65

**RASCO 180° VARIOCOUPLER**  
This coupler while extremely low in price will do anything and everything that the more expensive ones accomplish. Silk wire wound on bakelite tubes. There are six taps. Wave length of coupler is from 150 to 600 meters. Coupler is made for panel mounting, 3/4" shaft. Your money refunded if it does not do all that we claim for it.

R-3100 Variocoupler, prepaid..... \$1.50

**MELOPHONE LOUD SPEAKER**  
The best popular loud speaker on the market. Has tuned feature the same as all "Rico" phones. Filter horn, heavy metal base, five foot cord. Nickete gousneck. Greatest tuned loud talker. Compares favorably with most expensive speakers. Size overall 14 1/2" horn length 11 1/2"; bell 6 1/2"; total height 9".

R-255. Melotone Speaker..... \$4.90

**RICO TUNED RECEIVERS**  
No better phones made. Supersensitive. Awarded Radio News Laboratories Certificate of Merit. The only tuned phone on the market. Can be tuned for any intensity and sensitivity. Magnetic pole of phone is in mathematical center of diaphragm. "Turn the cap to tune."

R-2020. 2000 ohms, double head set..... \$4.45  
R-3030. 3000 ohms, double head set..... \$5.59

**"RASCO" VERNIER**  
Cleverest vernier made. Can be used with any dial. Soft rubber ring engages dial. Goes away with vernier condenser. We guarantee results. All metal parts moulded in best black composition. Nothing to compare apart. Biggest hit of the season.

R-1450. Vernier..... \$3.30

**"RASCO" POSTS**  
R-650. Post made entirely of best black composition. 8/32" screw—each..... .08  
R-202. Post has nickel-plated bottom part, each..... .88  
Dozen, each style..... .90

**"RASCO" SWITCH POINTS**  
Nickel-plated and polished. The following have been found the most popular.

R-301. 1/4"x1/4", 6/32" thread, doz..... \$1.18  
R-302. 3/16" high, 1/4" dia., 6/32" thread, doz..... .18  
R-303. 3/16"x3/16", 4-56" thread, doz..... .18  
R-304. 1/4" dia., 1/8" thick; shank 6/32"..... .18  
R-305. 3/4" dia., 3/16" thick; shank 1/32"..... .18  
R-306. 3/16" dia., 3/16" thick; shank 4/36"..... .18  
R-307. 3/16" dia., 1/8" thick; shank 4/36"..... .18  
R-373. Switch Stop, 3/8" long, 1/36" thread, complete with nut, each..... .18

**"RASCO" SOCKETTES**  
Substitute for Vacuum Tube Socket. Four of these take one Vacuum Tube. Grasp tube firmly. Best contact possible. Take less room. Are better.

R-1550. Sockettes, nickled, set of 1..... \$2.25  
R-1551. Sockettes, nickled, set of 1 (to take WD-11 Tube)..... .25  
Note: Set of 4 sufficient to hold 1 Tube.

**COPPER FOIL**  
Thinnest copper foil made, .001" thick. Comes 4" wide.

R-5025. Copper Foil, per ft. x 10-ft. length..... .30

**PHONEHORN**  
Fills a new and distinct want. Base consists of R-1510 Phonodapter described on this page into which fits a fine enameled fibre horn. Size of horn 12"; bell 6 1/2". Slip Phonodapter end on a single telephone receiver and you have the lowest priced loud talker ever made. Mounted in your set or hung in corner of room it will bring sound all over the room. A most useful article. Welcome by all radio fans.

R-1321 Phonehorn, prepaid..... \$1.45

**AUDIO FREQUENCY TRANSFORMERS**  
No better Transformer on the market. Highest class materials. Impregnated coils. Silicon steel stampings used. Save 50 per cent by assembling it yourself.

R-1100. A.F. Transformer, ratio 1 1/4 to 1..... \$2.00  
R-1150. A.F. Transformer, ratio 6 1/2 to 1..... \$2.00

**RADIO FREQUENCY TRANSFORMERS**  
The best Radio Frequency Transformer developed so far. Designed for us by Mr. R. E. Lacomit, Associate Editor of RADIO NEWS. Air core. Guaranteed to do the work. This Transformer brings in the long distances.

R-2800. Radio Frequency Transformer, size 1 1/2" x 2 1/2"..... \$1.50

**RHEOSTATS AND POTENTIOMETERS**  
Highest grade Rheostat made. High heat dielectric composition base. Wound with best non-corrosive resistance wire. Comes with tapered, knurled knob. Diameter, 2 1/2". Complete with pointer.

R-4310—6 ohm, each..... \$1.45  
R-4311—30 ohms, for 301a and 201a tubes, each..... \$1.65  
R-4312—Potentialmeter, 200 Ohms each..... \$1.85

**SPIDER WEB FORMS**  
At last! Fine forms to wind your spider webs. Made from hard, well seasoned fibre, 1-16" thick, center and side holes for wiring. 3200 has 13 slots, 3201, 11 slots, both 57 ohm meter.

R-3200—Spider web form, each..... \$1.25  
R-3201—Spider web form, each..... \$1.25

**BRASS RODS**  
Sold in 6" lengths only

R-8032. Brass Rod, 8/32" thread, per length..... \$1.08  
R-1425. Brass Rod, plain 1/4" round, per length..... .06  
R-6032. Brass Rod, 6/32" thread, per length..... .10  
R-3616. Brass Rod, plain 3/16" round, per length..... .06

**"RASCO" NAME PLATES**  
The circular plate is our new Binding Post Name Plate. Diameter, 3/4". These denominations: PHONES, GROUND, OUTLET, "A" BATTERY, "B" BATTERY, "A" P. B. V., LOOP SPEAKER, GRID, LOAD, "C" BATTERY, AERIAL, "A" INPUT, "A" BATTERY.

TERRY + "B" BATT + LOOP, TICKLER, PLATE, "C" BATT + FILAMENT  
R-6000 to 6019. Binding Post Name Plates, each denomination..... \$1.00  
Dozen..... \$3.00

**REINARTZ SPIDERWEB COIL**  
Here is a very fine inductor for Reinartz circuit, 200-600 meters. 19 taps. Size 3 1/4" diameter; 1 1/2" center opening. Can be used in nearly all new circuits. Construction: spider-web throughout. Coil is firm and will not fall apart as is case with many inferior makes. A few of these coils will work wonders in your set.

P-2550 Spider web Reinartz coil..... \$1.15

**PHONODAPTER**  
The Phonodapter will fit any phone. Metal tube fits any standard phonograph. Make your phonograph a loud talker. Fits Columbia, Victor and Sonora phonographs. Is made entirely of one soft rubber with brass tube inserted.

R-1310 Phonodapter..... \$1.50

**DOUBLE PHONODAPTER**  
The Double Phonodapter fits all phonographs and will take any standard double head set, thereby making your phonograph a loud talker. Made of cast metal, nickel plated and highly polished. Has three generous soft rubber bushings.

R-1320 Double Phonodapter..... \$1.65

**RASCO TELEPHONE PLUG**  
This is the plug that is sold from 75c. to \$1.00 everywhere. Has hard rubber composition shell and patented card tip holder. Must be seen to be appreciated. Finest workmanship throughout.

R-1030 Rasco Telephone Plug, each..... \$1.35

**LITZ WIRE**  
R-323. equals No. 25 B&S, per foot..... \$1.02  
R-890. equals No. 28 B&S, per foot..... .01  
R-891. equals No. 21 B&S, per foot..... .01  
R-892. equals No. 20 B&S, per foot..... .04  
Discount of 10 percent in 100-ft. lots.

**UNIVERSAL BEARING**  
THE bearing to hold rafter motor and variocoupler rotors. Total length of bearing 2 1/4". Outside shaft, 1 1/4". Length of thread 1 1/2". Length of threaded sleeve, 3/4".

R-1375. Bearing..... \$2.25

**PANEL MOUNTING VARIABLE CONDENSERS**  
This condenser presents the latest word in precision mechanics. Plates, washers, and all other parts are accurately machined. Positively no better condenser on the market. Shafts 1/4". Save from 10% to 60% by assembling condenser yourself. A child can do it in a few minutes spare time. Capacities guaranteed.

R-1111 11 plate condenser, .00025 mfd..... \$1.10  
R-2121 21 plate condenser, .0005 mfd..... 1.22  
R-4343 43 plate condenser, .001 mfd..... 1.50

**The "Rasco" Catalog**  
CONTAINS 75 VACUUM TUBE HOOK-UPS. 350 ILLUSTRATIONS. No. 10. 550 ARTICLES, 84-PAGES

All Armstrong Circuits: These important circuits are explained clearly, all values having been given leaving out nothing that could puzzle you. Just to name a few of the Vacuum Tube Circuits: The V.T. as a detector and one-step amplifier; Armstrong circuits; one-step radio frequency amplifier and detector; three stage audio-frequency amplifier; short wave regenerative circuits; 3-stage radio frequency amplifiers; radio and audio frequency amplifier; inductively coupled amplifier; Armstrong superautodyne, etc. Catalog mailed only upon receipt of 15 Cents in Stamps or Coin.

**Radio Specialty Co.**  
100 Park Place - New York City  
Oldest and Original Exclusive Radio Parts House in U. S.  
Factories: Brooklyn, N. Y. Elkridge, Md.

**DEALERS**  
Get Our Special Proposition





## Take This Short Cut to Accomplish Your Ambition

The field of electrical engineering offers wonderful opportunities for trained men to direct and carry out great industrial and commercial projects. Get a thorough and practical training here in our course of

### ELECTRICAL ENGINEERING with B. S. Degree in 3 years

A faculty of specialists is leading hundreds of ambitious young men to sure success. Why not you?

If you are lacking some preparatory studies you can make them up here as you go along. This is an exceptional opportunity to become an electrical engineer in the shortest possible time.

### ELECTROTECHNICS

From 1 to 2 years in this course makes you a completely trained electrotechnician—prepared to fill such positions as general plant superintendent, director of construction, superintendent of maintenance, chief draftsman, etc. The Electrotechnician is the man between the Electrical Engineer and the Electrician—a well paid position and a stepping stone to higher executive work. A grade school diploma or equivalent admits you without examination. New term opens every 6 weeks.

### COMMERCIAL ELECTRICAL ENGINEERING in 1 Year

Unparalleled opportunities for brilliant, successful careers in the new field of Commercial Electrical Engineering. To meet the extraordinary present-day demand for trained electrical business men, consulting and efficiency engineers, we offer this thorough, condensed and very practical training, especially adapted to high school graduates.

### PRACTICAL ELECTRICITY

In this complete 6 months' Electrical Course—8 hours daily—you can learn house, factory and theatre wiring, testing and meter work, A.C. and D.C. Armature Winding and all necessary mathematics.

A 3 months' course in A.C. and D.C. Armature Winding, or a 3 months' Course in Light and Motor Wiring and Testing is offered to those with limited time and means.

### AUTOMOTIVE ELECTRICITY

Electrical specialists who instinctively diagnose and locate automotive electrical troubles command high positions and are well paid. Specialize in starting, lighting, ignition and storage batteries and command a big job at a big salary.

### "EARN WHILE YOU LEARN"

We agree to provide, for a limited number of worthy young men, half-time jobs at good wages, and permanent positions with unlimited prospects to all duly qualified graduates. Here is the opportunity of your life to acquire a thorough, practical training for big-paying profession that is in urgent need for trained men.

### ESTABLISHED 17 YEARS AGO

The S. of E. stands absolutely alone in the field of thorough, practical electrical education and in commercial and electrical engineering.

### NO NEED OF YOUR BEING WITHOUT AN S. OF E. TRAINING

It does not matter how old you are or what schooling you have had. Students from 16 years up to 50 are in attendance here.

Fill out the following coupon and mail it to-day.

## SCHOOL of ENGINEERING of Milwaukee

SCHOOL OF ENGINEERING OF MILWAUKEE  
S. & I.-10, 415-17 Marshall Street,  
Milwaukee, Wis.

Without obligating me in any way, please mail free 72-page illustrated book "Electricity and the One Best Way to Learn It" and particulars regarding the course I have marked with an X.

- .... Electrical Engineering.
- .... Electrotechnics.
- .... Commercial Electrical Engineering.
- .... Automotive Electricity.
- .... Armature Winding.
- .... Light, Motor Wiring and Testing.
- .... Practical Electricity.
- .... I am interested in your "Earn While You Learn" Plan.

Name ..... Age .....

Address .....

City ..... State .....

Education .....

## Radio Broadcast

(Continued from page 586)

Call	Name	City and State	Lengths
KFBC	W. K. Azbill	San Diego, Cal.	
KFBE	Reuben H. Horn,	San Luis Obispo, Cal.	
KFBG	First Presbyterian Church,	Tacoma, Wash.	
KFBK	Kimball-Upson Co.	Sacramento, Cal.	360
KFBL	Leese Bros.	Everett, Wash.	224
KFBS	Trinidad Gas & Electric Supply Co. and Chronicle News.	Trinidad, Colo.	
KFBU	The Cathedral	Laramie, Wyo.	
KFCB	Salem Electric Co.	Salem, Ore.	
KFCF	Frank A. Moore.	Walla Walla, Wash.	
KFCH	Electric Service Station (Inc.),	Billings, Mont.	
KFCJ	Colorado Springs Radio Co.,	Colorado Springs, Colo.	
KFCL	Los Angeles Union Stock Yards,	San Antonio, Cal.	360
KFCM	Richmond Radio Shop (F. T. Doeing)	Richmond, Cal.	
KFCP	Ralph W. Flygare	Ogden, Utah	
KFCV	Fred Mahaffey, Jr.	Houston, Texas	
KFCY	Western Union College, Le Mars,	Iowa	
KFCZ	Omaha Central High School,	Omaha, Neb.	
KFDA	Adler's Music Store	Baker, Ore.	
KFDB	Mercantile Trust Co. of Calif.,	San Francisco, Calif.	
KFDC	Radio Supply Co. (E. B. Craney),	Spokane, Wash.	283
KFDD	St. Michaels Cathedral	Boise, Idaho	252
KFDF	Casper Community Radio Corporation	Casper, Wyo.	360
KFDH	University of Arizona,	Tucson, Ariz.	
KFDJ	Oregon Agricultural College,	Corvallis, Ore.	
KFDL	Knight-Campbell Music Co.,	Denver, Colo.	
KFDO	H. Everett Cutting	Bozeman, Mont.	248
KFDP	Hawkeye Radio & Supply Co.,	Des Moines, Iowa	278
KFDR	Bullock's Hardware & Sporting Goods	York, Neb.	
KFDU	Nebraska Radio Electric Co.,	Lincoln, Neb.	240
KFDV	Gilbrech & Stinson,	Fayetteville, Ark.	
KFDX	First Baptist Church,	Shreveport, La.	360
KFDY	South Dakota State College of Agriculture and Mechanic Arts,	Brookings, S. D.	360
KFDZ	Harry O. Iverson,	Minneapolis, Minn.	360
KFEC	Meier & Frank Co.	Portland, Ore.	360
KFEJ	Guy Greason	Tacoma, Wash.	
KFEL	Winner Radio Corp.	Denver, Colo.	
KFEP	Radio Equipment Co.	Denver, Colo.	240
KFEQ	J. L. Scroggin	Oak, Neb.	
KFER	Auto Electric Service Co.,	Fort Dodge, Iowa	231
KFEV	Radio Electric Shop	Douglas, Wyo.	263
KFEX	Augsbrug Seminary,	Minneapolis, Minn.	261
KFEY	Bunker Hill & Sullivan Mining and Concentrating Co.	Kellogg, Idaho	360
KFEZ	American Society of Mechanical Engineers	St. Louis, Mo.	360
KFFA	Dr. R. O. Shelton	San Diego, Cal.	242
KFFB	Jenkins Furniture Co.	Boise, Idaho	240
KFFC	Eastern Oregon Radio Co.,	Pendleton, Ore.	
KFFD	Dr. E. H. Smith	Hillsboro, Ore.	229
KFFP	First Baptist Church	Moberly, Mo.	275
KFFQ	Marksheffel Motor Co.,	Colorado Springs, Colo.	360
KFFR	Nevada State Journal (Jim Kirk),	Sparks, Nev.	360
KFFV	Graceland College	Lamoni, Iowa	360
KFFX	McGraw Co.	Omaha, Neb.	278
KFFY	Pincus & Murphey	Alexandria, La.	375
KFFZ	Al. G. Barnes Amusement Co. (Portable)	Dallas, Texas	226
KFGC	Louisiana State University,	Baton Rouge, La.	254
KFGD	Chickasha Radio & Electric Co.,	Chickasha, Okla.	248
KFGH	Leland Stanford University,	Stanford University, Cal.	
KFGJ	Missouri National Guard, 138th Infantry	St. Louis, Mo.	266
KFGL	Arlington Garage	Arlington, Ore.	234
KFGP	Cheney Radio Co.	Cheney, Kan.	229
KFGQ	Cray Hardware Co.	Boone, Iowa	226
KFGV	Heidreder Radio Supply Co.,	Utica, Neb.	224
KFGX	First Presbyterian Church,	Orange, Tex.	250
KFGY	Gjelhaug's Radio Shop,	Baudette, Minn.	224
KFGZ	Emmanuel Missionary College,	Berrion Springs, Mich.	268
KFHA	Colorado State Normal School,	Gunnison, Colo.	360
KFHB	Rialto Theater	Hood River, Ore.	280
KFHD	Utz Electric Shop Co.	St. Joseph, Mo.	226
KFHF	Central Christian Church,	Shreveport, La.	266

(Continued on page 590)



A SIX MONTHS' SUBSCRIPTION For Only **25c**

(This is 1/2 the regular price)

## An Army of Boys

more than 400,000 strong are regular readers of THE BOYS' MAGAZINE. This army is gaining recruits every day because this splendidly illustrated magazine contains just the sort of reading every red blooded American boy wants. The very best stories, both serial and short, by the world's best writers. Special departments devoted to Radio, Mechanics, Electricity, Athletics, Physical Training, Stamp Collecting, Amateur Photography, Cartooning, etc., etc. Beautiful big pages with handsome covers in colors. A big lot of jokes and comic drawings.

We give away \$132.00 in Cash Prizes for the best amateur short stories, drawings, cartoons, articles or radio, mechanics, electricity, etc. There is no reason why your boy should not win some of these Cash Prizes. These Prize Contests are continuous and each issue of THE BOYS' MAGAZINE gives full particulars regarding them.

Just think of it! A SIX MONTHS' subscription for only 25 CENTS. Surely you would like to invest this small amount in giving your boy, or boy friend, six solid months of pleasure, entertainment and instruction.

Remit in stamps if more convenient.

(On sale at all newsstands 10c a copy.)

THE SCOTT F. REDFIELD CO., INC.,  
7228 Main St., Smethport, Pa.

I enclose 25 cents for a six months' subscription to THE BOYS' MAGAZINE as per your special half price offer. Enter my subscription promptly and send me my first copy of THE BOYS' MAGAZINE by return mail.

You agree to return my 25 cents at once should I not be more than pleased with THE BOYS' MAGAZINE.

My Name is .....

My Address is .....

(Please write plainly)

### 30 X 3 1/2 CORD NEW TIRE PRICE

**\$2.00**

**GUARANTEED 8 MONTHS AT HALF PRICE**

These are Goodrich, Goodyear, Firestone, Fisk and other best known standard make tires. All slightly used, but readily give our customers thousands of miles of splendid service.

LOWEST TIRE PRICES IN AMERICA			
Tires	New	Tires	New
	Price		Price
30x3	\$1.90	32x4	\$3.75
30x3 1/2	2.00	32x4 1/2	3.75
32x3 1/2	2.50	34x4	4.00
31x4	2.75	35x4	4.25
32x4	3.00	35x4 1/2	4.25
33x4	3.25	35x5	4.25
34x4	3.50	37x5	4.25

SEND ONLY \$1.00 for each tire shipped. Balance C.O.D. Express shipment to seat section unwrapped for inspection. Tires guaranteed eight months. Another tire given at half price for any not perfectly satisfactory. Dealers and Agents wanted everywhere. WRITE-RUSH ORDERS.

**ROSE TIRE CORPORATION**  
Dept. 1302 1526 S. WABASH AVE., CHICAGO, ILL.



# Build Your Own Radio Apparatus

As Easily as a Woman Makes a Dress!

## "CONSOLIDATED" PATTERNS

are designed by the foremost radio engineers and by our novel method of construction anyone can easily make efficient apparatus to receive all wave lengths. All Patterns are Full Size, printed on heavy Blue-Print paper and put up in attractive packet of heavy manila, 9x12". Each one is fully illustrated by photographs.

Every packet contains complete instructions for the construction of these circuits including the tools required, parts needed, directions and pattern for drilling, mounting and wiring and most important of all, full instruction on how to tune the circuit. Sets constructed from these plans have been thoroughly tested and pronounced perfect.



### How to Make a Cockaday Receiver

The Cockaday four-circuit tuner is one of the latest advancements in radio. Its main advantage lies in the fact that the set can be adjusted to the highest point of regeneration, and tuning accomplished over a wide band of wave-lengths without the necessity for readjusting the regeneration control. The set described in our folder was designed and built at our own shop. All dimensions, size of wire, number of turns, etc., are given, leaving nothing to the imagination.

50c.

### How to Make a Reflex Receiver

The plans for the reflex receiver were gotten out only after considerable research work by our engineers. Most people have trouble with reflex receivers. It takes an expert to build one that will work satisfactorily. The trouble lies in the values of condensers, etc., in the circuits. If they are incorrect, the set is a dismal failure. The constructional details of a reflex receiver, contained in this folder, are the results of their successful efforts.

50c.



### How to Make a Reinartz Receiver

The original Reinartz Receiver is the most popular type of set in existence today. It gained its popularity through its simplicity of operation and capability of long-distance reception. Full directions for building this receiver are given in this folder. The construction of the coil—the most difficult part—is made easy with the concise instructions we furnish. The connections of the set are shown plainly, so that the novice will have no trouble in following them.

50c.

### Twenty Radio Phone Diagrams and Hook-Ups With Supplements of Latest Hook-Ups

These diagrams show how to get the best possible efficiency from the instruments you make or purchase. They cover hook-ups from the simplest to the most complicated, in a way that any amateur can understand and follow without difficulty. Printed on heavy paper, 8 1/2 x 11 1/2 inches, and together with KEY CHART OF SYMBOLS and pamphlet "HOW TO READ DIAGRAMS", are contained in a heavy two-color envelope.

50c.



### All About Aerials and Their Construction

These blue prints were made after practical erection of each aerial, and point out how simple it is to erect not only the proper aerial for your particular need, but how to erect this aerial in the most practical manner and at the least expense.

Consists of 12 blue prints 8 1/2 x 11 inches and one four-page instruction pamphlet 8 1/2 x 11 inches.

50c.

### 14 Radio Formulae and Diagrams

With this packet of radio knowledge you need never worry about schematic wiring diagrams, measurements and radio tables. All formulae and diagrams are printed on heavy paper in black and blue; and contained in two-color printed envelope, 9x12 inches.

50c.

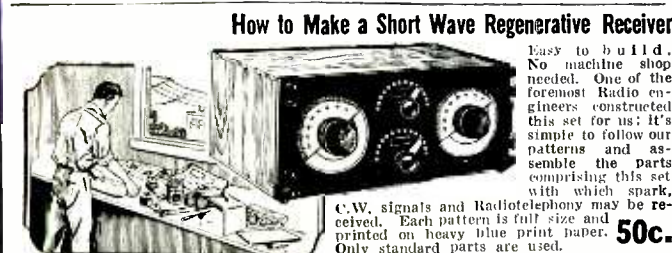

### How to Make a Short Wave Regenerative Receiver

Easy to build. No machine shop needed. One of the foremost Radio engineers constructed this set for us. It's simple to follow our patterns and assemble the parts comprising this set with which spark, C.W. signals and Radiotelephony may be received. Each pattern is full size and printed on heavy blue print paper. Only standard parts are used.

50c.

### How to Make Detector and Amplifier Units

Can be built anywhere in your house; no machine shop needed. May be used with any type of Regenerative Receiver or short wave set, with which spark, C.W. Signals and Radiotelephony may be received. We've tested these patterns by actually building the outfit—they're perfect! Only standard parts used in making the outfit.

50c.



Order from dealers whose names appear on page 614

If your dealer cannot supply you, order from us, giving his name and address

**The Consrad Co.**  
INC.  
Formerly The Consolidated Radio Call Book Co.

233 Fulton Street, New York City

Publishers of Consolidated Patterns and Sales Agents for E. I. Co. Books





# HIGH SCHOOL COURSE IN TWO YEARS

## You Want to Earn Big Money!

And you will not be satisfied unless you earn steady promotion. But are you prepared for the job ahead of you? Do you measure up to the standard that insures success? For a more responsible position a fairly good education is necessary. To write a sensible business letter, to prepare estimates, to figure cost and to compute interest, you must have a certain amount of preparation. All this you must be able to do before you will earn promotion.

Many business houses hire no men whose general knowledge is not equal to a high school course. Why? Because big business refuses to burden itself with men who are barred from promotion by the lack of elementary education.

## Can You Qualify for a Better Position?

We have a plan whereby you can. We can give you a complete but simplified high school course in two years, giving you all the essentials that form the foundation of practical business. It will prepare you to hold your own where competition is keen and exacting. Do not doubt your ability, but make up your mind to it and you will soon have the requirements that will bring you success and big money. **YOU CAN DO IT.**

Let us show you how to get on the road to success. It will not cost you a single working hour. It costs you nothing but a stamp.

### American School

Dept. H.726 Drexel Ave. & 58th St., Chicago

### American School

Dept. H.726 Drexel Ave. and 58th St., Chicago  
Send me full information on the subject checked and how you will help me win success.

- |                              |                            |
|------------------------------|----------------------------|
| .....Architect               | .....Lawyer                |
| .....Building Contractor     | .....Machine Shop Practice |
| .....Automobile Engineer     | .....Photoplay Writer      |
| .....Automobile Repairman    | .....Mechanical Engineer   |
| .....Civil Engineer          | .....Shop Superintendent   |
| .....Structural Engineer     | .....Employment Manager    |
| .....Business Manager        | .....Steam Engineer        |
| .....Cert. Public Accountant | .....Foremanship           |
| .....Accountant and Auditor  | .....Sanitary Engineer     |
| .....Bookkeeper              | .....Surveyor (& Mapping)  |
| .....Draftsman and Designer  | .....Telephone Engineer    |
| .....Electrical Engineer     | .....Telegraph Engineer    |
| .....Electric Light & Power  | .....High School Graduate  |
| .....General Education       | .....Fire Insurance Expert |
| .....Vocational Guidance     | .....Wireless Radio        |
| .....Business Law            | .....Undecided             |

Name.....

Address.....

## Radio Broadcast

(Continued from page 588)

Call	Name	City and State	Lengths	Wace
KFHH	Ambrose A. McCue,	Neah Bay, Wash.	283	
KFHI	Charles V. Dixon,	Wichita, Kan.	224	
KFHL	Fallon & Co.,	Santa Barbara, Cal.		
KFHL	Penn College	Oskaloosa, Iowa	227	
KFHP	Radio-Bug Products Co.,	Kearney, Neb.	246	
KFIIQ	Curtis Bros. Hardware Store (Alfred E. Fowler),	Los Gatos, Cal.	242	
KFIR	Star Electric & Radio Co.,	Seattle, Wash.	270	
KFIS	Clifford J. Dow,	Lihue, Hawaii	275	
KFHU	M. G. Sateren,	Mayville, N. D.	261	
KFHX	Robert W. Nelson,	Hutchinson, Kan.	229	
KFHY	R. S. McEwan,	Trinidad, Colo.	242	
KFI	Earle C. Anthony (Inc.),	Los Angeles, Cal.	469	
KFIB	Franklin W. Jenkins,	St. Louis, Mo.	244	
KFIC	Phillip Laskowitz,	Denver, Colo.	224	
KFID	Ross Arbuckle's Garage,	Iola, Kan.	246	
KFIT	Benson Polytechnic Institute,	Portland, Ore.	360	
KFII	Sidney I. Thoreau,	Platte, S. D.	236	
KFIR	Gladbrook Electrical Co.,	Gladbrook, Iowa	234	
KFIL	Windisch Electric Farm Equipment Co.,	Louisburg, Kan.	234	
KFIO	North Central High School,	Spokane, Wash.	252	
KFIQ	Yakima Valley Radio Broadcasting Association,	Yakima, Wash.	224	
KFIU	Alaska Electric Light & Power Co.,	Juneau, Alaska	226	
KFIV	V. H. Broyles,	Pittsburg, Kan.	240	
KFIX	Reorganized Church of Jesus Christ of Latter Day Saints,	Independence, Mo.	240	
KFJA	Central Power Co.,	Grand Island, Neb.	244	
KFJB	Marshall Electric Co.,	Marshalltown, Iowa	248	
KFJD	Weld County Printing & Publishing Co.,	Greeley, Colo.	236	
KFKA	Colorado State Teachers' College,	Greeley, Colo.	248	
KFKH	Denver Park & Amusement Co.,	Lakeside, Colo.	226	
KFLE	National Education Service,	Denver, Colo.	268	
KFZ	Doerr-Mitchell Electric Co.,	Spokane, Wash.	283	
KGB	William A. Mullins Electric Co.,	Tacoma, Wash.		
KGG	Hallock & Watson Radio Service,	Portland, Ore.		
KGM	Northwestern Radio Mfg. Co.,	Portland, Ore.		
KGO	Altadena Radio Laboratory,	Altadena, Cal.		
KGU	Marion A. Mulrony,	Honolulu, Hawaii		
KGW	Portland Morning Oregonian,	Portland, Ore.	492	
KGY	St. Martins College,	Lacey, Wash.	258	
KHJ	Times-Mirror Co.,	Los Angeles, Cal.	395	
KHQ	Louis Wasmer,	Seattle, Wash.		
KIQ	C. O. Gould,	Stockton, Cal.		
KJR	Northwest Radio Service Co.,	Seattle, Wash.	270	
KJS	Bible Institute of Los Angeles,	Los Angeles, Cal.		
KLN	Monterey Electric Shop,	Monterey, Cal.	261	
KLS	Warner Bros.,	Oakland, Cal.		
KLX	Tribune Pub. Co. (Oakland Tribune),	Oakland, Cal.		
KLZ	Reynolds Radio Co.,	Denver, Colo.	360	
KMC	W. W. Lindsay, Jr.,	Reedley, Cal.		
KNJ	San Joaquin Light & Power Corp.,	Fresno, Cal.		
KMO	Love Electric Co.,	Tacoma, Wash.		
KNJ	Roswell Public Service Co.,	Roswell, N. M.		
KN1	Grays Harbor Radio Co.,	Aberdeen, Wash.	263	
KNV	Radio Supply Co.,	Los Angeles, Cal.		
KNX	Electric Lighting Supply Co.,	Los Angeles, Cal.		
KOB	New Mexico College of Agriculture and Mechanic Arts,	State College, N. M.		
KOP	Detroit Police Department,	Detroit, Mich.	286	
KPO	Hale Bros.,	San Francisco, Cal.	423	
KQI	University of California,	Berkeley, Cal.		
KQI'	Apple City Radio Club,	Hood River, Ore.	360	
KQV	Doubleday-Hill Electric Co.,	Pittsburgh, Pa.		
KQW	Charles D. Herrold,	San Jose, Cal.		
KRE	Berkeley Daily Gazette,	Berkeley, Cal.	278	
KSD	Post Dispatch,	St. Louis, Mo.	546	
KSS	Prest & Dean Radio Co. and Radio Research Society of Long Beach,	Long Beach, Cal.		

# A Better Job Now!

Why take small pay from uncertain jobs? Why be buffeted around from this to that, not knowing whether you will have a job tomorrow or not? You can change all that. Learn the auto repair business. Have a job at good pay wherever you go. Later have an independent business of your own. If you are mechanically inclined, a few weeks training at Detroit can start you to real success.

## BE A TRAINED MAN—SUCCESSFUL!

Over 13 million autos need constant service. 50 million tires, millions of batteries, electrical systems to be kept going. Welding to be done. There are amazing opportunities for men who start now. Fit yourself to win one of the good jobs or to start a business of your own.

## COME TO THE AUTO CENTER

Get first-hand knowledge and training (by factory-approved methods) at the Michigan State Automobile School. Hudson says: "Best school in America." Other auto leaders say the same. Learn on latest equipment, under expert instructors.



Act at once. Grasp this opportunity. Find out what we can do for you. Write today for School Catalog and personal letter for answering your questions.

A. G. Zeller  
President

Michigan State Automobile School  
Box 670, 3729 Woodward Avenue, Detroit, Michigan

## Get the FACTS—Write TODAY

## You, Too, Can Play the HAWAIIAN GUITAR Just as the Natives Do—

### After Your First LESSON You Will Play "ALOHA". We Guarantee That—

Our method is so simple, interesting and appealing that you begin in your first lesson to learn the famous Hawaiian Folk Song "ALOHA". Think how happy you will be when you surprise your friends by playing the fascinating Hawaiian Guitar just as the natives do!

### Only Four Motions— and You Master Them Quickly!

In a few minutes you acquire the four motions necessary to play any piece—after that a short period of practice and you will have mastered this widely-sweet music. Complete course of 52 lessons includes FREE beautiful Hawaiian Guitar, necessary picks, steel bar, etc. No extras.

No Previous Musical Knowledge Necessary  
If you never read a musical note in your life—if you have not even the slightest knowledge of music, we can quickly and positively teach you to play this wonderfully popular instrument. Don't be just a "listener"—when you can easily be the center of interest among your friends.

Just Mail a Post Card for Details  
of our remarkable FREE Hawaiian Guitar Offer— simply write: "I am interested"—but do it today!

Address  
First Hawaiian Conservatory  
of Music, Inc.  
Desk 10—233 B'way  
(Woolworth Bldg.)  
New York City

**FREE**  
A Beautiful  
Hawaiian  
Guitar

## "ELECTRO-CONDITE"

### STARTLES THE WORLD

Thousands of people are marveling at the wonderful performance of the "Electro-Condite" Converter. Clarifies, purifies, sterilizes, matures and mellows most kinds of beverages. Makes hard water soft, etc. May prevent poisoning.

Send \$5.00 for device with 5 days trial money-back guarantee or ask for circular.

Best grade Proof Hydrometers, \$1.00 each prepaid.

A-B-C LABORATORIES, INC.  
Dept. X., 100 Lawrence St.,  
(W. 126th St.) New York



## SEND FOR THE INTERNATIONAL CATALOG



Our net price list. Full line of auto bodies and accessories for Parts at Wholesale Prices. Save big money on bodies by buying Direct from Factory.

FOR FORD—Prices from \$27.85 up. Factory to consumer direct. Pay only One Profit!

International Body Works, 914 W. Ohio St., Dept. 4, Chicago, Ill.



## OLD FIELD NATURES Own Cured

TOBACCO gives more enjoyment. No bite or sting Direct from Grower. Sample 10cents

Hast Mailing Co. Paducah, Ky



Call	Name	City and State	Watts
KTW	First Presbyterian Church.	Seattle, Wash.	
KUO	Examiner Printing Co. (San Francisco Examiner).	San Francisco, Cal.	360
KUS	City Dye Works & Laundry Co.	Los Angeles, Cal.	
KUY	Coast Radio Co.	El Monte, Cal.	
KWG	Portable Wireless Telephone Co.	Stockton, Cal.	
KWH	Los Angeles Examiner.	Los Angeles, Cal.	360
KXD	Modesto Herald Publishing Co.	Modesto, Cal.	
KYO	Electric Shop	Honolulu, Hawaii	
KYW	Westinghouse Electric & Manufacturing Co.	Chicago, Ill.	345
KZM	Preston D. Allen	Oakland, Cal.	
KZN	The Deseret News.	Salt Lake City, Utah	360
KZV	Wenatchee Battery & Motor Co.	Wenatchee, Wash.	
WAAB	Valdemar Jensen	New Orleans, La.	268
WAAC	Tulane University	New Orleans, La.	
WAAD	Ohio Mechanics Institute.	Cincinnati, Ohio	
WAAF	Chicago Daily Drovers Journal.	Chicago, Ill.	
WAAG	Commonwealth Electric Co.	St. Paul, Minn.	
WAAM	Gimbel Bros.	Milwaukee, Wis.	280
WAAN	I. R. Nelson Co.	Newark, N. J.	263
WAAP	University of Missouri.	Columbia, Mo.	254
WAAR	United Electric Co.	Wichita, Kan.	
WAAS	Omaha Grain Exchange.	Omaha, Neb.	360
WAAT	Hollister-Miller Motor Co.	Emporia, Kan.	
WABA	Lake Forest College	Lake Forest, Ill.	266
WABB	Dr. John B. Lawrence.	Harrisburg, Pa.	266
WABC	Fulwider-Grimes Battery Co.	Anderson, Ind.	229
WABD	Parker High School	Dayton, Ohio	283
WABE	Young Men's Christian Association.	Washington, D. C.	283
WABF	Mount Vernon Register-News Co.	Mount Vernon, Ill.	234
WABG	Arnold Edwards Piano Co.	Jacksonville, Fla.	248
WABH	Lake Shore Tire Co.	Sandusky, Ohio	240
WABI	Bangor Railway & Electric Co.	Bangor, Me.	240
WABJ	The Radio Laboratories.	South Bend, Ind.	240
WABK	First Baptist Church.	Worcester, Mass.	252
WABL	Connecticut Agricultural College.	Storrs, Conn.	283
WABM	F. E. Doherty Automotive & Radio Supply Co.	Saginaw, Mich.	254
WABN	Waldo C. Grover	La Crosse, Wis.	234
WABO	Lake Avenue Baptist Church.	Rochester, N. Y.	252
WBAA	Purdue University.	West Lafayette, Ind.	
WBAD	Sterling Electric Co.	Minneapolis, Minn.	
WBAF	Fred M. Middleton.	Moorestown, N. J.	
WBAG	The Dayton Co.	Minneapolis, Minn.	
WBAN	Wireless Phone Corp.	Paterson, N. J.	244
WBAO	James Millikin University.	Decatur, Ill.	
WBAP	Wortham-Carter Publishing Co. (Star Telegram).	Fort Worth, Tex.	476
WBAU	Republican Publishing Co.	Hamilton, Ohio	258
WBAV	Erner & Hopkins Co.	Columbus, Ohio	390
WBAW	Marietta College	Marietta, Ohio	246
WBAX	John H. Stenger, Jr.	Wilkes-Barre, Pa.	
WBAY	American Telephone & Telegraph Co.	New York, N. Y.	492
WBBA	Newark Radio Laboratories.	Newark, Ohio	240
WBBC	Sterling Radio Equipment Co.	Sterling, Ill.	229
WBBD	Barbey Battery Service.	Reading, Pa.	234
WBL	T & H Radio Co.	Anthony, Kan.	261
WBS	D. W. May (Inc.)	Newark, N. J.	
WBT	Southern Radio Corporation.	Charlotte, N. C.	360
WBU	City of Chicago	Chicago, Ill.	286
WBZ	Westinghouse Electric & Manufacturing Co.	Springfield, Mass.	337
WCAD	St. Lawrence University.	Canton, N. Y.	280
WCAE	Kaufmann & Baer Co.	Pittsburgh, Pa.	462
WCAG	Clyde R. Randall	New Orleans, La.	268
WCAH	Entrekin Electric Co.	Columbus, Ohio	286
WCAJ	Nebraska Wesleyan University.	University Place, Neb.	
WCAK	Alfred P. Daniel	Houston, Tex.	
WCAL	St. Olaf College	Northfield, Minn.	
WCAM	Villanova College	Villanova, Pa.	
WCAO	Sanders & Stayman Co.	Baltimore, Md.	
WCAP	Chesapeake & Potomac Telephone Co.	Washington, D. C.	469
WCAR	Alamo Radio Electric Co.	San Antonio, Tex.	



THE compact, convenient and complete Portable Typewriter. Sold by over 3,000 dealers and Remington branches everywhere. Easy payment terms if desired. Send for our illustrated "For You—For Everybody." Address Department 14

**REMINGTON TYPEWRITER COMPANY**  
 374 Broadway, New York      Branches Everywhere

We believe we make the best typewriter ribbon in the world—and its name is PARAGON



**10,000 TIRES GUARANTEED FOR 8 MONTHS**

These are Goodrich, Goodyear, Firestone, Fisk and other best known standard make tires. All slightly used, but readily give our customers thousands of miles of splendid service.

**30x3 1/2 \$2.00**  
ANY OTHER SIZE \$2.95

The greatest tire values ever offered. Thousands of satisfied customers.

**Beat These Prices**

You could never even equal these prices. Send only \$1.00 for each tire shipped. Balance C. O. D. Express shipments sent subject to inspection. Tires guaranteed eight months. Another tire given at half price for any not perfectly satisfactory. 10% discount when ordered in lots of 12 or more.

UNITED FINANCING SYNDICATE Dept. J629  
1526 South Wabash Avenue CHICAGO, ILL.

**WHY SAW BY HAND ?**

When you can do it quicker, easier and better with this low-cost precision machine.



**Boice Pony Bench Machine**

Combines in one machine, a saw, sander, drill, grinder, polisher and buffer. Handles wood, fibre, bakelite, brass, copper, aluminum, carbon, asbestos, etc. Uses 1/2" and 3/4" saws, 6" and 8" sand discs, polishing and buffing wheels and scratch brushes, 3/4" drill chuck. Easily driven with 1/4 to 1/3 H.P. motor or from line shaft. Top 10"x12" easily removed or elevated for propping. Saws 1 1/2" stock. All metal construction. Efficient, practical, economical in large or small shops. Sold with Money-Back Guarantee.

Write today for literature on this and other Boice-Built Bench Machines and Motors.  
**W. & J. BOICE Dept. S. I. 10 Toledo, Ohio**



You've heard your neighbor praise the Pathfinder, the wonderful weekly news and story magazine with over half a million subscribers. Unbiased digest of national and world affairs. Check full of just the kind of reading you want. Fun, fashions, question box, books, health-entertainment and instruction for all. Exciting serial and short stories. Send 15c (coin or stamps) today for this big \$1 paper 13 weeks. Money back if not satisfied. Sample copies free. **PATHFINDER, 555 Langdon Sta., Washington, D. C.**

**Electrical Engineering**

men with training are in demand. For more than a quarter of a century this school has been training men of ambition and limited time for the electrical industries. Condensed course in Electrical Engineering enables graduates to secure good positions and promotions. Theoretical and Practical Electricity, Mathematics, Steam and Gas Engines and Mechanical Drawing, students construct dynamo, install wiring and test electrical machinery. Course with diploma complete.

**In One Year**  
Over 3000 men trained. Thoroughly equipped fireproof dormitories, dining hall, laboratories, shops.  
Free catalog. 31st year begins Sept. 26, 1923.  
**BLISS ELECTRICAL SCHOOL**  
106 TAKOMA AVE., WASHINGTON, D. C.



**LATHES**

9 to 18-inch Swing  
List price \$135.00 and up, according to size. When ready to buy, send for Lathe Catalog and prices.

**W. F. & John Barnes Co.**  
412 Ruby Street  
**ROCKFORD, ILLINOIS**



**Sell Shirts**

Sell Madison "Better-Made" Shirts, Pajamas, and Nightshirts direct from our factory to wearer. Nationally advertised. Easy to sell. Exclusive patterns. Exceptional values. No experience or capital required. Large steady income assured. Entirely new proposition.  
**WRITE FOR FREE SAMPLES.**  
**MADISON SHIRT CO., 502 B'way, N.Y. City**

Call	Name	City and State	Wave Lengths
WCAS	William Hood Dunwoody Industrial Institute	Minneapolis, Minn.	
WCAT	South Dakota State School of Mines	Rapid City, S. D.	240
WCAU	Durham & Co.	Philadelphia, Pa.	286
WCAV	J. C. Dice Electric Co.	Little Rock, Ark.	
WCAX	University of Vermont	Burlington, Vt.	
WCAY	Kesselman O'Driscoll Co.	Milwaukee, Wis.	261
WCAZ	Robert E. Compton & Carthage College	Carthage, Ill.	
WCBA	Charles W. Heimbach	1015 Allen St., Allentown, Pa.	280
WCBB	K & K Radio Supply Co. (Charles W. Katzenberger)	Greenville, Ohio	240
WCBD	Wilbur G. Voliva	Zion, Ill.	345
WCE	Findley Electric Co.	Minneapolis, Minn.	
WCK	Stix-Baer & Fuller Dry Goods Co.	St. Louis, Mo.	
WCM	University of Texas	Austin, Tex.	
WCN	Clark University	Worcester, Mass.	360
WCX	Detroit Free Press	Detroit, Mich.	517
WDAD	Central Kansas Radio Supply	Lindsburg, Kan.	
WDAE	Tampa Daily Times	Tampa, Fla.	360
WDAP	Kansas City Star	Kansas City, Mo.	411
WDAG	J. Laurance Martin	Amarillo, Tex.	
WDAH	Trinity Methodist Church (South)	El Paso, Tex.	
WDAI	Hughes Radio Corporation	Syracuse, N. Y.	246
WDAJ	Atlanta & West Point R. R. Co.	College Park, Ga.	360
WDAK	The Courant	Hartford, Conn.	261
WDAL	Florida Times-Union	Jacksonville, Fla.	360
WDAO	Automotive Electric Co.	Dallas, Tex.	
WDAP	Board of Trade	Chicago, Ill.	360
WDAR	Lit Bros.	Philadelphia, Pa.	395
WDAS	Samuel A. Waite	Worcester, Mass.	
WDAU	Slocum & Kilburn	New Bedford, Mass.	
WDAX	First National Bank	Centerville, Iowa	
WDAY	Fargo Radio Service Co. (K. M. Hance)	Fargo, N. D.	244
WDBC	Kirk, Johnson & Co.	Lancaster, Pa.	258
WDBF	Robert G. Phillips	Youngstown, Ohio	261
WDM	Church of the Covenant	Washington, D. C.	
WDT	Ship Owners Radio Service	Stapleton, N. Y.	405
WDZ	James L. Bush	Tuscola, Ill.	278
WEAA	Tallain & Lathrop	Flint, Mich.	280
WEAB	Standard Radio Equipment Co.	Fort Dodge, Iowa	360
WEAD	Henry Radio and Electrical Supply Co.	Atwood, Kan.	268
WEAF	Western Electric Co.	New York, N. Y.	492
WEAG	Nichols-Hineline-Bassett Laboratory	Edgewood, R. I.	231
WEAH	Wichita Board of Trade and Lander Radio Co.	Wichita, Kan.	
WEAI	Cornell University	Ithaca, N. Y.	286
WEAJ	University of South Dakota	Vermilion, S. D.	
WEAK	Julius B. Abercrombie	St. Joseph, Mo.	
WEAM	Borough of North Plainfield	North Plainfield, N. J.	250
WEAN	Shepard Co.	Providence, R. I.	273
WEAO	Ohio State University	Columbus, Ohio	360
WEAP	Mobile Radio Co.	Mobile, Ala.	
WEAR	Baltimore American & News Publishing Co.	Baltimore, Md.	
WEAS	Hecht Co.	Washington, D. C.	
WEAU	Davidson Bros. Co.	Sioux City, Iowa	360
WEAY	Iris Theatre (Will Horowitz, Jr.)	Houston, Tex.	
WEB	Benwood Co.	St. Louis, Mo.	
WEV	Hurlburt-Still Electrical Co.	Houston, Tex.	360
WEW	St. Louis University	St. Louis, Mo.	261
WFAA	Dallas News and Dallas Journal	Dallas, Tex.	476
WFAB	Carl F. Woese	Syracuse, N. Y.	234
WFAF	H. C. Spratley Radio Co.	Poughkeepsie, N. Y.	
WFAG	Radio Engineering Laboratory	Waterford, N. Y.	
WFAH	Electric Supply Co.	Port Arthur, Tex.	
WFAJ	Hi-Grade Wireless Instrument Co.	Asheville, N. C.	
WFAM	Times Publishing Co.	St. Cloud, Minn.	
WFAN	Hutchinson Electric Service Co.	Hutchinson, Minn.	360
WFAQ	Missouri Wesleyan College and Cameron Radio Co.	Cameron, Mo.	
WFAT	Daily Argus-Leader	Sioux Falls, S. D.	360
WFAV	University of Nebraska	Lincoln, Neb.	360
WFI	Strawbridge & Clothier	Philadelphia, Pa.	395
WGAL	Lancaster Electric Supply & Construction Co.	Lancaster, Pa.	248
WGAN	Cecil E. Lloyd	Pensacola, Fla.	
WGAQ	Glenwood Radio Corporation (W. G. Patterson)	Shreveport, La.	

**NUMERICAL RELATIONS BETWEEN LETTERS OF THE ALPHABET**

By H. O. Bernstrom

THE purpose which an article of this sort, based on the numerical relations of the letters used in the English language, can serve is not necessarily confined within narrow limits.

The first column of the table presented, gives the letters in their descending order of importance in numerical terms for letters used in words. It is seen that while "e" is used 154.3 times, "t" is used 140 times, etc.

The second column gives the order of the letters occurring as first letters of words. The number of words from which these relations were derived, was about 140,000, representing the words in the English dictionary. The numerical relation is transformed to a basis equal to a unit of the first column, so that it can be observed that "S" is used 201 times (see second column) as the first letter of a word when it is used as a letter in a word 91.3 times (see first column), or when X is used 1.5 times (see second column), as the first letter in a word.

The letters in the third column illustrate their order of occurrence as first letters of proper nouns. The source for this comprised catalogs and directories, including about 440,000 proper nouns. Similar observations, as described before can now be obtained with the use of all three columns. For instance: "S" is used as a first letter in proper nouns 169.2 times when it is used 201 times as a first letter in a word. It may appear now, in order to get the representative numerical relation, that these three columns should be combined and the numerical relation be thus obtained. This is not the case, because column one gives the order of importance of the letters as used in words, whether as first letters in proper nouns or otherwise.

**TABLE OF NUMERICAL OCCURRENCE OF LETTERS OF THE ALPHABET IN THE ENGLISH LANGUAGE**

IN WORDS	AS FIRST LETTER	AS FIRST LETTER IN PROPER NOUNS	ORDER GIVEN BY POE
Letter No.	Letter	No.	Letter
e 154.3	S 201.0	S 169.2	e
t 140.0	C 165.0	M 148.3	t
o 108.3	P 142.0	B 129.16	o
a 100.00	A 108.0	C 98.3	a
i 99.00	D 99.5	H 95.0	i
s 91.3	T 94.0	G 87.5	s
n 85.0	M 90.0	R 84.2	n
r 82.6	B 81.5	W 82.5	r
h 64.6	R 80.0	L 80.0	h
l 44.0	F 72.5	F 70.5	l
u 38.6	E 71.0	K 69.2	u
d 38.0	I 70.0	P 64.16	d
c 37.6	H 61.0	A 62.5	c
w 30.3	L 57.5	D 59.16	w
f 26.3	G 55.0	N 41.6	f
p 25.3	W 49.5	T 40.0	p
m 23.0	O 40.0	E 37.5	m
g 23.0	V 30.0	J 24.16	g
y 19.6	U 29.5	O 21.6	y
b 19.0	N 27.5	V 15.8	b
v 10.3	K 12.5	I 14.16	v
k 6.7	J 12.5	U 10.0	k
x 3.3	O 10.0	Z 9.2	x
j 0.7	Y 5.5	V 5.8	j
z 0.7	Z 4.5	O 3.3	z
q 0.7	X 1.5	X 0.3	q

Poe's order in his "The Gold Bug," as a matter of interesting comparison, is given in the fourth column. He did not give complete numerical relations and he also omitted the letters "v" and "j", which have been added on to his list in the order of their importance as determined in this investigation.

In concluding, it is evident that the first column represents the numerical order of importance of the letters of the English language in words, and if a bold spirit were to initiate the idea of an alphabetical re-arrangement, we would refer to our A B C's as our E T O's.



Call	Name	City and State	Wave Lengths
WGAR	Southwest American	Fort Smith, Ark.	360
WGAU	Radio Mfg. and Service Co. (Marcus G. Lumb)	Wooster, Ohio	226
WGAW	Ernest C. Albright	Altoona, Pa.	261
WGAX	Radio Electric Co.	Washington Court House, Ohio	
WGAY	Northwestern Radio Co.	Madison, Wis.	
WGAZ	South Bend Tribune	South Bend, Ind.	
WGF	The Register and Tribune	Des Moines, Iowa	360
WGI	American Radio & Research Corp.	Melford Hillside, Mass.	
WGL	Thomas F. J. Howlett	Philadelphia, Pa.	
WGM	Atlanta Constitution	Atlanta, Ga.	
WGR	Federal Telephone & Telegraph Co.	Buffalo, N. Y.	
WGV	Interstate Electric Co.	New Orleans, La.	360
WGY	General Electric Co.	Schenectady, N. Y.	380
WHIA	University of Wisconsin	Madison, Wis.	360
WHAA	State University of Iowa	Iowa City, Iowa	283
WHAB	Clark W. Thompson	Galveston, Tex.	
WHAC	Cole Bros. Electric Co.	Waterloo, Iowa	
WHAD	Marquette University	Milwaukee, Wis.	280
WHAG	University of Cincinnati	Cincinnati, Ohio	222
WHAH	Hafer Supply Co.	Joplin, Mo.	
WHAJ	Radio Equipment & Manufacturing Co.	Davenport, Iowa	
WHAJ	Robert Hardware Co.	Clarksburg, W. Va.	
WHAL	Lansing Capital News	Lansing, Mich.	248
WHAM	University of Rochester (Eastman School of Music)	Rochester, N. Y.	360
WHAO	Frederic A. Hill	Savannah, Ga.	
WHAP	Otta & Kubns	Decatur, Ill.	
WHAQ	Semmes Motor Co.	Washington D. C.	
WHAR	Paramount Radio & Electric Co. (W. H. A. Paulus)	Atlantic City, N. J.	
WHAS	Courier-Journal and Louisville Times	Louisville, Ky.	400
WHAV	Wilmington Electrical Specialty Co.	Wilmington, Del.	
WHAY	Huntington Press	Huntington, Ind.	380
WHAZ	Rensselaer Polytechnic Institute	Troy, N. Y.	
WHB	Sweeney School Co.	Kansas City, Mo.	411
WHC	West Virginia University	Morgantown, W. Va.	
WHK	Radiovox Co. (Warren R. Cox)	Cleveland, Ohio	
WHN	Ridgewood Times Printing & Publishing Co.	Ridgewood, N. Y.	360
WTAB	Joslyn Automobile Co.	Rockford, Ill.	252
WTAC	Galveston Tribune	Galveston, Tex.	360
WIAD	Ocean City Yacht Club	Ocean City, N. J.	254
WIAP	Gustav A. DeCortin	New Orleans, La.	234
WIAH	Continental Radio & Manufacturing Co.	Newton, Iowa	
WIAT	Beer Stores Co.	Springfield, Mo.	360
WIAT	Fox River Valley Radio Supply Co. (Quinn Bros.)	Neeenah, Wis.	224
WIAK	Journal-Stockman Co.	Omaha, Neb.	278
WIAO	School of Engineering of Milwaukee and Milwaukee News	Milwaukee, Wis.	
WIAQ	Chronicle Publishing Co.	Marion, Ind.	
WIAR	Paducah Evening Sun	Paducah, Ky.	
WIAS	Home Electric Co.	Burlington, Iowa	
WIAT	Leon T. Noel	Tarkio, Mo.	
WIAT	American Trust & Savings Bank	Le Mars, Iowa	
WIAV	New York Radio Laboratories	Binghamton, N. Y.	
WIAW	Saginaw Radio & Electric Co.	Saginaw, Mich.	
WIAZ	Woodward & Lothrop	Washington, D. C.	360
WIK	K. & L. Electric Co.	McKeesport, Pa.	
WIL	Continental Electrical Supply Co.	Washington, D. C.	
WIP	Gimbel Bros.	Philadelphia, Pa.	509
WIZ	Cino Radio Manufacturing Co.	Cincinnati, Ohio	
WJAB	American Electric Co.	Lincoln, Neb.	
WJAD	Jackson's Radio Engineering Laboratories	Waco, Tex.	
WJAF	Press Publishing Co.	Muncie, Ind.	
WJAG	Norfolk Daily News	Norfolk, Neb.	360
WJAJ	Young Men's Christian Association	Dayton, Ohio	
WJAK	White Radio Laboratory	Stockdale, Ohio	360
WJAM	D. M. Perham	Cedar Rapids, Iowa	
WJAN	Peoria Star	Peoria, Ill.	280
WJAP	Kelley-Duluth Co.	Duluth, Minn.	
WJAO	Capper Publications	Topeka, Kan.	
WJAR	The Outlet Co.	Providence, R. I.	
WJAS	Pittsburgh Radio Supply House	Pittsburgh, Pa.	

# No Matter What Your Vocation

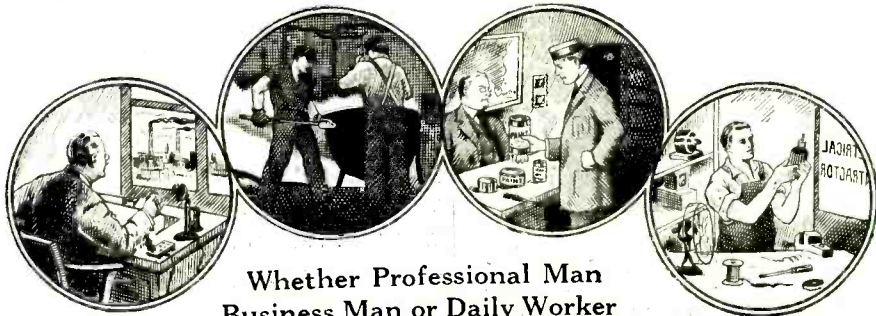

Whether Professional Man  
Business Man or Daily Worker

## A Thorough Training In CHEMISTRY Will Help You To Get Ahead

TO be successful today is to know Chemistry! Every line of business, every branch of industry depends upon Chemistry in some form. You may not realize it, but your own proficiency in whatever work you are doing would be increased by a knowledge of Chemistry. In many lines such knowledge is absolutely essential. In others it is a guarantee of promotion and more money.

The keen competition that exists in every commercial activity today requires that a man know all there is to know about his vocation. If you have something to sell—no matter what—Chemistry enters into its make-up. The salesman who knows the chemical composition of his article can talk about it more intelligently than the one who lacks this information, and his sales are proportionately larger. In the building trades Chemistry is of prime importance. The mason, electrician or painter who knows something about Chemistry can do better work and command more money than the one who does not. Through Chemistry a shop-keeper learns how to attract the most trade, and even in clerical positions one can capitalize his chemical skill.

Chemistry should be as much a part of your mental equipment as the ability to calculate or to write correct English. The world is paying a thousandfold more for ideas than for actual labor. The big rewards go to the man who can show how to turn out a little better product at a little lower cost. And Chemistry will give you the ideas that will save money for yourself or your firm in the very fundamentals of your business. There is nothing remarkable about this; it is going on every day. If you have not heard of it before, it is because the general public has been slow to recognize the tremendous value of chemical training. People have been content to leave Chemistry in the hands of a few trained chemists who could not possibly develop the subject to anywhere near its greatest extent.

Now we are on the eve of a great awakening. Our heritage from the World War has been an intense development of the chemical industries in the United States and a tremendous interest in all the applications of Chemistry. People are taking up the subject merely for the good it will do them in their own line of business.

It is no longer necessary to enter college in order to learn this fascinating science. Our Home Study Course trains you just as thoroughly, and with the same assurance of success, as those who took the longer way. And our methods are so simple that we can teach you no matter how little previous education you may have had. Many of our graduates now hold responsible positions or have materially increased their incomes from private enterprises as a result of taking our course. Hundreds of letters from students testifying to the benefits they have derived from our training are here for your inspection.

Remember that you do not need to study Chemistry with the idea of actually practicing as a chemist, although a great many of our students are taking our course with this object in view. If you want to know more about what Chemistry will do for you, if you want to know what our home study course offers, sign and mail the coupon today for FREE BOOK "Opportunities for Chemists."

### Chemical Institute of New York, Inc.

Home Extension Division 10

66-D West Broadway, New York City

DR. T. O'CONNOR SLOANE Will  
Teach You Chemistry In  
Your Own Home

The Chemical Institute of New York, of which Dr. T. O'Connor Sloane is Educational Director, was founded to fill the need of ambitious, far-sighted men who realize and recognize the splendid future Chemistry offers them, but who cannot spare either the time or the money to attend college. Dr. Sloane, a foremost authority on Chemistry, will teach you and will give you any individual help you may require. He will personally go over your papers, correct them, point out your faults, teaching you in a practical and interesting way. No special education required other than the ability to read and write English. One student has characterized our lessons as "The course that takes the mystery out of Chemistry."

Read What One of Our Recent  
Graduates Reports

"I thought I would let you know of my success. I finished your course about two months ago and now have a fine position as chemist at the DuPont Dye Works. I am getting along fine with my work and like it very much. It was through your course alone that I have been so successful. It is wonderful and I hope you have great success with it."  
(Name and Address on request).

### Easy Monthly Payments

You do not have to have even the small price of the course to start. You can pay for it in small monthly payments—so small that you won't feel them. The cost is very moderate, and includes everything, even the Laboratory Equipment—there are no extras to buy with our course. Our plan of monthly payments places a chemical education within the reach of everyone.

Laboratory Equipment Given  
To Every Student Without  
Additional Charge

We give to every student without additional charge his chemical equipment, including forty-two pieces of laboratory apparatus and supplies, and seventeen different chemicals and reagents. These comprise the apparatus and chemicals used for the experimental work of the course.

### Special 30-Day Offer

For a short period we are making a special offer that will be worth your while to take advantage of. Write for particulars, using the coupon below or simply a postal card. This will not obligate you in the least. Do not wait until to-morrow. Send the coupon now while you think of it.

Sign and Mail the Coupon for  
FREE BOOK

CHEMICAL INSTITUTE OF NEW YORK, Inc.

Home Extension Division 10.

66-D—West Broadway New York City.

Please send me at once without any obligation on my part, your Free Book "Opportunities for Chemists," and full particulars about the Laboratory Equipment furnished to every student. Also please tell me about your plan of payment and your special 30 day offer.

NAME .....

ADDRESS .....

CITY .....

STATE .....

S. & L. 10-23





### "Don't tell me you never had a chance!"

"Four years ago you and I worked at the same bench. I realized that to get ahead I needed special training, and decided to let the International Correspondence Schools help me. I wanted you to do the same, but you said, 'Aw, forget it!' You had the same chance I had, but you turned it down. No, Jim, you can't expect more money until you've trained yourself to handle bigger work."

There are lots of "Jims" in the world—in stores, factories, offices, everywhere. Are you one of them? Wake up! Every time you see an I. C. S. coupon your chance is staring you in the face. Don't turn it down.

Right now over 180,000 men and women are preparing themselves for bigger jobs and better pay through I. C. S. courses.

You can join them and get in line for promotion. Mark and mail this coupon, and find out how.

#### INTERNATIONAL CORRESPONDENCE SCHOOLS

Without cost or obligation on my part, please tell me how I can qualify for the position or in the subject before which I have marked an X:

##### BUSINESS TRAINING COURSES

- Business Management
- Industrial Management
- Personnel Organization
- Traffic Management
- Business Law
- Banking and Banking Law
- Accountancy (Including C.P.A.)
- Nicholson Cost Accounting
- Bookkeeping
- Private Secretary
- Business Spanish
- Salesmanship
- Advertising
- Better Letters
- Foreign Trade
- Stenography and Typing
- Business English
- Civil Service
- Railway Mail Clerk
- Common School Subjects
- High School Subjects
- Illustrating

##### TECHNICAL AND INDUSTRIAL COURSES

- Electrical Engineering
- Electric Lighting
- Mechanical Engineer
- Mechanical Draftsman
- Machine Shop Practices
- Railroad Positions
- Gas Engine Operating
- Civil Engineer
- Surveying and Mapping
- Metallurgy
- Steam Engineering
- Architecture
- Blueprint Reading
- Contractor and Builder
- Architectural Draftsman
- Concrete Builder
- Structural Engineer
- Chemistry
- Pharmacy
- Automobile Work
- Airplane Engines
- Agriculture and Poultry
- Mathematics

Name.....  
 Street.....  
 Address..... 3-27-23  
 City.....State.....

Occupation.....  
 Persons residing in Canada should send this coupon to the International Correspondence Schools Canadian, Limited, Montreal, Canada.

### \$4.00 ADDING MACHINE



The GILSON ADDER will do your figuring easily, quickly and with absolute accuracy. It adds, subtracts, multiplies and divides and automatically carries from one column to the next. Capacity 109,999,999 or \$1,099,999.99. Size 3 1/2" x 6" x 3/4". Made with aluminum case and steel operating parts. Written Two-Year Guarantee. Catalogue free.

Price, postpaid, \$4.00

Your money back if you are not satisfied.

GILSON SLIDE RULE CO., NILES, MICH.

### Selenium Cells

ENTIRELY IMPROVED

Porcelain base, Platinised wire permanent action up to 2000 per second instantly, 3-year guarantee. We manufacture selenium cells since 1905. We also manufacture a very small sensitive, quick acting polar relay.

Write for circular.

F. V. MADALER, Hampton Bays, L. I., N. Y.

Call	Name	City and State	Wave Lengths
WJAT	Kelly-Vawter Jewelry Co.,	Marshall, Mo.	
WJAX	Union Trust Co.....	Cleveland, Ohio	390
WJAZ	Chicago Radio Laboratory,	Chicago, Ill.	448
WJD	Richard H. Howe...Granville, Ohio	229	
WJH	White & Boyer Co.,	Washington, D. C.	263
WJX	De Forest Radio Telephone & Telegraph Co. ....	New York, N. Y.	
WJY	Radio Corporation of America,	New York, N. Y.	405
WJZ	Radio Corporation of America,	New York, N. Y.	455
WKAA	H. F. Paar.....	Cedar Rapids, Iowa	360
WKAC	Star Publishing Co.....	Lincoln, Neb.	275
WKAD	Charles Loeff (Crescent Park),	East Providence, R. I.	
WKAF	W. S. Radio Supply Co.,	Wichita Falls, Tex.	
WKAN	United Battery and Service Co.,	Montgomery, Ala.	226
WKAP	Dutee W. Flint.....	Cranston, R. I.	
WKAQ	Radio Corporation of Porto Rico,	San Juan, P. R.	
WKAR	Michigan Agriculture College,	East Lansing, Mich.	280
WKAS	L. E. Lines Music Co.,	Springfield, Mo.	
WKAU	Laconia Radio Club, Laconia, N. H.		
WKAW	Turner Cycle Co.....	Beloit, Wis.	242
WKAX	William A. McFarlane,	Bridgeport, Conn.	231
WKAY	Brenau College.....	Gainesville, Ga.	
WKC	Joseph M. Zamoiski Co.,	Baltimore, Md.	
WKY	WKY Radio Shop..	Oklahoma, Okla.	
WLAC	North Carolina State College,	Raleigh, N. C.	
WLAG	Cutting & Washington Radio Corp.,	Minneapolis, Minn.	417
WLAH	Samuel Woodworth..	Syracuse, N. Y.	360
WLAJ	Waco Electrical Supply Co.,	Waco, Tex.	360
WLAK	Vermont Farm Machine Corp.,	Bellows Falls, Vt.	
WLAL	Tulsa Radio Co. ....	Tulsa, Okla.	
WLAN	Putnam Hardware Co.....	Houlton, Me.	
WLAP	W. V. Jordan.....	Louisville, Ky.	
WLAQ	Arthur E. Schilling,	Kalamazoo, Mich.	
WLAT	Radio & Specialty Co.,	Burlington, Iowa	
WLAV	Electric Shop .....	Pensacola, Fla.	
WLAW	Police Dept., City of New York,	New York, N. Y.	
WLAX	Putnam Electric Co. (Greencastle Community Broadcasting Station),	Greencastle, Ind.	231
WLAY	Northern Commercial Co.,	Fairbanks, Alaska	
WLAZ	Hutton & Jones Electric Co.,	Warren, Ohio	248
WLB	University of Minnesota,	Minneapolis, Minn.	360
WLW	Crosley Manufacturing Co.,	Cincinnati, Ohio	309
WMAB	Radio Supply Co.....	Oklahoma, Okla.	
WMAC	J. E. Page (Olive B. Meredith),	Cazenovia, N. Y.	261
WMAD	Atchinson County Mail,	Rock Port, Mo.	
WMAF	Round Hills Radio Corporation,	Dartmouth, Mass.	
WMAH	General Supply Co....	Lincoln, Neb.	254
WMAJ	Drovers Telegram Co.,	Kansas City, Mo.	275
WMAK	Norton Laboratories,	Lockport, N. Y.	360
WMAL	Trenton Hardware Co.,	Trenton, N. J.	256
WMAM	Beaumont Radio Equipment Co.,	Beaumont, Tex.	
WMAN	Broad Street Baptist Church,	Columbus, Ohio	286
WMAP	Utility Battery Service..	Easton, Pa.	246
WMAQ	Fair Corp. and Chicago Daily News,	Chicago, Ill.	448
WMAT	Paramount Radio Corporation,	Duluth, Minn.	266
WMAV	Alabama Polytechnic Institute,	Auburn, Ala.	250
WMAW	Wahpeton Electric Co.,	Wahpeton, N. D.	
WMAZ	Kingshighway Presbyterian Church,	St. Louis, Mo.	
WMAZ	Mercer University .....	Macon, Ga.	268
WMAZ	Commercial Appeal .....	Memphis, Tenn.	500
WMH	Precision Equipment Co.,	Cincinnati, Ohio	248
WMU	Doubleday-Hill Electric Co.,	Washington, D. C.	261
WNAB	Park City Daily News,	Bowling Green, Ky.	
WNAC	Shepard Stores .....	Boston, Mass.	
WNAD	University of Oklahoma,	Norman, Okla.	
WNAL	R. J. Rockwell.....	Omaha, Neb.	
WNAM	Ideal Apparatus Co. ....	Evansville, Ind.	
WNAN	Syracuse Radio Telephone Co.,	Syracuse, N. Y.	286
WNAP	Wittenberg College, Springfield, Ohio		
WNAQ	Charleston Radio Electric Co.,	Charleston, S. C.	
WNAR	C. C. Rhodes .....	Butler, Mo.	

## SMASHING SALE

By Oliver Typewriter Co.



While They Last

1000 No. 9 Oliver

Rebuilt like new, right in Oliver Factory, only

\$44.50

Save \$50

Never before an offer like this, and probably never again! Only the great Oliver Company itself could do it. Famous Model No. 9 Oliver at the slashed price of only \$44.50—and a year to pay! Genuine No. 9 Oliver with standard keyboard and all late improvements, rebuilt throughout like new right in our own factory. The equal—yes the superior, we say, of any \$100 typewriter on the market. And yours for only \$44.50 on this special sale of 1,000 machines.

### Free Trial—A Year to Pay

Act quick before the 1,000 machines are gone. Try, however before you buy. We give you 5 days free trial. Return or keep the Oliver as you decide. No cost to you whatever for the free trial. A year to pay if you buy. Write today for full particulars of this sale. Mail coupon or postal.

Oliver Typewriter Co. (Rebuilt Machine Dept.) Chicago  
 Oliver Typewriter Co. (Rebuilt Machine Dept.) 678 Oliver Typewriter Bldg., Chicago  
 Please send me full particulars of your sensational sale of 1,000 No. 9 Oliver.  
 Name.....  
 Address.....

## NEW TIRE

GUARANTEE!

ACT NOW

30x3 1/2 CORD 2.00

### WRITTEN GOLD BOND GUARANTEE WITH EACH TIRE

Greatest tire sale in America now on! Goodyear, Goodrich, Firestone, Fisk and other fine makes of tires going at record-breaking prices. These almost new tires will easily give thousands of miles of satisfactory service.

### GUARANTEED 9 MONTHS

TIRES	TUBES	NEW	TIRES	NEW
30x3	\$1.90	\$.90	32x4 1/2	\$3.75
30x3 1/2	2.00	.90	32x4 1/2	3.75
32x3 1/2	2.50	.90	34x4 1/2	4.00
31x4	2.75	.90	35x4 1/2	4.25
32x4	3.00	1.40	36x4 1/2	4.25
33x4	3.25	1.40	35x5	4.25
34x4	3.50	1.40	37x5	4.25

Just send \$1.00 deposit for each tire ordered. Balance C. O. D. subject to inspection. Our written gold bond guarantee with each tire positively assures you nine months satisfactory service or another tire will be given at half price. Shipment made same day order is received. Order today—NOW!

INTERNATIONAL TIRE CORP.  
 114 EAST 14th STREET CHICAGO, ILLINOIS

### New Single Phase A. C. Motors

1/4 H.P. — 110 volt, 60 cycle, 1725 speed, complete with cord, plug and grooved pulley... \$12.00  
 Same motor equipped with buffer and grinder \$27.50

REBUILT MOTORS  
 All sizes, direct and alternating. We repair and exchange motors and generators. Let us quote on your needs.

ONE YEAR GUARANTEE



Satisfaction guaranteed or money refunded  
 Illustrated Catalog of Motors and Supplies FREE

### HYRE ELECTRIC CO.

631-H So. Dearborn St., Chicago, Ill.

### LEARN WATCH REPAIRING

You can learn by our modern and original system of instruction every part of the Watch Repairing Trade at home as good or better than at a shop. You can earn money while learning and secure a well paying position or start in business after completing our course of instruction. Good watch repairers are always in demand and earn from \$30 to \$65 per week. For particulars apply to the

MILWAUKEE SCHOOL OF WATCH REPAIRING, 166 Mason St., MILWAUKEE, WIS

### Wrestling Book FREE

Be an expert wrestler. Learn at home by mail. Wonderful lessons prepared by world's champions Farmer Burns and Frank Gotch. Free book tells you how. Secret holds, blocks and tricks revealed. Don't delay. Be strong, healthy. Handle big men with ease. Write for free book. State age. Farmer Burns School, 1257 Railway Bldg., Omaha, Neb.





Call	Name	City and State	Lengths	
WNAS	Texas Radio Corporation and Austin Statesman	Austin, Tex.		
WNAT	Lennig Bros. Co.	Philadelphia, Pa.		
WNAV	Peoples Telephone and Telegraph Co.	Knoxville, Tenn.		
WNAW	Peninsular Radio Club,	Fort Monroe, Va.		
WNAX	Dakota Radio Apparatus Co.,	Yankton, S. D.	244	
WNAY	Ship Owners Radio Service,	Baltimore, Md.		
WNJ	Shotton Radio Manufacturing Co.,	Albany, N. Y.		
WOAA	Dr. Walter Hardy	Ardmore, Okla.		
WOAB	Valley Radio	Grand Forks, N. D.		
WOAC	Maus Radio Co.	Lima, Ohio	266	
WOAD	Friday Battery & Electric Corporation	Sigourney, Iowa		
WOAE	Midland College	Fremont, Nea.		
WOAF	Tyler Commercial College,	Tyler, Tex.		
WOAG	Apollo Theatre (Belvidere Amusement Co.)	Belvidere, Ill.	224	
WOAH	Palmetto Radio Corporation,	Charleston, S. C.		
WOAI	Southern Equipment Co.,	San Antonio, Tex.	385	
WOAJ	Erwins Electrical Co.	Parsons, Kan.	258	
WOAK	Collins Hardware Co.,	Frankfort, Ky.	240	
WOAL	William E. Woods,	Webster Groves, Mo.		
WOAN	Vaughn Conservatory of Music,	Lawrenceburg, Tenn.		
WOAO	Lyradion Manufacturing Co.,	Mishawaka, Ind.		
WOAP	Kalamazoo College,	Kalamazoo, Mich.		
WOAQ	Portsmouth Kiwanis Club,	Portsmouth, Pa.	360	
WOAR	Henry P. Lundskow,	Kenosha, Wis.		
WOAS	Bailey's Radio Shop,	Middletown, Conn.		
WOAT	Boyd M. Hamp	Wilmington, Del.		
WOAV	Pennsylvania National Guard,	112th Infantry, 2d Battalion,	Erie, Pa.	242
WOAW	Woodmen of the World,	Omaha, Neb.	526	
WOAX	Franklyn J. Wolff (Monument Pottery Co.)	Trenton, N. J.	240	
WOAZ	Penick Hughes Co.	Stamford, Tex.		
WOC	Palmer School of Chiropractic,	Davenport, Iowa	484	
WOE	Buckeye Radio Service Co.,	Akron, Ohio		
WOF	Iowa State College	Ames, Iowa	360	
WOK	Pine Bluff Co.	Pine Bluff, Ark.		
WOO	John Wanamaker	Philadelphia, Pa.	509	
WOQ	Western Radio Co.	Kansas City, Mo.	360	
WOR	L. Bamberger & Co.	Newark, N. J.	405	
WOS	Missouri State Marketing Bureau,	Jefferson City, Mo.		
WPAB	Pennsylvania State College,	State College, Pa.		
WPAC	Donaldson Radio Co.,	Okmulgee, Okla.		
WPAD	W. A. Wieboldt & Co.,	Chicago, Ill.		
WPAE	Peter Anderson Radio Co.,	Council Bluffs, Iowa		
WPAH	Wisconsin Department of Markets,	Waupaca, Wis.	360	
WPAJ	Doolittle Radio Corporation,	New Haven, Conn.	268	
WPAK	North Dakota Agricultural College,	Agricultural College, N. D.		
WPAL	Superior Radio & Telephone Equipment Co.	Columbus, Ohio	286	
WPAM	Auerbach & Guettel	Topeka, Kan.		
WPAP	Theodore D. Phillips,	Winchester, Ky.		
WPAQ	General Sales & Engineering Co.,	Frostburg, Md.		
WPAR	Ward Battery & Radio Co.,	Beloit, Kan.		
WPAS	J. & M. Electric Co.,	Amsterdam, N. Y.		
WPAT	St. Patrick's Cathedral,	El Paso, Tex.		
WPAC	Concordia College,	Moorhead, Minn.		
WPAW	Radio Installation Co.,	Wilmington, Del.		
WPAY	Bangor Radio Laboratory,	Bangor, Me.		
WPAZ	Dr. John R. Koch,	Charleston, W. Va.	273	
WPG	Nushlawg Poultry Farm,	New Lebanon, Ohio		
WPI	Electric Supply Co.	Clearfield, Pa.		
WQAA	Horace A. Beale, Jr.,	Parkesburg, Pa.		
WQAB	Southwest Missouri State Teachers College	Springfield, Mo.	236	
WQAC	E. B. Gish	Amarillo, Tex.		
WQAD	Whitall Electric Co.,	Waterbury, Conn.	242	
WQAE	Moore Radio News Station,	Springfield, Vt.	275	
WQAF	Sandusky Register	Sandusky, Ohio	240	
WQAH	Brock-Anderson Electrical Engineering Co.	Lexington, Ky.	254	
WQAJ	Ann Arbor Times News,	Ann Arbor, Mich.		
WQAK	Appel-Higley Electric Co.,	Dubuque, Iowa		
WQAL	Coles County Telegraph Co.,	Mattoon, Ill.	258	

# Be an Electrical Expert— Make Big Money



© A S 1923

## 22 Big Electrical Experts Prepared This Course

C. C. Adams, B. S., Switchboard Specialist, General Electric Company.

Morton Arendt, E. E., Assistant Professor of Electrical Engineering, Columbia University

F. E. Austin, B. S., E. E., Professor of Electrical Engineering and Mechanics, Thayer School of Engineering, Dartmouth College

Winfield Dexter Bearce, B. S., E. E., Statistician—Railway and Traction Engineering Department, General Electric Company.

O. J. Bushnell, Superintendent, Meter Department, Commonwealth Edison Company, Chicago.

Francis B. Crocker, E. M., Ph. D., Formerly Vice-President, Crocker-Wheeler Electric Company, Amper, New Jersey.

Louis Derr, S. B., A. M., Professor of Physics, Massachusetts Institute of Technology.

William Esty, S. B., M. A., Head, Department of Electrical Engineering, Lehigh University.

W. H. Freedman, C. E., E. E., Head, Department of Electrical Engineering, University of Vermont

H. B. Geat, A. B., M. E., Engineer of Distribution, Commonwealth Edison Co., Chicago.

Ward Harrison, M. E., Illuminating Engineer, General Electric Company.

George J. Kirkgasser, E. E., Electrical Engineer, The Cutler-Hammer Manufacturing Co., Milwaukee.

Robert A. Millikan, Ph. D., Sc. D., Norman Bridge Laboratory, California Institute of Technology. Pres. of the Board of Research.

John Mills, A. M., Engineer American Telephone and Telegraph Company.

David Penn Moreton, E. E., Associate Professor of Electrical Engineering, Armour Institute of Technology, Chicago.

Arthur N. Nelson, Superintendent, Interior Wiring Department, Commonwealth Edison Company, Chicago.

Henry H. Norris, M. E., Formerly Professor of Electrical Engineering, Cornell University.

Dana Pierce, B. A., Electrical Engineer, Underwriters' Laboratories, Inc., Chicago.

E. W. Seeger, M. E., Electrical Engineer, The Cutler-Hammer Manufacturing Co., Milwaukee.

George E. Shoad, E. E., Professor of Electrical Engineering, University of Kansas.

H. M. Stoller, B. E., M. S., Electrical Engineer, Western Electric Company.

A. G. Turnbull, Meter Department, Commonwealth Edison Company, Chicago.

## The Best Electrical Home-Study Course That Money Can Buy

This is the most practical Electrical course ever offered. Over 20 world famous engineers—note their names and positions—have prepared our special instruction papers. This practical training course will help the ambitious man to rise quickly in the greatest field of all.

### Salaries \$3,000 to \$10,000 a Year

Ten thousand a year is not at all unusual in the electrical field. Many ELECTRICAL EXPERTS are getting more. Even the small job repair man is making big money—there is no limit to what a real expert—the man with thorough electrical training—can earn. That is just the kind of training we are equipped to give you.

### Be an Electrical Expert

The Electrical Expert is the BIG PAY MAN. All Electrical lines pay big and no other trade or profession offers as many chances for quick advancement. Do YOU want to be in the BIG PAY CLASS? Here is your chance. You can get into it quickly. We can make you a **Certified Electrical Expert** in a short time.

### Own Your Own Business—Earn While You Learn

A few weeks after you start you can earn good money on the side by doing electrical repair and installation jobs. This gives you a fine start towards an electrical contracting or repair shop business of your own. We will tell you just how to do it when you are ready.

### Satisfaction or Money Back

We do more than SAY we can make you an ELECTRICAL EXPERT—we GUARANTEE it. If you are not absolutely satisfied when you have finished our Practical Electrical Course, we will refund every cent you paid us.

### Free Electrical Outfit

We give absolutely free a real Electrical Outfit—containing a high-grade motor, wheatstone bridge, electrical magnet, etc. It is not a plaything, but a practical experimental outfit, that would cost you \$30.00 retail.

### Make Money by Joining the Big Pay Class

You wish you were in it now. You can be in it a year from now. Send in the coupon for full information and get our free 300-page Bulletin.

### American School

Dept. E726 Drexel Ave. & 58th St., Chicago

AMERICAN SCHOOL, Chicago  
Dept. E726 Drexel Ave. & 58th St.  
Send me a free copy of your 300 page bulletin describing the wonderful opportunity for me in Electricity. This request puts me under no obligation.

Name .....

Address .....

City..... State.....



### American School

The American School is not a money-making corporation, but like resident schools and colleges, is chartered strictly as an "Educational Institution, not for profit."

More than 200 famous engineers and educators prepared the special instruction papers for our students.

For over a quarter of a century, Big Engineers, Educators and Business Men have recommended the American School. They know that our long experience as an educational institution guarantees better training at less cost than can be given by any school conducted for profit.



# Study and Experiment with the **ULTRALENS MICROSCOPE** || **\$5.00**



TYPE MS-11

**Magnifies 225 Diameters or  
50,625 Times Surface Area**

The ULTRALENS MICROSCOPE is a practical instrument made possible by the recent development of a new system of lens construction. Powers from 125 to 325 diameters (15,625 to 100,625 times surface area) are available. Microscope is a marvel of simplicity, perfection and compactness, giving enormous magnification and a clear definition. Quantity production brings price within the reach of all.

The MS-11 type of ULTRALENS MICROSCOPE is a complete outfit as it includes everything necessary to conduct numerous experiments. A 225 diameter objective is standard equipment. Extra ULTRALENS objectives of either 125 or 325 diameters can be furnished for \$1.00 each. Objectives are only sold to owners of ULTRALENS microscopes.

This type is well finished throughout. Stage, knob, and mirror casing are of black moulded bakelite. Brass work finished in gold lacquer. Die-cast enameled horse-shoe base. Micrometer screw focusing arrangement. Objectives are interchangeable and plug in top of pillar. Outfit furnished in brown moulded bakelite case which is provided with places for holding slides and extra objectives.

By means of a special attachment microscope can be securely clamped to outside of case thus making it serve as a sub-base.

**A HIGH POWERED MICROSCOPE AT ONE-TWELTH USUAL COST**

Common Objects As Seen Through An Ultralens Microscope

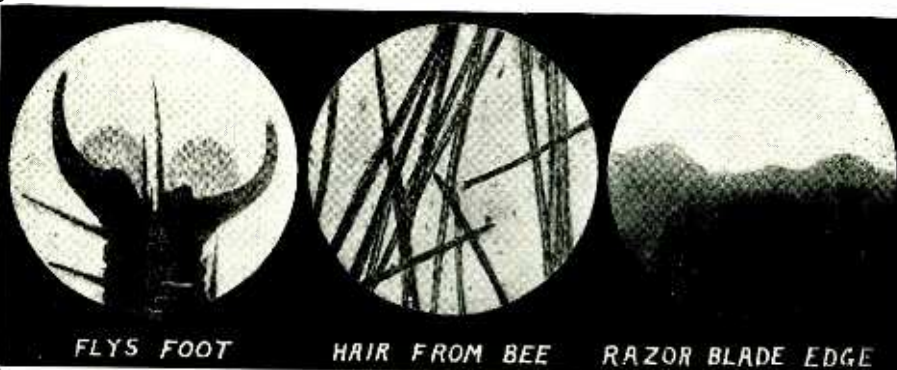

FLY'S FOOT

HAIR FROM BEE

RAZOR BLADE EDGE

An ULTRALENS MICROSCOPE will be shipped prepaid to any part of the United States and Canada on receipt of \$5.00 Foreign countries \$6.00.

EXTREMELY INTERESTING CATALOG IS FREE ON REQUEST

DEALERS, JOBBERS, AGENTS, and SALESMEN—Get Our Distributors Proposition.

**SCIENTIFIC APPARATUS CORP., Milton, Pa., U. S. A.**

Call	Name	City and State	Leagues
WQAM	Electrical Equipment Co.,	Miami, Fla.	
WQAN	Scranton Times	Scranton, Pa.	280
WQAO	Calvary Baptist Church,		
		New York, N. Y.	
WQAO	Abilene Daily Reporter, (West Texas Radio Co.),	Abilene, Tex.	
WQAS	Prince-Walter Co.,	Lowell, Mass.	266
WQAT	Radio Equipment Corporation,	Richmond, Va.	
WQAV	Huntington & Guerry (Inc.),	Greensville, S. C.	258
WQAW	Catholic University,	Washington, D. C.	236
WQAX	Radio Equipment Co.,	Peoria, Ill.	360
WQAY	Gaston Music & Furniture Co.,	Hastings, Neb.	
WQAZ	Greensboro Daily News,	Greensboro, N. C.	360
WRAA	William M. Rice Institute,	Houston, Tex.	
WRAB	Board of Public Education,	Savannah, Ga.	
WRAD	Taylor Radio Shop,	Marion, Kans.	
WRAP	The Radio Club (Inc.),	Laporte, Ind.	224
WRAH	Stanley N. Read,	Providence, R. I.	360
WRAL	Northern States Power Co.,	St. Croix Falls, Wis.	248
WRAN	Black Hawk Electrical Co.,	Waterloo, Iowa	229
WRAO	Radio Service Co.,	St. Louis, Mo.	
WRAP	Winter Park Electric Construction Co.,	Winter Park, Fla.	360
WRAR	Jacob C. Thomas,	David City, Neb.	226
WRAS	Radio Supply Co.,	McLeansboro, Ill.	360
WRAU	Amarillo Daily News,	Amarillo, Tex.	
WRAV	Antioch College, Yellow Springs, Ohio		
WRAW	Avenue Radio Shop (Horace D. Good)	Reading, Pa.	238
WRAX	Flaxon's Garage,	Gloucester City, N. J.	268
WRAY	Radio Sales Corporation,	Scranton, Pa.	360
WRAZ	Radio Shop of Newark (Herman Lubinsky),	Newark, N. J.	233
WRC	Radio Corporation of America,	Washington, D. C.	
WRK	Doron Bros. Electric Co.,	Hamilton, Ohio	
WRL	Union College,	Schenectady, N. Y.	
WRM	University of Illinois,	Urbana, Ill.	
WRP	Federal Institute of Radio Telegraphy,	Camden, N. J.	
WRR	City of Dallas, Police and Fire Signal Department,	Dallas, Tex.	
WRW	Tarrytown Radio Research Laboratory,	Tarrytown, N. Y.	273
WSAA	B. S. Sprague Electrical Co.,	Marietta, Ohio	
WSAB	Southeast Missouri State Teachers' College,	Cape Girardeau, Mo.	
WSAC	Clemson Agricultural College,	Clemson College, S. C.	
WSAD	J. A. Foster Co.,	Providence, R. I.	261
WSAG	City of St. Petersburg (Loren V. Davis),	St. Petersburg, Fla.	244
WSAH	A. J. Leonard, Jr.,	Chicago, Ill.	
WSAI	United States Playing Card Co.,	Cincinnati, Ohio	309
WSAJ	Grove City College,	Grove City, Pa.	248
WSAK	Foster Egner (Daily News, Pomeroy, Ohio)	Middleport, Ohio	258
WSAL	Franklin Electric Co.,	Brookville, Ind.	246
WSAN	Allentown Radio Club,	Allentown, Pa.	229
WSAP	Seventh Day Adventist Church,	New York, N. Y.	360
WSAQ	Round Hill Radio Corporation,	Dartmouth, Mass.	280
WSAR	Doughty & Welch Electrical Co.,	Fall River, Mass.	254
WSAT	Plainview Electric Co.,	Plainview, Tex.	268
WSB	Atlanta Journal,	Atlanta, Ga.	249
WSL	J. & M. Electric Co.,	Utica, N. Y.	273
WSY	Alabama Power Co.,	Birmingham, Ala.	
WTAB	Fall River Daily Herald Publishing Co.,	Fall River, Mass.	248
WTAC	Penn Traffic Co.,	Johnstown, Pa.	
WTAG	Kern Music Co.,	Providence, R. I.	258
WTAK	Swan-Bower Co.,	Steubenville, Ohio	266
WTAS	Charles E. Erbstein,	Elgin, Ill. (near)	275
WTAU	Ruegg Battery & Electric Co.,	Tecumseh, Neb.	
WTAW	Agricultural & Mechanical College of Texas	College Station, Tex.	254
WTG	Kansas State Agricultural College,	Manhattan, Kans.	
WTP	George M. McBride,	Bay City, Mich.	
WWAC	Sanger Bros.,	Waco, Tex.	
WWAD	Wright & Wright (Inc.),	Philadelphia, Pa.	
WWAX	Wormser Bros.,	Laredo, Tex.	
WWB	Daily News Printing Co.,	Canton, Ohio	268
WWI	Ford Motor Co.,	Dearborn, Mich.	
WWJ	Detroit News	Detroit, Mich.	273
WWL	Loyola University,	New Orleans, La.	507
WWZ	John Wanamaker,	New York, N. Y.	507

## OIL EXPERTS in Demand

**Good Positions Await Trained Men**  
The Petroleum Engineering field needs men. It needs them badly. With 10 million autos and thousands of new power plants a great shortage of lubrication engineers now exists—greater than ever before. Petroleum experts and lubrication engineers command big pay—\$250 to \$600 monthly. Thousands of National men are doing it—so can you. Learn at home in your spare time with the oldest and only school giving same instructions by correspondence as is given through resident school. (Certificate of Lubrication Engineering given).

**BIG BOOK of Opportunities FREE**

Send NOW for New Book, just out, "Opportunities in Petroleum Engineering." It is intensely interesting and instructive. It will show you many things you never knew about oil and lubrication problems. Also full particulars and special low fee awaiting those who ACT NOW!

**National Engineering Schools**  
619 Manhattan Bldg., Chicago, Ill.



**30 DAYS FREE TRIAL \$10 Worth of Records FREE**

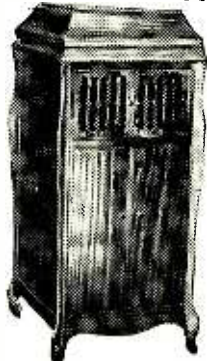

Simply wonderful! The limit of value giving! Just think! **AGENCE DAVIS PHONOGRAPH** on 30 Days' Free Trial, and on terms as low as **\$2 A MONTH** in case you decide to buy. Magnificent instruments in quartered oak or mahogany piano finished cases, equipped with the finest worm gear motors, rich toned machines—at less than half the standard prices—and \$10 worth of records FREE.

**Send No Money**  
Just a postal with your name and address. Only a limited number of machines shipped on this extra-liberal offer. Better act quickly. This is a life-time opportunity.  
**DAVIS, 314 West 43rd St. Dept. D-51 CHICAGO**



**Dr. Hackensaw's  
Secrets**  
By CLEMENT FEZANDIE.  
(Continued from page 539)

Each signal is alike in strength, but as my distance from earth increases, the signal is weaker and weaker when it reaches me, hence moves the needle of the dial a lesser distance. This tells me my distance from earth. An automatic counter subtracts the distance the preceding second from the last distance and hence gives the speed per second, or more strictly speaking, the speed during the last second."

"I see"—  
"I am now going to open the shutters and take a look at the sky."  
As he said the words, the doctor threw open a slide, and Pep put her eye to the end of the telescope. This was by no means easy to do, for, of course she could not stand, her body floating in the air as it would float in water. When she did finally manage to look through the instrument, however, she gave a cry of surprise:

"Why, it's already night-time!" she exclaimed. "That gets my goat! I thought we left the earth only a few minutes ago! But it's dark as pitch outside, and the stars are out, and they're turning around in the sky as if all the hootch in New York had been sent up there. And what in the world is that immense light over there like an enormous moon! Why it must be the earth—see those dark spots—that must be North America, Gee! how quickly its moving! The whole earth is out of sight now! What in the world is the matter?"

"I think I can explain," said Doctor Hackensaw quietly. "Our diffused daylight on earth is due to our atmosphere. Here in the car, or even on the moon, when we reach it, the sky will be black even in the day-time. The sun will be a very brilliant circle of light, but the rest of the sky will be black. It will appear to us like perpetual night!"

"Here comes the earth back again!" cried Pep—"What makes it act that way."  
"It is our car that is spinning around!" explained the doctor. "Every time we pull one of the straps on the side of the car we set the whole car spinning around, just as a squirrel does in a rotary cage. My internal car as I told you, is free to revolve inside an outer shell, but the act of opening the slide to the telescope joins the two shells, so the two shells revolve together—otherwise we couldn't use the telescope at all. However we can slow up the revolution of the car by pulling a strap in the opposite direction. But now, Miss Pep, don't you think we'd better attend to the department of the interior. Aren't you hungry?"

Pep was always ready for eats, and was gratified when the doctor took from a fireless cooker a meal that would have sufficed for half a dozen persons.

"What shall we do with the garbage, doc?" she asked, after the meal was finished, holding up a paper bag containing the bones, etc., left from the feast. Shall I throw them overboard?"

Doctor Hackensaw hesitated a moment, then said: "Very well. I'll open the window for just a second, so as not to allow too much air to escape; be ready, and throw the bag out quickly."

Suiting the action to the word, he opened the casement and the young girl hurled the paper package forth with all her might. Away it sped as if shot from a cannon, and, lighted up by the sun's rays, it looked for all the world like a shooting-star, until a new revolution of the car hid it from

# This great electrical library may be worth \$25,000 to you

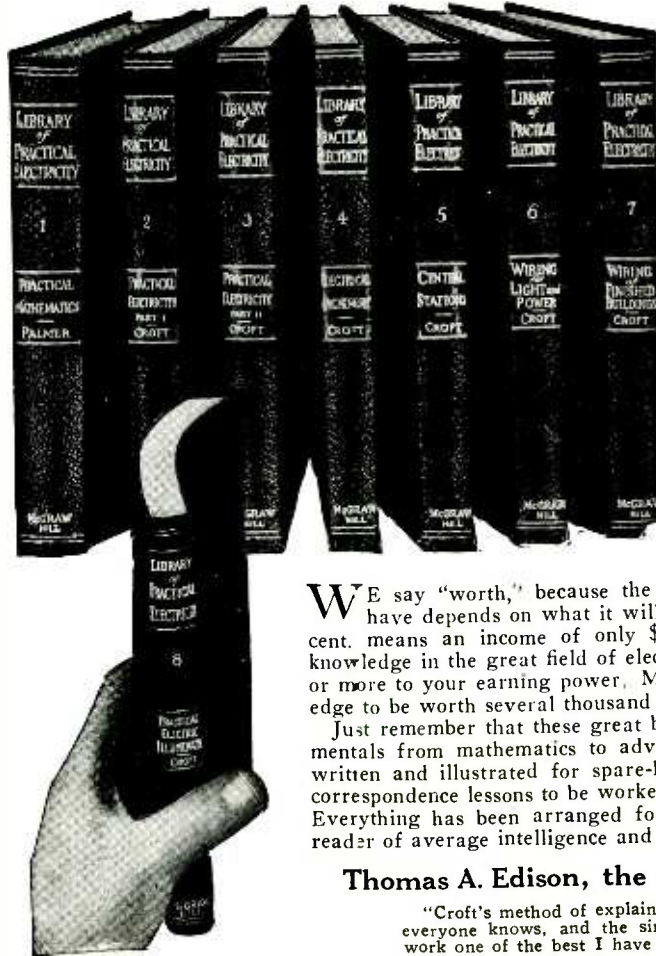

**Yet it  
costs  
only  
\$19.50  
in ten  
easy  
monthly  
payments**

WE say "worth," because the value of anything you may have depends on what it will bring you. \$25,000 at 6 per cent. means an income of only \$1,500 yearly. An all-round knowledge in the great field of electricity may easily add \$1,500 or more to your earning power. Many have found such knowledge to be worth several thousand dollars a year to them.

Just remember that these great books, covering all the fundamentals from mathematics to advanced electrical practice, are written and illustrated for spare-hour reading. There are no correspondence lessons to be worked out, no keys to be consulted. Everything has been arranged for easy understanding by any reader of average intelligence and education.

**Thomas A. Edison, the electrical genius, said:**

"Croft's method of explaining by analogy with things everyone knows, and the simple illustrations make his work one of the best I have seen."

It would take you many, many years and cost you thousands of dollars to gather together the information, the diagrams, the results of experiment and experience that are available between the covers of these eight handy volumes—all summarized, illustrated and brought up to date, printed clearly and thoroughly indexed.

Every page of this Library is taken from every-day electrical practice. Croft deals only with the kind of problems you meet in daily work.

The author's knowledge of electricity has been obtained through actual shirt-sleeves practice. Beginning as an apprentice lineman, he went through the various stages of wireman, draftsman, etc., until he attained the position of electrical engineer with one of the big electrical manufacturing companies. Now he heads his own consulting company.

Own a set and join the 40,000 men who have found the Croft Library to be a real working companion to bigger accomplishment in the electrical field. Keep these books handy in your room. Put one in your pocket when you take the car or train in the morning. Give them the odd hours. They are not tiresome treatises, but as interesting as any reading matter you ever owned. Consult your set regularly, acquire just one new fact a day, and in a few years you will be a broadly informed electrical man.

**Free inspection—No advance charge  
10 easy monthly payments**

You don't have to take any one's word. You can be the judge. These work-shop books of the electrical business sell themselves. We send them to you on receipt of the coupon below and let you decide about their value for yourself—without the persuasion of any salesman.

Bound in flexible red keratol, a total of 3,000 pages and 2,100 illustrations, a handsome valuable possession for the practical electrical worker who is determined to get ahead.

**FREE EXAMINATION COUPON**

McGraw-Hill Book Co., Inc. 370 Seventh Avenue, New York

Gentlemen:—Send me the LIBRARY OF PRACTICAL ELECTRICITY (shipping charges prepaid) for 10 days' free examination. If satisfactory, I will send \$1.50 in ten days and \$2 per month until the special price of \$19.50 has been paid. If not wanted, I will write you for return shipping instructions. (Write plainly and fill in all lines.)

Name .....  
Home Address .....  
City and State .....  
Employed by .....  
Occupation ..... S&I 10-23

**Titles and Scope  
of Books**

**Volume One—Practical Mathematics,** 258 subject headings. Tells you how to use mathematics as a tool.

**Volume Two—Practical Electricity,** 1,000 subject headings. The basic principles of all electrical practice.

**Volume Three—Practical Electricity,** 1,100 subject headings. A continuation of Volume Two.

**Volume Four—Electrical Machinery,** 1,400 subject headings. Contains what every electrical man wants to know.

**Volume Five—Central Stations,** 500 subject headings. All phases of central station operation are covered.

**Volume Six—Wiring for Light and Power,** 1,700 subject headings. Tells how to do the big and little jobs right.

**Volume Seven—Wiring of Finished Buildings,** 1,000 subject headings. The very meat of wiring practice.

**Volume Eight—Practical Electric Illumination,** 1,000 subject headings. Lamps and the art of lighting properly.

Seven years of thought, time and effort were put into these great books. In them you will find all the essentials of modern electrical practice. Their thoroughness makes them the standard electrical reference books of today.

The books contain nothing but live, practical material. They are kept up to the minute by periodical revisions by the author. Every electrical worker will appreciate the value of this.



## The Man Who Talked At Random



HE sat in the window-corner of the Pullman's smoking-compartment and breathed fatly as he uttered his large opinions. It grew late, as so often it does; and he put the quietus on a discussion with the ponderous statement:

"I don't read advertisements. They have no effect on me at all. I'd never miss them if they stopped printing 'em."

Then he glanced at his advertised watch and sought his lower-berth.

In the morning the ad-skeptic contorted himself out of his advertised pajamas into his advertised underwear, drew on his advertised socks, adjusted them with his advertised garters, got into his advertised suit, laced his advertised shoes and added himself to the congestion in the wash-room.

There he shaved with an advertised razor, using advertised shaving soap; brushed his teeth with an advertised toothbrush and advertised dental cream, washed with advertised soap, and brushed his hair with an advertised brush. Fastening his advertised collar on an advertised button, he neatly knotted his advertised tie, gave his advertised suspenders a tug or two, and finished dressing.

Let us leave him there, this man who never reads advertisements!

Everything worth using is advertised. Everything that isn't, rarely is.

*Read the advertisements for value's sake*

sight. It reappeared again in a moment or two, as the car came around, but fainter and further away.

"Gee!" cried the astonished girl, "I knew I was a good pitcher all right, but I didn't know I could throw anything so fast or so far! That bag must be a couple of miles away now! And it isn't falling to the earth, either. I suppose its because it hasn't any weight that I can throw it so far?"

"Precisely," replied the doctor. "The same force will move a body sixteen times as fast when it has no weight, as it would move it against the attraction of the earth. And the body will keep on moving forever unless stopped by some resistance. That is why all our motions in the car are so violent. One's muscles retain their accustomed power, but there is no weight to be moved, merely the force required to move the mass of matter that composes our arms and legs, for mass and weight are no longer identical here."

"But how is it that objects in the car have no weight if we're only six thousand miles away from the earth? The attraction of the earth and moon cannot be equal yet?"

"No indeed. The earth's attraction is about one hundred times that of the moon, so the half-way place, if I may call it so, is very near the moon. But the reason bodies in the car have no weight is that they are traveling at the same speed as the car, hence their relative positions are not affected by gravitation. Shoot two bullets at the moon with the same speed, and the second will not catch up with the first. We ourselves are one bullet and the car is the other. We are traveling now at the same speed, and if we hung in mid-air in the car we should remain there during the whole trip. The condition is exactly the same as if a car with a passenger were allowed to fall from one part of the earth to the antipodes, through a tunnel bored through the center of the earth. Objects in the car then, as in the present instance, would appear to have lost all their weight. The package of rubbish you threw from the car shows the same thing. It, too, was traveling at the speed of the car, and will never return to earth again. As a matter of fact, it will reach the moon, but several hundred miles away from the point where we shall land. You will have thrown it really more than a thousand miles!"

"Gee!" cried Pep, delighted. "Then I've broken all records for pitching!"

"If you had been awake when the car started," continued Doctor Hackensaw, you would have noticed another curious fact. Owing to the tremendous resistance of the air during the first few seconds of our flight, the car was considerably retarded, while we, had we been suspended in the air inside, were not so retarded. The effect would have been the same as if we had weighed thousands of pounds instead of nothing, as we do at present."

"At what speed did we start?" asked Pep.

"The centrifugal wheel gave us a speed of seven miles per second in one direction, the revolution of the earth around the sun gave us a speed of nine miles per second in another direction, and the rotation of the earth on its axis gave us a speed of nearly one-third of a mile per second in a third direction. By aiming the car so as to reach the moon when the lines from the earth to the sun and from the earth to the moon made a right angle at the earth, I could have obtained a speed of nine miles per second toward the moon. By aiming my Ferris wheel in the same direction, I could get seven miles per second extra, or a total speed of sixteen miles per second at the start. By aiming the wheel in the opposite direction, my speed would be only two miles per second. Combining either of these speeds with that obtained from the rotation of the

## HEALTH

is the Greatest Joy of Life. Only the robust, vigorous and healthy can enjoy life to its fullest. The complaining, ailing, sickly ones are unhappy, discontented, dejected, failures. For 25 years I have been making people well through Strongfortism. I have helped tens of thousands to become strong. No matter what ails you, write me fully about it, and I will prove to you I can help you. The experience and research of a lifetime are contained in my wonderful FREE BOOK "Promotion and Conservation of Health, Strength and Mental Energy." Send a ten cent piece (one dime) to cover postage.

**LIONEL STRONGFORT**

Physical and Health Specialist  
713 Strongfort Institute, Newark, N. J.



Lionel Strongfort  
Perfect Man

## STRONGFORTISM

### Play this Jazzy Sax Without Practice

Any one can play this imported Jazzy Sax right away. No knowledge of music required, no lessons. Play by numbers instead of notes. All instructions and 15 songs free! Be Popular at parties, dances, picnics, entertainments. Glistening polished brass all over, except nickel mouthpiece. Looks just like regular saxophone.

Same size. Weighs over 8 lbs. Beautiful, clear, ringing tones and delightful harmony.

Supply Limited.



V.D.Beatty says: This is easy. I played tunes after fifteen minutes and am delighted."

### Send No Money

No need to spend \$85 when you can own a Jazzy Sax. Send just your name. When the Sax arrives pay the postman only \$5.98 plus a few pennies postage. Play Jazz right away. Guaranteed or money refunded. Don't delay, act now! FERRY & COMPANY, Dept. 1254 75 W. Van Buren Chicago, Illinois



earth on its axis I could leave the earth at any speed I desired between about one and two-thirds miles per second to about sixteen and one-third miles per second."

"And of course you made this an express train, at the quickest speed?"

"Not at all. There is no hurry. And too great a speed would be dangerous, not only in passing through the atmosphere, but also when we reach the moon. If aimed straight at the moon, we should hit it too hard, while if aimed to one side of the moon, too great a speed would carry us beyond the lunar attraction."

By this time the air in the car began to become rather close, so Doctor Hackensaw proceeded to open one of the oxygen tanks. As he did so, he gave a cry of dismay.

"What's the matter?" asked Pep.

"Miss Pep," said he, solemnly, "are you a good sport. Can you stand it to learn that we are in great danger?"

"Try me and see!" replied the young girl, bravely "I just love to shiver!"

"Well, by some infernal mistake, tanks of nitrogen instead of oxygen have been put in the car. There is only one oxygen tank in the lot besides the one on tap.

"And that means?"

"And that means that we have air for one day less than our trip will require. It means that we must live a whole day without breathing." And Doctor Hackensaw looked grim. It was nothing to him to face death, but the idea of being the innocent cause of this young lady's death unmanned him.

But Pep was game. Only a more rapid coming and going of her breath showed that she was affected by the news. "Is there nothing we can do?" she asked.

"I see nothing," replied the doctor, "unless. . . ." Suddenly his face brightened: "I have it!" he cried. "I think we can save ourselves yet!"

"How so?"

"A sleeping person requires less air than one who is awake. We must sleep during the remainder of the journey. There is not a moment to lose. I shall prepare a sleeping potion at once!"

A few minutes later the doctor handed the young lady a tumbler half full of a rose-tinted liquid.

"Drink this," said he, "and then fasten yourself in your couch. I have calculated the dose so it will keep us asleep until a couple of hours before we land on the moon. I must be wide awake then, at all hazards."

"Will the landing on the moon be dangerous?" asked Pep, innocently, as she raised the glass to her lips and drained its contents, while the doctor quaffed his potion at the same time.

"Dangerous?" echoed the doctor, as he stepped into his couch. "My dear young lady, is it possible that you don't realize that the car is bound to strike the moon with considerable force. It is true the moon is smaller than the earth, and less dense, hence its attractive power is smaller, but on the other hand, it has no atmosphere to retard our fall. The chances are that we shall fall with such velocity that we shall reach the moon as flat as pancakes—and pretty badly burnt pancakes at that!"

(To be continued)

**FLYING MAIL TRAIN**

A "flying mail train" is the latest type of airplane to be developed in England. In the plane's mail chamber, sorters will be able to carry on their work just as they might in a railway mail train. It will have a radius of 2,000 miles and will be able to stay in the air twenty-four hours, without alighting.

The machine will virtually fly itself and all the helmsman will have to do will be to keep it on a compass course by means of the rudder.

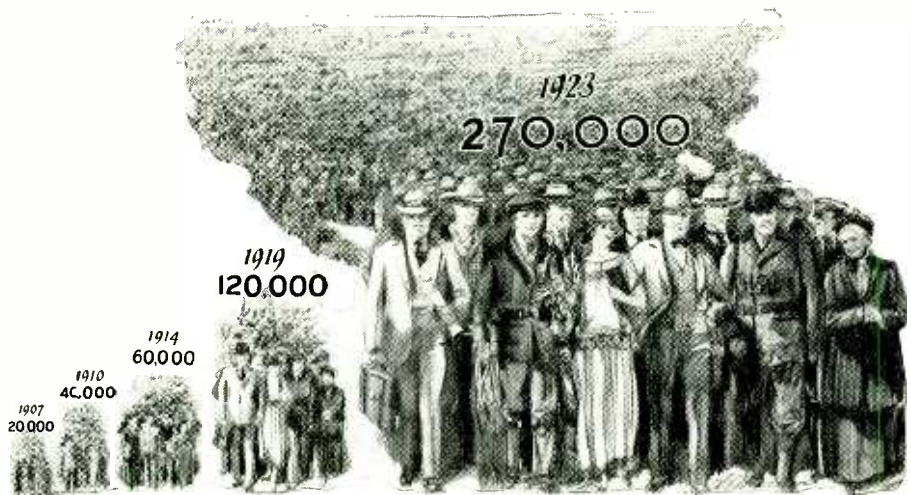

These groups of stockholders illustrate the rapid growth in ownership of the Bell System.

**A Community of Owners Nation-wide**

"Who owns the company?" "What is behind it?" These questions are asked in appraising the soundness of a business and in determining its aims.

The American Telephone and Telegraph Company is owned by more than 270,000 people living in every state in the Union. Could the stockholders of the Bell System be gathered to one place, they would equal the population of a city about the size of Providence or Denver.

They constitute a representative cross-section of American citizenship. Among them, of course, are bankers and men of large affairs; for the idea of

ownership in the Bell System appeals to sound business judgment and a trained sense of values.

In this community of owners are the average man and woman, the storekeeper, the clerk, the salesman, the professional man, the farmer and the housewife—users of the telephone who with their savings have purchased a share in its ownership. The average individual holding is but twenty-six shares.

No institution is more popularly owned than the Bell System, none has its shares distributed more widely. In the truest sense it is owned by those it serves.

"BELL SYSTEM"

**AMERICAN TELEPHONE AND TELEGRAPH COMPANY AND ASSOCIATED COMPANIES**

*One Policy, One System, Universal Service, and all directed toward Better Service*



**EVERY EXPERIMENTER should own a Taylor Compass.**



Taylor Compasses have jeweled centers. Cases are moisture and dust proof. Can be supplied with bar needle or floating dial with screw stops. Popular prices make it possible for every experimenter to own a Taylor Compass. Write for free booklet and prices.

15c brings booklet "Compass, the Signpost of the World."

**Taylor Instrument Companies**  
Rochester, N. Y. U. S. A.  
There is a Taylor or Taylor Temperature Instrument for every purpose.

**Prices Reduced On All Standard Make TYPEWRITERS**



**Lowest Prices in Years** We will ship any make you choose for one week's trial. Underwood, Royal, L. C. Smith, Remington, Oliver, etc.

**Easy Terms** Pay less than rent each month and own a typewriter. Guaranteed as good as new. Perfectly rebuilt by experts—the famous "Young Process." Send for our free trial offer and new low price list now. **WRITE TODAY.**

**Young Typewriter Co.**  
World's Largest Dealers in Standard Typewriters  
654 W. Randolph St., Dept. 116A, Chicago, Ill.



# Learning to Dance is as Easy as Walking - this New Way

**Why Good Dancers Are Popular**

Isn't it foolish for a person not to be a good dancer? Are not the best dancers the most popular members of your set? Good dancers never lack partners and are always invited to every affair because dancing is the most popular form of amusement and really good dancers are in demand all the evening. Dancing gives poise to the carriage. It helps one overcome self-consciousness when in the presence of strangers. It teaches perfect mental and physical control—helps one overcome timidity and awkwardness.

## Learn Any Dance in One Evening

Even if you don't know one dance step from another, now, Arthur Murray, through his new method can quickly teach you all of the latest dances without the need of personal instruction, music, or partners. His picture methods make learning to dance just as simple as taking one step after another. In fact, entire families, including the children, have learned from the one set of instructions.



## Five Dancing Lessons Free

So sure is Arthur Murray that you will be delighted with his amazingly simple methods of teaching dancing that he has consented, for a limited time only, to send FIVE FREE LESSONS to everyone who signs and returns the coupon.

These five free lessons are yours to keep—you need not return them. They are sent merely to prove that you can learn to dance in your own home without either music or partner.

You do not obligate yourself in any way by sending for these free lessons. Just fill in the coupon and they will be promptly mailed to you. Just enclose 25c. to pay cost of postage, printing, etc., and the lessons will be promptly mailed to you. Don't hesitate. Write today.

Arthur Murray, Studio, 290 Broadway, New York City.

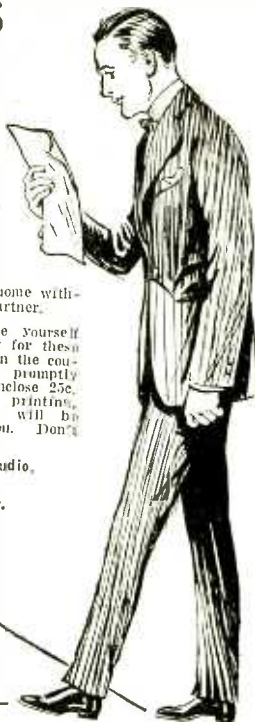

Arthur Murray, Studio 838, 290 Broadway, New York City

To prove that I can learn to dance at home in one evening you may send the FIVE FREE LESSONS. I enclose 25c (stamps or coin) to pay for the postage, printing, etc.

Name .....  
 Address .....  
 City ..... State .....  
 Would you like to teach dancing? .....

## ANALYSIS SHOWS ELEMENTS TO HAVE MANY ATOMIC WEIGHTS

By PROF. LINDLEY PYLE

M<sup>R</sup>. F. W. ASTON, physicist and chemist of Cambridge, England, has recently been awarded a Nobel prize for his researches on the atomic weights of the elements. His work with certain vacuum tube phenomena has verified what was suspected before, that the atoms of any given element are not necessarily alike in weight although they do have identical chemical properties. Professor Soddy had already found that lead from uranium ore is about ten per cent lighter in atomic weight than the lead obtained from thorium ore element. Dr. Aston has found two isotopes, as the different parts of the element are called, of chlorine. Ordinary chlorine consists of a mixture of two kinds of chlorine, all the atoms of one group having an atomic weight of 35 (compared to oxygen 16), and all the atoms of the other group

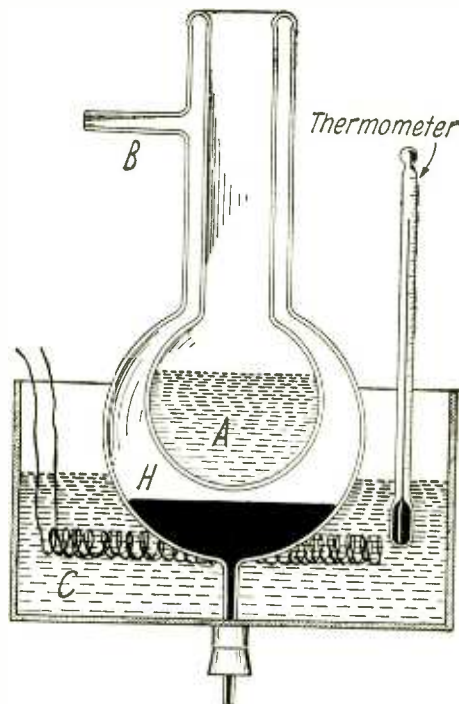

The Above is Apparatus Used by Dutch Chemists to Obtain Mercury Isotopes. The Mercury (H) is Boiled in the Vacuum Envelope of a Thermos Bottle by Immersing Bottle in Electrically Heated Oil. The Lighter Isotope Comes Off First and Freezes Against the Inside of the Bottle Containing Liquid Air. Residue is Then Poured Off and Frozen Product Allowed to Drip Back. Isotopes Obtained Thus Differed One-Half of One Per Cent. in Atomic Weight.

having an atomic weight of 37. The two groups are present in such proportions that the average atomic weight is 35.46—a figure that the chemist has heretofore accepted as the atomic weight of a one-kind-only atom of chlorine. It is found that the atomic weight difference between isotopes does not arise from a difference in size of the atoms but from a variation in mass of the tiny nucleus at the center of the atom. The isotopes of any given element are identical chemically and cannot be separated by strictly chemical methods.

The separation of isotopes being chemically impossible, any separation must depend upon mechanical methods founded upon the properties of mass.

# SAVE YOUR BODY

Conserve Your Health and Efficiency First  
 "I Would Not Part With It for \$10,000"

So writes an enthusiastic, grateful customer. "Worth more than a farm" says another. In like manner testify over 100,000 people who have worn it.

## THE NATURAL BODY BRACE

Overcomes WEAKNESS and ORGANIC AILMENTS of WOMEN and MEN. Develops erect, graceful figure. Brings restful relief, comfort, ability to do things, health and strength.

**Wear It 30 Days Free At Our Expense**

Does away with the strain and pain of standing and walking; replaces and supports misplaced internal organs; reduces enlarged abdomen, straightens and strengthens the back; corrects stooping shoulders; develops lungs, chest and bust; relieves backache, curvatures, nervousness, ruptures, constipation, after effects of Flu. Comfortable and easy to wear.

**Keep Yourself Fit**

Write today for illustrated booklet, measurement blank, etc., and read our very liberal proposition.

**Howard C. Rash**

Pres. Natural Body Brace Co.

286 Rash Bldg., Salina, Kansas



**For Boys and Girls Also**

# WANTED

Railway Mail Clerks  
 \$1600 to \$2300 Year

MEN—BOYS 18 or Over  
 Write Immediately

Steady Work. No Layoffs. Paid Vacations.  
 Travel on Pass  
 Common Education Sufficient.  
 Send Coupon Today—SURE.



FRANKLIN INSTITUTE, Dept. B181, Rochester, N. Y.  
 Sirs: Send me without charge, (1) Sample Railway Mail Clerk Examination questions; (2) List of Government jobs obtainable; (3) Send free sample book, "How to get Government Jobs."

Name .....  
 Address .....





Edited by  
Joseph H. Kraus

In this Department we publish such matter as is of interest to inventors and particularly to those who are in doubt as to certain Patent Phases. Regular inquiries addressed to "Patent Advice" cannot be answered by mail free of charge. Such inquiries are published here for the benefit of all readers. If the idea is thought to be of importance, we make it a rule not to divulge all details, in order to protect the inventor as far as it is possible to do so.

Should advice be desired by mail a nominal charge of \$1.00 is made for each question. Sketches and Descriptions must be clear and explicit. Only one side of sheet should be written on.

NOTE:—Before mailing your letter to this department, see to it that your name and address are upon the letter and envelope as well. Many letters are returned to us because either the name of the inquirer or his address is incorrectly given.

**RHEOSTAT**

(732) Fred Schriber, Sault St. Marie, Mich., has designed a rheostat which will control the current more gradually than the ordinary types. This is very simply constructed. He requests our advice.

A. Your idea seems to be meritorious, but before advising a patent on the same, we would suggest that you build a working model of the rheostat and test it out comparatively with other rheostats now found on the market. A comparative test is absolutely necessary. We do not hold that this finer graduation near one end of the rheostat is necessary, but the suggestion is worthy of further development.

**LAUNDRY MARKER**

(733) John Throp Wellbourn, New Wilmington, Penn., asks for our advice on a laundry marker made in the form of a button, which is to be clipped to the garments.

A. We do not see what advantage your laundry marker possesses over other devices now found on the market. It stands to reason that a marker of this nature if intended for laundry that is to be washed, would not only damage the material, but would also create a lot of trouble in attempting to remove the same from the garments. It produces a button-like effect which is liable to cut the individual upon whose articles the same is secured, and if made of non-rusting or non-tarnishing metal will be expensive. It cannot compete with India ink for wet wash; is more difficult to place on the object, and is ruinous. We do not advise a patent on the same.

**ELECTRICITY FROM WATER**

(734) J. C. Mangan, Portland, Oregon, writes, "In your July issue you published an article on 'Electricity From Sea Water'—I cannot understand how this is to work. Can I submit some ideas?"

A. With reference to the power machine described in the July issue of our magazine, we would advise that this device although scientifically possible, is very poor practically, an engineer having figured out that the maximum efficiency which such a machine could develop, is about .3%, which by the time all friction is overcome, causes the machine to remain at a standstill. We will be very glad indeed to receive your ideas, and give "patent advice" on the same. The scheme is susceptible of development and may prove practical in some other form at some future date. We published the idea for what it was worth. It possesses the germ of future possibilities.

**ADAPTOR SOCKET AND RHEOSTAT COMBINATION**

(735) Victor J. Humbrecht, Yardley, Pa., requests our advice on a very clever rheostat and adaptable socket combination, with a well designed additional 25-ohm rheostat placed into the circuit for low voltage tubes.

A. With regard to your rheostat, we would advise that although the idea presents a reasonable possibility of sale, the manufacturing of the same is more or less of a hazard. Most of the individuals who are purchasing and using U. V. 199's have no storage battery, and consequently the 25-ohm resistance element would have no particular use. The only place such a socket would be of value, would be in amplifying circuits where the individual desires to use a low voltage tube in the detector circuit in addition to his six volt tubes.

We doubt that a patent on the same will enable you to sell the device, although we are of the impression that should you place it on the market, you will be fairly well repaid for your trouble. It necessitates your actually manufacturing the device, however, in order to effect financial returns.

**TROUSER HANGER**

(736) C. W. Jackson, San Francisco, Calif., submits a sketch of a trouser hanger and asks our opinion on the same. It is convoluted and made of a single piece of wire or ribbon.

A. Your hanger for men's trousers is not such a remarkable novelty that it would warrant the expenditure of several hundred dollars in order to patent it and further develop it. You have given us no information regarding the width of the steel spring band which is to hold the trousers, and how this is to be employed.

There are many skirt hangers on the market with a duplex clip and a holder, far superior to your device, which are likewise employed by many men in hanging up their trousers, and which hold these trousers in an upright position, placing the seams in their proper position.

We would advise careful investigation before endeavoring to put your hanger upon the market, and suggest that you investigate the device from the angle of its worthlessness rather than its worthiness.

**INVENTIVE COURSES**

(737) R. E. Benson, Deer Lodge, Montana, asks several questions regarding our aim in conducting the patent advice columns, and asks advice regarding inventive courses. The questions are made clear by the answers to them here given.

A. SCIENCE AND INVENTION MAGAZINE makes it a duty to give advice to inventors like yourself, for which a charge of \$1.00 is made if a personal letter is requested, no charge if the answer is to be printed. This advice covers nearly every conceivable angle of the patent subject.

With reference to the course of which you speak, its originator is quite well known through his previous connections, as well as his present associations. He is, we believe, a free lance author, and was at one time editor of a small magazine dealing with mechanical subjects. He is likewise the author of several books.

Needless to say, no course in inventive science can make you an inventor. This depends on your own foresight, and your own ability. It can but assist you with your present ideas. This course will not tell you what is wrong with your invention.

**U.S. PATENTS**



SEND FOR THIS FORM

**Don't Lose Your Rights**

Before disclosing your invention to anyone send for blank form "Evidence of Conception" to be signed and witnessed. A sample form together with printed instructions will show you just how to work up your evidence and establish your rights before filing application for patent. As registered patent attorneys we represent hundreds of inventors all over the U. S. and Canada in the advancement of inventions. Our schedule of fees will be found reasonable. The form "Evidence of Conception" sample, instructions relating to obtaining of patent and schedule of fees sent upon request. Ask for them.—a post card will do.



255 OURAY BLDG.,  
WASHINGTON, D. C.

"Originators of form Evidence of Conception"

**PATENTS**

**TO THE MAN WITH AN IDEA**

I offer a comprehensive, experienced, efficient service for his prompt, legal protection and the development of his proposition.

Send sketch, or model and description, for advice as to cost, search through prior United States patents, etc. Preliminary advice gladly furnished without charge.

My experience and familiarity with various arts frequently enable me to accurately advise clients as to probable patentability before they go to any expense.

Booklet of valuable information and form for properly disclosing your idea, free on request. Write today.

**RICHARD B. OWEN, Patent Lawyer**  
164 Owen Building, Washington, D. C.  
2276-8 Woolworth Bldg., New York City

**PATENTS TRADE-MARKS AND COPYRIGHTS**

Before disclosing an invention, the inventor should write for our blank form, "RECORD OF INVENTION." This should be signed and witnessed and if returned to us together with model or sketch and description of the invention we will give our opinion as to its patentable nature. Radio and Electrical cases a specialty.

Our illustrated Guide Book, "HOW TO OBTAIN A PATENT," sent Free on request. Highest References Prompt Attention Reasonable Terms

FREE COUPON

**VICTOR J. EVANS & CO., Patent Attorneys**

Chicago Offices: 1114 Tacoma Bldg. Pittsburgh Offices: 514 Empire Bldg. Philadelphia Offices: 714-715 Liberty Bldg. San Francisco Offices: 1001 Woolworth Bldg. Hobart Bldg.

MAIN OFFICES: 779 NINTH, WASHINGTON, D. C.

Name..... Address.....



**UNITED STATES  
AND  
FOREIGN  
PATENTS  
PROTECT  
YOUR RIGHTS**

**PATENTS**

Any new article, machine, design or improvement thereof, or any new combination of parts or improvements in any known article which increases its efficiency or usefulness, may be patented, if it involves invention.

**IF YOU HAVE ANY  
NEW IDEAS**

which you feel are useful, practical and novel, take prompt action toward protecting your rights. If you have invented any new machine, or new combination of parts or improvement, or new process or design,

**Send Drawing, Model  
or Description**

of it for information as to procedure to secure protection.

**WRITE TODAY FOR  
BLANK FORM**

**"Record of Invention"**

to be returned to me with drawing, description or model of your idea. Promptly upon receipt by me of your idea I will write you fully as to procedure and costs.

**No Charge for the Above  
Information**

All communications are held in strict confidence. My personal, careful and thorough attention is given to each case. I offer you efficient, reliable and prompt service—based upon practical experience. *Highest references.*

Write today for free book "How to Obtain a Patent." This book will give you valuable information, and it may save you much time and effort. *Send for it NOW.*

My practice is devoted exclusively to United States and foreign patents and trade marks. Very probably I can help you. Write today.

**CLARENCE A. O'BRIEN**

*Registered Patent Attorney*  
241 Southern Bldg. Washington, D. C.

CLARENCE A. O'BRIEN,  
241 Southern Building,  
Patent Attorney,  
Washington, D. C.

Please send me your free booklet, "How to Obtain a Patent" and blank form "Record of Invention" without any obligation on my part.



NAME .....

ADDRESS .....

(WRITE PLAINLY)

You have been correctly informed by a lawyer that the only way to find out if your invention is patentable is to have a patent search made on the idea. The prices of a search vary, ranging from \$5.00 to \$15.00. Ten dollars is a reasonable price. This means that each one of your ideas, in order to be investigated, will necessitate an expenditure of \$10.00. This is the only possible way of assuring yourself that your suggestion has not been previously patented, unless you yourself desire to look through the patent files, and then, not knowing the classifications under which these patents appear, you would have difficulty in finding the patents which approach your idea.

It is of no value to protect yourself by means of priority claims unless you actually reduce the invention to practice, viz., building a working model of the same. The mere fact that you do not attempt to put this on the market because of a lack of funds will not protect you. It is up to you to find the necessary funds, and consequently any priority claims which you may have established are of no value unless the device is being sold. If, on the other hand, you should attempt to patent your idea, and find that some one else is attempting to secure a patent on a similar scheme, your priority claims will prove of immense value, provided that the dates on them precede those which the other inventor furnishes. Pleading poverty will not enable you to attach the property of some other inventor.

If you care to submit any of your ideas to us for more direct advice, we will be very glad to comment upon the same.

**RADIO PATENTS**

(738) H. B. Conant, Ouray, Colo., asks whether we would advise a patent on a new type of inductance for radio circuits, wound in layers in a combination inductive and non-inductive winding. He also requests our advice on a variometer vernier rotor shown in the il-

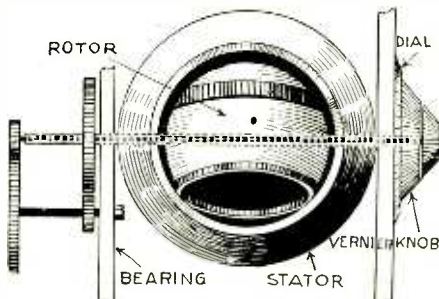

Above is shown a gear device for obtaining highly selective tuning with a plain variometer by means of reducing the torque of the shaft and knob through a series of gears. To the right is shown an adaptation of the Turney method of mounting crystals used as radio detectors. Querist asks if the two ideas are patentable.

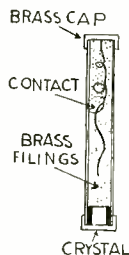

Illustration here, and a crystal detector likewise illustrated. The crystal detector is of the filings type.

A. Your first idea for a new type of inductance for radio purposes is not as new as you think. We have received some combination coils of this nature from France which are, in our opinion, very similar to your design. Nevertheless, we believe you could patent the same here in this country, and in view of the fact that you are the President of a radio concern, you could market such a coil with greater ease than an individual without such connection. We believe that you should at least go the extent of having a patent search made on this.

We would certainly advise against the gearing arrangement for the variometers and vario couplers. No doubt, the construction will give very fine tuning, but it is extremely expensive, difficult to mount and takes up entirely too much room. The gears are liable to get out of order if placed on the extreme end of such a long shaft, and in general the device would be more or less unsightly. We would advise against patenting this system as well as the system for mounting crystals which latter, in our opinion, cannot be patented. It is simply the restoration of the original Turney invention patented years ago by Mr. Eugene V. Turney.

**SHIP SALVAGER**

(739) Cecil F. Crusen, Green Bay, Wis., requests our advice on a ship salvager made in the form of gigantic tongs, like ice tongs, which are to go down, fasten themselves around the ship and hoist it up.

**READ!!**

**WORLD OF INVENTION**

**A Monthly Magazine  
INSTRUCTIVE and ATTRACTIVE**

THE MARKET PLACE—a department of immense possibilities—aims the sale of inventions and furnishes information of inventions needed—it is here that the minds of the seller and buyer meet.

Interesting contributions from scientists, inventors and prominent writers.

ENGINEERING DEPARTMENT is especially valuable to inventors.

Many other very desirable features.

Subscription \$2.50 for one year

Advertising rates on request.

For full particulars address

**World of Invention Company**

Three Thirty-four Fifth Avenue  
New York City, U. S. A.

**PATENTS**

**PROTECT YOUR INVENTION TODAY**

Write for FREE illustrated Patent Book. Radio-Electrical, Chemical and Mechanical Experts; Over 25 years' experience. Prompt, Efficient Service. Write today

**A. M. WILSON, Inc.**

311-17 VICTOR BLDG. WASHINGTON, D. C.

**PATENTS**

C. L. PARKER  
Formerly Member Ex-  
amining Corps, U. S.  
Patent Offices.  
**PATENT LAWYER**

McGill Bldg., Washington, D. C.

Patents, Trade Marks, Copyrights, Patent Litigation

Handbook for Inventors, "Protecting, Exploiting and Selling Inventions," sent upon request.

**PATENTS**

BOOKLET FREE HIGHEST REFERENCES  
PROMPTNESS ASSURED BEST RESULTS  
Send drawing or model for examination and report as to patentability.

**WATSON E. COLEMAN, Patent Lawyer**  
624 F Street N. W., Washington, D. C.

**PATENTS**

Trade-Marks, Copyrights and Patent Litigation  
Write for advice and instructions how to proceed, costs, etc.

Hand Book with illustrations of 100 Mechanical Movements sent free on request.

**ALBERT E. DIETERICH**

Patent Lawyer and Solicitor  
Successor to Fred G. Dieterich & Co.  
601 OURAY BLDG. WASHINGTON, D. C.

**PATENTS, TRADEMARKS  
PROTECT YOUR INVENTION!**

Prompt, Efficient, Personal Service.

Reasonable fee. Full explanation in my booklet "PATENTS." Send for free copy today.

**AMBROSE T. BUCKLEY**

150 NASSAU ST. NEW YORK CITY



**CAN YOU**

think of a simple, practical idea that will fill one of the many requests we have on file for new inventions? It may mean a fortune for you. Thousands of things are needed right now. Your brains can help. Send today for our great new book—**"Inventions and Trade Marks. Their Protection and Exploitation"** and learn more about making money from ideas than you ever knew before. It tells many things that are wanted, too.

A postal will do—  
it is free.

We help our clients, without charge, to get the dollars out of their ideas—having facilities none others possess.

Advice free.  
Don't delay—get the book at once.

**AMERICAN INDUSTRIES, INC.**  
225 Patent Dept.,  
WASHINGTON D. C.

**PATENTS ADVERTISED For SALE FREE**

In Invention and Manufacturing Supplement.

Published for the man with an idea. Send for free sample copy. One year's subscription 50c.

**PATENTS**

Hand Books on Patents, Trade Marks, etc., sent free. Our 77 years of experience, efficient service, and fair dealing assure fullest value and protection to the applicant. The Scientific American should be read by all inventors.

**MUNN & CO.**

618 Woolworth Building, New York

Tower Bldg., Chicago, Ill.  
Scientific American Bldg., Washington, D. C.  
Hobart Bldg., 582 Market St., San Francisco, Cal.

**PATENTS**

If you have an invention and desire to secure a patent, send for our Free Guide Book, **HOW TO GET YOUR PATENT**. Tells our Terms, Methods, etc. Send model or sketch and description for our opinion of its patentable nature.

**RANDOLPH & CO.**

Dept. 172 Washington, D. C.

**INVENTORS**

who derive largest profits know and heed certain simple but vital facts before applying for Patents. Our book **Patent-Sense** gives those facts free. Write **Lacey & Lacey, 644 F St., Washington, D. C.** ESTABLISHED 1869.

**MODEL MAKING**

When you have made your Model Boiler, you will naturally wish to mount it with the best Steam Fittings obtainable. We can supply accurately made miniature Steam and Water Gauges, Steam Valves, Pumps, etc., also finished Engines and Boilers suitable for Model boats and stationary purposes. Special work to order. Large illustrated catalog 20c (refunded on first order).

**BATHE MFG. CO.,**  
Dept. 2, 5214 Woodland Ave., Phila. Pa.

**HOME STUDY**

Become More Efficient through courses in **Mathematics, History, English, Chemistry, Psychology, Education, Business** and 35 other subjects which the University gives by mail. They command credit toward a Bachelor degree and may be begun at any time.

**The University of Chicago**  
27 Ellis Hall Chicago, Ill.

A. We frankly do not believe that the particular ship salvager which you have devised can be used practically. There are many such systems which in an attempt to place gigantic tongs around the ship and lift it up, would simply crumble the deck and in general destroy the vessel ripping it to pieces.

We doubt whether it could even be used to budge the vessel from the bottom, and what happens when the vessel is lying on the side, where it would be impossible for divers to reach it so as to apply the tongs, and where all efforts of the divers are mere haphazard guesses, is almost beyond the power of imagination. Furthermore locating the wreck and fastening the tongs is more difficult than you think.

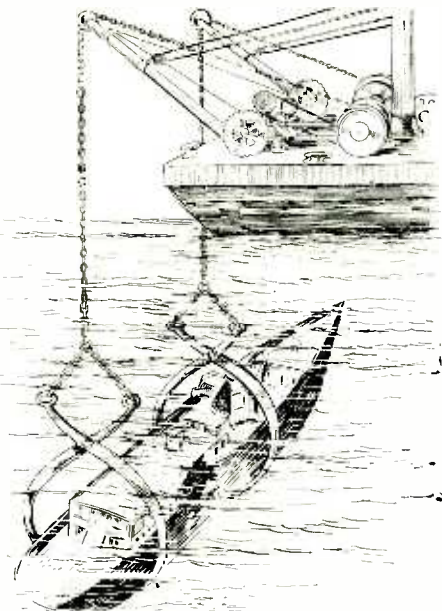

Above is Shown an Idea Brought Forward for Salvaging Sunken Ships. Advice is Asked. The Trouble with the Idea is That the Power Exerted on the Tongs Will, Likely, Crush the Ship.

**COMBINATION CIGARETTE AND MATCH**  
(740) Conly Clancy, Binger, Okla., asks for our advice regarding a combination cigarette and match, it being merely necessary to strike the cigarette on the side of the package and it will light.

A. Sometime ago we made a patent search on a combination cigarette and match, and found that the idea was fairly well covered by patents. Unfortunately, this suggestion is not as good as you may think it is, for the reason that should the match go out, one would have to light the cigarette as usual. On the other hand, the chemical mixture found on the head of a match, whether it is a safety match or an ordinary lucifer, seems to have a very peculiar effect on the tobacco of the cigarette. This tobacco is permeated with a sulphurous taste and odor when the two articles are placed together in close combination. At the same time when the match is lit and the smoker inhales his first puff of smoke, he will find that the products of combustion filtered through the tobacco make the cigarette taste badly. The same effect is obtained if one should light a match, and before the sulphur has had a chance to become thoroughly ignited, light the cigarette with the match. A nauseating taste is produced which will not leave the mouth for quite some time.

In view of the fact that some of the matches will go out, and that the taste of the cigarette is very poor, and further—that moisture will effect the properties of the match, and that the invention cannot be thoroughly covered, we would not suggest further action.



Upon Search, It is Found That This Idea of a Combination Match and Cigarette is Fairly Well Covered by Patents. Also the Fact That the Chemicals of the Match Have an Ill Effect on the Taste of the Tobacco.

**Renew Old Pieces With**



**JOHNSON'S WOOD DYE**

Johnson's Wood Dye is very easy to apply—it goes on easily and quickly, without a lap or a streak. It penetrates deeply bringing out the beauty of the grain without raising it—dries in 4 hours and does not rub off or smudge. Made in fourteen beautiful shades.

**FREE-This Book on Home Beautifying**

This Book tells how to finish wood in artistic stained and enameled effects. Gives practical suggestions on making your home artistic, cheery and inviting. Tells just what materials to use and how to apply them. Includes color card—gives covering capacities, etc. Use coupon below.



**S. C. JOHNSON & SON, Dept. 51 10, Racine, Wis. (Canadian Factory—Brantford)**

Please send me free and postpaid your Instruction Book on Home Beautifying and Wood Finishing.

The best dealer in paints here is.....

MY NAME .....

MY ADDRESS .....

CITY & STATE .....





# FREE Trial Lesson DRAFTING

Mail the coupon and we will send you this Free Trial Lesson which will show how well prepared you are to master Drafting. No obligation on your part, nothing to pay. While other schools ask you to enroll and pay a fee at once, we send you this lesson first. Before you pay a cent or even decide about enrolling—test your ability and learn about the Chicago Tech. Method of teaching Drafting by mail.

## Double Your Earnings

Big concerns everywhere are seeking expert Draftsmen. Top notch salaries are paid to experts. This is your chance to step ahead just as R. L. Cory did who reports 300% salary increase since training with Chicago Tech.; or as J. A. Da Costa did who was doing manual labor and rose to an executive position.

## Train by Mail

By the Chicago Tech. Method you can become an expert Draftsman by home study. Practical men will give you the training that brings highest pay. No useless theories—you learn how to handle actual problems. Direct personal instruction. We furnish full size professional Drawing Outfit (retail price \$25) free or credit you on fees if you already have one.

## Send the Coupon

Ask now for the Trial Lesson. We will send catalogs and full information about the Chicago Tech. Method. No obligation—no promise on your part. Send today.

**CHICAGO TECHNICAL COLLEGE**  
1045 Chicago Tech. Bldg., Chicago, Ill.

Without cost or obligation on me please send instructive matter about opportunities in line I have marked with "X".  
 **DRAFTING.** (The Big Salary Course). No experience necessary. Free Lesson sent now.  
 **BUILDING TRADE COURSE.**  
 For men in the building lines.

Name .....

Address .....

Post Office ..... State .....

### MAKE MONEY AT HOME

YOU CAN earn \$1 to \$2 an hour writing show cards at home in your spare time. Quickly and easily learned by our new simple "Instructograph" method. No canvassing or soliciting. We show you how, guarantee you steady work at home, no matter where you live, and pay you cash each week. Full particulars and booklet free. Write to-day.

**AMERICAN SHOW CARD SYSTEM LIMITED**  
Authorized and Fully Paid Capital, One Million Dollars.  
110 Adams Bldg., Toronto, Canada.

### STAMMER NO MORE

Kill the fear of stammering. Re-education the key. The widely famed Hatfield Method fully outlined in an accurate, dependable, worthwhile book—"HOW TO STOP STAMMERING." It has inspired thousands. Free copy today.

THE HATFIELD INSTITUTE, 109 N. Dearborn, Chicago, Ill.

## Around the Universe

By RAY CUMMINGS.  
(Continued from page 541)

"Ask him about Saturn, Uranus and Neptune," the quick-witted girl said immediately.

Sir Isaac put the question as humbly and placatingly as possible.

"They are uninhabited," said the Interpreter sourly.

His Supreme Highness was making ready to depart, apparently without further interest in the proceedings. Tubby had almost managed to climb to his feet, but at last he gave it up and sank back again.

"Come on," he panted. "Let's get—out of this. . . . This ain't no place for us—we're wastin'—time again."

Without further ceremony, like little disappearing manikins in a mechanical box, the three voyagers pulled themselves back out of the doorway of their vehicle and closed the door after them. Sir Isaac rolled across the floor of the instrument room—the easiest mode of locomotion—and hoisted himself into reach of the keyboard.

An instant later the vehicle, freed from the tremendous gravitational pull of Jupiter, flew like a rifle bullet into Space.

### Chapter VII

In Which the Voyagers Pass Saturn, Uranus and Neptune, and Leaving the Entire Solar System Behind Them Boldly Launch Into the Outer Realms of Interstellar Space.

**A** GAIN, after a voyage of some 450,000,000 miles the would-be saviours of their own world were doomed to disappointment! When they had again safely traversed the Jovian atmosphere, avoided Satellites II and IV with one of which they very nearly collided and were again launched into space, headed they cared not whither for the moment, the adventurers sat down to discuss this terrible misfortune.

As might be expected, the discussion yielded nothing. The miserable Jovian affair was most discouraging, though Tubby took a measure of satisfaction in it.

"I'm sorry for them Mercurians when they get there," he declared, with a sudden grin at the thought. "I wouldn't wish them no worse luck than askin' a favor of that Mogul guy."

"But what will we do?" Ameena asked. The brave little girl was extremely agitated as the possibility—even probability—of their final failure forced itself upon her. "Saturn, Uranus and Neptune are uninhabited! That leaves us nowhere else to go—and we must have help. We must!"

"I wouldn't bet a plugged nickel on anything that guy said about them other Planets," Tubby declared doggedly. "I say—let's see for ourselves. It ain't so much of a trip, is it?" Tubby, with Ameena's hand to hold most of the time, was not finding the voyage unpleasant in the least. Ameena flashed him a look of admiration as he made this sturdy suggestion. Sir Isaac pondered.

"We are now about 485,000,000 miles from the Sun," he said thoughtfully. "Saturn's mean distance is 887,098,000 miles; Uranus is 1,784,732,000 miles, and Neptune is 2,796,528,000 miles from the Sun!"

Tubby was slightly staggered; but he tried not to show it.

"That ain't so far," he declared. "Maybe we could speed it up a little out here."

Sir Isaac, as the idea began taking hold of him, was making a swift mathematical calculation.

## WE TEACH COMMERCIAL ART

**Meyer Both Company, the largest Commercial Art Organization in the World,** offers you an unusual opportunity for practical training, based upon twenty-three years of success. This nationally known organization each year produces and sells to advertisers over 15,000 commercial drawings. Meyer Both instruction is the difference between successful fact and experimental theory. This well paid profession equally open to men and women. Home study instruction.

**Get Facts Before You Enroll in Any School**

Ask the Advertising Manager of the leading newspapers in your city, anywhere in the United States, Canada, England or Australia about the Meyer Both Company—let them tell you about us. Write for our illustrated book telling about the success of our students—for one-half the cost of mailing—four cents in stamps.

**MEYER BOTH COMPANY**  
Department of Art Instruction  
Michigan Ave. at 20th St., Dept. 64 CHICAGO, ILL.  
Note—To Art and Engraving Firms: Secure practical artists among our graduates. Write us.

**Send for FREE story**  
Interesting, illustrated folder "How to get Greater Desk Efficiency" shows how to keep your desk cleared for action. Thousands of Kleradesks are giving entire satisfaction. Saves time locating, distributing or sorting papers. Takes less space than a tray. Sent FREE trial.

## Kleradesk



**Free Mailing Lists**  
Will help you increase sales  
Send for FREE catalog showing details covering names of your best prospective customers. Counts and prices are given on thousands of different mailing lists.

**99% Guaranteed 5¢ each**  
by refund of 5¢ each

**Ross-Gould Co**  
809 N. 10th Street, St. Louis

## SEND NO MONEY FOR THESE AUTOMATICS

LOWEST PRICES IN THE COUNTRY

**20 SHOT** MILITARY MODEL \$9.50  
32 cal. with Extra Magazine FREE



25 Cal. 6-shot Blue Steel..... \$6.25  
25 Cal. 8-shot Mauser..... \$11.95  
32 Cal. 7-shot Mauser..... \$12.95  
30 Cal. 9-shot Luger..... \$16.25



38 or 32.20 Cal. \$17.25  
**HAND EJECTOR**  
32 or 38 Cal. \$8.25  
**Break-Open REVOLVER**  
Brand New Guns Use Standard Ammunition.

Satisfaction Guaranteed or Money Back.  
Pay Postman Our Price, Plus Postage.  
**EDWARDS IMPORT TRADING CORP.**  
258 Broadway Dept. 9400 New York

**Send To-day for the "Electrical Worker's Friend"**  
An electrical book of 66 motor drawings with complete instructions for re-winding and reconnecting A. C. motors.  
**\$3.00**  
Special at .....  
Or write for full particulars of this valuable book.  
**SMITH & SMITH PUBLISHING CO.**  
Dept. B., 7428 Hermitage St., Pittsburgh, Pa.



"We might go past each of them without stopping to land if they are not habitable," he said finally. "Owing to their present positions it would be a trip of about 3,281,000,000 miles from here."

He added:

"That's nearly a third further than a direct route to Neptune owing to Saturn and Uranus being out of line." He showed Tubby and Ameena his chart again. "However, we ought to be able—"

"Sure thing," Tubby interrupted. "Let's get goin'. We're always wastin' so much time."

They were comparatively uneventful, the days that followed—uneventful that is, so far as Astronomical occurrences were concerned. To Tubby however, they were days of never-flagging interest. Sir Isaac, with his charts and his mathematics, concerned himself almost exclusively with navigating the vehicle. He had started on a rapidly-growing manuscript also—a sequel to the "War of the Worlds," he said; and except for a brief game of poker in the evening, he left his fellow-travelers entirely to their own devices.

Tubby and Ameena cooked the meals together, and washed the dishes; and, for relaxation sang their *Inter-planetary duets*. For the rest, Tubby held her little hand, and with his arm around her awed into silence, they watched together the never-ending vista of glorious stars toward which the vehicle was falling with constantly accelerating velocity.

Now that their voyage was extended into such gigantic distances, Sir Isaac, more than ever before, felt the need of haste. Only fifty-five days and some six hours from the time they left Jupiter remained before the fatal opposition of Mars with the Earth. Much could be accomplished in fifty-five days; but still, as Tubby lugubriously remarked, at the rate they were accomplishing it, fifty-five days was a very little time. Wherefore Sir Isaac, setting his determined jaw firmly, hurled the vehicle with prodigious velocity onward.

The danger of collision, which had so perturbed Sir Isaac in the region of Minor Planets between Mars and Jupiter was now greatly lessened. They had plenty of room now—for Asteroids, Meteors, even Comets were seldom sighted. It was a run of some 460,000,000 miles to Saturn, through a region of space comparatively deserted.

**THE TRAVELERS APPROACH SATURN**

At their former maximum velocity of twenty-eight million miles an hour, which Sir Isaac now maintained as an average, sixteen hours after leaving Jupiter they were approaching Saturn. It was then half-past four the following morning. Sir Isaac had slept the afternoon previous and was on watch. He awakened Tubby; and Tubby went immediately upstairs and called Ameena. Shortly afterward all three were crouched over the instrument room floor window, peering down at the great Ringed Planet above which they were seemingly poised some twelve million miles away. Sir Isaac had decreased their speed materially so that they might make observations without approaching too close.

Saturn, a globe almost as large as Jupiter, and with its marvelous system of rings very much larger, at this proximity was a magnificent sight. The globe itself—a gigantic silver disc occupying half the firmament visible through the window—had broad bands of darkened area upon it similar to those the voyagers had observed on Jupiter. But those rings! Tubby and Ameena were amazed into silence; even Sir Isaac was awed by their splendor.

**You Can Fill One of These Big-Pay Positions Waiting in Radio!**

**\$2,500 to \$10,000 a Year**

**N**O other training offers such opportunity for success as a Certified Radiotrician. Honor, power, position, wealth — all are easily possible for those who enter this great new profession NOW, while it is growing.

**Now the Easiest Growing Business**

Radio has jumped into the front rank of the world's great industries, yet it is only in its infancy. It's vast, amazing possibilities are as yet undiscovered in a large measure. And great as it is today, it will be a thousand times greater tomorrow! The man who gets into Radio today—who prepares NOW to grow up with this wonderful new science—will have a great share in its glorious future.

**Master Radio at Home**

To the ambitious man, Radio offers greater opportunities for success than any other profession or trade. It offers you a wonderful position, interesting work, and a fine salary. Radio spells SUCCESS.

The National Radio Institute, known the world over as the largest Radio Training Organization, will prepare you quickly in your spare time at home to qualify for the position you want. Hundreds of our graduates are today reaping big returns from their instructions. Some of them are radio inspectors and engineers. Others are in charge of land and sea stations. Still others are in charge of radio departments in stores or are in business for themselves.

**Pick Out the Job You Want We Will Help You Get It**

- Brief list of the positions in the radio field today and the salaries paid.
- Radio Mechanic, \$1,500 to \$4,000 a year.
  - Radio Inspector, \$1,800 to \$4,500 a year.
  - Radio Salesman, \$2,000 to \$10,000 a year.
  - Radio Engineer, \$3,500 a year and up.
  - Radio Executives, up to \$15,000 a year.
  - Radio Instructor, \$200 to \$500 a month.
  - Radio Draftsman, \$7 to \$15 a day.
  - First Class Ship Operator, \$105 a month, all expenses paid.
  - Second Class Ship Operator, \$95 a month, all expenses paid.
  - Third Class Ship Operator, \$85 a month, all expenses paid.
  - Commercial Land Station Operator, \$150 a month and up.
  - Broadcasting Station Operator, \$125 to \$250 a month.

**Big Money—Easy Work**

Most of our graduates when they started our course, knew little or nothing about Radio. Yet, in a few short months, our instructions qualified them to earn big money as Certified Radiotricians. The same instruction, the same help that brought quick success to these men, is now offered to you. You have the same opportunities, you have the same pros-



pect they had. Take advantage of them. Get into Radio NOW. Grow up with it. Advance with it.

**Send for FREE Book**

We have just prepared a wonderful book which is filled with the latest information about the wonderful opportunities in this newest and fastest growing profession. It will be sent to you absolutely FREE. Send for this book. It will tell you all about how we prepare you for, and help you to get or secure the wonderful positions open in this fascinating field. Mail coupon for this book NOW! National Radio Institute, Dept. 14-J, Washington, D. C.

National Radio Institute, Dept. 14-J, Washington, D. C.

Send me your wonderful book, "Your Opportunity in Radio" with full particulars about the opportunities in Radio, and how you will quickly train me in my spare time at home to become a Certified Radiotrician. Also tell me how your free Employment Service will help me to a position and particulars of your special short-time offer.

Name ..... Age .....  
 Street .....  
 City ..... State .....

**CATALOG E19-112 PAGES FREE**

**EVERYTHING IN RADIO**

One of the largest complete stocks in the world. 40 diagrams of latest Hookups.

**DEALERS ALL OVER THE U.S.**

Making big profits handling our supplies. 24-hour service. Goods shipped same day order received.



**WHOLESALE RADIO DISTRIBUTORS**  
 Dept. F. 107 E. 13th St. Kansas City, Mo.





## Thousands Can Draw CARTOONS Who Have Never Even Tried

Cartoonists earn from \$60 to far over \$300 a week. Why tie yourself to work that is drudgery when through a remarkable new method you can easily learn at home in spare time to draw cartoons that SELL?

Many are earning pitifully small salaries who could make wonderful salaries in cartooning. Briggs, Fox, Fisher, Goldberg and other leading cartoonists earn more than the President. Yet a few years ago many of our most successful cartoonists never dreamed they could draw a good cartoon!

### The World's Easiest, Pleasantest and Best Paying Profession

Just watch a cartoonist work. A few little lines—a couple of simple curves—a splash of black here and there—and then you see a splendid cartoon before you. With a few strokes of his pen, he has taken some little incident of his day's experience—some humorous or sad scene he has witnessed—and produced a wonderful cartoon.

### New Easy Way to Learn Cartooning

This fascinating ability to draw cartoons can now easily be yours—this ability which can mean so much real pleasure and profit to you. Through a wonderful new method you receive right at home through the mail a complete training in Cartoon Making, and personal corrections on all of your work from one of America's most prominent cartoonists!

With his help, you can in an amazingly short time learn to draw the comic strips, humorous, political and animated cartoons which are in such big demand.

### Learn More About Cartooning Send for FREE BOOK

Never have cartoons been so popular. Millions of dollars were spent last year on cartoons of all kinds—and every week newspapers increase the amount of cartoons used. Get full details on the amazing opportunities in this fast growing field of Cartooning and full information on this remarkable home study method. Mail coupon for FREE BOOKLET today.

WASHINGTON SCHOOL OF CARTOONING  
Room 2610, 1113—15th St., N. W. Washington, D. C.

WASHINGTON SCHOOL OF CARTOONING,  
Room 2610, 1113—15th St., N. W., Washington, D. C.

Please send me without obligation your illustrated FREE BOOKLET on Cartooning and details of Free Offer.

Name .....

(Write name plainly—State Mr., Mrs. or Miss)

Address .....

City..... State.....

If under 16 years, please state age.....

## Filters 4 Gallons in 5 minutes



### Fastest Portable Filter in the World FOR GRAPE JUICE, CIDER, ETC., ETC.

HOME SIZE filters quart of water a minute, No. 6A \$8.00.

LARGE SIZE filters gallon of water a minute, No. 6B \$15.00. Write for free circular.

VACCU-FILTERSALES CO., Inc.  
Dept. 6 70 Fifth Ave. New York

## ANYBODY CAN PLAY

So simple a child can play—by numbers instead of notes.

"FUN" at parties, entertainments, etc.

SEND NO MONEY, just your name. Pay postman only \$2.79 on arrival. We pay postage.

PUBLIC TRADING CO. New York  
23-5 5th Ave., Dept. 76.

FREE—15 SONGS!

### SATURN'S RINGS A GORGEOUS SIGHT

As viewed from the vehicle's present position, the concentric rings—the inner one somewhat darker—were opened up to an angle of nearly thirty degrees—a glistening, gleaming silver band, like the broad brim of a crownless hat encircling the Planet—a silver brim more than 37,000 miles broad, with a total diameter, including the sphere it encircled, of nearly 167,000 miles! Hanging there in space below them, the Planet, its rings and its several tiny moons bathed the interior of the instrument room with silver fire. It was the most glorious, most stupendous sight that human eyes had ever looked upon!

"Let us go down close," said Sir Isaac quietly.

A little later they could make out the composition of the rings with perfect clarity. Billions upon billions of tiny fragments of star-dust, each of them infinitesimal satellites, each of them like tiny moons reflecting the sunlight, whirled in their respective orbits about the mother Planet!

"The wonder of it!" Sir Isaac murmured. "A billion billion, and yet countless other billions of satellites—all on one identical plane, each separate, each holding its place and following its own circular orbit!"

Through the cloud-masses occasionally the onlookers could distinguish the surface of the Planet itself—could observe that it also was in motion, moving in gigantic whirlpools.

"It is undoubtedly entirely liquid or gaseous," said Sir Isaac, "of a density very much less than water. We shall find no inhabitants here."

"No; I 'spose not," Tubby agreed. He seemed, for once, reluctant to proceed with the journey. He sat with his arm tightly encircling Ameena's waist—as who would not, with such a girl and such a sight before one? "I guess we got to get on our way," he added with a sigh.

### THE COURSE IS SET FOR URANUS

Sir Isaac altered their course; and in an hour more they were well on their way to Uranus, with Saturn and his rings high in the firmament above them.

It was a run of about eleven hundred million miles from Saturn to Uranus. Sir Isaac had already maintained an average velocity of twenty-eight million miles an hour for some hours. He now determined to better it. Beyond Saturn, he was convinced, there was still less chance of encountering any derelicts. And, with each passing hour—each passing Planet from which they hoped to obtain help for their own threatened world—the panic in their hearts grew.

It was Tubby who voiced it most strongly.

"In fifty-four days from today the Earth goes out of business," he remarked dolefully, from a deep, reflective silence into which all three had fallen.

"Fifty-four days and twelve hours," corrected Sir Isaac. "If we don't succeed."

"We shall succeed," declared Ameena. "We must never think but that we shall."

Thus, always, woman's stronger hope and courage never flag.

The run to Uranus occupied some 28 hours—an average velocity of a trifle over 39,000,000 miles an hour. It was about noon of the following day when, after no particularly unusual incidents—Sir Isaac again slowed down for them to make observations.

It had grown colder steadily; the vehicle's heating plant was in active operation. The Sun had dwindled to a little blazing point among the stars.

All that morning the travelers had sat looking downward, watching Uranus grow from a brilliant star to a little moon; from

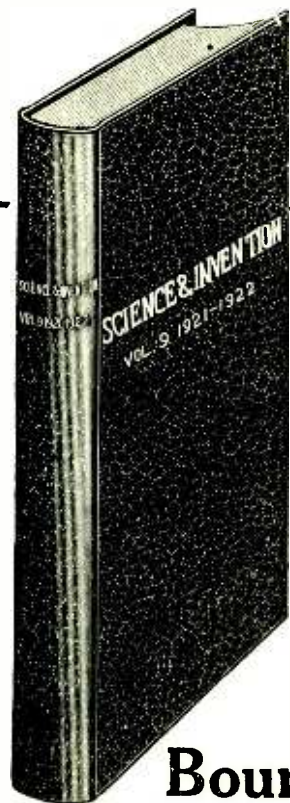

## Bound Volume No. 9

May, 1921—April, 1922

CONTAINS

1200 Pages with over 1500  
Illustrations

and

Over 700 Articles by the  
Foremost American and  
Foreign Writers

We have also a limited amount  
of the following Bound Vol-  
umes of *Science and Invention*  
(Electrical Experimenter):

Vol. No. 6—May, 1918, to  
April, 1919.

Vol. No. 8—May, 1920, to  
April, 1921.

Each volume bound in stiff  
board covered with green vel-  
lum and gold stamped.

Price for vol. No. 9.....\$2.25

Price for vol. 6 or 8..... 2.00

ALL THREE VOLUMES 6.00  
Send Express Collect.

EXPERIMENTER PUBLISHING Co.  
53 Park Place, N. Y.

Gentlemen:

Enclosed find \$..... for  
which send me bound vol. of S. & I.  
No. 6 ( ), No. 8 ( ), No. 9 ( ),  
by express collect.

Name .....

Address .....

Town..... State.....



moon to glowing silver-green disc. And now, at noon when they slackened their fall, the seventh Planet of the Solar System lay beneath them.

After Saturn, the sight was disappointing. Uranus, 32,879 miles in diameter, lay perfectly barren. Its axial motion, observed closely over a period of time, was distinguishable—like the minute hand of a clock that creeps slowly forward. Sir Isaac believed it to be of some six or eight hours duration.

Heavy banks of cloud masses obscured the Planet's surface; Sir Isaac had not believed Uranus would prove to have an atmosphere—but it had, and a very dense one obviously. But the surface of the Planet itself, what little they occasionally could see of it, was obviously liquid.

**URANUS NOT INHABITED**

"No inhabitants here," said Sir Isaac. Quite evidently he was tremendously disappointed, for he knew that the average density of Uranus was not much more than that of Jupiter, and he had hoped that in this instance the Jovian interpreter had been lying.

"No inhabitants here," Tubby echoed sadly. "Well, let's get on our way."

Between the orbits of Uranus and Neptune there lies a mean distance of 1,011,796,000 miles—that is to say, something over a thousand million miles. Neptune now, however, was unfortunately very much further along in its orbit, so that the oblique course necessary to reach this latter Planet lengthened the distance to nearly eighteen hundred million miles. Sir Isaac, after a very abstruse calculation, announced the exact mileage to be seventeen hundred, and ten million and twenty-six.

Tubby was getting used to these gigantic figures, which as anyone can realize, are only relative. Sir Isaac pointed this out clearly.

"On Earth, in a railroad train," he said, "if you were going at the rate of fifty miles an hour and had a journey of 1,710 miles to make, it would not be very confusing to fathom the figures, would it? Or to calculate how long it would take you to make the run? That is exactly comparable to this run we have before us now, from Uranus to Neptune. We have about 1,710 million miles to go, and I propose to average about 50 million an hour."

Here Sir Isaac fell back upon one of his favorite topics. "All distances are relative to other distances. A mile to a snail is a long trip, but an airplane makes it in two or three dozen seconds. There is no such thing as absolute distance—or absolute motion, or time or size. Everything is relative to something else. Twenty-four hours is a very little time in the life of an elephant—but it is more than a life-time to many insects. Our trip from here to Neptune is not more than an inch in all the countless miles of space. . . . But I'll tell you more about that some other time."

"Right," said Tubby, considerably relieved. "Just now we got to eat. Ameena's got lunch all ready."

The flight to Neptune occupied just thirty hours—an average of 57 million miles an hour. Sir Isaac was intensely pleased, though as he admitted to Tubby, the real velocity of the vehicle had never yet been tested.

Tubby and Ameena were also enthusiastic. "Wonder what become of them Mercurians who was after us?" Tubby speculated. "Swell chance of them gettin' way out here."

"They must have stopped at Jupiter," said Ameena. "We were gone then—they could not tell where."

(Continued on page 609)

**1923 ATLAS WITH MAPS OF NEW EUROPE FREE**

To the readers of Science & Invention who take advantage of this offer now made in connection with **Webster's New International Dictionary**

**The Only Grand Prize**  
(Highest Award) given to dictionaries at the Panama-Pacific International Exposition was granted to Webster's New International and the Merriam Series for superiority of educational merit.

**Words of Recent Interest**  
rotogravure, Flag Day, vitamin, fourth dimension, skidfin, Fascista, reactor, overhead, soviet, Blue Cross, camp-fire girl, Esthonia, Devil Dog, broadcast. These are but a few from the thousands of late words—all clearly defined in this Great Work.

**"The Supreme Authority" The Merriam Webster**

A Complete Reference Library in Dictionary Form—with nearly 3000 pages and type matter equivalent to a 15-volume Encyclopedia, all in a single volume. India-Paper Edition in Rich, Full Red Leather or Government Test Tan Buckram Binding also Regular Edition in strong, Red Fabricoid, can now be secured by readers of Science & Invention on the following remarkably easy terms.

**THE ENTIRE WORK (WITH COMPLETE 1923 ATLAS) DELIVERED FOR \$1.00** and easy monthly payments thereafter (in United States and Canada) on SUPERIOR INDIA PAPER

**Reduced About ONE-HALF** In Thickness and Weight

**India-Paper EDITION**

Printed on thin, opaque, strong, superior India paper. It has an excellent printing surface, resulting in remarkably clear impressions of type and illustrations. What a satisfaction to own the new Merriam Webster in a form so light and so convenient to use! This edition is only about one-half the thickness and weight of the regular edition. Size 12 3/4 in. x 9 3/4 in. x 2 3/4 in. Weight 8 1/4 lbs.

**Regular-Paper EDITION**

Printed on strong book paper of the highest quality. Size 12 3/4 in. x 9 3/4 in. x 5 1/2 in. Weight 16 1/2 lbs. Both editions are printed from the same plates and indexed. Over 407,000 Vocabulary Terms, and, in addition, 12,000 Biographical Names, nearly 32,000 Geographical Subjects besides thousands of other references. Nearly 3,000 Pages. Over 6,000 illustrations.



"To have this work in the home is like sending the whole family to college." The only dictionary with the New Divided Page, characterized as "A Stroke of Genius."

**The Atlas**

is the 1923 "New Reference Atlas of the World" containing 148 pages, with 96 pages of maps beautifully printed in colors, including changes brought about by the Great War, New Census Figures, Parcel-Post Guide, etc., all handsomely bound in red cloth, size 9 3/4 x 12 3/4.

To Those Who Mail This Coupon at Ocel G. & C. Merriam Co. Springfield, Mass.

Home Office Dept. S (Publishers of Genuine Webster Dictionaries for over 75 Yrs.)

Please send me free of all obligation or expense, a copy of "Dictionary Wrinkles" containing an amusing "Test in Pronunciation" (with key) entitled "The Americanization of Carver"; also "125 interesting questions" with references to their answers, and striking "Facsimile Color-Plate" of the new binding. Please include specimen pages of India and Regular paper with terms of your free Atlas offer on Webster's New International Dictionary to Science & Invention readers.

Name .....  
Address .....

**Smashing Reduction!**



**BOXING, Jiu-Jitsu, Wrestling**

**\$1.97** Plus Actual Postage

Here's your chance to get the famous Marshall Stillman Boxing Course for the price of a good necktie. Six books clearly printed on fine paper, over 240 half-tone illustrations. The most scientific method of teaching boxing ever devised.

You should see all the letters we receive regarding the wonderful results obtained. Some subscribers have whipped men 30, 50 and 60 lbs. heavier than themselves. Even professionals who have taken the course are enthusiastic.

Marshall Stillman teaches by association of ideas. You hold out your hand as though for a coin, lower your head like a goat butting, etc. Then you are led to similar movements in hitting, ducking, etc. You learn quickly and never forget. Soon you are feinting, ducking, sidestepping, blocking and hitting like a veteran.

FREE book included containing lives of 69 famous boxers with little known stories.

Also a book devoted to the wonderful art of Jiu Jitsu.

**10-Day Trial—Send No Money**

Simply mail the coupon. When you receive the course, deposit 97 cents plus actual postage. Try it out for 10 days. Then send us the small final payment of \$1, or return the course, and we'll send your deposit back.

**COUPON**

**MARSHALL STILLMAN ASSOCIATION**  
Dept. 1423-K, 42nd St. and Madison Ave., New York

You may send me on approval the Marshall Stillman course. I will deposit 97 cents (plus actual postage) with the postman with the understanding that if, after 10 days, I wish to return the course I may do so and my money will be instantly refunded. If I keep the course I am simply to send you \$1 in final payment.

Name .....  
Address .....

(Canadian and foreign orders must be accompanied by cash (\$1.97 U. S. funds) subject to money back guarantee if not entirely satisfactory.)



# NEW 25c BOOKS

## That Every Novice or Amateur Needs

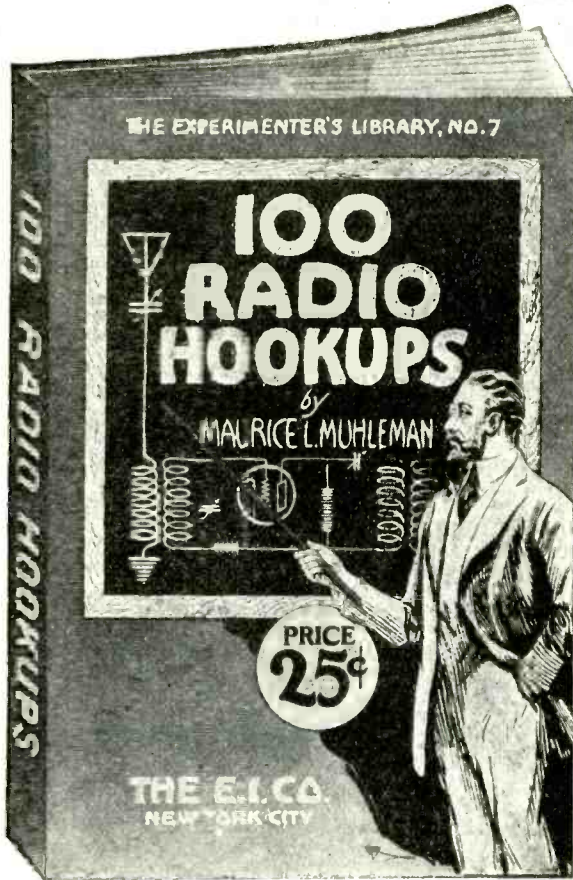

### 100 Radio Hook-ups

By M. L. MUHLEMAN

A book for both the novice and advanced radio amateur containing a varied selection of hook-ups from the simple crystal to the more elaborate circuits, with a circuit for every requirement. Crystal hook-ups, combined crystal with radio and audio frequency amplifiers, non-regenerative, and regenerative vacuum tube circuits with and without radio and audio amplifiers. Amplifier units, with straight jacks, filament and switching arrangements, power amplifiers, choke coil, resistance coupled and transformer coupled radio frequency amplifiers.

Includes all of the latest, one and multi-tube hook-ups including the numerous types of Reflex, super regenerative, super-Heterodyne, Neutrodyne, Reinartz, Flewelling, and Bishop. The values and constants of all apparatus employed in the hook-ups are given. A list of radio symbols is included, which are of material help to the reader in determining the meaning of the conventional hook-up diagrams. The text includes much helpful information.

52 Pages—Two-Color Cover ..... **25c.**



This book covers in comprehensive form, the fundamental principles of tuning. The characteristics of radio waves are fully described and illustrated. Illustrations are used so that the non-technical reader can easily understand the identical actions as applied to radio. Several chapters are devoted to the use and functions of all radio apparatus. The book describes how to tune such sets as the Reinartz, Flewelling, Neutrodyne, radio frequency amplifier receivers and other.

52 pages,  
25 Illustrations  
Prepaid ..... **25c**

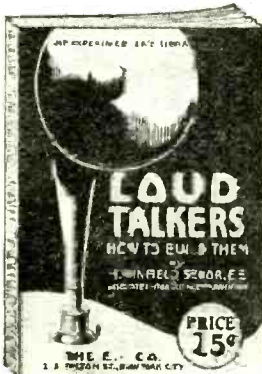

This book describes and gives complete data for building two distinct types of loud talkers. One chapter deals with improvised loud talkers, and gives complete instructions on how to build suitable horns for use in loud receivers of the Baldwin and other types. In preparing these designs, the point has been constantly kept in mind to use the simplest parts possible, so that anyone can build a successful loud talker, equivalent to the commercial types, costing \$40.00 or more.

48 pages, Profusely  
Illustrated  
Prepaid ..... **25c**

A non-technical book for the beginner. Gives complete constructional data on the building of a complete Crystal Detector Set, Tuning Coil, Loose Coupler and a Single Audion Tube Set with Amplifying Units. It furnishes all dimensions and working drawings of every part that must be constructed by the amateur. Written in plain, simple language that anyone can understand. The opening chapter gives a complete description of the theory of radio and tells what it's all about, teaching the principles of wireless so that the constructor knows what he is doing.

48 Pages, 26 Illustrations  
Bound in Beautiful Two-  
Color Cover. Size, 5 1/2  
x 7 1/2 in. Prepaid ..... **25c**

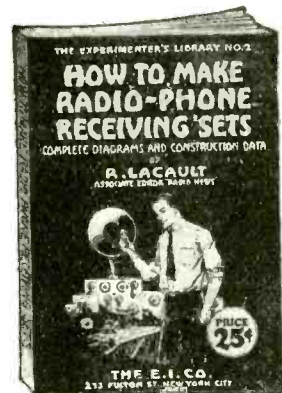

This book is for the more advanced amateur, showing the construction of the Radio Frequency Amplifying Transformer and giving complete constructional data. It shows the application of Radio Frequency to amplifying units that the amateur may already possess and gives 15 hook-ups showing practically every use Radio Frequency Amplifying Transformers can be put to.

32 Pages, 15 Illustrations  
Bound in Beautiful Two-  
Color Cover. Size, 5 1/2  
x 7 1/2 in. Prepaid ..... **25c**

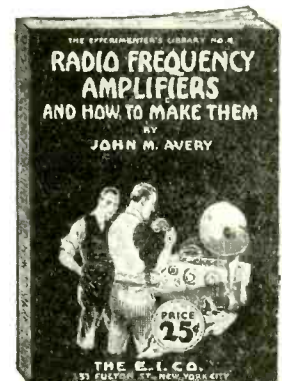

A complete list of dealers carrying these books will be found on page 614

If your dealer cannot supply you—order direct from us—giving dealer's name and address.

**THE E. I. COMPANY (THE CONRAD CO.)** 233 Fulton St., N. Y. City  
Selling Agents



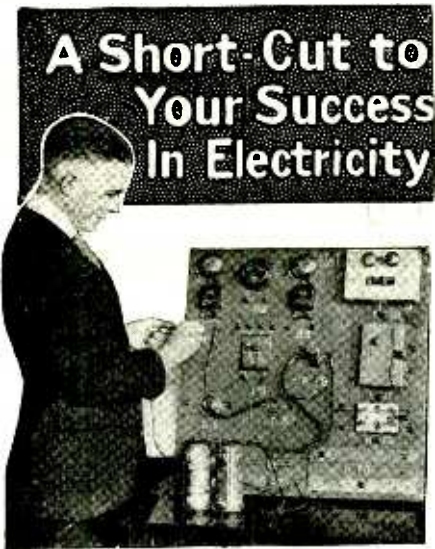

## A Short-Cut to Your Success In Electricity

**FREE** \$500.00 ELECTRICAL LABORATORIES

### Sent to Your Home

NOT toys—but real actual-size, expensive units of electrical apparatus are mailed to you without extra charge while learning. The illustration shows one of the new home-laboratory outfits. As fast as you have completed the work of one laboratory, another is sent, until you have mastered the entire field. You, therefore, advance step by step, from simple electrical experiments to complicated, intricate, important practical work.

### Learn Electricity this New Quick Way

You can get the finest electrical training at home in your spare time. You need not leave your job, your friends, your home. This wonderful new home-laboratory training course in Practical Electricity brings this great, big technical school to your very door—into your very room. It develops ability, step by step, and leads you to every reward the great field of electricity can offer.

### Just Like Going to School

Our large faculty of experts offer you a short cut that combines theory and practice, eliminating all the non-essentials. The plan is so simple—so logical—so carefully arranged, and also so interesting, that in a surprisingly short time you will have made yourself a master of technical electricity.

### Earn Big Pay

Billions of dollars are invested in this great industry. Trained experts are in demand and handsome salaries are paid. You can easily master the work through our personal coaching and "home-laboratory" plan so that you can step immediately into the industrial field. **WE ASSIST ALL OUR GRADUATES TO POSITIONS WITH THE WORLD'S GREATEST ELECTRICAL FIRMS IN THE UNITED STATES.**

### Free—Electrical Apparatus

In addition to the free use of our 9 large electrical experimental boards we will give you all materials and apparatus needed for experimental work with the 9 outfits, absolutely free and ship it with the first laboratory shipment. No materials to be purchased by you. We furnish everything needed.

EXTENSION-DIVISION  
**SCHOOL OF ENGINEERING**  
of Milwaukee

415 Marshall Street Milwaukee, Wis.

Extension-Division,  
School of Engineering,  
Dept. F-10, 415 Marshall St., Milwaukee, Wis.

Please send me full details of your "new wonderful laboratory method" of home-study in Practical Electricity. This request obligates me in no way.

Name .....

Address .....

Town ..... State .....

## Around the Universe

(Continued from page 607)

This obviously, was logical. At all events, the Mercurian vehicle was now the least of their worries. Neptune lay beneath them. Would they secure, on this far outpost of the Solar System, the help they needed? Fer- vently they prayed so, for it seemed their last chance.

### THE SKY FLIERS APPROACH NEPTUNE

It was just 6 P. M., on the day following their departure from the vicinity of Uranus, when Sir Isaac held the vehicle poised above the surface of Neptune. The Planet, very slightly smaller than Uranus, lay com- pletely enveloped in its dense atmospheric envelope.

"We got to go down," said Tubby frown- ing. "Can't see nothin' from way up here."

The descent through Neptune's atmos- phere was pleasurable, for the friction warmed the vehicle once more to comfortable temperature. At an altitude of some fifteen thousand feet they emerged from the dense cloud-banks into Neptunian daylight. And what a dim, miserable daylight it was! And below, what a bleak, dreary sight met their disappointed gaze! With sinking hearts—their last hope gone—they stared downward. Neptune's surface—flat un- marked by a single distinguishing physical conformation—might have been the surface of a polar sea! In all directions, to the circular rim of the raised horizon, stretched a level surface of grey-white snow, dirty- looking in the twilight which was Neptune's day. But whether land lay beneath, or merely some frozen liquid, could not be told.

There was not a sign of life—nothing but bleak desolation. It was an amazing sight—an old world seemingly, when every- thing in the logic of Sir Isaac's scientific mind had led him to anticipate a new one—a world of heat, of liquid or gas turbulent from its own internal fire.

Sir Isaac muttered to himself. Looking upward through the side window with Tubby, they saw the Sun through a rift in the clouds—a tiny pencil-point of light in the dull, reddish-blue sky—a dreary, re- mote Sun, hopelessly impotent to light or to warm this far-away off-spring.

Tubby's face was solemn as he turned to his friend.

"Ain't no use goin' down no farther. That's our finish—that put's our Earth out of business."

Silently the vehicle, with its three sad- dened, frightened occupants, ascended through the Neptunian atmosphere, again into space.

"Well," said Tubby finally. "Now what? That's the end, ain't it?"

Again it was Ameena who first recovered her courage. Her lips were compressed; her beautiful, dark eyes blazed with deter- mination.

"It is *not* the end, my friends! To such men as you the end never comes before de- feat!"

She pointed to the Stars blazing outside the window—the band of "Milky Way," a myriad stars brighter now from this outer edge of the Solar System—and added:

"There are other worlds—countless other worlds. Let us go to them! With all the haste we can make—forgetting danger to ourselves—let us hurry. Here at home, in our own little Solar System, we have been rebuffed. But somewhere in this Universe there must be humans who are unselfish—

(Continued on page 611)

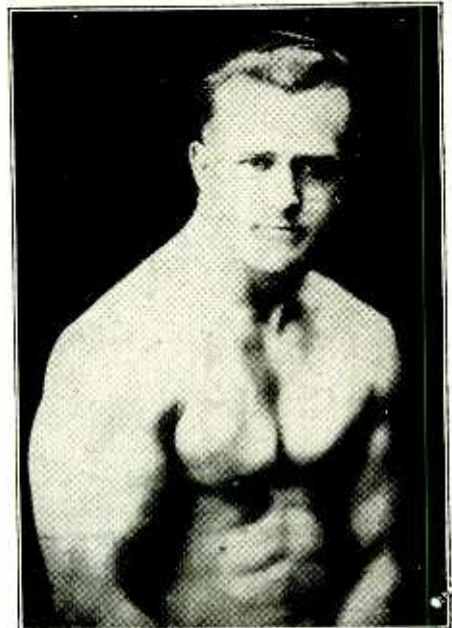

Earle E. Liederman as he is to-day

## Gee! But It's Great To Be Healthy

Up in the morning brimming with pep. Eat like a kid and off for the day's work feeling like a race horse. You don't care how much work awaits you, for that's what you crave—hard work and plenty of it. And when the day is over, are you tired? I should say not. Those days are gone forever. That's the way a strong, healthy man acts. His broad chest breathes deep with oxygen purifying his blood so that his very body tingles with life. His brain is clear and his eyes sparkle. He has a spring to his step and a confidence to tackle anything at any time.

### Pity the Weaking

Don't you feel sorry for those poor fellows dragging along through life with a neglected body? They are up and around a full half hour in the morning before they are half awake. They taste a bit of food and call it a breakfast. Shuffle off to work and grax through the day. It's no wonder so few of them ever succeed. Nobody wants a dead one hanging around. It's the live ones that count.

### Strength Is Yours

Wake up fellows and look the facts in the face. It's up to you right now. What do you plan to be—a live one or a dead one? Health and strength are yours if you'll work for them, so why choose a life of suffering and failure?

Exercise will do it. By that I mean the right kind of exercise. Yes, your body needs it just as much as it does food. If you don't get it you soon develop into a flat-chested, narrow-shouldered weaking with a brain that needs all kinds of stimulants and foolish treatments to make it act. I know what I am talking about. I haven't devoted all these years for nothing. Come to me and give me the facts and I'll transform that body of yours so you won't know it. I will broaden your shoulders, fill out your chest, and give you the arms and legs of a real man. Meanwhile, I work on the muscles in and around your vital organs, making your heart pump rich, pure blood and putting real pep in your old backbone. This is no idle talk I don't promise these things—I guarantee them. If you doubt me, come on and make me prove it. That's what I like.

Send for My New 64-Page Book

### "MUSCULAR DEVELOPMENT"

It contains forty-three full-page photographs of my- self and some of the many prize-winning pupils I have trained. Some of these came to me as pitiful weak- lings, imploring me to help them. Look them over now and you will marvel at their present physiques. This book will prove an impetus and a real inspiration to you. It will thrill you through and through. All I ask is 10 cents to cover the cost of wrapping and mailing and it is yours to keep. This will not obligate you at all, but for the sake of your future health and happiness, do not put it off. Send to-day—right now, before you turn this page.

EARLE E. LIEDERMAN

Dept. 210, 305 Broadway, New York City.

EARLE E. LIEDERMAN,  
Dept. 210, 305 Broadway, New York City.

Dear Sir:—I enclose herewith 10 cents for which you are to send me, without any obligation on my part whatever, a copy of your latest book, "Muscular Development." (Please write or print plainly.)

Name .....

Street .....

City ..... State .....



JUST OFF THE PRESS

12th Edition

# WIRELESS COURSE IN 20 LESSONS

By S. GERNSBACK, A. LESCARBOURA and H. W. SECOR

Very Greatly Enlarged

Price  
**\$2.00**  
Postpaid

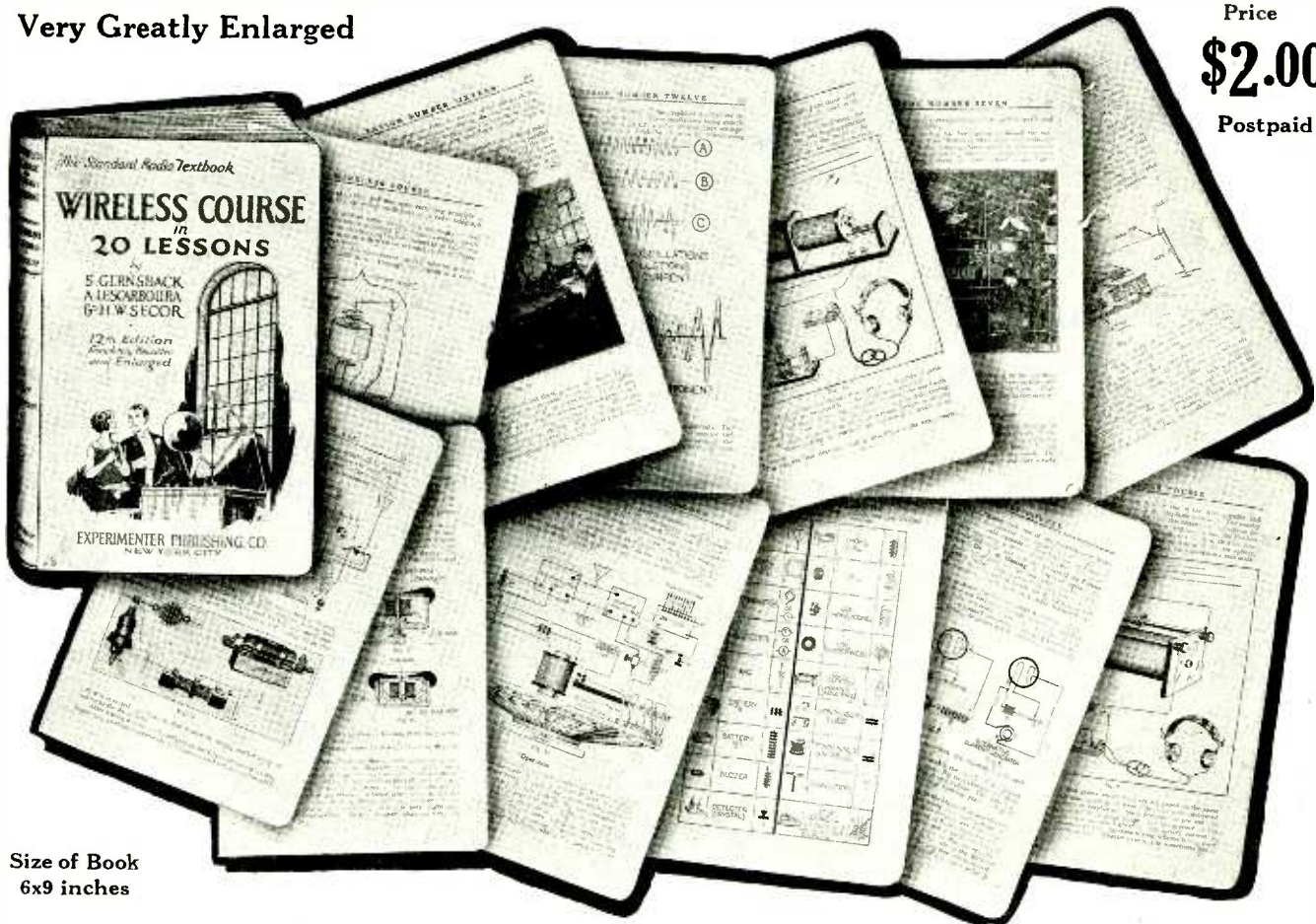

Size of Book  
6x9 inches

264 pages. 500 illustrations, diagrams and photographs. Binding de luxe; black leatherette cover, genuine gold stamped; red edges; round corners; semi-flexible covers; multi-colored jacket.

This new edition contains over 100 pages more than the previous editions, of which over 100,000 were sold. It is printed in a larger type, on better paper and has better and more illustrations.

- Lesson No. 1: Principles of Electricity:**  
History and Explanation of Electricity, etc.
- Lesson No. 2: Principles of Magnetism:**  
The History and Explanation of Magnetism, etc.
- Lesson No. 3: Dynamos, Motors, Generators, and Wiring:**  
Explanation of Construction and Operation of each of the above, etc.
- Lesson No. 4: Principles of Wireless Telegraphy:**  
History and Explanation of the Wave Transmission and those concerned in the development of early radio, etc.
- Lesson No. 5: Amateur Transmitting Sets and Apparatus:**  
Apparatus and Circuits used by Amateurs in the early days of radio telegraphy, etc.
- Lesson No. 6: Transmitting Sets (Continued):**  
Apparatus and Circuits of Transmitting Apparatus, etc.
- Lesson No. 7: Commercial Transmitting Systems:**  
Apparatus and their operation, etc.
- Lesson No. 8: Aerials and Underwriters Installing Regulations:**  
Explanation of the Antenna System and Constructional details of the various types used. Official regulations, etc.

- Lesson No. 9: Radio Receiving Apparatus:**  
Description of the Various Types of Receiving Apparatus with an explanation of their operation, etc.
- Lesson No. 10: The Detector:**  
An explanation of the various types of detectors used for reception purposes, including circuits, etc.
- Lesson No. 11: The Vacuum Tube as a Detector:**  
Principles of operation of the vacuum tubes, etc.
- Lesson No. 12: Regenerative Receiving Set:**  
Description and explanation of various vacuum tube circuits, etc.
- Lesson No. 13: The Vacuum Tube as an Amplifier:**  
Operation of the types of amplifiers as in conjunction with tuners. Loud Speakers, etc.
- Lesson No. 14: Practical Vacuum Tube Circuits:**  
An explanation of various up-to-date Circuits used in Radio, etc.
- Lesson No. 15: Super-Regenerative Receiver:**  
Operation of the Super-Regenerative Receiver, etc.
- Lesson No. 16: Vacuum Tube Transmitter:**  
Vacuum Tube Transmission and Broadcasting Systems, etc.
- Lesson No. 17: Radio Compass—The Wavemeter—Radio Control:**  
The Radio Compass. Principles and operation of the Wavemeter and Radio Control, etc.
- Lesson No. 18: Learning to Operate—The Codes—The Wireless Law:**  
Methods of learning the International Code. Appendix: Detailed regulations of the wireless law, etc.
- Lesson No. 19: History of the Development of Radio:**  
A progressive history of radio and those concerned in its progress, etc.
- Lesson No. 20: Mathematics of Wireless Telegraphy and Appendix:**  
Formulas for the Calculation of Wave-length, Inductance, Capacity, and other measurements, etc.

Sent postpaid upon receipt of \$2.00

If your Dealer cannot supply you, order direct from us, giving Dealer's name and address

**Experimenter Publishing Co., 53 Park Place, New York, N.Y.**



**Learn to Write**

**I TEACH BY MAIL**  
I can make a good penman of you at your home during spare time, no matter where you live or how poorly you write. My simplified system has shown thousands the way to good penmanship during the past twenty-five years—it CAN and WILL do the same for YOU.

*How to Write*  
The system above and below show the wonderful improvement made in less than six months. Price of 200 B. C. Glenside, Pa.

*How to Write*  
It contains three beautiful specimens accomplished by the Tamblin System with instructions and general information about our courses. (Your name elegantly written on a card if you enclose stamp for postage.) Ladies taught as successfully as men. Write Tamblin, Address: W. TAMBLIN, 424 Ridge Bldg., Kansas City, Mo., U.S.A.

*W. Tamblin*

**Around The Universe**

(Continued from page 609)

who though without hope of reward, still will not suffer their own kind to go down into disaster and death!

Her enthusiasm was contagious. "Come on!" shouted Tubby. "Let's get going! There's a big star—let's go to that one!"

Sir Isaac thumped his fist on the table. "We will!" he exclaimed. "I shall attain a velocity never before even imagined! We must—we shall find help for our Earth."

A few moments later, sweeping circularly around Neptune, the undaunted adventurers left the Solar System behind them and launched themselves boldly out into the uncharted realms of Inter-stellar Space!

**CHAPTER VIII**

**IN WHICH, EN ROUTE TO ALPHA CENTAURI, SIR ISAAC EXPLAINS THE STRUCTURE OF THE UNIVERSE AND PLUNGES INTO THE MOST ABSTRUSE MATHEMATICAL CALCULATION EVER ATTEMPTED BY THE HUMAN MIND.**

"We must not rush into this thing thoughtlessly," Sir Isaac declared, when the first flush of their enthusiasm was passed and practicality began to creep in. "We must plan—calculate. Our time is limited. We only have—"

"Fifty-two days exact," Tubby finished. "How far we got to go? Ain't we gone a good ways already?"

Sir Isaac had made several brisk computations a few moments before. Neptune, with the entire Solar System behind it, already hung far above them. They were falling downward, apparently toward a very bright Star which gleamed amid a myriad of its fellows in the lower firmament.

"We have relatively a very great distance to go," said Sir Isaac, answering Tubby's question. "We are already on our course to the nearest of all the Stars—and fortunately we happen to be at that extremity of the Solar System nearest to it." He pointed to the lower window.

"Very good," approved Tubby as usual. "The closest Star. Very good. What's its name an' how far away are we? An' say, what's a Star anyway? We been dealin' in Planets so long—"

Sir Isaac smiled. "To answer your last question first, I shall have to give you a brief explanation of the nature of the entire Universe."

Anticipating a somewhat lengthy dissertation of the sort Sir Isaac seemed to delight in, Ameena settled herself beside Tubby and gave him her hand to hold.

"Go on, Sir Isaac, please do," she pleaded. "Go ahead—shoot," said Tubby.

Thus encouraged, Sir Isaac began: "The region we call Space is a limited area whose boundaries I shall explain some other time. You have not read my book about the 'Golden Atom,' I assume?"

Tubby and Ameena expressed their regrets.

Sir Isaac frowned slightly. "Oh well—that is immaterial. In that scientific narrative I dealt with infinite smallness, and now we are dealing with infinite largeness. The theory is the same. . . . However, this region we call Space is devoid of air. It is not, of course, a vacuum, but is completely filled by the ether."

"What's that?" demanded Tubby. "The ether, my friends, is an agglomeration of imponderable atoms, which, relatively to their small dimensions, are as far removed from each other as are the Celestial bodies in Space. It is these atoms which, by their vibratory motion, produce both light



**Leading Electrical Concerns**

**Join America's Foremost School in Practical Electricity**

**to Develop Trained Men**

To meet the extraordinary present-day demand for trained electrical men, a number of big Milwaukee Industrial Concerns have taken a step without precedent or parallel. They have entered into a contract with the School of Engineering of Milwaukee to give their students part-time employment at practical electrical work during their entire course of study.

This gives you an opportunity absolutely unique in the history of technical education—the opportunity to secure a sound, through-and-through training in both the "book" and the "dollar-and-cents" sides of

**Commercial and Electrical Engineering**

You can earn your living expenses while pursuing your studies. Mornings—lectures and laboratory work at school; afternoons—actual practice in the work rooms of the industrial companies. What better start in life could you ask than this chance to acquire a complete job-insuring, technical training under actual wage-earning, working conditions, giving you confidence in yourself and a feeling of security in holding your job?

**A Permanent Job For Every Graduate**

Feeling the tremendous need for more men with the sound, technical training afforded by this school, these same concerns have agreed to employ all our duly qualified graduates at good salaries the moment they receive their diplomas.

To meet this demand, we offer the following courses to students with fourteen high school units:

- Commercial Electrical Engineering . . . . . 1 year
- Electrical Engineering, B.S. Degree . . . . . 3 years

Students with only a common school education may take Electrotechnician Course in 1 to 2 years; Practical Electricity in 6 months to 1 year; Armature Winding in 3 months; Wiring and Testing in 3 months; and Automotive Electricity in 3 months.

Established eighteen years ago, the School of Engineering of Milwaukee stands absolutely alone in the field of electrical and commercial engineering. Has the emphatic and unqualified endorsement of all leading engineering industries. Write at once for full particulars. New classes now organizing.

**SCHOOL of ENGINEERING of Milwaukee**

S.1.-10-415 Marshal Street, Milwaukee, Wis.

Fill out this coupon and return now for full information.

SCHOOL OF ENGINEERING, S.1.-10, 415 Marshall St., Milwaukee, Wis.

Gentlemen: Please send me complete details regarding your Earn-While-You-Learn proposition and the . . . . . Course. (Fill in the course most interested in.)

Name . . . . .

Address . . . . .

City . . . . . State . . . . .

**Mechanics Agents Wanted**

This gauge as shown is an angular gauge, graduated on the front, at the right of the slot, to show the sizes of screws of the "American Standard" screw gauge from 2 to 11 which includes the measurement of both machine and wood screws.

In addition to the gauge numbers it is also graduated on the left of the slot by 32nds of an inch making it very handy for determining the diameter of small rods, wires, etc., quickly and accurately. A screw, wire or rod is measured by passing it down into the angular opening till it touches on both sides of the slot. Gauge complete with instructions as to the various uses and agents' proposition 25c postpaid; 8 for \$1.00.

**DAYTON-ROGERS**  
3101 Lyndale, S.  
Minneapolis, Minn.

**Agents: 90c an Hour**

Introduce "Soderose." A new wonder. A pure solder in paste form. Works like magic. Stops all leaks. For mending water buckets, cooking utensils, milk pails, water tanks, tin roofs—everything including granite ware, agate ware, tin, iron, copper, zinc, etc.

**Quick Sales—Nice Profit**

Everybody buys. Housewives, mechanics, electricians, jewelers, plumbers, tourists, automobilists, etc. No leak too bad to repair. Just apply a little "Soderose," light a match and that's all. Put up in handy metal tubes. Carry quantity right with you. Write for money-making proposition.

**AMERICAN PRODUCTS CO., 4817 American Bldg., Cincinnati, Ohio**

**A THRILLING CAREER**

Become a reporter and news writer at home. Practical New York newspaper men quickly teach you this fascinating, well paid work. Personal instruction in Reporting. Writing for Out-of-Town Papers, Sports, Publicity, Society, etc. You can earn \$100 to \$400 monthly, part or whole time. Men and Women. Metropolitan School of Journalism, 50 East 12nd St., Dept. 105, New York, N. Y.

**Become A Reporter! FREE BOOK Tells All**

**BECOME A LIGHTNING TRICK CARTOONIST**

Make money chalk talking. Send \$1.00 for snappy program of trick drawings, with instructions by a professional cartoonist. Satisfaction guaranteed. Circular free. Balda Art Service, Dept. 4, Oshkosh, Wis.

**SELL COAL IN CARLOAD LOTS**

Salesman Wanted. Side or main line. Experience unnecessary. Earn week's pay in an hour. Washington Coal Co., Steek Yards Sta., Dept. BE, Chicago.

**SALESMEN**

Largest radio publishing organization in the world, wants salesmen, either whole or side line, to sell an assortment of 20 books to the trade. Liberal Commission to Hustlers. Box 233, RADIO NEWS, NEW YORK CITY



# Every Question ANSWERED for only \$1

At last you have under one cover a Complete Radio Handbook



**JUST OUT 562 PAGES**

Compiled by **HARRY F. DART, B.S.E.E.**

Formerly with the Western Electric Co., and U. S. Army Instructor of Radio.

Technically Edited by F. H. DOANE

**N**O more need you turn from book to book, hoping to find what you want. It is all here, in 562 pages crammed full of every possible radio detail. Written in plain language, by engineers for laymen. Clears up the mysteries, tells you what you want to know. A complete index puts everything within your reach in a few seconds.

**IT EXPLAINS:** Electrical terms and circuits, antennas, batteries, generators and motors, electron (vacuum) tubes, every receiving hook-up, radio and audio frequency amplification, broadcast and commercial transmitters and receivers, super-regeneration, codes, license rules. Many other features.

**Under one cover.** Yes, it is all in one volume of 562 pages of clear type with hundreds of diagrams and illustrations. Takes the place of eleven or more specialized texts, each costing from two to ten times the dollar you pay for this single book. Belongs in every radio-equipped home, on every amateur's table.

Send \$1 to-day and get this 562-page I. C. S. Radio Handbook—the biggest value in radio to-day. Money back if not satisfied.

TEAR OUT HERE

INTERNATIONAL CORRESPONDENCE SCHOOLS  
Box 6209-C, Scranton, Penna.

I enclose One Dollar. Please send me—post-paid—the 562-page I. C. S. Radio Handbook. It is understood that if I am not entirely satisfied I may return this book within five days and you will refund my money.

Name.....  
Address.....

**ELECTRIC SOLDERING IRON**

EVERY RADIO FAN has been looking for this iron for both radio and home use. Operates on A. C. or D. C. current.

**\$2.28**

GUARANTEED one year. Sent anywhere in U. S. or Canada. Parcel Post prepaid on receipt of money order for \$2.28.

FANS Send 2c stamp for our list of RADIO BARGAINS

**RADIO BARGAINS**  
17 N. LA SALLE ST. - CHICAGO

**You can be quickly cured, if you STAMMER**

Send 10 cents for 288-page book on Stammering and Stuttering. "Its Cause and Cure." It tells how I cured myself after stammering 20 yrs. B. N. Bogue, 799 Bogue Bldg., 1147 N. W. St., Indianapolis.

and heat in the Universe. . . That's my own definition. I hope you like it?"

"It's—it's beautiful," declared Ameena.

"Thank you," replied Sir Isaac, smiling graciously. "I think it is rather neat. I've used it frequently. Though lately, these foolish modern scientists of Earth are beginning to dispute me. . . Well, to proceed. In this region of Space, billions upon billions of Celestial bodies are whirling. They all obey recognized laws of Celestial mechanics—all are acted upon by different balancing forces. . . I shall not weary you with that."

"No," said Tubby. "We'll pass that up. Go on."

"These Celestial bodies range in size, from the most gigantic blazing Suns, millions of times the volume of our own Sun of the Solar System, down to the very minutest fragment—which is nothing more or less than an atom of the ether itself!"

"We call these Celestial bodies by different names. A Star, for instance, refers to luminous bodies. Our own Sun is one of them. Planets are reflecting, or partially self-luminous bodies revolving around a central Sun. You already understand what Satellites are. Then there are Asteroids, which are merely Planetoids—smaller Planets. And there are Comets, and Meteors, and—"

"Never mind all them," Tubby interrupted hastily. He squeezed Ameena's hand consolingly as Sir Isaac plunged on:

### OTHER WORLDS THAN OURS

"Therefore, you understand, we live on one of the Planets—I beg your pardon, Ameena—on two of the Planets of the Solar System—the Earth and Venus. Our Sun, with all its Planets, forms only one System of an infinite number. Each of those Stars—" He waved his hand again toward the window—"Each of those Stars very probably has revolving about it a system of worlds much greater than our own 'Solar System.'"

"My goodness," Tubby commented. "This here Universe is a big place, ain't it? We only got started, so far."

The memory of those fifty-two days of grace which were all that remained to them, struck Tubby forcibly. He added anxiously:

"How soon do we get to this first Star, perfessor?"

### THE SPACE FLYER IS HEADED FOR ALPHA CENTAURI—THE NEAREST STAR

Sir Isaac referred to a memorandum. "The nearest Star to the Solar System is Alpha Centauri," he answered. "The Astronomers of Earth recently claim to have found one slightly nearer, but I do not recognize it. That is Alpha Centauri we are heading for—a splendid binary of the First Magnitude, with a parallax of 0.75" whose components revolve in 81 years. I mean—" he added apologetically, "it is really two Stars several hundred million miles apart, revolving around each other. It is drifting through Space with a velocity of some sixty miles a second."

Tubby lifted his eye-brows; Sir Isaac continued hastily:

"Every Star is moving—drifting. I call it—as though they were in gigantic currents circulating about—I don't know just whither or why. Our own Sun, for instance, with all its Planets, is drifting—floating toward some of the Stars and away from others—at the rate of many miles a second, but always holding its mass of Planets intact."

Tubby turned to the girl beside him. "Kind of complicated, ain't it, Ameena?" Then to Sir Isaac:

"How far is this closest Star we're headin' for? I ast you that, an' you—"

"I was getting to that. But if you must know at once—" Sir Isaac spoke with some asperity. "If you insist, I'll tell you that Alpha Centauri is a trifle less than 25,000,000,000,000 miles from here!"

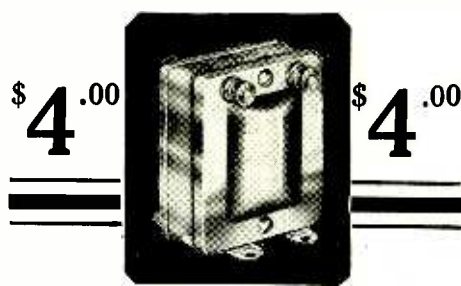

## NATIONAL AUDIO TRANSFORMERS

Are Giving PERFECT SATISFACTION

on thousands of sets. Use them on your set—with any type of tube. Better Transformers are not made. Highest grade materials and workmanship. Approved by experts everywhere. At your dealers. If not, order direct, mentioning his name. Dealers: Write for sales proposition.



NATIONAL TRANSFORMER MFG. CO.  
154 Whiting Street, Dept. 1015, Chicago, Illinois

## MASTER ELECTRICITY AT HOME

A practical man will lead you to success. Write only if you are in earnest. Our FREE Book plainly tells how Burgess Home Training enables men and boys to get good jobs and hold them. Shows world-wide opportunities in electricity. Tells how fellows like you have stuck and studied until now they are on top. Write for your copy TODAY. Romance of real success on every page.

### Practical Course Easily Applied

No frills or feathers; no mystery; no bunk. Just honest, helpful instruction, which any one can understand and follow. For the man high in the profession as well as for the beginner. All branches of electricity covered: Hydro-Electricity, Alternating Current, Motors, Power-Plant Practice, Slide Rule (30 additional lessons), Automotive Electricity, Electrical Drafting, Etc. We help you to a position during and after instruction.

### Endorsed by Leading Engineers

For Instance: Twelve electrical Engineers of Big Public Utility Corporation critically examined our course—approved it thoroughly. Result: Fifty-five young men in that plant became students. The course for you if you mean business. Write for fully illustrated book TODAY.

New Radio Course Now Ready

**BURGESS ELECTRICAL SCHOOL**  
YORKE BURGESS, Superintendent  
745 East 42nd Street, CHICAGO  
Canadian Branch: 201 B. Crawford Street, TORONTO

## ELECTRICAL HANDBOOK

We have prepared a pocket size note book for practical men. Contains drawings and diagrams of electrical machines and connections; over 200 formulas, with problems worked out.

"THE BURGESS BLUE BOOK" contains drawings for Motor Starters, Controllers, Transformers, Reversing Switches, Lighting Circuits, Calculations include Electrical Mathematics, Units, Resistance, Wire Gauge Rules, Ohm's Law, Unknown Resistance, Dynamo Troubles. Also Alternating Current Calculations, finding Impedance, Frequency, Speeds, Power Factor, Formulas for Line Transformers. Price only \$1.00 postpaid on money back guarantee.

AGENTS WANTED. Write for actual proposition to agents, cash value \$1.00 and money a day.

**THE BURGESS COMPANY, Consulting Electrical Engineers**  
745 East 42nd St. Radio Apparatus and Supplies Chicago, Ill.

**CHARGE YOUR OWN BATTERY**

You can do it—without removing your battery or even disconnecting terminals. The Valley Battery Charger will end your battery troubles. Plugs in on lamp socket; clamps to battery. Cannot overcharge or harm battery. Price \$15.00. Send for booklet.

**Valley Electric Company**  
Department S. ST. LOUIS, MO.





**Beat 'em all with Auto-Wheel**

You can beat 'em all, race or no race, if you are "driving" an Auto-Wheel—the speediest boys' coaster. Winning is dead easy. Only another Auto-Wheel can give you any competition.

It's the self-contained, friction-reducing roller bearings which make an Auto-Wheel Coaster go so easily that it seems to be running itself. But roller bearings are only one of the many superior features in the Auto-Wheel Coaster. Some of the other features are: rubber-tired disc wheels (3 largest models have over-size tires); steel-tired disc or wood spoke wheels if desired; all wheels interchangeable; hand brake; hand brake; special hub cap and locking pin; sides mortised as well as nailed. Every one is a reason why live boys prefer the

**Auto-Wheel Coaster**

**Auto Cart**

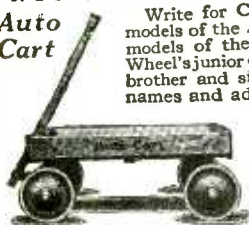

Write for Catalog which shows all models of the Auto-Wheel and also all models of the Auto-Cart, the Auto-Wheel's junior companion for your little brother and sister. If you send the names and addresses of three local coaster wagon dealers telling which ones sell the Auto-Wheel, we will give you a year's subscription FREE to the "Auto-Wheel Spokesman," a dandy little magazine for a boy like you.

**Auto-Wheel Coaster Co., Inc.**  
North Tonawanda, N. Y.

Big Slogan Contest Now on. Write for Full Details and Win a Prize.

Tubby and the girl stared blankly as Sir Isaac stated this astounding figure.

"You see? I knew you would not understand me. What I wanted to explain first, was that in dealing with these larger figures to save confusion we generally use a larger unit than the mile. The best one is the Light-year. It is the distance light travels in a year."

"How far?" Tubby asked, with rapidly recovered poise.

**THE PROFESSOR EXPLAINS MEANING OF LIGHT-YEAR**

"Light travels about 186,000 miles a second," said Sir Isaac. "Multiply that up to a year and divide it into 25,000,000,000,000 and you get 4.35. A child could do that by simple arithmetic. Thus you find that Alpha Centauri is distant 4.35 Light-years."

This latter figure was considerably less awe-inspiring. Tubby seized it eagerly. "Only four Light-years. That ain't so far."

"No," said Sir Isaac, smiling with returned good humor. "Comparatively speaking, of course, it isn't far. All distance is relative. If you can travel fast enough, 4.35 Light-years, especially compared to the many hundred Light-years which separate some of the Stars, is relatively quite near. . . . Now about our own velocity—"

It was, in truth, the problem of attaining a sufficiently great velocity to cope with these greater distances that had worried Sir Isaac from the moment they decided to launch out into Inter-Stellar Space. Within the comparatively narrow confines of the Solar System—menaced by Asteroids and Meteors—a great velocity was neither necessary nor desirable. But now—in the outer realms—it was both.

Sir Isaac, in spite of his bombastic statement to Tubby as they left the Earth, had never really anticipated a prolongation of the voyage beyond Neptune. Nevertheless he had always believed that the vehicle's velocity, theoretically, was illimitable. Several factors contributed to this conclusion. It is one of the laws of motion, inertia to be exact, that a body once in motion and not acted upon by any force, will continue

(Continued on page 615)

**ONLY \$3**  
Down

**Brings You This Genuine Underwood Typewriter**  
on 10 Days' FREE TRIAL

**A perfect machine, complete in every detail. Read all about this great offer**



**Yes, We Will Positively Ship You**

this splendid Underwood upon receipt of only \$3.00. This is by far the most liberal typewriter offer that has ever been made on so perfect a machine. Nearly two million Underwoods have been made and sold, proving conclusively that it is superior to all others in appearance, mechanical perfection and all-round excellence.

**Ten Days' Free Trial**

We want you to see for yourself that this is the typewriter you ought to have, and, therefore, we make our great free trial offer. You merely send us the three dollars deposit and we ship the machine for you to try for ten full days before you decide to keep it. If not satisfied, every penny of your money will be returned to you.

**Rebuilt Like New**

Every Underwood we sell is rebuilt just like new. It is dismantled right to the very bottom, and remanufactured to make it just like a new typewriter, with new enamel, new nickel, new platen, new key rings, new type; a complete, perfect typewriter, with two-color ribbon, back spacer, stencil device, automatic ribbon reverse, tabulator, key shift lock, etc. Impossible to tell it from a brand new Underwood, either in appearance, durability or quality of work.

**Easy Monthly Payments**

Our easy monthly payment plan makes it possible for YOU to own this splendid machine without having to pay out any big sum of money. You will hardly know you are paying for it. REMEMBER, you have the full use of the machine, just the same as though it was fully paid for.

**Over 325,000 Sold**

Over 325,000 people have purchased and been satisfied with our product. What better proof could anyone ask of the perfection of our typewriters and the integrity of this firm?

**Your Money Back**

Yes, you can have your money back if you want it. After you have examined the typewriter carefully, used it to write letters, if you decide for any reason whatever that you do not care for it, you may return it to us at our expense and every penny you have paid will be cheerfully and promptly refunded.

**No Obligation on Your Part**

When you send in the coupon for either further information about our great typewriter offer or for the typewriter itself on our free trial plan, you are under no obligation whatever until after you have tried it and have decided for yourself that you want to keep it.

**Write Now for Our Big Typewriter Book**

telling all about our great big typewriter factory. In this book we illustrate and describe all of the various processes of re-manufacturing, re-erecting and assembling this splendid Underwood. It tells in an interesting way how each part is examined and tested carefully and thoroughly to insure the finished machine being one you will be proud to own.

**Write Right Today Use Coupon Below**

**SHIPMAN-WARD MFG. CO.**  
2167 Shipman Bldg., Chicago

Send me your big bargain catalog and complete details of your surprising offer, without obligation on my part.

NAME .....

STREET .....

CITY..... STATE.....

**Indestructible, Seamless, Made entirely of fibre, metal base.**

**\$10.50 Complete**

**SOLID FIBRE HORN**

No. 115 — (illustrated) Fibre "RICOHORN" with "Rico" Loud Speaker 'Phone, height 23", bell 10", each **\$10.50**

No. 01—Fibre "RICOHORN", height 28", bell 14", each **\$15.00**

Both complete with the "RICO" TUNED Loud Speaker 'Phone and Cord.

**The Fibre "RICOHORN"**

WITH TUNED LOUD SPEAKER PHONE

Eventually Replaces All Other Radio Horns Because it is a Scientific Development Which Produces Only True Mellow Tones. This presents the latest development in loud talker horns. It has been realized by every acoustic expert that metals should never be used in connection with loud talkers, as they give rise to "metallic" sounds.

"Ricohorns" are made entirely of fibre. No metal is used at all, the sounds come through not only mellow and undistorted, but, due to the higher amplifying power of fibre much louder as well. "Ricohorns" are unbreakable. Cannot be dented and do not lose their shape. By means of an ingenious arrangement, the 'Phone is clamped against the lower extremity of the "Ricohorn" in such a way that no echo pockets are formed. Consequently there is nothing lost in the emission of the sounds. The "Rico" Loud Speaker 'Phone can be dismantled, if desired, in less than a minute's time.

"Ricohorns" are put up in strong corrugated cardboard boxes and we insure safe delivery. Send for illustrated circulars on all "Rico" Radio Specialties.

**RADIO INDUSTRIES CORPORATION**

131 Duane Street New York, N. Y.

**SEND NO MONEY**

RADIO INDUSTRIES CORPORATION S.&L.-10  
131 Duane Street, New York

Gentlemen:—Please send me by Parcel Post one No. .... Fibre "RICOHORN" for which I will pay the postman the amount of ..... plus postage.

You guarantee that the Fibre "RICOHORN" is exactly as represented by you.

NAME .....

STREET AND NO. ....

City..... STATE.....



# THESE DEALERS CARRY

# "Consolidated" E.I. Company

# Patterns and 25c. Books

See Full Page Ads on Pages 589 and 608

- |  |   |   |   |   |   |
|--|---|---|---|---|---|
| <p><b>Abilene, Kans.</b><br/>Union Elec. Co.</p> <p><b>Albany, Ga.</b><br/>Lonsbergs Book House</p> <p><b>Akron, O.</b><br/>Radioart Supply Co.</p> <p><b>Albany, N. Y.</b><br/>Havens Elec. Co.<br/>Ignition Service Supply Co.<br/>Cramer &amp; Hotchkiss<br/>Kimball Bros.<br/>Peoples Radio Store<br/>Standard Elec. Co.<br/>Wanger Bros.</p> <p><b>Amsterdam, N. Y.</b><br/>Anderson Elec. Co.</p> <p><b>Allentown, Pa.</b><br/>Hess Bros.<br/>Buchman Book Store</p> <p><b>Altoona, Pa.</b><br/>Altoona Elec. Supply Co.</p> <p><b>Anthony, Kans.</b><br/>LeRoy Highbanks Rad. Co.</p> <p><b>Astoria, Ore.</b><br/>Astoria Radio Shop</p> <p><b>Astichon, Kans.</b><br/>Low &amp; Blythe Co.</p> <p><b>Atlanta, Ga.</b><br/>Capital Elec. Co.<br/>Millers Book Store</p> <p><b>Atlantic City, N. J.</b><br/>Paramount Radio Co.<br/>Eastern Hdwe. &amp; Sup. Co.<br/>Sport Shop<br/>Just Elec. Co.<br/>Sea Coast Radio Co.</p> <p><b>Auburn, Me.</b><br/>C. L. Foster</p> <p><b>Baltimore, Md.</b><br/>Jos. A. Becker<br/>Jos. M. Zamoiski<br/>Wilbur Elec. Co.<br/>Racharach Basin Co.<br/>W. W. Hentzschel<br/>S. B. Berkowich<br/>Joel Gutman<br/>Herdas Elec.<br/>Little Joes Dept. Store<br/>C. D. Kellert<br/>J. Meyer<br/>Murdoch Co.<br/>E. I. Rosenfeld &amp; Co.</p> <p><b>Batavia, N. Y.</b><br/>H. F. Smith</p> <p><b>Bethlehem, Pa.</b><br/>Lehigh Radio Co.</p> <p><b>Billings, Mont.</b><br/>Torgerson Bros.</p> <p><b>Birmingham, Ala.</b><br/>Interstate Elec. Co.</p> <p><b>Bluefield, W. Va.</b><br/>Burgess Elec. Co.</p> <p><b>Boston, Mass.</b><br/>Atlantic Radio Co.<br/>Cutter &amp; Wood Supply Co.<br/>Seth Fuller Co.<br/>International Radio Corp.<br/>Lewis Elec. Supply<br/>F. D. Pitts Co.<br/>New Eng. Elec. Spec. Co.<br/>Williams Book Stores<br/>J. B. Hunter &amp; Co.<br/>James H. Jones, Inc.<br/>Samuel J. Beckwith<br/>Chandler &amp; Farghauer Co.<br/>A. P. Merchant Co.<br/>Eugene Proctor Co., Inc.<br/>Radio Sales &amp; Service Co.<br/>Farrington &amp; Clark<br/>Berman Radio<br/>Bridgeport, Conn.<br/>Morison Radiophone Parts<br/>Flynn &amp; Power<br/>Conn. Radio Supply Co.</p> <p><b>Brooklyn, N. Y.</b><br/>Arthura<br/>Brooklyn Radio Serv. Co.<br/>O. Olsen<br/>Tollner Elec. Co.<br/>Bklyn. Radio Center<br/>Jobs Radio Service<br/>Bklyn. Elec. Lamp &amp; Nov.<br/>Globe Radio &amp; Bat. Shop<br/>Haag &amp; Vinze Co.<br/>G. Kleintsch<br/>C. G. Rosewall<br/>J. Steiff<br/>Denmarks<br/>American Phon. Exch.<br/>Arlington Radio Service<br/>Barnes Radio Shop<br/>Bence Elec. Co.<br/>J. D. Cunningham<br/>Delta Elec. Co.<br/>H. A. Dietz<br/>Duckmans Music Store<br/>Kelley &amp; Feist<br/>Hainen Elec. Co.<br/>Kensington Radio</p> | <p>E. C. &amp; H. B. Lagerholm<br/>G. Moskowitz<br/>G. Scharff Sons<br/>H. Schur &amp; Son<br/>Victor Radio Sport Shop<br/>Walker Elec. Co.<br/>Breuer Bros.<br/>20th Century Radio Co.<br/>M. Ulrich<br/>B. Haupt<br/>David M. Isaac<br/>Starr Radio</p> <p><b>Buffalo, N. Y.</b><br/>Merrill Bros. &amp; Ford<br/>Robertson Cattract<br/>O. Ubrlich Co.</p> <p><b>Burlington, N. J.</b><br/>Burlington Elec. Co.</p> <p><b>Butte, Montana</b><br/>Montana Elec. Co.</p> <p><b>Cambridge, Mass.</b><br/>Clapp-Bastham Co.<br/>University Book Store</p> <p><b>Canton, Ill.</b><br/>Frank White &amp; Bros.<br/>Camden, N. J.<br/>Neisner Bros.<br/>Carrollton, Mo.<br/>Carrollton Radio Shop</p> <p><b>Centerville, Ia.</b><br/>H. E. Luther</p> <p><b>Champaign, Ill.</b><br/>H. C. Swannell &amp; Son<br/>Charlesstown, W. Va.<br/>John R. Koch<br/>Charlesstown, S. Car.<br/>S. C. Radio Shop<br/>Charlotte, N. C.<br/>Smith Novotay Elec. Co.<br/>Caroline Radio Co.</p> <p><b>Chester, Pa.</b><br/>Neisner Bros.</p> <p><b>Chicago, Ill.</b><br/>Harry Alter &amp; Co.<br/>Barawik Co.<br/>Beckley-Ralston Co.<br/>Chicago Radio App. Co.<br/>Elec. Appliance Co.<br/>Inland Elec. Co.<br/>Marshall-Ellis &amp; Co.<br/>A. C. McClurg &amp; Co.<br/>Montgomery Ward &amp; Co.<br/>Newark Elec. Co.<br/>Henry Paulson &amp; Co.<br/>Seurs-Roebuck &amp; Co.<br/>Chicago Cut Rate Book<br/>Community Book Store<br/>Izenstark Radio Co.<br/>Pollett Book Co.<br/>McArthur Elec. Co.<br/>P. O. News Co.<br/>Max Stein<br/>E. J. Spingros<br/>Eireside Radio Co.</p> <p><b>Cincinnati, O.</b><br/>Midwest Radio Co.<br/>Milnor Elec. Co.<br/>Reuter Elec. Co.</p> <p><b>Cleveland, O.</b><br/>Radio Electric Shop<br/>Radio Eng. &amp; Sales Co.<br/>H. Lesser &amp; Co.<br/>Oliver C. Schroeder<br/>Radio Sales &amp; Rep. Co.</p> <p><b>Columbus, O.</b><br/>Hall Elec. Co.</p> <p><b>Corsopolis, Pa.</b><br/>T. C. O'Donovan</p> <p><b>Cumberland, Md.</b><br/>J. A. Fulton</p> <p><b>Dallas, Texas</b><br/>Huey &amp; Phillip Hdwe. Co.<br/>Southwest Radio Sup. Co.<br/>Radio Equip. Co.</p> <p><b>Denton, Tex.</b><br/>Evers Hdwe. Co.</p> <p><b>Denver, Colo.</b><br/>Electrical Auto App. Co.<br/>Pratt Book Store<br/>Reynolds Radio Co.</p> <p><b>Des Moines, Ia.</b><br/>H. W. King<br/>Iowa Radio Co.</p> <p><b>Detroit, Mich.</b><br/>Federal Elec. Supply Co.<br/>Twentieth Century Radio Co.<br/>Crowley Milner Co.<br/>McCauley Bros.<br/>Detroit Elec. Co.<br/>Velvetine Radio Co.<br/>Northwestern Radio Co.</p> <p><b>Duluth, Minn.</b><br/>Kelley Duluth Co.</p> <p><b>Easton, Pa.</b><br/>E. &amp; W. Grand Stores<br/>E. Orange, N. J.<br/>Essex Radio Shop<br/>United Radio &amp; Sport Shop</p> | <p>Elizabeth, N. J.<br/>H. Richmond &amp; Son<br/>Elizabeth Elec. Sup. Co.</p> <p><b>Eureka, Ill.</b><br/>Klaus Radio Co.</p> <p><b>Fergus Falls, Minn.</b><br/>Grande &amp; Setzer</p> <p><b>Far Rockaway, L. I.</b><br/>Dunlap Spg. Goods Co.<br/>Scientific Radio Co., Inc.</p> <p><b>Fishing, L. I.</b><br/>The Electric Shop</p> <p><b>Ft. Worth, Tex.</b><br/>H. C. Meacham Co.</p> <p><b>Galveston, Tex.</b><br/>Galveston Wireless Sup. Co.</p> <p><b>Gardner, Mass.</b><br/>Gardner Hdwe. Co.</p> <p><b>Gloucester, N. J.</b><br/>Lenny's Variety Store</p> <p><b>Granite City, Ill.</b><br/>Rosenberg Dept. Store</p> <p><b>Great Bend, Kans.</b><br/>Great Bend Radio Co.</p> <p><b>Greensburg, Pa.</b><br/>H. Hamilton</p> <p><b>Hamilton, O.</b><br/>Radio Co.</p> <p><b>Hartford, Conn.</b><br/>Elec. Sup. &amp; Equip. Co.<br/>E. &amp; W. Grand Stores<br/>G. Fox &amp; Co.</p> <p><b>Havana, Cuba</b><br/>Diamond News Co.<br/>Liberia de Jose Albele<br/>Helena, Mont.<br/>Van Blaricom Co.</p> <p><b>Hoboken, N. J.</b><br/>International Book Store</p> <p><b>Hockensack, N. J.</b><br/>Wm. &amp; E. Biss</p> <p><b>Jacksonville, Fla.</b><br/>Southern Elec. Co.</p> <p><b>Jersey City, N. J.</b><br/>Arrow Elec. Co.<br/>M. Schlein<br/>Guarantee Elec. Co.</p> <p><b>Johnson City, Tenn.</b><br/>Bishop Elec. Co.</p> <p><b>Johnstown, Pa.</b><br/>W. T. Grant Co.</p> <p><b>Joliet, Ill.</b><br/>Joliet Book &amp; Sta. Co.</p> <p><b>Kansas City, Mo.</b><br/>Valenzuela Supply Co.<br/>Donaldson Radio Co.</p> <p><b>Lancaster, Pa.</b><br/>Radio Outfit &amp; Sup. Co.</p> <p><b>Lawrence, Mass.</b><br/>Schwarzberg, W.</p> <p><b>Los Angeles, Cal.</b><br/>Leo J. Meyberg<br/>S. California Elec. Co.</p> <p><b>Lock Haven, Pa.</b><br/>Burkett Bros. Co.</p> <p><b>Louisville, Ky.</b><br/>Sutcliffe Co.</p> <p><b>Lowell, Mass.</b><br/>G. A. Hill Co.</p> <p><b>Lyons, Kans.</b><br/>R. T. Case</p> <p><b>Macon, Ga.</b><br/>J. W. Burke Co.</p> <p><b>Memphis, Tenn.</b><br/>Street Elec. Co.</p> <p><b>McKeesport, Pa.</b><br/>F. C. Wampler &amp; Son</p> <p><b>Milwaukee, Wis.</b><br/>Julius Andrae &amp; Co.<br/>Dewey Sport Goods Co.<br/>Radger Radio Co.</p> <p><b>Minneapolis, Minn.</b><br/>Jacob Andrusen Co.<br/>Pindley Elec. Sup. Co.<br/>Nagel Hdwe. Co.<br/>Reinhard Bros. Co., Inc.<br/>Sterling Elec. Co.<br/>Peerless Elec. Co.</p> <p><b>Missoula, Mont.</b><br/>Missoula Elec. Sup. Co.</p> | <p><b>Montgomery, Ala.</b><br/>Alabama Radio Mfg. Co.<br/>R. P. Reeves</p> <p><b>Nashville, Tenn.</b><br/>Zibart Bros.</p> <p><b>Newark, N. J.</b><br/>Banberger &amp; Co.<br/>Bassett Radio Sup. Co.<br/>Davis Elec. Co.<br/>Eddies Wireless Ex.<br/>Bannister &amp; Holland<br/>Essex Mfg. Co.<br/>W. T. Grand Co.<br/>United Elec. Sup. Co.<br/>Friedmans Music Shop</p> <p><b>Mt. Vernon, N. Y.</b><br/>Stephens Shop</p> <p><b>New Brunswick, N. J.</b><br/>Schneider Bros.<br/>The Elec. Supply Co.</p> <p><b>New Orleans, La.</b><br/>Interstate Elec. Co.</p> <p><b>Newport, R. I.</b><br/>Geo. H. Chase</p> <p><b>New Haven, Conn.</b><br/>W. W. Gale &amp; Co.</p> <p><b>New York City</b><br/>Femo &amp; Co.<br/>Frank Radio Co.<br/>Frenou Radio Co.<br/>J. J. Kelleher &amp; Co.<br/>David Killoch &amp; Co.<br/>Liberty Radio Co.<br/>R. H. Macy &amp; Co.<br/>Manhattan Elec. Sup.<br/>Overland Radio &amp; Equip. Co.<br/>Peerless Light Co.<br/>Radio Specialty Co.<br/>Stanley &amp; Patterson<br/>Viking Radio Co.<br/>The Winchester Store<br/>Army &amp; Navy Dist. Co.<br/>Chamberlain Elec. Co.<br/>Economy Radio<br/>Elec. Service Eng. Co.<br/>Goldfinger Bros.<br/>Gimbel Bros.<br/>R. G. Haslinger<br/>Herbert &amp; Huesgen<br/>Herald Radio Co.<br/>J. Belnuth<br/>J. H. Bunnell &amp; Co.<br/>Laurier Bros.<br/>Cushman &amp; Dalzell, Inc.<br/>Bway Radio Corp.<br/>P. M. Dreyfuss Co., Inc.<br/>Delta Elec. Co.<br/>Fordham Radio Spec. Co.<br/>F. &amp; W. Grand Stores<br/>J. L. Lewis &amp; Co.<br/>Lowe Motor Sup. Co.<br/>Rova Radio Stores<br/>Live Wire Elec. Co.<br/>Marks Radio<br/>Modells—8 Stores<br/>Phillips Sport Shop<br/>Wehman Bros.<br/>A. &amp; A. Elec. Co.<br/>Aene Radio Co.<br/>Am. Elec. Tech. App.<br/>Atlas Elec. Supply Co.<br/>Atlas Radio Co.<br/>Bergmaier Bros.<br/>Franklin Radio Shop<br/>J. Gabler<br/>Globe Radio Shop<br/>Hygrade Elec. Co.<br/>International Radio Store<br/>J. K. Kelleher<br/>Marlen Hdwe. Co.<br/>Nassau Radio Co.<br/>Times Sq. Auto Sup. Co.<br/>Triggers<br/>Ace Elec. Co.<br/>A. &amp; P. Radio Co.<br/>Baker &amp; Taylor Co.<br/>Bovough Elec. Co.<br/>Combia Elec. Co.<br/>J. Edelson<br/>Keystone Battery Service<br/>S. S. Kresge &amp; Co.<br/>Langers Radio Store<br/>A. Marcus<br/>G. H. Masten &amp; Co.<br/>Milbro Radio &amp; Elec. Co.<br/>Radio &amp; Mech. Trad. Corp.<br/>Radio Parlor<br/>Radiophone Equip. Co.<br/>Rialto Elec. Shop<br/>St. Marks Radio Co.<br/>K. R. Schulstrom<br/>F. F. Silverman<br/>Wooler<br/>M. Workman<br/>Perfection Radio<br/>Corfland Radio</p> | <p><b>James Gear</b><br/>A. J. Goldman<br/>T. Eaton &amp; Co.<br/>Progressive Book Store<br/>S. Asser<br/>M. &amp; T. Elec. Co.<br/>Horough Elec. Co.<br/>Marvel Elec. Sup. Co.<br/>O. R. K.<br/>A. E. Zimmerman<br/>Sam Astor<br/>Davidson Radio Co.<br/>Van Auto Supply Co.<br/>Mogul Elec. Co.<br/>Brunswick Supply Co.<br/>Stuyvesant Radio Co.<br/>Oscars Radio<br/>Fordham Sup. Co.<br/>M. H. Elec. Co.<br/>The Heights Radio Sup. Co.<br/>Eclipse Elec. Co.<br/>Fordham Radio Co.<br/>Gyessent Radio Co.<br/>Terminal Rad. &amp; Mus. Shop<br/>United Anchor Tire Co.<br/>Inter City Radio Co.<br/>Josephson<br/>Redifon Corp.<br/>Greenwich Radio Co.<br/>H. Goldstein<br/>Isador Fajans, Inc.<br/>Grand Radio<br/>M. Rubin<br/>Hannes &amp; Co.<br/>Madison Hdwe. Store<br/>American Radio Co.<br/>American Elec. Tech. Co.<br/>Electrical Eng. &amp; Con. Co.</p> <p><b>Niagara Falls, N. Y.</b><br/>H. Messersmith &amp; Sons</p> <p><b>Norristown, Pa.</b><br/>E. M. Law</p> <p><b>Oakland, Cal.</b><br/>Warner Bros.<br/>E. M. Sargent Co.</p> <p><b>Omaha, Nebr.</b><br/>Wolfe Elec. Co.</p> <p><b>Onset, Mass.</b><br/>W. C. Spring</p> <p><b>Passaic, N. J.</b><br/>J. L. David<br/>Simon Bros.<br/>Passaic Radio Shop</p> <p><b>Perth Amboy, N. J.</b><br/>Smerling, J.<br/>Amboy Lighting Co.<br/>Amboy Radio<br/>Paterson, N. J.<br/>Federal Radio &amp; Elec. Co.</p> <p><b>Pawtucket, R. I.</b><br/>Delancey Felch &amp; Co.</p> <p><b>Peoria, Ill.</b><br/>Peoria News Stand</p> <p><b>Philadelphia, Pa.</b><br/>Gimbel Bros.<br/>H. C. Roberts El. Sup. Co.<br/>Sayre Level Radio Co.<br/>Goetz Music Stores<br/>F. &amp; W. Grand Stores<br/>E. P. Noli &amp; Co.<br/>Trilling &amp; Montague<br/>Neisner Bros.<br/>Schimmel Elec. Co.<br/>Radio Sales Co.<br/>John Wanamaker</p> <p><b>Phoenix, Ariz.</b><br/>Nielsen Radio Sup. Co.</p> <p><b>Poughkeepsie, N. Y.</b><br/>C. P. Raymond</p> <p><b>Pittsburgh, Pa.</b><br/>Goldsmith &amp; Son Co.<br/>Ludwig Honnert &amp; Co.<br/>Gahn-a-Day Elec. Co.<br/>Liberty Incan. Sup. Co.<br/>Pitts Radio &amp; App. Co.<br/>U. S. Radio Co. of Pa.<br/>Doubleday Hill Co.</p> <p><b>Pittsfield, Mass.</b><br/>W. T. Grant Co.</p> <p><b>Plainfield, N. J.</b><br/>H. E. Gayle Hdwe. Co.</p> <p><b>Plattsburgh, N. Y.</b><br/>H. E. Atwater</p> <p><b>Portland, Me.</b><br/>Chisholm Bros.</p> <p><b>Portland, Ore.</b><br/>E. L. Knight Co.<br/>Fynson Elec. Co.<br/>Hylands Old Book Store</p> <p><b>Pottstown, Pa.</b><br/>T. S. Reidenhour &amp; Son<br/>Pottstown Radio Sup. Co.</p> <p><b>Princeton, N. J.</b><br/>Princeton Cycle Shop</p> <p><b>Providence, R. I.</b><br/>R. &amp; H. Supply Co.<br/>R. I. Elec. Equip.</p> | <p>The Shepard Co.<br/>The Outlet Co.<br/>Boston Store<br/>Reading, Pa.<br/>F. &amp; W. Grand Stores<br/>Rochester, N. Y.<br/>Hickson Elec. Co.<br/>Rochester Elec. Sup. Co.<br/>Wheeler Green El. Sup. Co.<br/>Eastman Radio Co.<br/>K. Schmidt &amp; Co.<br/>E. C. Sykes &amp; Co.<br/>Neisner Bros.<br/>Miller Drug &amp; Elec. Co.<br/>Ridgewood, L. I.<br/>Ridgewood Radio Shop<br/>Rock Island, Ill.<br/>H. E. Gelhart &amp; Co.<br/>Beardley Specialty Co.<br/>Valle Co.<br/>St. Joseph, Mo.<br/>Empire Elec. Co.<br/>Mannschrecks Book Stores<br/>St. Louis, Mo.<br/>The Benwood Co.<br/>Linze Elec. Supply Co.<br/>Foster Iron &amp; Cigar Co.<br/>St. Paul, Minn.<br/>North-West Elec. En. Co.<br/>Premier Radio Mfg. Co.<br/>Pioneer Elec. Co.<br/>St. Paul Book &amp; Sta. Co.<br/>Crist Book Shop</p> <p><b>San Francisco, Cal.</b><br/>Richter, Conrad<br/>Scheneck, N. Y.<br/>Albany St. Radio Store<br/>Seattle, Wash.<br/>F. B. Wilson<br/>Stamford, Conn.<br/>Arthura</p> <p><b>Stillwater, Okla.</b><br/>Stillwater Elec. Shop</p> <p><b>Syracuse, N. Y.</b><br/>Grant's Alexander Sons<br/>Hughes Radio Corp.<br/>M. H. Salmon Elec. Co.</p> <p><b>Toledo, O.</b><br/>Kuebler Radio Co.<br/>W. J. Nagel Elec. Co.</p> <p><b>Toronto, Ont., Can.</b><br/>H. M. Kidd<br/>T. Eaton &amp; Co.</p> <p><b>Trenton, N. J.</b><br/>Fleron &amp; Son, Inc.<br/>Radio Chain Stores<br/>Troy, N. Y.<br/>L. H. Cooper &amp; Son<br/>Tyler, Tex.<br/>R. E. Bryan</p> <p><b>Union Hill, N. J.</b><br/>N. V. Friedman</p> <p><b>Uniontown, Pa.</b><br/>Frederick Piano Co., W. F.<br/>Utica, N. Y.<br/>Dent, Co., M. F.<br/>Olds Book Store<br/>Utica Elec. App. Co.<br/>Utica Elec. Sup. Co., Inc.</p> <p><b>Waco, Tex.</b><br/>Jackson's Radio Eng. Lab.</p> <p><b>Washington, D. C.</b><br/>Continental Elec. &amp; Sup. Co.<br/>Radio Auto Sup. Co.<br/>Wartertown, Wis.<br/>D. &amp; E. Kusel Co.<br/>Watertown, N. Y.<br/>F. A. Empsall &amp; Co.<br/>W. Hoboken, N. J.<br/>The Heraco Exchange<br/>New York, N. J.<br/>W. N. Y. Heraco<br/>Wheeling, W. Va.<br/>Gee Electric Co.<br/>Wapakoneta, Ohio<br/>Heine &amp; Nagel Elec. Co.<br/>Waupeca, Wis.<br/>Waupeca Radio Sales Co.<br/>Wausau, Wis.<br/>Janke, Kurth Co.<br/>Wilkes-Barre, Pa.<br/>Foster Radio &amp; Elec. Co.<br/>Wilmington, Del.<br/>L. P. Moore<br/>Wilmington Elec. Spec. Co.<br/>Worcester, Mass.<br/>Neisner Bros.<br/>Willsamport, Pa.<br/>Wilhelm Book Store<br/>Yonkers, N. Y.<br/>Kneifer, F.<br/>Westchester Elec. En. Co.<br/>York, Nebr.<br/>Bullecks<br/>Youngstown, Ohio<br/>Robert F. Phillips</p> |
|--|---|---|---|---|---|



Order direct from these dealers. If your dealer cannot supply you, send us his name and address

**233 Fulton Street, New York City**

Publishers of Consolidated Patterns  
Sales Agents for E. I. Co. Books





**"Read'em" Binding Posts**  
With Knobs That Won't Come Off

Anyone can "read 'em." All popular styles—Antenna, Ground, Pones, A and B Battery plus and minus—abbreviations of different names engraved on knobs. Ask your dealer for "Read 'em"—the kind for real Radio fans. If your dealer does not have them—write direct.

The Marshall-Gerken Co.  
Manufacturers  
Dept. C. Toledo, Ohio

**RADIO CATALOG**  
CONTAINING  
**LATEST HOOK - UPS**  
14 Up-to-Date Hook-ups and List of  
**STANDARD QUALITY PARTS**  
AT REDUCED PRICES  
SEND 10c. TO COVER COST OF MAILING  
SERVICE AND QUALITY GOODS  
BUILT THIS HOUSE  
**GREAT LAKES RADIO CO.**  
136 W. LAKE ST., Dept. S, CHICAGO, ILL.

**LEARN RADIO**

Here's your opportunity. Radio needs you. Win success in this fascinating field. Trained men in demand at highest salaries. Learn at home, in your spare time.

**Be a Radio Expert**

I will train you, quickly and easily, to design, construct, install, operate, repair, maintain, and sell all forms of Radio apparatus. My new methods are the most successful in existence. Learn to earn

**\$1,800 to \$10,000 a Year**

**FREE** Wonderful, home-construction, tube receiving set, of latest design. Write for "Radio Facts" free. Engineer Mohaupt, American Electrical Association, Dept. 610 4513 Ravenswood Ave., Chicago



**MIRACO GETS 'EM 1500 MILES AWAY**

At the low prices shown below you get the efficiency of sets costing three times as much. These radio frequency receivers—pick up stations over 1500 miles away under good conditions—everywhere. Operate either on DRY CELLS or storage battery cabinets of solid mahogany and workmanship the finest throughout. Order direct or send for bulletin.

Two tube outfit, as shown above, headphones only \$29.50  
Four tube outfit for loudspeaker or headphones 54.50

DEALERS—AGENTS  
Write for proposition quickly—its a winner.

**THE MIDWEST RADIO COMPANY**  
809 Main St. Cincinnati, Ohio

**Radio Fans**

Rejoice when using these pneumatic phone cushions. They gently hug the ears, shutting out all room noises. Fits any type headset. Money back guarantee if you are not satisfied.

HEADPHONE CUSHION (HUDSON ROSS)

List of Bargains **FREE**

**RADIO BARGAINS**  
17 N. LA SALLE ST.—CHICAGO

**PROTECT YOUR TUBES**

Trade "Vac- Mark Shields"

Stop Howling, Prevent Electro-Static coupling. Make DX Tuning easy, and protect tubes from damage.

Shipped direct from our laboratories prepaid on receipt of \$1.00 or C.O.D., \$1.15.

Orange Research Laboratories  
41 N. 16th Dept. 12 East Orange, N. J.

**Around the Universe**

(Continued from page 613)

forever in motion at exactly its original rate. Thus, whatever force was applied to the vehicle must *accelerate* its rate of speed indefinitely.

The entire Solar System now lay above them, and thus the combined repellent force of all its Planets and its Sun could be used. This, with the attractive force of all the countless gigantic Stars that lay below, Sir Isaac was confident would cause them to fall into the void of Space with tremendous velocity—a velocity that had no limit except the time allowed for acceleration.

Haste was needed, and now, for the first time since leaving the Earth, Sir Isaac used almost all the total force at his command. They had left the vicinity of Neptune about 8 P. M. At midnight, just when the sleepy Aemeca was about to retire, Sir Isaac looked up from the most complicated calculation he had so far made.

**SPEEDING THROUGH SPACE AT 200,000 MILES PER SECOND**

"Our velocity is now approximately two hundred thousand miles a second," he announced triumphantly.

"Thousand!" Tubby exclaimed in dismay. "We was goin' in millions this afternoon!"

"I said a *second*," Sir Isaac returned. "We did attain—at one short period last night—about a hundred million miles an hour. But I cut it down at once. This is per second—not per hour."

"Oh," said Tubby with relief. "How much is that a hour?"

"About seven hundred and twenty million—that is to say, seven times our former maximum."

This was joyful news indeed; but Sir Isaac's next words dispelled the joy completely.

"At this rate," he added, "we should reach Alpha Centauri in about four years!"

And in fifty-two days Mars would destroy the Earth unless they were back there to prevent it!

"But—but then—" Tubby protested. Sir Isaac's quiet smile stopped him.

"You need not worry over that," he said. "There are many forces acting upon us which you do not understand. The acceleration of a falling body is in astounding ratio—especially when it has an additional repellent force above it. . . . I've told you that before. Wait until tomorrow—then we shall see."

There followed a somewhat lengthy silence.

"Say, pefessor," Tubby began finally. "ain't this kind of *re-mark-able*—this extra speedy travelin'?"

Sir Isaac looked up from his mathematics. "My dear fellow, I do suppose these Astronomical figures confuse you. I've already tried to explain—"

"No—I mean, *us* bein' able to go so fast."

Sir Isaac laid aside his pencil, and frowned. "I see nothing extraordinary in it. Your mind is still in its Earth-rut. You must get out of that line of thinking."

"I will," Tubby declared humbly. "Only tell me how to."

Sir Isaac's good nature returned, promptly as usual. He laughed.

"You must understand that on Earth you have always been dealing—personally, I mean, with mileage the longest distance of which is the circumference of the Earth—25,000 miles. All your life you have been a little ant, chained down by gravity. Naturally, for you, motion has had a very narrow meaning. Your own motion, in relation to the ground beneath you, is all your mind daily recognized. That, for you, was the standard of motion.

"But, my dear friend, that is not really motion at all. You were like an ant, crawl-



**Wins a Welcome**

You are welcome everywhere with a sweet-toned Buescher Saxophone. It is an infallible key to social popularity.

Everyone has a perfectly normal desire to produce music, yet most people have not the time nor patience to become a musician.

**See How Easy It Is**

But a Buescher Saxophone is different. It looks complicated, but it is really very easy to play.

With the aid of the first three lessons, which are sent free (upon request) with each new Saxophone, the scale can be mastered in an hour; in a few weeks you can be playing popular music. Practice is a pleasure because you learn so quickly. You can take your place in a band within 90 days, if you so desire.



**TRUE-TONE SAXOPHONE**

For Bands and Orchestras, for church and lodge, and school musical affairs, for social and home entertainment, the Saxophone is the most popular instrument and one of the most beautiful. A good Saxophone player is always popular socially and enjoys many opportunities to earn money. Saxophone players are always in demand for dance orchestras. Every town should have a Saxophone quartette or orchestra. (17)

**Try It In Your Own Home**

You may order any Buescher Saxophone, Cornet, Trumpet, Trombone or other Band or Orchestral Instrument and try it six days in your own home, without obligation. Easy terms of payment may be arranged if preferred. Mention the instrument interested in and a complete catalog will be mailed free.

**Buescher-Grand Trumpet**

Especially easy to blow, with an improved bore and new proportions. With the mute in, it blows so softly and sweetly that practice never annoys. A splendid home instrument.



**Free Saxophone Book**

We have prepared a very interesting book on the history and development of the Saxophone. It tells which saxophone takes violin, cello and bass parts and many other things you would like to know. Also illustrates first lesson. Every music lover should have a copy. It is sent free on request. Just send your name for a copy.

**BUESCHER BAND INSTRUMENT CO.**

Everything in Band and Orchestra Instruments  
6017 Buescher Block Elkhart, Indiana

Buescher Band Instrument Co.  
6017 Buescher Block, Elkhart, Ind.

Gentlemen:

I am interested in the instrument checked below:  
Saxophone.... Cornet.... Trombone.... Trumpet....  
(Mention any other instrument interested in)

Name .....

Street Address .....

Town .....

State.....





# MARKO "A" BATTERY

90 AMP. HRS.

IN RUBBERLITH CASE

*Highly Ornamental As Well As Efficient*

The Rubberlith case is a composition case with a high gloss giving the appearance of ebony. It is moulded in one piece, including handles and cells—no jars to break—and is practically indestructible. A worthy addition to your set.

ALL SIZES, FROM 2 VOLT BATTERIES UP, CARRIED IN MAHOGANY FINISH CASES

SOLD BY

MANHATTAN ELECTRICAL SUPPLY CO., 17 Park Place, New York, N. Y.  
 STANLEY & PATTERSON, 23 Murray St., New York, N. Y.  
 J. H. BUNNELL & CO., 32 Park Place, New York, N. Y.  
 PACENT ELECTRIC CO., 22 Park Place, New York, N. Y.

ALSO RADIO SUPPLY STORES AND ALL MARKO SERVICE STATIONS

MADE BY

## MARKO STORAGE BATTERY CO.

1402 ATLANTIC AVENUE, BROOKLYN, N. Y.

Branch, Jefferson at Bedford Ave., Brooklyn, N. Y.

210 W. 54th St., New York, N. Y.

WE ARE EXHIBITING AT GRAND CENTRAL PALACE, NEW YORK, OCTOBER 6-13

# Big Profits in 8 Hour Battery Charging

**START YOUR OWN MONEY-MAKING BUSINESS**  
 You can make big profits charging batteries with HB Constant Potential 8-Hour System. No experience needed. You can Clear \$150 to \$300 Every Month. Its outfit comes complete, ready to connect and operate. New Built-in Patented HB Voltage Regulating Winding Absolutely Eliminates Reversing. Saves current and labor; runs all night without attention. Charges 12 or 24 volt batteries. Better, longer-lived charge than old 3-day system. Quick service builds trade, satisfies customers, makes big, steady profits for you. **\$30 MONTHLY PAYS FOR YOUR HB CHARGER.** Small cash payment brings your HB Constant Potential Charger. Easy Terms of Only \$30 Monthly Quickly Pay Balance from Your Profits. 30 Days' Free Trial on Money-Back Guarantee Lets You Try HB Outfit at Our Risk. Oversize HB construction insures 1-3 More Output Than Any Other Outfit of Similar Rating. Start now to make big battery charging profits. Write today for information. Ask about other HB money-makers—air compressors, buffers, motors etc. All sold on easy payments. **HOBART BROS CO. Box 510, Troy, Ohio.**



Small Cash Payment - Your Profits Quickly Pay Balance

# "THERE'S MONEY IN IT" LEARN TELEGRAPHY AT HOME

**TEACH YOURSELF** in half usual time, at trifling cost, with the wonderful Automatic Transmitter THE OMNIGRAPH. Send unlimited Morse or Continental messages, at any speed, just as an expert operator would. Adopted by U. S. Government, and leading Universities, Colleges and Telegraph Schools. 3 styles. \$14 to \$30. Catalog free. If you own a Radio Phone Set and don't know the Code, you are missing most of the fun. **OMNIGRAPH MFG. CO. 22 Hudson St., NEW YORK**



# ELECTRIC LITE \$2 Complete Outfit For Only

Install the Midget Marvel lighting outfit and enjoy electric light for only a few cents a day. No muss or bother, just snap the switch and you get a dazzling flood of brilliant white electric light. Just the thing for bedroom, garage and porch illumination. It spreads a soft clear glow everywhere. Cannot blow out or go out suddenly. Anyone can install it in 30 minutes with 1 1/2 inch or screw driver. No license or special knowledge of electricity necessary. No matter how far you are from a power plant this amazing new discovery gives you electric light at the touch of the switch. Thousands of satisfied users everywhere. No electricity necessary for Recharging Battery, you charge and recharge your battery yourself right at home with a harmless 10c powder obtained direct from your druggist. An outfit that will last for many years. Complete lighting outfit ready to install, shipped Postpaid anywhere for only \$2. Consisting of 60 feet copper wire, insulated staples, snap switch, completely wired drop light fixture with shade, guaranteed Mazda lamp, battery system, battery charger and complete instructions for installing and recharging your battery at home, with ordinary use one 10c charge supplies light from 7 to 10 days. No circulars or C. O. Ds. Money back instantly and without question if not more than delighted. Ref. Ogden Ave. State Bank of Chicago.



S. IRVING ELECTRIC CO., Chicago, Ill. 1636 S. Lawndale Ave.

# Standard Spanish ARMY



Used by French During World War Buy direct from sole U. S. importers and SAVE 1/2 on this GENUINE ASTRA AUTOMATIC

Your chance to have the finest European pistol—the equal of any similar American gun—at about 1/2 the price. Order direct at these special prices.

- \$7.75 25 calibre—7 shot—C. O. Q. Automatic.
- 8.95 25 calibre—7 shot—Astra Automatic.
- 9.95 25 calibre Astra with triple safety.
- 10.95 32 calibre—10 shot Astra, extra magazine.
- 16.95 32-20 and 38 cal. swing-out cyl. revolvers.

We guarantee every gun against defective workmanship; brand new; of Drop Forged Steel Through-out. Before buying any weapon INSIST on this guarantee. SEND NO MONEY unless you wish. State model desired—pay postman on delivery plus postage. Satisfaction guaranteed or money refunded. Write for new firearms catalogue.

CALIFORNIA TRADING CO. Dept. 2510, Terminal Bldg., Los Angeles, Cal.

ing around the narrow limits of its little world. How can you expect an ant to understand, or to fathom the velocity of an airplane, or a rifle bullet, which covers in a fraction of a second, a space—a distance—equal to the entire known world of the ant?"

Sir Isaac was gradually warming up. "You call that motion. On the other hand, though you did not know it, perhaps, both you and the ant have always been moving with great rapidity. For instance, the rotation of the Earth on its axis, if you happened to be on the Equator, would carry you around a circle of 24,000 miles in one day—every day. That is a thousand miles an hour. Added to that, the Earth also moves around in its orbit some 66,000 miles an hour. Still more than that, the Sun drags the Earth along at about 36,000 miles an hour. This motion of the Sun can only be calculated by its relation to the other Stars. And, so far as I know, the whole Universe may be hurtling through Space a thousand times that fast. In fact, I think it is. And still more than that probably Space itself is moving—a million times faster than everything else. . . . But that you cannot understand yet. . . . I'll explain that to you later."

"Tell me more," Tubby murmured desperately. "Well," said Sir Isaac, "in Space you see, all Earthly ideas of motion must be reconstructed. We are now a Celestial body ourselves—obeying all the laws of Celestial Mechanics—a little world all our own—a world of three inhabitants."

It was an interesting thought; it aroused in Tubby a sudden patriotism for the vehicle and its welfare.

Sir Isaac went on quietly and earnestly: "Some of the Stars are drifting at the rate of 250 miles a second. Drifting—you understand. But we are not drifting, we are falling—pulled down by attraction from below and pushed down by repulsion from above. Is it any wonder then—after falling freely for millions of miles, and with such a constant, tremendous impulse—that we should attain an enormous velocity?"

Both Tubby and Ameena admitted the reasonableness of this. Motion, as Sir Isaac so clearly pointed out, depended entirely upon the motion of something else with which you compared it.

"I guess it ain't so wonderful, professor," Tubby said finally. "But you got to get used to thinkin' about it."

Sir Isaac smiled, and turned to the tired girl. "Hadn't you better run along to bed, Ameena?"

Tubby escorted her to the foot of the stairs. As he parted with her for the night, she said softly:

"Do not worry, Tubby dear. We shall succeed—I know it."

With a radiant smile she kissed him good-night and darted up the stairs. For an hour thereafter Sir Isaac's figures fell upon deaf ears; the memory of Ameena's beautiful face and the tenderness in her voice—attributes that had all the inherited intensity of hundreds of Venus-women ancestors behind them—absorbed Tubby's entire consciousness.

During the night, Tubby and Sir Isaac alternated keeping watch, though as usual Tubby did most of the sleeping. Poor Sir Isaac was getting thinner than ever; but his wonderful courage and vitality held him up. He was almost always either working with his calculations, or using some of the many scientific instruments with which the room was equipped; and, for diversion, writing his manuscript, which hourly grew in bulk.

### THE PROFESSOR WRITES A NARRATIVE OF THE TRIP

He was engaged in this latter occupation the following morning after breakfast, when Ameena, coming in from washing the break-



fast dishes, timidly asked him what he was writing. He looked up to her with tired eyes as she and Tubby, with arms around each other, stood beside him.

"I am writing a scientific narrative which I think I shall call 'Around the Universe,'" he said quietly.

Ameena clapped her hands. "Oh, isn't that fine? All about our trip! Will you publish it on your Earth? Everyone will love to read about all these wonderful things, won't they?"

Sir Isaac's smile was very gentle, slightly cynical.

"My dear child," he said, "you do not understand human nature. People may condescend to read what we have done, but do you think they will believe it?"

"But, of course, they must," the girl cried. "Is it not actually happening to us?"

Sir Isaac sighed. "It is, most certainly. But people are so skeptical. They do not even believe that Jupiter is habitable. They will think I made it all up—treat it as a joke. All my scientific data—my personal observations—the most wonderful Astronomical—"

"Let 'em go to blazes," Tubby put in fiercely. "We'll give it to Venus. If them Earth-people ain't got no more sense than—"

"But first we must save the Earth-people, or those terrible Martians will destroy them," reminded Ameena.

Tubby sobered. "That's so." Another thought struck him. "We'll save all them Earth-people from gettin' murdered—an' then they'll laugh at us for tellin' them how we did it! That's gratitude for you! That's —"

Ameena kissed him gently. "Never mind, Tubby. We shall do what we can—for the sake of humanity—without hope of reward."

Sir Isaac, practical as always, remarked somewhat cynically:

"To accomplish that, we must have help. We must find some other humans in this Universe as unselfish as ourselves. Can we do that? I doubt it."

"You are extreme, Sir Isaac," Ameena said. "On your Earth, when you have had war, have not Nations aided each other?"

"Yes," he answered. "But only for their own interest—for their own defense. I cannot recall a single instance of real unselfishness. Yes, I think there were two. A few years ago there was a little Nation—"

"A little Nation!" Tubby exclaimed. "Say, maybe that's the answer! Maybe we was wrong to pass up all them little Planets between Mars and Jupiter!"

"I thought of that," Sir Isaac responded. "A small Nation or a world, I think, is more likely to be completely unselfish. I don't know why it should be so—but it seems to be. There are Ceres, Juno, Pallas—many Minor Planets—and we ignored them all." He shrugged. "You see, a little world, however willing, would be powerless to help us materially anyway—even if they wanted to. That is why I did not consider them."

The train of thought which this conversation brought to Sir Isaac worried him afterward very considerably. In drawing an analogy between individual Nations and Planets, it became perfectly clear that to ask aid of any Nation is a very different matter from going to another world. Nations on the same Planet have infinitely diversified interests interwoven. War comes. However unselfish a Nation may appear—may in fact really and sincerely in its heart feel itself to be—it cannot by the very nature of things, be wholly detached. But go to another Planet. The detachment is complete. Then—and then only—can you put the real test of altruism.

Thus the identical attitudes of the people of the Light Country of Mercury, and of Venus, and Jupiter, while they cannot be condoned, at least can be understood. And following this train of thought, as Sir Isaac

(Continued on page 619)



Nothing speaks so eloquently of HOMCHARGER satisfaction as the fact that thru sheer merit alone it has become the standard by which all other battery chargers are judged. Over 125,000 HOMCHARGERS already in use offer the most convincing proof that it is the most efficient, economical and fool-proof battery charger at any price.

**A NEW TRADE-MARK FOR A TRIED AND PROVEN PRODUCT**

Its phenomenal success has led to the introduction of many inferior and make-shift imitations. To insure our reputation and protect the buying public against substitution, the Radio De Luxe HOMCHARGER henceforth will be sold under a new Trade-Mark, viz.:



Retaining the same fundamentally correct operating principle and beautiful appearance of our Radio De Luxe model, it is a step nearer ultimate perfection through adoption of several construction refinements dictated by the policy of Progress.

**HOMCHARGER'S 10 POINTS OF SUPERIORITY**

1. **Simple**—Only one moving and wearing part, replaceable after thousands of hours use for \$1.00. Will last a lifetime.
2. **Efficient**—Uses less than one-half the current of any bulb or liquid type rectifier. Will charge any radio or automobile battery for a nickel.

3. **Quick**—Its high charging rate of 7 amperes eliminates long waiting for battery to become charged. Will charge any "A" or "B" battery over night, or three times as fast as a 2-ampere machine.
4. **Clean**—No expensive bulbs to break or acids to spill or replace. No acid fumes. Charges without muss, fuss or bother.
5. **Dependable**—Tungsten contacts insure continuous operation—prevent sticking and stopping.
6. **Fool-Proof**—Can be operated by anyone. Attach to lamp socket and connect battery either way, it will always charge. High-grade ammeter eliminates guess work.
7. **Safe**—No danger of shock or fire. Tested and approved by Fire Insurance Underwriters everywhere. Gives tapering charge—will not overheat or injure battery.
8. **Beautiful**—Mahogany and Gold Finish.
9. **Unqualifiedly Guaranteed.**
10. **Popularly Priced**—Retail at \$18.50 complete (\$22.00 Canada). No extras to buy. Sold by all dealers.

**FREE BROADCASTING LIST.** Send today for Free List of Broadcasting Stations, and Circular Describing the Gold Seal Homcharger.

**DEALERS! JOBBERS!**

GOLD SEAL HOMCHARGERS will outsell any other radio device this season. "GOLD SEAL Business Builders" illustrates many attractive sales helps and explains how we are prepared to cooperate with the Trade in making this a "HOMCHARGER Year." Send for your copy and Trade Discounts, TODAY.

**Insist on the GOLD SEAL**



It is your protection against substitution. When buying order by name and verify by the GOLD SEAL, which appears on the carton as well as the nameplate.

**The Automatic Electrical Devices Co., 116 West Third St., Cincinnati, O.**  
*Largest Manufacturers of Vibrating Rectifiers in the World*



**RUSONITE**  
**CRYSTAL RECTIFIER**  
 (Patent Pending)  
**THE PERFECT SYNTHETIC CRYSTAL DETECTOR SENSITIVE OVER ENTIRE SURFACE**  
 No Hunting for "Spots." Load and Clear. Endorsed by Thousands of Satisfied Users.  
 Sensitiveness Guaranteed Price Mounted **50c**  
 14 K. Gold Supersensitive RUSONITE CATWHISKER. Price **25c**  
 Permanent. Will not Oxidize.  
 RUSONITE REFLEX CRYSTAL  
 Manufactured Expressly for Reflex Circuits Will Stand Up Under Heavy Plate Voltage  
 Guaranteed Price Mounted **\$1.00**

Order from your dealer or direct from RUSONITE PRODUCTS CORP.  
 15 Park Row New York, N. Y.

The Real Metal Solder in Paste Form

**SOLDERALL**

Introducing Our New **SOLDERALL BLOW TORCH** of Heavy Solid Brass

Indispensable in the Home, Garage and to the Electrician. For Soldering Radio, House Wiring, Jewelry, Ignition, Kitchen Utensils, Etc.

Improved \$1.00  
 TUBE 25c

**SOLDERALL CO. Dept. S Newark, N. J.**



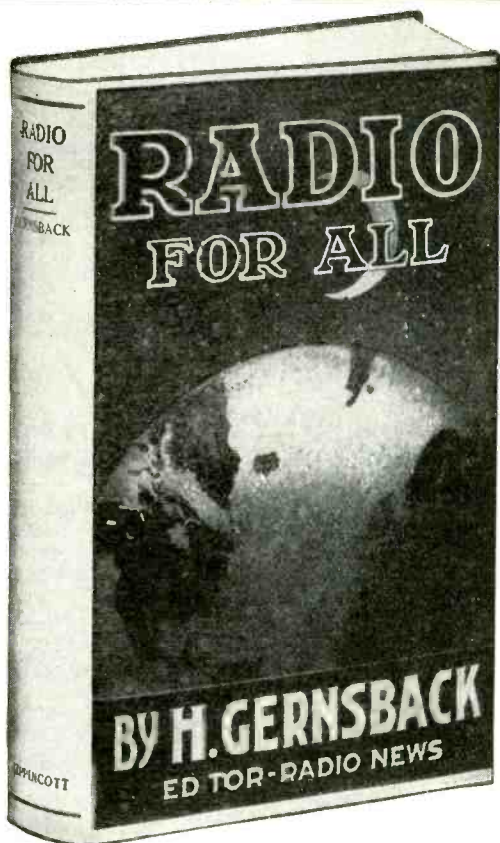

# RADIO FOR ALL

By H. GERNSBACK

Editor "Radio News," "Science and Invention" and "Practical Electrics"

With over 130 illustrations and diagrams, and 12 photographs, 300 pages, size 8¼" x 5½".

What the novice in radio needs is a book in which he can get all the information necessary for him to understand radio telephony and telegraphy, to make or buy a receiving set suitable to his means, to know how to operate his set, and after he has an understanding of the radio art, information that will enable him to advance and get the most out of his outfit. All this must ordinarily be dug out of text-books, pamphlets and government publications, but the aim of this book is to have all the data and information that the beginner will need from the time that he takes up radio. It is a permanent, comprehensive reference book for the dyed-in-the-wool dabbler in Radio.

### What the Book Is.

A combination of a radio course for the novice in radio telephony and telegraphy with a reference book for the more experienced amateur. Half a dozen books in one.

### For the Beginner.

The theory of radio carefully explained with drawings.  
Description of and instruction for operating instruments of receiving and sending sets, with all picture diagrams of the wiring of the apparatus.  
How to make your own receiving set, costing from \$3.00 to \$50.00.  
How to read diagrams; for every picture diagram there is a corresponding technical diagram using the symbols instead of drawings.  
How to tune sharply and eliminate interference from other stations.  
How to protect your set from lightning and the laws regarding installation.  
Explanation of time and weather signals.

### For the More Experienced Amateur.

How to make a practical vacuum tube detector, two stage amplifier set costing less than \$50.00, that will work.  
How the radio compass works.  
All about underground aerials, loop aerials and directional aerials.  
Formulae for finding wave length; miscellaneous formulae for finding capacity of condenser and other instruments. Tables of wire resistances, wave lengths and their corresponding frequencies, approximate wave lengths for different aerials, tuning coil data, and much more invaluable information.

### Special Features.

Lists of all the broadcasting stations in the United States and Canada for concerts, time signals, weather reports, press, stock market reports, etc., with their call, wave length and time of sending.  
Detailed description of Washington weather signals and their translation.  
Description of a modern broadcasting station and its operation.  
Large map showing location of all U. S. radio telephone broadcasting stations suitable for hanging up in radio room.  
Collection of miscellaneous radio information for the amateur.

### In Other Words.

The information that you ordinarily have to dig out of government publications, text-books, pamphlets, etc., is handily combined in this one book.

The Complete Book of All Radio Information

**\$2.00**

PRICE POSTPAID

PRACTICAL ELECTRICS COMPANY

53 PARK PLACE, NEW YORK CITY

# Each a Leader In Its Field

## Science & Invention

Is one of the most interesting magazines published. It is more interesting than fiction.

It is profusely illustrated and covers in word and picture the latest achievements in the sciences—in Invention, Astronomy, Physics, Chemistry, Electrics, Mechanics, etc.

It has a large section devoted exclusively to Radio. SCIENCE & INVENTION has the distinction of being more often quoted than any other magazine in the world.

More than 100 large pages—with over 300 illustrations, drawings, etc.

Special prize contests are offered each month. On all newsstands, 25c a copy.

## Radio News

"The 100 Per Cent Wireless Magazine"

The Largest Radio Magazine in the World

Is read by more than a million Radio enthusiasts each month.

Its position as the leader of all Radio publications is universally recognized by dealers, radio manufacturers and every branch of the radio industry and its pages reflect their confidence.

RADIO NEWS contains more articles by Radio Experts—more specific information—detailed drawings—illustrations and news—than is published in any other magazine.

More than 200 large pages monthly. Profusely illustrated.

On all newsstands, 25c a copy.

## Subscription Prices

Science & Invention	} One Year 12 Issues \$2.50 Each
Radio News	

(Add 50c to the cost of each magazine for Canada or Foreign)

**FREE PRESENTS FOR SUBSCRIPTION RAISERS.**

Write for our Premium Catalog containing valuable rewards given away **FREE.**

Premium Dept.  
Experimenter Pub. Co.  
53 Park Place, N. Y.

Experimenter Publishing Co., Inc., 53 Park Place, New York, N. Y.

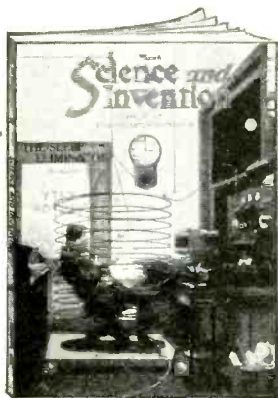



## Around the Universe

(Continued from page 617)

did that morning while he sat staring with unseeing eyes at his neglected manuscript, an additionally disturbing conclusion was inevitable.

All the Planets the voyagers had so far importuned, belonged to the Solar System. To some extent, therefore, their theoretical interests were mutual. And, if Mercury, Venus and Jupiter were willing to stand by and see the War Lords of Mars overrun the Earth, how much more likely were worlds far outside the Solar System to adopt a similar attitude? Sir Isaac pondered this, until at last he began to realize how inevitable would be their rebuff, no matter where in the Universe they went.

Noon came. Sir Isaac ate moodily, then went back to the instrument room and his gloomy reverie. Ameena put the kitchen in order with Tubby's help, after which the two young people sat in the store-room. Ameena strumming her lyre and Tubby singing with enthusiastic abandon.

It finally became too much for Sir Isaac's overwrought nerves.

"Won't you please stop?" he called querulously. "I can't stand that infernal noise when I'm thinking."

They stopped obediently; and a moment later joined Sir Isaac.

"How we makin' out perffessor?" Tubby asked timidly. "We're sorry we disturbed you—this here house is so awful quiet."

Sir Isaac was never one to hold rancor. **SPEEDING ON AT 45 MILLION MILES PER SECOND**

"We are doing very nicely. Our per second velocity now is approximately 45 million miles. At this rate we would reach Alpha Centauri in about six days. I shall, however, do much better than that—our rate of acceleration is quite satisfactory."

But Sir Isaac only shook his head and went back to his reverie.

It was a futile thing—Sir Isaac smiled cynically to himself as he thought of it. The Stars themselves would not be inhabited since they were blazing Suns. Hope only remained with their individual Planets; and to locate these Planets and land upon them would consume much more time than the meagre 51 days of grace that were left.

A very real problem of Celestial Mechanics showed Sir Isaac the mathematical impossibility of landing upon more than two or three additional Planets at the most, in such a time. The vehicle, during these many hours that Sir Isaac had remained lost in thought, had accelerated to a velocity of some two hundred million miles a second—enough to take it far beyond Alpha Centauri in a very few days—especially since the acceleration was constantly progressing. But more than twenty-four hours had been consumed in attaining this velocity; and to check it entirely, under similar conditions would require an equal length of time. But suppose Alpha Centauri had no planets? Or suppose the Planets were not inhabited? To go to the next nearest Star would require many days more—a still higher velocity—a still greater loss of time in starting and stopping. And then the actual time necessary to land upon a Planet—the slow descent through its atmosphere—the ascent, and hours afterward proceeding at a snail's pace such as they had used within the Solar System! No, it was impossible. A year would be required to make any extended exploration—a year at the very least.

"I will figure it out," he muttered grimly. "The most delicate, abstruse mathematical problem ever attempted! But it can be solved—and I will—I must—solve it.

(To be Continued.)

# RADIOGEM

## The Dollar Radio Receiving Set

### The Simplest Radio Outfit Made

—Yet as Practical as the Most Expensive!

You need know absolutely nothing about wireless to operate and enjoy the RADIOGEM. It is so sturdy, so simply constructed that it is small wonder radio engineers who have tested it have pronounced the RADIOGEM a brilliant achievement. The RADIOGEM is a crystal radio receiving set for everyone at a price anyone can afford.

### Why The RADIOGEM Can Be Sold For Only \$1

Here's the secret: The RADIOGEM Construction eliminates all unnecessary trimmings, cabinets and the like, which do not play any part in the operation of a set. You receive the RADIOGEM unassembled, together with a clearly written instruction book, which shows you how to quickly and easily construct the set, using only your hands and a scissor. The outfit comprises all the necessary wire, contact points, detector mineral, tube on which to wind the coil, etc., etc. The instruction book explains simply and completely the principles of radio and its graphic illustrations make the assembling of the RADIOGEM real fun. Remember the RADIOGEM is a proven, practical radio receiving set and will do anything the most expensive crystal set will do.

### The RADIOGEM is the Prize Winner of the Age

Out of hundreds of radio models submitted recently in a great nation-wide contest, radio engineers, the judges, unanimously chose the RADIOGEM as the winner—the simplest radio-receiving set made! And the RADIOGEM costs you nothing to operate; no form of local electricity is required.

Sent Postage Prepaid on receipt of \$1—stamps, money-order or check.

Order Your Radiogem To-day—  
or send for Free Descriptive Circular

# DEALERS

The RADIOGEM is the wonder item of the radio age. It is storming the country, for the RADIOGEM'S price is so low everyone is able to buy one. Write immediately for full particulars before that shop across the street beats you to it.



Hear the programs of the Broadcasting Stations on the RADIOGEM



without PHONE or AERIAL (Patent Pending)

### What They Say About RADIOGEM

I am enclosing herewith \$1.00 to pay for the Radiogem. I had it carefully wound by our wireless operator and find that it works beautifully—fully as good as any crystal set we know of.

Radiogem received, which we assembled and were very much astonished at results obtained and the clearness and volume of tone produced.

The greatest distances I heard on one of your sets is 1900 miles, having heard WGY at Schenectady, N. Y. I think your set is the best I have ever sold at any price.

On an aerial 160 feet long and 20 high one of my customers has heard WOC and WHB, RSD, WMC on one of your sets using a Peerless headset.

Herewith P.O.M.O. amt. \$1.00 for another "RADIOGEM." The one received is O.K. Placed about 15 ft. of picture cord under front porch and grounded to a gas meter, and heard the Sacramento Bee and Sacramento Broadcasting Union much better than with my large crystal set.

Your RADIOGEM RECEIVER is a wonder. I have received every station in Philadelphia with it much louder than with a high-priced crystal set.

Your two Radiogem sets received last night, and one was wired up for testing. WOC is about 40 miles away, and their signals could be heard with headphones on table. After they quit KYW at Chicago about 170 miles east was heard. Every word could be plainly heard here. WMC at Memphis, Tenn., could also be easily heard and understood.

We find that this set does a great deal more than you claim for it. We took WBAR on our audion set last night; this being the Baltimore American Broadcasting station, and then cut in the Radiogem and got excellent results. After the Baltimore concert was over, we continued to use the audion set and about ten o'clock were listening to WEAF—New York—and a little later we disconnected the audion set entirely and hooked up the Radiogem, very clearly hearing both piano music and announcement of name of station and its location.

You claim a radius of 20 miles over your "Radiogem" is sometimes a possibility. You should adhere to the truth. I constructed one for my mother, installed it with an aerial, and she listens not once in a while, but at her will, to Schenectady, Newark, New York, or Providence, P. I., and her home is Attleboro, Mass. I can't give your set too much praise. (Names and Addresses on Request)

## REPAIRS

guaranteed equal to new. SAVE HALF the cost of a new tube. All repaired tubes returned parcel post, C. O. D.

Harvard Radio Laboratories

P. O. Box 1781 BOSTON, MASS.

Tubes returned P.P., C.O.D.

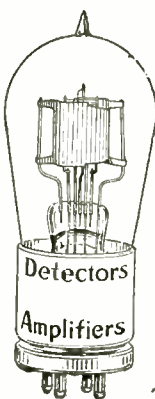

## PERFECT CONNECTIONS

are always sure with Fahnestock Patent Wire Terminal Grips Like a Vise Eliminates Vibration Easily Attached No Soldering Best of All for RADIO OUTFITS Clip No. 45 (Illustrated) especially adapted for bus wire

Made in all Sizes and Shapes At your Dealer's **FAHNESTOCK ELEC. CO.** East Ave. and 8th St. Long Island City, N. Y.





## Opportunity Ad-lets

**Y**OU will find many remarkable opportunities and real bargains in these columns. It will pay you to read and investigate the offerings made every month by reliable firms, dealers and amateurs from all over the country. No matter what you may be seeking, whether supplies, automobile accessories, the opportunity to make money, or anything else, you will find listed here the best and most attractive specials of the month.

Advertisements in this section twelve cents a word for each insertion. Name and address must be included at the above rate. Cash should accompany all classified advertisements unless placed by an accredited advertising agency. No advertisement for less than 10 words accepted.

Ten per cent. discount for 6 issues, 20 per cent. discount for 12 issues. Objectionable or misleading advertisements not accepted. Advertisements for the December issue must reach us not later than October 15.

**The Circulation of Science and Invention is over 160,000 and climbing every month**

EXPERIMENTER PUBLISHING CO., INC., 53 Park Place, New York City, N. Y.

### Agents Wanted

**Agents—Best seller;** Jem Rubber Repair for tires and tubes; supercedes vulcanization at a saving of over 800 per cent; put it on cold. It vulcanizes itself in two minutes, and is guaranteed to last the life of the tire or tube; sells to every auto owner and accessory dealer. For particulars how to make big money and free sample, address Amazon Rubber Co., Dept. 601, Philadelphia, Pa.

**Big money and fast sales.** Every owner buys gold initials for his auto. You charge \$1.50; make \$1.35. Ten orders daily easy. Write for particulars and free samples. American Monogram Co., Dept. 71, East Orange, N. J.

**Make \$25 to \$50 week** representing Clows' Famous Philadelphia Hosiery, direct from mill—for men, women, children. Every pair guaranteed. Prices that win. Free book "How to Start" tells the story. George Clows Company, Dept. 27, Philadelphia, Pa.

**Success in Business and Personal Affairs!** Read character by handwriting and features. Conlin System. Low price for entire course. Write. H. E. Conlin, Dept. G, 21 St. John's Place, Buffalo, N. Y.

**Men's Shirts.** Easy to sell. Big demand everywhere. Make \$15.00 daily. Underseil stores. Complete line. Exclusive patterns. Free samples. Chicago Shirt Manufacturers, 241 W. VanBuren, Factory, 115, Chicago.

**Wonderful Invention—Eliminates** all needles for phonographs. Saves time and annoyance. Preserves records. Lasts for years. 12,000,000 prospects. \$15.00 daily. Free sample to workers. Everplay, Dept. 107, McCurtig Bldg., Chicago.

**We want Salesmen and Agents,** either whole or side line, to sell our low priced radio books to the trade. Excellent proposition for live wires. The E. I. Company, Publishers, 233 Fulton Street, New York City.

**Greatest Sensation!** Eleven Piece toilet article set selling like blazes at \$1.75 with \$1.00 dressmakers shears free to each customer. Spring rush on. Foster Reid Co., 28 Winslow Bldg., Station C, Chicago.

**Write and learn how to start profitable business** without capital or experience. Silvering mirrors, refinishing auto headlights, tableware, plating. Outfit furnished. International Laboratories, Dept. 25, 309 Fifth Ave., New York.

**Earn big money fast** applying gold initials to autos. Every owner buys—\$1.35 profit on \$1.50 sale—particulars and samples free. Write quick. Lithogram Co., Dept. 19, East Orange, N. J.

**Only one sale a day means \$200 per month!** Five sales, \$1.00 per month! Marvelous new adding machine. Retail \$15. Work equals \$350 machine. Adds, subtracts, multiples, divides automatically. Speedy, accurate, durable, handsome. Five-year guarantee. Offices, stores, factories, garages, buy one to dozen. A fortune for live agents. Write quick for protected territory and free trial offer. Lightning Calculator Co., Dept. W., Grand Rapids, Mich.

**Big Fast Profits For Agents.** Repeater Six Fuse Plugs sell on sight wherever there is electricity. Do away with lightning troubles. Welcomed everywhere. Get details. Sample 25c. Moss-Schury Manufacturing Company, Inc., 18-A Detroit, Mich.

**Agents: Big Profits,** no competition. Make \$5.00 to \$15.00 daily selling our beautiful Scripture Text Calendars. Agents now selling from 10,000 to 50,000 yearly. Write now. Messenger Publishing Co., Dept. 141, 314 West Superior St., Chicago, Ill.

**\$60—\$200 a week.** Genuine Gold Letters for store windows. Easily applied. Free samples. Liberal offer to general agents. Metallic Letter Co., 433 B, North Clark, Chicago.

**Sell Madison "Better Made" Shirts** direct from our factory to wearer. No capital or experience required. Easily sold. Big profits. Write for Free Samples. Madison Mills, 503 Broadway, New York.

**Agents—\$15 a day—Easy, quick Sales—Free Auto—Big weekly bonus—\$1.50 premium Free to every customer.** Simply show our beautiful, 7-piece, Solid Aluminum Handle Cutlery Set. Appeals instantly. We deliver and collect. Pay daily. New Era Mfg Co., 803 Madison St., Dept. 88E, Chicago.

**Agents—Big returns, fast office seller;** particulars and samples free. One Dip Pen Co., 12 Daily Record Bldg., Baltimore, Md.

**Rummage Sales make \$50.00 daily.** We start you. Representatives wanted everywhere. Wholesale Distributors, Dept. 32, 609 Division Street, Chicago.

**Earn \$10 daily** silvering mirrors, plating and refinishing metalware, chandeliers, bedsteads, headlights. Outfits furnished. N. Dele Laboratories, 1133 Broadway, New York.

**Agents—Our soap and toilet article plan is a wonder;** get our free sample case offer. Ho-Ro-Co., 119 Locust, St. Louis.

**Get our prices on vacuum tube repairs.** Good opportunity for wide awake boys. Harvard Radio Laboratories, P.O. Box 1781, Boston, Mass.

### Agents Wanted—(Continued)

**Tailoring Salesmen.** Biggest producers in the country handling our line of guaranteed Virgin-Wool tailor-made clothes at one low price of \$31.75. We supply finest Sample Outfit showing biggest assortment of fabrics, more than 75 percent of which are fine, firm-weave pure worsteds—just the character of goods most men want. We give unequalled service and deliveries and pay big cash prices. There are other reasons. Write for them at once. Goodwear Clothing, Inc., Dept. 603, Chicago.

**Agents—I am paying \$2 an hour** taking orders for complete new line of household necessities. Write quick for particulars. Albert Mills, General Manager, 9862 American Bldg., Cincinnati, Ohio.

**300 Percent Profit: Sells Like Wildfire.** Kleanrite, Magic Washing Compound. Sample free. Bestever Products Co., 1945-D Irving Park, Chicago.

**Live Agents make \$10 Day** selling Eureka Strainer and Splash preventer for every water faucet. Takes on sight. Widely advertised and known. Get details today. A. J. Seed Filter Co., 73 Franklin, New York.

**Start your own business** as our sole agent, selling 100 famous home products. All or spare time. Dr. Blair Laboratories, Dept. 535, Lynchburg, Va.

**Burglar Proof Key Lock.** Just out. No competition. Self advertises and demonstrates itself. No tools required to install. Absolutely guaranteed. Sample 25c. Agents wanted. Clinton Supply Co., 1326 Clinton St., Sandusky, Ohio.

**300 Percent Profit: Free Auto.** Whirlwind Seller. Tremendous Repeater. Sample free. Bestever Products Co., 1945-K Irving Park, Chicago.

**Agents—Make big money** taking orders for Insyde Tyres. Positively prevent punctures and blowouts. Double tire mileage, any tire, old or new. Old worn out casings give 3 to 5 thousand miles more service. Use over and over again. Low priced. Big demand. One customer brings four others. Big money saver. Write for terms. American Accessories Co., B-684, Cincinnati, Ohio.

**\$10 daily silvering mirrors,** plating and refinishing lamps, reflectors, autos, beds, chandeliers by new method. Outfits furnished. Write Gunmetal Co., Ave. D, Decatur, Ill.

### American Made Toys

**Manufacturers on large scale,** also homemakers, wanted to manufacture Metal Toys and Novelties. Millions needed of Barking Dogs, Wag-Tail Pups, Wild Animals, Automobiles, Indians, Cow-Boys, Baseball Players, Cannons, Toy Soldiers, Crowing Roosters, Statues of Liberty, Miniature castings of Capital, Bathing Girl Souvenirs and others. Unlimited possibilities. Guaranteed Casting forms furnished manufacturers at cost price from \$5.00 up, with complete outfit. No experience or tools necessary. Thousands made complete per hour. We buy goods all year and pay high prices for finished goods. Cash on Delivery. Contract orders placed with manufacturers. Catalog and information free. Correspondence invited only if you mean business. Metal Cast Products Co., 1696 Boston Rd., New York.

### Automobiles

**Automobile owners, garagemen, mechanics,** send for free copy America's popular motor magazine. Contains helpful, money-saving articles on repairing, overhauling, ignition, carburetors, batteries, etc. Automobile Digest, 541 Butler Bldg., Cincinnati.

### Correspondence Courses

**Used correspondence courses** bought and sold. Bargain catalogue 1000 courses free. Students' Exchange, Dept. 4, 47 West 42d St., New York.

**Degrees earned by correspondence** study in Engineering, science, law, theology, medicine, etc. 700 courses. Catalogue free. Oriental University, 1702 Oregon Ave., N. W., Washington, D. C.

**Dollars Saved.** Used correspondence courses of all kinds sold, rented and exchanged. List free. (Courses bought.) Lee Mountain, Pisrah, Alabama.

### Books

**Free—Upon request** will send you my literature illustrating the following books. Astrology, Character, Clairvoyance, Concentration, Healing, Hypnotism, Magnetism, Mediumship, Personal Magnetism, Personality, Physiognomy, Salesmanship, Seership, Success, Sex, Will, Yoga Philosophy, Gazing Crystals, etc. A. W. Martens, E.E. 6, Burlington, Iowa.

**"Lights, Colors, Tones and Nature's Finer Forces,"** including Vibrations; Odic-Uras; Electro-Magnetics, Gold-Lights; Radio; Coming Inventions, 270 pages. Satisfaction Guaranteed; \$2.00, Circulars Free. Stevens Research Laboratories, 212 Powell Street, San Francisco, Calif.

**Perpetual Motion, by Percy Verance.** A history of the efforts to discover same from earliest days to the present, together with a scientific discussion regarding the possibility of its ultimate achievement. Profusely illustrated, 357 pages. Price postpaid, \$2.00. The Enlightenment Specialty Co., 305 Fourth St., Edwardsville, Ill.

**Diseases and Their Innate Healer.** Book 25 cents. Arthur Stevens, Wauson, Ohio.

**Send for New Illustrated Catalog of Books on Mechanical Subjects** Free. Spon & Chamberlain, 122 S Liberty Street, New York.

**Hypnotism—Controls self and others.** Wants gratified. Ten easy methods, \$1.10. "Mindreading" (any distance) Wonderful, \$1.10. Science Institute, SE1014 Belmont, Chicago.

**New Book Chemical Wonders.** Secrets and Mysteries, fully explained, 10c postpaid. Catalog of Books 2c. Henry S. Collins Co., 197 Fulton Street, Brooklyn, N. Y.

**Experimental Electricity Course in 20 Lessons.** By S. Gernsback and H. W. Secor, E.E. A course of the theory and practice of Electricity for the Experimenter. Every phase of experimental electricity is treated comprehensively in plain English. New experiments are described and explained and nearly every application of Electricity in modern life is given. 160 pages—100 illustrations. Flexible cloth cover, 75c. postpaid. Stiff cloth cover, \$1.25 postpaid. Experimenter Publishing Co., Book Dept., 53 Park Place, New York City.

**The How and Why of Radio Apparatus,** by H. W. Secor, E. E. This newest book on radio matters fulfills a distinct gap in wireless literature in that, while the treatment is made as understandable and as free from mathematics as possible, it at the same time incorporates a wealth of technique and instruction for the Radio Amateur—the Radio Operator—the Installation and Designing Expert—as well as teachers and students of the subject in general. A very broad field has been covered by the author, at the same time giving a great deal of information not found in other text books. If you are engaged in any branch of the Radio or allied arts at all you will surely need this latest contribution to radio literature, which is destined to be found on every radio man's book shelf before long. A glance at the following list of chapters gives but a very scant idea of the extensive and useful radio knowledge provided in its text: The Induction Coil; The Alternating Current Transformer; Radio Transmitting Condensers; The Spark Gaps; Radio Transmitting Inductances; Radio Receiving Tuners; Radio Receiving Condensers; Detectors; Telephone Receivers; Radio Amplifiers; Construction of a Direct Reading Voltmeter and Measurement of Inductances; Appendix containing very useful tables, covering all subjects treated in this very unusual book. This newest Radio Works, cloth bound in Yellow de Luxe, Gold Stamped and Hand Sewed, has 160 pages. Size of book 6x9 inches. The How and Why of Radio Apparatus. Postpaid, \$1.75. Experimenter Publishing Co., Book Dept., 53 Park Place, New York City.

### Chemistry

**Learn Chemistry at Home.** Dr. T. O'Connor Sloane, noted educator and scientific authority, will teach you. Our home study correspondence course fits you to take a position as chemist. See our ad on page 593 of this issue. Chemical Institute of New York, 66 W. Broadway, New York City.

### Duplicating Devices

**"Modern" Duplicators save Time, Labor and Money.** Gets Business. Reproduces Typewritten or penned letters, Drawings, Lessons, Music, Menus, Bids, Notices, Specifications, Maps or anything in one or more colors. Prints two per minute. Special Sale On 30 Days' Free Trial. \$2.25 up. Booklet Free. B. J. Durkin-Reeves Co., Pittsburgh, Pa.

### For Advertisers

**25 words—355 Rural Weeklies, \$14.20.** Ad-Meyer Agency, 4112SI Hartford, St. Louis.

**I write letters, folders, booklets,** complete follow-up for manufacturers, mail-order dealers. Long Experience. Write for details. L. Taylor, Box 44E, Freeport, Illinois.



**Business Opportunities**

**Make money with your camera.** P. Lancaster, Box 967, Los Angeles.

**Dollars yearly in your spare time.** Indoors or outdoors I'll show you how. Particulars free. S. I. Metz, 313 East 89th, New York.

**Join National Institute Inventors,** 8 E. 14th St., New York City, strong protective membership society. Will secure, develop, manufacture, market patents. Dues, \$10. Booklet free.

**Sell us your spare time.** You can earn Fifteen to Fifty dollars weekly writing show cards at home. No canvassing; pleasant profitable profession, easily, quickly learned by our simple, graphic block system, artistic ability unnecessary; we instruct you and supply work. Wilson Methods, Limited, Dept. J, Toronto, Canada.

**You can have a business-profession** of your own and earn big income in service fees. A new system of foot correction: readily learned by anyone at home in a few weeks. Easy terms for training, openings everywhere with all the trade you can attend to. No capital required or goods to buy, no agency or soliciting. Address Stephenson Laboratory, 18 Back Bay, Boston, Mass.

**Stop Plodding! Be Successful.** Operate a Tire Repair Shop. Make big profits in any locality. We teach you and furnish complete equipments \$100 up. Book of Opportunity free. Hayward's 1312 South Oakley Avenue, Chicago.

**Be a Broker,** buy and sell Currencies and Bonds, make 100 to 300 percent profit. Write for interesting information. George Grigoleit, 20 E. Jackson, Chicago.

**Money Making Opportunities—particulars free.** Lemke, Box 572, Cincinnati, Ohio.

**Succeed with your Own Products—Formulas, Processes.** Different, dependable, guaranteed. Catalog free. D. Thaxly Co., Washington, D. C.

**Ford Owners**

**Sport Cars.** Fast, saucy, hug the turns and stick to the road—make you glad you're a Ford owner. Can easily be built by aid of life size "Red-i-Kut" patterns and picture instructions. The "Pal" system delivered complete with pressed metal streamlining tail for \$8.40. Garage men make big money building them. Send for prospectus on making sport cars—Jifty Tops and Gosum windshields. Kuempel Co., 1100 Kuempel Bldg., Gutsenberg, Iowa.

**For Inventors**

**Get your own patents.** Application blanks, complete instructions \$1. Cutting Bros., Campbell, Calif.

**Before or after filing your application for patent,** it will pay you to read over my "Inventors Advisor No. 4." Free for asking. Write: M. Labiner, Registered Patent Attorney, 3 Park Row, New York.

**We Develop Your ideas** into commercial shape for presentation to purchasers, making working models, drawings, experiments or tests. Courtesy, efficiency, secrecy and ample equipment; 30 years' experience. Ducoron-Rich Engineering Co., 504 Pacific Mutual Bldg., Los Angeles, Calif.

**Your Chemical problem solved** and working process furnished for Five Dollars. Write me. W. Stedman Richards, Consulting Chemist, Box 2102, Boston, Mass.

**Patent application blanks,** sample drawing, complete instructions all for \$1. Will Watt, Box 31 South Pasadena, Calif.

**Inventions Developed** to commercially practical shape. Expert machine designing. Working Drawings, patent drawings, tracings, etc. H. Wettstein, M.E., 150 Nassau St., New York.

**Formulas**

**Moneymaking Books, Plans, Formulas, Catalog Free.** Ideal Book Shop, 5501-E, North Robey, Chicago.

**Games and Entertainment**

**Tricks, Puzzles, Jokes, Magical Apparatus, Plays, Stage Supplies, Mind-Reading, Acts and Sensational Escapes.** Send 10c for 100-page illustrated 1922 professional catalogue. Oaks Magical Co., Dept. 549, Oshkosh, Wis.

**Health**

**Asthma and Hay Fever Cured to Stay Cured.** Write for particulars. A. Butterworth, 374 DeWitt, Belleville, N. J.

**Don't Die Yet.** Eat for health. Order "Chemist's Tested Health Recipes and Scientific Cook-Book." One dollar. "Making Sixty Delicious Drinks and Tonics." Fifty cents. M. Hobson, Riverside, Calif., Box 407.

**Christians Red Food Salt.** Greatest Natural Aid for Nutrition \$1, \$2 sizes. Guaranteed. Vegetarian Food Co., St. Louis, Mo., Literature free.

**Free to Men—Information** of a scientific nature that has brought physical vigor and happiness to thousands. No charge; no obligation. Enclose stamp for reply. C. I. Wood & Co., Colorado Springs, Colorado.

**Improved Made Toys**

**We show you how to earn big money** easily with our casting forms making Whistling Birds, Wild Animals, Crowing Roosters, Automobiles, Baseball Players, Statue of Liberty, Indians, Toy Soldiers, Cowboys, Barking Dogs, Wag Tail Pups, Miniature castings of Cabitol, Bathing Girl Souvenirs and others. No experience necessary. We furnish you with molds and necessary outfit from \$3.50 up. We buy large quantities of finished goods at highest prices. Spot cash. Send for catalogue and information free. The Improved Metal Casting Co., 342 East 145th St., New York.

**Help Wanted**

**We want Salesmen and Agents,** either whole or side line to sell our low priced radio books to the trade. Excellent proposition for live wires. The E. I. Company, Publishers, 233 Fulton Street, New York City.

**Detectives Earn Big Money.** Travel. Excellent opportunity. Great demand everywhere. Experience unnecessary. Particulars free. Write, American Detective System, 1968 Broadway, N. Y.

**Be a Mirror Expert.** \$3 to \$10 a day; spare time home at first; no capital; we train, start you making and silvering mirrors French method. Free prospectus. W. R. Derr, Pres., 26 McKinley St., Baldwin, N. Y.

**Be a Detective; Excellent opportunity; good pay; travel.** Write C. T. Ludwig, 1417 Westover Bldg., Kansas City, Mo.

**Make Money in spare time** mailing letters. Rare opportunity now. Men, send addressed envelope for special plan. Normande R, 147 W. 23d St., New York.

**All men, women, boys, girls, 17 to 60,** willing to accept Government positions \$117-\$190, traveling or stationary, write Mr. Ozment, 293, St. Louis, Mo., immediately.

**Silvering Mirrors, French plate.** Easily learned, immense profits. Plans free. Wear Mirror Works, Excelsior Springs, Mo.

**Earn \$25 Weekly,** spare time, writing for newspapers, magazines. Experience unnecessary; details free. Press Syndicate, 5665 St. Louis, Mo.

**Railway Postal Clerks—Start \$133 month.** Railroad Pass; expenses paid; questions free. Columbus Institute, H-4, Columbus, Ohio.

**Firemen, Brakemen, Baggage men, Sleeping car, train porters (colored).** \$140-\$200. Experience unnecessary. 897 Railway Bureau, E. St. Louis, Ill.

**Is your job steady? Be U. S. Railway Postal Clerk, \$133-\$192 month.** Travel. See the country. Particulars free. Write immediately. Franklin Institute, Dept. B24, Rochester, N. Y.

**Earn \$110 to \$250 monthly,** expenses paid as Railway Traffic Inspector. Position guaranteed after completion of 3 months' home study course or money refunded. Excellent opportunities. Write for Free Booklet G-57 Stand. Business Training Inst., Buffalo, N. Y.

**Instruction**

**Instruct Yourself for desired Successes.** Illustrative chart shows Success (live) Steps. Postpaid 50 cents. J. E. Morvey, Box 304, Madison Sq. Sta., N. Y.

**Learn Chemistry at Home.** Dr. T. O'Conor Sloane, noted educator and scientific authority, will teach you. Our home study correspondence course fits you to take a position as chemist. See our ad on page 593 of this issue. Chemical Institute of New York, 66 W. Broadway, New York City.

**Languages**

**World-Romie System, Masterkey to All Languages.** Primers, 25 languages, \$1.94 each language: English, French, German, Italian, Portuguese, Spanish. Pronunciation—Tables, 102 languages, 30c each language. Languages Publishing Company, 8 West 40th Street, New York.

**Machinery and Tools**

**Concrete Building Block Machines and Molds.** Catalogue free. Concrete Machine Co., 305 South Third St., St. Louis, Mo.

**Manufacturing**

**Something special in metal? Models, Tools, Patterns.** Experimenting, Manufacturing, Inventions developed. Parma Engineering Works, Brooklyn Station, Cleveland, Ohio.

**Miscellaneous**

**Radio! Mystery of the 20th Century** Complete—simple explanation of this mysterious communication, with instructions for making sets. Cloth bound, 350 pages. Special \$1.10. Avery Co., Zionsville, Ind.

**\$50 to \$150 Weekly** Writing Jokes, Epigrams and Humorous Stories for publications. Write for details. American Institute of Humor, Office E, 411 Park Bldg., Cleveland, Ohio.

**Spark-Plug.** Cleans like a pipe, at tright or royalty. Box 100, Worth, N. C.

**Questions Answered.** \$1.00 each, any subject. If answer impossible, money returned. Dept. 2, 31 N. E. 11th Street, Miami, Florida.

**Moon-O-Light radium** paint shines in darkness: 25c per bottle. Gray & Breyer Co., Dept. 45, 1463 St. Lawrence Ave., Bronx, N. Y.

**Buy your cigars direct,** 50 Arumor prepaid, \$1.50. Money back if dissatisfied. Agents wanted. Havana Smokehouse, Homeland, Ga.

**Special Financial Service.** Obtain capital. Any Amount. Banking connections in United States and Europe. Incorporate your business. Sell Stock. Keep control. Transact any business, anywhere. Avoid personal liability. Low cost for Expert Services, all corporation supplies, engraved stock certificates, etc. Lists of Investors. Here and Abroad. Write for full information. Advice Free. Registrar and Trustee Co., Rochester, N. Y.

**Motorcycles—Bicycles**

**Don't buy a Bicycle Motor Attachment** until you get our catalogue and prices. Shaw Mfg. Co., Dept. 6, Galesburg, Kansas.

**Motion Picture Business**

**\$35 Profit Nightly.** Small capital starts you. No experience needed. Our machines are used and endorsed by Government institutions. Catalog free. Atlas Moving Picture Co., 470 Morton Bldg., Chicago, Ill.

**Patent Attorneys**

**Inventors—Send for form "Evidence of Conception"** to be signed and witnessed. Form, fee schedule, information free. Lancaster and Allwine, 212 Ouray Bldg., Washington, D. C.

**Millions spent annually for ideas!** Hundreds now wanted! Patent yours and profit! Write today for free books—tell how to protect yourself, how to invent, ideas wanted, how we help you sell, etc. 212 Kreske Bldg., American Industries, Inc., Washington, D. C.

**Patents.** Send for free booklet. Highest references, Best results. Promptness assured. Send model or drawing for examination and opinion. Watson E. Coleman, Patent Attorney, 624 F Street, Washington, D. C.

**Inventors write me about patents.** My fees payable monthly. Booklet free. Frank Fuller, Washington, D. C.

**Herbert Jenner, Patent Attorney and Mechanical Expert.** 624 F Street, Washington, D. C. I report if patent obtainable and exact cost. Send for circular.

**Lacey Patent-Sense.** "The book the inventor keeps." Free. See page 603.

**Patents Procured, Trade Marks Registered.** A comprehensive, experienced, prompt service for the protection and development of your ideas. Preliminary advice gladly furnished without charge. Booklet of information and form for disclosing idea free on request. Richard B. Owen, 130 Owen Bldg., Washington, D. C., or 2275-T Woolworth Bldg., New York.

**Inventors! Record invention** legally before disclosing to others. Our Invention Record and Data Sheet shows how. Sent free and valuable information given on patent procedure, costs, etc. Report on patentability includes copies of patents nearest your idea. O'Connell & O'Connell, 409 Jenifer Building, Washington, D. C.

**Monroe Miller, Ouray Building,** Washington, D. C., patent attorney, mechanical and electrical expert. Best quality of work and results. Moderate charges.

**Patents—Prompt, personal, efficient service** by an attorney-at-law skilled in all branches of Patent Practice. Over 18 years' actual experience; full information upon request. B. P. Fishburne, 330 McGill Bldg., Washington, D. C.

**Inventors.** Send sketch or model of invention for opinion concerning patentable nature and exact cost of patent. Book "How to Obtain a Patent," sent free. Tells what every inventor should know. Established twenty-eight years. Highest references, prompt service, reasonable charges. Chidsey & Chandler, 411 Seventh Ave., N. W., Washington, D. C.

**"Inventors' Guide" free** on request; gives valuable information and advice for all who have original ideas or improvements. Frank Ledermann, Registered Attorney and Engineer, 15-B Park Row, New York.

**Edward C. Sasnett,** formerly a Principal Examiner U. S. Patent Office, Personal Service, 531 McGill Bldg., Washington, D. C.

**H. F. Lowenstein,** Registered Patent Attorney, Radio Expert, 825 McLaehlen Building, Washington, D. C.

**Unpatented ideas can be sold.** I tell you how and help you make the sale. Particulars free. Write W. J. Greene, Juffer Building, Washington, D. C.

**Inventors.** Protect your invention through A. M. Wilson, Inc., Washington, D. C. Over 25 years of efficient, expert, confidential service. Skilled in Radio-Electrical, Chemical and Mechanical fields. Our new illustrated booklet, giving much necessary and very useful information which every inventor should know, will be sent free upon request. Prompt and careful attention. Highest references. Moderate fees. Send sketch or model for our careful opinion and preliminary advice. Write today to A. M. Wilson, Inc. (Radio 3 ARID), 312 Victor Bldg., Washington, D. C. (Successor to business established in 1891 by A. M. Wilson)

**Patents**

**Inventions Commercialized.** Patented or unpatented. Write Adam Fisher Mfg. Co., 295 St. Louis, Mo.

**Unpatented ideas can be sold.** I tell you how and help you make the sale. Particulars free. Write W. B. Greene, Juffer Building, Washington, D. C.

**Patents For Sale**

**Brush's Pad** for cleaning and spotting any garments, etc. No. 1,224,581 for \$16,000.00. C. B. Twyford, 617 Bailey. Zanesville, Ohio.

**Photoplays, Stories, Etc.**

**Wanted.** Men and women ambitious to make money writing Stories and Photoplays. Send for wonderful Free Book that tells how. Authors' Press, Dept. 131, Auburn, N. Y.

**\$\$\$ For Ideas.** Photoplay Plots accepted, any form; revised, criticised, copyrighted, marketed. Advice free. Universal Scenario Corporation, 223 Security Bldg., Santa Monica & Western Ave., Hollywood, Calif.

**Big Money in Writing** photoplays, short stories, poems, songs, etc. Send today for free copy America's greatest magazine for writers. Filled with practical help in writing and selling. Writer's Digest, 637 Butler Building, Cincinnati, Ohio.



## SENSATIONAL SALE



**TYPEWRITERS**  
with a  
**5 Year**  
Guarantee  
**FREE TRIAL**  
Before You Buy

This is the famous L. C. Smith typewriter which has set the world's standard for quality and service for over twenty years. It has every late style feature and modern operating convenience. Comes to you with everything complete; tools, cover, operating book and instructions—nothing extra to buy. You cannot imagine the perfection of this beautiful rebuilt typewriter until you have seen it. We do the most perfect rebuilding known to the industry. We have sold thousands of these perfect late style machines at this bargain price and every one of these thousands of satisfied customers had this beautiful, strictly up-to-date machine on five days' free trial before deciding to buy it. These typewriters will write as clean cut and as perfect a letter as quickly and easily as any typewriter you can buy at any price. We send it to you F. O. B. Chicago for five days' free trial. It will sell itself, but if you are not satisfied that this is the greatest typewriter you ever saw, you can return it at our expense. You won't want to return it after you try it, for you cannot equal this wonderful value anywhere.

**Send TODAY For Details**

The supply on this offer is limited, the price will probably be raised when next advertisement appears, so don't delay. Fill in the coupon today. There is no red tape to our free trial and easy payment plan. We employ no salesmen. It is the greatest typewriter opportunity you will ever have. Don't send us a cent. Get the coupon in the mails today—sure.

Smith Typewriter Sales Co., 303-360 E. Grand Ave., Chicago  
Send me without obligation your FREE book of valuable typewriter information and sensational Special Sale Bulletin.

Name.....  
Street Address.....  
City..... State.....

## PIMPLY SKIN made WELL

When a few applications of this wonder working lotion has cleared faces of pimples, blackheads, acne eruptions on the face or body, enlarged pores, oily or shiny skin, you can realize why CLEAR-TONE has been tested and approved in over 100,000 Test Cases.

The simplicity of the treatment. The Story of How I Cured Myself are all explained in my free booklet. Write for your copy and learn of the results obtained by thousands of men and women.

**E. S. GIVENS**  
168 CHEMICAL BLDG. KANSAS CITY, MO.

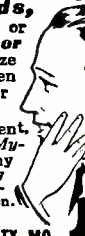

## SEX

Part of other sex books don't dare discuss are plainly told in "Where Knowledge Means Happiness." Creates a new kind of married love. One reader says: It contains more real information than all other sex books put together.

From "Where Knowledge Means Happiness" sent in plain cover, by redge Means Happiness" turn mail, for \$1.00, cash, money order, check or stamps  
Copyright 1921  
Dept. 39 COUNSEL SERVICE, 257 W. 71st St. N.Y.



### DEAFNESS IS MISERY

I know because I was Deaf and had Head Noises for over 30 years. My invisible Antiseptic Ear Drums restored my hearing and stopped Head Noises, and will do it for you. They are tiny Mesaphones. Cannot be seen when worn. Effective when Deafness is caused by Catarrh or by Perforated, Partially or Wholly Destroyed Natural Drums. Easy to put in, easy to take out. Are "Unseen Comforts." Inexpensive. Write for Booklet and my sworn statement of how I recovered my hearing.

**A. O. LEONARD**  
Suite 369, 70 5th Avenue -- New York City

### ARE YOU SELF-CONSCIOUS?

Embarrassed in company, lacking in self-control? Let me tell you how you can overcome these troubles.

**VERITAS, Desk 15, 1400 Broadway, New York City**

### ADULTS! SEX KNOWLEDGE BOOKS

Instructive, authoritative, profusely illustrated in natural colors, etc. Not the cheap sort. Contains everything one should know both before and after marriage to insure health and happiness. Large catalog free. **K. F. SMETANA & COMPANY, OWOSSO, MICH.**

*Personal*

Exchange interesting letters with new friends. Write Dolly K. Gray, Box 386, Denver, Colorado.

Exchange Cheery Letters with New Friends. Write Betty Lee, Inc., 4254 Broadway, New York City. Stamp appreciated.

Exchange jolly letters with new friends. Lots fun! Send stamp. Eva Moore, Box 908, Jacksonville, Fla.

Exchange letters with new friends everywhere. Pleasant pastime, particulars free. Smith, Box 1167Y, Denver, Colo.

Lately Hearts. Join our Club, be happy; correspondence everywhere; many wealthy, descriptions, photos free. Standard Club, Box 609, Grays Lake, Ill.

Civilization saved by "Right Rule," easy as water's flow. One Amendment turns Chaos to Order, here—now—forever. Greatest plan, of man for man, since man began. Billions need it. \$1. N. Y. World, Dept. J, Benton Harbor, Mich.

Heaven on Earth now by "Automatic Civil Service." World's greatest discovery to utilize selfishness and civilize civilization. \$1. New World, J. Benton Harbor, Mich.

*Phonographic Supplies*

Build Your Phonograph. Quality phonoparts. Famous Seregnato Motors. Also original Perfection Motors. Electric Motors, tonearms, reproducers, amplifiers, case material, accessories. Free blueprints and building instructions. Big Savings. Wonderful prices. Prompt delivery. Catalog mailed for ten cents. Hoosier Mfg. & Supply Company, 221 Baldwin Block, Indianapolis, Indiana.

*Printing*

100 Each letterheads, Envelopes, Return Envelopes. \$1.50. Jacobus Advertising Service, Irvington, N. J.

*Radio Equipment*

Edison Elements for making "B" Batteries, 6c per pair; tubes 2c each. Nickel Wire, Insulators, and Cabinets, at reasonable prices. Todd Electric Co., 178 Lafayette St., New York City.

*Radium*

Genuine Radium Paint. Complete Application Set, \$1.00. Illuminates 6 watches. Also for Switches, Gauges, Locks, Signs. Applied with pen. Hammer Radium Company, Denver, Colorado.

*Salesmen Wanted*

4742 Last Month for Beck of Buffalo introducing latest advertising plan; nothing else like it; every merchant wants it; easy sales; no deliveries; no collections; specialty salesmen write quick for offer. National Adv. Service, P.O. Box 43, La Grange, Ind.

*Short Stories, Manuscripts Wanted*

Earn \$25 Weekly Spare Time writing for newspapers, magazines. Experience unnecessary; details free. Press Syndicate, 566 St. Louis, Mo.

Short Stories, Poems, Plays, etc., are wanted for publication. Literary Bureau, 165 Hannibal, Mo.

*Song Poems Wanted*

Write the Words for a Song. We compose music. Our Chief of Staff wrote many big song-hits. Submit your song poem to us at once. New York Melody Corp., 412 Ramax Bldg., New York.

*Song Writers*

Prominent London Music Publisher is open for available songs by American Writers, Amateur or professional; songs judged on merit, not writers' reputation. For further particulars write to American representative. Jack Mahoney, Dept. 1—145 West 45th St., New York.

*Stammering*

St-Stu-t-t-tering and Stammering cured at home. Instructive booklet free. Walter McDonnell, 105 Potomac Bank Bldg., Washington, D. C.

*Stamps and Coins*

Stamps—20 Unused. All different. Free. Postage 3c. Mention paper. Quaker Stamp Co., Toledo, Ohio.

California Gold, quarter size, 27c; half-dollar size, 53c. Columbian nickel and catalogue, 10c. Norman Schulz, Box 146, Colorado Springs, Colo.

20 Stamps Free, to Applicants of our approval sheets. Frank Thoms, 1311 Hushwick Avenue, Brooklyn, New York.

Stamps Free—Fine set War Stamps, Surcharged, Unused, Pictorials, British, French Colonies, postage 2c. Midland Stamp Company, Toronto, Canada.

*Typewriters*

Typewriters sold on payments. Free trial. Payne Company, Rosedale, Kansas.

All standard makes, \$10 up. Fully guaranteed. Free trial. Write for complete illustrated lists. Northwestern Exchange, 320 Goethe St., Chicago.

*Battle Photos and War Relics*

For Dens: Relics Collected from Europe's Battlefields. Firearms, medals, helmets, etc. Illustrated catalogue and sample War Photographs 25c. Lieut. Welch, 2117 Regent Place, Brooklyn, N. Y.

*Wanted*

Detectives Earn Big Money. Work home or travel. Experience unnecessary. Particulars free. American Detective System, 1974 Broadway, N. Y.

*Wireless*

Attention! 50 Vacuum Tube Hook-Ups. The greatest collection of Vacuum Tube Circuits ever brought under two covers at such insignificant cost. These diagrams will be found in the great "Rasco" catalogue which contains raw materials and parts in a greater profusion than any other catalogue. Use in stamps or coin will bring catalogue to you. Radio Specialty Company, 100 Park Place, New York City.

Boys, don't overlook this! The "Rasco" Baby Detector. Greatest detector ever brought out with molded base. Fully adjustable. See former advertisements in this publication or our catalogue. Detector with Galena Crystal complete, 50c; the same Detector with Radiolux Crystal, 75c, pre-paid. Send for yours today. Radio Specialty Co., 100 Park Place, New York City.

Tested Recipes. Transmitter Button Hook-Ups. Amplification. Loud Speakers. Free Circular. K. Electric Co., 15 Park Row, New York City.

Radio Generators—500 Volt 100 Watt \$28.50 each Battery Chargers \$12.50—High Speed Motors, Motor-Generator Sets all sizes. Motor Specialties Co., Crafton, Penna.

Motors—G. E. 1/4 HP. \$15.00—1/2 HP. \$32.50—1 HP. \$62.50. Generators 8 volt 10 amp \$15. 32 volt 500 watt \$30. Other sizes. Low prices. Motor Specialties Co., Crafton, Penna.

The How and Why of Radio Apparatus, by H. W. Secor, E. E. This newest book on radio matters fulfills a distinct gap in wireless literature in that, while the treatment is made as understandable and as free from mathematics as possible, it at the same time incorporates a wealth of technique and instruction for the Radio Amateur—the Radio Operator—the Installation and Designing Expert—as well as teachers and students of the subject in general. A very broad field has been covered by the author, at the same time giving a great deal of information not found in other text books. If you are engaged in any branch of Radio or allied arts at all you will surely need this latest contribution to radio literature, which is destined to be found on every radio man's book shelf before long. A glance at the following list of chapters gives but a very scant idea of the extensive and useful radio knowledge provided in its text: The Induction Coil; The Alternating Current Transformer; Radio Transmitting Condensers; The Spark Gaps; Radio Transmitting Inductances; Radio Receiving Tuners; Radio Receiving Condensers; Detectors; Telephone Receivers; Radio Amplifiers; Construction of a Direct Reading Wavemeter and Decrementer; Antenna Construction; The Calculation and Measurement of Inductances; Appendix containing very useful tables, covering all subjects treated in this very unusual book. This newest of Radio Works, cloth bound in Yellum de Luxe, Gold Stamped and Hand Sewed, has 160 pages. Size of book, 6x9 inches. The How and Why of Radio Apparatus. Postpaid, \$1.75. Experimenter Publishing Co., Book Dept., 53 Park Place, New York City.

## One Thousand Agents Wanted

**Whether You Are Fifteen or Fifty  
This is a Good Proposition**

**WE** want one thousand agents to sell subscriptions to **RADIO NEWS, SCIENCE and INVENTION and PRACTICAL ELECTRICS.** We will pay a generous commission for this work and help you in every way. Our three publications are leaders in their fields, ready sellers and this is an offer well worth your while. A few spare hours a day will bring you a handsome return. Write regarding our proposition at once and be the first one to get started in your vicinity.

**Experimenter Publishing Co.**  
HERBERT H. FOSTER, Sales Manager  
**53 Park Place New York**



CIRCULATION 60,000 COPIES

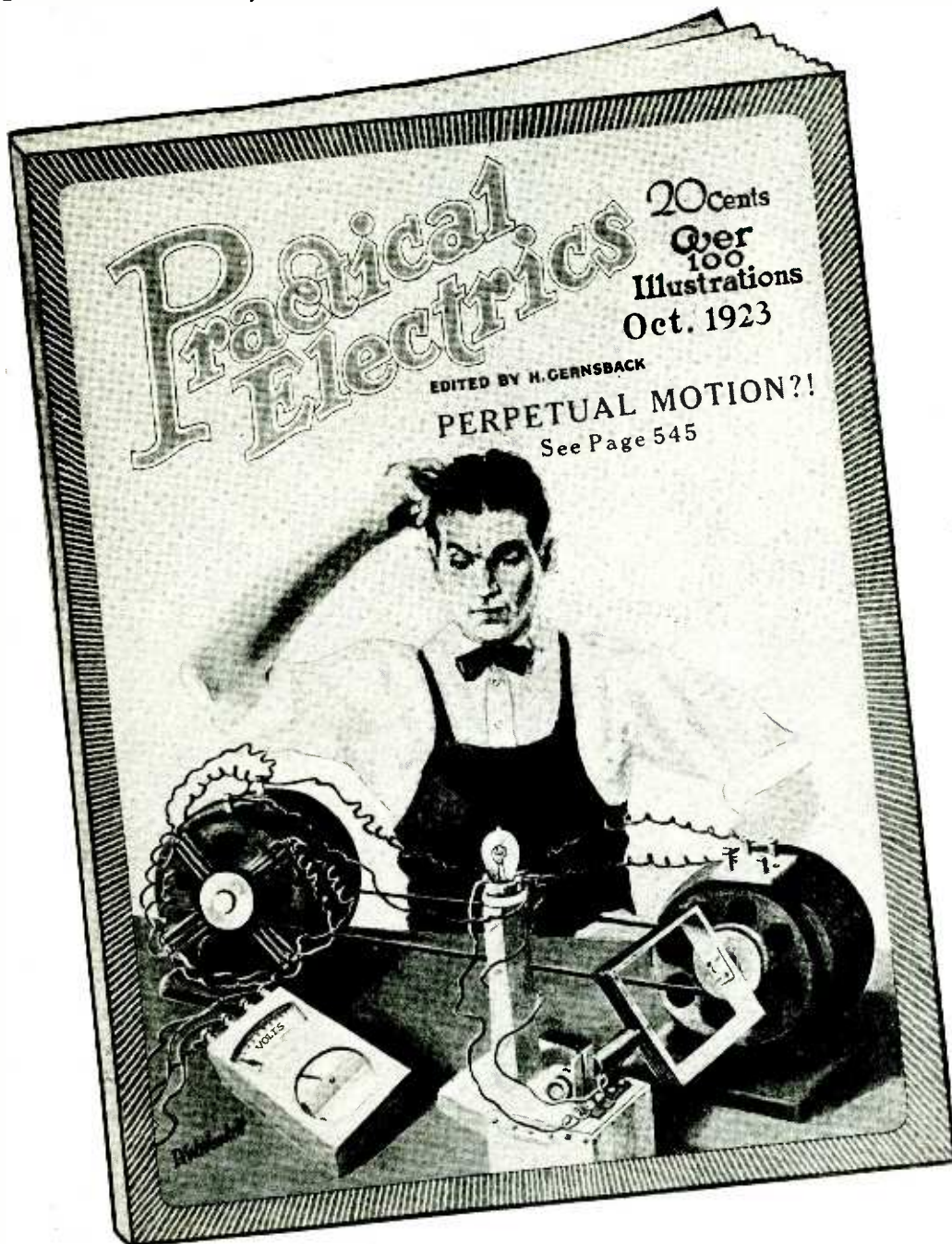

This magazine is edited by  
**H. GERNSBACK**  
 also Editor of  
**RADIO NEWS**  
 and  
**SCIENCE and INVENTION**

100 Articles  
 Over  
 100 Illustrations

FOR SALE AT  
 ALL NEWS STANDS

20c. the Copy  
**\$2.00 a Year**  
 Canada and Foreign  
**\$2.50 a Year**

SEND FOR  
**FREE**  
 SAMPLE COPY  
 TODAY

See Coupon Below  
 for SPECIAL OFFER

# "The Electrical Magazine for Everybody"

**P**RACTICAL ELECTRICS is probably the most novel magazine of its kind ever conceived. It is personally edited by H. Gernsback, editor of SCIENCE & INVENTION and RADIO NEWS. Mr. Gernsback, who founded the old "Modern Electrics" as well as the "Electrical Experimenter," knows thoroughly what his readers want and have wanted for many years. PRACTICAL ELECTRICS, the 100% electrical magazine eclipses the best that was in "Modern Electrics" and "Electrical Experimenter."

Electricity covers such a tremendous field that the man who does not keep abreast with it does himself a great injustice. PRACTICAL ELECTRICS covers that field from every angle. It is written in plain every-day language that all can understand. It portrays the entire electrical development of the month faithfully in non-technical language. It caters to everyone interested in electricity, be he a layman, an experimenter, an electrician or an engineer—each will find in this magazine a department for himself and plenty more.

The October issue now on the news-stands contains 48 pages and over 100 different articles and over 100 illustrations, with an artistic cover in three colors. Professor T. O'Connor Sloane, Ph.D., is associate editor of the magazine.

- INTERESTING ARTICLES IN OCTOBER  
 "PRACTICAL ELECTRICS"
- Electric Bell Ringing Living Electric Batteries
  - New York's Electric Map Thermic Telephones
  - Storage Battery for Demonstrations Small Transformers
  - Perpetual Motion, By H. Gernsback, Member American Physical Society
  - Four-Way Switches Electricity from Earth's Magnetism Rotary Current Rectifier

**PRIZES**  
 This magazine offers a number of prizes, as follows:  
 Our \$50.00 Prize Contest for Junior Electricians and Electrical Experimenters includes as its elements simplicity, as great a degree of novelty as possible, and practicability.  
 An interesting \$100 prize contest is announced, for best new uses for old spark plugs.  
 Also a new prize contest giving four prizes amounting to \$27.50 for the best account of an odd electrical experience.  
 \$3.00 for the best article on Elec-Tricks, the new department.  
 \$3.00 for the best "short-circuit," the semi-humorous department.  
 In addition to this, the magazine pays high prices for all electrical experiments, electrical articles, etc.  
 See Current Issue for Full Details.

This issue also contains articles by some of the greatest electrical writers, workers and students. The magazine will prove a revelation to any one interested in electricity.

Every issue besides its many other features contains the following departments:

- "New Things Electric"
- "Experimental Electrics"
- "Electrical Digest"
- "Junior Electrician"
- "Elec-Tricks"
- "Motor Electrics"
- "Short Circuits"

"How and Why" (Questions and Answers.)

Make all checks payable to: "Practical Electrics Co."

S.I. 10-23  
**SPECIAL OFFER**  
 Gentlemen:  
 Although your regular price is \$2.00 per year, you will accept my subscription at \$1.75 per year (Canada and foreign \$2.25). I enclose the money herewith and I have written my name and address in margin below.

**PRACTICAL ELECTRICS CO., 53 Park Place, New York**



# CHIROPRACTIC and Smallpox

By JAMES G. GREGGERSON

National Lecturer for the Universal Chiropractors' Association

ALL RIGHTS RESERVED



**T**WENTY years ago compulsory vaccination was taken for granted, but in recent years the movement to abolish it has gone by leaps and bounds in every state in the Union. England, after testing the vaccination theory for more than a century, entirely abandoned it. Dr. Walter Hadwen, M. D., M. R. C. S., of Gloucester, England, speaking on this question at a public meeting in Los Angeles, Calif., June 16, 1922, said:

"Now, my friends, the whole of this wretched vaccination and inoculation system is based upon superstition! Thank God, we have carried a law in my country that no one need be vaccinated, and 75 per cent of the children born in the United Kingdom remain unvaccinated. We never had so little smallpox in all our history. It is practically non-existent."

This vaccination idea was tested in Kansas City, Missouri, during 1921, and here are the facts as published by the Advertisers' Protective Bureau of the Kansas City Advertising Club, George M. Husser, Sec'y, 801 Graphic Arts Bldg., Kansas City, Missouri:

"It is the policy of this bureau to deal only in facts. This policy underlies the bureau's work as a quasi-public institution in its mission of suppressing for the benefit of the public fraudulent and misleading advertising or publicity. . . .

"The facts seem to be that health conditions just before the 'epidemic' were favorable, from the less than 50 per cent hospital attendance, the small list of contagious cases on record at the health office (see list) and the fact that E. H. Bullock, health officer, felt the time opportune to take his annual vacation. We learned also that medical practitioners had fewer cases, and were not overrun with calls.

"The sudden calling of the epidemic and the attendant publicity changed all this. Every medical practitioner in the city found his hands full with vaccinating patients, both at the office and in the homes. Unofficial estimates place the number of paid vaccinations (as distinguished from free vaccinations of school children and at health centers) at 200,000, for which it is alleged fees ranging from 25 cents up to \$5 each were charged. An estimated average fee of \$2.50 would yield an aggregate of one-half million dollars expended by the public of Kansas City during this period for vaccination alone. Besides the vaccination expenditure many people suffered from the after-effects of vaccination, some of them severely. For these, medical attention was required, in some instances over a period of months, with added expenditure. Besides, there were numbers who, from reading of the epidemic, imagined they had the symptoms of smallpox and desired medical advice, which added to the cost. This phase need not be entered into at length, the above outlining being, we believe, sufficient to emphasize our point."

The vaccination theory was also put to the test in the Philippine Islands for seven-

teen years, with the following results as given by the Masonic Observer of Minneapolis, Minn., issues of Dec. 17th, 1921, and of Jan. 14th, 1922. This paper is the publication of the Free Masons, a body of gentlemen than whom there is none greater.

"Sixty thousand, six hundred and twelve cases of smallpox, and 43,294 deaths from smallpox in the Philippines in 1919. . . .

"We were unable to secure a 1919 report of the Philippine health service, and this is not surprising in view of a discovery made in the report of that organization for 1920, tucked away in one small paragraph on page 24 of the report, which discloses that the smallpox epidemic of 1918 continued during 1919 with a total of 60,612 additional cases and 43,294 deaths for 1919. . . .

"The Philippines have experienced three smallpox epidemics since the U. S. first took over the islands, the first in 1905-1906, the second in 1907-1908, and the third, and worst of all, the recent epidemic of 1918-1919. Before 1905 (with no systematic general vaccination) the case mortality was about 10 per cent. In the 1905-1906 epidemic, with vaccination well started, the case mortality increased to over 16 per cent. In the epidemic of 1907-1908, with general systematic vaccination going strong, the case mortality ranged from 25 to 50 per cent in different parts of the islands. During the epidemic of 1918-1919, with the Philippine Islands, supposedly, almost universally immunized against smallpox by vaccination, the case mortality averaged over 65 per cent. These figures can be verified by reference to the report of the Philippine health service for 1919, see page 78. These figures are accompanied by the statement that the 'MORTALITY IS HARDLY EXPLAINABLE.' To anyone but a Philippine medical health commissioner it is plainly the result of vaccination."

Not only has smallpox become more deadly in the Philippines, but in addition,

"The statistics of the Philippine health service show that there has been a steady increase in recent years in the number of preventable diseases, especially typhoid, malaria and tuberculosis."

(Quoted from the 1921 Report of the special mission on investigation to the Philippine Islands, of which commission General Leonard Wood was the head.)

Just as a sort of condiment to this mass of facts, let us quote from Physical Culture of June, 1922. It places the facts very briefly as follows:

## "IS THERE METHOD IN VACCINATION MADNESS?"

"Most vaccinated country, Philippine Islands, population 10,350,640, smallpox deaths, 1919, 44,408. Least vaccinated country, England and Wales, population 37,885,242, smallpox deaths, 1919, 28.

These facts admit of no contradiction. Kansas City can be reached with a one-

cent postal card, the report of the surgeon general of the Philippines is public property, and the authorities from which Physical Culture quotes are accessible to everyone. It is an established fact that the public has been victimized for over a hundred years by those whose science consisted of getting the cash by frightening the people with repulsive pictures. The injection into your body of the rotten tissue from the sores of a cow with cowpox to prevent smallpox, was a superstition when performed by those who knew no better. Its continuance with the facts established is a crime against humanity.

Chiropractic teaches that smallpox is the result of poisons accumulating in the body because the organs of elimination are not functioning properly. The poisons that ordinarily pass out through the kidneys, bowels, etc., are retained in the body and the 'power within,' that throws these poisons out, starts to expel them through the pores of the skin. These pores being closed permit the poisons to accumulate until they produce the eruption peculiar to smallpox.

We teach that the reason the bowels and kidneys do not work right, is because the functional impulse does not reach these organs, due to the fact that a vertebra in the spine is misaligned, thereby impinging the nerve and interrupting the normal flow of these functional impulses to bowels, kidneys, etc.

This adjustment of the vertebrae is the chiropractor's work, and this practice of ascertaining which vertebrae are misaligned by palpation, and adjusting them to normal alignment by hand, is all the chiropractor does. It is upon this simple practice of the palpation and adjustment of the vertebrae of the spinal column with the hands for the purpose of releasing the prisoned impulse, that Chiropractic has made the most astonishing growth of any profession in the history of the world.

Of course, Chiropractic is not the practice of medicine, and of course the real chiropractor is but a demonstrator of an idea. He is not a jack of all trades. Those who do other things beside palpating and adjusting the spine, in the name of Chiropractic, simply adopt the name chiropractor for business reasons. The denser the ignorance of these gentlemen, the more contraptions they use to conceal their ignorance. Those who wish to try Chiropractic should see that they secure a *competent* practitioner, and the service of directing you to the office of a competent practitioner will be performed by the



## Universal Chiropractors' Association of Davenport, Iowa

THE PERIODICAL PRESS, NEW YORK



# ENGINEERS

## JUST OUT

### A \$10,000

#### MASTER SET

##### ON LATEST

###### ENGINEERING



**AUDEL'S ENGINEERS & MECHANICS GUIDES** 4750 pages—8754 Illustrations—Pocket Size—Flexible Binding

**\$1** Per Month

Every Engineer, Mechanic and Electrical Worker will welcome this new Master Set. It will answer your problems. It will help you with your daily work. A sure source of advancement and higher pay. Complete up-to-date information that is thoroughly and easily explained on every branch of Modern Engineering and Electrical Practice.

A dollar a month is all it costs to have in your possession all the latest information on engineering.

**\$12** Complete

**THE GUIDES TELL YOU ALL ABOUT**

Theory, Practice and Operation of ALL Steam Engines, Valve, Motions, VALVE SETTING; CORLISS ENGINES, UNIFLOW and POPPET VALVE ENGINES, LOCOMOTIVES—Locomotive—Marine Engines; Turbines; Rotary Engines—the Indicator—Lubrication—PRACTICAL MANAGEMENT. How to use Indicator—GAS, OIL and DIESEL ENGINES—Aeronautics, Aviation—HOW TO SELECT AN ENGINE. STEAM ENGINE DESIGN. Theory and Construction of ALL Steam Boilers; Heat-Combustion; Fuel and Flue Gas Analysis—CO<sub>2</sub> Recorders—Characteristics of Boilers—

Materials. Boiler Construction—Mechanical Stokers—Oil Burners—Setting—Chimneys—Mechanical Draught—HOW TO SELECT A BOILER. BOILER DESIGN based on A. S. M. E. BOILER CODE—OPERATION of Steam Boilers—Pipes and Pipe Fitting—Heating and Ventilation—Refrigeration—Cooling Towers—Condensers—Distilling Apparatus—Elevators—Cranes and Hoisting Machinery—Ropes and Cables—Splicing—Compendium of Practical Electrical Engineering—Ready Reference Index, covering entire field of Modern Electricity.

**SHIPPED TO YOU FREE!**

Not a cent to pay until you see the books. No obligation to pay unless you are satisfied. Send coupon now—today, and get this new Master Set for Engineers and see if it is not worth \$100 to you. Pay only \$1.00 a month.

Theo. Audel & Co., 72 Fifth Ave., New York City. Please submit me for free examination Audel's "New Eight" Master Set for Engineers and Mechanics. If satisfactory I agree to send you \$1 within seven days, and to further mail you \$1 each month until \$12 is paid.

Name.....  
 Occupation.....  
 Employed by.....  
 Home Address.....  
 S. I. Oct.



# I Pay Your Railroad FARE



B. W. Cooke  
President

Come to Chicago—the Electrical Center of the World—I pay your railroad fare from any place in the United States. Grasp this opportunity to see the country at my expense. Don't stick in one spot—travel—get experience. Come to Coyne—learn electricity in 3 months. Fit yourself for a big paying job. The largest electrical school in the country specializing in electrical instruction ONLY.

## Learn Electricity in 3 Months

Get a complete training so you can make big money as Power Plant Operator, Superintendent, Telephone man, Construction worker, auto, truck or tractor electrician, battery man, radio expert, or you can go into business for yourself as electrical contractor, dealer, auto ignition or battery expert and make from \$3,000 to \$20,000 a year. Hundreds of our graduates today are making big money and you can do the same if you grasp this opportunity—act now.

## Great Shops of Coyne

No books or useless theory. You are trained on \$100,000 worth of electrical equipment. Everything from door bells to power plants. You work on motors, generators, house-wiring, autos, batteries, radio, switch-boards, power plants—everything to make you an expert ready to step right into a position paying from \$45 to \$100 a week.

We give you free a course in Radio—the marvel of the age. Constructing, installing and operating. You can build your own receiving set.

The complete electrical course gives you practical training in Circuits, House Wiring, D. C., A. C., Armature and Stator Winding, Drafting, Auto, Truck and Tractor Electricity, Battery Building and Repairing and Radio. In addition you receive Free, a Life Membership which enables you to stay as long as you want or come back for further training at any time without charge.

*Earn While You Learn! We help students to secure jobs to earn a good part of their expenses while studying*

## Send this Coupon Today

B. W. COOKE, Pres.  
Coyne Electrical School  
1300-1310 W. Harrison St., Dept. 53-37, Chicago  
Dear Sir: Please send me free your big catalog and full particulars of your special offer of Free Railroad Fare and Free Radio Course.

Name .....

Address.....

Don't delay a minute—send that coupon *right now* for our big free catalog and full particulars of Free Railroad Fare offer. Remember this special offer is limited so act now!



Student winding a Stator

**COYNE**  
Electrical School

Endorsed by Electrical Industry  
1300-1310 W. Harrison St., Dept. 53-37 Chicago