

THE ELECTRICAL EXPERIMENTER.

FEB.

1915

5

CONTENTS

Lackawanna R. R. Radiotelegraphy and
Telephony,
By Frank C. Perkins.

Course Lesson No. 18, on
"Electrical Measuring Instruments."

The Use of a Condenser on Shunt to
Telephones in Radio Circuits,
By H. Smith, B. Sc.

Making Your Own Electric Cycle Lamps.

Some Novel Wireless Telephone Schemes,
By H. Winfield Secor, A. M. I. R. E.

The Wave Length of Radio Antennae,
With Curves.

The "How-to-Make-it" Department.

Question and Answer Column.

Among the Amateurs.

Vol. 2

No. 10

"The Experimenters' Magazine"

- THE - ELECTRICAL EXPERIMENTER

VOL. II

FEBRUARY, 1915

NUMBER 10

Lackawanna Railroad Radio Telephony and Telegraphy

By Frank C. Perkins

THE accompanying illustration and electrical equipment show the station wireless tower at Scranton, Pa., utilized on the Lackawanna Railroad for radio telephony and telegraphy to and from trains while in motion.

by last winter's blizzard, caused the officials of that system to investigate the possibilities of the Radio telegraph and telephone for their moving trains and with Marconi telegraph transmitters communication was maintained from a passenger

telegraph amount to 6 per cent. per annum on \$15,000, L. B. Foley, superintendent of telegraph for the D. L. & W. System accepted the proposal of Dr. Lee De Forest that the Radio Telephone and Telegraph Co. install the new De Forest Wireless Telephone at Scranton, Pa., and on one of the through fast trains.

It is held that although the Scranton installation was hurriedly made, it was able on its second trial to maintain clear voice transmission to this train up to Stroudsburg, Pa., a distance of 53 miles, the train running 60 miles an hour. The antenna at Scranton is 300 feet long and 150 feet elevation. That on the train extends over the four forward cars only, the wireless station on board being in the second car from the locomotive.

It is claimed that the train noises render it imperative to use the Audion Amplifier with the Audion Detector and a two-step Amplifier, giving from 50 to 60 times amplification, was used on the train. In the permanent train installations now being utilized, the generator is direct connected to a steam turbine in the baggage coach, supplied from the steam-heating pipes beneath the car.

It is of interest to note that at the Scranton station direct current is supplied at 125 volts. The new De Forest radio telephonic transmitter operates on a radically different principle from the arc system. It is far more reliable, there being no adjustments or regulations whatever after once setting to a given wave-length. This feature alone makes possible the present application to railroad work, for the attention and skilled adjustments which are frequently necessary with any arc apparatus, render such a telephone system actually less applicable to the service in question than a spark telegraph would be. The present apparatus is of only 1 kilowatt capacity but not the slightest difficulty is had in telephoning from Scranton to Binghamton, a distance of 67 miles, over rough, wooded and mountainous country. It is maintained that for a given antenna current this transmitter is far more efficient than an arc transmitter using like current. The fact that the Audion is strictly a potential operated device probably accounts for this in-

(Continued on page 148)

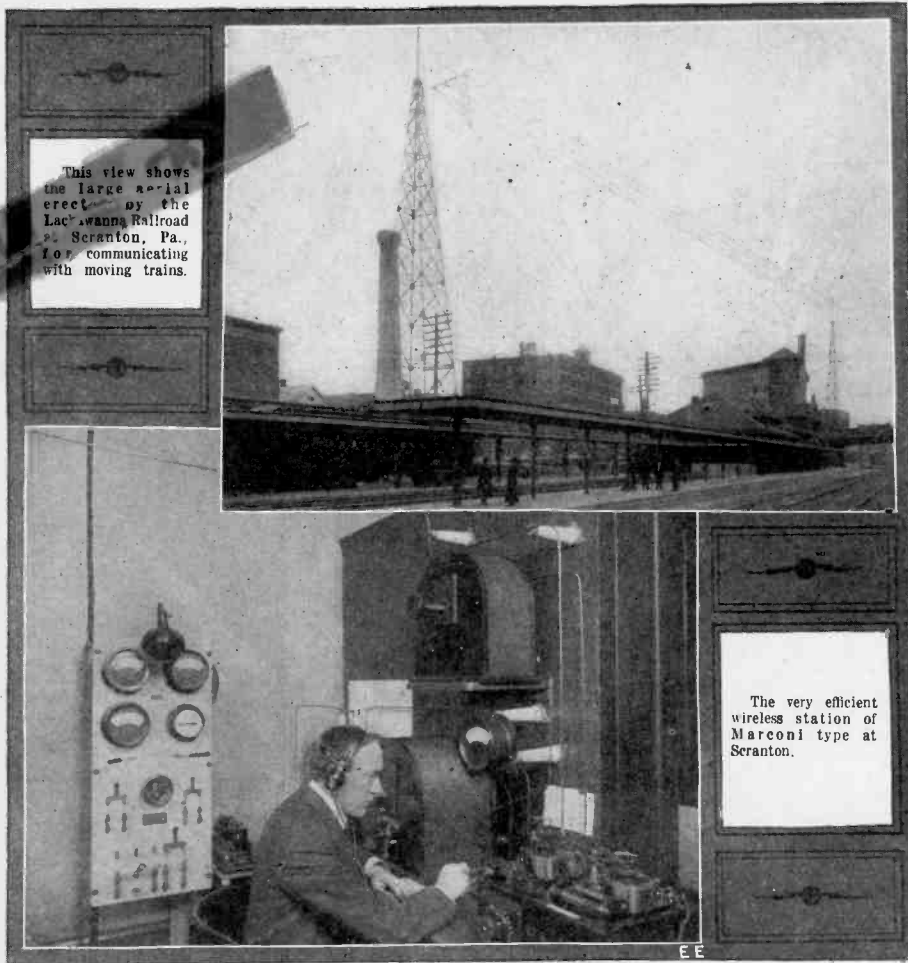

This view shows the large aerial erected by the Lackawanna Railroad at Scranton, Pa., for communicating with moving trains.

The very efficient wireless station of Marconi type at Scranton.

It may be stated that radio telephony for railroads is a comparatively new art, the signal success which attended the wireless telegraph installations at division headquarters on the Delaware, Lackawanna and Western Railroad during the 9 days paralysis of their wires

train up to 60 miles, and from 100 to 207 miles from a trackside station to the train. It is of interest to note that in all this work the Audion was the detector used, and considering the fact that the wages of the special Morse operator necessary to operate the train

"The Electrical Experimenter" is published on the 15th of each month at 233 Fulton Street, New York. There are 12 numbers per year. The subscription price is 50 cents a year in U. S. and possessions, as well as Canada. Foreign countries 75 cents a year. U. S. coin as well as U. S. stamps accepted (no foreign coin or stamps). Single copies 5 cents each. A sample copy will be sent gratis on request. Checks and money orders should be drawn to order of the Electro Importing Co. If you change your address, notify us promptly, in order that copies are not miscarried or lost.

All communications and contributions to this journal must be addressed to: Editor, "The Electrical Experimenter," 233 Fulton Street, New York. We cannot return unaccepted contributions unless full return postage has been included. ALL accepted contributions are paid for on publication. A special rate is paid for novel experiments; good photographs accompanying them are highly desirable.

Title registered U. S. Patent Office. Copyright 1915 by E. I. Co., New York.

An Electrical Machine That Writes

By C. Beckmann

EFFORTS have been made for many years to transmit ordinary handwriting by electrical methods, says the London "Electrician," in reviewing Mr. Beckmann's article. In 1842 Bakevell proposed a kind of copying telegraph, the writing being done by means of an insulating ink on the surface of tin foil. In the receiver, electro-chemical methods were used to reproduce the writing on a piece of prepared paper. Neales' hydraulic machine, invented in London in 1884, may be taken as the forerunner of the present-day electrical writing machine, the movement of the writing being effected by pistons which moved in cylinders and were connected to an ordinary waterpipe.

In the year 1888, the American, Elisha Gray, produced an instrument in which interruptions of the current were caused by the movement of the pencil. The currents were received by electromagnets which acted on a common pencil and so reproduced the writing. Cerebotani also used the same principle. Gray then introduced the improvement of varying the currents by regulating resistances, and it may be said that developments of his machine led to the only practical instrument of the kind, which is largely in use at the present day. But Gray's method is the only one that has been found to work properly. It was first introduced by the Western Union Co. in Chicago in 1893. It was used in 1895 for transmitting messages from Paris to London, and from Chicago to Cleveland, a distance of 692 km. Instruments of this kind are now largely used in America in business houses, banks, hotels, &c. In 1909 an exchange was started in London, which was used for communications between the subscribers, and for sending telegrams to the post office. Lately the firm of Mix & Genest has introduced Gray's system into Germany; it is now used in the German Navy and in various private business houses, and arrangements have been concluded with the German Post Office, according to which it is likely that the instruments will find a more extended use in the immediate future.

The present-day type of the machine may now be described in some of its details. The work done by the Gray machine may be subdivided in the following way: (1) The transmitter and receiver are switched into circuit; (2) the pencil is moved by the writer, and this motion is analyzed into its co-ordinates as far as horizontal and vertical motion are concerned; (3) the pencil is lifted from the surface of the paper, and is then put down again, thus forming spaces; (4) the motion of the paper itself must be arranged; (5) the writing pen must be dipped into the ink; and (6) the whole of the apparatus is switched out of circuit. The adjoining figure is a diagram of the connections between the transmitter and receiver, and a battery is provided at each end, the positive and negative poles being connected as shown. The line is shown as *a, b*, and is connected at both ends to relays, which are connected to the apparatus used in connection with the pen. This apparatus consists of a lever 2, which by means of the pen can be placed beneath the bar 3. In this position the lever 2 touches the contact bar 4, which otherwise floats

above the armature 5, and thus puts the relay 6 in connection with the positive pole of the battery. As soon as the contact lever 2 is pressed down, current flows from the positive pole through the armature 5, the contact bar 4, the lever 2, the relay 1, and so to the negative pole. The relay attracts its armature, and at the transmitting station connects the leads *a, b*, with the contacts 7, 8, and the positive pole of the battery by means of the contact 9 with the transmitting apparatus. The leads *a, b* are thus in

32. Two movable coils 33 and 34 are connected to the levers 28 and 29, the windings being in a strong magnetic field which is produced by the windings 35, 36 and 37. The current at the receiver end is switched on by the relay 38, which connects the negative pole by means of the contact 39 with the windings 35, 36 and 37. The ends of these windings are connected through the magnet 6 to the positive pole. In parallel with the winding 35 there is a buzzer 40, which causes a slight vibration and thus overcomes

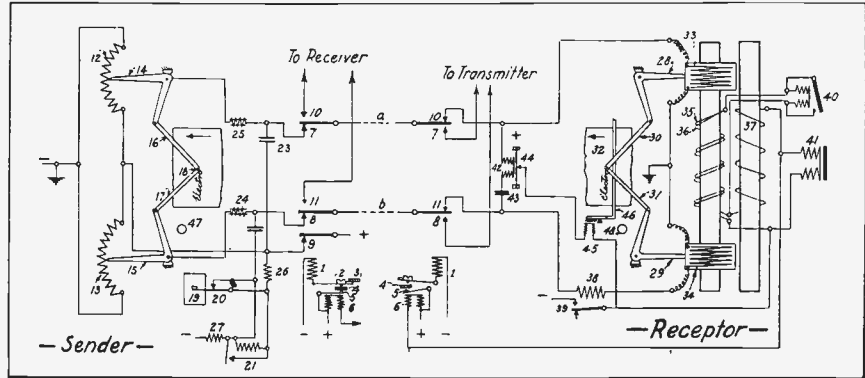

The circuits for the "Telautograph," the electrical machine that's almost human.

connection with the receiver, the connection being made through the contacts 10, 11. Essentially the transmitter consists of two regulating resistances 12 and 13; the arms 14, 15, which can be turned round pivots, move over contacts which are connected to the regulating resistances. These contact arms 14, 15, are of the bell-crank type and are connected by the links 16, 17 with the pen. Thus these linkages form an unclosed hexagon, which analyses the motion of the pen into the polar co-ordinates, and transmits it to the levers 14 and 15. The two rheostats 12 and 13 are connected on the one side with the negative pole and on the other side with the contact 9 leading to the relay. Currents therefore flow from the positive pole, through the resistances 12 and 13 to the contact levers 14 and 15. From these they flow through the leads *a, b*, and the receiver, and then to earth. As the pen moves, the currents flowing in *a* and *b* are varied according to the position of the pen. Beneath the pen 18 there is a movable plate 19, which is above a contact 20, which when no current is flowing short-circuits the buzzer 21. The latter is in connection with the leads through the condensers 22, 23, which on the transmitter side shut off alternate currents by means of the choking coils 24 and 25. The current for the buzzer flows from the positive pole through the contact 9, the resistance 26, the buzzer winding 21, and the resistance 27 leading to the negative pole. As soon as the pen is put on the plate 19, the buzzer comes into action, and current flows through it to the condensers 22, 23, and through the leads *a, b* to the receiving station. This current is, therefore, superposed on the currents regulated by the motion of the pen.

At the receiving end the hexagon linkage is precisely similar to that at the transmitting end; it consists of 28, 29, 30 and 31, being connected to the pen

some of the friction of the mechanism. The magnet 41 and its armature regulates the motion of the paper. The telephone relay 42 and the condenser 43 are connected as shown. On the membrane there is a microphone contact 44, through which a current can flow from the positive pole through the magnet 45, the contact 39, and the relay 38 to the negative pole. So long as buzzer currents flow through the telephone, the resistance of the microphone contact is so great that the magnet 45 cannot attract its armature. When the buzzer current is switched off, the armature is attracted, and thus the pen 32 is lifted from the paper by means of the lever 46.

The various operations are now easily understood. The writer at the transmitting end puts the lever 2 under the bar 3, and thus sends current through the relay 1, which closes the path 9, 12, 13. The leads *a, b* are connected to the receiver at the same time through 7 and 8. Currents flow from 12 and 13 through 14 and 15; and thus by *a, b* to 10 and 11, the relay 38, and the coils 33 and 34 and thus to earth. The relay 38 closes the circuits for 35, 36 and 37, the buzzer 40, the magnets 41 and 45. The manner in which the hexagon linkages vary the currents at the transmitting end, and move the pencil at the receiving end by means of the motion of the coils 33 and 34 requires no explanation. The pressure produced on the surface 19 by the act of writing breaks the contact 20. The buzzer 21 begins to buzz; the buzzer currents pass through the telephone 42, shaking the contact 44; the armature of 45 falls and the pencil is brought into contact with the paper. The converse takes place when the writing ceases. If the paper requires to be moved forward, the circuit through the relay 1 is several times opened and closed by means of the lever 2. Therefore the magnet 41 attracts its armature and effects the desired motion.

PHOTOGRAPHING MAGNETIC FIELDS.

By Milton W. Hymes.

Those who have never thoroly studied magnetism find it very hard to grasp the meaning of lines of force with their

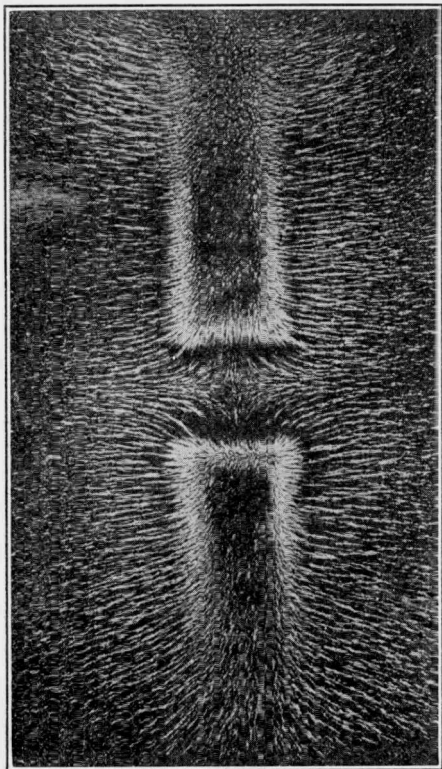

Fig. 1. The magnetic field of two bar magnets. Two north poles opposing.

paths and actions. The method described here will produce perfect photographs of

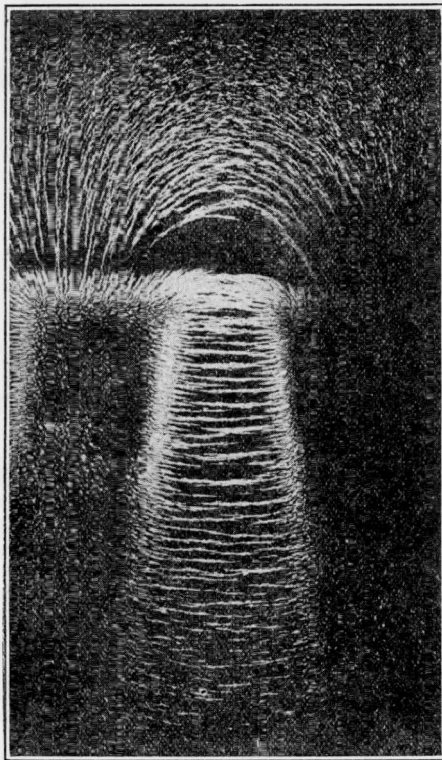
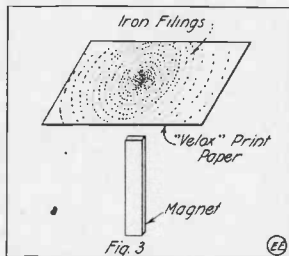

Fig. 2. How the flux lines form the poles of a horse-shoe magnet.

the lines of force of magnets. The method consists simply of placing a mag-

net or series of magnets which it is desired to photograph on a non-magnetic surface. On the magnet is placed (in dim light only) a piece of velox print-paper, sensitized side up. Iron filings which have previously been placed in a small bag made of a double thickness of cheese cloth are then sprinkled over the paper and directly in the position to be photographed. When the paper is covered with the filings evenly a slight tap on it will cause the filings to assume the shape of the lines of force of the magnet underneath. It is absolutely necessary that the Velox paper be handled in very dim light and only exposed when the filings have assumed the position to be photographed. After the paper is exposed to light a sufficient length of time it is developed in the usual manner. Results produced by this method are shown in the accompanying illustrations.

At Fig. 1 is shown a photograph of the lines of force of two like poles of two bar magnets and the juncture plainly shows the lines of force diverging. Fig. 2 illustrates the lines of force of a plain steel horseshoe magnet, in which the lines of force flow freely from one pole to the other. Fig. 3 shows the arrangement of the simple apparatus for this interesting and instructive experimental work.



LACKAWANNA RAILROAD RADIO TELEPHONY AND TELEGRAPHY.

(Continued from page 146)

disputable difference in "radiation and reception efficiency" for the transmitter potentials employed are considerably higher than with a Poulsen set.

It is said that the officials of the D. L. & W. System propose to make these installations a permanent part of their two-track train equipments, for facilitating dispatcher's service, and especially for the convenience of the travelling public. The messages will be handled at a fixed rate, same as with the telegraph, but telephoned by a regular member of the train crew. Already great interest in this radical innovation is being shown by other railroads in the United States, and it is confidently predicted that the long-deferred practical application of the Radio telephone to the railroad and marine fields will shortly be realized and soon be as indispensable as the present long distance wire and cable telephone service. The Mignon "Vario-Selective Coupler" served very efficiently indeed in these tests, which was especially developed by the Consulting Radio Engineer of D. L. & W. System, Mr. Ernest C. Mignon. This marvelously compact receiving tuner, combining both primary and secondary as well as loading inductance, operates on the variometer principle.

A special brand of insulated wire has to be used in the Philippines because the ants and cockroaches feast on the insulation.

A NEW MULTI-CALL DEVICE FOR FACTORIES.

The art of quickly and accurately locating a certain person about a factory or works is boiled down to a science in the new apparatus known as the National Multi-Call. It is claimed to be the most compact and easily operated factory signal system on the market. It can be adjusted to signal once, twice, or any number of times up to seven. It can be used for number signaling, giving both the number of the party wanted and the party calling. It is the only factory signal system which is adjusted for signaling by keys on a flexible keyboard. It has the additional features of a complete fire alarm system, and can be attached either to batteries or by relay, to any direct current circuit.

It will immediately locate the party wanted, and no other, by means of a code signal assigned to each person to be called. Simply pressing a key starts the machine in motion. On every floor, in every department, in the foundry and the yard a signal is sounded, and the party wanted is responding to his call in less than thirty seconds usually.

Standard sizes are for 10, 20, 30 and 40 calls. Fire alarm attachment can be furnished when desired.

The signals given may be of the aural or visual type; i. e., a buzzer, bell, lamp, horn, etc., is available, to suit the conditions obtaining in each locality.

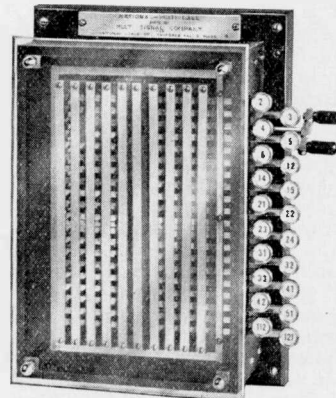

The keys on the side of the calling cabinet here illustrated are numbered to correspond with the parties wanted, and all stations act at the same time.

YOUTHS AT YAZOO INSTALL WIRELESS.

Yazoo City, Miss., has two wireless stations, and a club is being formed for the erection of several more.

At each of the stations, which have just been completed, messages can be received from any distance up to a thousand miles, and messages can be sent 40 or 50 miles. With the installation of a dynamo the sending power of the stations could be increased to 1,000 miles.

The builders of the wireless stations are William Earl Crane, son of E. S. Crane, and Ernest Royster, a nephew of Mrs. Taylor. Each is 15 years old.

Some time ago a son of the editor of the Presbyterian Sunday school paper, and a former Mississippian, built a similar wireless station, and the father printed a full description of its mechanism in the Sunday school paper. The Yazoo City boys read the description and at once went to work to build their stations.

The Use of a Condenser as a Shunt to a Telephone

By H. Smith, B.Sc.

IN practically all systems of wireless telegraphy the telephone receiver has superseded all other forms of reception, and it is, therefore, a matter of importance to examine the conditions under which the telephone is employed

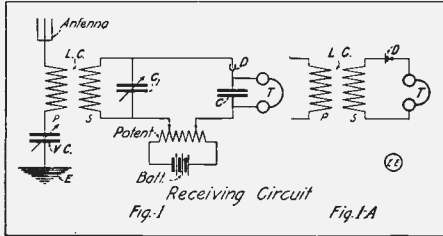

in order to determine the most advantageous relations between the constants of the various parts of the circuit. This is considered in a paper which appears in the Proceedings of the University of Durham Physical Society.

It has been found for the telephones used in practice that the best results are obtained when the telephone is shunted with a capacity. As is commonly known the simplest radio receiving hook-up employs a receiver and detector in series only, as in Fig. 1 A. The fixed condenser across the telephone is best for long distance work in every case tho. The best value of the capacity depends, among other things, on the telephone, and the practical rule has been that the greater the resistance of the telephone the less the value of the capacity to give the loudest sound. It is sometimes stated that the function of the capacity is to form an easy path to the oscillations past the telephone whose inductance when introduced into the oscillating circuit would otherwise seriously enfeeble the current strength. That this explanation is insufficient is clear from the fact that there is an optimum value of the capacity. It was with the object of affording an explanation of this phenomenon that the following work was undertaken.

Fig. 1 shows a very usual method for coupling the receiving circuit with the antenna. The adjustable condenser C_1 , made use of only under certain circumstances, allows of tuning in the receiving circuit, and is generally very much smaller than the block condenser, C, used as shunt to the telephone, T. If C is increased while the messages are being received, the intensity in the telephone increases at first, followed by a deadening and lowering of the note, due, one might imagine, to the suppression of the higher harmonics. As the condenser, C, and the inductance of the telephone form an oscillatory circuit, it is reasonable to expect resonance with some of the harmonics. If this be so, the best value of the capacity, C, will be when the telephone circuit is in resonance with the more pronounced of these harmonics. Moreover, the addition of an inductionless resistance, if of sufficient value, to the telephone circuit should effectually prevent all resonance, and no rise in intensity in the telephone would be observed.

Experimenting with the arrangement shown in Fig. 2, I have found this actually to be the case; indeed, with one telephone tested, whose resistance was large compared with its inductance (2,000 ohms and 0.02 henry respectively), there was a continuous falling off in intensity from the moment condenser C was put

across it without any further addition of resistance.

The current through the telephone is, of course, intermittent, occurring every time the detector, D, is traversed by oscillations picked up from the antenna. We may, however, regard it as an alternating current whose frequency is that of the break in the primary current at the sending station, and which has superposed on it a direct current, and contains in it also a large number of harmonics.

The following arrangement was adopted as sufficiently well reproducing the condition of things in the receiving circuit: L represents the inductance of the receiving circuit. The seat of the E. M. F., as before, is the circuit LC, but is produced by coupling with an alternating current instead of being taken from a potentiometer.

With such an arrangement as this the current due to any particular harmonic thru the telephone is a maximum when

$$C = \frac{L}{R^2 + \omega^2 L^2} + \frac{L}{R_1^2 + \omega^2 L_1^2}$$

where L and R are the inductance and resistance of the coupling circuit LC, L_1 and R_1 the inductance and resistance of telephone circuit, consisting of the telephone and the condenser, C, and $\omega = 2\pi X$ frequency of the harmonic.

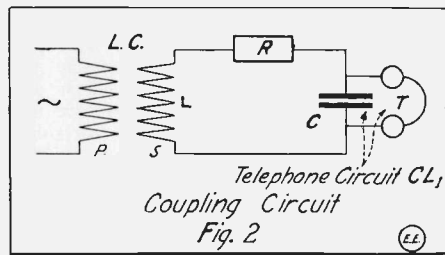

When R_1 is very large and R small, very beautiful resonance in the coupling circuit, with the harmonics in the alternating supply, is obtained. The intensity of the sound in the telephone is a series of maxima, each maximum giving a different note, whose frequency is the same as the harmonic. In the case of wireless telegraphy, the resistance R is in general greatly due to the detector, and from the symmetry of the expression given for the value of C, if R, were small this time, we should expect to have the same phenomena in the telephone. R_1 , however, is not small, and, instead of hearing several notes at different maxima, the intensity rises to one maximum only, not very sharply defined.

With three different telephones the following results were obtained:

TABLE I.

Telephone's Resistance.	Telephone's Inductance;	Value of Capacity to Produce Maximum.	Frequency of Telephone Circuit
Ohms.	Millihenries	Microfarads	
3.75	4	4.5	1,190
130	48	0.3	1,340
157	100	0.2	1,130

We see from this that when the maximum occurs the frequency of the telephone circuit is very approximately the same for very different telephones. No very good agreement can be expected, as not only is the inductance of a telephone difficult to measure accurately, owing to its resistance, but the optimum value of the capacity is not very easy to

note. The constants of the coupling circuit, LC, were $L=158$ millihenries and $R=4,000$ ohms.

To study better the effects of resonance in the telephone circuit, the following arrangement was adopted as at Fig. 3.

Circuit A is brought into resonance with any desired harmonic by varying C_1 and listening in the telephone T (R_1 must be large—say, 10,000 ohms) till the corresponding note is a maximum. Circuit B is now coupled with A and C, varied till the harmonic gives a maximum in the second telephone T. In this way the following results were obtained:

TABLE II.

Harmonic	Frequency of Harmonic	Telephone's Resistance	Telephone's Inductance	Value of Capacity to Give Maximum	Frequency of Telephone Circuit
3rd	240	157	mlh. 100	mfd. 1 (appx)	437
15th	1,200	3.75	4	4.5	1,190
.....	130	48	0.35	1,230
.....	157	100	0.2	1,130

The discrepancy between the frequency of the harmonic and that of the telephone circuit (calculated by taking into account its resistance which is effective in low frequencies) in the first case is very great. It is due partly to the fact that it was very difficult to decide when the maximum occurred, but chiefly to the existence of the higher harmonics, as the fifth and seventh, which were still quite strong. To separate mentally the effect of each note was impossible.

In the case of the other telephones I was unable to determine the optimum capacity at all, the change in intensity was so imperceptible, but for the small inductance telephone it was certainly greater than 12 microfarads. With the 15th harmonic it was different, as it was very much more powerful than any of its neighbors when separated in the way given above, and fair agreement between its frequency and that of the telephone circuit was obtained.

It would appear, then, that when a telephone is shunted with a condenser, the maximum intensity in the sound which occurs is due to resonance in the telephone circuit with the various harmonics, the maximum being in reality a

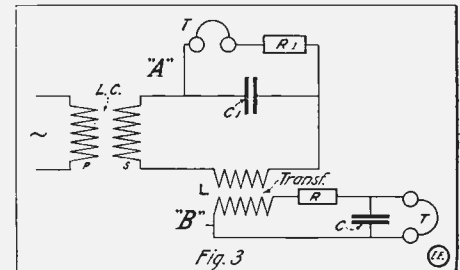

compromise of several maxima due to several harmonics. In the case worked out above it occurred in the region of the maximum produced by the 15th harmonic, which was a particularly prominent one.

Applying these results to the case of the telephone used as a receiver in wireless telegraphy, we see that the value of the capacity used as a shunt to the telephone, which produces the maximum intensity in the telephone, is not independent of the break in the primary current at the sending station; that in the

(Continued on page 155)

Experimental Electricity Course

S. Gernsback and H. Winfield Secor

LESSON 17. STATIC ELECTRICITY AND STATIC GENERATORS—Cont'd.

L EYDEN jars are bottle forms of condensers, other forms being the glass plate, tinfoil and paper, etc. The Leyden jar, owing to its peculiar design, has the property of retaining a charge longest, and hence it is most always used for holding static electric charges. In wireless telegraph sets, the condenser is often composed of glass plates, as they are more compact than Leyden jars, and in this case, they are almost immediately discharged, so any retentive qualities offered by the jar form of condenser is not of such great importance.



Fig. 8.

In Fig. 3 is illustrated a semi-sectional view of an ordinary Leyden jar condenser, having a glass shell with bottom. The inside and outside, as well as the bottom, are well coated with tinfoil about half way up. Banana oil is a good adhesive for making the tinfoil stick to the glass, altho shellac may be utilized. An insulated top of fibre, hard rubber or wood holds the metal rod,

ball and chain, as shown, for making contact with the inner tinfoil coating. Contact with the outer metal coating is easily affected, of course. Typical manufactured Leyden jars are shown at Figs. 4 and 5. A discharger for these jars is seen at Fig. 6.

The Leyden jar is charged from a static machine, of the frictional of Wimshurst influence type, by holding the jar in

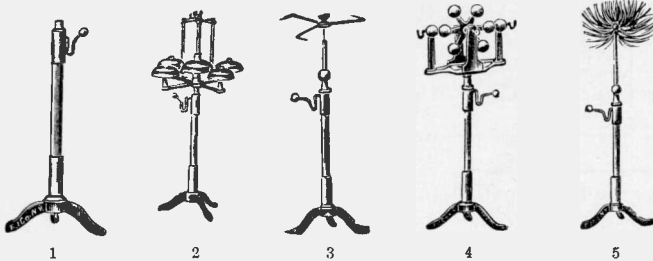

Fig. 9.

the hand, and approaching the ball on top of it, to within sparking distance of the discharging knob of the machine. The jar has its outer coating thus grounded to earth thru the operator's hand and body. The charge of static electricity passing from the machine to the inner coating of the Leyden jar, thus attracts an electric charge of opposite sign from the earth to the outer tinfoil coating, and retains it there, the two opposite charges mutually attracting each other and trying to combine. The jar is now said to be charged, and in heavy work the stress set up in this manner upon the dielectric or glass, often shatters it. A condenser breaking down in this manner is said to be "punctured." The jar is discharged by connecting the inner and outer metal coatings together, thru a small air gap. If discharged thru the body, a shock will be felt. For batteries of Leyden jars or large ones, the discharger, seen at Fig. 6, should be used.

An interesting point about the charge in Leyden jars or other condensers, is that the charge does not reside upon the metal surfaces, but upon the glass or other dielectric separating them. The metal portions serve simply to induce the

charge or relinquish it upon discharge. This is easily proved by means of a separable Leyden jar as seen in Fig. 7. The jar is first charged, and then its outer and inner metal coatings removed by insulated hooks. If an electroscope is approached to the glass it will be actuated, showing that the charge is on the glass portion of the condenser. Presented to the metal parts, it shows no charge. Reassembled the condenser may be discharged in the regular manner.

As aforementioned, there are two principal classes of static generators: the frictional machine and the influence machine. The Wimshurst influence machine is widely used, both for experimental and professional purposes, and so it will be described here.

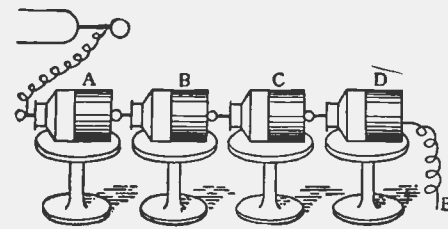

Fig. 11.

The Wimshurst influence machine produces static electricity by electro-static induction between charged metal plates instead of a rubbing action on the plates, as in the frictional type. James Wimshurst was its inventor, and hence its name.

A cut of the "Electro" Wimshurst Influence Machine is portrayed at Fig. 8. It delivers a 3-inch spark under practically all conditions, which is quite remarkable, as ordinarily static machines are unreliable and refuse to generate a current unless everything is just about perfect. Dry, cool weather is best for their operation.

To resume, the Wimshurst influence machine produces its charge by the rotation of two similar glass discs in opposite directions, the two discs being mounted close together. Each disc on its outer surface carries a number of tinfoil segments spaced equally apart. The same number must be on each disc, and each disc so set that at any given instant the foil sectors on one will be just opposite those on the other.

Two metal rods called neutralizing rods are mounted parallel to the outer surfaces of the two glass discs, the ends of the arms carrying tinsel brushes, making contact with the foil segments on the discs. The neutralizing rod and its brushes on each side of the generator make connection between diametrically opposite foil sectors on the glass or ebonite plates. The two rods on opposite sides of the machine are set at right angles to each other, or less, up to 60 degrees.

Rotating the plates causes changing values of electro-static induction to react between them, and the sectors on one plate act inductively to charge those upon the other. The static current is taken from the plates by collecting combs or points a short distance away from the moving plate. The action of the influence machine, which allows it to charge when starting without being separately excited from an external source of electricity, is not fully understood as yet, but is probably due to the uneven electro-static condition permanently existing on the plates, causing some of the sectors to be in a different state of charge from others.

In operation, positive electricity is collected at one comb, and negative at the other, these signs remaining constant. If a stationary glass plate is placed between the two rotating glass plates, the polarity reverses regularly and the machine is then termed an alternating Wimshurst machine. When Leyden jars are connected to the machine, as in the "Electro" type, the inner coatings to the collecting combs, and the outer coatings to the earth, the jars become charged, resulting in a thicker spark discharge at slower intervals between the discharge balls. The maximum spark length of the machine is attained without the jars. Influence static machines include such types as the Voss, and Holtz, also the Topler-Holtz.

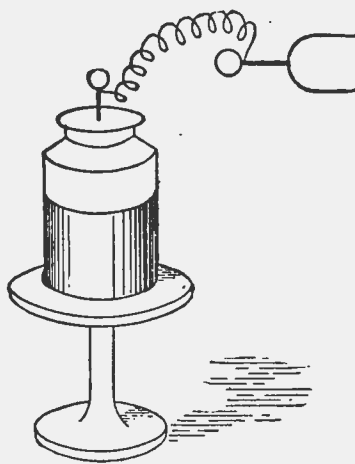

Fig. 10.

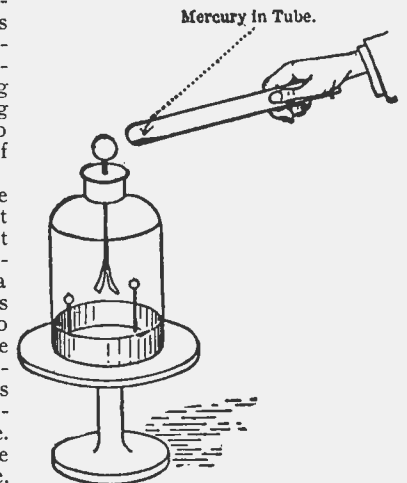

Fig. 12.

The polarity of the static machine can be ascertained by observing the electrode terminals. The negative electrode, when in a horizontal position, gives a sharp hissing sound, distinguishing it from the positive electrode which does not give any sound. The polarity is easily found by means of the electroscope, previously described.

Many amusing and instructive experiments can be performed with the aid of such a machine as the "Electro" Wimshurst generator. A number of pieces of apparatus that can be worked by it or other static charges are illustrated by Fig. 9, cuts 1 to 5.

At cut 1 is seen a universal stand adaptable to holding geissler tubes, or other apparatus. Cut 2 shows the electric chimes, which are very useful for demonstrating. A spinning wheel is depicted at 3, while a static motor appears at 4. The hair-riser which projects upward when connected to one pole of the machine is seen at 5.

Magnetization can be done by static electricity in the following manner: Form a helix of copper wire separating the turns and then insulating the whole. Within the helix a hard steel bar or needle is placed, and if a few discharges from a Leyden jar are passed thru the helix, the bar will be found to be magnetized.

It should be noted that if a condenser, such as a Leyden jar be placed upon an insulated glass stand as in Fig. 10, no charge will be accumulated by the jar, but if its outer coating is touched with the finger, it immediately assumes a charge, as it is then earthed.

In the cut, Fig. 11, is shown the method of charging Leyden jars in "cascade," as it is termed, or in series. They rest upon insulated stands, such as glass tumblers, and the outer coating of the last one is connected to earth.

A peculiar manner of producing a static charge is depicted at Fig. 12, where a glass tube, containing mercury, is shaken briskly, and then presented to the ball of an electroscope, whose leaves will diverge. A test tube, containing mercury and corked at the open end, will serve well for this experiment.

Lesson No. 18.

ELECTRICAL MEASURING INSTRUMENTS.

To measure the degree of strength and quantity, also several other diversified factors, use is made of electrical measuring instruments. The two types most generally employed are the voltmeter, for ascertaining the potential strength of a certain current, and the ammeter, which indicates what quantity of electricity is passing at a certain point in a circuit.

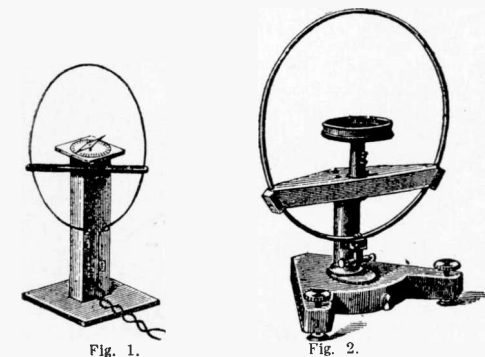

Fig. 1.

Fig. 2.

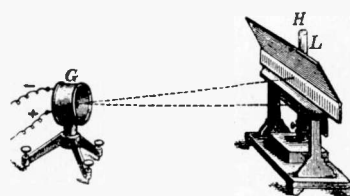

Fig. 3.

Most measuring instruments work upon the original galvanometer principle, which involves the use of a magnetized needle pivotally mounted within a coil of one or more turns of insulated wire.

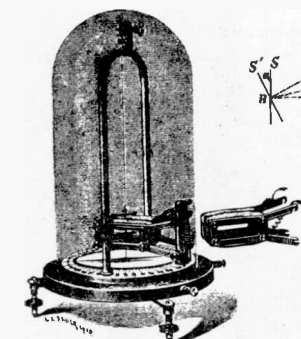

Fig. 5.

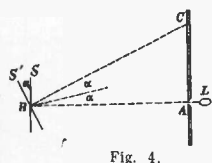

Fig. 4.

The tangent galvanometer was one of the first electrical measuring instruments developed, and a cut of such a type is seen at Fig. 1. It is easily made, comprising a loop of one turn of No. 6 or 8 B. & S. gauge copper wire, made into a loop having a diameter of 62.8 cm. (24.7 in.), and a circumference of 197.2 cm. (77.7 in.). If the instrument is made carefully after the above dimensions, and a galvanometer needle placed upon the pedestal (an ordinary compass needle will serve), a current of 10 amperes passing thru the loop will cause the needle to deflect over 45 degrees of the

circular dial ($\frac{1}{8}$ of the circumference). The compass needle should be placed at the exact center of the coil or loop of wire. A more adjustable type of this galvanometer is illustrated at Fig. 2, which has leveling screws provided in the base feet, so it can be readily set level. Ordinarily, the coil is set parallel

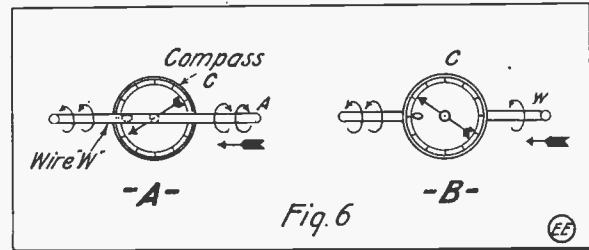

Fig. 6

with the needle, when the needle has set itself north and south, or with the magnetic meridian of the earth.

Galvanometers as a rule are very delicate and used only for determining very fine differences of current or voltage, as in Wheatstone Bridge measurements, etc. A type much in favor to-day for laboratory research, but unsuited to field work, is the mirror or reflecting galvanometer, shown at Fig. 3. At G is a very sensitive galvanometer provided with a delicately hung mirror of small size. The mirror is suspended on quartz or cocoon silk fibre. Behind a graduated stationary scale H, is placed a source of light, L. This light is allowed to filter thru a small slit in the scale frame, but below the scale, and falls upon the mirror of the galvanometer. When a very minute current is passed through the galvanometer coil, the mirror, with minute permanent steel magnets attached to it, is deflected a trifle, and consequently the beam

of light reflected from the mirror is caused to make a relatively large movement over the scale H. In this way, very small currents are made to give easily

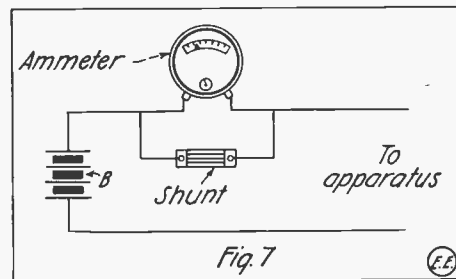

Fig. 7

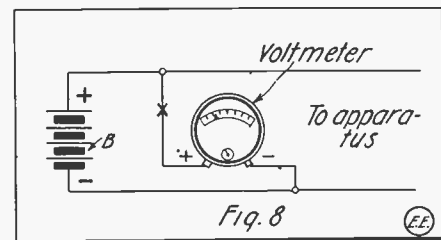

Fig. 8

readable indications. At Fig. 4 is shown the plan view of the mirror type and its action.

A positive type of direct reading galvanometer is depicted at Fig. 5. It has removable coils, enabling the operator to substitute coils of different resistances for high and low potential current measurements. A glass cover is fitted to it, preventing dust or draughts from reaching it.

The principle of the action of all types of electrical measuring instruments is that all conductors carrying electric current, set up a magnetic field of force about themselves. This is simply proved with the aid of an ordinary 25 cent pocket compass.

In Fig. 6, A and B, is illustrated the manner of using it. The compass needle is set parallel with the wire, by moving the wire, or by the aid of a small steel directing magnet. Now if as at A, where the wire passes over the top of the compass needle, and a current of several amperes passes in the direction of the arrow, i. e., from right to left, then right-handed whirls of magnetic flux are produced about the wire, when looked at from the A end. These cause the compass

needle to deflect as shown, if the north-seeking pole of the needle points toward the left. If the current passes from left to right thru the wire, W, then the needle would be de-

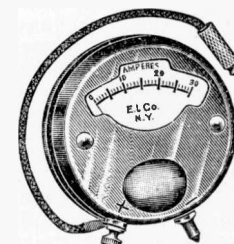

Fig. 9.

flected just oppositely to the direction indicated at 6A. If the wire W, Fig. 6A, with current passing in same direction, is placed under the compass needle, then the needle will be deflected as shown at B, providing the north-seeking pole of same is pointing toward the left. The north-seeking pole of a magnetic compass needle is actually the south pole of the magnet. The north magnetic pole of the earth, which is not the geographical north pole, attracts the south magnetic needle pole, as like poles repel, and unlike poles attract.

If a galvanometer is to be employed to measure the quantity of electric current in amperes, its coil is wound with heavy copper wire, the size depending upon the number of amperes.

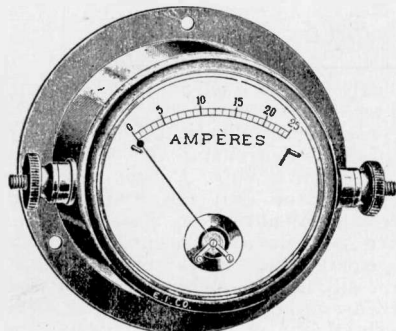

Fig. 10.

Such a measuring instrument is termed an ammeter providing the scale, over which the needle swings is suitably graduated and calibrated in amperes, enabling the deflection to be noted in amperes direct.

This is sometimes referred to as the direct reading instrument. The manner of connecting an ammeter into a circuit is seen from Fig. 7, and this is the usual method. It is placed in series with the circuit whose current is to be measured.

For large currents, it is standard practice to connect the ammeter across a shunt SH, as seen. The shunt is highly conducting, and has a certain resistance ratio to the resistance of the ammeter, so that a large proportion of the current passes thru the shunt, while only a fraction of it passes thru the ammeter coil and movement itself. For instance, the shunt might have 1/10 and the ammeter winding 9/10 of the total resistance, and hence the greater portion of the current would pass thru the shunt, while but a small portion would pass thru the ammeter, and when it is calibrated, the shunt should be connected in circuit, otherwise the ammeter needle would indicate only a fraction of the actual current traversing the circuit.

In measuring the intensity of the current or its voltage, the instrument is connected as in diagram, Fig. 8, and here the current passed thru the coil of the voltmeter or intensity meter, is very small, and so the coil's resistance is many times higher than that of the ammeter. Fine wire is therefore used to wind the coil with. For ordinary voltages not exceeding 500 to 1,000, the voltmeter coil is usually designed to care for the potential along with its resistance coil enclosed within its case. An ordinary voltmeter calibrated to read up to, say, 150 volts, can readily be employed to register voltages much higher than this, by inserting a proper multiplying coil in series with it, as at X, Fig. 8. In these circuits, B represents a battery or dynamo supplying current to apparatus, such as motors, lamps, etc.

The multiplying coil for connecting in series with the voltmeter is made to have a certain definite ratio of resistance, thus: Suppose a Weston 150-volt scale instrument is to be used on voltages up to 500 or 600. If the multiplier has a resistance of three times the voltmeter (which is here about 15,000 ohms), then the multiplying value of it is 4. Hence if it had 45,000 ohms resistance, and the voltmeter but 15,000

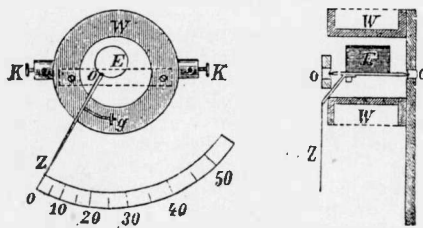

Fig. 12.

ohms, then when the meter registered 50 volts, it would be really reading 4x50 volts, or 200 volts. If the multiplying coil had nine times the resistance of the voltmeter, then the multiplying factor would be 10, or the voltmeter reading times 10, would be the real value of the electro-motive force present.

A small type of pocket measuring instrument calibrated to read amperes direct, is shown at Fig. 9. It is also made to read volts, having in this case a winding of higher resistance than in the ammeter. Such an instrument is extremely suitable

for electricians, motorists, and all others having occasion to test batteries and the like. When testing dry cells, the voltage of new ones should be about 1.5 volts, and the current on short-circuit thru the ammeter from 20 to 30 amperes.

A cut of an "Electro" ammeter suitable for use on small switchboards, battery circuits, etc., is illustrated at Fig. 10. It is calibrated to read from 0 to 25 amperes. A similar type of instrument made to read volts and having a range of 1 to 6 volts, is depicted at Fig. 11. This instrument can also be had arranged with two windings to read volts and amperes. These types operate on magnetic vane principle, which is that form having a soft iron vane mounted on a pivoted staff, and suitably arranged within a coil of wire. Its action is illustrated by Fig. 12, where E is the iron vane, W the coil of wire, and Z the needle deflecting over a scale.

Magnetic plunger or solenoid types of voltmeters and ammeters are extensively used, but are not extremely accurate. In Fig. 13 is seen a German style, comprising a coil of wire, arranged to suck into its center a piece of soft iron, which is fastened by levers to a needle Z. A spiral spring F ordinarily holds the iron plunger up out of the coil. The magnetic pull exerted on the iron is proportional to the strength or quantity of the current passing thru the coil winding, and hence it is an easy matter to calibrate the scale, by comparing the needle's deflection with a standard instrument in the same circuit.

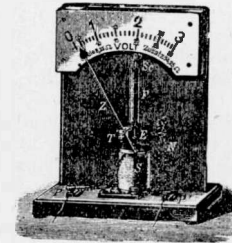

Fig. 13.

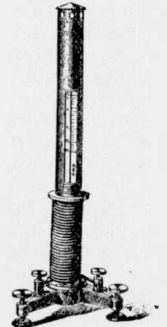

Fig. 14.

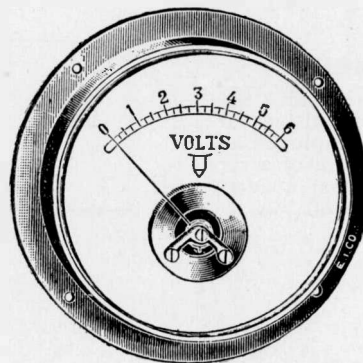

Fig. 11.

Instead of causing a needle to be actuated by the iron plunger, as just described, some makers simply arrange the soft iron core to indicate direct, as in the instrument at Fig. 14. This is an easy form to make for the experimenter, the iron core being placed in a tube having a window, as shown, and the window suitably calibrated. Exact details for making one of this type and reading both volts and amperes is well described in "Modern Electrics" for June, 1912, page 259. A cut of its make-up is given here, Fig. 15. A hollow tin cylinder, made air-tight, is placed in a glass vial or test tube, half-filled with water or alcohol. Two windings are wound about the lower

part of the tube, one a coarse wire for the amperes and the other a fine wire for the volts. These are used separately.

An instrument for use on A. C. or D. C. circuits is seen at Fig. 16, where a side and top view of it are shown. It is known as the Thompson inclined coil meter. The odd feature of it is the soft iron armature E, secured to the moving spindle F. Two coils for volts or amperes are shown on this instrument also, but for commercial work, as built by the General Electric Co., it is invariably provided with one coil, for either volts or amperes, as the case may be.

An instrument originally employed and built by Cardew, of England, is the hot wire meter. Its principle of action will be understood by looking at the diagram, Fig. 17. A length of fine platinum or other wire, E, is suspended between the support F, and adjusting screw A. At the center of the platinum wire is fastened a string or fine wire, G, actuating the

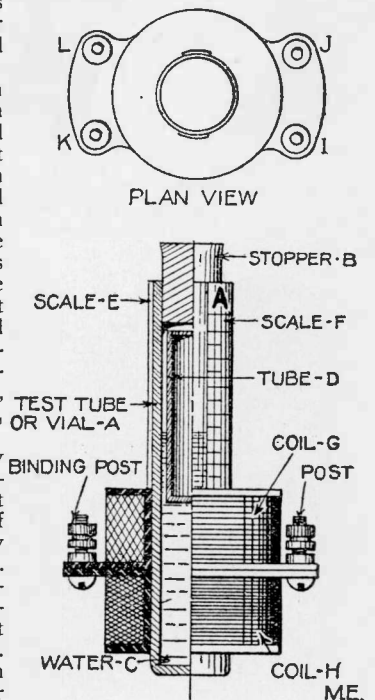

Fig. 15.



THE CONSTRUCTOR



MAKING YOUR OWN ELECTRIC CYCLE LAMPS.

By A. Tire.

Most cyclists are interested more or less in electric cycle lamps to take the place of their bothersome oil lights, etc., but the price of these electric head-lamps is usually quite high, especially those making use of dynamos in place of storage batteries.

The following explains how to rig up a small dynamo on the bicycle with little trouble, and the dynamo is belt driven from a friction pulley, making contact

Any small dynamo serves for this lighting plant, but the small imported plants of this type utilize a miniature magneto built as at Fig. "D," and any amateur electrician can readily make one from an old telephone magneto. These small dynamos usually have their friction pulley on end of shaft placed in contact with the tire directly.

One or two steel horse-shoe magnets are necessary for making this generator, and the armature is simply a shuttle wound "H" type affair, with one end of the single coil grounded to the

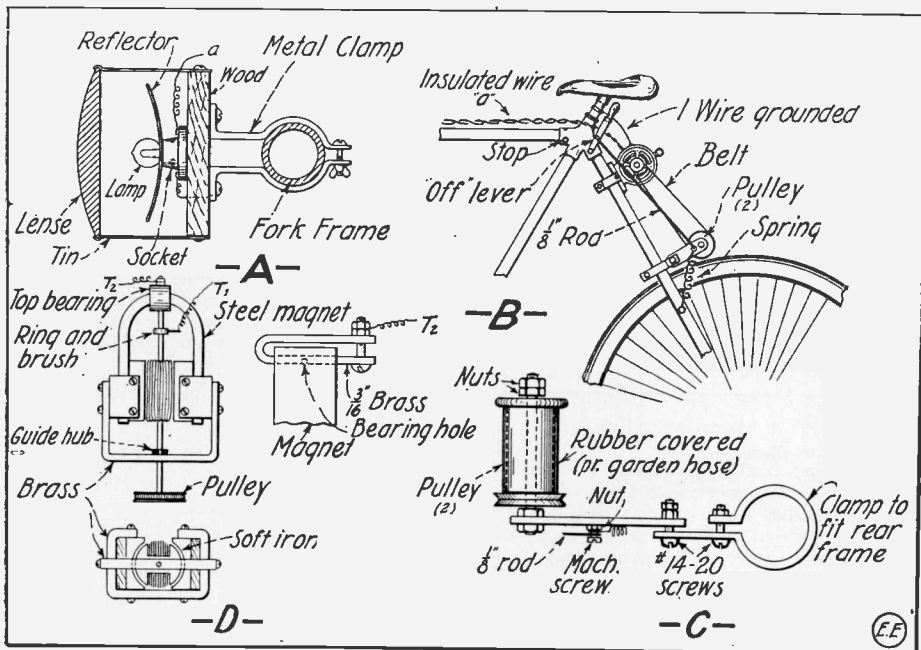

with the rubber tire of the rear wheel, as the sketch, "B," shows.

At Fig. "A" is shown the make-up of the head-lamp, composed of a tin cylinder, grooved at one end to accommodate a regular lens, purchasable from any cycle repair shop. At the other end of the tin cylinder is fastened by a few screws a 3/4 inch wood disc, to which is fastened the lamp socket and also the clamp straps to hold the lamp on the fork-frame. The lamp is fitted with a miniature base Tungsten lamp of voltage suitable for dynamo used, and also a nickel reflector. One lamp socket wire is grounded thru the clamp, and the other terminal is composed of a rubber insulated conductor, run along the cycle frame to the dynamo.

The cuts Figs. "B" and "C" indicate the dynamo drive arrangement, and a leather belt is placed in the groove cut in the side of the wood pulley (2), which is covered with rubber to give a good friction drive from the cycle tire. This is provided for very well by fitting a piece of rubber garden hose over the wood pulley, made, of course, somewhat larger in diameter. The rubber is held in place by some Le Page's glue or by a few brads around the outer ends. Fig. "C" shows how the swinging pulley arm is supported and a clamp provided out of strap iron, to secure the driving rig to the rear frame. A spiral spring tends to hold the friction wheel against the tire and to release it the "off" lever is used, as shown; this being pivoted and connected by the 3/8 inch rod, as illustrated, so that when thrown forward, it stays there, similar to an eccentric.

shaft of same and the other coil terminal connected to an insulated contact ring, fitted with brush contact as indicated. This machine thus supplies alternating current to the lamp, but either D. C. or A. C., of course, serves nicely for lighting purposes. These dynamo plants can also be used to operate an alarm bell or whistle, etc., naturally. A type "S" "Electro" dynamo is used by the writer successfully.

MEASURING HORSE POWER WITH PRONY BRAKES.

The horsepower (actually developed mechanically by electric motors, water wheels, gasoline engines, etc.) is usually measured by means of the friction brake clamped around the pulley, and this is termed the "Prony brake method." The brake band may be of hard wood for small machines, or leather lined, etc. Large size brakes sometimes have a number of shoes on them and these sizes are often lubricated with soapy water, as a large amount of friction is developed between the brake band and the pulley face.

Our illustration shows a common arrangement of the Prony brake, and its arm rests on a scale, or a spring scale may be used between the end of the brake lever and a fixed support above it. As pointed out by Mr. M. E. Griffin in "Power," the usual formula for using the brake can be much simplified if, when making a prony brake, the arm is of such length that the distance A, in the illustration, is 63.024 in., or the radius

• A 50-CENT RADIO RECEPTOR.

A wireless receiving set for half a dollar comprises an "Electro" No. 1024 forty-cent 75-ohm telephone receiver and one of their ten-cent galena detectors,

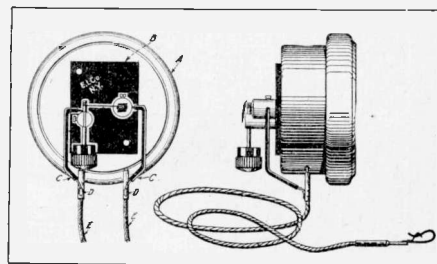

arranged as shown in the illustration. The detector is best screwed to the back of the watch case receiver, the detector binding posts being connected on shunt to the receiver terminals as indicated. This forms the simplest wireless receiving set one can employ and a regular elevated aerial wire system and ground to the nearest water pipe may be used, or in cities like New York, etc., where a great many radio stations are located, a brass bed may be used; and it is best to place some china or glass dishes under the feet of the bed to thoroughly insulate same. A water, gas or steam pipe ground is also used. Bell wire serves well for the aerial and all connections to ground, etc.

A 1,000-ohm or 1,500-ohm telephone receiver is always preferable, of course, as they are several hundred times more sensitive to the weak wireless signals. In using this outfit, the "cat-whisker" wire on the detector is moved about on the galena mineral in the cup until the signals are heard best. A buzzer test is the quickest way, of course, to adjust the detector, or an electric socket clicked on and off will give a click in the receiver, showing that the detector is in a sensitive condition.

Contributed by FRED SAMPSON.

[The editors have tried this arrangement at various times and with the aerial and ground wires connected to the gas and steam pipes in an apartment; on the second floor of same, radio messages from a considerable distance have been readily picked up.]

of a circle the circumference of which is 33 ft. If W equals the weight indicated on the scale in lbs., N the revolutions per minute of the pulley, and A the arm radius in feet, the usual formula

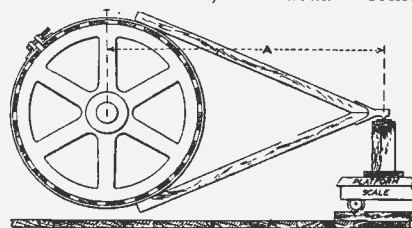

$$\text{hp.} = \frac{2 \pi A W N}{33,000}$$

will be simplified to

$$\text{hp.} = \frac{W N}{1000}$$

which makes the use of the brake much simpler.

A MODEL ELECTRICAL HAMMER.

Many of our younger readers will be interested in the electrical hammer here shown. It is easy to make and if constructed of fair size, it can be utilized for practical riveting and other light work, such as jewellers, model makers and others run into. A solenoid or suction type electromagnet forms the basis of the design and this may be about three inches long with fibre or wooden end discs $1\frac{3}{4}$ inches in diameter, with a $\frac{1}{2}$ inch inside diameter brass or fibre tube running thru its centre. If a metal

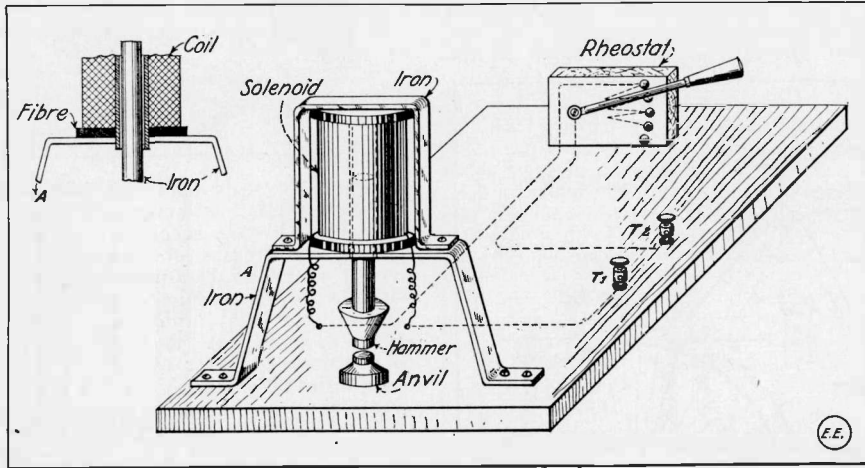

tube is used, it should be insulated by several layers of paper and the coil is then formed of about No. 16 enameled or cotton covered magnet placed on same in even layers, filling the bobbin. Two leads are left from the inner and outer coil terminals, of course, and these are connected in series with a controller as illustrated in the sketch. This is easily made from a switch lever and five to six points to which a set of resistances are connected. The resistance in each step between points may be a few feet of copper or iron wire, about Nos. 26 or 28 gauge. On the lower point the switch breaks the solenoid circuit allowing the hammer to drop quickly, if the switch lever is depressed sharply. On the upper point the coil receives its greatest current from a battery of four to six dry cells connected to the terminals T 1 and T 2. It can be made to work very rapidly by arranging the iron core to automatically break the coil circuit as it reaches its uppermost point of travel, and then to close the circuit again, as it reaches the lower level or anvil.

Stuart W. Pierson, member of the Carrollton Wireless Club, Carrollton, Ill., writes the E. I. Co.:

"It may be of interest to you to know that I am doing good work with your instruments. With the use of your $\frac{1}{2}$ K. W. open core transformer I am able to sent to East St. Louis, Ill., 58 miles distance. In receiving I use the Electro tuner converted into the 3 slide type; one Jr. fixed condenser; one Universal detector and a home-made detector; one variable condenser and one loading coil and a pair of "Electro" amateur 'phones in connection with an aerial 130 ft. long and 60 feet high, of 4 wires. With this set I can hear N. A. A., G. O., etc., I furnish the standard time for 6 of the local jewelers.

"The Electro Importing Co.'s instruments are the best on the market.

"Hoping to send you an order for a time receiving outfit soon, I remain, yours truly, etc."

A CRYSTAL TESTING SET.

Below is a description of a piece of apparatus which ought to be in every up-to-date radio station and laboratory. This set is very simple and easy to make and with it, testing minerals is a delight; whereas testing crystals in an ordinary detector, usually brings on a pepperish temper after a few minutes of fumbling.

The case is of wood, preferably mahogany, $6 \times 3\frac{1}{2} \times 2\frac{1}{4}$ inches high inside. The case has a hinged cover $1\frac{1}{2}$ inches deep, and a top $\frac{1}{4}$ inch thick, to which all connections are brought.

The other materials are an E. I. Co. Liliput Buzzer, Jr. Fixed Condenser, one single point battery switch, six binding posts, a small receiving transformer, a testing needle, two clamps and six feet of flexible cord. The transformer is of the pancake type. The primary is composed of fifty turns of No. 24 D. C. wire. This wire is wound on a tube three inches in diameter (a dry battery carton is good). The coil should not be over $\frac{1}{4}$ inch thick. When the winding is finished, slip the coil off the tube and tape it. Wind the secondary with 150 turns of No. 30 D. C. wire in the same manner. When finished, lay the secondary on the primary and bind them together with tape.

The testing needle (Fig. 1) consists of a wooden or rubber handle about two

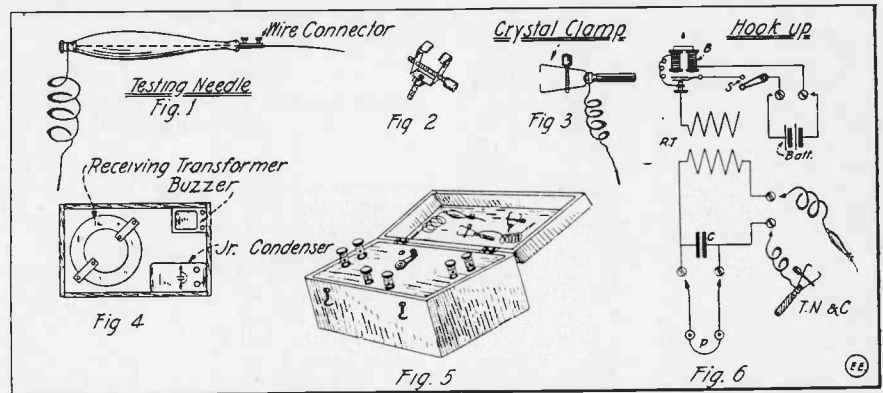

inches long, with a hole bored thru the center, thru which a rod having $\frac{8}{32}$ inch thread is passed. On one end of rod is fastened a small binding post and on the other end is clamped a small wire connector. The drawing explains the rest.

The clamp (Figs. 2 and 3) consists of a piece of spring brass $\frac{3}{8}$ inch wide bent in the form shown. A bolt and knob control the pressure. To the bottom of the clamp is bolted an $\frac{8}{32}$ inch screw. Make two of these clamps. One is fastened to a handle and cord, as in Fig.

ATTACHMENT FOR ALARM CLOCKS.

I wish to make a contribution to your department in the form of an alarm and automatic light switch of my own make. It is mounted on a board $14 \times 7 \times 1$ inches, with one upright piece. A cheap alarm clock is obtained and the glass and large hand taken off. It is faced toward the upright piece where holes have been bored before the figures on the clock.

After arranging as in diagram, wind clock, set at right time, place nail thru hole till it touches white face of clock over figures when you wish clock to

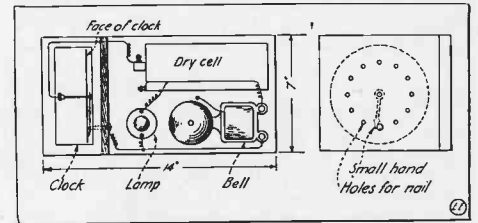

alarm. At desired time in the morning, the small hand will touch nail switching on electric bell, and the lamp will light the room. The current is shut off by pulling out the nail or switch.

The bell and light can be held in place by tacks, while battery can be held by a leather strap.

Contributed by WADE WILLIAMS.

WIRELESS AT LITITZ, PA.

R. J. Kofroth, the electrician, has installed a wireless telegraph apparatus in his office on the second floor of the Ritchie restaurant building. This is the second one for Lititz, Jeweler H. R. Wertsch having one installed about a month ago. Mr. Kofroth's apparatus is a powerful one and messages can be received from stations 2,000 miles away.

3. This, when used in connection with a pointed wire in the testing needle can be employed for testing galena, etc.

When it is desired to experiment with combinations of crystals, both clamps are used. The extra one being clamped in

the testing needle in place of the wire.

The arrangement of instruments is shown in Fig. 4. The terminals on the top are shown in Fig. 5. Fig. 7 is the hook up. Any 'phones can be used with this set. When not in use the testing needle and clamps can be fastened to the inside of the cover by means of spring brass clips. Some hooks can be placed on the side to lock the cover and a handle on top if so desired. Fig. 6 gives the general appearance of the set.

Contributed by E. H. SWANSON.

ELECTRIC BRAKE FOR SMALL MOTORS.

The following description of a unique electric brake arrangement was suggested by Mr. Milton Hymes, of the E. I. Co. staff, and it has been used in practice considerably. The action involved depends upon the fact that when the controller (frequently of the foot type actuated by a treadle, as shown in the sketch, and which is widely employed for sewing machines, winding machines, etc.) has its contact arm A, switched to the "off" position, it will close the circuit thru the button B, and hence the armature of the motor can pass current around the circuit thus formed, and in so doing it energizes the buzzer or relay magnet coils at C, causing the buzzer armature to keep closed against the contact connected to the field winding of the motor. Thus the field of the motor is kept excited or magnetized so long as the armature is rotating and generating an E. M. F. The electromagnetic action thus set

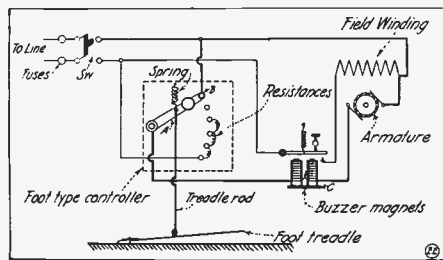

up in the motor will tend to stop it in a remarkably short space of time, which function is so often desired on winding machines, etc. The only part to be made up or rather redesigned, is the buzzer and its contact screw, as will be evident from the foregoing. For small 110 volt D. C. motors, (the diagram is for a shunt wound type), the buzzer magnet coils should be wound with about No. 20 enameled magnet wire, and for larger motors than above about 1/8 to 1/4 H. P. larger size wire may be wound on the buzzer coils; allowing about 900 to 1000 circular mils per ampere in calculating the size of wire necessary in any case. The sparking at the buzzer contact can be almost entirely eliminated by connecting a condenser across the moving contacts.

ELECTRICITY IN RAIN.

Rain drops are almost always charged with electricity. The charge is often positive, rarely negative. Many observers have measured the charge approximately and made it from 0.000,000,000,000,000,01 to 0.000,000,000,000,001 amperes per square centimeter. Prof. F. Herath, of Kiel, describes in The Revue Electrique the experiments by which he has measured them.

He received the rain on a fine metallic cloth twenty-five meters square, insulated and attached to a galvanometer in a cellar. The galvanometer registered photographically. Among the facts he proves are these:

Rains with a constantly positive charge are much more frequent than those that charge to a negative. The passage from a positive to a negative charge corresponds to a momentary cessation of the shower. The quantity of positive electricity brought by the rain is fifteen times greater than that of the negative. The positive currents in a steady rainfall are about 0.000,000,000,000,000,1 amperes per square centimeter. The negative current never exceed 0.000,000,000,000,001 amperes per square centimeter.

MAGNETIC DETECTOR ADJUSTMENT.

An English wireless operator is making use of a method for adjusting contact between crystals in the detector which he claims is an excellent one. In this case the contact between two crystals is obtained, not by hand, but by the use of an electromagnet which produces the pressure and can be given a very fine adjustment. One crystal cup is mounted on the base of the apparatus, and above it the second cup lies on the end of a short vertical slide arm, placed on the end of a rather long tongue or spring strip. Midway on the tongue is an iron armature which can be drawn down by an electromagnet on the base. A rough adjustment is made by sliding the top crystal in its screw slide and fixing it, then current is put on the magnet so as to draw down the spring blade and so adjust the contact between the top and

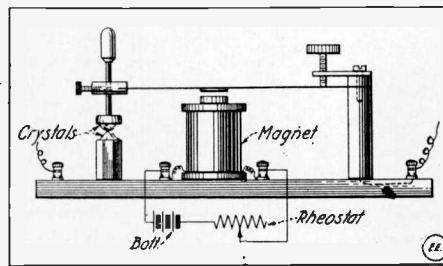

bottom crystals. A rheostat of the sliding kind is used to give a close adjustment of the current.

INSULATORS AND THEIR PROPERTIES.

All figures given in the tables are only approximate, and vary widely with the quality of materials and the way in which they are mixed. They are taken from a bulletin on insulation from the Boonton Rubber Mfg. Co. It is practically impossible to measure resistance above 100,000 Megohms, and when any insulation shows a higher value than this it is satisfactory for all purposes in this respect. Glass has a very great surface leakage. A polished hard rubber surface is ten per cent better than an unpolished surface, and polishing also helps the dielectric strength of the composition.

	Specific Inductive Capacity	Specific Gravity	Specific Resistance at 20° C (68° F)
			Millions of Megohms Per Centimeter Cubed.
All Gases and Vacuum.....	1.00		
Bakelite	5.60 to 8.85	1.25 to 1.89	0.01 to 35.
Celluloid	1.19 to 2.66	1.40 to 1.50	0.07 to 0.6
Glass	2.80 to 9.90	2.64 to 4.50	90. to 20000.
Gutta-Percha	2.50 to 4.20	0.97 to 0.99	45. to 450.
Hard Rubber	1.90 to 3.48	1.40 to 1.90	3600. to 28000.
Soft Rubber	2.12 to 2.69	1.65 to 2.00	210. to 1400.
Marble	4.00 to 6.00	2.52 to 2.85	0.005 to 0.007
Mica	4.60 to 8.00	2.50 to 2.80	0.2 to 80.
Paraffin	1.68 to 2.47	0.92 to 0.95	240. to 24000.
Paper	1.25 to 2.25	0.95 to 1.10	0.05 to 0.10
Porcelain	4.38 to 6.84	2.40 to 2.46	0.5 to 2000.
Rosin	1.80 to 2.57	1.15 to 1.25	240. to 1500.
Shellac	2.70 to 3.73	1.07 to 1.20	1500. to 9000.
Water (Distilled, 60 F.).....	75. 90.	100	(2650 ohms)
Ambroin		1.40 to 1.80	0.16 to 0.25
Dry Wood		0.46 to 1.33	50. to 600.
Red Fibre		1.30 to 1.35	10. to 70.
Slate		2.60 to 2.70	0.08 to 0.10
Micanit		2.45 to 2.50	2500. to 6500.
Stabilit		1.51 to 1.80	24. to 60.
Hi-Tensit		1.58 to 1.70	29. to 75.

CONSTRUCTING AN IMPROVED ELECTROSCOPE.

Electroscopes for testing high voltage charges, whether from a static machine or other high voltage sources, are frequently of service and an improved form is described here, the common defect in the usual form of Electroscope being that the metal rod leading down thru the top of the glass jar or bell carrying the gold leaf leaves is supported by a wooden lid or cover on the glass jar. The cover for this instrument is split diametrically and only put in place when the apparatus is not in use to keep the dust out of it.

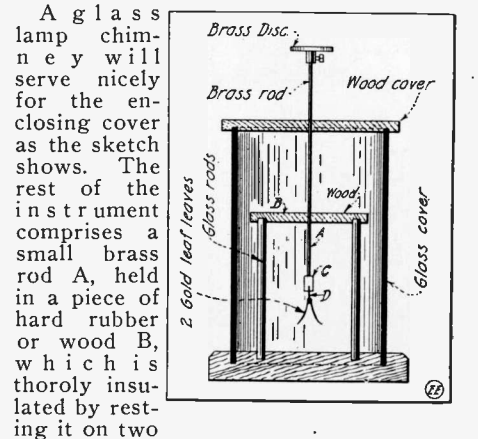

A glass lamp chimney will serve nicely for the enclosing cover as the sketch shows. The rest of the instrument comprises a small brass rod A, held in a piece of hard rubber or wood B, which is thoroly insulated by resting it on two glass pillars as indicated. Counter-sunk holes in the base and upper bar B serve to accommodate the glass uprights which may be of 1/4" round stock. The gold leaf is cut into two leaves about 1/2" by 2" and glued or otherwise secured to the brass tongue D, mounted in a slot of the lower support C, at the end of the connecting rod A. A brass plate about 1/8" thick and 1 1/4" diameter surmounts the upper end of the rod A and this can be made removable if desired.

THE USE OF A CONDENSER AS A SHUNT TO A TELEPHONE.

(Continued from page 149)

general case, where circuits in parallel with the telephone have a large resistance, this maximum is due to resonance in the telephone circuit alone; that the "harmonics" in the break, and not the frequency of the break itself, may be the most important factor in determining the value of the capacity to produce the best effect for any one telephone.—(From *Wireless World*, London.)

WIRELESS DEPARTMENT

WIRELESS TIME

SIGNALS IN GERMANY.

The first wireless astronomical time signals were tried in 1906 and the first regular wireless time signal service was established in 1907 at Camperdown Wireless Station near Halifax. In 1910 wireless time signal service was placed in operation between Eiffel Tower in Paris and German Norddeich Wireless Stations and the Imperial Marine Observatory at Wilhelmshaven.

The wireless time signal equipment of the Hamburg Observatory at Bergedorf, Germany, seen in the accompanying illustrations, is under the direction

of Prof. Dr. R. Schorr, who established this wireless installation in August, 1911. The antennae consist



Time Signal Station at Treptow Observatory.

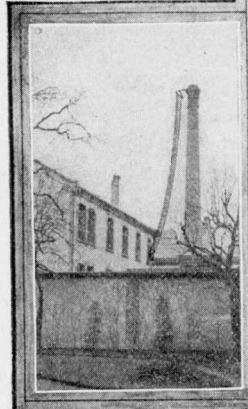

The aerial for time signal reception at Muhlhausen.



Radio Time Signal Office at Hamburg Observatory, Bergedorf.

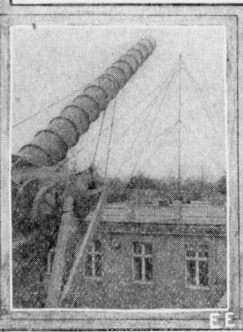

The aerial and telescope at the Treptow Observatory.

SOME NOVEL WIRELESS TELEPHONE SCHEMES.

By H. Winfield Secor, A. M. I. R. E.

Wireless telephony is one of those problems which does not lend itself to so easy a solution, as at first supposed. The one prominent feature of the radiophone problem is the production of a sustained oscillating current, with a frequency of reversal from positive to negative values of 20,000 cycles per second and more. 30,000 cycles is desirable in most radiophonic work where a single train of oscillations is utilized on which to superimpose the voice waves. Voice waves, of course, have a varying frequency for the different tones, and above 20,000 to 25,000 cycles per second, the singing sound due to the current frequency is reduced to a small factor.

We are all more or less familiar with Poulson arc generators, Goldschmidt,

Fessenden and Alexanderson alternators and other diversified schemes for producing a suitable radio frequency current, which can be utilized for the wireless transmission of speech. However, from an experimental and commercial aspect, we are bound to be interested in

some more stable and simpler scheme than those enumerated above for the purpose in question.

Many experimenters have undoubtedly tried to use the common induction or spark coil of their wireless telegraph station for transmitting speech, but

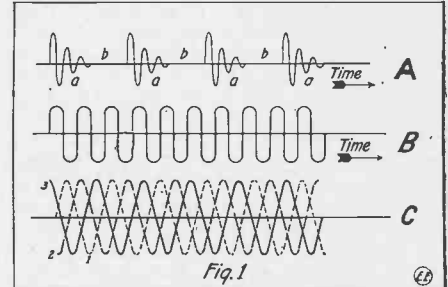

without success. This latter statement is made advisedly, because the writer and Mr. H. Gernsback have in the past few years conducted hundreds of tests with battery type radiophone outfits, utilizing spark coils with and without vibrators, and with all kinds of common and special spark gaps, et cetera, and in general it has been found impossible to transmit articulate speech regularly and clearly. It may be said that whistling and calling of numbers from 1 to 100, etc., carried best over these battery type sets. Numerous inventors have appeared from time to time with what they claimed to be practical radiophone outfits for battery operation, but after careful tests, they have all proved to be a myth, due in some cases to freak conditions obtaining; such as might occur in the apparatus itself, or the aerial positions, etc. Why this trouble occurs in spark coil transmission is readily perceived from the oscillographs at Fig. 1, which show at A, the detached wave trains a, a, a, etc., produced by a spark coil oscillation generator, and the dead time intervals b, b, b, etc., between these oscillation trains a, a, naturally will cause the transmitted speech to be broken up. At diagram 1-B is indicated the form of an undamped or sustained wave as produced by a Poulson arc, for instance. Also at A, the wave frequency is very low, causing the

of copper conductors of two millimeters stretched in a horizontal position, the total length of these aerial wires being 32 meters, located at a height of from 8 to 15 meters from the earth.

The wireless receiving equipment used is that of Dr. Erich F. Huth of Berlin. This apparatus measures 180 mm. in length and 170 mm. in width, with a height of 260 mm., and includes a thermode detector and double head telephone receivers of high resistance. There is a small transmitting equipment used of 2,000 meter wave length utilized at Norddeich and Paris. The total weight of the apparatus is only 5.5 kilograms. The distance between Norddeich and Bergedorf is about 200 kilometers, while the distance between Bergedorf and Paris is full 730 kilometers.

The Berlin wireless signal installation at the Treptow Observatory includes a mast 18 meters high carrying the antennae with wireless instruments of the Normalzeit Gesellschaft. At the municipal Technical school at Muhlhausen, in Elsas, Germany, there is a wireless time signal station under the direction of Dr. Hans Zickerdraht. This wireless is so arranged that any wave length may be used from 200 to 2,500 meters. Time

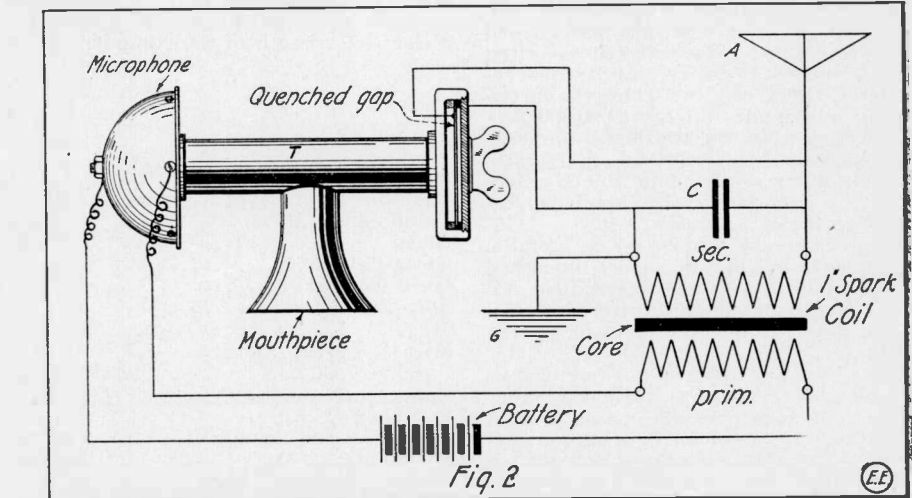

signals are sent at intervals day and night, although usually not more than four signals in 24 hours. The details as to wireless time signals were described at the International Conference at Paris, in October, 1912.

FRANK C. PERKINS.

spark tone in the receiving station to greatly interfere with the voice reception, as the voice waves are of much higher periodicity. A compromise between the broken up wave train at A, and the undamped train at B, is shown at C, which illustrates what happens

when 3 distinct oscillations or currents are superimposed on one another. If the frequency in this case is fairly high, it is plausible that fairly good radio-phonetic transmission can be accomplished and several early radio investigators

in different kinds of gas, several dozen gap tubes having been made up specially for the tests.

Resuming the multiphase type of transmitters, very interesting work is reported in the researches of Simon (see

that the waves overlap by the proper amount, the oscillations produced, even by a 500 cycle 3-phased transmitter can be made to completely lose their tone characteristics. The high frequency radiation thus obtained is very constant and causes only a slight, steady hissing sound in the telephones at the receptor. It is believed that with this frequency or a somewhat higher one, preferably, that if the voice waves are superimposed upon the aerial oscillations, the successful transmission of speech can be accomplished. A 3-phase 2,000 or 3,000 cycle generator can be readily constructed and should be entirely suitable for this use."

Along this line of 3 or more phase generators, the writer would suggest experimentation by amateurs and others interested in using spark coils with synchronous multiple vibrators, somewhat after the fashion outlined at Fig. 4. The vibrator of one spark coil (1 inch size, for instance) would carry suitably spaced pins, which would break the springs Nos. 2 and 3, after No. 1, i. e., to give 120 degrees difference between the successive phases or break currents in the 3 spark coils, with secondary windings S_1 , S_2 and S_3 . Condensers C are placed across the vibrator contacts as usual. Looking at Diagram B, the complete layout is indicated, M being the microphone transmitter of common type, with a hot wire ammeter, if used, inserted as shown in the ground lead. Oscillation transformers of small size are best employed at o, o, o. Small quenched gaps of 7 to 10 plates about .01 inch apart in

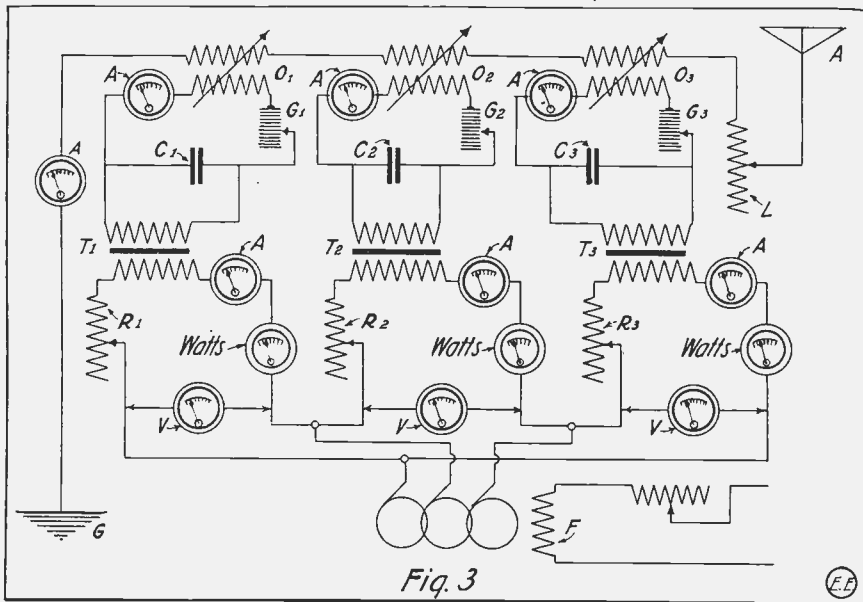

Fig. 3

claimed this feature in their patents; notably Eisenstein, in his U. S. Patent No. 991,837, issued May 9, 1911. His system has been found to be rather impractical.

Also Seibt was an investigator along these lines of multiphase oscillation producers, but his system has been found inoperative for various reasons, says E. J. Simon, a well known radio engineer.*

Before going further the spark coil method for radiophone work seen at Fig. 2 may be mentioned. This has been tried by the writer and Mr. H. Gernsback, and like most of these "systems," it works in bunches, to use the vernacular. This idea was described some time ago in *Modern Electrics* and a quenched spark gap of two plates fitted with a mouthpiece, as shown, and also with a common telephone microphone at the opposite end of the tube T. The effect was to vary the primary current from a battery through a spark coil, and also to simultaneously vary the spark gap length of the secondary circuit. A high voltage condenser was used at C, and the quenched spark gap is composed of two 2 inch diameter copper plates about .007 inches thick, and spaced about .01 inch

I. R. E. Proceedings previously mentioned), and a diagram of his arrangement of a 500 cycle, 3-phase quenched spark radio-telegraphic transmitter is il-

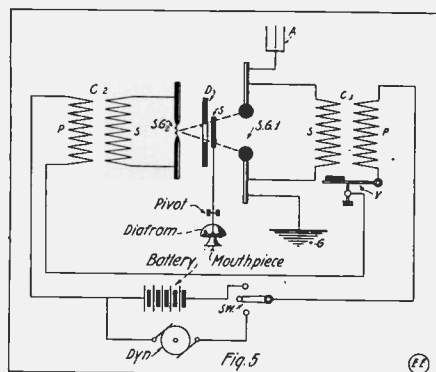

Fig. 5

apart. Also special spark gaps have been tried on these battery systems, such as quenched gaps in different vacua and

*See Vol. 2, No. 3, "Proceedings of Institute of Radio Engineers," page 220.

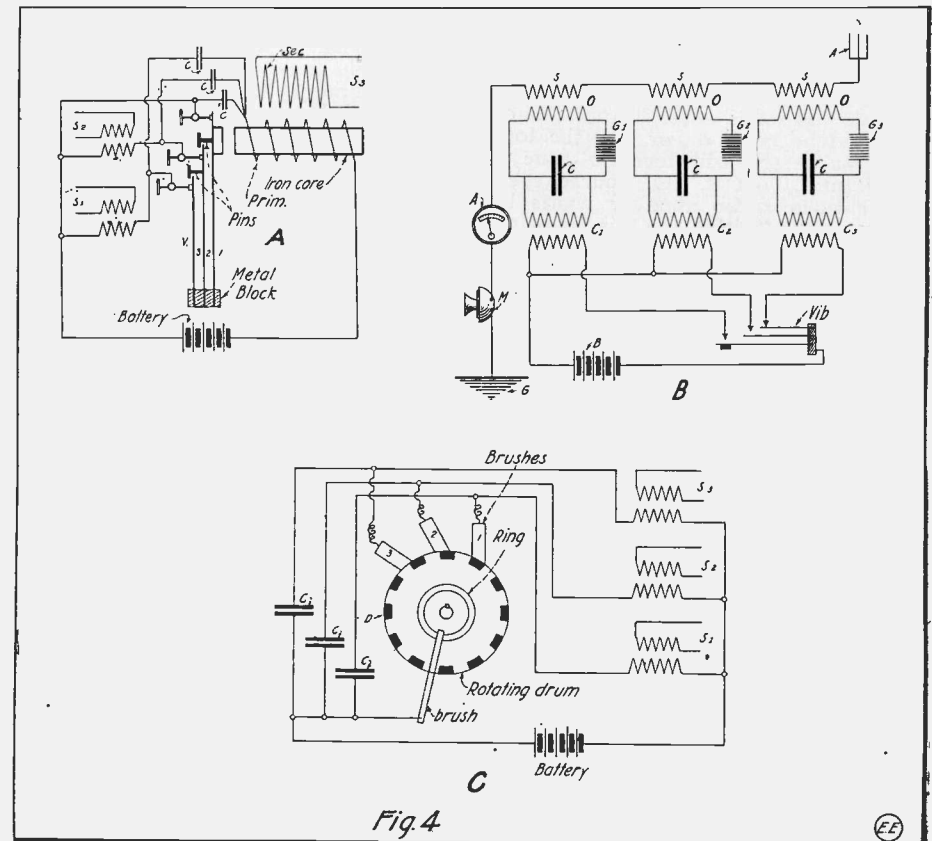

Fig. 4

lustrated by Diagram 3. A 3-phase 500 cycle alternator was used in these researches and excellent results obtained. The quenched gaps G_1 , G_2 and G_3 , help out this arrangement and also oscillation transformers O_1 , etc., as well as the primary controlling inductances R_1 , etc. The step-up transformers are indicated at T. At F is the field winding of the alternator. Simon says of this set, that "it appears practical for telephony and by arranging the antenna constants so

each phase secondary circuit, as well as regular high tension condensers at C. It is very easy to build a stiff vibrator which shall have a frequency of 500 or more cycles per second, as used on the "Dubilier" portable 500 cycle a. c. or d. c. wireless pack sets. An alternative method of making the 500 cycle or higher interrupter is seen at Fig. 4-C. The 3 spark coils are fed battery current 120 degrees apart by means of the three ad-

(Continued on page 159)

The Wave Length of Radio Antennae*

By H. Winfield Secor, A. M. I. R. E.

WHAT is the wave length of a flat top aerial 40 feet high and 60 feet long, comprising 4 strands spaced 2 feet apart? That is the question asked by hundreds of amateur Radio operators the country over, at the present time. What the

span between spreaders, along the lower base line of the chart; and then following upward, the corresponding vertical chart line until it reaches the proper aerial height "curve," the natural wave length is at once found on the column immediately to the left

intersection, of the "curve" and vertical chart line. These values have been carefully calculated from the exact inductance and capacity of the flat-top and of a vertical lead-in cable, composed of 4 strands of No. 14 B. & S. copper wires, bunched together, and leading directly down from one end of the aerial flat-top, and terminating 10 feet from the ground. The ground lead from the instruments should in this case be

oscillation transformer secondary winding must be made. Hence, if upon looking over the chart, the designer finds a suitable length of flat-top and lead-in to give the 200 meter wave length required by the law; he should select an aerial whose dimensions will give about 12 to 15 per cent. less wave length for its natural period to allow for the extra wave length added by connecting the O. T. secondary winding in circuit.

It may be remarked that the total length of the aerial is taken as equal to the length of the flat-top plus the vertical lead-in length for an inverted "L" type. In reference to the commonly used wave length factor for aerials of the "T" or inverted "L" types, it may be stated that for small aerials this factor has a value very closely approximating 4.5. The natural period or wave length of a "T" type aerial, is always less than the same size "L" connected type, due to the fact that while the flat-top section in the "T" connected type has sensibly the same capacity as in the "L" system, its inductance is less.

It is sufficiently accurate for rough calculations to figure on the total length of a "T" connected aerial as equivalent to the lead-in length plus the mean length of the flat-top.

Thus, suppose a "T" aerial has a lead-in length of 100 feet, and the vertical lead-in cable connected to the centre of a 200 foot span flat-top. Then the total effective length of this system would be assumed at 100 feet, plus 100 feet for the flat-top; and 4.5 times this gives us 900 feet wave length, which divided by 3.28 gives 274 meters.

The common way to tune up a transmitting set to the required 200 meters or less, wave length, is to work backward from the closed condenser oscillation circuit, represented by the diagram at Fig. 2. To measure the W. L. period of this circuit, having the aerial entirely disconnected of course; the wave meter exploring coil is approached to the helix

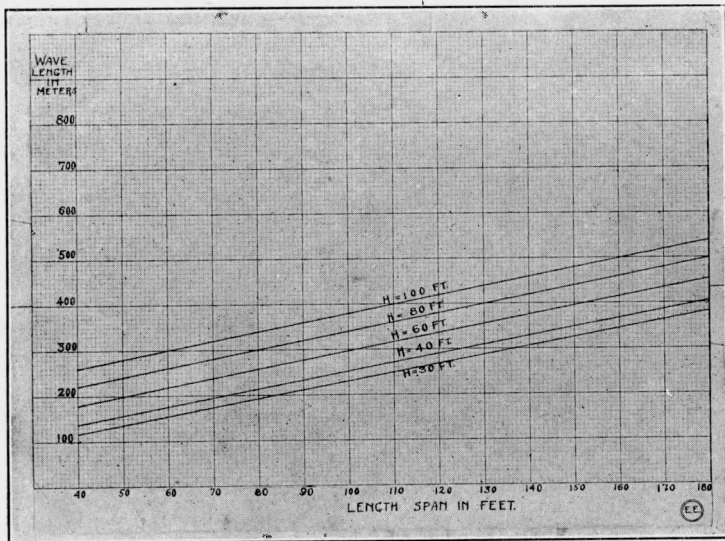

Fig. 1. Curves for Natural Wave Lengths of Radio Antennae.

wave length really is, does not particularly worry the operator owning a wireless receiving station only, but when a transmitting set is used, he must know just what he is about, or else the local Radio Inspector will lose no time in telling him about it. Of course every conscientious Radio amateur wants his set to operate "within the law," and the purpose of this paper is to aid him as much as possible in this direction. The scope of the subjects presented embraces a wave length chart, enabling anyone to quickly and correctly ascertain the natural wave length or vibration period of common size, aerials, and lead in wires.

There are a host of complicated formulas for calculating the wave length functions of tuned circuit apparatus, such as the oscillation periods, helix inductance, etc., but from actual measurements of this class, it has been found that the formulas do not always give the close results desired and expected. Where advisable, however, these formulae are here cited, and it is hoped that this slight effort may be of some service to the young radio student and also the lay reader as well.

To begin with, we will consider the set of wave length curves which have been plotted at Fig. 1. These were computed and drawn from formulae due to Dr. Louis Cohen, of the U. S. Bureau of Standards, and are very close to the exact values, which, it may be stated here, can never be exactly calculated, due to the effect of metallic bodies or structures near the aerial, etc., et cetera.

This set of 5 horizontal curves are all for 4 wire flat top aerials of the inverted "L" type, composed of No. 14 solid copper or phosphor bronze conductors, with 2 foot spacing between the strands. By reading off the desired length of the

about 10 feet long, and the same size as the lead-in cable described above. The total natural wave length of any flat-top aerial and lead-in is thus readily found from this chart.

To more clearly elucidate:—Suppose it is desired to know the fundamental wave length of a 4 strand flat-top aerial of the inverted "L" type, having a span of 100 feet between spreaders, with 2 foot spacing and elevated 80 feet above the earth, connected by a vertical lead-in cable as outlined above. Looking at the chart for a flat-top 80 feet high, and with a span between spreaders of 100 feet, the natural period or wave length of same is seen to be 340 meters. That is, if the aerial was excited by a buzzer or a spark coil connected to a break in the vertical lead-in wire, it would vibrate at a natural or fundamental wave length period of 340 meters. Of course the Radio law, affecting amateur stations, exacts a sending wave length of not over 200 meters, and the above is only cited as an example in the use of the chart. The above 340 meter aerial system, could be reduced to 200 meters, by the connection of a suitable condenser or capacity in series with it. Long lengths of water pipes used for grounding in buildings, must be considered, as they also influence the wave length directly.

Aerials of greater spread, i.e., having more strands, can be judged approximately from the chart, as they do not differ in wave length value so radically, for an ordinary size aerial. In designing a sending station antenna, it must be borne in mind, that some allowance for the wave length of the necessary

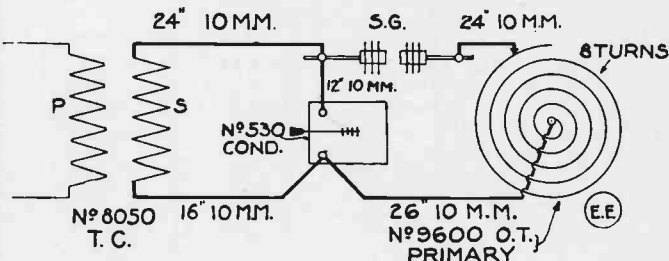

Fig. 2.

winding, until it registers only sufficiently distinct to give a clearly defined indication in the Geissler tube or the head 'phones. The wave length of this closed condenser circuit is variable by adjusting the condenser capacity, the length of the connecting leads, or the inductance of the helical winding of the oscillation transformer. When the closed circuit oscillates at 200 meters or less wave length; being duly excited by the spark from the transmitter P. S. (which in the case under discussion was an E. I. Co. No. 8050 transformer coil operating with a No. 8000 electrolytic interrupter on 115 volts D. C.), the open aerial oscillating circuit may be induc-

*Reprinted in part from the January, 1914 issue of "Electrical Experimenter," by request of numerous readers.

tively coupled through the oscillation transformer, to the closed condenser circuit. By varying the amount of inductance on the secondary O. T. coil in circuit with the aerial, the greatest radiation current is tuned for; as gauged either by a hot wire ammeter connected in series with the aerial, or by a small anchor gap in series with it. The hot-wire meter is much to be preferred for several reasons. The anchor gap, if employed to judge the maximum radiation current, by the loudness and thickness of the spark in same, should be cut out or closed after testing; as such a gap in the aerial circuit produces a considerable loss of energy. Hot wire ammeters are used in two ways by large radio stations, i.e., they are sometimes left in circuit continuously and at other times only while making a test. For small sending sets under 5 K. W. the H. W. meter is best cut out of circuit, when not required for a test. When the aerial is quite large and its complete circuit, including O. T. inductance, will not permit of its oscillating at 200 meters wave length, a glass plate condenser will have to be connected in series with the ground lead, preferably as near the last ground connection as possible. The number of glass and metal plates required will vary with different sizes of aerial circuits, helix inductance, etc., and it is a good scheme to build up several plates in the condenser, and then by tuning and varying the value of this series condenser the maximum radiation will be attained; also synchronism between the closed condenser circuit and the open aerial circuit oscillations.

The E. I. Co. adjustable No. 530 or No. 531 high tension condensers are suitable for this work.

The secondary wiring as outlined at Fig. 2 is quite simple, but a little care should be taken to keep all of the connections as short as possible, especially those leading to the condenser, spark gap, and oscillation transformer primary winding. (An oscillation or 2-coil air transformer is absolutely essential now to insure a pure wave form, to conform to the Government Radio Law, and a helix cannot be employed, except for inland stations sufficiently distant from the state border; (see "Treatise on Wireless Telegraphy," by H. Gernsback supplied gratis by the E. I. Co., or also see their latest catalogue No. 14 which incorporates this "Treatise.") The connections in the condenser circuit should not have a length of more than 14 to 18 inches or 24 inches maximum, so that as many turns of the primary of the oscillation transformer can be placed in circuit as possible. It is customary to use large stranded copper cable or copper strip to make these high frequency connections with, and E. I. Co. 10 mm. Pirelli cable, with heavy rubber insulation, is very good for the purpose.

As the dimensions and quantities involved in tuning these circuits are the most constant in the closed condenser or primary circuit of the oscillation transformer, it is best to tune this circuit to the desired wave length; and then to tune the aerial oscillating circuit into synchronism, until the hot wire meter indicates the maximum radiation current, as previously mentioned.

The following data derived from actual measurements in the E. I. Co. Radio Laboratory with a wave meter, will be of service in helping to tune the closed oscillating or primary circuit to a definite wave length, which is 200 meters or less for an amateur station, as required by law. These figures were obtained from the circuit arrangement shown at

Fig 2, in which the apparatus used was an E. I. Co. No. 530 adjustable glass plate condenser having .009 M. F. maximum capacity; Commercial Oscillation Transformer No. 9600; Commercial Spark Gap No. 9225; ½ K. W. Transformer Coil No. 8050, and Electrolytic Interrupter No. 8000. The exciting circuit was 115 volts, direct current, and an adjustable choke coil was inserted in the primary transformer circuit. The energy used in this circuit approximated 690 watts, i.e., 115 volts and 6 amperes. (No. 9600) No. Turns (No. 530) Indicated

of O. T. Primary in Circuit.	Condenser Plates in use.	wave-length in meters.
3 inside turns	8 plates	145 meters
3 inside turns	6 plates	125 meters
4 inside turns	8 plates	180 meters
4 inside turns	6 plates	145 meters
5 inside turns	8 plates	230 meters
5 inside turns	6 plates	180 meters
6 inside turns	8 plates	275 meters
6 inside turns	6 plates	230 meters
7 inside turns	8 plates	310 meters
7 inside turns	6 plates	275 meters

Turns of helix	Indicated wave-length in meters.
1 inside turn	180
2 inside turns	195
3 inside turns	228
4 inside turns	255
5 inside turns	285

This data will be of service to those building an oscillation transformer from two No. 9270 helices.

Having set the closed oscillating circuit to 200 meters wave length, the secondary inductance or coil of the oscillation transformer should be adjusted until the maximum reading is obtained on a hot-wire meter inserted in series with the aerial lead. An anchor gap about ⅛ inch long, in the aerial lead, can be used for a rough gauge of the radiation, and when the loudest and fattest spark occurs in the gap the set is tuned correctly as regards the closed and aerial oscillating circuits.

To keep the wave form and decrement as near the Government requirements as possible, a slight gap of about ½ inch to 1 inch is left between the primary and secondary coils of the oscillation transformer. A rotary spark gap is also advised, or better yet, a quenched gap. By using 500 cycle A. C. in the primary circuit of the transformer, and a quenched gap, the amateur can have a station second to none, even though of limited size, as required by the Radio Law. For prices on 500 cycle sets address the Special Sales Dept. E. I. Co., New York.

SOME NOVEL WIRELESS TELEPHONE SCHEMES

(Continued from page 157)

justable brushes, 1, 2, 3, fitted about the rotating fibre or other drum "D," having upon its periphery a number of metal segments. These are connected to the battery through a contact ring and brush as shown. The drum is rotated at proper speed by a small motor. Each of the coil brushes are adjustable so that the period at which each coil is excited may be varied.

There are many interesting and novel radiophone patents brought out, but one evolved by a Brooklyn inventor, Mr. Walton Harrison, is of more than passing interest. His idea was tried out at first by ordinary spark coils, etc., and the basis of his patent is better understood by reference to the diagram, Fig. 5.*

In the sketch is indicated two spark coils or high frequency transformers, C₁ and C₂. For experimental work, a vibrator is shown at V, which interrupts the primary current for both coils. Coil 1 discharges across the large spark gap, SG₁, between which and gap 2 is inserted a screen to ultra violet rays D, which can be of iron, or heavy lead glass, etc. This screen has a shutter, S, arranged to be moved by the voice waves falling on a diaphragm, as shown. Hence when speech occurs at the diaphragm, it will cause the shutter, S, in front of an opening in the screen, D, to open and close more or less, and the ultra violet light rays from spark gap 2, falling on the gap 1, tend to ionize the air in same and a spark then passes, as the air is then more conductive, and vice versa.

This is a crude description and arrangement, but the basic principle is there, indeed, and undoubtedly can be applied in practice.

*U. S. Patent No. 1,118,004, filed March 11, 1902. Also see "Signalling Thru Space Without Wires," by Sir Oliver Lodge, for discourse on mutual effect of spark gaps on each other.

DO YOU

realize when reading this 5 cent, 32 page magazine, that it contains a great deal more text than a 64 page standard size magazine?

"The Electrical Experimenter" today offers the greatest value in technical magazines in the U. S.

Show this issue to your friends, or better, send us their names so we can send them a free sample copy.

THE PUBLISHERS

The flat spiral winding making up the O. T. primary in this case, was 8 turns of No. 6 B. & S. aluminum wire; the mean diameter of the inside or smallest convolution being 4½ inches, and each turn spaced ½ inch from the centre of its neighbor. The connections were as shown at Fig. 2, and all leads were of 10 mm. Pirelli stranded cable of the length there given. Shorter lengths of connecting cable would give lower wave lengths, and likewise greater lengths, a higher wave length. Increasing the condenser capacity by adding more plates on multiple, also raises the wave length, and vice versa. The inductance of the 8 turns was measured and found to be 4,250 centimeters. The inductance of the "Electro" No. 8271 helix was ascertained to be 5,400 centimeters.

Some experiments were made with a No. 530 condenser, using all 8 plates, and similar lead wires, for an Electro helix No. 9270, wound in a flat spiral of brass ribbon ½ inch by 1-32 inch. The mean diameter of the inside turn was 1⅝ inches, and the successive turns were spaced ⅜ inch apart, centre to centre. The results as observed on a wavemeter are appended below.



HOW-TO-MAKE-IT DEPARTMENT



This Department will award the following monthly prizes: **FIRST PRIZE \$5.00; SECOND PRIZE \$2.00; THIRD PRIZE \$1.00.** The idea of this department is to accomplish new things with old apparatus or old material, and for the most useful, practical and original idea submitted to the Editors of this department, a monthly series of prizes will be awarded. For the best ideas submitted a prize of \$5.00 will be given; for the second best idea a \$2.00 prize, and for the third best a prize of \$1.00. The article need not be very elaborate, and rough sketches are sufficient. We will make the mechanical drawings.

FIRST PRIZE \$5.00.

THE PROJECTION OF ELECTROLYSIS ACTION.

By James Dunwoody.

The experimenter who is interested in electro chemistry, electro metallurgy and allied work usually dreads work in their direction owing to the apparent difficulty of observing the details or pro-

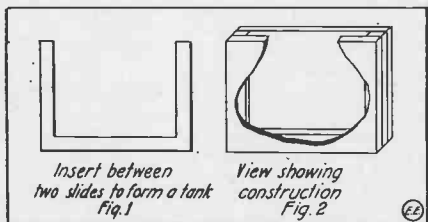

cesses of an experiment. This difficulty is very largely overcome by the following method, which is frequently used in more complex forms for lecture purposes in universities, colleges, etc.

It consists primarily of a transparent glass tank in which all the experiments are performed and this glass tank and its contents are projected, enlarged, on a convenient screen through a magic lantern, post card projector or moving picture machine.



Fig. 3.

The tank can easily be made by cementing a piece of glass, shaped as in Fig. 1, between two pieces of thin, smooth glass (lantern slides are ideal for this purpose), making sure the joints are water-proof. This tank when completed can be used for all the experiments, the electrodes required being simply wires. This tank slide is inserted in the lantern or projector the same as if it were a plain slide or postcard. Of course, in a lantern which projects pictures upside down, the tank will be projected in that way, and it is an unusual sight to see the bubbles of gas falling at a great rate in an experiment, when in actuality, they are rising rapidly.

The great advantages of performing experiments in this way are the economy of working with very small quantities of material, the simplicity of the arrangement and the ease with which every detail can be observed as the picture is from 15 to 50 times as large as the actual material, and tank in test. A

SECOND PRIZE \$2.00.

A USEFUL BATTERY.

The following is a description of a simple battery which I have constructed and from which I have obtained excellent results. The materials required are a glass jar (over one (1) pint capacity), one (1) pure zinc rod, one carbon rod, (an old battery carbon will do), three (3) ounces of concentrated sulphuric acid, and three (3) ounces of potassium bichromate. Dissolve the potassium bichromate in one (1) pint of hot water. Then pour the sulphuric acid into the bichromate solution and set aside to cool. Thoroughly amalgamate the zinc rod, which may be accomplished by dipping the rod into dilute sulphuric acid, and then rubbing with mercury. Also cleanse the carbon by immersing it in hot water for a few minutes, and using a stiff brush. The carbon and zinc rods are then placed in a rack or stopper for the jar, which contains holes into which the rods fit tightly to prevent evaporation. (See sketch.) Fill the jar with the solution and put in the rods. This battery should give between 1.5 and 2 volts. The zinc should be withdrawn when battery is not in use, and a plug cut to fill in the hole.

The zinc and carbon rods may be purchased from the E. I. Co. as well as the glass jar.

Contributed by ED. CONNELLY.

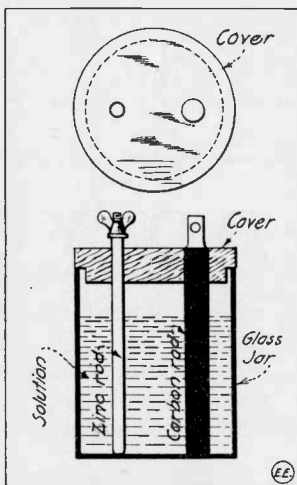

AN EFFICIENT TUNING

COIL SLIDER.

This slider is made from a piece of hard rubber 1x3/4x1/2 inches. A slot is first cut along the bottom 1/4x1/4 inch for the slider rod; then cut a piece of

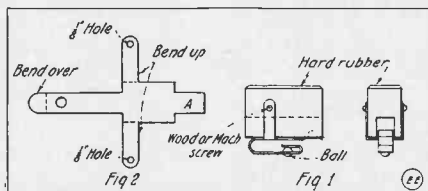

brass shaped like Fig. 2, with a small brass ball placed in the hole.

Contributed by W. McALEXANDER.

prime consideration is also the reasonable cost of the apparatus. A projector as shown in Fig. 3, costing only \$1.85 from the E. I. Co.

THIRD PRIZE \$1.00.

HOW TO MAKE A SIMPLE ANNUNCIATOR.

The diagram gives an idea of the annunciator better than I can describe it.

A is the armature, which is about 1/2" diameter by 1/8" thick, made of iron. It is supported on the phosphor bronze (or other springy metal) strip B which is fastened to a strip of wood at the bottom of the case and which runs the length of same to support the other strips if there are any. The top end of this strip is bent, as shown, so as to hold the drop up when no current is passing thru the magnet, and to allow the drop to slip by easily when being reset by the drop lever D.

A board C runs the length of the case and has holes bored in it, the proper size to allow the electro-magnets to fit snugly in them and thus support them.

Thru each spring B is drilled a hole large enough to admit a screw easily without the threads touching the spring, but small enough so that the head will not slip thru. It is screwed into the board C and forms a stop for B. The drop may be made of ordinary tin with paper glued on the front for the number or letter to be printed on. Two lugs are left on the top end of the drop and bent around as shown. These may be riveted. The rod runs the length of the case. The drop is reset by hand if there is no glass in the window, or the reset extension is left at D.

The magnets may be old bell or telegraph instrument magnets, or 01107 "Electro" magnets.

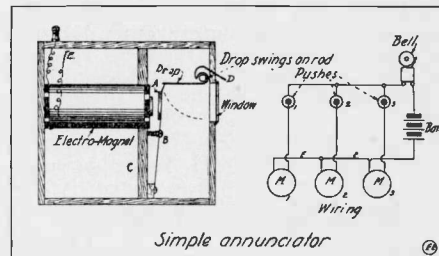

Simple annunciator

One wire from each magnet is connected to a single binding post as shown, and the other magnet coil terminals are connected to a common wire.

A NON-INDUCTIVE

POTENTIOMETER.

The potentiometer here described is one which will and does give excellent results, and may be made by anyone in a short time, at the cost of a few cents.

The dimensions are of small account but the ones shown will be found convenient. The base is made from any hardwood 13 1/2 inches long, 1 1/2 inches wide, by 1/2 inch thick. Central on one side, a groove 3/8 inch wide, 1/8 inch deep, 10 inches long, is cut. Holes are drilled the length of the groove 1/8 of an inch apart and large enough to admit 8/32 inch brass screws rather tightly. Then file the heads flat on enough screws to fill the thirty-three holes and screw them in place. These screws should be all the same height, and the shanks should be less than 1/2 inch long.

Then get a No. 2222 Hard Rubber slider, 12 inches of 1/4 inch square brass rod for slider and two No. 5025 Hard Rubber Pillars from the E. I. Co. Cut the pillars, short enough so that the

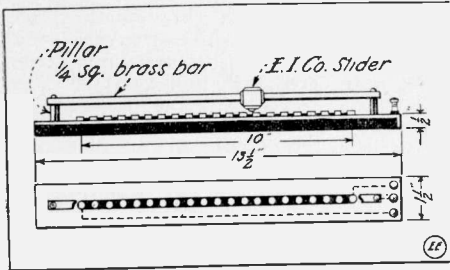

slider will press well on the screws, and mount the rod and slider. The groove is then filled with a paste made of lamp black and shellac. This will dry in a day or so and the resistance will be between 300 and 500 ohms (according to the paste). Three binding posts are mounted at one end of the base and connected as in sketch. Contributed by THOMAS F. CARROLL.

MAKING AN ELECTRIC HORN.

The following is a sketch of an electric horn which I have constructed and find very effective. Referring to the sketch, No. 1 is the baseboard which may be of any size to suit the maker. An electro-magnet, such as are procurable from E. I. Co., may be used. No. 8 is a sound reproducer from an old phonograph with a thin sheet metal disc put in place of the regular diaphragm to give a sharper sound. The drawing makes everything very plain, in

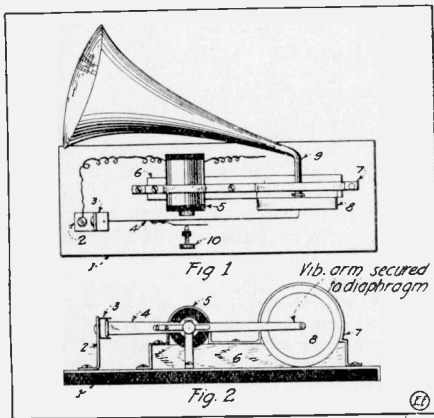

fact the construction is the same as that of an electric bell. No. 7 is a sheet metal strip screwed over the magnet and sound box neck to hold same in place. If a large horn such as the regular phonograph horn is placed on the sound box it will produce a nerve shattering rattle. Contributed by SELMER WICK.

ABOUT SWITCH POINTS.

The beginner constructing radio and electrical apparatus does not care to use expensive switch points. In the following way a good inexpensive switch point may be obtained.

No doubt you have seen the small copper rivets that tin and copper smiths use. These can be purchased with various sized heads and shanks. If the shank is threaded and a nut attached you will have a good switch point.

If the constructor has no die to thread the shank the connecting wire can be soldered to the shank, providing the shank is forced through a tight hole, in this position it will stay in place.

The appearance can be improved by nickel plating or polishing the head. The rivets can be purchased in any hardware store at a reasonable price.

Contributed by HAROLD A. SANDERS.

SIMPLE CONNECTOR FOR TWO 'PHONES.

As you will see in the diagram that A A are single Fahenstock connectors while B is a similar double connector, which is screwed fast with a wood or machine screw between A A, which are connected to the other instruments as usual. When using one phone connect No. 1 to A B and No. 2 to B A.

More can be used as desired. The dotted lines show the single 'phone connection and the dot and dash line, the connections for two sets of 'phones.

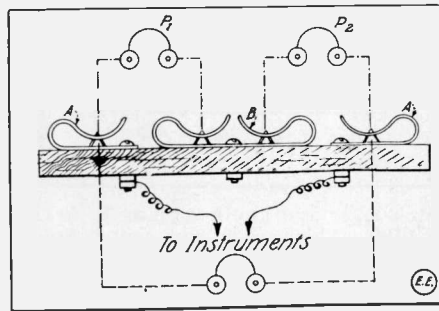

Contributed by C. M. CHORPENNING.

HOW TO MAKE A SIMPLE BURGLAR ALARM.

All that is necessary in making this alarm is a 5 cent "Joker" mouse trap, a bell, battery and some wire. To set it up; cut a groove at the bottom of the window (on either side) "A." Then tack the spring part of the trap in the groove, so that the window can slide easily over the spring, "B." Then tack the piece of flat copper which is on the trap, in the back of the groove so that when the window is raised above the groove the spring will come in contact with it. Drill a small hole through the window frame to the groove, and attach one piece of wire to the hole in the piece of copper and one to the tack that holds

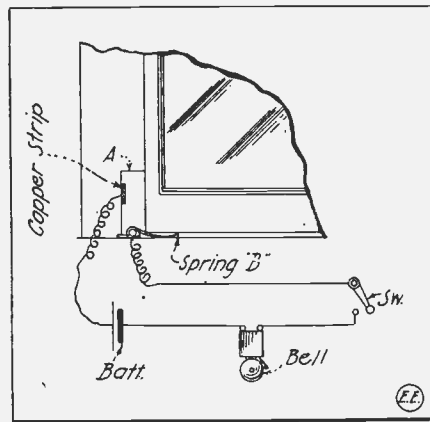

the spring, then connect as per drawing. To set the alarm, bend down the spring and let the window rest on it; when the window is raised the spring will jump back into the groove and will ring until turned off by the switch, even if the window is let down over it; as the spring must be pushed down with the hand to

set the alarm. I have used this successfully in my home.

Contributed by LOUIS FRIEDMAN.

A NOVEL SILICON DETECTOR.

I am giving you herewith a description of a silicon detector which I built. First a glass tube 2 inches long by 1/2 inch

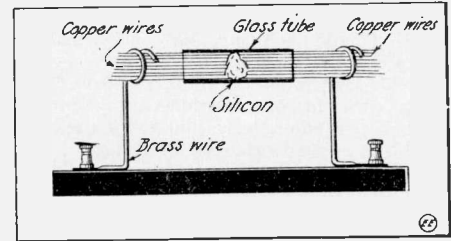

in diameter was procured. Then a piece of silicon was ground so that it would fit in the tube snugly. Then some bare copper wire No. 20 was cut into strips 1 1/2 inches long. There should be enough to fit into the tube at both ends. These should be perfectly straight. I then procured two binding posts from the E. I. Co. and then I found some brass wire that was very springy. I assembled them in the manner shown.

The silicon was placed in the tube and the copper wire pushed in against the silicon.

Then the springy brass wire was cut and bent so as to clamp the copper wires.

If results do not come immediately when it is connected with a receiving set, see that all the wires are pressing against the silicon. If no results are then obtained, twist the copper wires until the signals are heard. The one that I built brought the messages in much louder than the regular detector.

Contributed by FRANKLYN STRATFORD.

HOME-MADE AERIAL INSULATORS.

Very good insulators for wireless aerials may be easily made by the amateur electrician from porcelain tubes filled

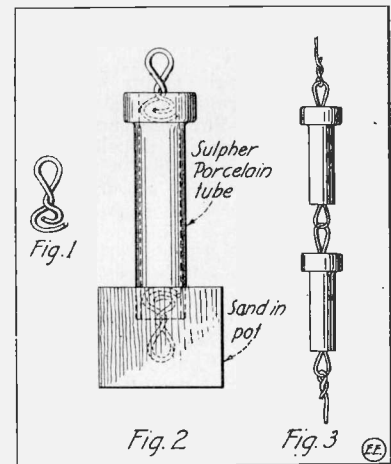

with sulphur. The tube is placed in a box full of sand as the sketch shows and stiff iron wire loops are first placed in the top and bottom of the tube. Molten sulphur is then poured into the top of the tube and the upper wire eye or loop may be quickly placed in the sulphur while hot. At fig. 1 is seen the wire eye; at fig. 2 the method of pouring the tube full of hot sulphur, and fig. 3 shows how to increase the insulation value by connecting several such insulators in series or tandem.

Wrinkles—Receipts—Formulas—Hints

By S. Gernsback.

Under this heading we will publish every month useful information in Mechanics, Electricity and Chemistry. This department will be edited monthly by Mr. S. Gernsback. We shall be pleased, of course, to have our readers send us any recipes, formulas, wrinkles, new ideas, etc., useful to the experimenter, which will be duly paid for, upon publication, if acceptable.

FORMULA NO. 6. Poison Antidotes.

(a) ACIDS.

POISONS AND THEIR ANTIDOTES.

Oxalic—Chalk, whiting, or magnesia in water.

Nitric, Hydrochloric, Sulphuric—Bicarbonate of soda, or carbonate of magnesia, chalk; in emergency, plaster of the wall of the room beaten up in water.

Carbolic, Muriatic, Nitro-Muriatic—White of egg well beaten up with water. A teaspoonful of mustard flour in a cup of hot water; very thick lime water.

Acetic—Soap and water, lime, magnesia, milk, oil; thick gruel.

Carbonic—Fresh air, artificial respiration, friction.

Tartaric—Lime water, castor oil.

Chromic—White of egg in water, mustard flour.

Prussic—Continuous and heavy douches of ice cold water over head and back. Mustard plasters on stomach and soles of feet. *Prevent sleep.*

(b) METALLIC SALTS.

Acetate of Lead—Sulphate of soda or magnesia.

Bichromate of Potash—Magnesia and chalk. Emetics.

Nitrate of Silver—Common salt in water, followed immediately by emetic.

Preparations or Compounds of Chromium, Antimony, Copper, Mercury, Zinc—White of egg in water. Teaspoonful of mustard flour in cup hot water.

(c) CAUSTIC ALKALINES.

Ammonia—Vinegar in water. Lemon juice.

Potash, Soda—Oil. Demulcent drinks. Large doses of milk.

(d) VEGETABLE POISONS.

Ivy—Saline laxative. Apply weak lead water and laudanum or lime water and sweet oil, or bathe freely with spirits of nitre.

Alcohol—Strong coffee, douche, stomach pump.

Belladonna—Stomach pump; emetics; coffee; artificial respiration.

Digitalis—Stomach pump; emetics; tannic acid; stimulants.

Mushrooms—Stomach pump or emetics; castor oil; warmth; stimulants.

Opium, Morphine—Stomach pump or emetics; inhale ammonia; douche; artificial respiration.

Nicotine—Stomach pump or emetics; stimulants; tannic acid; hot applications to skin; keep patient lying down.

(e) MISCELLANEOUS.

Ether, Petroleum, Benzine, Fruit Essence—Plenty of mustard flour in large quantity of hot water. Cold water douches. Fresh air. *Prevent absolutely sleep.*

Arsenic and all Compounds—Stomach pump, teaspoonful mustard flour in hot water. Teaspoonful dialyzed iron mixed with same quantity of calcined magnesia every five minutes for one hour, then plenty of oil or milk.

Chloroform—Stomach pump or emetic. Solution of carbonate of soda. Mustard to the heart.

Coal Gas—Mustard to the heart. Artificial respiration. Stimulants.

Iodine—Stomach pump or emetic. Starch.

Phosphorus (Matches)—Emetic. French oil of turpentine. Copper sulphate. Purgative.

Snake Bite—Cauterization and ligature. Stimulants; permanganate; liquor potassæ; artificial respiration; ammonia injection. S. G.

IMPROVED DETECTOR SWITCH.

This switch, I think, is a first class instrument. To make it, first get a hard rubber base, 4x6 inches, and ¼ inch thick and mount on it, 3 inches from the end and 1¼ inches from the side, a

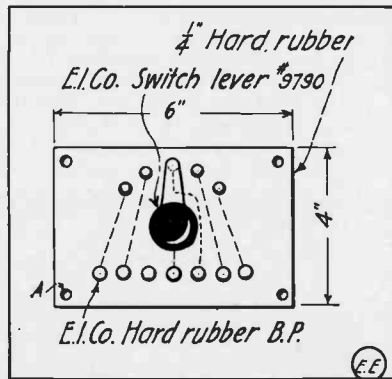

switch lever and knob, such as E. I. Co., No. 9790. Then mount five switch points around lever, as shown in diagram; next seven hard rubber binding posts, as shown in diagram. By studying the diagram you will understand clearly how this switch is made and wired up, and the large leakage due to using wood bases is done away with.

Contributed by EDGAR S. PURDOM.

DETERMINATION OF ELECTROSTATIC CAPACITY.

By Paul F. Shney.

"I wish I knew the capacity of this condenser," is frequently the wish of the radio amateur. Yet, altho he probably has all the apparatus necessary, he may not know he has the equipment or how to proceed.

With ordinary wireless equipment, he is able to use either one or both of the following methods:

For the first method, he will need a source of alternating or pulsating current, preferably of radio frequency, one or two receivers, radio or telephone; a graduated variable condenser of known

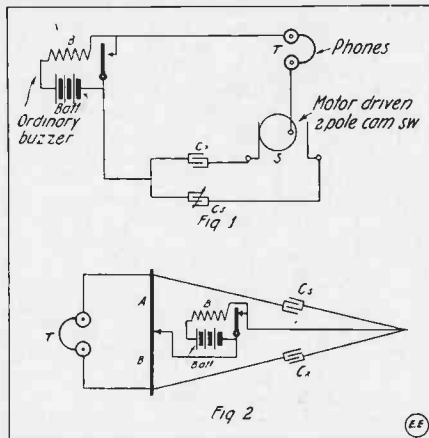

capacity; some wire and a three-point switch, motor or hand operated.

If these are connected according to Fig. 1, so that the variable (alternating or pulsating) current flowing thru the receivers passes alternately at short intervals thru one condenser, and then thru the other, and the variable condenser

is so adjusted that the currents thru the two condensers are equal or give a tone of exactly the same intensity and quality in the receivers T; then the two condensers are equal, and the capacity of the unknown is read from the scale of the variable condenser.

If when the current intensities are equal, the qualities are not equal, a difference in the leakage or absorption of the condensers is indicated, which means that the true capacity is not determined but rather the apparent capacity for that frequency. For this reason a radio frequency is to be preferred in making the test.

For the second method, the amateur will not require the 2 point cam switch, and he may use a "fixed" standard condenser in place of the variable standard condenser. In addition, he will need two high resistances. At least one of these must be variable if the standard condenser is fixed. A convenient arrangement is to use a potentiometer, such as the E. I. Co. sell, for the two resistances. For if the resistance rod is not of uniform quality from end to end, the accuracy of the results are decreased.

If these are connected as in Fig. 2, and one or both resistances or the standard condenser are varied till the tone in the receivers is zero or the least that can be obtained, the capacity of the unknown condenser is expressed as follows:

$$C_x = \frac{A}{B} \times C_s$$

Where:

C_x = unknown capacity,

and

C_s = standard capacity,

A = Resistance or length of rod between the separation of the two resistances and the standard condensers,

B = Resistance or length of rod between the separation of the two resistances and the unknown condenser.

For greatest accuracy, A and B should be nearly equal, *i. e.*, the standard capacity should be chosen so that it is nearly equal to the unknown. Also the smaller the capacities are, the greater the value of the resistances should be.

Neither method can be used with accuracy for measuring the capacity of an aerial, for in the case of the aerial, the admittance, which term includes both capacity and inductances, is determined instead of the capacity alone.

For the very small values of capacity used in radio work, the first method will usually be found the more satisfactory.

LARGEST WIRELESS STATION.

The world's greatest wireless station has been built in Italy, powerful enough to communicate with North and South America when similar stations are erected on this side of the Atlantic.

Magdalen Islanders will get from the Canadian Government a weekly wireless despatch of 800 words of war and other news, which the clergy will read to their congregations every Sunday morning from December to May.

Wireless telegraphy is being used in Canada in reporting on forest fires.

New Wireless Truck of U. S. Signal Corps of 800 Mile Range

By Frank C. Perkins

THE accompanying illustration shows a new wireless truck of U. S. Signal Corps of 800 mile range, developed at Cleveland, Ohio.

There is a great advantage in Army Field Work from the use of this High Tension Outfit operated by the gasoline power of this motor truck and it is considered a remarkable advance in the construction of portable wireless sets for army field service.

ing when there is less electrical disturbance due to electrical plants of various kinds.

It may be stated that the antennae is of the umbrella type, mounted at the top of an 85-foot mast which is built in nine sections. The first, or top section is raised by hand but the other sections are lifted by a block and tackle suspended from struts mounted on a platform on the roof of the truck. These

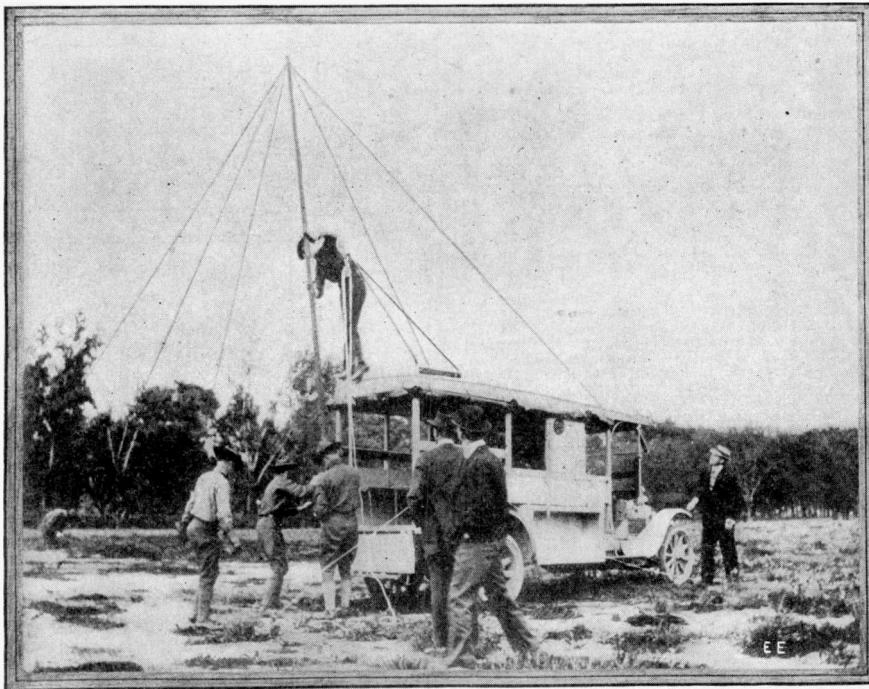

Erecting section of 85 foot mast, which can be completed in a few minutes.

It is pointed out that for the next field operations of the army, or for immediate use in Mexico, if necessary, this wireless truck is available and can be set up for use in twelve minutes and send messages within a radius of 800 miles under favorable conditions. In tests that have already been made this set has received messages from points 2,500 miles distant. The electrical pressure reaches 90,000 volts at the top of the antennae. The great range of the new equipment and the speed with which it may be brought into action is due to the employment of a powerful electric generator driven through a train of gears by the 30-horsepower motor of the White truck.

It is of interest to note that the generator delivers electric current of 500 cycles at 110 volts and from 18 to 32 amperes. This current is interrupted by the relay, operated by the sending key, and is transformed so that it leaves the side of the wireless truck at a pressure of 22,000 volts and an amperage varying from 8 to 12. As the current rises to the top of the antennae the voltage rises to approximately 90,000 while the amperage approaches zero. The radiation under these conditions gives a sending ability from 200 miles under the worst conditions in day time up to 800 miles under good conditions obtained in the early hours of the morn-

struts are quickly detachable when not in use. The guy wires are attached to the fifth section of the mast. When disassembled, the nine sections of the mast are carried in long compartments built along both sides of the truck. The counterpoise, or artificial ground, consists of heavy insulated wires radiating from a common center, to which is attached the ground wire of the wireless set. For convenience in grounding there is a socket on the outside of the truck body into which a ground-wire plug fits.

It is claimed that the truck has been subjected to many interesting tests and the wireless officers are pleased with its work. It was sent to the practice camp of the heavy field artillery at Tobyhanna, Pa., last month where artillery guns, set up on one side of a mountain, fired over the mountain at targets on the opposite side. During this test the wireless truck was used to send messages from Tobyhanna to Washington. Prior to the artillery practice it was tested in Washington and messages were received from Boston, Brooklyn, Key West, Porto Rico and ships at sea. At the same time the operators took up one end of a conversation between the operator of the big station at Arlington and the Honolulu station in the Pacific Ocean.

OXYOLINE.

Oxyoline is a special form of curative agent consisting of an oxygenized vapor produced by passing ozonized air into a mixture of Oils from the Eucalyptus and Pinus groups. At room temperature of 70 degrees Fahr. or less, it is visible to the eye as blue or white in color; has a pleasant, fragrant odor; when diluted with atmospheric air and inhaled, is non-irritating; in an undiluted form it is mildly irritating, but may be inhaled without discomfort. The illustration shows a patient about to inhale some Oxyoline thru a special inhaling attachment.

The sponsors for the Oxyoline treatment claim that the action is that of oxygen, nascent oxygen and the Cineols, an alterative increasing metabolism, antiseptic inhibiting germ growth, haematinic increasing the oxygen content of the blood, the red blood cell count, and indirectly increasing phagocytosis.

The Oxyoline generator is similar in general to the well-known Ozonators on the market, which employ some form of high voltage step-up transformer, and in this way to liberate ozone, etc.

Oxyoline is said to be a powerful nerve tonic and sedative by its alterative properties, improving sleep and vaso-motor control, and decreasing nerve irritability, resembling the bromides in action, except that it does not depress the vaso-motor action or check secretions. Its alterative action greatly resembles that of mercury, arsenic, iron, manganese and gold, except that it acts entirely without systemic resistance, and being readily absorbed, its action is more rapid, certain, positive and dependable. Elimination is increased thru the skin, bronchial and nasal mucosae, and renal apparatus. Its action as an antiseptic resembles the results secured from a 10 per cent. solution of carbolic acid or 1-2000 hichloride of mercury solution without the corrosive or irritant properties. It has been found useful in most of the affections associating themselves with the pulmonic, bronchial and nasal mucosae, and has been used with remark-



Patient about to take Oxyoline treatment.

able effects in the treatment of tuberculosis. The treatment is pleasant to take and can be administered by the physician or the patient himself.

LATEST PATENTS

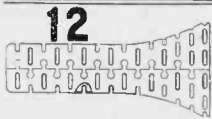
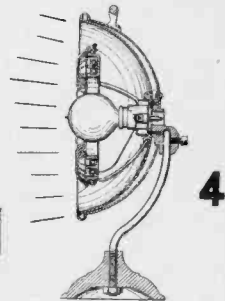
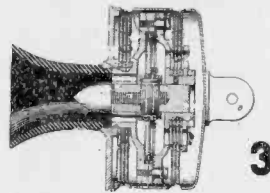
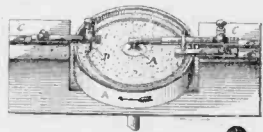
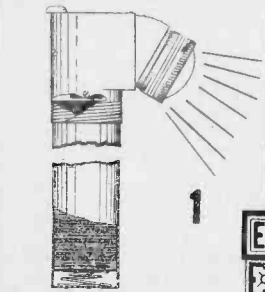

ELECTRIC FLASHLIGHT (Fig. 1)—Another flashlight adapted for use with standard dry cells. Uses a 1½ volt, 1½ c.p. Tungsten lamp.

COHERER (Fig. 2)—An improved coherer for radio or other work, arranged with a fixed electrode of circular shape placed in a rotating cup filled with loose metallic filings.

LOUD-SPEAKING TRANSMITTER (Fig. 3)—Improvement in transmitter design for heavy current, having a granule cup supported on a vibrating diaphragm, as well as two electrodes at both ends of the cup, also mounted on vibrating diaphragms.

ELECTRIC HEATER (Fig. 4)—A new heater having a heating unit of wire wound in a circular spiral, mounted in front of parabolic reflector, to throw the heat outward, said reflector of two walls with vacuum between them, etc.

WIRELESS DETECTOR (Fig. 5)—A mineral detector stand, perfected by G. W. Pickard, arranged with two adjusting screws N and L, to move the crystal cup R, to any desired position under the usual pointed electrode. The cup is pushed toward the screws by a spring arm E, swinging on a point.

TELEPHONE RECEIVER HOLDER (Fig. 6)—An arm with holder for telephone receiver when off the hook, this arm then keeping the hook depressed.

ELECTRIC SOD-IRON RESISTANCE (Fig. 7)—The resistance wire is laced in and out of grooves or slots cut in a non-combustible grid of mica, etc., and so distributed to give the maximum even heating effect.

MAGNETIC LAMP SUPPORT (Fig. 8)—A flash-lamp provided with an electro-magnet in the base, operative from the lamp battery, and designed to support the lamp on any iron body.

REFILLABLE FUSE (Fig. 9)—Fuse cartridge of refillable design, having two end caps threaded on a central tube portion, with suitable gas vents, et cetera.

ANNUNCIATOR (Fig. 10)—An electric indicator having the usual bell and numbered drop 2, with electro-magnet 8, which attracts 2 supported on a retractile spring 3.

WIRELESS ARC GENERATOR (Fig. 11)—Invented by Dubilier, and pertaining to the movement of the upper electrode by a spring and threaded thumb screw arrangement. A gas jacket is provided around the arc.

RECEIVER SHELL REINFORCEMENT (Fig. 12)—A metallic, slotted structure to be placed in moulded receiver shells to strengthen them. A very good idea.

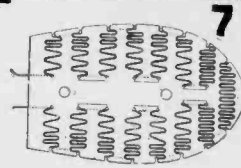
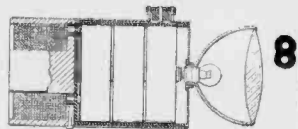
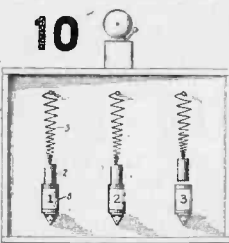
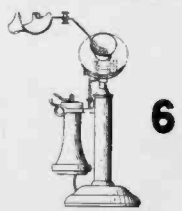
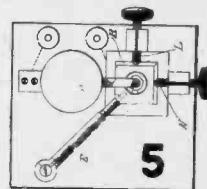

GOES PERPETUAL MOTION ONE BETTER.

The following clipping from the Kansas City Post of Sept. 5 should interest power-plant men:

An engine that runs itself on its own power, developing energy to operate machinery, has been invented in this city. The inventor has been working for five years on his self-operating engine, and now has it near perfection. A few alterations are to be made. These will increase its efficiency.

The engine is run by compressed air, making its own pressure as it runs. The exhaust from the cylinders returns through a series of eight-port automatic valves, to a large steel pressure tank. This tank is a double affair, there being a smaller tank within the larger one.

An air space of 6 inches intervenes between the two tanks. Into the air space the exhaust from the cylinders is forced, the action being such that the nitrogen gases are separated from the oxygen and, forming a lighter gas, rises to the top of the tank, at the same time creating a pressure which forces the fresh air down through the inner tank and back into the engine, which is operated by this pressure.

The only serious feature of the foregoing is the fact that men do actually

attempt to get something for nothing, mechanically, says "Power."

[The electrical analogy of this perpetual motion scheme is the familiar one making use of an electric generator and a motor belted or otherwise connected together mechanically. Also the electrical circuits of the two machines are arranged with switches so that the motor may be started up from the Electric Companies' lines, and when the motor is driving the generator at normal speed, the motor circuit is quickly switched from the outside line to that connected to the generator which it is driving. The "motor-generator set" is then supposed to go on operating indefinitely; the dynamo supplying the electric current for running the motor, et cetera. To the initiated, this, of course, is like all the rest of the perpetual motion hoaxes, "a joke eventually." It always seems thoroly feasible to the young electrician, however. Its impracticability is evident, as the electrical efficiency of both machines would have to be 100% in any event; not to mention the friction losses in bearings, etc.—Editor.]

What is said to be the largest order for electric flatirons was recently received by the General Electric Company, calling for 10,500 irons and filling four large freight cars.

HAVE YOU AN IDEA?

Are you using a new device or an improved modification of such, in your wireless or electrical laboratory? If so, why not write it up and send to us with a photo or sketch? Drawings invariably have to be made over by our draughtsman, and just so you express your ideas concretely and as briefly as possible, we are always glad to publish them, when the article possesses merit. Look over this issue carefully, re-read the articles twice, and you will soon pick up the knack of writing articles, and moreover, we pay you well for your efforts. Why not get busy to-day and get in the swim? Be a live, wide-awake Electrical Experimenter! Boost your paper and boost yourself. It's very easy!

The "early bird catches the worm" is an aged yet truthful jingo, so "throw in your switch and increase your radiation;" in other words, help us and help your pocket-book.

Make all sketches on separate sheets of paper, and write only on one side of your text sheets. Send all contributions to "Editor," The Electrical Experimenter, 233 Fulton St., New York City.

Electric heaters are used to increase the flow of oil wells in the Whittier, Cal., district.



AMONG THE AMATEURS

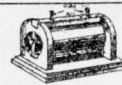

AMATEUR RADIO STATION CONTEST.

Monthly Prize, \$3.00.

This month's prize winner.

DESCRIPTION OF THE WIRELESS STATION OWNED BY DON I. SHEPHERD, ST. JOHN, KAN.

The sending set consists of Blitzen 1 K. W. Special Transformer, High-tone Rotary Gap, Murdock Make, with an Oscillation Transformer and Suitable Condenser.

The receiving set includes the following: Long Wave Loose Coupler, having a Blitzen Variable Condenser shunted across the Primary, with a condenser also in series to vary the short wave of incoming station.

In the secondary I have E. I. Co. sliding Plate Condenser in shunt; the two lat-

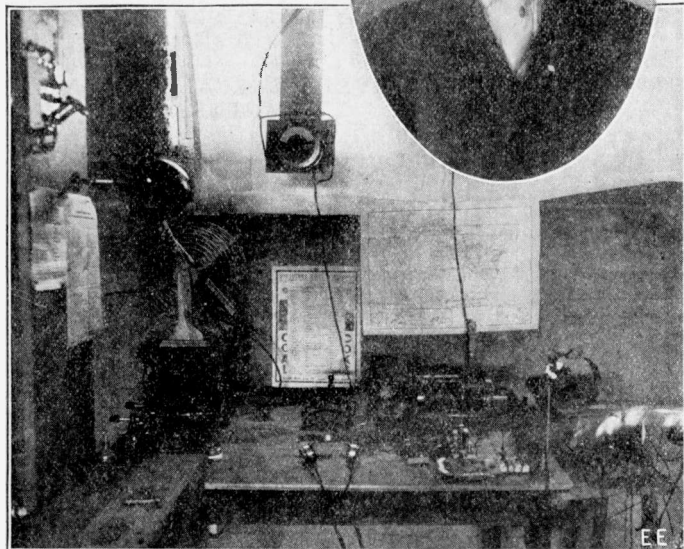
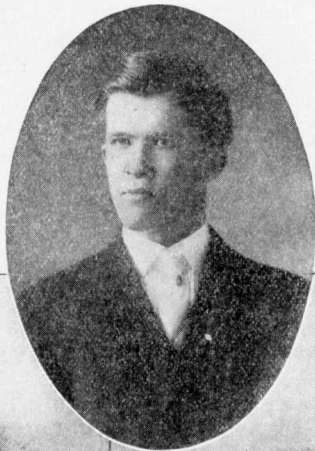

Mr. Shepherd and his excellent radio station.

I have my station in a basement room at my home and it affords me great pleasure to spend the evening there with the receivers on my head listening to various stations working.

Some of the stunts: Myself and a friend got the lead-in wire connected to the table at 15 minutes to nine one night last May, and we heard Arlington send the time plain.

About this time you will remember the U. S. War Ships were ordered to Vera Cruz, and during those interesting evenings we sat in the little radio room and heard order after order sent to the war - ships; heard time and again Key West and Colon working. On one of the evenings, we heard messages being sent to the English Battle-ship "Hawk," which was sunk a short time ago by a German Submarine. We also heard the station at Colon send the report to the Stations in the U. S. about the Marines taking the Custom House at Vera Cruz. On this same evening we heard the S. S. Louisiana working in Mexican waters with Colon.

Time at this station is received from Arlington and Key West many times with the phones laying on the table as they show in the photo; in fact, I have the set just as I left it on the reception of time.

I have a Radio License from the Government (Second Grade, Amateur), and my call letters are "9BG."

DON I. SHEPHERD,
St. John, Kansas.

NORWOOD, N. Y., YOUNG MAN HAS WIRELESS SET.

The first wireless apparatus installed in this section has been put up by Herbert Phillips. Mr. Phillips is a son of Mr. and Mrs. A. J. Phillips, and is 18 years of age.

The young man has strung a 300-foot aerial near his home in Main street, which is over 100 feet above ground. The sending outfit consists of a one-half kilowatt transformer, which takes a 110-volt current and steps the voltage up to 10,000 volts. The apparatus is capable of sending fifty miles.

The receiving outfit installed is the latest loose coupled device and will receive messages from 1,000 miles. The outfit has been successfully tried out. The wireless was installed by Phillips alone, and a special amateur's license will be taken out to comply with the law.

W. MURTZ'S RADIO STATIONS.

The following are photographs and description of my two wireless stations.

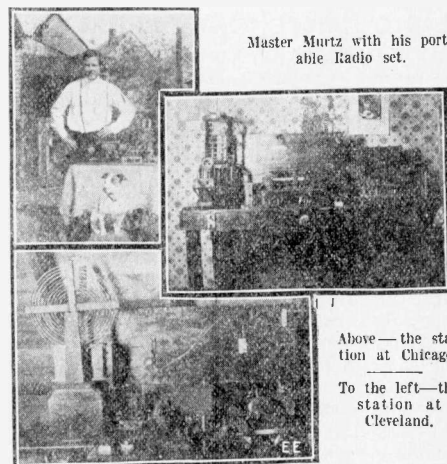

Master Murtz with his portable Radio set.

Above—the station at Chicago.

To the left—the station at Cleveland.

The first is located in Chicago and a friend of mine is in charge of same. The sending set consists of 2" Spark Coil, Wireless Key, 6 Plate Condensers, Marconi Type Aerial Switch, Anchor Gap, Rotary Gap and Helix.

For receiving, I have the following: One Loose Coupler, mounted on box, two loading coils (which are located in box), Silicon Detector, Galena Detector, 17 Plate Variable Condenser, one Fixed Condenser, one D. P. D. T. Switch, one S. P. S. T. Switch and 2,000 ohm 'phones.

My next photograph is my wireless station in Cleveland, which I operate myself. The sending set consists of 1/2 K. W. Transformer, a 20 Plate Condenser, a Quenched Gap, an Oscillation Transformer, Anchor Gap, 2 D. P. D. T. Switches, and 3 S. P. S. T. Switches. I use 110 Volt A. C. Current and can send about 35 miles.

The receiving set consists of Loose Coupler (with 14 variations on secondary), 2 Loading Coils, Variometer, 17 Plate Condenser, variable type; 3 Detectors, Galena, Ferron and Silicon; 3,000 ohm 'phones. The small receiving set consists of a 3 slide tuner, tubular variable Condenser, a 3 Mineral Detector, 1 Fixed Condenser and same 'phones.

The aerial of the first station is 106 feet long, made of copper wire. The aerial of the Cleveland station is 132 feet long, with 10 feet spreaders and 80 feet high at one end, 36 feet at the other end. The photo of myself shows my portable receiving set.

Yours truly,

W. MURTZ.

RADIO CLUBS! ATTENTION!

We are always pleased to hear from young Edisons and Radio Clubs. Send us write-up on your Club with photos of members and apparatus to-day to: Editor "Amateur Gossip" Section, The Electrical Experimenter, 233 Fulton St., New York City.



QUESTION BOX



This department is for the sole benefit of the electrical experimenter. Questions will be answered here for the benefit of all, but only matter of sufficient interest will be published. Rules under which questions will be answered:

1. Only three questions can be submitted to be answered.
2. Only one side of sheet to be written on; matter must be typewritten or else written in ink, no penciled matter considered.
3. Sketches, diagrams, etc., must be on separate sheets. Questions addressed to this Department cannot be answered by mail.

RADIO ANTENNAE PROBLEMS.

(200.) W. G. L., Cape Girardeau, Mo., writes the Question Department, asking several queries, and we advise him as follows:

A. 1. At \$17.50, the E. I. Co. supply their highest grade X-Ray tube, adapted to 6" spark coils, and this tube is fitted with automatic regulator to keep the vacuum approximately constant.

Their \$35.00 large size Tesla coil is very well adapted for 6" spark coil excitation, and one of their No. 531 A, especially insulated glass plate condensers at \$10.00, can be used as the condenser for this outfit.

In reference to your radio antennae, and the best lay-out of same, we would suggest that you erect the longest span possible, which, of course, from your sketch would appear to be the 500 foot one, and if you use about 2 to 3 strands for this stretch, you should get very excellent results indeed for radio receiving work; and when you eventually install a transmitting set, it would be of course best to use a small aerial, not exceeding 100 to 150 feet preferably, if the station is to operate in accordance with the 200 meter wave length required by the law now in effect, and also if the highest efficiency is to be realized for this particular plant using such a short wave length.

Of course, you might employ a much longer aerial with a high fundamental wave length for the transmitting set, at 200 meters emitted wave length, by utilizing a certain capacity in series with the ground wire, but this naturally is inefficient, as you of course know. No. 14 solid "antennium" wire will, we are sure, stand the strain of a 500 foot span all right, but you will get best results in this case, both electrically and mechanically, by using seven strand "antennium" phosphor bronze cable.

TUNING COILS WITH METAL CORES.

(201.) Whittaker & Wilson, Jackson Summit, Pa., asks us about their radio receiving station:

A. 1. With regard to your radio station operation would say that we are quite surprised to note that you are using a metal core in your tuning coil, as all of these coils are invariably built with a cardboard tube or a wooden core, and a metal tube should never be used as it greatly lowers the efficiency and also has other untoward effects on the apparatus in question. We believe you will be able to tune much better with a loading coil and for tuning in very short wave lengths, such as used by amateur stations, you should connect a variable condenser in series with the ground wire, which will bring in these stations very nicely.

½ K. W. TRANSFORMER COILS.

(202.) H. Morrish, Gravenhurst, Ontario, Canada, says:

Q. 1. I have tried out the use of two distinct aeriels, one above the other, so as to get better results. Why will this not work out well?

A. 1. Replying to this query will say

that undoubtedly the effect you mention in regard to your two aeriels is due to the fact that there was a considerable reaction between them, owing to their differing lengths, etc.

Q. 2. Why is it that the "Electro" ½ K. W. Transformer coils can transmit 100 miles, when a closed core ½ K. W. transformer can only send about 50 miles?

A. 2. The secret of long distance transmission with the ½ K. W. Transformer Coil No. 8050 lies in the fact that it is always used invariably with a No. 8000 Gernsback interrupter on 110 volt circuit, and this interrupter gives a very high frequency current in the primary circuit; and in this way the transformer coil produces of course a very heavy, high frequency flaming discharge at the secondary; while the discharge from the regular closed core transformer is entirely at low frequency, viz., depending on either a primary frequency of 60 or 120 cycles, etc.

coils, and these are wound with No. 36 enameled magnet wire. They are worth \$6.75 each, and each one produces about a 2" spark with proper primary; or, in other words, they used four of them for an 8" coil. The inside diameter of the circular bore thru them is 2 1/8" about and they are about 3" long by 1 1/2" winding depth.

IN-DOOR AERIALS.

(206.) Raymond G. Schlegel, Pittsburgh, Pa., writes us regarding in-door aeriels:

A. 1. Of course, it reduces the efficiency of any wireless aerial a great deal when it is of the in-door type, as compared to a similar size out-door type; especially where such an interior aerial is placed under a metal roof. Quite possibly, in your case, you could obtain about two-thirds as good results with the in-door aerial, as you would with the same size aerial placed out-doors.

UNIVERSAL SCALE HYDROMETERS.

(207.) E. Schlig, E. Walnut Hills, Cincinnati, Ohio, wants a price on a hydrometer to measure both lighter and heavier liquids than water?

A. 1. Answering your query would say that the E. I. Co. can furnish a hydrometer with a universal scale for measuring liquids both heavier and lighter than water and registering from 0.700 to 2.000 degrees specific gravity at \$2.25 each.

EXTRA STRONG FLASHLIGHTS.

(208.) Messrs. "S." Bros., Tampa, Fla., wants data for extra strong flashlights:

A. 1. You might of course readily make up a very powerful battery type flash light by using a couple of H. O. "Electro" storage cells, mounted in a wooden cabinet with handle and arranging a 4 1/2 volt Tungsten lamp to burn from same or 2 or even 3 of these lamps might be nested together at the center of a reflector, so as to give a more powerful light, etc. Also if this lighting outfit could be made quite heavy and weigh as much as 40 to 50 pounds, you could then use a 6 volt 40 A. H. storage battery with 3 or 4 6-volt, 6 C. P. Tungsten lamps nested together in a common reflector, etc.

"ELECTRO" BLOCK SECONDARIES.

(209.) Donald Frazier, Adrian, Mich., asks about using E. I. Co. block secondaries No. 8080 for spark coil purposes:

A. 1. We would suggest that the No. 8080 block secondaries are wound with No. 36 magnet wire and they are suitable of course for induction coil work as they are the same as used in the No. 8060 coil, which operates of course, on 6 to 8 volts battery current with vibrator. You may figure on about 3/4 inch to 1 inch spark from each of these block secondaries when proper primary winding is used and for further data on induction coil construction we refer you to the 25c. treatise "Construction of Induction Coils and Transformers."

Want to Swap?

If you have anything to buy, sell or exchange and want to make sure of doing it quickly and at an insignificant cost advertise in the

Scientific Exchange Columns

OF

The Electrical Experimenter

Starts next issue. You will find advertised in these columns:

Photographic supplies, Phonographs, Wireless Apparatus, Electrical goods, Bicycles, Motorcycles, Rifles, Gasoline Engines, Microscopes, Books, Skates, Typewriters, Etc.

The owners of these things wish to "swap" them for something else, something which you may have.

The Rates

One cent per word (name and address to be counted) minimum space 3 lines. Average 7 words agate to the line. Remittance must accompany all orders.

The Classified Columns of the ELECTRICAL EXPERIMENTER GET RESULTS

More than 30,000 Electrical Experimenters will see your ad.

SPARK COIL WINDINGS.

(205.) Henry Winkels, Superior, Wisconsin, wants E. I. Co. prices on special transformer windings:

A. 1. While they cannot make up the special transformer secondary coils you wish, they have a number of large size spark coil secondaries, which were previously used in making their 8" spark

ELECTROLYTE DENSITY.

(210.) J. W. Nordstrom, Galletzin, Pa., wants data on the specific gravity measurement of battery electrolyte:

A. 1. In regard to measuring the specific gravity in your storage cell solution would say that quite possibly you are using a Baume scale hydrometer; and in this case about 25 degrees on the scale corresponds with about 1200 degrees specific gravity.

RADIO PROBLEMS.

(211.) C. S. Fernyak, Mansfield, Ohio, asks several queries and we advise him as follows:

A. 1. The "Electro" regular 1½ pint Leyden Jars, etc., are designed principally for wireless and high frequency duty, where they are to be connected constantly across a spark coil or transformer, etc. If you desire special hard flint glass Leyden Jars suitable for holding static charges for a considerable time, they can supply them in corresponding sizes to those listed in their catalogue No. 14 at 100 per cent. above the catalogue price.

We do not know just what the effect is on your Mazda lamp when a wireless message is coming in, except that when the signals may be extra strong, they may have some electronic effect on the ions in same.

ELECTRIC ARC FURNACE.

(212.) ———, Elreno, Okla., asks about making a small electric arc furnace:

A. 1. An electric arc furnace of small size is easily made by using 110 volts direct current with a suitable ballast resistance in series with 2 ordinary arc carbons and of course in this type of furnace it is the heat developed from the arc between the two carbons that is utilized for melting various metals. The electric furnace of this type is the hottest known and practically all metals, etc., are quickly melted or decomposed in its fierce heat.

ONE-HALF TON LIFTING MAGNETS.

(213.) H. C. Lane, Solon, Ohio., desires price on building a 1,000-lb. electro-magnet:

A. 1. The E. I. Co. build any size electro-magnets to order, when the work to be operated by same is specified by the customer. If you desire a plain electro-magnet of the tractive or lifting type to fully sustain a load of 1,000 pounds or one-half ton, they can supply same, wound to any voltage desired, at \$60.00. The common voltage for the most efficient operation of these magnets is 110 to 220 volts D. C., or also 50 volts can be used all right, and in special cases you can, of course, use a lower voltage than this, if preferred for any reason. Probably about a ¼ K. W. 110 volt D. C. generator will suffice for the 1,000-pound lifting magnet.

FORMING ELECTROLYTIC RECTIFIERS.

(214.) Albert E. Dock, Centralia, Kans., writes regarding starting up an E. I. Co. 4-cell electrolytic rectifier of the aluminum-lead type:

A. 1. In regard to the E. I. Co. electrolytic rectifier, will say that when first starting up this rectifier, it does not form at once, but must be connected in circuit with a load of lamps, etc., for an hour or so, so that the aluminum plates begin to gas freely, and when the lamps connected across same as a load on the D. C. side, begin to grow dim, the rectifier plates have formed sufficiently, and it is then ready to rectify 110 volts A. C. into D. C. at about 80 to 85 volts. Also

Leiman Bros. VACUUM

FOR CLEANING RESIDENCES, INSTITUTIONS, HOTELS, OFFICE BUILDINGS, DEPARTMENT STORES AND OTHER STRUCTURES

PUMPS

—Take Up Their Own Wear

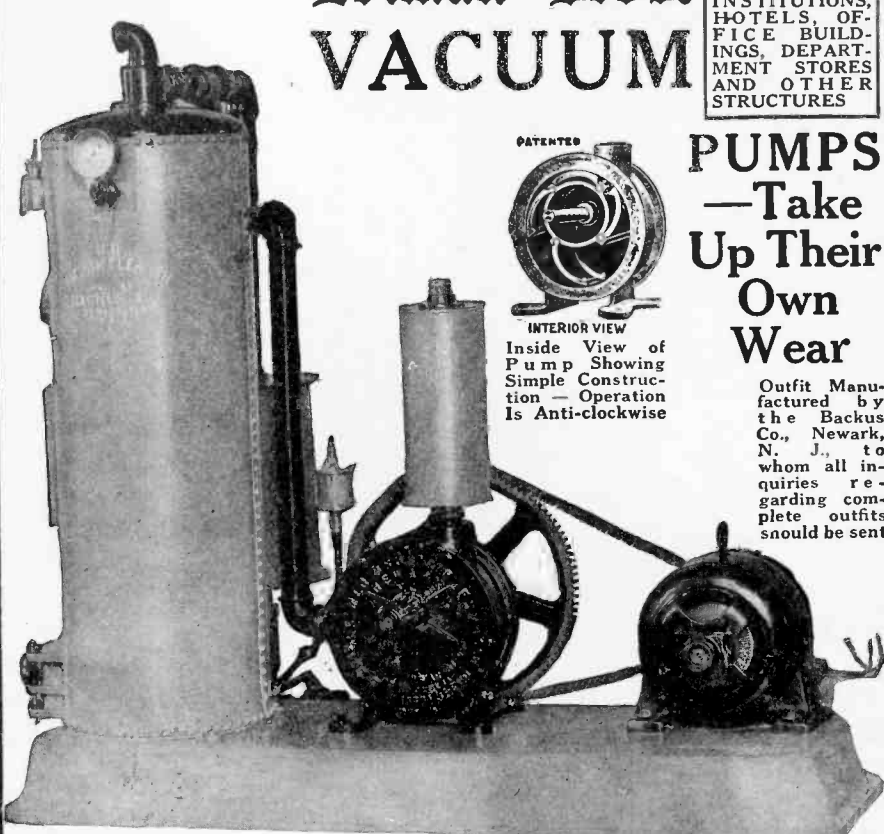

PATENTED

INTERIOR VIEW of Pump Showing Simple Construction — Operation Is Anti-clockwise

Outfit Manufactured by the Backus Co., Newark, N. J., to whom all inquiries regarding complete outfits should be sent

Outfit meant for use in large residences, schools, factories, department stores, churches, theatres, halls and institutions. We only supply the pumps. Anyone mechanically inclined can make up a vacuum cleaner. Pumps made in many sizes. An outfit could be mounted on a wagon, automobile or hand truck for moving about. Can be operated with electric motor, gasoline engine or any other available power.

1 oz. to 10 lbs. PRESSURE

ALSO USED IN CONNECTION WITH AUTOMATIC MACHINES, MILKING, MAILING, PRINTING, ETC. ALSO FOR BLOWING AS IN MELTING, ANNEALING, SOLDERING, BRAZING, TESTING.

1 to 20 inches VACUUM

LEIMAN BROS.

62 East John Street
NEW YORK CITY

THE BEACON FOUNTAIN FLASH LIGHT

The finest example of flashlight Novelty, Convenience and Quality. Clip prevents loss, acts as a contact in use, and prevents short circuit in the pocket. Only one of the BEACON products of quality in Flashlights, Batteries, and Electrical Novelties. For sale by all good dealers.



THE FLASHLIGHT WITH THE CLIP-CONTACT GRIPS THE CLOTH PREVENTS SHORT CIRCUIT

THE "NIFTIEST" FLASH LIGHT EVER CONCEIVED

BEACON MINIATURE ELECTRIC CO.

108-110 DUANE ST., N. Y. CITY
11-17 S. DESPLAINES ST., CHICAGO

Learn Wireless At the ONLY School in New England Specializing in Wireless Telegraphy

Our instructors have seen SERVICE with the U. S. Government, Fessenden and Marconi Wireless Tel. Companies. Therefore we assure you of a PRACTICAL day or evening course. Fall classes commence Sept. 8th. Reserve your seat early. Call, write or phone.

EASTERN RADIO INSTITUTE 899-E Boylston St., BOSTON, MASS.

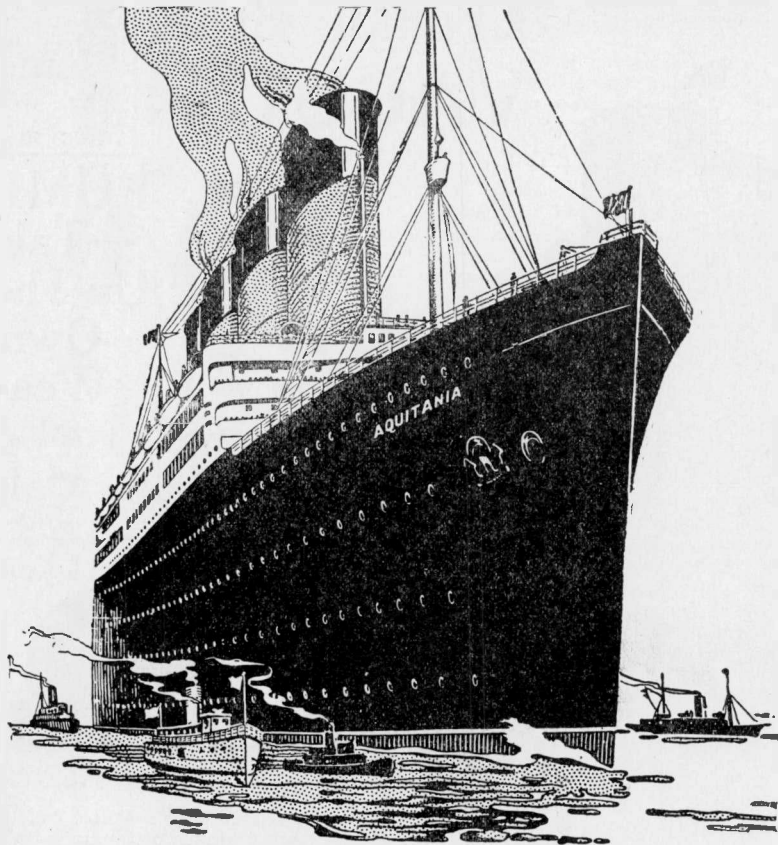

CUNARD LINE Fastest Passenger and Mail Service in the World

New York—Liverpool
 AQUITANIA MAURETANIA LUSITANIA

Boston—Liverpool
 Montreal Quebec London New York Mediterranean

CUNARD S. S. CO., Ltd 21-24 State St. NEW YORK

you might try some new solution in same, and a common one is a saturated solution of sodium phosphate. Ammonium phosphate solution is said to be the best and this is the salts supplied by the E. I. Co.

HOT WIRE AMMETER CONSTRUCTION.

(215.) Lester M. Smith, Salem, Wis., wants E. I. Co.'s price on No. 36 Climax Wire for Hot Wire Ammeter:

A. 1. They do not handle any No. 36 Climax resistance wire, but for hot wire meter construction, you cannot use anything better than some fine copper wire, No. 36 or 38 gauge, and for heavy currents, you can use several of these fine copper wires on parallel in the meter, which is the method recommended by several of the foremost radio authorities, including Dr. J. A. Fleming, and it is also suggested by Mr. C. I. Hoppough in his book entitled "Wireless Telegraphy and Telephony Hand Book," and a cable of these wires may be employed successfully for high capacity meters of this class. The meters are calibrated by connecting on shunt with a standard D. C. ammeter on a direct current circuit. Fine wires, as No. 36 B. & S., have the same resistance for D. C. or A. C. at radio frequency.

OIL INSULATED CONDENSER CAPACITY.

(216.) Geo. C. Henny, Portland, Ore., asks several questions:

A. 1. The four-strand "Antenium" cable will stand a strain of 350 to 400 pounds.

A2. With reference to your condenser query, will say that sensibly the capacity of a certain glass plate condenser will remain the same, whether it is immersed in oil or not, as it is the glass used in same that determines and controls the capacity and not the oil, but which, of course, would help to cut down brushing.

The oil would have some effect undoubtedly on the capacity if the condenser is operated a very high voltage, as ordinary condensers of the high tension type used in air, generally increase their capacity a small percentage, due to the brushing, but this, of course, is indirect.

"ELECTRO" QUENCHED SPARK SETS.

(217.) O. L. H—, c/o American Consular Service, Roatan, Honduras, C. A., wishes advice on E. I. Co. commercial sets for radio-communication over tropical country, at a distance of 125 miles and more:

A. 1. It appears to us as tho undoubtedly the parties interested in a 125-mile wireless transmitting set, etc., would do best to employ an "Electro" 1/2 K. W. quenched spark set. They have supplied a number of these quenched transmitting sets for commercial and semi-commercial radio work, including steamship equipment, etc., and they work very nicely indeed, and they are particularly efficient for tropical locations, as in your case, as they have found from actual tests with same in the Gulf of Mexico.

For your requirements and for such a set we would suggest an aerial 100 to 150 feet long, elevated 75 to 80 feet above the ground, if possible, and comprising four to six strands of 7-strand "Antenium" phosphor bronze cable, the strands being spaced four to five feet apart. They furnish all diagrams, engineering data and blue-prints for the erection and connections, etc., of these

Everybody Needs **The BEERS Lantern**
 GIVES LONG SERVICE AT VERY LOW COST
Burns from 40 to 60 Hours

Made to use a common dry cell battery which can be bought anywhere for 25 cents. Not a toy but a reliable, practical, electric lantern, sure to displace the old unsafe oil lanterns and uncertain flashlights. Durable, handsome, compact, absolutely safe. A sensible, economical article for every day use. Indispensable for housekeepers, automobilists, farmers, sportsmen, yachtsmen, watchman, deliverymen, etc.

Permanent and intermittent contact switch. Tungsten lamp. Imported optical lens. Silver plated reflector.

Dealers write quick for sample and further information

Prices delivered anywhere in the United States
 No. 1005 Pressed Steel, black rubber finish, \$2.00
 No. 1000 Solid Brass, highly polished..... 2.50
 No. 1002 Solid Brass, nickel plated..... 3.00

THE BEERS SALES COMPANY
 1008 E BROAD STREET . . . BRIDGEPORT, CONN.

You Benefit by Mentioning "The Electrical Experimenter" When Writing to Advertisers

sets and their excellent improved type, No. 1603 *Transcontinental* receiving set, will most probably fulfill the requirements in your case nicely.

The ½ K. W. set here mentioned is capable of transmitting a couple of hundred miles when properly tuned up with a fairly large aerial, as here outlined, etc.

POLARITY OF SPARK COIL AND TRANSFORMER DISCHARGE.

(218.) R. C. Dickinson, So. Hadley Falls, Mass., wishes to be advised as to the polarity of spark coil and transformer secondary discharges:

A. 1. With an ordinary spark coil operating with vibrator on batteries, the spark discharge is frequently of one polarity, when the gap is quite long, so that the inverse wave of secondary current induced at the make of the vibrator contact cannot jump the air gap in the secondary circuit; but if this secondary spark gap in air is short enough, so that both positive and negative waves of the secondary can jump the gap; then the spark discharge is alternating in character. Of course, if you intend to use a radio transformer of the closed core type on one phase of your 3-phase system, the secondary discharge from same will be alternating in character.

The best results for medium and large size Tesla coils are obtained with closed core step-up or radio type transformers operating on A. C. circuits.

INDOOR RADIO ANTENNAE.

(219.) Geo. Lane W—, N. Y. City, is much interested in indoor radio aerials for receiving signals with and we make the following suggestions:

A. 1. The E. I. Co. do not under any conditions attempt to guarantee the performance or efficiency of any radio receiving or transmitting sets, when used with an indoor aerial, but have known of instances where patrons have obtained fairly long distance results, but to our mind, this in most cases depends upon the kind of building the station is located in, i. e., the steel frame work, etc., and also the location of the building among other steel frame buildings, et cetera. Metal roofs, where they are permanently grounded, always tend naturally to reduce the efficiency of an indoor aerial and also the pipes running through a building have an untoward effect on such an apparatus, naturally, as they are invariably grounded.

We would refer to the March, 1914, *Electrical Experimenter*, containing an article with reference to a wireless receiving set, using no aerial of the common type, as employed in France, and the best we can say in this direction is that indoor aerials are invariably to be experimented with by the user of same, for each location, etc., as there are a number of important factors which can nullify the effects of the radio waves, the same as mentioned above in part.

With reference to buzzer test effect you mention, will say that this occurs in every case invariably and the reason why test signals sound louder in the 'phones when a metal part of a switch in the circuit is touched, is due to the fact that the body takes on a charge, which indirectly affects the 'phones, or otherwise unbalances the circuit.

There are more amateur wireless operators in Philadelphia, Pa., than in any other city in the country.

NEW DE FOREST RADIO TELEPHONES.

At last there has been commercialized a small compact and simple form of wireless telephone, which, altho not cheap, has at least the merit of reliability to commend it. This improved form of radiophone, here illustrated, is mounted in a cabinet resembling the usual long distance telephone cabinet familiar to all of us. The generator of the high frequency alternating current for transmitting the speech is of the dynamic type, and altho it produces a current whose frequency is above audibility it does not run at extraordinary speeds. Thus, as a motor-driven high frequency generator is utilized in place of the cumbersome arc generator, which usually requires expert and frequent adjustment, the apparatus is made easy of manipulation by the merest tyro.

Briefly considered the apparatus as illustrated comprises the complete receiving set of the audion type, with tuning condensers and inductances adjustable by the knobs at the base of the cabinet front. The slider under the heavy current microphone is for adjusting the transmitting wave length to any aerial employed for the set. The battery for the audion detector is contained within the cabinet, and a small cam switch of the telephone type serves to change the apparatus from "talking" to "listening," so that all the operator has to do is to throw this switch to "talking" and by pressing a "generator" button the motor-driven radio frequency wave generator is automatically started up by a solenoid type controller. The operator can then talk or listen by simply throwing the cam switch referred to above.

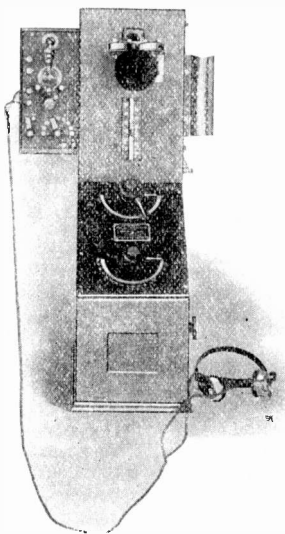

This instrument sends and receives wireless talk.

The average ranges of the 2 K. W. Radio Telephone set follow:

Nature of Transmission.	(Without Amplifier)	
	Height in Feet.	Range in Miles
Over Sea	40	20-40
	100	75-100
Over Level Country..	40	15-25
	100	50-75

(Two masts at each station 50 ft. or more apart, or their equivalent.)

The average ranges of the 5 K. W. Radio Telephone sets:

Nature of Transmission.	(Without Amplifier)	
	Height in Feet.	Range in Miles
Over Sea	40	20-40
	100	75-100
Over Level Country..	40	15-25
	100	50-75

You Benefit by Mentioning "The Electrical Experimenter" When Writing to Advertisers

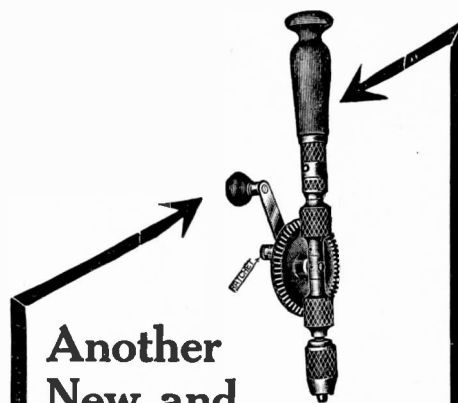

Another New and Improved Tool of Millers Falls Make

Here is a new hand drill designed to do a better job in quicker time with less effort and less trouble and fulfilling each purpose perfectly.

MILLERS FALLS HAND DRILL No. 306

It is provided with a simple and effective ratchet, located on the crank handle, which is of great convenience when working in cramped corners or on a delicate job. The handle is detachable and hollowed for holding twist drills up to the largest size within the capacity of the chuck. The chuck is of the famous STAR three jaw pattern closing evenly on, and centering accurately, round shanks from 0 to ¼ inch in diameter. Jaw springs are protected from injury.

Solid steel frame. Cut gears with a small steel working gear and steel idler gear to equalize bearings, both encased and rendered dirt-and-dust-proof. Choice hardwood stained handle, all metal parts handsomely nicked with exception of large gear.

The splendid quality of material and workmanship in this drill is typical of all tools of Millers Falls Make. Ask your dealer to show you Hand Drill 306 and also Millers Falls Bit Brace 732. Automatic Borer 8 and Hack Saw Gauge 53, new tools that include new features to make work easier.

Send for pocket catalog showing complete line.

Millers Falls Co.
DEPT. E MILLERS FALLS, MASS.

SOME CAR! BOYS! Send for Booklet Today



The Lad's Car
Send 20c today for Booklet, telling how to build this automobile. Complete instructions and descriptions of parts and sizes, illustrated with diagrams, blue print, cuts made from photographs, and price list of parts.
Special Inducement to first boy in your town
NIAGARA MOTOR CAR CORP'N
Dept. EE, Niagara Falls, N. Y.

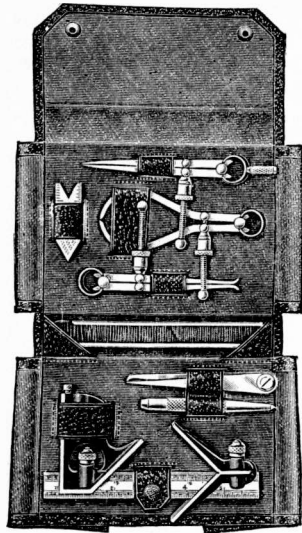

For That Boy Who Likes Shop Work

Is he taking a mechanical course in school or college, or in his apprenticeship? Then the thing that will please him most, yet prove a useful gift and incentive to future skilled workmanship, is one of

Brown & Sharpe's Sets of Standard Tools For Students and Apprentices

The Sets are made up of our regular mechanics' tools, standard for accuracy, handiness and finish for over fifty years. Such tools are included as experience shows are necessary for every-day Machine Shop work.

There are two styles. Set No. 847 above, comprises 8 tools in neat leather case. Set No. 849 includes 8 tools and "Handbook for Apprenticed Machinists" in nicely finished wooden box. Ask your hardware dealer to show them. If he has none, drop us a postal for an illustrated folder.

If interested in other mechanics' tools send for free catalogue No. 25

Brown & Sharpe Mfg. Co.
Dept. E. Providence, R. I.



A Fortune to the Inventor

who reads and *heeds* it, is the possible worth of the book we send for 6 cents postage. Write us at once. R.S. & A. B. LACEY, Dept. E, Washington, D. C.

PATENTS
MASON, FENWICK, & LAWRENCE,
Washington, D. C., New York City, Chicago, Ill.
Established over a half century. No. 12 Booklet Free.
Ref. McLachlan Bank & Corp., Wash., D.C.

(Two masts 100 ft. or more apart)

Over Sea	100	150-200
	200	200-400
Over Level Country..	100	100-150
	200	150-300

Some of these sets are being supplied to the D., L. & W. Railroad for station to train service, etc. The 2 K. W. set complete with transmitting and receiving apparatus costs in the neighborhood of \$1,900, and the 5 K. W. set \$2,500. Calling is generally done on a prearranged time basis, but other means may be utilized in some instances, such as radio-telegraphic calling.

ELECTRICAL WATER PURIFIER.

You cannot tell by looking at water whether it is pure or not—nor can you tell by tasting. Suddenly a leak in the filtration or purification system is discovered and the water may be contaminated rendering the drinker a victim of a deadly disease. Filtration removes

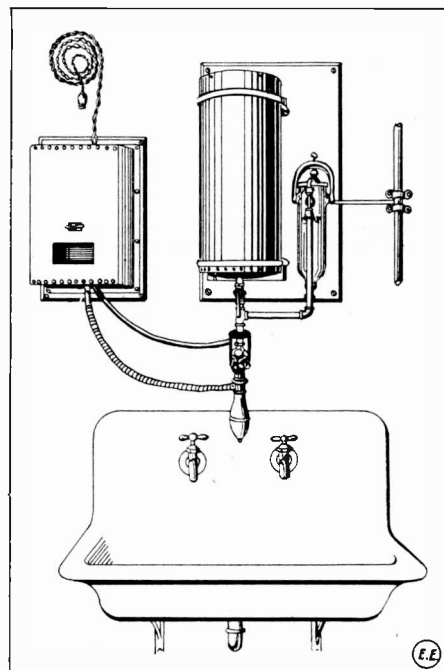

only a percentage of the germs that live in drinking water. Even one disease germ can snuff out a human life, so that no drinking water is safe unless every germ has been eliminated. It is not enough to merely clear the water you drink by filtration.

The only safe drinking water is therefore, that in which all deadly disease germs are eliminated before the eyes of the person using the water.

Electricity, when converted into ozone, will kill every dangerous germ in any drinking water in an instant and render that water absolutely safe to drink; protecting the drinker against typhoid fever and other diseases due to impure water. Ozone and electricity have been widely used in foreign countries to purify the city water supply, especially at Paris and Petrograd, and its introduction into the United States is only a matter of a short time. Until that time comes, it is desirable for every home owner, school, hospital, etc., to install individual purification plants. To meet this need, there has been developed the Aeroelectric Water Purifier, a small machine which is easily installed at a price that is within the reach of nearly every water user. It is illustrated in our cut, attached to a kitchen sink.

"VIM" ENGINE COMPLETE

Save money by using a VIM 1 1/4 H. P. Farm Motor for churning, washing, pumping, separating, spraying, etc. Women operate easily. No valves, cams or complicated parts. Water Cooled, automatic positive lubrication, sensitive governor. Weighs only 75 lbs. Comes ready to run. Fully guaranteed. Get catalog and special agency offer.

THE VIM MOTOR CO.
801 E WATER ST. SANDUSKY, OHIO

AGENTS \$24 A WEEK
R. M. King Made \$45 in 6 Days

15 IN ONE

Forged steel. Patented. Low priced. Sells to auto owners, farmers, mechanics in the shops and the home. Not sold in stores. No competition. Sales easy. Big profits. Ten-inch sample to workers. Write at once.

THOMAS TOOL CO., 2499 West St., Dayton, Ohio

5 H.P. 1915 Peerless Motorcycle

with Free Engine, Bosch Magneto, together with the best there is in Motorcycle construction, Power, Speed, Silence, Endurance, and those wearing qualities so essential for low cost of maintenance

5 Miles for One Cent
Agents Wanted—Liberal Discount

PEERLESS MOTORCYCLE CO., 179 E Hunting Ave., Boston, Mass.

SMALL ENGINES

Our 1/2, 1 and 1 1/2 H. P. Gasoline Engines for Farm and Shop are the best small engines made because we specialize on them. The

"SIEVERKROPP"

at \$19.50 will run a washing machine, grinder or any small machine. Buy one for your Boy! Shipped on trial. Send stamp for Booklet and Special Offer

SIEVERKROPP ENGINE CO.
E 1224 18th St. Racine, Wis.

LATHES
9 to 18-inch Swing

List price \$75 and up according to size. When ready to buy send for Lathe catalog and prices.

W. F. & John Barnes Co.
100 E Ruby St., Rockford, Ill

BE A WELL-PAID ARTIST

We were first to teach DESIGNING, ILLUSTRATING, CARTOONING. Chalk-Talking by mail. Open Air-Resident-Dept. also Guaranteed Plan. Test Lesson on Approval. Send for free copy of "The Proof." See what Briggs, N. Y. Journal, Herbert Johnson, Sat. Eve. Post and other students making big money say. Ask for story "Peterson the Gritty." **Write today.**

THE LOCKWOOD ART SCHOOL
DEPT. E KALAMAZOO, MICH.

Copy This Sketch

and let me see what you can do with it. You can earn \$20.00 to \$25.00 or more per week, as illustrator or cartoonist. My practical system of personal individual lessons by mail will develop your talent. Fifteen years successful work for newspapers and magazines qualifies me to teach you. Send me your sketch of President Wilson with 6c in stamps and I will send you a test lesson plate, also collection of drawings showing possibilities for YOU.

THE LANDON SCHOOL of Illustrating and Cartooning
1438 E Schofield Building, Cleveland, O.

*** KNAPP * KNAPP ***

BOY ELECTRICS
THE KNAPP LEADER
-THE BEST PRICE **\$2.50**

Guaranteed as Represented



Many other motors at all prices. Live dealers everywhere. Order direct or ask your dealer to show you the Knapp line and insist on getting Knapp goods. Dealers not already handling the Knapp line should ask for prices. Catalog illustrating full line of dynamos, motors and electrical novelties on request.

Knapp Electric & Novelty Co.
 523 West 51st St. New York

*** KNAPP * KNAPP ***

Every drop of water used must first pass through a filter and then through the purification nozzle which injects germ destroying ozone into every drop of water drawn. The water is purified with electricity as it is drawn and the cost is only about one cent for every 500 gallons of water used; much cheaper than spring or distilled water. And the quality of the water is not disturbed. It looks and tastes just the same and is just as refreshing and satisfying. The water still retains the minerals so essential to growing children.

PERMANENT DETECTOR ADJUSTMENT.

Perhaps some of the readers of the *Electrical Experimenter* have had trouble with mineral detectors going out of adjustment, and for this I used a few drops of sealing wax to a great advantage.

The sealing wax was melted and a few drops dropped on the wire and silicon when it was in perfect adjustment and on a good, sensitive spot.

I have used this detector myself and therefore know the working qualities. I also can say I have been using the same almost a month and it has not as yet

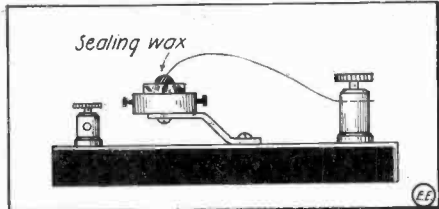

lost its adjustment even tho I hear a 1/2 kilowatt station, which is only a few doors from me.—Submitted by **RANDOLPH ROLAND.**

A LEAD PENCIL STARTING RHEOSTAT.

Once I had to temporarily install a two-horsepower motor and needed a rheostat for starting it, but did not have the necessary wire to make one, says a writer in "Power." Therefore, I built up one, using ordinary carpenter's pencils for the resistance, as shown in the sketch. The results were very satisfactory. Also our readers will find this a handy design of rheostat for various

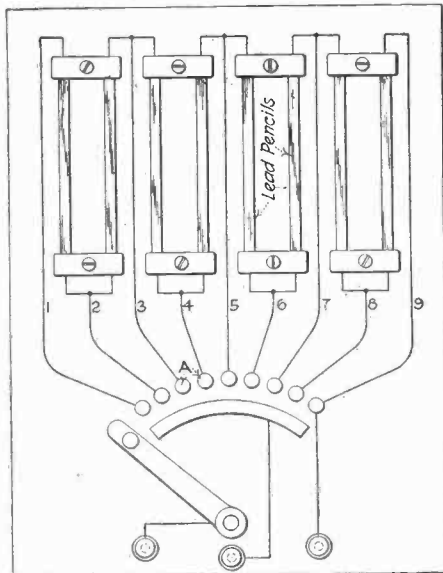

purposes, and the resistance of each step is easily made much lower than above mentioned by connecting in only a portion of the pencil for each step. The middle binding post on the motor starter here illustrated connects to the shunt field terminal of a shunt wound D. C. motor.

Bursting Brilliant Steady Light!

—at a touch of your thumb. A little electric lighting plant in itself. Entirely out of the pocket flasher class. No smoke, no heat, no oil can to fill and spill, no cleaning, absolutely safe anywhere. Wind and rain proof.



Federal SAFETY FIRST Electric Hand Lamp

stands or hangs in any position. Almost a necessity for farmers, merchants, railroadmen, plumbers, repairman, night watchmen, janitors, stablemen, suburbanites; good emergency light for automobiles, motor boats; a handy bedside lamp. Has a number of exclusive Federal features. Strong; handsomely finished. Uses ordinary dry cells—obtainable anywhere cheap and easily inserted. Price ready for use, only \$2 prepaid. If you cannot obtain FEDERAL appliances at your electrical dealer's, write us for catalog and nearest dealer's name.

SPECIAL INDUCEMENTS TO NEW DEALERS
FEDERAL SIGN SYSTEM (ELECTRIC)
E. 206 N. Desplaines St. Chicago
 Offices in Principal Cities

FREE-SEND FOR THIS

Large Illustrated Catalogue of **Home-Study BOOKS** ON **Electricity, Engineering, Carpentry, Building, Painting, Business**

Check the subjects you are interested in and mail with your name and address. We will send full particulars by return mail.

... MOTION PICTURE OPERATING	... Gas Engine Engineer
... Electrical Engineering	... Automobile Mechanician
... Elec. Light and Power Supt.	... Bookkeeper
... Electrical Wiring	... Plumber
... Telephone Expert	... Mason and Bricklayer
... Architect	... Carpenter
... Building Contractor	... Painter, Signs and Card Writing
... Architectural Draftsman	... Letter Writing
... Concrete Engineer	... Railroadng
... Mechanical Draftsman	... Motorman
... Steam Engineer	... Traction Farming
... Stationary Engineer	... Civil Service
... Telegraphy	

FREDERICK J. DRAKE & CO.
 1325 E Michigan Ave. CHICAGO, ILL.



ELECTRIC LIGHT & POWER WITHOUT COST IF YOU OWN A HORSE.

ELECTRIC POWER FOR THE FARM

No gasoline to buy; no fire risk; no engine to get out of order; always ready; two-year guarantee; patented. Every farmer can afford it. Six hours' work of the horse makes electric light for a week or more. Write for prices and circulars. Farmer agents and dealers wanted everywhere.

The Electric Horsepowers Co., Mfgs.
 908 Elm Street Cincinnati, Ohio

Electric Light



gasoline motor water... tion once a week.
 The ideal electric lighting system for country homes. Nothing like it ever sold before. Costs less than other systems to buy and to operate. Will last for years.

Waterman Motor Company
 182 E MT. ELLIOTT AVENUE
 DETROIT, MICH.

Write today for descriptive literature and prices.

Uni-Lectric
 GASOLINE-ELECTRIC UNIT LIGHTING SYSTEM



TELEGRAPHY TAUGHT

in the shortest possible time. The Omnigraph Automatic Transmitter combined with standard key and sounder. Sends you telegraph messages at any speed just as an expert operator would. Five styles, \$2 up; circular free.

OMNIGRAPH MFG. CO.
 30 East Cortlandt Street New York

You Benefit by Mentioning "The Electrical Experimenter" When Writing to Advertisers

PATENTS That Protect and PAY

Send for **Free** 96-page book
 Advice Free. Terms Reasonable. Highest References. Best Results.
 Send sketch or model for **FREE** examination and opinion.
 Recommended Patent Lawyer in the Bankers' Register and Special list of selected lawyers,
 Also in Martindale's Law Directory, Sharp and Alleman's Directory of Lawyers,
 The Gast-Paul Directory of Lawyers, and Kime's International Law Directory.
ALL BUSINESS GIVEN PROMPT and PROPER ATTENTION
 A large list of strong recommendations furnished free.
WATSON E. COLEMAN PATENT LAWYER 622E-F ST., N., WASHINGTON, D. C.



This Pocket Stove—only 50c

Burns Lava Fuel—Alcohol Solidified

No liquid to spill or explode. No bulky bottle, no wick, no smoke, no odor. Saves trouble and time many times a day. Has no equal for cooking a hasty meal, heating a chafing dish, boiling water, warming baby's milk, heating curling irons; invaluable for campers and travelers.

ORDER ONE NOW—Send 50c and we will mail the Lava Heater, prepaid, with fuel ready for instant use. An excellent gift. Guaranteed satisfactory or money refunded. Keep extra supply of Lava Fuel on hand; large can, 25c. Descriptive literature and name of dealer on request. Write today.

THE ELLANEM CO., Inc.
 72E East 131st Street
 New York City

LAVA HEATER
 Patented, Trade Mark Reg.



Carleton Lighting Generators

Direct Current—6 Volts—8 Amperes (48 C.P.)

With unique, accurate, adjustable, governor and cut-out if desired.

A perfect lighting outfit at a price lower than ever before published. Can be attached to any automobile or motor boat, or used for charging storage batteries anywhere.

Special Ford Brackets allow attachment to Ford cars by using wrench and screwdriver only.

THE CARLETON COMPANY
 Fans, Imp Torches—Generators—Storage Batteries
 178E Summer Street Boston, Mass.

INVENTORS Our Brain Belongs to You. Our Ideas Are Free of Charge.

All we want in return is to build your model, special machinery, dies, tools, and jigs to manufacture sheet metal goods, etc. We are expert mechanics, over thirty years' experience and have one of the best equipped shops in the country. Ask for Booklet No. 17. Consultation free. Experimental work strictly confidential.

A. NACKE & SON
 J. Uhrmann, Prop.
 A. Heldrich.
 236 E. S. 9th St.
 Philadelphia, Pa.

ACTIVE POWERS OF INVENTIVE GENIUS

Practical Electricity and Steam Engineering School

Qualify as an expert electrician or high salaried steam engineer. Our students learn by actually running our great plant of boilers, engines, dynamos, and electric apparatus. References: any of our 3,500 graduates. If you are interested in machinery or electricity write for free catalog.

Hawley Engineering School Boston, Mass.

PATENTS C. L. PARKER
 Formerly Member Examining Corps. U.S. Pat. Office
Patent Lawyer

Patents, Trade Marks, Copyrights, Patent Litigation
 Handbook for Inventors, "Protecting, Exploiting and Selling Inventions" sent free upon request.
 210 MCGILL BLDG. - WASHINGTON, D. C.

THE BEST Evening Course in Wireless in New York

If you live nearby and wish to hold your present position, while studying at night. Complete equipment—twelve instructors. Prepare for a government license—under a Marconi Engineer

Day Courses in Operating and Construction
Evening Courses in Engineering, Operating and Drafting Spanish for Operators
New Class in Engineering starts soon.

Y. M. C. A. TELEGRAPH SCHOOL 145 East 86th Street, NEW YORK

TELEGRAPHY The Only Trade that is not Crowded. It insures steady employment and good wages. Promotion is assured for the ambitious.

We are official instructors for the Western Union Telegraph Co., and the only school instructing Western Union employees.

Largest attendance of any Telegraph School; also authorized school for Illinois Central Railway Company; Agency course free. Practical instructors; main line wires. Employment furnished to earn expenses if desired.

JONES SCHOOL OF TELEGRAPHY, Dept. E, 305 S. LaSalle St., CHICAGO, ILL.

WIRELESS COURSE

JUST ADDED, PERFECT EQUIPMENT FOR INSTRUCTION IN WIRELESS TELEGRAPHY

Write for full particulars

NEW STATIC CURRENT APPARATUS.
 The illustrations herewith show two interesting models of physical apparatus

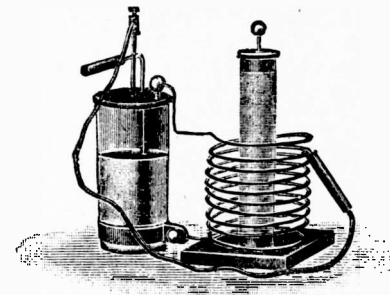

designed for excitation on a static machine. The first is a small Oudin coil or transformer together with a Leyden jar. Its primary coil, as will be seen, is well spaced so as to prevent the static exciting current from jumping across the turns.

The second figure shows a "resonant jar" set for demonstrating the resonance of tuned circuits after Dr. Lodge's method. First one jar and variable inductance is charged by a static machine in the regular manner and by adjusting

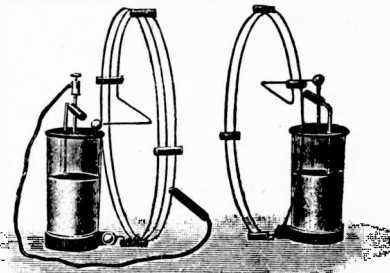

the second inductance the jar connected to same will discharge when the two circuits are in electrical tune or resonance.

A BOOST FOR THOSE WITH RADIO TROUBLES.

About the middle of August, last, I wrote to you asking you to help me out, as I was having trouble trying to get a wireless receiving set to work, and you were good enough to answer me, trying to help me out; so it is no more than fair to let you know what results I have had so that it may possibly benefit someone else.

The first thing I did, was to make almost an entirely new set of receiving instruments and cut out everything that wasn't absolutely necessary, such as switches to change over the primary condenser from in parallel to in series with ground wire, and another switch I had on the old set to cut out the secondary of loose-coupler, using the primary as a double slide tuning coil.

The loose-coupler I made was built entirely out of hard rubber except the base, and I used bare wire for primary instead of enameled, as in the old one. In comparing the two loose-couplers on identically the same circuits, I find the new one way ahead of the old one, as the signals come in ever so much clearer and sharper, due mostly, I think, to the use of a perfect insulator.

Before I tried to get results, using a loading coil in my primary circuit so I could get Sayville and Arlington; so cut that out and made a variometer and find that I get better and much clearer signals by using a variometer.

Next I experimented with different hook-ups in my secondary circuit and find I get the best results as per sketch. Will say here that everywhere that a

wire or connection touches, I use hard rubber, no wood at all.

I have tried using the electrolytic detector, peroxide of lead, silicon, Perikon and galena and so far the galena has them all beat, but has one drawback that I am trying to get rid of, and that is the necessity of frequent adjustment.

In using galena I find that a piece of No. 30 German silver wire gives slightly better results than using copper wire, and the sensitivity remains the same whether I cover the mineral with oil or use it dry. I prefer an oil-covered mineral, as I find that galena loses its sensitiveness if exposed for any length of time to the open air.

Now comes the part that I think has more to do with my success than anything else, and that is my aerial. My original aerial was of 4 No. 12 copper wires 100 feet long and 50 feet high at one end and 30 feet at the other, and could get signals all right with it, but they weren't clear enough to suit me; so I built up the high end to 73 feet high, making a highly directive aerial. The signals were better but could only get 2 stations, Sayville and Arlington; so took it down from the small end and extended it to 250 feet long, to a tree up on a hill. It is about 30 feet above ground on the hill now, and 73 feet at the other end, and has only 2 No. 12 wires spaced 7 feet apart. My lead in is taken from the top of the 73 foot pole and is about 100 feet long. The sketch here shown will make it clear how it looks at present.

I can get Sayville now very clear and sharp; also Arlington, and Cape Code is very good; also some other stations using wave lengths about 1500 meters that I haven't caught the call letters of yet.

I have the aerial at present connected to instruments as a loop aerial, but find I get better results by connecting both ends together and using it as a straight-away. There has been but very few nights that I couldn't get signals, even tho it is rainy and wet, altho some nights the induction from the 6000-volt trans-

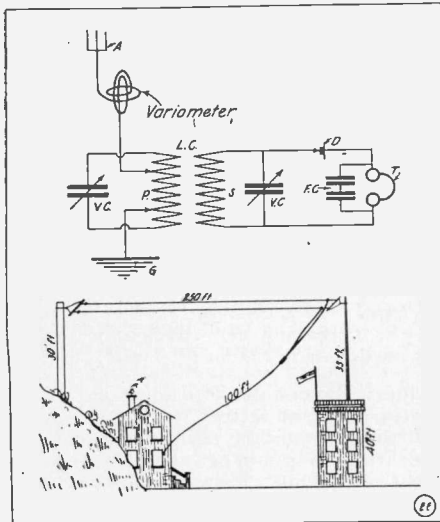

mission line is so bad I give it up in disgust.

In making my variometer I used two cardboard tubes boiled in wax, such as described in Philip Edelman's book on wireless, and wound them both with No. 24 enamel wire.

In closing I want to thank you very much for your suggestions before and you can use this letter or any part of it you see fit for publication in *Electrical Experimenter* if you like. Maybe it would be a help to someone in a like fix.

HARRY L. DEARBORN.

FREE! for New Subscriptions.

HERE is your chance to get valuable electrical and wireless articles free of all cost to you, by simply showing THE ELECTRICAL EXPERIMENTER to your friends. Most anybody will give half a dollar for 12 issues of a bright, newsy, up-to-date electrical paper like this one. When you get the number of subscriptions necessary for the premium desired, send us the total remittance with the names and addresses of the new subscribers, (or renewals), and state issue to start them with. Every article of standard quality and guaranteed to give satisfaction.

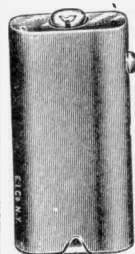

Midget Flashlight. Smallest made. Measures only 2½ x 1¼ x 1¼. Beautifully finished in nickel. Fitted with high grade 2½ volt Tungsten lamp. Fits vest pocket. No. 3418 Flashlight sells for 75c. Shipping weight 4 oz.

No. 3418

Given free for 3 yearly subscriptions!

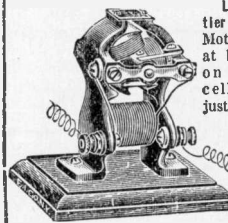

Little Hustler Battery Motor. Runs at high speed on one dry cell. Built just like the large motors of commercial type. 3 pole armature; starts in any position. Stands 3½" high, perfectly finished. No. 100 Motor sells for 85c. Shipping weight 1 lb.

No. 100

Given free for 4 yearly subscriptions or 2 two-year subscriptions.

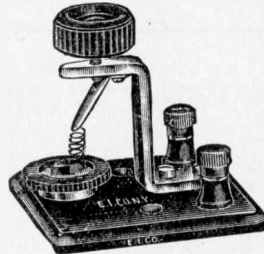

No. 9700

Galena Detector, with Rotary Cup, rubber base. This detector will enable you to hear radio signals over long distances, with a small aerial. No. 9700 Detector costs \$1.25. Shipping weight 1 lb.

Given free for 4 yearly subscriptions or 2 two-year subscriptions.

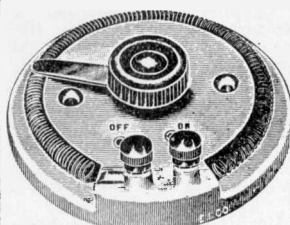

No. 5000

Rheostat Regulator. Resistance 10 ohms, finely adjustable. Porcelain base, air cooled. Capacity about 40 watts, 2 amperes rating. Fine for controlling speed of battery motors, electrocautery work, dimming battery lamps, etc. No. 5000 rheostat costs 60c. Shipping weight 1 lb.

Given free for 2 yearly subscriptions or 1 two-year subscription.

SEE NOTE BELOW HOW TO CALCULATE FOR MORE THAN ONE SUBSCRIPTION.



No. 1125A

Geissler Tube, 3 inches long. Most beautiful tube you ever used on your spark coil. Several colors show. A ¼" or ½" spark coil lights tube nicely. Gives a very weird effect. No. 1125A Geissler tube sells for 30c. Shipping weight 1 lb.

Given free for 1 yearly subscription.

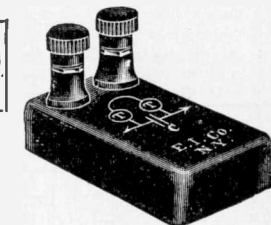

No. 10010

Jr. Fixed Condenser. Hard rubber comp. case. Widely used in radio receiving circuits. Should be used with tuner, phone and detector here shown, etc. Cap. .0165 M. F. size 2½ x 1½ x 1¼. No. 10010 condenser sells at 50c. Shipping weight 4 oz.

Given free for 2 yearly subscriptions or 1 two-year subscription.



No. 1024

Pony Telephone Receiver. Single pole, 75 ohms resistance. Hard rubber comp. shell. Two of these receivers connected without batteries will carry talk up to 150 feet. Excellent with galena detector for wireless.

No. 1024 receiver, regular price 40c. Shipping weight 1 lb.

Given free for 2 yearly subscriptions or 1 two-year subscription.

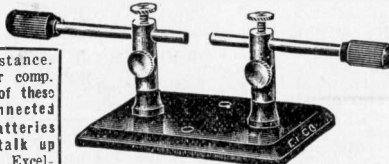

No. 9220

Zinc Spark Gap, works on any spark coil. Can be used as an anchor gap or break gap in "break-key" systems. Zinc rods are 3/16" in diameter, and fitted with two insulated handles. Handsome instrument. Base is hard rubber comp. No. 9220 spark gap sells for 60c. Shipping weight 1 lb.

Given free for 2 yearly subscriptions or 1 two-year subscription.

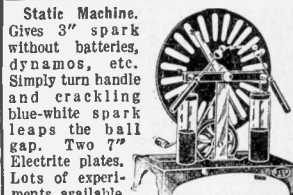

No. 9000

Static Machine. Gives 3" spark without batteries, dynamos, etc. Simply turn handle and crackling blue-white spark leaps the ball gap. Two 7" Electric plates. Lots of experiments available. Best machine made. Size 8x5x10½". Price \$3.75. Shipping weight 6 lbs.

Given free for 12 yearly subscriptions or 6 two-year subscriptions.

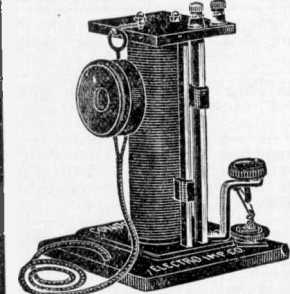

No. 1500

"Interstate" Wireless Receiving Set. Receives messages up to 300 miles on fair size aerial. Has tuning coil, detector, condenser and 75 ohm receiver. Hard rubber comp. base and top. No. 1500 Interstate set sells for \$3.75. Shipping weight 4 lbs.

Given free for 12 yearly subscriptions or 6 two-year subscriptions.

Jr. Tuning Coil. A beautiful instrument. Bare wire wound. Polished hard rubber composition ends. Two sliders. A useful loading coil, 400 meters wave length capacity. No. 9950 tuner sells at \$2.00. Shipping weight 2 lbs.

Given free for 6 yearly subscriptions or 3 two-year subscriptions.



No. 1024A 1000 Ohm Wireless Receiver. Shipping weight 1 lb. No. 1024A Given free for 4 yearly subscriptions or 2 two-year subscriptions.

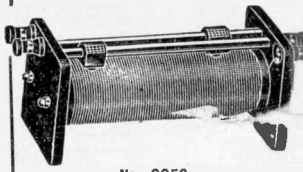

No. 9950

NOTE—Your own subscription may be included in the above offers. If you are a subscriber already we will extend your subscription. Example: Suppose you desire the No. 9700 Galena Detector; you may get four friends, each to subscribe for 1 year; or three friends and yourself for 1 year; or two friends for 2 years; or two friends for 1 year and yourself for 2 years; or finally yourself for 4 years, etc., etc., whichever way you like. Collect the \$2.00 for us and the Detector is yours.

The Electrical Experimenter
Premium Dept. 233 Fulton Street New York City

Opportunity Exchange

YOU will probably find more opportunities and real bargains in these columns than anywhere else in the country. Most good things in life are hard to find and worth going after—these little ads illustrate that point; you alone will be the real loser if you don't take the time to scan through these columns.

Advertisements in this section 4c a word for each insertion. Count 7 words per line. Name and address must be included at the above rate. Cash should accompany all classified advertisements unless placed by an accredited advertising agency.

Ten per cent discount for 6 issues, 20 per cent discount for 12 issues from above rate. Objectionable or misleading advertisements not accepted.

Advertisement for the March issue should reach us not later than February 5th.

THE ELECTRICAL EXPERIMENTER, 233 Fulton Street, New York, N. Y.

BOOKS

"TRAFFIC in Souls." This book is based upon the most widely discussed motion picture production. It is a powerful study of vice conditions in New York, and the facts upon which it is based were compiled from the Rockefeller White Slave Report. Illustrated with striking photographs. 300 pages. Sent prepaid for 60 cents. Hesse Mercantile Company, 12 East 22d Street, New York.

HANDSOME premiums to new subscribers' list; catalogue of three thousand publications, four cents. Edwards Magazine Agency, Atlantic City, N. J.

PIGEONS—The finest Pigeon Magazine, \$1.00 a year, or send 25 cents for four months' trial. Pigeons Magazine, 948 Advertising Bldg., Chicago.

MODERN Dances—Best Instruction Book for beginners. 17 dances fully illustrated. 25c prepaid. Danse Publishing Co., 500 Fifth Ave., N. Y.

ENGINEERS' questions and answers for license, by Hobson, for twenty-five cents, postpaid. Send stamps. Reilly's Book Store, Philadelphia, Pa.

BICYCLES AND MOTORCYCLES

1908 H. D. SINGLE with clutch and magneto, \$30. 1910 H. D. battery model. A-1 condition, \$35. 1911 H. D. single magneto model and clutch, \$40. 1910 H. D. clutch and magneto, \$45. 1 Indian motorcycle motor with magneto and Schebler carburetor, \$25. 1 Excelsior motorcycle motor, \$25. C. H. Lang, 1704 Michigan Ave., Chicago, Ill.

CLOSING Out Sale high grade, slightly used motorcycles. We have about 50 left to sell, in standard makes which we are offering at big bargains, such as twin and single cylinder Indians, Yales, Harley-Davidsons, Merckels, Thors, Excelsiors, Popes, 4-cylinder Hendersons and Pierces. These motorcycles we want to close out this year. No reasonable offer will be refused. Write today for our list giving description and prices. Gotham Sporting Goods Co., 57 Warren St., New York City.

RIDERS: Write for our catalogue of motorcycle accessories and supplies. Andrews Specialty Co., 55 Warner Street, Rochester, N. Y.

5-HORSE Pierce, single cylinder, magneto, Shebler carburetor, new tires, perfect running order, \$125.00. Fred Gile, 50 Forest Ave., Portland, Maine.

FOR Sale, cheap. 1914 Harley-Davidson twin. Write for particulars. Walter Goerke, 321 Washington St., Newark, N. J.

WE have twenty-five used motorcycles from \$20 up. Ask for list. Will save you money. Answer quick. Sterling Motor Company, Brockton, Mass.

GET copy of "Motor Cycle" published in England. Special War Issues received here weekly. Price 15 cents. Two for 25 cents. Distributors, 143 So. Wabasha, St. Paul, Minn.

YALE, Pope, Thor, bargains. Late models. Walter Munger, Excelsior, Minnesota.

OUR folder showing the new 18-~~25~~ 2-speed models is ready for mailing. Write for this and for the agency today. Sterling Motor Company, Brockton, Mass.

BIG bargains in good motorcycles we have taken in exchange on new ones. Send for special bargain list. Shaw Mfg. Co., Galesburg, Kansas.

1914 MODEL R Pope, Two-Speed Motorcycle—Will exchange for 18-inch swing Engine Lathe. E. H. E. Thieroff, Sherwood, Ohio.

SEND for latest Bulletin of real Motorcycle Bargains, used and slightly used, all makes, models and prices; if you have \$25 and really want a powerful Motorcycle, send for this Bulletin; hundreds of machines at all prices, new ones on easy payments; tell us what you want and how much you can pay; we can fix you up. Peerless Motorcycle Co., Dorchester, Mass.

MOTORCYCLES cheap now. Write me what you want and price. Chas. Walsh, 878 St. Paul, Detroit, Mich.

MOTORCYCLES—Everybody rides them. You're next. New and rebuilt motorcycles; every motorcycle fully guaranteed. Singles and twins, \$25 to \$100. Tire casings, \$3; belts, \$4; carburetors, \$6; automobile tires, \$3. Send for catalogue. Deninger, the price cutter. Rochester, N. Y.

DON'T buy a Bicycle Motor Attachment until you get our catalogue and prices. Shaw Mfg. Co., Dept. 27, Galesburg, Kansas.

\$50 TO \$150 buys the best Motorcycles, every make and model, in our large stock—must be cleared. Half price. Send for list today. Talking Machines, \$5 and up. Brown Music Co., 9119 Commercial Ave., Chicago, Ill.

MOTORCYCLES, all makes, rebuilt, guaranteed good as new. Indians, Harleys, Excelsiors, Readings, Kulthers, Merckels, Single and Twins, \$25 to \$100. Buy direct, save dealers' profits. Deninger Cycle Co., Rochester, N. Y.

USED Motorcycles, all makes, bargains. Send for list. Ward Bros., 212 Broadway, Camden, N. J.

FORMULAS

FORMULAS for inks, black, blue, red, gold, green, silver, indelible, 15c each. 7 for \$1.00. Stephen Rafferty, 2122 Arch St., Philadelphia, Pa.

1,000 TRADE secrets and formulas, 25c. 500 selected formulas, 20c. Resilver mirrors, guaranteed process, 20c. Make Sneezing Powder and Itch Powder, 10c each. Entire lot, 50c. Service Bureau, 3111-T, Belleplaine Ave., Chicago.

SIX Valuable formulas for sympathetic inks, 50c. Wayne Thomas, Ithaca, N. Y.

MAKE Candy evenings; pays; receipt, 10c. Elmer Zimmerman, 1435 Walnut, Harrisburg, Penn.

IS the formula you want worth a quarter? State exact requirements. Raymond, Roosevelt, N. Y.

START factory making candles, gums, crack-erjack, orangeade, ciders, etc. Sells fast. Nearly all profit. \$15 course \$1.00. Catalog, 2c. Robert Hamilton, Barnes City, La.

LATEST FAD. The celebrated everlasting fragrant rose beads can be easily made and sold with big profit. Strings sell as high as \$3.50 to \$5.00. Formula with full instructions for making same, 25c coin. J. C. Regan, 1162 Broadway, N. Y.

PRINTING

PREPAID, Printing (600 miles) 1,000 bond letter heads, \$2.39; envelopes, \$2.14; return envelopes, \$1.77; imitation typewritten letters, 150 words, \$1.73; 300 words, \$2.64; 6x9 circulars, \$1.75; art ad slips, \$1.00. Ask for prepaid prices on any printing. Good's Quick Print, Harrisonburg, Va.

OUR splendid plan of Publishing a Magazine of your own, will increase your business. Let us send you free particulars. Co-operative Magazine Co., 2530 N. Clark St., Chicago, Ill.

PHOTOGRAPHIC

KODAK films developed, 5c. all sizes; Prints 3c. each, any size. P. Johnson, 100 W. Bridge St., Oswego, N. Y.

KODAK Films Developed, 10c per roll, any size. Prompt attention given mail orders. Prints, 2 1/4 x 3 1/4 to 3 1/4 x 4 1/4, 3c; 4x5 to 3 1/4 x 5 1/2, 4c. J. M. Manning, Box B, 1062 Third Ave., New York City.

HEADQUARTERS for selling or exchanging Cameras of all kinds. Carry a full line latest Kodaks. Graflex, Premos, foreign Cameras. Write for big bargain list. Glocker & Newby Co., 171 Broadway, New York.

EXPERT Kodak Finishing! Send for price list. Electric Studio, 162 Stephenson St., Freeport, Ill.

\$54 CENTURY Grand, bargain, \$25. Magnificent Ensign Reflex, Zeiss Triotar Anastigmat, complete, \$65. \$22.50 Auto-graphic Kodaks, \$19.75. Slipin Calendar Mounts, assortment, \$1. Catalogues mailed. Newark Photo Supply Co., Newark, New Jersey.

ROLL Films developed 10c per roll. Printing Post Cards, 3c each. 15 years' experience. Give me a trial. You will be pleased. F. C. Hoyt, Sac City, Iowa.

FILMS developed 10c, all sizes. Prints 2 1/4-3 1/4, 3c; 2 1/2-4 1/4, 3 1/2-3 1/2, 3 1/4-4 1/4, 4c; Post Cards, 50c doz. Work guaranteed and returned 24 hours after receiving. Postpaid. Send negatives for samples. Girard's Commercial Photo Shop, Holyoke, Mass.

FILMS developed 10c, all sizes, prints 2 1/4-3 1/4, 3c; 2 1/2-4 1/4, 3 1/2-3 1/2, 3 1/4-4 1/4, 4c; Post Cards, 50c dozen. Work guaranteed and returned 24 hours after receiving. Postpaid. Send negatives for samples. Girard's Commercial Photo Shop.

THINK OF IT! Only \$20 for finest German Double Anastigmat in Ibsco shutter, for 3A Kodaks and postal card cameras. Send for matter describing best Lenses on earth at way down prices. Lafbury Co., 305 North Fifth Ave., Chicago.

WHAT THEY THINK.

Arthur Sager of Appleton, Wisconsin, writes us:

"I liked very much that article in the September 'Electrical Experimenter' on How to Measure High Voltages. I had been looking for an article like the one mentioned for quite a long time, but never saw it before in any publication that I happened to read."

H Voltman of Buffalo, N. Y., writes us:

"I received the second number of the 'Electrical Experimenter' recently. I like the magazine very well and I think it is well worth the price I paid for it."

Albert Baxendale, of Indianola, Iowa, says in a recent letter:

"I think yours is the best Electrical paper that is published for the money. 'The Constructor,' 'How to Make It Department,' and the 'Question Box,' are very good features. 'The Experimental Electricity Course' is the best thing in your magazine."

Normay Otto, of Oshkosh, Wis., writes us:

"I have just received my fourth copy of the 'Electrical Experimenter,' and I want to say, it is and was the best magazine I ever read."

You Benefit by Mentioning "The Electrical Experimenter" When Writing to Advertisers

SPOT Cash paid for high-grade Kodaks, Lenses and Cameras. Send full description, stating lowest price. Cameras exchanged. In business since 1885. David Stern Co., Dept. M, 1047 W. Madison St., Chicago.

TRANSFER pictures to china, etc.; no formulas; particulars. Flinn, 286 West 142nd St., New York City.

WE buy, sell and exchange. Bargains in Microscopes, Telescopes, Binoculars, Cameras, etc. Bargain list sent. Kahn & Son, Opticians, No. 54 John St., New York. Established 62 years.

MAIL ORDER OPPORTUNITIES

EUROPEAN War Map and chances to start a profitable business of your own, 10c. C. S. Mathews, 69 East 87th St., Portland, Ore.

FREE—A 1-4 kt. Amsterdam Gem, can't tell from a genuine diamond, set in a Tiffany ring. Send 10 names and addresses from friends and 12c. to pay postage. S. E. Muller, Maplewood 5, Malden, Mass.

MAIL Order Men. Would you like to know how 61 successful mail order men do business? Especially if these men tell you their own experience in their own words. The Mail Order Business Builder gives you such information direct from these men's private offices from month to month. Send dime for sample copy of this 68 page magazine. Randolph Rose, Publisher, No. 8 Broad St., Chattanooga, Tenn.

EVERYTHING in the mail order line; State your wants and we will do the rest. Pacific Specialties Co., Los Angeles, Cal.

MAGIC AND TRICKS

GREENBACKS—Yellowbacks, Stage money. New kind, 10c bunch; 4-25c. Eureka Supply, P29, 3827 N. Kenneth, Chicago.

250 **MAGIC** Tricks with cards, coins, etc., 10c. Greenbacks, big wad, 10c. Novelty Shop, 3311-T, Belleplaine Ave., Chicago.

SECRE-WRITO; New System of secret writing. Keeps your correspondence safe and private. Strangers cannot read your cards and letters. Great fun for everybody. Samples and instructions, 10c. H. J. Teeple, Decatur, Indiana.

GREENBACKS — Big wad, 10c. 4-25c. Enterprise Co., 1003-PM, Morton Bldg., Chicago.

NOVELTIES, Books, Tricks, Games, Etc. Illustrated catalogue free. Sample 25c Card trick, 10c. Auburn Supply Co., Specialty Dept., 7745 Peoria St., Chicago.

MAGIC Bargain Sheet and Catalog 2c. Gilnovec, Morgan Park, Ill.

MAGIC tricks for the profession. Big catalogue and pocket trick free. Ventriloquial figures, \$6.00 up. Magic Parlors, 192 Clifford, Providence, R. I.

GIVE 'em the "creeps" with the Mysterious Skull. Shines, without any light, in the dark. Really wonderful, 10c. Bartlett, Box 960, Milwaukee.

GREAT book wonders, secrets and mysteries, and novelty catalogues, 10c. Wright Spec. Co. (D), Brewster, N. Y.

FAKE Money—Big, flashy roll, 10c. Gilnovec, Morgan Park, Ill.

MAGIC Tricks, Jokes and Puzzles. Trick with my catalogue, 10c coin. H. V. Dils, Huntington, W. Va.

MAGIC disappearing coin and ring trick, mystifies, amuses. Send 10c in coin. Catalog. Powell Sales Company, Dept. E, Ossining, N. Y.

MAGIC Catalogue, 160 pages, greatest on earth, ten cents. Learn magic at home. We teach you to do these tricks as good as the great professionals — escape acts, rope ties, mind reading, handcuff secrets. Satisfaction guaranteed. Chicago Magic Co., Dept. B, 72 W. Adams St., Chicago, Ill.

BIG Catalogue. Magic, Entertainment goods free. Bates Company, Melrose, Mass.

BE a Magician. Travel. Give shows; earn money. I tell how. Send stamp. Prof. Rapp, Box F1115, Madison, Wis.

POST Cards, Tricks and Jokes, Coins, Notes, Stamps and curious things. Catalog for stamp. Coin Exchange, New Rochelle, N. Y.

BE a handcuff king. We teach you. Escape from handcuffs, boxes, ropes, etc. Secrets of 20 sensational escapes, \$1. Particulars free. The Magcraft Co., Dept. A, Box 251, Detroit, Mich.

MAGIC pocket trick free. Worth 25c. With illustrated catalog of 250 tricks, puzzles, illusions, for 6c. Stamps. Magic Co., Sta. 10, 249 West 38th St., New York.

MODELS

WE make working models for inventors; also dies and stamping of specialties, and carry a complete stock of brass gears and model supplies. Send for catalogue. The Pierce Model Works, 3405 Pierce Ave., Chicago, Ill.

FREE catalogue of model supplies. Castings, metal specialties on contract. North Chicago Tool Works, 15 Grove Ave., North Chicago, Ill.

PRODUCERS of Results; Inventions Developed, Light Mfg., Models, Experimental Work, Tools, Dies and Stampings. Johns Machine & Stamping Works, Middle Bldg., Dept. C, Cleveland, Ohio.

I **MAKE** models for inventors and guarantee first-class workmanship; also do repair work and light manufacturing. George Wood, 223 Postal Telegraph Bldg., Kansas City, Mo.

INVENTORS: We manufacture metal articles of all kinds to order. Also special machinery, tools and dies, punchings, lathe and screw machine work, metal splittings, castings, plating, wood and metal patterns, etc. Send sample for estimate and expert advice, free. The Eagle Mfg. Co., Dept. B, Cincinnati, Ohio.

MODELS made for inventors; general machine work; designing and perfecting; developing automatic devices and machinery; in a position to do all kinds of light tool and machine work. Prices reasonable; estimates cheerfully given. Ideal Machine Works, 62 Ann Street, New York City.

STAMPS

6 **POSTER** Stamps Free. Send your name and address on postcard to A. S. Hinds, 183 West Street, Portland, Maine.

FOREIGN Stamps Free, 52 different foreign, including China and Venezuela, to all who apply for our high grade approval selections. Send two cent stamp for return postage. Edgewood Stamp Co., Dept. H, Milford, Conn.

104 **DIFFERENT** Stamps, including United States 1861 Civil War, Japan, Argentine, etc. Large price list and sample New England Stamp Monthly, only 5c. Finest approval sheets, 50 per cent. discount. New England Stamp Company, 19 Washington Bldg., Boston.

STAMP Album with 538 Genuine Stamps, incl. Rhodesia, Congo (tiger), China (dragon), Tasmania (landscape), Jamaica (waterfalls), etc., 10c. 100 diff. Jap., N. Zld. etc., 5c. Big list; coupons, etc. Free. We buy stamps. Hussman Stamp Co., St. Louis, Mo.

STAMPS—105 China, etc., stamp dictionary and list, 2c. Bullard, Sta. A, Boston.

TWO hundred different United States Stamps, worth six dollars, only one dollar. Fifty cent 1894 free with order. Lloyd, 606 Royal, New Orleans.

FREE War Packet to approval applicants. Reference. Litten, Rock Island, Ill.

STAMP Special, \$3 catalogue value, 35c. Crockett, Nutley, N. J.

HIGHEST prices paid for Stamps or Collections. Buying Catalog, 10c. Michigan Stamp Co., Detroit.

CANADA, 25 different, postage and revenue, 10c; 50 different, 40c; 100 different, \$1. Denyson Duggan, 72 Oxford St., Toronto, Canada.

MISCELLANEOUS

FATHERS, MOTHERS! Let your son learn a clean, high-class, educational trade that pays \$1,200 yearly. Mastered day or evening. Unlimited course (usually takes three to five months), \$150. Short courses also. Please call or write for particulars. EMPIRE MERCHANTIAL LINOTYPE SCHOOL, 419 First Avenue, New York City.

COLUMBIA Grafanola and eight records used one week, \$20. Typewriter, two-color ribbon, back spacer, tabulator, etc., \$30. Full particulars. Frank Cowles, Canton, Conn.

FIELD—Marine Day and Night Glasses with case, 25-mile adjustment, \$30.00 value, only \$6.50. Money back if not satisfied. Ye Curiosity Shop, 20 S. Second St., Philadelphia, Pa.

100 **IMITATION** Elks' Teeth, guaranteed very fine, \$2 each. H. Beddow, 2156 8th West, Seattle, Wash.

TYPEWRITER, Moving Picture machine, Reflex camera. E. O. Waltz, Medina, O.

GASOLINE Engine Castings, with drawings, cheap. Catalog for stamp. Novelty Manufacturing Co., 853 West 6th St., Cincinnati, Ohio.

SILVER Plating Tablets. Old brass or copper, spoons, watches, etc., can be instantly plated silver in a beautiful manner with the silver plating tablets. Sample tablet, 10c. Agents wanted. Utility Co., Cardston, Alberta, Canada.

KEYLESS DOOR LOCKS placed on any door without tools. Pocket size, 25c; postpaid. Order sample, get to work. Postals not answered. Hoosier Novelty Company, Indianapolis, Ind.

AGENTS—Big money in perfumes, toilet articles, etc., make them yourself—we show you how. Mixers Supply Company, Poughkeepsie, N. Y.

YOUR PHOTO on a pillow top or handkerchief on high class material. Swaboda Satin; washable, will not fade. Pillow top in any one of 6 colors, namely: white, blue, green, lavender, pink or yellow. Prepaid to you only \$1; 6 for \$5. Satisfaction guaranteed or money refunded. Rogers Supply Co., 4435 Washington Blvd., Chicago, Ill.

COST 1c, sell for 10c. Ready-made sign letters anyone can apply. Unlimited demand. Five samples, instructions, 10c. Particulars free. Everbrite Co., Long Island City, New York.

AGENTS—1 ten cent articles for 10 cents. National Business Supply Co., 86 Bowles St., Springfield, Mass.

AGENTS and Canvassers—Household article; sells at sight; repeat orders; will start you to work to make money immediately. Write or call after 3 p. m., Joseph Ober, 118 East 28th St., N. Y.

PLAYS, Vaudeville Sketches, Monologues, Dialogues, Speakers, Minstrel Material, Jokes, Recitations, Tableaux, Drills, Musical Pieces, Entertainments for all occasions. Make-up Goods. Large Catalog Free. T. S. Denison & Co., Dept. 11, Chicago.

APPROVALS of United States, 1/2c each and up. Best on the market. Stamp or bank reference required. Rare Parcel Post 50c at 25c; 75c at 45c; \$1.00 at 50c; complete set dues (5 vars), 65c; excellent copies. I buy U. S. Auctions a specialty. Wendover Neefus, U. S. Specialist, Hudson, N. Y.

You Benefit by Mentioning "The Electrical Experimenter" When Writing to Advertisers



THE E. I. CO. NEWS



SOME SPECIALTIES FROM OUR LATEST SPECIAL CATALOG No. 14A

Send 3 cents for your copy today before you forget

The "Beers" Lantern

OVER 50 HOURS STEADY LIGHT

Always ready for use. Can be carried anywhere with perfect safety. No danger of fire or explosion. Indispensable for housekeepers, automobilists, farmers, sportsmen, watchmen, yachtmen, deliverymen, and all others who require a practical hand lamp of long life which can be maintained at low cost. From 6 months to a year's use from a common dry cell battery such as is used for door bells, automobile ignition, etc.



Not a toy but a real lantern which can always be depended upon. Is substantial, economical, convenient.

Length 9 inches; diameter 2 3/4 inches. Shipping weight 2 lbs.

The Beers Lantern sells at electrical stores for \$2.00 to \$2.50 for the cheaper kind and for \$3.00 to \$3.50 for the higher grade.

No. 8305

No. 8305 "Beers" Lantern, Steel, Black Rubber Finish, WITHOUT BATTERIES

\$1.25

No. 8300 "Beers" Lantern, Solid Brass, Polished, WITHOUT BATTERIES

\$1.70

No. 8304 Extra Mazda Bulb (Special) for Lantern

\$0.30

NOTE—If battery is wanted add 23 cents extra to above prices for a No. 6 "Columbia" battery. If shipped with battery the shipping weight will be 5 lbs.

The "Wallace" Portable Electric Lamp

(Pat. Nov. 10, 1908, April 21, 1914.)

The Handiest Little Lamp in the World. The Lamp with a Hundred Uses.



It Stands, Hangs, Clamps or Sticks.

Any place and at any angle you put it.

Handsome, Convenient and Durable. Will Last a Life Time.

Manufactured of high grade brass, beautifully nickeled.

Height 11 inches. Shipping weight 2 lbs. This lamp sells everywhere from \$2.25 to \$3.00.

NOTE—The "Wallace" lamp takes any standard carbon or Tungsten bulb.

No. 7309 The "Wallace" Lamp, complete, WITHOUT BULB

\$1.95

No. 7309

The "Crown" Electric Toaster

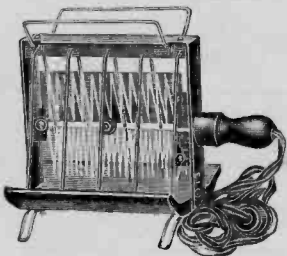

The ideal toast is made on the CROWN ELECTRIC TOASTER. Set it on the dining room table, in the invalid's room, in the kitchen, or anywhere you like—screw the connecting plug into any electric light socket, switch on the current, and rest a slice of bread on either side of the toaster. The wire coils will glow with a dull, red heat, and when the bread is done to your taste, whether to a faint golden color or a deep, rich brown, take it off and learn the delights of eating fresh, crisp toast the instant it is made.

The current consumption of the Crown Electric Toaster is low, being only 400 watts and at 10 cents per k. w. hour twelve large slices of bread can be toasted AT A COST OF 1 CENT.

This toaster sells at department stores for \$3.00 to \$3.50. A three year guarantee accompanies each toaster.

No. 7304

Works on 105 to 125 volts A. C. or D. C. current.

Size 6 1/2 x 6 3/4 x 8 1/2 inches. Shipping weight 2 lbs.

No. 7304 "Crown" Toaster, as described

\$2.25

"Jewel" Electric Iron



Here is the electric iron which can be unconditionally guaranteed against mechanical and electrical imperfections and give perfect service and all at the remarkably low price of \$2.50. The "Jewel" iron can be used on any circuit of 110 volts either A. C. or D. C.

Base of heavy steel, shell very heavy and nickel plated. Cord is extra heavy and to prevent abrasion or breakage at the entering point in the shell of the iron is held rigidly by the special double ring brace attached to the cord and handle supports.

This iron heats quickly and retains the heat. It is decidedly economical, using far less current than similar low priced irons, now being sold by mail order houses. Irons far inferior to the "Jewel" are sold elsewhere for \$4.00 and over.

Shipping weight 8 lbs.

No. 7371 "Jewel" 6 Lb. Electric Iron, complete with cord, plug and stand

\$2.50



No. 7600

A flashlight closely resembling a standard fountain pen and about same size. It is carried just like a fountain pen; the clip-cap keeps it from falling out. A powerful light just where you want it. Weighs but little more than a fountain pen.

(Patented Sept. 24, 1914.)

Shipping weight 1 lb.

No. 7600 "Beacon" Ideal Fountain Lamp, complete with battery \$1.00
State if Nickel Plate or Black Rubber finish is wanted.

"Utility" Electric Toaster and Stove

Put it on the table beside you when you sit down to your meals. It will make toast faster than a family can eat it. The most digestible, delicious, sweet, moist toast. It is the most convenient cooking help ever put in a home. Cook your whole meal if you wish while you sit comfortably at the table.

Fry chops, eggs, or anything. Keep dishes warm on the table. It is always ready in the sick room for every emergency. Warm baby's milk by your bedside. For night lunch in your room. It is the quickest, safest, cleanest and most convenient stove for light housekeeping. For travelers it is light, small, compact and easy to carry. You can use it wherever electric lights are used.

The "Utility" Toaster Stove is the most economical electrical cooker on the market. It uses less than two-thirds the current of an ordinary toaster. Concentrated heat action and "Hold-Heat" material saves the heat which other toasters waste. Works on 110 volts A. C. or D. C. current.

No. 7312 "Utility" Electric Toaster Stove \$1.95
Size 6x2 1/2 inches. Shipping weight 5 lbs.

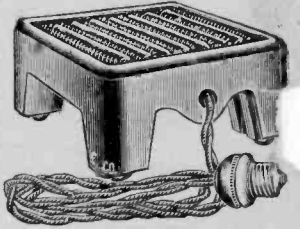

No. 7312

"Utility" 3 Heat Electric Heating Pad

The "Utility" Electric Heating Pad has displaced the bothersome hot water bottle, both for household and for hospital use. It has all the advantages of a hot water bottle and none of its disadvantages. The extremely soft, light, flexible "Utility" Pad readily adapts itself to any position of the body and will not injure the most sensitive flesh.

Stays hot all night (all year if you want it to). Never gets cold or clammy. Never needs filling and can't leak. Maintains absolutely even degree of heat. Is always under perfect control. Deliver any one of three degrees of heat. Always ready on an instant's notice. Has sanitary white washable cover. Weighs practically nothing. Will last a lifetime. Runs eight to sixteen hours for one cent. Guaranteed for one year.

This heating pad retails for \$5.50 to \$6.50 at the leading electric stores.

Size 12x15 inches. Shipping weight 2 lbs.
No. 7313 "Utility" Three-Heat \$4.50
Electric Pad, as described

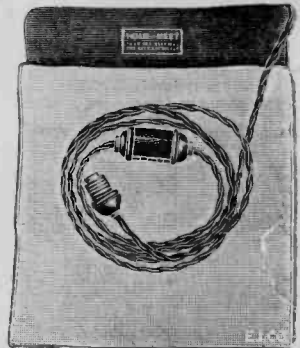

No. 7313

The "Diamond" Electric Water Heater

For those frequent occasions when you need hot water—a little of it, but quickly—the DIAMOND Water Heater is the thing.

Simply attach to the electric light fixture, immerse the heater and it heats the water in a few moments. Will boil a large glass of water in less than 2 minutes.

The DIAMOND Water Heater is simple, efficient and economical, sanitary and safe. With proper care it will last indefinitely. If worked under water or other liquid it will last for an indefinite period and will not burn out even if used for 10 hours at a time.

The size of this heater is 8 1/2 x 2 ins. Shipping weight 1 lb.

This heater sells at department stores for from \$3.00 to \$3.50.

No. 7314 "Diamond" Electric Water Heater \$2.00
as described. Price

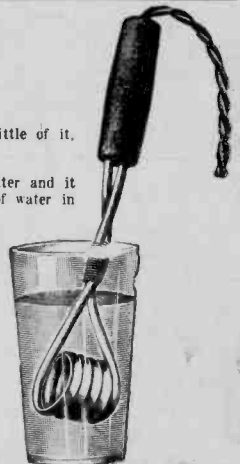

No. 7314

When ordering goods from this page enclose postage else goods must go by express. Shipping weights are given.

WAR IN EUROPE DOES NOT AFFECT OUR LARGE STOCKS. We ship within 24 hours as in the past. 95% of our goods are made in our factories in the U. S. Send 3 cents for our latest special catalog containing over 400 illustrations, 1600 articles and valuable information on Electricity and Wireless. Book also contains 20 coupons for 160-page free Wireless Course. Send for it now before you forget.

THE ELECTRO IMPORTING CO.

236 Fulton Street, New York City