

ME

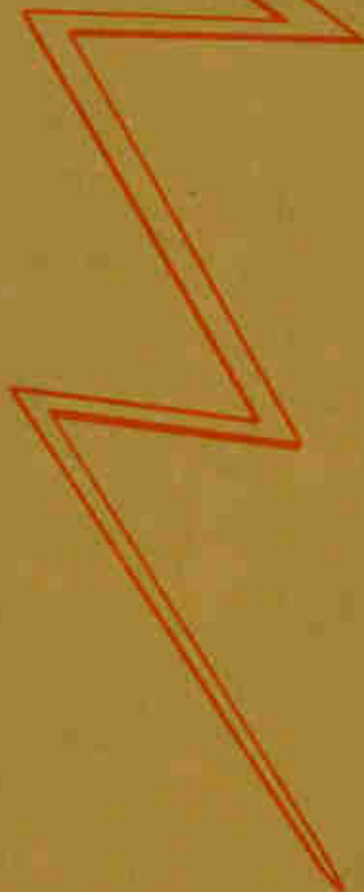

Van-Ashe Radio Co.

TENTH AND PINE

ST. LOUIS MO.

CATALOG 1925-26



"IF IT'S RADIO VAN-ASHE HAS IT"

PHONES
OLIVE 1046
OLIVE 8047**Van - Ashe Radio Company**

10TH - PINE

ST. LOUIS, MO.

To Our Customers:-

The Van-Ashe Organization is not one of the new Radio distributors which was organized in the hope of prospering on the present wave of Radio buying. Our Corporation is one of the Pioneers, and has won its place in the confidence of the hundreds of Radio dealers it has served. This confidence was built through our policy to co-operate with the dealer and to recommend and distribute only merchandise of the highest quality, being guided in this respect by the advice of our Engineers.

Realizing the ever changing demand for Radio parts we have never caused our customers to over stock by requiring them to buy large quantities of any one item in order to obtain the maximum discount.

Van-Ashe Wholesale Radio Service is real service to the dealer, as we stock the nationally advertised products that are in demand and recommended in the various circuits, hence the slogan: "If its Radio Van-Ashe has it."

We know that Radio Engineers in developing new circuits and designing new sets have reason for using certain makes of parts. Substitution creates doubt, and is not real service to the buyer.

The Van-Ashe Organization feels a deep responsibility to render only the Best of Service.

Sincerely,

Van-Ashe Radio Co.
W. W. Van Sickle
President.

Silver-Marshall, Inc.

On these pages will be found the principal parts manufactured by Silver-Marshall, Inc. These parts have been designed or developed by McMurdo Silver, Assoc., I. R. E., and have won the approval of radio engineers and editors the country over. Silver-Marshall parts and circuit designs have been advertised in all the national radio magazines and in the radio sections of the largest newspapers. And scores of newspapers from coast to coast every month publish the circuits and articles of McMurdo Silver. No missionary work is needed when you stock S-M Products. The radio public knows all about them. These parts work most efficiently when used with the famous Silver laboratory model Super-heterodyne and Super-heterodyne Silver Six designs, as well as the Four-Tube Knockout, all of which are described below.

Type 305, 306 and 307 S. L. W. Condensers

The Silver-Marshall Straight-Line Wave-Length Condensers were the first properly designed condensers of their type to be placed upon the market. They fill a long-felt need for a true straight-line wave-length condenser, which possessed not only this feature, but the balance of the design of which was in accordance with the best engineering practice.

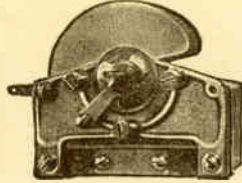

They are of the single-bearing type, equipped with a long cone brass bearing, adjustable, and an ingenious and original tension adjustment mounted on, but independent of the bearing. All plates are of heavily hardened and flattened brass, entirely silver-plated as are all current-carrying surfaces. This feature, in conjunction with the use of a minimum of high-grade insulation well out of the electro-static field results in this condenser having even lower losses than many laboratory standards. The single end plate, as well as the shape of the plates, is responsible for the very low minimum capacity and the exceptionally high capacity ratio.

- No. 305—.000009 to .0005 \$5.00
(9 to 500 MFD.)
- No. 306—.000008 to .00035..... 4.75
(8 to 350 MFD.)
- No. 307—.000007 to .00025..... 4.50
(7 to 250 MFD.)

Type 205 Low-Loss Antenna Coil

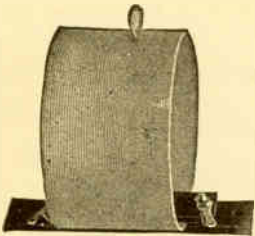

This coil has been designed for use as an antenna coupler in circuits designed for loop reception, or for any purpose where an absolutely low-loss moisture-proof inductance is needed.

It is wound upon air, being supported only by the compound with which it is moisture-proofed, and is clamped between two thin bakelite strips for mounting purposes.

It is composed of but a single winding, with both ends brought out to lugs, and a tap taken at the tenth turn.

- No. 205—Price, each..... \$2.50
- Loop Aerial (3-tap)..... 6.50

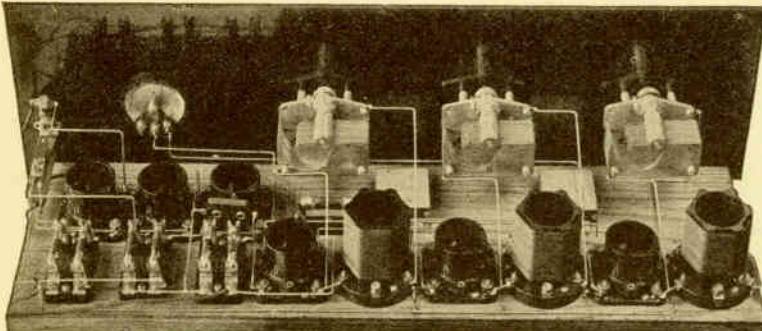

Two-Ten and Two-Eleven Transformers

The Silver-Marshall Type Two-Ten and Two-Eleven Long-Wave Inter-stage Transformers have been designed to meet the demand of more discriminating experimenters for intermediate frequency amplifying transformers of definitely known characteristics.



Heretofore transformers of this general type have been sold as "matched" or "tested," but with no definite data given out by the manufacturer as to just what was meant by "matching" or "testing." In no case has a manufacturer supplied definite amplification measurements with each transformer. This dearth of information has been due, aside from the skilled labor involved in making such measurements, to the fact that it has been impossible to produce radio-frequency transformers of uniform characteristics. It follows that if each transformer were measured, those varying from the prescribed standards would have to be discarded, if these standards were of sufficient rigidity to be of any value. Few manufacturers care to face the junking of a large portion of their output.

Supplied in sets of one Two-Eleven and two or three Two-Tens, with uniform curves and individual amplification charts.

Two-Ten is a long-wave inter-stage transformer peaking at 60 kilocycles and passing a frequency band 11 kilocycles wide. Its amplification is from 1½ to 3½ times that obtained with other transformers. It is of the iron core type, with an extremely small core of high-grade silicon steel, which accounts for its combining the best features of both iron-core and air-core transformers to an unequalled degree. Turn ratio, 1 to 2.3.

- No. 210—Price, each..... \$8.00

Two-Eleven is a sharply tuned transformer peaking at 60 kilocycles in conjunction with the tuning condenser supplied, connected across its primary (P to B). It is of the air-core type, and should be used at the input or output end of the amplifier. Turn ratio, 1 to 10.

No. 211—With Matched Tuning Capacities.

- Each..... \$8.00

The Silver Six

This set represents Mr. Silver's challenge to the Radio World and is a six-tube outfit that anyone can build in a few hours. Three stages of resistance coupled audio amplification result in a quality of reproduction never before experienced. The circuit is one of the most sensitive and selective ever developed, out-performing by far the work of the average super-heterodyne. It is a marvel of simplicity, and handles with equal efficiency all wave-lengths above 50 meters. The set operates with either one, two or three controls as desired, on either a loop or an antenna.

Style No. 600 contains all necessary parts for building the six-tube receiver, including drilled and engraved panels and all other parts.

- Price, Silver Six complete..... \$53.00

The Type No. 610 kit contains only the essential coils and condensers.

- Price, Silver Six Essential Kit only \$27.75

Silver-Marshall, inc.

101B Coupling Unit

Type 105 Low-Loss Coupler

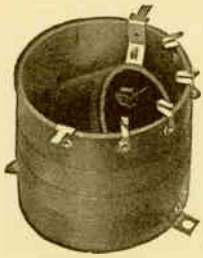

This Type 101B coupling unit supercedes the Type 101 unit, heretofore supplied with adjusting knob, which has been found unnecessary, since the coupler is used principally as an oscillator or antenna adapter, or as a radio frequency transformer. When the rotor position is once set, it need not be readjusted.

Both stator and rotor coils are wound with double green silk-covered wire upon genuine bakelite tubing, with leads brought out to soldering lugs on the stator tube. The stator tube is wound with two equal sections of No. 28 wire, and will cover a wave-length range of 150 to 550 meters when both coils are shunted with a .0005 Mfd. condenser.

The rotor coil is so arranged that a very great coupling variation may be obtained with respect to the stator. Its position may be adjusted with a pencil or the fingers, and when once set, will retain its position.

No. 101B—With mounting lugs attached.

Each.....\$2.50

Low-loss condensers have been in use for some time, but little attention has been paid to low-loss coil design.

Type 105 is composed of a low-loss stator coil wound with No. 20 double cotton-covered wire, rendered self-supporting by virtue of the insulating compound used to prevent moisture absorption.

A small rotor coil of twenty turns is provided at one end of the stator, and a small fixed coupling coil is wound inside the stator at its lower end. This renders the unit suitable for three-circuit tuned radio frequency or other circuits requiring a highly efficient inductance unit. All leads are brought to lugs mounted on the bakelite supporting strip. A tap is provided on the stator ten turns from the bottom.

Test conducted by Armour Institute of Chicago indicated that the windings of this unit had lower losses than similar coils wound on air, and untreated, in dry weather. In damp weather the undoped coils had five times the resistance of the Type 105 coils.

Wave-length range, with stator shunted by .0005 Mfd. condenser, 200 to 550 meters.

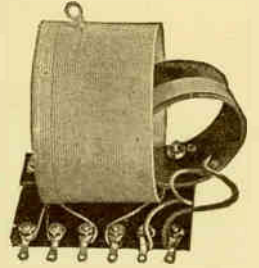

No. 105—With mounting screw. Each.....\$5.00

The Silver Four-Tube "Knockout"

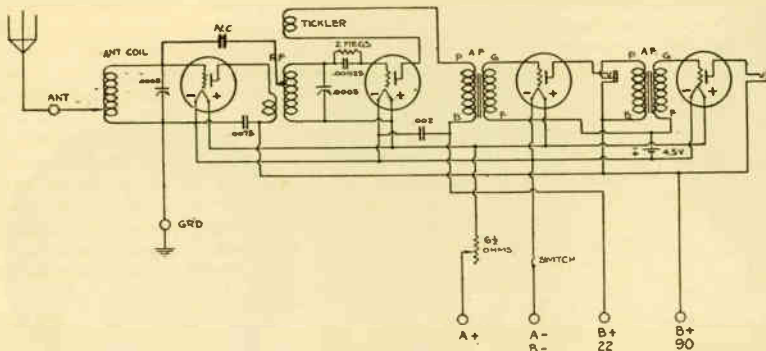

This receiver is considered by radio experts as the ultimate in four-tube performance. Uses only a 70-foot aerial and will do the work that any average super will do on a loop.

It is so simple to construct that the novice can construct it in a short time. Easy to operate. Parts mouned on panel. No base-board or complicated wiring.

The selectivity, volume and clarity of tone cannot be surpassed with Silver's Knockout Set.

Complete Parts for Knockout Circuit.....\$44.40 With solid walnut cabinet.....\$58.40

McMurdo Silver's Booklet on the Construction of the Knockout may be had for..... .25

The Silver Super-Autodyne

McMurdo Silver's latest contribution to the radio art is this six-tube super-autodyne design—the perfected super-heterodyne.

Since its introduction in June it has been tested and approved by all the radio magazines. It will achieve seven and eight-tube results, with just as much volume and distance as the seven-tube laboratory model, although with not so much selectivity. The tone has never been surpassed. Easy to build in either portable or permanent type. The first practical six-tube super-heterodyne. Works from a loop aerial only and with wet or dry batteries.

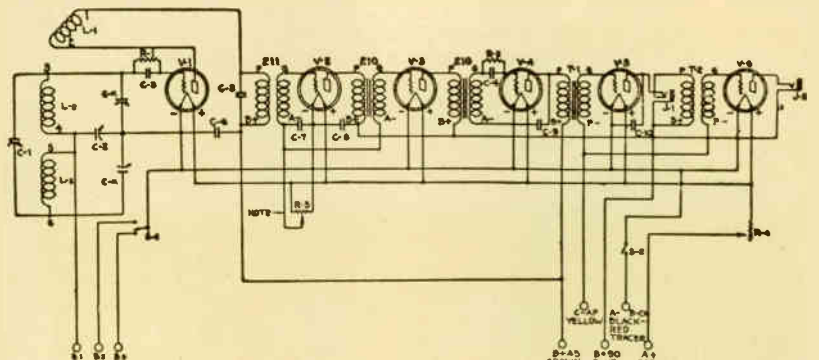

Super-Autodyne Instruction Blue Prints. Each.....\$ 0.50

Complete parts with the new Silver-Marshall silver-plated straight-line wave-length condensers and bakelite-cased intermediate transformers..... 79.80

With solid walnut cabinet..... 94.80

We have just received booklets on the new improved Silver-Marshall Laboratory Super-Heterodyne Set, using seven tubes with new interchangeable coils which gives the set a range of from 50 to 1000 meters.

Price, each.....\$0.10

Weston

Weston Radio Table Voltmeter

(Size: 3 3/4 inches long, 3 1/8 inches wide, 1 7/8 inches high.)

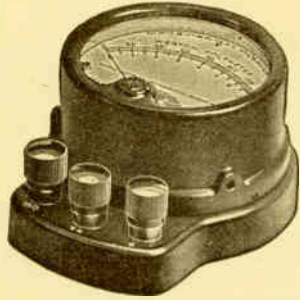

An indispensable radio table voltmeter for measuring filament, plate and grid voltages, checking battery conditions and locating broken or loose connections.

Because of its relatively high resistance, 62 ohms per volt, it causes very little drain on the batteries.

Each Model 489 is provided with a pair of flexible cables and pin jacks for permanently connecting the filament circuits to the panel. The voltmeter can then be readily plugged into the circuit at will. A set of instructions for making radio tests accompanies each instrument.

This voltmeter is made in double range, 150 and 7.5 volts. It has a silver etched scale and is enclosed in a handsome bakelite case.

No. 489—Price, each.....\$13.50

Weston Direct-Current Voltmeters

(Flange diameter: metal case, 3 1/4 inches; bakelite case, 3 3/8 inches.)

Their size and accuracy, for the job of measuring filament and plate voltages, put them ahead of all others in the small instrument class.

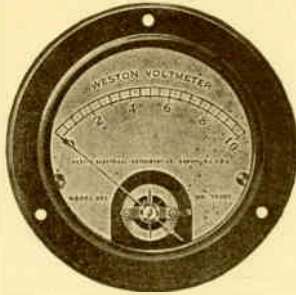

Range, 7 volts; Model 301.	Price....	\$ 8.00
Range, 8 volts; Model 301.	Price....	8.00
Range, 10 volts; Model 301.	Price....	8.00
Range, 15 volts; Model 301.	Price....	8.00
Range, 50 volts; Model 301.	Price....	8.00
Range, 100 volts; Model 301.	Price....	11.00
Range, 150 volts; Model 301.	Price....	11.00
Range, 500 volts; Model 301.	Price....	13.00
Range, 1000 volts; Model 301.	Price....	24.75
Range, 1500 volts; Model 301.	Price....	30.75
Range, 2000 volts; Model 301.	Price....	36.75

Weston Direct-Current Ammeters

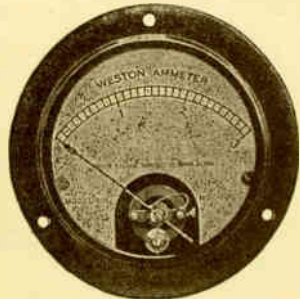

Ammeters and low-range voltmeters can be supplied with bakelite cases at 75 cents extra.

Range	Model	Price
1.5 AM.	301	\$8.00
3 AM.	301	8.00
5 AM.	301	8.00
10 AM.	301	8.00
15 AM.	301	8.00

Weston Milliammeter

Range, 5 MA.; Model 301.	Price.....	\$10.00
Range, 100 MA.; Model 301.	Price.....	8.00
Range, 200 MA.; Model 301.	Price.....	8.00

Small Radio Frequency Instruments

Thermo-Couple Type

(Flange diameter: metal case, 3 1/4 inches; bakelite case, 3 3/8 inches.)

The Weston Thermo-Couple Type Ammeter is one of the most noteworthy contributions to the art of radio transmission as well as to the art of electrical measurement.

It eliminates all the numerous objections of the "hot-wire expansion" type instruments such as sluggish indications, zero shift with consequent errors and errors due to surrounding temperatures, or temperature in the instrument itself and will measure accurately on direct current as well as alternating currents at low frequency.

1.5 amps., 3 amps., 5 amps.; Model 425.

Each.....\$17.00
10 amps, 20 amps. Each..... 18.00

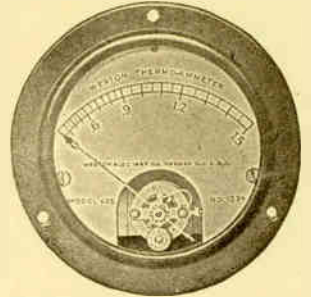

Weston Thermo-Galvanometer

(Flange diameter: metal case, 3.25 inches; bakelite case, 3.375 inches.)

A sensitive thermo-couple type instrument for the indication and measurements of A. C., of either low or high frequency.

Designed especially for use in a wave meter circuit for the measurement of wavelength and decrement, and for the measurement of high frequency resistance by the resistance and reactance variation methods. The scale is calibrated in terms of the square of the current. It requires only 115 MA. for full scale deflection and has a resistance of 4.5 ohms.

No. 425—Price, each.....\$18.50

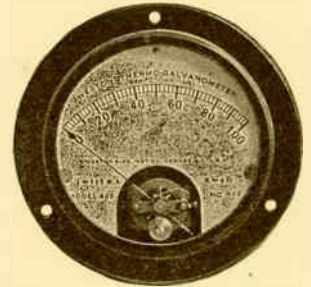

Weston Radio Plug

The Pioneer Instant-Change Radio Plug



Frequently imitated, but never equaled. Two seconds from headphones to loud speaker. Beautifully made with genuine bakelite case. TO SEE IT IS TO WANT ONE.

To connect, just push the terminals in.

To disconnect, press the terminals and pull the cables out.

Weston Plug. Price, each.....\$0.60

WESTON

UNIVERSAL

The New Weston Radio Panel Voltmeter

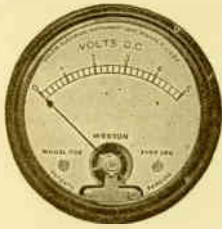

Model 506 Voltmeters are instruments of distinction. They have been especially developed for service in connection with radio receiving sets. This means that every part has been designed and constructed in such manner that the completed instruments shall, in fact, be high grade, dependable products, notwithstanding that the dimension of the containing case has been reduced to a 2-inch diameter. It also means that electrical adjustments and selection of ranges have been made to properly conform to the essential requirements whether they be merely to measure filament voltage of a single tube, or to measure voltages at various points of the receiving circuit, including "A" and "B" batteries.

We, therefore, wish to emphasize that Model 506 is not merely an instrument of small size. On the contrary, notwithstanding its small size, it is an excellent voltmeter of standard Weston quality and workmanship, and purchasers may feel assured that it will render an unequalled character or permanently satisfactory service.

Model 506 Voltmeters

Single Range (Two Binding Posts)

3, 5, 7, 8, 10, 15, 50 or 150 volts. Price, ea. \$7.00

Double Range

(Three Binding Posts With Push Button)

125/5, 140/7 or 150/7.5 volts. Price, each. \$9.00

Double Range

(Four Binding Posts Without Push Button)

125/5, 140/7 or 150/7.5 volts. Price, each. .8.25

Weston Portable Mounting Base

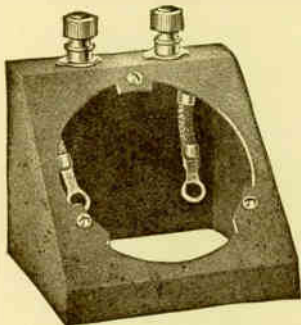

Designed so that Models 301 and 425 instruments may be used as portable units, or where space does not permit the mounting of an instrument on the panel. Furnished with an alligator finish.

Price, each \$2.75

Battery and Radio Clips

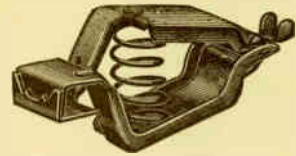

Made of steel, lead coated. Teeth on one jaw and notch on the other. Will stand up on a battery post without lopping over; 40-lb. spring; jaw spread, 1½ inches; rated capacity, 35 amperes, but due to a copper shunt around the spring it will carry a big overload on short tests. Standard equipment in battery service stations for constant potential and series charging systems.

In radio work recommended for "A" batteries and as a ground connection. The lead coating protects it against acid and rust.

No. 21-A—3¾ inches long. Price, each . . . \$0.20

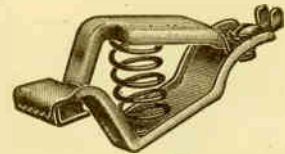

Made of steel, lead plated. Teeth on one jaw and notch on other. Will stand up on battery post without lopping over; 18-lb. spring; jaw spread, 1 inch; 15-ampere capacity.

For use on all types storage batteries. Lead coating protects the metal against acid. Standard equipment with manufacturers of rectifiers.

No. 24-A—2½ inches long. Price, each . . \$0.12½



Made of steel, lead plated. Teeth on one jaw and notch on other. Will stand up on battery post without lopping over; 14-lb. spring; jaw spread, ¾ inch.

For use on "B" storage batteries. Lead coating protects the metal against acid. Standard equipment with manufacturers of "B" storage batteries and rectifiers.

No. 48-B—1¾ inches long. Price, each . . \$0.07½



Teeth on all three sides of both jaws; 12-lb. spring; jaw spread, ⅞ inch.

For use on dry cells, transformers and other radio apparatus. Capacity, 10 amperes.

No. 27—2¼ inches long. Price, each . . . \$0.12½



Teeth on both jaws and 7-lb. spring assures good contact. Jaw spread, ⅜ inch. For use on dry batteries and other points where lack of space is a factor.

No. 45—Pee Wee, 1½ inches long. Price, each \$0.05

REMLER

Remler Twin-Rotor Condenser

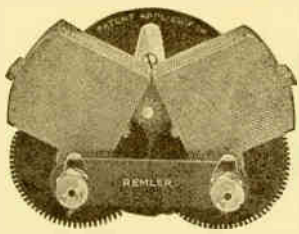

Development of the Remler Twin-Rotor Condenser has marked a distinct advance in the efficiency of the variable condenser. This Remler unit, original in design, brings into play a tuning range heretofore unattainable. Among the outstanding features of this unit are: The use of twin rotors in place of the usual rotor and

stator construction, allowing the attainment of straight-line wave-length characteristic in compact forms; unusually large bearing surfaces, insuring smooth running; correctly designed reduction gearing, eliminating clicks or back lash; 360-degree dial motion, allowing easy tuning on short-wave stations and attainment of the highest ratio of maximum to minimum known, 165 to 1.

No. 631—.0005. Price, each.....\$5.00

The Remler 63-Degree Recording Dial

Is a fitting index to the advanced character of this unit throughout. The dial is four inches in diameter, with a large bakelite knob, and is equipped with a removable paper chart. A permanent record of the adjustment for each station is kept simply by writing its call letters in the space provided opposite the reading at which the station is obtained. Extra charts are included with each unit, and a change may be made by unscrewing the bakelite knob.

No. 630—.00035. Price, each.....\$5.00

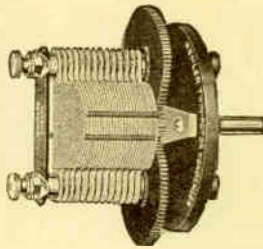

Remler Coupling Unit

Remler Type 620 Coupling Unit is made specially for use in a super-heterodyne circuit. The balanced winding permits the employment of an oscillator circuit, which furnishes a uniform output over the entire broadcast wave-length range. Pig-tail connections, 180-degree coupling, table or panel mounting. Windings are of green silk-covered wire

on bakelite tubing; over-all height, 3 1/4 inches.

No. 620—Price, each.....\$3.00

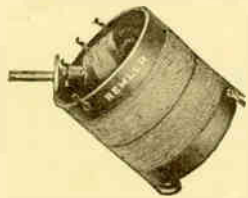

Remler Intermediate Transformer

The Remler Type 600 Intermediate Transformer is designed to provide one or more stages of amplification at long wave-length or low frequency and will produce satisfactory amplification when used at any frequency between 30 and 90 kilocycles. In super-heterodyne circuits radio engineers agree the best results are obtainable when the amplification is employed at a frequency of approximately 45,000 cycles. This transformer is ideal for such use, as maximum and uniform amplification is obtained between 40,000 and 50,000 cycles. Balanced winding eliminates electro-static capacity and insures maximum stability in operation. It is possible to provide the proper grid bias, thus securing maximum amplification from the tubes without the necessity for using a grid potentiometer or stabilizer.

No. 600—Price, each.....\$6.00



Remler Tuned Stage Transformer

Both Types 600 and 610 have their windings mounted on small bakelite castings, and are enclosed in compact and beautifully finished bakelite cases. All terminals are brought out at the top and marked to designate their proper connection to the associated parts of the amplifier. Every Remler transformer receives a careful individual test of frequency characteristic and voltage amplification before leaving the factory.

No. 610—Price, each.....\$5.00



Remler Socket

Remler Type 399 Socket is designed for the accommodation of the Cunningham dry battery tube C-299. Among other important improvements the socket automatically cleans the contact points of the tube as it is inserted. The use of this socket simplifies the wiring of multi-tube receiving sets to an extent that is unattainable with any other type.

No. 399—Price, each.....\$0.75



Complete Parts Best's 45,000-Cycle Super

- 3 Remler No. 600 Transformers, at \$6.00.....\$18.00
- 1 Remler No. 610 Transformer..... 5.00
- 1 Remler No. 631 Oscillator..... 3.00
- 2 Thordarson Transformers, at \$5.00..... 10.00
- 2 Single Circuit Jacks (closed) No. 2A, at 60 cents.. 1.20
- 1 Single Circuit Filament Control No. 3..... .70
- 1 10-Ohm Rheostat..... 1.35

- 1 30-Ohm Rheostat.....\$ 1.35
- 2 Remler Variable Condensers, at \$5.00..... 10.00
- 1 Midget Condenser..... 1.50
- 7 Benjamin Sockets, 199, at \$1.00..... 7.00
- 1 Benjamin Socket, Standard..... 1.00
- 1 0-5 Weston or Jewell Voltmeter..... 8.00
- 1 Yaxley Jack Switch No. 40..... 1.00

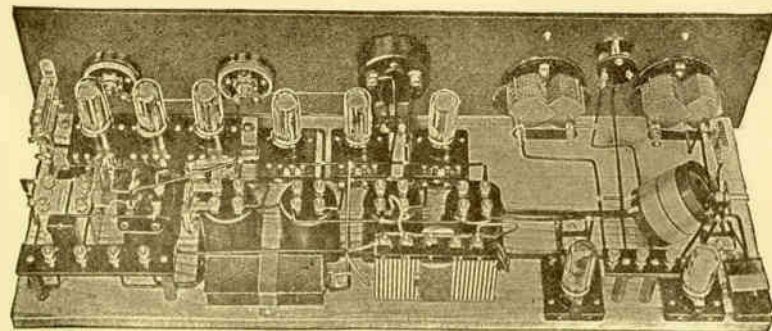

- 2 Dubilier By-Pass Condensers, 2 MFD. \$1.75 each..... 3.50
- 2 Dubilier Micadons, .006 Cap., at 75c..... 1.50
- 1 Dubilier Micadon, .00025 Cap..... .35
- 3 Dubilier Micadons, .0025 Cap., at 40c..... 1.20
- 1 Dubilier Micadon No. 640, .0005 Cap..... .55
- 1 2-Megohm Grid Leak..... .30
- 1 1A Amperite..... 1.10
- 10 Eby Binding Posts, at 15 cents..... 1.50
- 1 7 1/2-volt "C" Battery..... .85
- 1 6x26 inch Formica Panel..... 3.65
- 1 9x25 1/2 inch Baseboard..... 1.00
- Miscellaneous Screws, Bakelite Strips, Bus Bar and Spaghetti Tubing.... 2.50

Total.....\$87.10

Special Solid Walnut Cabinet for above.. 22.50

Van-Ashe Radio Company, St. Louis, Mo.

Frost Sockets

FROST-RADIO FROST FONES

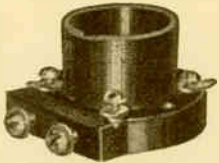

FROST-RADIO
No. 612

Note our new shock absorber sockets, cushioned with finest sponge rubber, and fitted with fusible coiled "lead" wires which remove all direct contact with the base and make these sockets absolutely non-microphonic.



FROST-RADIO
No. 617

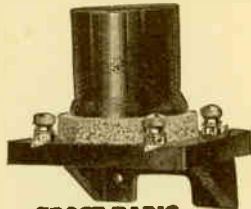

FROST-RADIO
No. 618

- No. 612—Bakelite Socket for C-299 Tubes \$0.65
 No. 618—Bakelite Shock Absorber Sockets, standard base..... 1.25
 No. 617—Bakelite Shock Absorber Socket for C-299 Tubes..... 1.25
 (No. 612 and No. 617 for 199 and 299 tubes.)
 (No. 618 for standard base.)



FROST-RADIO
No. 616

- No. 616—Bakelite for 199 and 299 Tubes... \$3.25
 No. 619—Bakelite for standard base..... 3.25

Pan-Tab Jacks

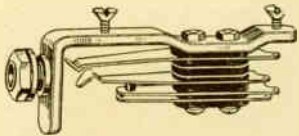

No. 224—4 spring, for radio frequency circuits. List price.....\$1.00

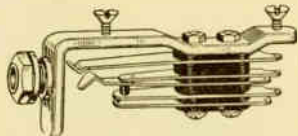

No. 225—5 spring, for radio frequency circuits. List Price.....\$1.00

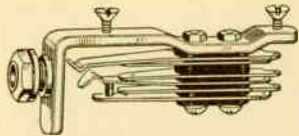

No. 226—6 spring, for radio frequency circuits. List price.....\$1.00

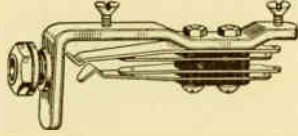

No. 231—A double circuit jack of superb quality. List price.....\$0.90

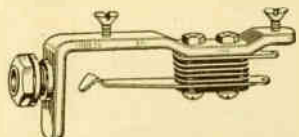

No. 233—A dependable first quality open circuit jack. List price.....\$0.70

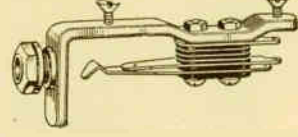

No. 234—A closed circuit jack that is widely used. List price.....\$0.80

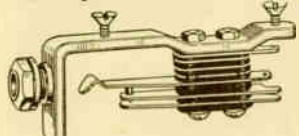

No. 235—The ideal jack for filament control purpose. List price.....\$0.95

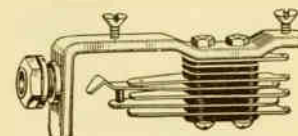

No. 236—Another high quality filament control jack. List price.....\$1.00

- No. 172—Frost Fone, 3200-ohm, double headset, bakelite shell and cap type, complete..\$6.00
 No. 174—Frost Fone, 2000-ohm, new model double headset, aluminum shell type, complete.....\$3.00
 No. 175—Frost Fone, 3000-ohm, new model double headset, aluminum shell type, complete.....\$3.50

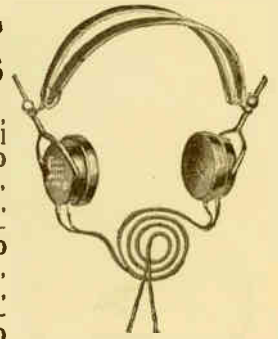

Frost Musette Speaker

A wonderful advance has been made in the development of the loud speaker through the introduction by us of Frost-Radio Musette—"The Stradivarius of Radio."

The base and throat are made from cast aluminum—the ideal material for the true reproduction of sound waves and their proper amplification.

- No. 10-B — Frost-Radio Musette, black crackle finish. Complete with cord.\$12.50



Frost Extension Cord

The proper means of connecting your loud speaker to your set.

- No. 322—30 feet Frost Radio extension cord, twin conductor.....\$2.50

Frost Radio Loop Aerial Plug and Jack

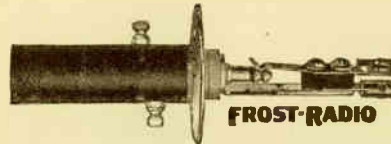

Designed to mount on top of cabinet in a vertical position. It provides a sturdy plug into which loop aerial may be fitted.

- No. 250—Loop Aerial Plug and Jack. Each.\$1.50

Frost Switches

- No. 620 — Potentiometer switch, \$0.50

- No. 621—Series Parallel Switch, \$0.50

Very efficient and well made switches.

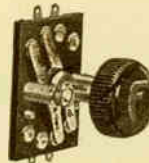

621 B

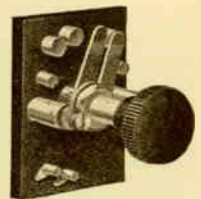

FROST-RADIO
620 B

New CX and UX Sockets

Made of genuine bakelite. This is a standardized socket to be used in connection with the new CX and UX tubes.

- No. 50—Remler Socket. Each...\$0.75

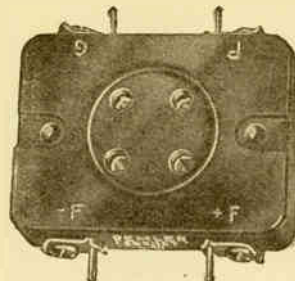

BENJAMIN CLE-RA-TONE SOCKET

CLEARER RADIO TONE

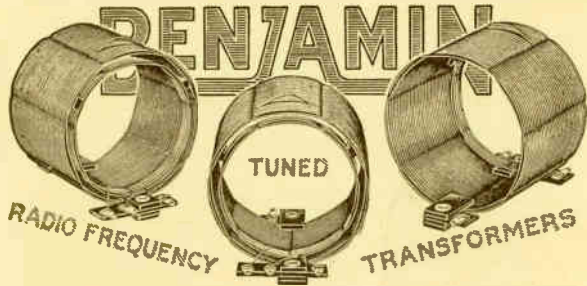

Benjamin Tuned Radio Frequency Transformers represent an advance in scientific design by which the following advantages are gained:

1. Minimum distributed capacity and greater tuning range.
2. Maximum inductance.
3. Minimum resistance.
4. Minimum capacity coupling between primary and secondary.

The uniform spacing of the wires makes these transformers admirably adaptable for single control.

Insulated wire used is of the highest quality and a waterproof anti-capacity cement is used where wires cross.

The coils are extremely rigid and can not be destroyed in ordinary use; due to their perfect mechanical design, each turn automatically forms a truss for bracing adjacent turns.

Set of three Transformers. List price \$7.50

Single Transformer. List price 2.75

Variable (Low-Loss) Condenser

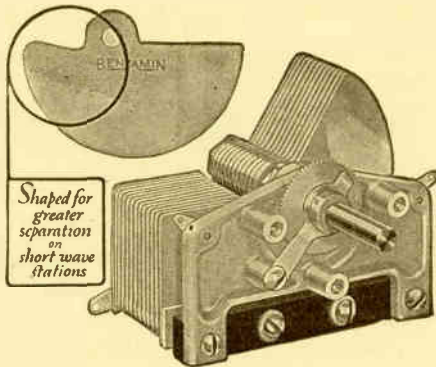

New features in design of the Benjamin Low-Loss Condenser are:

1. All metal frame.
2. No insulated bushings.
3. Frictional adjustment of the rotor shaft.
4. Specially designed shape of rotor plate.

Frictional adjustment of the rotor shaft to suit the user's need can be accomplished by the turning of an adjusting thumb nut. This adjustment does not loosen the rotor plates or throw them out of alignment.

The special shape of the rotor plates not only gives greater separation on short-wave stations, but the following desirable results also:

- (a) Positive control of minute changes in condenser capacity.
- (b) Sharper tuning.
- (c) Greater selectivity.

There being no rear-end plates makes this condenser very small, which reduces the condenser resistance. Resistance is also reduced by the use of a minimum amount of insulation so arranged that leakage must go through long paths outside the strongest field.

Due to its small size, the condenser is adaptable to any type of set. A drilling template is supplied with each condenser.

Finish: Silver plate, unpolished.

Cat. No.	Capacity Mid.	Description	List Price
8660	.00025	13 Plates	\$4.50
8661	.00035	17 Plates	4.75
8662	.0005	25 Plates	5.00

Cle-Ra-Tone Sockets

Stop tube noises in radio reception by counteracting the mechanical shocks which ordinarily would be transmitted to the tube filament. Vibrations that are permitted to reach the filament of the tube set it in motion and are reproduced as very annoying microphonic disturbances.

Here are some additional advantages:

1. Life of tube is lengthened by shock absorbing feature.
2. Spring suspension not affected by stiff bus wiring.
3. Ample separation between contacts.
4. Made of moulded bakelite, highly polished.
5. Indispensable for portable sets.



Cat. No.	Description	List Price
8645	For Standard Base Tubes	\$1.00
8646	For UV-199, etc., Tubes	1.00

Cle-Ra-Tone Gang Socket—Shelf Type



The Gang Sockets listed below have a polished black finish.

With Standard V. T. Sockets

Cat. No.	No. of Sockets	Shelf Size	List Price
9023	3	7 $\frac{7}{8}$ x4 $\frac{1}{8}$ x $\frac{1}{4}$ in.	\$4.25
9025	5	17 $\frac{1}{4}$ x4 $\frac{1}{8}$ x $\frac{1}{4}$ in.	8.00
9026	6	17 $\frac{1}{4}$ x4 $\frac{1}{8}$ x $\frac{1}{4}$ in.	8.75
9027	7	17 $\frac{1}{4}$ x4 $\frac{1}{8}$ x $\frac{1}{4}$ in.	9.50

With Sockets for UV-199, Etc., Tubes

Cat. No.	No. of Sockets	Shelf Size	List Price
9003	3	7 $\frac{7}{8}$ x4 $\frac{1}{8}$ x $\frac{1}{4}$ in.	\$4.25
9005	5	17 $\frac{1}{4}$ x4 $\frac{1}{8}$ x $\frac{1}{4}$ in.	8.00
9006	6	17 $\frac{1}{4}$ x4 $\frac{1}{8}$ x $\frac{1}{4}$ in.	8.75
9007	7	17 $\frac{1}{4}$ x4 $\frac{1}{8}$ x $\frac{1}{4}$ in.	9.50



Cat. No. 8640

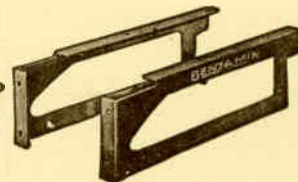

Cat. No. 8629



Cat. No. 8632

Cat. No.	Description	List Price
No. 8640	—Benjamin Radio Battery Switch . .	\$0.30
No. 8629	—Benjamin Shelf Supporting Bracket70
No. 8632	—Benjamin Grid Leak Panel15

Thermiodyne

Reg. U. S. Pat. Off. [Ther-my-odyne]
Licensed under Trade and other patent pending

Model TF6—The New Six-Tube Thermiodyne

A powerful, smooth-working, beautiful instrument, with three stages of thermionic frequency, detector and two stage of audio frequency. Six tubes. One master control. Indoor or outdoor antenna. Genuine walnut cabinet with interior compartment for "B" battery. Height, 12 inches; length, 29 inches; depth, 12½ inches.

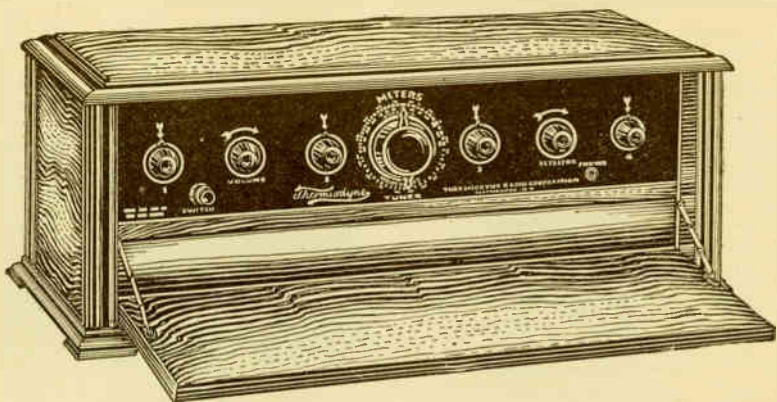

Price (without accessories)\$150.00

Model TF5—The New Five-Tube Thermiodyne

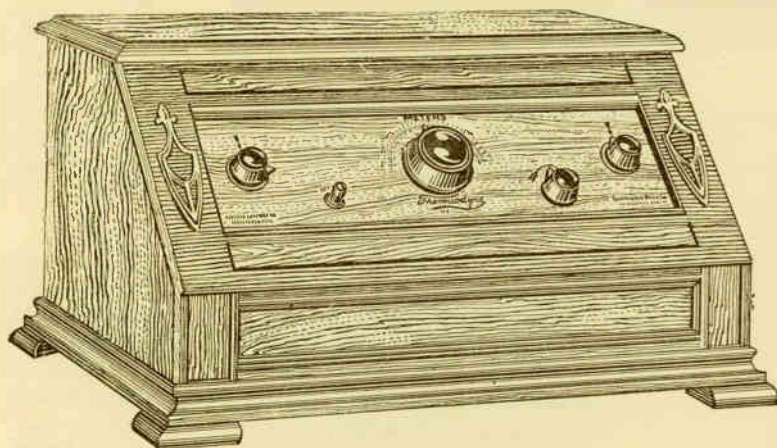

An efficient master control radio built on the same successful principles as TF6, and possessing phenomenal selectivity, distance-getting ability and tone quality. A receiver that cannot be surpassed in excellence of performance by any other receiver at any price.

Two stages of thermionic frequency, detector and two stages of audio frequency. Five tubes. One master control. Outdoor antenna.

and handsomely finished in duotone walnut. Height 12⅝ inches; length, 23 inches; Depth, 17 inches.

Price (without accessories)\$100.00

Model CTF6

In this Thermiodyne Console De Luxe are all of the virtues of Model TF6, combined with a magnificent console cabinet of genuine walnut with built-in loud speaker, and space for batteries and charger. All equipment concealed. No wires required for local stations. Height, 53 inches; length, 33 inches; depth, 15½ inches. Without tubes, batteries or charger.

Price\$275.00

Speaker Table

A handsome, well-constructed table with built-in loud speaker, speaker unit and horn, and ample room for batteries and charger. The tones filter through the open grille work in any volume desired. Constructed of genuine walnut and finished to match Model TF6. Height, 31 inches; length, 32 inches; depth, 14 inches.

Price\$60.00

Our Territory on THERMIODYNE SETS: SOUTHERN ILLINOIS, EASTERN MISSOURI



Sangamo Mica Condensers

Accuracy Guaranteed

Sangamo Mica Fixed Condensers are guaranteed to be accurate to within 10 per cent under all temperature and humidity conditions. Neither the intense heat of soldering, nor the dampness of the rainy season will impair the accuracy of these condensers. Even at the seashore where the salt air creeps in to change the capacity of exposed condensers, the accuracy of the Sangamo is not affected in the least.

The average accuracy of these condensers is much closer than the accuracy guaranteed and is far higher than the average accuracy of fixed condensers. Rough handling, absorbed moisture and soldering frequently result in great deviation in other types, but will not affect Sangamo condensers.

Entirely Enclosed for Protection

The Sangamo Condenser is molded in bakelite, which completely excludes all moisture and protects the condenser from changes in capacity due to pressure, accidental falls or high temperature. The high ribs and rounded edges give great mechanical strength.

Neat and Compact

Molded in smooth brown bakelite, the Sangamo Condenser presents a pleasing appearance that adds to the attractiveness of any set, instead of standing out as untidy spots that mar neat workmanship. For the first time, you can now buy fixed condensers that harmonize with other finely made parts.

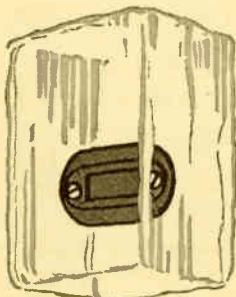

Sangamo Mica Condensers can be frozen in a cake of ice without injury or change in capacity.

Easy Soldering Connections

For ordinary connections use the binding screws and solder in the ordinary way. Fig. 1 shows another method of connection, in which the wire or bus bar passes right through the terminals and the condenser is used as a physical support for long leads. There is no paraffine or other melt-able material that can be harmed in soldering. Much easier to put on without burning your fingers.

This condenser is also supplied with resistor clips at an extra charge of 10 cents.

Insist on Sangamo

The difference in quality between the Sangamo and the common fixed condenser is so great that you cannot afford to accept any substitute. It is exactly what you have been looking for—accurate, compact, sturdy, neat and easy to connect—and it is guaranteed to stay accurate.

Sangamo Accuracy

High accuracy, sustained in service, has been inseparably identified with the name "Sangamo" for over a quarter of a century. It has won worldwide renown for Sangamo Meters, found in the majority of electrically wired homes. Linked with a reputation for accuracy too great to be jeopardized by the least deviation from its high standards, the name "Sangamo" is your assurance of the highest accuracy obtainable in radio parts.

Actual size: 1 3/4 inches long, 1 3/8 inches wide, and 1/2 inch thick, including reinforcement ribs.

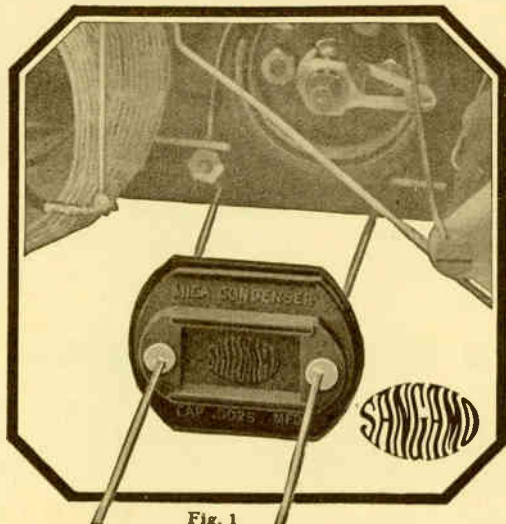
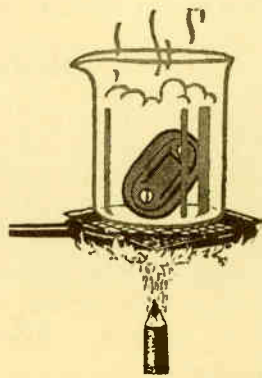

Fig. 1

You can use the Sangamo Mica Fixed Condenser as a bus bar spacer and support. Simply run the bus bars through the holes for the binding screws and solder. No need of cutting bus bar.

List Prices

.00005 Mfd.	\$0.40	.001 Mfd.	\$0.50
.0001 Mfd.40	.0015 Mfd.50
.00015 Mfd.40	.002 Mfd.50
.00025 Mfd.40	.0025 Mfd.50
.0005 Mfd.40	.005 Mfd.70
.003 Mfd.60	.006 Mfd.85
.004 Mfd.60	With resistor clips, ex.10



Sangamo Mica Fixed Condensers can be kept in boiling water for several hours without affecting their appearance or their accuracy.

Van-Ashe Radio Company, St. Louis, Mo.

Acme Wire

Acme Spaghetti



We wish there were a better name for a high-grade flexible varnished tubing than "spaghetti." But so it has been christened in radio and "spaghetti" it shall be. Acme spaghetti is a superior insulating tubing to be slipped over round or square bus-bar wire.

Five colors: Yellow, red, green, brown and black. Five sizes: 12, 13, 14, 15 and 18, the number being

the round wire size it is made to slip over. If you use square wire and want an easy fit order spaghetti two sizes larger than for round wire of the same size. Of course, it is oil, moisture and acid-proof, and is a real electrical insulation. Cut in 30-inch lengths.

Acme Spaghetti, 30-inch lengths. Each \$0.10

Acme Non-Inflammable Celatsite Wire

A New Hook-Up Wire

The new circuits call for covered wire in the hook-up. Protection for all circuits. The old circuits need it just as much.

Celatsite is a No. 14 tinned copper wire .064 in. diameter covered with an improved non-inflammable spaghetti insulation to an outside diameter approximately .110 inch. Smaller in outside diameter than spaghetti over bare wire and makes a neater job. The insulation strips easily, doesn't crack on the bends and will stand a high voltage. It is moisture-proof and will not burn from touching a hot soldering iron. Made in five colors: Black, yellow, red, green and brown. Cut in 30-inch straight lengths. It has the unqualified endorsement of the leading radio engineers and designers.

Acme Celatsite Wire, 30-inch lengths. Each . . \$0.10



Flexible Celatsite Wire

(Stranded)



If you do not like the rigid bus bar type of wiring, but want to hook up your receiving set by direct "point to point" wiring, in the manner of the telephone switchboard, you can do this best with Acme Flexible Celatsite Wire which has all the merits of solid Celatsite, but is made by twisting a number of fine tinned copper wires into a cable and covering with the improved non-inflammable Celatsite compound.

This insulation will not ignite from a hot soldering iron and can be easily removed for making connections. For convenience flexible Celatsite is put up in coils of 100 feet and in five colors: black, yellow, red, green and brown.

Acme Flexible Celatsite Wire (Stranded). Per foot \$0.05

Permway Soldering Iron

The Permway Soldering Iron is Different

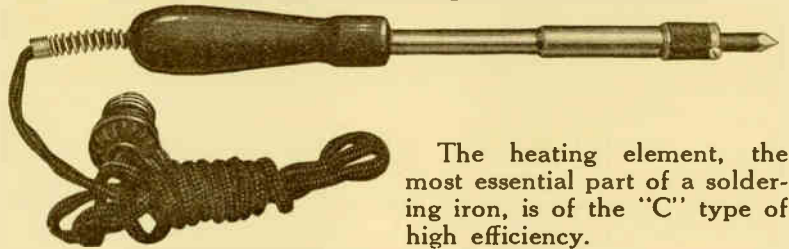

The heating element, the most essential part of a soldering iron, is of the "C" type of high efficiency.

The heat is where you want it—at the top, and not in the handle. The tip is adjustable to fit the requirements of all soldering jobs—from heavy duty to extremely light duty.

This illustration shows the adjustable screw by which it is possible to set the soldering tip at its best working point.

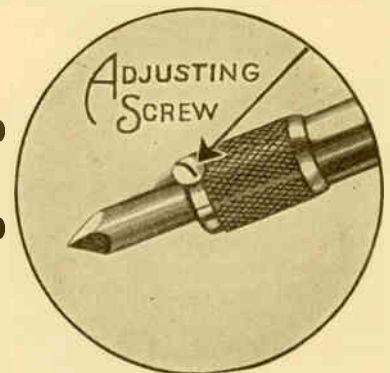

No. 1 Permway Iron \$4.00

No. 2 Permway Iron \$5.50

(No. 2 Extra Heavy Duty)

Uncle Sam Coils

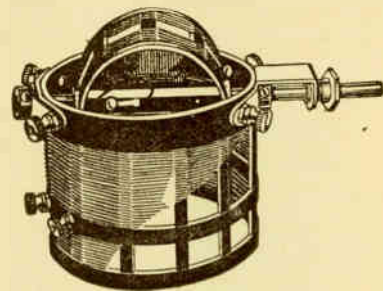

1. This coil is wound on latted molded hard rubber, giving compactness and rigidity with low losses.

2. Special Ambassador Litzendracht wire is used which spaces wire as well as each strand of wire.

3. The rubber forms are similar to the ones used by the Bureau of Standards in their inductance standards.

4. The Bureau of Standards wind their coils by spacing the wire—Ambassador Litz does the same thing.

5. Adhesives are eliminated in winding this coil and tests prove a low-loss coil cannot be made if adhesives are used.

6. The contacts are self-cleaning and adjusting through compensating phosphor bronze springs.

Low-Loss Baby Coil. Each \$6.00

Regular Low-Loss Coil. Each 6.00

Van-Ashe Radio Co.

TENTH AND PINE

ST. LOUIS, MO.

Erla Reflex Kits

(Old Style)

- One-Tube Erla Duo-Reflex. List.....\$19.50
- Two-Tube Erla Duo-Reflex. List..... 29.50
- Three-Tube Erla Duo-Reflex. List..... 39.50
- Four-Tube Erla Duo-Reflex. List..... 44.50
- Five-Tube Erla Duo-Reflex. List..... 49.50
- Five-Tube 199 Loop Duo-Reflex. List..... 49.50

Shamrock-Harkness Reflex Kit

(Old Style)

- Three tubes. Each.....\$39.50

Branston Super-Het Kit

(Old Style)

- Reflex (199 tubes). Each.....\$35.00

Super-Heterodyne

The "Pacific Quintet" Super-Het Kit

- 45,000-Cycle. Each.....\$15.00

Lugs

- Liberty Lugs. Per dozen.....\$0.10

Polyplug

Eliminates every inconvenience so annoying in the operation of the unsatisfactory screw type plug. There is no necessity to take Polyplug apart, no screws to tighten, and what's even more important, positive contact is always maintained.

- Price, each.....\$0.75

N. & K. Phones

The casing, instead of the usual stamped aluminum, is of brass, heavily nickel plated inside as well as outside. The ear cap, large enough in size to cover the entire ear and exclude interrupting outside sounds, is of hard polished rubber and has a fine machine-cut thread insuring perfect seating of the diaphragm. The head bands are covered with genuine leather, a sanitary feature much appreciated; all exposed metal parts nickel-plated.

- 811A—N. & K. New Model Phones.....\$8.50

Switches

Antenna Lightning Switch

- Single-pole, double throw, 30-amp.....\$0.45

Panel Switch Levers

Enclosed tension spring insures perfect electrical connection. Switch blade, embedded in brass collar, cannot work loose. Black or mahogany bakelite knob. Requires 3/8-inch hole in panel for mounting.

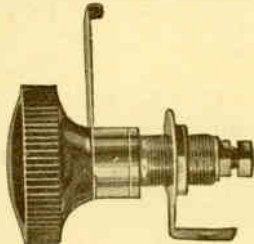

King Quality Levers

- 623 R773, 1 1/2 lever. Each.....\$0.60
- 624 R774, 1 1/4 lever. Each..... .55
- 625 R775, 1 lever. Each..... .55

Fine Knurl Levers

- 626—Fada, 1 1/2 lever. Each.....\$0.25
- 627—Monarch, 1 1/4 lever. Each..... .25

Sockets

Hoosick

- 115—Standard tubes.....\$0.50
- 102—Standard tubes..... .35
- 107—Panel mounting..... .70
- 199—99 tubes..... .35

Federal Anti-Capacity Switches

All anti-capacity keys are equipped with highly nickel plated face plates. Springs are of phosphor bronze, silver plated, for good conductivity. The insulating block in which the springs are mounted is phenol plate—the best insulating material known. The cam arrangement is of the roller type, providing smooth and easy lever action.

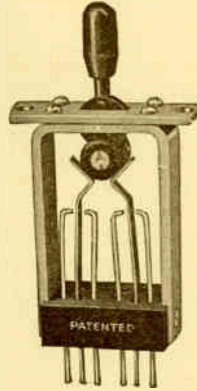

- No. 1424-W—Federal Anti-Capacity Switch, 4 P. D. T., 12 spring. Each.....\$3.35
- No. 1425-W—Federal Anti-Capacity Switch, D. P. D. T., 6 spring. Each..... 3.30
- No. 1426-W—Federal Anti-Capacity Switch, D. P. S. T., 4 spring. Each..... 3.05
- No. 1427-W—Federal Anti-Capacity Switch, D. P. S. T., 4 spring. Each..... 3.20

Tape

- 635—Friction Tape, 2-oz. roll.....\$0.10

Reflex Kits

Acme, for Amplification

The Acmeflex circuit uses both radio and audio frequency amplification on same vacuum tubes. Gives the best consistent results for least expenditure, least construction, tuning effort, and least trouble.

- Acme Type "A". Each.....\$65.00

Hedgehog

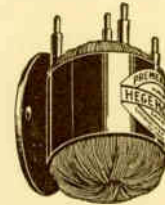

- Ratio 1 to 3. Each.....\$3.50
- Ratio 1 to 4. Each..... 3.50
- Ratio 1 to 5. Each..... 3.50
- Ratio 1 to 10. Each..... 4.50

Jefferson

- Jefferson No. 45—Ratio 7 to 1....\$7.00
- Jefferson No. 41—Ratio 4 to 1.... 4.25
- Jefferson Star—Ratio 3 to 1..... 3.25

Acme Radio Frequency Amplifying

- Acme R-2—Wave-length 200-600 meters.....\$3.00
- Acme R-3—Wave-length 250-700 meters..... 3.00
- Acme R-4—Wave-length 175-500 meters..... 3.00

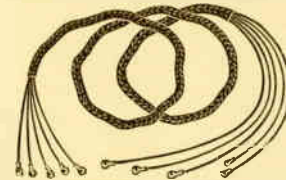

Van-Ashe Hook-up Cords

Five cords under one braid, each a different color. Terminal on each end makes hooking up set easy. Six feet long. Price, each.....\$1.00

Lopez Low-Loss Tuners

Designed to tune from 90 to 225 meters with 0.00025 Mfd. secondary condenser having minimum capacity of 0.00001 Mfd. or less.

Equipped with flexible lead and clip for wave-length range of 45 to 110 meters with the same condenser.

- 821—Amateur Type, Regular.....\$10.00
- 821A—Amateur Type, Special.....\$10.00

Designed for a wave-length range of 40 to 80 meters when used with a secondary condenser having a capacity range of 0.00001 Mfd. or less, to 0.00025 Mfd.

- 821B—Broadcast Type.....\$10.00

Designed to tune from 225 to 600 meters with 0.0005 Mfd. secondary condenser.

Electrad Curtain Aerials

- Curtain Aerials.....\$1.50

Sickles Coil

- For Roberts Knockout.....\$8.50

Van-Ashe Radio Co.

TENTH AND PINE

ST. LOUIS, MO.

Bushings

Reduce 1/4 inch to 3/8 inch. Each \$0.06

Clamps

For ground connections. Each \$0.10

Cleats

Porcelain split knobs. Each \$0.05

Cardwell Rotor Grounded Condensers

.00025, 11-plate. \$4.25

.0005, 23-plate. 5.00

.001, 43-plate. 6.00

Midget Condensers

Chelton Midget. Each. \$1.50

(Panel Mounting)

Chelton Midget. Each. 1.75

(Base Mounting)

Hammerland Jr. Each. 1.80

Federal By-Pass Condensers

Capacity .1 Mfd. \$0.50

Capacity .05 Mfd.75

Capacity .1 Mfd. 1.00

Connectors

Pig-tail Contact Connectors will fit standard switch point.
Each \$0.03

Per 100. 2.50

Phone Connectors

Will take four phones. Each \$0.50

Contacts

For Fore Charger. \$1.50

For Valley Charger. 1.00

For Homecharger 1.00

Contact Points

Small, sharply cut threads and small nuts which fit properly. Heavy nickel finish. Hand buffed heads. Easy to assemble and satisfactory in service.

Nickeled, with nuts. \$0.01

Nickeled stops02

Union Phone Tip Jacks

Price, per pair. \$0.25

Durham Variable Grid Leaks

No. 100—Range 1000 to 100,00 ohms. \$0.75

No. 101—Range 1 to 5 megohms.75

No. 201—Range 2 to 10 megohms.75

Brownlie "Quick" Contact Crystals

Manufacturers of high-grade reflex sets use Brownlie crystals as standard equipment in their sets and enthusiastically endorse them for their reliability and satisfactory results obtained therefrom.

Brownlie Crystals. Each. \$1.00

Crystal Detectors

Brownlie Vernier \$2.00

Refill for above.75

Ajax, unmounted25

Ajax, mounted50

Head Bands

Carried in stock for any standard phones.

Specify make. \$1.00

Van-Ashe Dials

4-inch and 2-inch Knob. \$0.65

3-inch Dial.40

Federal Dials (Four Sizes)

4-inch Knob and dial, 180-degree scale. \$1.50

3-inch Knob and dial, 180-degree scale.65

2-inch Knob and dial, 180-degree scale.45

Insulators

Screw Eye Insulators (Stand-off). Each \$0.15

Vario-Densers

No. XL—Price. \$1.00

Grid-Densers

Amplex, .005. Price. \$1.25

Amplex, .0001. Price. 1.25

Amplex, .000025. Price. 1.25

Rotors

Radion standard, to fit 4-inch tubing. \$0.75

Screws and Nuts

Dixie assortment contains 200 of twenty different kinds of bolts, washers and nuts.

Each \$20.00

Dixie 100-piece assortment, screws, nuts and washers. Each50

Sliders—Brass

No. 3/8 inch square. \$0.25

Shielding

Copper foil for shielding. Per square inch. . . \$0.01

Solder

String Solder, 10 gauge. \$0.05 Per foot \$0.75 Per lb.

String Solder, 18 gauge.05 2.50

Rosin Core, 12 gauge.05 1.50

Rosin Core, Brach, 18 gauge.05 1.00

Soldering Paste

No-Korode, 2-ounce tins. \$0.25

Solderall, tubes25

Soldering Irons

Electrohot No. B51. \$2.50

Electrohot No. B53. 2.00

Dial Pointers

Marle Arrow Type Pointers. Each \$0.15

Rheostats

No. King
R-631—6 Ohm Vernier. \$1.50

R-630—6.5 Ohms. 1.10

R-632—25 Ohms. 1.10

No. Hoosick
300—6 Ohm.75

301—30 Ohm.75

308—2 Ohm.75

304—10 Ohm.75

306—20 Ohm.75

Premier

Microstat, 6 Ohm and 40 Ohm. 2.50

No. Federal
18—Resistance, 5.5 Ohms. 1.40

19—Resistance, 1.5 Ohms. 1.50

22—Resistance, 25 Ohms. 1.50

23—Resistance, 16 Ohms. 1.70

26—Resistance, 60 Ohms. 1.60

27—Resistance, 60 Ohms. 1.90

Fil-Ko-Stat

Fil-Ko-Stat. Each. \$2.00

Cunningham RADIO TUBES



CX112



CX310



CX220



CX299

CX112—Power amplifier for use in last audio stage only. Filament, 5-volt, 0.5-ampere; plate, 135-volt.
Price, each \$6.50
(Will fit standard sockets)

CX310—Special super-power amplifier for use in last audio stage only. Filament supply, 6-volt storage battery or 7½-volt rectified A. C.; plate, 90 to 425 volts.
Price, each \$9.00
(Will fit standard sockets)

CX220—Power amplifier for use in last audio stage only. Filament, 3-volt, 0.125-ampere; plate, 135 volts.
Price, each \$2.50

CX299—Same as regular C299, except equipped with new navy standard base. Filament, 3-volt; amp., .06; plate, 90-volt (maximum).
Price, each \$2.50

(The above tubes will not fit the standard C299 socket. When used with adapter will fit standard C301A socket.)



CX301A



CX300

CX301A—Same as regular C301A, except equipped with new navy standard base. Filament, 5 volts; filament amp. .25; plate, 20 to 120 volts.
Price, each \$2.50
(Will fit standard sockets)

CX300—Same as regular C300, except equipped with new navy standard base. Filament, 5 volts; filament amp., 1; plate volts, 18 to 25.
Price, each \$2.50
(Will fit standard sockets)

We will carry the following old-style base tubes in stock as long as we can procure them from the manufacturers:
C301A—Detector and amplifier. Price, each \$2.50
C300—Gas content detector. Price, each 2.50
C299—Detector and amplifier. Price, each 2.50
C 12—Detector and amplifier. Price, each 2.50
C 11—Detector and amplifier. Price, each 2.50

Notice

Any of the Cunningham tubes listed herein can be used in the RCA sets and devices. The tubes being the same in every respect in regard to voltage, etc.



CX316B



CX313

CX316B—Single wave rectifier tube for use in "B" battery eliminators and similar devices. Specifications opposite page.

Price, each \$7.50

CX313—Double wave rectifier tube for use in "B" battery eliminators and similar devices. Specifications opposite page.
Price, each \$7.00

CX374—Blow tube for regulation of plate voltage of devices designed for rectified A. C. operation of radio receivers (RCA devices). For specifications see opposite page.
Price, each \$5.50

C-376—Ballast tube for regulation of line voltage supply to rectified A. C. operated devices (RCA devices). For specifications see opposite page.

Price, each \$6.50

C-377—Tube for protection against "shorts" in plate circuit of radio receivers. For specifications see opposite page.
Price, each \$1.75

Notice

Where "B" battery eliminators are used and the specifications call for the use of a C301A or UV201A is recommended that the CX316B be used in these "B" eliminators. In some cases the CX313 is used.

Technical Data—New Cunningham Radio Tubes

TYPE	List Price	Filament Terminal Voltage	Filament Current (Amperes)	Plate Voltage	Normal Operating Grid Bias (Volts)	Plate Current (Milliamperes) Not at Zero Grid See Note §	Plate Resistance (Ohms)	*Mutual Conductance (Micromhos)	*Voltage Amplification Factor	Dimensions		Type of Base
										Length	Diameter	
CUNNINGHAM CX-220	\$2.50	3.0	0.125	135	22.5	6.5	6600	500	3.3	4 1/8"	1 11/16"	Small Standard CX Base
CUNNINGHAM CX-112	6.50	5.0	0.5	157.5 Max.	10.5	7.9	4800	1670	8.0	4 11/16"	2 1/8"	Large Standard CX Base
				135**	9	5.8	5500	1435	7.9			
				112.5	7.5	2.5	8400	940	7.9			
				90	6	2.4	8800	890	7.9			
CUNNINGHAM CX-310	9.00	7.5	1.25	425 Max.	35	22	5000	1550	7.75	5 5/8"	1 1/8"	Large Standard CX Base
				350	27	18	5100	1500	7.65			
				250	18	12	5600	1330	7.5			
				157.5	10.5	6	7400	1020	7.5			
				135	9	4.5	8000	940	7.5			
				112.5	7.5	3	9700	775	7.5			
				90	4.5	3	9700	775	7.5			

	List Price	Filament Terminal Voltage	Filament Current (Amperes)	Maximum AC Voltage*** Plate to Filament	Maximum DC Load Current (Milliamperes)	Dimensions		Type of Base
						Length	Diameter	
CUNNINGHAM CX-313 (Full-Wave Rectifier)	\$7.00	5.0	2.0	220 (RMS) Maximum AC Input Voltage per Anode, or 440 (RMS) Across Both.	65	5 5/8"	2 1/8"	Large Standard CX-Base
CUN'HAM CX-316-B (Half-Wave Rectifier)	7.50	7.5	1.25	550 (RMS) Maximum AC Input Voltage.	65	5 5/8"	2 1/8"	Large Standard CX-Base

TYPE	List Price	Rated Voltage		Starting Voltage	Maximum DC Current	Dimensions		Type of Base
		90 Volts D. C.	125 D. C.			Length	Diameter	
CUNNINGHAM CX-374 (Voltage Regulator Tube)	\$5.50	90 Volts D. C.		125 D. C.	50 Milliamperes	5 5/8"	2 1/8"	Large Standard CX-Base
CUNNINGHAM C-376 (Ballast Tube)	6.50	Current 1.7 Amperes		Voltage Range 40 to 60 Volts		8"	2 1/8"	Standard Mogul Type Screw Base
CUNNINGHAM C-377 (Protective Tube)	1.75	Voltage Drop Across		at 20 Milliamperes D. C. at 90 Milliamperes D. C.		2 1/2"	1 7/8"	Double Contact Bayonet (‡) Automobile Type
		Half Filament 2.5 45	Entire Filament 5 90					

NOTE 1—* At normal operating grid voltage (not at zero grid).
 NOTE 2—*** Plate voltage for average use is 90 to 135 volts.
 NOTE 3—***RMS indicates "root mean square" as indicated on an AC voltmeter.
 NOTE 4—† Connection to shell of base for fifth terminal, which is the common return lead for the output of the tube.

NOTE 5—‡ Connection to shell of base for third terminal which is the lead to mid-point of filament.
 NOTE 6—§ The plate current values given are less than those obtained with zero grid, but are the currents actually obtained when the tube is operated at indicated values of plate voltage and grid bias voltage.



Bradleystat

The Bradleystat is a graphite disc rheostat for radio filament control. No wire rheostat can duplicate the stepless, noiseless control obtained with the Bradleystat, ranging from approximately 1/4 ohm to 100 ohms. By having your set equipped with Bradleystats, you can use any tube now on the market at any time, without changing the rheostat or your wiring connections.

Price, each \$1.85

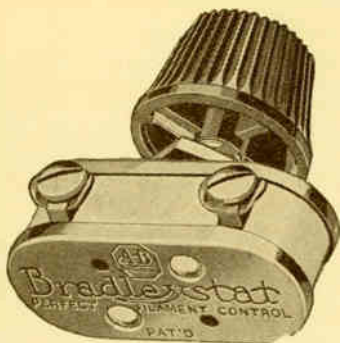

The Bradleystat is the smallest and most satisfactory rheostat that you can install on your set.

Bradleyleak

The Bradleyleak is an adjustable graphite disc grid leak with a stepless, noiseless range from 1/4 to 10 megohms. It is highly endorsed by Cockaday, Flewelling, Kennedy, Crosley and other radio authorities. A 0.00025 mfd. fixed condenser can be furnished to fit the Bradleyleak terminals. One-hole mounting is provided, as well as holes for baseboard mounting. Requires only 1/8 inch space behind panel.

Price, each . . . \$1.85

Condenser (.00025 Mfd.), extra .35

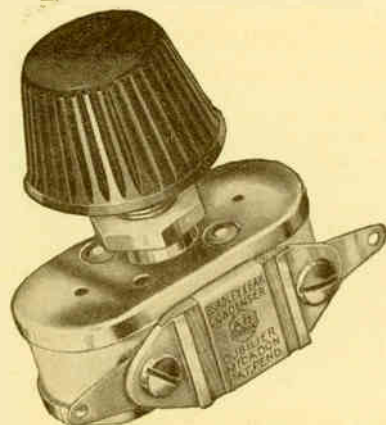

Bradleyometer

The Bradleyometer marks a distinct advance in potentiometer construction. Because of the use of the graphite disc principle, a stepless, noiseless variation of potential is obtained. It eliminates troubles due to corrosion and breaking of fine wires.

The Bradleyometer is made in two sizes, 200-ohm and 400-ohm. Metal parts are nicked, and one-hole panel mounting is provided, as well as holes for baseboard mounting. Extends only 7/8 inch behind panel and is 2 inches long. It is non-inductive, a feature highly essential in many radio frequency circuits.

200-Ohm. Price, each \$2.00

400-Ohm. Price, each 3.00

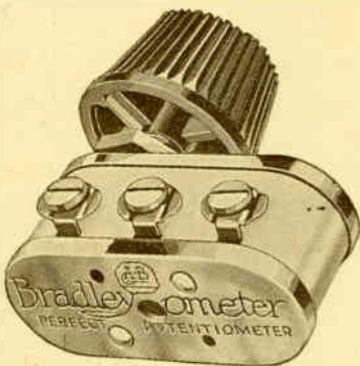

Bradleyohm

The Bradleyohm is an adjustable resistor made in three ranges, as follows:

Bradleyohm No. 10—10,000—100,000 ohms.

Bradleyohm No. 25—25,000—250,000 ohms.

Bradleyohm No. 50—50,000—500,000 ohms.

All ranges. Price, each \$2.00

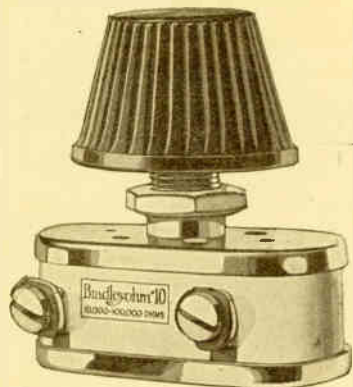

Bradleystat E-210

For transmitters of 10 watts capacity or less. Construction similar to regular receiving Bradleystat, except that it is larger.

Suited for either panel or base mounting. Not recommended for transmitters employing more than two 5-watt tubes.

No. E-210—Price, each \$4.00

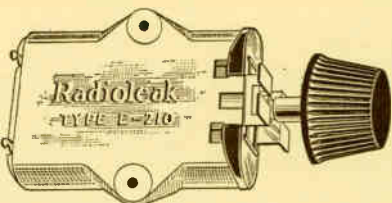

Bradleyswitch

Is a compact, substantial battery switch for radio circuits. Like the other Allen-Bradley radio devices, it is arranged with "one-hole" mounting, requiring only one 3/8-inch hole to be drilled. The Bradleyswitch extends only 1 1/8 inch in back of the panel and the over-all width is 1 inch.

The Bradleyswitch is operated by pulling the black, polished button, which closes the battery circuit. By pushing the button the circuit is opened.

No. 5-Z—Price, each \$0.60



The Bradleydenser

The Bradleydenser, like other Allen-Bradley radio devices, offers new advantages to the radio enthusiast. Every attention has been given to combine rugged construction with improved efficiency.

.00025 M. F. \$4.50

.0005 M. F. 5.00

.001 M. F. 6.00

Bradley-Amplifier

With the Bradley-Amplifier a violin sounds like a violin and a flute sounds like a flute. The perfectly balanced Bradleyunit resistors, neatly concealed in



the base, transfer the music from tube to tube with perfect clarity. They do not age or deteriorate. They need no adjustment.

No. 7-Z—Price, each \$15.00

Radiostat

For amateur transmitters of any capacity. Specially treated graphite discs provide the resistance and afford noiseless, stepless control over a wide range. Equipped with handsome composition knob and highly polished copper mounting plate. A real job.

No. 8-Z—Price, each \$6.50

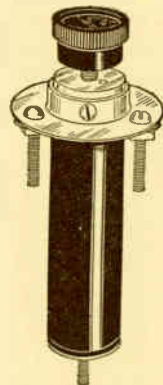

The Bradleyunit is a fixed resistor, manufactured by the Allen-Bradley Co. for use in radio circuits, such as resistance-coupled amplifiers. It is accurately calibrated and offered in three fixed values, as follows:

No. 12R—12,000 Ohms. Price, each . . . \$0.75

No. 50R—50,000 Ohms. Price, each75

No. 100R—100,000 Ohms. Price, each75

Fleron Glass Insulators

A glass insulator of the finest quality at a reasonable price.

Fleron glass insulators are made of a special temperature resisting glassware which is unaffected by sudden changes of heat or cold or any atmospheric condition.

No. 33 has a tensile strength well over 300 pounds, while the strength of No. 44 runs in excess of 500 pounds.

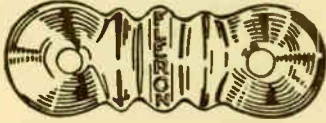

No. 33—Size 3x1 1/8. Price, each \$0.20



No. 44—Size 4x1 1/8. Price, each \$0.30

Fleron Porcelain Insulators

(Each in a Carton)



Bureau of Standards says that large power losses in the antenna can be traced to wooden masts, nearness to trees and defective insulators, etc.

Power losses due to dielectric absorption are reduced to the very minimum with correctly made porcelain insulators. This is true because of the low phase difference of porcelain.

Fleron Porcelain Insulators are made in seven sizes of a highly vitrified close texture porcelain with a heavy black glaze.

No. 0—Size 3	x1 1/8.	Price, each	\$0.20
No. 1—Size 4	x1 5/8.	Price, each30
No. 2—Size 3 3/4	x2 1/8.	Price, each40
No. 3—Size 5	x1 5/8.	Price, each40
No. 4—Size 8	x1 5/8.	Price, each60
No. 5—Size 5	x1 5/8.	Price, each	1.00
No. 6—Size 10	x1 5/8.	Price, each	1.50

Fleron Lightning Arrester

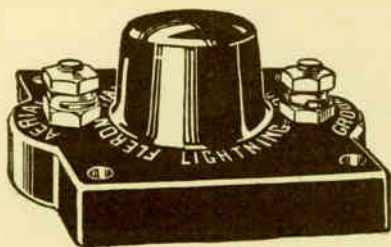

Meets the need for a high-grade, attractive arrester at a medium price. Built entirely to the specifications of the National Board of Fire Underwriters.

Moisture-proof, dust-proof and of low capacity.

No. S—Price, each \$1.10



Fleron Porcelain Lead-in Bushing



This device makes a workmanlike finish at a point in aerial installation that has been a source of power loss. Maximum length, 14 inches. Use a 5/8 drill for soft wood, 1 1/8 for hard wood. Porcelain sections slide off brass rod to any wall thickness up to 9/4 inches. Threaded rod can then be cut at any desired point. Black porcelain. Black glaze. Approved by Underwriters Laboratories.

No. L. I. B.—Price, each \$1.10

Fleron Stand-off Insulators

Each of these two numbers is a substantially made, good looking device.

The 4-inch insulator is made of one piece of porcelain packed one to a carton with two brass screws and leather heads for use as a cushion under the screw heads. Black body, black glaze.

The 8-inch insulator is made by combining our regular No. 4 insulator with a heavy cast brass holder, made in two parts, fastened together as shown. It is a very rugged device, developed for the finest antenna installations. One insulator to a carton. Brass screws furnished.

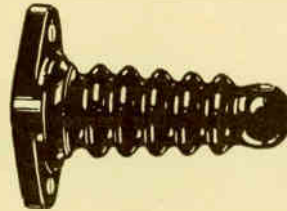

No. 14—Size, 4 inch
Price \$0.45

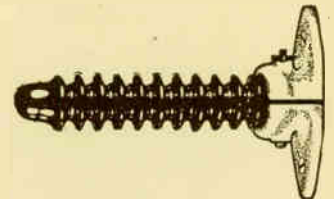

No. 8 S. O.—Size, 8 inch
Price \$1.25

Fleron Complete Radio Aerial Outfits

These packages eliminate the bother and annoyance of gathering together from stock the various items necessary to make up a complete antenna equipment.



No. 350 kit meets the average condition. It contains:

- 100 ft. 7-strand No. 22 aerial wire.
- 50 ft. No. 14 R. C. wire.
- 2 Fleron porcelain insulators.
- 1 Fleron refillable lightning arrester.
- 1 Lead-in window strip.
- 3 Nail knobs.
- 2 Galvanized screw eyes.
- 1 3-inch porcelain tube.
- 6 Insulated staples.
- 1 Ground clamp.
- 1 6-inch porcelain tube.
- Directions for installing.

No. 350—Price, each \$3.50

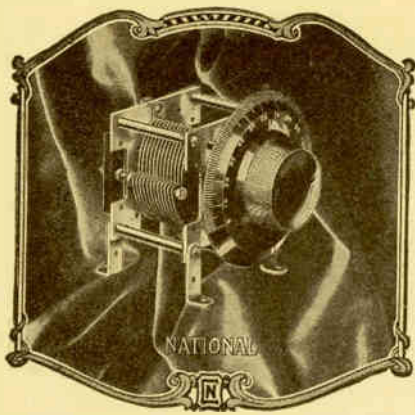

VELVET VERNIER

The National Velvet Vernier Condenser and Dial

The National Company, Inc., has developed a distinctive type of condenser, which, in design, embodies a high degree of scientific precision not found in ordinary condensers.

The rotor is of aluminum with grounded end plates of special alloy. The stator is completely shielded and supported by three pieces of the best radion hard rubber. The bearings are exceptionally smooth, of special

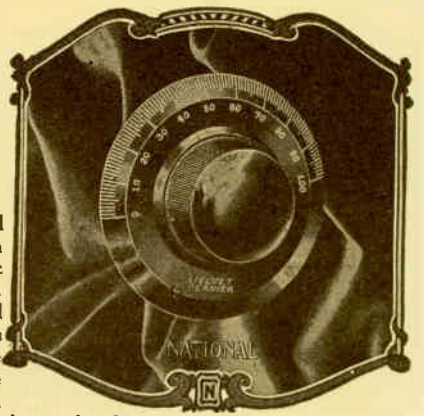

ball and cone type, and are adjustable. Plates are made of 1/32-inch heavy aluminum for both rotor and stator. The whole unit is exceptionally rugged and will hold its alignment under all conditions.

The convenience of the constructor is not forgotten. There are ten tapped holes in the two shielding plates in addition to the standard binding posts for electrical connections or to mount coils. Also the unit may be used either for table or panel mounting.

Capacity—maximum—MF.....	.001—45 pl.	.0005—25 pl.	.00035—17 pl.	.00025—13 pl.
Capacity—minimum—MF.....	.000018	.000016	.000014	.000014
Complete with 3-inch Metal Dial.....	\$7.00	\$6.00	\$5.75	\$5.50

Type A—Velvet Vernier, bakelite dial, 3 3/8 inches. Price, each.....\$2.25

Type A—Velvet Vernier, bakelite dial, 4 inches. Price, each..... 2.50

Type B—Velvet Vernier, bakelite dial, variable ratio. Price, each..... 2.50

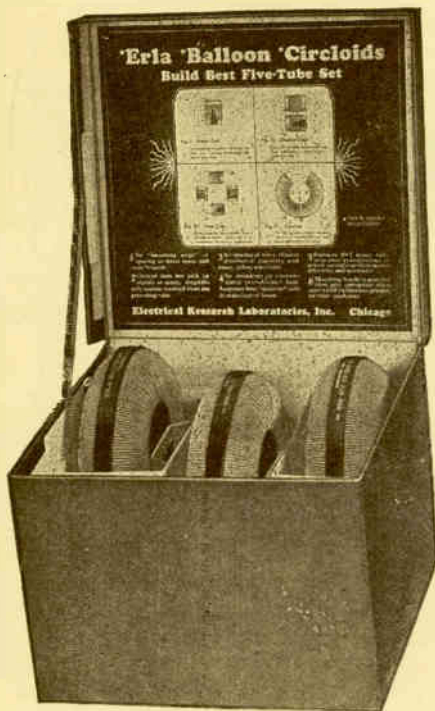

Erla Balloon Circloids

Erla Balloon Circloids

Big improvement in coil design. No external field, air spaced, self-supported winding, tremendously increased sensitivity and amplifying power.

Can be used in place of most any coils in tuned radio frequency circuits and neotrodyne circuits.

Erla Circloid, each, \$4.00

Kit of three, \$12.00

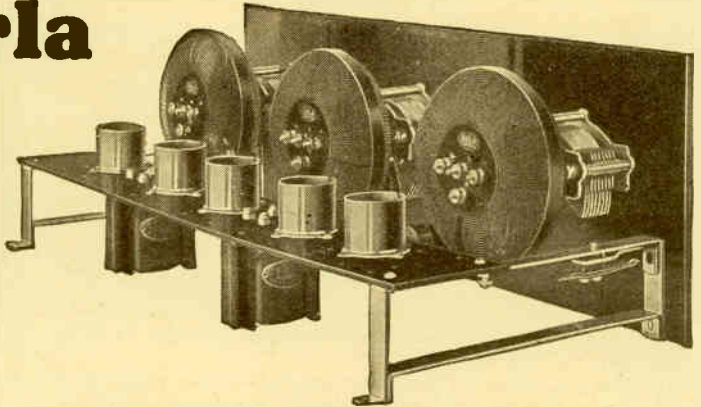

Erla Circloud Five-Tube Kit

The five-tube model comes pre-assembled, requiring only an hour or two to complete. Flexible, eyeleted leads eliminate soldering and make child's play of construction.

Erla Five-Tube Kit.....\$49.50

Erla Walking Crystal Rectifier

A dual contact rectifier that enables adjustment without breaking contact. The only rectifier that can be adjusted in a reflex circuit without producing a howl.

Price, each.....\$1.50

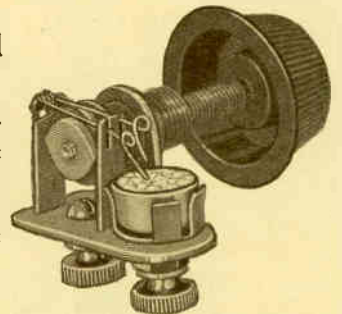

Erla Maxitran R. R. Transformer

An iron core untuned radio frequency transformer with unduplicated high and uniform amplification from 200 to 550 meters. In beautiful bakelite one-piece shell.

Price, each.....\$4.00

Erla Bezels, 1-inch and 1 1/2-inch. Each.... .20

Erla Fixed Detector

The Erla Fixed Detector can be used in most any reflex circuits and is also recommended for crystal sets.

Price, each.....\$1.00



Erla Audio Transformers

Erla, 3 1/2 to 1. Price.....\$4.00

Erla, 6 to 1. Price..... 4.50

Erla 1000-cycle Transformer..... 6.50

(For code reception)

Erla Concert Grand Audio. Price.....10.00

National Browning & Drake Kit

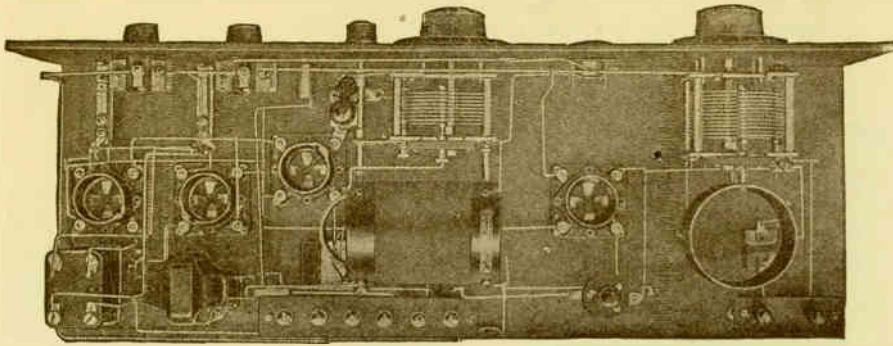

Photograph of Parts

Browning-Drake Receiver

The Browning-Drake Receiver is one of the newest developments in tuned radio frequency sets. It incorporates a special type of radio frequency transformer, developed by Mr. F. H. Drake and Glenn H. Browning of Harvard University, which gives much more amplification than it has been possible to attain before.

The radio frequency stage is neutralized and regeneration is used in the detector circuit. Results fully equal those obtained with the best five-tube neutrodyne.

1 National Browning & Drake Kit	\$22.00	1 Type 601 .002 MF. Dubilier Condenser. \$	0.40
This kit contains one .0005 MF. National Condenser with a 4-inch Velvet Dial, and one antenna coil mounted as a unit.		1 Type 601 .00025 MF. Dubilier Con.35
One .00035 MF. National Condenser with 4-inch Velvet Dial, and one National Regenerator mounted as a unit.		1 Electrad Variohm	1.75
1 Formica Panel, 7x24 inches.	3.94	1 Yaxley No. 4 Double Circuit Jack.80
1 Marco Neutralizing Condenser.	1.25	1 Yaxley No. 3 Single Circuit Filament Control Jack.70
4 Benjamin Sockets, \$1.00 each.	4.00	1 Cutler-Hammer Filament Switch.60
1 General Radio No. 285 Transformer.	6.00	1 1 Mfd. Dubilier By-Pass Condenser.	1.25
1 General Radio No. 285L Low Radio Transformer	6.00	9 Eby Binding Posts 15c each.	1.35
1 30-Ohm General Radio Rheostat.	1.25	10 Lengths of Bus Bar Wire, 3c length.30
1 10-Ohm General Radio Rheostat.	1.25	1 No. 2370 Burgess "C" Battery.60
1 Type 601 .0001 MF. Dubilier Condenser35		
		Total.	\$54.14
		1 Cabinet, 7x24 inches.	8.40

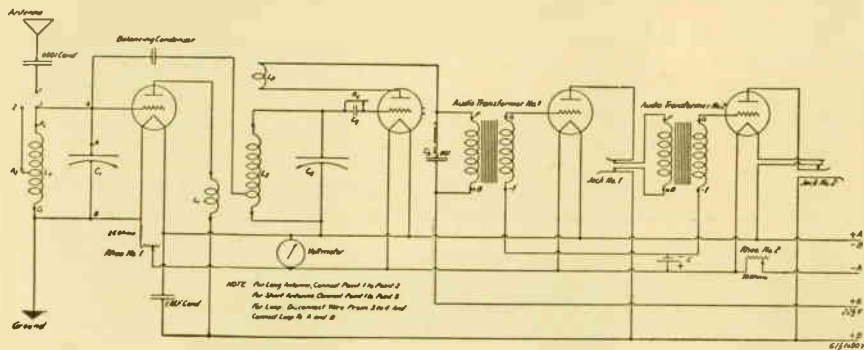

Wiring Diagram

Questions Which Are Commonly Asked About the Receiver

1. What is the best size antenna to use with the receiver? The Browning-Drake receiver operates on even a ten-foot antenna very well, but a thirty or forty one is recommended.
2. Can UV-201-A tubes be used throughout? Yes, but the balancing is not as easy, and a UV-199 or DV-3 is recommended in the first socket.
3. Can UV-199 or DV-3 tubes be used throughout, and what changes are necessary? The above tubes give very satisfactory results. The change necessary is to leave out the 25-ohm fixed resistance and turn rheostat No. 1 on completely or nearly so.
4. Can a loop be used? Yes, but even a very short inside antenna gives fully as good results, costs less, and is less bother in the home.
5. What makes the set go into oscillation with a "snap"? The grid leak is not properly adjusted, or the "B" battery on the detector is too high. Adjust the leak so that the circuit goes into oscillation very smooth for best results.

Van-Ashe Cabinets

These cabinets are constructed of selected full thickness wood, finished imitation walnut, hand rubbed. The lids are carefully fitted and the openings for the instrument panels are made for panels to slide in and are accurate in size. Four rubber toes are furnished for the bottom of each case. Each case is wrapped in wax paper and enclosed in straw-board carton.

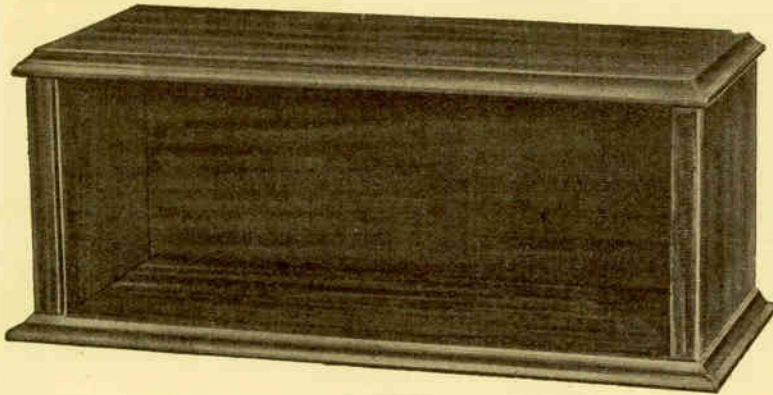

Model B

Prices on Model B Cabinet

	Width of Panel	Length of Panel	Depth Behind Panel	Price
B—9	7 in.	9 in.	7 in.	\$3.90
B—12	7 in.	12 in.	7 in.	4.30
B—14	7 in.	14 in.	7 in.	4.90
B—18	7 in.	18 in.	7 in.	5.30
B—18a	7 in.	18 in.	9 in.	6.60
B—21	7 in.	21 in.	9 in.	7.50
B—24	7 in.	24 in.	9 in.	8.40
B—26	7 in.	26 in.	9 in.	9.30
B—27	7 in.	27 in.	9 in.	9.50
B—28	7 in.	28 in.	9 in.	9.75
B—30	7 in.	30 in.	9 in.	10.00

These cabinets are constructed of selected full thickness wood and finished imitation walnut, two-tone effect. Best varnish, hand rubbed. The lids are carefully fitted with non-rusting piano hinge, lid support and rubber bottom supports. The opening for instrument panel is made for panels to slide, and is accurate in size. Each cabinet is wrapped in wax paper and enclosed in strawboard carton.

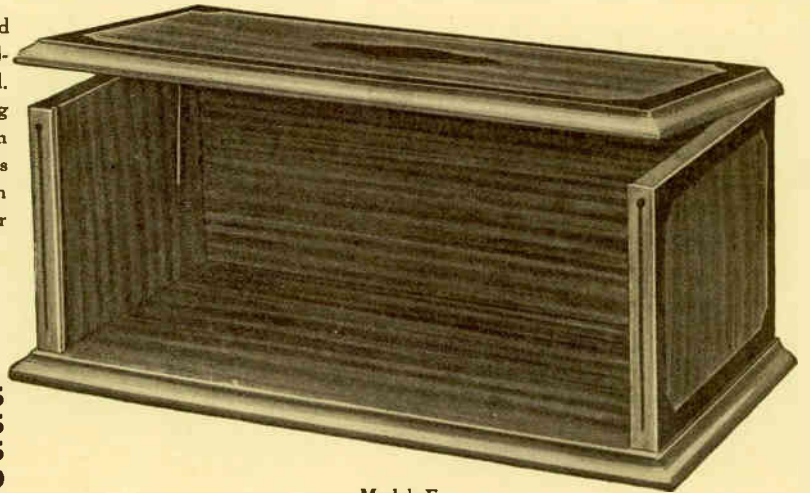

Model F

Prices on Model F Cabinets

	Width of Panel	Length of Panel	Depth Behind Panel	Price
F—18	7 in.	18 in.	8 in.	\$7.55
F—21	7 in.	21 in.	8 in.	8.35
F—24	7 in.	24 in.	8 in.	9.25
F—26	7 in.	26 in.	8 in.	9.80

These cabinets are made of genuine mahogany, full thickness wood, and finished walnut, with best varnish, and hand rubbed. The top front cross bar is removable for allowing panel to slide in groove and is accurate in size. It requires no screws to fit panel in the cabinet. Is fitted with continuous non-rusting piano hinge and lid support and rubber bottom supports. Each cabinet is wrapped in wax paper and enclosed in strawboard carton.

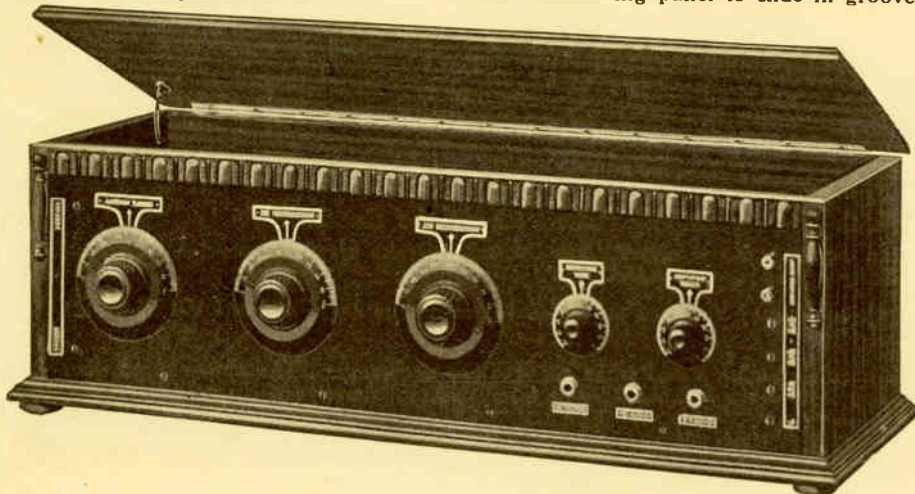

Model C

Prices on Model C Cabinets

	Width of Panel	Lgth. of Panel	Depth of Behind Panel	Price
C—18	7	18	9	\$12.20
C—21	7	21	9	13.30
C—24	7	24	9	14.45
C—26	7	26	9	15.55
C—27	7	27	9	16.65
C—28	7	28	9	17.25
C—30	7	30	9	18.35

Cut shows how panel will look in cabinet.

We can furnish suitable mounting boards $\frac{3}{8}$ -inch thick in all sizes, each \$0.80



General Radio Type 247 Condensers

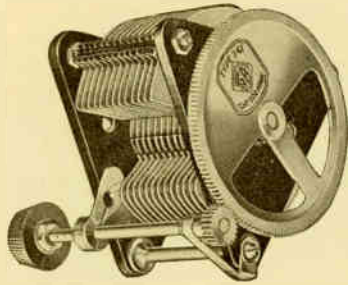

General Radio Type 247 Condensers have long been popular favorites among set builders and experimenters because of their high electrical efficiency. They have good interplate conductivity through solder-sealed contacts. End plates are of hard rubber. Vernier adjustment is by metal gear operated by a fibroil pinion.

- Type 247-G—500 MMF., Case mounted with gear **\$7.25**
- Type 247-H—500 MMF., Panel mounting with gear..... **5.00**
- Type 247-P—350 MMF., Panel mounting with gear..... **4.75**
- Type 247-L—250 MMF., Case mounted with gear **7.00**
- Type 247-M—250 MMF., Panel mounting with gear **4.50**

General Radio Type 334 Condensers

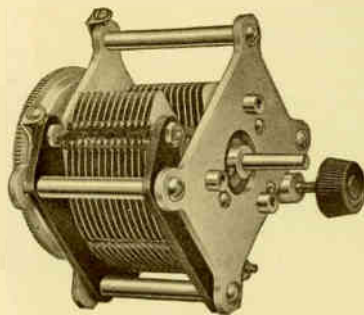

The Type 334 Condensers are designed to meet the popular demand for metal and plate condensers for use in radio broadcast reception. Rotor and stator groups are the same as those used in the Type 247 Condensers and good inter-plate conductivity is assured through solder sealed contacts. End plates are of aluminum.

- Type 334-K—Cap., 250 MMF.; Plain..... **\$3.75**
- Type 334-M—Cap., 250 MMF.; Vernier.... **4.75**
- Type 334-N—Cap., 350 MMF.; Plain..... **4.00**
- Type 334-P—Cap., 350 MMF.; Vernier.... **5.00**
- Type 334-F—Cap., 500 MMF.; Plain..... **4.25**
- Type 334-H—Cap., 500 MMF.; Vernier.... **5.00**

General Radio Type 247-W Wavemeter and Filter

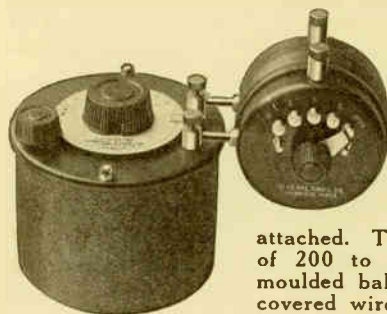

The Type 247-W Wavemeter and Filter increases the selectivity of a receiver and tunes out interference from conflicting broadcast stations. It is composed of a condenser with specially shaped plates and filter coil attached. The filter coil has a range of 200 to 600 meters and is of moulded bakelite wound with silk-covered wire.

Price **\$10.00**

Extra interchangeable filter coils for shorter or longer wave-lengths are available as follows:

- Type 247-W— 2 (400 to 1200 meters) **\$3.00**
- Type 247-W— $\frac{1}{2}$ (100 to 300 meters) **3.00**
- Type 247-W— $\frac{1}{4}$ (50 to 150 meters) **3.00**

General Radio Type 248 Tandem Condensers

The Type 248 Tandem Condensers are double condensers. They are assembled of rotor and stator units identical to those used in the popular Type 247 Condensers.

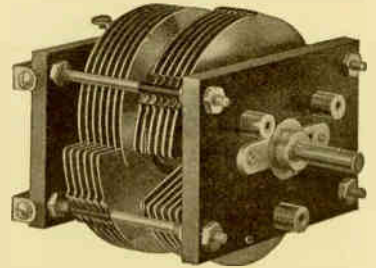

The end plates are of hard rubber, rectangular in shape, and with most of the dielectric placed in weak electrostatic field. Rotor units are on opposite sides of the shaft and perfectly balanced. Bearings are standard General Radio bearings—tight, yet smooth in operation and designed to compensate for wear.

- Type 248-K—2 Sections; Cap., .00025 MF. . **\$5.75**
- Type 248-N—2 Sections; Cap., .00035 MF. . **6.15**
- Type 248-F—2 Sections; Cap., .0005 MF. . **6.50**

General Radio Type 247 Condensers (Without Vernier)

The Type 247 Condensers without vernier are similar in construction to the vernier type with the single exception that the counter balanced gear is substituted by a plain counterweight to balance the rotor plates. For close adjustment on these condensers the Types 302 and 303 geared dials are recommended.

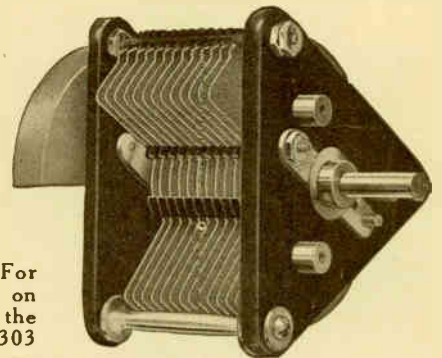

- Type 247-E—500 MMF., Case mounted without gear **\$6.25**
- Type 247-F—500 MMF., Panel mounting without gear **4.00**
- Type 247-N—350 MMF., Panel mounting without gear **3.75**
- Type 247-J—250 MMF., Case mounted without gear..... **5.75**
- Type 247-K—250 MMF., Panel mounting without gear..... **3.50**
- Gear and pinion vernier attachment separate **1.00**
(When ordering vernier attachment specify type letter.)

General Radio Type 285 Amplifying Transformers

Two stages of amplification using a 6-to-1 ratio Type 285 Transformer in the first stage and a 2-to-1 in the second stage operates a loud speaker with remarkable volume and with a purity of tone that makes radio reception delightfully natural.

The transformers mark a real advance in audio frequency transformer design.

They are completely shielded in a metal case with black japanned finish and have accessible terminals individually marked for proper connections.

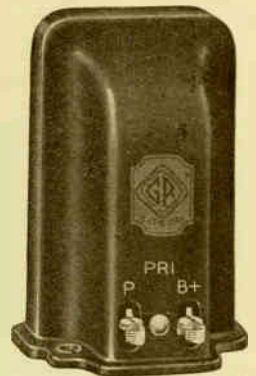

- Type 285—Amplifying Transformer, 6 to 1. **\$6.00**
- Type 285-L—Amplifying Transformer, 2 to 1 **6.00**



General Radio Type 231 Transformers

The core is of closed shell type construction and is of carefully selected steel. The windings are of proper ratio to insure good results with respect to quality and volume of signals. Binding posts and mounting brackets are easily accessible. The Type 231-A Transformer has a high and flat amplification curve which indicates that it may be used with equal efficiency in all stages.

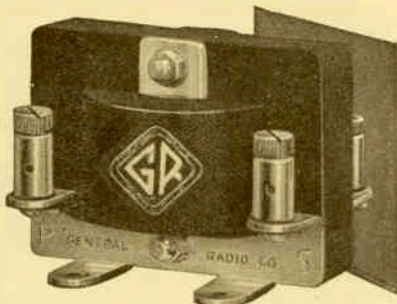

- Type 231-A Amplifying Transformer \$5.00
- Type 231-M Modulation Transformer 5.00
- Type 231-W Impedance Adjusting Trans. 5.00

General Radio Type 300 Amplifier Unit

This unit is self-contained except for tubes and batteries. It is ready for use with either crystal or vacuum tube detector. The parts used are standard General Radio instruments described in these pages.

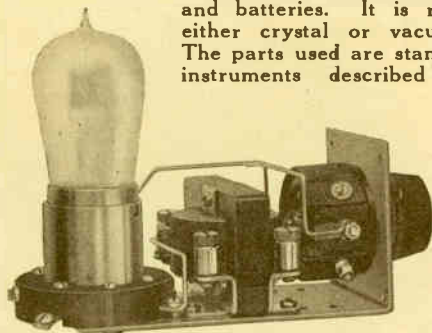

For persons building their own sets the complete unit is particularly convenient, since the bother of assembling and wiring the parts is eliminated. Provision is made for either panel or table mounting.

- Type 300-D—For standard tubes \$8.00
(UV-201-A)
- Type C-300—For dry cell tubes 7.75
(UV-199)

General Radio Type 271 Transformer

The Type 271 Transformer has been specially designed for amplification of medium frequencies for use in long-wave reception (10,000 meters—30 K. C.) and in the super-heterodyne circuit. The instrument is completely enclosed in a metal shell. It is shielded both electro-statically and electro-magnetically. These instruments may be used in a super-heterodyne with excellent results with a distance of less than an inch between transformers.

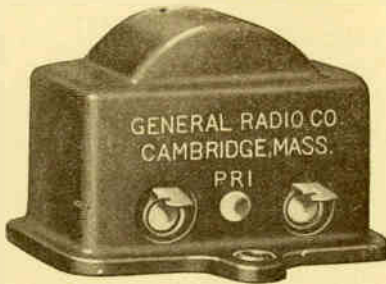

- Type 271 Medium Frequency Transformers . . \$5.00

General Radio Type 331 Transformer

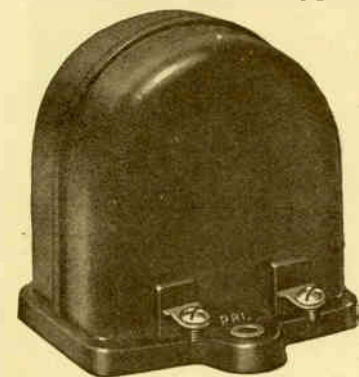

The Type 331 Transformer is designed for the amplification of medium frequencies and has a sharp peak at 10,000 cycles.

It is tuned sharper to 10,000 cycles than the Type 271 Transformers and recommended in place of the four other 271 Transformers where it is found that four Type 271 Transformers do not provide sufficiently sharp tuning. It has an air core and is enclosed in a moulded bakelite shell. Has accessible terminals which are individually marked for proper connections. Mounting holes are the same as 271.

- Type 331 Tuned Transformer . . \$5.00

General Radio Type 268 Vario-Coupler

This instrument is designed to cover a range of wave-lengths from 150 to 500 meters. It is very compact and rugged, and is ideal for the portable set. The stator coil has but a single tap which simplifies installation, operation, and reduces losses. Bearings are accurate and very smooth running. Stator and rotor forms are of genuine moulded bakelite wound with green silk-covered wire.

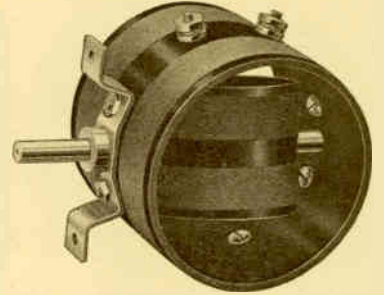

- Type 268 Vario-Coupler \$2.75

General Radio Type 269 Variometer

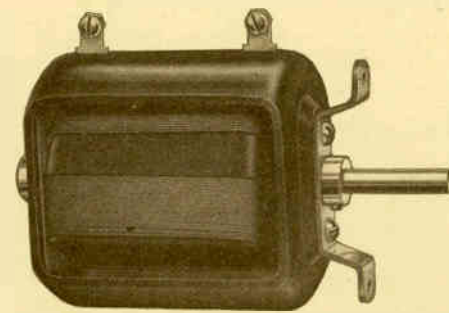

The outstanding feature of the Type 269 Variometer is its compactness and efficiency of operation. It has a maximum to minimum inductance 660 to 60 microhenries. Stator and rotor forms are of moulded bakelite wound with green silk

covered wire. Terminals are very accessible and a soldering lug is provided for use in circuits requiring split variometer connections.

- Type 269 Variometer \$5.00

General Radio Type 277 Low-Loss Coils

Models A, B and C are inductance coils covering wave-length ranges from 50 to 600 meters. When used with Type 247-H and F Condensers having specially shaped plates, wave-lengths may be read directly from the Type 313 Dial. Models D have a primary and secondary winding very closely coupled.

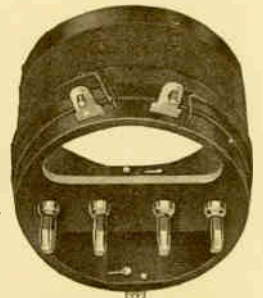

Models C and D may be used with excellent results as oscillator and antenna coupling coils in super-heterodyne circuits. Model D may also be used in sets employing tuned radio frequency.

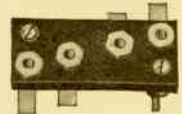

- Type 277-A—50 to 150 meters \$1.25
- Type 277-B—100 to 300 meters 1.25
- Type 277-C—200 to 600 meters 1.25
- Type 277-D—Antenna coupling coil 1.50
- Type 277-D 1/2—100 to 300 meters 1.50
- Type 277-D 1/4—50 to 150 meters 1.50
- Type 277-U—Unwound coil form75
- Type 274-B—Mounting base with four sockets 1.00
- Type 274-C—Mounting base with two sockets .75
- Type 274-P—Contact terminals15
- Type 274-J—Jacks, per pair25



General Radio Type 274 Multi-Connector Plug

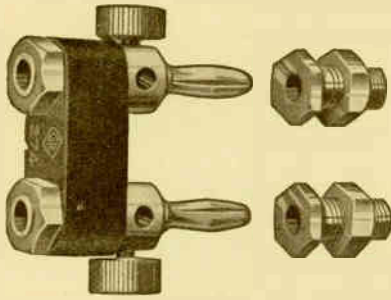

The many uses of the Type 274 Multi-Connector Plug will be readily appreciated by radio experimenters.

This combination makes an excellent phone or loud speaker plug, and any number of parallel connections may be made using several of these plugs.

The contact points consist of four springs which are squeezed together as the plug is inserted into the socket, thus making a perfect sliding contact.

A binding post is provided on the shank of the contact point for making external connections.

Type 274 Multi-Connector Plug, complete with Jacks.....\$1.00

General Radio Type 301 Rheostat

The Type 301 Rheostat maintains positive contact at all times. There is no momentary opening of the circuit to cause a bothersome click in the earphones.

The resistance units are tightly wound on specially treated fibre strips.

The base and tapered knob are of genuine moulded bakelite. Pointer on knob indicates the position of the contact arm. Furnished with resistance units of 6-10 or 30 ohms.

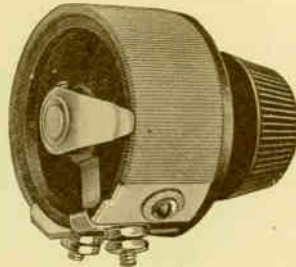

Type 301 Rheostats.....\$1.25

Potentiometer similar in construction, but with 200-ohm resistance unit.

Price.....\$1.25

General Radio Type 214 Rheostat and Potentiometer

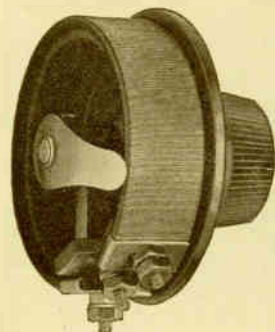

Where the best there is in rheostat design is desired and for laboratory use, the Type 214 is especially recommended.

It is considerably larger than the Type 301, the diameter of the base being 3 inches. It has a shaft 1/4 inch in diameter.

Furnished in two models — Type 214-A for panel mounting and Type 214-B for table mounting. With resistance units of 2, 7, 20 or 50 ohms.

Type 214 Rheostats.....\$2.25

Potentiometers similar in construction with resistance unit of 400 ohms.

Type 214 Potentiometer.....\$3.00

General Radio Type 156 Standard Tube Socket

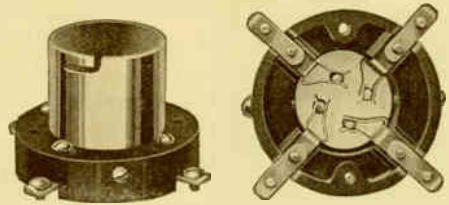

The Type 156 Socket is so designed as to hold the tube securely to prevent vibration and to make firm electrical contact with the four tube prongs. The base is of heavy moulded bakelite. The springs are of phosphor bronze, nickel finished. These sockets are for mounting all tubes with standard bases. The contacts are heavy enough to carry without arcing the high filament current of a 5-watt transmitting tube.

Type 156 Standard Socket.....\$1.00

General Radio Type 299 Tube Socket

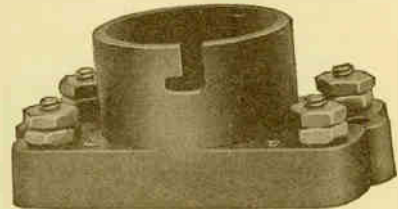

This socket is designed for UV-199 tubes. It is of genuine moulded bakelite and has its four terminals plainly marked. The springs are of phosphor bronze with double leaf blades to provide good contact with the tube prongs.

Type 299 Tube Socket.....\$0.50

General Radio Type 309-S Tube Socket Cushion

Because of shock absorbing properties of this base, tubes are completely protected against any vibration and greater clarity of reception results. The space between mounting holes is the same as between mounting holes of the Types 299 and 156 Sockets and the cushion may be used with either socket with equal efficiency.

Type 309-S Tube Socket Cushion.....\$0.25

General Radio Type 349 Socket

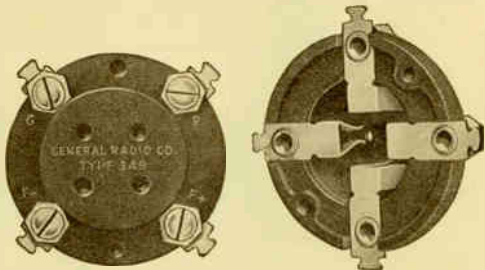

The Type 349 is constructed especially for the UX-120 amplifier tube. The base is of genuine moulded bakelite with tube prong mounting holes so arranged that it is impossible to insert the tube unless the prongs are properly placed. Contact blades are of nicked phosphor bronze and make a wiping contact on both sides of the four tube prongs.

Type 349 UX-120 Socket.....\$0.50



General Radio Type 346 Tube Adapter



The Type 346 Tube Adapter is designed to permit the use of UX-120 tubes in sets equipped with standard sockets. It is made of moulded bakelite. A set screw is provided for securing the tube base firmly in the adapter before it is placed in the socket.

Type 346 UX-120 Tube Adapter \$0.30

General Radio Types 302 and 303 Dials

The Types 302 and 303 Dials are provided with a specially designed vernier attachment. A brass gear with accurately machined teeth is swedged firmly to the back of the dial. A small fibroil pinion under the vernier knob is kept in tight contact with this gear by a spring arm. The finish of the dial is frosted silver with graduated scale in black. Extremely accurate adjustments are made possible by the use of this vernier dial, inasmuch as there is absolutely no back-lash. Each dial is packed with a celluloid hair-line indicator and template for drilling panel for mounting the spring arm.

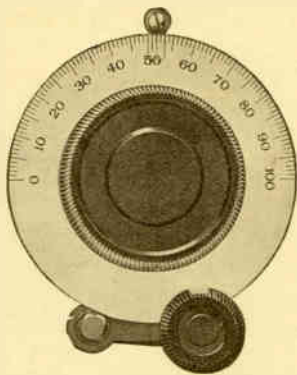

- Type 302—2¾-in. Vernier Dial for ¼-in. shaft \$1.75
- Type 303—4-in. Vernier Dial, for ¼-in. or ⅜-in. shaft 2.50
- Type 310—2¾-in. Dial and Indicator60
- Type 317—4-in. Dial and Indicator 1.50

General Radio Ammeters

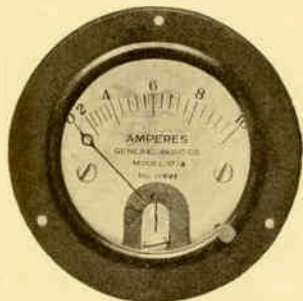

These hot-wire ammeters are available in three types, A, flush mounting; B, front of panel mounting; C, portable.

	Range	Type	Price
100 Milliampers		127-A and B	\$9.00
250 Milliampers			7.75
500 Milliampers			7.75
1 Ampere			7.75
1.5 Amperes			7.75
2.5 Amperes			7.75
5 Amperes			7.75
10 Amperes			7.75
Galvanometer			7.25

General Radio Type 178 Buzzer

This buzzer has been designed for both laboratory and amateur use. It combines pureness of tone, simplicity of adjustment and durability. The frequency is approximately 800 cycles.

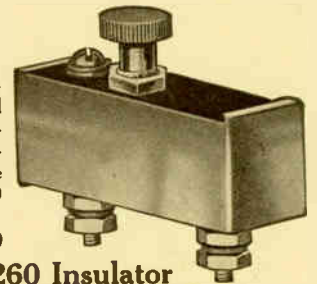

Type 178 Buzzer . . . \$2.00

General Radio Type 260 Insulator

The Type 260 is a convenient insulator for inside or outside use for insulating lead-ins or ground wires.

Type 260 Wall Insulator \$0.25

The 280 Antenna Insulator is made of glazed brown porcelain to withstand severe weather conditions.

Price 280 Antenna Insulator \$0.15

General Radio Type 283 Resistance Unit

The Type 283 Unit protects tubes from burning out when the "B" battery is accidentally connected across the terminals of the "A" (filament) battery. Also protects "B" batteries from short circuits. Consists of 500-ohm resistance unit contained in moulded bakelite shell.



Type 283 Resistance Unit \$6.00

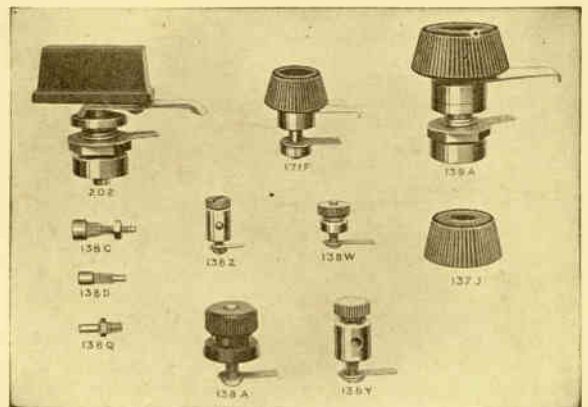

Type	Description	Diameter	Height	Screw Size	Price
138A	Insulated	3/4	3/8	10-32	\$0.25
138W	N. P. Brass	1/8	1/2	6-32	.12
138Y	N. P. Brass	1/2	3/4	10-32	.15
138Z	N. P. Brass	3/8	3/8	6-32	.10

Switches and Parts

Type	Description	Price
139A	Multiple Leaf Switch, 1 3/8 in. radius	\$0.95
171F	Single Leaf Switch, 7/8 in. radius40
202	Low Contact Resist. Switch, 1 3/8 in. radius	1.25
138C	3/8 in. Contact for 139A or 202 Switches05
138D	3/8 in. Contact for 171F Switch04
138Q	Switch Stop, with nut05
137D	Moulded Knob (used on 139A Switch)35
137H	Moulded Knob (used on 317 Dial)75
137J	Moulded Knob (used on 301 Rheostat)25
137K	Moulded Knob (used on 247 Vernier)25

The Types 137D and J are for ¼-inch shaft, while the 137H may be supplied for either ¼-inch or ⅜-inch shafts. The 137K knob is tapped for a 10-32 thread.

B-T Premier Tully

B-T "Torostyle" Transformers

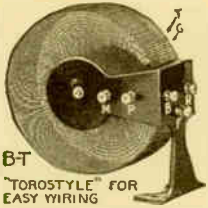

B-T
"TOROSTYLE" FOR
EASY WIRING

This latest form of R. F. transformer when properly designed and used in efficient circuits gives results hitherto impossible. No radio product, however, requires more refined knowledge and experience in inductance design.

B-T Inductances, such as the first tuner, air-core transformer and three-circuit transformers have led the world, and this product of three years' laboratory research reduces external fields, eliminates critical angles, and lessens inter-stage coupling and signal "pick-up." Frame is of moulded bakelite and seven binding posts are arranged so simply for simplified wiring. B-T regard this product as their highest achievement.

- Type TA—For antenna coupler.....\$4.00
- Type TC—For intermediate R. F. stages.... 4.00
- Type T4—For four-tube sets..... 4.00

B-T Torostyle Kits

B-T Torostyle Kits are marketed under B-T U. S. Patent No. 1,543,417, U. S. Navy license and other patents pending, and are sold for amateur use only. The Torostyle circuit and transformers give all the efficiency of the famous B-T "Nameless" with many added advantages. Through use of the B-T Dual Resistance and Double Condensers greater selectivity is secured as well as greater volume, distance and greatly simplified control.



The six-tube circuit employs three stages of R. F. with only two tuning dials. One knob on the dual resistance operates the combined sensitivity and volume control and is simply turned to the right or left as volume or sensitivity is desired.

The six-tube sets bring in far distant stations with a short inside antenna, and include one TA and three TC Torostyle Transformers, two LD-17 and 3 Micro-Mike Condensers, one Dual Resistance, complete wiring form for R. F. stages, with complete set of blue prints and instructions. (List price separately, \$42.45.)

B-T Torostyle Kit No. 6.....\$38.00

The five-tube kit employs the same circuit with two stages of R. F. detector and two audio. Designed for unequalled results with outside antenna. Parts included are one TA and two TC Torostyle Transformers, one L-17, one LD-17 and two Mikro-Mike Condensers, one Dual Resistance (list \$3.00), one easy wiring cable, blue prints and instructions. (Price of parts individually, \$32.80.)

B-T Torostyle Kit No. 5.....\$28.50

Blue prints and instructions for five and six-tube kits..... .75

B-T "Nameless Kits." Price, each..... 26.50

B-T Short-Wave Outfit

Designed for greatest efficiency on short-wave work. Consists of variable rotor mounted on bakelite base and a set of four interchangeable coils covering the following range: 12 to 25 meters, 25 to 50 meters, 50 to 100 and 100 to 200, when tuned with B-T L-7 .00015 condenser.

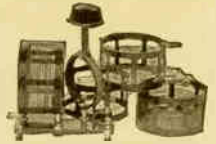

Short-Wave Outfit, complete.....\$8.00

B-T "Lifetime" Condensers

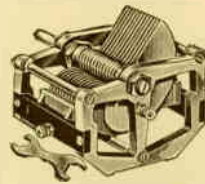

The B-T "Lifetime" Condenser is an acknowledged leader. It has been proved and is guaranteed to be the most reliable and efficient on the market, mechanically and electrically. It is not surpassed as regards station separation under present conditions. Die-cast aluminum construction gives lightness, positive rigidity and accurate

spacing, guaranteeing uniform capacity and lower resistance than the usual laboratory standards.

The adjustable "Lifetime" bearing insures any desired degree of friction without danger of disturbing plate alignment. Fully backed by manufacturer's guarantee.

- L-7—.00015 (or 150 M. M. F.).....\$4.25
- L-13—.00025 (or 250 M. M. F.)..... 4.50
- L-17—.00035 (or 350 M. M. F.)..... 4.75
- L-23—.0005 (or 500 M. M. F.)..... 5.00
- L-35—.0008 (or 800 M. M. F.)..... 6.00

B-T "Lifetime" Multiple Condensers

The double condenser is a necessity in circuits designed for simultaneous tuning. The same high-grade construction is used as in the B-T single condenser, and similar shape of plates assures best possible tuning under present conditions. The compensating "trimmers" is an exclusive feature of highest merit. The secondary "trimmer" is adjusted but once, after which slight adjustments of the small knob compensate for any possible variations. This feature is a necessity in practically every circuit employing a multiple control. B-T does not recommend a triple condenser. Made in two sizes:

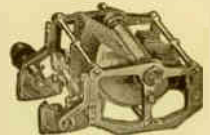

Type LD-13—Each Unit .00025.....\$9.00
(250 M. M. F.)

Type LD-17—Each unit .00035..... 9.50
(350 M. M. F.)

(Type LD-17 is used with all B-T Torostyle inductances.)

B-T Straight-Line Frequency Condensers

Type S. L. F.-13—Capacity, .00025.....\$5.50

Type S. L. F.-17—Capacity, .00035..... 5.75

Type S. L. F.-23—Capacity, .0005..... 5.75

The B-T Radio Frequency Choke is used to prevent passing of radio frequency currents into the audio circuit. Many circuits, especially of the regenerative type, require a coil of this type.

The B-T Radio Frequency Choke Coil is wound in several banks to reduce distributed capacity.

Neatly mounted in bakelite case with terminal posts on the top. Mounted with single screw from the top.

Price, each.....\$0.90



BT Non-Inductive Variable High Resistance

A high-grade product with a rapid increasing demand. Distinctive patented features insure smooth, positive control, unimpaired by continued service. The circular resistance element is mounted in bakelite disc.



Variable engagement is secured by a shoe which slides over a yielding disc but does not wear against the resistance. The best high resistance made. Single hole mounting, with knob.

No. VHR- 2—	2,000 ohms.....	\$2.00
No. VHR- 50—	50,000 ohms.....	2.00
No. VHR-100—	100,000 ohms.....	2.00
No. VHR-200—	200,000 ohms.....	2.00

B-T Non-Inductive Potentiometer

A variable high resistance of similar construction to the above, but with three terminals.

Slider connects to center terminal and varies from zero at either outer terminal to maximum resistance—stepless, noiseless, and without choking effect.

No. P- 400 Potentiometer,	400 ohms.....	\$1.75
No. P-2000 Potentiometer,	2000 ohms.....	2.00

B-T Volume Control or Modulator

Similar in appearance and construction to potentiometer, but with 500,000 ohms of non-inductive resistance. Used in audio circuits for noiseless adjustment of volume and improvement of tone qualities.

No. VC500.....	\$2.00
----------------	--------

B-T Universal Socket

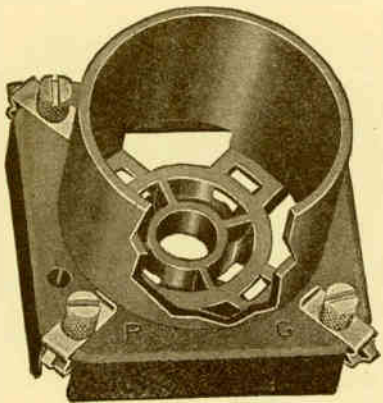

Takes either present navy base tubes or either large or small tubes with new UX base without an adapter. A new type of phosphor-bronze spring makes a gripping side contact and connects directly to wiring. Keyed screw heads prevent turning, sidewise spring displacement is impossible, and wide separation gives lowest possible capacity. Designed to eliminate adapters and the constantly recurring trouble caused by poor contacts.

Type UL—Price.....	\$0.75
--------------------	--------

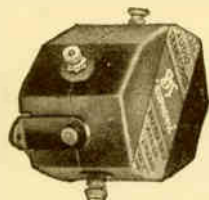

B-T Euphonic Audio Transformer

The B-T "Euphonic" (meaning "pleasing to the ear") is an audio transformer of unsurpassed merit. Nothing on the market today, regardless of size, will give better amplification or tone qualities, its superiority being particularly noticeable on low notes.

It shows the first constructional improvement in years. The special mounting features and placing of terminals allows mounting either side up in such various positions as will eliminate all crossed wires, helping greatly to prevent howling and distortion.

The Euphonic is the result of two years of radio experience.

Type 210—Ratio 2.2 to 1.	Price.....	\$5.00
Type 410—Ratio 4.7 to 1.	Price.....	5.75



B-T Mikro-Mike Condenser

A high-quality straight-line unit with indicator showing uniform capacity variation from 1/2 to 30 M. M. F. over twelve turns of adjusting screw. Molded bakelite case.

Used in B-T patented circuits or wherever a highly accurate capacity capable of minute uniform variations is desired.

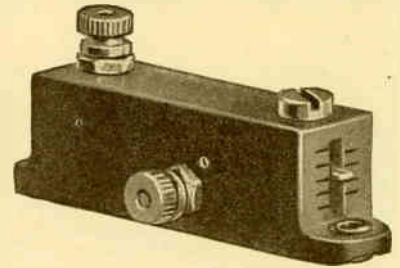

Type M. M.
Condenser
Price
\$0.90

B-T Tuning Control

A tuning control that combines attractive appearance with the highest degree of efficiency. A 12 to 1 ratio provides positive control with a smooth, easy flowing action. There is no pull on the condenser shaft and no side strain. The same unit works with either right or left-hand condensers. A reversible, erasable disc is calibrated on one side in wave-lengths and the other is for station letters.

This is the only dial made that reads in fractional degrees, if desired.

Finished in black and gold. Diameter, 4 inches.

Price	\$2.50
-------------	--------

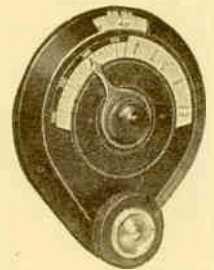

B-T Three-Circuit Tuners

The Three-Circuit Tuner, an original B-T development, reaches its highest form in the present bank-wound, skeleton frame product. The scientifically balanced relations between inductance values, circuit coupling, insulation and resistance gives results that are admittedly unequalled in one to four tube sets.

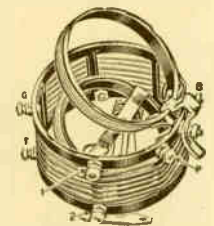

Type B, for broadcasting, covers 200 to 565 meters with B-T L-13 condenser. Price.....	\$5.00
Type SW, for short wave, covers 50 to 150 meters with B-T L-13 condenser. Price.....	4.00

B-T Air Core Transformers

A two-circuit bank-wound transformer, similar in construction to B-T Tuner, but without rotor. The best unit for adding a stage of radio-frequency.

Type AC-1 Transformer, fixed primary.....	\$2.50
Type AC-3 Transformer, adjustable primary.....	3.50

Bremer-Tully Six-Tube Counterphase

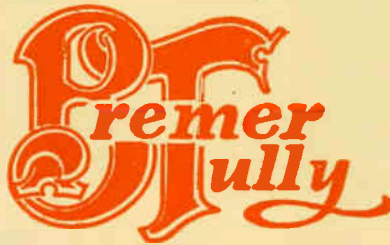

Listed as recommended by Bremer-Tully engineers.

Complete parts for the new wonderful Bremer-Tully six-tube counterphase.

1 No. 6 Kit.....	\$38.00
2 B-T 2-1 Euphonic Transformers, at \$5.00.....	10.00
2 Kurz-Kasch 4-inch Dials, at 85 cents.....	1.70
2 1 Mfd. Fixed Condensers, at \$1.25.....	2.50
1 Dubilier .001 Fixed Condenser.....	.40
1 Dubilier .00025 Grid Condenser and Clips.....	.45
1 Electrad 2-Megohm Grid Leak and Mounting.....	.40
6 B-T UL Sockets, at 75 cents.....	4.50
1 Yaxley No. 4 Double Circuit Jack.....	.80
1 Filament Switch.....	.60
1 Yaxley No. 1 Single Circuit Jack.....	.50
1 Yaxley Battery Switch.....	.75
1 General Radio 6-Ohm Rheostat.....	1.25
1 Yaxley 7-Point Inductance Switch.....	1.00
5 Eby Binding Posts, at 15 cents.....	.75
1 Burgess 4 1/2-volt "C" Battery.....	.60
1 7x24 Formica Panel.....	3.95
1 10x23 1/2 Baseboard.....	.80
1 Imitation Walnut Cabinet.....	\$ 6.45
1 Genuine Walnut Cabinet.....	14.45
1 Blue Print.....	.75

Total.....\$69.70

Complete parts for Bremer-Tully Five-Tube Counterphase. 60.40
Cabinets, same price as above.

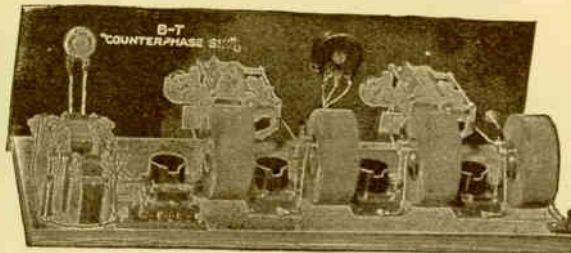

Completed Bremer-Tully Counterphase
Showing Construction of Five and Six-Tube Sets

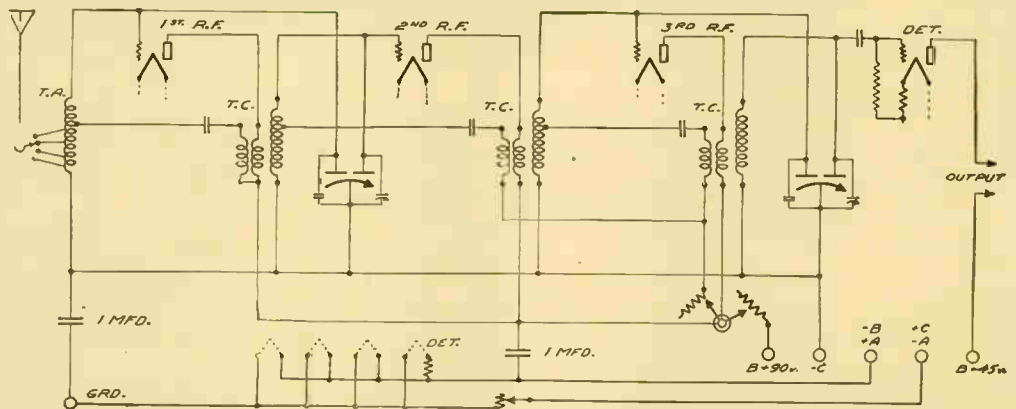

Bremer-Tully Famous "Nameless" Circuit

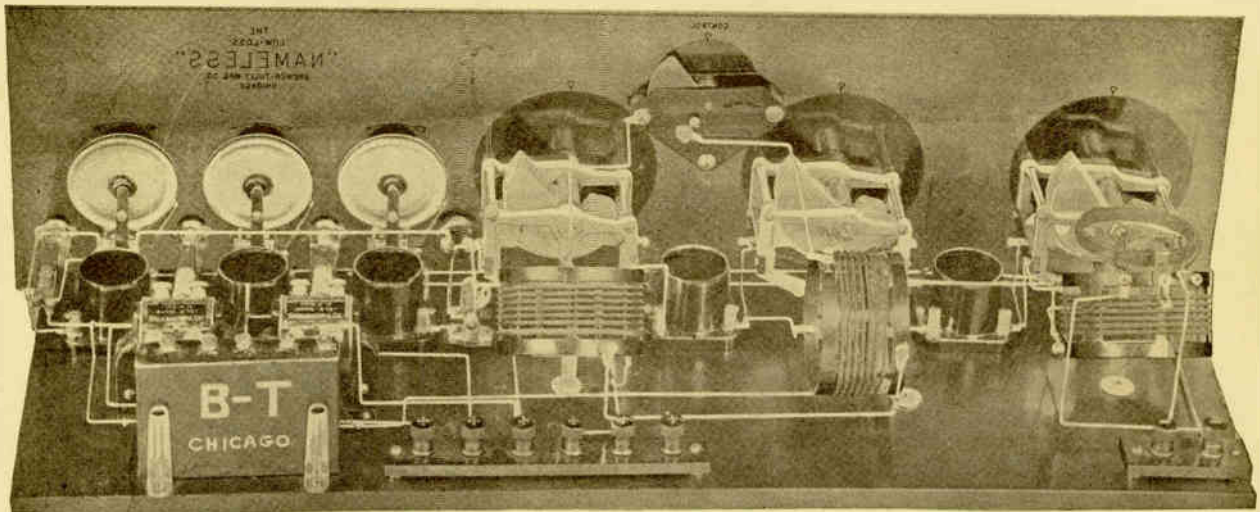

Complete Parts B-T "Nameless"

1 B-T Low-Loss Nameless Kit No. 3.....	\$26.50	1 Dubilier .00025 Grid Condenser, with Clips.....	\$ 0.45
1 7x26x 1/2 inch Panel (Special Engraving).....	6.00	1 Dubilier .001 Fixed Condenser.....	1.40
1 8x25x 1/2 inch Wood Baseboard.....	.80	8 Initialed Eby Binding Posts, at 15 cents.....	1.20
2 20-Ohm Yaxley Rheostats, at \$1.35.....	2.70	3 4-inch Dials, at \$1.00.....	3.00
1 6-10-Ohm Yaxley Rheostat.....	1.35	12 Lengths No. 14 Tinned Bus Bar, at 3 cents.....	.36
5 Standard Sockets, at 50 cents.....	2.50	2 Pieces of Bakelite for Binding Posts.....	.20
2 Yaxley Double Circuit Jacks, at \$1.00.....	2.00	Miscellaneous Screws, Lugs, etc.....	.50
1 4-Prong Filament Control Jack.....	.90	2 Brass Strips for "C" Battery Holder.....	.10
1 C. H. Battery Switch.....	.60	Total.....	\$60.51
1 All-American 5-1 Transformer.....	4.75	Special Cabinet for above.....	9.30
1 All-American 3-1 Transformer.....	4.50	Complete.....	\$69.81
1 2-Megohm Daven Grid Leak.....	.50	Blue Print for above.....	1.00
1 7-Volt "C" Battery.....	.85		
1 Dubilier .00025 Condenser.....	.35		

Index on 78 and 79

KARAS

Karas Orthometric

This new Karas Condenser positively eliminates any crowding whatever of stations on any part of the dial.

What It Does

Separates all adjoining wave-lengths by equal distances on the dial. With the proper inductance to tune with the capacity of the condenser every point of a 180 degree—100 division dial, covering the 100 wave-lengths between 200 and 600 meters, is equally separated from its adjoining point in both directions by 10 kilocycles—exactly the same as wave-lengths are separated and allocated by the Government.

Three hundred meters—1,000 kilocycles—comes in where it belongs—at 50 on the dial. KDKA, 309 meters—970 kilocycles—comes in at 53 on the dial.

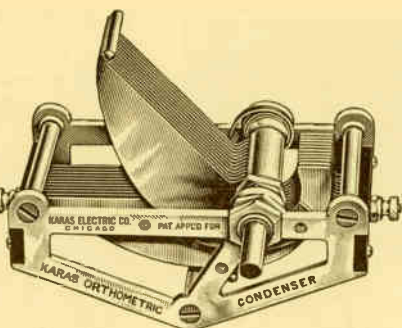

Easy Tuning

With Karas Orthometrics there is no crowding whatever of stations on any part of the dial. Every point on the dial from 1 to 100 is a separate broadcast wave-length. This wide, even separation of wave-lengths makes tuning extremely easy.

With ordinary condensers the first 50 wave-lengths are jammed into the first 15 points of the dial—with straight-line wave-length condensers the first 50 wave-lengths are crowded into the first 25 points of the dial—with Karas Orthometrics the first 50 wave-lengths are spread apart. They are equally and evenly distributed over the first 50 points of the dial—the last 50 wave-lengths evenly and equally over the last 50 points.

This result is achieved by the scientific, eccentric form and position of Karas Orthometric rotor and stator plates.

Highest Quality Possible

Karas Orthometric Condensers are of the very highest possible efficiency, both electrically and mechanically. They are constructed throughout of highest quality brass. Plates and frame are die-stamped and solidly braced, insuring perfect and permanent alignment and rigidity. All stator and rotor plates are soldered at every point of contact. Rotor has wide copper pig-tail connection soldered at both ends. Rotor plates and entire frame are grounded, preventing any body capacity effect. Stator plates have binding posts at either end permitting any convenient arrangement of the condenser on the panel.

Due to our two scientific cone bearings, rotor plates turn firmly, but easily, with a liquid-like smoothness. The dielectrics are of the highest quality hard rubber, and are placed outside the effective electro-static field, eliminating absorption losses.

Results

Because of the unusual design of this eccentric condenser the vital, harmonic carrying side-bands are fully retained. Resistance has been reduced to an absolute minimum. Result—strong, powerful signals with full, round, natural tones.

Sizes and Prices

23 Plates, .0005 Mfd. capacity	\$7.00
17 Plates, .00037 Mfd. capacity	6.75
11 Plates, .00025 Mfd. capacity	6.50

Karas Harmonik

You secure marvelous reception with these new Karas Harmonik Audio Frequency Amplifying Transformers.

What Karas Harmoniks Do

They amplify with great volume with extremely low frequency tones. Karas Harmoniks also amplify equally all of the many vital harmonics and rich overtones that combine to form musical sounds. With Karas Harmoniks there is no muffling or sounds—no fuzz on the edges of words—no thin, squeaky, distorted tones. Instead every tone is clean-cut, separate and distinct from every other tone—natural.



The Results of Karas Harmoniks

The result from any radio set of any and all efficient circuits is an outpouring from the loud speaker of soft, rich, round, full, mellow tones such as you have never before heard from any radio—a surprising volume of real music to which it is a delightful pleasure to listen.

Structural Factors That Produce the Flat Curve

Large coils of many thousands of turns of wire giving a very high inductance. Large iron core offering an easy path for the lines of magnetic force to influence the secondary windings. Very high impedance to retain the full amplification delivered by the amplifier tubes. Controlled air gap insuring high amplification of low frequency, volume-carrying, fundamental harmonics—this factor enables Karas Harmoniks to deliver more total amplification with a low ratio than cheap transformers do with a high ratio. Low distributed capacity insuring full amplification of high audio frequency harmonics and overtones. Low hysteresis loss insuring a maximum amount of energy available for amplification of all frequencies. Scientifically shielded against inter-coupling of electro-static and electro-magnetic fields. Perfectly matched insuring the same values of amplification in both first and second audio stages.

The secret of the strikingly wonderful reception of Karas Harmonik Transformers is disclosed by this scientific laboratory curve of their actual performance.

Low frequencies represent low notes—high frequencies represent high notes and the harmonics of low notes. All musical sounds are composed of a fundamental harmonic and many other harmonics and overtones of varying and successively higher frequencies.

Equal Amplification

It is the combination of these many harmonics and overtones forming a single note that makes it a beautiful, pleasing, musical sound. The inability of ordinary transformers to fully and equally amplify all of these many harmonics and overtones is the cause of distorted and unnatural sounding tones in the loud speaker.

This scientific laboratory curve shows that Karas Harmonik Transformers amplify all sounds and all harmonics and overtones of all sounds nearly equally—delivering to the loud speaker a pure, natural sounding musical reception.

Price, each..... \$7.00

Van-Ashe Radio Company, St. Louis, Mo.



The name Cutler-Hammer has held an enviable position in radio. Consistently from the earliest days has the C-H trade-mark been synonymous with proper design and unequalled precision. Radio builders everywhere justly had faith in these foremost engineers and millions of their radio parts in the orange and blue boxes have helped build receiving sets of quality.

The Perfected C-H Rheostats

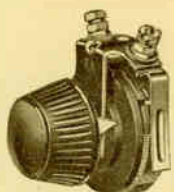

These new C-H Rheostats are built like a watch. They are accurate, compact, smooth running and dependable.

Requires but one hole for mounting. A rigid, self-centering mounting is obtained, independently of the adjustment on the panel. A single hex nut fastens the instrument snugly in place on panels of any thickness.

- No. 8011—Size, 6 ohms. Price, each . . . \$0.75
- No. 8013—Size, 15 ohms. Price, each75
- No. 8014—Size, 30 ohms. Price, each75

C-H Variable Resistance Unit



The C-H Variable Resistance Unit attaches instantly to standard 6-ohm rheostats and adds just enough resistance to control the 1/4-ampere 6-volt "A" type or the UV-199 type tubes.

It saves the cost of new rheostats and the trouble of redrilling the panel. Fully adjustable for the charge in battery potential. Also used in many circuits wherever a variable low resistance is required. Resistance from 0 to 25 ohms.

- No. 8004—C-H Variable Resistance Unit. Price, each \$0.25

C-H Heavy Duty Radio Switch

The positive, quick make-and-break mechanism, the self-cleaning contacts, the large contacts, the patented floating contactor construction, and the minimum resistance of C-H Heavy Duty Radio Switch insure most satisfactory operation.

Touching the button or jarring the set does not affect the contact nor introduce microphonic noises even in the most sensitive circuits.

Easy to mount, requiring but one hole. Adjustable to panels of any standard thickness.

- No. 8008—C-H Heavy Duty Radio Switch. Price, each \$0.60

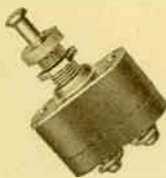

The C-H Precision Potentiometer

400 Ohms

The C-H Precision Potentiometer is similar in construction to the new C-H Rheostats. It is the smallest, most compact 400-ohm potentiometer on the market, the rotor being only 1 3/8 inches in diameter and extending only 3/4 inch back of the panel. And with its desirable small size comes perfect smooth and quiet operation.

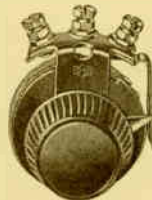

- No. 8016—C-H Potentiometer, 400 ohm. Price, each \$1.00

C-H Radioloc



The C-H Radioloc is similar in construction to the C-H Heavy Duty Radio Switch, except that it is controlled by a key instead of the push-and-pull button.

The switch mechanism is entirely enclosed in a dust-proof case and insulated with fibre. The heavy brass terminals are convenient and designed with soldering lug for tight connections.

- No. 8020—C-H Radioloc Switch. Price, each \$0.60

C-H Radio Toggle Switch



The C-H Radio Toggle Switch is the first application of the popular toggle switch idea to radio control.

A flip of the operating lever, with the finger, turns the current "on" or "off." A black aluminum lettered plate positively indicates whether the circuit is open or closed.

The toggle lever, operating through a ball bearing actuates the large fan-shaped contact, which gives smooth and quiet operation.

- No. 7135—C-H Radio Toggle Switch. Price, each \$0.60

C-H Low Loss Radio Socket

It embodies a minimum of both metal and insulation. The shell is of thin orange bakelite and the base of heat-proof genuine thermoplas. All current carrying parts are widely spaced, both in the air and insulation.

The contacts make connection on both sides of each tube prong and are firmly held in place by spring washers to assure unchanging operation of the tube. Each contact is designed in one piece, eliminating joints that contribute to losses. They are plated with genuine silver.

- No. 8009—C-H Radio Socket. Price, each . . \$0.60



C-H Variable Grid Leak

Every tube and every circuit requires a different value of resistance that allows the charge that "piles up" on the detector grid to "leak off" at just the proper rate.

If this value is too high, the charge chokes the tube; if too low, reception is "mushy;" in some cases the grid condenser cannot function at all.

That is why the grid leak must be variable.

It has a complete range from infinite resistance to a value lower than needed for any condenser.

- No. 8007—C-H Variable Grid Leak. Price, each \$1.50

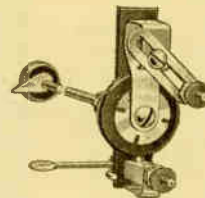

KISMET

Five-Tube Tuned Radio Frequency

List Price
Set

\$37⁵⁰

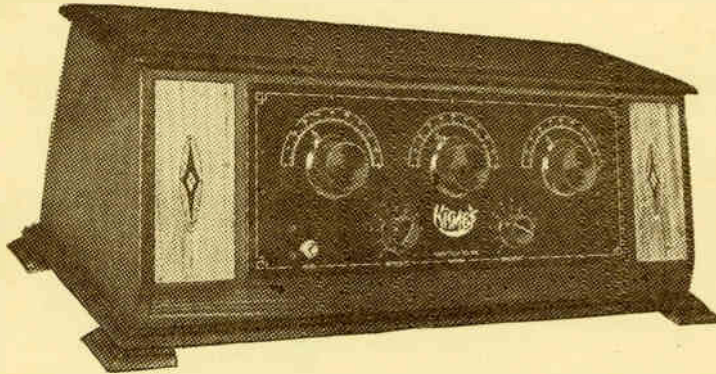

Complete
Ready to Use

\$89⁰⁰

The Kismet Set is an extremely scientific and highly developed tuned radio frequency receiver, embodying the last word in radio construction, workmanship and materials.

Genuine bakelite is used throughout. New type, straight-line condensers are used, and there are but eleven wires in the entire set. The cabinet is of sloping panel design in two-tone walnut finish. Battery compartments are provided on either side of the panel, eliminating unsightly wiring. Four-foot leads are furnished for all connections in the Kismet.

The Equipment Consists of the Following Standard Parts

1 Kismet Set. List.....	\$37.50	2 45-Volt Burgess "B" Batteries.....	6.50
5 301A Cunningham Tubes.....	12.50	1 Phone Plug.....	.50
1 Complete Aerial.....	2.00	1 Keco "A" Battery.....	20.00
1 Loud Speaker.....	10.00	(Guaranteed 90 amp. hours)	
(Choice of any \$10.00 Speaker)		List Price.....	\$89.00
	\$62.00		

Each and every set has a written guarantee by the manufacturers, and the Van-Ashe Radio Company, which gives every buyer an iron-clad guarantee that the set will perform and is free from all mechanical defects.

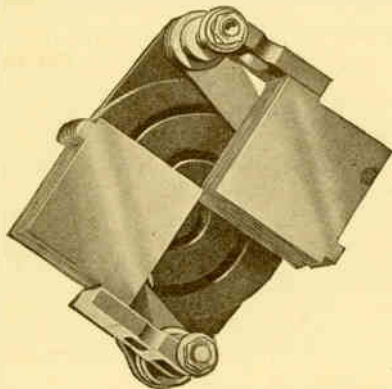

Signal Spiral Cam Condenser

- Type R-1—23-plate, .0005. Each.....\$4.00
- Type R-2—11-plate, .00025. Each.....\$4.00
- Type R-3—17-plate, .00035. Each.....\$4.00

Accuratune Micrometer Control

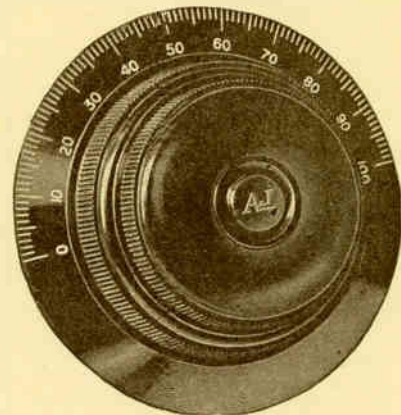

The Accuratune is an actual micrometer control superior to any other tuning device. For coarse adjustment the larger knob is used like any ordinary dial. The smaller knob operates the vernier mechanism for fine tuning, at a reduction of 80 to 1. By rotating the dial from 0 to 180 degrees, by means of the vernier knob, you can pick up station after station you never dreamed existed. The Accuratune is made of genuine bakelite (highly polished, black or mahogany) with beautiful silvered or gold dial and neatly engraved graduations. Fits 1/4-inch instrument shafts. Dial 4 inches diameter. Guaranteed by the manufacturer. Furnished either 0-right or 0-left. Non-micrometer dials can be furnished to match large instruments.

- No. 101—Frosted silver.....\$3.50
- No. 101—Frosted gold..... 4.75
- Accuratune Rheostat Control, silver..... .75
- Accuratune Rheostat Control, gold..... 1.25

Signola Loop

- "Bracket Type"—
Price, ea. . \$8.50
- "Table Type"—
Price, ea. . \$8.50

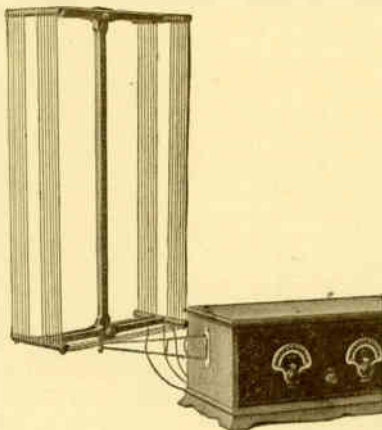

YAXLEY

APPROVED RADIO PRODUCTS



No. 1—Open Circuit.
Price, each...\$0.50



No. 2—Circuit Closing.
Price, each...\$0.60



No. 2A—Two Circuit.
Price, each...\$0.60



No. 3—Single Circuit Filament Control.
Price, each...\$0.70

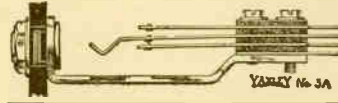

No. 3A—Circuit Reversing.
Price, each...\$0.70



No. 3C—Double Circuit.
Price, each...\$0.70



No. 4—Interstage.
Price, each...\$0.80



No. 4A—Two Circuit Filament Control.
Price, each...\$0.80



No. 5—Two Circuit Filament Lighting.
Price, each...\$0.90



No. 6—Interstage Filament Control.
Price, each...\$1.00

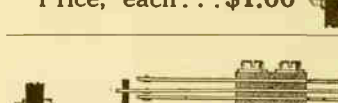

No. 7—Interstage Filament Lighting.
Price, each...\$1.10

Average weight of jacks, box of ten, 1 pound, 2 ounces.

Extension Jack

Connects to extension cord or wire so that loud speaker or headphones may be plugged in at distance point.



No. 100—Price, each...\$0.75

Designation Plates

Mounts under jack nut. Furnishes correct marking for jacks. Eliminates engraving on panel and adds to the attractiveness of set. Packed in bulk; 50 to envelope.



<p>"Telephone" "Radio" "1-Stage"</p>	<p>Markings "2-Stage" "Detector" "Off—On" "Loud Speaker"</p>	<p>"3-Stage" "4-Stage" "L-S"</p>
--	---	--

Price, each...\$0.05



No. 20—Battery Switch.
Price, ea...\$0.75



No. 30—Two Circuit.
Price, ea...\$0.90

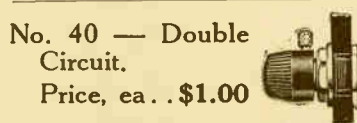

No. 40—Double Circuit.
Price, ea...\$1.00

No. 45—Five Spring. Price, each...\$1.15
(Not illustrated)

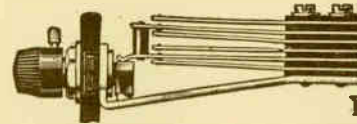

No. 60—Two-Way Two Circuit.
Price, ea...\$1.25

Average weight of Jack Switches, box of ten, 1 pound 4 ounces. Black knob is standard for Jack Switches. Mahogany knob also furnished at 5 cents list extra.

Midget Jack



Smallest and neatest jack made. Easy to mount. Highly efficient. For connecting battery leads, ground, antenna, etc., has no equal. Notice the low list. Every set builder will want several on each set. A great convenience to add to factory-built sets. Packed in bulk.

No. 16...\$0.35

Midget Plug



The baby plug, but a wonderful baby at that. It is designed especially for use with the Pup Jack. Neat in appearance; efficient in operation.

No. 15...\$0.15

Midget Battery Switch

The most efficient filament control switch made. Never gets out of order. One nut mounting, in 1/8-in. panel hole. Hard rolled phosphor bronze springs, pure silver contacts. Terminals tinned for soldering. Insulated from brass frame. Quick make and break. Furnished complete with "Off" and "On" plate, as illustrated.



YAXLEY No.10

This switch is standard equipment in thousands of the best sets on the market today. To see it is to appreciate the correct design and the splendid construction. A big seller everywhere.

No. 10...\$0.50

No. 11 switch same as No. 10, excepting it has three springs for two circuits.

No. 11...\$0.65

Inductance Switch

(Yaxley Patent No. 1,543,468)

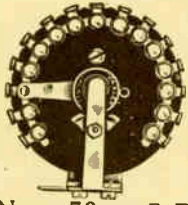

Mounts back of panel; no front contacts. Coil wires solder direct to one-piece terminal. Graduated dial eliminates panel marking. Copper ribbon pig-tail prevents loose connections. Has a single-nut mounting in 1/2-inch panel hole. Provided with knob and etched dial.

- No. 70—7 Point.....\$1.00
- No. 90—9 Point..... 1.15
- No. 150—15 Point..... 1.25
- Double Contact Arm. List, extra..... .10

Inductance Switch Dial

Diameter of dial, 2 1/8 inches; graduated into 15 equal divisions to correspond with contact spacing on inductance switch. Mounts on 1/8-inch plain shaft with set screw. Packed in bulk.

- No. 363.....\$0.50

Panel Lights

Neat in appearance. Mounts in a single 1/2-inch panel hole.

- No. 330.....\$0.50

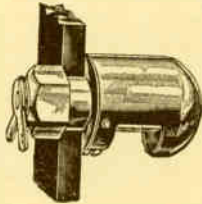

Rheostat

The Air-Cooled Rheostat

The new Yaxley Rheostat is scientifically designed to give the most perfect results. The large number of turns of special non-rusting resistance wire make this "the straight-line rheostat." Smooth as silk in operation. Has very fine adjustment, feeding current slowly and evenly.

The resistance unit is suspended in air. This permits an even rise in temperature and does away with excessive heating.

No steel is used in the construction of this rheostat. Mounts in single panel hole (1/8-inch). Furnished complete with bakelite knob.

- No. 102-K—2 Ohms
 - No. 13-K—3 Ohms
 - No. 16-K—6 Ohms
 - No. 110-K—10 Ohms
 - No. 115-K—15 Ohms
 - No. 120-K—20 Ohms
 - No. 125-K—25 Ohms
 - No. 130-K—30 Ohms
 - No. 140-K—40 Ohms
- Each.....\$1.35

Potentiometer

Air-Cooled

Potentiometer has exactly same construction as rheostat. Knob and etched dial plate regularly furnished with potentiometers.

- No. 200—200 Ohms.....\$1.75
- No. 400—400 Ohms..... 1.75

Rheostat Knob

Diameter of knob, 1 1/2 inches. Has nickel-plated pointer attached. Mounts on 1/4-inch plain shaft with set screw. Packed in bulk.

Also furnished for 3/8-inch shaft, when so ordered.

Add 5 cents list extra for mahogany.



- No. 367.....\$0.20

Pilot Light Switch

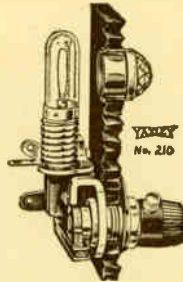

A decided novelty as well as a great utility for every set. Shows when the set is on or off. Cost of the Pilot Light Switch is comparatively small—it is easily installed. It has a wonderful sales appeal. There is something alluring about the Pilot Light, and to see one is to want it.

- No. 210.....\$1.00

Pilot Light Bracket

Has the same characteristics as the Pilot Light Switch, excepting it is intended for sets which are already equipped with a filament switch.

- No. 310.....\$0.50

Lamps extra.

Jewels for the above devices may be had in red, green or amber. Please specify color in ordering.

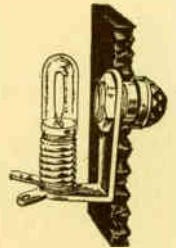

Lamps

We have made special arrangements to furnish the radio trade with a one-tenth (.1) ampere, six (6) volt lamp for use in connection with our No. 210 Pilot Light Switch and No. 310 Pilot Light Bracket, and also our No. 330 Panel Light.

This lamp has a very low current consumption, and is, therefore, to be recommended especially for sets operating on dry batteries. The lamp has an extremely long life. However, the standard six (6) volt miniature screw base lamp will operate successfully with our Pilot Lights and Panel Lights.

As a matter of convenience, we show a list price of 50 cents on these lamps. This price is subject to our usual discounts.

Our suggested resale for the No. 210 complete is \$1.50; No. 310 complete is \$1.00; No. 330 complete is \$1.00. We can furnish the lamps separate or part of the device as is desired.

- Lamps.....\$0.50

13
15
17
48

Majestic A and B Current Supply

TRADE MARK PAT PENDING

Eliminates all batteries.
No liquids or acids to spill or corrode.
Positively no "hum" when used for loud speaker reception.
Excellent on DX stations.
Costs 1/2c per hour to operate.
Reception results will be found better than with batteries. Plate voltage can be varied from 50 to 130 volts.



Can be used with any type of receiving set using from one to eight tubes, either 201-A or 199 type.

Does not require any change in set wiring.

Connect same as batteries.

No moving parts or contacts to get out of order.

GUARANTEED FOR ONE YEAR

Questions and Answers

What Is It?

The Majestic A and B Current Supply is so far the greatest single contribution to the radio art. It is a simple, fool-proof, ruggedly built device of attractive design and proportions, which replaces the present system of large, bulky, liquid, acid storage battery, troublesome battery charge, and constantly depreciating "B" batteries.

Can It be Used With Any Type of Radio Set?

Yes! Majestic A and B Current Supply can be used with any of the present known makes and types of radio receiving sets. They have been tested with uniformly excellent results on regenerative, tuned radio frequency, untuned radio frequency, neutrodyne, super-heterodyne, reflex, and combinations of these circuits.

Does It Hum?

No! There is positively no "hum" when used for loud speaker reception; in fact, tone quality and volume are superior to ordinary battery equipment.

Can It be Used With Any Type of Tubes?

Connections are provided for use with either 5-6 volt 301-A type tubes, or with 4-volt 199 type tubes. It will handle up to eight 1/4-ampere type tubes, or the equivalent of any other type of tube up to 2 amperes maximum filament current.

Model AB-1—Majestic A and B Current Supply (less tubes). Each **\$47.50**

Note: For "A" use one 2-ampere rectifying tube; 2-ampere "Tungar" or "Rectigon" bulbs are satisfactory. For "B" use two amplifier tubes; Type 301-A, or equivalent, are satisfactory.

Complete with all tubes **\$57.50**

Majestic Reproducer

Home Concert Model

Your set is no better than its loud speaker. There is no better loud speaker than the G-G-H Majestic Reproducer.

Extremely sensitive—the exclusive Constant Tension Diaphragm (Pat. Pending) of "Stannfer" metal has the essential elastic qualities to respond instantaneously to the delicate variations in the reproducing circuit.

A sound projector horn of scientific construction—a round, mellow tone quality with surprising volume. Practically non-breakable.

Specifications: Height over all, 22 inches; diameter of bell, 13 inches.

Complete with 5 feet of cord. Base finished in beautiful crystalline lacquer. Volume adjustment control. Packed in single cartons.

Standard Model No. 2GG, ebony finish. Each **\$12.50**



Index on 78 and 79

URECO

RADIO TUBES



Prices and Types of "URECO" Radio Tubes

"URECO" Dry Cell Tubes

Type	Voltage	Amperage	Maximum Plate Voltage	Use	List Price
U12	1.1	.25	90	Detector & Amplifier	\$2.50
X12	1.1	.25	90	D and A	2.50
U120	3.	.12	135	Last Audio Stage	2.50
X120	3.	.12	135	Last Audio Stage	2.50
U199	3.	.06	90	D and A	2.50
X199	3.	.06	90	D and A	2.50

Type 12—Designed for single dry cell use, or for dry cells connected in parallel.

Type 120—Tube of new design, to be used in last audio stage for greater volume and quality.

Type 199—Standard 3-volt dry cell tube.

Prefix U designates old style (navy) base.

Prefix X designates new plunger type base.

"URECO" Storage Battery Tubes

*U112	5or6	.5	160	Last Audio Stage	\$6.50	*URECO Famous Goldentones.
*X112	5or6	.5	160	Last Audio Stage	6.50	**Can also be purchased MATCHED in sets of five.
U200	5or6	1.	22.5	D.	2.50	Type 112—Special tube of low impedance and high mutual conductance for use in last audio frequency position where volume and clarity are desired. (One of the Goldentone tubes.)
X200	5or6	1.	22.5	D.	2.50	Type 200—Detector tube for certain storage battery sets.
**U201	5or6	.25	135	D and A	2.50	Type 201—Standard storage battery detector and amplifier.
**X201	5or6	.25	135	D and A	2.50	Type 210—Power amplifier for use in last stage of audio. (Another Goldentone.)
*X210	6	1.25	350	Last Audio Stage	9.00	
Hy. Mu 1	5or6	.25	135	1st and 2nd Audio Stages in Resistance Coupled Sets	4.00	

"B" Eliminator Tubes (Rectifiers)

Type	Voltage	Use	List Price
X213	5.	Full Wave	\$7.00
X216	7.5	Half Wave	7.50

X213—Rectifier for "B" eliminators designed for full-wave rectification.

X216—Rectifier for "B" eliminators designed for half-wave rectification.

All URECO tubes are packed in individual cartons, five to a box, and in standard packages of 100.

THE URECO CORPORATION HAS GIVEN US AUTHORITY TO MAKE ALL ADJUSTMENTS ON URECO TUBES. THIS ARRANGEMENT GIVES YOU IMMEDIATE ADJUSTMENT ON URECO TUBES, WHICH IS REAL TUBE SERVICE.



Utah

Made in Salt Lake City

Guaranteed Loud Speaker

Made of Semi-Hard Rubber

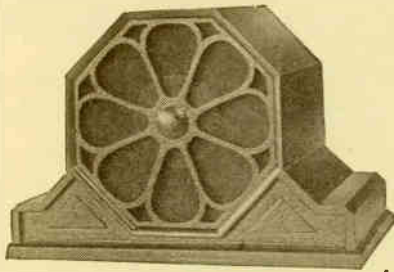

Utah Supreme

Finished in a soft antique mahogany, designed to please both eye and ear. Measures 10½x8x7½ inches. Weight, 8 pounds. Packed one in a carton, three in a crate.

Price\$25.00

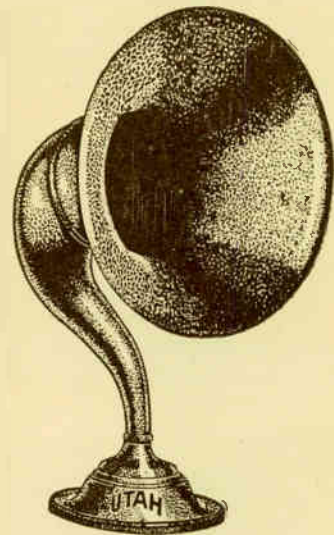

Utah Standard

Horn is finished in a rich semi-dull black Morocco leather finish; 14-inch bell. Weight, 11½ pounds. Packed one to a carton.

Price\$25.00

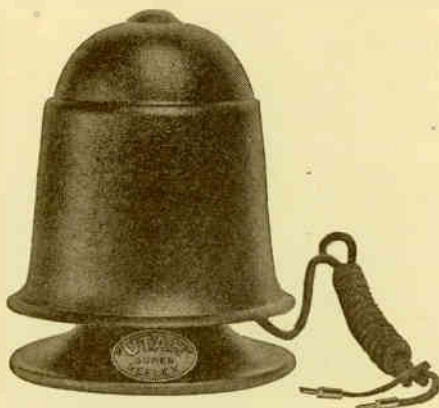

Utah Superflex

The Superflex has a tone chamber equal to that of the usual horn type. Stands but 8½ inches high by 6 inches wide. Finished in a harmonious brown. Weight, 3 pounds. Packed one in a carton, twelve in a crate.

Price\$14.00

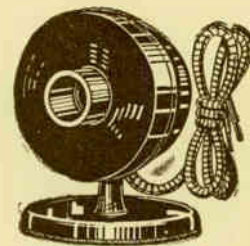

Utah Phonospeaker

Handsomely finished in black rubber. Furnished with base to rest on turntable of talking machine, or without.

Price, with Stand.....\$10.00

Price, without Stand..... 9.50

Jewell Meters

Jewell Filament Control Instruments

The life of any vacuum tube filament depends upon the way it has been handled over its entire life. It is stated by experts that the life of a tungsten vacuum tube filament is doubled by operating it at a current of 3 per cent less than normal and if the current should be increased to 3 per cent over normal, the life will be cut in half.

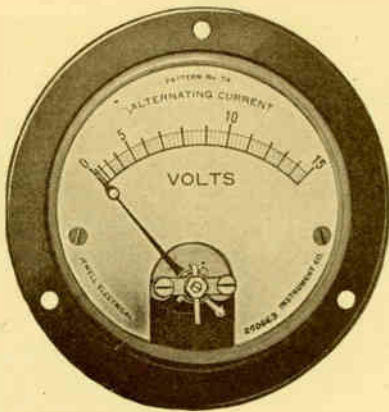

Pattern No. 74 for 60-Cycle Alternating Current

- 0-10 V. or 0-3 A. for all 5-watt Trans. tubes. . \$7.50
- 0-15 V. or 0-8 A. for 50-watt Trans. tubes. . . 7.50
- 0-15 V. or 0-15 A. for 250-watt Trans. tubes. 7.50

Pattern No. 54 for Direct Current

- 0-3 V. or 0-.5 A. for dry cell Rec. tubes. . . \$7.50
- 0-7.5 V. or 0-1.5 A. for standard Rec. tubes. 7.50
- 0-10 V. or 0-3 A. for all 5-watt Trans. tubes. 7.50
- 0-12 V. or 0-8 A. for 50-watt Trans. tubes. . . 7.50
- 0-12-120 volts for receiving set. 8.50

Jewell Radiation Ammeters

The Pattern No. 64 Radiation Ammeter, as shown, is connected in the antenna lead as is common practice. It may be connected in the ground lead, if desired, but if this is done, care must be taken that some of the antenna current does not leak to ground through the set and hence not be registered.

Pattern No. 64 for Radio Frequency Currents

- Full scale value of .5, .8, 1, 1.5, 2, 2.5, 3, 5, 8, 10 or 15 amperes. \$12.00

Jewell Pattern No. 53

For receiving sets particularly we recommend our 2 1/2-inch Pattern No. 53 direct current instrument which can be made up as an ammeter or voltmeter, as desired. The control of receiving tube filament is becoming a matter of importance, and this instrument is especially suitable because of its accuracy and small size for mounting on the control panel of a receiving set.

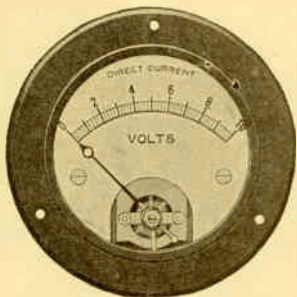

- 0-5, 8, 10, 15, 25, 50 or 0-80 volts. \$7.50
- 0-100 volts. 9.00
- 0-150 volts. 9.50
- 0-1, 1.5, 2, 3, 5, 8, 10 or 0-15 amperes. . . . 7.50
- 0-10, 15, 20, 25, 30, 50, 75, 100, 200 or 0-500 milliamperes. 7.50

Jewell Plate Milliammeters

The Jewell Pattern No. 54 direct current milliammeters are ideal for this work and are listed below. Those up to 10 milliamperes are usually used for receiving tubes, those up to 75 milliamperes on 5-watt tubes, those up to 200 milliamperes on 50-watt tubes and up to 400 milliamperes on 250-watt tubes. Tubes in multiple may be grouped and their sum total plate current read on one instrument, although this will not show the distribution between the several tubes.

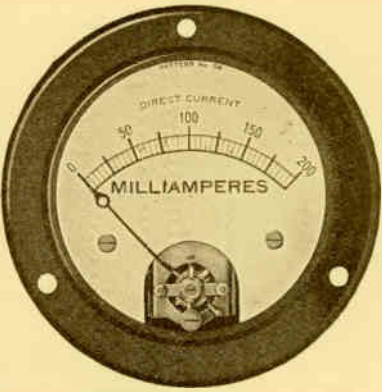

Pattern No. 54

- Full scale value of 3, 5, 10, 15, 20, 25, 30, 50, 75, 100, 150, 200, 250, 300, 500, 800 or 1000 milliamperes. \$7.50

Jewell Combination Panel Voltmeters

The batteries in a radio set are the parts which must be renewed most frequently, and hence should be checked more often than some of the other elements. It is extremely convenient to have on the panel of a radio receiving set a voltmeter with which it is possible to check the voltage of the "A" and "B" batteries.

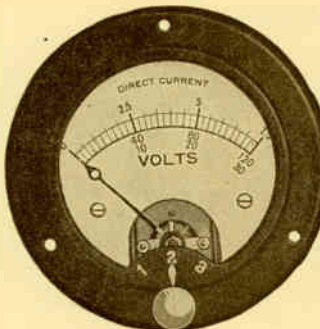

Pattern No. 55 for Direct Current

- 0-7.5-150 volts two readings. \$10.00
- 0-7.5-30-120 volts, three readings. 12.50
- 0-7.5-30-150 volts, three readings. 12.50
- 0-8-80-160 volts, three readings. 12.50

Jewell Battery Testing Instruments

Many of the troubles with receiving sets may be traced to low batteries, and a convenient voltmeter for checking batteries is becoming a necessity. Our Pattern No. 57 Combination Voltmeter fills this demand, having a double range to cover both "A" and "B" batteries.

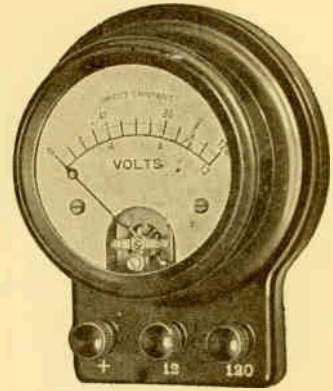

Pattern No. 57 for Direct Current

- 0-10-50 or 0-10-100 or 0-12-120 volts. . . . \$10.00
 - 0-7.5-150 volts. 10.50
 - 0-40 amperes, 0-80 volts. 12.50
 - Jewell Lightning Arresters. 1.10
- (Can be used inside or outside.)

Jewell Battery Tester

Jewell Meters

Jewell Tube-Checker

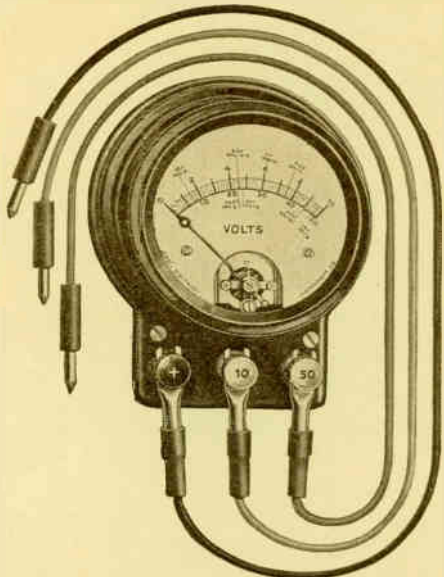

The Jewell No. 98 Voltmeter was designed especially to meet the demand coming to us from radio dealers and set owners for an instrument for checking the voltages of both dry and wet batteries. It has become a quite general practice among the best radio dealers to check batteries as they sell them, thus gaining the confidence of their customers. Set owners are fast learning that much of their trouble arises from weak or discharged batteries and that with the use of a dependable voltmeter, most of this trouble can be avoided. No. 98—Complete with leads. Each \$12.50

Jewell Radio Test Set

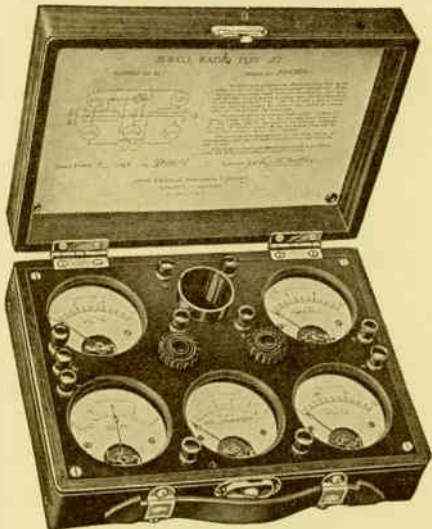

A distortionless amplifier, a repeater without any time lag, the thermionic vacuum tube is recognized today as a very remarkable device, which may be used to solve innumerable engineering problems. This, in addition to the use of the vacuum tube, is radio and other high-frequency work. The Pattern No. 95 radio test set makes the taking of characteristic curves nearly as easy as that of taking a single reading on a voltmeter.

While arranged and intended for vacuum tube testing, any one of the instruments may be used separately, which makes the instrument a most versatile piece of apparatus and of great value in the laboratory.

No. 95—Radio Test Set. Each \$75.00
 Extra pads of special cross-section paper, 40 sheets. Per pad, each25

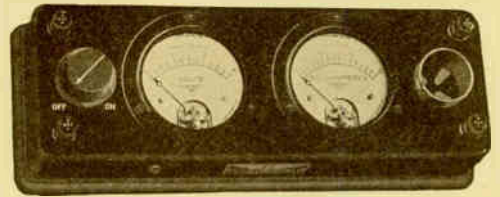

The enormous sale of vacuum tubes has resulted in the demand for a simple but efficient device for checking tubes in the hands of the dealer or distributor.

A table of values is given on the tube checker which can be used as a basis of comparison.

In general, the tube checker will be found to be the most practical device on the American market for the rapid checking of a large number of tubes. We should like to point out, however, that for the taking of complete tube characteristics our Pattern No. 95 radio test set is necessary.

No. 110—Tube Checker. \$35.00

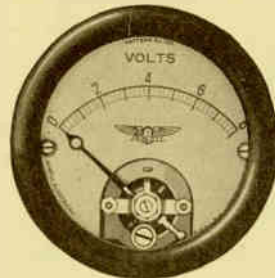

New Jewell Meter No. 135

Pattern No. 135 is supplied as a single reading voltmeter for filament control, which is probably the most important controlling factor in a radio set. It is also supplied as an ammeter to read "A" battery current and as a milliammeter to read "B" battery drain.

Double reading instruments are supplied with a common negative terminal and can be used with different switch or push button combinations so that either filament or "B" battery voltage may be read.

Voltmeter—0-5, 0-8 or 9-10 volts. \$7.00
 Voltmeter—0-100 volts 7.50
 Double Reading—0-5-100 or 0-10-100 volts. 8.00
 Double Reading—0-7-5-150 volts. 8.50
 Ammeters—0-3 or 0-5 amperes. 7.00
 Milliammeters—0-10 or 0-50 milliamperes. . 7.00

New Jewell Meter No. 140

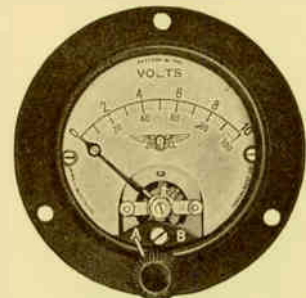

Pattern No. 140 simplifies the use of instruments, for it includes a self-contained switch, enabling the instrument to be used to read both filament and "B" battery voltage with no further external apparatus.

This instrument enables the operator to have complete control on his two power units, the "A" and the "B" batteries, and he is never embarrassed by failure of a set to function due to low or discharged batteries. He always knows the condition of his batteries.

0-5-100 volts. \$9.50
 0-10-100 volts. 9.50
 0-7.5-150 volts. 9.50

TWIN BULB HANDY CHARGER

Ultra Handy Charger

Charges them all—radio and automobile batteries; 5 to 7 amperes to "A" batteries.

"A" Batteries: 2-volt, 4-volt, 6-volt, 8-volt, 10-volt and 12-volt.

"B" Batteries: Four terminals for 24-volt and 48-volt "B" Storage batteries.

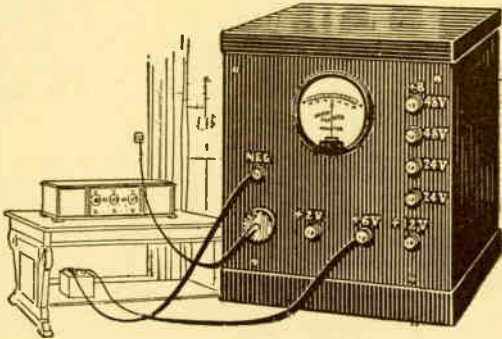

This Ultra Charger will charge all size radio and automobile batteries from the ordinary 110-volt house lighting circuit within the least possible time, and at a minimum cost. Gives high initial charge tapering off at finish automatically as recommended by battery manufacturers. No sloppy liquids—no sticky contacts. Very economical to use.

Charger is contained in a substantial yet attractive all-metal mahogany finished case—making it absolutely fire-proof and shock-proof. Weston ammeter on machine tells just what is going on at all times.

For 110-volt, 50 and 60-cycle. Price, each. **\$18.00**

For 110-volt, 25 to 40-cycle. Price, each. . . **20.00**

"Handy Grip" Battery Clip

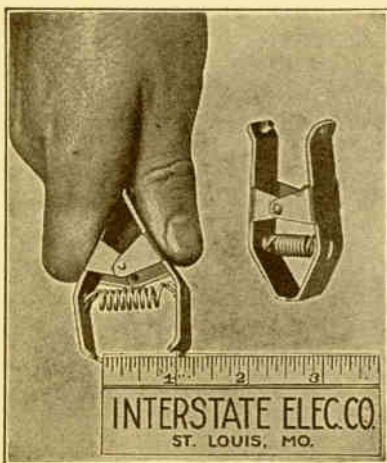

15-Ampere Screw Connection

The "Handy" Battery Clip is a positive acid resisting clip of a size that covers the general need in battery work. It is especially adapted for "A" and "B" radio batteries as well as automobile starting and lighting batteries. All parts of these clips are electro-plated with acid resisting metal which is both a protector and an excellent conductor of electricity.

As illustrated, it will grip the smallest and the largest battery terminals with practically the same tension.

List price, each. **\$0.15**

Complete with 5-foot rubber battery lead and terminal. Price, each. **.40**

Twin Bulb Handy Charger

Charges all automobile and radio storage batteries quickly and quietly.

A simple, permanent hook-up possible with this Twin Bulb Handy which makes the charging of your batteries a matter of merely throwing a switch.

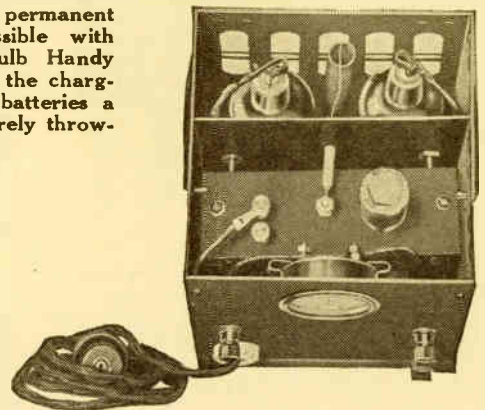

The Twin Bulb Handy Charger is a noiseless fast-rate battery charger for charging all types of radio and automobile storage batteries from the ordinary house lighting circuit. It employs the advanced "push-pull" principle, using both halves of the A. C. wave and operates without liquids or vibrators—has no moving or wearing parts—no mess—no odors—no adjustments. Obviously it is very efficient—consuming a minimum of current while in operation.

One or two standard rectifier bulbs may be used to operate this machine, but in order to charge 4, 6, 8, 10 or 12-volt storage batteries quickly it is advisable to use two bulbs, as the charging rate is then double that of one bulb. For "B" batteries only one bulb is used, as one produces plenty of current for this type battery.

The Twin Bulb Handy is especially adapted to overnight charging, as it cannot overcharge batteries, giving a tapered flow of current as battery becomes restored to full strength. It cannot discharge the battery nor can it burn out from any cause. Its oversized transformer prevents undue heating and will stand considerable overload. An ammeter shows the rate of charge going to the battery.

Price, complete, without bulbs. **\$14.00**
(110-volt, 60 cycles or 50 cycles)

25, 30 or 40 Cycles. **17.00**

Rectigon or Tungar bulbs, 2-amp., for above **4.00**



If It is a "Keco," It is Guaranteed



In radio service a storage battery is required to heat the filament of the audio-vacuum tube when used either as detector or amplifier, and to operate the "loud speaker." This service requires a battery designed with uniform and steady discharge characteristics. "Keco" Radio Batteries are famed for their long service per recharge, owing to their special construction and the famous "Cristol" plate used only in "Keco" batteries.



Type	Sizes	Box Mts.	List
6540	40-Amp.	Wood or rubber	\$16.80
6767	67-Amp.	Wood or rubber	20.44
6990	90-Amp.	Wood or rubber	23.16
6110	110-Amp.	Wood or rubber	24.30
6130	130-Amp.	Wood or rubber	30.64

Things Worth Knowing About a Storage Battery

- That a battery receives its life acid at its birth and should receive no more.
- That a battery will freeze at zero, when half charged.
- That a battery can stand 90 degrees below zero when fully charged.
- That a battery that has been frozen once, never regains its former strength.
- That it is very injurious to a battery to let it stand in a discharged condition.
- That it is as injurious to overcharge a battery as it is to have it stand in a discharged condition.
- That a fully discharged battery requires from 24 to 36 hours to recharge.
- That a fully charged battery should read 2½ volts per cell when connected to a 5-ampere charging line.
- That the cristol plate is used in all Keco batteries.
- Do not recharge at a high rate for very long at a time.
- Do not add acid at any time. Leave this to an expert battery man.

The New Keco Kombinator De Luxe The Silent Power Source of the Modern Radio Set

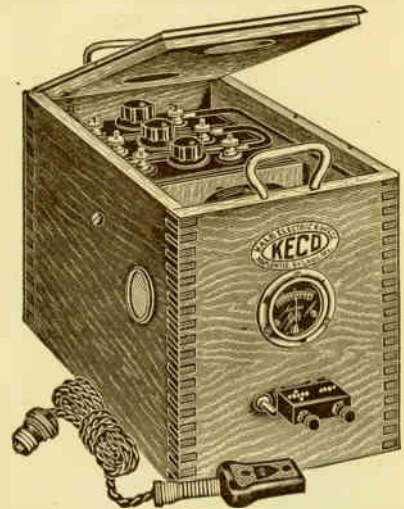

A storage battery and a charging device contained in one cabinet. All connections made. The Kombinator is the only solution for the troubles experienced with the storage battery radio set. It is an accepted fact that a radio set equipped with a storage battery is the only set that gives volume, distance and accuracy under all conditions, but without the Kombinator you have the recharging troubles. With the Kombinator you simply attach to any 110-volt A. C. lamp socket or wall socket and it recharges itself—steady, silent and safe. No switches or moving parts to give trouble. The meter shows the rate you are charging, and also, when connected to your radio set, shows the amount of current you are consuming. No confusing connections to make. No chance of a mistake. Over 4000 in use.

Built in Four Sizes

- Type 701—67 Amperes, for 2 to 4 tubes and speaker. \$50.00
- Type 702—110 Amperes, for 3 to 6 tubes and speaker. 53.00
- Type 703—130 Amperes, for 5 to 8 tubes and speaker. 54.00
- Type 704—150 Amperes, for oversize. 65.00

The Keco Charger "It Charges 'Em All"

Charges "A" batteries, auto batteries and "B" batteries.

Here is a charger at last that requires no additional attachments to charge any size battery up to 90 volts. A charger that is really simple in operation. No moving parts, no switches. Is of the bulb type, therefore, no contacts to replace. Works off any 100-volt A. C. lighting circuit.

Keep your battery fully charged for a dime.



Charges any make. List price, each. \$18.50



The individual certified characteristic curve is furnished only with Musselman Certified Tubes. It tells what the tube is worth and is the only index known by scientists for determining the value of a radio tube. The characteristic curve is assurance of a perfect tube. Buy a thoroughbred with a pedigree.

Model 5VA Electron Tube Specifications

Made for 5-volt "A" batteries. Filament amperage, .25; plate voltage, 20 to 100 volts, "B" batteries. Test specifications at 90 volts on the plate and 0 on grid: Mutual conductance, 700 micromohos or higher; amplification constant, 7.5 or higher; plate flow, 4.75 to 6 milliamperes.

These test specifications were arrived at from definite facts obtained from the leading radio tube engineers and scientists of the world. With figures of these experts as a guide we have produced this wonderful tube. The certified characteristic curve slip enclosed gives the exact curve of the tube it accompanies. No tube is certified unless the readings are better than the above minimum figures. When you buy a Musselman Certified Tube it is positive assurance you are getting the best radio tube it is possible to buy regularly in the market. We also make Musselman Certified Tubes in 3 volts for dry batteries, with standard base and the small base.

Model 5VA—Musselman Tube. Price, each \$3.00

Model 3VA Electron Tube Specifications

Made for 3-volt "A" batteries. Filament amperage, .12; plate voltage, 20 to 100 volts "B" batteries. Test specifications at 90 volts on the plate and 0 on grid: Mutual conductance, 500 micromohos or higher; amplification constant, 6.5 or higher; plate flow, 3.8 milliamperes or higher.

The 3VA or compromise tube operates from either dry cells or storage batteries at 3 volts, .12 ampere, consuming but one-fourth the wattage used by the ordinary 5-volt detector-amplifier tube with practically the same results. It is an unusually economical and efficient tube, taking little more current than the peanut tube or ordinary dry cell tube. Due to its rigid construction it will stand up under handling far better than the peanut tube and is less subject to microphonic and other construction defects.



Model 5VA Electron Tube



Model 3VB

The 3VA converts the portable set into an indoor set or conversely changes the indoor or storage battery set into a portable operating from dry cells.

Model 3VA Musselman Tube. Price, each \$3.00

Each and every Musselman Tube contains a characteristic curve, as shown below. Mutual conductance, amplification constant, plate resistance.

Model 5VC—Musselman Mogul Tube, power amplifying tube \$5.00

Models 5VA, 3VA and 5VC fit 201-A sockets. Model 3VB fits 199 socket.

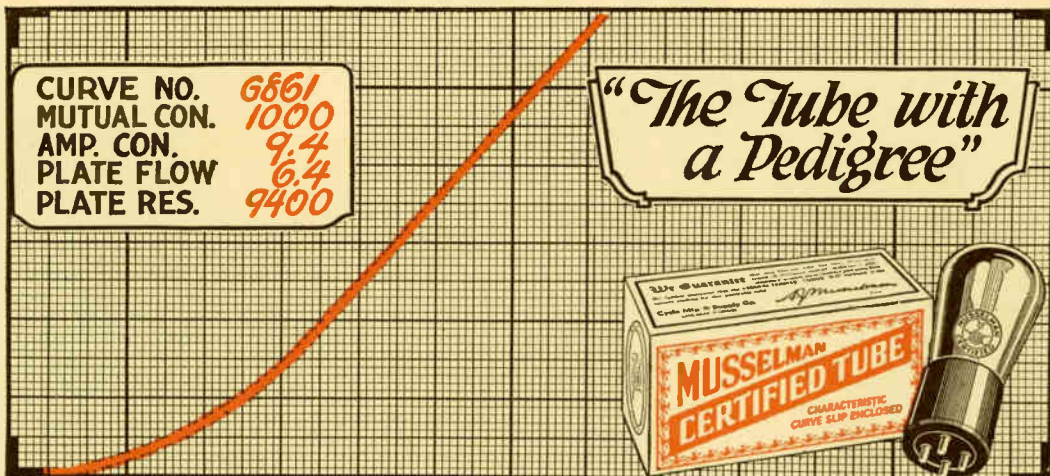

Centralab

Centralab Radiohm



Can be varied smoothly throughout its entire range from zero to maximum resistance. Non-inductive and noiseless in adjustment, it works particularly well in the plate circuit of tuned radio frequency amplifiers and is being used for that purpose by many set manufacturers; also

used as an oscillation control in regenerative circuits of various types, including the super-heterodyne. Base and knob of bakelite. Single-hole mounting.

- No. 2M Radiohm \$2.00
- No. 50M Radiohm 2.00
- No. 100M Radiohm 2.00
- No. 200M Radiohm 2.00

A popular tuned radio frequency circuit with radiohm control that gives unexcelled results. The audio circuit illustrated by Fig. 2 can be added to make a five-tube set. L-1, L-2 and L-3 are tuned inductances of standard type. Variable condensers C-1, C-2 and C-3 have a maximum capacity of .00035 Mfd. or .0005 Mfd. as required for the coils used. Condenser C-4 is .001 or .002 Mfd. capacity, and C-5 is 1/2 to 1 Mfd. Any standard tubes can be used.

Neutrodyne or any tuned radio frequency circuit can be easily converted to this circuit with a marked improvement in quality and efficiency.

Centralab Modulator



A volume control that is smooth, positive and noiseless in action at all times, and unimpaired by long service. The resistance is a smooth graphite strip with pressure contact through a tilting metal disc. The sliding shoe furnishes the pressure, but does not rub on the graphite at all and there can be no wear. This construction is used in all Centralab modulators, radiohms or potentiometers.

Centralab Modulator control is essential for impedance, coupled radio amplification, and is desirable for all audio amplifiers. Base and knob of bakelite.

Single-hole mounting.

- No. 500M—Modulator, 500,000 ohms max. . \$2.00

A standard transformer, coupled audio circuit with modulator control. Gives any desired tone volume from a whisper to maximum loudness, with improved quality of reproduction. Interstage jacks are eliminated, thus doing away with a frequent source of transformer burn-outs and permits the loud speaker to be permanently attached to the set.

Modulator control is recommended by Thordarson and other transformer manufacturers.

Centralab Rheostat

The sturdy contact arm slides smoothly and is positively locked to the shaft. End plates are metal, heavily nicked. One-fourth inch straight shaft, with arrow engraved bakelite knob. Single-hole mounting.

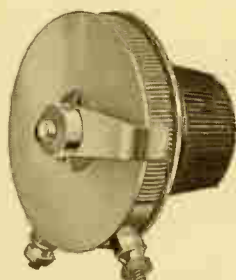

- No. 206—Rheostat, 6 ohms resistance \$1.25
- No. 220—Rheostat, 20 ohms resistance 1.25
- No. 230—Rheostat, 30 ohms resistance 1.25

Centralab Potentiometer

The original non-inductive potentiometer. No sliding contacts to become noisy, or wires that form an inductive choke to radio currents, but an absolutely quiet control that is a pleasure to operate.

Base and knob of bakelite. Single-hole mounting.

- No. 110—Potentiometer, 400 ohms maximum for ordinary use \$1.75
- No. 111—Potentiometer, 2,000 ohms maximum for special application 2.00

Centralab Adjustable Grid Leaks

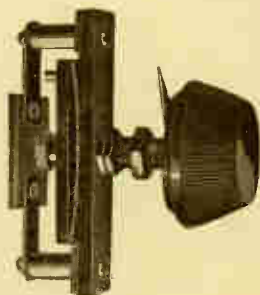

The most successful variable grid leak that has ever been marketed. Gives smooth, unbroken adjustment through 2 1/2 turns of the knob, with absolutely uniform variation from 1/4 to 8 megohms. Gives perfect control of the grid potential for the lifetime of the set. Single-hole mounting.

- No. 106—Grid Leak only \$1.25
- No. 107—Grid Leak with .00025 Mfd. Cond. 1.60

Centralab Battery Switch



A sturdy, compact switch; only 5/8 inch in diameter. Three knurled nuts permit proper adjustment to any thickness of radio panel. All metal parts heavily nickel-plated.

- No. 300—Battery Switch \$0.50

BURGESS BATTERIES



No. 10308—Burgess Heavy Duty "B" Battery

Length, 8 inches; width, 4¼ inches; height, 7 inches; unit packages, 5; weight, 16 pounds.

No. 10308—Each. . \$5.50



No. 2158—Burgess "B" Battery
Vertical

Length, 4⅛ inches; width, 3⅛ inches; height, 7 inches; unit packages, 10; weight, 5 pounds.

No. 2158—Each. \$2.00

No. 4156—Burgess "B" Battery
Flat

Length, 3⅜ inches; width, 2 inches; height, 2½ inches; unit packages, 10; weight, 1 pound.

No. 4156—Each. \$1.50



No. 2308—Burgess "B" Battery

Vertical

Length, 3⅛ inches; width, 8⅞ inches; height, 7 inches; unit packages, 5; weight, 9½ pounds.

No. 2308—Each. \$4.00



No. 5156—Burgess "B" Battery
Flat

Length, 4⅛ inches; width, 2⅞ inches; height, 2¾ inches; unit packages, 5; weight, 1 pound, 9 ounces.

No. 5156—Each. \$1.75



No. 5360—Burgess "C" Battery

Length, 2⅞ inches; width, 1⅞ inches; height, 2⅝ inches; unit packages, 10; weight 4 ounces.

No. 5360—Each. \$0.40

No. 2156—Burgess "B" Battery
Flat

Length, 6⅝ inches; width, 4 inches; height, 3 inches; unit packages, 10; weight, 5 pounds.

No. 2156—Each. \$2.00



No. 2370—Burgess "C" Battery

Length, 4 inches; width, 1⅜ inches; height, 3 inches; unit packages, 10; weight, 1 pound.

No. 2370—Each. \$0.60



No. 2306—Burgess "B" Battery
Flat

Length, 7⅞ inches; width, 6⅝ inches; height, 3 inches; unit packages, 5; weight, 9½ pounds.

No. 2306—Ea. . \$4.00

No. 5158—Burgess "B" Battery
Vertical

Length, 2½ inches; width, 2½ inches; height, 6 inches; unit packages, 5; weight, 2 pounds.

No. 5158—Each. \$1.75



No. 5540—Burgess "C" Battery

Length, 4 inches; width ⅞ inches; height, 2⅞ inches; unit packages, 10; weight, 9 ounces.

No. 5540—Each. \$0.85



No. 5308—Burgess "B" Battery
Vertical

Length, 2½ inches; width, 4¼ inches; height, 5⅞ inches; unit packages, 5; weight, 3 pounds, 4 ounces.

No. 5308—Each. \$3.25

No. 6—Burgess "A" Battery

Diameter, 2½ inches; height, 6 inches; unit packages, 50; weight, 2 pounds.

No. 6—Each. \$0.50





Kurz-Kasch Aristocrat Dial

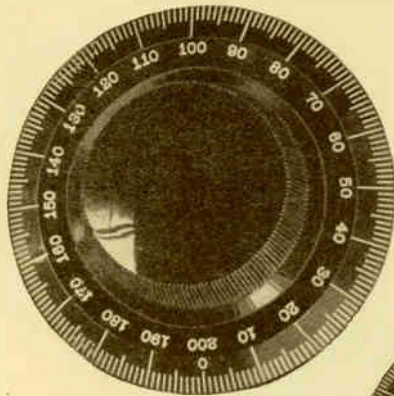

No. 530—3-in., 200-0, 2-in. knob.

Price, each \$0.70

No. 531—3-in., 0-200, 2-in. knob.

Price, each \$0.70

When ordering, specify $\frac{1}{8}$ in. or $\frac{1}{4}$ -in. shaft.

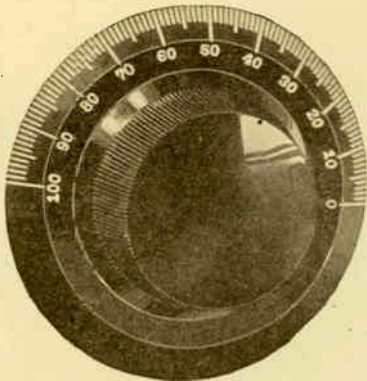

No. 529—3-in., 0-100, 2-in. knob. Price, each \$0.60

No. 528—3-in., 100-0, 2-in. knob. Price, each \$0.60

When ordering, specify $\frac{1}{8}$ -in. or $\frac{1}{4}$ -in. shaft.

Kurz-Kasch Aristocrat Knobs



No. 505

No. 505—2-in. Rheostat Dial, $\frac{1}{8}$ -in. or $\frac{1}{4}$ -in. bushing, complete with set screw.

Price, each \$0.40

No. 17— $1\frac{1}{8}$ -in. Arrow knob; $\frac{1}{8}$ -in., $\frac{1}{4}$ -in. or $\frac{8}{32}$ -in. thread. Complete with set screw.

Price, each \$0.15



No. 17

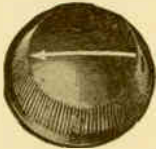

No. 18

No. 18— $1\frac{1}{2}$ -in. Arrow knob; $\frac{1}{8}$ -in., $\frac{1}{4}$ -in. or $\frac{8}{32}$ -in. thread. Complete with set screw.

Price, each \$0.20

Kurz-Kasch Aristocrat Pointer Knobs

No. 706—One-piece Pointer knob. Complete with set screw ($3\frac{1}{4}$ -in. circle) \$0.45

No. 702—One-piece Pointer knob. Complete with set screw ($2\frac{1}{4}$ -in. circle) \$0.30

No. 705—Two-piece Pointer knob with split bushing ($3\frac{1}{4}$ -in. circle) \$0.40

Kurz-Kasch Aristocrat E-Z-Toon Dial

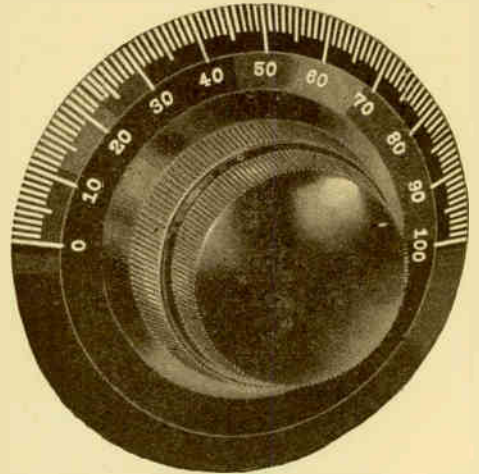

Fifty to one ratio gives that close tuning so desirable and necessary with the large number of stations now broadcasting. Kurz-Kasch patented split bushing for mounting. Fits any length of shaft. No cogs or gears, no back-lash or lost motion.

No. 775— 0 to 100. Price, each \$2.25

No. 776—100 to 0. Price, each 2.25

No. 777— 0 to 200. Price, each 2.35

No. 778—200 to 0. Price, each 2.35

(Order by number, black or mahogany, $\frac{1}{4}$ -in. bushing.)

Kurz-Kasch Aristocrat Socket

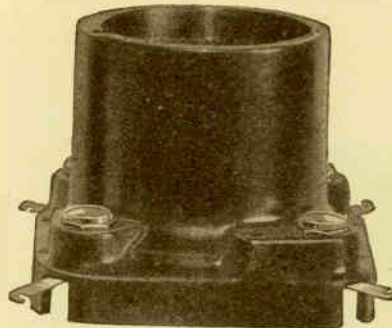

One-piece bakelite socket — durable, attractive.

The double spring action assures a positive contact. Not only is the bottom of the tube terminal strong in contact, but the side is also gripped tightly by the socket spring—a double action is thus secured.

Made for screw or solder connections.

Sockets will be packed in individual cartons—ten to a unit carton—one hundred to a standard package. Black sockets are standard; mahogany effect can be furnished on special order.

No. 701—Tube Socket (Type 201), black or mahogany. Price, each \$0.75

Kurz-Kasch Aristocrat Rheostats

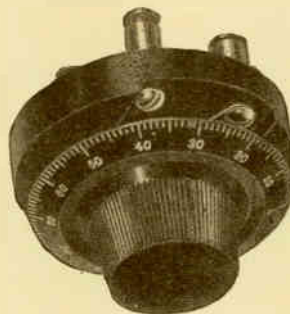

Price, each

No. 733—4-Ohm, with No. 505 Dial . . . \$1.45

No. 734—6-Ohm, with No. 505 Dial . . . \$1.15

No. 717—10-Ohm, with No. 505 Dial . . . \$1.15

No. 735—20-Ohm, with No. 505 Dial . . . \$1.15

No. 736—30-Ohm, with No. 505 Dial . . . \$1.15

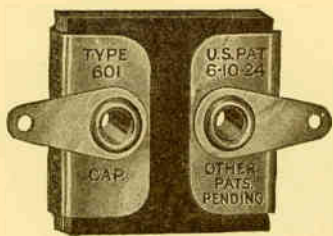

The Micadon—Type 601

The Type 601 Micadon may be used wherever an efficient mica condenser is called for.

Capacities	List Prices	Capacities	List Prices
.00005	\$0.35	.002	\$0.40
.0001	.35	.0025	.40
.00025	.35	.003	.50
.0005	.35	.004	.50
.001	.40	.005	.60
.0015	.40	.006	.75

The By-Pass Condenser

Capacities	List Prices
.1	\$0.70
.25	.75
.5	.90
1	1.25
2	1.75
3	2.75
4	3.75



The Micadon—Type 601-G

Capacities	List Prices
.0001	\$0.45
.00025	.45
.0005	.45

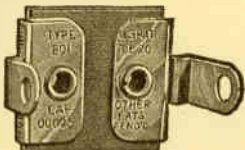

The Micadon—Type 601-T

Capacities	List Prices
.0005	\$0.45
.001	.50
.002	.50
.006	.85

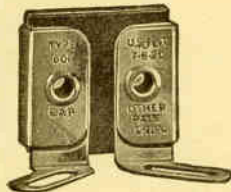

The Micadon—Type 601-L

Capacities	List Prices
.00025 Mfd.	\$0.45
.0005 Mfd.	.45
.001 Mfd.	.50
.002 Mfd.	.50

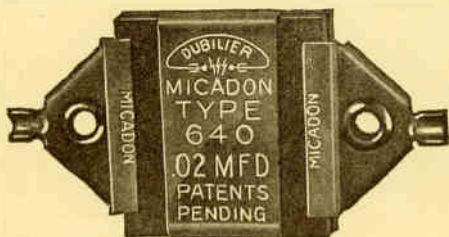

The Micadon—Type 640

Capacities	List Prices	Capacities	List Prices
.00025	\$0.45	.005	\$0.70
.0005	.45	.006	.85
.001	.50	.0075	.90
.002	.50	.01	1.00
.0025	.50	.015	1.50
.003	.60	.02	2.00
.004	.60		

The Micadon—Type 640-A

Capacities	List Prices
.006 Mfd.	\$1.00
.0075 Mfd.	1.10
.01 Mfd.	1.20
.015 Mfd.	1.70
.02 Mfd.	1.95

Filter Condensers—Type 765

For Battery Eliminators

Type	Capac.	D. C. Flash Test	D.C. Max. Working Voltage	A.C. Max. Working Voltage	List Prices
765	1 Mfd.	800	160	110	\$1.25
766	2 Mfd.	800	160	110	2.00
767	4 Mfd.	800	160	110	4.00
768	1 Mfd.	2000	400	220	1.75
769	2 Mfd.	2000	400	220	3.50
770	4 Mfd.	2000	400	220	7.00

The Duratran

The Dubilier Radio Frequency Transformer is designed for a wave-length band of 225 to 550 meters and has an amplification factor of over 20.

Operates on all standard tubes.

Dubilier Duratran . . . \$4.00

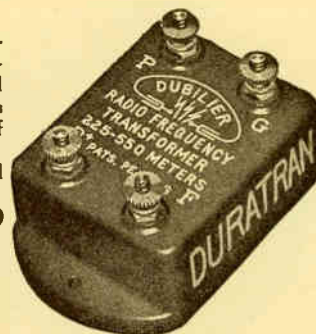

The Ducon

The Dubilier Ducon is a device which enables you to use the house wiring as an aerial.

The Dubilier Ducon is absolutely shock-proof and practically indestructible. It is sold on a money-back basis.

Dubilier Ducon \$1.50



The Dutec

The Dutec is a synthetic rectifier that will not oxidize from age or exposure. The signal strength obtained by using the Dutec is remarkable, results in many cases approaching that of a single-tube receiver.

Dubilier Dutec \$0.30



The Dubilier Super-Ducon

Type 800—For alternating current \$47.50

Type 801—For direct current 30.00

UV-196 Rectron Tube for above 5.00



The Micadon—Type 640-G

Capacities	List Prices
.00025	\$0.40

WALBERT MFG. CO.

The New Walbert Univernier For Micro-Selective Tuning

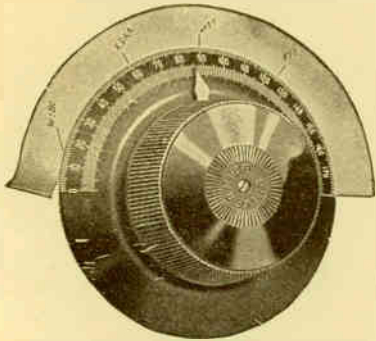

The Walbert Univernier is the original vernier dial. The new univernier, made of genuine bakelite, the knob $2\frac{1}{4}$ inches in diameter and the dial 4 inches in diameter, is assembled as a complete unit (no separate parts). The mechanism is improved through the use of much heavier reduction gearing, very accurately made, affording smooth, positive vernier adjustment and a standard vernier ratio 12 to 1, the ideal ratio for straight-line frequency condensers. Mounting extremely simple and may be used on center hole mounting condensers. Takes standard shaft projections without alteration. Mounting and anchorage positive, using no friction which involves harmful pressure on condenser bearings. Dial graduated 0° to 180° in standard clockwise direction. Counter clockwise supplied if desired. Provided with removable logging record affording maximum convenience in logging.

List price.....\$1.50

The New Walbert S-L-F Vernier Dial

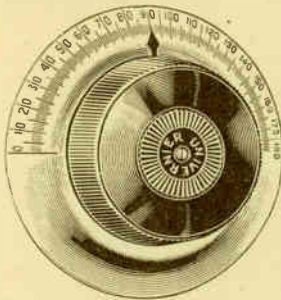

The New Walbert S-L-F Vernier Dial is the original straight-line frequency vernier control. Substituted for the ordinary dial and converts ordinary semi-circular plate condensers to straight-line frequency and at the same time provides perfect vernier control. Contains heavy gearing and ingenious mechanism which turns condenser very slowly at low wave lengths with progressive increase of motion toward higher wave lengths while knob and pointer revolve at uniform speeds at vernier ratio of 12 to 1. This simulates action of straight-line frequency condenser. May also be used on variometers. Consists of large genuine bakelite knob, 4-inch solid nickel-silver dial (not plated), graduated 0 to 180 degrees clockwise (standard). Concentric mounting and occupies same space as old dial. Equipped with hair-line pointer, easily installed and takes standard shaft projections without alternation. May be used on center hole mounting condensers. Stations are as easily separated at low wave-lengths as at high wave-lengths. A perfectly constructed precision instrument.

List price.....\$2.00

The Walbert Lock Switch Is the Original Locking Switch

Provides perfect control of "A" battery current in quiet, smooth and positive manner. No parts to get out of order.

A fool-proof device.
Finished in nickel or gold plate.

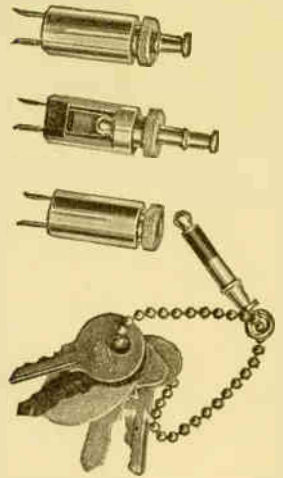

List Prices

Nickel plated.....\$0.50
Gold plated......65

The Walbert Panelite A New Light on Tuning

The first and original panelite. A necessity for comfortable operation of a receiver. Easily installed on radio panels above the tuning controls and provides illumination of dial graduations. Permits placing a radio receiver anywhere without regard for house lighting facilities. Connected to "A" battery circuit of your receiver. Draws negligible amount of current. Eliminates necessity of using house lighting fixtures to illuminate your receiver and thus removes annoying 60-cycle hum which is audible in loud speaker when reading or portable lamp is brought near set.



Nickel plated, each.....\$1.00
Gold plated, each..... 1.25
Extra miniature lamp..... .12

The Univernier Condenser

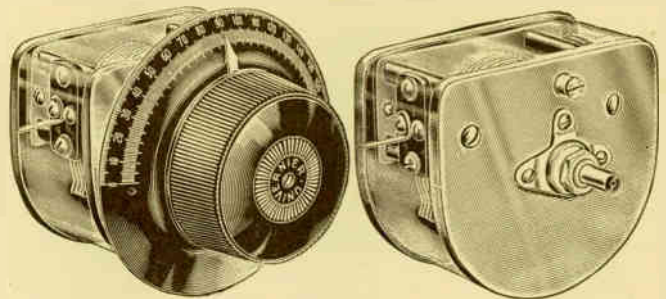

The Univernier Condenser has been designed to meet the demand for a small-sized precision instrument with straight-line characteristics and with complete protection against intrusion of dust. The electrical advantage of small size is recognized by leading engineers, and the elimination of dust which shorts or alters condenser capacities, is of utmost importance. Plates made of spring brass insuring accurate alignment, with bearings carefully engineered for long life and precision. Higher in efficiency than expensive laboratory standards. Average minimum capacity 10.05 MMF., average maximum capacity 356 MMF. Single-hole mounting with auxiliary support. If mounted with new univernier a single screw unites and fastens both to the panel. Licensed under Straight-Line Frequency Patents (March 5, 1918).

Price.....\$3.50
With Univernier..... 5.00

Atlas Loud Speakers

Cabinet Speaker

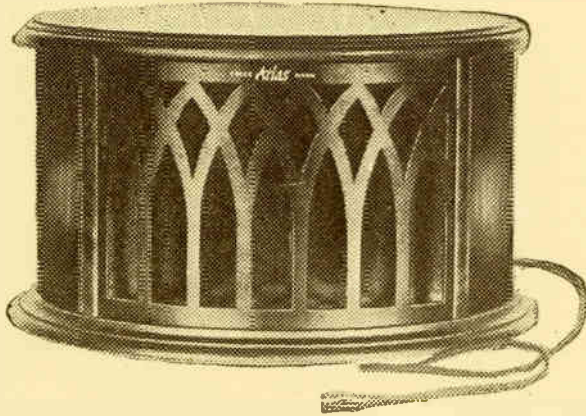

Wonderful Performance
Non-Vibrating Walls
Attractive Design
Atlas Cabinet Speaker. Each.....\$18.00

Low Volume
Adjustable Unit
Three-Tone Finish

Atlas Goose-Neck Model 104-A

Special finished horn makes it non-vibrating. Bronze color. Large, non-tilting base, highly gold finish new Atlas unit with adjustable Harmonizer. Unit guaranteed to give maximum volume on any set, and will not chatter on any volume it is asked to handle.

Each and every horn has a guaranteed serial number on bottom of base for your protection.

No. 104-A—Atlas Loud Speaker. Each...\$18.00

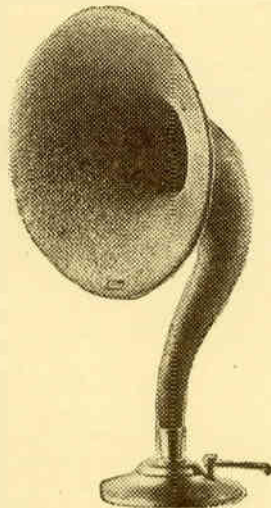

Atlas SRS Speaker



This speaker challenges comparison with any speaker, regardless of price on the market today. With the new unit it has revolutionized the performance of a speaker at this price. Each and every speaker has a serial number which guarantees its faithful performance, and is guaranteed under this serial number by the manufacturers.

Atlas SRS Loud Speaker.. \$10.00

Atlas SRS Units

Atlas SRS Unit. Each.....\$5.00
Atlas SRS Unit, with Phonograph Attachment 5.50

All-American

Toroid Coils

Type T-1 Antenna Coupler Type T-2 R. F. Transformer

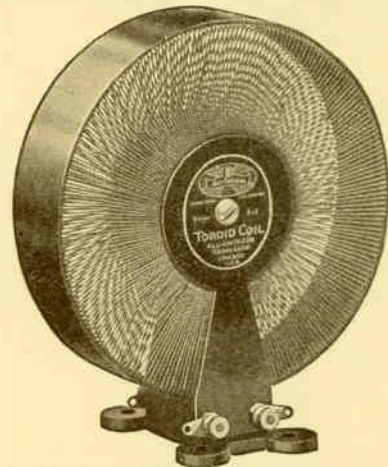

The closely confined field that characterizes this instrument does away entirely with the disadvantages of inter-stage coupling and makes it possible for any radio fan to easily build a set of laboratory precision.

The design of this coil is such that, with a condenser of unusually low minimum capacity, such as the All-American straight-line frequency types, they will easily reach down to a wave-length of 175 meters. All wave-lengths up to 550 meters can likewise be obtained without difficulty.

Resistance in the All-American Toroid Coil is very slight because of the small amount of wire used in its construction. The Type T-1 (antenna coupler) is tapped in such a way as to make provision for both long and short antennas. The Type T-2 coil (R. F. transformer), because of the ingeniously designed air-insulated primary winding provides an abundance of amplification, at the same time getting away from the tube oscillation that hitherto invariably accompanied transformers of high efficiency.

Size: 4 3/4 inches high; is 4 1/4 inches in diameter, with a width of 2 1/2 inches at its base.

All-American Toroid Coils are sold separately or in sets of three.

Type T-1—Antenna Coupler. Each.....\$3.50

Type T-2—R. F. Transformer. Each..... 3.50

Set of one Antenna Coupler and two R. F. Transformers. Price.....10.50

Type R-110—All-American Long-Wave Transformer. Price, each..... 6.00

Type R-120—10-000-Meter Transformer... 6.00

Type R-130—Radio Frequency Coupler.... 5.00

Type R-30—Input Transformer. Each..... 6.00

Type R-31—Output Transformer. Each.... 6.00

Type R-500—Rauland - Lyric Audio Transformer. Price, each..... 9.00

Type R-140—Universal Coupler. Each.... 4.00

Type R-199—Self-Tuned R. F. Transformers, for "199" Tubes. Each..... 5.00

Type R-201A—For "201-A" Tubes. Each. 5.00

Type C-35—350 Mfd. Condenser..... 4.50

Type C-50—500 Mfd. Condenser..... 5.00

Type R-12—Audio Transformer, ratio 3-1. Each..... 4.50

Type R-21—Audio Transformer, ratio 5-1. Each..... 4.75

Type R-13—Audio Transformer, ratio 10-1. Each..... 4.75

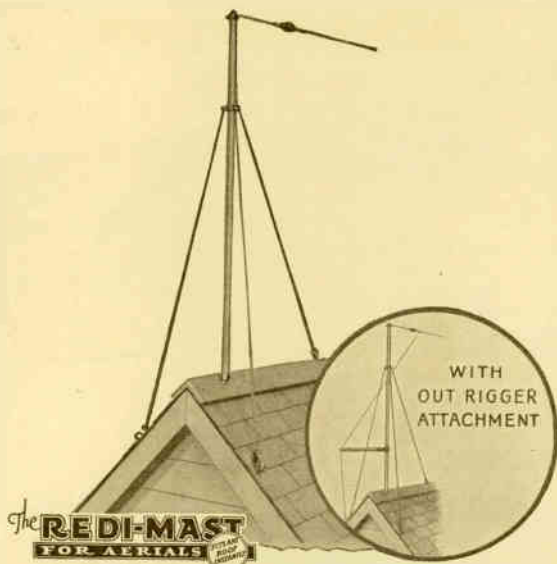

The Redi-Mast
FOR AERIALS
PATENT PENDING

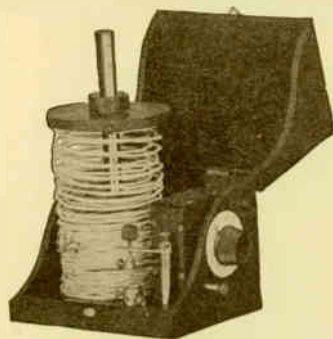

Crystal Set

Three-hundred-mile radius, with a good aerial and ground. Sets here receive Chicago, Davenport and Kansas City. A truly wonderful crystal set.

Price, each \$10.00
Price, complete 14.00

The Redi Mast (for Aerials) Makes a Hard Job Easy

Here it is—the Redi-Mast—a complete, ready-to-put-up, sturdy mast for aerials. It saves the dealers and radio fan real money and hours of labor which formerly were used to buy attachment wire, pipe and “whatnot” and put them up.

The Redi-Mast can be erected instantly on any part of any kind of roof by the most inexperienced. Simple, printed instructions show the user how to attach to roof (water-tight roof collar furnished), spread and adjust the guy rods, tighten with patented adjusters and the mast is up. (The aerial wire is not furnished.)

Specifications

Mast—Sturdy timber, 5 feet high by 1 1/4 inches diameter. Has ferrule and roof lag screw secured to bottom.

Tripod Guys—Strong steel rods 1/4 inch diameter, with patented adjusting devices. All steel parts black baked enamel.

Hardware—Everything complete, including aerial pulley, mast nebs irons, roof socket and anchor pins (no aerial wire furnished).

Packed—Assembled with loose parts in canvas envelope. Twenty complete Redi-Masts in strong crate.

Price, each \$3.50
With outrigger 4.00

BODINE

BASKET WEAVE
FOLDING LOOP

Bodine Loop

The Bodine Loop graces the most attractive home surroundings. Its design is unusually artistic and its English mahogany finish and silk-covered wire make it strikingly handsome in appearance.

The Bodine is very responsive to directional setting, giving great selectivity, and allowing you to easily tune out undesired local stations. In order to secure full advantage of this feature it is fitted with a calibrated satin-silver dial, marked off in degrees. You can log the setting of the loop for any particular station and return to that station without trouble at any time.

The loop is also fitted with an insulated handle that allows you to turn it conveniently, without disturbing its magnetic field by body capacity.

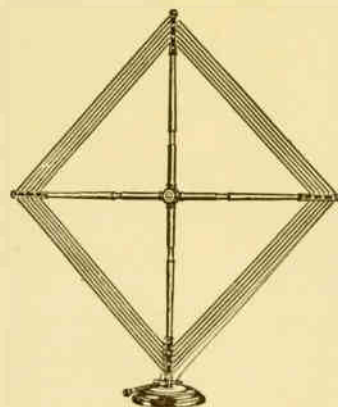

Collapsible and Portable

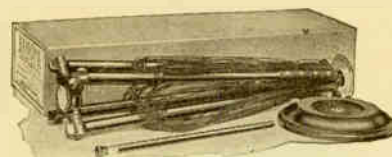

All models of the Bodine Loop are two feet square when erected, yet fold in an instant to fit into a box only 3 1/2 x 6 x 18 inches in size. You can conveniently take this loop with you anywhere.

Sliding sleeves cover the joints at the center and hold the loop rigidly extended. The wires are always taut; phosphor bronze strands interwoven with the stranded copper wire prevent stretching and loss of efficiency.

Model B-12—Bodine Standard Loop \$8.50

Fits all popular loop circuits and sets, including reflex, radio frequency and most super-heterodyne circuits. Gives fine results with Acme Reflex and Kennedy Model XV.

Model B-12 CT—Bodine Super-Het Special Loop \$8.50

Same as Model B-12, except that it has a third binding post connected to the center of the loop coil for super-heterodyne circuits that require this feature.

Model B-10—Bodine Radiola Super-Het Special Loop \$8.50

Brings in stations at same settings of both dials. Greatly increases the range of this wonderful set and saves batteries and tubes. The only folding loop that exactly fits this receiver; use it for increased enjoyment from your Radiola.

Model B-12-TS—Bodine Tapped Loop \$10.00

Has a five-point tap switch, allowing the whole or any part of the loop to be used. Suited for Inverse-Duplex circuits. A universal loop-ideal for experimental work.

Model B-16-TS—Bodine Grebe Synchrophase Special Loop \$10.00

The only loop which exactly fits this receiver. Full instructions and log sheet accompany each loop.

Jones MULTI-PLUG

THE STANDARD SET CONNECTOR



Cabelug consists of a five-wire coded battery cable anchored to an insulated block; the cable wires projecting from the block providing the terminals for connecting set leads. The block is permanently attached to the base board or sub-panel, and no binding posts are necessary.

Furnished with 4 or 8-foot cables.

- 4-foot Cabelug.....\$1.00
- 8-foot Cabelug..... 1.25

Affords a plug and socket connection between the radio set and batteries, antenna and ground leads. (Can't be plugged in wrong.) Eliminates messy and complicated wiring. Simplifies demonstration of sets. Furnished in two types as shown with 8-foot coded cable.

When B.M. type is used set wires are soldered to posts at back of socket. (No binding posts are necessary.)



- Plug and cable only.....\$3.20
- B.M. Socket only..... 1.30
- B.M. Multi-Plug, complete..... 4.50



Type BP adaptable to any set now equipped with binding posts (no soldering is necessary). Simply connect the leads on socket to the seven binding posts.

- Plug and cable only.....\$3.20
- B.P. Socket only..... 1.80
- B.P. Multi-Plug, complete..... 5.00

Type P.M. same as B.M., without bracket.

- Plug and 8-foot cable only.....\$3.20
- P.M. Socket only..... .80
- P.M. Multi-Plug, complete..... 4.00

Type P.M. same as B.M., Without bracket.

- Plug and 8-foot cable only.....\$3.20
- P.M. Socket only..... .80
- P.M. Multi-Plug, complete..... 4.00

The (Insured) Filko Lightning Arrester

You need not be afraid to have your set struck by lightning or your radio table burned up, as this policy will cover all these things, and you will feel protected by installing it. Passed on by the Underwriters. Order one or more and have your customers fully protected.

- Filko "Insured" Arrester.....\$1.50

Filko Leak

For Improved Reception

Each Filko Leak is individually hand calibrated in the laboratory. Atmospheric conditions will not affect it. Each and every instrument is doubly checked.

- Filko Leak. Price.....\$2.00
- Fil-ko-stat. Each..... 2.00

Aero Coil

95 Per Cent Air Dielectric

Replace your old coils with Aero-Coils. You will get enormous volume on distant stations; reception will be crystal clear—your set will tune "needle" sharp. You will be amazed at the difference.

Primary, 6½ turns; secondary, 60 turns. Beautifully made.

- Aero Coils, set of three.....\$12.00

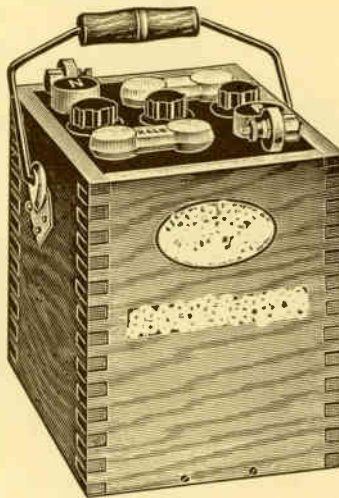
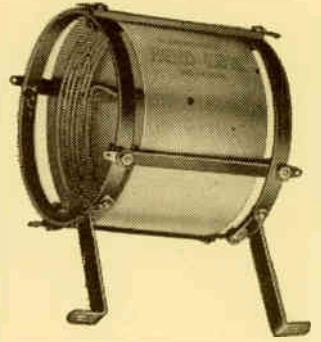

Varco "A" Batteries

Hand rubbed oak case. Guaranteed eighteen months.

Built under our special supervision and specification.

Guaranteed 90 ampere hours.

- Each.....\$20.00

Queen Quality Soldering Iron

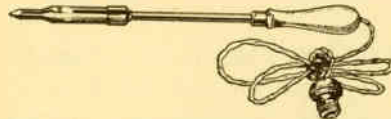

For Radio Work, Shop Work, Home Work and Automobile Work

Each and every iron guaranteed by the manufacturer and Van-Ashe Radio Co. Will save you many a dollar for repair work.

- Price.....\$1.00

Crescent (Bulb Type) Battery Charger

The Crescent Battery Charger has been designed to meet the demand for a low-priced, silent and trouble-proof bulb type rectifier for charging automobile and radio storage batteries.

- 2-Ampere (less bulb) ..\$ 8.00
- 6-Ampere (less bulb) .. 11.00

Bulbs

- 2-Ampere.....\$4.00
- 5-Ampere..... 8.00

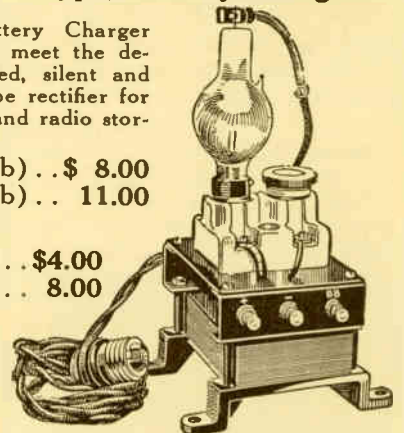

One Phone Plug

Licensed Under Patent No. 1,498,196



YAXLEY No. 50

This new phone plug has a polished bakelite handle, is small in size and has a neat appearance. Phone tips instantly connected without use of tools. Connected without use of tools. Contact assured. All bakelite insulation prevents current leakage. Shorting is impossible.

No. 50\$0.50

Twenty plugs packed in cardboard box.

Duplex Plug

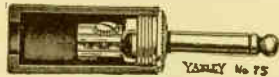

YAXLEY No. 75

Has same general construction as One Phone Plug, only has screw terminals for connecting two or more phones. Knurled binding screws have coin slots—no screw driver required.

No. 75\$0.60

Twenty plugs packed in cardboard box.

Fixed Condenser



Hermetically sealed in brass container; has solder terminals and nut and washer method of mounting.

No. 101—.01 M. F.\$1.00
No. 104—.04 M. F. 1.00

Etched Dial Plate

The latest and one of the most useful innovations in radio, an etched dial plate for use in connection with knob on rheostat knob, and does away with the necessity of a jobber or dealer stocking both knobs and dials for rheostats. Neatly etched. Standard finish silver and black; also furnished in gold and black. Packed in bulk; 10 plates to package.



No. 369—Silver and black\$0.15
No. 369G—Gold and black15

A and B Voltmeter Switch



YAXLEY No. 12

A double-throw non-locking switch to be used in connection with a voltmeter for conveniently reading both "A" and "B" batteries. The Voltmeter switch has the distinctive one-nut method of

mounting in a single 1/8-inch hole, and can be turned in any direction to suit the wiring layout. Has the same characteristics, insulated from frame, hard rolled phosphor bronze springs, pure silver contact rivets and tinned terminals, as Yaxley Jack Switches. Designation plate furnished with switch.

No. 12\$1.25

Six-Point Switch

A six-spring, three-position switch mounted on frame as shown above (see No. 12).

No. 69 (not illustrated)\$1.50

Wall Socket Jack

For Radio House Wiring

More and more homes are being wired with radio convenience outlets. Semi-public buildings, such as apartments, hotels, etc., are also going in for the convenience and utility of this latest advance in the radio field.

The new Yaxley Wall Socket Jack is a decided improvement in radio convenience outlets. It is easily wired, either in series or parallel, and is substantially constructed. Mounts in smallest size outlet box. Complete information, together with wiring diagrams and useful suggestions for the application of this popular device, is packed in each carton.

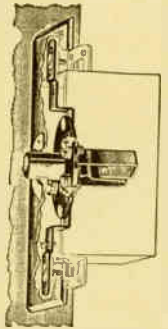

No. 135\$1.00

Resistance Unit

Used in series with 6-ohm rheostat to cut down current supply. Packed in bulk.

No. 215—15-ohm for use with UV-201 tubes. \$0.50
No. 225—25-ohm for use with UV-199 tubes. .50



YAXLEY

Resistance Unit

Talking Tape

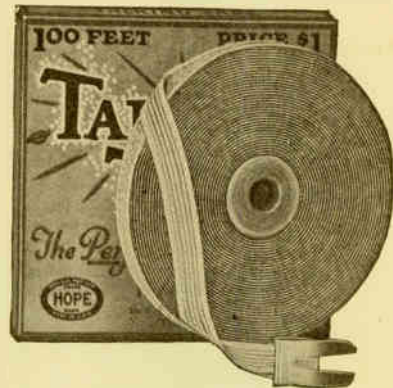

The Perfect Radio Aerial

Price, each—100 ft.\$1.00
Price, each—50 ft.60



Goodrich Radio Panels

Standard sizes, 1/8-inch thick

	Black Each	Mahogany Each		Black Each	Mahogany Each
6x12	\$0.88	\$1.06	7x21	\$1.80	\$2.16
6x14	1.02	1.22	7x24	2.04	2.44
6x21	1.54	1.84	7x26	2.22	2.66
7x 5	.44	.52	7x30	2.56	3.08
7x10	.86	1.04	7x48	4.10	4.92
7x12	1.02	1.22	8x12	1.16	1.40
7x14	1.20	1.44	8x24	2.34	2.80
7x18	1.54	1.84	9x28	3.08	3.70

Phone Ear Cushions

Goodrich Rubber Co.\$0.80

Goodrich Battery Mats

Large, approximately 15 inches square. Each\$1.30
Small, approximately 9x12 inches square. Each50

FORMICA

Made from Anhydrous Bakelite Resins
SHEETS TUBES RODS

Formica Will Not Sag or Cold Flow

Formica in all finishes combines high insulating strength with mechanical strength that enables it to support heavy instruments without sagging. It will not cold flow—the material will not squeeze out from under binding posts and screws so that they loosen up. It will not break while you are working on it.

Formica is used for radio insulation by 125 of the leading American set builders.

FORMICA PANELS Smooth Sawed Edges				FORMICA PANELS Smooth Sawed Edges				FORMICA PANELS Smooth Sawed Edges				FORMICA PANELS Smooth Sawed Edges			
1/4-Inch Thick		1/4-Inch Thick		1/4-Inch Thick		1/4-Inch Thick		1/4-Inch Thick		1/4-Inch Thick		1/4-Inch Thick		1/4-Inch Thick	
Size Inches	List Price Each	Size Inches	List Price Each	Size Inches	List Price Each	Size Inches	List Price Each	Size Inches	List Price Each	Size Inches	List Price Each	Size Inches	List Price Each	Size Inches	List Price Each
6x 6	\$0.92	7x 8	\$1.36	8x11	\$2.06	9x15	\$3.10	6x25	\$3.51	7x27	\$4.42	8x30	\$5.51	9x34	\$7.02
6x 7	1.06	7x 9	1.50	8x12	2.20	9x16	3.30	6x26	3.65	7x28	4.59	8x31	5.69	9x35	7.23
6x 8	1.19	7x10	1.64	8x13	2.38	9x17	3.51	6x27	3.79	7x29	4.75	8x32	5.88	9x36	7.44
6x 9	1.31	7x11	1.80	8x14	2.57	9x18	3.72	6x28	3.93	7x30	4.92	8x33	6.06	9x37	7.64
6x10	1.43	7x12	1.96	8x15	2.75	9x19	3.92	6x29	4.07	7x31	5.08	8x34	6.24	9x38	7.85
6x11	1.54	7x13	2.13	8x16	2.94	9x20	4.13	6x30	4.21	7x32	5.25	8x35	6.43	9x39	8.06
6x12	1.68	7x14	2.29	8x17	3.12	9x21	4.34	6x31	4.35	7x33	5.41	8x36	6.61	9x40	8.26
6x13	1.82	7x15	2.46	8x18	3.30	9x22	4.54	6x32	4.50	7x34	5.57	8x37	6.79	9x41	8.47
6x14	1.96	7x16	2.62	8x19	3.49	9x23	4.75	6x33	4.64	7x35	5.74	8x38	6.98	9x42	8.68
6x15	2.10	7x17	2.78	8x20	3.67	9x24	4.96	6x34	4.78	7x36	5.90	8x39	7.16	10x10	2.29
6x16	2.25	7x18	2.95	8x21	3.85	9x25	5.16	6x35	4.92	7x37	6.07	8x40	7.34	10x11	2.52
6x17	2.39	7x19	3.11	8x22	4.04	9x26	5.37	6x36	5.06	7x38	6.23	8x41	7.53	10x12	2.70
6x18	2.53	7x20	3.28	8x23	4.22	9x27	5.58	6x37	5.20	7x39	6.39	8x42	7.71	10x13	2.92
6x19	2.67	7x21	3.44	8x24	4.41	9x28	5.78	6x38	5.34	7x40	6.56	9x 9	1.89	10x14	3.15
6x20	2.81	7x22	3.60	8x25	4.59	9x29	5.99	6x39	5.48	7x41	6.72	9x10	2.10	10x15	3.37
6x21	2.95	7x23	3.77	8x26	4.77	9x30	6.20	6x40	5.62	7x42	6.89	9x11	2.27	10x16	3.60
6x22	3.09	7x24	3.93	8x27	4.96	9x31	6.40	6x41	5.76	8x 8	1.53	9x12	2.48	10x17	3.82
6x23	3.23	7x25	4.10	8x28	5.14	9x32	6.61	6x42	5.90	8x 9	1.68	9x13	2.68	10x18	4.05
6x24	3.37	7x26	4.26	8x29	5.32	9x33	6.82	7x 7	1.21	8x10	1.87	9x14	2.89	10x19	4.27

The above panels can be furnished in walnut or mahogany on one side and black on the other (guaranteed not to fade) at the above quoted prices.

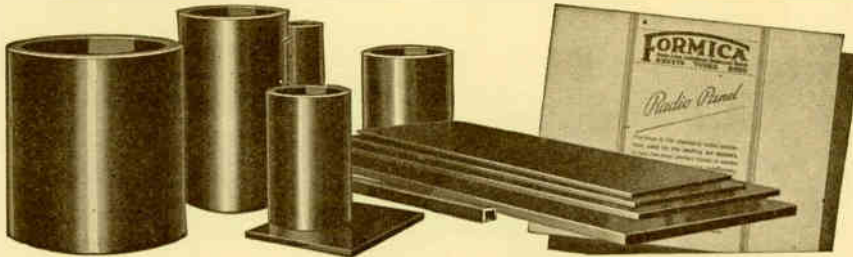

Round Formica Tubing

List Prices Per Foot				List Prices Per Foot			
Inside Diameter Inches	Thickness of Wall 1/4-Inch	Inside Diameter Inches	Price	Inside Diameter Inches	Price	Inside Diameter Inches	Thickness of Wall 1/4-Inch
3/16	\$0.45						
1/4	.46	1	\$0.64	1 3/4	\$0.79	3	\$1.48
5/16	.48	1 1/8	.66	1 1/2	.81	3 1/8	1.51
3/8	.49	1 1/8	.67	1 7/8	.82	3 1/4	1.54
7/16	.51	1 1/8	.69	1 1/2	.84	3 3/8	1.57
1/2	.52	1 1/4	.70	2	.85	3 1/2	1.60
5/8	.54	1 5/8	.72	2 1/8	.97	3 5/8	1.63
3/4	.55	1 3/8	.73	2 1/4	1.00	3 3/4	1.65
7/8	.57	1 7/8	.75	2 3/8	1.02	3 7/8	1.68
3/4	.58	1 1/2	.75	2 1/2	1.05	4	1.69
1 1/8	.60	1 5/8	.76	2 5/8	1.08	4 1/4	1.72
1 1/8	.61	1 3/8	.78	2 3/4	1.09	4 1/2	1.75
1 1/8	.63	1 1/8	.79	2 7/8	1.12	4 3/4	1.80

Experience teaches us that 1/8-inch wall is right up to 3-inch tubing; 3 inches and over should be 3/32-inch wall. Standard length of tubing, 3 feet. We cut tubing at any desired length for 10 cents per length, net charge, no discount. Our radio engineers have put Formica Panels and Tubing to every test and have found it as represented by the manufacturers, and that is the reason we are featuring Formica in this year's catalogue.

FANSTEEL Balkite Battery Charger

All Balkite Radio Power Units are tested and listed as standard by the Underwriters' Laboratories.

For Charging Radio "A" Batteries Fansteel Balkite Battery Charger

This is the most popular and successful battery charger on the market—the standard of the industry. Over 150,000 are in use. It is the only charger which is commonly used while the radio set is in operation. The only operating instructions necessary with the charger are that it be properly connected to the battery when the line current is turned on. It cannot discharge or short-circuit the battery. It delivers a taper charge which decreases as the battery becomes charged, so that it is impossible to damage the battery by overcharging. It is not affected by fluctuations in line voltage or by extreme temperatures. It will charge a completely dead battery. It is the simplest and most efficient charger made—ideal for home use.

The charging rate is 2.5 amperes. This charger will furnish enough current to take care of the largest radio installation. It is very economical, consuming about the equivalent of a 60-watt lamp. It is absolute insurance against run-down "A" batteries, for if the battery should be low the charger will put enough current into the battery while the set is being used to operate the set satisfactorily.

This charger may also be used to charge automobile batteries and, without added attachments, to charge radio "B" batteries of the lead

type in multiples of six cells: Size: 6 inches long, 10 1/4 inches high, 6 1/2 inches wide. Shipping weight, 20 lbs. Complete with necessary leads and electrolyte. Operates from 110-120 A. C. 60-cycle current. Special model for 50 cycles.

Price, each.....\$19.50

Special Adapter for charging 2 and 4-volt batteries..... 1.50

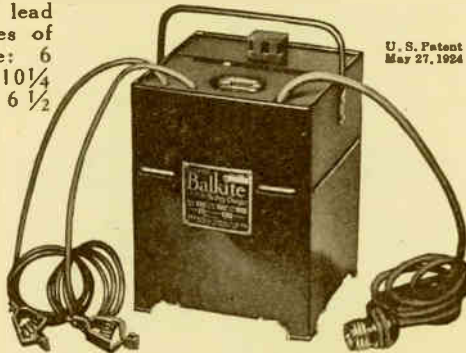

U. S. Patent
May 27, 1924

FANSTEEL Balkite Trickle Charger

For Charging Radio "A" Batteries The Balkite Trickle Charger

A low-rate charger for 4 and 6-volt "A" storage batteries. Specially adapted to use with sets of relatively small "A" current requirements—dry cell sets and sets having a small number of storage battery tubes.

With a low-capacity storage battery of the sort commonly used with dry cell tubes makes possible a very economical installation with sets using these tubes.

Will furnish more current than is used by six dry cell tubes so that if the charger is used while the set is in operation it need not be used at any other time.

Also adapted to use with the usual type of storage battery if allowed to charge for longer periods. Will furnish current necessary for as many as eight storage battery (201-A tubes) if the charger is allowed to "trickle charge" continuously.

Size: 5 1/2 inches long, 2 3/4 inches wide, 5 inches high. It may be put in the usual dry cell compartment. Shipping weight, approximately 3 lbs. Charging rate, 1/2 ampere with a 4-volt 2-cell storage "A" battery; .4 ampere with the 6-volt 3-cell storage battery.

Characteristics and principles of operation the same as those of the standard Balkite battery charger. Current consumption less than that of a 10-watt lamp. Shipped dry, without electrolyte, which may be purchased from us, or standard battery electrolyte may be used. Operates from 110-120 A. C. 60-cycle current.



U. S. PAT.
MAY 27, 1924

Price, each.....\$10.00

Brach Power Control (for above)..... 3.50

FANSTEEL Balkite "B" II

This is the same model, unchanged, as offered last year. It is the same as the new Balkite "B," except it is

larger and has a much greater capacity and flexibility. It is a unit of universal application and fits any set, including sets of as many as ten tubes or more. Its capacity is 40 milliamperes at 90 volts. Thousands in use. Size: 9 inches high, 6 1/4 inches wide, 7 1/2 inches deep. Operates from 110-120 A. C. 60-cycle current. Special model for 50 cycles.



U. S. Patent
May 27, 1924

Balkite "B" II. Retail price.....\$55.00

FANSTEEL Balkite "B"

When using Balkite "B" no changes or additions to the set are necessary. The binding posts provided are simply connected by means of leads to the corresponding connections on the set. It can be used with either storage battery or dry cell type of tube. It requires no other attention than the addition of a few drops of water to the rectifier cells, usually not oftener than once a year.

This is a new model, designed especially to serve sets of five tubes or less, or sets where four 22 1/2-volt blocks of dry batteries are recommended. Current cost about that of a 10-watt lamp. Size: 8 1/8 inches long, 8 inches high, 3 1/4 inches wide. Occupies approximately the same space as a 45-volt dry "B" battery. Operates from 110-120 A. C. 60-cycle current.



Balkite "B". Retail price.....\$35.00

Pearson Radio

Model PS-5

Pearson De Luxe Floor Console

The De Luxe Floor Console Model is probably the finest development of the cabinet idea in radio.

The cabinet stands 38½ inches high, is 21½ inches wide and 16¼ inches deep. Constructed of beautiful two-tone quartered and matched French walnut. The upper front panel opens to form an arm-rest or logging desk when the set is being used, or closes to conceal the set when idle.

Scroll work over a gold cloth panel conceals a full-size loud speaker of superior tone quality. The lower part of the cabinet is large enough to accommodate both charger and all batteries.

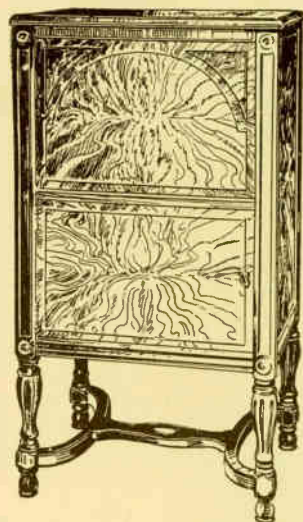
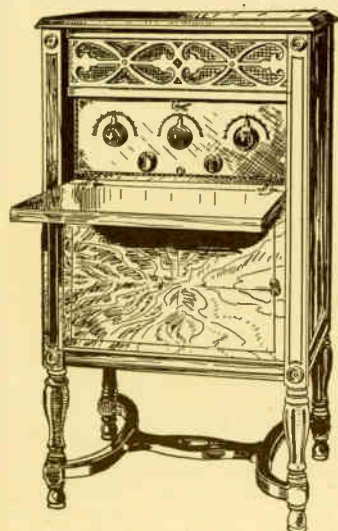

The set itself is the famous Pearson navy license tuned radio frequency. Five 5-volt tubes — uses either indoor or outdoor aerial. In range, volume, selectivity and tone this Pearson receiver ranks with any on the market—and at a price one-half to one-third.

\$146.50

Model PS-5 De Luxe Floor Console (without batteries or tubes) . . .

Pearson Special

Here is a receiver you can rely on—performance, design, price—all are right. The Pearson Special is a 5-tube set. Circuit licensed under navy patents. Made for selectivity and volume. Clarity and positive control are unsurpassed.

\$50.00

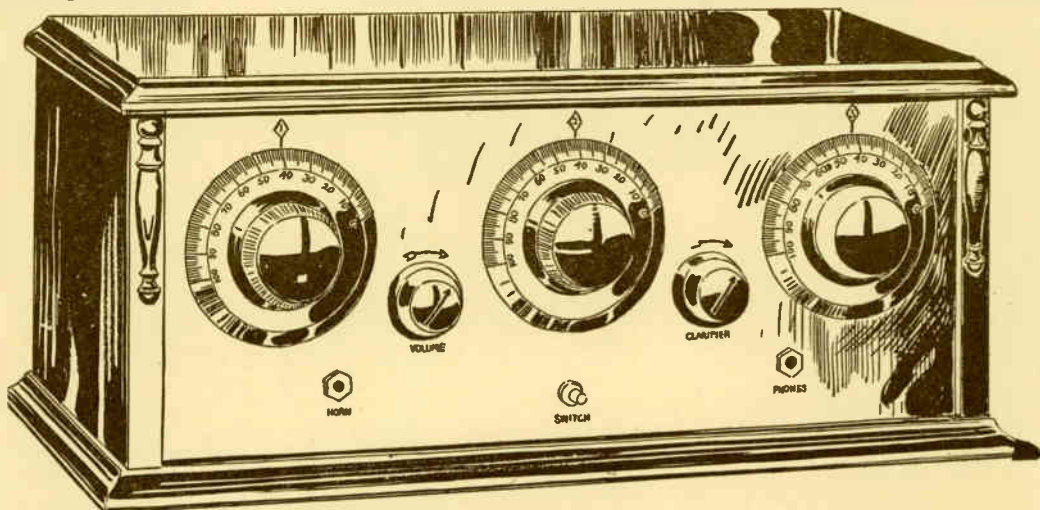

Pearson PS-5 De Luxe

Same circuit as above, in a two-tone quartered and matched French walnut cabinet, carved at sides and top in an exclusive design. A piano-hinged lid permits easy access to the wiring. Bronze panel; bakelite sub-panel and bakelite indicator type dials. Erla precision rheostats control the radio frequency tubes and detector; automatic filament control for the audio frequency tubes. Condensers: Erla tested capacity fixed, Erla Miniloss variable condensers. Pearson Nil-loss coupler and radio transformers. Indoor or outdoor aerial.

Cabinet holds receiver and "C" battery only.

Size, 11½x21x10½ inches.

\$78.50

The Pearson PS-5

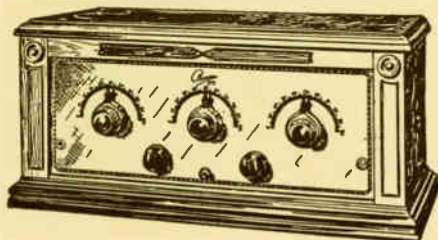

Sterling

Sterling No. 24 Pocket Ammeter



All Sterling pocket meters have correct scale calibration, are durable, have clearly marked dials and handsome full nickel finish.

(Universally used for testing dry cell "A" batteries.)

No. 24—0-35 ampere scale, 1 ampere division.....\$1.00

(Packed one in a box.)

Sterling Pocket Voltmeter

No. 33—For testing voltage of individual cells; 0-3 volt scale, 1/10 volt div.....\$1.25

No. 34—For testing voltage of "A" batteries, dry or storage; 0-10 volt scale, 1/5 volt div.....\$1.25

No. 34B—For testing 22½-volt dry "B" batteries; 0-30 volt scale, 1 volt div.....\$2.00

No. 34C—For testing voltage of 22½ and 45-volt "B" batteries, dry or storage; 0-50 volt scale, 1 volt divisions...\$2.25

No. 35—For testing total voltage of several "B" battery units connected in series; 0-120 volt scale, 5 volt divisions.....\$3.50

No. 36—Combination voltmeter for testing both "A" and "B" batteries; 0-50 volt scale, 2½ volt divisions, 0-10 volt scale, ½ volt divisions.....\$3.50

No. 37—For testing voltage of 24-cell storage "B" batteries or equivalent dry battery voltages; 0-75 volt scale, 2½ volt divisions.....\$2.50

No. 38—For testing voltage of 48-cell storage "B" batteries, also dry batteries; 0-150 volt scale, 5 volt divisions.\$3.50

No. 39—Combination voltmeter for testing "A" batteries, storage or dry; also for testing up to 48-cell "B" battery voltages whether in use or on charge; 0-8 volt scale, ¼ volt divisions; 0-160 volt scale, 5 volt divisions..\$4.00

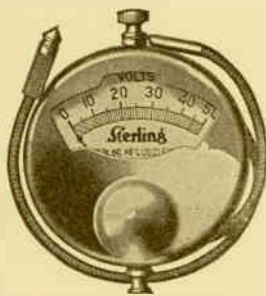

Sterling Pocket Voltammeter

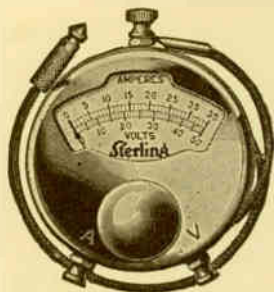

(A combination of the voltmeter and ammeter in a single case.)

No. 45—For testing amperage of dry cell "A" batteries and voltage of either dry or storage "B" batteries up to 50 volts, 0-35 ampere scale, 1 ampere divisions; 0-50 volt scale, 1 volt divisions..\$3.50

Radio Frequency Transformers

Gives high amplification and sharp tuning. May be used with spacing as close as 5-inch centers without interference. Size 1½x2x2⅞ high.

No. R302—Radio Frequency Transformer.....\$3.50

Sterling "Soft Tread" Rheostats

Bakelite, polished nickel case, completely housed, dust-proof, requires only one panel hole. Contact shoe of spring tempered phosphor bronze—smooth running and noiseless. Fully insulated and very substantial.

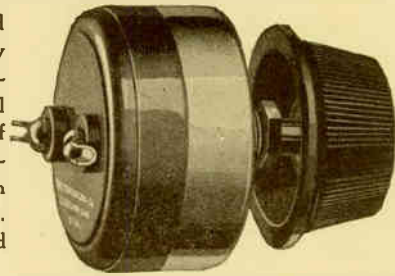

No. R305—6 ohms, 1 ampere.....\$1.25

No. R306—15 ohms, ½ ampere.....1.25

No. R307—30 ohms, ¼ ampere.....1.25

No. R308—50 ohms, ⅛ ampere.....1.25

No. R309—400 ohm Potentiometer, built in same style 2.00

Sterling Transformers—Audio and Radio

Ratio 4 to 1. Resistance: primary, 1100 ohms; secondary, 16,000 ohms. Impedance at 800 cycles—primary with secondary open 112,000 ohms. Secondary with primary open 4,000,000 ohms.

Japanned case, with nickel top. Size 1¾x2¼x2¾ high.

No. R356 — "Full Range" Audio Transformers..\$6.00



Sterling Adjustable Micro-Condensers

Invaluable for increasing the grid to plate capacity, or equalizing radio frequency circuits.

No. R312 is ideal for equalizing the capacity of imperfectly matched intermediate transformers. No. R311—Cap., approx. 1/4 min., 5 max. MMF...\$1.00 No. R312—Cap., approx. 4/10 min., 40 max. MMF... 1.50

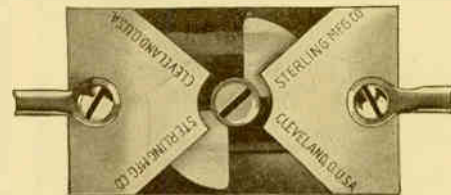

Sterling "Home" Tube Tester No. R401

A compact, accurate instrument for testing the amplifying ability of UV-201A, C-301A; also UV-200 and C-300 vacuum tubes. Operates with receiving set without disconnecting any units, simply by exchanging positions of tube and tester plug. Two readings taken on millimeter dial of tester show rise in plate current of tube. This rise compared with table affixed to bottom of tester accurately determines whether tube is good, fair or poor amplifier. Popular for home use, also store counter and repairmen. Weight, 28 ounces. Size, 4x7x2.

Price.....\$8.50



Sterling

Sterling "Universal" Tube Tester



This tester operates the same as the No. R401 and in addition is provided with an adapter and mechanism suited to testing UV-199, C-299, WD-12 and C-12 tubes in the radio set. It has also a combination meter for testing plate and filament voltages, in addition to the milliammeter.

Thus it serves not only as a tube tester, but as an "A" and "B" battery tester, and is also valuable in locating defective set wiring, open transformer wiring and weak sockets. This R406 portable instrument is truly a "universal" tester adapted to the home user, but is invaluable to the repairman and dealers' service departments or store counters.

Size, 6½x7¼x3½ inches high. Black finish, silver etched dials. Furnished with adapters. Individually boxed in packages of 6 or 12.

No. R406—Price, each.....\$18.00

Sterling "Professional" Tube Tester

(Equipped with Three Sterling Meters)

Invaluable to dealers for checking tubes when secured from source of supply, when matching them in sets or as protection against tube returns when sold over counter. The R402 Tester is equipped with filament voltmeter and rheostat to establish correct filament voltage for testing any tube. Also has plate voltmeter to test "B" battery voltage. With normal receiving conditions established by these meters, simply push button and note on plate milliammeter change in plate current. The change, compared with standard table, accurately determines the amplification value of tube. Invaluable to the radio tube dealer and repair expert. Size, 6½x8½x3 inches high. Black finish, silver dials. Equipped with adapter—FOR ALL TUBES.



No. R402—Price, each.....\$30.00

Sterling Vacuum Tube Reactivator

By the use of this Reactivator, UV-201-A, C-301-A, UV-199 and C-299 tubes may be reactivated time after time, thereby multiplying the use of the tube to many times its normal life.

One of the distinct advantages of the Sterling Reactivator is provided by its being equipped with filament emission meter, thus enabling the user to determine instantly by test whether a tube needs reactivation. A reading from this meter, when compared with a table of standard values furnished with the instrument, also shows to what degree the filament emission has been restored by the process of reactivation.

This meter also enables the user to select tubes of approximately equal filament emission for matching in sets. A protection and profit maker for the radio dealer, a tube saver for the home user.

No. R403—50 to 60 cycle. Price, each...\$12.50

No. R403—25 to 40 cycle. Price, each... 14.00

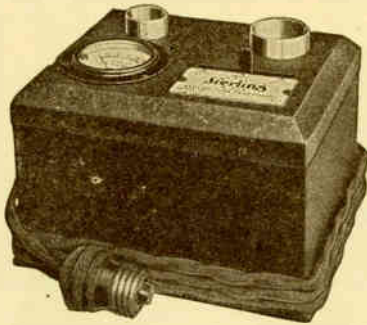

Exide

RADIO BATTERIES

Exide "A" Batteries

Type No.	Plates	Volts	Capacity Amp. Hrs.	List Price
14806	5	6	50	\$15.65
14807	7	6	75	16.75
14808	9	6	100	21.30
14809	11	6	125	24.50
14810	13	6	150	27.80
14231	3	4	12	8.15
13920	5	4	50	11.55
14230	5	2	24	5.95
15071	9	2	100	9.25



Exide "B" Batteries

No.	Type	Volts	Capacity Milliamp. Hrs.	Gross Price
15292	2	24	6000	\$11.65
15293	2	48	6000	21.65



Exide Rectifier

No. 14881—Price.....\$2.75

A compact and efficient rectifier, designed for the home charging of radio "B" batteries from the usual 110-120 volt A. C. lighting circuit.

Salts, per pkg., 24 volts...\$1.00
Salts, per pkg., 48 volts... 1.50



The "SELF-ADJUSTING" Rheostat

Amperite operates on the thermo-electric principle. It consists of a special treated filament hermetically sealed in a glass tube and surrounded by an inert gas. This filament has the unique property of changing in resistance automatically as the "A" battery voltage changes. Thus the vacuum tube filament is constantly operated at maximum efficiency—for best volume and longest life.

Amperite No. 1-A—For the UV-201-A, C-301-A, DV-2, or similar tubes on the 6-volt battery. Amperite No. 1-A may also be used for the WD-11, WD-12, C-11 and C-12 on the 2-volt storage battery.

Price, each.....\$1.10

Amperite No. D-11—For the WD-11, WD-12, Northern Electric Peanut Tube, or similar tubes on the usual 1½-volt dry cell.

Price, each.....\$1.10

Amperite No. 4V-199—For the UV-199, C-299, DV-3, on 4½ volts (3 dry cells) or on the 4-volt storage battery.

Price, each.....\$1.10

For New CX-212 and CX-220 Tubes

For CX-212 No. 112. Price, each.....\$1.10

For CX-220 No. 120. Price, each..... 1.10

Amperite No. 6V-199—For the UV-199 and the C-299, or similar tubes, on the 6-volt "A" battery.

Price, each.....\$1.10

Amperite No. 1—For all 1-ampere 5-volt tubes on the 6 volts.

Price, each.....\$1.10

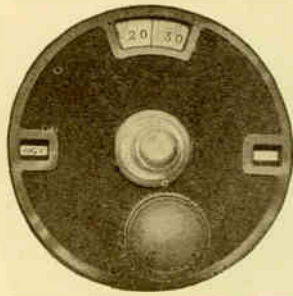

Mar-Co 4-inch Bakelite Vernier Dial

Non-microphonic. Absolutely no back-lash. Provides for filling in station call letters.
Only one hole to mount. Metal template supplied.
Nickel finish \$2.50
No. 192—Gold plate finish 3.00

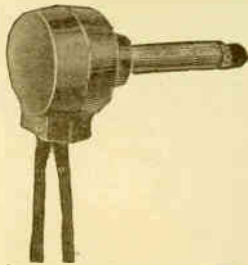

Mar-Co Perfection Sta-Put Plug

Bakelite construction. About the size of a quarter in diameter. Panel projection less than one inch. Spring terminal grips. Entirely encloses cord tips.
No. 186—Price, each . . . \$0.50

Mar-Co Multi-Plug

Takes four headsets in series or parallel connection. Radion hard rubber casing.
No. 105—Price, ea. \$1.00

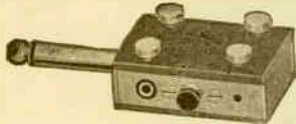

Mar-Co Switch Plug

Hard rubber casing. Metal parts highly nickeled.
No. 107—Price, ea. \$1.00

Mar-Co Multi Connector

Hard rubber casing. Highly nickeled metal parts. Furnished with extension cord.
No. 106—Price, ea. \$1.00

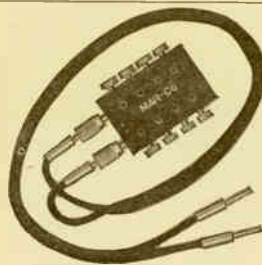

Mar-Co Battery Switch

Bakelite case and knob. Rotary knife action. Visible on and off positions. Quick make and break.
No. 145—Price, each \$1.00



Mar-Co Pull Switch

Hard rubber insulation. Nickel finished metal parts.
No. 144—Price, each \$0.30

Mar-Co Extension Cord

Including nickel finish plug, nickel finish parallel connector and 20 feet of covered cord.
No. 190—Price, each . . \$1.50

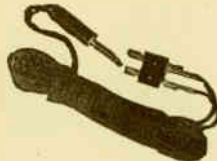

Mar-Co Switch

Double Pole, Double Throw

For panel mounting.
Only one drilling necessary. Insulated with hard rubber, bakelite knob. Metal parts nickeled.
No. 146—Price, each . . . \$1.25

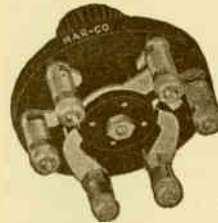
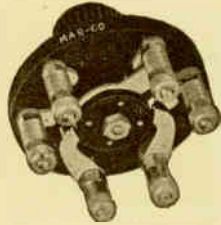

Mar-Co Series Parallel Switch

For panel mounting. Only one drilling necessary. Insulated with hard rubber. Bakelite knob. Metal parts nickeled. Furnished with dial.
No. 147—Price, each . . . \$1.25

Mar-Co 5-Point Inductance Switch

For panel mounting. Only one drilling necessary. Insulated with hard rubber. Bakelite knob. Metal parts nickeled. Positive stop. Furnished with dial.
No. 148—Price, each . . . \$1.00



- Mar-Co 7-Point Inductance Switch No. 149—Price, each \$1.25
- Mar-Co 9-Point Inductance Switch No. 150—Price, each 1.25
- Mar-Co 11-Point Inductance Switch No. 151—Price, each 1.50
- Mar-Co 19-Point Inductance Switch No. 152—Price, each 2.00

Mar-Co Radio Frequency Kit No. 1

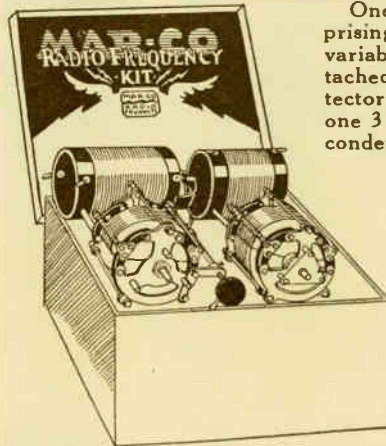

One aerial tuning unit comprising one 500 Mfd. Mar-Co variable condenser with attached inductance; one detector tuning unit comprising one 375 Mfd. Mar-Co variable condenser with attached radio frequency coupling coil, secondary coil and adjustable tickler for controlling regeneration. This assembly is one of proven merit and has made remarkable records for distant reception. It excels on a short indoor aerial. Any modern three-element tube may be used with the proper rheostat.

Mar-Co Radio Frequency Kit, each \$17.00

Mar-Co Bakelite Knobs

- Straight
- No. 175—1 1/4 in. Each . . \$0.20
- No. 174—3/4 in. Each 20
- Tapered
- No. 175T—1 1/4 in. Each . . 20
- No. 174T—3/4 in. Each . . . 20

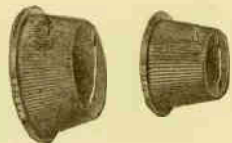



Mar-Co Variable Resistance

15,000 to 100,000 ohms. Used as resistance shunt on audio transformers in power circuits. Bakelite base and knob. Moisture-proof construction.

No. 172—Price, each. \$1.50



Mar-Co Miniature Armor-Clad 30-Ohm Rheostat

For use with UV-199, UV-201-A, C-299, C-301-A, DV-1 tubes. Diameter less than 1 3/4 inches. Extra small size. Polished nickel finish. Bakelite knob. Calido nickel chromium resistance unit.

No. 161—Price, each. \$1.00

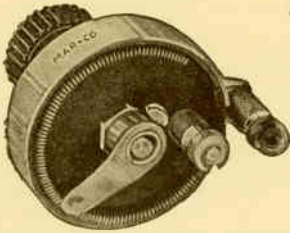

Mar-Co Variable Grid Leak

One-fifth to 5 megohms guaranteed resistance. Dust and moisture-proof bakelite construction. Bakelite knob.

No. 171—Price, each. \$1.50



Mar-Co Super Vernier Condenser

Terminals widely spaced. The very finest type of vernier with the lowest losses in the smallest panel space. Diameter, 1 3/8 inches. Bakelite knob, nickel finish, hard rubber insulation.

No. 167—Price, each. \$1.25

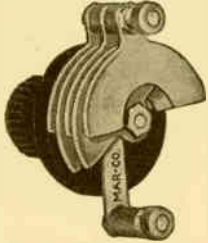

Mar-Co Knife Switches

Hard rubber insulation. Metal parts nicked. Complete with binding posts.

No. 153—Price, each. \$0.60

No. 154—Price, each.70

Single pole, single throw.



Hard rubber insulation. Metal parts nicked. Complete with binding posts.

No. 157—Price, each. . . . \$1.25

Triple pole, single throw.

No. 158—Price, each. . . . 1.50

Triple pole, double throw.

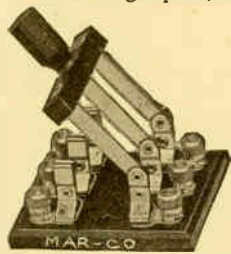

Hard rubber insulation. Metal parts nicked. Complete with binding posts. Combined cut-out switch for "A" and "B" battery lines.

No. 159—Price, each. \$1.75

Four pole, single throw.

No. 160—Price, each. 2.00

Four pole, double throw.

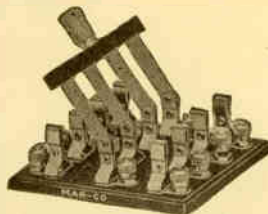

Hard rubber insulation. Metal parts nicked. Complete with binding posts.

No. 155—Price, each. \$0.90

Double pole, single throw.

No. 156—Price, each. 1.00

Double pole, double throw.



The "Straight-Line Frequency" Dial

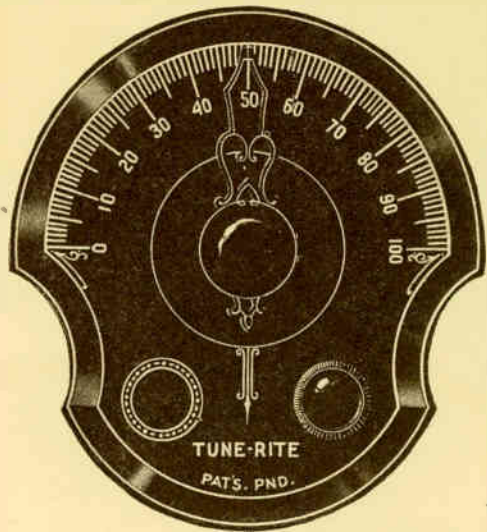

A dial which converts any variable condenser to straight-line frequency characteristics; separates the stations at lower wave-lengths where they should be separated, and gives an even distribution of stations over the entire dial scale. Back-lash permanently eliminated by a special type of gear teeth, exclusive with the Tune-Rite Dial. Bunching of stations at low wave-lengths is prevented by a system of gear trains, which perform a variable ratio vernier action ranging from 24-1 to 2 1/2-1 as required. The knob and pointer turn at a uniform rate in the same direction. No drilling necessary. Immediately attached to any set with only a screw driver.

Guarantee: Every Tune-Rite Dial is absolutely guaranteed.

Tune-Rite Dials fit any set. Beautifully finished in black and gold. Tune-Rite Dial, Type CW, for condensers turning clockwise. Tune-Rite Dial, Type CCW, for condensers turning counter clockwise.

Price (either type) \$3.50

M-V Pan Brackets

They are made in cast aluminum and are drilled and threaded for mounting panel and sub-base. Can be furnished for either straight front or sloping front panel.

Price, per pair. \$1.50

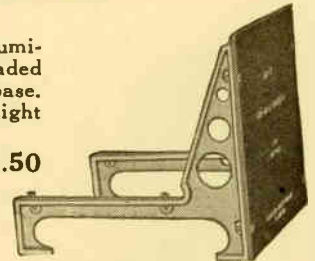

Lenk Automatic Blow Torch

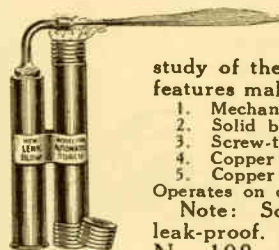

The new Model No. 108 represents improvements developed after years of close study of the automatic torch principle. Five features make this a better torch.

1. Mechanically leak-proof.
2. Solid base improves stance.
3. Screw-top makes it easier to fill.
4. Copper heat conductor generates quickly.
5. Copper heat conductor gives hotter flame.

Operates on denatured or commercial alcohol. Note: Solid base makes it mechanically leak-proof. Size, 5 1/2 x 2 1/8 x 1 inches.

No. 108—Price, each. \$1.50

Van-Ashe Tables and Consoles



Model 21—Complete.
Price \$55.00

Radio Table and Loud Speaker Combined

Made of American black walnut, finished with best varnishes. Hand rubbed, two-tone effect. Is fitted with a loud speaker horn that is scientifically correct, and a Utah unit giving a loud, clear reproduction.

This table has fine grille in front, which is backed with a fine silk damask cloth. The front of case is cut out for ample leg room for operator.

There is ample room inside of table for batteries and charger.

Size over all: 39 in. long, 16½ in. wide, 29 in. high.

A Word About Our Cabinets, Tables and Consoles

All our cabinets, tables and consoles are made of well seasoned wood, hand rubbed and will not warp or become shabby looking after being exposed to sudden heat and cold. Every weak part has been strengthened so they will stand up under every condition which you could expect from a fine piece of furniture.

Console With Loud Speaker

Made of genuine solid mahogany or walnut plywood, finished in walnut or mahogany two-tone effect.

This model is equipped with loud speaker horn of excellent tone and quality, and fitted with Utah loud speaker unit built into the right-hand side of instrument compartment behind a beautiful grille. The instrument board is large enough to accommodate a panel 24 inches long and 10 inches high, or smaller. Material and workmanship are high grade. Hardware carefully select of best quality, nickel finish.

Size of case over all: 39 in. high, 36½ in. long, 15½ in. deep.

Size of instrument compartment: 34 in. long, 11 in. deep, 10 in. high.

Size of instrument panel board: 32 in. long, 10 in. high.

Size of battery compartment: 34 in. long, 13 in. deep, 12 in. high.



Model 57—Complete.
Price \$77.50

Stevens *SPEED UP* Tools

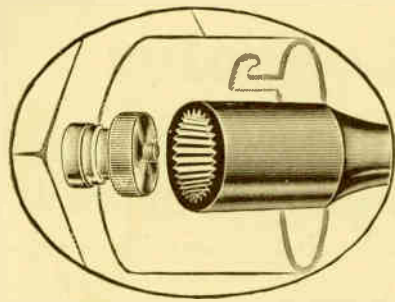

New Round Spintite.
The short teeth are spiraled and tapered to get a firm, solid grip on the knurled **ROUND** nut.

T-825 — Set of Round Spintites,
3 sizes, $\frac{1}{8}$ in., $\frac{3}{8}$ in., $\frac{7}{8}$ in. List price **\$1.00**



T-825 Round Spintites

The improved spiral cutting edge produces a round hole in any material without ragged surface. You can enlarge a $\frac{1}{8}$ -inch hole to $\frac{3}{4}$ inch.

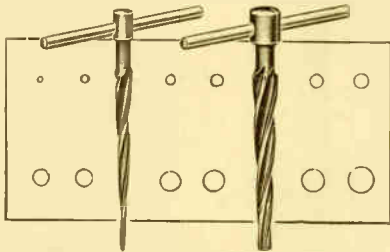

T-580 Utility Reamers

T-580—Size $\frac{1}{8}$ in. to $\frac{1}{2}$ in. Price \$1.50
T-581—Size $\frac{3}{8}$ in. to $\frac{3}{4}$ in. Price 2.00

This Spintite gets a full grip on the hex nuts, hollow stem goes over projecting screws —ebonized handles for comfortable leverage. Easy to reach cramped corners.

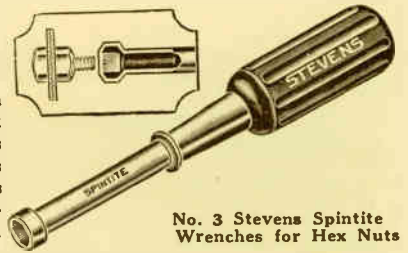

No. 3 Stevens Spintite Wrenches for Hex Nuts

This bit is machined from one piece of steel and hardened to give lasting service. Now made in all sizes. Numbers indicate 16ths of an inch.

No.	Description	List Price
No. 3	(Switch points)	\$0.35
No. 4	(Switch points)	.35
No. 5	(Popular size)	.35
No. 5 1/2	(Standard 8/32 nut)	.35
No. 6	(Standard 10/32 nut)	.35
No. 7	(Phone jack)	.65
No. 8	(Phone jack)	.65
No. 9		.65
No. 10		.65

For winding induction and trans. coils for use in neodyne and superdyne circuits. For cylinders in $3\frac{1}{2}$ in. in diameter and 6 in. long. Automatically centers the cylinders. Length over all $12\frac{1}{2}$ in.

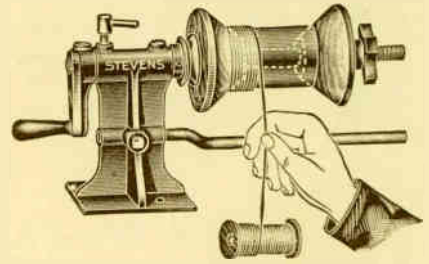

T-585 Coil Winder

T-585—Coil Winder.
Price . . **\$5.50**

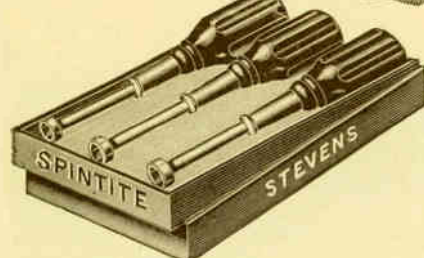
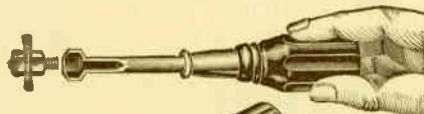

T-71 Hex Spintite Set

It contains the three most popular sizes of Hex Spintites: No. 4, $\frac{1}{4}$ -inch; No. 5, $\frac{5}{8}$ -inch; No. 5 1/2, $1\frac{1}{8}$ -inch.

T-71—Hex Spintite Set. Price \$1.00



No. 3015 Work Chest

These cabinets are solid oak, steel back; drawer bodies formed from one piece of galvanized sheet steel. Each drawer has card frame and pull.

No. 3015—Size over all $19\frac{1}{2}$ x $8\frac{1}{2}$ x $12\frac{3}{4}$ in. \$11.00
No. 3018—Size over all $19\frac{1}{2}$ x $8\frac{1}{2}$ x $12\frac{3}{4}$ in. 12.50



No. 3018 Work Chest

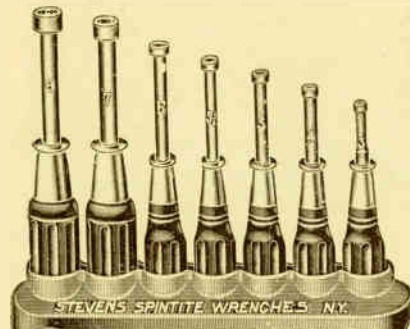

T-73 Hex Spintite Set

This is the complete Hex set for the radio enthusiast. Consists of seven sizes: Nos. 3, 4, 5, 5 1/2, 6, 7 and 8 (these numbers indicate 16ths of an inch across flats); mounted in neatly finished metal base.

T-73—Spintite Hex Set. Price . \$3.50

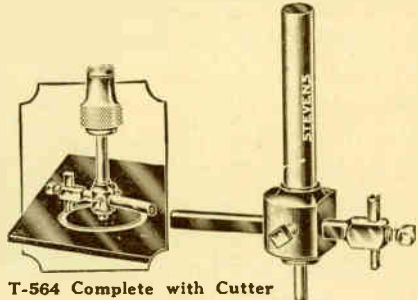

T-564 Complete with Cutter

This is quickly adjusted from $1\frac{1}{2}$ in. to 6 in. Shank is $\frac{1}{8}$ in. diameter.

T-564—Complete. Price . . \$1.75

T-563—Set of 3, 1 ea. size. \$2.50
T-560—Radio Panel Cutter, $\frac{3}{4}$ in. . . . \$0.75
T-561—Radio Panel Cutter, 1 in. . . . \$0.85
T-562—Radio Panel Cutter, $1\frac{1}{2}$ in. . . \$1.00

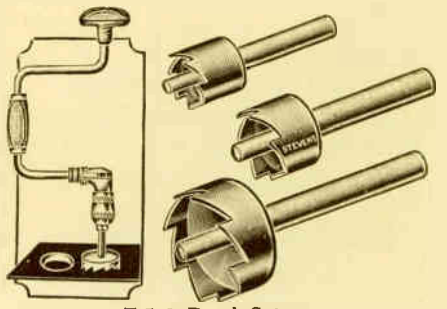

T-563 Panel Cutters

Stevens SPEED UP Tools

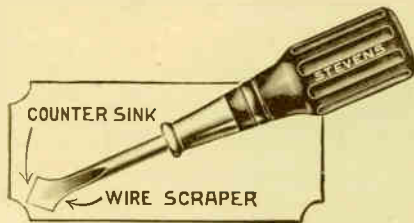

T-582—Burring Tool

This handy little tool is a combination countersink and wire scraper. Made of hardened steel. Length over all 6½ inches.

T-582—List each . . . \$0.35

Drills hole and countersinks. One operation.

T-565—List, each . . \$0.35

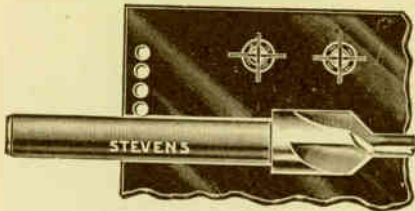

T-565—Countersink and Drill

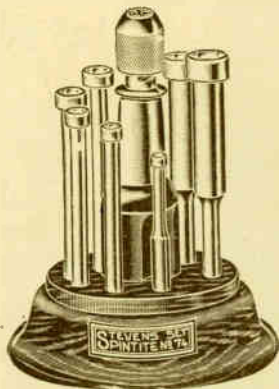

T-74-B—Hex Spintite Set

Hex Spintites in separate shanks with universal handle. Set has sizes Nos. 3, 4, 5, 5½, 6, 7 and 8. Mounted on mahogany finished block.

T-74-B—Hex Spintites Set. Price . . . \$3.25

Scriber for laying out panel. Best steel. Twisted handle. Bent end for confined places. Length, 7¾ inches.

T-550—Each . \$0.45

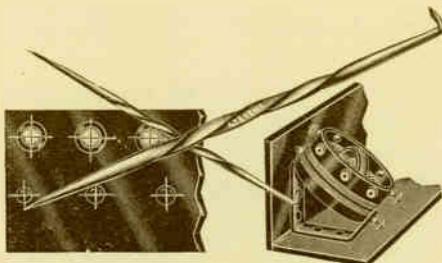

T-550—Stevens Radio Scriber

Easy to get at hex nuts on panel mounted parts. Reaches anywhere. Made in 4 sizes: Nos. 4, 5, 5½ and 6. Price, each . . . \$0.35

T-820—Four sizes . \$1.25

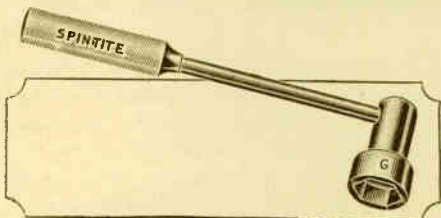

T-820—Offset Hex Spintite

Speed - a - Loop bends any size wire, in round or square b. u. s. Attachment sold extra.

T-570—Speed-a-Loop complete. Each . . . \$1.50

T-571—Attachment. Each \$0.50

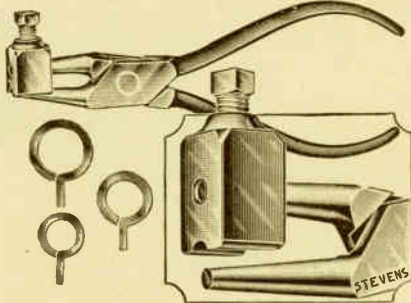

T-570 and T-571—Speed-a-Loop



T-77—Pliers

Size of blade, 4½ in. Length over all, 9½ in. Furnished complete with blade.

T-584—Midget Hack Saw. Each . . \$0.50

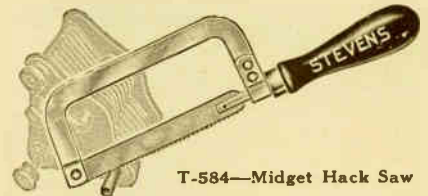

T-584—Midget Hack Saw

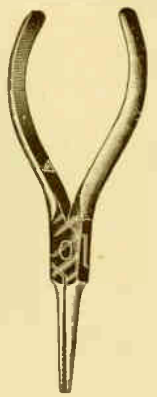

T-88—Pliers

These pliers will straighten condenser plates, extension on socket springs, and are needed by every radio owner. High-grade forged steel. Jaws hardened and polished.

T-88—Curved jaws. Ea. \$1.25
T-77—Straight jaws. Ea. 1.25

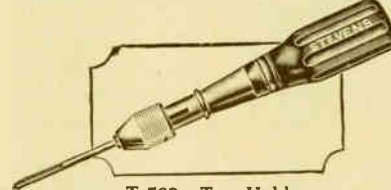

T-583—Tap Holder. Price . . . \$0.35

These reamers assist to fit dials to shaft. Cleans perfectly any obstruction in hole. Handy tool.

T-555—⅜-in. size . . . \$0.75

T-556—¼-in. size . . . \$0.75

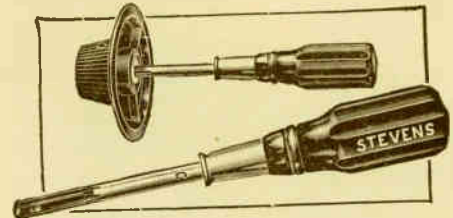

T-555—Reamer ⅜-inch and ¼-inch

An invaluable tool to the radio builder. Adjusted to fit any size tap, from No. 4-40 to 10-32.

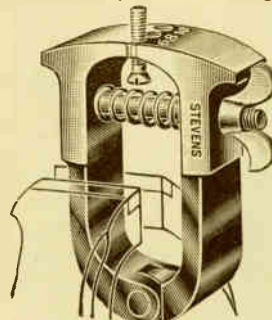

T-551—Screw Clamp

Holds screw for filing down required lengths. The jaws hold screws for Nos. 6, 8 and 10 screws, 32 head. Forged steel. Jaws may be used for rethreading dies.

T-551—Screw Clamp. Each . . . \$1.50

Consists of three screw-driver blades, 1 reamawl, 7 hex shanks, universal handle. Hex shanks fit all nuts in radio. Inflexible roll.

T-51—Hex Spintite Set. List \$4.00

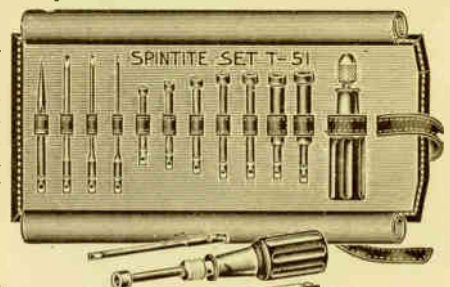

T-51—Hex Spintite Set

Bosch Set and Cone Speakers

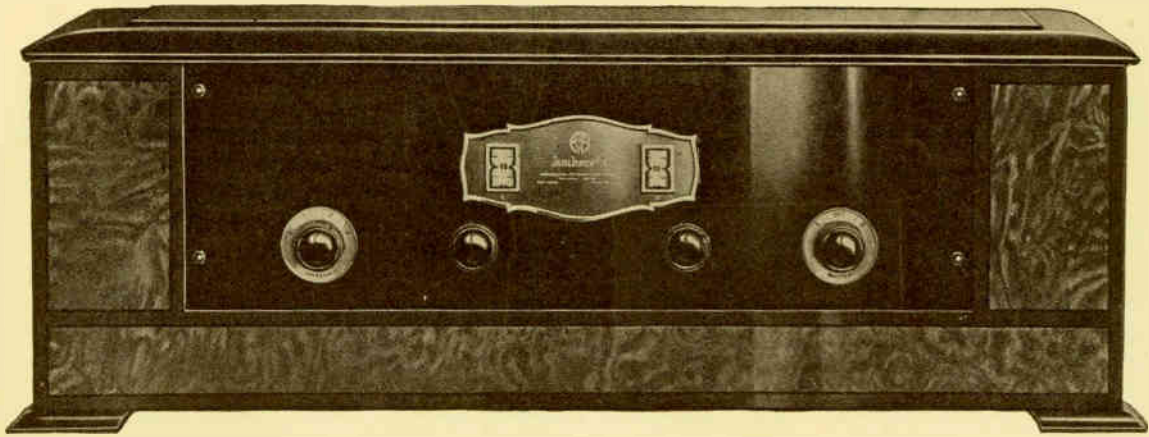

Bosch Amborola Receiver (without accessories)..... \$145.00

Technical Description of Bosch Amborola

Simplicity—The operation of tuning in any broadcast program on the Bosch Amborola is reduced to the simplicity of a slight movement of only two indicators. A multiplicity of dials is not necessary.

Range—The range of the Bosch Radio Receiver is subject to installation conditions and no manufacturer can honestly state positively the full range of his set to meet any and all conditions. Quality of tone and quality of reception, night after night, throughout the year, are more interesting to an owner than lavish and unsupported claims of great distance.

Selectivity—The Bosch Amborola is extremely selective. On country-wide tests it has penetrated, with ease, powerful local broadcasting stations, sacrificing in no way quality of reception of the more distant programs. The simplicity of operation, together with the ability to tune in night after night the logged stations at exactly the same point, is a delight to the novice and a surprise to the radio-wise operator.

Quietness—The complete elimination of internal set noises has placed the Bosch Amborola practically alone in its quietness of reception.

Power—The Amborola has six tubes, giving it power to receive the broadcast programs in the volume you desire on the loud speaker without outside amplification. No headphones are necessary on the Bosch receiving set.

Dimensions—The over-all dimensions of the Bosch Amborola are: Length, 29 $\frac{3}{8}$ inches; height, 10 $\frac{1}{8}$ inches; depth, 10 $\frac{3}{16}$ inches.

The Bosch Ambotone Reproducer

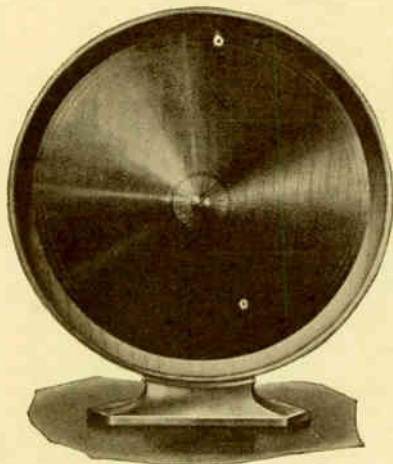

The Bosch Ambotone is instantly recognized for its mellow, natural tones. This Bosch radio reproducer brings a musical program into the home just as it is broadcast. The bass tones, which form the background of all music, are preserved with true fidelity. The voice reproduction is as natural as though the artist were in the room.

The Bosch Junior Ambotone

The Bosch Junior Ambotone Radio Reproducer has been developed for those who want quality radio reproduction at the minimum outlay. It is a quality reproducer—yet it is inexpensive. It costs little more than a set of good ear phones. In the Bosch Junior Ambotone, true broadcast tones are possible through the use of the Bosch Ambotone principles of reproduction. Aside from its perfect tone, the Junior Ambotone is an attractive ornament.



Bosch Ambotone. Price.....\$27.50 Bosch Junior Ambotone. Price....\$14.50

Our Territory on Bosch Sets and Speakers: Southern Illinois and Eastern Missouri

DeJur

DeJur Rheostats

Made of the same high-grade material as the potentiometers.

Made in the following ohms: 6, 10, 15, 20, 30, 50.

Price, each . . . \$0.65

2-Ohm (power)
Each 1.10

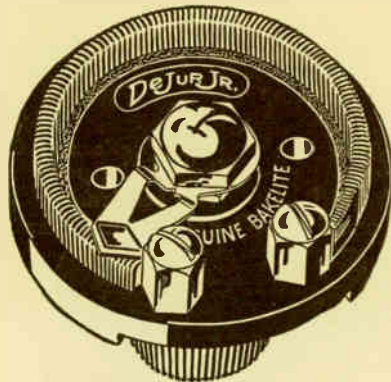

DeJur Low-Loss Socket Losses Eliminated

Improved Type V. T. Sockets. Utmost protection against leaks and losses, spring contacts of spring phosphor bronze, positive contact with each tube prong made possible by side-wiping and bottom pressure. Soldering connections part of contact spring. No other connections necessary. Battery nuts for temporary connections.

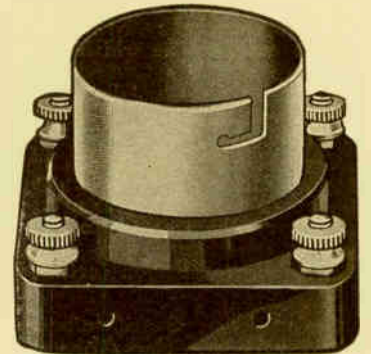

Price, each \$0.35

DeJur Radio Battery Cable

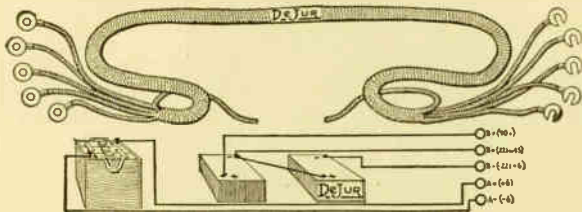

For Connecting "A" and "B" Batteries to the Radio Set
Untidy wires, loose connections, confusion in tracing wire—ELIMINATED.

Each wire marked in color with terminals on all wires that can easily be connected. Packed in attractive display carton.

Price, each \$0.90
Furnished with Battery Clamps. Each 1.10

DeJur Improved Grid Leak Soldered Caps



The only grid leak made with caps soldered to the connections. Absolutely moisture-proof, water-proof, air-tight. Suitable to all climatic conditions. No glue or "woods-metal" used. Noiseless. Accurate. Testing—thorough and accurate; measured on a calibrated instrument.

Price, each \$0.20

DeJur Potentiometers

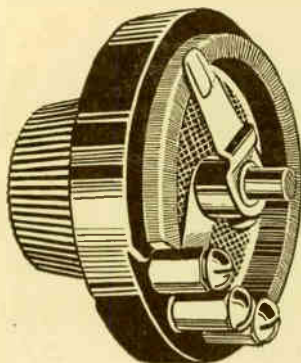

Contact slide made of a high-grade spring phosphor bronze, nickel plated, which runs smoothly over the unit, making it absolutely noiseless in operation.

Made in the following ohms: 100, 240, 400, 800.

Price, each \$0.90

Fore Battery Charger

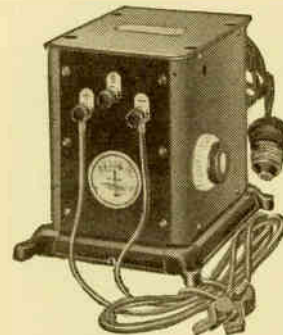

Worthy of its name. We have sold hundreds of them, and it will give you perfect satisfaction in every way.

Simplicity first consideration—a boy can operate it. Absolutely no chance for a shock.

Practically noiseless in its operation.

Has the high-class Fore ammeter with a range of 15-0-15, charge and discharge.

Has no heat element whatever.

Terminals are marked, positive (+), negative (-), and "B" battery, which insures a correct connection.

Charges both 6-volt auto and radio "A" batteries. Charges up to 120 volts "B."

Has the standard plug fuse, same as used in the home lighting circuit. Has a 6-foot extension for attaching to light socket with a standard two-piece attachment plug.

Price, each \$18.50

Armatures 1.50

Workrite Hydrometers

Securely packed in mailing tubes to prevent breakage in the mails. Full instructions for care of the battery with each hydrometer.

Workrite Hydrometer. Price, each \$0.75

Testrite Hydrometer. Price, each75

The "Voice from the Sky" Loud Speaker



This speaker is finished in mahogany, walnut and ebony. The horn is made of "Italian gesso," cast in one piece, which, the manufacturer points out, has no audible period vibration. "The most beautiful speaker in the market." It is in itself a beautiful piece of furniture. The over-all height is 24 inches, with a bell diameter of 12 inches. A Utah unit is used in the base.

Price, each \$30.00

Belden

Belden Loop Antenna Wire

A special flexible wire on small metal spools for winding radio loops. Furnished 125 feet on a spool in attractive individual cartons.

Specifications: Code Fashion-B 60xNo. 38 copper wire stranded with 5x No. 36 copper wire which has been specially treated to prevent stretching, double serve of maroon cotton over all.

Code Floor-B 60xNo. 38 copper stranded with 5xNo. 36 copper wire which has been specially treated to prevent stretching. One serve of cotton and a braid of brown or green Rayon (artificial silk) over all.

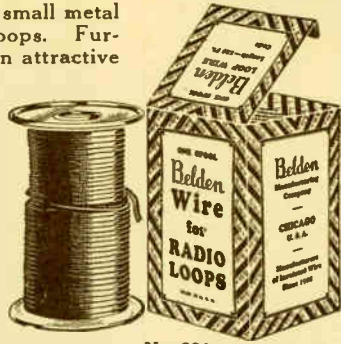

Code	Specifications	Unit	List Price
Fashion-B	See Above	Pkg. Spools 125-ft.	\$0.95
Floor-B	See Above	125-ft.	1.75

Belden Litz Wire—High Frequency Cable

The scientifically correct conductor for radio frequency currents. Ideal for winding vario-couplers, radio frequency transformers and loop antennae. Belden Litz Wire consists of fine strands of Beldenamel wire, protected by wrappings of silk.



No. 602

Specifications: Code Grizzly-B 35xNo. 36 Stranded Beldenamel with two servings of green Tussah silk. Equivalent to No. 21 B. & S. gauge. Maximum diameter, 0.041 inch.
Code Faggot-B 48xNo. 38 Stranded Beldenamel with two servings of green Tram silk. Equivalent to No. 21 B. & S. gauge. Maximum diameter, 0.045 inch.
Code Grove-B 37xNo. 38 Stranded Beldenamel with two servings of maroon Tram silk. Equivalent to No. 22 B. & S. gauge. Maximum diameter, 0.037 inch.
Code Fissure-B 20xNo. 38 Stranded Beldenamel with two servings of green Tram silk. Equivalent to No. 25 B. & S. gauge. Maximum diameter, 0.025 inch.

Code	Specifications	Unit	List Price
Grizzly-B	See Above	Pkg. Spools 100-ft.	\$1.00
Faggot-B	See Above	100-ft.	1.80
Grove-B	See Above	100-ft.	1.00
Fissure-B	See Above	100-ft.	.65

Belden Radio Replacement Cord

These are 5-foot headset and loud speaker cords for replacement of worn cords.

Specifications: Conductors are 18 strands best copper tinsel twisted into three cords for maximum flexibility and service. Two dry cotton braids on each conductor. Solid pin tip terminals (code Consol) on both ends. Packed in individual cartons for convenient resale.

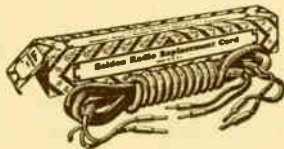

No. 617

Code	Specifications	Carton	List Price
Flite-A	(See Above) Single Headset or Loud Speaker	Contains 1 Cord	\$0.35
Doily-A	Double Headset	1 Cord	.55

Belden Radio Terminal Packets

In order to provide a ready sales unit to save time for Belden dealers, the most popular Belden Radio Terminals are being merchandised this season in small cartons containing 25 consumer packets to the carton.

Actual Sizes

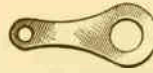

No. 619



No. 620



No. 621

Code	Specifications	No. Terminals Per Packet	List Price Per Packet
New	Tinned Copper	25	\$0.10
Conoid	Tinned Brass	25	.10
Consol	Nickel-Plated Brass	4	.10

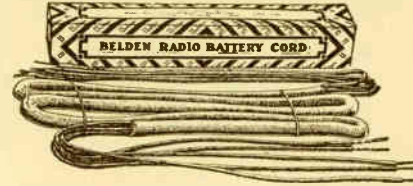

No. 614

marked cotton braid. All conductors contained in brown braid of glazed cotton.

Code	Specifications	Carton Contains	List Price Per Cord
Friend	See Above	1 Cord	\$0.75

Belden Radio Extension Cord

This 200-foot extension cord permits moving loud speakers and headphones far from radio receiver set. Two or more extension cords may be used together for greater distance.

Specifications: A two-conductor cord with solid tip terminals (code Consol) at both ends. Conductors are 18 strands best copper tinsel twisted into three cords for maximum flexibility and service. Two cotton braids on each conductor are protected by an over-all braid of black mercerized cotton.

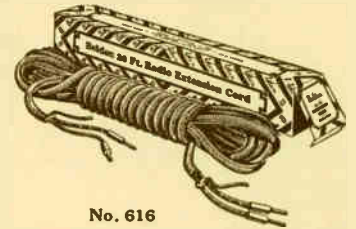

No. 616

Code	Specifications	Carton Contains	List Price Per Cord
Few-A	See Above	1 Cord	\$0.65

Belden Radio Battery Cable

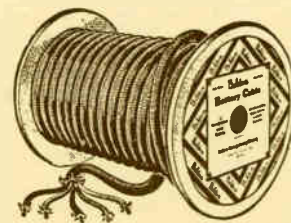

No. 615

This cable is somewhat similar in construction to the Belden Battery Cord described above. It serves the same purpose as the battery cord, except that it is supplied in 100-foot lengths and can be cut to the right length to meet special conditions.

Specifications: Five conductors under a black glazed cotton braid, two of No. 16 B. & S. stranded and three of No. 20 B. & S. stranded. All conductors are rubber covered and insulated with cotton braid color coded in accordance with standards of A. M. E. S.

Code	Specifications	List Price
Rabat	See Above	Per Foot \$0.09

Belden Flexible Hook-up Wire

Bare Rubber Insulation

Price, per foot	\$0.03
Price, per roll, in 250-foot lengths	2.50

Magnet Wire

List Prices of Magnet Wire on Standard 1-lb., 1/2-lb. and 1/4-lb. Spools

We carry the most complete line of magnet wire in the Middle West. Send us your mail orders on all kinds of wire used in radio.

Size B & S Gauge	Feet Per Pound	Size in Inches	Plain Enamel Wire 1 Pound	Double Cotton Covered 1 Pound	Double Silk Covered 1 Pound	Plain Enamel Wire 1/2 Pound	Double Cotton Covered 1/2 Pound	Double Silk Covered 1/2 Pound	Plain Enamel Wire 1/4 Pound	Double Cotton Covered 1/4 Pound	Double Silk Covered 1/4 Pound
16	127.9	.0508	\$0.60	\$0.75	\$1.15	\$0.35	\$0.40	\$0.60	\$0.20	\$0.25	\$0.35
18	203.4	.0403	.65	.90	1.40	.35	.50	.75	.20	.30	.40
20	232.4	.0320	.70	1.00	1.65	.40	.55	.85	.25	.30	.45
22	512.2	.0253	.70	1.05	1.75	.35	.55	1.00	.25	.35	.55
24	817.6	.0201	.70	1.25	2.30	.40	.70	1.20	.25	.40	.65
26	1300	.0159	.80	1.55	2.75	.45	.80	1.45	.25	.45	.75
28	2067	.0126	.95	1.95	3.50	.55	1.00	1.80	.30	.55	.95
30	3287	.0100	1.15	2.40	4.85	.65	1.30	2.25	.35	.70	1.20
32	5227	.0080	1.25	3.60	5.95	.65	1.90	3.05	.40	1.05	1.60
			One Pound Spools			One-Half Pound Spools			One-Fourth Pound Spools		

Winding Data Based on Actual Winding Space

Size Wire	Low Tension Coils		High Tension Coils Turns Per Square Inch	Size Wire	Low Tension Coils		High Tension Coils Turns Per Square Inch
	Turns Per Square Inch	Ohms Per Cubic Inch			Turns Per Square Inch	Ohms Per Cubic Inch	
16	282	.098		26	2395	8.15	2200
18	431	.229		28	3990	21.50	3270
20	647	.547	653	30	5960	51.20	4750
22	980	1.315	988	32	8960	122.3	7650
24	1590	3.400	1465				

Radio Hook-up or Bus Bar Wire

No. 12—Round, 2-foot length \$0.05
 No. 14—Round, 2-foot length03

Sub-Antenna

You have read about this remarkable discovery. We have the genuine, made by the Subantenna Corporation. Their guarantee reads as follows:

"You must get these results. If you do not, ask us for your money back."

Complete instructions for installing with every set.

Sub-Antenna, 60-foot. Each \$ 7.50
 Sub-Antenna, 75-foot. Each 8.50
 Sub-Antenna, 100-foot. Each 10.00

Aerial Wire

Per 100-foot Lengths
 7 Strands No. 22 Enameled \$1.50
 7 Strands No. 22 Copper85
 No. 14 Bare Copper, soft drawn60
 No. 12 Enameled 1.00

The Aero \$2.00 Kit

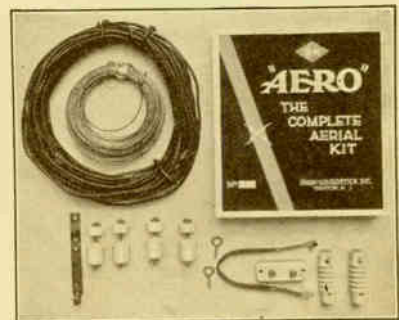

Owing to the demand for a medium priced antenna kit complete, we have arranged with one of the largest manufacturers to make up this standard kit, which contains the following approved parts:

One S-H approved lightning arrester, 1 S-H window lead-in strip, 4 nail knobs, 1 copper ground clamp, 2 porcelain insulators and 2 screw eyes.

Price, complete kit \$2.00

Index on 78 and 79

Brandes Products

New Adjustable Table Talker

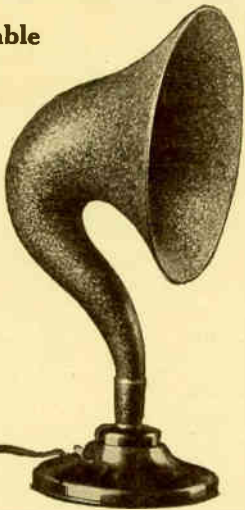

Brandes Table Talker

This is an improved table talker at the old, low price. It is built to meet the need for a speaker that will sell easily to those customers in moderate circumstances. It gives the best quality of reproduction obtainable at the price.

1. It has a goose-neck horn which produces more rounded and mellow tones.
2. The table talker is only 18 inches high, and has a 10-inch diameter of bell.
3. It is finished in a pleasing shade of brown with a felt-padded base, and is sold under the Brandes money-back guarantee.
4. The adjustment lever which controls the volume and the sensitivity of the speaker is located at the rear of the base.
5. No extra batteries are required for operation.

No. 400—Brandes Table Talker. Each \$10.00

Phonograph Attachment

For those who prefer to use the horn of their phonograph, the unit of the cabinet speaker has been made available suitably encased for this application.

1. This unit has laminated pole pieces, a separate alternating magnetic flux path, a large diaphragm and a thumb screw volume adjustment.
2. It is easily attached to the reproducer arm of the phonograph.

No. 800—Brandes Phonograph Attachment. Each \$10.00

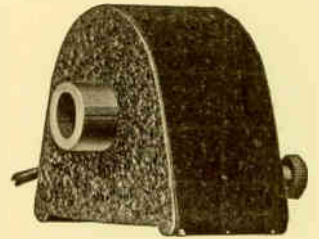

Cabinet Speaker

The new Cabinet Speaker is especially designed for well appointed homes. It has quality of tone, built into a beautifully simple cabinet, finely finished. It is of the correct size to fit on top of the average receiving set.

1. The horn is of special molded construction, providing 27½ inches of air column, which construction and length produce mellow rounded tones and unusual volume.
2. The cabinet speaker is 14½ inches wide, 9⅞ inches deep and 9⅞ inches high.
3. It is constructed of mahogany and finished to harmonize with all types of modern furniture.

Price \$30.00

Brandes "Type H" Speaker

There is a very definite demand for two types of horn speakers—one, the table talker, which gives the public great value at a low price. The other, the new Type H Speaker, which meets the needs of those who want supreme performance and are willing to pay for it.

1. The volume of the speaker is also increased by the provision of a separate path for the alternating magnetic flux (supplied by the alternating current) which eliminates the customary practice of having the alternating magnetic flux pass through the large permanent magnets.

2. The large diaphragm used in the new (Type H) speaker adds to the low range of the speaker and improves reproduction over the full frequency range from 200 to 4000 cycles per second.

3. Adjustable thumb screw in back of base.

4. The speaker is 26¼ inches high, with 12¼ inches diameter of bell.

No. 600—Brandes "Type H" Speaker. Each . \$18.00

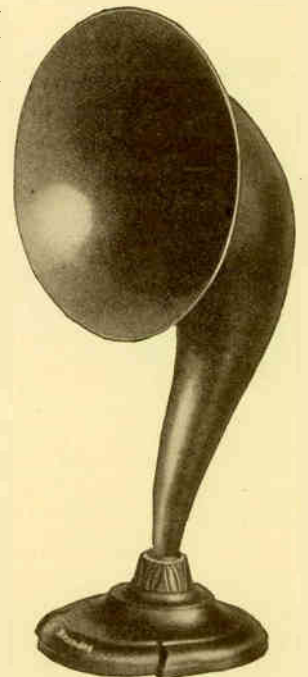

Brandes Matched Tone Superior Headset

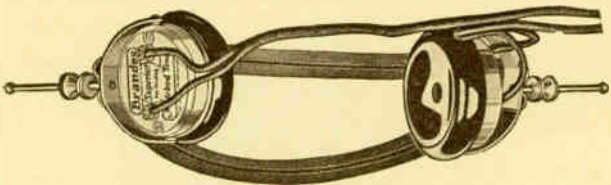

No. 100—Brandes Superior Headset. Each . . \$4.50

Brandes Navy Type Headset

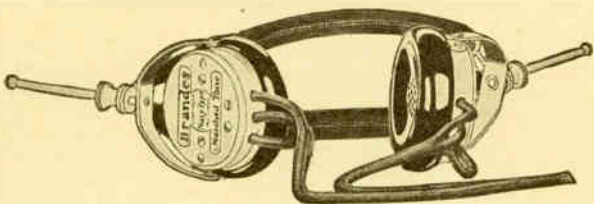

No. 200—Brandes Navy Type. Each \$6.00

Van-Ashe Radio Company, St. Louis, Mo.

Electrad, Inc.

"Electrad" Lead-Ins

Simplify Installation—Improve Reception

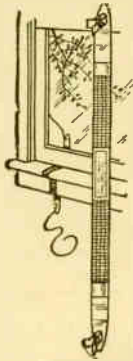

Ungainly porcelain tubes showing in the room, holes in the window sash and all other "lead-in" ills are eliminated by this ingenious device. Can be bent into any shape to fit ledges and around corners. Goes under windows or doors. You close and lock them on it. There is a difference! Get the genuine! Many inferior imitations of the original "Electrad" Lead-In have appeared, but "Electrad" quality remains the same. Nothing but the most electrically correct materials and methods used in the manufacture of "Electrad" Lead-Ins.

No. 1-E—Price, each \$0.40

"Electrad" Audiohm

Eliminates distortion. Every set with one or more audio transformers needs one of these tone and quality controlling devices.

Placed across secondary of first audio transformer it eliminates distortion and transformer noises. Once adjusted remains permanent.

Requires no drilling or soldering. No tools needed to attach. Fits any transformer.

Audiohm. Price, each \$1.50

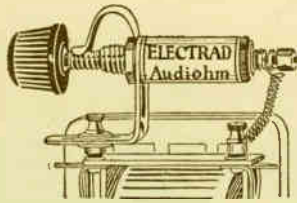

"Electrad" Variohm

Gives Distance

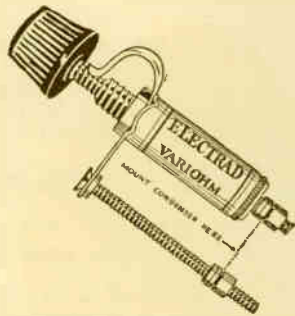

The Variohm, "Electrad's" improved variable grid leak makes possible that last hair's breadth tuning which brings in distant stations.

Complete range of resistance from 1/4 to 30 megohms. Non-microphonic, moisture-proof, guaranteed against wear, and will last for years. Mounts on panel or comes with bakelite bracket for baseboard mounting.

Variohm, for panel mounting. Price \$1.25

Variohm, for base mounting. Price 1.50

"Electrad" Glass Grid Leaks



Where a good, low-priced grid leak is required the "Electrad" Glass Grid Leak is unsurpassed. Each grid leak is individually tested. Resistance is accurate and constant.

Price, each \$0.30

Jones Radio Jacks

Jones Improved Anti-Capacity Radio Jacks are about one-half length of ordinary jacks. The use of binding posts as terminals eliminates soldering wires. Can be securely fastened with the use of hexagon nut only.

- 431—Open circuit \$0.70
- 432—Closed circuit85
- 433—Double circuit 1.00

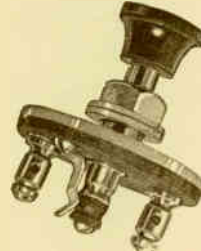
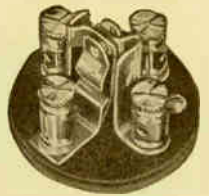

The Jones Improved Battery Switch provides a simple means for connecting and disconnecting the "A" battery. It has some of the features of the No. 31 jack, and is particularly simple in construction. The bright red button is a most attractive part of this equipment.

- 618—No. 61 Battery Switch. Each \$1.00
- 619—No. 62 S. P.-D. T. 1.25
- 620—No. 63 Det. Amp. 1.50
- 621—No. 64 Series-Parallel 1.50
- 622—No. 65 D. P.-D. T. 1.60

Hoyt's Peep-Hole Meter

Is designed to fit in radio panel peep-hole and mounts flush. Easily installed without screws.

- Type
- 541—0-10 volts . . \$3.00
- 541A—0-.8 volts . . 3.00
- 541B—0-1.2 volts . 3.00

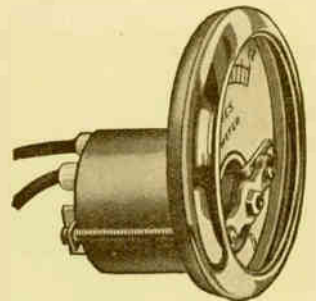

Bruno Engravings

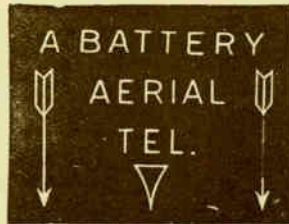

Set No. 1 contains: Directions, cement, and 1 aerial, 1 ground, 1 tickler, 1 off, 1 on, 1 coupler, 1 plate, 1 variometer, 3 pointers, 2 "A" batteries, 2 "B" batteries, 3 + + +, 3 — — —, 1 wave length, 1 set numerals (1-10), 1 detector, 1 first stage, 1 second stage, 1 third stage, 1 increase, 1 decrease, 1 rheostat, 3 arrows, 4 curved arrows, 1

potentiometer, 1 input, 1 output, 1 amperes, 1 volts, 1 discharge, 1 filament, 1 radio frequency, 1 audio frequency, telephone, charge.

Price, complete \$0.50

Set No. 2 contains: 1 aerial, 1 ground, 1 primary, 1 condenser, 1 secondary, 1 "A" battery, 1 "B" battery, 2 + +, 2 — —, 1 detector, 1 first stage, 1 second stage, 3 curved arrows, 1 input, 1 output, 1 telephone.

Price, complete \$0.35

Set No. 5, for Neutrodyne: Directions, cement, and 1 long antenna, 1 short antenna, 1 ground, 1 "A" battery, 1 "B" battery, 1 vernier, 4 + + + +, 4 — — — —, 5 pointers, 2 curved arrows, 1 antenna tuning, 1 first neutro-stage, 1 second neutro-stage, 1 detector rheostat, 1 amplifier rheostat, 1 first audio, 1 second audio.

Price, complete \$0.40

COLONIAL SETS

Are Designed for 299 Tubes and Work on Dry Cells



COLONIAL SETS

Designed by the Eminent Radio Engineers Drs. Cutting and Washington

The Sixteen-Six

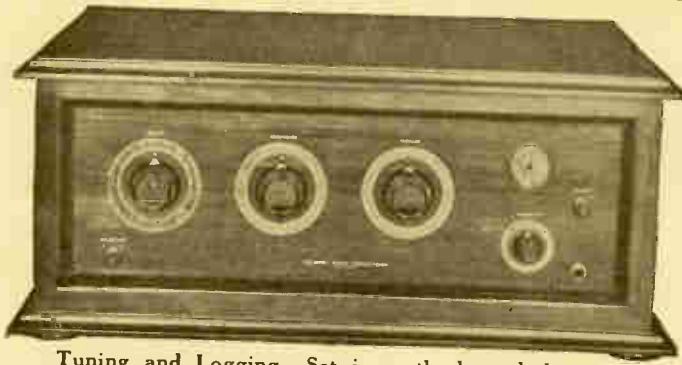

Circuit—Three stages of tuned compensated radio frequency amplification, detector and two stages of audio amplification. All circuits are electro-statically and electro-magnetically shielded and compensated to give uniform response on all waves. No regeneration; no radiation; no howling. Radio and audio transformers designed for full volume from dry battery tubes.

Tubes—Six UV-199 or C-299.

Dry Batteries—Enclosed in cabinet and accessible by simply lifting cover.

Cabinet—Made by Brewster.

Panel—Bronze, done by a new etching process.

Meter—"A" battery voltmeter insures proper operation of tubes.

Volume Control—Provides for use of either five or six tubes.

Tuning and Logging—Set is partly logged during test in factory. This facilitates determination of complete log. Condensers are cut to produce uniform frequency variation. This makes it equally easy to tune both short and long waves. Special chucks on controls mean that dial settings never vary.

Mechanical Construction—All parts mounted on a copper-plated steel frame. Die-cast low-loss condensers. Pure moulded bakelite knobs with special chucks which eliminate chance of slipping, and insures absolute centering on shaft. Pure moulded bakelite tube sockets, terminal boards and jack and switch bodies. Non-vibrating wiring. Non-microphonic spring-mounted multiple tube socket. "B" battery by-pass condenser to prevent condenser howling with partly worn-out batteries. Non-corroding rheostat wire.

- No. 16-6—Colonial. Price, each \$175.00
- No. 20-6—Colonial. Price, each 175.00

(Same as No. 16-6, except that it is built for UV-201-A or C-301-A in the detector and two audio stages.)

The Seventeen-Five



Circuit—Two stages of tuned radio frequency amplification, detector, and two stages of audio amplification. Radio and audio transformers designed to give full volume on dry battery tubes.

Tubes—Five 199 or C-299.

Dry Batteries—Enclosed in cabinet and accessible by simply lifting cover.

Cabinet and Panel—A novel combination of beautifully decorated metal and natural grained, lightly polished wood.

Meter—"A" battery voltmeter insures proper operation of tubes.

Volume Control—Provides for use of either one or two stages of audio amplification.

Tuning and Logging—Set is partly logged during test in factory. This facilitates determination of complete log. Condensers are cut to produce uniform frequency variation. This makes it equally easy to tune both short and long waves. Special chucks on controls mean that dial settings never vary.

Mechanical Construction—Die-cast low-loss condensers. Pure molded bakelite knobs with special chucks which eliminate chance of slipping, and insure absolute centering on shaft. Pure molded bakelite tube sockets, terminal boards and jack and switch bodies. Non-vibrating wiring. Non-microphonic spring-mounted multiple tube socket. "B" battery by-pass condenser to prevent howling with partly wornout batteries. Non-corroding rheostat wire.

- No. 17-5—Colonial. Price, each \$58.00

The Twenty-One Five

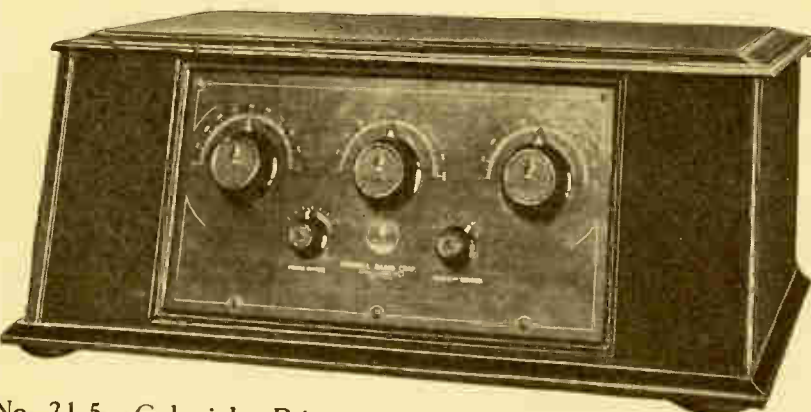

Panel—Bronze, done by a new etching process.

Volume Control—On the panel is an adjustable knob to control output according to the volume desired.

Tuning and Logging—Set is partly logged during test in factory. This facilitates determination of complete log. Condensers are cut to produce uniform frequency variation. This makes it equally easy to tune both short and long waves. Special chucks on controls means that dial settings never vary.

Circuit—Two stages of tuned compensated radio frequency amplification, detector and two stages audio amplification.

Tubes—Five UV-201-A.

Batteries—Wet cell "A" battery, dry "B" and "C" batteries.

Cabinet—The cabinet is of graceful design and dark mahogany finish. There is space within the cabinet for "B" and "C" batteries.

- No. 21-5—Colonial. Price, each \$87.50

Van-Ashe Radio Company, St. Louis, Mo.

HOOD PANELS

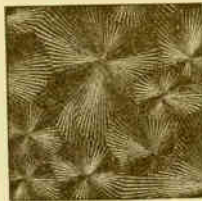

Hood Radio Panels
1/8-inch Thickness

Size	Black	Mahogany	Florentine (Frieze)	Combination (Frieze and Mahogany)
7x9	\$0.80	\$0.90	\$0.95	\$1.00
7x10	.85	1.00	1.10	1.15
7x12	1.00	1.20	1.30	1.35
7x14	1.20	1.40	1.50	1.55
7x18	1.55	1.80	1.90	2.00
7x21	1.80	2.10	2.20	2.40
7x24	2.00	2.40	2.55	2.70
7x26	2.20	2.55	2.75	2.95
7x28	2.40	2.75	2.95	3.15
7x30	2.55	2.95	3.15	3.35

Eby Binding Posts

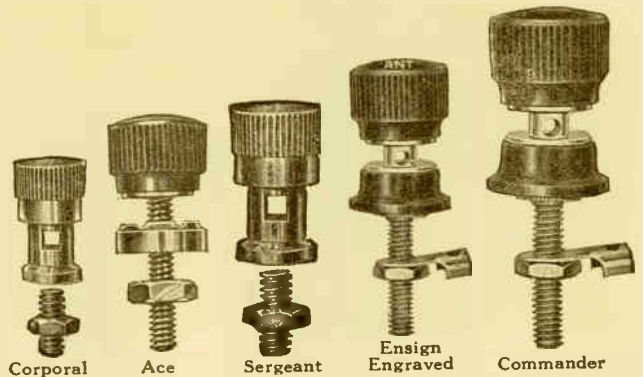

Eby Posts come in the following markings:

130 Volts +	45 Volts +	22 Volts +
90 Volts +	A-Bat. C. +	"C" Battery +
"A" Battery +	"B" Battery +	"C" Battery -
"A" Battery -	"B" Battery -	Ant.
"B" Amp. +	Speaker -	Long Ant.
"B" Det. +	Speaker +	Phone
Short Ant.	Loop	A+ Bat. B-
Gnd.	Input	Plain
Minus	Plus	

Corporal—List, each.....	\$0.12
Ace (furnished in plain tops only, with nut) . .	.10
Sergeant—List, each.....	.16
Ensign (engraved in all markings and plain)	.15
Commander (plain top only, with nut and lug)	.20

Crowe Name Plates



Crowe Conductor Markers or Cable Tags indicate plainly and beyond possibility of mistake the cables leading to the various connections. Every radio manufacturer and set owner will appreciate the safety and convenience they afford.

Thousands of tubes, valued at many thousands of dollars, are destroyed annually because conductors are not plainly marked to show the proper connections at a glance.

Characters etched in black on metal background:

The following are stock wordings:

A+	B22½V	C-
A-	B90V	C+
B+		
B-	A- C+	ANT.
B45V	A+ B-	GRD.

List price, each.....\$0.021½

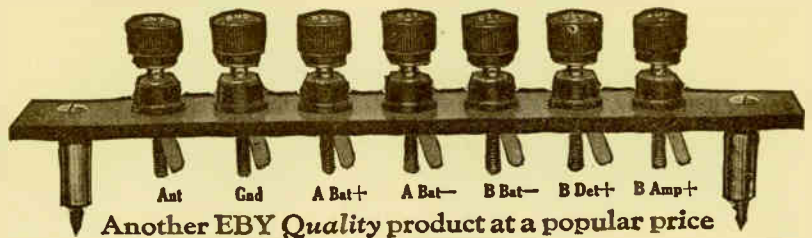

Another EBY Quality product at a popular price

Eby Binding Post Strip

This strip contains seven posts engraved in most popular markings, mounted on a polished hard rubber strip. Each strip, including nickel-plated brackets and wood screws, packed in an individual carton.

List price, each.....\$1.25

The Better Tuning Dial

The Apex Vernier Dial provides that vernier control so essential to easy and selective tuning for long-distance stations. The Apex Vernier Dial makes unnecessary the use of a geared type of condenser and with its adoption to any condenser shaft, provides that ease of tuning which permits more stations to be brought in clearly and with all interference tuned out.

Ratio 12 to 1. Always runs true, parallel to panel. No back-lash. Quiet in operation, no friction noises. Easily installed. Artistic and distinctive design. Metal dials handsomely etched, giving them a jewelry finish thereby improving the appearance of every set. Furnished in 4-inch size in three finishes.

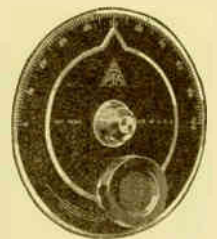

Royal brass, No. 600CW, 4 in.....	\$2.00
Satin silver, No. 602CW, 4 in.....	2.50
De Luxe gold plated (24-karat), No. 604CW, 4 in.....	3.50

Index on 78 and 79

AMPLION The Amplion Dragon

Stands 20½ inches high. Beautifully curved. Mahogany finished paneled horn, 14½ inches diameter. Acoustically correct, exclusive "dragon shaped" sound conduit is non-resonating, being rubber insulated at both ends. Crystalline enamel on conduit and unit add to the beauty of this model. The weighted, nickel-plated base is hinged to permit tilting horn to any angle. "Floating diaphragm" unit may be removed and with proper adapter attached to a phonograph. No battery or power amplifier required.

You are assured an entirely new conception of what loud speaker reception can be. A treat awaits you. Abroad, Amplions outsell all other loud speakers combined—solely on their supremacy of performance. America is rapidly registering a similar preference. All are won to the Amplion who hear it—in comparison. Not only is the Amplion the most sensitive of loud speakers. It is also supreme for clarity, natural tone and distortionless volume—over the entire musical range. To hear the Amplion is to agree. Convince your ears today.

Amplion Dragon No. AR-19.....\$42.50

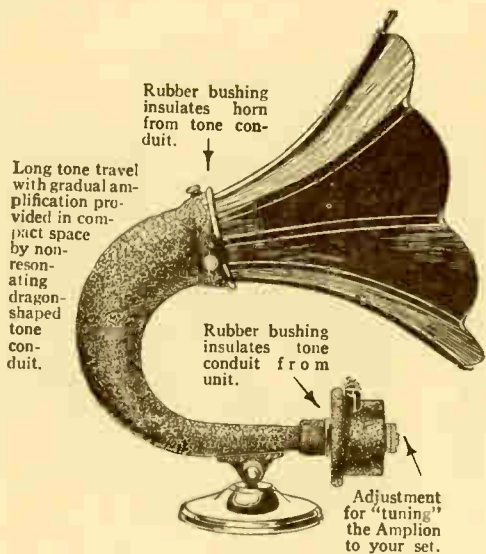

The Amplion "Junior De Luxe"



The new Amplion "Junior De Luxe" Model AR-114, 15 inches high, incorporates all of the advantageous features of the new Amplion "Junior" as described below. In addition, it possesses a wood paneled horn of unique design, 10 inches in diameter at the mouth, and handsomely finished in mahogany.

Amplion "Junior De Luxe" AR-114.....\$27.50

Amplion "Junior"

The new Amplion "Junior," Model AR-111, also has the exclusive "dragon-shaped," non-resonating, rubber insulated sound conduit. The "Junior" stands 15 inches high. The horn, of metal, is 10 inches in diameter at the mouth. Horn, conduit and unit are attractively finished in crystalline enamel. The hinge on the weighted nickel-plated base permits tilting the horn to any angle. The "floating diaphragm" unit may be

taken off and with proper adaption attached to a phonograph whenever desired. No battery or power amplifier required. The Amplion "Junior" will be found—by comparison—to surpass in sensitivity, clarity, natural tone and volume the run of expensive "full size" loud speakers.

Amplion "Junior" No. AR-111.....\$24.00

Amplion "Dragonfly"

The Amplion "Dragonfly," Model AR-102, is a perfect replica on a reduced scale of the new Amplion "Junior." Although it stands only 9 inches high, and the metal horn has a 5½-inch diameter, it is outstanding in efficiency for reproducing programs in considerable volume—with extreme clarity and surprising "full" tone!

Amplion "Dragonfly" No. AR-102.....\$12.00

Amplion Unit No. AR-102..... 8.00

Amplion Standard Phonograph Unit

Amplion Phonograph Unit

Amplion Phonograph Units produce exceptional volume without the use of a battery or power amplifier, although the "Concert" Model is equipped with a double resistance switch to permit use of a power amplifier if extreme volume is desired. These units—as do those used on Amplion Loud Speakers—possess supreme and lasting sensitivity, clarity and ability to naturally reproduce voices, instruments and sound throughout the entire musical range—without distortion. Adjustment knob at rear. Adaptor with each unit for attaching to phonograph.

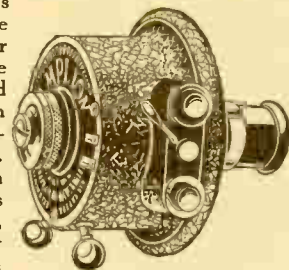

Amplion "Standard" Unit AR-67.....\$19.00

Amplion Concert Phonograph Unit

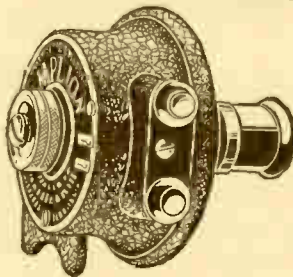

Same description as above, only unit made to give greater volume.

Amplion "Concert" Unit AR-35a...\$25.00

Exclusive Features of the Amplion "Diaphragm"

The "Floating Diaphragm" is one of the outstanding exclusive features which account for the Amplion's supreme and lasting sensitivity, purity, clarity and natural tone. Diaphragm insulated from contact with metal by rubber gaskets, rests on narrow ledge—lightly held there by a spring ring with enough pressure to prevent "chatter" when extreme volume is desired. Diaphragm thus "floats," free from strain, stress or undue tension and free to vibrate in exact accord with the variations of current flowing through electro-magnetic system. As a consequence, faithful reproduction is obtained throughout the entire musical scale—without distortion.

Super Amplifier Type 3-S

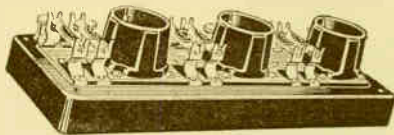

A compact 3-stage resistance coupled unit including all resistors, grid leaks and coupling condensers of the proper capacity. Eight binding post terminals in the rear. Black molded bakelite base, approximately 4x10 inches. All interior wiring complete. Sockets fit all standard tubes. Daven High-Mu Tubes described below are especially suitable and designed for this amplifier.

Price\$15.00

Amplifier Kit Type 3-K



This kit is for 3 stages of amplification and is supplied (without sockets) for those who prefer self-assembly. All resistors and grid leaks are included. Contains three Daven No. 42 Resisto-Couplers which are fitted with coupling condensers of proper capacity.

Price\$9.00

Resisto-Coupler No. 42

(Patent Applied For)

The Daven Resisto-Coupler was the first unit of its kind on the market, and many thousands of them have been sold for the construction of resistance coupled amplifiers. It has now been improved so that it includes underneath the base the fixed coupling condenser. Resistor and grid leak are not included in the price as below. The recommended values of these are as follows:

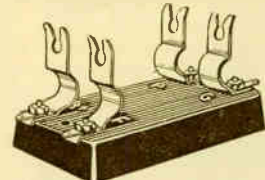

Plate resistor, all stages, 100,000 ohms (.1 meg.). Grid leaks: 1st stage, .1 meg.; 2nd stage, 1/2 meg.; 3rd stage, 1/4 meg. Packed in cardboard cartons with instructions.

Price\$1.50

Daven Resistors and Grid Leaks

Ohms	Megohms	List Price
2,500	.0025	\$1.00
5,000	.005	1.00
12,000	.012	.75
25,000	.025	.75
40,000	.04	.75
50,000	.05	.75
100,000	.1	.75
150,000	.15	.50
200,000	.2	.50
250,000	.25	.50
300,000	.3	.50
400,000	.4	.50
500,000	.5	.50
600,000	.6	.50
750,000	.75	.50
1,000,000	1.	.50
1,250,000	1.25	.50
1,500,000	1.5	.50
1,750,000	1.75	.50
2,000,000	2.	.50
2,500,000	2.5	.50
3,000,000	3.	.50
4,000,000	4.	.50
5,000,000	5.	.50
6,000,000	6.	.50
7,000,000	7.	.50
8,000,000	8.	.50
9,000,000	9.	.50
10,000,000	10.	.50

Daven High-Mu Tubes

For Resistance Coupled Amplification

The Daven tubes are designed by Daven engineers to increase the amplification of Resistance Coupled A. F. Amplifiers to that equivalent, or exceeding that, obtainable with transformer coupling.

Heretofore most tubes on the market have been designed for all purposes and are said to be "universal" tubes; that is, suitable for average good results whether employed as radio frequency amplifiers, audio frequency amplifiers or detectors. Having in mind the necessity for a special tube to obtain superior results with resistance coupled amplifiers, Daven engineers have designed a vacuum tube intended solely for this purpose and they have succeeded through specialized research in obtaining excellence and superiority in the types MU-20 and MU-6.



The MU-20 is a 6-volt 1/4 ampere tube, and is recommended for use in resistance coupled amplifiers, where a plate coupling resistance of 100,000 ohms is employed. For the last or output stage, however, Daven Power Tube Type MU-6 should be used, since there are no loud speakers on the present-day market designed for operation from a "high-mu" tube.

Employing the Daven MU-20 in the first two stages of a resistance coupled amplifier and the MU-6 power tube in the third stage, adequate volume for any purpose may be obtained. A plate voltage of 100 to 200 may be used, although satisfactory volume may be obtained with as low as 90 volts. In a two-stage resistance coupled amplifier the MU-20 will only be needed in the first stage.

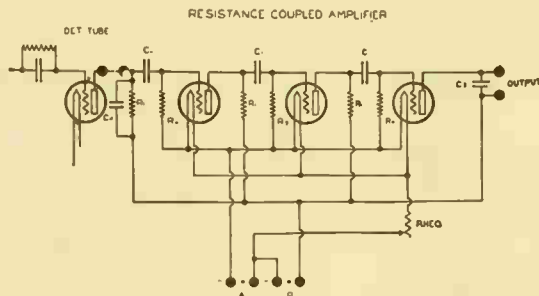

Herewith is shown the typical circuit for a 3-stage amplifier. Further data will be found in the Daven Resistor Manual.

Specifications

Daven tubes have red polished bases of best dielectric material and fit all standard sockets. No rheostat or filament resistance is required when used with 6-volt lighting battery. They are not designed for use with transformer amplifiers, and satisfactory results therewith are not guaranteed.

Characteristics	MU-20	MU-6
Filament Voltage.....	6 Volts	6 Volts
Filament Current.....	.25 Amp.	.5 Amp.
Plate Voltage.....	90-200 Volts	90-150 Volts
Plate Current.....	1.1 M. A.*	12 M. A.†
Amplification Constant.....	20*	7†
Mutual Conductance.....	500 Micromhos*	1,400 Micromhos†
Plate Impedance.....	40,000 Ohms*	5,000 Ohms†
Price, each.....	\$4.00	\$5.00

* (With 60 volts on plate, Zero Grid, Neg. Fil., and no resistance in plate circuit.)

† (With 110 volts on plate, Zero Grid, Neg. Fil., and no resistance in plate circuit.)

Packed in individual cartons, 25 tubes in standard pkg.

Daven Mountings

No. 50 Standard Resistor Mounting for the superior Daven Resistors, Grid Leaks, Ballasts, Leakandenser, Fixed Detectors, or similar tubular devices. (Illustrated on the right with ballast resistor.)

Price, without leak.....\$0.35

The Resistor Manual



Every radio experimenter should have a copy of the Daven Resistor Manual, prepared by Mr. Zeh Bouck, in the hope that all who read, may absorb sufficient of the technique of resistance coupling to at least lend a little polish to their handiwork in fine set building. It is particularly valuable to service men and dealers in radio equipment who consider it worth the while to closely study and keep informed on current radio progress. Illustrated and containing useful circuit diagrams and technical data.

Price, per copy.....\$0.25

Dealers' Display Carton



An attractive cardboard display box for the dealer's stock. Contains 45 assorted values of Daven Grid Leaks. There are ten units of the 2-megohm value, and five units each of the 1/2, 1, 1 1/2, 3, 4, 5 and 7 megohms. This assortment satisfies the selection of the majority of customers who ask for a grid leak for use with any particular tube or circuit. Carton is permanent and may be refilled on replacement orders.

Price\$22.50

Daven Leakandenser

(Reg. U. S. Pat. Off.)

The Leakandenser is a new unit similar in size to the Daven Grid Leak, which combines two devices in one, the well known Daven Grid Leak as well as the fixed capacity needed for the Grid Condenser. It is conveniently held in the No. 50 mounting. The capacity of the condenser is proper for all detector tubes and is absolutely guaranteed for uniformity and permanence of value. All of the usual values of grid leak resistance are supplied.

Price, each\$1.00

Ballast Resistors

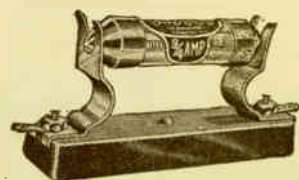

Daven Ballasts are designed for use with the standard 201-A or similar type of tube, operating on a 6-volt battery. The ballasts regulate the filament current of the tube most uniformly during the drop in battery voltage from full charge to discharge. They are uniform in resistance, and in manufacture they are subjected to an overload of 100 per cent on test. They are wound with a special resistance wire and are so constructed that it is impossible for them to become open in service. They are most conveniently held in our Mounting No. 50, and supplied in five types—1/4, 1/2, 3/4, 1 and 1 1/4-ampere for 1, 2, 3, 4 or 5 tubes respectively. Packed in individual boxes.

Price, without mounting, each.....\$0.75

Superette Head Phones



Weight, 8 ounces; fibre insulated; chrome steel magnet; double pole; aluminum cups. These phones are guaranteed by the manufacturers and us to give you perfect satisfaction. They are rated 3000 ohms.

"Superette" Radio Headset. Each.....\$1.95

Citizens' Radio Call Book

Complete and up-to-date list of all broadcasting stations in the world, showing wave-length, power and schedules.

Complete articles showing how to build 45-kilocycle super-heterodyne, Browning Drake, Roberts, Hoyt Augmentor, Harkness and many others.

Maps, log sheets, distance chart, hook-ups and other valuable data.

Price, each.....\$0.50



Philmore Straight-Line Frequency Condensers

There has been quite a demand for a medium price condenser, and after testing this condenser in our laboratory we find it to meet the requirements of a condenser of this type.

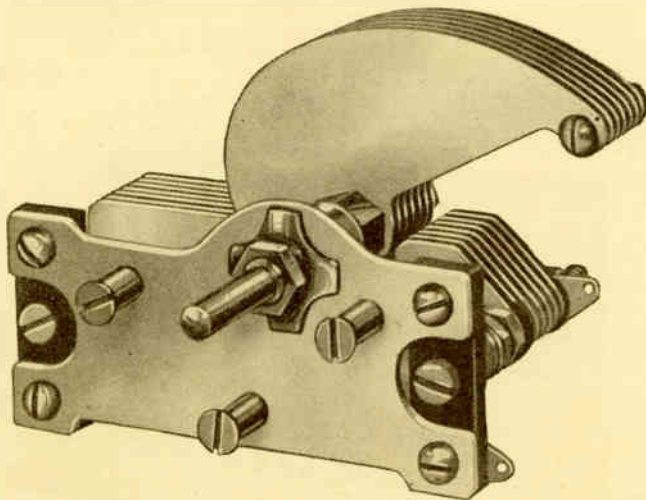

.00025 Mfd. Each.....\$2.00
 .00035 Mfd. Each..... 2.25
 .0005 Mfd. Each..... 2.50

The Imported English Grid Leak

The Bretwood Variable Grid Leak

The Bretwood Variable Grid Leak is used in over 50 per cent of the tube receivers in Great Britain. It is an instrument of demonstrated accuracy and permanency, giving a smooth, constant variation of from 3/10 megohm to 10 megohms (300,000 to 10,000,000 ohms). Its inclusion in a detector circuit will strengthen weak signals, make DX easier, eliminate tube noises and otherwise curtail internal howling due to choked leakage path from grid. The micrometer action, made possible by the 25-turn range of the knob, insures exactly the right resistance for any detector tube on the American or Canadian market.

The Bretwood Grid Leak. Each.....\$1.50

Carter Radio Co.

Carter Imp Rheostat

Smallest rheostat made. Contact arm designed to control constant pressure. Rheostat projects from panel 3/8 inch and is 1 3/8 inches in diameter.

No. IR 6—6 ohm. Each...\$1.00
 No. IR25—25 ohm. Each... 1.00

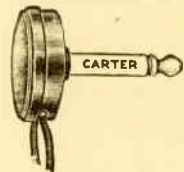

The cord tips are completely concealed so that there is no danger from shocks. The cords hang from the bottom of this circular flat handle.

Price, each.....\$0.75

Quarter turn snap switch makes positive contact. "On and Off" name plate and pointer indicate position of switch.

Price, complete.....\$0.65



Inductance Switch

No. 115—15-point\$2.00
 No. 215—15 point, dead arm contact..... 2.10
 No. 109—9 point, single arm. 1.90

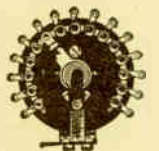

Carter "Hold-Tite" Jacks

No. 101—One spring, open circuit.....\$0.70
 No. 102A—Two springs, one break contact, closed circuit80
 No. 103—Three springs, single filament control90
 No. 104—Four springs, breaks two contacts, double circuit 1.00
 No. 105—Five springs, opens two and closes one contact, double filament control..... 1.10

Harkness Counterflex Kits

Harkness Scores Another Knock-out

The original Harkness reflex circuit was called a "Knock-out." The new three-tube Harkness Counterflex Circuit is called the "Knock-out of Knock-outs!" This three-tube circuit is better than the average five-tube circuit—not just theoretically better, but actually better.

By means of a new method of varying neutralization for different frequencies Kenneth Harkness has succeeded in obtaining greater amplification per stage with this circuit than was hitherto thought possible.

- | | | |
|---|-------|---------|
| Model B—Two-Tube Kit | | \$33.50 |
| With new type of Fixed Crystal Detector | | |
| Model C—Three-Tube Kit | | 36.00 |
| Model E—Five-Tube Kit | | 47.50 |

Brach Radio Products Outdoor Vacuum Radio Arrester

Listed under the Re-examination Service of Underwriters' Laboratories.

This arrester has outsold all other types.

Type 223—Price,
each.....\$2.50



Indoor Vacuum Radio Arrester

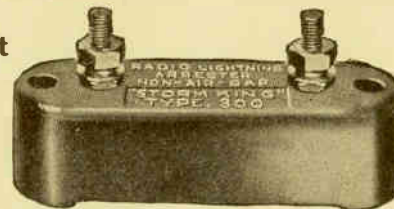

Brach Type 210 Lightning Arrester has the same advantages as Type 223 listed above and is arranged for indoor mounting.

Type 210—Price, each.....\$2.00

Brach De Luxe Electric Iron

This iron comes with a broad guarantee and embodies the latest achievements in electric iron construction.



Brach De Luxe Iron.

Price, each.....\$2.00

The Audio-Tone Junior, Two-Tube

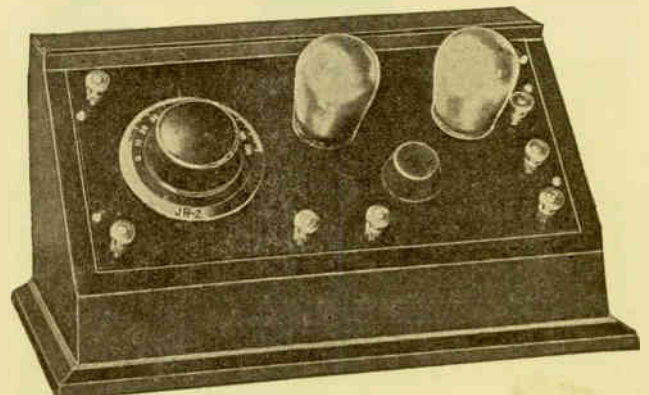

Price, each\$15.25
Complete 29.00



Storm King Antenna Outfit

Storm King Aerial Outfit includes all the necessary parts for erecting a complete aerial, including a Storm King non-air gap lightning arrester. Full instructions in simple language in each set.

Type 300—Price,
each.....\$4.00

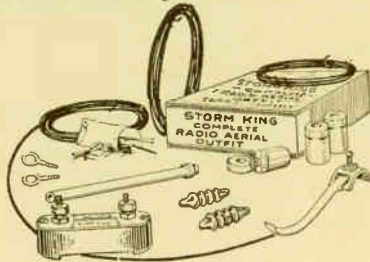

The New Audio-Tone Junior

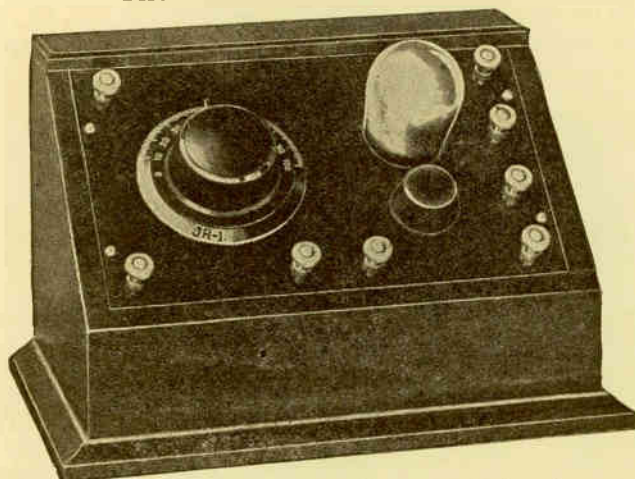

The Junior is remarkably well constructed and exceptionally suited to dry cell operation. Any of the standard tubes may be used with excellent results.

Price, each.....\$8.25

Complete Set and Equipment

One aerial, one pair headphones, one WD-12 tube, two "A" batteries, one 22½-volt "B" battery.
Complete\$17.75

NA-ALD

Na-ald 5-inch Dial

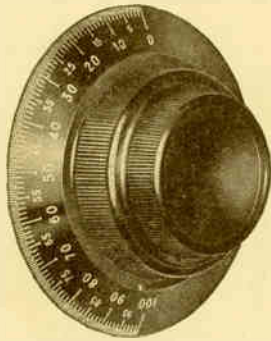

No. 3054—Na-ald 5-inch Dial. Price... **\$1.50**
 Brilliant Tortoise... **3.00**
 Malachite Green... **2.50**
 Garnet... **2.50**

Here it is! A big, massive 5-inch dial. The biggest on the market. The superior hand grip it affords plus the 200 division dial, making it possible to swing from station to station surely, quickly and accurately. These dials will greatly enhance the appearance of any set. Particularly they add distinction to a

set with but a single tuning control. Moderately priced to the consumer.

Na-ald Vernier Dial

No. 6044—Na-ald Vernier Dial. Price... **\$1.50**
 Brilliant Tortoise... **3.00**
 Malachite Green... **2.50**
 Garnet... **2.50**

A new vernier dial so smooth and positive in operation. No gears, nothing to get out of order. This dial matches the regular Na-ald No. 3044 Super De Luxe Dials and may be used with them where one out of two or three controls is critical.

Na-ald Super De Luxe Dial

To Match the Na-ald Vernier Dial

No. 3044—Price, each... **\$0.75**
 In colors... **1.50**

Adapters for UX Tubes

No. 420X—Each... **\$1.25**
 No. 419X—Each... **.35**
 No. 421X for UX Tubes in WD11 Sockets.
 Each... **.75**

Na-ald Knobs



K-3044

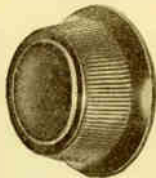

K-3674



K-3844

Here are three new knobs. K3044 exactly matches the Super De Luxe Dial; K3674 and K3844 are of a new and attractive pattern. These knobs will add a distinctive appearance to any set on which they are used. K3044 and K3674 are 2 1/8 inches and 2 3/8 inches in diameter, providing for easy and accurate handling. K3844 is 1 3/4 inches in diameter and has an indicator for use on rheostat or similar service. Standard knobs are for 1/4-inch shaft.

	Price	In Color
K3044	\$0.35	\$0.75
K3674	.30	.65
K3844	.20	.50

New Na-ald Socket

For All New Tubes

The new Na-ald Socket to take all the new tubes is known as the 481-X. This is made with either spring cushion or standard binding post for the amateur constructor and rivet mounting for the regular set manufacturer. Prices of the new sockets are as follows:



No. 481-X—Socket for rigid mounting... **\$0.35**
 No. 481-XS—Socket for cushion mounting... **.50**

Na-ald Adapter

To fit UX-120 and UX-199 tubes in old-style sockets.

In order that the new UX-120 and UX-199 Tubes may be used in old-style sockets, we have made an adapter known as 419-X to fit these new tubes to any UV-201-A socket. This adapter consists of a bakelite fitting which clamps tightly over the tube base and contains a bayonet pin to hold the tube in place in the UV-201-A socket. Price of the new adapter is as follows:



Adapter No. 419-X... **\$0.35**

New Cushion Socket

Newest socket on the market. Direct connection can be made either above or below panel. No binding post required. Positive contact and hidden wiring. The period of vibration of the Na-ald Cushion Socket is so adjusted that it prevents microphonic tube noises. Na-ald sockets in all sizes may be had with this spring cushion mounting. The cushion sockets with their low price, backed up by extensive advertising, will move rapidly and profitably. Na-ald cushion sockets are designated by the letter "S" following the regular socket number.

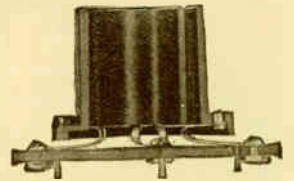

No. 400-S... **\$0.75**
 No. 401-S... **.50**
 No. 499-S... **.50**
 No. 481-XS... **.50**

Regular Binding Post Mounting

Low loss and high resistance are assured with Na-ald Alden-processed bakelite sockets. With the De Luxe type, simply turning the tube three or four times without removing from the socket scrapes a clean contact on the side of each of the tube terminals. Besides the No. 400 De Luxe Socket for storage battery tubes, there is the No. 401 Small Space Socket, and there are the Na-ald No. 499 Socket for UV-199 tubes and the Na-ald No. 411 for WD-11 tubes, all Alden-processed bakelite.



No. 400

No. 400... **\$0.75**
 No. 401... **.35**
 No. 411... **.75**
 No. 499... **.50**



No. 401

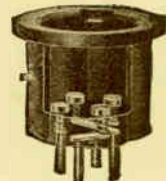

Construction

Thordarson Super Amplifying Transformers (Audio Frequency)

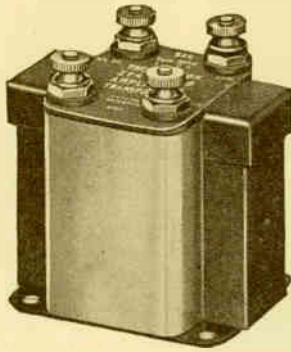

6-1 Ratio

Recommended for one-stage amplifiers where maximum amplification from one tube is desired. Primary D. C. resistance, 750 ohms; secondary 5100 ohms. Inductance of primary approximately 12 henrys. Allowable current, 10 milliamperes.

No. R-151—6-1 Ratio.
Price \$4.50

3½-1 Ratio

Recommended for the average two-stage amplifier under normal conditions. Primary D. C. resistance, 1075 ohms, secondary 5100 ohms. Inductance of primary approximately 20 henrys. Allowable current, 10 milliamperes.

No. R-150—3½-1 Ratio. Each \$4.00

2-1 Ratio

For all three-stage amplifiers and for two-stage amplifiers in connection with sets having a large detector output, such as tuned and untuned radio frequency and reflex. Unrivaled for bass note production.

No. R-152—2-1 Ratio. Price \$5.00

Thordarson Sub-Panel Mounting Type Amplifying Transformers

The super amplifying transformer is also furnished with leads coming out the base for use in sets mounted on a sub-panel. Provides neater assembly, shorter leads, and makes set look like a factory-made job.

Same characteristics as transformers listed above.

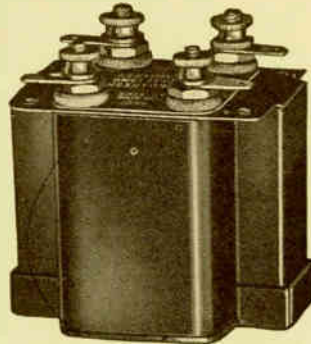

No. R-181—6-1 Ratio. Price \$4.50

No. R-180—3½-1 Ratio. Price 4.00

No. R-182—2-1 Ratio. Price 5.00

Inter-Stage Power Amplifying Transformers

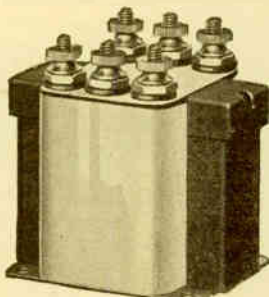

Designed to couple input and output transformers of standard power amplifier circuit. This transformer, together with Types R-155 and R-156, provides two stages of power amplification.

No. R-157—Price, each \$8.00

Thordarson Power Amplifying Transformers

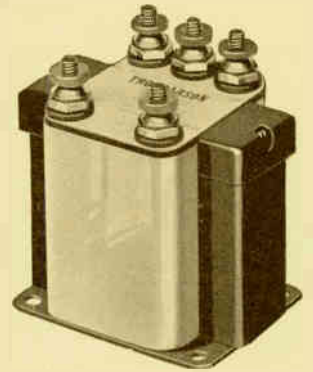

For use in third stage of amplification in cases where power desired would normally overload the third stage vacuum tube if straight audio frequency were used. Can be used as a standard amplifying transformer and as a coupling transformer for loud speakers.

No. R-155—Input } Price, Per Pair
No. R-156—Output } \$13.00

Thordarson Autoformer All-Frequency Amplifier

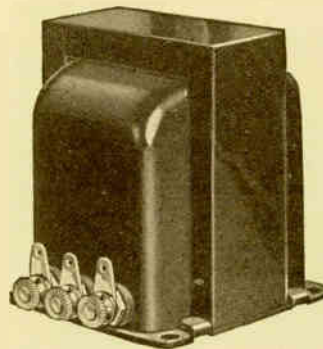

The Autoformer is an all-frequency amplifier. It is not a transformer; Autoformer amplification is an adaptation of capacities, impedances and resistances—a special Thordarson development.

The Thordarson Autoformer amplifies, with even magnitude, all notes within range of the human ear. Thus, with the Autoformer, the deepest notes of the grand organ receive the same attention as the high C of the soprano.

Superior to all other forms of audio frequency amplification.

No. R-190—Price, each \$5.00

Fett & Kimmel Craftsman Condensers

The Outstanding Features

Grounded Rotor: Body capacity in tuning has been eliminated through this method of construction.

Low Loss Insulation: Through the use of Pyrex, the most efficient insulation material known in radio field, dielectric losses are brought to lowest possible minimum.

Straight-Line Wave: Highest degree of selectivity afforded. Clear, sharp tuning, even distribution of stations broadcasting on lower wave-lengths.

Distance, reception, volume—all hinge on the efficiency of your condenser. There is very little difference between the price of the best condenser and the mediocre types, but there is a vast difference in the results to be secured.

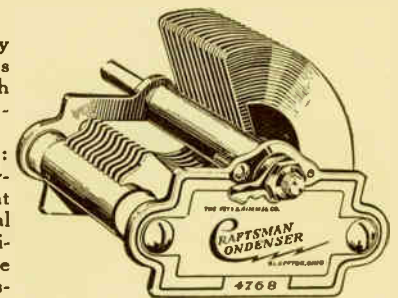

Craftsman Condenser Prices

15-Plate, .00025. Price, each \$4.50
19-Plate, .00035. Price, each 4.75
25-Plate, .0005. Price, each 5.00



Amsco Allocating Condensers

(Straight-Line Frequency)

A variable condenser with plates shaped to give equal changes in oscillation frequency of circuits tuned by condenser as condenser is varied by equal amounts. Grounded rotor, aluminum outer frames, stop studs at zero and full scale positions, flexible pig-tail connection and rotor shaft of chromium nickel needle steel make this a highly efficient and desirable instrument.

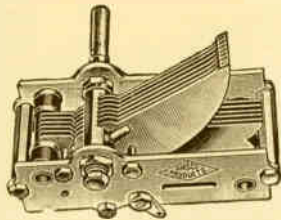

Single Unit

No. S.L.F.1213—13-Plate, cap. .0003 Mfd. \$3.50
 No. S.L.F.1217—17-Plate, cap. .00035 Mfd. 3.75
 No. S.L.F.1223—23-Plate, cap. .0005 Mfd. 4.25

Double Unit

No. S.L.F.1226—13-Plate each, cap. .0003
 Mfd. each. \$7.00
 No. S.L.F.1234—17-Plate each, cap. .00035
 Mfd. each. 7.50
 No. S.L.F.1246—23-Plate each, cap. .0005
 Mfd. each. 8.50

Amsco Rheostats

Suitable for either table or panel mounting. Moulded bakelite base with high-grade resistance unit and attractive knob or dial. All that is desirable in a rheostat is embodied in our unit.

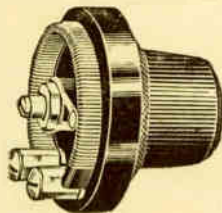

Arrow Knob

RF104—2-Ohm \$1.35
 A101—6-Ohm . . . 1.00
 A108—8-Ohm . . . 1.10
 A110—10-Ohm . . . 1.10
 A112—12-Ohm . . . 1.10
 A115—15-Ohm . . . 1.10
 A102—20-Ohm . . . 1.10
 A103—30-Ohm . . . 1.10
 A105—50-Ohm . . . 1.10

Bakelite Dial

RFD104—2-Ohm . . . \$1.50
 D101—6-Ohm . . . 1.15
 D108—8-Ohm . . . 1.25
 D110—10-Ohm . . . 1.25
 D112—12-Ohm . . . 1.25
 D115—15-Ohm . . . 1.25
 D102—20-Ohm . . . 1.25
 D103—30-Ohm . . . 1.25
 D105—50-Ohm . . . 1.25

Amsco Switch Levers

A popular item, with contact arm of polished nickel silver. Adjustable arm 1/4 x 1/2 inches.

No. 200—Price, each. . . . \$0.20

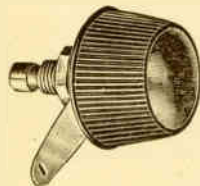

Amsco "Dublwunders"

A combination potentiometer and rheostat for filament and voltage control. Like the double rheostat this is a space saver and affords effective control. Rugged construction insures long life and no trouble.

PR106 — 6-Ohm Rheo., 250-Ohm Potent. \$2.00
 PR106A— 6-Ohm Rheo., 400-Ohm Potent. 2.00
 PR120 —20-Ohm Rheo., 250-Ohm Potent. 2.25
 PR120A—20-Ohm Rheo., 400-Ohm Potent. 2.25

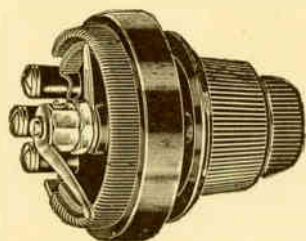

Amsco Tube Sockets

A socket with base of polished bakelite. Highly nicked and polished brass sleeve guaranteed not to come loose. Affords perfect insulation with positively no leakage. Special phosphor bronze contact prongs.

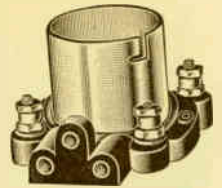

No. 100—Table mounting. \$0.60
 No. 101—Panel mounting.60

Amsco Tinned Terminal Lugs

Of Brass—Highly Tinned

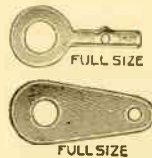

No. 300—Per hundred. \$0.50
 No. 301—Per hundred.50
 Packed 100 to a box

Phone Caps

Standard Phone Caps No. 1 will fit the following phones: Baldwin, Brandes, Frost, Holtzer-Cabbot, Redhead, Auth, Stromberg-Carlson, Eisemann, Blue Streak, True Tone, Tatler, Diamond, Excello, Pacent, Niehoff and Clarion.

Price, each. \$0.75

Phone Caps No. 6 will fit the following phones: Murdock and N. & K.

Price, each. \$1.00

JEFFERSON TUBE REJUVENATOR

For Large or Small Tubes

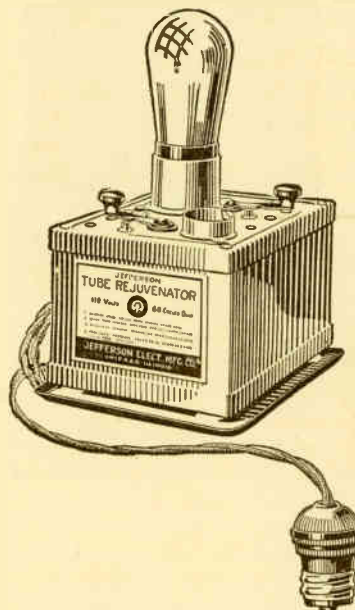

The Jefferson Radio Tube Rejuvenator is intended for 201-A, 301-A, UV-199 and C-299 types of tubes having thoriated filaments. The distinctive feature of 201-A, 301-A, UV 199 and C-299 tubes is that they use thoriated filaments. Certain unscrupulous tube manufacturers are marking their tubes with these numbers and using certain non-thoriated types of filament which cannot be rejuvenated. Usually such tubes will burn out in a few seconds if applied to the rejuvenator. It will not recondition tubes which are burned out or mechanically injured or which have filaments crossed with plates of grids. Aside from the above Radio Corporation tubes the following radio

tubes may be rejuvenated. Type 201-A—The Van Horne Co., Model 5VA A. J. Musselman, Model 5-Va.

Price, each. \$7.50

Timmons B-Liminator



The New Timmons B-Liminator comes complete with a specially constructed tube, giving the instrument a greater current output. It will furnish "B" battery current to any of the present-day radio receivers. Each and every instrument is guaranteed by the manufacturer. Both the detector and the amplifier voltage is variable.

Timmons B-Liminator with tube \$28.50

Also in Kit Form

The B-Liminator Kit contains all the parts that go to make up the factory-assembled instrument with the exception of the outside metal case. The kit is intended for mounting either right in the radio set or on a separate small baseboard and panel. It is very simple to assemble and gives the same results as the standard B-Liminator.

Timmons B-Liminator with tube in kit form. \$20.00

Branston Duo-Lateral Coils

	Unmounted	Mounted
No. D. L. 25	\$0.50	\$1.25
No. D. L. 3550	1.25
No. D. L. 5055	1.30
No. D. L. 7560	1.35
No. D. L. 10065	1.40
No. D. L. 15070	1.45
No. D. L. 20080	1.55
No. D. L. 25085	1.60
No. D. L. 30095	1.70
No. D. L. 400	1.15	1.90
No. D. L. 500	1.30	2.10
No. D. L. 600	1.45	2.25
No. D. L. 750	1.60	2.40
No. D. L. 1000	1.90	2.80
No. D. L. 1250	2.20	3.10
No. D. L. 1500	2.50	3.40

Branston Coil Mounts

R-61	\$5.00	R-74	\$0.50
R-62	6.00	R-7550
R-73	4.50	R-7750
R-71	3.25	R-68-6990

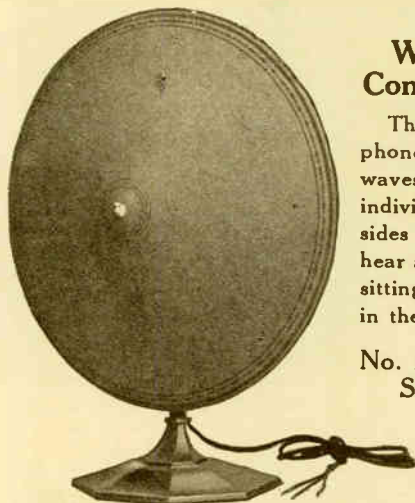

Western Electric Cone Type Speaker

This loud speaker telephone projects the sound waves in all directions, and individuals may sit at the sides of the instrument and hear almost as well as those sitting directly in front or in the rear of it.

No. 540-AW—W. E. Speaker . . . \$35.00

Pyrex All-Weather Insulators

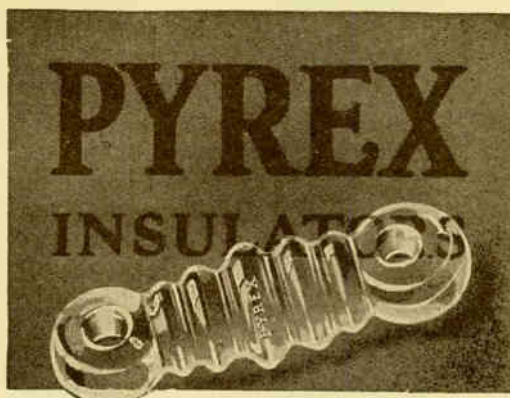

Pyrex Broadcast Reception Insulator, 3 1/2 inches long. Price \$ 0.45

Pyrex Low Power Transmitting Antenna Insulator, 7 1/4 inches long. 1.50

Pyrex Medium Power Transmitting Antenna Insulator, 12 1/4 inches long. 3.50

Pyrex High Power Broadcasting Station Antenna Insulator, 30 inches long. (Price on application.)

Pyrex Stand-off Insulator, height 3 inches over all. 2.75

Pyrex Stand-off Insulator, height 7 inches over all. 3.00

Pyrex Stand-off Insulator, height 12 inches over all. 8.00

Pyrex Pillar Insulator, height 4 1/2 inches over all, with brass insert molded in top and tapped 3/8 inch—16 inches, complete with brass base 6.00

Pyrex Lead-in Insulator, Navy standard bowl type, for voltages up to 10,000. 1.50

Pyrex Lead-in Insulator, Navy standard bowl type, for high-power broadcast stations and ships. 20.00

Valley Battery Charger

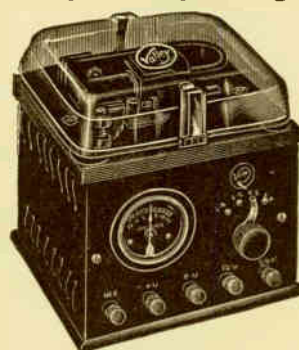

Battery Chargers (A. C.)

Simplicity its big feature. The case is finished in black enamel and the instrument panel is genuine grained and engraved bakelite, on which is mounted a high-class hand calibrated ammeter, five rubber covered binding posts for charging either 2-volt, 6-volt, 12-volt, or one to four 24-volt "B" batteries, also radio type switch for varying the charging current of the 24-volt "B" batteries.

Valley Chargers ABC, 110-volt. \$19.50

Valley Battery Clip.15

PHILCO

DIAMOND GRID BATTERIES

Philco Socket Power "B"

For 115-volt alternating current, 1.1 and 3-volt dry cell tubes and 6-volt storage battery tubes. Rich brown metal case. Contains no batteries. Rectifies, filters and smooths light socket current making it practically equal to the absolutely smooth current obtained from a "B" storage battery. No hum, roar or buzz. No high voltage transformers. Use of Philco aluminum rectifier tubes insures reception without distortion and keeps voltage within range, so that life of the radio set tubes is not shortened. Current cost extremely small, less than one-fourth cent per day in average use. No dry cells to replace. No storage batteries to recharge. Quality and volume of reception at its best at all times.

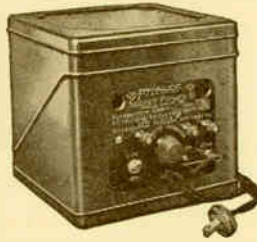

Philco Socket Power "B"

Price

Type B-60—For 50 and 60-cycle A. C. . . . \$47.50

Type B-25—For 25, 30 and 40-cycle A. C. . . 52.50

Philco Socket Power "A"

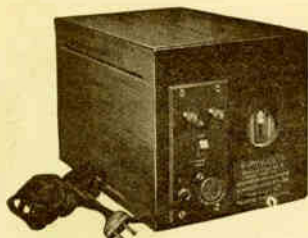

Philco Socket Power "A"

For 115-volt 60-cycle alternating current, 6-volt tubes, UV-201-A, C-301-A, UX-201-A, UX-112 tubes, etc. Handsome Adam-brown mahogany case. Permanently plugged into a light or wall socket. Absolutely no hum.

Built-in switch, in the "ON" position, connects the pressed-glass case "A" battery to the radio set and in the "OFF" position turns off the tubes, disconnects the battery from the radio and connects it to a built-in Special Tungar Charger. The battery floats on the Tungar at a very low current while the radio is not in use. No worry about when or how much to charge. Leave plug in house socket all the time. Just throw switch to the "OFF" position when you stop using the radio and battery automatically absorbs the charge it needs.

Type A-60—For 60-cycle A. C. Price . . . \$42.50

Philco Socket Power "AB"

For 115-volt alternating current 3-volt dry cell tubes UV-199, C-299, UX-199, UX-120, etc. Due to the small current required, it has been possible to combine "A" and "B" Socket Power in one housing for Radiola Super-Heterodyne and other so-called dry battery tube sets. Handsome Adam-brown mahogany case. One enclosed switch controls everything. A Philco aluminum rectifier is used to insure great efficiency at the low currents required. Current cost one cent per day in average service.

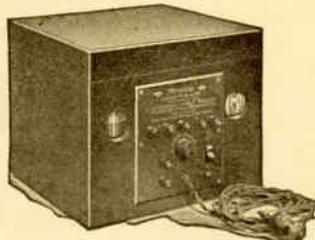

Philco Socket Power "AB"

Type AB-460—For 50 and 60-cycle A. C. . \$65.00

Type AB-425—For 25, 30 and 40-cycle A.C. 68.50

Rubber Case "A" Batteries

(With Bail Handles)

Beautiful paneled real rubber case. Philco design. Famous Diamond grid plates and quarter-sawed separators. Meets the demand for a thoroughly dependable storage battery of moderate price for standard 6-volt tube sets. Conservatively guaranteed one year. Should be sold equipped with a Filler Cap Charge Tester (\$1.00 extra), making it easy to tell the state of charge at any time without danger of spilling acid.



76 RX With Filler Cap Charge Tester

Type	Voltage	A. H. Capacity at Radio Rates	Price
56 RX	6	60	\$14.85
76 RX	6	90	18.85
96 RX	6	120	21.85

Mahogany Finish Case "A" Batteries (With Bail Handles)

116 RW	6	150	\$25.00
135 RW	6	180	30.00

4-Volt Battery for UV-199, C-299, DV-3, UX-112 and UX-120 Tubes

74 RW	4	90	\$13.85
-------	---	--------------	---------

2-Volt Battery for WD-11, WD-12, C-11 and C-12 Tubes	2	180	\$12.85
--	---	---------------	---------



Filler Cap Charge Tester

Permanently replaces one of the original filler caps. Tells how much charge is left in battery without the use of an old-fashioned, sloppy hydrometer. Both balls float when battery is over 75 per cent charged. If one floats and the other sinks, the battery is between 75 per cent and 25 per cent charged. If both sink, the battery is less than 25 per cent charged. An indispensable accessory for clean, dry, intelligent charging.

Filler Cap Charge Tester for "A" batteries . . \$1.00

Pressed Glass Case "A" Batteries

Exclusive Philco construction. Visible built-in charge indicator tells at a glance when battery needs charging. High and low electrolyte level marked on glass. Easy to see when to add water and how much. Spray-proof. Acid-tight. Clean. Compact. Diamond grid plates. Philco retainers. Quarter-sawed separators. Double plate and separator assembly insures extraordinarily long life.

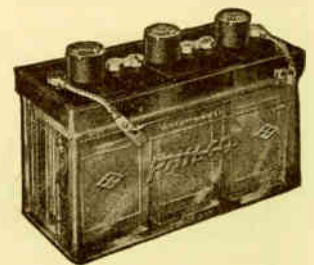

No expense has been spared in the design of these batteries to keep all the acid inside at all times. They are, therefore, especially desirable for fine living-room and cabinet use. The terminal posts are moulded solidly in the hard rubber covers to prevent even the smallest leakage of acid. The vents are ingeniously designed to prevent the escape of any spray. These Philco glass-case batteries represent the highest development of a storage battery for home use.

Battery for standard 6-volt tubes, UV-201-A, C-301-A, UX-112, DV-2, etc.

Type	Voltage	A. H. Capacity at Radio Rates	Price
UD 86	6	30	\$16.00

PHILCO

DIAMOND GRID BATTERIES

Pressed Glass Case "A" Batteries

Dry Cell Replacement Battery for 3-Volt Tubes



For UV-199, C-299, DV-3, UX-120 and other 3-volt tubes. Occupies the space of three dry cells and fits inside Radiola Super-Heterodyne Cabinets.

Type	Voltage	A. H. Capacity at Radio Rates	Price
UD-44	4	15	\$8.00

Charge in your living room, without changing any wires, using a Philco Single Charger.

The UD-44 is easier on tubes than dry cells and gives more uniform reception. This because dry cell voltage is variable. At the start it is so high that it shortens tube life. Later it falls so low that reception is weakened. Voltage of the UD-44 storage battery is practically constant and at a level low enough to preserve tube life and high enough to insure good reception always.

Glass Jar "B" Storage Batteries

In Mahogany Cases

Individual glass cells in handsome mahogany wood cases. Square shape saves space and makes Philco the most compact "B" battery on the market. Extra height makes filling with water unnecessary, except at long intervals. Built-in visible charge indicator tells the state of charge at all times. Charge in your living room, without changing any wires, using a Philco Charger and "B" Charging Panel, or charge with the new-style Tungar or Rectigon.

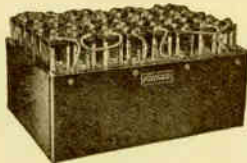

Standard "B" replacement for 90-volt dry battery.

Type	A. H. Capacity	Price
83 X	3000 M. A. H.	\$19.85
86 H	6000 M. A. H.	25.00

Complete—only one required for each set.

Average voltage 5 to 10 per cent higher than 90 volts of dry "B" battery. This is because dry cells are rated at their initial voltage. A 90-volt dry "B" battery delivers 90 volts only at the very beginning of its life. After that the voltage falls to 80, then to 70, then to 60 or below before the rated capacity of the battery is obtained, and it is thrown away, so that the average voltage of a 90-volt dry battery is only 72 to 75 volts. An 83 X or 86 H starts at a little over 84 volts, which gradually falls to about 76 volts before recharging is necessary, so that the average voltage even with infrequent recharging is 80 volts. In fact, the minimum voltage of an 83 X or 86 H is above the voltage of a 90-volt dry battery.

Glass Jar "B" Storage Batteries

In Mahogany Cases—Super "B" Batteries



Type	A. H. Capacity	Price
248 DXO	3000 M. A. H.	\$14.95
248 DX	3000 M. A. H.	17.50
248 DHO	6000 M. A. H.	18.75

Two required for most radio sets.

Average voltage of a single unit is 48 volts and of a complete battery (two units) is 96 volts. This is 25 to 30 per cent higher than the average voltage of a 90-volt dry battery. Divided into two cases for more convenient handling and positioning. DXO and DHO types without lids. DX type with lids and satin mahogany finish, and DX cells equipped with Philco Retainers for extremely long life. Insure greatest volume and distance.

For one and two-tube sets, one 48-volt unit is sometimes sufficient. For sets specifying 67½ volts of dry cells use one Type 83 X or 86 H unit, tapping off less than the full number of cells if reception is too loud. For sets specifying 135 volts use three 48-volt units. These may be paralleled for charging with a Philco Charger without changing any wires by using two "B" Charging Panels.

Philco Noiseless A. C. Charger

For "A" and "B" Batteries

Perfected aluminum rectifier. Metal case. Attractive brown mahogany finish. Silent, odorless. Designed for frequent, gentle, spray-free-charging of "A" and "B" batteries, insuring maximum reception at all times. Requires no attention in operation except occasional filling with water. Equipped with plug and built-in socket for charging in the living room without changing wires.



To charge "B" battery merely insert "A" plug in charger. For "B" charging use in connection with charger a "B" Charging Panel (illustrated below). To charge, merely throw panel switches and insert "B" plug (on panel) in charger. Charging is made so easy that it is no trouble to charge frequently, thus keeping batteries and reception up to full value at all times.

Single charger (for any "B" storage battery and UD-44 "A" battery) \$ 9.75

Double Charger (for any "B" storage battery and UD-86 "A" battery) 15.00

Philco Noiseless A. C. Charger

For "A" and "B" Batteries

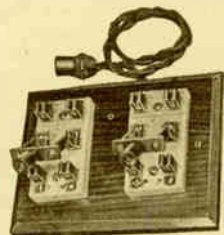

This panel is wired at the factory so that with the switches thrown to the set side the "B" batteries are in series on the radio set and, when the switches are thrown to the other side, in parallel on the Philco Charger. Connect the panel permanently to the "B" batteries. An indispensable accessory for convenient charging without changing any wires. No chance of getting "B" batteries on the "A" circuit and burning out tubes, once they are permanently connected to a "B" Charging Panel. Be sure to use a "B" Charging Panel with a Philco Charger and "B" battery.

"B" Charging Panel \$2.00

INDEX

	Page		Page		Page
A					
ADAPTERS (Socket)		BATTERY ELIMINATORS		CONDENSERS (Mikro-Mike)	
General Radio, UX Tubes	24	Balkite	51	Bremer-Tully	26
Na-ald, All Tubes	72	Dubilier	44	Sterling	53
ADAPTERS (Phonograph)		Majestic	33	CONDENSERS (Neutralizing)	
(See Phonograph Units)		Philco	76	Chelton	13
ADJUSTERS (Vernier)		Philco	77	Marco	56
Fleron	17	Timmons	75	Sterling	53
AERIAL INSULATORS		BATTERY MATS		CONDENSERS (Tandem)	
(See Insulators)		Goodrich	49	Amso	74
"A" AND "B" CURRENT SUPPLY		BATTERY METERS		Bremer-Tully	25
Majestic	33	(See Meters)		General Radio	21
AERIALS (Indoor)		BATTERY SWITCHES		CONDENSERS (Variable)	
(See Loop Aerials)		(See Switches)		Amso	74
(See Aerial Tape)		BEZELS (Panel)		Benjamin	8
AERIALS (Curtain)		Erla	18	Bremer-Tully	25
Electrad	12	BINDING POSTS		Bradleydensen	16
AERIALS (Loop)		Eby	67	Cardwell	13
(See Loop Aerials)		General Radio	24	Chelton	13
AERIAL MASTS		BLUE PRINTS		Fett & Kimmel	73
Redi-Mast	47	(See Circuits)		General Radio	21
AERIAL OUTFITS		BOOKS		Hammarlund	13
Brach	71	Citizens' Call	70	Karas	28
Fleron	17	Daven	69	Marco	56
Aero	63	Silver-Marshall	3	National	18
AERIAL SOCKETS		BRACKETS (Sub-Panel)		Philmore	70
Ducon	44	Benjamin	8	Remler	6
AERIALS (Tape)		Mississippi Valley	56	Signal	30
Talking Tape	49	Yaxley	32	Silver-Marshall	2
AERIAL WIRE		BRADLEYUNIT		Walbert	45
(See Wire)		Allen-Bradley	16	CONNECTORS (Multi-Phone)	
AIR CONDENSERS		BULBS (Rectifier)		General Radio	23
(See Condensers)		Crescent	48	Marco	55
AIR CORE TRANSFORMERS		BUS BAR WIRE		Van-Ashe	13
(See Transformers)		BUZZERS		COMBINATION CHARGER	
AMMETERS		General Radio	24	AND BATTERY	
General Radio	24	C		Balkite	51
Hoyt	65	CONDENSERS (By-Pass)		Keco	39
Jewell	36	Dubilier	44	Philco	76
Jewell	37	Federal	13	Philco	77
Sterling	53	CABINETS		CONSOLES	
Weston	4	Van-Ashe	20	Van-Ashe	57
AMPLIFIERS		CABLE MARKERS		CONTACTS	
Allen-Bradley	16	Crowe	67	Fore	13
Daven	69	CHARGERS		Homecharger	13
General Radio	22	(See Battery Chargers)		Valley	13
ANTENNAS		CHEMICAL (Rectifier)		CONTACT POINTS	
(See Loops—See Wire)		Exide	54	Van-Ashe	13
ANTENNA COILS		Balkite	51	CORDS	
(See Coils)		CHOKE COILS		(See Battery Cables)	
ANTENNA INSULATORS		Bremer-Tully	25	CORDS (Extension)	
(See Insulators)		Best's	6	Frost	7
ANTENNA KITS		Bremer-Tully	27	Marco	55
(See Aerial Outfits)		Browning-Drake	19	Belden	62
ANTENNA PLUGS		Daven	69	CORDS (Headset)	
Ducon	44	Erla	18	Belden	62
ANTI-CAPACITY SWITCHES		Remler	6	Van-Ashe	13
Federal	12	Silver-Marshall	2	CORD TIP JACKS	
ARRESTERS (Lightning)		Silver-Marshall	3	(See Jacks)	
Brach	71	Assembling Cost	80	COUPLERS (Oscillator)	
Filko	48	CLAMPS (Ground)		All-American	46
Fleron	17	(See Ground Clamps)		Bremer-Tully	25
ATTACHMENTS (Phonograph)		Van-Ashe	13	Remler	6
(See Loud Speaker Units)		CLEATS		Silver-Marshall	3
AUDIO AMPLIFIERS		Handy Grip	38	COUPLER (Resistor)	
(See Amplifiers)		Universal	5	Daven	69
AUTOMATIC RHEOSTATS		Valley	75	COUPLERS (Vario)	
Amperites	54	CLIPS (Grid Leak)		General Radio	22
B					
BATTERIES (Wet "A")		Daven	69	COUPLERS (Low-Loss)	
Burgess (Storage "A")	42	Sangamo	10	Silver-Marshall	3
Exide	54	COILS		CRYSTALS	
Keco	39	All-American	46	Ajax	13
Philco	76	Branston	75	Brownlie	13
Varco	48	Bremer-Tully	25	DuTec	44
BATTERIES (Wet "B")		Erla	18	Erla	18
Burgess (Storage "B")	42	General Radio	22	CRYSTAL DETECTORS	
Exide	54	Silver-Marshall	2	Brownlie	13
Philco	76	Sickles	12	Erla	18
BATTERIES ("A," "B," "C")		COIL HOLDERS		CRYSTAL SETS	
Burgess	42	General Radio	22	Crystal Mystery	47
BATTERY CABLES		Branston	75	CUSHIONS (Ear)	
Belden	62	COILS (Doughnut)		Goodrich	49
DeJur	61	(See Transformers)		CUSHIONS	
Jones	48	COILS (Honeycomb)		(Rubber, for Sockets)	
BATTERY CHARGERS		Branston	75	General Radio	23
Balkite	51	(COILS (Inductance))		Na-ald	72
Balkite (Trickle)	51	Branston	75	DIAL ADJUSTERS	
Crescent (Kodel)	48	Bremer-Tully	25	(See Adjusters)	
Exide	54	Erla	18	DIAL POINTERS	
Handy	38	General Radio	22	Marle Arrow	13
Fore	61	Silver-Marshall	2	DIALS	
Keco	39	Uncle Sam	11	Federal	13
Philco	77	COILS (Toroid)		General Radio	24
Valley	75	(See Transformers)		Kurz-Kasch	43
BATTERY CLIPS					
(See Clips)		COIL MOUNTS		Na-ald	72
		Branston	75	Van-Ashe	13
		CONDENSERS (Fixed)			
		Dubilier	44		
		Sangamo	10		
		Yaxley	49		

INDEX

	Page		Page		Page		Page
JACKS (Portable Extension)		Jewell	36	King	13	Bremer-Tully	26
Frost	7	Jewell	37	Marco	56	Erla	18
Yaxley	31			Premier	13	General Radio	21
JACKS (Switches)		MODULATORS		Radiostat	16	General Radio	22
Yaxley	31	Bremer-Tully	26	Sterling	53	Hedgehog	12
JACKS (Wall Receptacle)		C. R. L.	41	Yaxley	32	Jefferson	12
Yaxley	49	MOUNTINGS (Grid Leak)				Karas	28
		Daven	69	ROTORS		Rauland Lyric	46
		Sangamo	10	Van-Ashe	13	Sterling	53
						Thordarson	73
		MULTI CONNECTORS		S		TRANSFORMERS	
		(See Connectors)		SCREWS AND NUTS		(Medium Frequency)	
K				Dixie Assortment	13	General Radio	22
KITS (Antenna)				SETS		TRANSFORMERS (Radio)	
Aero	63	N		(See Receiving Sets)		All-American	30
Brach	71	NAME PLATES		SHORT-WAVE OUTFIT		Acme	12
Fleron	17	Bruno	65	Bremer-Tully	25	Benjamin	8
		Crowe	67	SHIELDING		Bremer-Tully	25
		Yaxley	31	Van-Ashe	13	Dubilier	44
KITS		NEUTRALIZING CONDENSERS		SHORT-WAVE TUNERS		Erla	18
Acme Reflex	12	(See Condensers)		(See Tuners)		General Radio	22
Baldwin Pacific, Super	12	O		SLIDERS		Sterling	53
Bremer-Tully Torostyle	25	OSCILLATOR COUPLERS		Van-Ashe	13	TRANSFORMERS (Push-Pull)	
Bremer-Tully Nameless	27	(See Couplers)		SOLDER		All-American	46
Bremer-Tully Counterphase	27	OUTFITS		Brach	13	Erla	18
Branston	12	(See Aerial Outfits)		Rosin Core	13	Thordarson	73
Daven Amplifier	69	P		String	13	TRANSFORMERS (Super-Het.)	
Erla Reflex	12	PANELS		SOLDERING IRONS		General Radio (Matched)	22
Erla Circuloid	18	Benjamin	8	(See Irons)		Remler	6
Harkness Counterflex	71	Formica	50	SOLDER PASTE		Silver-Marshall (Matched)	2
Marco Browning-Drake	55	Goodrich Hard Rubber	49	Van-Ashe	13	TRANSFORMERS (Torostyle)	
National Browning-Drake	19	Hood	67	SOLDERING TERMINALS		Bremer-Tully	25
Silver-Marshall Super Auto-dyne	2	Stevens	58-59	(See Terminals)		TUNING CONTROLS	
Shamrock (Reflex)	12	PANEL CUTTERS		SOCKETS (Tube)		(See Dials, Vernier)	
Cost of Assembling	80	Engraving	80	Amsco	74	TUNING COILS (Low-Loss)	
KNIFE SWITCHES		PANEL LIGHTS		Benjamin	8	Aero	48
(See Battery Switches)		Walbert	45	Bremer-Tully	26	Bremer-Tully	26
KNOBES (Rheostat)		Yaxley	32	DeJur	29	General Radio	22
General Radio	23	PHONES		Frost	7	Lopez	12
Kurz-Kasch	43	(See Headsets)		General Radio	23	Uncle Sam	11
Marco	55	PHONE CAPS		Hoosick	12		
Yaxley	32	Van-Ashe	74	Kurz-Kasch	43	TUBES	
KOMBINATOR		PHONE CORDS		Na-ald	72	Cunningham	14
Keco	39	Belden	62	Remler	6	Cunningham (Description)	15
		PHONE JACKS		SOCKETS (Gang)		Daven (for B-Limitator)	69
L		(See Jacks, Phone)		Benjamin	8	Musselman (Certified)	40
LAMPS		PHONE TIP JACKS		Frost	7	Ureco	34
Yaxley	32	(See Jacks, Phone Tip)		Hoosick	12	TUBE ADAPTERS	
LEAD-IN BUSHINGS		PHONOGRAPH UNITS		Acme	11	(See Adapters)	
Fleron	17	(See Loud Speaker Units)		Cambric	11	TUBE REACTIVATORS	
LEAD-INS		PLUGS		Rubber	11	TUBE REJUVENATORS	
Electrad	65	Carter	70	SPAGHETTI		TUBE REVIVORS	
LEAKS		Dubilier (Ducon)	44	Jefferson	74	Jefferson	74
Filko	48	Frost	47	Sterling	53	Sterling	53
LIGHTNING ARRESTERS		General Radio	23	Sterling	54	TUBE TESTERS	
(See Arresters)		Jones (Multi)	23	Jewell	37	General Radio	63
LIGHTNING SWITCHES		Marco	48	Sterling	53	Sterling	54
(See Switches)		Polyplug	12	TUBING		Formica	50
LITZ WIRE		Weston	4				
(See Wire)		Yaxley	49	U			
LOCK SWITCHES		POINTERS (Dial)		UNITS			
(See Switches)		Marle Arrow	13	Loud Speaker			
LOW-LOSS COUPLERS		POTENTIOMETERS		Phonograph			
(See Couplers)		Amsco	74	(See Phonograph Units)			
LOW-LOSS CONDENSERS		Bradleyometer	16	V			
(See Condensers)		Bremer-Tully	26	VARIABLE CONDENSERS			
LOOP AERIALS		Centralab (C. R. L.)	41	(See Condensers, Variable)			
Bodine	47	Cutler-Hammer	49	Van-Ashe Service	80		
Signola	30	DeJur	29	VARIABLE GRID LEAKS			
Silver-Marshall	2	General Radio	61	Bradleyeak	16		
LOUD SPEAKERS		Sterling	53	C. R. L.	41		
Amplion	68	Yaxley	32	Cutler-Hammer	29		
Atlas	46	R		Marco	55		
Bosch	60	RECEIVING SETS		VARIABLE HIGH RESISTANCE			
Brandes	64	American Bosch	60	Bradleyohm	16		
Frost	7	Audio Tone	71	Bremer-Tully	26		
Majestic	33	Colonial	66	Electrad	65		
S-R-S	46	Kismet	30	Marco	56		
Utah	35	Pearson	52	VARIO-COUPLERS			
Voice From the Sky	61	Thermodyne	9	General Radio	22		
Western Electric	75	Repairing of Sets	80	VERNIER ADJUSTERS			
(See Adjusters)		RESISTANCE UNITS		(See Dials)			
LOUD SPEAKER UNITS		Cutler-Hammer	29	VERNIER DIALS			
Amplion	68	Daven	69	(See Dials)			
Atlas	46	Marco	56	VARIOMETERS			
Brandes	64	General Radio	24	General Radio	22		
Utah	35	Yaxley	49	VOLTAMMETERS			
LUGS				Sterling	53		
Amsco	74	RESISTORS		VOLTMETERS			
Liberty	12	Daven	69	(See Meters)			
Belden	62	RHEOSTATS		W			
M		Amperites	54	WAVE METER AND FILTER			
MAGNET WIRE		Amsco	74	General Radio	21		
(See Wire)		Bradleystats	16	WIRE			
MARKERS		Carter	70	Aerial (Van-Ashe)	63		
(See Cable Markers)		C. R. L.	41	Bus Bar (Van-Ashe)	63		
MATS (Battery)		Cutler-Hammer	29	Celatsite (Acme)	11		
Goodrich	49	DeJur	61	Litz (Belden)	62		
METERS (Battery)		Federal	13	Loop	62		
Hoyt	65	Filkostat	13	Magnet (Analyte)	63		
Jewell	36	General Radio	23				
Jewell	37	Hoosick	13				
Sterling	53						
Weston	4						
Weston	5						
MILLIAMMETERS							
Sterling	53						
Weston	4						

Radio Set Repair Service

We Have the Only Service of Its Kind in the Middle West
A COMPLETE RADIO RESEARCH LABORATORY

This department is in the hands of competent Radio Engineers who understand thoroughly the construction and operation of the present-day radio circuits.

We have this service at your command and our engineers will be pleased to answer any questions of a technical nature or furnish you with any kind of circuit diagram or construction data. Let us solve your and your customers' problems.

Our Circuit Assembling Department

A great many of our customers are buying the parts of the different circuits, having our laboratory build them the complete circuit with or without cabinet. This is under the personal supervision of our Mr. Geo. W. Van Sickle, Radio Engineer, who inspects each and every set on distance, selectivity and workmanship, which insures you not merely an assembly of parts, but a perfected circuit. The prices with laboratory test are as follows:

Silver-Six, without cabinet.....	\$35.00
Silver-Knockout, without cabinet.....	25.00
Silver Super-Autodyne, without cabinet.....	45.00
Silver-Seven, without cabinet	40.00
Best's Eight-Tube Circuit, without cabinet.....	45.00
Bremer-Tully Nameless, without cabinet.....	25.00
Bremer-Tully Counterphase, without cabinet (five-tube).....	35.00
Bremer-Tully Counterphase, without cabinet (six-tube).....	40.00
Kenneth-Harkness Counterflex, without cabinet.....	20.00
Browning-Drake, without cabinet	25.00

We can also quote you prices on any special circuit you may wish us to build. Our engineering department will furnish you the cost on a completed diagram.

Drilling and Engraving Panels

We drill and engrave panels. Engraving, 5 cents per letter, net. Panels drilled to your specifications and prices furnished on receipt of your template.

Repairing Sets

If you have a set you wish repaired, kindly send us a letter stating you are sending us the set by PREPAID EXPRESS and we will quote you the price on repairs, and if any new parts are needed, we will give you the regular price on parts used and quote you the total cost before proceeding with the work, and give it a final test on distance before shipping, which insures you a perfect repair job.

SEND US YOUR
REPAIR BUSINESS

Van-Ashe Radio Co.

Tenth and Pine Streets

St. Louis, Mo.

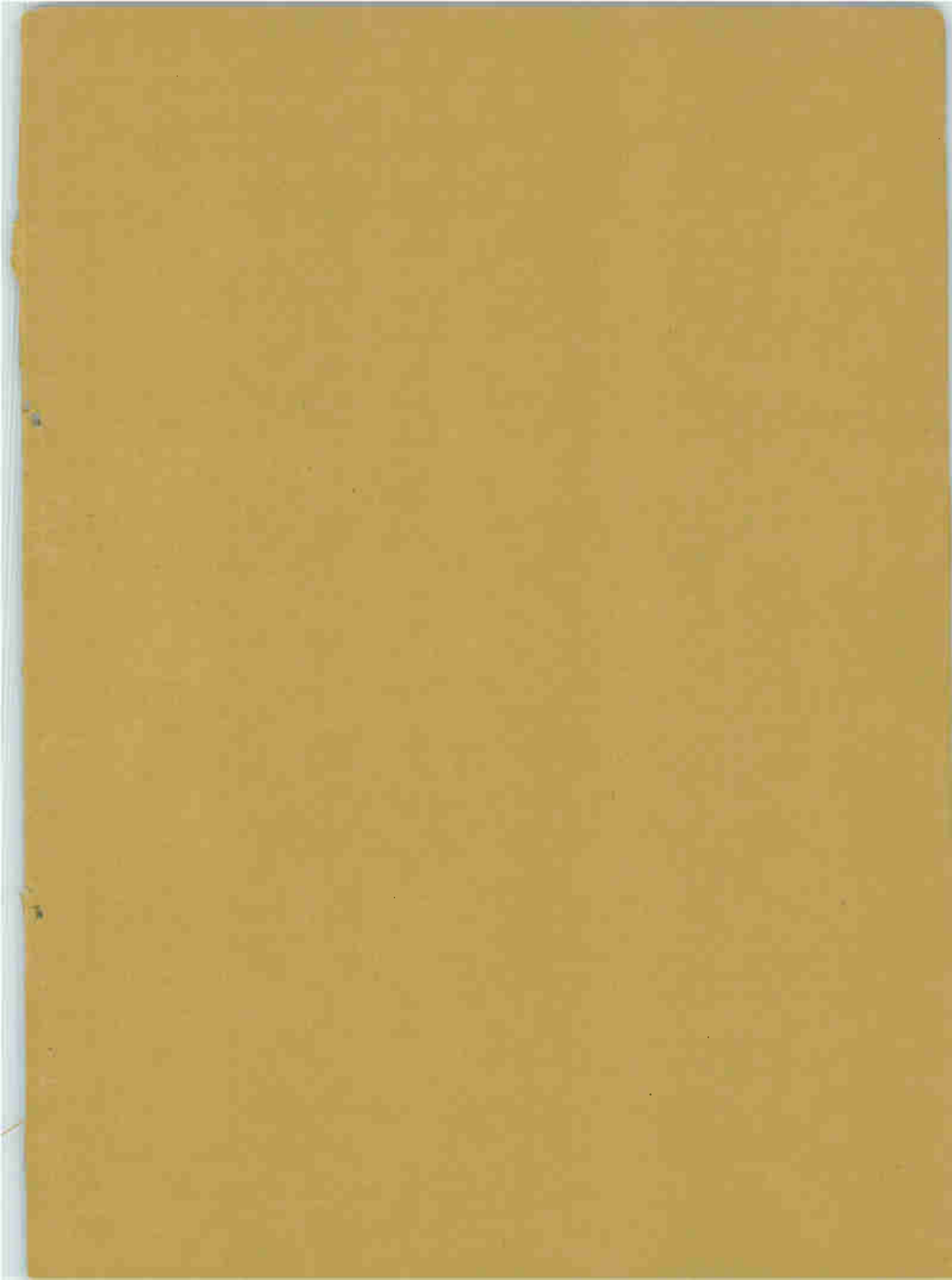

Van-Ashe Radio Co.

TENTH AND FINE

ST. LOUIS, MO.