

POPULAR EDITION

THE STANDARD RADIO GUIDE



How to Enjoy Radio at Home

How to Listen - In

What You Can Hear

**How Much to Pay
for Your Set**

**How to Make Your
Own Set**

Published by Popular Science Monthly Price 50 Cents



“Ready-to-Operate”

ABC UNITS come to you complete in every detail and ready-to-operate. The first *UNIT* of the series, shown above, is an entirely practical receiving outfit which will respond to wireless telephone 25 to 35 miles and wireless telegraph much farther. Phones, aerial, in fact every item of accessory equipment is included. Just put up a simple two or four wire aerial, make an easy ground connection and you are ready to listen in. There is no danger, no current, no technical adjustments.

Start with an *ABC UNIT* and when you want to add to your set later, as you surely will, you have all the advantages of the exclusive *UNIT* system. (See inside back cover.)

Jewett Manufacturing Corporation

Canadian Pacific Building

Madison Ave., and 44th St. New York City

ABC UNITS
Standardized Radio
Sectional Receiving
ABC UNITS

THE STANDARD RADIO GUIDE

**Wireless Explained in Simple Language
With Pictures, Diagrams, Radio Map
and Complete Directions for
Using Receiving Outfits**

Popular Edition

Published by

**POPULAR SCIENCE MONTHLY
225 West 39th Street
New York City**

*Copyright, 1922, by the
Modern Publishing Company*

Printed in United States of America

TABLE OF CONTENTS

Chapter	Page
I What You Can Hear with a Radio Set	5
A description of the types of broadcasted entertainments now available to all owners of radio receiving sets	
II How Wireless Speech Is Possible	9
A simple explanation of the way voices and music are sent through the air and received	
III A Picture Story of Radio	12
The various parts of a sending and receiving set, illustrated and explained	
IV Radio Equipment You Will Need	14
Describing sets costing from \$15 to \$200, and explaining what broadcasts each will bring you	
V How to Assemble Your Receiving Set	26
Simplifying what seems to many a difficult task. Learn what troubles to look for, before they are met	
VI How to "Tune" Your Set	32
With these instructions the procedure of "tuning in" is made so simple that success is assured	
VII What Radio Stations You Can Hear	49
The range of typical receiving sets explained, and illustrated with a broadcasting chart of the United States	
VIII How to Make a Crystal Detector Set	52
Full directions for laying out and constructing a set at home, using a minimum of purchased articles	
IX How to Make a Vacuum Tube Set	56
This set has actually been built, and gives excellent results. Costing \$30, it equals a \$100 set in receiving range	
X A Few Facts about Transmitting Sets	61
An outline of the status of amateur sending stations, with some data on the expense of conducting broadcasting stations	
XI Important Tips and "Trouble Spots"	64
The experimenter may discover that one of these diagrams will add miles in receiving range to his set	
XII Glossary of Radio Terms	67
The principal terms encountered in radio literature explained in words understandable by all	



The owner of a simple radio outfit can "listen in" upon the great events of the world. Exciting news, sporting events described play by play, as well as concerts and great speeches can be picked up from the air

The Standard RADIO GUIDE

CHAPTER I

What You Can Hear with a Radio Set

OVER all the United States, to-day, the air is throbbing with the songs of famous soloists, with instrumental music played by concert orchestras and popular jazz bands, with humorous talks by noted entertainers, with lectures, sermons, and bits of vaudeville, with news bulletins, business information, educational talks, friendly gossip, market reports, weather forecasts, and important political speeches.

The ether has become one vast concert hall, offering a free selection of every variety of entertainment.

And all that is necessary to make the silence of the night speak to you with a thousand voices is to own one of the magic little radio receiving outfits, which you yourself can make at small cost, or purchase.

The purpose of this booklet is to tell you what sort of radio entertainment you can enjoy; to explain in simple terms the secrets of radio about which everybody wants to know; to tell you what sort of wireless sets to buy, just how to install them, and how to get the very best results from them; and, finally, to describe simply, step by step, how easy it is to build your own radio set, if you prefer.

Over a score of powerful radio broadcasting stations are nightly flinging music to the air. One or another of them can be heard in almost every part of the country. Boston, New York, Pittsburgh, Detroit, Washington, Omaha, Denver, Kansas City, Seattle, San Francisco, Los Angeles

THE STANDARD RADIO GUIDE

—each of these cities, to mention only a few, is a broadcasting center, and many of their programs are enjoyed by amateurs a thousand miles away. Most readers of this book live so near to some broadcasting station that they can hear its programs with a low-priced receiving set; while with a somewhat better equipment they can enjoy the magic thrill of listening nightly to noted men talking, or to vaudeville entertainers singing in some city half a continent away.

A Typical Radio Program

IN some cities the newspapers give special types of program; in others the state universities broadcast music, news, and educational talks; while in numberless others, smaller stations send out varied musical programs. But the following is a typical daily schedule of any one of the score or more powerful stations that have suddenly become national institutions:

- 11 A. M. —News and music, government weather forecast.
- 12 M. —News and music, government weather forecast, agricultural report.
- 12:30 P. M.—Music.
- 1:00 P. M.—News and music.
- 2:05 P. M.—Shipping news.
- 3:00 P. M.—News and music.
- 4:00 P. M.—News and music.
- 5:00 P. M.—News and music, government weather forecast.
- 6:00 P. M.—News and music, agricultural report.
- 7:30 P. M.—Children's bedtime stories.
- 7:45 P. M.—Special news, market, weather, and Stock Exchange reports.
- 8:00 P. M.—Talk on business conditions.
- 8:30 P. M. to 9:45 P. M.—Concert and entertainment by musical comedy stars.
- 9:55 P. M.—Arlington time signals.

Such week-day programs as the above are varied on Sundays with sermons by noted preachers, and with selections of music and choral singing. The programs

WHAT YOU CAN HEAR WITH A RADIO SET



This picture shows how a duet is sent out from a broadcasting station. The small cylinder suspended from the frame at the right contains the transmitter. The man at the left is signaling the generator room, where the energy is controlled

that are offered the radio listener are as varied as the regions covered. Often on the same evening, the fortunately located expert listener can, by turning a knob back and forth, hear a concert from one town, pick up a lecture from another, get the latest news from a third, catch a bit of wireless chat between two amateurs, hear conversations between two ships at sea, and wind up his evening of adventure in the ether by getting the correct time and weather forecast from Washington.

These broadcasting programs are being heard simultaneously by the plantation worker in Cuba and the lumberjack in a lonely North Woods hut. They are bringing the remotest corners of the land into touch with civilization. News of the world that otherwise would be weeks old before it reached some of these spots is spread by the radiotelephone with the speed of light from Canada to Cuba, from ships in the Atlantic to other vessels

THE STANDARD RADIO GUIDE

many days out from the Golden Gate, and from the United States to her farthest possessions.

It is in this great drama of world-wide intercommunication that you can share when you install a radio set in your own home. Before long, every American will feel it as much a part of his duty to share in it as he now feels it his duty to read the papers and visit the voting booth at election time. For the government sees itself as the logical broadcasting agency. With 61 governmental experimental stations, and 40 state universities as a nucleus of a national broadcasting system, the scope of government broadcasting will surely be increased until every square mile of the country is daily in direct vocal touch with the seat of government. Health advice in times of epidemics; warnings of floods; short talks on rural improvements; speeches by high officials; and the more prosaic, but equally important, weather, news, and market reports—the broadcasting of these and many other items will be considered a normal function to be performed by the government for its citizens. But on the shoulders of the private corporations will continue to fall the pleasing burden of entertaining the great mass of people with concerts, operas, and music in all its forms.

CHAPTER II

How Wireless Speech Is Possible

EVERYBODY whose fancy is caught by the magic of radio, and every purchaser of a radio set, wants first of all to try to visualize just what is happening in the sending and receiving sets, to make the miracle of wireless speech possible. A few simple steps toward understanding the fundamentals of radio will make your enjoyment and success with it infinitely greater.

If you plunge a stick vertically into a sheet of still water at regular intervals, a series of small waves will start from the stick and gradually widen in circles across the water, until they diminish in size and disappear.

The radiotelephone transmits speech by starting similar waves in the air. The human voice is produced by vibrations of the cords in the throat. These vibrations, varying in frequency from 4000 to 10,000 a second, set up sound waves in the air. Now if these waves are changed into electric vibrations, instead of sound vibrations, they can be sent broadcast over great distances in much the same way that the water waves traveled on the water's surface. The sounds are easily converted into electrical waves by a small device called the *vacuum tube*. This tube, when fed with electric current, commences to vibrate, or, as it is technically termed, oscillate. The waves that it sends out do not vary in intensity until a voice, speaking into an ordinary telephone transmitter, is impinged upon the current passing through the tube, when the sound vibrations will be added to the normal vibrations of the tube, and the ether or air waves will

THE STANDARD RADIO GUIDE

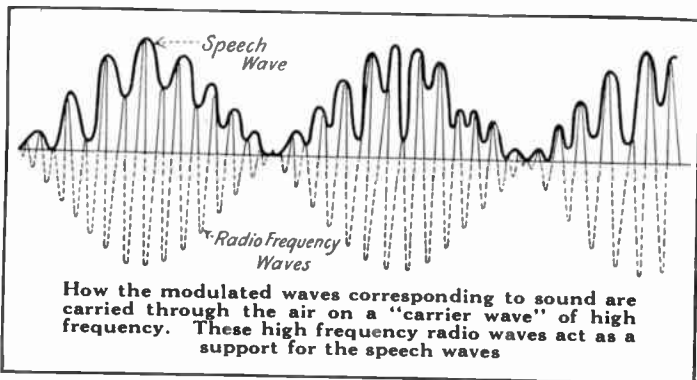

vary with the sound vibrations. Once the sounds have thus been converted into electric waves, some method must be adopted at the receiving stations to convert the electric waves back into sound waves, so that the man listening at the phones will have the words translated for him in the sender's own voice.

This is accomplished by devices almost identical with those of the sending station, except that the instruments are in reverse order. First, there is the *aerial wire*, or *antenna*, connected with which are the coils used for adjustment. Next there is a small instrument called the *detector*, which does the actual converting of the waves. And finally comes a pair of telephone receivers, through which the listener hears the sounds.

When a singer or an orchestra at the transmitting station sends its sound waves into the transmitter, and the latter translates them into electrical waves, they race to the antenna and generate the waves in the air, or *ether*. These waves travel in every direction at the rate of 186,300 miles a second. The distance at which they may be received will depend on the power behind the waves, the land over which they travel, and the receiving set which

HOW WIRELESS SPEECH IS POSSIBLE

tries to pick them up. In reality, the waves might pass completely around the earth, but at the end of that journey they would be so weak as to make detection impossible.

Thus, while the radio waves from any given broadcasting station travel enormous distances almost instantly, the purchaser of a receiving outfit may find that it is not sensitive enough to pick up the concerts he wishes to hear. What stations you are likely to hear in your vicinity, and what type of set you will require to do so is explained on page 49 of this book.

The broadcasting chart published on page 50 is a simplified copy of the elaborate national broadcasting map of the United States compiled by POPULAR SCIENCE MONTHLY, and showing in great detail all the most important stations in the country, together with their range for various types of receiving sets, their call letters, addresses, etc. The map is invaluable, both to the prospective purchaser of a radio set, who cannot wisely determine how expensive an apparatus to buy, without consulting it, and to the owner of an outfit, who will be able to locate from it the stations he picks up.

The map is procurable from POPULAR SCIENCE MONTHLY. See page 73 for further description.

CHAPTER

A Picture Story of

TRANSMITTING AERIAL—Transmitting stations must have aerials of four or more wires. The aerial is only one half of the electric circuit, the other half being the ground.



INDUCTANCE—Change in the length of wires in the aerial is effected by using a larger or smaller number of wires on the inductance, a cylinder 10 inches or more in diameter.

VACUUM TUBE—Sound currents from the voice entering the transmitter pass through this tube, where they meet a high frequency, powerful wave already being generated. The sound waves combine with the tube waves and ride on the latter to their destination.

TRANSFORMER—A transformer becomes necessary, to raise the voltage of the impulses after they have been produced in the phone circuit by the action of the sound on the diaphragm.

TRANSMITTER—The phone used for sending out radio broadcasts is not unlike the ordinary desk transmitter. It consists of a mouthpiece to catch and direct the sound wave, a flexible metal diaphragm and two carbon buttons, between which are placed a quantity of fine carbon granules. One of the carbon buttons is stationary, but the other is connected with the diaphragm. When the diaphragm vibrates, the carbon granules are alternately packed more tightly and more loosely together, thus providing a better electrical circuit and varying the amount of current.

STORAGE BATTERY—When radiotelephone messages are to be carried only a short distance, one or more storage batteries may be used. The larger stations are connected with huge direct current generators, instead.

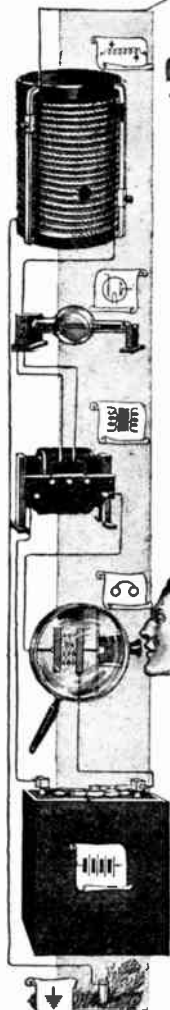

THREE

How Radio Sets Work

NOTE—Each part bears its symbol as used in diagrams.

VARIOCOUPLER — The variocoupler supplies the means for altering the amount of wire in the aerial. This is called *tuning*, and on it depend the strength and clearness of the signals received.

VARIOMETER—Sometimes a variometer is used to make accurate changes in the wave length of the aerial. A variometer consists of two coils of wire connected by a flexible cord, the inner coil rotating inside the larger.

VACUUM TUBE—Radio waves vibrate too rapidly to actuate ordinary phone receivers. The vacuum tube is employed to alter the frequency without distorting the sound. The vacuum tube is an incandescent bulb containing a filament, a metal plate and a network of fine wires.

STORAGE BATTERY—A storage battery, which is required to heat the filament of the vacuum tube, is the most reliable source of constant current.

A second variometer is sometimes added, when by so doing the signals may be strengthened.

"B" BATTERY—The voltage on the plate of the vacuum tube is supplied by a dry battery, usually known as the "B" battery.

HEAD PHONES—The electric impulses received from the aerial and altered in form and frequency by the vacuum tubes, pass through sensitive magnets in the phone receivers and vibrate the diaphragm in agreement with the electric wave. The movement of the diaphragm produces sound waves that are translated by the ear into speech.

VARIABLE CONDENSER—A variable condenser consists of two series of aluminum or brass plates, with one series stationary and the other rotatable, so that it may be revolved inside or outside the stationary plates.

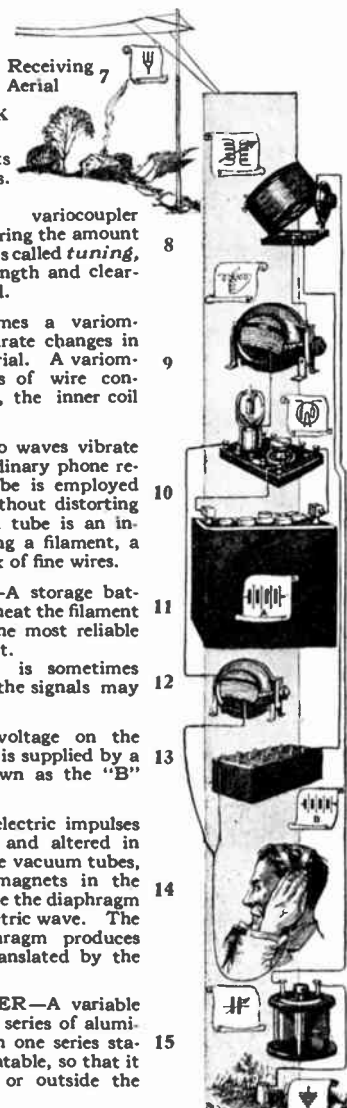

CHAPTER IV

What Radio Equipment You Will Need

NOTE: Reference from this and following chapters back to the preceding chapter, "A Picture Story of Radio," will make all the terms, parts mentioned, and wiring description more quickly intelligible to the non-technical reader.

THOUSANDS of persons—men, women, and children—suddenly aroused to enthusiasm toward the science of the radiotelephone, are asking the same question: "What kind of equipment do I need, to hear these concerts, operas, and other broadcasts?" The answer depends, in part, on the location of the house. If it is situated close to a broadcasting station, nothing would be gained by installing one of the more expensive outfits; but if the home is several hundred miles away, then care should be exercised in purchasing a receiving set and aerial of proper design. If this is not done at the start, the results will be exceedingly disappointing. Even if the house is only 25 miles distant from a broadcasting station, the purchaser should realize that every additional dollar he spends for an outfit, up to \$200, will improve the regularity and clearness of the sounds received and lessen the possibility of interference.

One of the first questions asked by a customer at a radio store is, "How far will this set receive?" The salesman may name a distance based on the success of some other owner of the same type of outfit. If the figure is 50 miles, the purchaser buys the set with the fixed impression that it will receive up to 50 miles. As a matter of fact, he may

WHAT RADIO EQUIPMENT YOU WILL NEED

This is a typical low priced crystal detector set. Unbelievable ranges have been covered with such outfits, but in a general way they should not be installed if the amateur is more than 15 to 25 miles away from the broadcasting station. In a crowded city, where there are many interferences, the crystal set is seldom satisfactory



find when he has finished the installation that it will "listen in" on a phone station 100 miles away, or he may find that a broadcasting station only 25 miles away cannot be heard even during the clear, crisp nights of fall and early winter, when radiotelephone transmission is at its best. Mysterious atmospheric and geographical conditions, unsolved even by experts, are responsible for this anomaly.

However, among the different classes of radio sets discussed in the following paragraphs, there is one or another which will probably be the best for you to start with; and from this description you should familiarize yourself with the sets and their possibilities, before going to the dealer to make your purchase; for radio stores are so busy that the purchaser who knows nothing about the apparatus is likely to be at a disadvantage.

The Lowest Price Radio Sets

Sets selling for about \$15 are of the simplest practicable sort, consisting of a small *inductance coil* for tuning purposes, a *fixed condenser*, a *crystal detector*, and a single *phone* to hold to the ear. With an aerial or antenna, consisting of one copper wire strung from a tree 100 feet or more away from the house, an outfit of this type should pick up the broadcasting concerts 10 miles from the station. The wire you should ask for is No. 14 gage. Even at this distance, the sounds may sometimes be so low in intensity that any interference from other wireless stations will garble or obliterate them, while on the other hand these sets have been known to receive over much greater distances. The simple tuning coil of this set does not permit of *selective tuning*; that is, if other stations are sending at the same time, whether in telegraphic code or vocal sounds, it will be impossible to separate the sounds produced by their waves from the sounds of the station you are trying to hear. Nevertheless, these \$15 sets are excellent as beginners' low-priced outfits, and many amateurs continue to use them for knockabout purposes, even after they have installed better sets.

Simple Definitions of Radio Terms

Before going further into the details of typical sets, many readers will want simple definitions of the various parts mentioned above. The *antenna* or *aerial* for receiving purposes does not need to be the elaborate type so often seen on roof tops. A single wire of copper or phosphor bronze, of almost any size between No. 10 and No. 16 may be used. This can be bought at any electrical supply store. Great height is not necessary. An aerial with one end 40 feet in the air will be sufficient. A 75-foot aerial might be considered as ideal, but is not always attainable, except at much expense. It is not essential that the wire

WHAT RADIO EQUIPMENT YOU WILL NEED

used be bare. Insulated wire is just as satisfactory, since wireless waves pass through anything, but the added weight of insulated wire requires heavier fastenings at the point of support. Complete working directions for the erection of the aerial will be found on page 26.

You can obtain a clear understanding of the other parts of typical sets by studying them in the order they are encountered by the radio waves passing down through this aerial and the *lead in wire*, which connects it with your receiving box.

The Tuning Coil

The first piece is the *inductance* or *tuning coil*. This is merely a number of turns—varying from 25 to 200—of insulated wire, about No. 22 gage, wound closely around a fiber or cardboard tube. At every 5 or 10 turns a connection is taken off and carried to a small switch with rotating handle, or knob. By turning this handle, contact may be made with the different points, so that a greater or lesser number of turns of the coil are connected with the aerial. The purpose of this tuning coil is to make it possible for the listener-in to increase or diminish the length of wire used in receiving the signals, so that the latter will be heard at their loudest. The secret of *tuning*, which you hear so frequently mentioned, simply lies in this adjustment of the length of your receiving wire, so that it will bring you only the radio waves you want to hear.

Next to the tuning coil is the *fixed condenser*. This is a part seldom seen, and never touched. Often it is not in evidence, being buried in the base of the detector. It is made up of alternate sheets of tinfoil and waxed paper, and functions in the same way that Benjamin Franklin's Leyden jar performed. It receives the minute charges of electricity from the air and stores them up until there are enough to make an impression on the telephone receiver.

THE STANDARD RADIO GUIDE

The detector in the less expensive sets consists of the *crystal*, on which rests the point of a fine wire or *catwhisker*. Sometimes the crystal is silicon, but in general it is galena, the ore from which lead is obtained. In operation, the point of the catwhisker is swung around on the surface of the crystal until, by the sound of the signals received, it is known that a "sensitive" spot has been located. After that, the adjustment is not touched, unless by accident the set is jarred.

Because of the low selling price of some sets it is not possible to supply a complete pair of telephone receivers or *head phones* and only one is sold with the instruments. This is usually a receiver of the "watchcase" type and is inefficient when compared with the special high resistance phones designed for radio.

Describing Some of the Moderate Priced Sets



Without doubt more sets costing around \$25 are in actual use than sets of all other prices combined, and yet they are suitable only for stations within 15 miles of the radio-telephone broadcasting stations. Their principal advantages over the less expensive

A crystal-detector set in the class costing about \$25

WHAT RADIO EQUIPMENT YOU WILL NEED

sets are in the greater range of the tuner and in the addition of a complete pair of head phones of correct design. By correct design is meant those phones having a high resistance of 2000 to 3000 ohms.

The phrase "greater range of tuner" does not necessarily mean that the distance over which a station can be heard is lengthened, but rather that the *number* of stations of all kinds that can be picked up is increased.

If a radio receiving set is being purchased for the purpose of rendering music and concerts loud enough for the family to hear, this will necessitate a loudspeaking device and none of the sets so far mentioned is suitable for this work.

Sets of Greater Refinement

The radio sets costing about \$75 contain an *audion* detector, which takes the place of the crystal detector in the lower priced outfits. A \$75 set is made up of a *vario-coupler* or similar tuning device; a condenser, generally fixed but sometimes variable; an audion or *vacuum tube* with accompanying dry batteries; a storage battery, and the resistance coil or *rheostat* to control the amount of current sent through the little filament in the vacuum tube.

This vacuum tube outfit is from 10 to 100 times as sensitive as the crystal detector. It has the added advantage that it is positive in operation

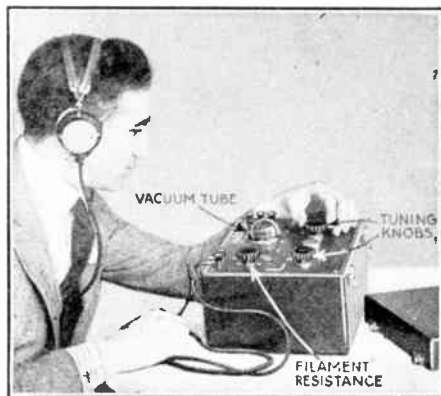

THE STANDARD RADIO GUIDE

Since the vacuum tube will be mentioned frequently in the pages that follow, it will be well to describe it here. The other devices referred to in the preceding paragraph will be described in detail in the chapters devoted to the adjustment of sets.

The vacuum tube is a glass bulb shaped like an incandescent lamp but, unlike the lamp, having in addition to a *filament* two other metallic elements called the *grid* and the *plate*.

The filament, generally of tungsten, gives off, when heated by the current from the storage battery, a multitude of *electrons* or minute negative charges of electricity.

The grid, of nickel or molybdenum in the form of a perforated sheet or a network of fine wires, is connected with the aerial.

The plate, also of nickel or molybdenum, is merely a sheet of metal sometimes flat and sometimes bent to enclose the filament and grid. As everybody understands, an electric circuit must have a *positive* and *negative* terminal to be complete. In the vacuum tube the filament supplies the negative while the plate is arranged to present a positive surface. It is connected with the positive pole of the dry battery.

How the Vacuum Tube Works

To best understand the working of a vacuum tube, consider the filament as being located at one side of the tube and the plate at the other, with the grid between. When the filament is heated by electric current from the battery, the little electrons fly off toward the plate, but in so doing they are forced to pass *through* the grid. The grid acts like a traffic policeman. The waves coming into the grid from the aerial are first positive and then negative, like the alternating current in the home. When the negative half of the wave comes to the grid, it holds up a "stop" sign to the stream of negative electrons from the

WHAT RADIO EQUIPMENT YOU WILL NEED

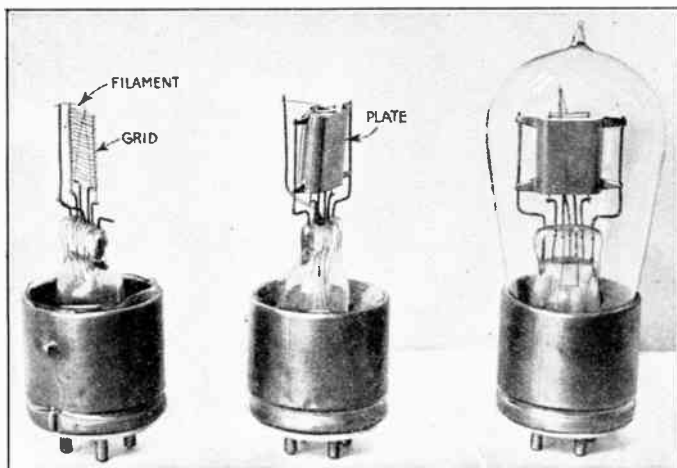

A typical vacuum tube, in three stages of construction. A vacuum tube contains three elements: The *filament* generates electrons, the *plate* receives them and the *grid* controls their flow

filament and refuses to let them pass. An instant later, when the positive half appears on the grid, the electrons are given the "go" sign and they pass to the plate with an added impetus, because the waves on the grid are added to those coming from the filament.

During all this procedure the plate is connected through a dry battery to the head phones and every time the electrons are allowed to pass from filament to plate, they produce an impulse in the phones. These impulses being controlled by the grid, coincide with the wireless waves on the grid and the sound in the phones must therefore agree with those sent out by the transmitting station.

In slightly less technical terms the audion or vacuum tube may be considered as a very sensitive valve which works like a gun trigger. The incoming waves being weak cannot operate the phones, but they are able to trip a

THE STANDARD RADIO GUIDE

trigger, which in turn allows plenty of current from a battery to pass through to work the phones.

In sets around the \$75 price there is often included an instrument marked *tickler*. A tickler is an auxiliary coil of wire wound on or near the tuning coil and is used only with circuits known as *regenerative*. A regenerative circuit is a particular way of connecting the devices comprising a receiving set which makes it possible for signals to be amplified or strengthened in the same tube where they are detected. This is accomplished by making some of the current from the plate pass around toward the aerial, through the tickler and back to the grid, adding its strength to the weak incoming impulses.

When properly installed and operated, these \$75 sets will receive long-distance broadcasts. Records up to 750 miles have been reported, but in general their range should not be considered over 75 miles. Although the wavelength range is limited to less than 1000 meters, it is possible, by adding a suitable *loading* coil, to increase this range sufficiently to permit reception of broadcasts from stations using higher wave lengths. A loading coil is merely a tuning coil containing a large number of turns of wire which, when inserted in the wire leading in from the aerial, has the effect of adding many feet of wire to the antenna circuit.

The Ideal Radio Outfit

The receiving outfits in the general class costing something under or over \$200 cannot easily be improved upon. With almost any aerial and at great distances from sending stations, they will pick up the broadcasts and amplify the weak signals to a strength sufficient to operate a loudspeaking device—thus allowing an entire group to enjoy the concert at once. The tuning facilities insure a minimum of interference from other stations. The sets

WHAT RADIO EQUIPMENT YOU WILL NEED

make a fine appearance and most of them are well built so that once installed they will last for years, or until obsolete.

Assuming that the aerial is a normal one of from 60 to 70 feet in height and 125 feet in length, these sets should permit the owner to listen in on stations 750 miles away.

This type of set consists of a tuning unit used in conjunction with a detector and two special vacuum tubes. Every tube added to the set in this manner is said to add one *stage of amplification*. Even though the electrical circuit employed is complicated to the layman, engineers have simplified matters, and usually the binding posts are plainly marked to enable the beginner to set up the outfit without expert assistance.

Another feature of this "ideal" set is the readiness

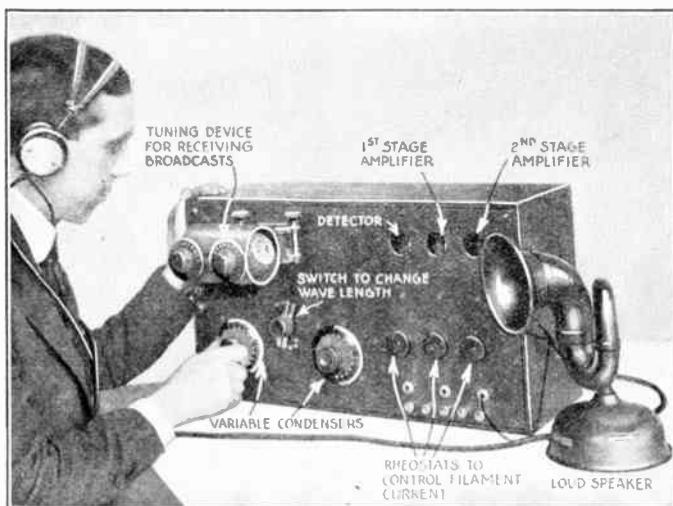

The higher priced set shown above will receive wave lengths from 200 to 20,000 meters. A special tuning device brings in broadcasts with unusual clearness. Note loudspeaker at right

THE STANDARD RADIO GUIDE

with which it may be improved by the simple addition of amplifying units. At the start of the amateur's interest, the two stages of amplification will be sufficient, but many of the more adventurous will want to widen their contact with the world by reaching out for the foreign stations

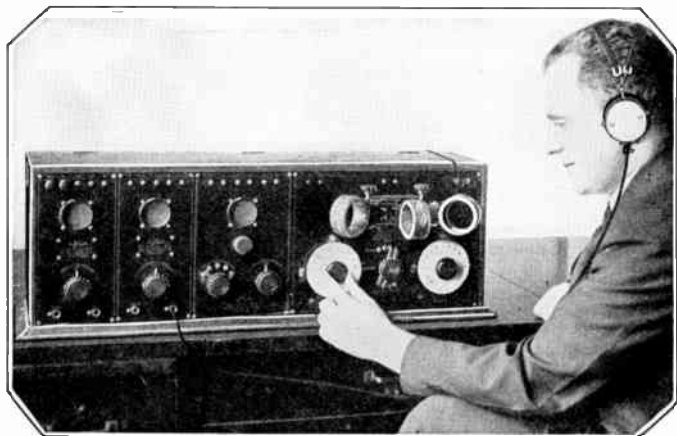

At the upper right of this set are three honeycomb coils, which make it possible to tune in any station by substituting the proper coil. Sets of this quality cannot be bettered for the advanced amateur

and the broadcasting stations at the opposite side of the continent. To operate a station with more than two stages of amplification requires experience, for amplifiers are not particular what they amplify. Not only do they increase the strength of signals, but they treat other sounds in the same way. Static, amateur interference, spark or telegraphic code stations—all are given the same amount of amplification.

Even the tubes themselves are not free from blame. A vacuum tube, when so minded, can produce in the most mysterious way a weird medley of groans, growls, and

WHAT RADIO EQUIPMENT YOU WILL NEED

howls. All this must be anticipated by the station owner who seeks to "step up" the strength of his signals by additional stages of amplification. During the transatlantic tests by the Amateur Radio Relay League the receiving station made use of ten stages of amplification. Six stages are frequently hooked up, but the beginner should forswear intricate sets until he has thoroughly familiarized himself with the peculiarities of the simpler outfits.

CHAPTER V

How to Assemble Your Receiving Set

WHEN the science of radiotelephony has advanced a few years, it will not be necessary to erect an outside aerial. Of course it is possible to do this now with certain types of outfits, but for the beginner it is not to be recommended.

Loop aeriels, consisting of 10 turns of No. 16 insulated wire wound around the outside of a boxlike frame, with the turns $\frac{1}{4}$ inch apart, will produce results with several stages of amplification. Indoor aeriels formed by laying several strands of insulated wire behind the picture molding in the room are also frequently found to give satisfactory returns. But the beginner in radio who wants to be more certain of success should leave these oddities alone and, for the time being at least, put up with the appearance of an outside wire aerial.

In placing the receiving set in the house, the location of the outside aerial will be the deciding factor. It is possible to place the set anywhere and carry the wire from the aerial to it; but if the distance between aerial and receiving set is great, the leakage of high frequency currents will cut down somewhat the operating efficiency of the instruments. In consequence, it is best to place the set near the lower end of the aerial.

Erection of Aerial

The aerial or antenna for receiving purposes is a simple affair to erect. It can be placed in position in an hour's time.

HOW TO ASSEMBLE YOUR RECEIVING SET

Determine on the location of the upper or farther end of the aerial and pace off the distance on the ground in order to arrive at a rough estimate of the length of wire required. Buy a coil of wire of the necessary length, and two small *electrose* insulators. The kind of wire to buy was described on page 16. Fasten one end of the wire through an eye in the insulator and pull through a 10-inch length.

Beginning at a point about 1 inch away from the eye, hold the long length of wire firmly and twist the short end round and round in such a way that the turns lie close together. This will make the neatest and strongest splice. Then, with a short piece of the same kind of wire, make a similar splice through the other eye of the insulator and carry the wire to the tree, building, or pole that is to be one terminus of the aerial. With end securely hitched, the coil of wire can now be unrolled until the lower end of the aerial—the end nearest the receiving set—is reached.

There are two methods of fastening this nearer end. The aerial wire can be cut off short at the insulator and a new wire soldered on for a wire to lead in to the set or, better still, the wire can be passed through the insulator, twisted back on itself several times to prevent wear by friction in the eye of the insulator and then carried direct into the house. By following the latter method there is no need to make soldered joints anywhere in the aerial, since both the aerial and lead-in wires are of one piece.

Simple Lightning Protection

Up to the present few cities have fire regulations governing the erection of aerials for receiving purposes. But the Board of Fire Underwriters, whose authority is recognized throughout the land, have suggested that the aerial, house, and instruments can best be protected from lightning discharges by placing a simple *air-gap* (see accom-

THE STANDARD RADIO GUIDE

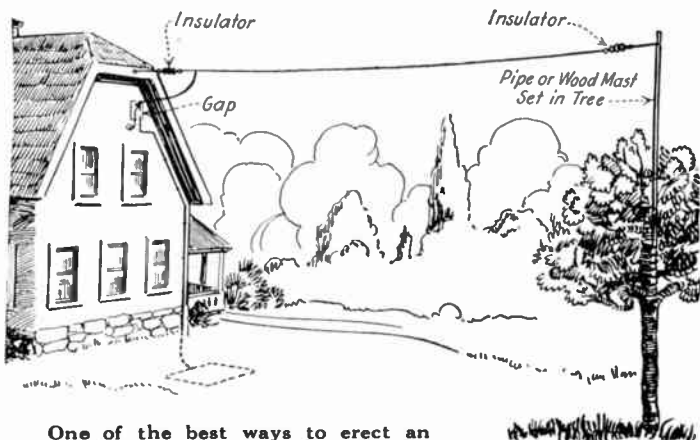

One of the best ways to erect an aerial. A single wire is best for the receiving set. Many other methods of suspension may be used, providing the wire is insulated from all objects

panying illustration) near where the aerial enters the building. One side of this gap should be carried straight down into the ground by means of a heavy copper wire of about the size of a pencil. The gap makes it possible for the waves to pass down the aerial and into the instruments without becoming grounded, while if lightning passes down the same aerial, it will choose to hurdle the gap and surge into the ground instead of taking the longer path through the wireless set and then into the ground. For those who can afford it, an outside switch is nevertheless a good addition to the equipment for the security it gives, if for no other reason. Its only drawback is the fact that it must be thrown to make connection with the ground before the shower arrives—and owners are apt to forget this. In contrast with this, the gap, while not so sure a safeguard, is always on the job and cannot be forgotten.

If possible, the lead-in wire should be brought into the

HOW TO ASSEMBLE YOUR RECEIVING SET

house through a hole drilled into a pane of glass, or else through one of the entrance tubes made for the purpose.

Ground Connection

Next to the aerial in importance ranks the *ground connection*. If a water-supply pipe passes near where the set will be located, it can be used. A radiator makes a second-class ground, but can nevertheless be used with fair success. The large number of pipe joints in heating systems makes them less desirable for radio grounds than the cold-water pipes. The ground connection is made by carrying a wire of No. 10 gage from the set to the pipe and wrapping several feet of the bare wire around a place scraped on the pipe. If the binding can be soldered, the ground will be improved.

If neither of these pipes is available, a ground will have to be prepared by driving a 6-foot pipe into the earth outside the house or by burying a section of wire netting several feet deep. The area of the netting will depend on the moisture in the soil. If the soil is dry, an area of at least 100 square feet will be needed. Any buried ground will be improved by embedding it in charcoal, which has the property of attracting moisture, thus making the soil damp at all seasons of the year.

If a driven pipe is used as a ground, scrape a place near the top for a ground clamp, which is a flexible metal band with patented devices for tightening it about the pipe. The clamp should be soldered in position or protected thoroughly by many layers of tape, otherwise corrosion will render the ground useless.

To Avoid Near-by Interferences

Almost all communities are in a sense a maze of wires, carrying electric current for house and factory lighting. In many neighborhoods high-tension transmission lines

THE STANDARD RADIO GUIDE

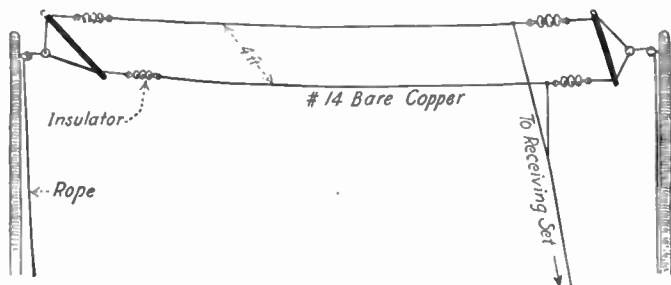

If the amateur is limited to a short aerial, the addition of an extra wire, as here shown, will improve the receiving powers of his station

are common. These seemingly innocent wires can cause a great deal of trouble to the amateur unless he considers and makes arrangements to circumvent them.

In laying out the aerial, the ground should be looked over for such sources of interference and if possible the aerial should be arranged to run at right angles to the course of these lines. When the aerial is suspended in this way, induction from the other wires—that unseen trouble-making electric force—has least effect. On the other hand, if the aerial runs parallel to the high-tension wires, the phones of the receiving station will be constantly assailed by a continuous buzz known as “*inductive hum.*”

Whether or not near-by trolley tracks will have a bad effect on the receiving set can never be foretold. During wet nights there may be some annoyance, but if there are no leaking insulators or bad rail joints, the cars will rarely bother in good weather.

In the suburban districts, where plenty of open spaces abound, there will be no trouble in finding a spot for the aerial, but in crowded city districts the beginner's ingenuity is taxed to arrange for the anchorages of an aerial of sufficient length. It sometimes becomes necessary to

HOW TO ASSEMBLE YOUR RECEIVING SET

string the wire vertically from the building top, down the side wall, with poles projecting from the building to keep the wires away from the walls. Signals can be heard with an aerial of this type, but they will invariably be weaker. Where no other location is possible, the vertical wire will give passable service.

Finally there is the amateur who can neither arrange with his landlord for an aerial on the roof nor secure a permit to hang one outside. His aerial must then be of the indoor type—one of the various forms of "loops."

Probably the most useful inside aerial will be one made by laying three or four strands of wire behind the picture molding of a room. Specially made separators should be purchased to keep the wires about $\frac{3}{4}$ inch apart. The wire should be No. 18 single cotton covered. This aerial can be used with or without a ground attachment, but the ground should be used if possible. If the ground is neglected, the owner will require the special hook-up described on page 65.

The second type of loop aerial is similar to the radio compasses used by vessels to obtain bearings at sea or in foggy weather. Its construction was described on page 26.

CHAPTER VI

How to Adjust Your Set for Signals

NOTE: Consult, on page 50, broadcasting chart and description of the range of various sets, to obtain full information as to what you should receive with the outfits described in these pages.

THE motions which must be gone through in tuning-in a receiving set are similar with both elementary and more intricate types of outfits; but for the sake of clarity the simple crystal detector set will be taken up first.

Crystal Detector Set

It is assumed that the aerial has been erected according to the instructions of Chapter V and that a ground wire of about No. 10 B. & S. gage has been carried from the room where the set will be used to a water pipe or outside ground, and that the connection between the ground wire and the ground has been well made and tightly soldered. The station is now ready to operate.

If the set is one of the types lately improved, the binding posts will be plainly marked. To begin with, take the wire leading in from the aerial, brighten it with knife or sandpaper and insert it in the binding post marked "Aerial" or "A." Place the ground wire on the post marked "Ground" or "Grd." Take the two nickeled tips of the phone receiver and insert them in the binding posts marked "Tel." Place the phones on the head to be pre-

HOW TO ADJUST YOUR SET FOR SIGNALS

pared for any signals. The next thing is to adjust the tuning coil and set the detector.

Most of the compact receiving sets have a tuning coil adjusted by a circular switch. Set this switch at its mid-point and leave it there for the minute. See that the crystal is in the detector. Whether it is a galena or a silicon detector, the mineral will have the appearance of freshly cut lead. Another crystal or a piece of fine wire may be connected in the other part of the detector. With the handle on the latter, place the fine wire on the galena so that it touches lightly. If nothing is heard, move the handle of the tuner and in the new position manipulate the detector. If there are signals or radiotelephone broadcasts in the air, a point will soon be found where they are heard. When they are noticed, leave the detector alone and turn the tuner handle slowly until the signals come in loudest. When this point has been found, experiment with the detector until the most sensitive spot is located. On some crystals there are many such spots, while others have only a few sensitive places. Once the tuner and detector have been accurately adjusted they should be left alone, unless the set is jarred.

Some crystal detector sets are equipped with a tuning device called the *loose coupler* and another called the



The sensitiveness of a crystal detector is seriously affected by dust, dirt and oil. The interesting detector at the left is made with a glass covering over the crystal, to protect it from these substances. The normal receiving range of such a set, properly installed and under favorable conditions, is about 10 to 25 miles

THE STANDARD RADIO GUIDE

This shows the construction of a variable condenser, which consists of two sets of brass or aluminum plates—one of the sets being stationary and the other movable. The movable plates rotate inside the stationary plates without touching them, thus varying the electrical capacity of the circuit



variable condenser. A loose coupler consists of two telescoping tubes, both wound with one layer of insulated wire. The outer coil, called the primary, has a path scraped bare along its entire length on which a sliding contact rests. The inner coil, called the secondary, is entirely separate from the primary. Sometimes the individual turns of the secondary winding are brought outside by means of flexible wires and connected with a circular switch having many contact points, but more frequently the secondary is wound without taps. A circular switch consists of a short, narrow strip of metal held by a

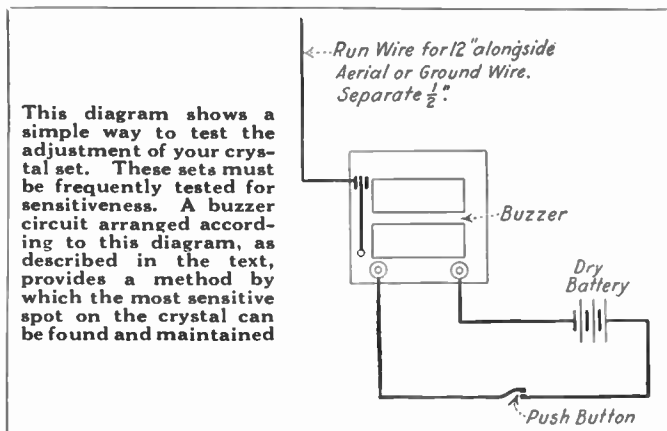

HOW TO ADJUST YOUR SET FOR SIGNALS

pivoting screw at one end and with the other end free to move in a circular path. Along this circular path and separated so that they do not touch one another are a number of flat headed screws. Each screw is connected in order with a tap from the coil winding so that by rotating the switch the number of turns used can be varied.

Tuning is accomplished with the loose coupler by sliding the inner or secondary coil about halfway out and then



A complete receiving layout, as fully described in the text

THE STANDARD RADIO GUIDE

moving the slider on the outer or primary coil until signals are heard. The secondary is then moved in or out until the signals are loudest. The new position of the inner coil may require a second adjustment of the primary before the point of greatest signal strength is located.

A *variable condenser* consists of a series of stationary and movable brass or aluminum plates so arranged that the movable plates may slide between the stationary ones. All of the latter or permanent plates are connected, as are also those that rotate. When one set of plates is all within the others, the capacity (see Glossary for meaning of term) is at its maximum; when the moving plates are all outside, the capacity is zero.

The variable condenser is set at zero until the tuning has been made clear and sharp by means of the loose coupler. Then the condenser is rotated to the point where signal strength is greatest.

The Buzzer Test

It will be apparent that any method of searching for the sensitive spot on the crystal, without knowing when it has been found, unless signals happen to be in the air at the time, could be improved upon. There is a simple attachment by which the detector can be adjusted with certainty and the entire attention given to tuning. All that is necessary is a buzzer, a pushbutton, and a dry cell. Connect the buzzer with the pushbutton and battery as in any bell circuit. Then connect a second wire with the left-hand binding post or the vibrating point of the buzzer and run this wire alongside the aerial wire for a foot or two. When this has been done, it will be noticed that if the pushbutton is pressed when the detector is adjusted, a clear note will be heard in the phones. Thus, when operating the set, the buzzer can be used to tell when the most sensitive spot on the crystal is touched.

HOW TO ADJUST YOUR SET FOR SIGNALS

No harm can come to the coils of the outfit through using this simple test, as the waves are produced by induction from the wire running alongside the aerial wire.

What to Look for if Nothing Is Heard

If no signals of any sort—either radiotelephone or telegraph code—are heard, try out the buzzer test to make sure the detector is properly adjusted. If no sounds are heard even then, the trouble lies somewhere in the set itself. Look over all connections and see that the wires are bright and firmly attached. Be sure that you have placed the different wires in their proper places. Look over the phones, but *do not remove the caps*. If there is trouble with the fine magnets inside the phone cases, they should be returned to the manufacturer. All you can do is to see that the tips of the cord have not dropped out of the holes in the receivers.

It is not always a sure test to touch the phone terminals to a battery circuit. Often they will respond to these heavy currents and refuse any action whatsoever when in a radio circuit. If there is an experienced radio amateur near you, have him try out your phones with his own set, to check up on their sensitiveness. If the trouble does not exist in the phones, then it is hidden somewhere in the coils and the set should be returned to the store.

If the detector will not remain in adjustment, it may be due to too much or too little pressure on it. The surface of galena is quite soft and heavy pressure will flake away the sensitive spot. On the other hand, a pressure that is too light will not hold the fine wire or catwhisker in position, and at every slight jar the wire will move.

If the signals suddenly stop and then start again, repeating the action frequently, there is a bad connection somewhere in the set, probably in the aerial or ground, although a loose phone terminal might cause the trouble.

THE STANDARD RADIO GUIDE

A Variocoupler—The wire-wound ball inside the outer tube of the variocoupler changes its position by rotation. This action is necessary to tune the wave length of the receiving station with that of the sending station. There is no connection between the two coils



How to Tune the Audion Set

The perfecting of the vacuum tube and the developments that have taken place since its advent have opened up a wealth of possibilities. The tube is used in a hundred different ways and with a thousand varieties of hook-ups. So varied are these that in a handbook of this nature it would be impossible to discuss them in detail. The owner of a receiving set consisting of one or more stages of amplification must study the instruction books just as a motor-car owner studies automobile treatises. Our treatment of the "v. t." sets will be confined to outfits using only the tube as a detector.

There are two principal types of vacuum-tube detector sets, the most common being those employing the "straight audion circuit." The second class makes use, by permission, of the patented "*regenerative circuit*," so called.

In the straight audion circuit the tuning facilities are provided by a simple tuning coil, a loose coupler, a variocoupler or a variometer. It is also possible to use two or more of these devices together, as will be noted in the chapter on hook-ups.

A variocoupler consists of two coils, the smaller swinging on a pivot inside the larger. Both are wound with

HOW TO ADJUST YOUR SET FOR SIGNALS

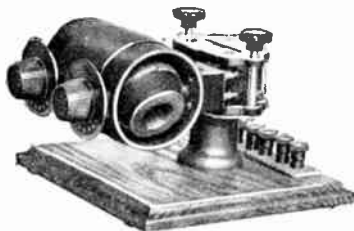

Broadcast Variocoupler—Some sets are not designed to tune-in the broadcasted entertainments. For these outfits a device such as the one at the left is added to the set for this purpose. It consists of a tube with a rotating coil at each end

wire, about No. 18 B. & S., but the only connection between them is by magnetic induction. The two coils in reality constitute a *transformer*, except that the variocoupler "secondary" (the inner rotating part) is able to change its position with respect to the outer coil and yet maintain a short distance between the two coils of wire. This feature is essential to obtain close tuning and high receiving efficiency.

In general, the primary is wound with "contacts" taken off every half dozen turns. These contacts are carried to a circular switch so that the number of turns used may be varied according to the wave length of the station being received. The secondary is seldom tapped. The variation there is secured by rotation.

A variometer appears much like a variocoupler. It has one coil that swings inside the larger one. The principal difference lies in the fact that the variometer coils are connected so that the current goes first through the outer coil, then passes through a short flexible wire to the second coil. When the two coils are parallel, the effect is practically the same as if all the wire had been wound on one coil. But if the inner coil is swung slightly, the inductive force commences to have an effect. The current induced in the inner coil tends to obstruct the passage of the current in the circuit. When the inner coil has been swung one half turn, the induced current will completely obstruct or "buck" the flow of current in the cir-

THE STANDARD RADIO GUIDE

cuit. By altering this "bucking effect," the induction in the circuit is changed to supply the exact amount required to give the receiving set the desired natural wave length.

With every audion set, whatever its characteristics, a storage battery of 6 volts, a low-voltage resistance and one or more cells of $22\frac{1}{2}$ -volt dry batteries, generally called *B batteries*, must be used. The storage battery is used to heat the filament of the tube. The resistance, or rheostat, controls the current passing through the filament and the dry cells supply the voltage in the plate and phone circuit.

In this connection it should be clearly understood that the vacuum tube will not detect unless the plate is con-

A Variometer — Variometers provide an additional tuning device with fine graduations. In this instrument the inner and outer coils of wire are connected by a flexible cable

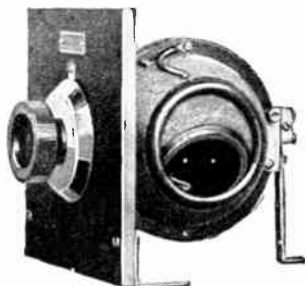

nected with the positive pole of the $22\frac{1}{2}$ -volt B battery. An easy way to remember this is to consider the two p's (plate and positive) as going together. It is advisable to make certain that the filament is properly connected also, although a difference in the polarity will not entirely eliminate the signals. The grid is always connected with the wire leading from the tuning device.

The procedure to employ in tuning an audion set is really simpler than in the case of the crystal detector set. In order to protect the tube many firms advise connecting the aerial with the ground just before connecting the aerial with the receiving set. This carries off any heavy

HOW TO ADJUST YOUR SET FOR SIGNALS

charge that may have accumulated on the aerial during its period of inaction.

The first thing to do is to see that the filament rheostat is at its "zero" position before connecting the storage battery, otherwise the rush of current through the filament would surely burn it out.

Don't Burn Vacuum Tube Too Brightly

"Light up" the filament slowly by rotating the rheostat handle. Do not let it burn brightly. This is not necessary to get good results. Place the phones on the head and adjust the tuner. If you have arranged the buzzer testing equipment, this should be tried to see that the vacuum tube is functioning. When this has been tried and proved, no further attention need be paid to the tube. Simply move the tuning device until the signals are brought in at their loudest.

Sometimes stations sending telegraphic code can be readily picked up, but no radiotelephone broadcasts. If this is the case, first make sure that some station which you should hear is on schedule. Listen for it at the lowest point on the tuning coil. If nothing can be heard, it is probable that the wave length of your station is too high. Many broadcasts are sent on 360 meters and if your set will not tune down below 400, it is certain that you would hear nothing. All that is required to correct this fault is the insertion of a variable condenser in the wire leading to the ground. Cut the ground wire and place the cut ends on the variable condenser. By throwing out the plates and then gradually swinging them in, the broadcasts will finally be heard.

If it is ever desired to listen in on a station of considerably longer wave length, the same variable condenser can be used, but its location should be *around* the primary of the tuning coil.

THE STANDARD RADIO GUIDE

Troubles with an Audion Set

After you have learned the ways of radio you will not hesitate to speak of "oscillations" in the vacuum tube. But as they are neither heard nor seen, it is not always easy for a beginner to determine if his tube is doing its duty. There are many kinks used by experienced operators. One is to wet the finger and press firmly on the bulb. If the tube is oscillating, it will buzz angrily in the phones. But the best and most reliable method is to hook up a simple buzzer as described above in this chapter and note whether the tube responds to local signals.

If the tube will not function, look first to the connections of the A (storage) battery and B (dry) battery. See that the positive terminal, marked +, of the B battery is connected with the plate of the vacuum tube. Trace out the storage battery wires and make sure that the positive wire is connected with the binding post on the tube socket or cabinet marked +. If there is more than one cell in the B battery, look over the connections to see that the cells are not bucking one another as would happen if the plus terminals were not connected with the minus posts.

With all the connections checked, there is still the possibility that the voltages of the batteries may not be up to normal. The one and only way to prove this is by means of a low voltage voltmeter, an instrument that should be in the tool kit of every owner of v. t. stations.

Assuming that all these possibilities have been traced down without result, the trouble lies either in the improper manipulation of the tube circuit or in a faulty tube. If you are in the habit of burning your tube at high brilliancy, try it at cherry red; or if you have refused to shorten the life of your tube by burning the filament at white heat, try it out at that current density. It may be that the tube is one that demands full voltage.

HOW TO ADJUST YOUR SET FOR SIGNALS

Vacuum tubes are wonderful devices, but they have more whims than all other apparatus combined, and it is only by careful, thoughtful experimentation that a station owner learns how to get the most from his outfit.

A Test for Vacuum Tubes

And, lastly, if none of the foregoing suggestions brings results, take your tube to a radio store where broadcasts are being received and have it substituted for one of the tubes in the demonstration set. This method will detect faults instantly.

All vacuum tube sets must be sensitively controlled. Remember that you are dealing with electrons—the smallest possible particle of electricity—and that it requires but little external force to send them on the wrong path. A crystal set can be roughly handled without lasting results, but a vacuum tube must be nursed along during its entire life, which under proper supervision should be over 1000 hours. Turn on the filament current slowly. When through with the set, don't disconnect the battery until the filament rheostat has been turned back to zero. The possibility of trouble does not lie in cutting off the current suddenly, but rather in the chance that when the station is next opened the position of the rheostat will be overlooked and the full 6 volts thrown into the filament.

Many of the audion sets now sold in cabinet form have the unusual Armstrong regenerative circuit, named after its inventor, Mr. E. H. Armstrong, and licensed by him for amateur use.

In the regenerative circuit, as mentioned previously, the potential on the plate of the tube is led around and fed back to the grid. As the plate potential depends on the grid potential, it will be seen that the regenerative circuit does what its name implies, *viz.*, feeds back and regenerates or strengthens the incoming signals. The

THE STANDARD RADIO GUIDE

advantage of the regenerative circuit is computed to be equal to one stage of amplification. Thus a regenerative circuit with one stage of amplification would be the equivalent in actual signal strength of a non-regenerative outfit with two stages.

In regenerative circuits there will be found a coil termed the *tickler*. Many station owners are using a tickler today without knowing its functions or how it is placed in the set. This is not important, but an understanding will enable the operator to produce better results.

The tickler is a small coil entirely separate in most cases from the primary and secondary of loose coupler or variocoupler and placed near one end of these tuning devices. In sets receiving only the short waves from broadcasting stations, the tickler coil is about the same size as the secondary of the coupler. This coil picks up some of the magnetic lines of force and adds the potential thus induced to that of the plate.

Manipulation of Dials

In adjusting a regenerative set, the tickler is held at zero until after the signals are brought in as loud as possible with the other tuning devices and then varied until the regeneration is at its maximum. When this has been reached, it may be necessary to tune still finer with the variable condenser and sometimes with the loose coupler or variocoupler.

For the benefit of those to whom the inside of a receiving set is a complete mystery and who are principally concerned with "making the thing talk," the different steps in setting up and adjusting a vacuum tube receiving set consisting of a regenerative circuit with two stages of amplification, will now be discussed.

The tuning knobs and dials will be found at the extreme left of most sets. There will be notations under them:

HOW TO ADJUST YOUR SET FOR SIGNALS

“Tuner,” “Vernier” and “Tickler.” Follow the directions with the set as regards the connections from the A and B batteries to the cabinets. If a loudspeaker is used, connect it with the terminals marked “Second Stage.” Do not plug the phones into the terminals except at the detector, unless you wish to pick up distant signals and are sure that no local station of high power is transmitting. The danger is not to the instruments but to the eardrums.

To Control Current in Tubes

At some place on the detector cabinet will be found a knob or dial marked “Fil. Rheo.,” or with the words, “Increase-Decrease.” These terms, or any variation of them, refer to the resistance coils controlling the amount of current through the several vacuum tubes.

When the set is ready, turn the filament rheostats from the zero point slowly and watch the vacuum tubes through the porthole in the cabinet. Do not turn “full on,” but try it first at the three-quarters point. Sometimes one dial controls both tubes in a two-stage outfit; this simplifies operation, but for general work the separate rheostat on each tube will permit of closer control.

When the detector tube and the two amplifying tubes have been brought to three-quarters brilliance, leave them for the moment and give attention to the tuning cabinet.

Set the *tuner* so that the pointer is at the center of the scale. This applies to short-wave sets only. Leave the vernier at zero. Listen closely and if no sounds are heard, turn the tuner slowly, first toward one terminus and then toward the other. If you are testing out your set during the evening, when there are broadcasting stations in operation, a point will be found where signals, perhaps faint, will be heard. Adjust the dial until these sounds are loudest. Move the dial marked “Vernier” until the

THE STANDARD RADIO GUIDE

signals reach their maximum and then do the same with the tickler. A great difference in the signals will now be noticed. When the sounds have been brought to their highest intensity, go back to the vacuum tubes and carefully manipulate the rheostats until the signals are clear cut and the words or music well toned. Make a note of the settings of all dials and knobs. A knowledge of this will help you in tuning thereafter.

The foregoing detailed description of the procedure will, of course, vary somewhat with every set, as the different circuits employed make use of a variety of instruments, but in general the order to be followed is the same. As has been stated so often before in these pages, it is only by constant experimentation that the fine points of a set can be learned.

Loudspeaking Devices

When broadcasted concerts, musical programs, and speeches can be sufficiently amplified to permit it, the radio amateur's equipment, to be complete, will include a loudspeaking device. The loudspeaker delivers the sounds loudly enough for all those assembled in the room to hear. It is particularly well suited for halls and auditoriums and for dancing in private homes. There are many such devices on the market varying in price from \$5 to \$100 or more. None will work with a crystal detector.

The simplest loudspeaker consists of a simple megaphone horn shaped with a special attachment in the base to take a phone receiver. Two stages of amplification will increase the intensity to a point where the phone in the base will vibrate loudly and the sounds passing through the tone chamber of the horn are further increased in volume. These horns find their greatest application where it is desired to entertain a small roomful of listeners. Unless many stages of amplification are added, it would

HOW TO ADJUST YOUR SET FOR SIGNALS

be inadequate for dancing or for auditoriums, for which purposes other models are used.

Loudspeakers delivering the sound in greater volume work on an entirely different principle. The electric wave impulses are strengthened and made to vibrate a delicate diaphragm suspended between two magnet coils. The movement of this diaphragm is communicated to a larger diaphragm by means of a series of levers. The levers magnify an infinitesimal movement of the delicate diaphragm many times. Between these two extremes of loudspeakers are a score of others using the principle of one or the other or in combination.

Pertinent Suggestions

In fairness to the industry as well as to the individual purchaser of radio equipment, there are several points connected with the merchandizing of radio receiving sets that should be borne in mind.

Nine out of every ten beginners ask the salesman this pertinent question, "How far will this set receive?" In reply the salesman frequently says: "A man living 150 miles away from KDKA (or other broadcasting station) is using one of these sets and gets all the broadcasts."

Such a statement should not be taken literally. Because one man is able to hear 150 miles with a particular set, it does not signify that another can do it. As a matter of fact, *the receiving range of a set is not a fixed quantity*. Once in a while an amateur hears POZ—the powerful German station at Nauen—and does it all with a crystal detector. Others less fortunately situated cannot cover 50 miles with a similar set.

It is easy to learn how far a set *ought* to receive and base the purchase on that, but there is no surety, and none can be given, that a set in itself will perform over a specified number of miles. For, remember: the trans-

THE STANDARD RADIO GUIDE

mitting station has a great deal to do with it, also the country over which the signals must travel. As one concrete example: A well known broadcasting station is regularly heard in Canada—400 miles away—but in a city 60 miles distant only the most sensitive sets are able to pick it up. Why this is has not yet been satisfactorily explained. It may be due to metal deposits in the ground that filter off the waves, or it may be caused by natural screens of a type so far unrecognized.

Don't expect too much of a loud speaking device. Many give excellent results, but a vacuum tube set with two stages of amplification is generally necessary.

There is one safe rule to follow in determining the type of set to install. It is, "Learn what others in the vicinity are using." Find an amateur near by and visit his station. Learn from him at first hand what instruments are needed to receive broadcasts. Listen in on his equipment and decide for yourself whether you would be satisfied with a station as good as his or would need a better one.

Among all radio enthusiasts there is a strong link of friendship and courtesy and it is seldom that one meets an amateur who is unwilling to help his brothers in every possible way. With the assistance now available in every state from coast to coast there is no reason why the beginner should not capitalize it. In doing so he practically assures himself of success.

CHAPTER VII

What Radio Stations You Can Hear

THE information on this page, and reference to the map on the following page will give you an idea of what great broadcasting services cover your vicinity, and what sort of radio set you should purchase to hear them.

If your aerial is properly erected, your set efficiently installed, and atmospheric conditions favorable, you should be able to hear:

10 miles with a crystal detector outfit, costing about \$15 to \$25

50 miles with a vacuum tube set, costing about \$60 to \$80

200 miles with a two-stage set, costing about \$130 to \$175

500 miles with sets costing \$250 and over

Any one of these sets may prove to have a much greater range than indicated.

Leading Broadcasting Centers

Some of the leading broadcasting stations shown on the map (page 50) together with their call letters, are the following:

- KDKA—Westinghouse Elec. & Mfg. Co., E. Pittsburg, Pa.
- WJZ —Westinghouse Elec. & Mfg. Co., Newark, N. J.
- WBZ —Westinghouse Elec. & Mfg. Co., Springfield, Mass.
- WWZ —John Wanamaker's Store, New York, N. Y.
- WVP —Signal Corps, Fort Wood, Bedloe's Island, N. Y.
- WGY —General Electric Company, Schenectady, N. Y.
- WGI —American Radio & Research Corp., Medford Hillside, Mass.
- NOF —Government Station, Anacostia, D. C.
- KYWA —Westinghouse Elec. & Mfg. Co., Chicago, Ill.
- WHA —University of Wisconsin, Madison, Wis.
- 9VA —University of Iowa, Iowa City, Ia.
- WOQ —Western Radio Co., Kansas City, Mo.
- 9YY —University of Nebraska, Lincoln, Nebr.
- WRR —City of Dallas Station, Dallas, Texas.
- 5ZU —State University, Austin, Texas.

(Concluded on page 51)

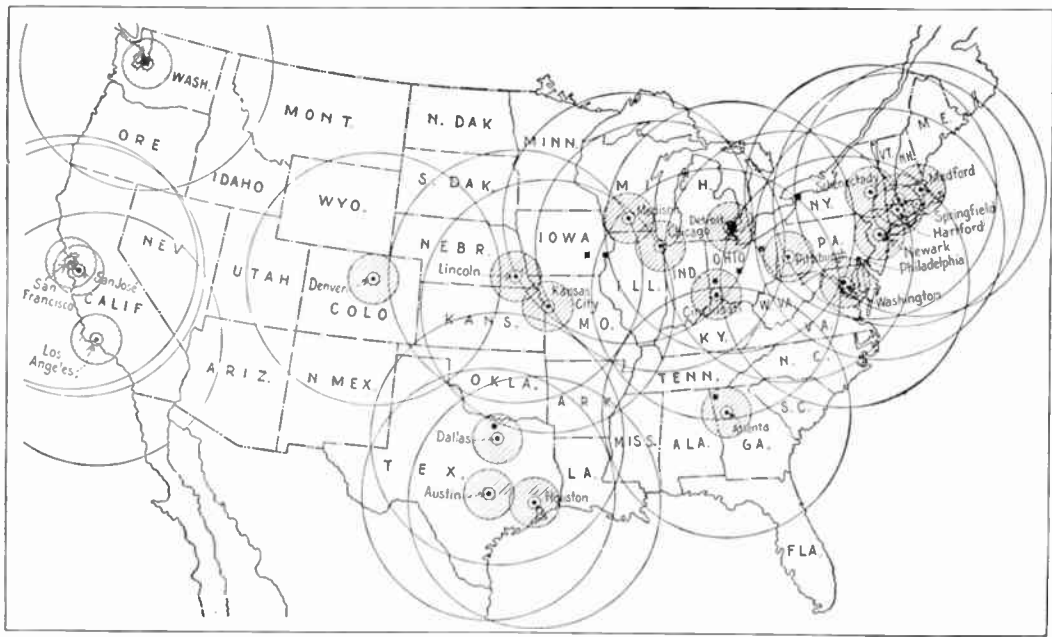

50

Broadcasting map of the United States, showing the most important stations that transmit radio entertainment. For details, see pages 49 and 51

WHAT RADIO STATIONS YOU CAN HEAR

(Concluded from page 49)

WRW —Tarrytown, N. Y.
WWJ —Detroit News, Detroit, Mich.
WLB —University of Minnesota, Minneapolis, Minn.
KZY —A-P Radio Supplies Co., Rockridge, Oakland, Cal.

On this broadcasting map the average range of each station, under normal conditions, is indicated by the circles. The small inner circle represents a 25-mile radius, the limiting distance of a good crystal set. The shaded circle, with its 100-mile radius, denotes the territory that can be covered by a single vacuum tube set. The large outer circle of the 500-mile radius represents the receiving range of outfits costing around \$200.

The Standard Broadcasting Map

A larger broadcasting map, giving more complete details, has been prepared by POPULAR SCIENCE MONTHLY for amateurs who wish to maintain a record of radio stations heard. This map shows the outlines of the states in size large enough to permit the use of tacks to indicate the location of stations. The price is 25 cents.

Further information regarding this map, or any of the broadcasting stations, can be obtained from the Information Department, Popular Science Monthly, 225 West 39th St., New York, N. Y.

CHAPTER VIII

How to Make a Crystal Detector Set

NOTE—The symbols used in the wiring diagrams in this and following chapters will be made clear to the beginner by reference to pages 12 and 13.

ALL who have read carefully the foregoing chapters will realize at once that this set is suitable only for amateurs living within 15 miles of the broadcasting stations. If the aerial to which it is connected is better than the average, a crystal detector set of this type can often be made to pick up concerts and other phone broadcasts 20 or 25 miles away, but the chances are against it.

The crystal detector does not admit of so many variations in hook-ups as the audion, but in the circuit about to be described the detector has been inserted in the tuning circuit in a manner that makes possible extremely sharp tuning.

To begin with, secure two pieces of cardboard tubing, one piece 3 inches in diameter and 2½ inches long, and

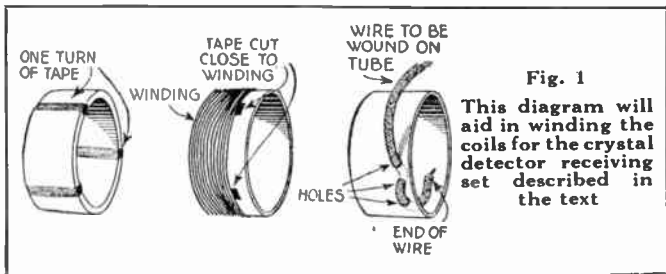

Fig. 1

This diagram will aid in winding the coils for the crystal detector receiving set described in the text

HOW TO MAKE A CRYSTAL DETECTOR SET

Fig. 2

The tuning coil for this set is unique and simple to construct, in that the secondary does not rotate inside the primary, but beside it

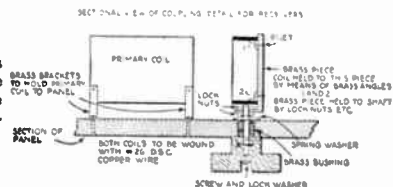

the other $2\frac{1}{2}$ inches in diameter and $1\frac{1}{2}$ inches long. Wind with short strips of tape as illustrated in Figure 1. The idea of the tape is to make the coil winding easier by providing a yielding surface to grip the wire.

Buy $\frac{1}{2}$ pound of No. 26 double cotton covered magnet wire. The same size is used on both coils. On the larger tube, marked L_1 in the drawings, wind 105 turns, taking taps off at the twentieth, fortieth, and sixtieth. These taps can be best taken off by using a small gimlet to punch a hole in the tube through which a loop of the wire is led. In this way the tap can be taken off without cutting the wire. A simple method of anchoring the wire at the start and finish is shown in Figure 1. It consists in making three small holes in a row and drawing the wire down and up through the openings, thus clinching them rigidly.

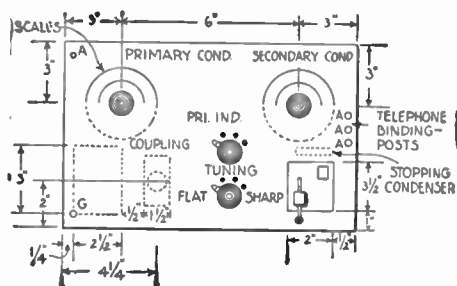

Fig. 3—One type of layout for the panel front

THE STANDARD RADIO GUIDE

The secondary coil, L_2 , is formed by winding 60 turns with taps taken off at the fifteenth, thirtieth, and forty-fifth turns. When completed, the secondary is attached to a special suspension, which allows it to be rotated by its coupling knob. The distance between the primary and secondary coils has been selected so that when rotated at right angles the coil L_2 will pass slightly within the opening to L_1 .

The detail of the detector is sufficiently plain without going into further instructions. The base may be made

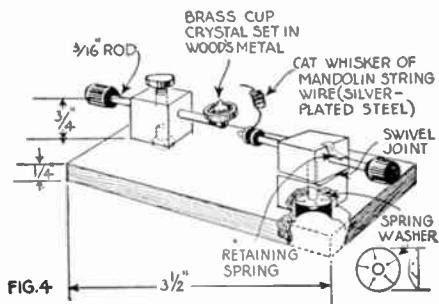

FIG. 4
A simple crystal detector that can be made with familiar tools found in any home workshop

of wood or any of the composition boards on the market. The $\frac{3}{4}$ inch square brass supports will need some machine work for the swivels, but if this is difficult to obtain, the novice should understand that a deviation from the details will not affect the operation of the set as a whole.

For the detector crystal, either galena, silicon, radiocite, or the double crystals—zincite and chalcopyrite—may be used. The crystal is held in a small metal cup by Wood's metal or any other low melting solder. By means of the knob the cup may be turned in any position and held there by the set screw.

HOW TO MAKE A CRYSTAL DETECTOR SET

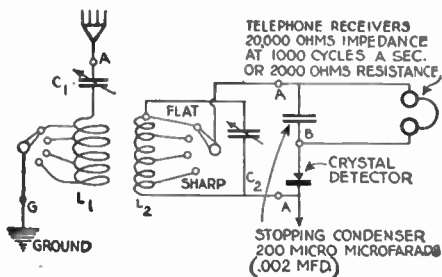

Fig. 5—Wiring diagram of crystal detector set described in this chapter. Its receiving range is limited to 25 miles

The catwhisker is adjusted by turning the handle or sliding the rod through the support. The brass spring is fastened to the support and presses on the catwhisker rod so that it will stay put in any position. The rod is also capable of swinging on the swivel, which is made to stay in any desired position by the spring washer.

By purchasing two switch knobs and four switch contacts for each knob, the taps that were taken off from primary and secondary coils can be led to the rotary switches and the tuning controlled from the panel. With this done it is necessary to purchase two variable air condensers of .00075 microfarad capacity each, to complete the set.

Figure 5 shows a diagram of connections. It will be seen that the detector, instead of being connected directly across the secondary, as is generally done, is placed across only a portion of it. This feature lifts the set from the ordinary and gives it a selectivity that can be improved only by a well adjusted vacuum tube outfit.

CHAPTER IX

How to Make a Vacuum Tube Set at Home

ALTHOUGH the inherent sensitiveness of the vacuum tube detector is greater than that of the crystal detector, this difference is not considered as having as great weight as the fact that the vacuum tube outfit can be expanded by adding parts until it is as sensitive and selective a set as one could wish. Expressed in percentages, the vacuum tube may be 50 per cent more sensitive than a galena detector, but the signal strength from the latter is fixed and can be but slightly improved, while the impulses from a vacuum tube can be "stepped up" repeatedly by adding stages of amplification.

This set was designed to be made in the home workshop. The types of coils have been selected because they can be wound at home and mounted out of odds and ends already at hand. The wire, the vacuum tube, the storage and the dry batteries must be purchased, but the total cost of these parts will not exceed \$30. When finished, the set will equal those on the market costing \$100.

To begin with, buy $\frac{1}{2}$ pound No. 22 single cotton covered magnet wire. The same wire is used on all the coils. Procure a cardboard or fiber tube 15 inches long and 4 inches in diameter and cut it into three equal sections. In addition, you will need a 9-inch length of $3\frac{1}{2}$ -inch tubing, cut as before in three sections.

Take one of the large tubes and beginning at a point 1 inch from the end, wind on the wire in one layer until you have 50 turns. At the start take off a tap every turn for 10 turns and thereafter only at every tenth turn. The

HOW TO MAKE A VACUUM TUBE SET AT HOME

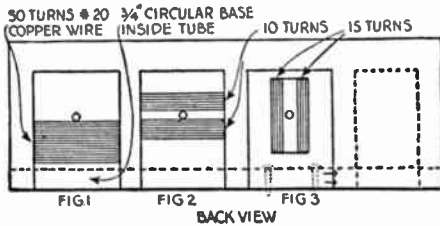

Back view of vacuum tube set, showing the variocoupler and two variometers in place

best way to take off taps is to punch two holes under the wire, then push through a loop, bringing the loop up again through the other hole. Leave about 4 inches of the loop outside for attaching to the switch.

The taps from the first 10 turns are carried to a switch called the "units switch." The taps from the other turns are connected with a "tens switch." Thus, if it is desired to use 46 turns on the primary coil, the "tens switch" would be placed on the fourth point and the "units switch" on its sixth point. This arrangement permits of close tuning.

When the primary has been completed, take one of the small coils and, commencing about $\frac{1}{2}$ inch from the edge, wind on 15 turns, then fasten the wire solid by passing it down and up through two holes, but do not cut the wire. Leave $\frac{1}{2}$ inch, then carry the wire across the gap thus

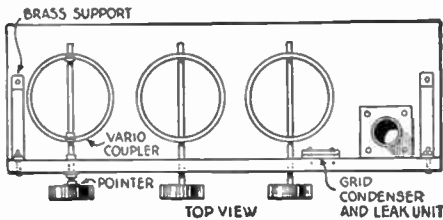

View of the vacuum tube set, looking down upon the apparatus

THE STANDARD RADIO GUIDE

left and wind on 15 more turns. The gap is for the brass rod that passes through both primary and secondary coils. When both coils have been completed, insert an 8/32-inch threaded brass rod, slipping on nuts to hold the secondary firmly to it. On one end of the rod attach a knob of some sort so that the secondary may be revolved. This completes the variocoupler. The next items are the two variometers, both alike and without taps.

On the large tubes wind 20 turns of the wire, 10 turns on each side of the swivel rod. On the small tubes wind the same as for the variocoupler. Insert the brass rods and connect one end of each larger coil to its corresponding small coil, making one continuous winding. All that is now necessary to finish the set are the vacuum tube, the grid condenser, and the batteries. The most expensive of these is the storage battery, but often it is possible to use a 6-volt storage battery from the automobile.

A vacuum tube requires about one ampere. This means that a storage battery of 80-ampere hour capacity

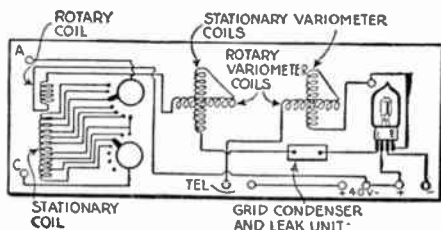

Wiring diagram for the vacuum tube outfit

should operate a tube for 80 hours on one charge. The best dry cells are those sold especially for radio under the name of B batteries. The voltage required is about 22.

Although it is not necessary, a panel on which the switches and knobs are mounted improves the appearance

HOW TO MAKE A VACUUM SET AT HOME

A suggestion for laying out the front of the receiving panel in the vacuum tube set

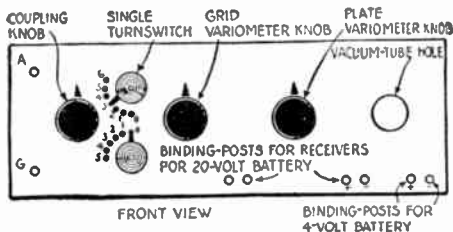

of a set. The panel may be of hard wood, fiber, hard rubber, or any of the patented compositions on sale at radio shops. Plan out the appearance of the front and then bore holes for the rods. When completed, the panel will look like the sketch above.

The diagram of connections for this set is shown on page 58 and the method of setting up the set and adjusting it may be copied from Chapters V. and VI.

Observe These Warnings for Success

In conclusion, it would be well to heed the following warnings:

Don't try to hook the filament of the vacuum tube to the house-lighting circuit, even when a toy transformer is used.

Don't expect to throw the parts together and still get good results. Professional workmanship is not essential, but the outfit will reflect the intelligence used in assembling it.

Don't be afraid to use solder when making connections. The vacuum tube will notify you of all bad connections by a persistent series of groans and squeaks.

Don't expect to hear 500 miles with the set. You will need several stages of amplification to do that. Master this simple set first.

Don't stint your aerial on your ground. The higher and longer an aerial can be made, the better and farther

THE STANDARD RADIO GUIDE

you will receive. A ground can never be quite good enough unless you have access to a deep well and can drop a wire into the water without a long run.

Careful study of this entire guide will make it apparent that the task of constructing your own set is not so difficult as may seem at first glance. If, however, any reader encounters problems that he cannot solve, a clearly worded letter to the Information Department of POPULAR SCIENCE MONTHLY will bring him all help within the editor's power to give, while in the columns of the magazine itself he will find much additional information of prime value to all interested in radio.

Vital Help in Making a Vacuum Tube Set

COMPLETE working drawings of an efficient radio set, with two stages of amplification, normally having a possible receiving range of several hundred miles, have been prepared in blueprint form by the radio experts of POPULAR SCIENCE MONTHLY. This sheet, containing bill of materials, dimensions in detail, and other necessary helps to the beginner, is obtainable from the Blueprint Editor of POPULAR SCIENCE MONTHLY. Send 25 cents and ask for Blueprint for Vacuum Tube Set.

No matter how helpful a textbook may be to the new radio fan, individual problems often arise that require special attention from an expert. The Information Department of POPULAR SCIENCE MONTHLY stands ready at all times to give help along these lines to readers.

CHAPTER X

A Few Facts about Transmitting Sets

A CERTAIN percentage of amateurs will not be satisfied with possessing only a receiving station, but will feel that the cycle of their enthusiasm must be completed by adding a transmitting set. This certain percentage is sure to be pretty well scattered over the country and, lest the attempts of these amateurs to transmit interfere with the broadcasting activities of the commercial companies, the government will no doubt find it necessary to step in with strict regulations governing the design and operation of sending outfits.



What an amateur music broadcasting station looks like. The horn conveys the sounds to the sensitive transmitter and vacuum tube

Get this Blue Print and Make **\$125 Set for \$40**

This blue print presents a two-stage regenerative receiving set complete with working drawings, instructions, and bill of materials, that a professional would be proud to own; it is the equal of any on the market. It comprises an Armstrong variocoupler and two-variometer-regenerative tuning circuit coupled, if desired, with two stages of audio frequency amplification. The tuning coils have been selected because of the ease with which they may be constructed at home.

In this set have been incorporated the best features of several types of outfits. It will tune from 180 meters to about 600 meters. It should hear for 500 miles.

Price 25 Cents, Postpaid

Popular Science Monthly, 225 W. 39th St., New York

Needed with Every Radio Set! *Popular Science Monthly's Standard* **BROADCASTING MAP** *of the United States*

You need it before and after buying a radio set, *because:*

It shows just what radio programs can be heard in your region; it explains the kind of receiving set you must buy to hear them.

It shows you all the big broadcasting stations you should try to "tune in" on; it gives you their call letters; it gives you their addresses, so you may write for complete programs; it helps identify the new stations you pick up by chance.

Every owner of a radio receiving set discovers sooner or later that the Standard Broadcasting Map of the United States is a necessary part of his equipment.

You can get yours NOW by writing for it to Popular Science Monthly, 225 West 39th Street, New York City, enclosing 25 cents.

A FEW FACTS ABOUT TRANSMITTING SETS

One fact is quite certain and that is that if amateurs are allowed to broadcast telephonic material, they will be restricted to the lowest possible wave length—somewhere between 100 and 200 meters. Such a law would work automatically to discourage them, since resources and ability would be taxed to keep the wave at this low figure.

Admittedly, a transmitting station is a worthy adjunct to a good receiving station, but the cost of installation and the later cost of upkeep and operation will deter most amateurs from attempting it.

A commercial broadcasting station costs about \$10,000 to install and about twice that amount in yearly expenses, not including the small fortunes paid to artists whose talents are sent out on the air.

An amateur transmitting station with a range of 75 miles costs approximately \$1000, and the replacements of power vacuum tubes added to the current cost, if the station is much used, would consume an equal amount yearly.

For the present, while the science is developing so rapidly and the regulations of both amateur and commercial stations are in a state of flux, it would seem undesirable for the average beginner to think of adding a transmitting set. Prudence suggests that he leave the important work of supplying entertainment to those companies able to do it best. The amateur in his own way can make radio-telephony more valuable to the world by extending the benefits of his receiving set to others who are not so fortunate as to possess the necessary apparatus.

CHAPTER XI

Important Tricks and "Trouble Spots" in Radio

ONCE you have been using a radio receiving set for a short time, you will find that there are numerous variations in the layout of the set that may make it serve you more satisfactorily. You will learn, also, of many "trouble spots" to watch over especially, and will discover little tricks that insure better reception or do away with some of the minor troubles that frequently plague the beginner.

The diagram on page 65 will help you, as you become more familiar with the pastime, to experiment with several of the most effective "hook-ups," while the following paragraphs in this chapter will prove of assistance in tracing the cause of unsatisfactory reception, or in getting the maximum of enjoyment out of the radio outfit, with a clearer understanding of the principles involved.

The Aerial

THE aerial must not touch a tree, building, metal roof, drainpipe, or other wire. Dry wood is a fairly good insulator, but if the lead-in wire comes within a few inches of a metal plate that is grounded, the loss of signal strength will be marked.

ARE your aerial and ground wires attached to the proper binding posts on the receiving cabinet? In many sets these wires can be interchanged without affecting the operation, but in others it is necessary to follow the de-

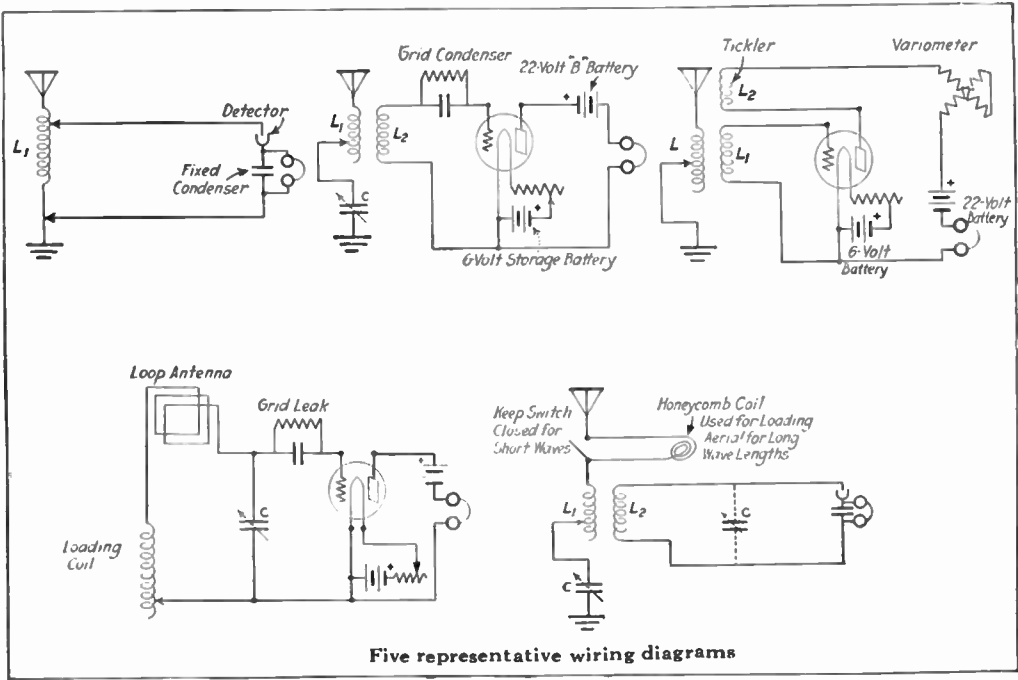

THE STANDARD RADIO GUIDE

designer's plan, and beginners frequently make the wrong connection.

How to Get the Longer Waves

THE prompt action of the Federal authorities in inquiring into the conditions of the ether caused by the radiotelephone broadcasting system has done a great deal to place the new form of entertainment on a sound basis.

One of the important results of the conference, however, is the desire it has created in the army of radio novices to listen to long-wave stations.

In a general way, there is only one means of doing it, and that is by the use of loading coils. Loading coils are simply coils of wire, similar in every way to ordinary tuning coils. They add a certain amount of wire in condensed form to the aerial wire, thus increasing the total amount of inductance in the tuning circuit.

In the first place, if you are using a simple crystal detector with a single coil, it is a simple matter to put a honeycomb coil in the aerial circuit in series with the usual tuning coil. In this case the honeycomb coil will have to have sufficient inductance to make up for the difference between the normal wave-length range of the receiving set and the wave length of the station you wish to listen to. Consult a dealer.

In the case of the more elaborate sets using vacuum tubes, it is not so easy to decide just where the loading coils should go, but it is a pretty safe bet that you will get the desired results if you load up the aerial, as in the simple sets just described, but with the addition, also, of a similar coil in the plate circuit. In the latter case it will be necessary to experiment until just the right position between the primary loading coil and the plate loading coil has been obtained, because a regenerative action takes place between them. Here, again, an expert's personal advice will be helpful.

CHAPTER XII

GLOSSARY OF RADIO TERMS

- Ampere**—The term used to indicate the volume of current flowing through an electric circuit. Corresponds to the *quantity* of water in a pipe line.
- Capacity**—A property of electricity, varied in receiving sets by means of the condenser.
- C. W.**—Continuous wave. This is the wave form generated by a properly controlled vacuum tube circuit. The length of a C. W. is definite, making it possible for a larger number of C. W. stations to use the air at one time without undue interference.
- Damped wave**—A wave whose oscillations decrease rapidly in amplitude.
- Electron**—The smallest electrical particle known. Electrons are given off whenever a filament is heated by an electric current. They are always negative.
- Fleming valve**—One variety of vacuum tube having a filament and plate but no grid.
- Formica**—A patented composition suited by its electrical properties as a material for wireless insulation.
- Honeycomb coil**—Tuning coils wound in compact shape with the wires crossing and recrossing each other. Also called *duo-lateral coils*.
- I. C. W.**—Interrupted Continuous Wave. The type of wave used to broadcast radiotelephone programs. It is produced by cutting up into short trains of wave the pure wave of the vacuum tube circuit. A C. W. cannot be picked up by a crystal detector, but an I. C. W. has no such limitation.
- Inductance**—One of the two electrical properties—the other being capacity—which must be properly balanced in a receiving set to bring in a wireless wave

THE STANDARD RADIO GUIDE

- of a certain length. The tuning coil is the apparatus used to vary inductance.
- Microfarad**—Usually shortened to mfd.—the term used to measure capacity.
- Microhenry**—The term used to measure inductance.
- Ohm**—The unit of resistance. A circuit is said to have one ohm resistance when a pressure of one volt is required to send a current of one ampere through it.
- Rheostat**—A coil of resistance wire used to control the flow of current in a circuit.
- Tickler**—See page 44. A coil used in the tuning circuit to make regeneration of signals possible.
- Vernier**—A supplementary device used principally with condensers to permit of minute changes in capacity.
- Volt**—The term used in an electric current to denote the *force* that causes the current to flow. Corresponds to the *pressure* of water in a pipe line.
- Wave length**—The distance usually expressed in meters from crest to crest of the wave propagated by the transmitting station. It has nothing whatsoever to do with the receiving distance of a station. A meter is equal to 39.37 inches.



Voices thru the Air~

*made easy in your home—
with "RADISCO RECOM-
MENDED" apparatus.*

**What "RADISCO RECOMMENDED"
means to radio beginners**

THIS company serves in every branch of wire-
less telephony and telegraphy. It is the larg-
est organization of its kind in the world.

When you buy from RADISCO dealers—when you
buy anything in radio "RADISCO RECOM-
MENDED" it means:

- | | |
|---|--|
| 1. Absolutely depend-
able apparatus. | 4. Dealers who know
radio. |
| 2. Any kind of appa-
ratus you want—
and always the best. | 5. Results that meas-
ure up to those
which experts get. |
| 3. The lowest prices | |

Buy dependable "RADISCO RECOMMENDED"
apparatus for greater economy, greater simplicity,
greater pleasure.

RADISCO

"Your Assurance of Satisfactory Performance"

Immediate Delivery of Radio Apparatus

The Nationally Famous "MARVEL"



1 MARVEL Radio Receiver (pat. applied for)
 100 feet solid, hard drawn copper wire
 25 feet insulated wire
 1,000-Ohm high sensitivity telephone
 Leather-covered headband
 Telephone cord
 Single pole, double throw antenna switch
 Adjustable ground clamp
 Official Code Chart
 International Abbreviation Chart
 Directions for Installation and Operation
*Nothing to add nor to buy to set this Receiver in
 operation in your home.*

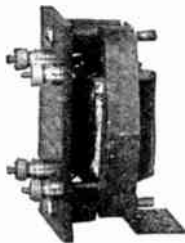

"F-E" Amplifier Transformer

An audio frequency transformer, designed to give maximum amplification without distortion, and suitable for use with high impedance amplifying vacuum tubes.

Model 120 \$6.25

If your dealer is not yet supplied, send check or money order direct.



"F-E" Condensers

Pat. Applied for

Made of pure tin foil and special dielectric material. For use in crystal or tube circuits.

Model 106—Grid Condenser, Capacity 0.0005. Price.....\$0.30

Model 107—Telephone Condenser. Capacity 0.0025 Mfd. Price..... 0.30



"F-E" Telephone Jacks

For use in amplifier, loud speaker and similar apparatus.

Model 116—Open Circuit..... \$0.55

Model 117—Closed Circuit..... 0.75

Model 118—Two Circuit..... 0.90

FREED-EISEMANN RADIO CORPORATION

255 4th Avenue,

NEW YORK



Unexcelled for wireless telephone reception

This outfit has been assembled from tested, proven units as unsurpassed in radio. It is the kind of equipment that anyone can use successfully to entertain a group of friends. It is also a set that, in the hands of an expert, produces record-breaking results.

The famous Paragon R.A. Ten Tuner, a Paragon DA 2 vacuum tube detector and two-step amplifier, a Radio Magnavox, a pair of Baldwin Type "C" headphones (standard of the world), tubes, batteries, aerial equipment and all accessories are included in the price of \$258.50. The work of installation has been reduced to a minimum. Just put up a simple aerial, insert tubes, hook on batteries—and you are ready to listen. See this splendid outfit at our store in New York or order by mail.

New catalog, "Modern Radio 1922," 35c.

**CONTINENTAL RADIO
AND ELECTRIC CORP.**
6 WARREN STREET NEW YORK CITY
"New York's Leading Wireless House"

Executive offices and wholesale dept.
15 Warren Street, New York

LET JACK BINNS KEEP

Jack Binns, Radio Hero
who Saved 3000 Lives
when the *Republic* Sank



DO YOU WANT TO KEEP up with the sensational developments in Radio? This miracle industry is only in its infancy. Every month will bring important developments that you should know about.

Jack Binns, hero of the sea, and famous radio expert, conducts *Popular Science Monthly's* authoritative Radio Department, and will keep you posted. Read Jack Binns' brilliant radio articles. Also read the latest discoveries in all these interesting subjects in

Popular Science MONTHLY

New Inventions
Automobile Progress
Radio Equipment
Marvels of Chemistry

Things You Can Make
with Simple Tools
New Era of Aviation
Keeping the Home Shipshape

You will Get Over 300 Pictures Every Month

Popular Science Monthly will answer any question you want to ask about Radio or Science Free of charge. Get acquainted with this vital, man's magazine. See Free Offer.

YOU POSTED IN RADIO

FREE

Big Radio Broadcasting Map of the United States

The Standard Broadcasting map, (12 x 20 inches) printed on heavy paper, is necessary if you want to get full value out of your Radio Set. It shows all the Broadcasting Stations in the United States and their distance away from you. It gives official call numbers of all stations. With the Broadcasting Map you can determine what stations you should hear and you can mark on the map the dates when you hear distant stations.

We will send you the Standard Broadcasting Map, Free of Charge in order to introduce to you Popular Science Monthly. To get the map Free, sign the coupon below—and enclose One Dollar for a four months' subscription to Popular Science Monthly.

***ORDER TODAY
Tear off Coupon
or Copy Coupon
and send with
\$1.00***

Popular Science Monthly,
225 W. 39th St., New York

Send me your broadcasting map Free and enter my subscription for the next four issues of Popular Science Monthly. I enclose One Dollar.

Name

Address

Brandes 'Phones Rest On Wise Heads



The experienced radio man knows that a good pair of sensitive 'phones is half of the receiving outfit. You may have a good aerial, a good tuning coil and a perfect detector but what happens after your signals or music reaches the 'phones? Do your 'phones make the most of the weak currents that pass through them?

The experienced radio man knows that he cannot depend upon appearance; he wants performance. That is the reason he insists on Brandes *Matched-Tone** Headsets. They "nurse" in that long distance "stuff" that you cannot get with ordinary 'phones. Be sure that you start right with Brandes.

Standard Since 1908

Used as standard equipment by the leading manufacturers.

C. BRANDES, Inc.,

237 Lafayette Street, New York, N. Y.

Chicago office: 33 South Clinton Street.

*Trade mark registered U. S. Pat. Office.



“What Do I Need and What Will it Cost?”

Let



Solve this problem!

AT each of the SORSINC offices there are thoroughly trained professional radio men who know from experience the past performance of each piece of apparatus.

Backed by the most complete stocks of the leading lines, these men can advise and help you in investing your money in radio equipment to your best advantage. It is well worth your while to take advantage of this service, and—it costs *no more* to buy from SORSINC.

We have just prepared an interesting little booklet illustrating the best apparatus on the market today. Send 6 cents in stamps for your copy.

SHIP OWNERS
RADIO SERVICE INC.

80 Washington Street, New York, N. Y.

“THE LARGEST RADIO CHAIN STORE SYSTEM
IN THE WORLD”

C. G. Conn, Ltd., National Radiophone Concerts



The World's
Finest Saxophone

As world's largest band instrument manufacturers, Conn, Ltd., has again proved its leadership.

We have arranged a series of nationwide radiophone concerts, broadcasted from the great sending stations. Watch for local announcements of dates and programs.

Dance to the music of America's most famous orchestras—Isham Jones' of Chicago; Joseph Smith's, New York; Benson's, Chicago; Hal Nichol's, Denver; Rosebrook's, San Francisco; and others to be announced.

Hear solos by stars on the saxophone, trombone, cornet as well as vocalists of note.

America's greatest artists, who choose Conn instruments because of their superior tone, tune and mechanism, are co-operating with Conn in providing these extraordinary treats for radiophone enthusiasts.

Conn Dealers everywhere are entertaining with radiophone concerts. Get in touch with your local dealer and be his guest.

C. G. CONN, Ltd.,
Dept. 32 Conn Bldg. Elkhart, Indiana

World's Largest Manufacturers of High
Grade Band and Orchestra Instruments.

MURDOCK REAL RADIO RECEIVERS have delivered complete satisfaction, on a "money-back" basis for 14 years. Those years of experience have so simplified and perfected our production that there are today no receivers quite so good at so low a price.

Many of the complete receiving sets now on the market include Murdock Phones as standard equipment. If the set you buy does not, be sure to get a set of Murdock receivers to complete your station. Go to your radio dealer and convince yourself of the quality of Murdock receivers by actual examination before you buy. Prices \$5.00 to \$6.00. Wm. J. Murdock Co., Dept. S, Chelsea, Mass.

MURDOCK PHONES

The Correct Answer To the "B" Battery Problem

50 VOLTS

2 VOLT

STEPS



EASILY
CHARGED

LONG LIFE

THE BIESMANN "B" Fully Guaranteed Combination Detector and Amplifier Battery

24 cells, individually tapped, permitting use of any voltage from 2 to 50 volts in steps of two volts each. Provides a noiseless circuit for the receivers. The electrolyte is a semi-solid; cannot spill or leak. One piece cast "Rub-Tex" Indestructo case, of which the individual cells are a part. Highly polished and neat in appearance. Pasted type plates especially developed for Radio service. Can be re-charged at any Battery Service Station, or on any type of vibrating rectifier by using the circuit provided with the battery. Complete instructions with each battery. Contacts between cells easily accessible. Over-all dimensions: 9 inches long, 4½ inches wide, 4½ inches high.

THE "BIG SIX" A-BATTERY

A FEW FACTS BRIEFLY STATED

Semi-solid electrolyte which cannot spill—No injurious sulphation—Plates will not buckle—Highest electrical efficiency and voltage maintenance—Quickly and easily re-charged—Can stand idle indefinitely without injury—Superior physical properties—Hard wood case.

THE "BIG SIX" IS FULLY GUARANTEED AS TO LIFE, CAPACITY,
ELECTRICAL EFFICIENCY, DESIGN AND WORKMANSHIP

Manufactured by
General Battery and
Supply Co.,
Chicago, Illinois

JOBBERS
Write For Our Interesting Sales Proposition

SOLE DISTRIBUTOR

HERBERT H. FROST, 154 West Lake Street, CHICAGO, ILLINOIS

ALL loud speakers require vacuum tube amplification. The heart of the amplifier is the transformer.

ACME TRANSFORMERS

have been brought to a high degree of efficiency through years of specialization on this one product. They amplify wireless telephone without detracting from the original tone value.

ACME transformers are for sale separately and are also incorporated in complete Acme vacuum tube detector and amplifier instruments designed to hook on to your present receiving equipment.

The **ACMEFONE**, illustrated below, is a complete long range installation. It includes in one handsome cabinet, the tuner for selecting the particular station you want to hear, the equipment for three vacuum tubes to amplify (or magnify) the sounds, and a loud speaker which sends the voice and music clearly all over the room. The price is only \$80.00. The work of installation has been reduced to the minimum. Just put up a simple aerial, insert tubes, hook on batteries and you are ready to listen.

ACME apparatus is for sale at all radio dealers.

ACME APPARATUS CO.
Cambridge, Mass.

*Transformers and Radio
Engineers and Manufacturers*



Acme

Radio Apparatus



Confucius has said:

"The accomplishment of great things consists in doing small things well."

Perfection of detail makes the GREBE RADIONELLE what it is.

Doctor Wfu

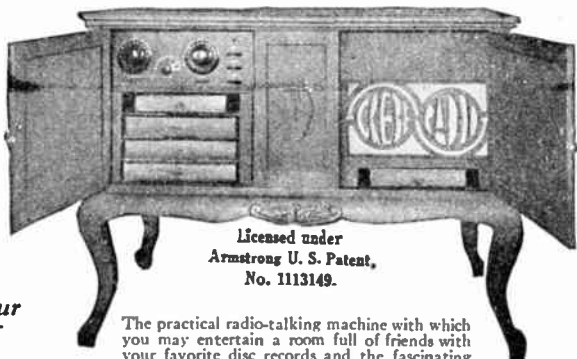

Licensed under
Armstrong U. S. Patent,
No. 1113149.

*Ask Your
Dealer*

The practical radio-talking machine with which you may entertain a room full of friends with your favorite disc records and the fascinating radio broadcasts.

A. H. Grebe & Co., Inc., Richmond Hill, N. Y.

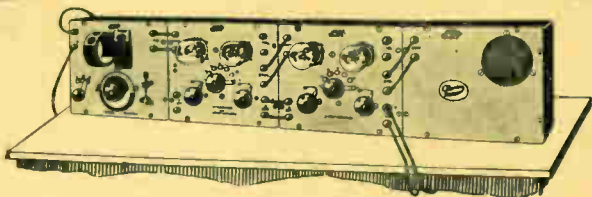

Build your Station on the Sectional System

ABC UNITS are built on the sectional plan, just like a sectional bookcase. You can gradually add to your outfit without discarding a nickel's worth of your previous equipment.

The first *UNIT* of the four *UNIT* combination shown above is a complete crystal detector outfit.

For longer range and louder signals, add the second *UNIT*.

To receive still farther and amplify your signals still more, add the third *UNIT*.

When you have these three *UNITS*, you can add the *ABC* "Clarion" Loud Speaker which eliminates the use of head phones by throwing the voice and music clearly all over the room.

Go to your radio or electrical supplies dealer and ask him about the exclusive sectional feature of *ABC UNITS*.

Jewett Manufacturing Corporation
Canadian Pacific Building
Madison Ave., and 44th St. New York City

ABC UNITS
Standardized Radio Sectional Receiving

POPULAR EDITION

THE STANDARD RADIO GUIDE



How to Enjoy Radio at Home

How to Listen - In

What You Can Hear

How Much to Pay
for Your Set

How to Make Your
Own Set

Published by Popular Science Monthly Price 50 Cents