

RADIO



RADIO FOR THE MILLIONS

•

PREPARED BY THE EDITORIAL STAFF
OF POPULAR SCIENCE MONTHLY

•

GROSSET & DUNLAP
NEW YORK

COPYRIGHT, 1943
BY POPULAR SCIENCE PUBLISHING CO., INC.
All Rights Reserved

Printed in The United States of America

I N T R O D U C T I O N

Radio building has a way of doubly repaying those who take it up. For in addition to being a hobby that provides more fun and educational entertainment than is likely to be expected, it very often becomes a highly profitable spare-time business.

But for whatever reason it is that you now enter the fascinating realm of radio, you are sure to find what you are looking for in these pages. Here is contained a wide variety of sets, ranging sufficiently in power, size, and design to satisfy anyone who wants to get an all-around education in how to be a radio builder. Whatever parts may be needed to build a particular set are listed in detail. The text explains just how the set is to be constructed, and for what purpose it is best suited. Complete diagrams show clearly the method of wiring, and operational details. Both text and diagrams are presented so that even the amateur builder can understand them. But let no one think that the material contained in this book is confined to the narrow horizons of the beginner. The very latest developments in radio building are to be found within these covers—and even those who may consider themselves builders of long experience will find answers and explanations to problems which may have long baffled them.

The editors take this opportunity to acknowledge their indebtedness to Arthur C. Miller, of New York, for much of the material contained in this volume.

Here, then, is your book. Good luck—and good hunting among the ether waves.

THE EDITORS

TABLE OF CONTENTS

One-Control Beginner's Radio	9
Get Started in Radio	10
Three-Tube TRF Receiver	13
One-Tube Loudspeaker Set	14
Four-Tube Speaker Receiver	16
Four Dollars Builds This Set	18
More Power for Your Two-Tube Radio	20
Homemade "Audio" Telegraph	22
Three-Tube Phonograph Receiver	24
Four-Tube TRF Receiver	27
Inexpensive Dual-Turntable Phonograph	28
Kitchen Radio	32
Two-Tube Set Gets Foreign Stations	35
Two-Way Radio Station	36
Combination Receiver and Amplifier	40
"Letter" Radio Can Be Mailed	43
Build an FM Receiver for \$22	44
A Tuner for Any Broadcast Set	48
World's Smallest P. A. Units	51
Twin-Bed Radio	54
Floor-Lamp Radio	58
Practice Code Sender and Receiver	61
Pocket Receiver for Sports	63
Tiny Portable Operates Anywhere	64

Low-Cost Power Supply	67
Three-Tube Superhet	68
Compact All-Wave Set	71
Two-Tube AC-DC Receiver	72
Portable Radio-Phonograph	76
One-Tube Short-Wave Set	79
Sliding Panel Tunes Novel Receiver	80
All-Wave Bands on Two Tubes	82
Compact Radio-Tube Tester	84
Europe on One Tube	87
Bicycle Radio	88
"B" Supply for Portables	91
Priority Receiver Uses New Tuning	92
Compact Rectifier Unit	95
Midget Broadcast Set	97
Week-Enders' Radio	98
Midget AC-DC Receiver	101
Book-End Radio for Your Den	104
One-Tube All-Electric Set	107
Superhet for Beginners	108
Pocket-Size Radio Tester	111
"Wireless" Radio Phonograph	112
Low-Cost Home Recorder	116
Tom Thumb Radio	119
Suitcase Phonograph	120
Two-Tube Portable	123
Library-Table Radio	126

All-Purpose Portable	130
One-Tube Receiver	133
High-Fidelity Amplifier	134
Small Radio with 400-Mile Range	137
Dressing-Table Radio	138
Unit Kills Fading	142
All-Wave Amateurs' Receiver	144
Camper's Radio	146
Television Antenna	148
Universal Power Supply	150
Tiny Radio Uses Two Detectors	152
Portable AC-DC Signal Tester	154
Book-Light Radio	157
Around-the-World Receiver	158
Two-Tube Radio Phonograph	162
Cabinet Ideas	165
Cane-and-Seat Radio	166
Vacation Portable	168
Bed Radio	172
Suppressor Reduces Static	175
Emergency Receiver	176
Light-Beam Transmitter	179
Blackout Receiver	182
Vest-Pocket Receiver	185
Football-Fan's Radio	186
Pocket-Notebook Radio	189
Novel Lamp Radio	190

SERVICING YOUR RADIO

Pilot Lights, Rectifier Tube, Squealing, Paper Tubular Condenser . . .	26
Various Causes of Humming	42
Bring Your Radio Up to Date	57
Reception, Volume Control, Dead Speaker, Connecting a Pickup . . .	75
How to Build a Loop Antenna	86
Line-Cord Breaks, Dial Pointers, Fuzzy Operation, Ballast Tubes . . .	96
Fixed Condensers, Reception, Fade Out, Humming	115
How to Refinish Your Radio Cabinet	129
Faulty Heater, Extending Reception, Noisy Condenser, Midget Circuit	141
Neon Condenser Tester, Defective Resistors, Pilot Light, Fading Reception	156
Battery Testing, Loop Antenna, Substitute Batteries, Loose Batteries	171
How to Correct Dial Troubles	184

ONE CONTROL

operates this beginner's

RADIO



Follow this rear view of the set when placing the parts. Below, the crystal detector with cap removed

A SINGLE dial operates this novel one-tube battery radio; turning the set on when it is rotated to tune in stations and turning it off when moved to its minimum setting. This automatic switching is accomplished by coupling the condenser shaft to an inexpensive rheostat which has been altered by flowing solder over the winding as shown in the sketch.

The circuit is easily wired.

A crystal detector is followed by a single stage of audio amplification. One 45-volt "B" battery provides the plate voltage and a single 1.5 volt dry cell serves the filament. Of the three antenna connections, Terminal A₃ is the most selective, while A₂ provides the greatest volume. Terminal A₁ connects a trimmer condenser into the lead for a short antenna.



The single knob that controls the receiver

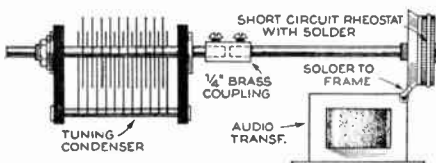
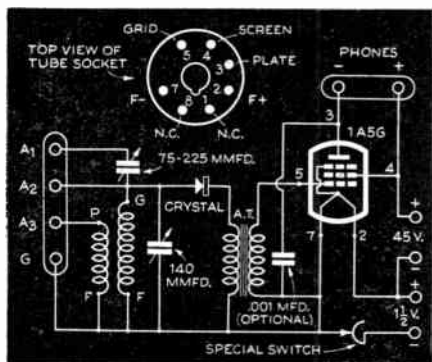

How the automatic switch is fashioned from a rheostat

Get Started in



Any well equipped radio store is likely to have all the parts that you will need. The prices shown at the right are approximately what you will have to pay for the various items. With these parts you can build this circuit—and then go on to build five other circuits merely by reassembling the parts. Thus you can give yourself a course in the theory and building of radios

IF YOU have always wanted to experiment with radio, here's your chance. With the parts listed at the right, costing about \$8.95, you can build six modern radio circuits—six different radio hook-ups specially designed not only to use the same parts but to provide a good course in general radio construction and theory.

The first circuit, described in this article, is a simple two-tube all-electric earphone receiver. On the following pages, details will be given on how to build a three-tube tuned radio-frequency circuit (page 13), a four-tube speaker receiver (page 16), a three-tube loudspeaker set (page 18), a three-tube phonograph amplifier (page 24), and a four-tube TRF receiver (page 27).

After purchasing the parts listed, together with the necessary connecting wire, fuse clips,

WITH A FEW
INEXPENSIVE PARTS
YOU CAN BUILD SIX
CIRCUITS DESIGNED
TO TEACH THE TRICKS
OF SET BUILDING
AND REPAIR

WHAT TO BUY

Line-cord, 135 or 160 ohm....	.29
Filter choke, 20 h., 500 ohm..	.29
Coils, plug-in, 100-570 meters	
(2)85
Variable condenser, .00014	
mfd.55
Mica condensers (2), .002	
mfd.42
Mica condenser, .0002 mfd.....	.15
Mica condenser, .0005 mfd.....	.15
Dual electrolytic condenser,	
16-16 mfd., 250 v.....	.97
Shielded paper by-pass con-	
denser, .1 mfd., 200 v.....	.13
Tubular paper condenser,	
.006 mfd., 600 v.....	.07
Electrolytic condenser, 10	
mfd., 25 v.....	.24
Pentode-triode tube, 25B8GT	.75
Pentode-rectifier tube,	
70L7GT75
Carbon resistors (4), ½ watt,	
1 meg.40
Carbon resistor, ½ watt,	
200,000 ohm10
Carbon resistor, ½ watt,	
150,000 ohm10
Carbon resistor, ½ watt, 600	
ohm10
Variable resistor, 25,000 ohm	.28
Variable resistor, 250,000	
ohms28
Six-inch magnetic speaker....	.88
Four-inch dial26
Octal molded sockets (2)....	.48
Six-prong molded socket.....	.18
Rotary S.P.S.T. switch.....	.16
R. F. choke, 2.5 mh.....	.12
	\$8.95

◆ TWO-TUBE ELECTRIC ◆ THREE-TUBE ELECTRIC ◆ FOUR-TUBE ELECTRIC

Radio for \$8.95

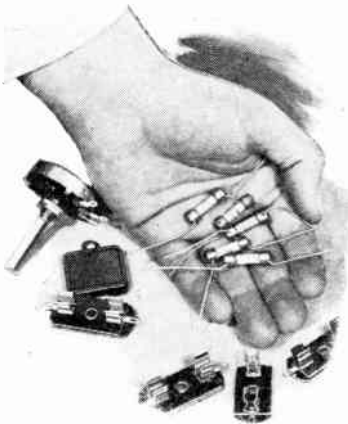

A few of the items you need. At right, assembling a two-tube, all-electric broadcast-receiving set, the first in a series of six

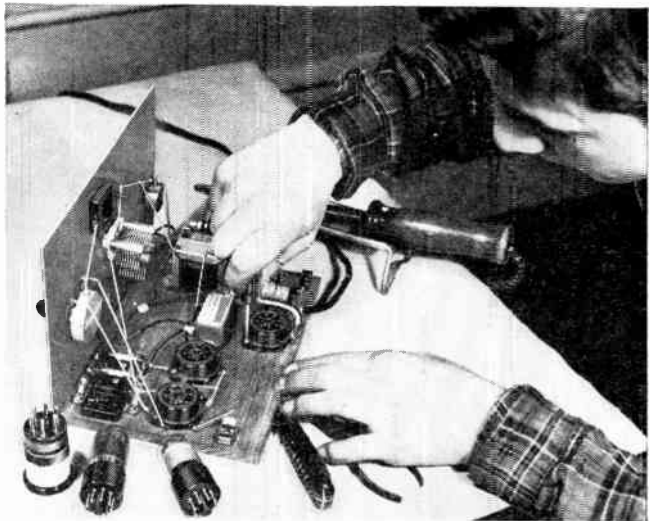

metal panel, wood base-board, and solder, you will have nothing more to buy.

Two tubes of the latest dual-purpose design provide all the tube elements needed in any one of the six circuits. The 25B8GT provides a high-frequency pentode and a high-amplification triode. The 70L7GT provides a half-wave rectifier and an output pentode. Both tubes have octal bases with eight pins or prongs.

Before going on to the construction of the first receiver, it will be well to review a few pointers on radio construction in general:

First of all, use only high-grade parts and make sure that they match the specifications. Second, don't manhandle the parts—remember they have to last for six different circuits. Third, always keep your soldering iron clean and use a solder with a resin core.

The first receiver in this series of six is a two-tube outfit designed to operate on either alternating or direct current of 110 or 115 volts. For these voltages a line cord hav-

ing a built-in resistance of 135 ohms is used and is the right value for all six circuits. If the line voltage in your home is 120 volts, a 160-ohm line cord must be used.

In this circuit, the pentode section of the 25B8GT is used as a regenerative detector (the triode is not used) while half-wave rectifier in the 70L7GT supplies the rectified current for the receiver. (See next page).

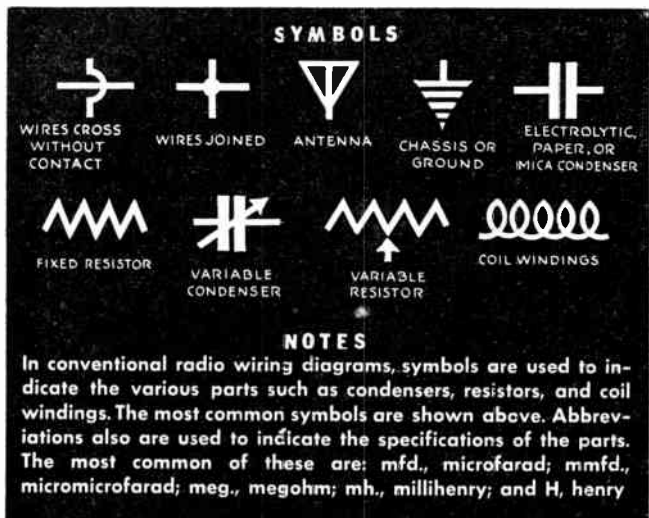

◆ PHONO AMPLIFIER ◆ THREE-TUBE TRF ◆ FOUR-TUBE TRF ◆

Three holes drilled in the metal panel receive the 25,000-ohm variable resistor (used for controlling the regeneration), the .00014-mfd. tuning condenser, and the rotary-type switch. All other parts, with the exception of the .0005-mfd. fixed mica condenser (shown mounted above the tuning condenser), are placed on the wooden baseboard.

As all the parts will be used over and over again, take care in mounting the resistors and condensers. Also, when buying the parts remember that fixed resistors and condensers with "pigtaills" cannot be used.

The electrolytic condensers can have flexible leads since they can be mounted in the same place in each circuit, but the resistors should be mounted in clips, like those used for small fuses.

As this is an A.C.-D.C. receiver, no ground is needed, the circuit being grounded through the house lighting system. Any type of antenna up to 80' in length can be used. For the reception of local stations an indoor antenna approximately 25' long will be found sufficient. It is not advisable to use a long antenna for receiving short-wave signals.

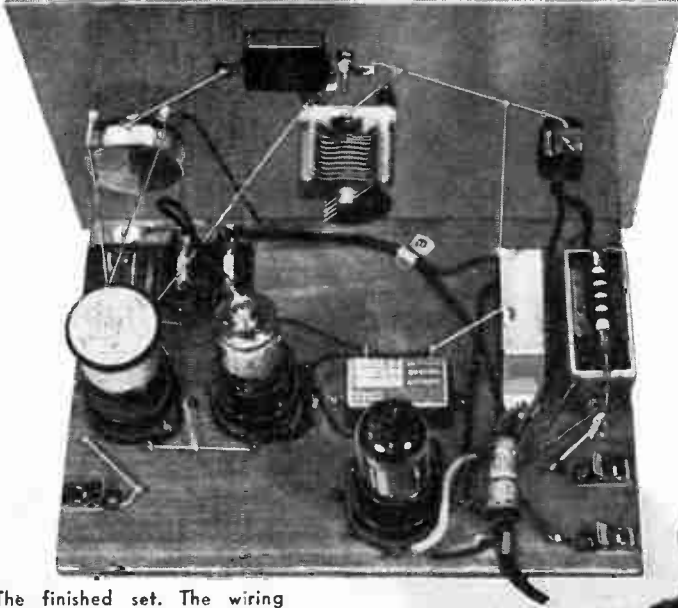

The finished set. The wiring diagram shows the parts used

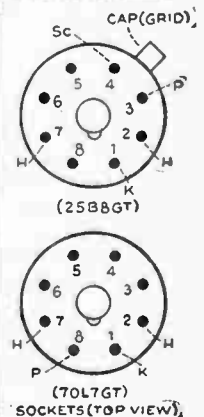
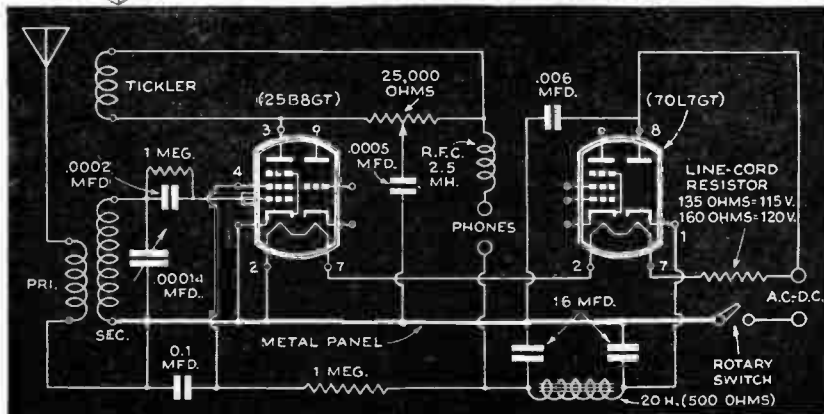
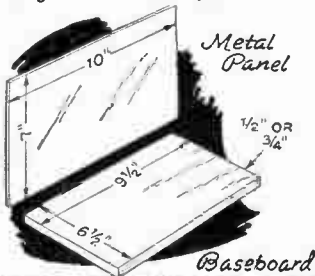

One-Tube Set Gives

WITHOUT the use of a tricky reflex circuit or hard-to-get parts this one-tube tuned-radio-frequency set will give full loudspeaker results on all local stations when a good outdoor antenna is used. Within ten miles of local stations, even an indoor antenna can be used, and its selectivity is such that powerful local stations only 30 kilocycles apart can be easily separated.

This remarkable performance is due chiefly to the fact that iron-core coils are used in the antenna and radio-frequency stages. Also, in order to get the most out of each stage, and to allow greater flexibility of control, two separate tuning condensers are used.

A double pentode power amplifier (1E7G) is the single tube used. One section serves as the radio-frequency amplifier, while the other provides the detector and output stages of the receiver.

Grid-leak detection is used on the second "tube" and its plate is connected directly to the speaker without any additional audio-frequency amplification. Sufficient power is obtained with this hook-up to work a 6"

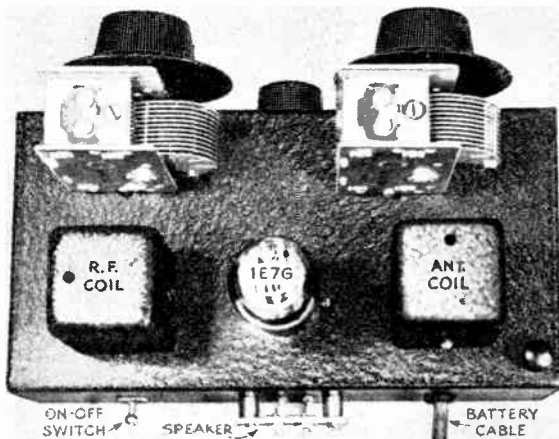

These views of the top and underside of the chassis will serve as a guide in placing the various parts. Below, the set in operation. Note the batteries and separate speaker unit

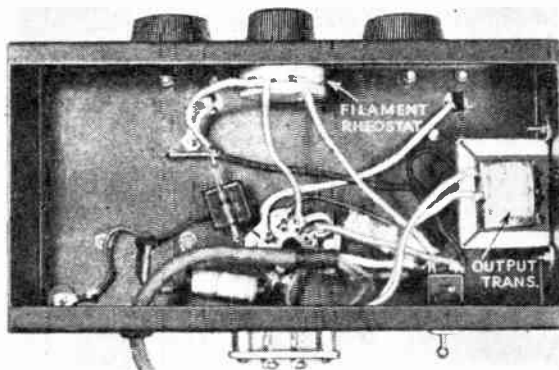

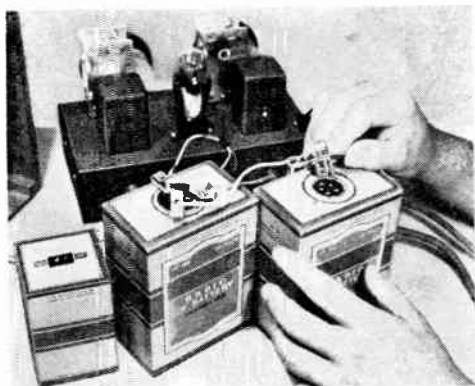

Three new-style batteries are used to power the receiver. The plug-in-type connectors save time

rheostat knob should never under any circumstances be turned. •

In tuning the set, remember that both tuning condensers must be operated. The two readings will be just about the same, provided the dials are mounted on their shafts in the same relation. As a matter of fact, these two condensers can be ganged if desired, but the double control does provide greater flexibility and makes it possible to make minor adjustments in any one condenser in order that maximum volume may be obtained.

No ground is necessary with the circuit, and as pointed out earlier the type of antenna, indoor or outdoor, will depend entirely on your geographical location with respect to strong local stations.

LIST OF PARTS

Shielded antenna coil, iron-core.
 Shielded RF coil, iron-core.
 Condensers, tuning, two, .00036 mfd.
 Condenser, tubular, paper, .05 mfd., 600 v.
 Condenser, tubular, paper, .005 mfd., 600 v.
 Condenser, mica, .0002 mfd.
 Resistor, carbon, 1 meg., ½ watt.
 Rheostat, 15 ohms, 4 watts.
Miscellaneous: Tube (1E7G), octal wafer socket, universal output transformer, chassis (2½" by 5" by 9½"), cabinet (4½" by 7½" by 8½"), two dials, D.P.-S.T. toggle switch, two 45-volt "B" batteries, one 3-volt "A" battery, PM speaker, wire, solder, etc.

A

Four-Tube Speaker Receiver

BY ADDING only a half-dozen parts to the all-electric receiver described on page 21 as part of this series, you can provide a final stage of amplification. For this stage, the power pentode in the 70L7GT tube is used, and with this additional power there will be sufficient volume to operate a loudspeaker. The speaker, included in the original list of parts that appears on page 10, is a 5" magnetic unit which can be mounted in a small homemade wooden cabinet. If you do not wish to go to the trouble of making up a special cabinet, the speaker can be mounted on a small baffle about a foot square. Two Fahnestock clips can be used to connect the speaker to the set. These are mounted just inside the cabi-

ADDITIONAL PARTS

Mica condenser, .002 mfd.
 Electrolytic condenser, 10 mfd.
 Fixed resistor, 150,000 ohm.
 Fixed resistor, 1 megohm.
 Fixed resistor, 600 ohm.
 Loudspeaker.

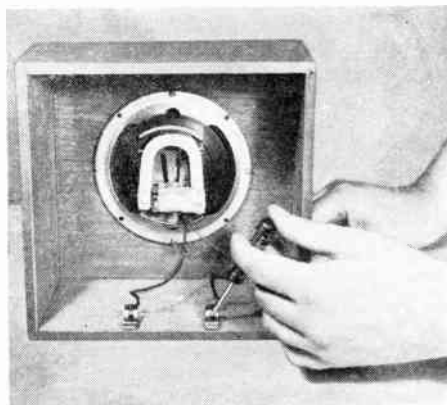

Two spring clips serve as speaker connectors

Four Dollars Builds

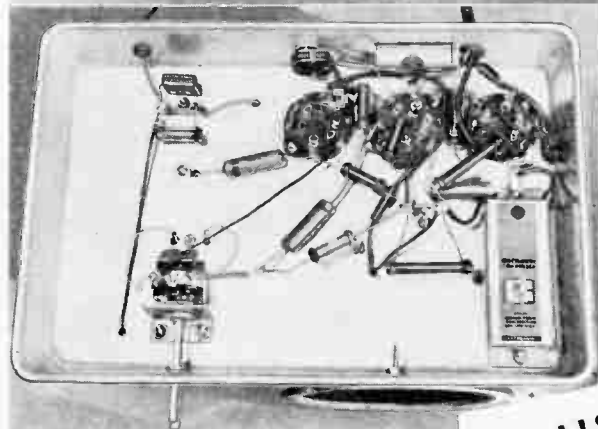
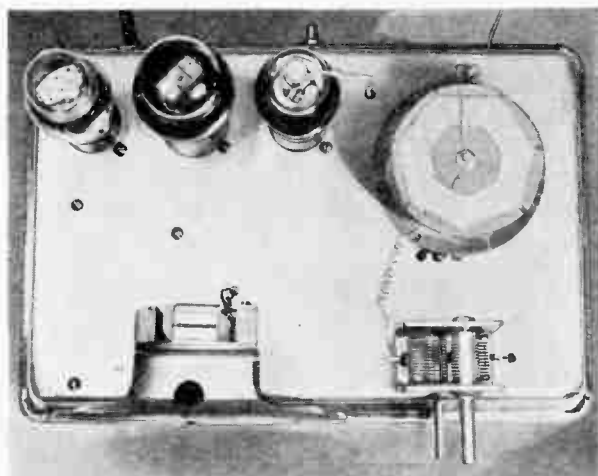

A drill saves time, but holes can be cut with scissors

WHEN I finished building the receiver shown, I dubbed it the "Economy Three," for it had cost me only \$4.06, not including the cost of the wood for the cabinet, which I salvaged from my workshop scrap pile. It was an easy receiver to build; the hand-wound coils were easy to make, and the parts fitted nicely into the chassis with plenty of room to spare.

The chassis I purchased for ten cents at my neighborhood "five-and-ten." It's simply an inverted aluminum cake pan 10" long and 6½" wide. Being made of thin aluminum sheeting it was easier to work than most chassis materials. In fact, although I used a regular chassis punch to cut the three holes for the tube sockets, they could

Top and bottom views of the receiver showing the placement of the parts on the ten-cent cake-pan chassis. The regeneration control, set back from the edge, is mounted on a small bracket

LIST OF PARTS

- Condenser, variable, .000365 mfd.
 - Condenser, mica, .00015 mfd.
 - Condenser, tubular, .0005 mfd., 400v.
 - Condensers, tubular, three, .01mfd., 400v.
 - Condenser, electrolytic, 20 mfd., 25v.
 - Condenser, electrolytic, 5 mfd., 1 watt.
 - Resistor, carbon, 1,000 ohm, 1 watt.
 - Resistor, carbon, 2,000 ohm, 1 watt.
 - Resistor, carbon, 600 ohm, ½ watt.
 - Resistor, carbon, 300,000 ohm, ½ watt.
 - Resistors, carbon, two, 1 meg., ½ watt.
 - Regeneration control, 25,000 ohm.
- Miscellaneous: Tubes, coil wire, cake-pan chassis, five-inch magnetic speaker, 200 ohm line-cord resistor, on-off switch, six-prong wafer sockets, wire, solder, etc.

This Loudspeaker Set

Get-Started-in-Radio Series

have been cut with an ordinary pair of scissors. Because of the pan's sloping sides, however, the 25,000-ohm regeneration control had to be mounted on a small aluminum bracket some distance behind the front edge as shown at the extreme left. The same screws that hold the variable tuning condenser can be used to support the bracket.

The A. C.-D. C. circuit is simplicity itself. It uses three tubes—a 43, a 6C6, and a 25Z5 rectifier—and provides sufficient pep to operate a loudspeaker. Because magnetic speakers are generally sensitive to weak signals, I chose one of that type. It cost me 93c.

The homemade coils are quite easy to wind. Before going into the actual construction details, however, there is one important point that must be remembered: In making the coils, adhere strictly to the



The completed outfit gives loudspeaker volume with a short antenna

specifications, such as the size of the wire, the length of the antenna attached to the antenna coil, the distance between coils, etc.

First cut out two round cardboard disks, one 2 3/4" in diameter and another 3 1/4". Then divide each form into seven equal sections and cut a slot down each line about 1/16" wide to within 5/8" of the center. On

the smaller form wind 55 turns of No. 30 double-cotton-covered magnet wire. Pass the wire first over one section and then under the next—alternating as you go round. When finished, this will be the antenna coil. The larger coil is the tickler coil and consists of 60 turns of the same wire. In checking the number of turns, add the turns on two adjacent sections. In other words, a coil of 55 turns will have twenty-seven windings on one "rib" and twenty-eight on the next.

The coils are mounted on the chassis by means

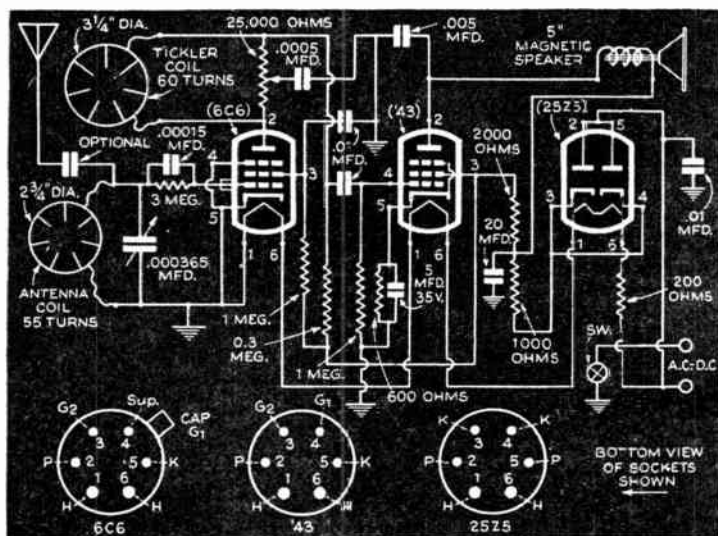

Specifications for the circuit and the hand-wound pancake-type coils

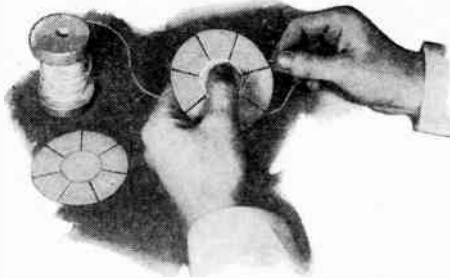

The wire goes over and under the form ribs

of a brass machine screw $2\frac{1}{2}$ " long and two brass-tubing spacers, $\frac{1}{4}$ " in diameter. The tickler coil should be placed nearest the chassis and 1" from it. The antenna coil should be placed $\frac{3}{4}$ " above the tickler coil. Refer to the drawing below for details.

The cabinet, whose dimensions also appear in the drawing below, can be made of any wood that you may have in your scrap pile. It has an open back, and the chassis can be conveniently held in place with two screws driven into the baseboard.

A 25' antenna should be used and it can be left on the floor or hung out of a window. On my version of the set I used rubber-insulated stranded wire and it worked particularly well. If a longer antenna is desired, a .00005-mfd. fixed mica condenser must be inserted in the antenna lead.

By adding to or reducing the number of turns on the antenna coil, the set's range can be varied to receive stations just below or just above the broadcast band.

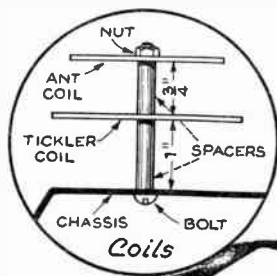

Dimensions for the cabinet and the cake-pan chassis, and mounting details for the two flat-wound coils

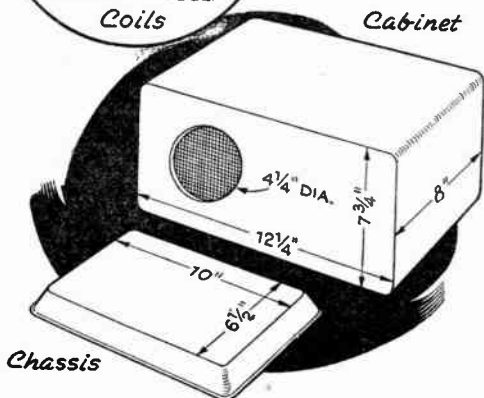

More Power

ON PAGE 10, as the first in a series of six articles on easily built circuits for radio experimenters, a two-tube all-electric receiver is described. On these pages a stage of resistance-coupled audio-amplification is shown to give the set more power.

For the additional stage we will use the triode section of the 25B8GT tube used in the original design and six new items from the original list of parts. The new parts consist of a .002-mfd. mica condenser, a 200,000-ohm, $\frac{1}{2}$ watt resistor, a 1-megohm, $\frac{1}{2}$ watt resistor, a Fahnestock clip for the ground connection, and two fuse mounts to hold the resistors. The .002-mfd. mica condenser is used for coupling the detector stage to the audio stage and is mounted on the baseboard in a vertical position. In the photographs, it can be seen next to the antenna clip. The two $\frac{1}{2}$ -watt resistors are also mounted on the baseboard, next to the other resistors.

In order to avoid feed-back and undesirable oscillation, the grid lead to the

LIST OF PARTS

(Included in list on page 10)

- Condenser, mica, .002 mfd.
- Resistor, Carbon, 200,000 ohm, $\frac{1}{2}$ watt.
- Resistor, carbon, 1 meg., $\frac{1}{2}$ watt.
- Fahnestock clip.
- Two fuse mounts.

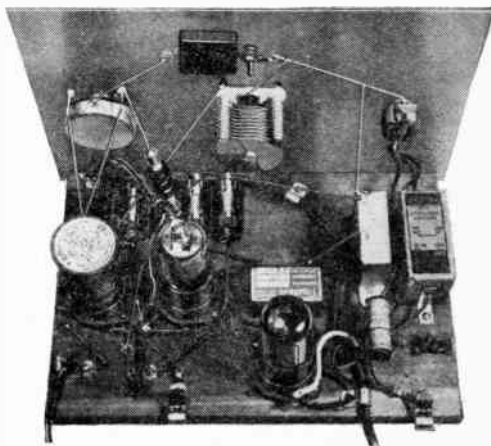

How the two-tube set on page 10 should look after adding a stage of audio amplification

H O M E M A D E "Audio" Telegraph

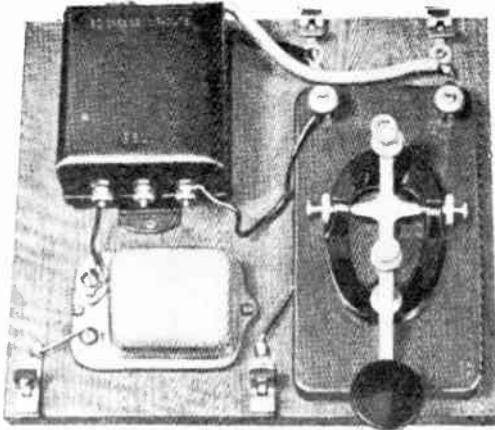

Above, the transmitter, and at the right, the receiver, both mounted upon boards with Fahnestock clips used as terminals

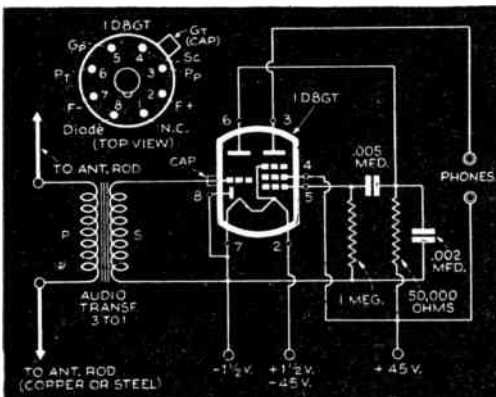
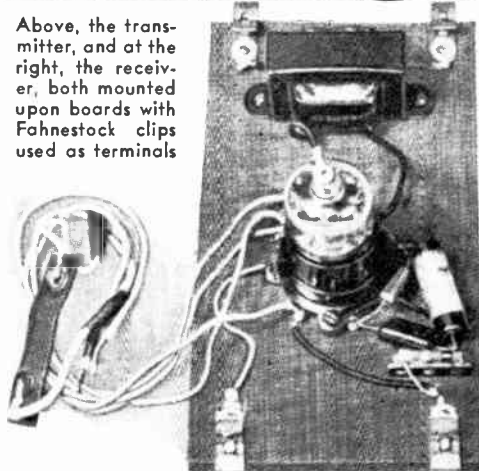

All connections are shown and all parts are represented in the wiring diagram of the receiver above. At right, sender and receiver are set up for use

NEEDS NO WIRES

WITH a few inexpensive standard radio parts you can experiment with a new and novel type of communication system. Dubbed an "audio" telegraph because it uses waves that are more than 30,000 meters long, the easily built hook-up makes it possible to send and receive dot-and-dash messages over distances of more than 200 feet without the use of wires.

In the "audio" telegraph the ground serves as the connecting link between stations, the receiver and transmitter being connected to the ground by means of 30" copper or steel rods driven deep into the soil as shown in the photograph below. The transmitter consists simply of an eighty-cent telegraph key, a house buzzer, a battery, and a bell transformer. The receiver is an easily wired conventional two-stage audio-frequency amplifier connected to an ordinary pair of earphones.

In the original transmitter circuit shown,

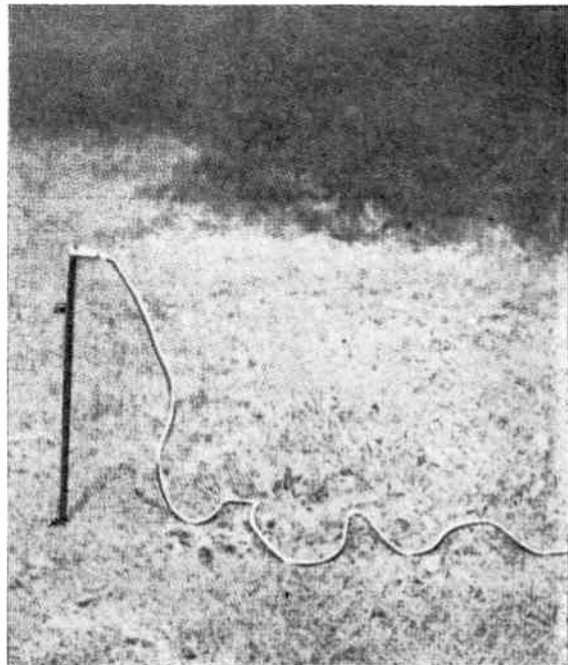

I mounted the parts on a 7" by 8" baseboard. It can, of course, be placed in a cabinet or it and the receiver can be housed together in a compact portable carrying case. When buying the bell transformer, which is the only critical part in the transmitter circuit, make sure that it provides a 110-volt primary and a 12-volt secondary. In the actual hook-up, the windings are used in reverse—the 12-volt winding serving as the primary and the 110-volt winding as the secondary. Connections to the copper antenna rods and to the 7½-volt battery can be made through Fahnestock clips screwed to the baseboard. (See next page.)

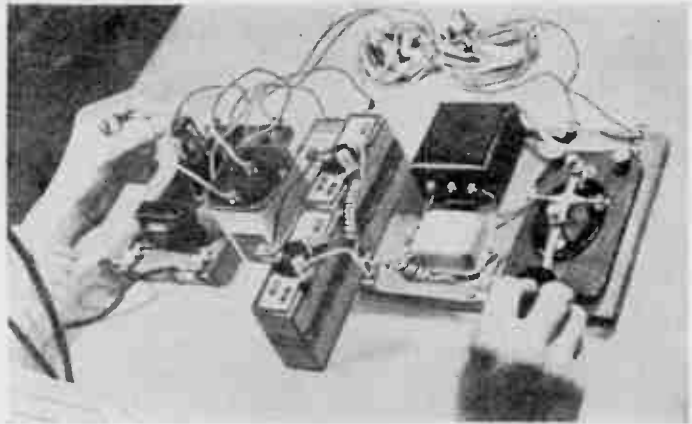

Follow this arrangement in mounting the parts of the two units on their baseboards. Below, how transmitter, receiver, and ground rods are set up

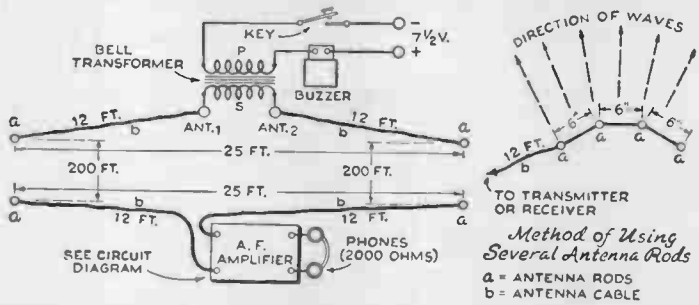

Sends Messages Over 200 Feet

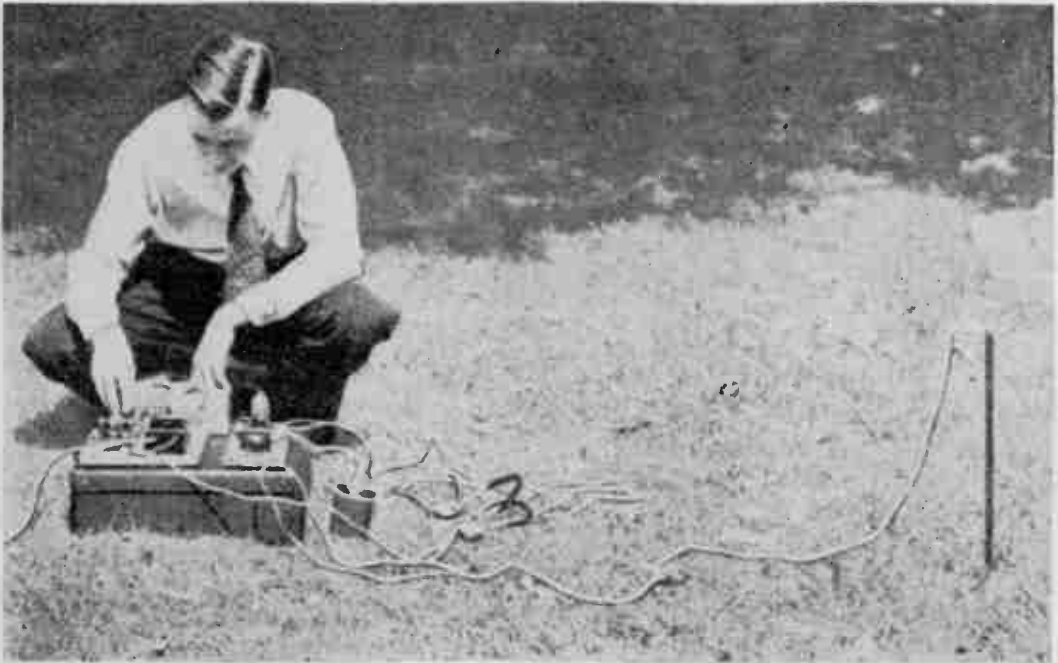



A small suitcase provides a handy carrier for the outfit, its batteries, and the necessary wires

For the audio-amplifier receiver, a dual-purpose 1D8GT tube is used. The diode portion of the tube provides the first or input stage, the pentode the second or output stage. Notice that an audio transformer is used in the first stage and resistance coupling is used in the second.

A small 1½-volt flash-light cell or an ordinary dry cell, and one 45-volt "B" battery, provide the current necessary to power the receiver circuit. These batteries are indicated on the wiring diagram together with the socket connections.

In setting up the receiver and transmitter, be sure to follow the directions given in the drawing. The antenna rods must be placed approximately 25' apart and in a line parallel to the line of the rods connected to the receiver. If a greater distance of transmission is desired, use additional antenna rods in the transmitter circuit and place them in open curves facing toward the receiver.

PARTS FOR "AUDIO" TELEGRAPH

Amateur transmitting key.
 Bell transformer (see text).
 House buzzer.
 Audio transformer, 3-to-1 ratio.
 Baseboard octal socket.
 Tube (1D8GT).
 Fahnestock clips (eight).
 Headphones, 2,000 ohm.
 Antenna rods (four, see text).
 Mica condenser, .005 mfd.
 Tubular paper condenser, .002 mfd., 600 v.
 Carbon resistor, ½ watt, 1 meg.
 Carbon resistor, ½ watt, 50,000 ohm.
Miscellaneous: Flash-light batteries, "B" batteries, wire, baseboards, etc.

A Three-Tube Phonograph Receiver

ALTHOUGH designed primarily as a phonograph amplifier for use with either a crystal or a magnetic pick-up, this three-tube set of the "Get Started in Radio" series which begins on page 10, is so versatile that it can be used for other purposes as well. Connected to a simple crystal receiver through a 3-to-1-ratio transformer, for instance, it can be used to provide loud-speaker volume on near-by broadcasting stations. Used with a microphone, it can be made to serve as a small public-address system.

The parts for the amplifier were all included in the main list of parts given in the first article. If you bought the list complete you have nothing more to buy, for even the baseboard can be used again by turning it bottom side up to conceal the holes that were made in mounting

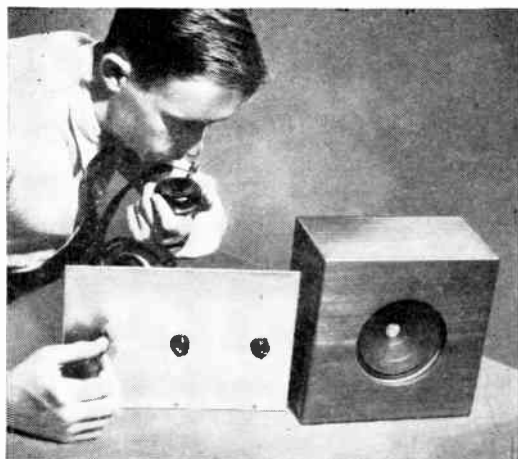

An earphone can be used as a public-address mike

The Get-Started-In-Radio Series

the parts for the first three circuits.

Your first job will be to take apart the four-tube receiver constructed on page 16. Be careful in removing the parts, as many of them will be used again.

Both tubes (25B8GT and 70L7GT) are used in the amplifier circuit. The 25B8GT, not using its triode section, serves as the input stage and the 70L7GT provides the output. As shown in the diagram, resistance coupling is used and offers sufficient volume for ordinary use.

In placing the parts, follow the photographs. Mount the 25,000-ohm tone control, the 250,000-ohm volume control, and the on-off switch on the front panel. The volume control fits conveniently in the space vacated by the variable tuning condenser used in the previous receiver circuits.

When used as a phonograph amplifier, the unit should be connected to a high-impedance pick-up with a rating of approximately 18,000 ohms.

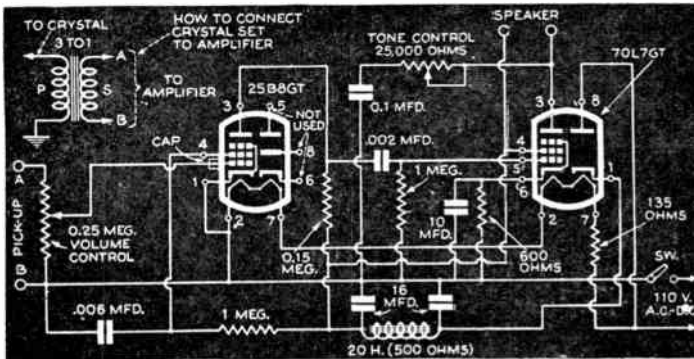
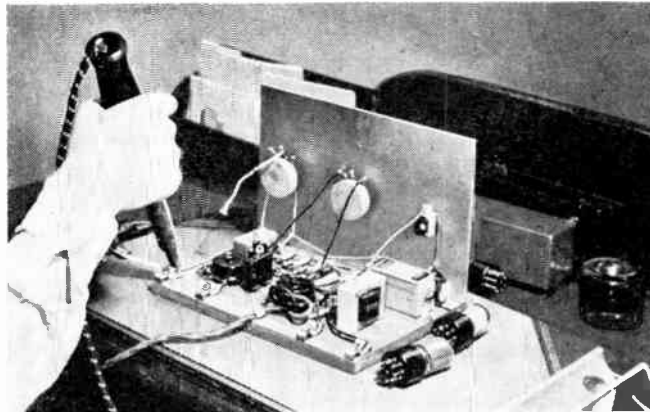
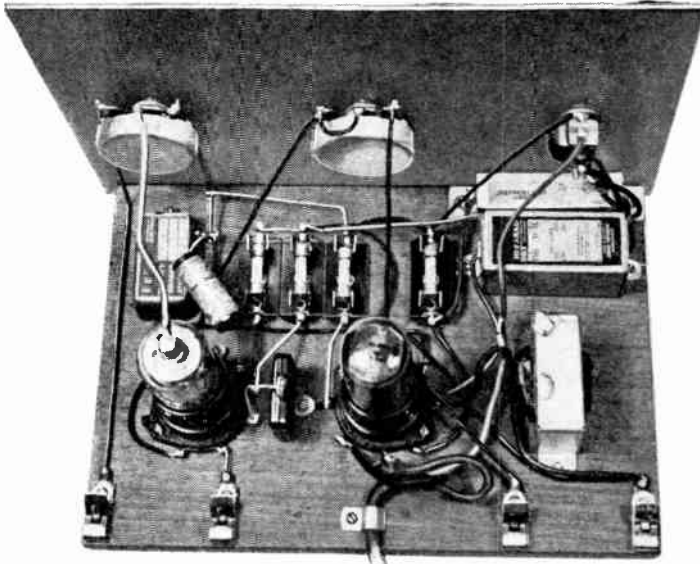

Soldering iron and pliers are the only tools needed to assemble the inexpensive amplifier

How the ports are wired. Below are the two socket wiring diagrams

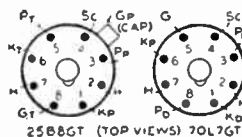

Servicing Your Radio

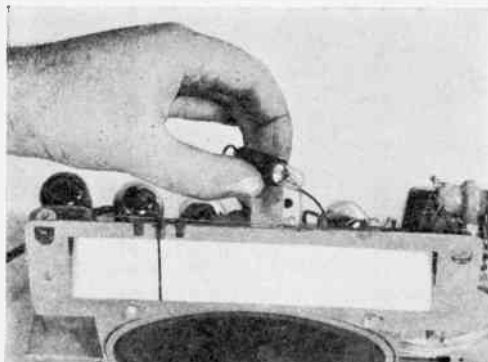

CHANGING PILOT LIGHTS is a simple operation in servicing a small A.C.-D.C. receiver, but be sure that you disconnect the radio at the wall socket—don't just turn off the switch. A serious short can occur if the pilot-light bracket and holder drop on the tuning condenser or chassis.



INCREASED HEATER VOLTAGE may be necessary if the rectifier tube burns out quickly on an A.C.-D.C. radio having a new high-voltage heater tube and no line-cord resistor. Try replacing the 3525-GT/G rectifier tube with a 45-volt rectifier, such as a 42Z5-GT/G, to increase the heater voltage to 120 volts.

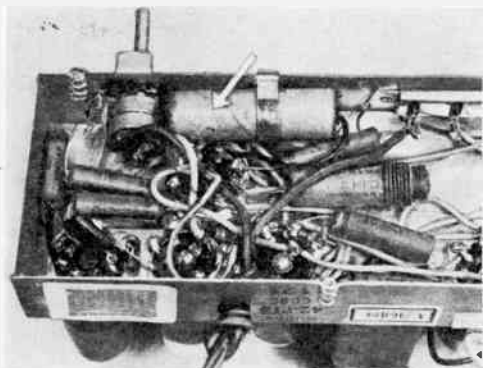

THE PAPER TUBULAR CONDENSER connected between the power pentode tube and chassis, as shown in the diagram below, may be shorted if an A.C.-D.C. radio has gone dead except for the heater glow inside its tubes. This is especially true if, upon testing, the D.C. voltage to the tubes shows only about 20 volts. Remove the power pentode tube (a 43, 25L6, 50L6, or similar tube) from its socket, and test the condenser by placing an ohmmeter across it. If the needle on the meter swings over, the condenser is shorted and a new one must be installed.

SQUEALING AND WHISTLING that make it impossible to tune in a station clearly on a small A.C.-D.C. receiver may mean failure of one or both of the filter condensers shown in the photograph above and the diagram below. The noise is usually accompanied by a noticeable loss in volume. If defective, the condensers must be replaced.

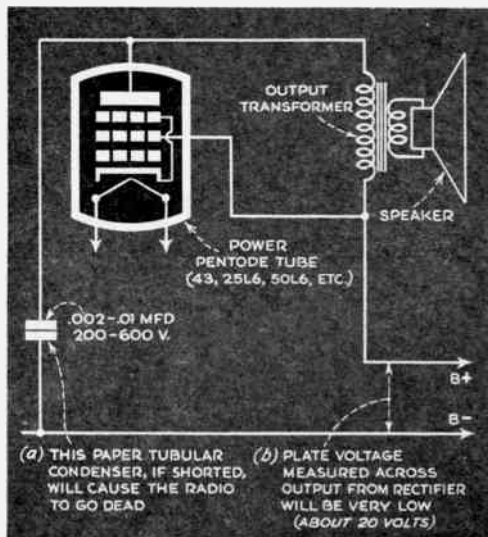
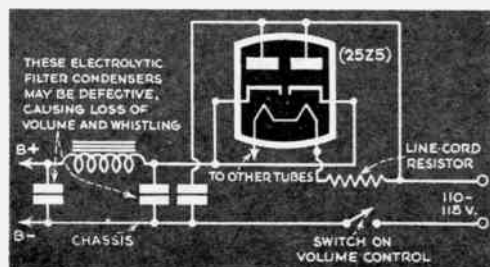

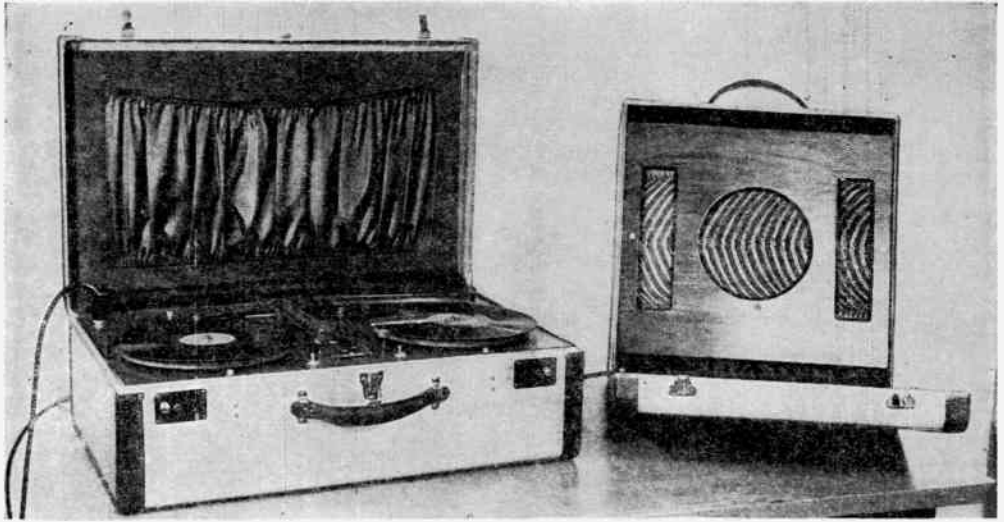

The twin phonographs and amplifier are installed in a 26" suitcase, the speaker in a matching hatbox

INEXPENSIVE DUAL-TURNTABLE PHONOGRAPH

**Portable and Easy to Build, It
Provides Sound Accompaniment
for Your Own Home-Movie Films**

ALL SORTS of entertainment possibilities are opened with this easily built twin-turntable phonograph. If you are a music lover, it will allow continuous reproduction of your favorite symphonies and operas. If you like nonstop music for dancing, it will supply that. And if your hobby is home movies, it can be used to provide realistic fade-in and fade-out accompaniments and sound effects for your favorite films. Complete and housed in two pieces of luggage for easy carrying, the outfit can be built for \$35.

The containers for the equipment consist of a standard 26" week-end bag and a standard hatbox, matching in color and design. Into the larger bag go the two self-starting, A.C. motors with 9" turntables,

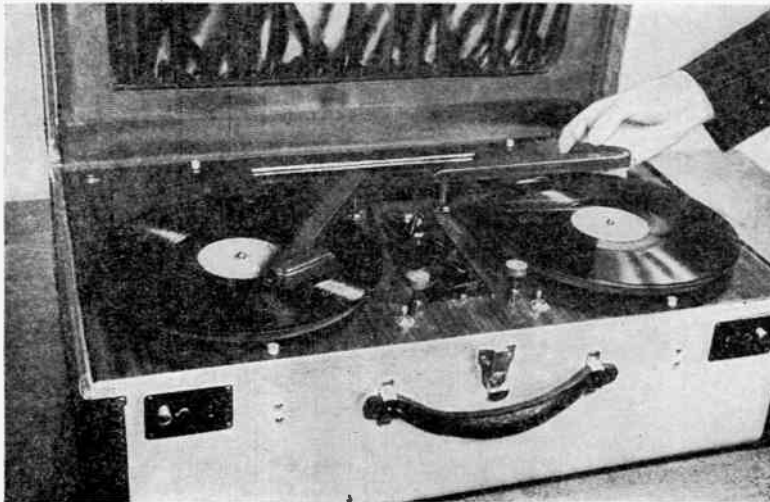

Close-up of the motor panel showing the two turntables and pick-up arms, and the tone and fader controls. The switches next to the turntables operate the phone motors. While one unit plays music, the other may provide the incidental sounds



How the two units are set up for use. The phonographs are beside the movie projector where the operator can put on and change records and regulate the volume. The speaker unit, connected by a 25' cable, is placed near the screen

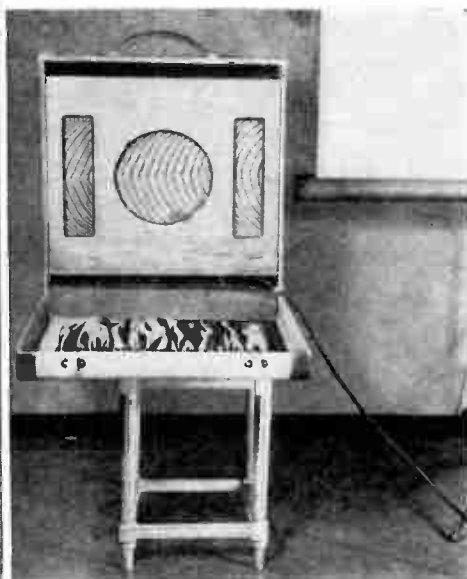

two crystal pick-ups, and the 4-watt amplifier system with fader and tone control. In the hatbox is the 8" permanent-magnet speaker, provided with a 25' length of heavy, rubber-covered cable so that the speaker can be placed beside a movie screen. At one end of the table is a microphone-type plug which fits into the jack at the motor panel.

On the motor panel, which is a $\frac{1}{2}$ " by $15\frac{1}{8}$ " by $24\frac{7}{8}$ " sheet of plywood, are mounted two S.P.S.T. toggle switches for starting or stopping the two phonograph motors. The motors should maintain a constant speed of 78 revolutions per minute at all times. Those used by the author have large bearings and laminated-bakelite helical-cut gears completely inclosed and protected.

Above the three-tube amplifier is an opening $3\frac{1}{2}$ " by 10" and protected by a piece of cane sheeting $4\frac{1}{2}$ " by 11". The cane sheeting may be obtained at any large hardware store. It should have a coating of black enamel paint to prevent rust and enhance the general appearance of the equipment.

On a small black-crackle aluminum panel, $2\frac{1}{2}$ " by 6", are mounted the two fader controls regulating the output of each pick-up, the tone control, and the amplifier on-and-off switch which is mounted on the 250,000-ohm tone control.

The fader controls are two 100,000-ohm

variable resistors connected in series between the control grid of the input triode and ground. Across these is a 1-meg., 1-watt carbon resistor.

The 6C5 is resistance-coupled to the 6F6 pentode by means of the 50,000-ohm, 1-watt resistor, the .1-mfd. coupling condenser, and the 500,000-ohm, 1-watt grid resistor. Amplification is ample with the crystal pick-ups used to operate the 6F6 at its maximum output of $3\frac{1}{2}$ to 4 watts.

The power transformer has three secondary windings—300+300 volts at 60 milliamperes, 5 volts at 2 amperes, and 6.3 volts at 2.5 amperes. A 30-henrys choke, rated to pass 75 milliamperes, and two 12-mfd. electrolytic condensers constitute the filtering circuit. A 10,000-ohm, 1-watt resistor in the plate circuit of the 6C5 and by-passed by an 8-mfd. electrolytic condenser stabilizes the amplifier and prevents feed-back.

A high-mu triode (the 6F5) may be substituted for the 6C5 if greater volume is desired. However, the output of this amplifier, with the 6C5, is ample even for a small dance hall. If needle scratch is noticeable, an inexpensive scratch filter may be connected in the output of each pick-up unit. The filters can be mounted beside the motors under the motor panel.

Instantaneous changing of the records is

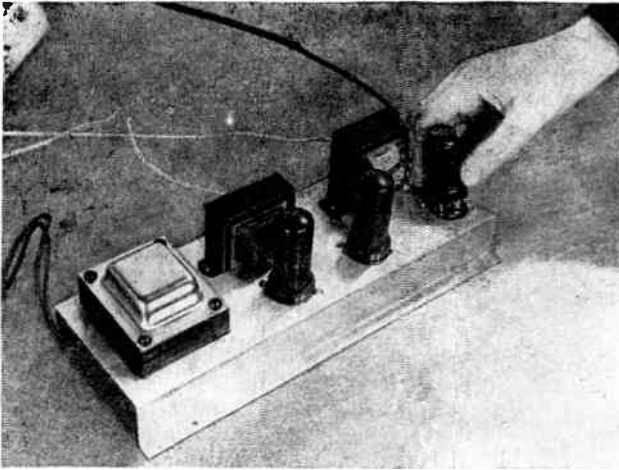

Top and bottom views of the amplifier chassis which should be bolted to the bottom of the suitcase under the motor-panel grill. Metal tubes are used—an important advantage in portable units

possible with the twin pick-up units, one record being readied while another is playing. For home-movie work, records or parts of them can be faded in or out at will. And, if desired, a sound-effects recording may be played simultaneously with an instrumental recording.

Ilya Laskoff, composer and conductor for the Columbia Broadcasting Company, suggests the following records for use with home-movie scenes:

For ocean scenes, Debussy's "La Mer" and Mendelssohn's "Fingal's Cave." For western scenery, Ferde Grofe's "Grand Canyon Suite" and "The Plains" by Bernard Rogers. For pictures of children, Debussy's "Children's Corner." For country scenes, "Pastoral Symphony" by Beethoven.

For industrial scenes of ship-yards, railroad terminals, or factories, Mr. Laskoff's choice is either "Ironworks" by Mos-solow, or "Steel Mills" by Ferde Grofe.

Pictorial diagram of parts under the motor panel. Needle-scratch filters may be added if necessary

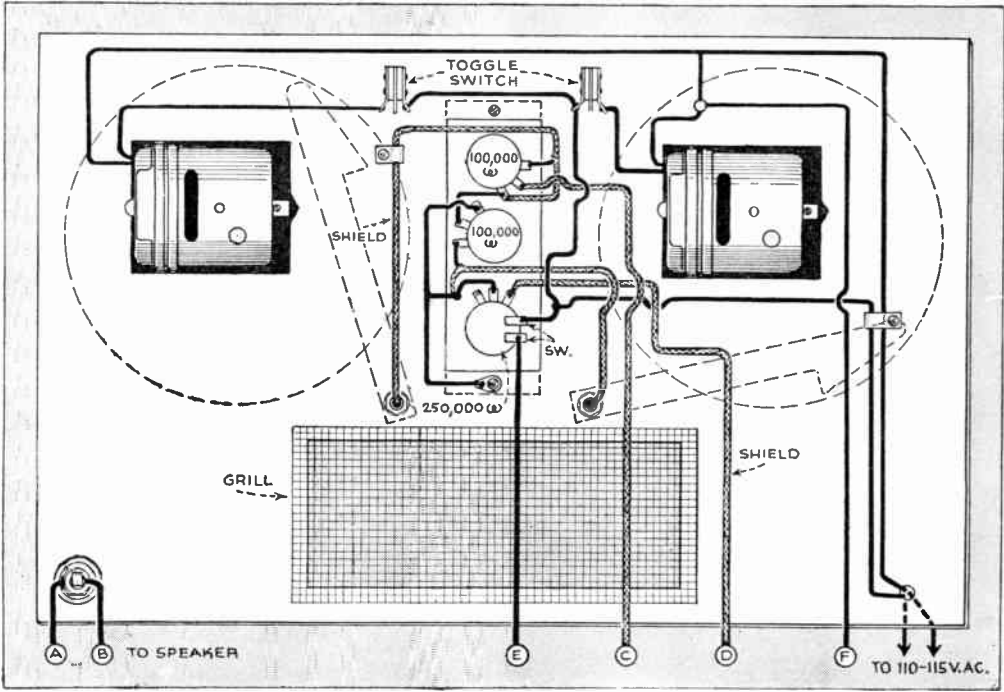

LIST OF PARTS

Power transformer, 600 volt, 50 ma.; 5 volt, 2 amp; 6.3 volt, 2½ amp.

Filter choke, 30 henrys, 400 ohm.

Universal output transformer.

Tubes, 6C5, 6F6, and 5W4.

Crystal pick-ups (2).

Phonograph motors (2) with 9" turntables.

P.M. speaker, 8".

Suitcase (26" size).

Hatbox.

Chassis, 1½" by 4" by 12".

Octal wafer sockets (3).

Shielded hook-up wire.

S.P.S.T. toggle switches (2).

Volume controls, 100,000 ohm (2).

Tone control, 250,000 ohm.

S.P.S.T.-switch cover plate (for above).

Electrolytic condensers, 12 mfd., 450 volts (2); 25 mfd., 50 volt; 5 mfd., 50 volt; and 8 mfd., 450 volt.

Tubular condensers, .05 mfd., 400 volt, and .1 mfd., 400 volt.

Carbon resistors, 500 ohm, 5 watt; 2,500 ohm, 1 watt; 10,000 ohm, 1 watt; 50,000 ohm, 1 watt; 500,000 ohm, 1 watt; and 1 meg., 1 watt.

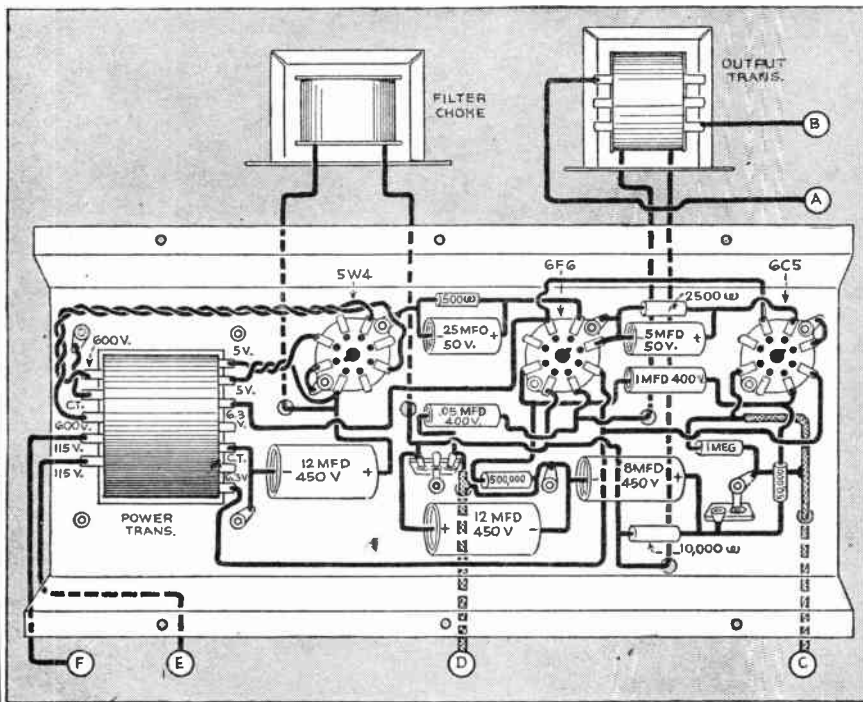
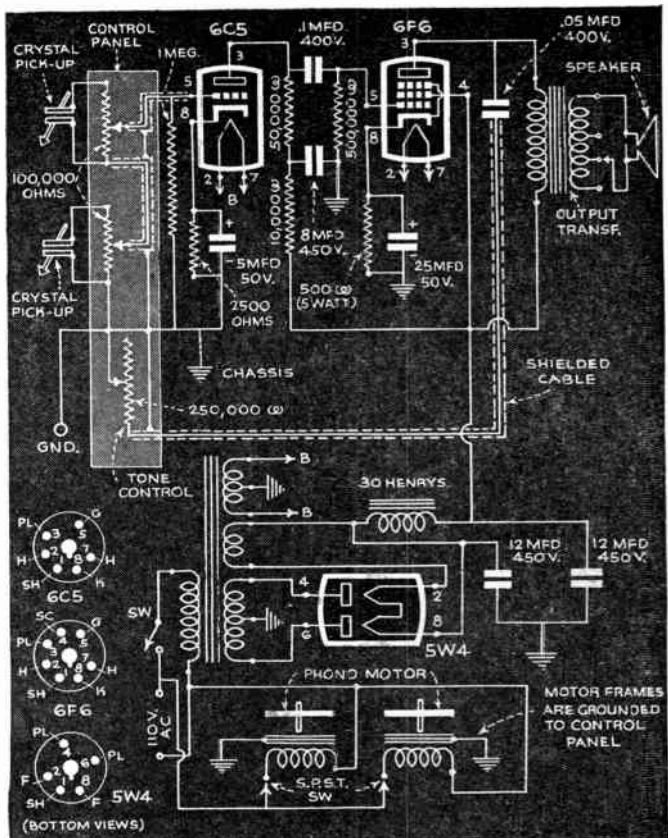

Above is a complete wiring diagram for the amplifier and loudspeaker circuit. The motor frames are grounded to the control panel

In this pictorial diagram, the placing of the parts of the amplifier circuit above and below its chassis are shown in detail. In making all connections, use solder

KITCHEN RADIO

RESEMBLES FLOUR CONTAINER

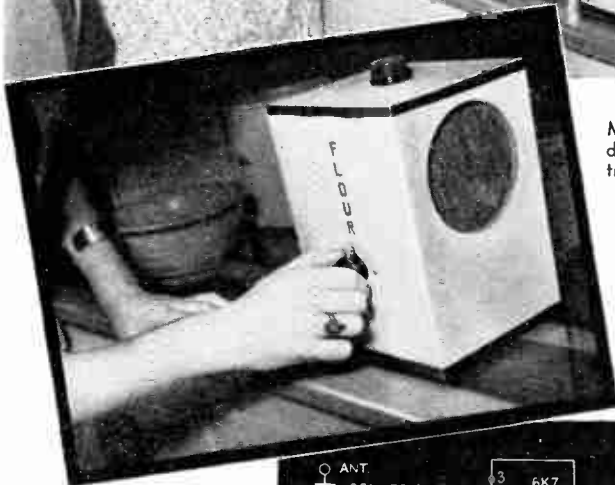

Matching kitchen bins, the radio is both decorative and handy. The lettering and trim are in black on an ivory background

An
A.C.-D.C. Three-Tube
Receiver

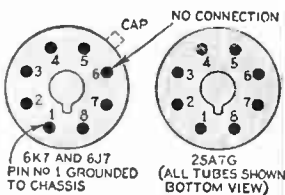

Follow the numbers in the circuit diagram for making the tube-base connections

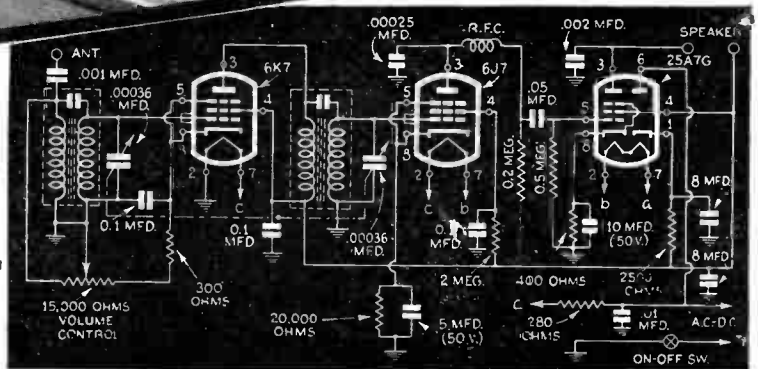

DESIGNED specially for use in a kitchen or kitchenette, this compact three-tube broadcast receiver is built to match the conventional canisters used by housewives to store flour, sugar, and other dry groceries. Operating on either alternating or direct current, the set can be plugged into any house-wiring outlet and requires only a short antenna and no ground.

To match the set of canisters already in the writer's kitchen, the wooden receiver cabinet was finished in ivory enamel with black lettering and trim. The word "FLOUR," which appears on the front just above the tuning dial, was painted on free-hand. However, if the reader prefers, he may cut the letters from a strip of black electrician's tape, and then press each letter in place. As electrician's tape is already adhesive, no glue will be required. Black paper letters, available at most large stationery or art-supply stores, also can be used, if desired.

Since most kitchen containers have some sort of handle on the top, the writer placed the volume control on the top of the cabinet. The knob makes the general appearance of the receiver more realistic. The speaker was mounted on the right side in order to leave room on the front for the word "FLOUR."

In designing the circuit, one of the new ultra-midget combined pentode and rectifier tubes was chosen as a combination rectifier and power tube to save space and make the chassis as compact as possible.

Two all-metal tubes are used in the radio-frequency and detector stages and are coupled through shielding iron-core coils. This provides maximum efficiency and results in an increase in sensitivity with the result that a greater number of stations can be heard with this set than with most standard A.C.-D.C.

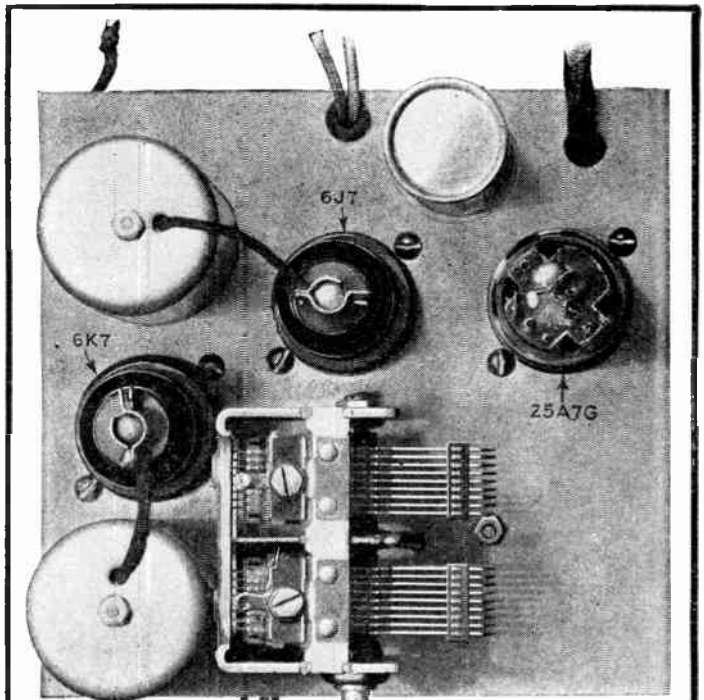

Note the arrangement of the tubes, coils, and condenser on top the chassis

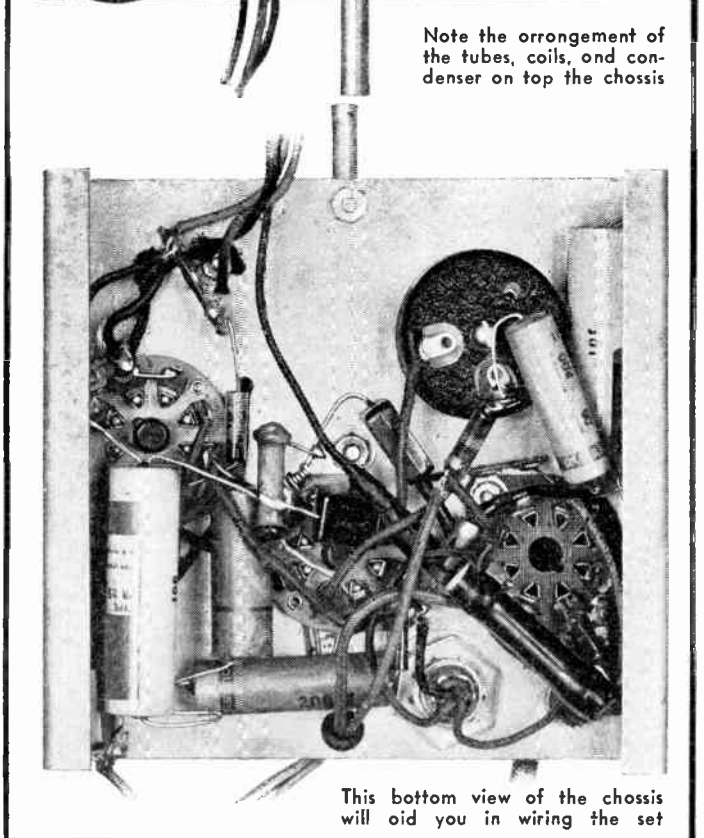

This bottom view of the chassis will aid you in wiring the set

tuned-radio-frequency receivers. Adequate filtering in the plate circuit of the detector tube avoids instability caused by feed-back between the audio and detector stages.

The chassis, which can be cut and bent to shape easily from sheet aluminum, measures 1½" by 5" by 5½". The front and back should be left open to provide ventilation for the 2,500-ohm filter resistor. In order to provide plenty of room for mounting the resistors and by-pass condensers, the dual electrolytic condenser should be placed above the chassis. As shown in the photographs, it will fit under the output transformer of the five-inch, permanent-magnet loudspeaker. Before installing the speaker, a piece of metallic cloth, which can be obtained from a radio-supply house, should be cut to shape and glued over the speaker opening on the inside surface of the cabinet.

As with all radio circuits, caution should be exercised in making the various connections, particularly those to the tube sockets. Remember that filament voltages are low, plate and grid voltages are high by comparison, and that one slip may destroy a radio tube. All connections should be made carefully with solder, and connecting wires should be made

LIST OF PARTS

Tuning condenser, two-gang, .00036 mfd.	Resistor, 2,500 ohm, 10 watt.
Tubular condensers (three), .1 mfd.	Resistor, 400 ohm, 1 watt.
Tubular condenser, .05 mfd.	Half-watt resistors, ½ meg., 20,000 ohm, 2 meg., 200,000 ohm, and 300 ohm.
Tubular condenser, .01 mfd.	Antenna and radio-frequency coils, shielded, iron-core.
Fixed condenser, mica, .002 mfd.	Volume control and switch, 15,000 ohms.
Fixed condenser, mica, .001 mfd.	Radio-frequency plate choke, shielded 30 mh.
Fixed condenser, mica, .00025 mfd.	<i>Miscellaneous</i> — Midget wafer 8-prong sockets, tubes (see diagram), speaker.
Electrolytic condensers, 50 volt, 5 mfd.; ultramidget, ultrathin, 8 and 8; and 50 volt, 10 mfd.	
Line-cord resistor, 280 ohms.	

as short as possible to insure low losses and good performance.

The reader will find that the wiring of the tubes will be greatly simplified if he will compare the numbering of the terminals on the tube-socket diagrams with those appearing in the circuit diagram.

In operating the receiver, thirty or forty feet of flexible insulated wire strung around the molding or baseboard will provide good reception. As with all A.C.-D.C. receivers, no ground connection should be used, since the circuit is already grounded through the power plug.



Putting finishing touches on the cabinet. At the right is a rear view of the completed set. The knob on the top is the receiver's volume control

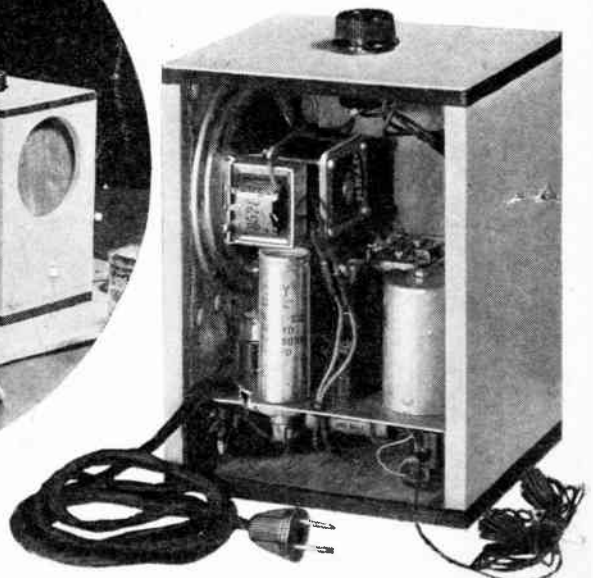

Two-way Radio Station

COSTS \$18 TO BUILD



Adjusting the midget transmitter described in this article. Left, the receiver, and right, the sending key

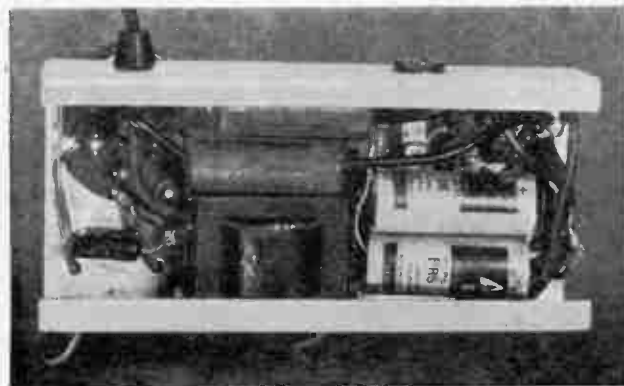

FOR the amateurs specially authorized by the Government to use transmitters for specified emergencies, a complete sending and receiving station is detailed on these pages. Inexpensive and compact, as well as easy to build, the efficient short-wave receiver and "punchy" little transmitter will provide an excellent stand-by station in case of trouble in regular equipment.

A choice of two circuits is given for the receiver. As a straight one-tube plus rectifier tube, the set will pull in South American stations and several amateurs—final results depending, of course, on the locality and position of the antenna. As a two-tube plus

On the transmitter chassis, left, are a four-prong 80-meter plug-in coil, crystal, and 117N7GT tube. Shown in the view from underneath are the filter choke, two 16-mfd. electrolytic and two paper tubular condensers

the rectifier, it should bring in the European stations and several more amateurs in the United States and possibly South America.

A few simple alterations change the receiver to a three-tube set, so we will describe only the two-tube version. This circuit calls for a 6J7 as a pentode detector and a 25Z6 as a half-wave rectifier. Both tubes are metal and require no external shielding. A six-prong coil is used and on it are three windings—a primary or antenna, a secondary or grid, and a tickler winding.

There are two antenna connections at the back of the chassis—one leading straight to the primary winding, the other through a .0001-mfd. mica condenser to the grid winding. The first is used when an outside antenna longer than 50' is employed, while the other is for short indoor antennas up to 30' or 40'. Tuning is accomplished with the .00014-mfd. condenser (the small dial to the left of the center dial in photo). When a band such as the 80-meter amateur band is tuned in, it is spread out over a 180-degree arc by means of the band-spread condenser (the large center dial). This system aids tuning on short waves.

Regeneration is controlled by the 50,000-ohm variable resistor in the screen circuit of the 6J7. This type of regeneration is extremely smooth and eliminates the loud "plop" as the receiver goes into oscillation. Any type of magnetic phones may be used if the resistance is between 2,000 and 4,000 ohms.

Ample filtering is provided by the 20,000-ohm, 5-watt wire-wound resistor and the two 20-mfd. electrolytic condensers. No hum should be heard, even at the point of oscillation, but if it is, try increasing the .01-mfd. tubular condenser in the plate circuit of the rectifier (25Z6) to about .1 mfd.

The transmitter uses the new 117N7GT, which is a combined power pentode and rectifier tube. It has a 117-volt heater, does not need a

line-cord resistor, and operates directly off a 115-volt AC or DC line. Tuning is done with the .0001-mfd. variable condenser across the four-prong plug-in coil. The antenna coupling is adjusted by the other .0001-mfd. variable condenser in the antenna lead. A crystal in the grid circuit of the pentode stabilizes the signal and prevents transmitter drift. The key is inserted in the cathode and by-passed by a .1-mfd. tubular condenser. Another .1-mfd. tubular condenser across the 115-volt line smooths out any remaining "ripple" in the signal sent.

Tuning a transmitter correctly involves patience, but can be done easily with the aid of a 0-50 milliammeter. With the antenna disconnected and both variable condensers in mesh, the 0-50 milliammeter (which is connected across the key terminals) should read 35 milliamperes. Gradual reduction of the capacity of the tank or tuning condenser will dip the needle to about 18 milliamperes. Further reduction will cause the needle to jump back to about 23 milliamperes and stop there. Regulate the tuning condenser so that it reads about

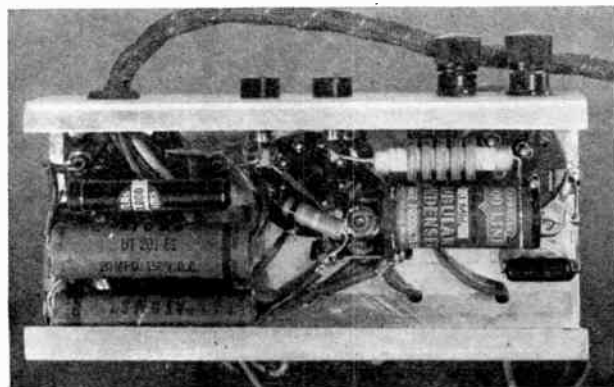
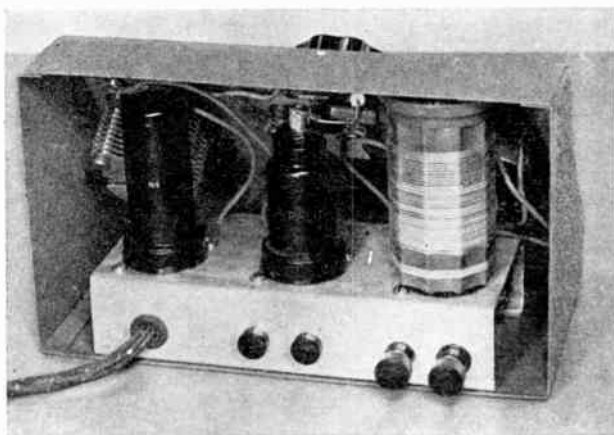

Amateur-band tuning is done with the coil (right) on the receiver chassis. The tubes are 6J7 and 25Z6. Above the two electrolytic condensers, at left in the bottom view, is the wire-wound resistor. The RF choke is shown at right

LISTS OF PARTS

TRANSMITTER

Cabinet, 7½" by 4½" by 4¼".
 Four-prong 80-meter plug-in coil.
 Rubber line cord and plug.
 Octal wafer socket.
 Four-prong wafer socket.
 Mounted crystal, 80 meters.
 Five-prong socket for crystal.
 Pentode-rectifier tube, 117N7GT.
 Filter choke, 12 Henrys, 250 ohms.
 Toggle switch, S. P. S. T.
 Condensers: Mica, .001 mfd.; electrolytic (2), 16 mfd., 150 volts; paper tubular (2), .1 mfd., 600 volts; tuning (2), .0001 mfd.
 Carbon resistor, ½ watt, 50,000 ohm.
 Ceramic antenna binding post.
 Transmitting key.

RECEIVER

Cabinet, 7½" by 4½" by 4¼".
 Six-prong 80-meter plug-in coil.
 Midget RF choke, 2.5 millihenrys.
 Resistor line cord, 290 ohms.
 Octal wafer sockets (two).
 Six-prong wafer socket.
 6J7 triple-grid detector tube.
 25Z6 half-wave rectifier.
 Variable resistor, 50,000 ohms.
 Attachable switch, S. P. S. T.
 Condensers: Electrolytic (2), 20 mfd., 150 volts; mica (3), .0001 mfd., .00025 mfd., and .0002 mfd.; tubular paper (2), .1 mfd., 600 volts, and .01 mfd., 600 volts; tuning (2), .00014 and .00002 mfd.
 Resistors: Carbon (2), 100,000 ohms, ½ watt, and 1 megohm, ½ watt; wire-wound, 20,000 ohms, 5 watts.

EXTRAS FOR THREE-TUBE RECEIVER

Resistor line cord, 260 ohms.
 Pentode-rectifier tube, 32L7GT.
 Condensers: Electrolytic, 5 mfd., 25 volts; paper tubular (2), .002 mfd., 600 volts, and .05 mfd., 600 volts.
 Resistors: Carbon (3), 1 watt, 600 ohms; ½ watt, 500,000 ohms, and ½ watt, 250,000 ohms.

20 milliamperes or at a degree on the dial where it is slightly more out of mesh than at the maximum dip of the needle.

Now connect the antenna. The needle will instantly jump back to 35 milliamperes. Turn this time the antenna condenser until the needle dips to about 30 milliamperes. Turning the condenser further out of mesh will cause the needle to dip to about 25 milliamperes. However, the antenna is correctly loaded at the 30 milli-ampere reading, so turn the condenser back until the reading is again 30 milliamperes.

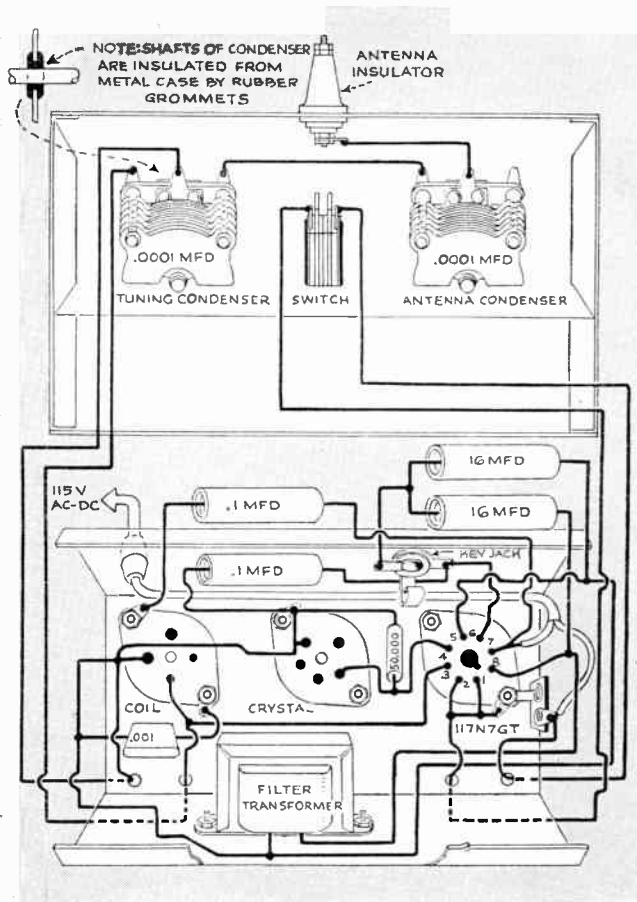

Pictorial diagram of the midget radio transmitter using the new 117N7GT combination power pentode and rectifier tube

Below, complete wiring diagram of the transmitter. About 3 watts are fed into the antenna by this little sending outfit

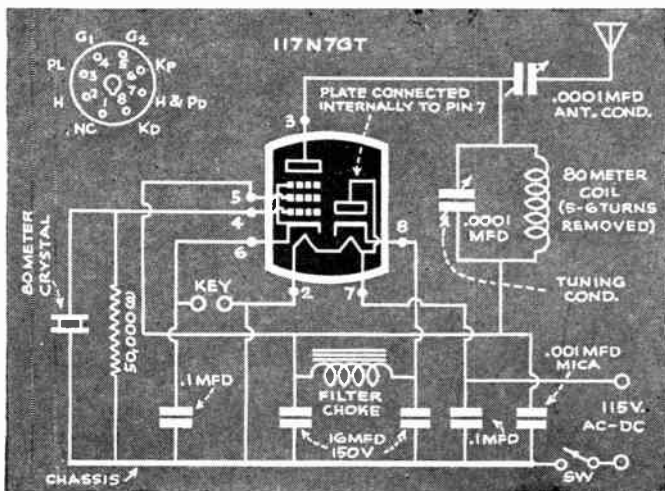

COMBINATION RADIO RECEIVER AND AMPLIFIER

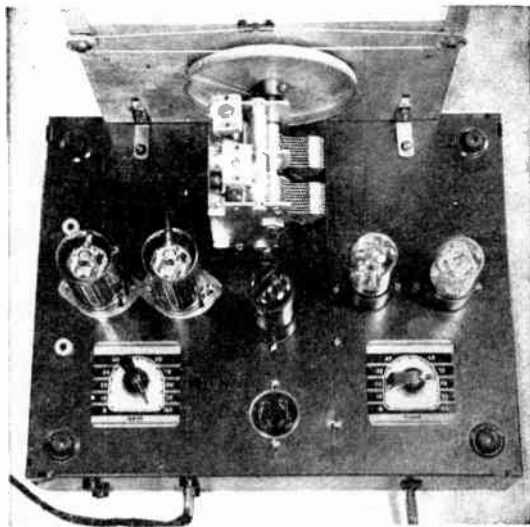

Top and bottom views of the receiver and amplifier. The condenser is raised to be in line with the center of the dial. In the tube bank, those unshielded are 35Z5-GT/G's. The unshielded coils are shown below

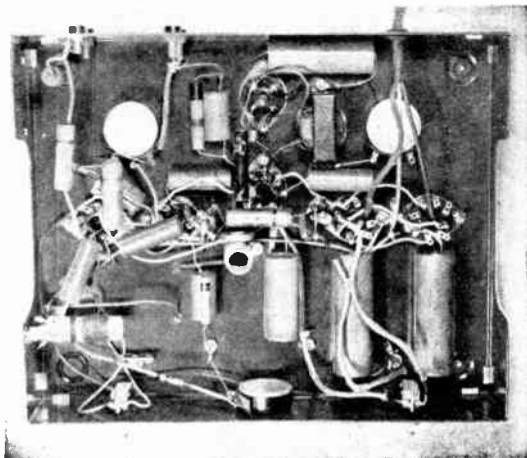

USING an inverted metal letter holder, found in most stationery stores, instead of the usual steel radio chassis, this instrument combines into one unit a TRF broadcast receiver and high fidelity P.A. amplifier. By an unusual circuit arrangement all five tubes are in operation when the instrument is in use either as a radio receiver or as a Public Address amplifier, that is, the radio frequency stage and detector stage double as the first two stages of the P.A. amplifier.

An analysis of the circuit shows at once that no power transformer is employed. The circuit is operated only on straight AC current. In spite of the lack of a power transformer, the output from the rectifier circuit is still higher than the line—200 volts to be exact—and the maximum power output of the 25L6-GT/G tube, about 5 watts, can be obtained. The high plate voltage is obtained by using a voltage doubler circuit with two 35Z5-GT/G's.

When the upper feed line in the diagram is positive, current flows through the lower tube and the 30 mfd. condenser and charges the condenser. When the reverse condition occurs on the other half of the cycle, the power line lead to the cathode is positive and no current can then

LIST OF PARTS

Metal letter holder.
Dial, 8". Octal sockets (5).
Socket and plug, 4-prong.
Electrodynamic speaker, 6",
field 450-500 watts.
Output transformer, 2,000 ohms.
Toggle switches: S.P.S.T. on-off,
S.P.D.T. radio-phon.
Volume control (2): 250,000
ohms, 750,000 ohms.
Tone control, 50,000 ohms.
Coils, unshielded: RF, antenna.
Tubes: (2) pentode-triode 12B8-
GT; beam power 25L6-GT/G;
(2) half-wave rectifier 35Z5-
GT/G.
Condensers: Tuning, 2-gang.
Paper tubular, 400 volts, (3)
.05 mfd., (2) .06 mfd., (3) .1
mfd. Electrolytic, 50 volts, 5
mfd., (2) 10 mfd.; 250 volts, 12
mfd.; (2) 450 volts, 50 mfd.
Resistors: Carbon, ½ watt,
3,000 ohms, 125,000 ohms, 150,
000 ohms, 200,000 ohms, 400,000
ohms, (2) 750,000 ohms, 1.5
megohms; 1 watt, 8,000 ohms,
30,000 ohms; 2 watts, 600
ohms. Line-cord, 140 ohms.
Wire-wound, 10 watts, 2,000
ohms.

Servicing Your Radio-

SOME of the most annoying experiences with old-model receivers or new models that have been in use for some time are caused by humming. This can be traced to several sources, most of them within the scope of the amateur repair man. Among

the most frequent are hum in the phonograph of a combination set or in an older-type electrodynamic speaker, or that caused by a broken filament resistor, weak or gassy tube, or faulty electrolytic condenser. The pictures below illustrate the cures.



WHEN the hum occurs in the speaker only when the phonograph is being used, ground the pick-up arm and motor frame to the radio chassis, both leads from the pick-up being grounded with braided shield covering. If the hum persists, a 1/16" metal plate, 8" to 12" in diameter, will act as a magnetic shield if screwed to the motor board between the motor and turntable.



SHOULD an old-type electrodynamic speaker lack a "hum-bucking" winding on the voice coil, connect a 30-ohm, 10-watt, center-tapped potentiometer across the power transformer's 2.5-volt or 6.3-volt heater winding in series with the voice-coil winding. A short, soldered wire serves as a center tap.

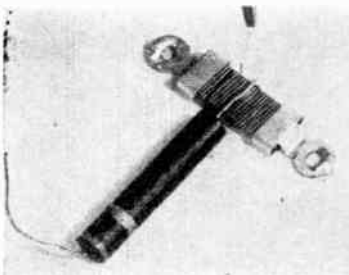
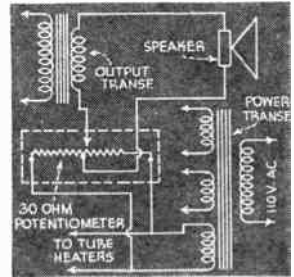

FILAMENT resistors, used in earlier models before indirectly heated tubes were perfected, must be replaced if they are broken. They are connected across the filaments of RF and other tubes to supply grid bias current and balance out hum from the power transformer's AC filament winding.

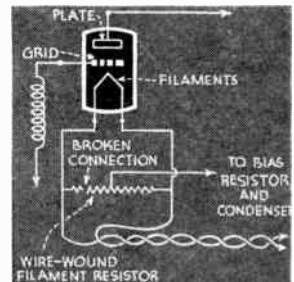

Often hum can be corrected by replacing a weak or gassy rectifier tube. If hum increases after the set has been on for a while, a power tube may be at fault, especially an old 47 power pentode tube

Electrolytic condensers go bad for many reasons—they may have open or short circuits, or the wet type may dry out and lose effective capacity. In any case, the best bet is to get a new condenser

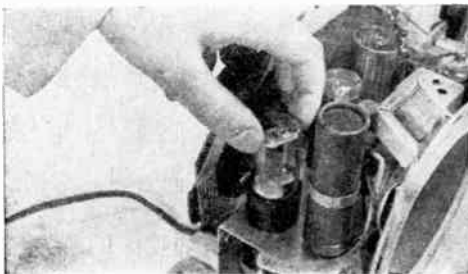

"LETTER" RADIO

CAN BE MAILED

HERE is a novelty radio receiver that you can slip into an ordinary envelope and mail to one of your radio-minded friends as an amusing birthday or holiday greeting. Mounted on a conventional scenic post card and covered with a second post card so that all wiring is concealed, the set consists of a simplified tuning coil and a crystal detector. With earphones clipped to two of its paper-fastener terminals and a ground and antenna attached to the two remaining terminals, the set is ready to bring in near-by broadcasting stations. Tuning is accomplished by fastening a small spring clip to the various taps on the homemade "spider-web" tuning coil, while a sensitive spot on the crystal can be found by shifting the cat whisker from one point to another until a station is heard in the earphones. The tuning coil is made by interlacing 100 turns of No. 30 double-cotton-covered wire around seven "spokes" cut in a $3\frac{3}{4}$ " diameter cardboard disk, as shown in the drawing below. The coil should be tapped every twenty turns by removing the insulation and applying a blob of solder. The two post cards, which

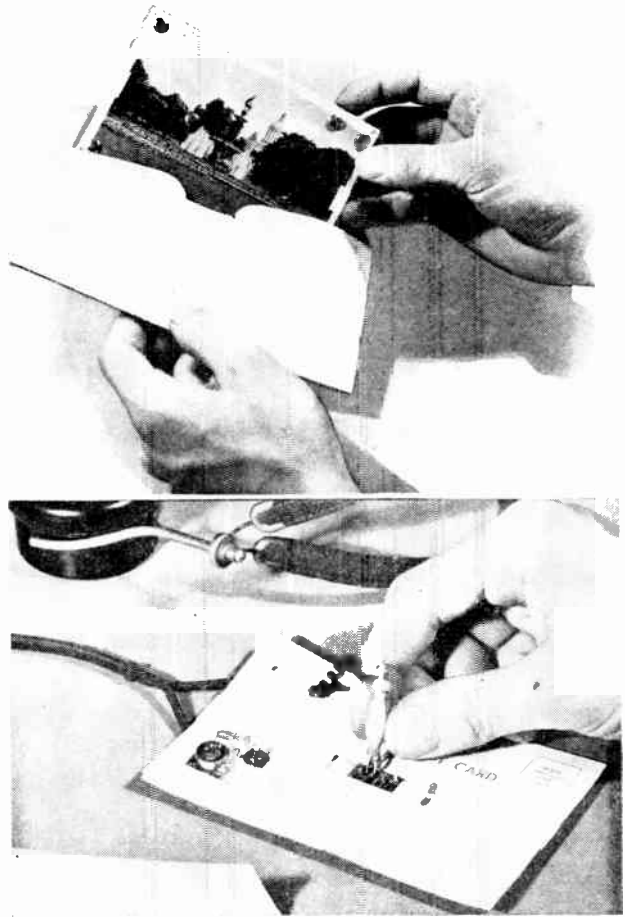

The letter radio can be mailed out of town for six cents. It is tuned by moving a spring clip from one coil tap to another

form the "chassis" and "cabinet" of the tiny receiver are held together by the paper-fastener terminals. To save space, flat copper ribbon was used in making the various connections.

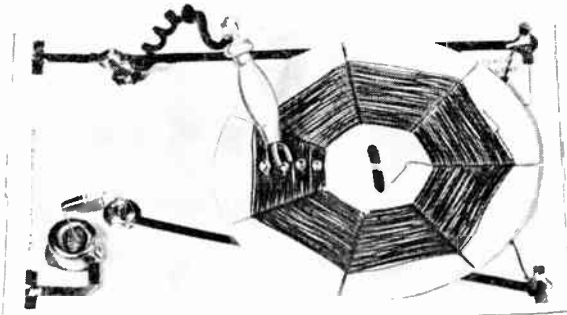

The tiny receiver with its post-card "cabinet" removed to show the wiring. Circuit and coil are shown at right

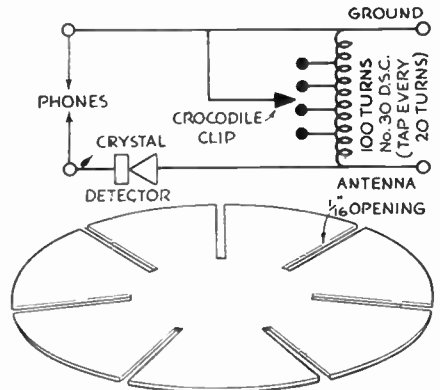

You Can Build— FM RECEIVER FOR \$22

A Complete Eight-Tube Set

THIS unit is not just another FM converter, but a complete eight-tube FM receiver, and it can be built for only \$22. Extremely compact, it is mounted in a cabinet usually sold for four-tube receivers.

A simplified version of the original FM circuit is used, a circuit so rapidly becoming standard that a kit of low-cost components has been put on the market. These parts, used in this design, are a set of three FM coils (antenna, RF, and oscillator), three special FM I.F. transformers peaked at 4,300 kilocycles, a discriminator transformer, also peaked at 4,300 kilocycles, and a three-gang tuning condenser, each section having a capacity of 7-22 mmfd.

The main difference between a standard broadcast superhet and an FM superhet is the use of a limiter tube and a "discriminator" stage. Otherwise this FM receiver consists of the usual R.F. stage (converter stage) and two I.F. stages (second detector and audio stage). The "discriminator" stage makes possible the detection of FM impulses and discriminates against standard or amplitude-modulated impulses.

In an FM receiver all grid and plate leads must be as short as possible, especially in the RF and converter stages. The layout here allows short leads between the tube prongs, condensers, coils, etc. The 10,000-ohm, 1-watt loading resistors across the secondary windings of the coils stabilize and balance the I.F. circuits. An elaborate decoupling system in each plate and screen lead of the first five tubes eliminates feedback between the circuits which would cause oscillation. The rectifier tube and circuit deliver 250 volts at about 60 milliamperes.

Front panel of the FM receiver described in this article

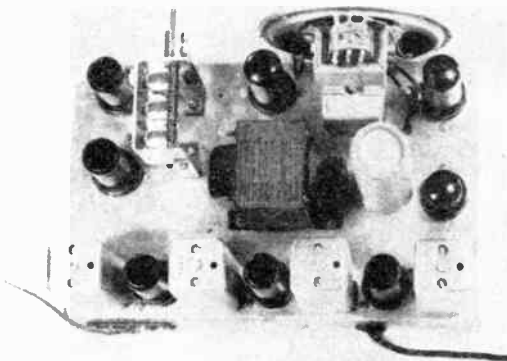

Top view of chassis, showing the compact layout of tubes, transformers, condensers, and speaker, which permits installation in a small, four-tube cabinet

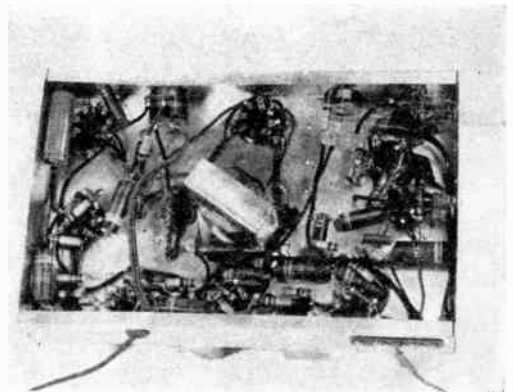

Bottom of chassis. Note filter choke in center and the special FM coils on extreme right. A phone jack indicated in diagram is not shown

It is difficult to align an FM receiver, and a dependable dealer will do it for you. Those who are ambitious, however, and can obtain a signal generator can do it at home. Align the discriminator transformer by applying a signal of 4,300 kilocycles to the grid of the 6SJ7 and connecting an O-1 ma. meter with a 100,000-ohm resistor in series with the meter across the 6H6 cathode. Adjust the secondary trimmer of the discriminator until a movement of the meter's needle is noted. As the trimmer is tuned, the meter will go plus or minus, either side of the resonant frequency. Set the trimmer so the meter reads zero voltage. The primary trimmer of the discriminator transformer is adjusted to the maximum reading when it is connected between the center tap of the transformer and ground.

To align the I.F.'s the same O-1 ma. is connected in series with the grounded side of the 50,000-ohm variable resistor (sensitivity control). By-pass the meter with a .02-mfd condenser, and apply a 4,300-kilocycle signal to the grid of the preceding 6SK7. Tune the transformer for a maximum reading on the meter. Apply a signal to the next 6SK7 and repeat the procedure. To align the trimmer condensers on the three-gang tuning condenser, tune in a station and adjust each trimmer, by ear, until the station is received at maximum volume.



Adjusting the trimmer condensers. The steel cabinet has a hinged lid

If the set is located within ten to 15 miles of an FM broadcasting station, a short piece of wire (about ten feet) connected to point "b" on the antenna binding post will suffice, but for best results a special doublet FM antenna should be connected to "a" and "c" on the binding post.

There are two important points about FM reception to keep in mind. First, the discriminator stage will not operate satisfactorily unless a sufficiently strong signal reaches the grid of the 6SJ7. Secondly, the range of FM is limited to about 50 miles.

The five-inch permanent magnet speaker does not do justice to high-fidelity FM reception. It is better to buy one of the high-fidelity speakers now sold for FM reception and use the small speaker just for speech or for monitoring the reception.

(CONTINUED)

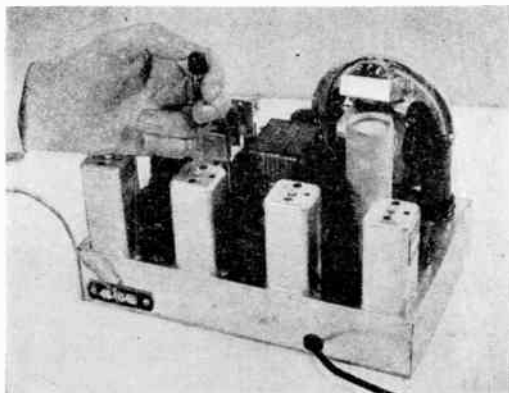

Making final adjustments. Since the tubes and power transformer generate heat, two four-inch ventilation holes should be cut in cabinet's back

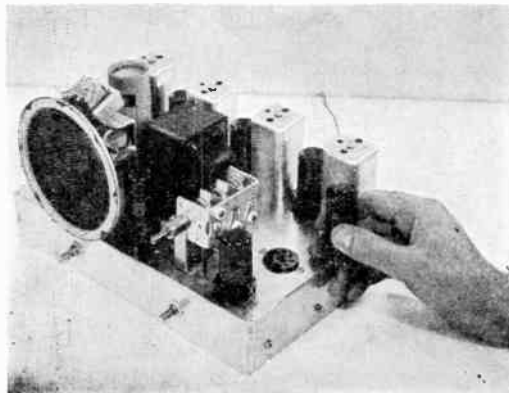

View of the RF portion of the FM chassis, showing the three-gang tuning condenser, the 6SK7 RF tube at front, and the 6SA7 mixer tube held in the hand

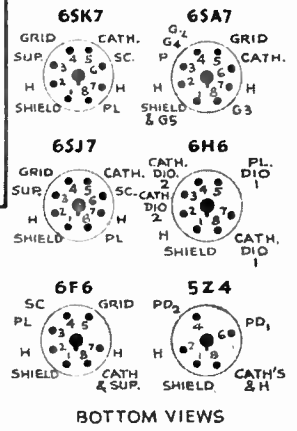
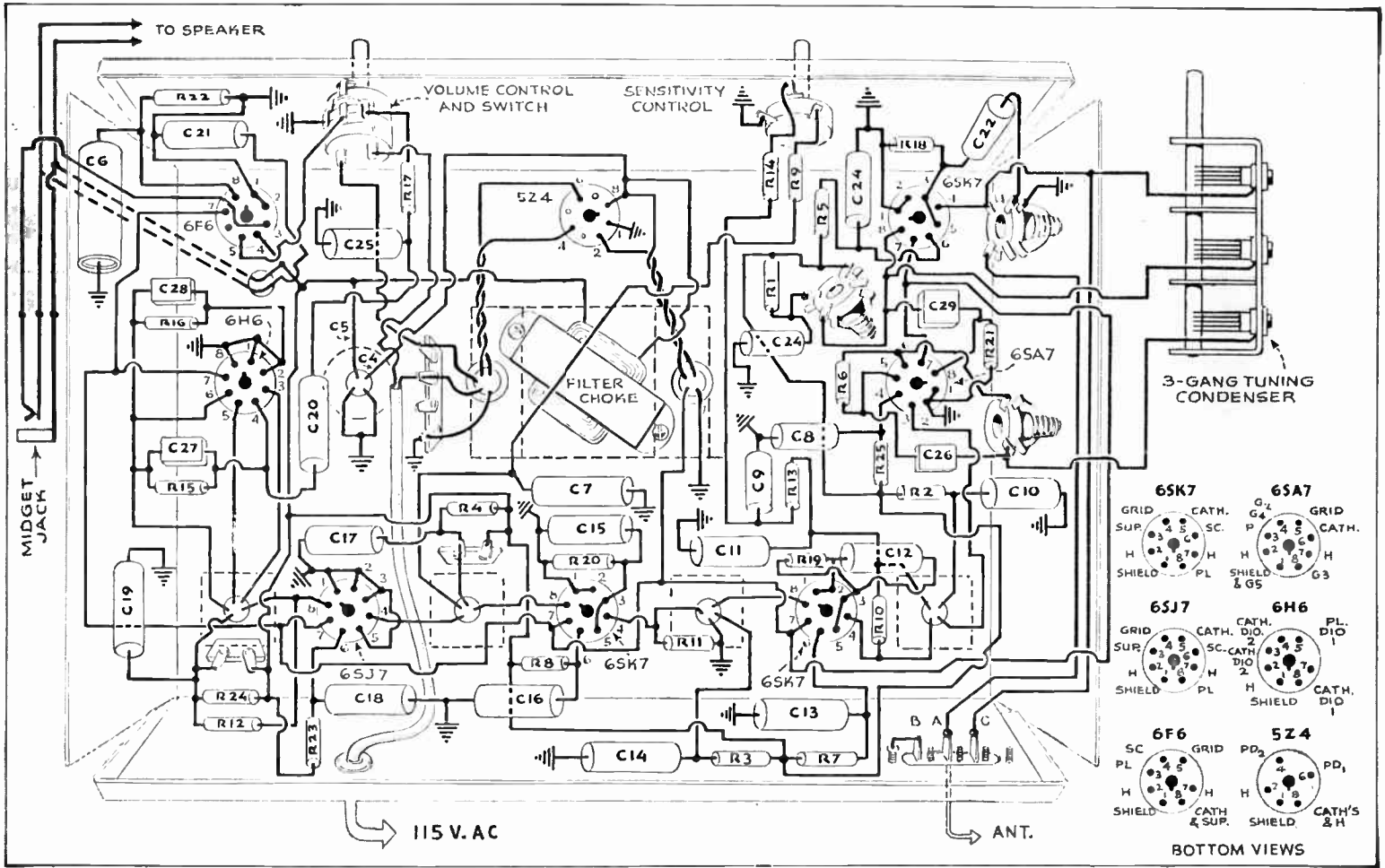

The diagrams above and on the facing page make it easy to follow the wiring connections. Above, lower right corner, are bottom views of tubes in the layout

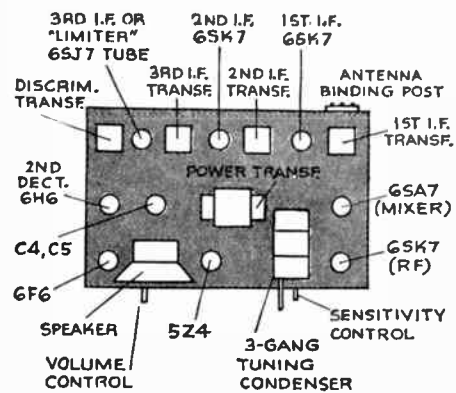
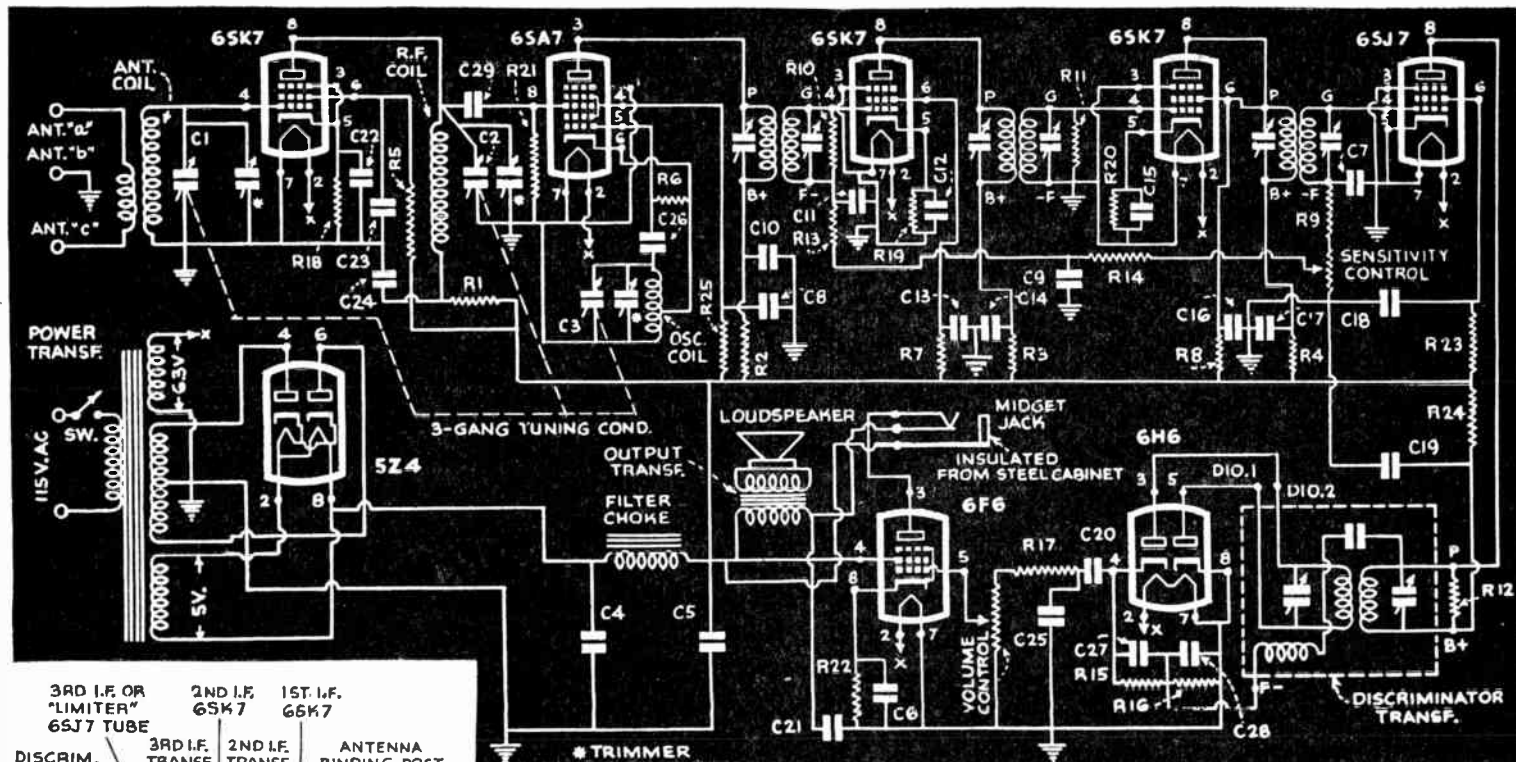

3-gang tuning condenser, 7-22 mfd., C26 to C28; .004, C29.
 Electrolytic condensers: dual 8-16 mfd., 25 volts, C4-C5; 50, 25, C6.
 Tubular condensers: .1 mfd., 400 volts, C7; (2) .01, 400, C8-C9; (11) .05, 400, C10 to C20; .006, 600, C21; (4) .001, 600, C22 to C25.
 Mica condensers: (3) .00005

mfd., C26 to C28; .004, C29.
 Carbon resistors: (4) 1,500 ohms, 1 watt, R1 to R4; (5) 50,000, 1, R5 to R9; (3) 10,000, 1, R10 to R12; (5) 100,000, 1, R13 to R17; (3) 150, 1, R18 to R20; 250,000, 1, R21; 400, 2, R22; 75,000, 1, R23; (2) 20,000, 1, R24-R25.
 FM coils: antenna; RF; oscillator.

Transformers: output; power, 680CT-70, 5 volts-2 amp. 6.3-2.5 amp.; discriminator, 4,300 kc.; (3) FM I.F., 4,300 kc.
 Filter choke, 11 henrys, 300 ohms.
 Variable resistors (2); 50,000 ohms; with switch, 500,000.
 Speaker; octal sockets; steel chassis; cabinet; tubes, etc.

Lazy-Man's Tuner

SIMPLIFIED PUSH-BUTTON REMOTE-CONTROL



IF YOU have always wanted a simplified remote-control tuner for your broadcast receiver here is an easily built unit that needs neither motors nor expensive equipment and requires only a minimum of connections to your receiver circuit. With it, you can turn your set on or off, select any one of six stations merely by pushing a button, and control the volume; all without budgeting from your armchair. Provided with a long cable, the small remote-control box can be carried to any room in your house.

Basically, the unit operates by automatically connecting into the receiver preset padding condensers that tune the circuit in place of the usual tuning condenser. Operating one of the buttons on the push-button tuner switch panel in the remote-control box energizes a corresponding relay at the receiver which serves to connect the desired condensers into the circuit. In the unit shown, six tuning buttons are em-

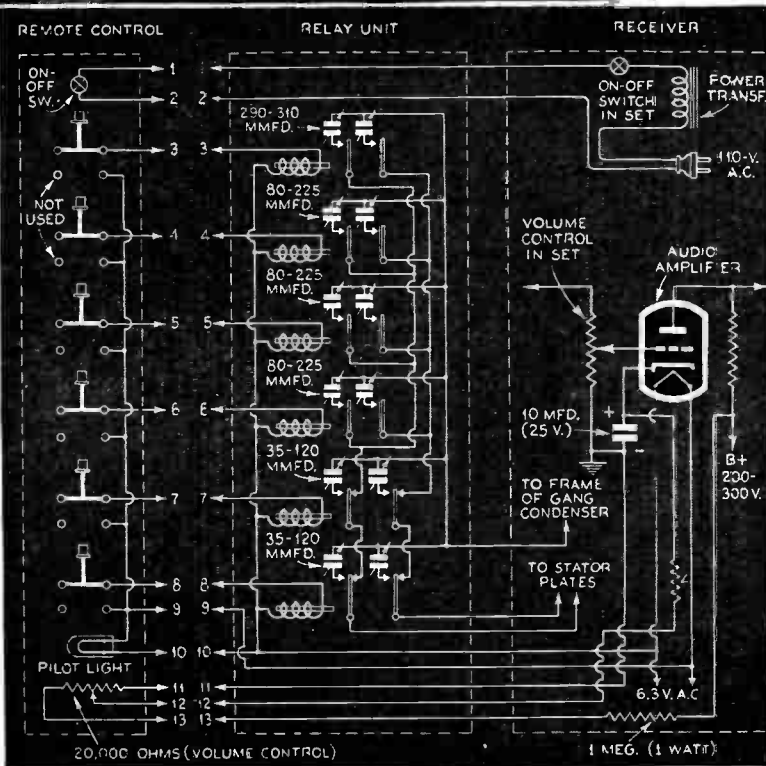

This comprehensive diagram shows the wiring of the remote-control tuner, the relay system which tunes the radio circuit, and the receiver connections



Fits Any Broadcast Set

UNIT IS EASILY ASSEMBLED FROM INEXPENSIVE PARTS

ployed to operate six relays, which in turn make the condenser connections and provide a selection of six stations. Volume control is obtained by a potentiometer built into the control box.

Designed for use with the conventional broadcast superheterodyne or tuned radio-frequency set employing a two-section tuning condenser, the unit makes use of twelve padding condensers, two for each relay circuit. When a relay is operated, one of these pre-tuned condensers is connected across each section of the two-section condenser. In receivers employing three-section condensers, three padding condensers must be used with each circuit, and three-pole relays will be required to make the necessary connections.

The actual details of construction should



Placed beside your chair, the tuner lets you adjust your radio with ease

not cause the set builder any great difficulty. The box for the remote-control unit is a standard wooden card-file case, 3" by 5", trimmed off until it stands 3 $\frac{1}{4}$ " high, outside measurement. A $\frac{1}{8}$ "-thick composition panel holds the push-button controls, a pilot light, and an on-off switch. A slot is cut in one end for the cable. Incidentally, the cable may be of any length and of any type so long as it has the necessary number of conductors.

However, since it must carry 110 volts A.C., the insulation must be good.

(Continued)

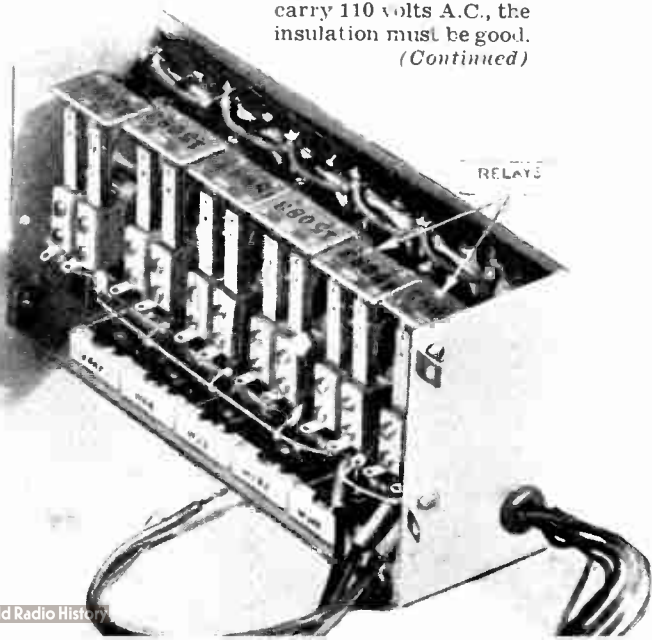
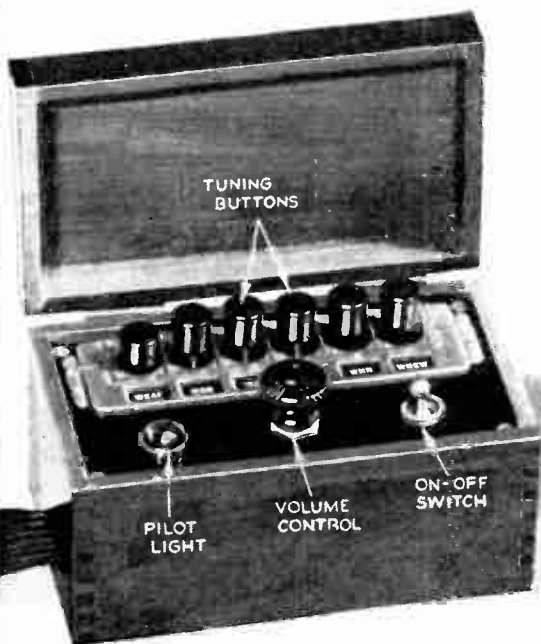

The push-button case also houses a volume control, an on-off switch, and a pilot light. Brackets aid in mounting the relay unit

LIST OF PARTS

One double padding condenser, 290-310 mmfd.

Two double padding condensers, 35-120 mmfd.

Three double padding condensers, 80-225 mmfd.

Electrolytic condenser, 10 mfd., 25 volt.

Variable resistor, 20,000 ohms.

Resistor, 1 watt, 1 meg.

Two relays, 6 volt, A.C., double-pole, double-throw.

Four relays, 6 volt, A.C., double-pole, single-throw.

Push-button tuning unit, six buttons.

Thirteen-wire cable.

Fifteen-connection plug and socket.

Miscellaneous:—Pilot lamp and socket, control box and panel, single-pole, single-throw toggle switch, wire, etc.

The relay unit can be fastened directly to the receiver chassis. It measures 2¼" by 3¾" by 7½". Here the six relays, controlled by the remote-control buttons, make the necessary connections between the padding condensers across each section of the receiver's tuning condenser. In this unit, the standard fifteen-connection socket for the control cable is also mounted.

Should the cable be removed at any time, the receiver will not operate unless a wire jumper is connected between the plug terminals 11 and 12, and 1 and 2 (see diagram).

It will be noted that relays 1 and 2 have their contacts connected somewhat differently from the others. When either of these operates, all connections

to the following relays are automatically opened. This is necessary to eliminate the unavoidable stray capacity in the relay connections. The four other relays may be of the double-pole, single-throw type, with contacts closed when the relay is in the "make" position.

The initial tuning of the padding condensers can be accomplished easily. They should be adjusted, section by section, until the loudest response for each desired station is obtained. Any type of tuning indicator on the receiver is a great help at this stage. The condenser values shown allow full coverage over the band.

Care must be exercised in setting the remote volume control. With the latter set at full volume, turn the receiver volume control up until the receiver output is louder than normal. Then reduce it to the desired level with the remote volume control.

When using the remote control, make sure that the receiver's tuning condenser is turned all the way out (to the high-frequency end of the dial). This procedure must, of course, also be followed during the initial tuning of the padding condensers.

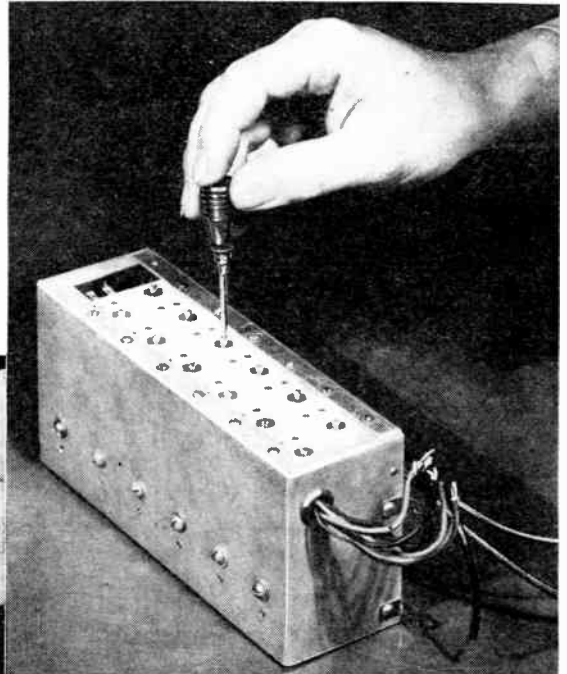
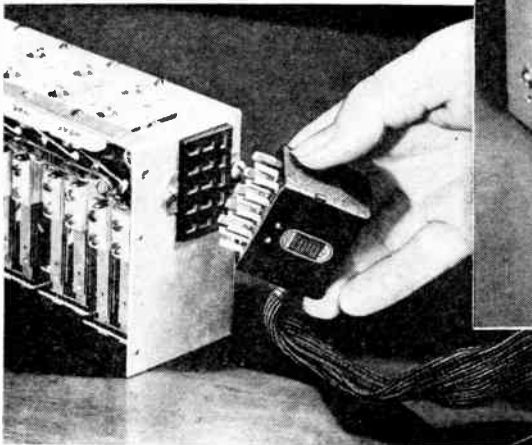

In pretuning the padding condensers, they should be adjusted with a screw driver to give maximum volume on the desired stations. A multiple plug makes the relay connections

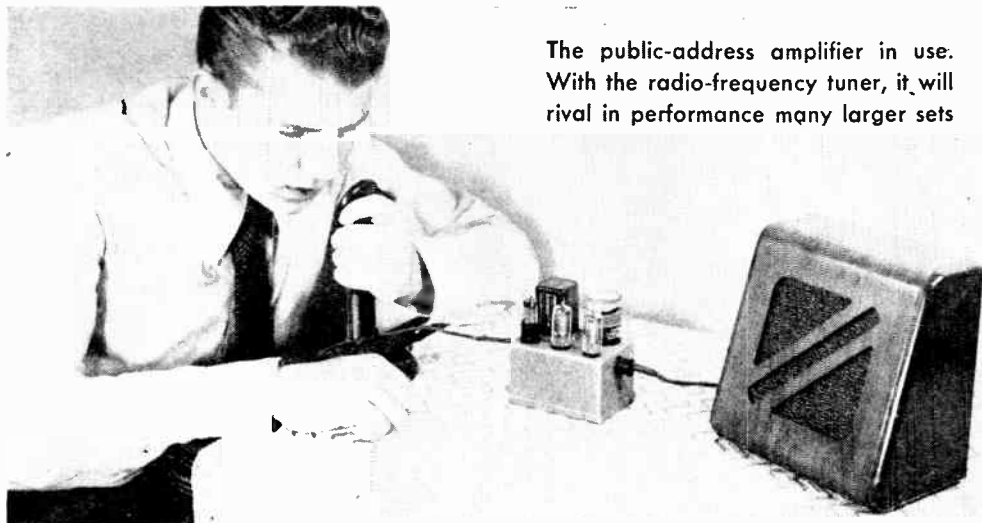

The public-address amplifier in use. With the radio-frequency tuner, it will rival in performance many larger sets

TUNER AND AMPLIFIER MAKE WORLD'S SMALLEST Public-Address Units

SMALL enough to fit into the palm of one's hand, these midget public-address amplifier and radio-frequency tuner units will perform as well as many larger battery or A.C.-D.C. sets. Only $3\frac{7}{8}$ " long, $2\frac{7}{8}$ " wide and $2\frac{3}{8}$ " high, they are completely self-contained, even to batteries.

In the tuner there is a $1\frac{1}{2}$ -volt "C" bat-

tery, used as a bias for the 1T4 detector tube, and two flashlight batteries (in parallel), supplying $1\frac{1}{2}$ -volt "A" current to the two 1T4 tubes. Inside the amplifier is a $67\frac{1}{2}$ -volt "B" battery which supplies plate current to all the tubes in both units, and a large-size flashlight cell for lighting the filaments of the three amplifier tubes (HY123-1Q4-1Q4).

The tuner consists of a radio-frequency amplifier stage using a pentode r.f. amplifier coupled to a detector stage using the same type of tube. Coupling is accomplished with an iron-core r.f. coil with a shielding can of $1\frac{1}{8}$ " diameter. The antenna coil, of the same size, also has an iron core.

The amplifier unit consists of a triode



At the left is the tuner unit. It may be used individually as a headphone receiver or with the amplifier as a broadcast set

When the amplifier is connected with the tuner, the triode tube is removed and the grid and plate terminals of the socket are joined by a piece of insulated wire

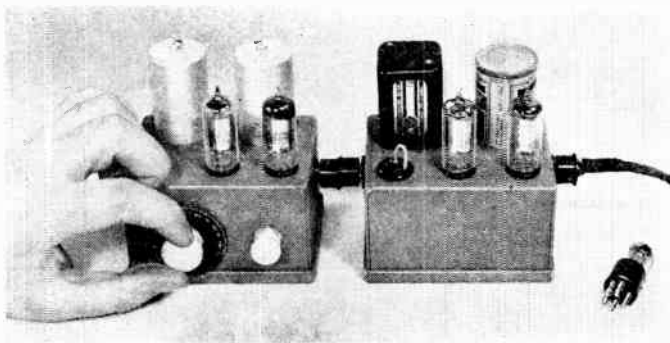

The tuner is a radio-frequency stage using a pentode r.f. amplifier coupled to a detector stage using a tube of the same type. Coupling is accomplished by means of an iron-core r.f. coil

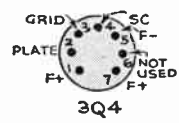
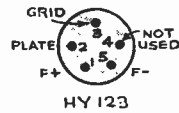
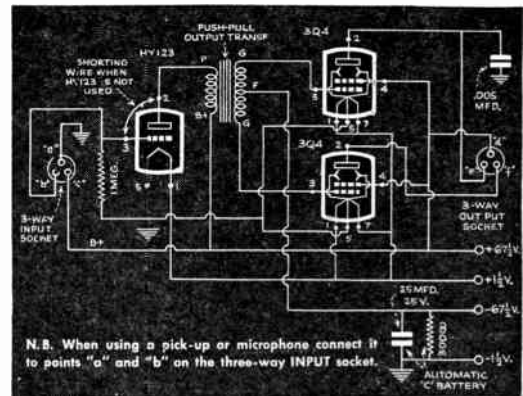
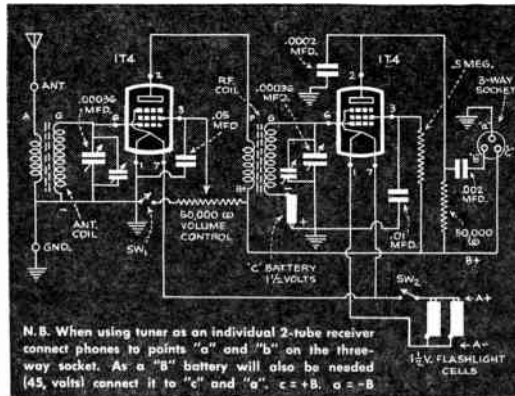
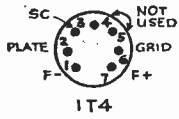
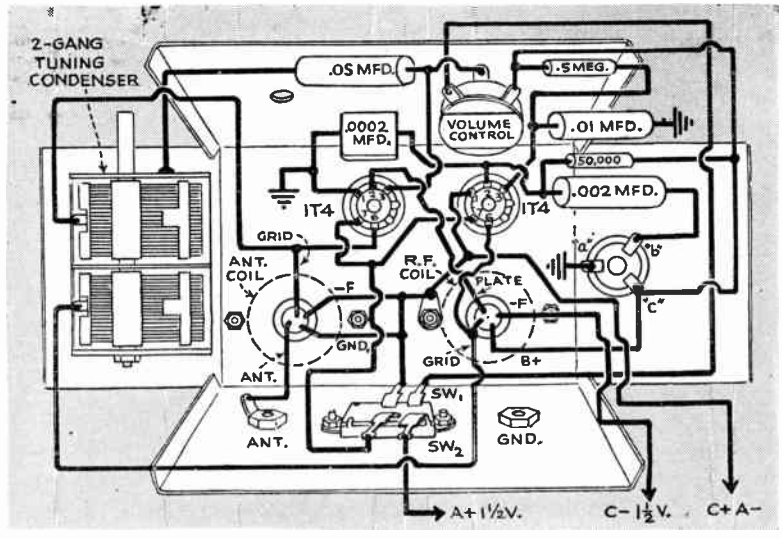

The amplifier unit consists of a triode input stage, transformer-coupled to a pentode push-pull output stage. Small three-prong plugs are used to connect the units together

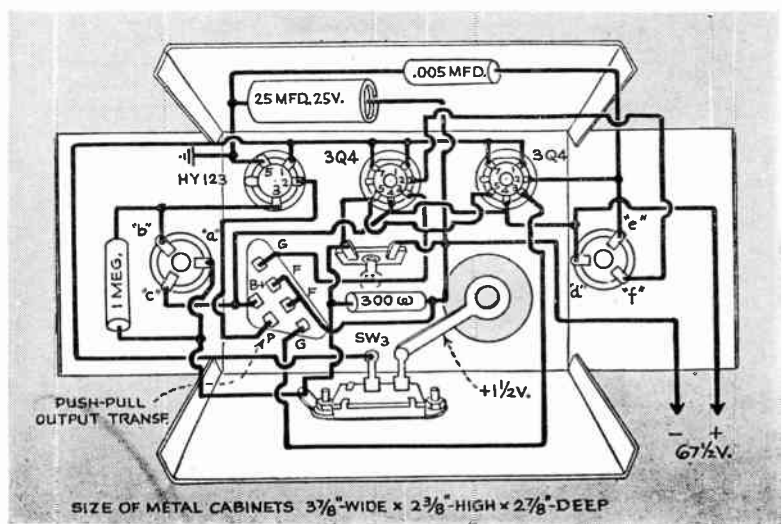

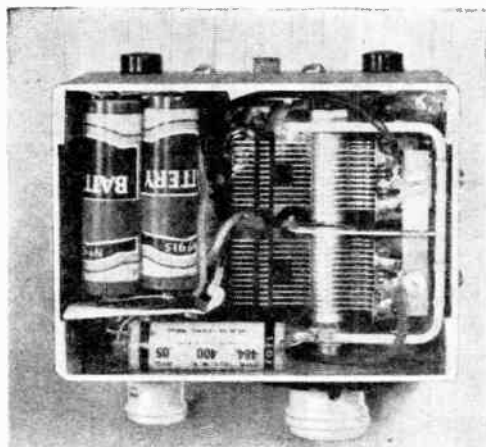

This is the underside of the tuner cabinet, showing the midget two-gang condenser and the batteries

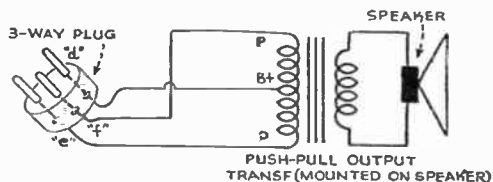

input stage transformer-coupled to a pentode push-pull output stage. When the amplifier is connected to the tuner, remove the triode tube (HY123) and join the grid and plate terminals of the socket as shown.

Small three-prong plugs are used to connect the units, and a similar plug joins the output transformer to the speaker, which may be any type of p. m. speaker.

The tuner may be used individually as a sensitive headphone receiver, or it may be connected to the amplifier to form a powerful broadcast set. Either a combination of antenna and ground, or just a short antenna, may be used with the tuner.

Since the amplifier "A" battery lasts only eight to ten hours, its replacement is simplified by mounting it above the chassis as pictured below

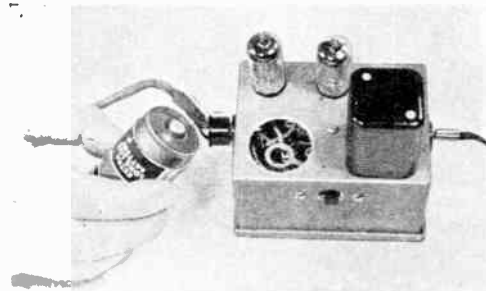

Positive contact of the "A" battery is made to a lug soldered to one of the lugs on the switch. The minus connection is made by contact with cabinet

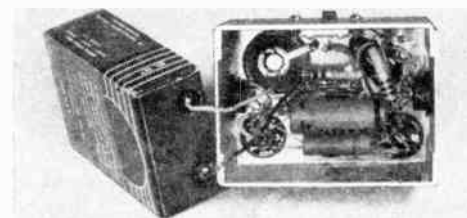

The 67 1/2-volt "B" battery that supplies plate current to all the tubes in the two units fits snugly in the bottom of the grey wrinkle amplifier cabinet



PARTS FOR TUNER

- Iron-core antenna and r.f. coils (shielded).
- Volume control, 50,000 ohms.
- Miniature 7-prong tube sockets (2).
- Midget two-gang tuning condenser.
- Miniature r.f. pentode tubes (2) 1T4.
- Miniature slide switch d.p.s.t.
- Three-way miniature plug and socket.
- Insulated banana plug and jack.
- Small 1 1/2-volt flashlight cells (3).
- Tubular condenser, .05 mfd., 200 volts.
- Tubular condenser, .01 mfd., 200 volts.
- Mica condenser, .0002 mfd.
- Carbon resistors, 1/2 watt, .5 megohm; 1/2 watt, 50,000 ohms.
- Tubular condenser, .002 m.f.d., 200 volts.

PARTS FOR AMPLIFIER

- Midget push-pull audio transformer (1.15:1).
- Miniature 5-prong tube socket.
- Miniature 7-prong tube sockets (2).
- Miniature s.p.s.t. slide switch.
- Three-way miniature plugs and sockets.
- Standard p.m. speaker with transformer.
- Miniature detector tube, HY123.
- Miniature beam-power pentodes, 3Q4.
- Flashlight battery, 1.5 volts.
- Miniature 67 1/2-volt "B" battery.
- Electrolytic condenser, 25 mfd., 25 volts.
- Carbon resistor, 1 watt, 300 ohms.
- Carbon resistor, 1/2 watt, 1 megohm.
- Tubular condenser, .005 mfd., 200 volts.

Twin-Bed Radio

**CAN BE TUNED
FROM EITHER SIDE**

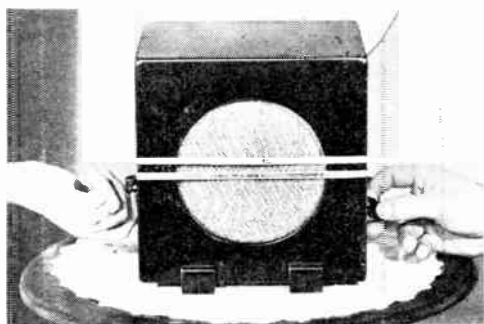

At the flip of a switch, either of two pairs of controls on opposite sides of this twin-bed radio will tune and regulate the receiver

WITH two independent sets of controls, mounted on opposite ends of its cabinet, this novel bedside receiver can be operated easily by either occupant of twin beds. A flick of a conveniently located switch instantly changes the operation of the set from one side to the other.

The circuit makes use of four all-electric tubes of the octal type. The filaments of these tubes are designed to function on either alternating or direct current, and in this particular set are coupled to each other in a rather interesting arrangement. The first tube, which is a radio-frequency pentode, is coupled to

the detector stage through a high-impedance radio-frequency choke, a .0005-microfarad mica condenser, and a one-megohm resistor, instead of the more conventional radio-frequency coil and tuning condenser. This method was chosen in order to simplify the connections for switching from one set of controls to the other. Two separate tuning stages would have resulted in the circuit being too unstable because of the feed-back through the switch wiring, unless careful shielding were employed.

However, choke-coupling of the radio-frequency stage has its disadvantages, the main ones being a slight loss in volume, and broader tuning. To eliminate the latter, an iron-core, radio-frequency choke should be used, together with a well-designed antenna coil. If the reader desires still greater selectivity, he may obtain it by using a shielded, iron-core antenna coil with a low-impedance primary.

The second disadvantage, namely, loss of volume, is eliminated by using impedance-coupling between the detector and audio stages, instead of resistance-coupling. A center-tapped impedance choke is employed for this. It is connected into the grid circuit of the output tube. Since such chokes are hard to find in radio-parts catalogues, a good substitute may be made by using a standardized transformer with a one-to-two or one-to-three ratio.

To change the audio transformer into a center-tapped impedance choke, simply connect the *out* wire of the primary winding to the *in* wire of the secondary winding, and then ground them directly to the chassis. The start of the primary winding then goes to the grid-coupling condenser, while the other end of the secondary winding goes to the grid of the 25A6G output tube. If the reader is unable to determine the correct connections beforehand, all he needs do is try the leads from the transformer first one way and then the other, retaining the connections that give the best results. The output pentode, which is a 25A6G, will easily handle a two-watt output without over-

The circuit's four octal tubes are grouped on the top of the chassis. All other parts but the speaker are below it. Note the two volume-control units and tuning condensers, and the handy selector switch at the back

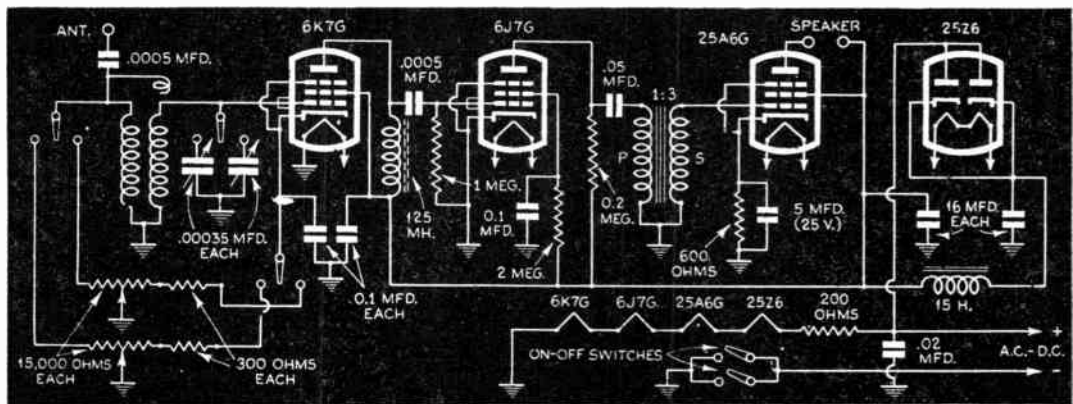
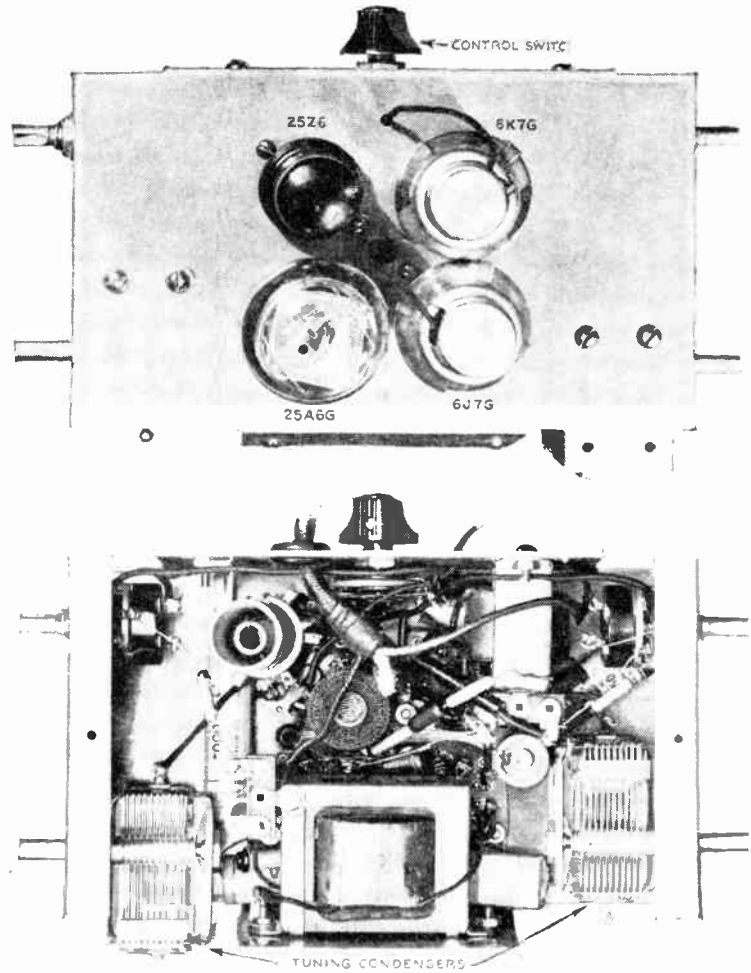



The chassis is placed well to the rear of the cabinet, to leave room for the speaker mounted behind the front panel

loading, which is ample for most purposes.

In the interests of compactness, a special, six-inch orthodynamic speaker is used to handle the output from the set. Its total depth is only $2\frac{1}{4}$ " , which is considerably less than the depth of a conventional six-inch electrodynamic speaker. The magnets of the orthodynamic speaker, mounted directly above the center of the cone, make this saving of space possible.

The switch used in the bedside radio to change the tuning controls from one side to the other is of the three-pole, double-throw type. Since it is impossible to obtain a toggle

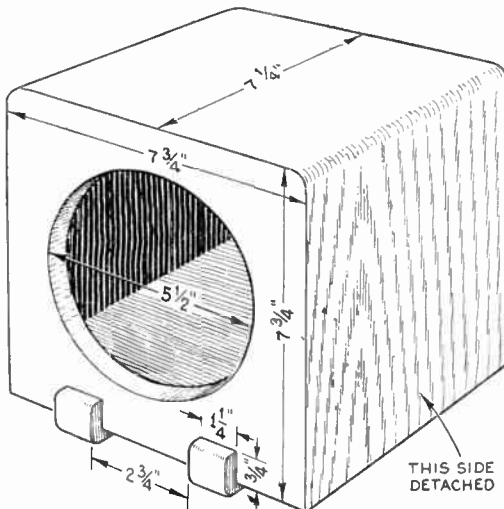

How the modernistic wooden cabinet is constructed

switch of this kind, a rotary switch such as that used in tube analyzers was chosen instead.

The cabinet, measuring $7\frac{1}{4}$ " by $7\frac{1}{4}$ " by $7\frac{3}{4}$ " , is constructed of wood, as shown in the drawing below. Because of the projecting shafts for the dual controls, one side of the cabinet must be made detachable so that the chassis can be slipped into place. To complete the modernistic appearance of the general design, the writer enamelled the cabinet black and applied strips of decorative silver banding. Although this can be thin metal, the same effect can be obtained with sections of metal-foil ribbon of the type sold for indoor antennas. These can be cemented in place after the finish has been applied.

Like all A.C.-D.C. receivers, this set requires no ground, the circuit being grounded internally through the house wiring. For an antenna, either an outdoor or an indoor aerial can be used. In the original, a twenty foot length of silk-covered wire strung around the molding gives excellent results.

LIST OF PARTS

- 6K7G tube.
- 6J7G tube.
- 25A6G tube.
- 25Z6 tube.
- Two .00035-mfd. midget condensers.
- Two 16-mfd. electrolytic condensers.
- One 5-mfd., 25-volt electrolytic condenser.
- Three .1-mfd. tubular condensers.
- One .05-mfd. tubular condenser.
- One .02-mfd. tubular condenser.
- Two .0005-mfd. mica condensers.
- One line-cord resistor.
- Two 300-ohm, $\frac{1}{2}$ -watt resistors.
- One 1-meg., $\frac{1}{2}$ -watt resistor.
- One 2-meg., $\frac{1}{2}$ -watt resistor.
- One 200,000-ohm, $\frac{1}{2}$ -watt resistor.
- One 600-ohm, 1-watt resistor.
- Unshielded antenna coil.
- Iron-core, radio-frequency choke.
- Three-pole, double-throw switch.
- Two 15,000-ohm volume controls with switches.
- Audio transformer, 1 to 3 ratio.
- Filter choke.

Miscellaneous:—Aluminum chassis, $7\frac{1}{2}$ " by $4\frac{1}{2}$ " by 3"; four octal tube sockets, four dials, two aluminum shields, two insulated grid-cap leads, speaker, etc.

Servicing Your Radio

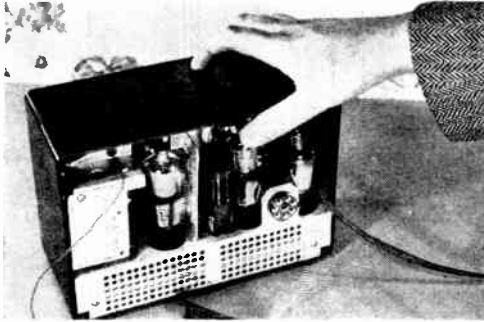

THIS OUT-OF-DATE SET is not hard to fix up

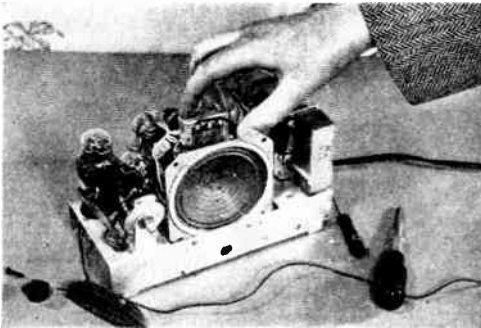

NEW SPEAKER will require an output transformer

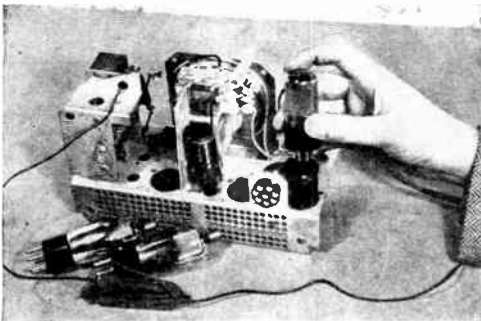

ADAPTER SOCKETS are essential for new tubes

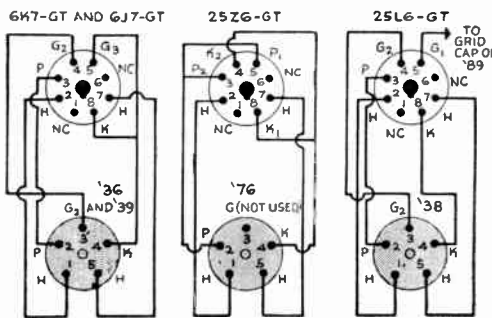

BOTTOM VIEWS SHOWN (N.B. - N C MEANS NO CONNECTION)

IF YOU HAVE an old radio set whose reception is not up to 1942 standards, you can modernize it yourself. The receiver illustrated here was one of the first AC-DC radios to use a plastic cabinet, and had no line-cord resistor, no 25Z5 or similar-type rectifier, and had a magnetic speaker.

The first thing to do, of course, is to remove the chassis from its plastic cabinet. Before starting to work on the chassis, be sure to dust and clean it thoroughly. The magnetic speaker is removed from the chassis and replaced by a four-inch permanent-magnet speaker. Since no output transformer is required with a magnetic speaker, one will have to be purchased. It is mounted directly to the four-inch speaker, on top, and may be seen clearly in the picture.

The set originally used a 39 tube as RF amplifier, a 36 tube as detector, an 89 tube as power amplifier, and a 37 tube as half-wave rectifier. Since those tubes first appeared several improvements have been made, and the new tubes now have greater sensitivity and clarity. Sockets and tube bases, however, have changed also, and it is not a simple matter of plugging a new tube into the old socket in order to use the new tubes. Adapter sockets have to be purchased. To replace the 39 RF amplifier tube use a 6K7-GT, instead of the 36 detector tube use a 6J7-GT, instead of the 38 power tube use a 25L6 or 25L6-GT, and instead of the 37 half-wave rectifier tube use a 25Z6 or 25Z6-GT. In using the 25L6 power tube, the bias resistor in the set will have to be changed to one having a value of approximately 600 ohms.

In the original set, a built-in heater resistor was used. It should be replaced by a line-cord resistor of 180 ohms. This is the correct value for the tubes listed above.

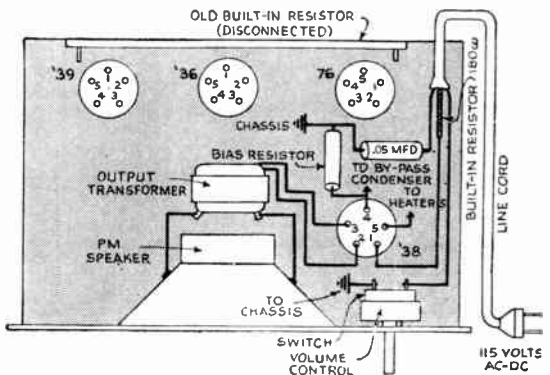

Tube wirings, left; general wiring diagram, above

A Radio for Your Floor

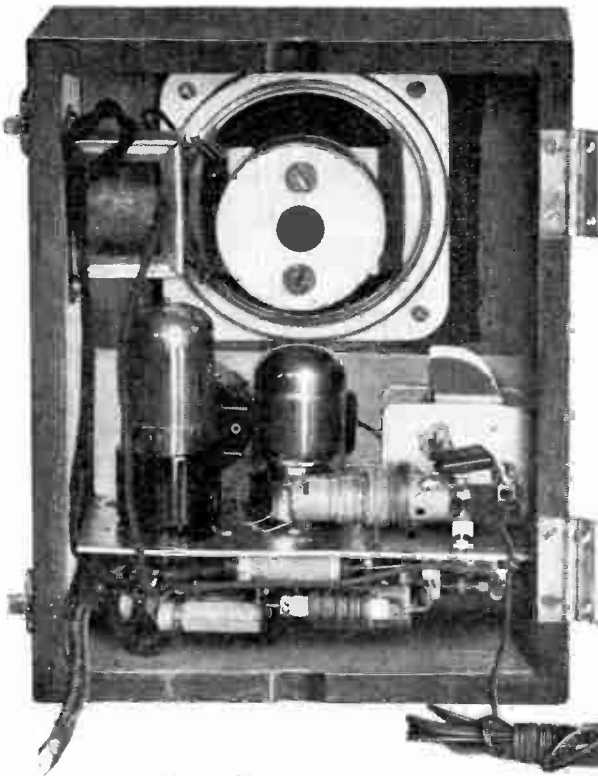

DESIGNED so that it can be attached to the standard of any floor lamp, the radio set illustrated forms a handy auxiliary receiver for living room, bedroom, or den. Mounted on a bridge lamp it provides a radio for card games; attached to a floor lamp beside your favorite chair it puts the evening's programs at your finger tips; and fastened to a standing lamp in your bedroom it serves as a convenient bedside set. Since the receiver's cabinet simply is clamped around the lamp's standard, the absence of exterior fittings or brackets also makes it possible to use the unit as a conventional table radio. The compact receiver requires no external ground, and can be operated with nothing more than a short indoor antenna.

There is nothing particularly complicated about the A.C.-D.C.

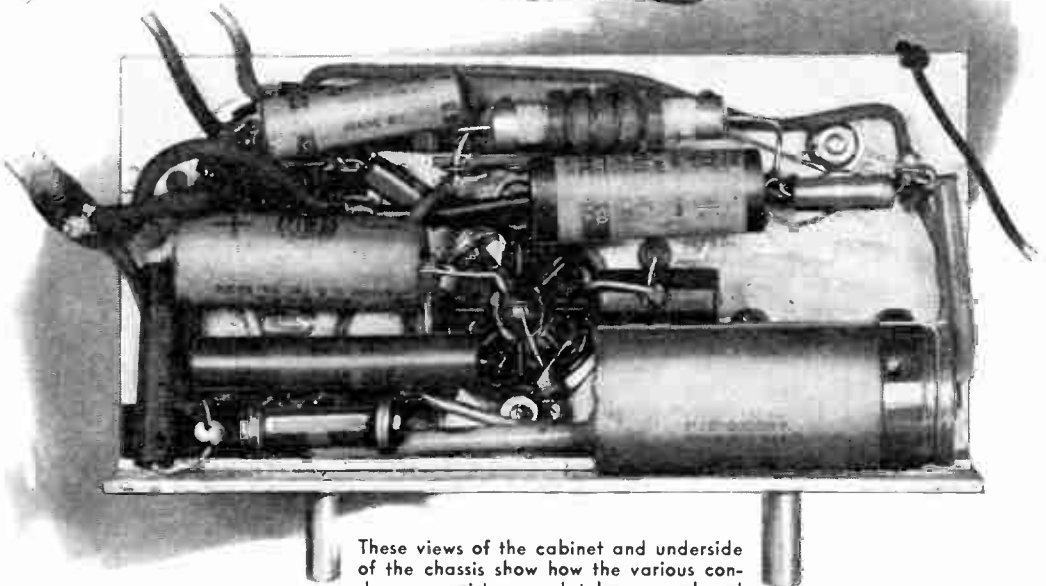

These views of the cabinet and underside of the chassis show how the various condensers, resistors, and tubes are placed

Lamp

circuit, which is unusually sensitive and free from hum. Only two tubes are used. One of the new locking-type-base pentode tubes (7A7) was chosen as the detector. It is resistance-coupled to a combination output pentode and half-wave rectifier (32L7). No grid cap is provided on the detector, as these new tubes are of the single-end construction, the grid connection being brought out at the base. Because the rated heater voltage of the 7A7 is slightly higher than that of the 32L7, a 2-watt resistor of approximately 1,500 ohms must be placed across the heater connections on the base of the 32L7. The resistor can be soldered directly to the lugs of the socket.

To save space, no filter choke is used. Instead, a 1,000-ohm, 1-watt resistor is connected between the dual electrolytic condenser (16-24 mfd.). This provides adequate filtering and allows the necessary voltage to get through to the plate of the tubes. A larger resistance cannot be used without an appreciable loss in volume.

The .00025-mfd. mica condenser indicated in the antenna lead is *extremely important*, since it eliminates any possibility of blowing out the tubes or burning the primary of the antenna coil (which could start a fire) should the antenna wire or antenna lead accidentally come in contact with a ground pipe or radiator.

The hinged mahogany cabinet measures 4 $\frac{3}{4}$ " by 6 $\frac{1}{4}$ " by 8", the lid being 1 $\frac{1}{4}$ " deep (this is included in the overall depth of 4 $\frac{3}{4}$ "). The sides are constructed of $\frac{3}{8}$ " wood, while the front and sides were cut from $\frac{1}{4}$ " wood. When completed the whole box was stained a deep mahogany, waxed, and then polished. The

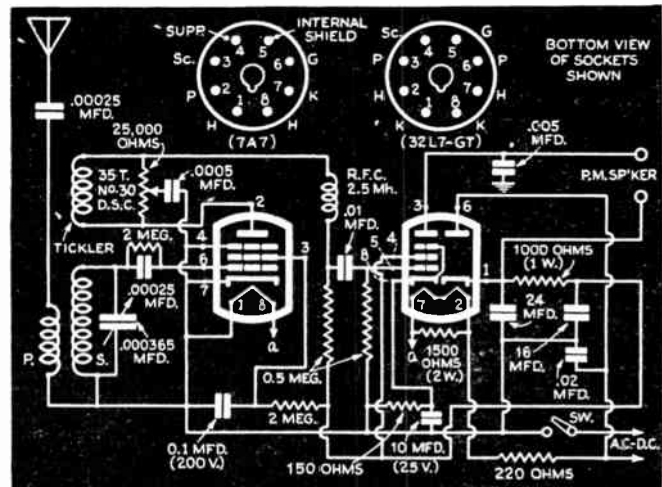

Easily built, the set can be clamped to the upright of any floor lamp

sides of the 3 $\frac{1}{4}$ " diameter opening for the speaker are beveled outward to give a more finished appearance to the cabinet, and a square of gold silk glued in place behind

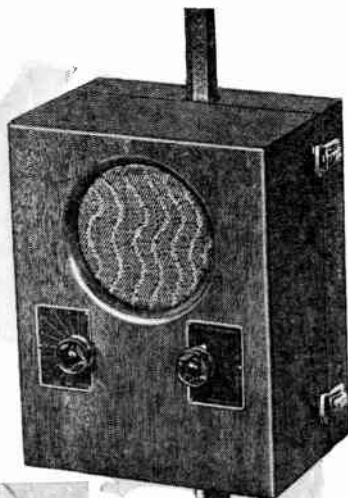
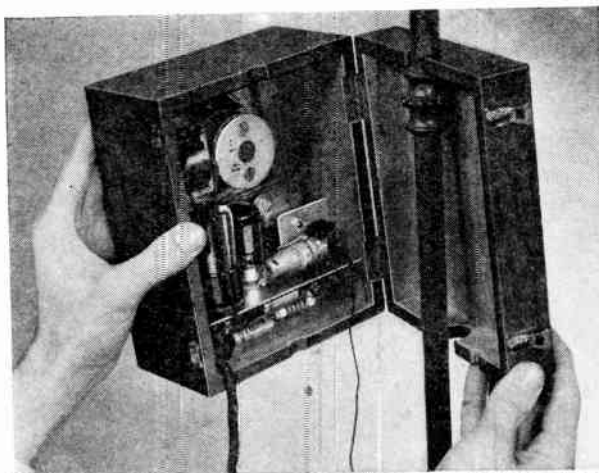

Either a decorative "bead" on the standard or a hose clamp can be used to support the mahogany cabinet shown in the drawings below, right

the opening serves as an attractive grille.

As indicated in the photographs and drawings, the parts, with the exception of the speaker and output transformer, are mounted on a small aluminum chassis and panel. The output transformer, separate from the speaker, can be fastened with screws to the side wall of the cabinet. In wiring the tubes, pay close attention to the accompanying socket diagrams, particularly the diagram for the new 7A7 tube. Watch the power connections to the resistor line cord. The 220-ohm resistance must be wired into the heater circuit to reduce the full 110-volt house current to the value required for the two heaters. A wrong connection at this point can blow out both tubes.

Holes cut in the top and bottom edges of the hinged lid and main cabinet serve to take the lamp standard. Naturally, the diameter of these holes will be governed by the size of the standard.

When using the receiver with direct current, remember that the house-wiring receptacle has a positive and a negative terminal. For this reason, it may be necessary to reverse the power plug to obtain the proper polarity.

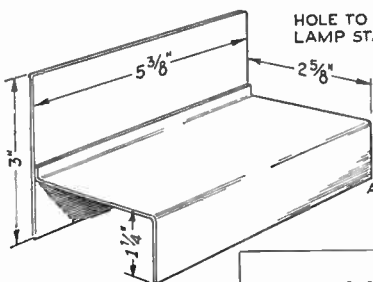
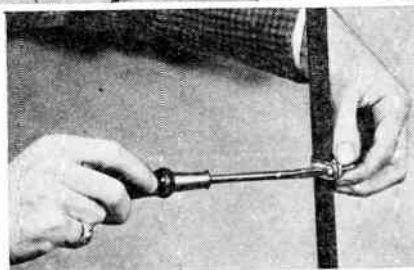

HOLE TO TAKE LAMP STANDARD

ALUMINUM CHASSIS

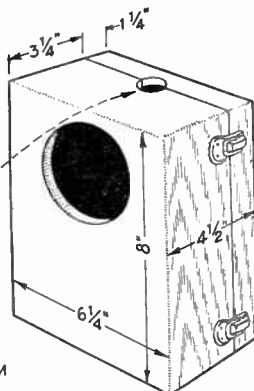

LIST OF PARTS

Midget tuning condenser, .000365 mfd.
 Midget antenna coil.
 Radio-frequency choke, 2.5 mh.
 Resistor, 1,000 ohm, 1 watt.
 Resistor, 1,500 ohm, 2 watt.
 Resistors, two, 500,000 ohm, 1/2 watt.
 Resistors, two, 2 megohm, 1/2 watt.
 Resistor, 150 ohm, 1 watt.
 Condenser, tubular, .1 mfd., 200 volt.
 Condenser, tubular, .02 mfd., 200 volt.
 Condenser, tubular, .01 mfd., 200 volt.
 Condenser, tubular, .005 mfd., 200 volt.
 Condensers, two, mica, .00025 mfd.
 Condenser, mica, .0005 mfd.
 Electrolytic condenser, dual, 16-24 mfd.
 Loudspeaker, 3" permanent-magnet type.
 Output transformer for speaker.
 Line cord and resistor, 220 ohms.
 Volume control and switch, 25,000 ohms.

Miscellaneous: Cabinet, chassis, 7A7 tube, 32L7-GT tube, sockets, wire, lugs, solder, knobs, grille cloth, etc.

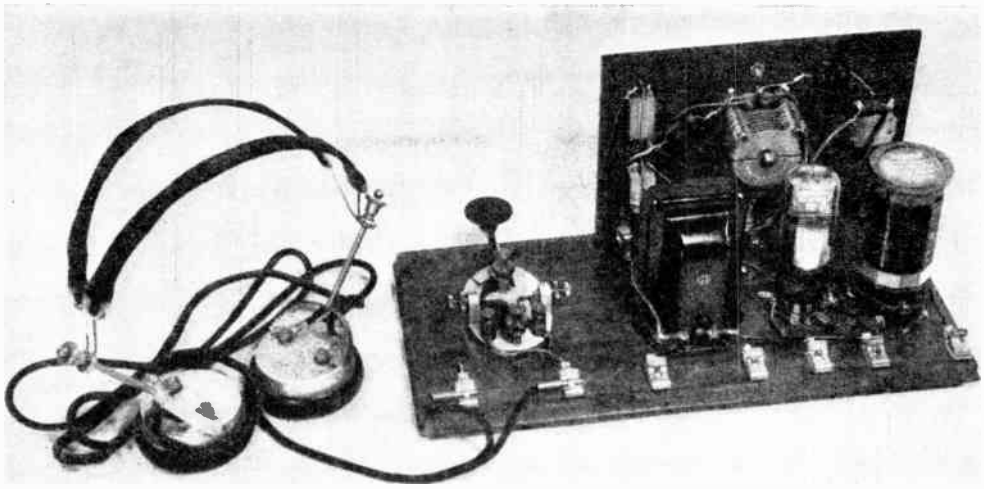

This combination set enables the student to practice sending code and to hear how it sounds when sent

Practice Code Sender and Receiver

Set Is Battery-Powered

MANY thousands of young men and women are busily engaged in America learning international code either for civilian-defense purposes or in preparation for enlistment in the Signal Corps, and a code oscillator—though impossible to buy now—is fast becoming a standard item in many homes. Extra advantage for these students can be had with a combination radio receiver and code oscillator which will give them an opportunity to hear how the code they are practicing really sounds when sent over the air. This instrument changes over with the flick of a switch for operation either as a code oscillator for practice sending or as an all-wave

radio receiver. It is used with earphones.

Obtain first a good 6" by 12" baseboard that will not warp and a piece of composition wood from which a 5" by 7" panel can be cut. The baseboard can be sawed out and glued up in the home workshop, or a small biscuit or pastry board that will serve excellently can be purchased for a few cents in one of the 10-cent stores. Both pieces should be given a varnish finish before any of the parts are mounted—a coat or two of walnut or other varnish stain for the base, and one or two of black wrinkle varnish for the panel.

On the panel are mounted a .00014-mfd.

Complete wiring diagram for a code oscillator and radio receiver. All connections should be carefully traced in the diagram before doing the wiring. Below, the six-prong coil base

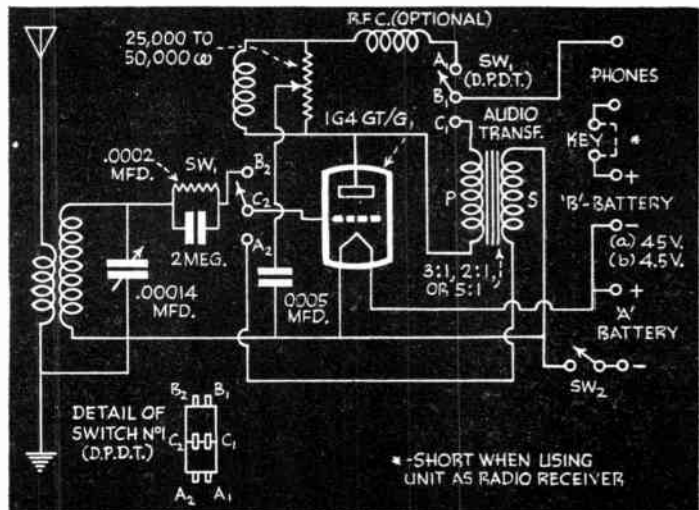

TUBE CONNECTIONS
1G4-GT/G
(TOP VIEW SHOWN)

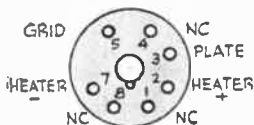

*-SHORT WHEN USING
UNIT AS RADIO RECEIVER

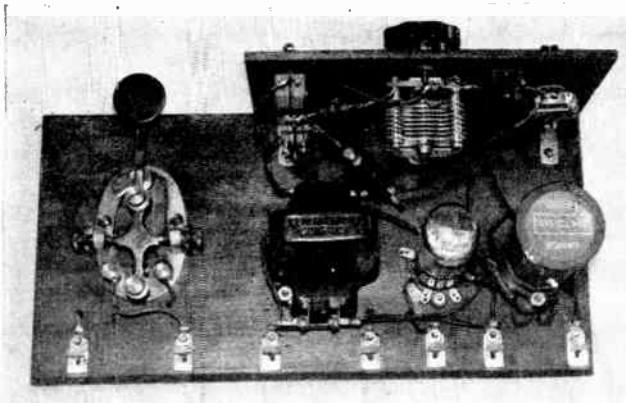

All parts have been mounted and connections made in this view of the top of the baseboard and rear of the panel. Below, the bottom view of the baseboard shows some of the simplified wiring

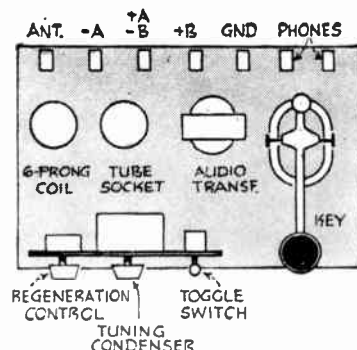
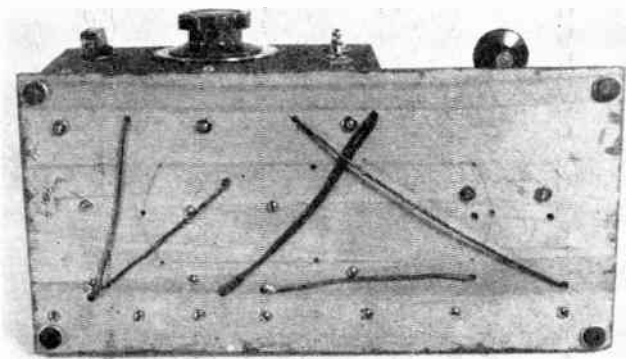

LIST OF PARTS

- Wooden baseboard, 6"x12".
- Composition panel, 5"x7".
- Toggle switches (2), D.P.-D.T. and S.P.S.T.
- Practice key.
- Potentiometer, 25,000-50,000 ohms.
- Audio transformer, any type, any ratio.
- Six-prong plug-in coil.
- Six-prong coil base.
- Eight-prong octal socket.
- Triode amplifier tube, 1G4-GT/G.
- Tuning condenser, .00014 mfd.
- Mica condensers (2), .0001 mfd. to .0005 mfd. and .0004 mfd. to .0005 mfd.
- Carbon resistor, 1/2 watt, 2 to 5 megohms.
- RF choke (optional), 2.5 to 8 millihenrys.

tuning condenser with a 2 3/4" dial and pointer, a 25,000-ohm regeneration control, and two toggle switches. One of these switches is of the double-pole, double-throw type and changes the circuit over for use either as a radio receiver or a code-practice oscillator. The other is an ordinary single-pole, single-throw switch and cuts off the filament supply whenever the unit is not being used.

The sending key and radio-oscillator unit are both mounted on the base. The latter unit includes a six-prong plug-in coil, octal wafer socket, and audio transformer. Connections to phones and batteries are made by means of Fahnestock clips arranged along the back of the baseboard.

For the audio transformer, take one out of the junk box, if possible, because the older it is the better it will work as an oscillator. A new audio transformer has too much inductance for this purpose, making it impossible to obtain a high-pitched note. If no oscillation is obtained when the oscillator is tested, reverse the leads to the primary of the transformer. It is important that cor-

rect polarity be observed. If desired, the pitch of the tone may be varied by placing a fixed condenser across the secondary of the audio transformer, using one of from .02-mfd. to .002-mfd. capacity. The higher the capacity (.02 mfd.) the lower the pitch will be.

When the instrument is used as a radio receiver, the plate supply ("B" battery) is usually about 45 volts, but when it is used as a code oscillator, the plate supply must be reduced to 4 1/2 volts. An ordinary 4 1/2-volt "C" battery will do for this purpose. In either case, whether the instrument is used for reception or for code practice, the filament voltage remains the same—1 1/2 volts.

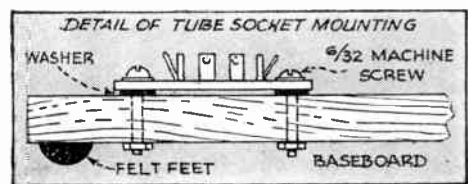

Pocket Receiver

FOR SPORTS FANS



You can stow this midget receiver in a coat pack. Note the parts arrangement at the right. Cigar-box wood forms the cabinet, and a loop antenna is wrapped around it, while flash-light cells to power the set are carried in the base

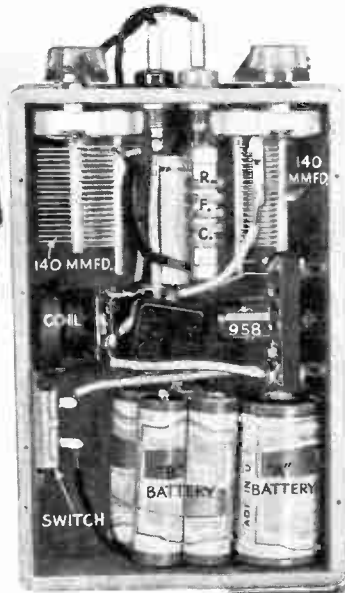

LITTLE larger than a tobacco tin, the pocket receiver pictured below is ideal for sports fans who want to hear the play-by-play broadcasts while watching a game or meet from the stands. The set employs a super-regenerative circuit, using a 958 tube that operates successfully on very low plate voltage. Around the cigar-box-wood case, a loop antenna is wound, consisting of thirty-five turns each side of center, with both sections wound in the same direction. Use No. 40 D.S.C. wire. The two 140-mmfd. variable condensers, of the air-padder type, should be mounted with screws before the loop is wound. A brass bushing $\frac{1}{4}$ " in diameter and $\frac{3}{8}$ " long is soldered to the stub shaft of each condenser. A medium-size flash-light cell serves as an "A" battery, while the "B" is composed of four "fountain-pen" cells in series. The latter should last almost indefinitely as the drain is very small. Although the set is decidedly not a distance getter, since it has limited voltage and only a tiny directional loop, it should give good results up to fifty miles on the bands between 650 and 1260 kc.

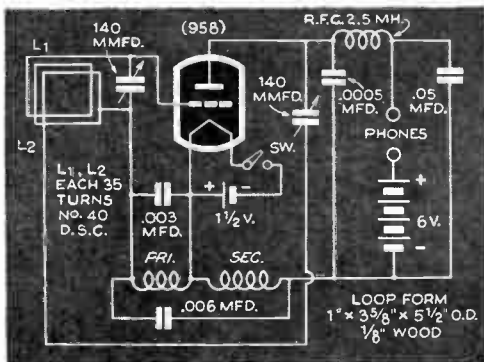

Wiring diagram also gives full parts specifications



Tiny Portable

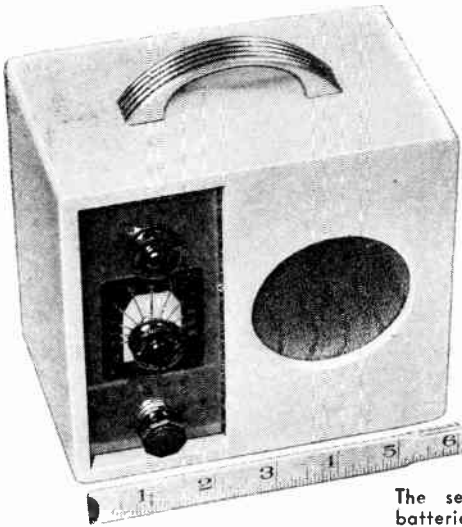

The set, complete with batteries, is little larger than a dollar box camera

POWERED by its own built-in battery supply, this compact portable receiver is a handy companion for use on picnics, at summer camps, on your garden terrace, or anywhere that a 110-volt house-lighting circuit is not available. Complete with loudspeaker, it weighs but a few pounds and is little larger than the average dollar box camera.

To cram as much radio into as little space as possible, the tuned radio-frequency circuit was designed around three of the newest $1\frac{1}{2}$ -volt midget tubes. Operating on plate voltages from 50 to 60 volts and having an extremely low current drain, the midget tubes make it possible to cut the battery supply to the minimum. Although the tubes are manufactured in England, they are available in the United States and can be obtained from any of the larger radio-parts supply houses.

All three tubes are of the pentode type and must be used with the special midget sockets designed for them. As shown in the diagram, the third grids, or suppressors, of the radio-frequency pentode and detector are brought out to pins in the bases of the tubes (pin No. 3) and should be connected to the minus lead of the "A" battery or to the aluminum chassis. The suppressor grid of the output tube (XY) is connected internally so that no external connection is required.

The antenna and radio-frequency coils are of the standard broadcast type used in commercial A.C.-D.C. receivers. As sold, they are mounted in square aluminum cans. Because of the limited space, these shields must be removed. As shown in the photographs, the radio-frequency coil is mounted vertically at the rear of the chassis, and the antenna coil is placed directly behind the antenna tuning condenser.

To conserve space, variable condensers of the "solid-dielectric" type are used for tuning the antenna and radio-frequency coils. These condensers, unlike

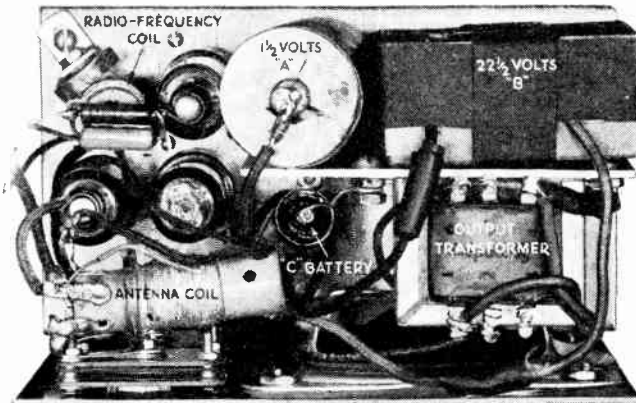

How the parts are arranged above and below the chassis. The three midget tubes are mounted at the left of the chassis

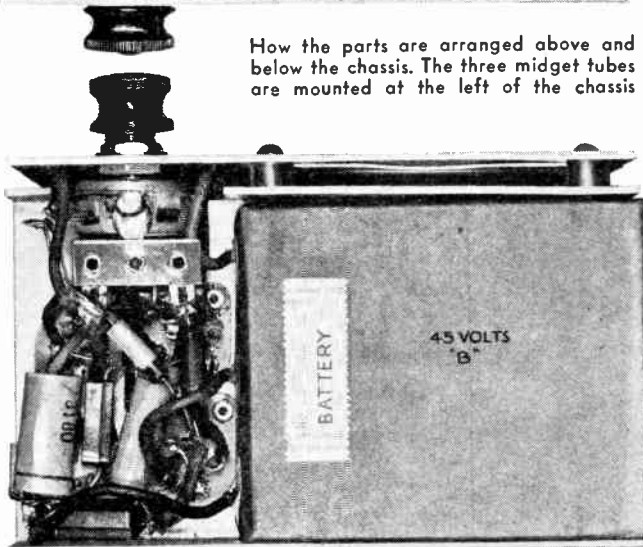

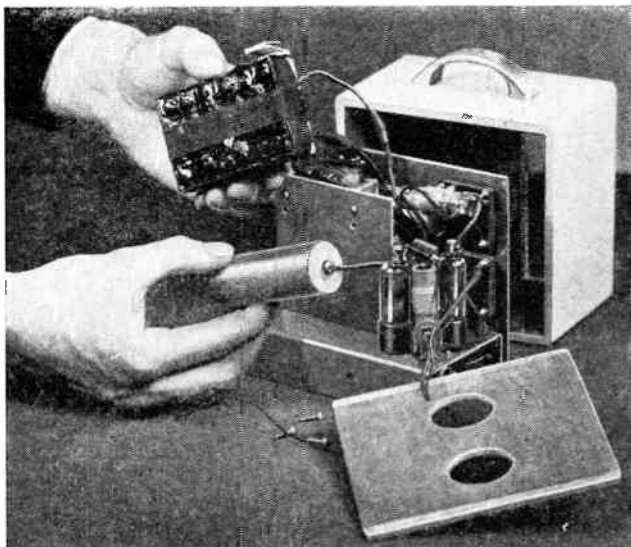

half to provide a $22\frac{1}{2}$ -volt source. The $22\frac{1}{2}$ -volt unit and the $1\frac{1}{2}$ -volt dry cell can be held in place on the transformer panel (C) with rubber bands or string. The 45-volt unit can be mounted conveniently under the chassis. A tiny $1\frac{1}{2}$ -volt flash-light cell of the type used in fountain-pen flash lights serves as the "C" battery and, being light enough to be supported by its own wiring, can be placed at the left of the speaker.

To provide maximum portability, the set is designed for use with two antennas—a long one about 40' in length and a shorter one approximately 25' long—instead of with an antenna and an actual connection to the ground. The long antenna is connected to the ground terminal on the receiver and the shorter one serves as the actual aerial. An actual ground can be used, of course, if desired.

The cabinet, measuring 6" square and $3\frac{1}{2}$ " deep outside, is made of $\frac{3}{8}$ " thick hard wood finished with quick-drying enamel in the desired color. The original shown is white. The modernistic handle is a silver and black metal drawer pull of the type available at most five-and-ten-cent stores for a dime. It blends in with the general modernistic design of the cabinet.

Two holes, one rectangular and the other circular, cut in the front of the cabinet provide openings for the aluminum control panel and the speaker. The speaker opening should be covered on the inside with silver and black speaker-grill cloth, to match the silver handle and the aluminum panel. Small black knobs should be used for the two tuning controls and the potentiometer. A dial need only be provided for the radio-frequency condenser, since the antenna circuit is not

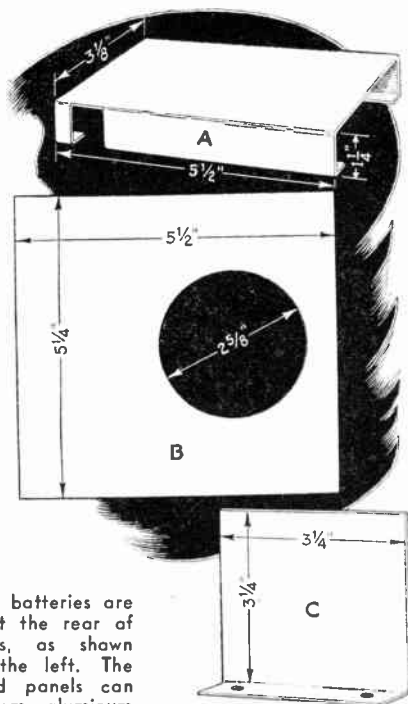

Two of the batteries are mounted at the rear of the chassis, as shown above at the left. The chassis and panels can be cut from aluminum

LIST OF PARTS

Three-inch permanent-magnet speaker.
 Output transformer.
 Tubes, XW (two), XY.
 Midget antenna coil.
 Midget radio-frequency coil.
 Snap-on switch (D. P. S. T.).
 Resistors, 1 meg., $\frac{1}{2}$ watt (two).
 Resistor, 400,000 ohm, $\frac{1}{2}$ watt.
 Volume control, 100,000 ohm.
 Special tuning condensers, .0005 mfd. (two).
 Mica condensers, .0003 mfd. (two).
 Mica condenser, .002 mfd.
 Tubular condensers, .02 mfd. (three).
 Midget "B" batteries, 45 volt (two, see text).
 Midget "C" battery, $1\frac{1}{2}$ volt.
 Small "A" battery, $1\frac{1}{2}$ volt.
Miscellaneous:—Three special sockets, cabinet, chassis, panels, wire, etc.

critical in tuning. As in the making of all radio receivers, much of the success of your efforts depends upon careful workmanship. Make sure that all wire connections are soldered well. One loose connection or one that is not made with clean contacts can destroy a receiver's performance. Careful workmanship on the cabinet will reward the builder with a portable set that is sturdy.

LOW-COST POWER SUPPLY

HERE is an "A" and "B" power supply that can be built for less than \$2, and will operate any one or two-tube receiver not provided with a power tube. It will supply six volts of alternating current for tube heaters and approximately 80 volts of filtered and rectified direct current for plates and screens of tubes similar to the 6J7, 6K7, and 6C5.

All the parts are mounted on a 4" by 7" wooden baseboard. An ordinary bell transformer with a primary of 110-115 volts and a secondary of 6-8 volts furnishes the heater supply for the diode detector rectifying tube (6H6) and the other tubes in the receiver.

The output of the 6H6 as a rectifier is approximately 8 milliamperes—ample for a two-tube set. A 2,000-ohm, 2-watt, wire-wound, fixed resistor; a 1,000-ohm, 2-watt, carbon resistor and a 20-mfd., 150-volt, electrolytic condenser are used to filter the "B" voltage. The 6H6 uses an eight-prong socket.

The plates and cathodes of the 6H6 are connected in parallel, with plates hooked to one side of the transformer primary, and the cathodes connected to the filter circuit. No ground connections should be made to the receiver, as it will be grounded through the power supply, which is connected to the house-wiring circuit.

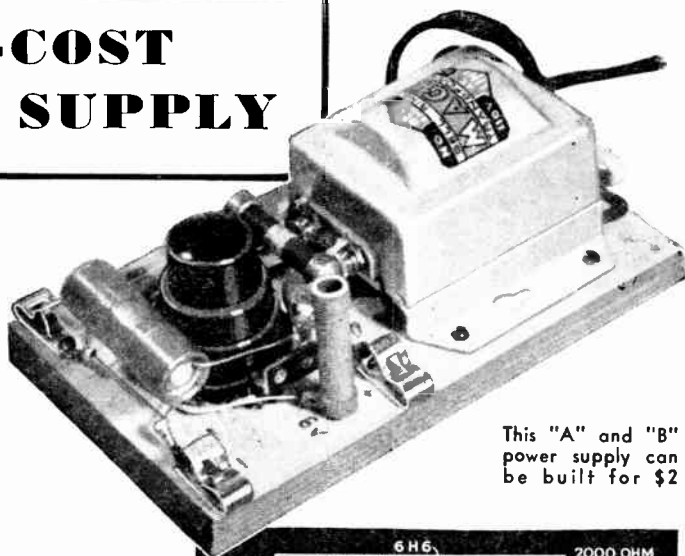

This "A" and "B" power supply can be built for \$2

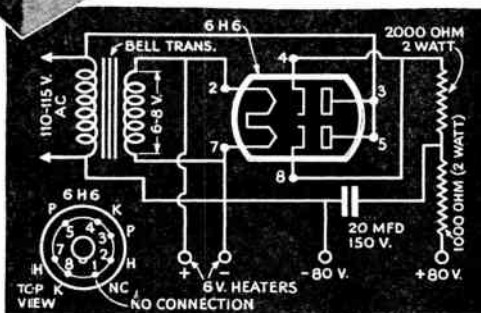

Plates and cathodes of the 6H6 are in parallel

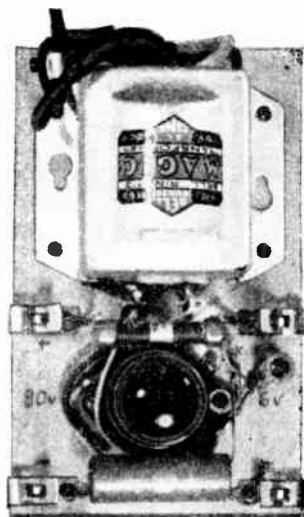
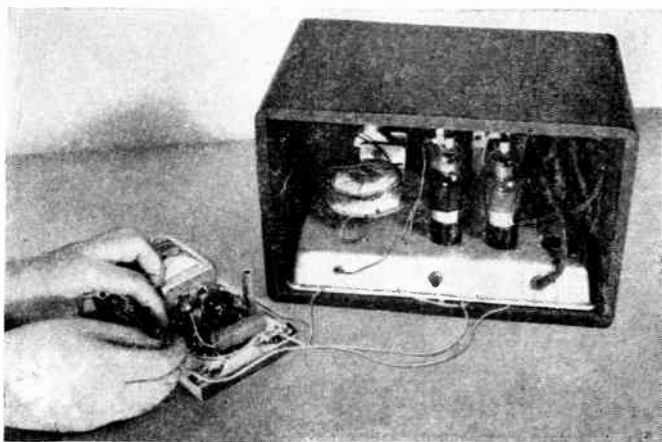

An ordinary bell transformer furnishes the heater supply. At left, hooked up and ready to go, showing its small size



THREE-

IS IDEAL SET FOR
BEGINNERS

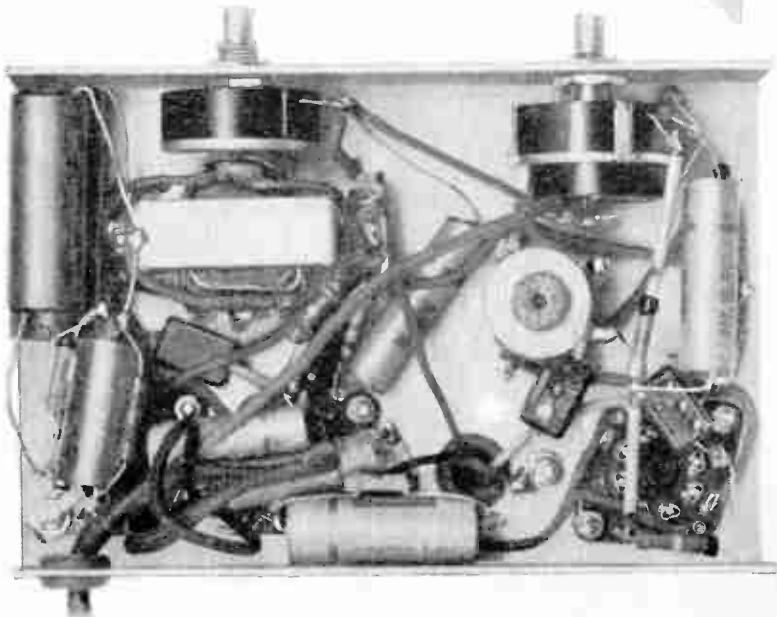
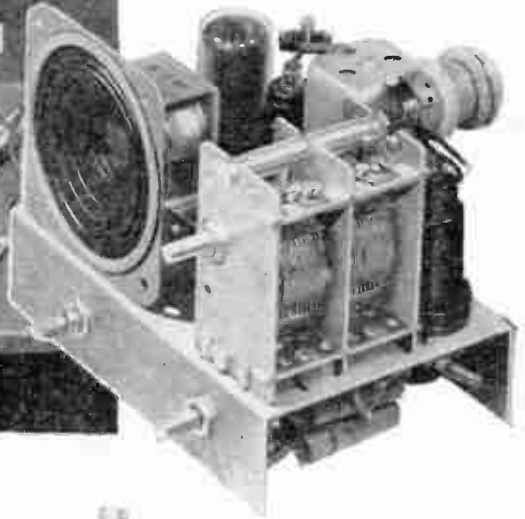

Top view of the chassis, above, will help you arrange the various parts. The chassis measures only $6\frac{1}{2}$ " long by $4\frac{1}{4}$ " in depth



Keep all connections as short as possible. The universal output transformer is mounted directly beneath the speaker, shown above, and secured by the same two bolts

TUBE SUPERHET

ASSEMBLED on a chassis only 6½" long, this three-tube superheterodyne costs little more to build than an ordinary tuned-radio-frequency receiver, and gives greater selectivity and sensitivity. As only one factory-tuned, 455-kilocycle intermediate-frequency transformer is needed with this special circuit, the receiver can be adjusted easily with a small screw driver. If the leads are kept short, there will be little deviation from the original transformer setting.

Though an intermediate-frequency transformer is used, there is no intermediate-frequency

stage in the receiver. The intermediate-frequency transformer is fed directly into the second detector stage (6K7). In order to obtain sufficient sensitivity, an iron-core transformer should be used. This *must* have a tap at the ground end of the second-



Extremely sensitive, the receiver tunes in distant stations with great selectivity

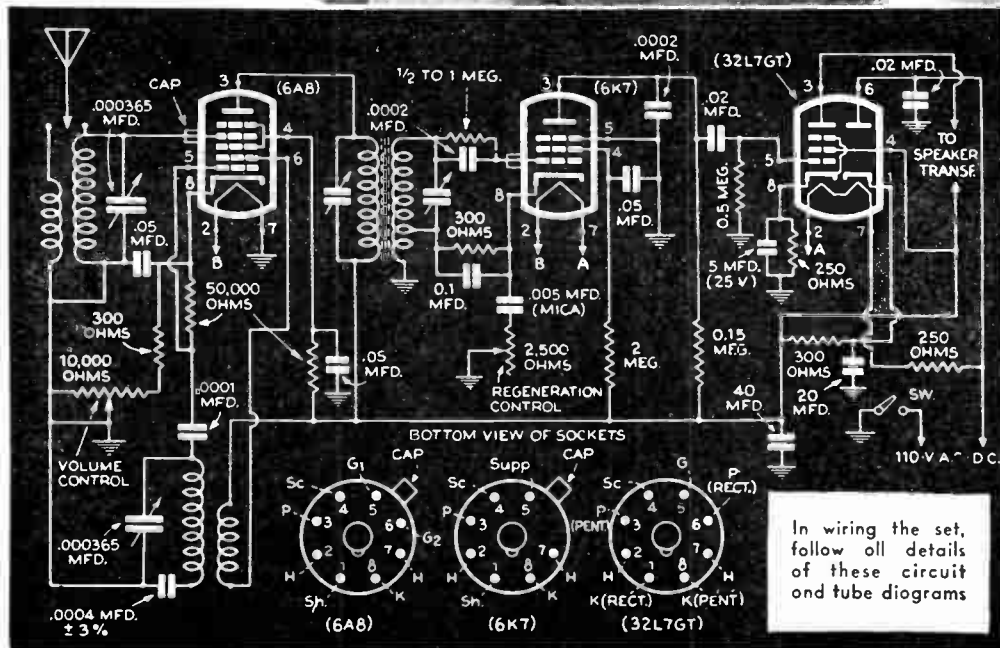

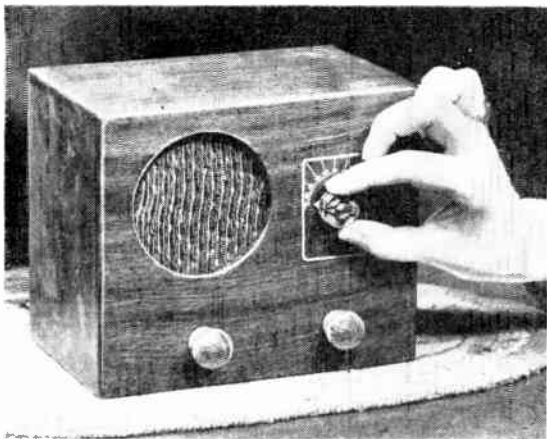

The author built the cabinet of $\frac{3}{8}$ " thick white wood

ary winding so that a regenerative detector stage can be used. This stage adds greatly to the receiver's volume.

A cathode feed-back circuit is used to obtain regeneration. It consists of a .005-mfd. mica condenser and a 2,500-ohm variable resistor. If the reader lives near a powerful local station, he should add a volume control consisting of a 10,000-ohm variable resistor in series with the 300-ohm cathode resistor of the first tube.

For tuning, a standard two-gang .000365-mfd. variable condenser is used. This controls the first detector and oscillator stages whose functions are performed by the first tube, 6A8. The .0004-mfd. padding condenser in the oscillator circuit must be within three percent of the rated capacity, to avoid trouble in ganging the two condensers.

The sensitivity of this receiver, especially on distant stations, is greatly increased by the use of the 1-meg. grid leak and the .0002-

Here are overall dimensions of chassis and cabinet

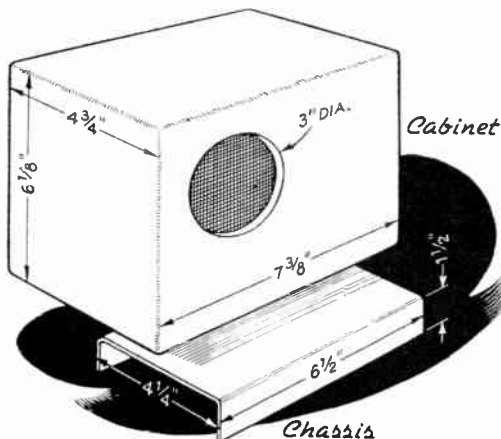

Inserting the grid leak and condenser in the grid lead of the second detector tube to step up sensitivity

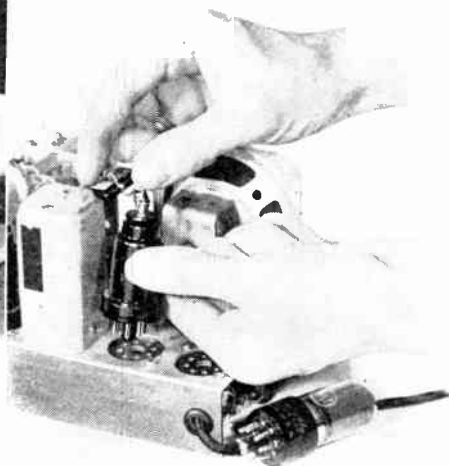

mfd. mica condenser in the grid lead of the second detector tube (6K7).

The small 3" permanent-magnet speaker is connected to the output of the 32L7GT. It is mounted directly to the chassis by means of two long machine screws and metal spacers $\frac{3}{4}$ " long. The universal output transformer is mounted directly beneath it under the chassis, held by the same two screws.

LIST OF PARTS

- 3" Permanent-magnet speaker.
- Universal output transformer.
- Regenerative I.F. transformer with tap, 455 kc.
- Line-cord resistor, 250 ohm.
- Antenna coil.
- Oscillator coil, 455 kc.
- Tubes, 6A8, 6K7, and 32L7GT.
- Regeneration control, 2,500 ohm.
- Electrolytic condenser, 20 mfd., 150 volt.
- Electrolytic condenser, 40 mfd., 150 volt.
- Electrolytic condenser, 10 mfd., 25 volt.
- Two-gang tuning condenser, .000365 mfd.
- Mica condenser, .005 mfd.
- Mica condenser, .0001 mfd.
- Mica condensers (2), .002 mfd.
- Tubular condensers (2), .05 mfd., 400 volt.
- Tubular condensers (2), .02 mfd., 400 volt.
- Tubular condenser, .1 mfd., 400 volt.
- Carbon resistor, 250 ohm, 1 watt.
- Carbon resistors (2), 300 ohm, $\frac{1}{2}$ watt.
- Carbon resistor, 300 ohm, 2 watt.
- Carbon resistors (2), 50,000 ohm, $\frac{1}{2}$ watt.
- Carbon resistor, $\frac{1}{2}$ meg., $\frac{1}{2}$ watt.
- Carbon resistor, $\frac{1}{2}$ to 1 meg., $\frac{1}{2}$ watt.
- Carbon resistor, 150,000 ohm, $\frac{1}{2}$ watt.
- Carbon resistor, 2 meg., $\frac{1}{2}$ watt.

Miscellaneous: Volume control (optional); S.P.S.T. switch plate; three octal wafer sockets; chassis; cabinet, wide, etc.

Compact All-Wave Set IS EASY TO BUILD

YOU should have no trouble getting world-wide reception with the all-wave set illustrated. It uses the new 1E7G tube containing two pentodes, independent of each other except for the connected screens, giving two-tube regenerative results in a one-tube set. A 15-ohm rheostat connected in the positive "A" lead regulates filament voltage, and a 20,000-ohm potentiometer across the tickler coil controls regeneration. The potentiometer is combined with an on-off switch.

Since one pentode is used as a detector, the common screen voltage must be kept down to 22½ volts. Although this means a slight loss of volume in the audio stage, since the screen voltage on the "second" tube should be higher than 22½ volts for maximum amplification, the combined amplification of both stages is greater than that obtainable with two separate triodes.

To obtain regeneration, the author found it necessary to use coils of the type shown in the illustrations.

Note the receiver's small size. Its three control knobs are all on the panel front

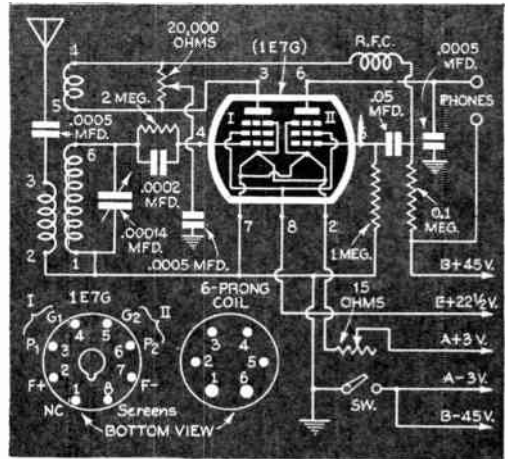
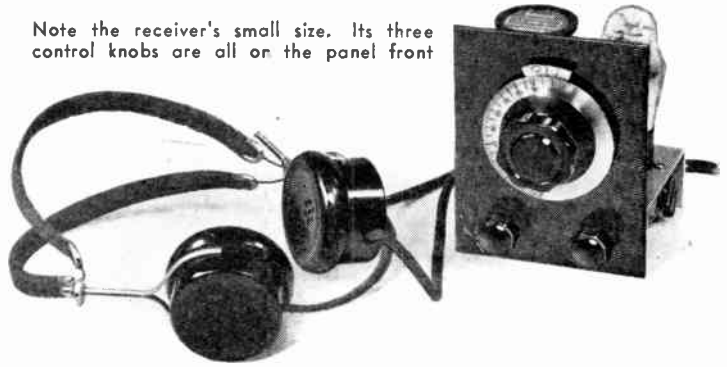

The diagram gives complete wiring details. Mount tube and coil sockets as below

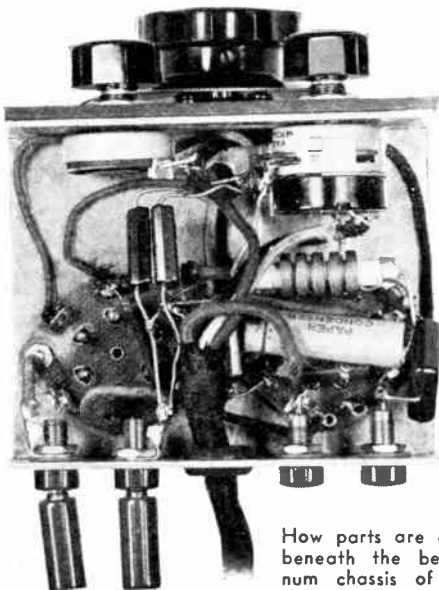

How parts are arranged beneath the bent-aluminum chassis of the set

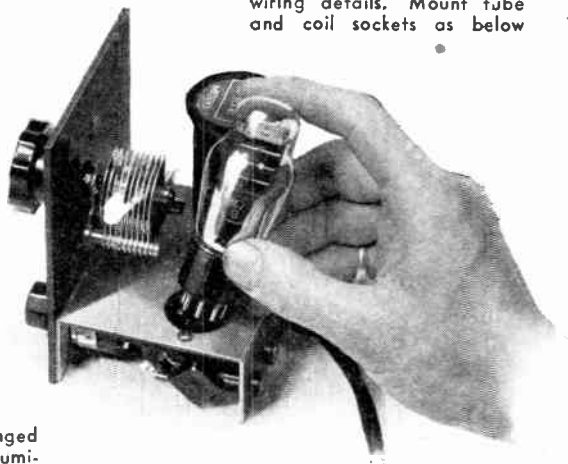

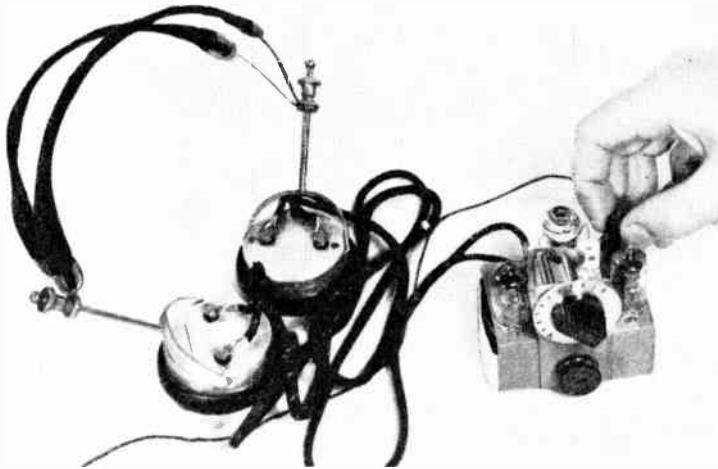

Beside the headphones, the tiny receiver is dwarfed. The plug being inserted is for the antenna

Two-Tube AC-DC Receiver

BUILT on a tiny chassis measuring only $1\frac{1}{4}$ " by $2\frac{1}{4}$ " by 3", this two-tube AC-DC headphone receiver is still powerful enough to pull in many stations besides the local broadcasters. No ground is used with it, and for an antenna a short piece of wire—about 18' long and strung along the floor—will be found sufficient for adequate reception in most cases. The little radio is selective enough to separate local stations and bring them in with great clearness.

Two of the newer midget tubes—the 9001 and the 9002—are used, the 9001 as a pentode detector and the 9002 as a half-wave rectifier. The 9002 is really a triode amplifier tube, but it will also function satisfactorily as a rectifier when its plate and grid are joined together. The 9001 is an RF pentode tube with a high amplification factor. Used in the detector stage, it will enable the listener to bring in stations situated more than 600 miles away if the

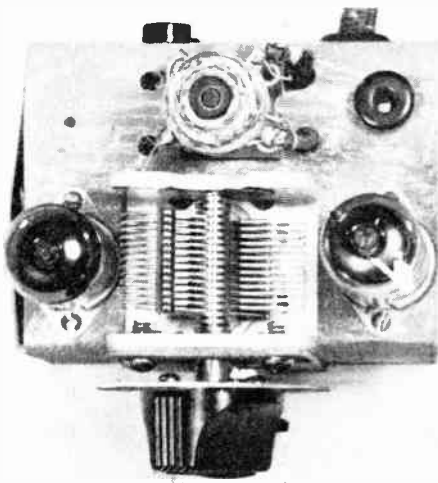

View of the chassis from above. The RF pentode tube is on the right, the rectifier tube of left

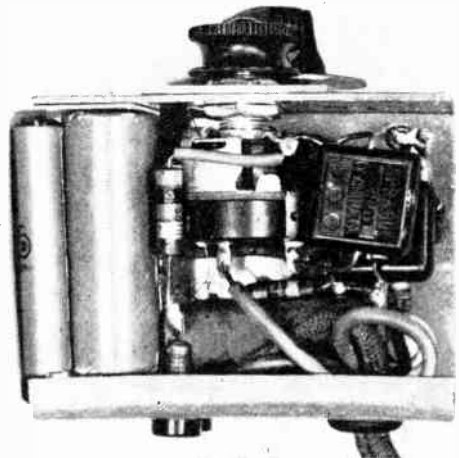

This bottom view shows one resistor of the left. The electrolytic filter condenser is next to it

receiver is used in the country and it is possible to put up a good outside antenna about 75' long.

Because of the low heater-current drain (0.15 ampere for each tube), a line-cord resistor of 600 ohms is required. Since it is impossible to purchase a line cord higher than 350 ohms, two 300-ohm line cords are used in series to bring the resistance up to the amount necessary. The plug is removed from one line cord and the three exposed wires are then soldered to the ends of the

corresponding wires of the second. To do this properly, be sure you disconnect the resistor from the wire to which it is soldered before attempting to join the two line cords. The method is illustrated in detail in the drawing at the lower left-hand corner of this page.

The capacities given in the wiring diagram are not critical, and both capacities and resistances (except that of the line cord) may vary as much as 25 percent. For instance, a .00041-mfd. variable condenser

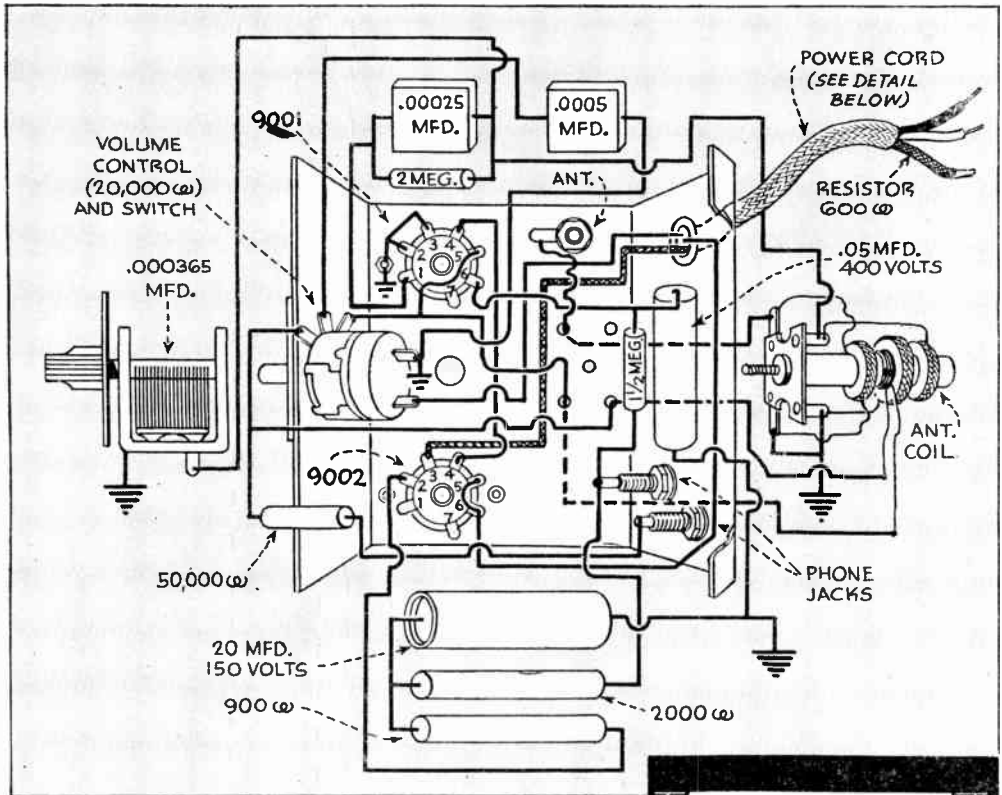

Arrangement of the parts is detailed in the pictorial diagram above. Note that the tickler-coil winding is placed between the antenna-coil and the first of two secondary-coil windings

Two line cords, joined as shown in the sketch below, will be needed to obtain the necessary line-cord resistance. Follow the directions carefully. At the right is the chassis layout

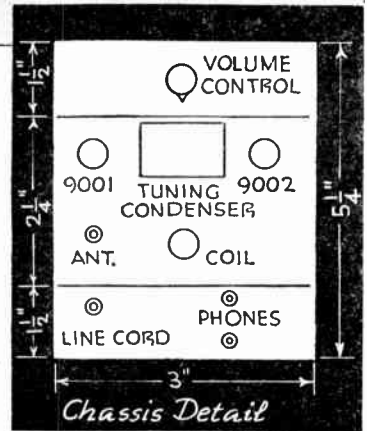
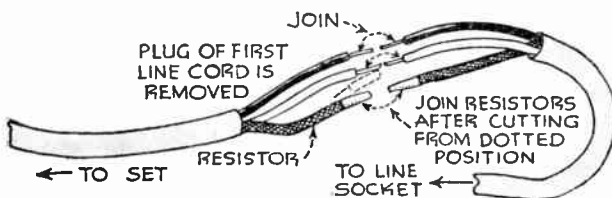

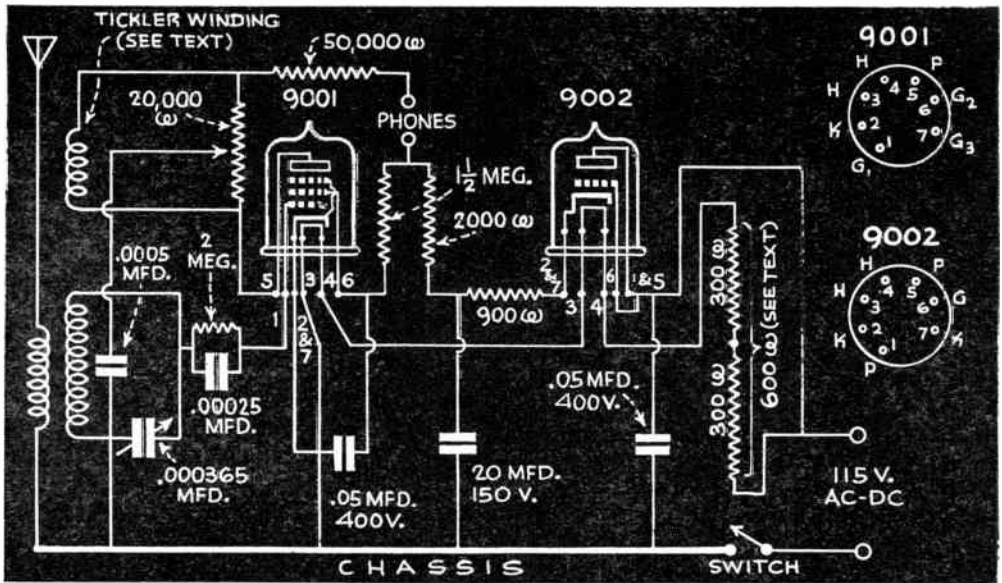

Wiring is made simpler by following this complete diagram. Base layouts for tubes are at right above

LIST OF PARTS

- Midget tuning condenser, .000365 mfd.
- Midget iron-core antenna coil.
- Volume control, 20,000 ohms.
- S. P. S. T. switch.
- Midget pentode tube, 9001.
- Midget triode tube, 9002.
- Seven-prong sockets (2).
- Carbon resistors (5), 2 meg-ohms, $\frac{1}{2}$ watt; $1\frac{1}{2}$ meg-ohms, $\frac{1}{2}$ watt; 50,000 ohms, $\frac{1}{2}$ watt; 2,000 ohms, 2 watts; 900 ohms, 2 watts.
- Line-cord resistors (2), 300 ohms.
- Electrolytic condenser, 20 mfd., 150 volts.
- Paper tubular condensers (2), .05 mfd., 400 volts.
- Mica condensers (2), .0005 mfd.; .00025 mfd.

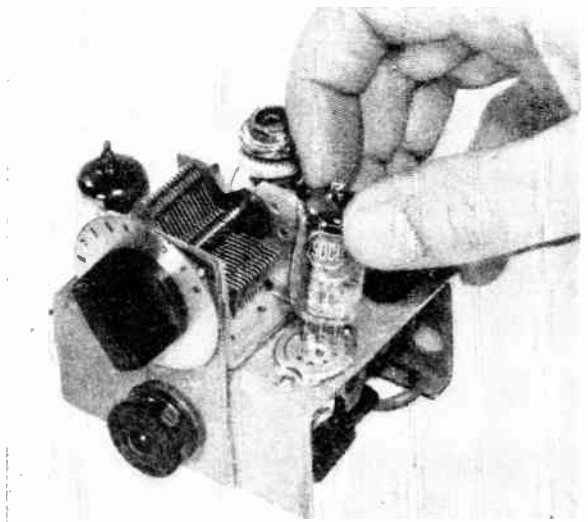

Here the RF pentode detector tube is being inserted. It is all glass with no base. The midget socket is shown clearly

may be used instead of the .000365-mfd. condenser called for in the diagram, and the 2-megohm grid leak may be changed to either a 1-megohm or 5-megohm resistor. This 25-percent margin will enable one to rummage around in old sets or in the junk box for many of the parts.

The simplified filter circuit (using but one electrolytic condenser) is ample to keep any hum from reaching the phones. A tickler winding, consisting of 25 turns of No. 30 double-silk-covered wire, is wound

next to the grid winding on the coil. The coil is a standard antenna coil of the type sold generally for use in small AC-DC receivers. Volume and oscillation are controlled by the 20,000-ohm variable resistor across the tickler winding.

The chassis is made of wood or any odd pieces of metal found around the workshop. A coating of gray wrinkle paint is applied to give it a professional finish. If a case is to be built, simulated leather or scrap may be used.

Servicing Your Radio

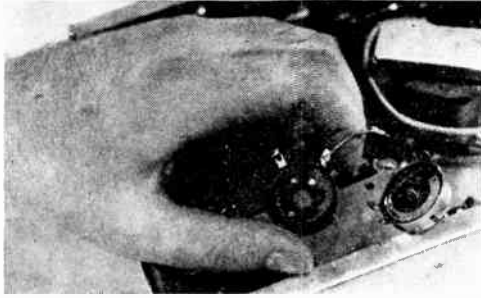

NOISY VOLUME CONTROL caused by the graphite wearing down or becoming coated with a hard film during the constant traction of the moving arm may be easily adjusted. Worn graphite can be restored with a dab of special liquid graphite lubricator. Film may be scraped away with a small screwdriver. Do not use a knife—it is too sharp—and do not scrape too hard.

SHOULD A SPEAKER GIVE NO SOUND even when the tubes light and test O. K. on the meter, the primary and secondary windings on the output transformer also test O. K., and each circuit is receiving the correct "B" voltage, it is a safe bet that the voice-coil winding is burned out. However, before cutting out the cone, make sure that the short pieces of stranded wire connecting the voice coil to the lugs on the speaker frame have not become corroded or disconnected. These are simple things which have happened in more than one receiver, and it saves needless trouble to inspect them.

CONNECTING A PHONOGRAPH PICKUP to the detector stage of a radio receiver—an easy matter with the old receivers where the detector stage usually was a pentode—is a much more difficult operation with the newer models where the detector tube usually is a diode plus a high-mu triode or pentode.

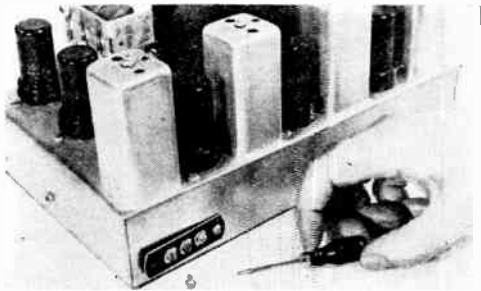

WHEN TUNING-STAGE ALIGNMENT, especially at the upper end of the dial, is not possible with a receiver using a loop antenna, reception may be improved in some cases by connecting a fixed condenser (.002 to .02 mfd.) across the loop antenna and ground, or by shorting the two.

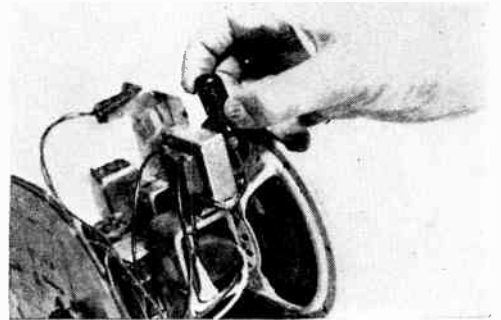
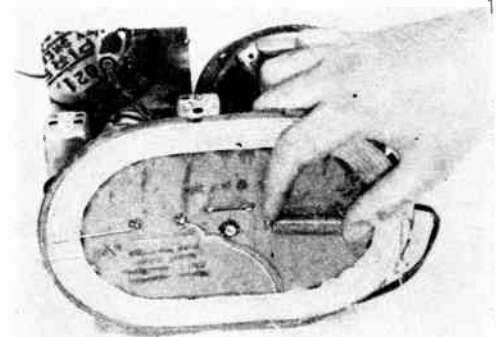

By following carefully the diagram of the simple circuit given below, the amateur serviceman should be able to make the proper connection without too much trouble. This diagram will serve for any of the newer sets, and a connection thus made should give excellent phonograph reception.

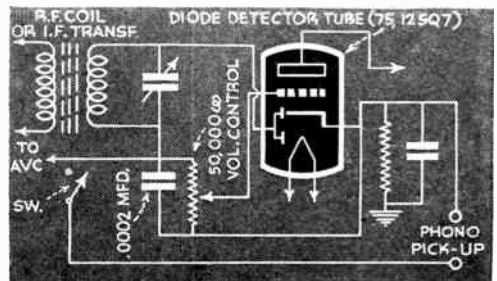

Portable Radio- Phonograph

World's Smallest Model
Has Four Tubes and Is
Compact for Carrying

JUST a year ago, there came from radio factories the first midget portable radio, weighing 4 lbs., light enough to carry about like a camera. There have not yet been any really compact portable radio phonographs. The plans given here for building the world's smallest portable radio phonograph are the first to be published.

Built into a case $9\frac{3}{4}$ " by $8\frac{3}{4}$ " by $4\frac{1}{2}$ " is a complete phono-amplifier, crystal pick-up, spring-wound phonograph motor, 6" steel turntable, four-tube radio receiver, 4" per-

manent-magnet speaker, 67½-volt "B" battery, 1½-volt "A" battery, and 3-volt "C" battery.

The four-tube radio circuit uses three 1T4 miniature seven-prong tubes (two as RF amplifiers and the third as a detector) and one 3Q4 miniature seven-prong tube (a beam power pentode, used in the output stage and handling up to 270 milliwatts; it is also the phono-amplifier tube).

Two stages of RF amplification are employed with only two .00036 mfd. tuning condensers because in the untuned antenna circuit the tuning condenser has been replaced by a 75,000-ohm, ½-watt resistor connected be-

Two stages of RF amplification are employed with only two .00036 mfd. tuning condensers because in the untuned antenna circuit the tuning condenser has been replaced by a 75,000-ohm, ½-watt resistor connected be-

Top view of radio chassis. Left to right, trimmer and tuning condensers, three 1T4 tubes, one 3Q4 tube, and output transformer.

View of radio chassis from the bottom, showing neat arrangement of the paper tubular condensers, tube sockets, and resistors, which permits installation along with equipment for a phonograph in a compact, convenient carrying case

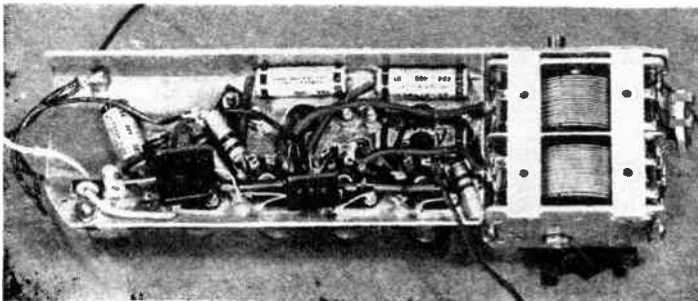
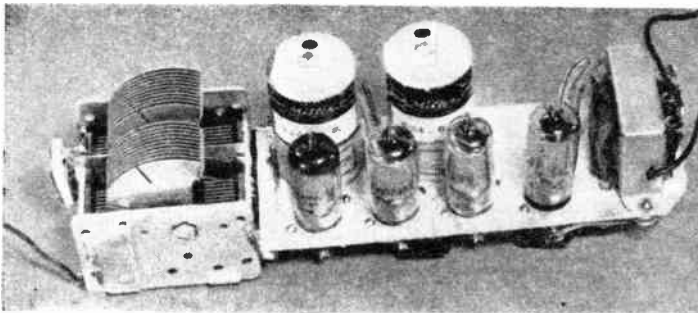

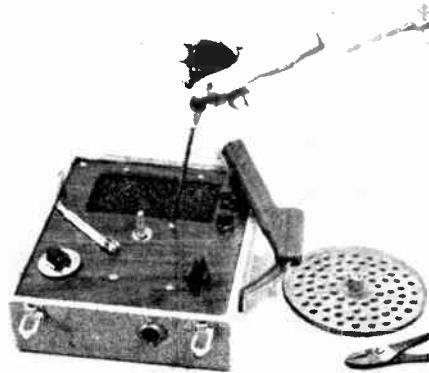
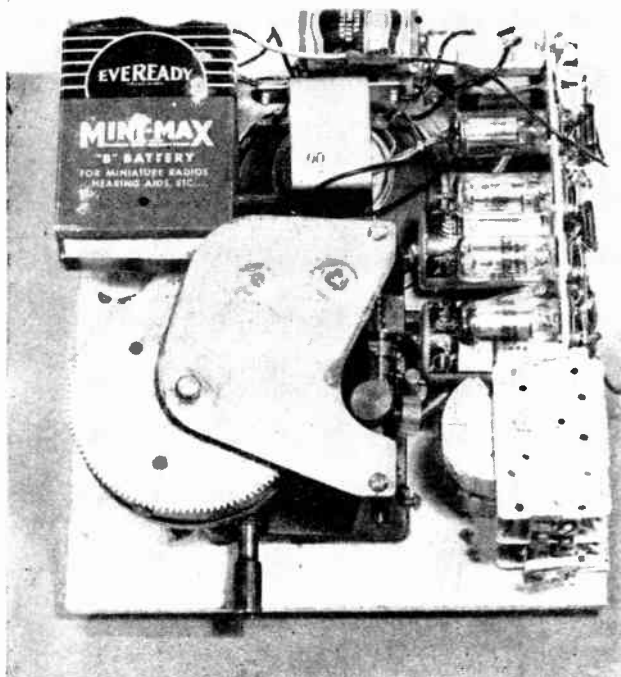

Above, the top of the control panel, with the record turntable removed. This gives a view of the opening for the speaker, in the rear, and the speed regulator under the turntable

Bottom view of the radio phonograph. The radio chassis, turned over on its side, fits snugly into the space left by the phonograph mechanism. The record player is spring-driven; the two batteries are for the radio

tion. Another variable resistor, in the grid circuit of the 3Q4, controls volume for the phonograph amplifier and pick-up. For radio, this is left at its maximum position.

Because of the size of the unit, a 6" turntable is the largest that can be used. One 8" in diameter would entirely cover the top panel, leaving no room from tuning or volume controls, and would completely hide the speaker.

For the same reason 2½" of the tone arm of the 9" crystal pick-up must be sawed off, reducing the length to 6½", a size that would fit inside the case. This does not impair the performance of the pick-up—the quality of the output being just as good. (When playing recordings, do not use a loud needle as this will overload the 3Q4, caus-

ing distortion in the reproduction of sound.

Inserted in the audio stage is a S. P. D. T. radio-phonograph switch. This is of the rotary type and is mounted in front of the panel to balance up with the small 1¼" tuning dial.

The case is constructed of ¼" thick white pine and is covered with tan airplane cloth fabric, which can be obtained in small rolls.

Removable hinges are used, but they are not essential.

The panel is made from a piece of plywood, also ¼" thick, and given a high-gloss finish. The size of the panel is 9" by 8". An oblong hole 5¼" by 2¾" serves as an opening for the 4" speaker.

For outings, or carried from one part of the house to another, this set will give good service.

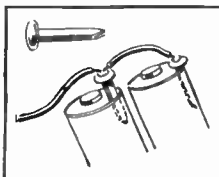

Wire soldered to paper clips makes connection to flashlight batteries

LIST OF PARTS FOR PORTABLE RADIO-PHONOGRAPH

Metal chassis, 6" by 2¼" by ¾".
 Two-gang tuning condenser, .00036 mfd.
 RF coils (2), iron core, shielded.
 Midget tuning dial.
 Volume controls: (for pick-up) 1 megohm;
 (for radio) 150,000 ohms.
 Switches: attachable, D. P. S. T.; rotary,
 S. P. D. T.
 Miniature seven-prong wafer sockets.
 Tubes: super-control RF amplifier pen-

todes (3), 1T4; beam power output, 3Q4.
 Permanent magnet speaker, 4".
 Midget output transformer.
 Spring-wound phonograph motor.
 Crystal pick-up.
 Condensers: paper tubular (3), .01 mfd.,
 400 volts; paper tubular, .002 mfd., 400
 volts; mica, .00025 mfd.; mica, .005 mfd.
 Carbon resistors, ½ watt (3): 75,000 ohms;
 500,000 ohms; 5 megohms.

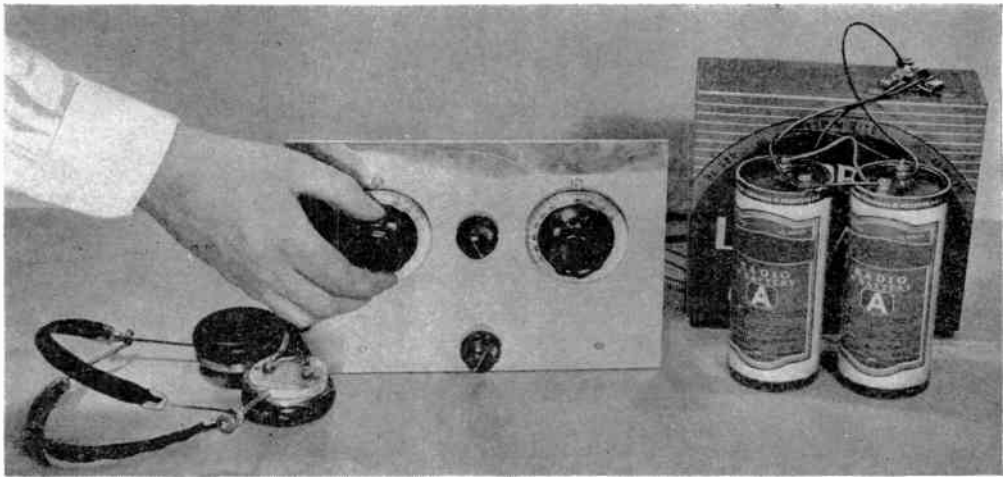

Anything from short waves to the long-wave aircraft beam signals can be tuned in on this one-tube set

One-Tube Short-Wave Set

ALL BANDS up to and including the aircraft beam signals can be worked with this one-tube receiver. The tube is a twin-pentode 1E7G, operating as a push-pull detector. Its output is sufficient to permit operation of a magnetic speaker on the broadcast band when close to the transmitter. Two 1.5-volt dry cells supply the "A" current. The tube operates satisfactorily with 45 volts on plates and screens, but best results are obtained with 90 on plates and 45 on screens. Two plug-in coils are used on each band, tuned by two .00014-mfd. variable condensers. Any type of antenna will do, though with one longer than 20 feet a trimmer condenser may have to be used in the antenna lead for short waves.

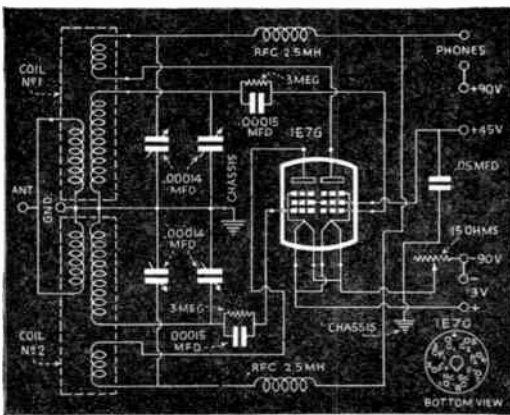
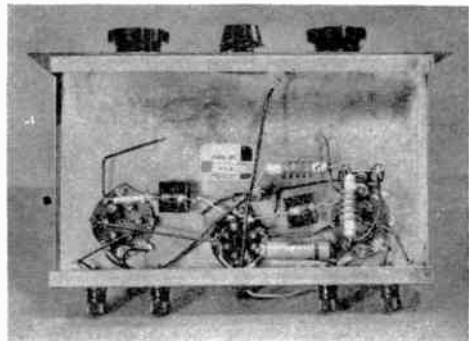
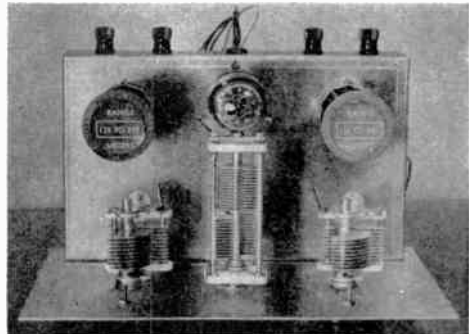

Above, top view; below, bottom view; and left, hook-up of the one-tube push-pull short-wave receiver. Two 1.5-volt dry cells supply the "A" current; "B" current runs 45 to 90 volts. Any type of antenna, ten to 75 feet, will do

Sliding Panel



Two controls — a sliding panel and a volume knob — operate this easily built receiver

Top and bottom views of the L-shaped metal chassis. Note trimmer condensers

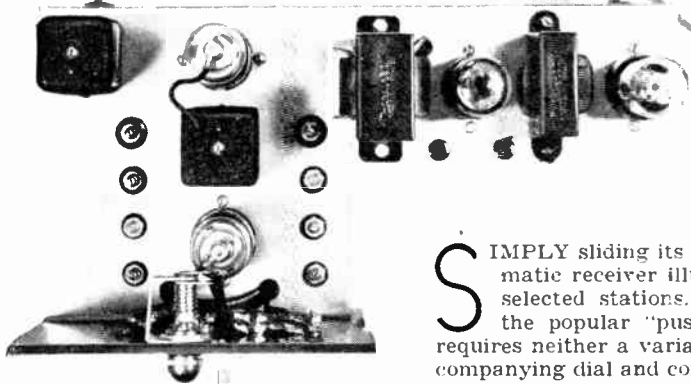
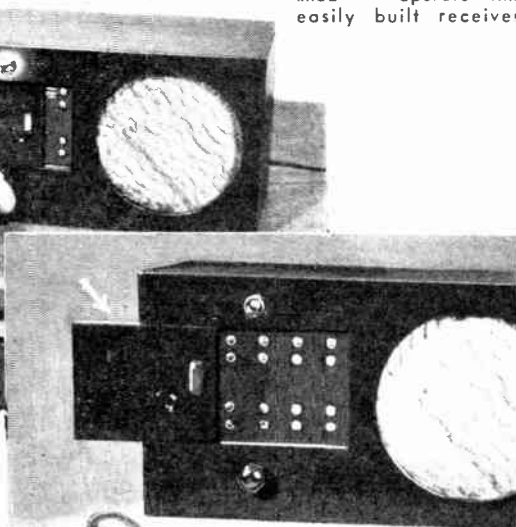

Metal strips backing the panel contact the screw heads to connect the condensers into the circuit

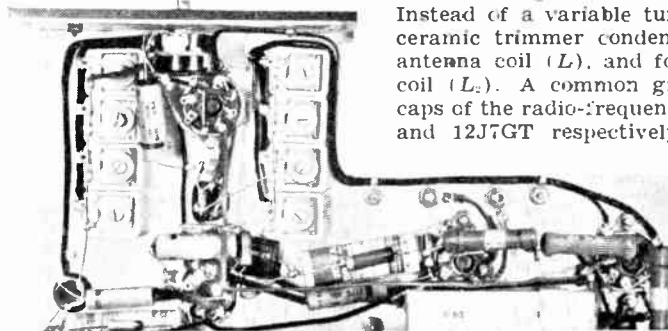

SIMPLY sliding its front panel tunes the novel automatic receiver illustrated to any one of four pre-selected stations. Operating on the principle of the popular "push-button" receivers, the circuit requires neither a variable tuning condenser nor its accompanying dial and control.

The arrangement of the circuit is unusually simple: Instead of a variable tuning condenser, a set of eight ceramic trimmer condensers is used—four across the antenna coil (L_1), and four across the radio-frequency coil (L_2). A common grid lead connects them to the caps of the radio-frequency and detector tubes (12K7GT and 12J7GT respectively). Their ground leads, not grounded directly to the metal chassis, are wired to sets of metal screws mounted on the composition panel, as shown. These screws serve as contacts, and as two phosphor-bronze strips mounted on the rear of the sliding

Tunes Novel Receiver

panel contact them, pairs of trimmer condensers become grounded. Since each pair has been pretuned to a station, sliding the panel serves to connect just the right capacities into the circuit to tune it to the desired wave length. The range of the condensers being wide, they can be adjusted with a screw driver to bring in any four stations in the broadcast band.

How the eight trimmers and their contacts are wired is clearly shown in the diagram. There are just two precautions that must be observed—the condensers must be insulated from the metal chassis, and the front panel must be of composition and not of metal.

Four of the latest-type tubes make up the heart of the circuit. The high heater voltage of these tubes makes it possible to eliminate the usual filament resistor built into the line cord and to substitute a simple wire-wound resistor which can be mounted on the chassis.

A 10-henry choke with a resistance of 475 ohms, and a dual 8-25-mfd. electrolytic

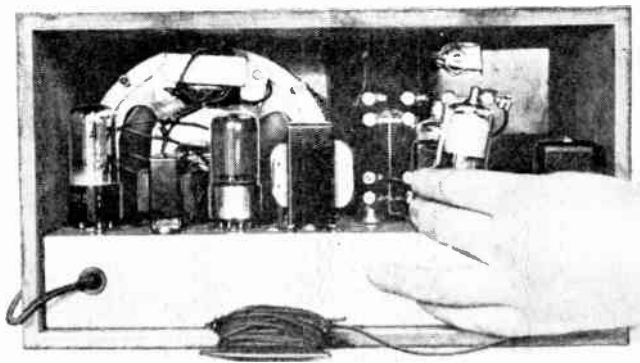

New-type tubes make it unnecessary to use a line-cord resistance

condenser serve to filter the rectified plate voltage and are adequate for providing hum-free reception. Electrolytic condensers are also used to by-pass the 30,000-ohm grid-bias resistor in the cathode lead of the detector tube and the 200-ohm grid-bias resistor of the power tube (35L6GT). These small electrolytic condensers are of the dry cartridge type and are rated at 25 volts and 50 volts respectively.

Impedance coupling was chosen for the audio-frequency stage and consists of a high-impedance choke (510 henry, 6,470 ohm) in the plate lead of the detector, a

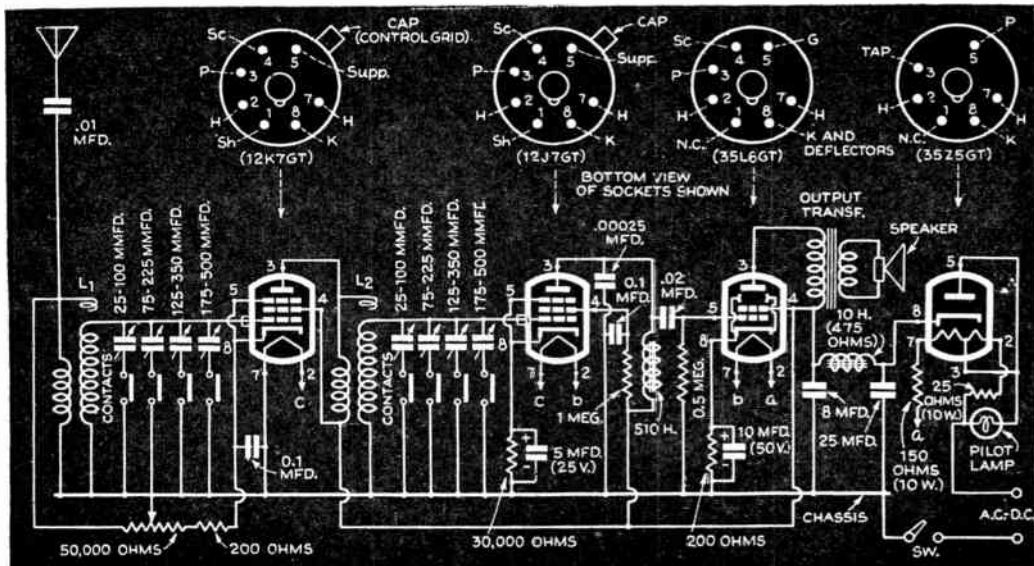

How the various parts are connected. The trimmer condensers must be pretuned to the desired stations

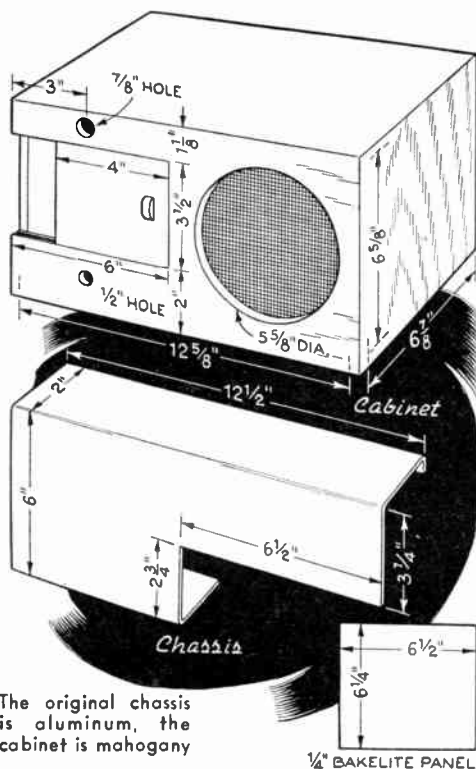

The original chassis is aluminum, the cabinet is mahogany

$\frac{1}{4}$ " BAKELITE PANEL

.02 mfd. coupling condenser, and a 500,000 ohm ($\frac{1}{2}$ meg.) fixed resistor.

The cost of this receiver is extremely low and the special tuning arrangement costs no more than a good two-gang condenser. No ground is necessary and any antenna can be used.

LIST OF PARTS

Volume control, switch, 50,000 ohm.
 Filter choke, 10 henry.
 High-impedance choke, 510 henry.
 Trimmer condensers, two, 25-100 mmfd.
 Trimmer condensers, two, 75-225 mmfd.
 Trimmer condensers, two, 125-350 mmfd.
 Trimmer condensers, two, 175-500 mmfd.
 Dual electrolytic condenser, 8-25 mfd, 250 v.
 Cardboard electrolytic, 10 mfd. 50 v.
 Cardboard electrolytic, 5 mfd, 25 v.
 Tubular condensers (two), .1 mfd, 200 v.
 Tubular condenser, .01 mfd, 200 v.
 Tubular condenser, .02 mfd, 200 v.
 Mica condenser, .00025 mfd.
 Resistor, carbon, 1 meg., $\frac{1}{2}$ watt.
 Resistor, carbon, $\frac{1}{2}$ meg., $\frac{1}{2}$ watt.
 Resistor, carbon, 30,000 ohm, $\frac{1}{2}$ watt.
 Resistor, carbon, 200 ohm, $\frac{1}{2}$ watt.
 Resistor, carbon, 200 ohm, 1 watt.
 Resistor, wire-wound, 150 ohm, 10 watt.
 Resistor, wire-wound, 25 ohm, 10 watt.
 Miscellaneous: Antenna and radio-frequency coils, tubes, chassis, cabinet, sockets, speaker, etc.

All Wave



EXTREMELY simple to assemble, this compact loudspeaker receiver will bring in foreign as well as domestic broadcasts. Built around two of the new low-drain $1\frac{1}{2}$ -volt battery tubes, the set not only packs a great deal of power, but is extremely economical to operate.

A set of six ready-made plug-in coils provide coverage for the various short-wave and broadcast bands. These coils, which plug into a socket conveniently located on top of the cabinet, should be of the two-winding, four-prong type. A midget, .00014-mfd. variable condenser used for tuning is wired across the secondary or grid winding. The smaller winding, called the tickler, is connected to the outside lugs on a 20,000-ohm variable resistor which serves as the regeneration control. The on-off switch, shown in the "A" minus lead, is mounted directly on the back of this 20,000 ohm variable resistor and is operated by the same control knob.

A 2.1-mh. plate choke wired into the plate circuit of the detector helps to provide smooth regeneration, so that the maximum sensitivity can be obtained when tuning in on the short waves.

Bands on Two Tubes

COMPACT LOUDSPEAKER SET IS INEXPENSIVE TO BUILD

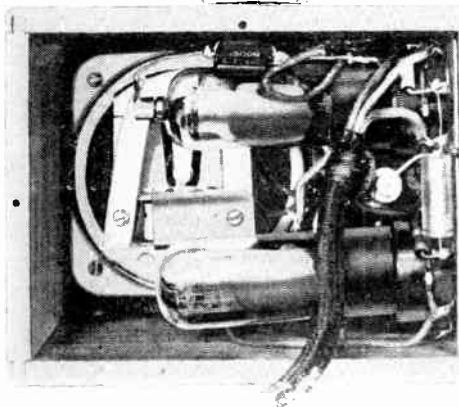

Rear view of the receiver with its back removed to show the tubes and other parts. The coil is mounted on top, as shown in the photo at the left

For the grid leak resistor (5 meg.), a higher than normal value was chosen. This was done to operate the detector tube at its maximum sensitivity. The experimenter can try even higher values (any resistance up to 10 meg. may be used).

The antenna is directly coupled to the grid winding by means of the 35-mmfd. trimmer condenser. A good outside antenna, sixty feet in length, must be used.

If difficulty is experienced in obtaining adequate regeneration, reverse the leads to the tickler coil. If this fails to bring results, increase the capacity of the .00025-mfd. plate by-pass condenser to .0005-mfd., or decrease the capacity of the antenna trimmer condenser by unscrewing the adjusting screw.

WHAT YOU NEED

Tuning condenser, .00014 mfd.
 Variable resistor, wire wound, 20,000 ohm.
 Switch coverplate, . P. S. T.
 Midget radio-frequency choke, 2.1-mh.
 Midget trimmer condenser, 3-30 mmfd.
 Magnetic speaker, 3 in.
 Tubular condenser, .01 mfd, 600 v.
 Tubular condenser, .05 mfd, 600 v.
 Mica condenser, .0005 mfd.
 Mica condenser, .00025 mfd.
 Resistor, carbon, 5 meg. ½ watt.
 Resistor, carbon, 1 meg., ½ watt.
 Resistor, carbon, 400,000 ohm, ½ watt.
Miscellaneous: four-prong wafer socket, two octal sockets, set of four-prong coils, battery cable, batteries, tubes (1N5G and 1A5G), etc.

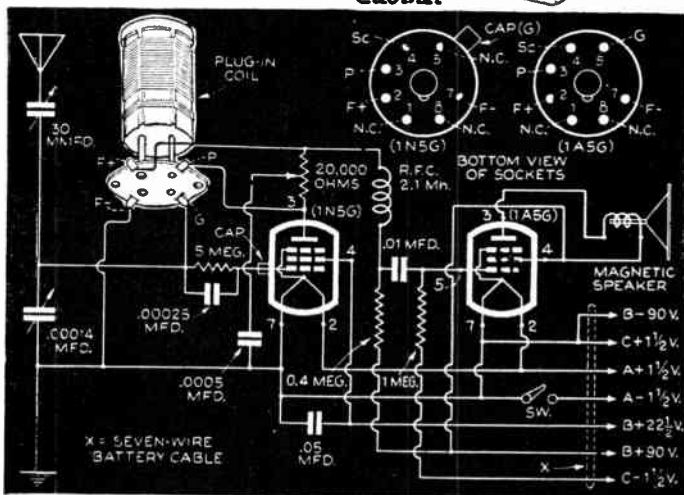
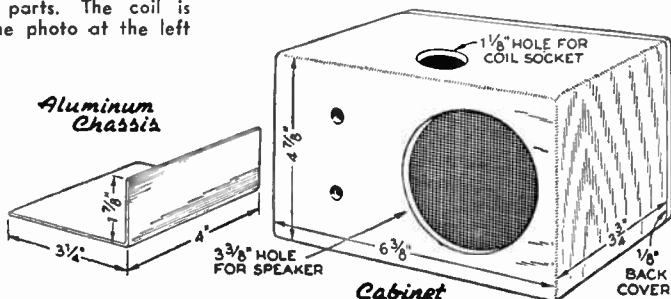

Low-drain 1½-volt tubes make this circuit economical to operate

Compact Radio-Tube Tester

BATTERY-OPERATED UNIT BUILT FOR SIX TYPES OF PRONGS



Leather covering makes a handsome carrying case



One of the eight-prong tubes is being fitted into its socket above. The panel has sockets for tubes with four to eight prongs and for the seven-prong miniature

Slipped into a brief case, as at right, this little unit leaves room for a battery and other accessories

At left, below, top of the panel with the 4.5-volt "C" battery connected. At bottom right is shown wiring, small battery, and flashlight bulbs on the underside

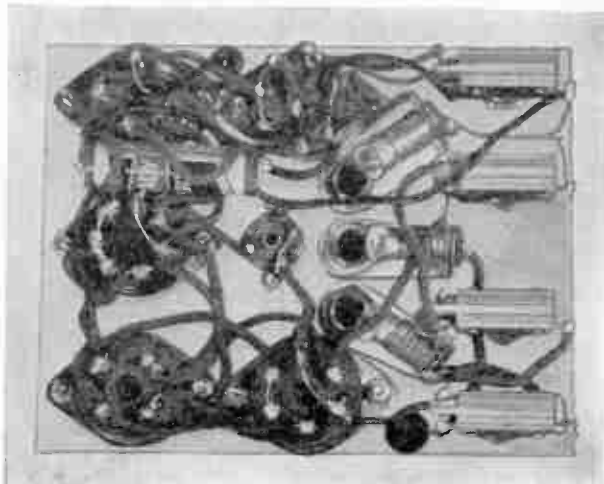

THIS tube tester is compact enough for the serviceman's brief case or tool box and simple enough for the radio owner who does his own servicing. It will handle 80 percent of all tubes made, and, with slight alterations, can be adapted for others. All materials are readily available—it employs, for instance, no meters since they are on the priority lists—and many of the parts may be salvaged from the junk box.

All four-prong to eight-prong tubes for battery, AC, or DC can be handled, and a socket is included for the new miniature seven-prong tube. The device will also test heaters and filaments, and will reveal shorts between elements inside a tube. A loktal-type tube socket can be added by enlarging the case.

No previous adjustment is necessary to test 1.5 and 2-volt DC tubes, 2.5 and 5-volt AC tubes, 6.3, 12.6, 25, 35, and 50-volt AC-DC tubes, or 117-volt heaters and filaments. A tube is placed in the proper socket, and the switch flipped. If it is good, the center jewel reflector lights; if burned out, the reflector remains dark.

Shorts can be detected between the plate of a tube and suppressor and either the screen grid or control grid, between the screen grid and control grid, or between the control grid and cathode or filament. Through operation of three toggle switches, these shorts illuminate the jewel reflector on either the left or right side.

The panel measures 4½" by 5¾", and may be of metal or pressed wood. Five large holes and a smaller one are drilled for tube sockets, three holes for jewel reflectors, and four for toggle switches.

Wiring instructions are given in detail in

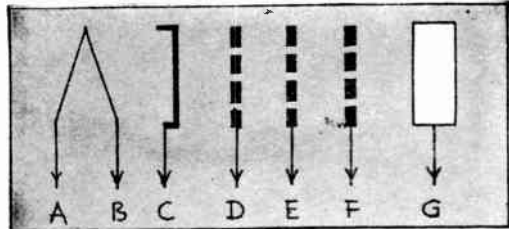

Shorts may be tested between plate and suppressor, G and F above; suppressor and either screen grid, E, or control grid, D; screen and control grid, E and D; control grid and cathode, D and C; and control grid and filament, D and A

the diagram below. The grid-cap and plate connections on each socket are wired together, as are the screens and suppressors, and the cathodes and one side of the heater and filament of each tube. Connections for testing shorts within a tube are shorted in and out of the circuit by toggle switches.

The source of current is a 4.5-volt "C" battery, but a small pen-type 1.5-volt battery is needed for testing shorts between the plate and suppressor or the control grid and screen of a tube. This 1.5-volt battery is installed under the chassis and supported by its own wiring.

The three flashlight bulbs used are the type made for small flashlights, and are rated at 2.2 volts. Do not use any other kind, for no other will work. Some bulbs might even blow out the filaments of a 1.5 or 2-volt battery tube.

A special leather-covered case, 2¼" by 5" by 6¼", may be purchased, or a case may be built from small pieces of wood glued together. If desired, cardboard may be used for the top and bottom.

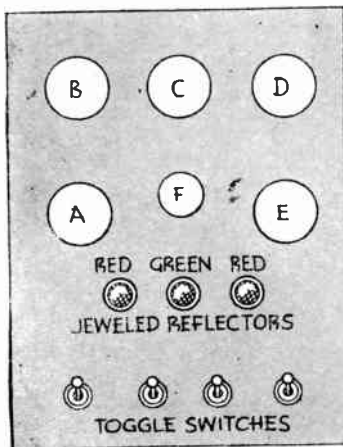

Sockets in the panel layout are: A, 8-prong; B, 5; C, 7; D, 4; E, 6; and F, 7-prong miniature

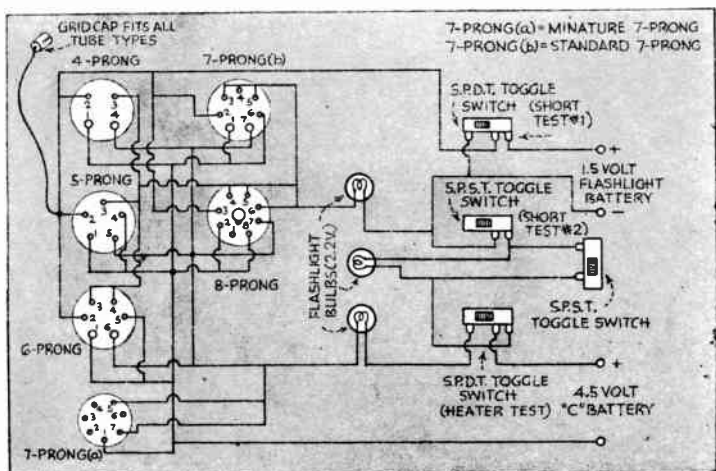

Wiring may be done in one evening by following this complete diagram

Servicing Your Radio

COST and utility make it well worth your time to build your own loop antenna to modernize your old radio and get rid of unsightly tangled wire strung along the floor or hanging out the window. The cost is but

a few cents, very little time is needed, and you can design the new antenna to fit your individual cabinet. The photographs below show the materials that are needed and also the step-by-step construction.

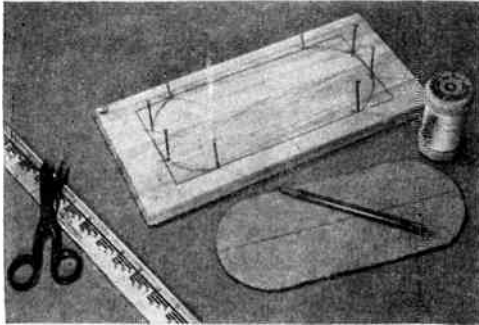

1 Cut a cardboard template about three fourths the size of the back radio cover or opening, lay the template on a board, and around it drive eight 2" nails or pegs. The one here is 4" by 9"

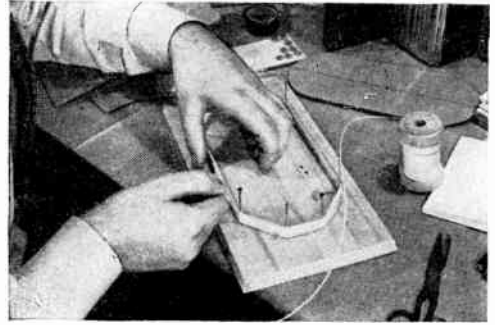

2 Remove the cardboard, and wind either No. 24 or No. 26 double-cotton covered wire around the nails in the form. Approximately 50 turns will be needed. Wind the wire evenly and tight

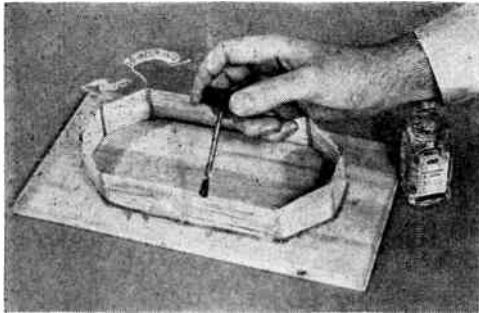

3 At the sides, carefully drive in two more nails to stretch the windings; then apply with a brush a special liquid dope solution carried by radio stores. This sticks the windings together

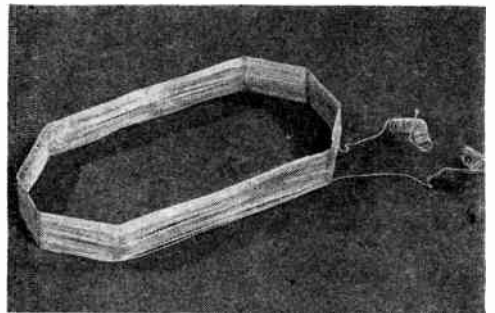

4 When this dope solution has dried so that the wires will not fall apart during handling of the loop, the nails are drawn from the base. The antenna can then be lifted off for installation



5 Adhesive tape or glued paper holds the loop to the back cover of the radio cabinet or suspends it from the top of the back opening. The antenna is light enough to need no other support

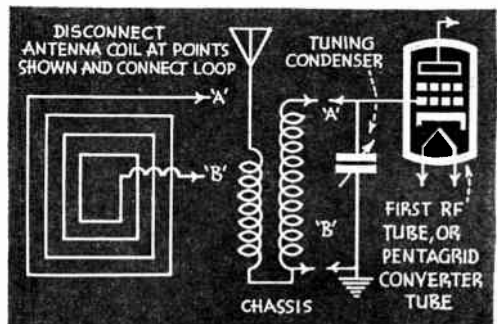

6 To use the loop, disconnect the old antenna coil, as shown. A few turns of the loop may be removed one at a time if needed to balance the trimmer condenser on the ganged tuning condensers

EUROPE ON ONE TUBE



This radio has only two controls. The cabinet scales 4¼ by 5 by 5¼ in.

BEGINNERS who want to try their hand at building a simple, inexpensive radio will find this compact, one-tube A.C.-D.C. set to be just the type of receiver for their needs. It is easy to build, and with a good outdoor antenna it will pull in stations from South America and Europe almost any evening. Tracing the circuit from the antenna, the signals enter the set through a .01-mfd. paper condenser to the primary winding of a 6-prong plug-in tuning coil. The secondary winding of this coil is tuned by means of a midget, .00014-mfd. variable condenser. A set of plug-in coils gives complete coverage for all wave bands.

The signals then enter the grid of the detector portion of the dual tube (12B8GT) by means of a .00025-mfd. mica condenser and a 3-meg., ½-watt resistor.

Signals from the plate of the detector then go to the headphones through the tickler winding and a 2.5-mh. plate choke. A 20,000-ohm potentiometer across the tickler winding controls the amount of feed-back between the tickler and secondary windings.

The second portion of the tube consists of a triode, which rectifies the alternating house current so that only direct current reaches the plate of the detector. Hum is filtered by a 20-h. choke and two 16-mfd., 150-volt electrolytic condensers.

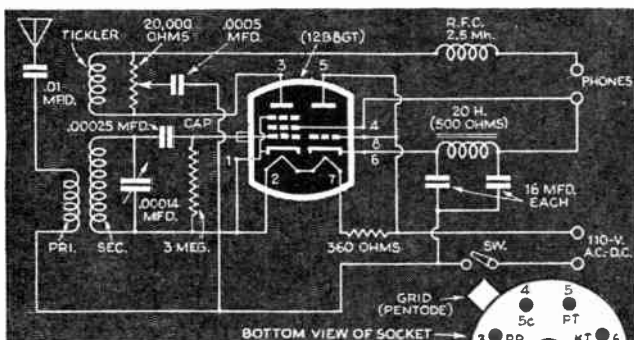

The diagrams above give specifications for the parts. Note the arrangement of the aluminum chassis

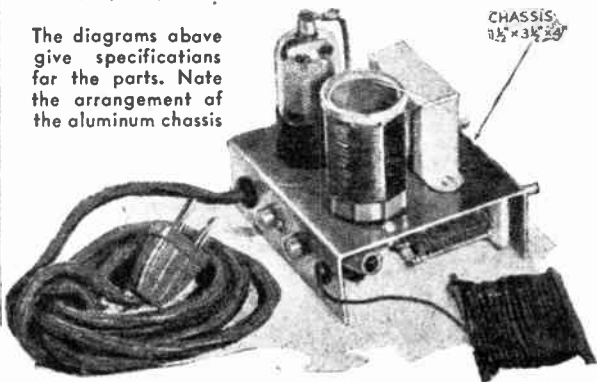
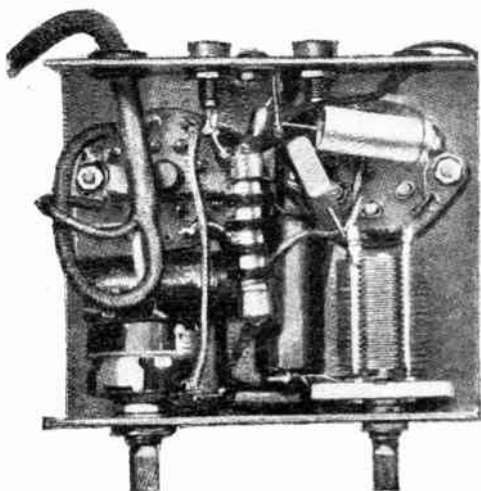

BICYCLE



FANS who would like to install a radio on their bicycles so they can enjoy their favorite programs while riding around town or on short trips will find the inexpensive set described on these pages just what they have been looking for. Fitting in a basket mounted on the handlebars, the battery-operated, four-tube receiver contains its own loudspeaker. It gives excellent results on local broadcast stations, and if iron-core coils instead of the air-space type specified are used this range will be increased.

Owing to the directional properties of a loop antenna, a 4' metal rod was chosen instead. The metal rod is connected directly to the grid cap of the radio-frequency tube. Both of the set's coils are tuned by a midget two-gang tuning condenser, which is mounted on the sloping panel by means of two right-angle brackets.

The antenna rod is insulated from the metal cabinet by a ceramic stand-off insulator. The tops of these insulators are usually threaded, and the best method of attaching the aluminum rod is to thread it to fit, and screw it into the insulator. For greater signal strength, the set will have to be grounded. The bicycle

Keep tuned as you ride with this receiver. Note below how tubes are mounted on aluminum chassis, and the speaker on the sloping panel

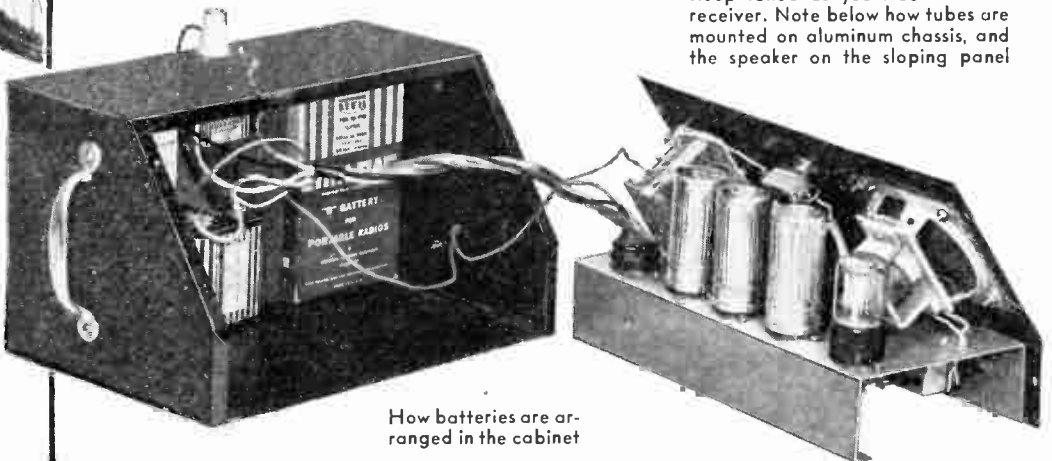

How batteries are arranged in the cabinet

RADIO IS EASY AND CHEAP TO BUILD

frame provides excellent counterpoise capacity for this purpose.

The steel cabinet used for housing the chassis and batteries measures 6½" by 7" by 11" and is small enough to fit inside a standard-size bicycle luggage basket. The panel is attached to the cabinet by means of self-tapping screws. The two "B" batteries that fit inside the cabinet along the back are the new small-size portable type employing the special flat cells with expanding seals. A 1½-volt "A" battery fits in between the two "B" batteries, with the 4½-volt "C" battery directly in front of it. The "A" and "B" batteries are of the plug-in type and use clip-in plugs with Fahnestock terminals. This system makes it an easy matter to change batteries whenever necessary.

In order to obtain ample volume from the speaker, two stages of audio-frequency amplification

are used after the detector. Both stages are resistance-coupled and use the latest-type tubes for maximum sensitivity. Type 1N5GT tubes are used in the radio-frequency, detector, and first audio-frequency stages. A beam power tube, 1T5GT, is used in the output stage, and provides a relatively high output with a very low filament drain.

A 15,000-ohm, ½-watt resistor is used in the grid circuit for the first audio tube. Any increase in value of this resistor will only cause instability and will fail to in-

It's as easy to tune as a car radio. View below shows the parts underneath the chassis

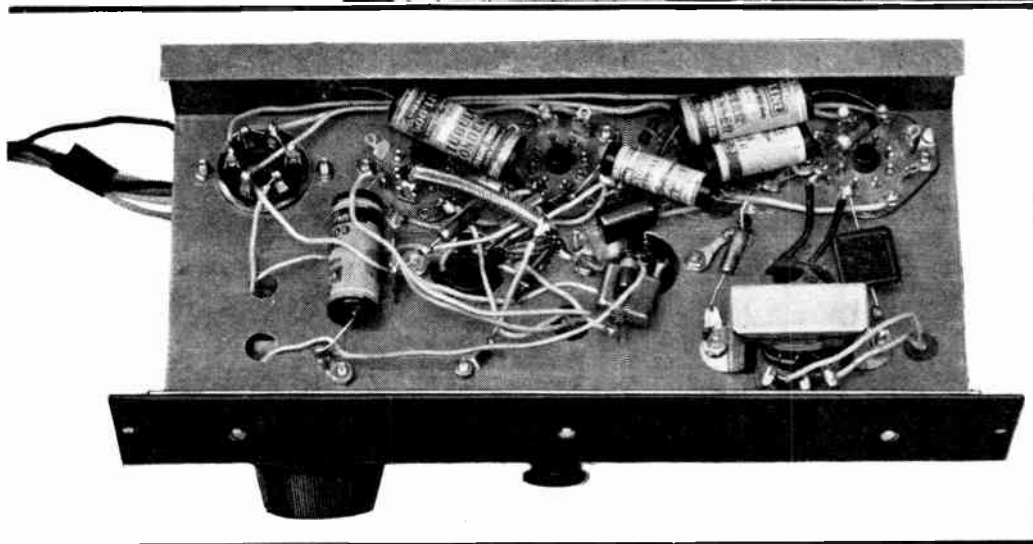

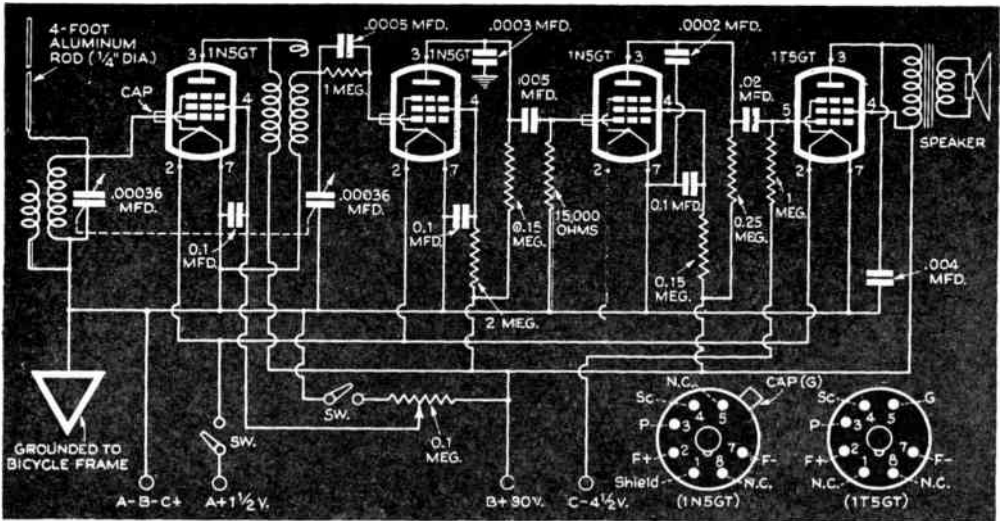

These circuit and tube-socket diagrams should be followed to the letter in constructing the set

crease the amplification. Volume is controlled by a 100,000-ohm potentiometer placed in the screen circuit of the radio-frequency tube.

The key-lock switch is of the double-pole, single-throw type and breaks two circuits at one time, the positive "A" supply and the ground lead of the volume control. This is done to avoid any drain through the "B" supply while the set is turned off.

As a safety measure, it is a good idea to lock the set in the basket or to the bicycle frame. The key switch prevents any one else from turning on the set.

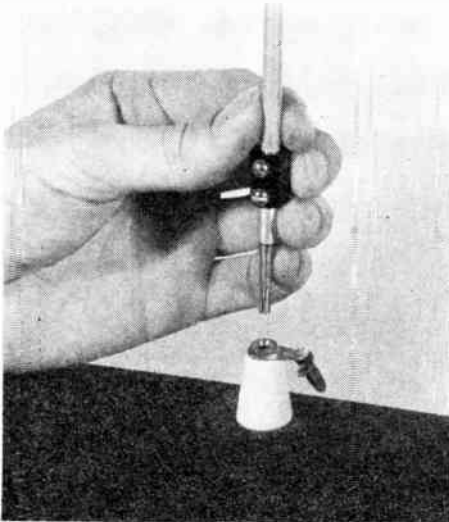

The antenna rod is set in a ceramic insulator atop the cabinet. Right, a key turns on the set

- ### LIST OF PARTS
- Midget 2-gang tuning condenser, .00036 mfd.
 - Shielded antenna coil.
 - Shielded radio-frequency coil.
 - Volume control, 100,000 ohm.
 - Output transformer.
 - Carbon resistor, 1/2 watt, 15,000 ohm.
 - Two carbon resistors, 1/2 watt, 150,000 ohm.
 - Carbon resistor, 1/2 watt, 250,000 ohm.
 - Two carbon resistors, 1/2 watt, 1 meg.
 - Carbon resistor, 1/2 watt, 2 meg.
 - Mica condenser, .0002 mfd.
 - Mica condenser, .0003 mfd.
 - Mica condenser, .0005 mfd.
 - Mica condenser, .004 mfd.
 - Tubular condenser, .005 mfd., 600 volt.
 - Tubular condenser, .02 mfd., 600 volt.
 - Three tubular condensers, .1 mfd., 600 volt.
 - Miscellaneous:** Tubes, four octal wafer sockets, three bantam-tube shields, six-prong speaker plug and wafer socket, key switch, six-way battery cable, batteries, 3" P.M. speaker, cabinet, chassis, antenna 3" dial, etc.

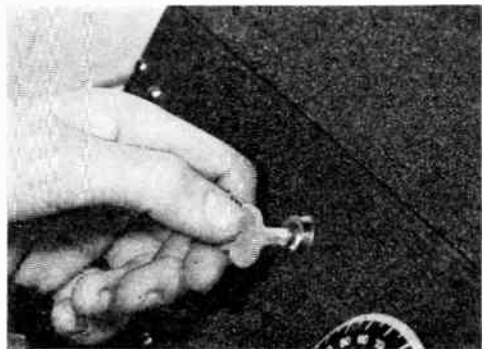

ELECTRIC 'B' SUPPLY FOR PORTABLE SETS

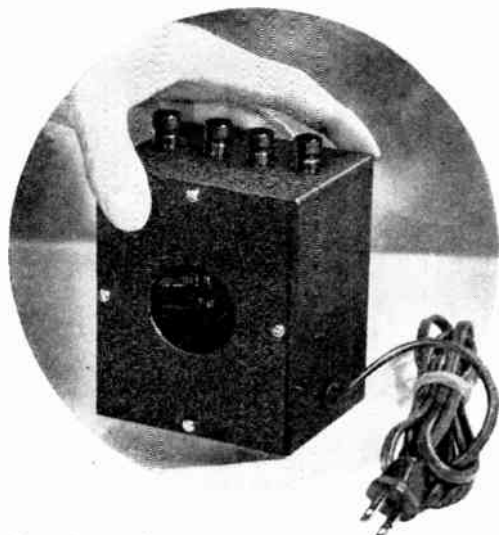

Scarcely a handful, it fits inside most portable radios

THIS compact "B" power pack, no larger than a standard-size portable "B" battery, is a highly useful radio accessory. It is small enough to fit in many of the modern battery portables and may be used to replace "B" batteries in small table receivers of either the tuned radio frequency or regenerative types, for hum-free reception.

An adjustable bleeder circuit is wired across the output of the rectifier, and the connections are brought out to four insulated binding posts on top of the cabinet. The bleeder circuit consists of a 10,000-ohm semi-variable wire-wound resistor with two sliders for adjusting the intermediate voltages.

Steel Cabinet

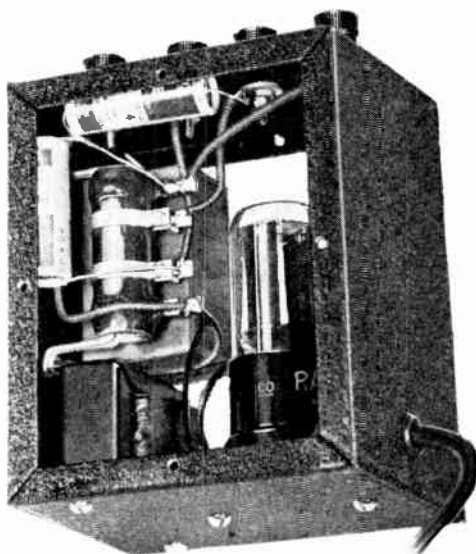
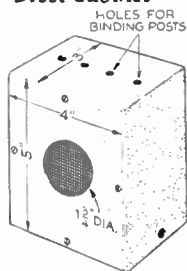

This photograph will help you assemble the outfit in its steel cabinet

As shown in the diagram, the circuit is adjusted to give 130, 90, and 30 volts at the different taps when connected to a set drawing about 15 milliamperes plate current.

The 117Z6GT rectifier tube is connected directly across a 117-volt power line without the use of resistors. A 1 3/4" ventilating hole should be drilled in one side of the cabinet.

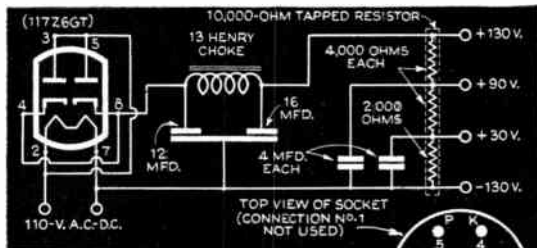
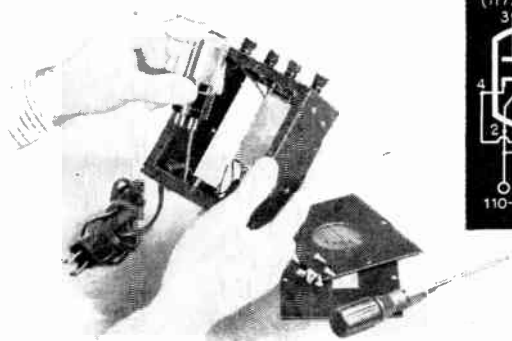

Ports needed for the unit can be itemized from the diagram. Note that the circuit is not grounded



Priority Receiver

USES NEW-TYPE TUNING UNIT

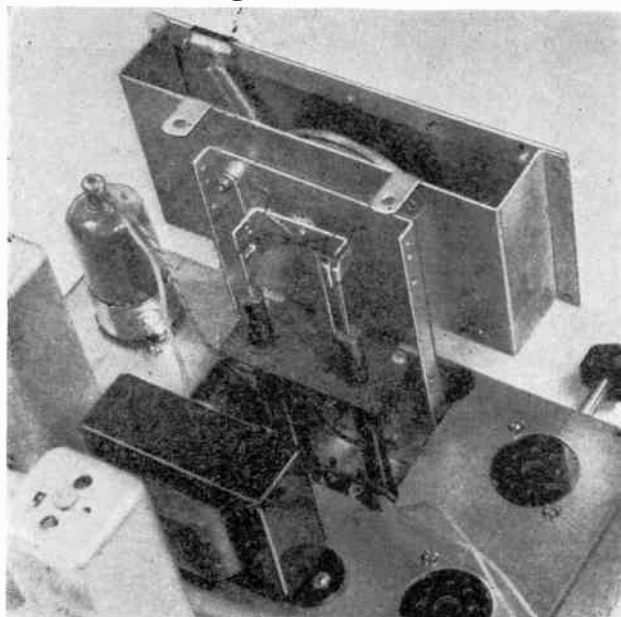

Iron cores moving in antenna and oscillator coils tune this set

WITH tuning condensers becoming increasingly scarce, a timely interest attaches to this five-tube superhet which tunes by varying the induction of the antenna and oscillator coils. A core of compressed powdered iron about $5/16$ " in diameter and $2\frac{1}{8}$ " long moves in and out of each coil. These

by the new tuning unit behind the tuning dial is approximately half that required by a two-gang variable condenser. And again, since the tuning unit already contains the antenna and oscillator coils, a further saving of space both above and below the chassis is obtained. Notice how well-spread the

iron cores are ganged and regulated by the horizontal tuning dial which, incidentally, is accurately calibrated in kilocycles. The tuning range of this set is similar to that of any standard-type receiver using variable condensers—550 to 1,500 kilocycles.

Tubes used are a 12A8-GT as a pentagrid converter; a 6S7 as an I. F. amplifier tube; a 12SQ7 as double-diode detector, AVC, and first audio amplifier tube; a 35L6-GT as power pentode tube capable of an output of $1\frac{1}{2}$ watts without overloading, and a 50Z7-G as a half-wave rectifier tube. The heaters of all these tubes are connected in series with a total voltage of approximately 117 volts, making a series heater resistor unnecessary.

Permeability tuning, as this new method is called, makes it possible to save space as the space taken up

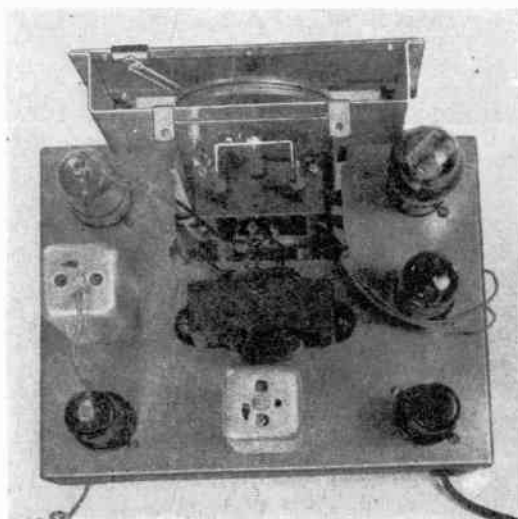

Top and bottom views of the chassis show how "permeability tuning" saves space, eliminates crowding, and simplifies wiring of the circuit

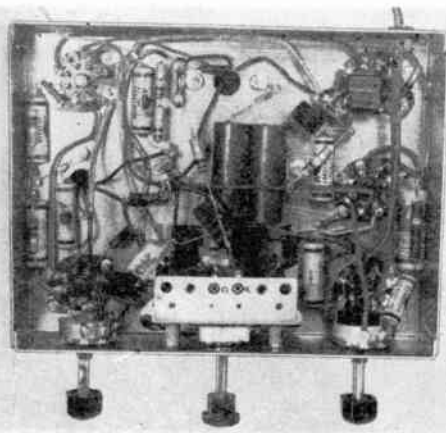

different components are above the chassis—no crowding and bunching. The same holds true for the underside portion of the chassis. It makes the set extremely simple to build and wire.

The war may make it difficult to obtain the exact tube type shown in the parts list. To give the reader as wide a choice as possible, we have given, on the wiring diagram, alternative tube types. The final results will be the same, as the set will operate satisfactorily with any of the tube types listed. The socket connections in most cases will be different. For instance, the 50Y6-GT rectifier tube has its heater brought out to pins Nos. 7 and 2 instead

Alternative tube types given in the wiring diagram below may be substituted if those first listed are unobtainable

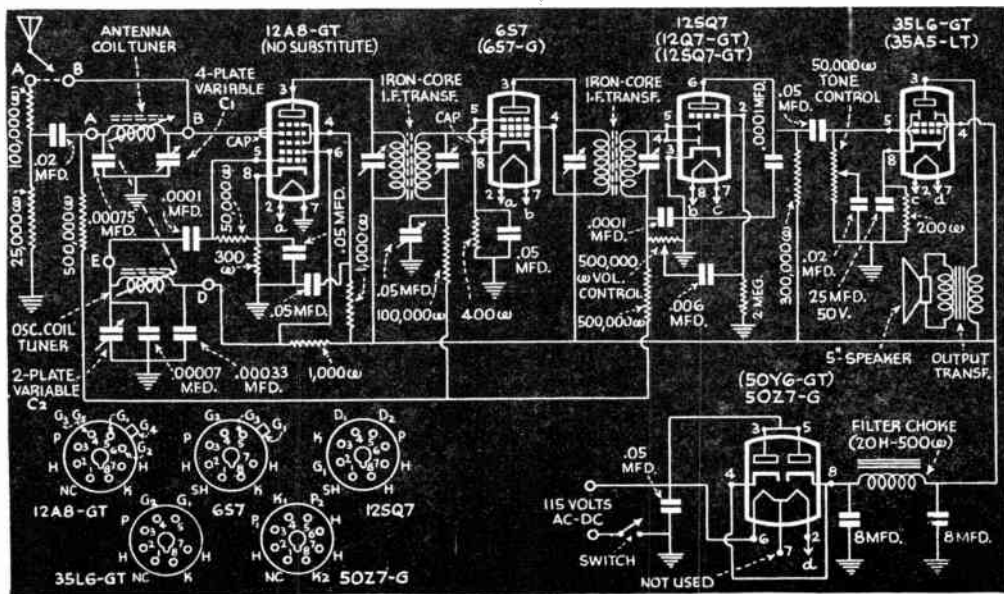
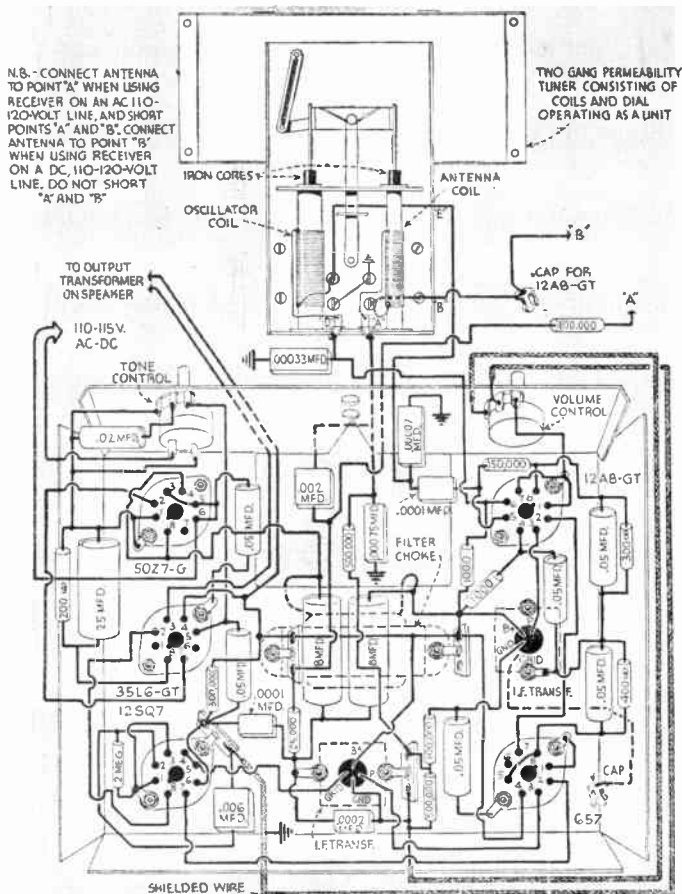

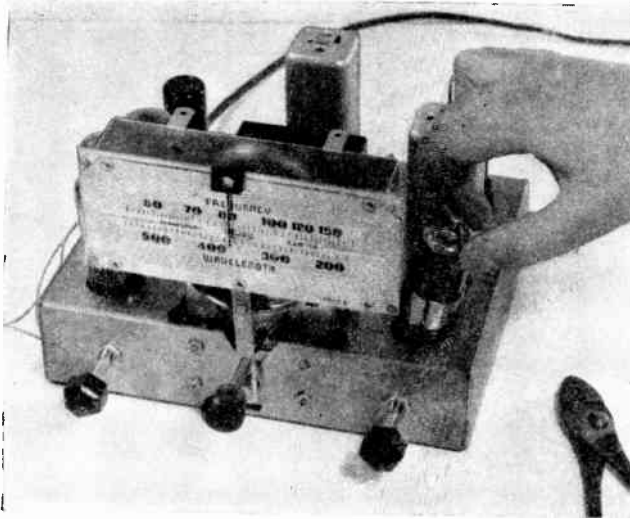

The horizontal slide-rule dial is calibrated in kilocycles. Tube being put into its socket in photo is the 12A8-GT

Tuning is easy. Left-hand knob turns set on and off and controls the tone. Right-hand knob is volume control



of Nos. 6 and 2 as in the case of the 50Z7-GT. If the 35A5-LT is purchased, be sure to buy a "loctal" socket for it instead of an "octal" socket.

Volume is controlled by the 1/2-megohm (500,000-ohm) variable resistor. Tone is controlled by a 50,000-ohm variable resistor and .02 mfd. tubular paper condenser connected in the grid circuit of the 35L6-GT. This arrangement provides an excellent method for artificially boosting the bass notes. It also helps in reducing static by decreasing the value of the high notes.

In order to make the mahogany cabinet as compact as possible, the 5" permanent-magnet speaker is mounted on top of the cabinet directly over the center of the chassis, facing upwards. It is a good idea to have the lid of the cabinet removable; otherwise it will be impossible to slide the chassis in and out of the cabinet unless the speaker is first removed, since the dial will not clear it. Of course the height of the cabinet could be increased, but this was not found as practical a method, as it would tend to unbalance the general appearance of the cabinet.

It will be noted that two holes are drilled in the front of the chassis just below the center of the tuning dial. These are for adjusting the two trimmer condensers of the tuning unit.

In setting the tuning dial, it should be borne in mind that with the cores of the antenna and oscillator windings moved all the way out, the set is tuned to the 1,550-kilocycle end of the dial.

Cabinet cover, below, serves as a baffle for the 5" P.M. speaker. The back is left open for ventilation



LIST OF PARTS

- Permeability tuning unit (with trimmers C₁ and C₂).
- P. M. speaker 5".
- Universal output transformer.
- Iron-core I.F. transformers, 456 kc. (two).
- Filter choke, 20 henrys, 500 ohms.
- Line cord and plug, 9'
- Volume control, 500,000 ohms.
- Tone control and switch, 50,000 ohms.
- Cadmium-plated chassis, 2" by 7" by 9".
- Octal tube sockets (five).
- Paper tubular condensers: .05 mfd., 400 volt (six); .02 mfd., 400 volt.
- Mica condensers: .0001 mfd. (three); .00033 mfd.; .00075 mfd.; .00007 mfd.; .002 mfd.; .006 mfd.
- Electrolytic condensers: 8 mfd. 450 v. (two); 25 mfd., 50 v.
- Carbon resistors: 1/2 watt, 500,000 ohms (two); 1/2 watt, 300,000 ohms; 1/2 watt, 2 megohms; 1/2 watt, 100,000 ohms (two); 1/2 watt, 50,000 ohms; 1/2 watt, 1,000 ohms (two); 1/2 watt, 20,000 ohms; 1/2 watt, 400 ohms; 1/2 watt, 300 ohms; 1 watt, 200 ohms.
- Cabinet, 8" by 8" by 10 1/4".
- Tubes: 12A8-GT, 6S7, 12SQ7, 35L6-GT, 50Z7-G.

Compact Rectifier Unit Fits Almost Any Radio Chassis

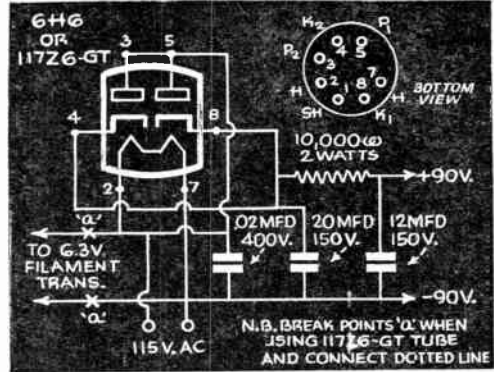
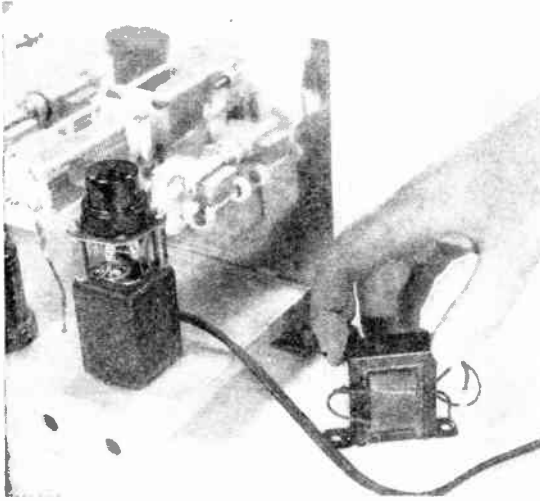

Midget rectifier (at left) mounted on a radio chassis. Filament transformer (on right) is compact and can be easily mounted under chassis. Diagram shows wiring

DRY BATTERIES are going to be increasingly difficult to obtain, and many owners of home-built or commercial one, two, and three-tube headphone receivers will have to convert theirs to operate on the electric house current. This is simple with a new rectifier unit, easily built at home and so compact that it will fit almost any radio chassis. It takes up no more room than a tube or electrolytic condenser, and yet contains a complete filtering circuit and rectifier tube! The metal box (1 1/4" by 1 1/4" by 2") is an old coil shielding can. Besides the rectifier, a compact (2 1/4" by 1 1/2") filament transformer with a 110-volt primary and a 6.3-volt secondary (1.5 amperes) is used.

The battery tubes will have to be replaced with 6.3 volt AC-DC tubes of equivalent types. Should the plate current drain be too high to use the 6H6 as a rectifier, replace it with a 117Z6-tube.

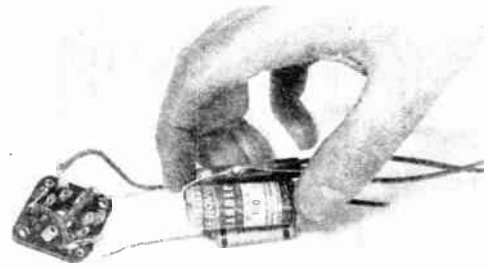

Illustrating how to make a compact "batch" of the condenser and resistor in rectifier, with connections

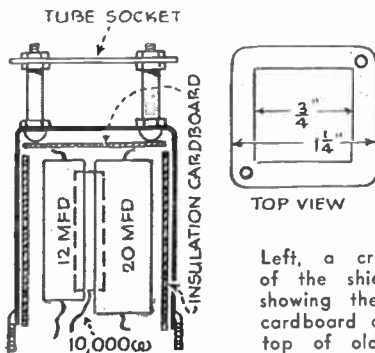
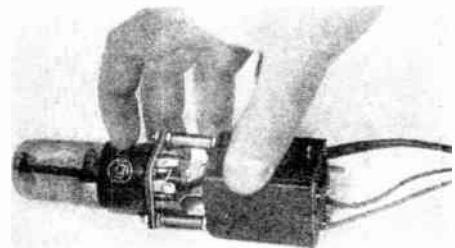

Left, a cross section of the shielding box, showing the insulation cardboard and, above, top of old coil can

Above is rectifier with a 117Z6-GT tube and 117-volt heater for direct connection to the line. Right, the bottom view of rectifier, showing posts of condensers and resistor

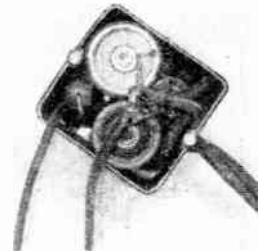

Servicing Your Radio

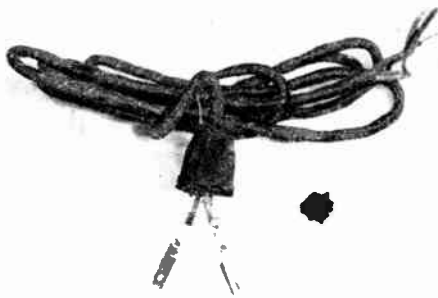

Yanking on a line cord often causes a break in the resistor wire. To avoid this, grasp the plug when removing it

LINE-CORD BREAKS, which occur most frequently in the built-in resistor in a cord of the type shown at the left, may be the reason a receiver goes dead. It is advisable to check this resistor if tests show that all the tubes are good. Sometimes it is possible to solder the thin resistor wire back to the prong, as shown in the sketch; if not, the whole line cord must be replaced.

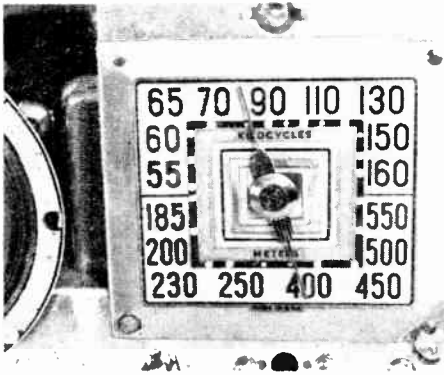
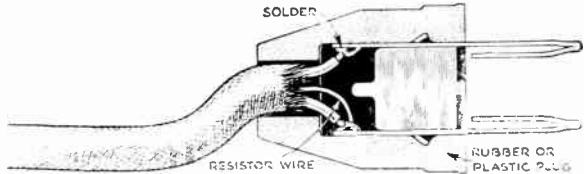

SOME TYPES OF DIAL POINTERS can be repaired easily with common liquid cement. If one cannot be set on the proper station indicator because it has come loose from the center plastic piece to which it was attached, remove the chassis from the cabinet and apply the cement as indicated in the drawing below. Best results can be obtained by removing the pointer assembly from the dial face and laying it flat, as shown. This will keep excess cement from spotting the dial face should any drip off the pointer during the application.

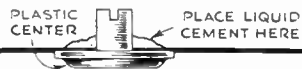

IF BATTERY OPERATION on a three-way portable is fuzzy, but reception is satisfactory on both A.C. and D.C., replacement of the battery pack is usually necessary. "B" batteries showing 75 volts on a meter have been known to have such high internal resistance that the voltage to plates and screens was reduced to as little as 35 volts.

BURNED-OUT BALLAST TUBES need not put a receiver out of service permanently even if the tubes cannot readily be replaced with new ones. Satisfactory results can be obtained by removing the old line cord from the set and substituting a new line cord having a built-in resistor of a resistance value matching the tube heaters.

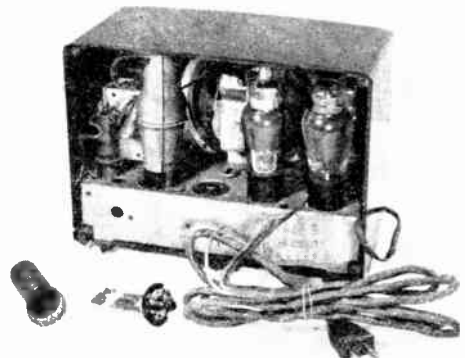
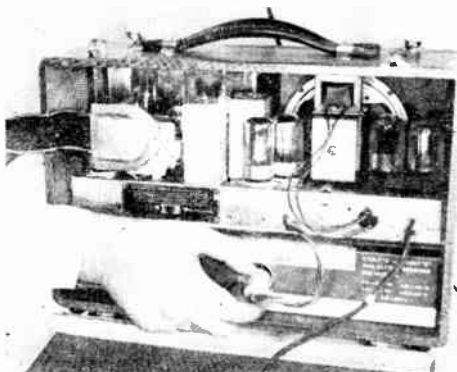

Midget Broadcast Set

USES TINY
ACORN TUBE
AND STANDARD
AC-DC TUNING
COIL

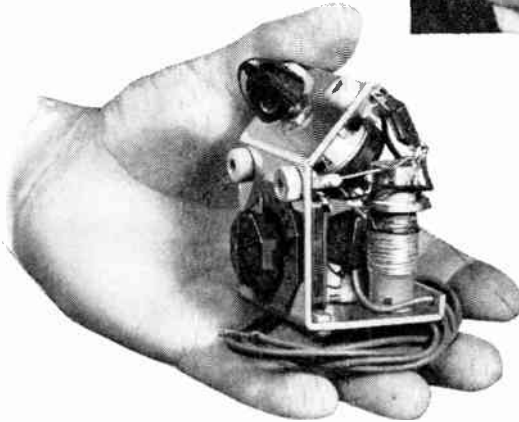

SO SMALL it fits in the palm of your hand, this little radio receiver makes use of one of the midget, acorn-type tubes. Powered by batteries, it provides good earphone reception on the broadcast band.

The tuning coil is a standard, A.C.-D.C. midget antenna coil with a high-impedance primary. Its shielding should be removed. Wind fifteen turns of No. 34, double-silk-covered wire around one end of the secondary coil (L_2), in the same direction as the coil winding, to serve as a tickler (L_3). The set is tuned by a small .00042-mfd. variable condenser. On the sloping panel of the 2" by 1 3/4" aluminum chassis, mount a midget 15,000-ohm volume control and switch. This is placed across the tickler coil (L_3), with its rotating arm bypassed to ground through a .00025-mfd. mica fixed condenser, to control regeneration. A good antenna should be used for best results, but a ground is not always necessary.

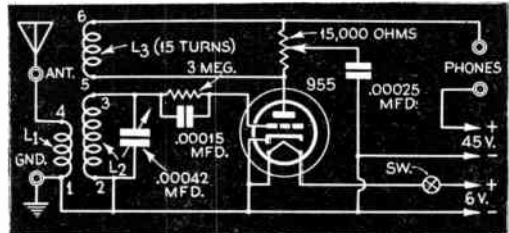
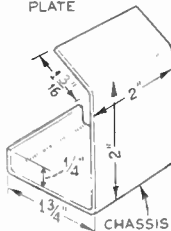
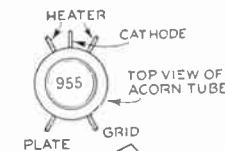
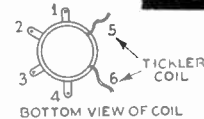
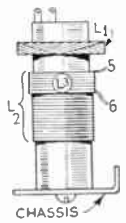

LIST OF PARTS

Volume control with switch, 15,000-ohm.

Resistor, 3 meg., 1/2 watt.

Fixed condensers, mica, .00015 and .00025 mfd.

Tuning condenser, .00042 mfd.

Four standard flash-light cells.

Midget 45-volt "B" battery.

Miscellaneous.—Aluminum chassis, acorn tube (955), A.C.-D.C. broadcast antenna coil, acorn-tube socket, knobs, dial plate, phone-tip plugs and jacks, wire, etc.

Week-Enders' Radio



Attractively finished, the portable radio shown in use above is designed to fit like a tray in the overnight case, ready to be removed and plugged into an electric outlet

Note the simplicity of controls and the airplane-luggage fabric covering. How the parts are arranged beneath the U-shaped chassis is shown in the photograph below

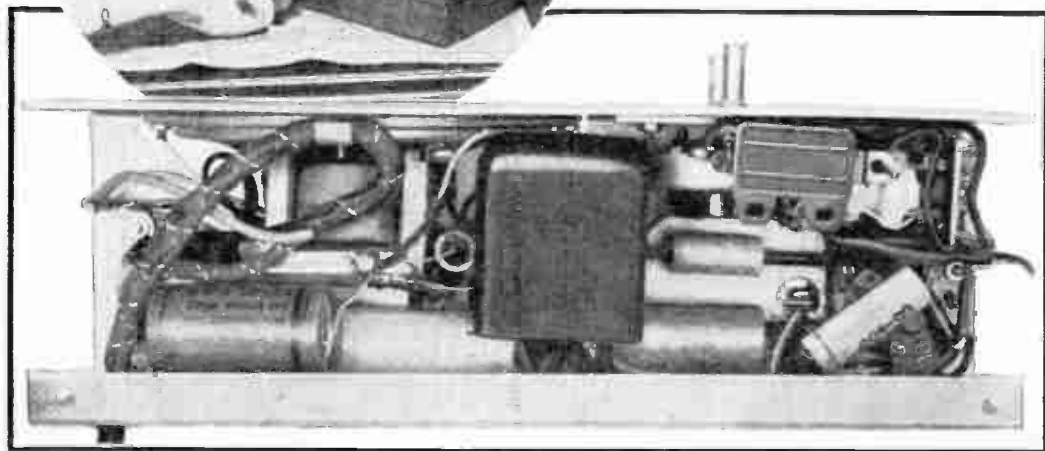

Fits in Handy Overnight Case

PROVIDING good volume and selectivity, the compact four-tube, A.C.-D.C. receiver illustrated will appeal to week-end travelers who like to take their radio entertainment with them, for it is more than just an ordinary portable set. Besides its own cabinet, it has a neat overnight luggage carrier into which it slips along with your toilet articles and the few apparel necessities for a short trip. You can build the suitcase and its radio-cabinet "tray" yourself, according to specifications on the next page, or have them made up at your local luggage shop.

Although a standard, four-tube, tuned-radio-frequency circuit is used, changes have been made to increase the set's efficiency. Iron-core coils for example, are used because of their greater selectivity and higher gain; while in the detector stage, one of the new "high-mu" triodes replaces the conventional high-frequency pentode. The triode provides better quality and can be operated to give a high signal output without distortion. For the output tube, a new beam power pentode, a 25L6, was chosen since it can be used without any added resistors or by-pass condensers, although care must be taken to use a cathode resistor of proper value.

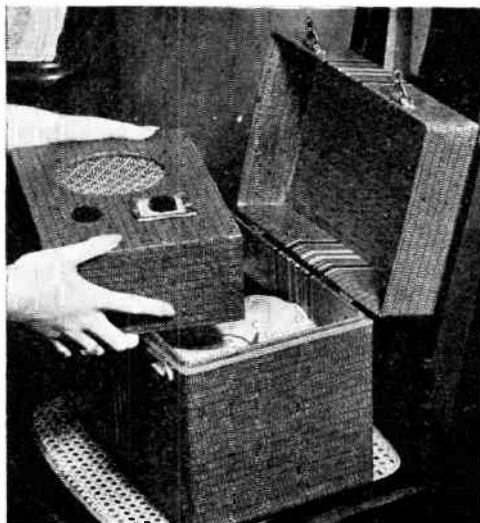

After packing the week-end bag, the receiver is set in place and the lid closed down for carrying

Instead of a filter choke, a 4,500-ohm, one-watt resistor is employed to save space and keep down the cost. To avoid overheating of the resistor, the plate current of the

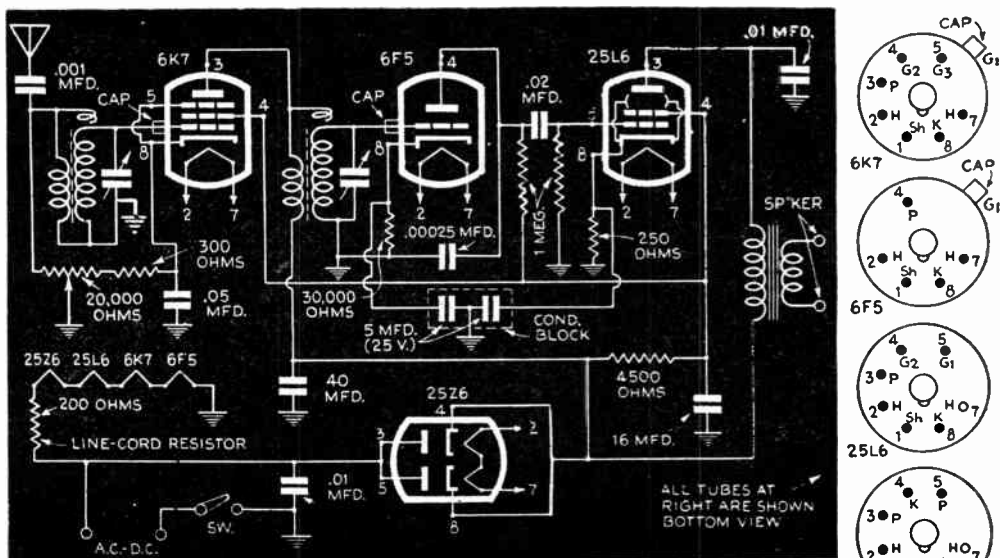

All connections for the A.C.-D.C. radio are given in this circuit diagram, while the sketches of the tube bases at right show how the tubes should be wired

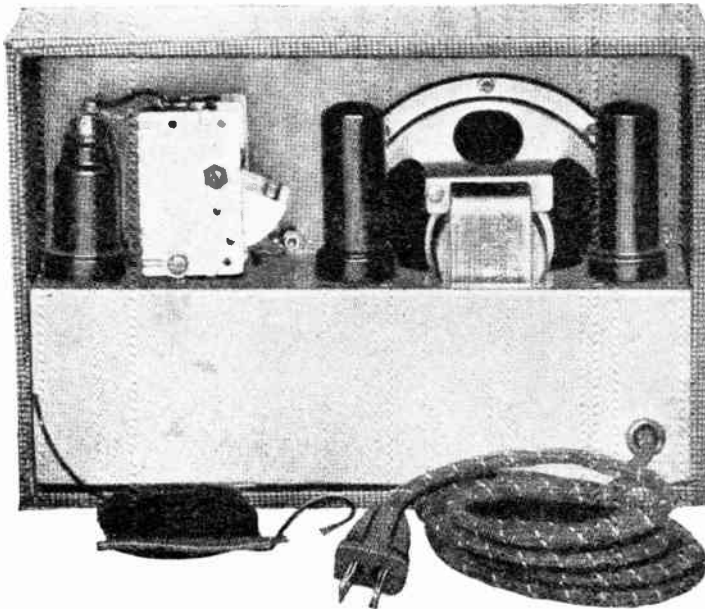

At left, parts mounted on top of the chassis, and the assembly as it fits inside the narrow cabinet. The finished set appears above, and specifications for the cabinet, case, and chassis below

25L6 tube is taken directly off the cathodes of the rectifier. To eliminate any possibility of hum due to this arrangement, a high-capacity (40-mfd.) electrolytic condenser must be used for filtering this part of the rectifier circuit.

A five-inch electrodynamic speaker was chosen instead of the usual permanent-magnet type, as the former costs less and is more sensitive to weak signals.

In laying out the chassis and cabinet, arrange the parts as shown in the illustrations so the receiver will be shallow enough to fit in the "tray." The tuning dial and knob harmonize with the color of the fabric, while brass locks and hinges were selected so that they would not rust. As the panel of the radio extends above the open suitcase, it is a simple matter to lift the set in and out.

LIST OF PARTS

Five-inch electrodynamic speaker.
 Iron-core antenna coil.
 Iron-core radio-frequency coil.
 Volume control, 20,000 ohm, with switch.
 Line-cord resistor, 200 ohm.
 Resistor, 250 ohm, 1/2 watt.
 Resistor, 300 ohm, 1/2 watt.
 Resistor, 30,000 ohm, 1/2 watt.
 Resistors (two), 1 meg., 1/2 watt.
 Resistor, 4,500 ohm, 1 watt.
 Two-gang tuning condenser, .00036 mfd.
 Mica condenser, .00025 mfd.
 Mica condenser, .001 mfd.
 Tubular electrolytic condenser, 5 and 5 mfd., 25 volt.
 Electrolytic condenser, 16 mfd., 150 volt.
 Electrolytic condenser, 40 mfd., 150 volt.
 Tubular condensers (two), .01 mfd., 200 volt.
 Tubular condenser, .02 mfd., 200 volt.
 Tubular condenser, .05 mfd., 200 volt.
 Miscellaneous:—Four octal sockets; four tubes (6K7 radio-frequency pentode, 6F5 high- μ triode, 25L6 output pentode, and 25Z6 rectifier); chassis, wire, etc.

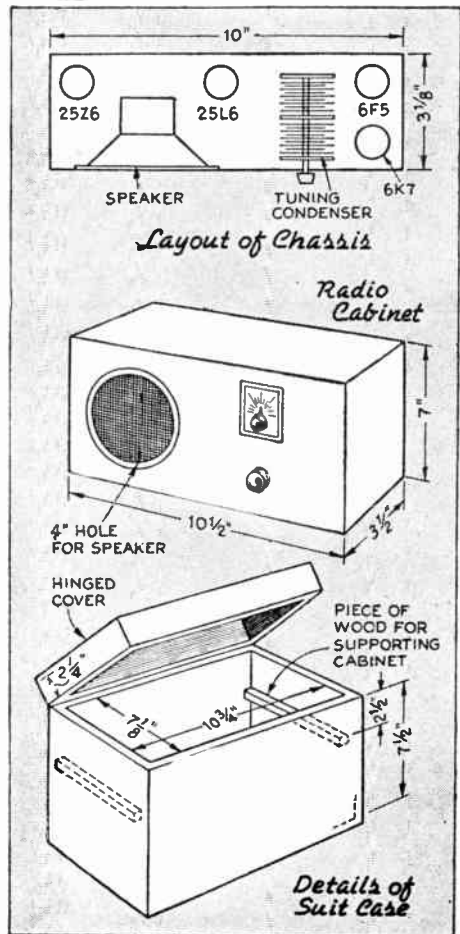

Measuring just over 5" square and less than 3" thick, this receiver and its 2" speaker cone equal the performance of much larger sets. The tiny cabinet is made of wood bound in genuine cowhide

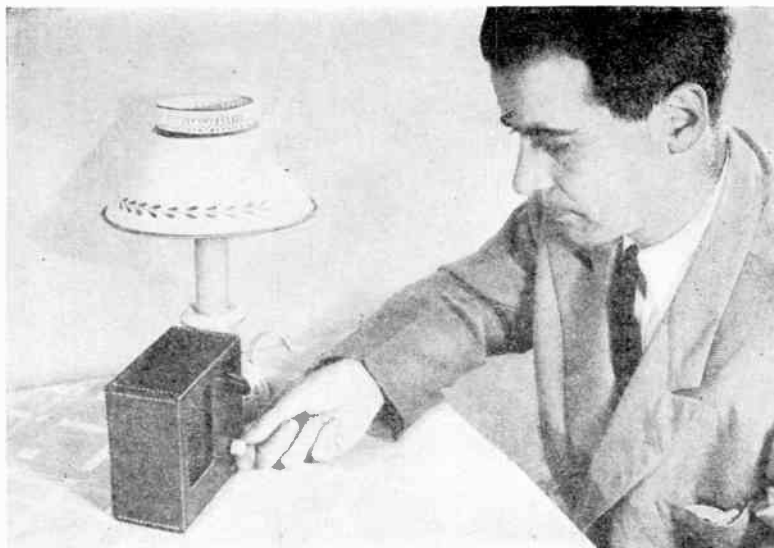

Midget AC-DC Receiver

PULLS IN LOCAL STATIONS AT FULL STRENGTH

Set Has A 50-Mile Radius

ALTHOUGH small enough to slip easily into a woman's handbag, this midget three-tube radio receiver is nevertheless capable of tuning in all local stations within a 50-mile radius at full loudspeaker strength on its tiny 2" speaker, which handles up to $\frac{1}{2}$ -watt power without distortion.

Making use of the new tiny electric tubes and iron-core coils, the set pictured on these pages was mounted on a front panel (no chassis was used) of unusual design and measuring only $4\frac{3}{4}$ " square. In the upper left-hand corner a circle $2\frac{1}{8}$ " in diameter was punched out for the speaker. Beside it, on the upper right-hand side, and mounted directly on the front panel, is a .00036-mfd,

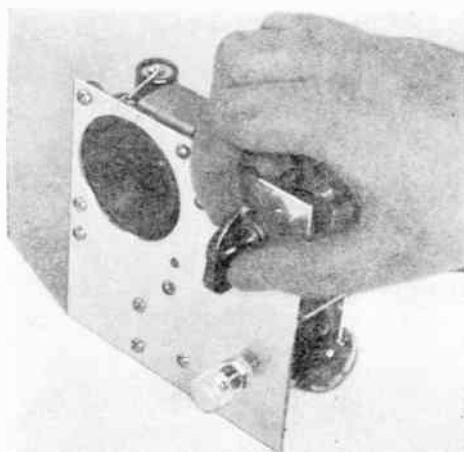

Front view of panel on which receiver is mounted

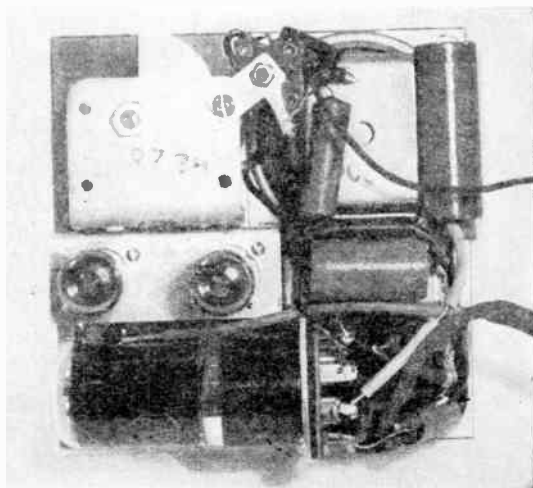

Close-up of the wiring. All parts are accessible

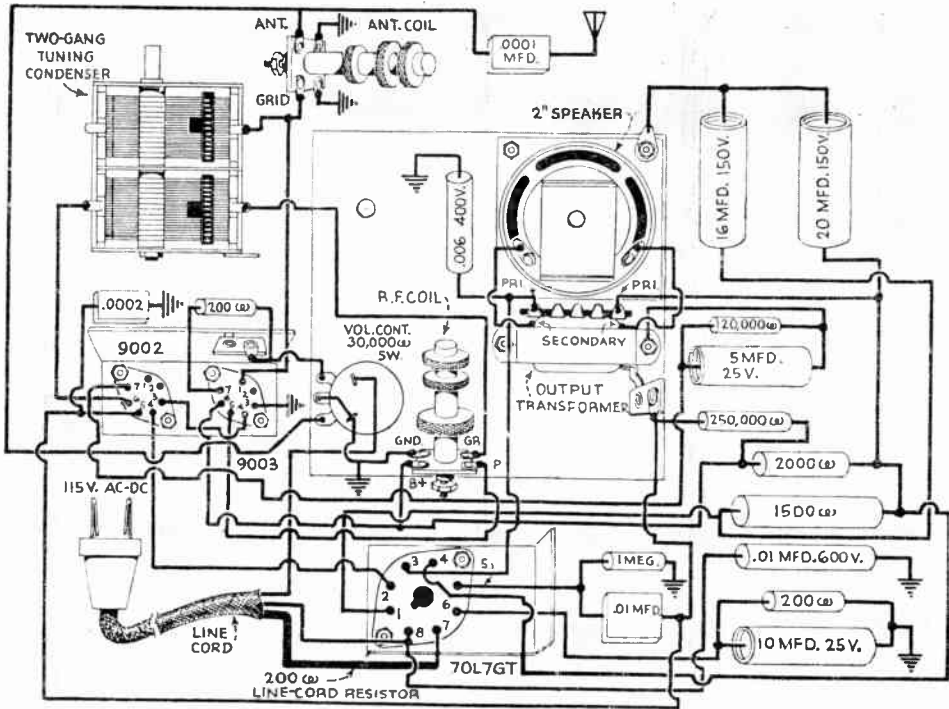

In this pictorial diagram, the compact placing of the parts of the midget receiver is shown in detail

two-gang tuning condenser. Clamped to the framework of the tuning condenser by means of two 6-32 machine screws, 1/4" long, is a small bracket on which were mounted the midget seven-prong wafer sockets for the tiny RF pentode amplifier (9003) and the high-mu detector triode (9002). Another bracket was used for mounting the standard-size eight-prong socket of the

70L7GT tube, which is a combination power pentode and half-wave rectifier. The midget output transformer, coupling the pentode portion of the 70L7GT tube to the 2" speaker, was mounted directly under the speaker.

The iron-core antenna coil was mounted on the two-gang tuning condenser just next to the speaker. The RF coil was mounted next to the bracket holding the 70L7GT tube. A 50,000-ohm variable resistor acts as a volume control and was put in place on the front panel directly under the two-gang condenser.

The four-stage TRF circuit which is used in this midget receiver consists of a tuned RF stage coupled to a biased detector stage, which in turn is resistance coupled to the beam power pentode. A half-wave rectifier furnishes plate voltage to the tubes, and this plate supply is amply filtered by the 2,000- and 1,500-ohm, 2-watt resist-

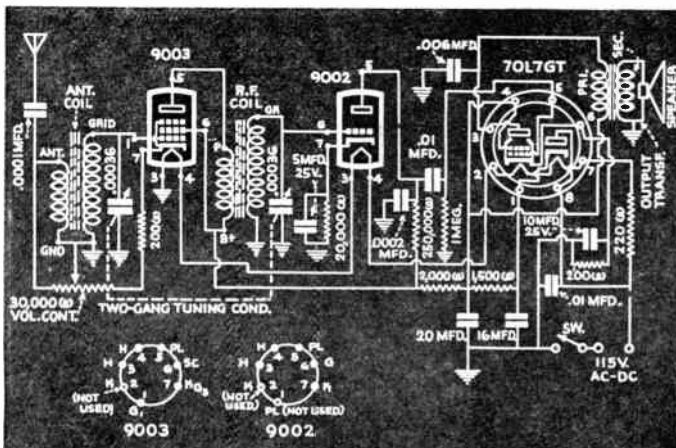

Complete wiring diagram, including base layouts (at bottom) for tubes

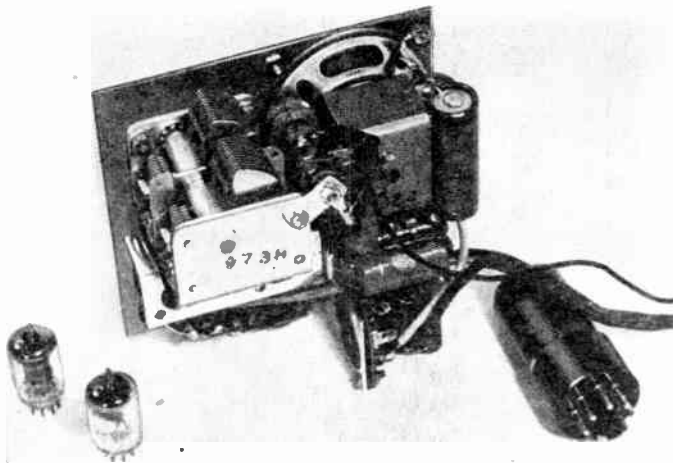

Back view of receiver, wired but with the tubes removed. The RF coil, mounted on the metal panel by means of a $\frac{3}{4}$ " angle bracket, is shown just next to the 50,000-ohm variable resistor. The 9002 midget high-mu triode tube and 9003 pentode are at left

Leather-covered cabinet from the rear. The opening at the lower left corner ventilates the three tubes and is $2\frac{1}{4}$ " square. The back cover is a piece of heavy cardboard and leather held by four screws

ors, the 20-mfd. and 16-mfd., 150-volt electrolytic condensers, and the .01-mfd. paper tubular condenser (400 volts) in the plate circuit of the rectifier.

The new midget tubes used employ mount structures similar to those of the older Acorn tubes, but the new ones have glass button bases which provide short leads and low-lead induction. Each tube employs two cathode leads which cause a reduction in input loading and provide an increased gain. The single-ended design of the new tubes has the added advantage of requiring a minimum mounting space. Although these tubes were designed primarily for use by engineers, experimenters, and amateurs working in the ultra-high frequencies, they can also be used for operation in a receiver designed for service in the regular broadcast band.

When completed, the receiver and its front-panel mounting were placed in a small wooden cabinet covered with cowhide leather stitched at the corners. The outside dimensions of the cabinet used were $5\frac{3}{16}$ " by $5\frac{3}{16}$ " by $2\frac{3}{4}$ ". A heavy piece of cardboard, also covered with leather, was used for the back cover. This cover was held in place by four small brass wood screws. An opening $2\frac{1}{4}$ " square was cut in the back cover to make allowance for the necessary ventilation of the tubes.

As this is an AC-DC receiver and therefore already grounded through the electric outlet, no further ground connection was needed. If a ground should be used it must be connected to the receiver through a .1 mfd., 400-volt tubular paper condenser, otherwise a short will occur, blowing out the tubes. Only a short antenna (about 15') is employed and may consist of stranded S.C.C. wire strung along the floor.

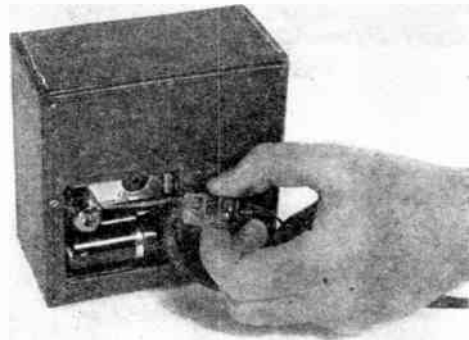

LIST OF PARTS

Cabinet, $5\frac{3}{16}$ " by $5\frac{3}{16}$ " by $2\frac{3}{4}$ ".
 Two-gang tuning condenser, .00036 mfd.
 Iron-core antenna and RF coils.
 Midget permanent-magnet 2" speaker.
 Midget output transformer.
 Midget tubes (two): Super-control pentode, 9003; high-mu triode, 9002.
 Pentode-rectifier tube, 70L7GT.
 Line cord resistor, 220 ohms.
 Variable resistor, 50,000 ohms.
 Plate cover switch, S. P. S. T.
 Electrolytic condensers (four): 20 mfd., 150 volts; 16 mfd., 150 volts; 5 mfd., 50 volts; 10 mfd., 25 volts.
 Mica condensers (three): .0001 mfd.; .0002 mfd.; .01 mfd.
 Tubular condensers (two): .006 mfd., 400 volts; .01 mfd., 600 volts.
 Carbon resistors (seven): $\frac{1}{2}$ watt, 20,000 ohms; $\frac{1}{2}$ watt, 250,000 ohms; $\frac{1}{2}$ watt, 200 ohms; $\frac{1}{2}$ watt, 1 megohm; 1 watt, 200 ohms; 2 watts, 2,000 ohms; 2 watts, 1,500 ohms.
 Midget wafer sockets: Seven prong (two), eight prong (one).

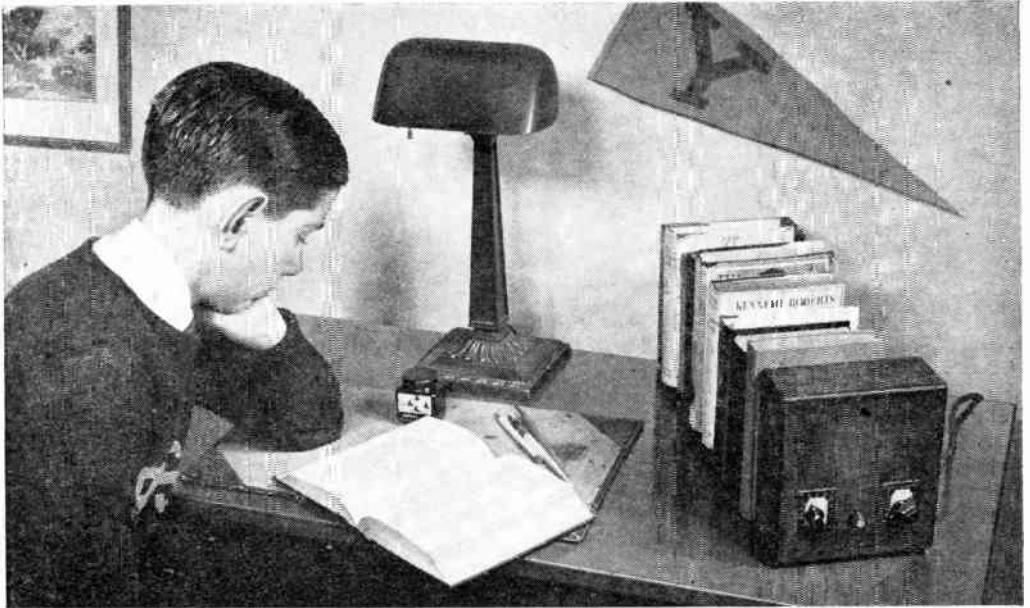

Decorative and doubly useful, the efficient radio shown above is a worth-while addition to one's desk top

COMBINING usefulness with novelty, this folding book-end radio provides something new and novel in the design of radio cabinets. It is a set that should appeal to every one who builds radio receivers as a hobby.

The circuit chosen uses four of the latest all-metal electric tubes and will operate equally well on either alternating or direct current. Although not a tuned-radio-frequency receiver, this set is just as sensitive and selective, and is cheaper to build because only one coil and one tuning condenser are needed. A regenerative detector built around one of the new radio-frequency pentodes is used in the first stage, and is resist-

BUILD THIS Book-End Radio for Your Den

ance-coupled to one of the new triodes, which is in turn resistance-coupled to a 25A6 output pentode. The fourth tube, the 25Z6, rectifies the current for the receiver, changing the al-

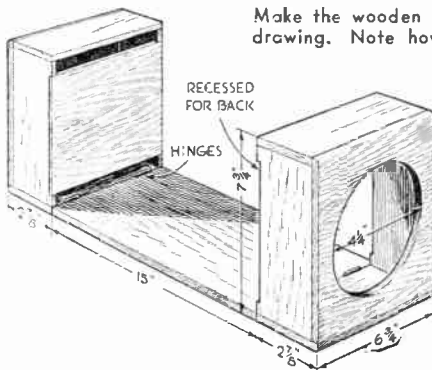

Make the wooden cabinet to dimensions in the drawing. Note how ends fold in for carrying

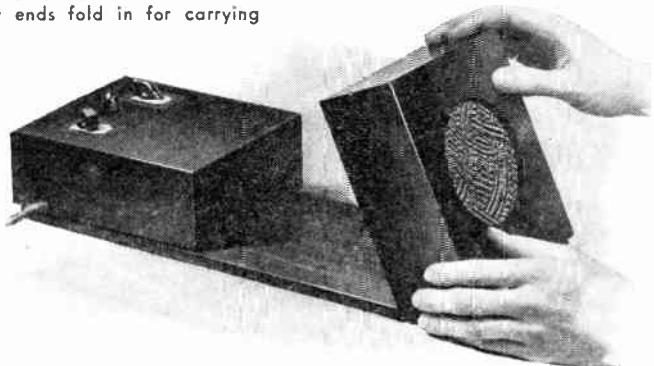

An A.C.-D.C. Four-Tube Set

ternating house current to direct. However, when plugged into a D.C. outlet, this tube merely acts as a resistance.

Regeneration is controlled by a 20,000-ohm variable resistor, which is connected across the tickler coil. The slider, or arm, of this variable resistor is grounded to the chassis through a .0005-mfd. mica condenser. A 6-mh. choke is inserted in the plate lead of the detector tube in order to keep radio-frequency currents out of the audio stages, and also to add to the smoothness of the regeneration control. The grid-lead detection, chosen because of its greater sensitivity over the usual bias method, consists of a one-meg. fixed resistor in parallel with a .00025-mfd. mica condenser.

A plug-in coil must be used with this circuit since a standard A.C.-D.C. antenna coil has no tickler winding. This coil is tuned by a .00036-mfd. single-gang variable condenser. Inserted in the ground lead of the primary winding on the coil is a new type of tuning control, which may be best described as a selectivity control. It consists of one of the new ultra-flat tuning condensers

using molded-plastic insulation, and is mounted on the front panel behind the plug-in coil, between the tuning condenser and the 20,000-ohm variable resistor.

Decreasing the capacity of this condenser increases the selectivity of the receiver. At its minimum setting, it will cut down the volume by decreasing the coupling of the primary and secondary coils. This is especially useful when tuning to a strong signal.

A .0005-mfd. and a .002-mfd. mica condenser are used in the plate leads of the first and second audio stages, and help to cut down feed-back and unwanted oscillation, which would cause distortion in the loudspeaker.

To avoid any excessive hum that might be caused by the compactness of the circuit, a

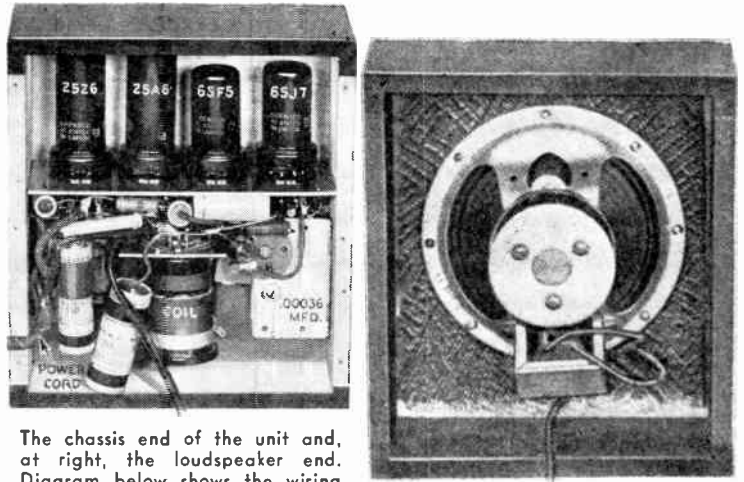

The chassis end of the unit and, at right, the loudspeaker end. Diagram below shows the wiring

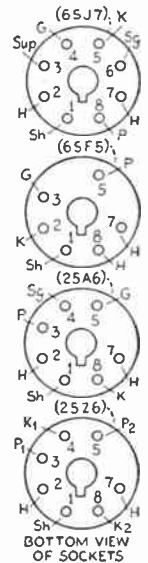
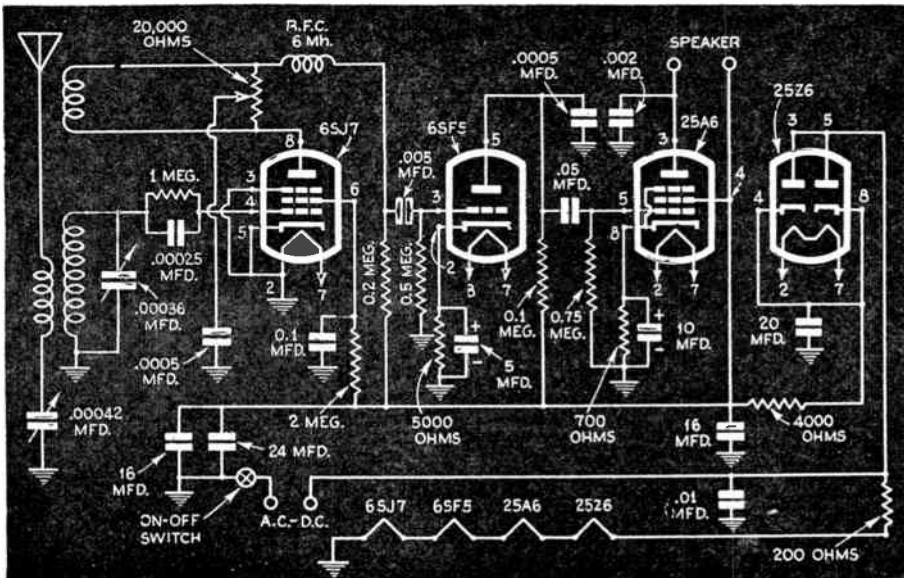

total of 76 mfd. should be used for filtering the rectified direct current. The filter circuit is made up of four electrolytic condensers, one 20 mfd., two 16 mfd., and one 24 mfd.

The cabinet is easy to build, and may be made at home from any kind of wood, such as pine, walnut, or mahogany. After careful sandpapering—with the grain, not against it—the finished cabinet can be given one or two coats of stain, depending upon how dark a finish is desired. Once these coats have thoroughly dried, a thin layer of shellac can be applied and rubbed down to kill some of the gloss. Rubber feet will raise the book ends and provide room for the speaker cord that runs from the compartment box at one end which houses the chassis to the compartment at the other end which houses the 5" permanent-magnet speaker. A built-in aerial is used so that no antenna or ground connections are needed for good reception.

LIST OF PARTS FOR BOOK-END RADIO

One 6SJ7 tube.
 One 6SF5 tube.
 One 25A6 tube.
 One 25Z6 tube.
 Antenna condenser, .00042 mfd.
 Tuning condenser, .00036 mfd.
 Electrolytic condenser, 24 mfd., 150 v.
 Electrolytic condenser, 20 mfd., 150 v.
 Two electrolytic condensers, 16 mfd., 150 v.
 Electrolytic condenser, 10 mfd., 25 v.
 Electrolytic condenser, 5 mfd., 25 v.
 Mica condenser, .0005 mfd. (two)
 Mica condenser, .00025 mfd.
 Tubular condenser, .1 mfd.
 Tubular condenser, .01 mfd.
 Tubular condenser, .005 mfd.
 Tubular condenser, .05 mfd.
 Tubular condenser, .002 mfd.
 Line-cord resistor, 200 ohm.
 Resistor, 1 meg., ½ watt.
 Resistor, 2 meg., ½ watt.
 Resistor, ½ meg., ½ watt.
 Resistor, 750,000 ohm, ½ watt.
 Resistor, 200,000 ohm, ½ watt.
 Resistor, 100,000 ohm, ½ watt.
 Resistor, 5,000 ohm, ½ watt.
 Resistor, 4,000 ohm, 1 watt.
 Resistor, 700 ohm, 1 watt.
 Switch and volume control, 20,000 ohm.
 Radio-frequency choke, 6 mh.
 Six-prong, plug-in coil.
Miscellaneous:—Speaker, four midget octal sockets, aluminum chassis, cabinet, wire, etc.

Beginner's

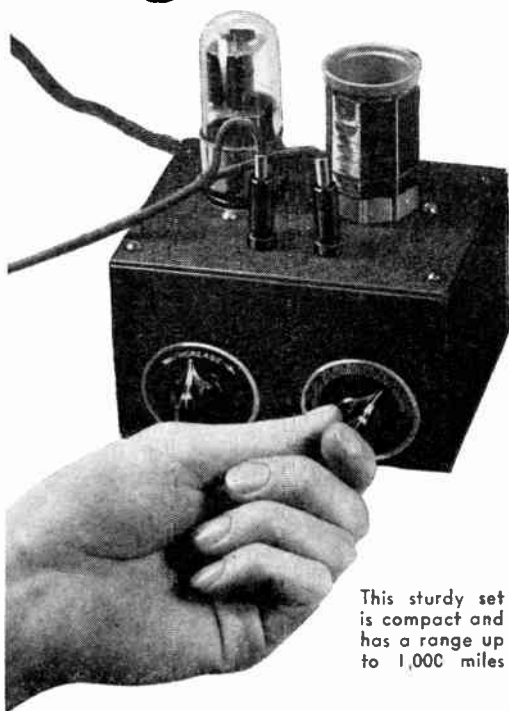

This sturdy set is compact and has a range up to 1,000 miles

WITH a broadcast-band range up to 1,000 miles, the one-tube, all-electric, A.C.-D.C. receiver illustrated is designed especially for beginners. It requires a minimum of parts, costs little to build, and is easy to assemble and wire.

The set is built around one of the new bantam-type, midget, octal-base tubes. This particular tube, the 25A7GT, is really a pentode tube and a half-wave rectifier in one. The pentode section is used as a regenerative detector.

In spite of the compactness of the steel cabinet (5" by 4" by 3"), it is an easy matter to mount and wire the parts, as the top and bottom panels can be unscrewed and taken off. The six-prong plug-in coil, the insulated earphone terminals, and the tube are all mounted on the top panel. The .00014-mfd. tuning condenser and the 15,000-ohm wire-wound combined regenerative control and switch are mounted on the front panel.

One-Tuber IS ALL-ELECTRIC

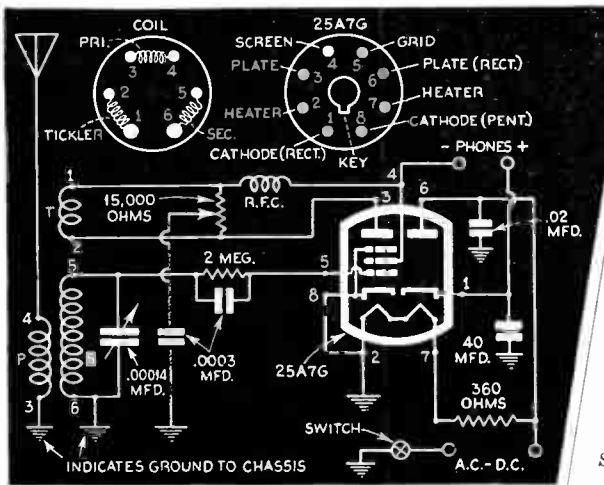

All connections are clearly shown in the diagram. Note particularly the negative phone connection to pentode-tube screen, and absence of a ground

Bottom view of the chassis, below, indicates how parts are arranged. Both top and bottom panels can be removed to facilitate the wiring

A very simple filtering system, consisting of only one high-capacity electrolytic condenser, is used. The earphones are connected in series with the cathode of the rectifier, and the reader should note that the screen of the pentode tube is connected to the negative terminal of the phones instead of the positive. No ground should be used with this receiver, as circuits of this type are grounded through the house wiring. A rubber grommet should be used to protect the line cord where it passes through the steel cabinet, otherwise the sharp metal sides of the hole may cut the insulation and cause a short circuit. Should the set hum, reverse the phone leads.

LIST OF PARTS

- One 25A7GT tube.
- Tuning condenser .00014 mfd.
- Electrolytic condenser, 40 mfd.
- Tubular condenser, .02 mfd.
- Two mica condensers, .0003 mfd.
- Switch and variable resistor, 15,000 ohm.
- Resistor, 2 meg., 1/2 watt.
- Line cord, 360 ohm.
- Radio-frequency choke, 2.5 mh.
- Set of six-prong coils.
- Miscellaneous:*—Cabinet (steel), octal-tube socket, six-prong-coil socket, two insulated banana jacks and plugs, earphones, wire, solder, etc.

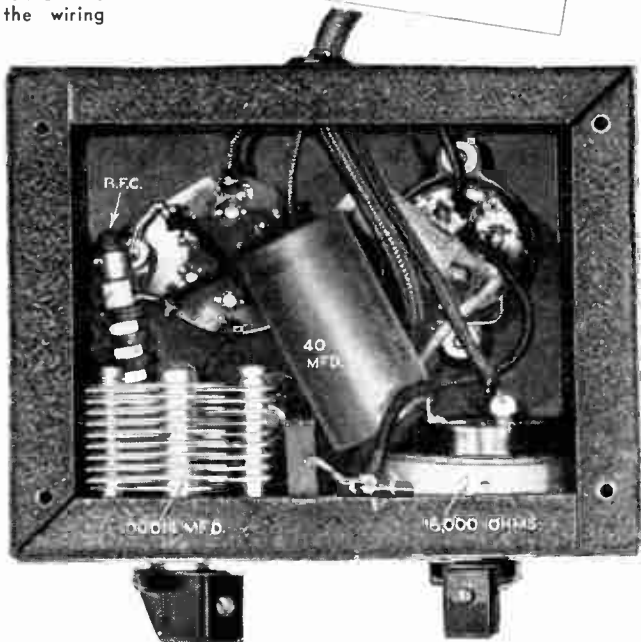

Superhet for Beginners

USES ONLY TWO TUBES

SEVERAL years ago, a superheterodyne receiver had to consist of at least seven tubes—sometimes nine, for in those days the multiple tubes we use so frequently in our present sets had not been perfected. A two-tube super is possible these days, and one of them is shown on these pages.

A 1A7GT pentagrid tube is used as the first detector and oscillator. A two-gang .00036 condenser tunes these two stages. To insure proper tracking of the oscillator tuning condenser a fixed mica condenser with a capacity of .0004 mfd. is wired in series with the oscillator coil. This condenser must be accurate within ± 3 percent.

Across the other tuning condenser (in parallel with it) is a low-capacity (.00005 mfd.) midget variable trimmer condenser. This is adjusted to compensate for any irregularities between the two tuning condensers. It is not necessary to adjust it for each station.

The output of the 1A7GT is coupled to the detector stage through a 456-kc. I.F. transformer (this may be either an iron-



This two-tube superhet gives loudspeaker reception of local stations with a 20-foot antenna laid on the floor

core or air-core type). Both primary and secondary windings of the I. F. transformer are tuned by tiny built-in trimmer condensers which have to be adjusted before the receiver will operate. This may easily be done by tuning in the strongest local signal and turning the two screws on top of the

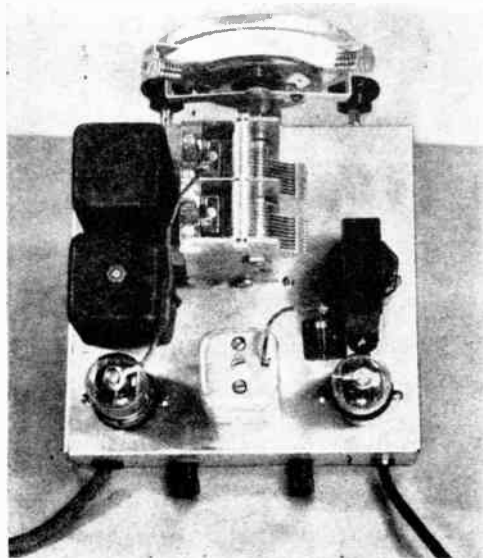

Topside of chassis, showing the two multiple tubes that do the work once performed by seven or more

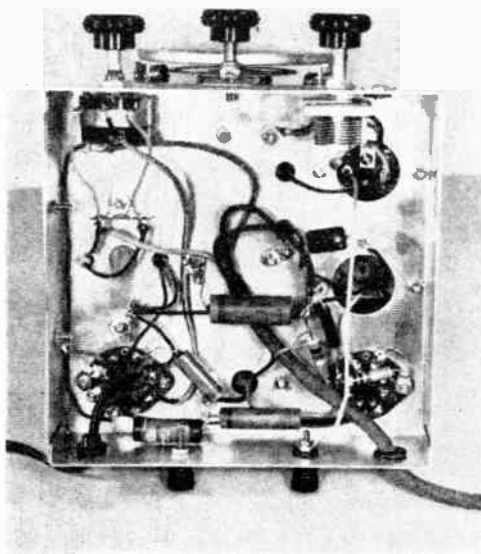

This is the underside of the chassis. The on-and-off switch is operated by the volume-control knob

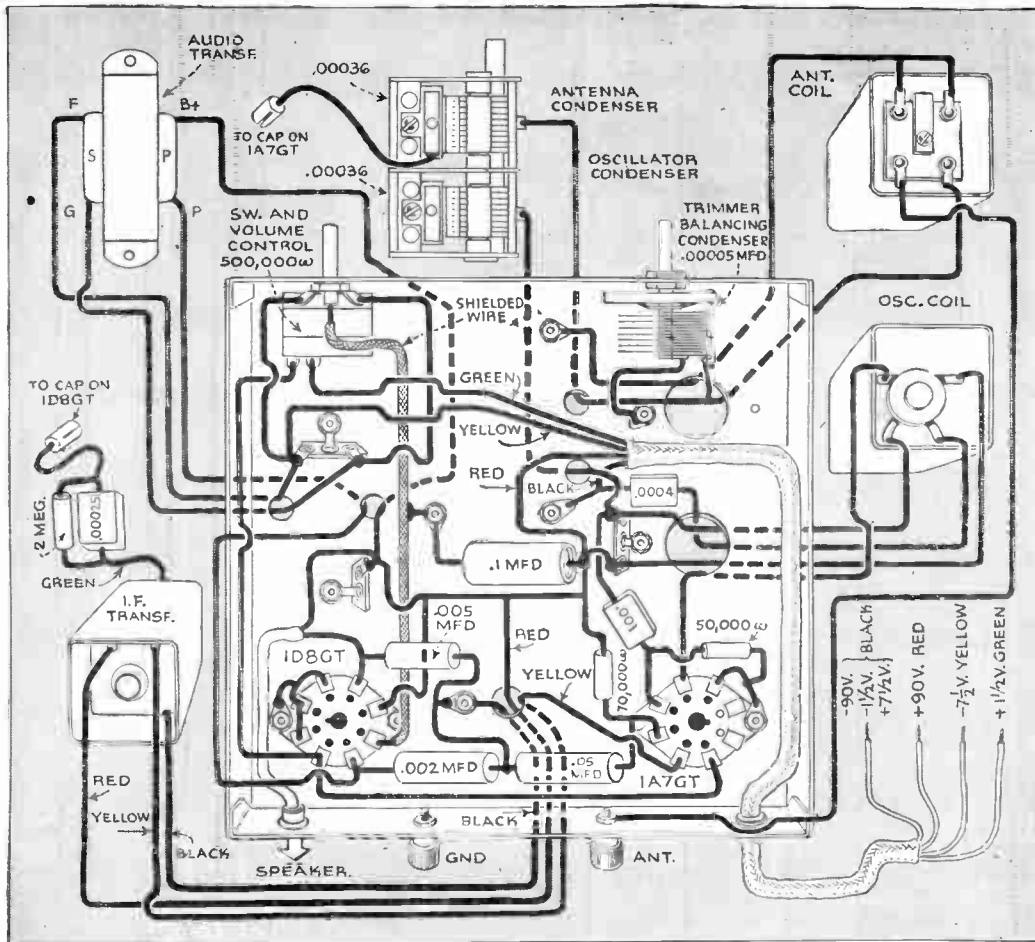

As shown in this pictorial diagram, the 1A7GT pentagrid tube is used as the first detector and oscillator, with the two-gang tuning condenser

The detector (triode portion of the 1D8GT) is transformer-coupled to the power-amplifier pentode of the same tube, as shown at the right

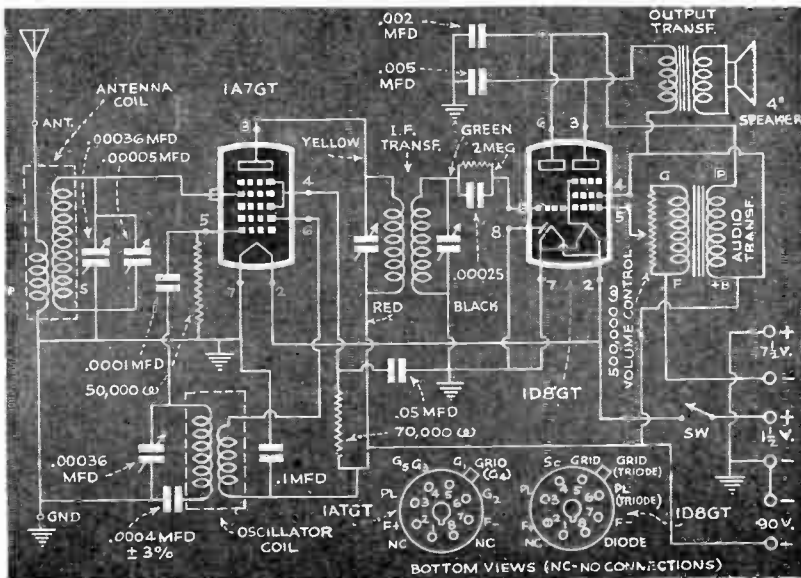

I. F. transformer can with a screw driver, until the signal is at its loudest. Then tune to a weaker station (near 1,500 kc.) and give it a final adjustment.

The detector (triode portion of the 1D8GT) is transformer-coupled to the power-amplifier pentode of the 1D8GT. Unrectified RF currents in the plate circuit of the detector stage are by-passed to the chassis through a .002-mfd., 400-volt tubular condenser. Volume is controlled by means of the 500,000-ohm variable resistor across the secondary of the audio transformer. The S.P.S.T. on-and-off switch is also controlled by the shaft of the resistor.

Output of the two-tube super is fed into a 4" or 5" permanent-magnet speaker installed in the lid of the gray-wrinkle steel cabinet. A 3¾" diameter opening must be drilled for the 4" speaker, and another opening about 4" in diameter in the front panel for the dial.

Loudspeaker reception of all local stations is possible, using an antenna of only about 20 feet, stretched across the room on the rug. No ground is necessary, although it may improve the volume on weak signals. A small trimmer condenser should be inserted in series with the antenna whenever a long antenna is used with the set.

Although 90 volts is shown in the wiring diagram as the plate or "B" battery voltage this value may be safely increased to 110 or 120 volts with a correspondingly greater signal strength. In this case the "C" battery voltage should be advanced to 9 volts.

LIST OF PARTS

Steel chassis, 7" by 7" by 2".
 Shielded iron-core antenna coil.
 Shielded air-core oscillator coil.
 Two-gang tuning condenser, .00036 mfd.
 Four-inch round dial.
 I. F. transformer, 456 kc.
 Audio transformer, 3:1 ratio, unshielded.
 Output transformer, universal type.
 PM speaker, 4" or 5".
 Steel cabinet, 8" by 12" by 8".
 Volume control, 500,000 ohms.
 Switch cover plate, S. P. S. T.
 Variable trimmer condenser, .00005 mfd.
 Pentagrid converter tube, 1A7GT.
 Triode-pentode amplifier tube, 1D8GT.
 Octal (eight-prong) wafer sockets (two).
 Mica condensers: .0001 mfd., .00025 mfd., .004 mfd. (padder).
 Tubular condensers: 1 mfd., 400 volts; .05 mfd., 400 volts; .005 mfd., 400 volts; .002 mfd., 400 volts.
 Carbon resistors: ½ watt, 50,000 ohms; ½ watt, 70,000 ohms; ½ watt, 2 megohms.
 Knobs, cable, binding posts, etc.

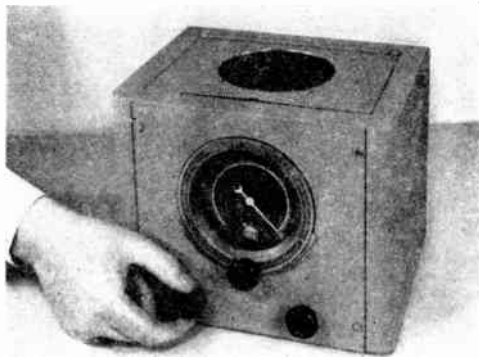

Front of the gray-wrinkle steel cabinet, showing the three control knobs and four-inch round dial

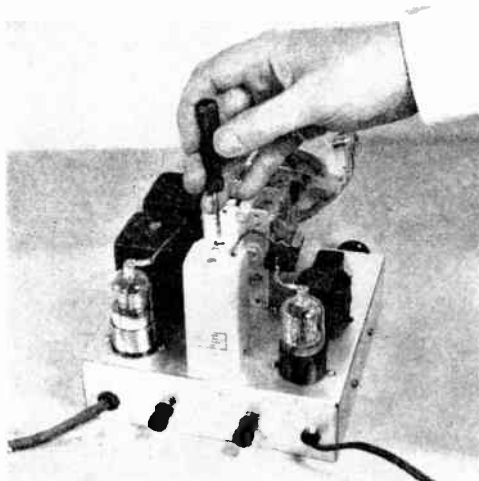

Both primary and secondary windings of the I.F. are tuned by turning the two screws on top of the transformer can until selected signals are loudest

Output is fed into a permanent-magnet loudspeaker (either four or five-inch) set in the cabinet lid

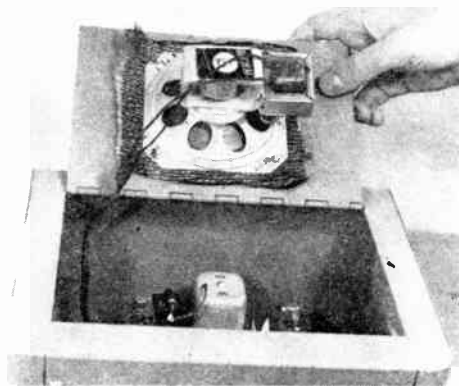

"Wireless" Radio Phonograph

REQUIRES NO CONNECTION TO SET

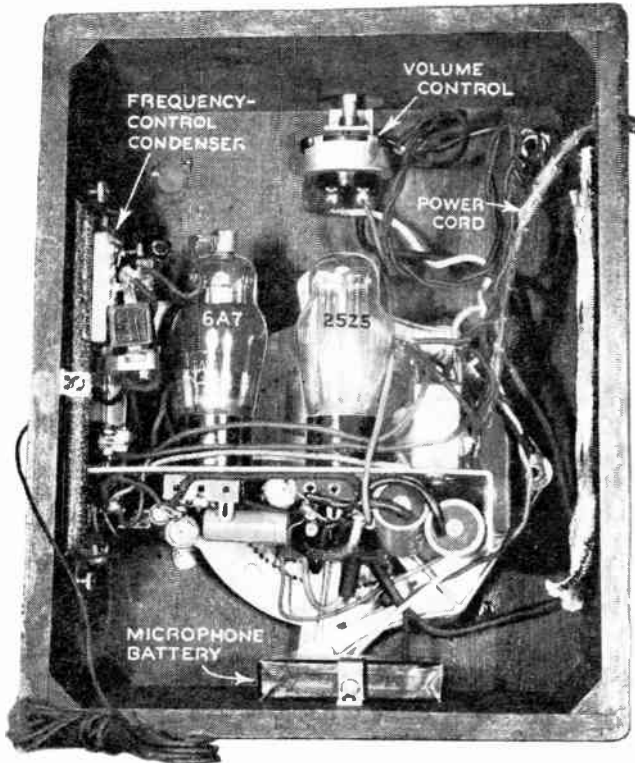

INEXPENSIVE and easy to build, this "wireless" record player may be used with any alternating-current radio receiver without making any actual connections to the receiver circuit. In addition, when you plug in a microphone and flip a switch, the record player becomes a public-address system that will allow you to do your own program announcing through the radio's loudspeaker. In use, the device is simply plugged into a convenient electric outlet.

Essentially, the "wireless" feature of the pick-up consists of a tiny radio transmitter (oscillator) tuned to a frequency around 550 kilocycles, or to any unused band at the upper end of your radio's tuning dial. The power of the little transmitter is, of course, very low, and the distance it may be placed from your receiver depends upon the radio's sensitivity. With a good superheterodyne, the phonograph can be used in an adjacent room. With less powerful receivers, it may be necessary to wrap the insulated antenna of the phonograph-transmitter loosely around the receiver's antenna lead-in, without making an electrical contact.

If the reader already has a synchronous electric turntable, and either a magnetic or crystal pick-up, he may use these with the wireless oscillator and avoid the expense of buying new ones.

The oscillator circuit is built on a compact aluminum chassis measuring 1¼" by 2½" by 6½". A black crackle panel serves as the mounting for the trimmer condenser that adjusts the tiny 550-kilocycle radio-frequency transformer, the microphone jack, and the switch for changing from pick-up to microphone.

The two tubes used are a 25Z5, as a rectifier, and a 6A7, as a combined modulator and oscillator. Two 6,000-ohm, one-watt

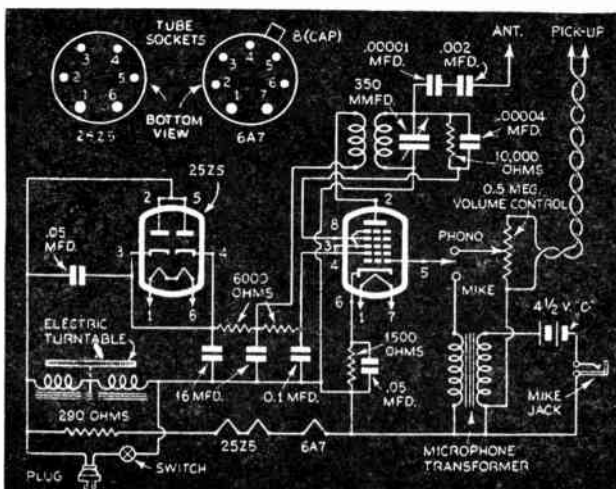

Study the wiring diagram carefully. The set is actually a two-tube transmitter. Parts are best arranged as in the photo above



Plugged into an outlet anywhere in the room with your radio, the unit "broadcasts" records through the loudspeaker.

Volume is controlled by a knob mounted near the pick-up arm. The antenna, seen leading out of the cabinet, is stretched on the floor during operation.

By flipping a switch and plugging in the microphone, you've got your own public-address system for entertaining friends. How the synchronous motor for the turntable is installed may be seen of the left

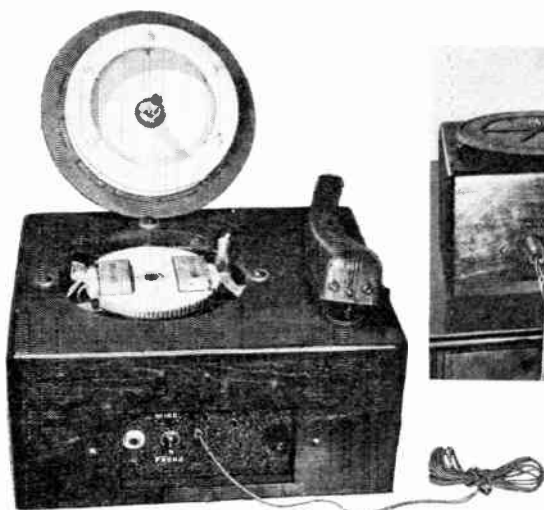

resistors, and two 16-mfd. electrolytic condensers are used for filtering the rectified current from the 25Z5.

To obtain the best results with the carbon-

type microphone recommended, a suitable transformer with a 200-ohm primary is used in conjunction with a 4½-volt "C" battery. As shown, the battery fits snugly inside the cabinet.

Care must be taken to follow the exact values of the fixed condensers and resistors specified in the wiring diagram, and under no circumstances ground any of the wiring to the chassis or panel. This is to prevent any possibility of shock should the user accidentally touch the chassis of the receiver while holding the pickup. Standard A.C.-D.C. antenna wire can be used for the aerial of the transmitter, which may be approximately twenty-five feet long. When making the wooden cabinet shown below, be sure and cut a ventilator opening in the back.

LIST OF PARTS NEEDED

- Rectifier tube, 25Z5.
- Oscillator-modulator tube, 6A7.
- Synchronous motor (2" deep).
- Magnetic or crystal pick-up.
- Radio-frequency transformer, 560 Kc. (special).
- Microphone transformer (midget).
- Hand microphone (carbon-type).
- Toggle switch.
- Midget wafer socket, six-prong.
- Midget wafer socket, seven-prong.
- Two electrolytic condensers, 16 mfd., 175 volt.
- Two tubular condensers, .05 mfd.
- Tubular condenser, .1 mfd.
- Trimmer condenser, 350 mmfd.
- Mica condenser, .00001 mfd.
- Mica condenser, .00004 mfd.
- Mica condenser, .002 mfd.
- Two resistors, 6,000 ohm, 1 watt.
- Resistor, 1,500 ohm, 1 watt.
- Resistor, 10,000 ohm, ½ watt.
- Line-cord resistor, 290 ohm.
- Volume control and switch, 500,000 ohm.
- Miscellaneous:* — Aluminum chassis, crackle panel, microphone jack and plug, A.C.-D.C. antenna, cabinet, etc.

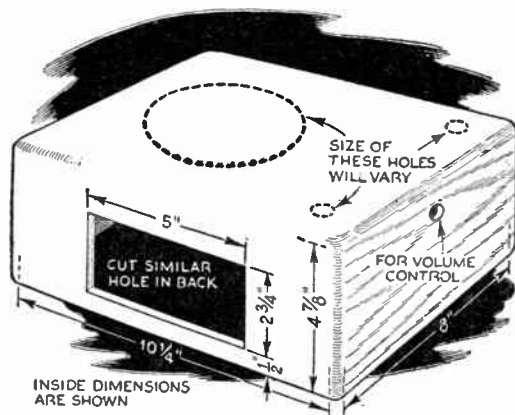

Details of the inexpensive wooden cabinet. No bottom is needed, but rubber feet should be used

Servicing Your Radio

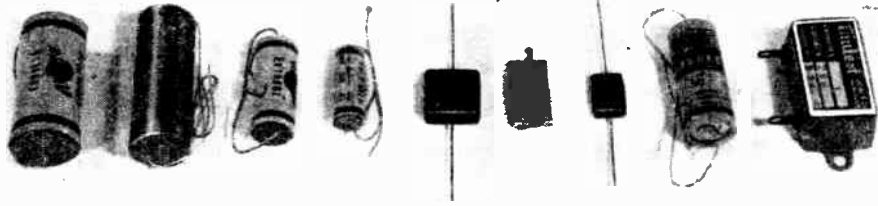

FIXED CONDENSERS. Nine types commonly used, left to right: .5-mfd. paper condenser; 8-mfd. midget electrolytic condenser; two (.05 and .02-mfd.) small paper condensers; three mica condensers (.002, .00075 and .0001-mfd.); a 50-volt, 25-mfd. electrolytic condenser; and a 1-mfd. paper condenser in a steel shell

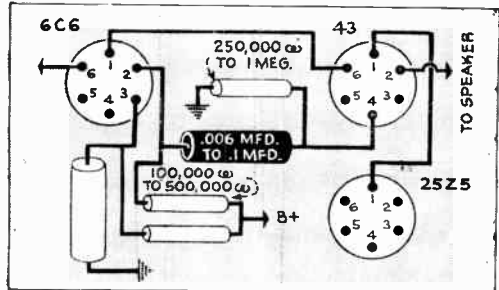
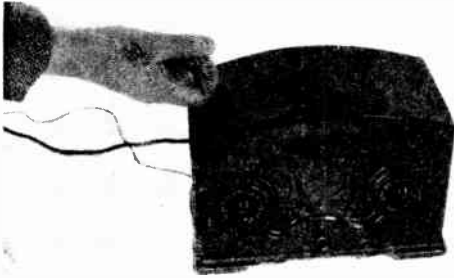

IF RECEPTION STOPS suddenly and resumes when the cabinet is knocked, the cause may be a loose connection or a bum tube. Or it may be a bad audio coupling condenser. This looks like the .05 or .02 paper tubular shown above. Diagram shows location.

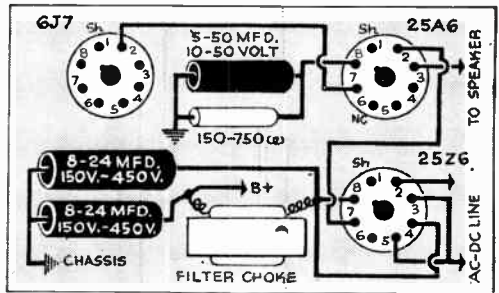
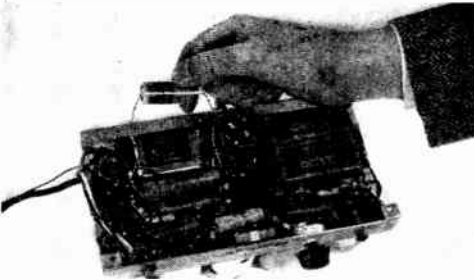

HUMMING is usually due to a faulty electrolytic condenser like the 50-volt, 25-mfd. shown above, across the power-tube bias resistor, or one like the 8-mfd., in the filter circuit. Connect an 8-mfd., 450-volt condenser across each electrolytic condenser in the set until the faulty one is found, and replace it

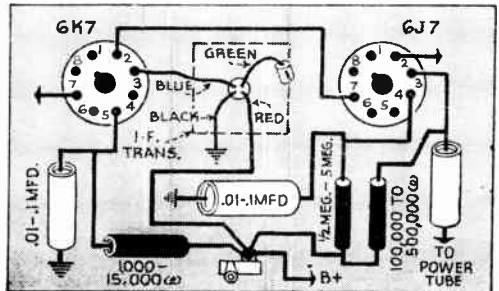
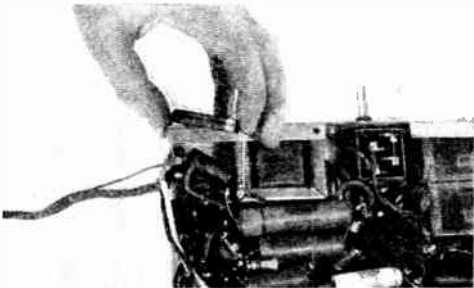

FADE-OUT experienced on many old sets is due to a fixed carbon resistor that has become crystallized. It usually can be recognized by a coating on its surface. If not, try connecting a 50,000-ohm, 2-watt resistor across each carbon resistor in the B+ circuit. If playing resumes, replace with one of correct value

Low-Cost Home Recorder



Making a record with the home recorder. It is just as easy to record radio programs, amplify weak stations, or play regular phonograph records by the simple flick of one of its switches

EXTREMELY versatile, this home recorder will enable anyone to record radio programs, to record home programs, to boost the volume on weak stations, and to play regular phonograph records.

The recording unit on top of the cabinet is very reasonably priced. It consists of a record-cutting mechanism with a concealed feed screw situated underneath the base plate, a high-impedance crystal play-back pick-up, a powerful induction-type self-starting motor, a weighted ten-inch turntable, a cutter-arm rest, a pick-up rest, and a base plate. The unit will cut records up to 10" in diameter and will play records up to 12" in diameter.

A compact three-tube amplifier is used with the home recording unit, and is installed just inside the back of the cabinet on a steel, cadmium-plated chassis measuring 2" by 7" by 7". Output from the amplifier is fed into a good-quality 5" permanent-magnet speaker mounted in the front of the cabinet. The rear of the cabinet is left open to ventilate the tubes and motor.

The amplifier proper consists of a high- μ triode, resistance-coupled to a beam power pentode. These two tubes provide all the power needed for either recording or playing records.

A 250,000-ohm variable resistor controls the volume for pick-up or microphone. The voice current for recording is tapped off the plate circuit of the audio output tube through a .1-mfd. tubular paper condenser.

Three toggle switches mounted on top of the chassis regulate the various operations of the instrument. Although an A.C.-D.C. amplifier is used, the motor will operate only on alternating current, so that the unit must not be used on direct current. For

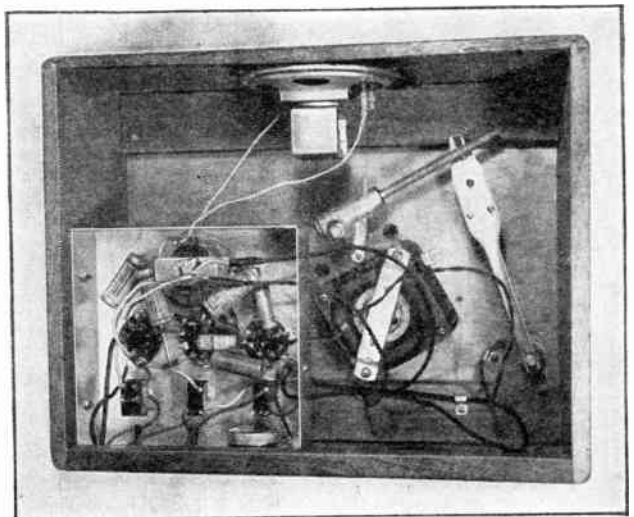

Bottom view of the finished unit, showing arrangement of parts

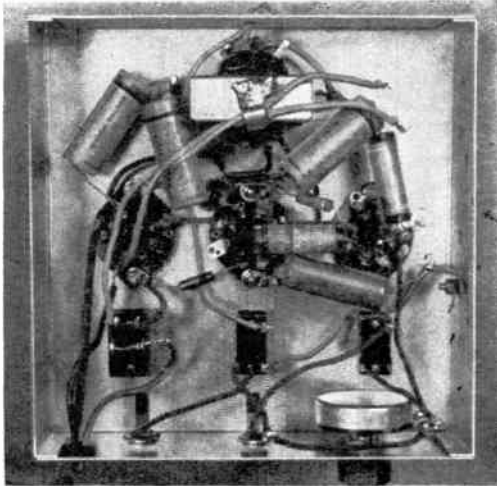
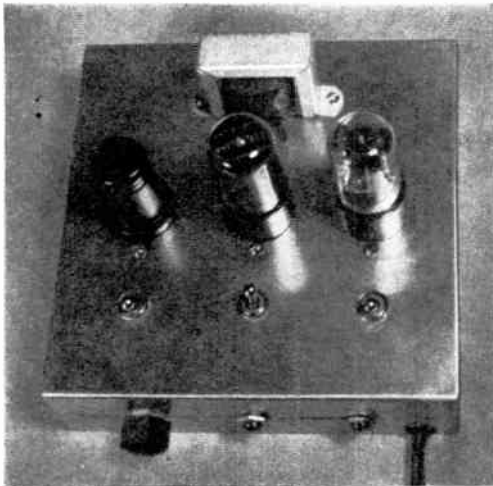

The three tubes, transformer, and control switches as they are mounted conveniently on the top of the chassis before mounting in a corner of the cabinet

All wire leads are kept as short as possible underneath the chassis. Be sure all connections are tight and arrange the parts approximately as shown here

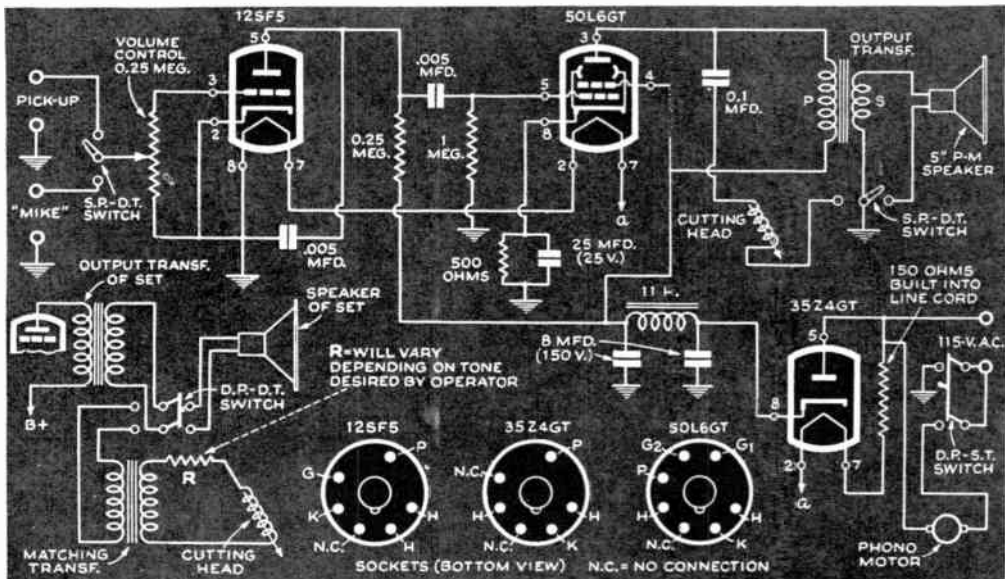

This circuit diagram will give you all the needed information for hooking up the home recording unit

LIST OF PARTS

Home recorder unit.
Cadmium-plated steel chassis.
Triode amplifier tube 12SF5.
Beam power tube 50L6GT.
Half-wave rectifier tube 35Z4GT.
Octal wafer sockets (3).
Volume control, 250,000 ohm.
D.P.S.T. toggle switch.
S.P.D.T. toggle switches (2).
Filter choke, 11 henrys.
Line cord with 150-ohm resistor.
Single-circuit jacks (2).

Permanent-magnet speaker (5").
Universal output transformer.
Electrolytic condensers (2), 8 mfd., 150 v.
Electrolytic condenser, 25 mfd., 25 v.
Tubular paper condensers (2), .005 mfd., 600 v.
Tubular paper condenser, .1 mfd., 400 v.
Carbon resistors: 500 ohm, 1 watt; 250,000 ohm, ½ watt; 1 meg., ½ watt.
Crystal microphone.
Miscellaneous: Cutting and play-back needles, wire, solder, etc.
Blank records.

CABINET-CONSTRUCTION DETAILS

Note that the back of the cabinet is left open to supply ventilation for the tubes and the phonograph-turntable motor. The recorder unit comes with its own base plate ready to be set on the top of the cabinet

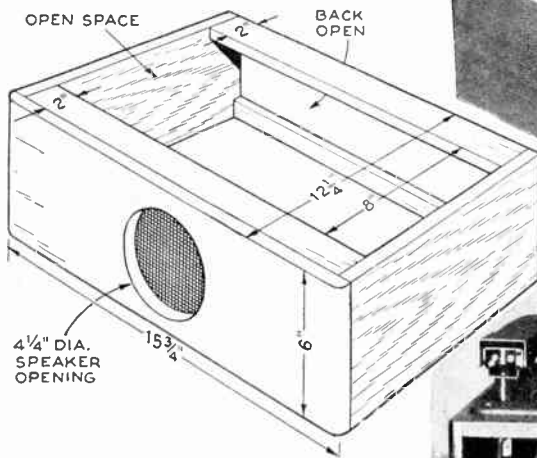

use in recording radio programs, the microphone is switched on and placed before the speaker of the radio receiver. In this manner, a permanent recording, right in one's own home, of a favorite dance tune or a historic speech can be made for preservation.

If better quality is desired in recording off the air one should connect the cutting heard directly to the output of the radio receiver through a special matching transformer.

For best results the radio must not be

played too loud, as distortion will occur on the record. The correct volume can best be found by trial and error. When this has been obtained it is a good idea to "monitor" future recordings in order to keep the volume constant. To monitor a recording, headphones are plugged in across the cutting-head circuit so that the quality and volume may be checked.

In recording a voice or home programs directly the microphone should be placed close to the source of the sound. It is advisable first to make a test through the speaker. When the results are satisfactory, switch in the cutting head and record on the blank disk.

A good crystal microphone may be obtained for about six dollars, complete with a desk stand, a 7' cable, and a spring protector for the cable at the mike.

The unit may also be used, as already stated, to boost the volume on weak stations by placing the microphone as close to the receiver's speaker as possible and using the amplifier in the home recorder to increase the volume further.



How the mike is used for recording or boosting programs

Tom Thumb Radio

FOR A MIDGET SPEAKER

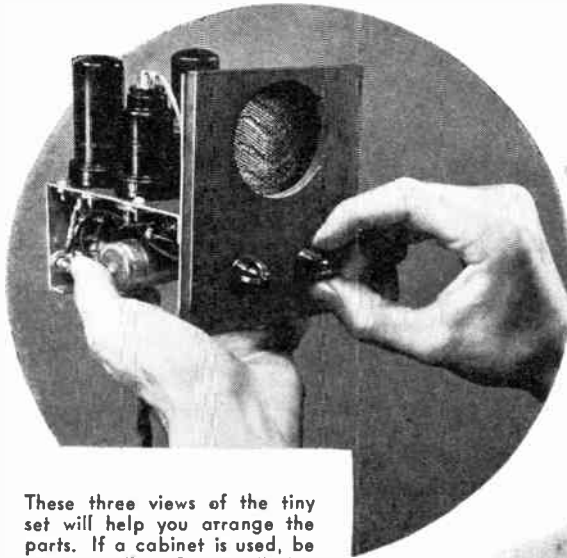

These three views of the tiny set will help you arrange the parts. If a cabinet is used, be sure to allow for ventilation

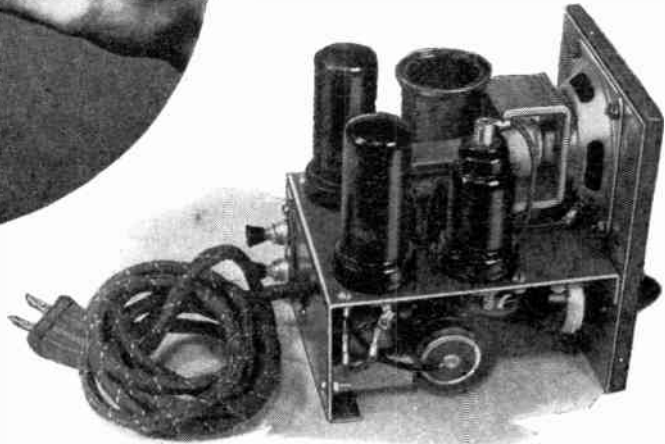
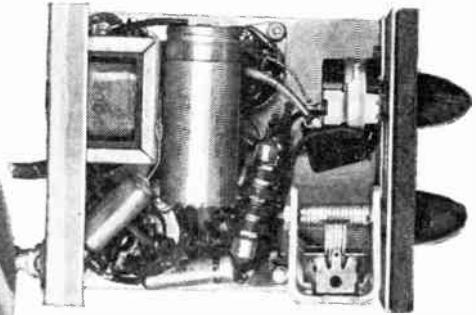

USING a new cone-type permanent-magnet speaker only 2" in diameter, this radio midget among midgets is inexpensive, easy to build, sensitive, and powerful despite its size. The broadcast-band set uses a four-prong coil consisting of a grid winding and a tickler winding (L_1 and L_2). Regeneration is obtained by a variable resistor across the tickler winding and grounded to the chassis through the .0005-mfd. fixed mica condenser. The 25-mh. choke in the plate lead of the detector (6F5) smooths re-

generation and keeps stray radio-frequency currents from the resistance-coupled audio stage. Another new item in the set is the compact 24-16-10 mfd. tubular electrolytic condenser. A 200-ohm line-cord resistor reduces the house current for the three metal tubes. A $\frac{1}{4}$ " wooden panel in front of the aluminum panel acts as a speaker baffle.

Note dimensions below for the aluminum chassis and panel. The wiring diagram gives all resistance and other values

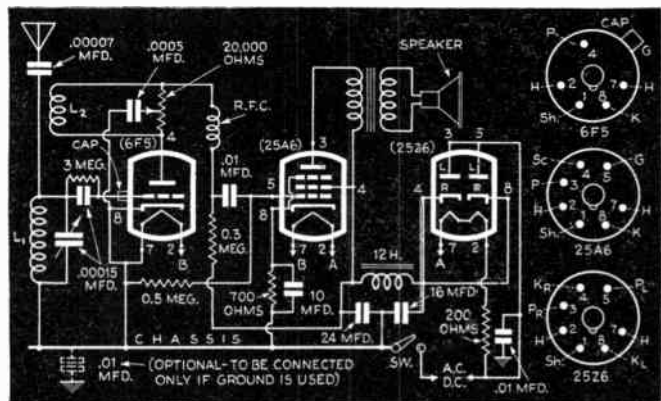
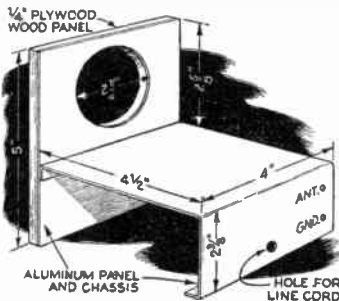



Suitcase Phonograph FOR PORTABLE RECEIVERS

You can "broadcast" a record directly from the suitcase phonograph to any portable radio

THIS SUMMER there will be thousands of battery-operated portable radios in use on beaches, in parks, and on picnics and excursions everywhere. They will range from the camera-style midget or "personal" radios to the "twenty-pounders," capable of bringing in Europe on the short-wave band.

This battery-operated "wireless" phonograph was designed for use with these portable sets. As the name implies, the unit will transmit recorded sounds to the portable, through the medium of radio waves. The radio in turn reproduces them through the loud-speaker. No connections between the phonograph and the portable are necessary.

This combination of radio and phonograph will enable you to fill the interludes between radio programs that appeal to you with recorded dance music, symphonies, or whatever you wish. The volume control will

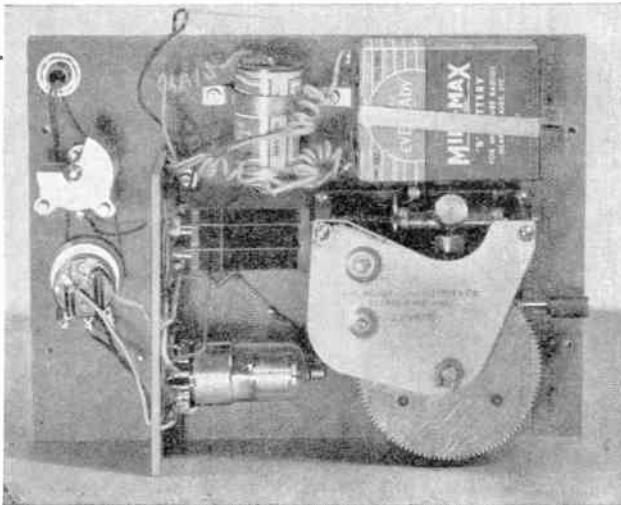

Underside of the phonograph's Masonite baseboard, showing transmitter, batteries, and turntable motor

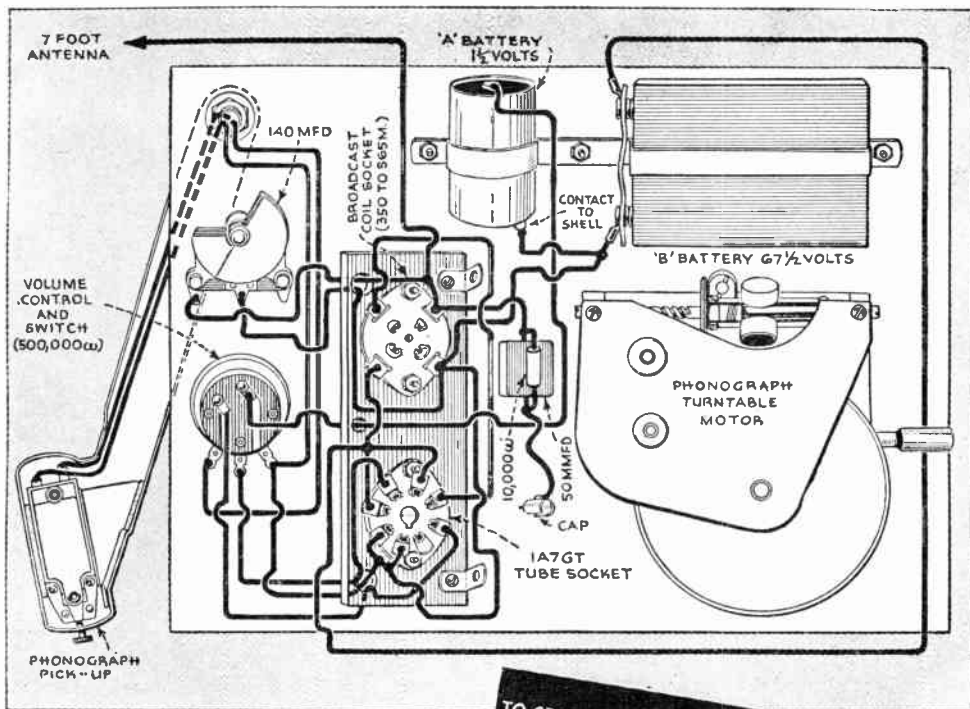

Above, sketch of the set-up of the suitcase "wireless" phonograph, as shown in photo on previous page. At right is wiring diagram

make it possible to lower the sound of your music so that it will not disturb your neighbors, or turn it up to fill a room with music for dancing.

Being light and compact (12 by 8¾ by 4¾ inches) the phonograph can be carried along as easily as a small suitcase. It is entirely self-contained and self-powered. Two small batteries (similar to those used in the personal-type radios—a 1½-volt flash-light cell and a 67½-volt "B" battery) supply all the current necessary to operate the transmitter. The power of this transmitter is so small that it will not radiate signals beyond a few feet. It is the only type of transmitter that can be operated without a license under Federal Communications Commission regulations.

The transmitter uses a 1A7GT converter tube which acts as a combined modulation and radio-frequency amplifier. The electric impulses from the phonograph pick-up are modulated by the first and second grids of the tube. In a 1A7GT, or similar tube, the second grid acts as a plate. The modulated signal is then superimposed on the carrier wave, generated by the second portion of the

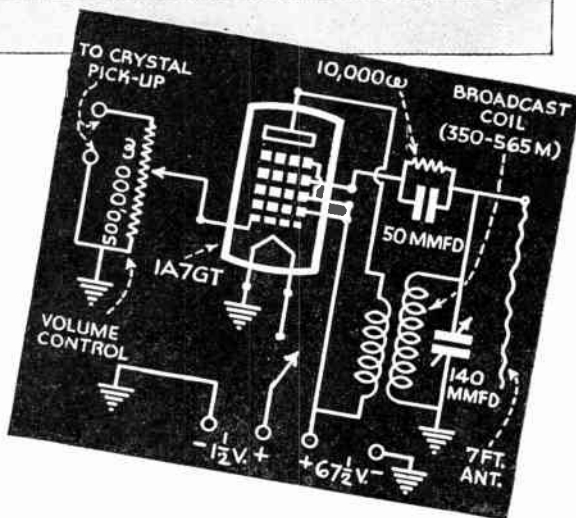

tube, and transmitted to the receiver, where it is amplified and transformed back into sound.

The transmitter is tuned by a .00014-mfd. (or 140-mmfd.) tuning condenser and a standard four-prong broadcast coil. To cut down costs, the four-prong socket for the coil and the eight-prong (or octal) socket for the tube are both wafer types, inverted so that they can be mounted on the Masonite baseboard and used instead of the more expensive molded socket.

The suitcase into which the phonograph is fitted can be purchased almost anywhere for

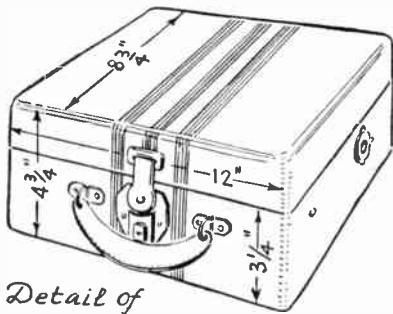

Detail of Suitcase

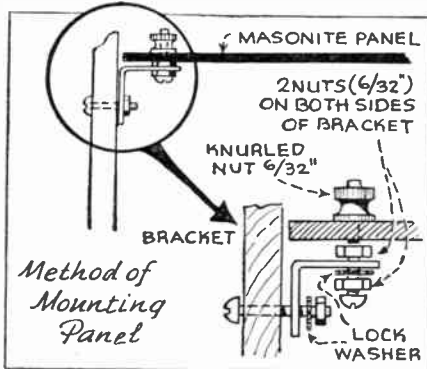

Method of Mounting Panel

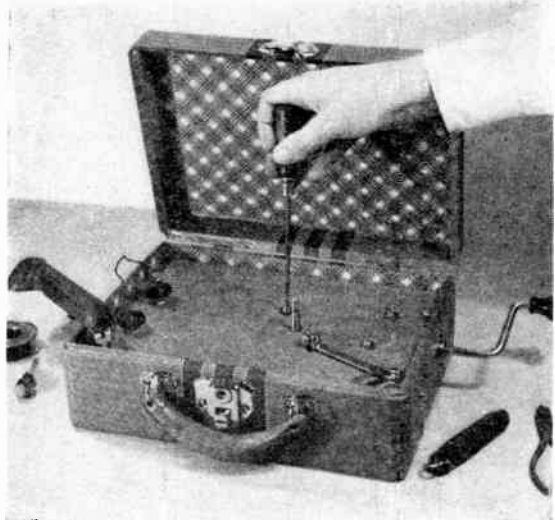

Left, detail of the suitcase, and above, a stage of mounting, before installation of the turntable



Completed phonograph seen from above, with eight-inch turntable. The seven-foot antenna is coiled

less than \$1. A spring motor can be picked up secondhand for about \$2.50, or it may be ordered direct from a manufacturer. An eight-inch or smaller turntable must be used, otherwise a larger suitcase than is shown in the accompanying illustrations will have to be purchased. A Masonite panel 11 1/4" by 8 3/4" is used for mounting the motor, pick-up, and transmitter parts. In the set shown here, the panel was left in its natural brown finish, since this blended with the brown-

striped covering of the suitcase. The two batteries are strapped to the undersides of the panel with a flexible brass band 3/8-inch wide. This will keep them from knocking about in the bottom of the case, and they may easily be replaced whenever necessary.

To operate the phonograph, place the seven-foot antenna near the back of the portable receiver (where manufacturers usually place the loop antenna). Then turn the transmitter on by means of the switch on the 500,000-ohm volume control, and tune the unit to some free spot on the receiver's dial by rotating the 140 mmfd tuning condenser. Records can then be played on the phonograph, and will be heard over the set's loudspeaker.

LIST OF PARTS

- Converter tube, 1A7GT.
- Volume control and S.P.S.T. switch, 1/2 megohm.
- Crystal pick-up.
- Four-prong broadcast coil, 350 to 565 meters.
- Tuning condenser, 140 mmfd.
- Octal and four-prong wafer sockets.
- Carbon resistor, 10,000 ohms, 1/2 watt.
- Mica condenser, 50 mmfd.
- Seven-foot antenna.
- Small, brown-striped suitcase.
- Masonite panel, 11 1/4" by 8 3/4".
- Midget "B" battery, 67 1/2 volts.
- Standard flashlight cell, 1 1/2 volts.
- Spring-wound motor with 8" turntable.

TWO-TUBE PORTABLE

A COMPANION FOR A
SUITCASE PHONOGRAPH



As a receiver, the set brings in local stations with good volume

DESIGNED as a companion piece to the suitcase phonograph shown on page 120, this battery-operated portable will provide many hours of radio entertainment in your home, at parties, or on summer trips and picnics. Though it has only two tubes, it has sufficient power to bring in all local stations. When used with the phonograph, which it matches in size and appearance, it will give you your choice of recorded music or broadcast programs anywhere and at any time.

The suitcase in which the set is built can be purchased at almost any five-and-ten-

cent store for 50 or 60 cents, and should measure 12" by 9" by 4½". If you made the suitcase phonograph, you will probably wish to get a second suitcase with a similar exterior finish.

The two-tube chassis of the set, the four-inch speaker, and the batteries are fitted in the lower half of the suitcase, while the 9½" loop antenna is placed inside the lid and fastened with two ½"-long 6/32" machine screws.

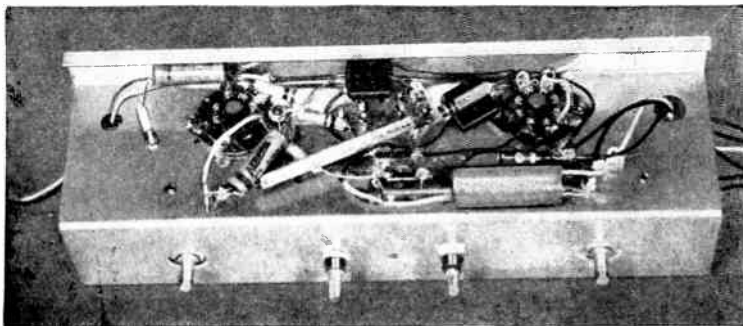
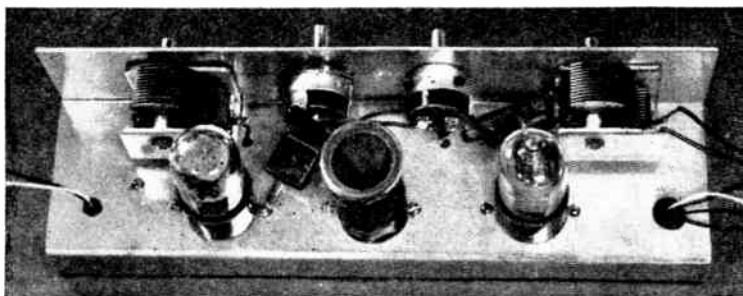

The upper picture at the left shows top view of the chassis with tubes and controls in place. Separate tuning condensers were found to be better than a gonged condenser. Lower photo shows the arrangement of ports underneath the chassis

Connections to the loop are made with two Fahnestock clips mounted on the lower inside edge of the lid. To hide the loop antenna, the author covered it with a 10" by 8" sheet of stiff paper.

The metal chassis and speaker are mounted on a wooden panel measuring $\frac{1}{4}$ " by $8\frac{1}{2}$ " by $11\frac{1}{4}$ ". The panel has a $3\frac{3}{4}$ " diameter hole drilled near the top for the speaker, which is decorated with a bronze escutcheon plate.

The set uses a three-tube tuned-radio-frequency circuit, built around the two tubes—a 3A8GT (diode-triode-pentode) and a 1Q5GT (beam-power output tube). The 3A8GT is used for the tuned radio-frequency stage and the regenerative detector. The diode portion of the tube is not used and is wired directly to the chassis.

Separate tuning condensers were found to be better than a ganged condenser, as

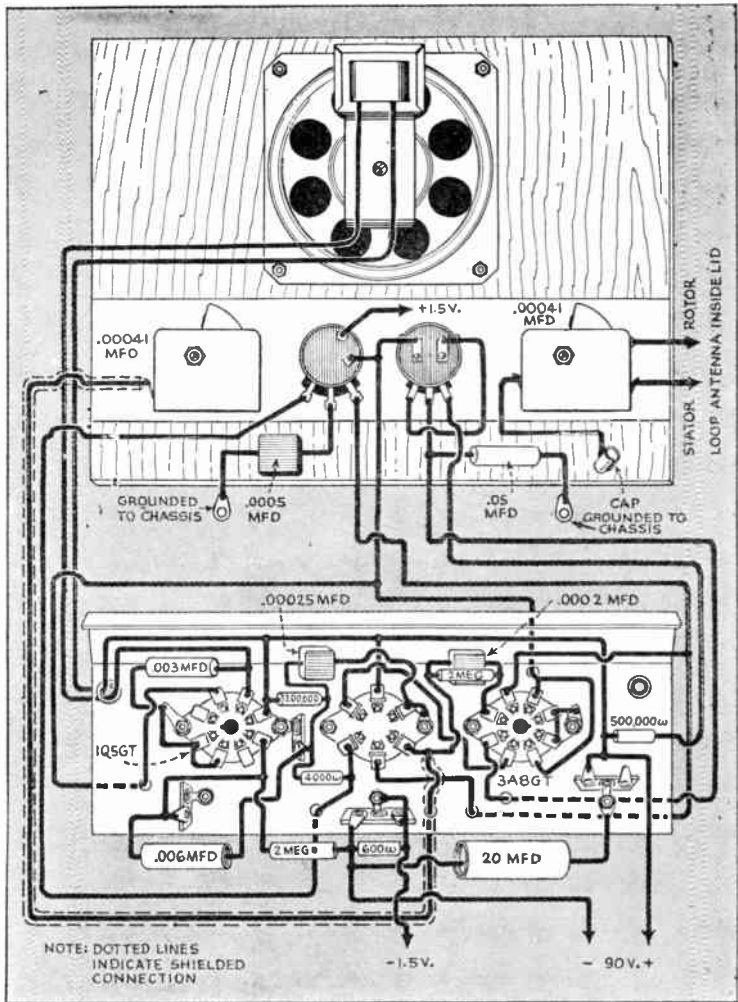

Complete wiring details for the circuit are given in this picture diagram

... and the schematic drawing below. Bios for the receiver is automatic

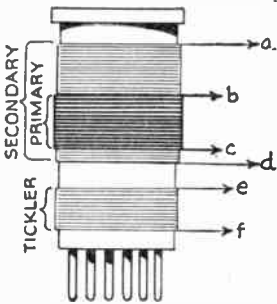

How the six-prong plug-in coil is wound. Below are tube-socket connections

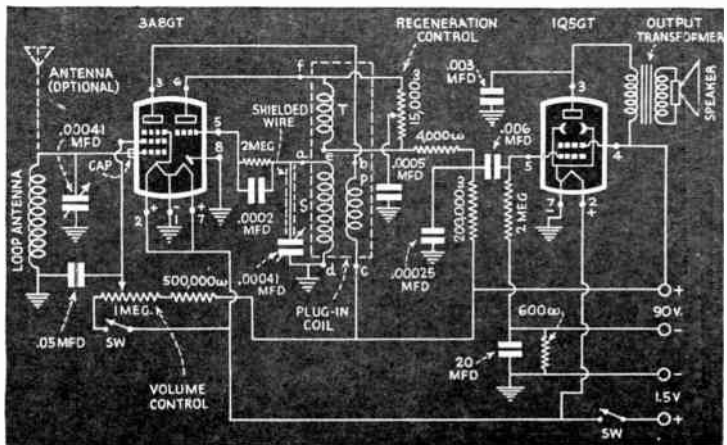
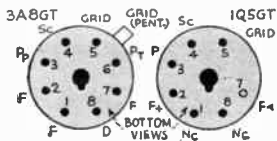

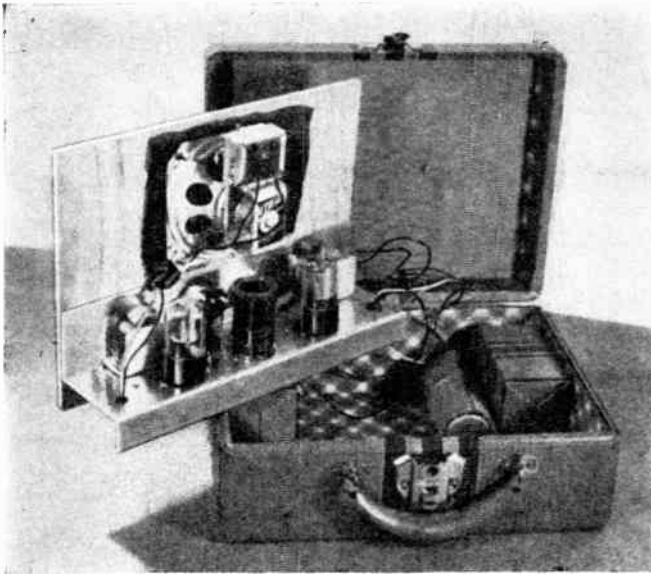

Metal chassis and speaker, mounted on a wooden panel, fit into the lower half of the suitcase along with the set's batteries

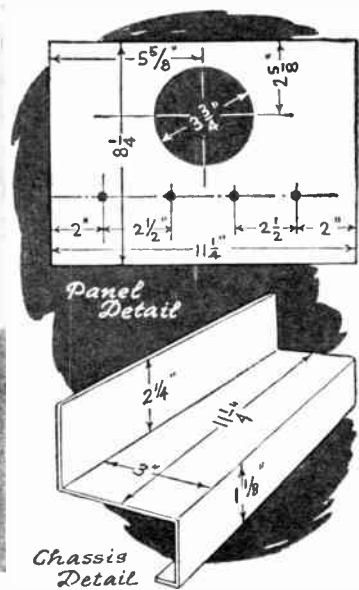

Panel and chassis details. Panel has a 3/4" hole for the speaker

they enable the receiver to operate at its best.

Single-pole, single-throw switches are mounted on the back of both the volume and regeneration controls. The one on the regeneration control turns the receiver on and off, while that on the 1-megohm volume control disconnects the grounded side.

Bias for the receiver is automatic and is supplied through the 600-ohm, 1/2-watt resistor and the 20-mfd. electrolytic by-pass condenser in the "B-" and "A-" circuits.

If more volume is desired from the set, the "B" power supply can be increased from

90 to 135 volts. Or a short length of antenna wire (about 10 feet can be connected to the grid side of the loop antenna.

LIST OF PARTS

- Loop antenna, 9 1/2" by 7 1/2".
- Suitcase.
- Tuning condensers, .00041 mfd.
- Three-inch tuning dials (two).
- Four-inch PM speaker.
- Universal output transformer.
- Six-prong plug-in coil.
- Six-prong wafer socket.
- Volume control, 1 megohm.
- Regeneration control, 15,000 ohms.
- S. P. S. T. attachable switches (two).
- Diode-triode-pentode tube, 3A8GT.
- Beam-power output tube, 1Q5GT.
- Octal wafer sockets (two).
- Carbon resistors (two), 2 megohm, 1/2 watt.
- Carbon resistor, 1/2 megohm, 1/2 watt.
- Carbon resistor, 200,000 ohms, 1/2 watt.
- Carbon resistor, 4,000 ohms, 1/2 watt.
- Carbon resistor, 600 ohms, 1/2 watt.
- Electrolytic condenser, 20 mfd., 150 volts.
- Paper tubular condenser, .05 mfd., 400 volts.
- Paper tubular condenser, .006 mfd., 400 volts.
- Paper tubular condenser, .003 mfd., 400 volts.
- Mica condenser, .0005 mfd.
- Mica condensers, .00025 mfd., .0002 mfd.
- Midget 1.5 volt "A" battery.
- Midget 45-volt "B" batteries (two).



The 9 1/2" by 7 1/2" loop antenna goes inside the lid of the case and can be concealed by paper if desired

Library-Table Radio



MAKING an attractive decoration for the library table, this book radio will appeal to all builders who prefer housing their receivers in some unusual type of cabinet. It can be easily assembled and built at home by any beginner, and the entire set, including the cabinet, should cost less than ten dollars.

The cabinet for the receiver was made from the wooden covers removed from a large scrapbook which cost less than a dollar at a local department store. The covers serve as the bottom and hinged top of the cabinet, while the sides were built up, as shown in the drawings, from matching wood. A jigsawed decoration on the cover, left intact, adds to the attractiveness of the cabinet.

Putting the finishing touches on the chassis of the extremely compact "scrapbook" radio

Notice the shield separating the two tubes, with its soldered connection to the metal frame of the permanent-magnet speaker

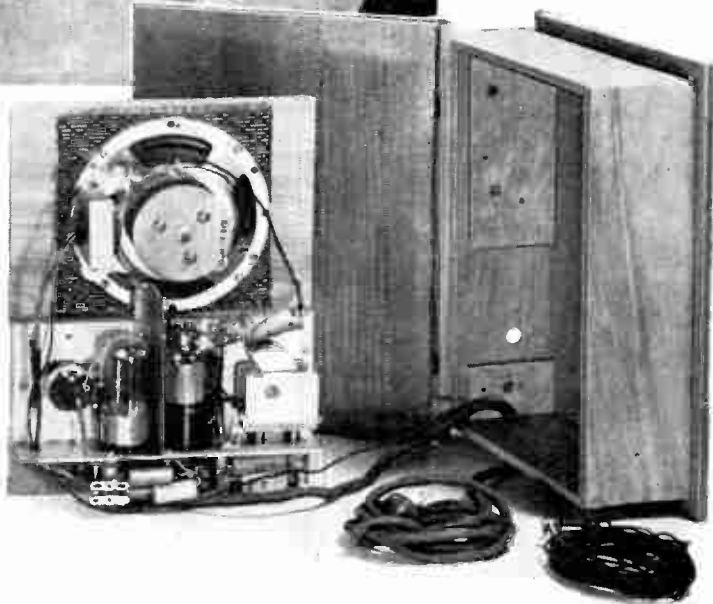

Resembles a Book

The circuit, which appears to use only two tubes, has in reality plenty of punch behind it, since the two tubes do the work of four. The first tube (12B8GT) contains a high-frequency pentode and a high-mu triode. The high-frequency pentode is used as a regenerative detector which is resistance-coupled to the triode. The triode is in turn resistance-coupled to a pentode element in the second tube. This second tube (25A7GT) contains, besides the output pentode, a half-wave rectifier. A 260-ohm line cord reduces the house current to the voltage required by the heaters of the two tubes.

For the sake of compactness, a small A.C.-D.C. antenna coil is used. As the coil has no tickler winding, the reader will have to add one himself. This can be done easily by winding approximately thirty-five turns of double-silk-covered wire around the bottom portion of the grid coil. If tests show too little volume, re-

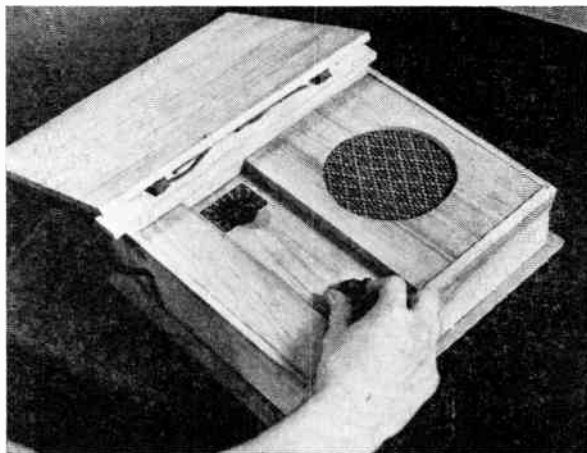

The booklike radio in use, showing its recessed control knobs

verse the connections to this tickler winding.

A five-inch permanent-magnet speaker is used, with its cone facing upwards. Choose a speaker whose depth does not exceed $2\frac{3}{8}$ ", otherwise the cabinet will have to be made deeper.

The reader will notice that a shield is used between the two tubes. This is necessary as the feed-back coupling between these tubes would cause a terrific hum. Arrange the shield so that its top portion almost touches the frame of the speaker and make a soldered



When the cover is shut, the set makes an ornamental piece to put on the library-table top

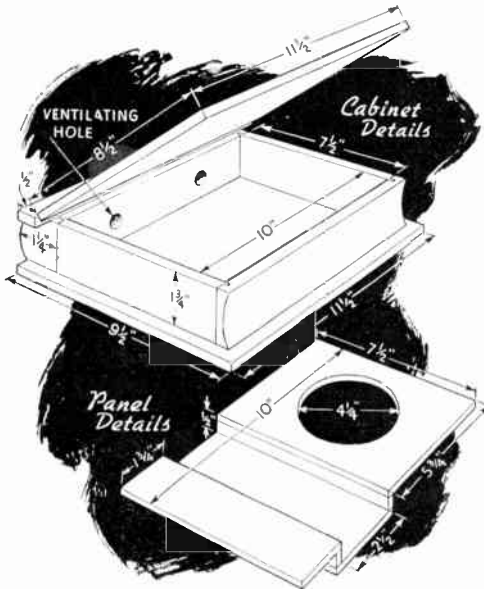
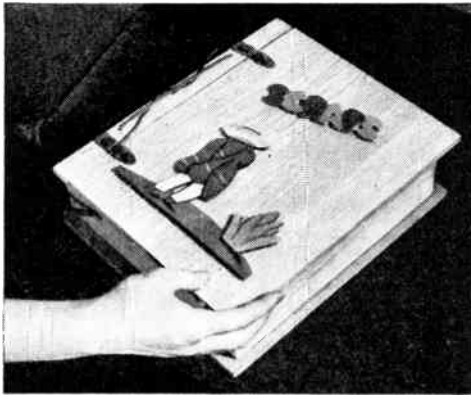

LIST OF PARTS

Midget antenna coil.
 Radio-frequency choke, 16 mh.
 Potentiometer (75,000 ohm) and switch.
 Line cord, 260 ohm.
 Triode-pentode tube (12B8GT).
 Rectifier-pentode tube (25A7GT).
 Permanent-magnet speaker
 (5" diameter).

Tubular paper condenser, .1 mfd.
 Tubular paper condenser, .05 mfd.
 Tubular paper condensers (two) .02 mfd.
 Tubular paper condenser, .01 mfd.
 Tubular paper condenser, .006 mfd.
 Mica condenser, .0005 mfd.
 Mica condenser, .00015 mfd.
 Mica condenser, .0001 mfd.
 Midget tuning condenser.
 Electrolytic condenser, 5 mfd., 25 volt.
 Electrolytic condenser, 16 mfd., 150 volt.
 Electrolytic condenser, 24 mfd., 150 volt.
 Electrolytic condenser, 30 mfd., 150 volt.
 Resistor, 500,000 ohm, 1/2 watt.
 Resistor, 250,000 ohm, 1/2 watt.
 Resistor, 150,000 ohm, 1/2 watt.
 Resistor, 75,000 ohm, 1/2 watt.
 Resistor, 1 meg., 1/2 watt.
 Resistor, 3 meg., 1/2 watt.
 Resistor, 2,500 ohm, 1 watt.
 Resistor, 250 ohm, 1 watt.

Miscellaneous: Two octal sockets;
 aluminum chassis, 1 3/4" by 3" by 7/8";
 special cabinet; knobs; dials, etc.

connection between the shield and the frame.

Regeneration is controlled by varying the screen voltage on the detector with the 75,000-ohm potentiometer, one side of which is connected to the plus "B" voltage through a 250,000-ohm, half-watt resistor, the other side grounded to the chassis.

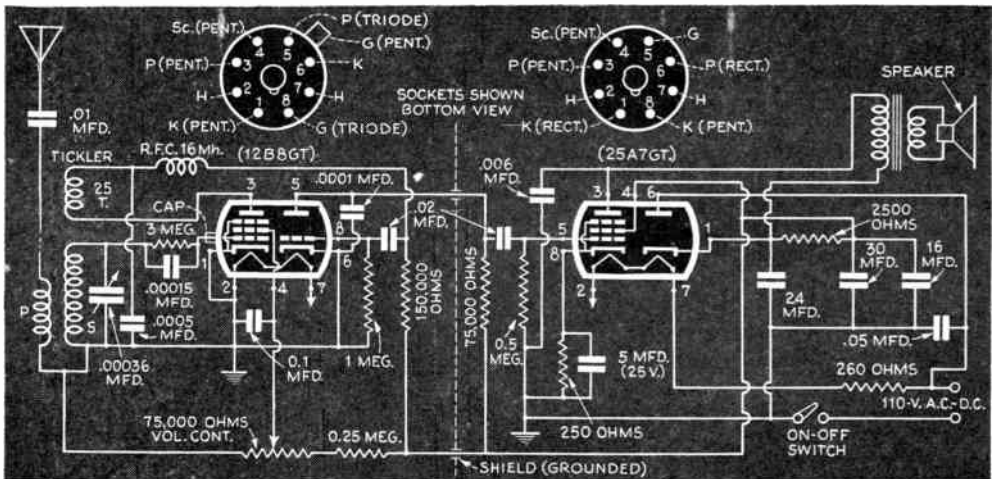

Top, the cut-out cover decoration. Diagrams—cabinet, panel, and wiring—give all construction details

Servicing Your Radio

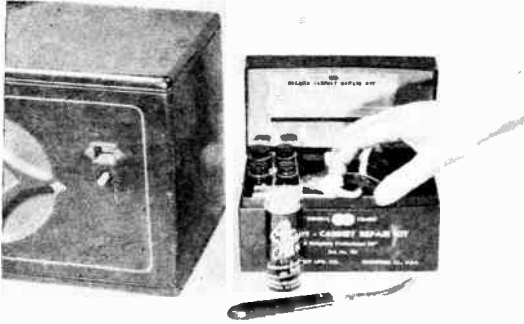

You can get a repair kit for fixing up your old cabinet

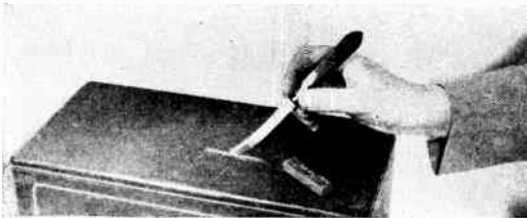

Deep scratches and dents are filled with stick shellac

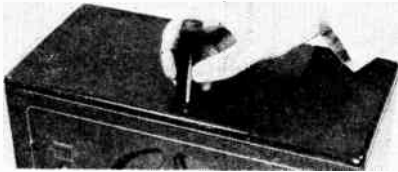

... while slight ones are removed by a special polish

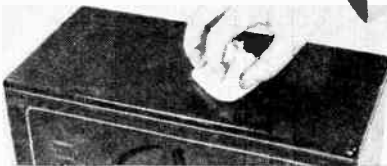

French polishing can be done with new synthetic materials

... and rubbing with fine steel wool gives a satiny finish

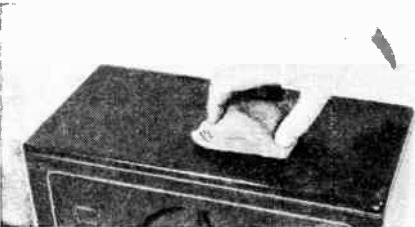

MANY radio cabinets today are in sad need of repair. The old finish has peeled off in places, nicks have been made in the wood, and maybe a few scratches have appeared.

Various kits are now on the market which will enable even an inexperienced person to patch up anything from a small scratch to a bad dent. First take the spatula which comes with the kit and heat it over the alcohol lamp. With the heated spatula melt a shellac stick cement of the proper shade and color into the hole, scratch, or dent. Once the imperfection is filled, it is smoothed off as well as possible with the spatula. The high spots are scraped off with a razor blade or sandpaper, and then rubbed down with fine steel wool and polished. Care should be taken not to injure the surrounding finish. Always make sure the spatula is clean and *never* use matches or a candle to melt the shellac stick.

For slight faults and scratches on the cabinet, you can use a special scratch remover and polishing liquid. This usually is made up into a convenient applicator with a felt brush at one end. Touch the injured spot with the brush and the mark disappears.

Synthetic materials now on the market make French polishing a simple matter. A small additional amount of the liquid is placed on a pad already saturated with the French polish and rubbed over the surface of the cabinet with a circular motion until a high gloss is obtained. Fine steel wool, lightly used, will tone down the gloss.

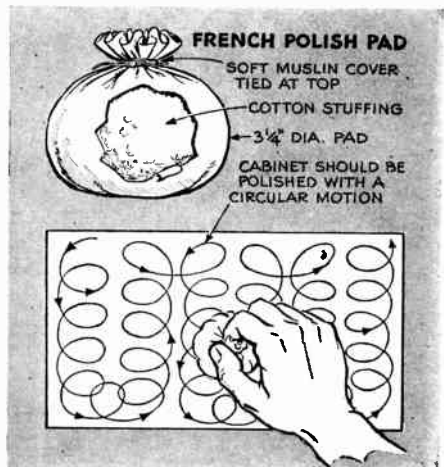

All-Purpose

EXTREMELY compact and light, this battery portable will work anywhere—on trains, in the home, on a boat, in the city or country. Having a loop inside the case, the set needs neither antenna nor ground connections. It has a nighttime range of 500 miles and a daytime range of more than 100 miles. If greater distances are required, an antenna may be attached to the loop by an extra connection provided for this purpose. It consists of two extra turns which are loosely coupled to the other turns on the loop. One side of this extra "coil" is grounded to the chassis—the antenna being attached to the other side.

The circuit consists of a four-tube superheterodyne using the

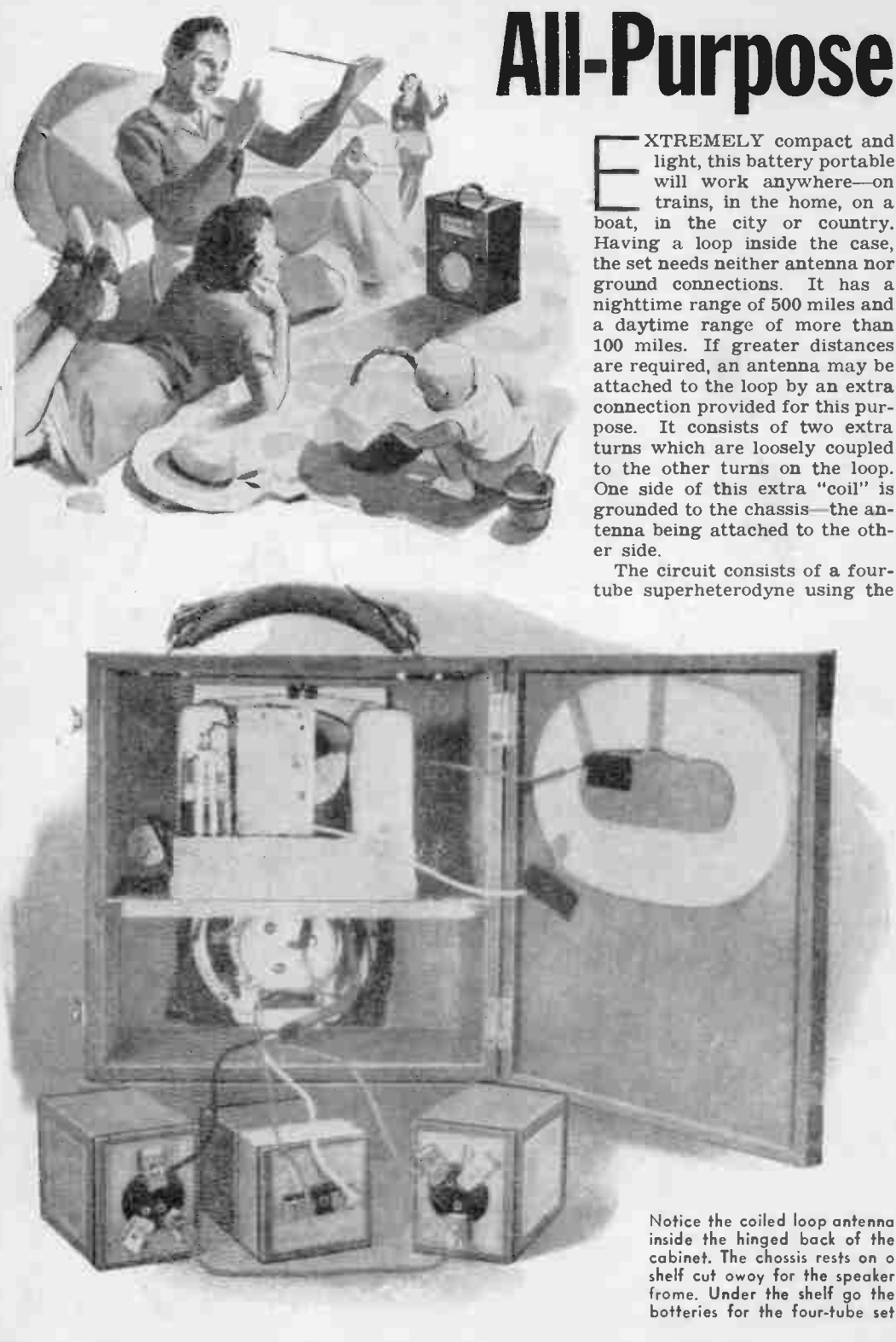

Notice the coiled loop antenna inside the hinged back of the cabinet. The chassis rests on a shelf cut away for the speaker frame. Under the shelf go the batteries for the four-tube set.



brackets attached to either side of the chassis in front. A piece should also be cut out in front of the chassis to clear the speaker frame, which otherwise is too large to fit in the bottom compartment. The speaker frame must be grounded to the chassis.

Mahogany, $\frac{3}{8}$ " thick, was used to make the cabinet. A shelf is placed inside the case to support the small steel chassis, which is held in place by two $\frac{1}{2}$ " right-angle brackets.

The tiny loop antenna ($\frac{1}{16}$ " by 5" by 8"), which can be purchased ready-made, comes with a paper backing so that it may be easily glued in place on any surface. The best place for it is on the inside of the back cover. Any ordinary glue may be used, but not paste. The back cover which is only $\frac{3}{8}$ " thick is hinged to the front portion by two $1\frac{1}{4}$ " brass hinges and is fastened by two small brass latches.

LIST OF PARTS

- P-M speaker, 5".
- Tuning condenser, 2 gang, .00036 mfd.
- Oscillator coil.
- Iron-core I.F. transformers, 455 kc.
- Volume control with D.P.S.T. switch, 1 meg.
- Tone control, 100,000 ohm.
- Tubes: 1A7GT, 1N5GT, 1H5GT, 1C5GT.
- Portable 45-volt "B" batteries (two).
- Portable 1.5-volt "A" battery
- Carbon resistors:
 - $\frac{1}{2}$ watt, 2 meg. (three).
 - $\frac{1}{2}$ watt, 500,000 ohm.
 - $\frac{1}{2}$ watt, 250,000 ohm.
 - $\frac{1}{2}$ watt, 75,000 ohm.
 - $\frac{1}{2}$ watt, 800 ohm.
- Tubular condensers:
 - .05 mfd. (three).
 - .01 mfd. (three).
 - .003 mfd.
- Mica condensers:
 - .0001 mfd. (two).
 - .0004 mfd. (padding).
 - .00005 mfd.
- Miscellaneous: Chassis, cabinet, 4 octal wafer sockets, dial, wire, battery cable, loop antenna, etc.

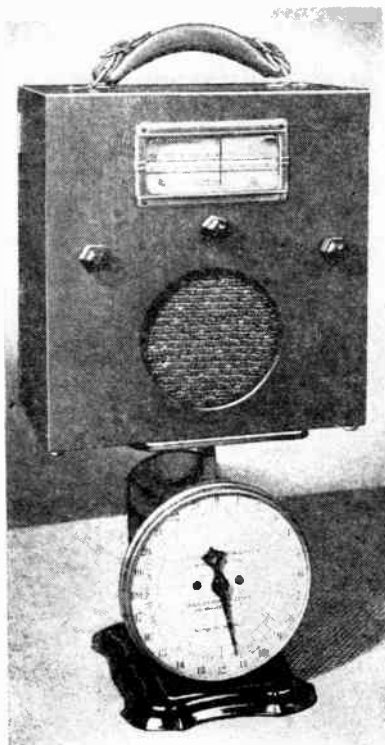

This good-looking portable is light. Follow the sketch below for cabinet

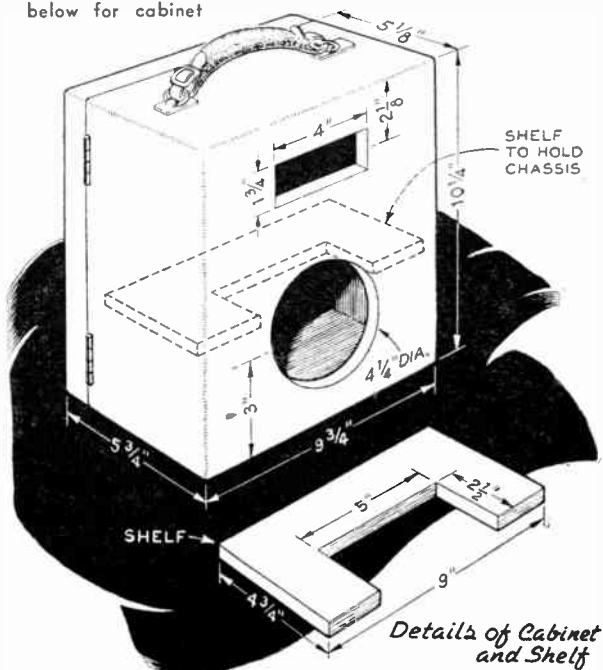

One-Tube Receiver

USES RECTIFIER
AS DETECTOR

BASED on a novel and simple one-tube circuit, operating on the house current, this new type of radio receiver brings in stations as clearly as a crystal set, with absolutely no hum, and with fine selectivity and sensitivity.

Using a rectifier as a detector tube, no filtering system is needed because no plate voltage is used! The A.C. voltage is needed only to heat the filaments of the 25Z5, with no connections between the A.C. line and the receiver proper. The 25Z5 acts as a diode and has its two plates and cathodes tied together. The plates are connected to the fixed plates of the .00015-mfd. tuning condenser, to the four-prong coil, and to the antenna. The cathodes are connected to the moving plates of the condenser and to the other end of the grid winding on the coil. The phones are placed in the cathode circuit of the tube.

The rectifier heater voltage must be adjusted critically to from five to six volts, instead of the rated 25, for satisfactory operation. As there is no line cord on the market rated at 600 ohms, use an 80-watt fixed resistor with an adjustable tap. Otherwise connect two 300-ohm line cords in series.

LIST OF PARTS

Tuning condenser, .00015 mfd.

Set of two 4-prong broadcast coils.

Rectifier tube, 25Z5.

Six-prong wafer socket.

Four-prong wafer socket.

Wire-wound resistor (tapped), 80 watt, 750 ohm.

Headphones, 2,000 ohm.

Line cord.

Black Bakelite panel for baseboard, 4" by 7".

Miscellaneous: Wire, solder, 20' indoor antenna, etc.

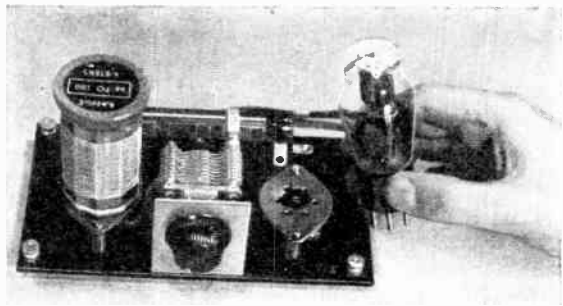

The complete receiver with its tube removed from its socket

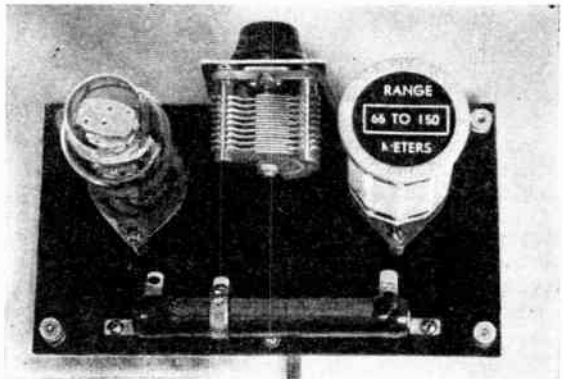

This close-up view shows how the four main parts are placed

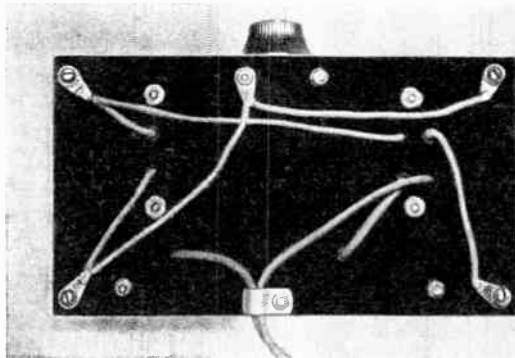

Bottom view, revealing the extremely simple wiring of the set

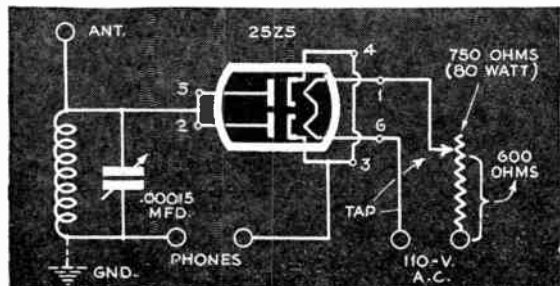

Only the heater uses power, so a ground may be safely used

High-Fidelity Amplifier

FOR YOUR P A SYSTEM, PHONOGRAPH, OR F M RECEIVER

EXTREMELY versatile, this 10-watt audio amplifier may be used with either a crystal or magnetic pick-up for playing recorded music, with a crystal microphone for public-address work, as an amplifier for a high-fidelity tuned radio frequency or super-het tuner, or as an amplifier for use with an FM receiver, such as the one described in book one (page 44) of this two-book series.

The amplifier employs a unique output, two different types of tubes being used in a push-pull circuit. A 6AD7G is used on one side of the circuit while a 6F6G is used on the other. The pentode section of the 6AD7G, however, has the same characteristics as the 6F6G, and the triode portion of the 6AD7G is used as a phase-inverter tube. No push-pull audio transformers are used. Instead the first audio stage (6SJ7) is resistance-coupled to the push-pull output stage.

The input is fed through a .005-mfd. mica condenser and 500,000-ohm volume control to the grid of the 6SJ7. This tube is one of the newest types, using the single-end construction where the grid cap has been eliminated from the top of the tube—the grid being connected to one of the prongs on the base of the tube. This, of course, helps to enhance the general appearance of the amplifier, since no wires are visible above the chassis.

In the plate circuit of the 6SJ7 there is a tone control consisting of a .006-mfd., paper tubular condenser in series with a 250,000-ohm variable resistor—one side of the variable resistor being grounded to the chassis. This tone control really acts as a treble control. In other words it cuts out only the high notes without affecting the low notes. No control for the low notes was considered necessary, as these are reproduced by the amplifier to their full value.



The new amplifier (right, above) in use with a FM receiver



Close-up top view of amplifier with cover removed. This and the bottom view of chassis below will help you locate parts

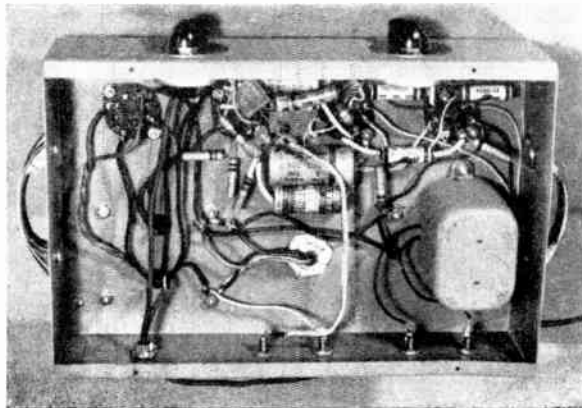

The plate and screen-grid circuits of the 6SJ7 are elaborately decoupled to avoid feedback. This helps to reduce hum and instability in the amplifier. An adequate filtering system is also used in the rectifier circuit—the 350-volt output from the 5Y3G full-wave rectifier being filtered by the

8-mfd. and 16-mfd., 450-volt electrolytic condensers and the heavy-duty, 25-henry filter choke. This choke is rated to pass 140 milliamperes. The power transformer, operating on 110 to 115-volt A.C. only, has three secondary windings: a 6.3-volt winding rated at 3½ amperes for the tube heaters, a 5-volt

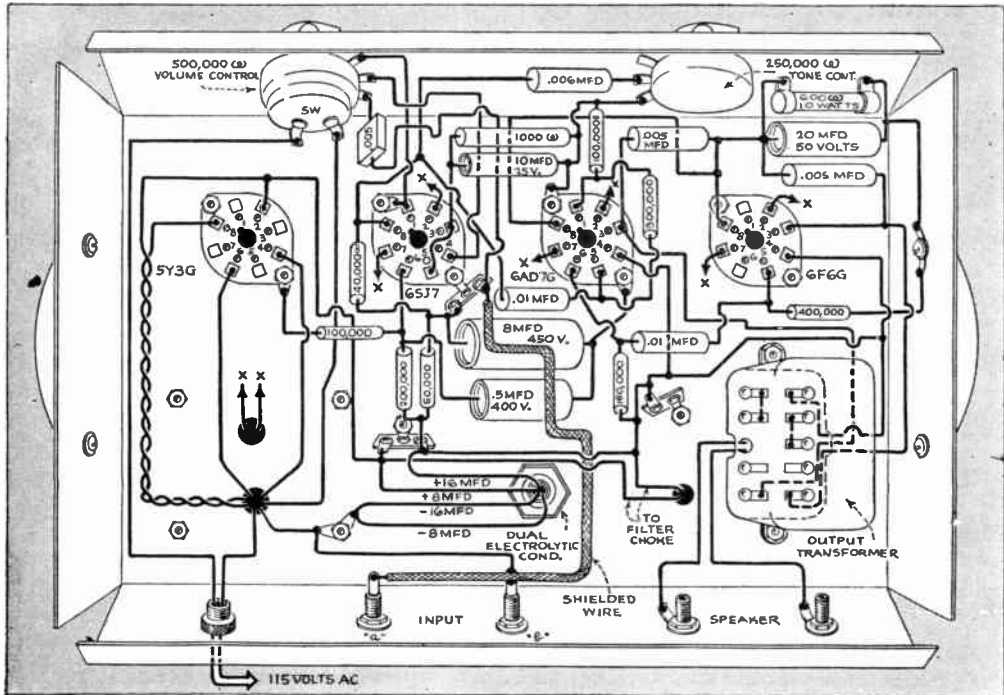

The plan diagram above (compare with underchassis view at bottom of opposite page) shows not only where each part is placed but the general path of the connecting wires. Below is shown the schematic wiring diagram. Bottom view of the tubes (below, left) identifies terminals (prongs) of tube elements

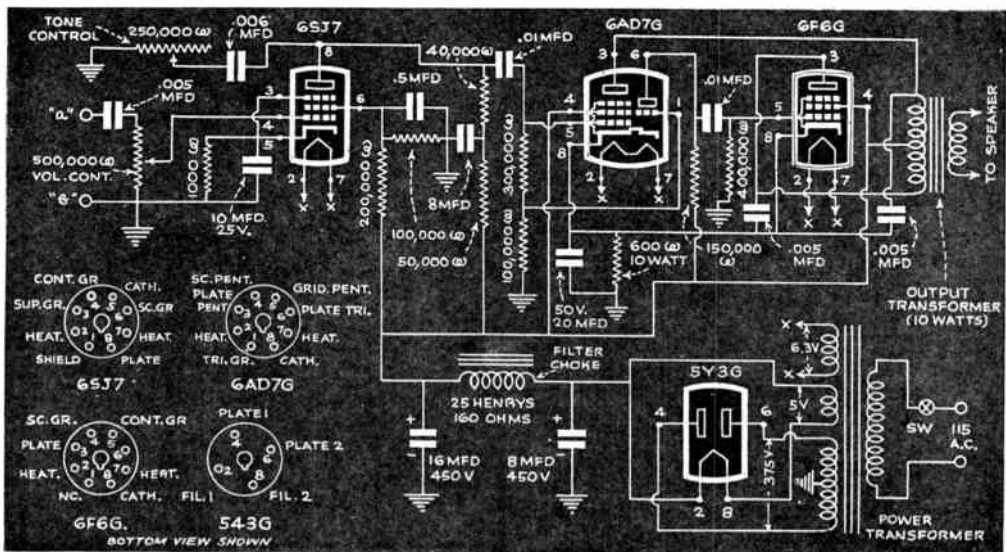

MARIE ANTOINETTE DOLL CONCEALS

Dressing-Table Radio

WHEN a friend asked me to design an all-electric dressing-table receiver that would provide good broadcast reception, yet would not look like a radio, I hit on the idea of housing the circuit in one of the old-fashioned dolls popular some years back for concealing bedroom telephones. The result is the Marie Antoinette radio shown in the photographs. It provides good loudspeaker volume on all major stations, yet it matches the frilly femininity of the average dressing table.

Compactness being an important factor, the A.C.-D.C. circuit was designed around two brand-new dual-purpose tubes, making it possible to obtain five-tube power and sensitivity with little more than half the number. The two new tubes are designated as the 6C8G and the 25A7G. The 6C8G, which consists of two triodes, is used in the set as the combined detector and first audio-amplifier stage. The detector, using the bias method of detection, is resistance-coupled to the first audio stage. Bias for the detector tube is obtained by means of a 100,000-ohm, $\frac{1}{2}$ -watt resistor bypassed by a 5-mfd. electrolytic condenser.

The second new tube used, the 25A7G, serves as a combined high-power pentode output tube and a half-wave rectifier. The 25A7G, although similar to the older 12A7, has a much higher output rating. Consequently, extreme care must be exercised to obtain adequate filtering to eliminate any possibility of trouble due to excessive hum. In the circuit shown, additional filtering was incorporated in the design in the form of a 1,000-ohm fixed resistor and a 24-mfd. electrolytic condenser. These parts are indicated in the wiring diagram of the circuit. Resistance coupling was used to couple the first and second audio stages, and a 5-inch permanent-magnet dynamic speaker was chosen to handle the output.

All parts, with the exception of

the speaker, can be mounted directly on the 2 by 5½ by 8-in. aluminum chassis. For convenience in wiring, the antenna coil can be mounted directly on the ganged tuning condenser, while the radio-frequency coil, the filter choke, and the electrolytic condensers can be mounted under the chassis. The grid lead to the 6C8G should be shielded to insure stability of operation and to avoid any possibility of troublesome coupling with other parts of the set. Both the 6K7G (radio-frequency tube) and the 6C8G can be shielded by means of the conventional ventilated aluminum cans.

When connecting up the rectifier and power

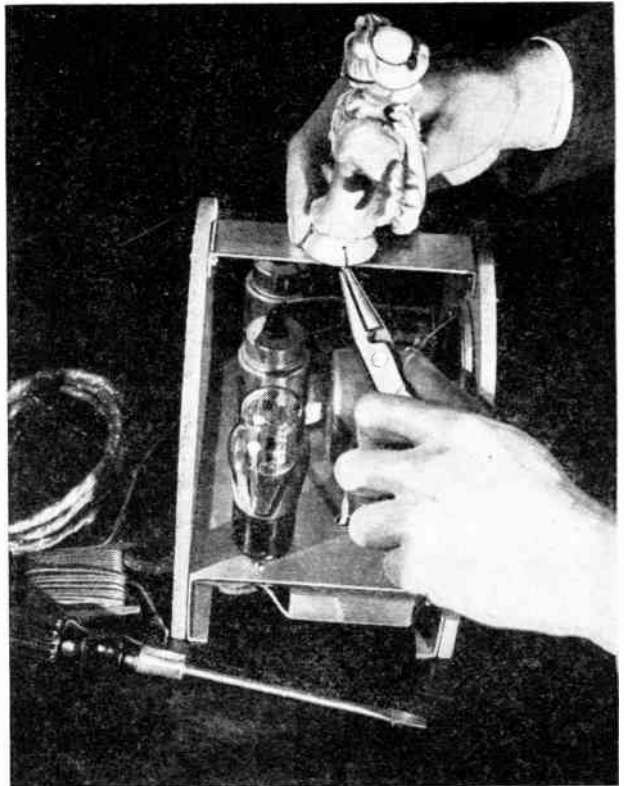

Wire and glue can be used to mount the porcelain figurine on the aluminum brace at the top of the cabinet. Suitable dolls, once popular as telephone covers, can be obtained for a dollar or less

circuit, care should be taken in wiring the power cord and its built-in filament resistor. The resistance wire, generally distinguishable by its asbestos covering, *must* be connected to the filaments.

To form the cabinet and provide a mounting for the doll figure, two rounded wooden panels, 8½ in. high, 8 in. wide at the base, and 5/16 in. thick are attached to the chassis. The panels should be reinforced at the top with an aluminum strip 5½ in. long and 1½ in. wide. This also serves as the support for the doll. Strong glue and wire can be used to hold the porcelain body of the

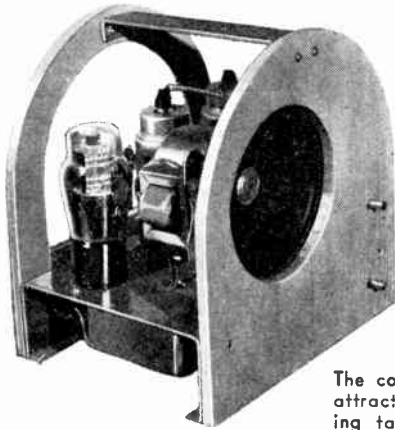

The completed Marie Antoinette doll forms an attractive and useful decoration for a dressing table. The cabinet is shown at the left

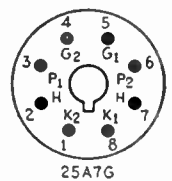
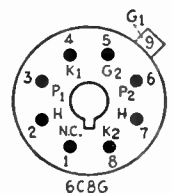
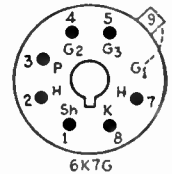
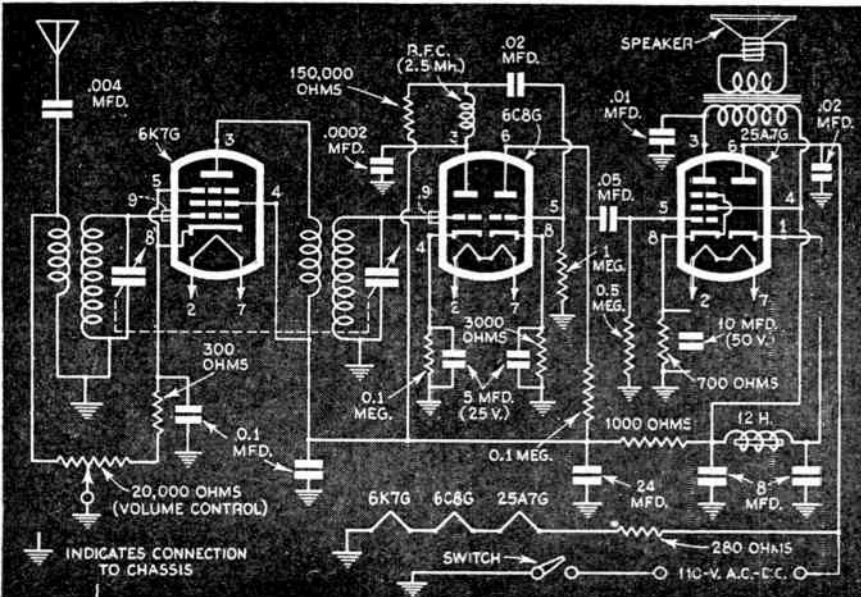

When wiring the tubes follow these socket diagrams carefully

doll securely in place. In the original, the doll's dress with its full skirt was made of taffeta and bordered around the bottom with a lace frill 2 in. wide. Any materials available, however, can be used. This completely hides the receiver. The doll was purchased at a small antique shop for a dollar. With a little shopping, however, less-expensive figures can be obtained.

To provide adequate ventilation for the tubes, a large hole should be cut in the rear panel of the cabinet. A sheet of cardboard; or better still, asbestos board; should be placed at the top of the cabinet to protect the skirt material from the heat of the tubes. The two tuning controls, one for the ganged tuning condenser and the other for the combination volume control and switch, can either be hidden under the doll's skirt or mounted on the outside.

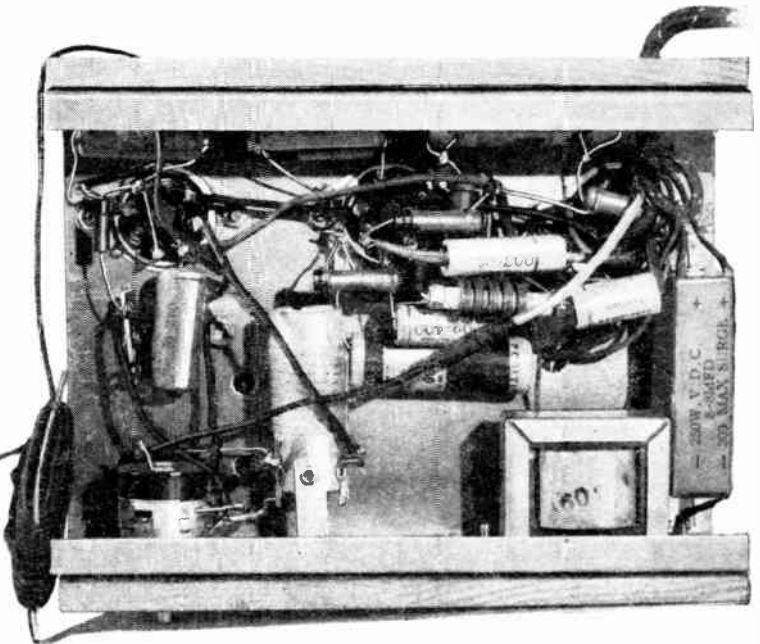

Condensers and other small parts are mounted under the compact chassis

In use, the receiver requires only an antenna, twenty or thirty feet long, strung around the baseboard or ceiling molding. No ground should be used, as the A.C.-D.C. hook-up is grounded through the house wiring and additional grounding would blow the tubes.

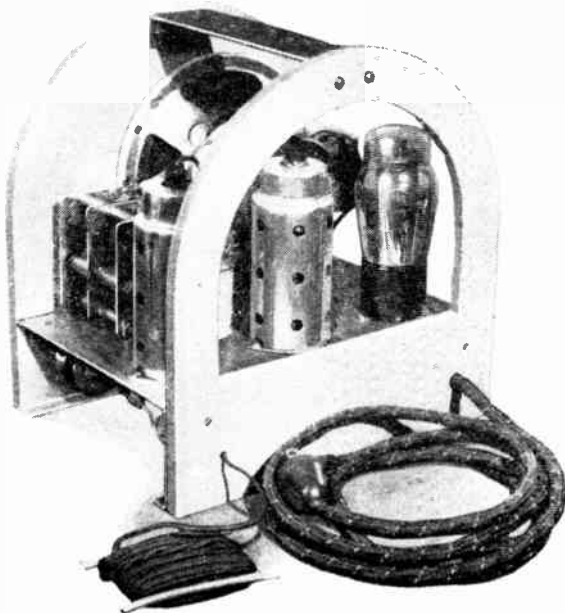

No outside ground connection is needed with the receiver. Only the short flexible antenna wire, at the left, is necessary to get excellent reception

LIST OF PARTS

- Two-gang tuning condenser, .00036 mfd.
- Fixed condensers, two, .1 mfd.
- Fixed condensers, two, .02 mfd.
- Fixed condenser, .05 mfd.
- Fixed condenser, .01 mfd.
- Fixed condenser, mica, .004 mfd.
- Fixed condenser, mica, .0002 mfd.
- Electrolytic condenser, dual, 8-8 mfd., 250 volts.
- Electrolytic condenser, dual, 5-5 mfd., 25 volts.
- Electrolytic condenser, 10 mfd., 50 volts.
- Electrolytic condenser, 24 mfd., 150 volts.
- Fixed resistor, 100,000 ohms, 1/4 watt.
- Fixed resistor, 150,000 ohms, 1/2 watt.
- Fixed resistor, 1/2 meg., 1/2 watt.
- Fixed resistor, 1 meg., 1/2 watt.
- Fixed resistor, 300 ohms, 1/2 watt.
- Fixed resistor, 700 ohms, 1 watt.
- Fixed resistor, 3,000 ohms, 1 watt.
- Fixed resistor, 1,000 ohms, 1 watt.
- Plate choke, 2.5 mh.
- Filter choke, 12 h.
- Midget volume control with switch, 20,000 ohms.
- Miscellaneous.*—Power cord with 280-ohm resistor, matched antenna coil and radio-frequency coil, speaker, chassis, tubes, sockets, shields, doll, dress materials, wire, solder, etc.

Servicing Your Radio

OFTEN minor adjustments that can be made at home will correct radio-receiver difficulties or give additional reception to an old set. Below are methods for

detecting a faulty heater in the power pentode tube, extending reception at the upper end of the dial, eliminating noise in a new condenser, altering a midget filter circuit.



REPLACE THE POWER PENTODE TUBE if the pilot light goes on and then immediately goes off again each time the receiver is turned on. The trouble is a faulty heater in the 50L6GT tube. It makes proper connection inside the tube when cold, but when it warms up the contact is broken.

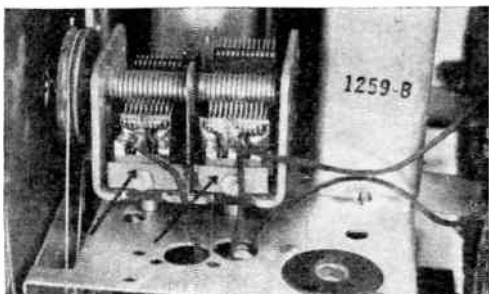

1,600-KC. STATIONS CAN BE BROUGHT IN on an old AC-DC midget set by readjusting the trimmer on the oscillator tuning condenser. The capacity is reduced a sixteenth of a turn at a time by loosening the nut shown at left above. Then loosen the nut on the other condenser to increase volume.

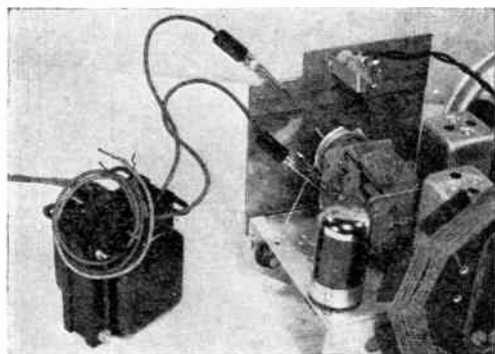

NOISY TUNING IN THE LATEST RADIOS may be caused by filings between plates of the oscillator tuning condenser. These may be burned out by connecting the secondary of a 700-volt power transformer across the condenser, as shown above and in the diagram. Be sure to disconnect the house current and the grid connection to the oscillator unit.

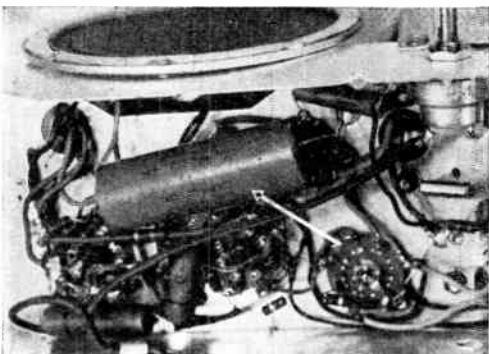

THIS SIMPLIFIED FILTER CIRCUIT for a midget AC-DC receiver uses only one electrolytic condenser, and may prove worth substituting when servicing a filter circuit that contains two or more electrolytic condensers if replacements for these condensers are hard to obtain. The diagram below shows how the substitute wiring is done.

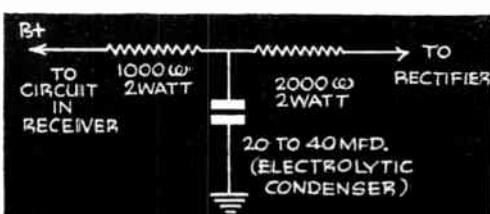
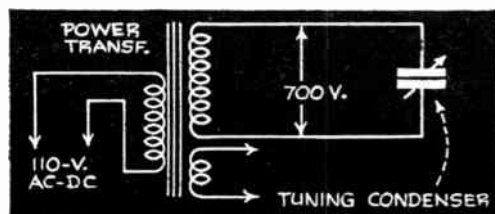

Easily Assembled Unit

WITH the easily assembled unit illustrated, you can convert your regular superheterodyne set into a "diversity receiver" that will provide signals of constant strength free from the bothersome fading so common to short-wave reception and often experienced on the broadcast band. Called a "diversity coupler," the unit operates on the same principle as the "diversity receivers" with this one main difference—what the receivers do electrically, the coupler does mechanically.

The secret of diversity reception is based on the fact that the degree of fading of a

given signal varies with different antennas. The coupler, acting as a link between two antennas—one vertical and the other horizontal—and the receiver, automatically couples the receiver by means of a motor-driven variable condenser to the antenna providing the stronger signal.

The coupling condenser, sold complete with its motor, consists of three plates, two stationary and one movable. One stationary plate is connected to the vertical antenna, the other to the horizontal antenna, while the movable plate is wired to the receiver's antenna terminal. As the signal in one antenna or the other fades, the movable plate is turned automatically to a new position. Thus, the antenna receiving the stronger signal becomes "capacity coupled" to the receiver in direct proportion to the signal strength.

Three tubes are used in the coupler circuit, a 6B8G amplifier, a 2A4G control tube, and a 25Z6 rectifier. The 2A4G, the heart of the circuit, acts as a sensitive relay to control the tiny magnetic motor that operates the dual coupling condenser. When the signal fades, this tube allows current to flow to the motor until the condenser has been adjusted to the new



All connections must be soldered carefully, and a metal shield, as at the right, must be used to eliminate radio interference



Kills Radio Fading

setting for maximum signal strength. The action is entirely automatic, and so swift that audible signal strength is constant.

In wiring the circuit, follow the diagram carefully. Make sure that all connections are well soldered, since any poor joints will cause losses that will completely upset the balance of the hook-up. When connecting the coupler to your receiver, use shielded cable and ground the outer sheathing as indicated. Shielded cable also should be used for the antenna lead-ins. A wafer adapter can be used to make the necessary connection to the plate prong of the receiver's last intermediate-frequency tube, as shown in the diagram.

To adjust the coupler, tune in a short-wave signal which is fading, as indicated by the rise and fall in volume, or by the fluctua-

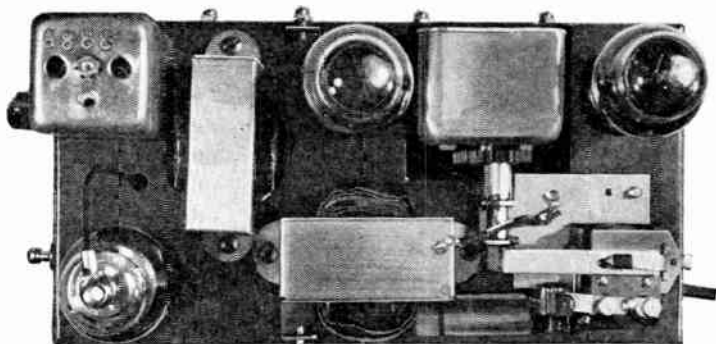

How the various parts are arranged above and below the metal chassis. The tiny motor, which turns the dual condenser to tune in the antenna giving the strong signal, is on the top face of the chassis

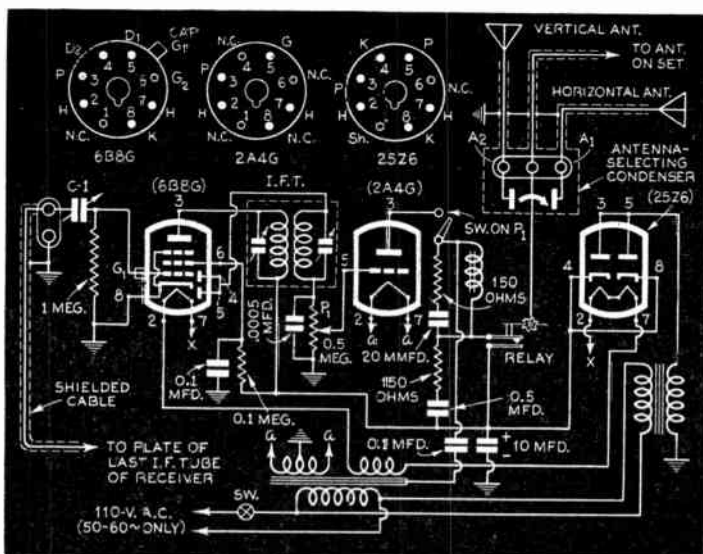
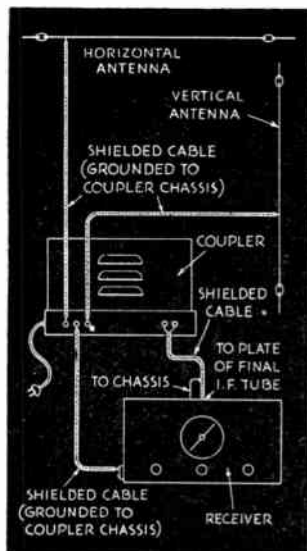
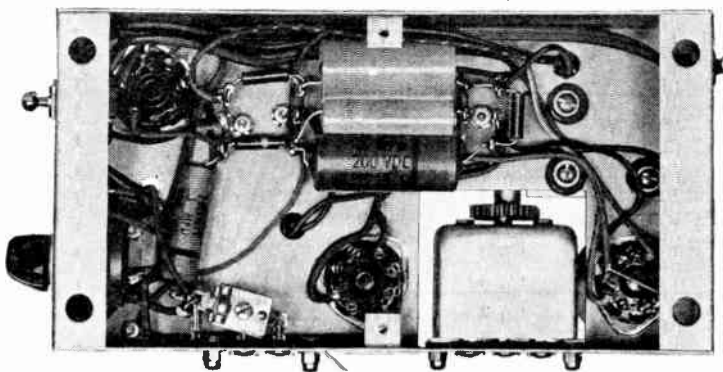

These drawings show how the coupler is connected to receiver and antennas, and the complete wiring diagram



A close-up of the motor that turns the dual condenser

tions of the visible tuning meter if the set is equipped with one. Then advance the sensitivity control or 500,000-ohm potentiometer until the signal remains constant. Do not turn the control too far or the motor will tend to operate continuously. It is best to adjust it to a point just below that of maximum response. The best point can be permanently marked on the dial with a pencil.

Some experimenting may be necessary in placing the two antennas for best results.

LIST OF PARTS FOR RADIO-FADING ELIMINATOR

Antenna - selecting condenser, and motor.

Plate transformer.

Filament transformer.

Intermediate - frequency transformer, 455 Kc.

Trimmer condenser (C-1).

Condenser, 10 mfd., 300 volt.

Fixed condenser, 20 mmfd.

Tubular condenser, .5 mfd., 200 volt.

Tubular condenser, .1 mfd., 200 volt.

Tubular condenser, .1 mfd., 400 volt.

Mica condenser, .0005 mfd.

Two resistors, 150 ohm, ½ watt.

Resistor, 1 meg., ½ watt.

Resistor, 100,000 ohm, ½ watt.

Volume control (500,000 ohm) with switch.

6B8G tube.

2A4G tube.

25Z6 tube.

Three octal sockets.

Toggle on-off switch.

Special chassis with cover and bottom plate.

Miscellaneous:—Nuts, clips, washers, lugs, wire, etc.

ALL-WAVE

HERE is an inexpensive alternating or direct-current receiver that covers all the wave bands from 430 to 10,000 kilocycles. It is of the regenerative type, but the functions of regeneration and detection are separate. Regeneration is furnished by a 6C5 tube and is controlled independently of the 6J7 detector tube, while the output tube, a 25L6, provides ample power for a 6-inch dynamic speaker, as well as earphones.

Contributing to the low cost of the set are the four tuning coils (L_1 , L_2 , L_3 , and L_4), which you can wind yourself with No. 26, enameled-copper wire, on tubing 1¼ inches in diameter. Three of these coils (L_2 , L_3 , and L_4) are wound on one form as shown in the diagram below. The only coil you need buy is a universal-wound inductance coil (L_5) used to tune the circuit to the very long wave bands. It may have any inductance value from 2.5 to 60 millihenries. A tap switch instantly selects the coil for the wave length desired. It should be noted that the lower end of the coil (L_5) goes to the cathode of the 6C5 tube instead of being grounded to the chassis. Plate voltage, and consequently the regeneration, of the 6C5 tube, is controlled by a .25-megohm potentiometer.

As a safeguard, a "polarized" plug is used on the power cord. One blade of the plug is slightly wider than the other for easy identification. When first plugging it into the outlet to be used with the set, take a 10-watt lamp and test to see if there is current flowing between the set chassis and a grounded

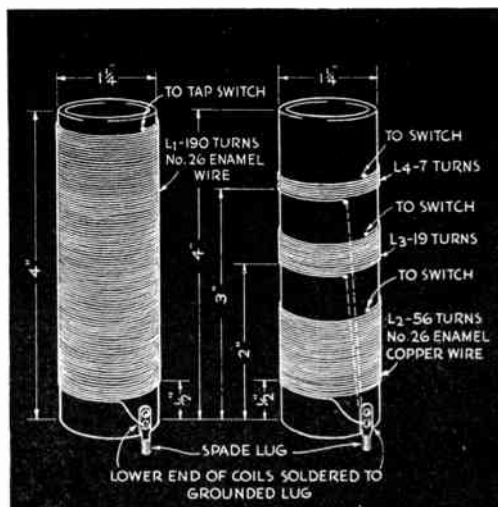

Follow these specifications in winding the coils

CAMPER'S RADIO

How the resistors and condensers are wired. The fishpole antenna plugs into a jack on the top control panel



SMALL enough to be slung over your shoulder like a camera, this lightweight portable has its own built-in battery supply and uses an ordinary steel fishing rod as an antenna. Housed in an attractive yet sturdy cloth-covered cabinet, the midget earphone set forms an ideal companion for use on camping and fishing trips, picnics, and long automobile tours.

Three of the latest-type midget tubes form the basis for the compact circuit. Operating on a filament voltage of $1\frac{1}{2}$ volts and a plate supply of 45 volts, the tiny tubes not only make it possible to pack a three-tube hook-up into a small amount of space, but they cut down the number of necessary batteries to a minimum—a 45-volt "B" battery and a small $1\frac{1}{2}$ -volt dry cell. These tubes, of English manufacture, can be obtained from almost

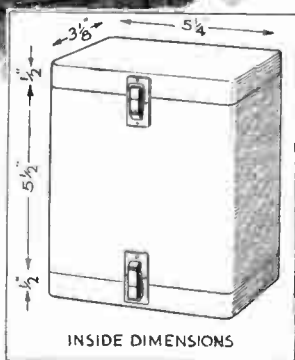

The chassis and panel assembly at the right fits snugly into the top of the compact cabinet

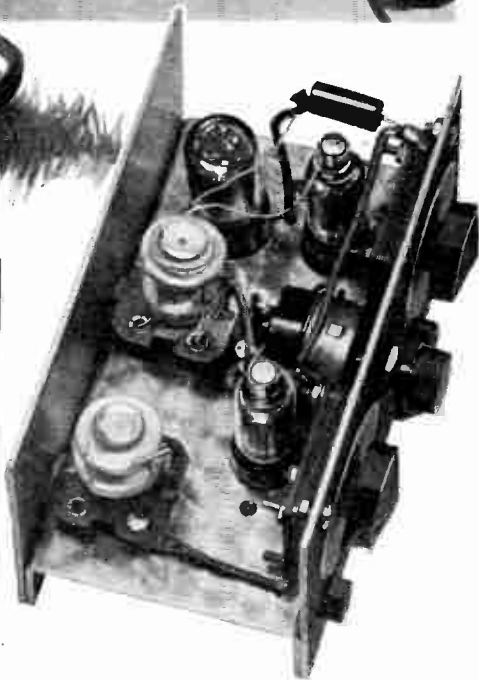

any large radio-parts supply house and must be used with the special midget sockets designed for them. In wiring the tubes, bear in mind that the metal connection at the top of each XSG tube is not the grid, as on most American tubes, but the plate.

To obtain the highest possible volume, iron-core coils are used. However, to save space they should be removed from their aluminum shielding cans. To obtain the necessary feedback in the detector or second coil, fifteen

Uses Fishpole Antenna

Camera-Size Set

turns of No. 28 double-cotton-covered wire should be mounted close to the grid winding. This is indicated in the wiring diagram.

Composition-insulated tuning condensers are used instead of the usual air-spaced variety. They cost no more, and do conserve space. However, since these condensers cannot be ganged or mounted on a single shaft, each stage must be tuned separately.

A 500,000-ohm variable resistor connected across the "B" battery serves to control the volume. To avoid any unnecessary drain on the batteries while the set is not in use, a switch should be placed in the ground lead of the volume control. This switch can be ganged with a second switch placed in the minus lead to the "A" battery, so that both then can be controlled by a single knob on the panel.

The cabinet used for the original set illustrated was made of wood and covered with airplane cloth. If you desire, it can be covered with imitation leather. To simplify the problem of changing the battery supply, two hinged covers are used—one at the top to cover the control panel and the other at the bottom to close the battery compartment. A leather strap run through leather loops mounted on the sides of the cabinet makes it easy to carry the receiver.

No ground is needed in operating the set, only an antenna, which need be nothing more than the business end of an inexpensive telescoping steel fishing rod. For the original, the author sawed about $\frac{3}{4}$ " from the bottom end of the main ferrule that fits into the socket in the fishing-rod handle and soldered a short banana-type plug in place. This plug fits in a small jack mounted in the lower left-hand corner of the control panel as shown



If you wire the receiver carefully according to the diagram below you will be able to get good radio reception miles from home

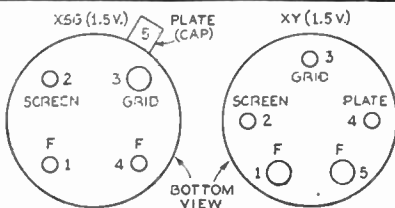
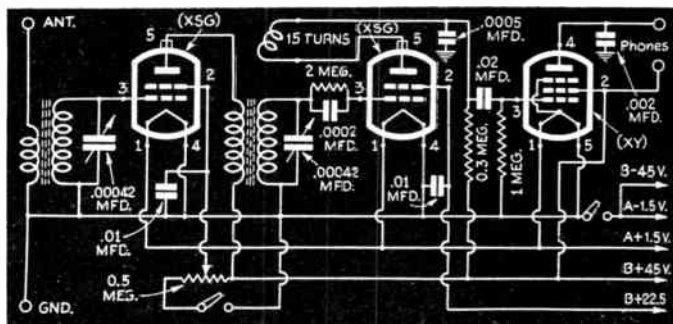

Follow these socket diagrams when making the various connections to the three tubes

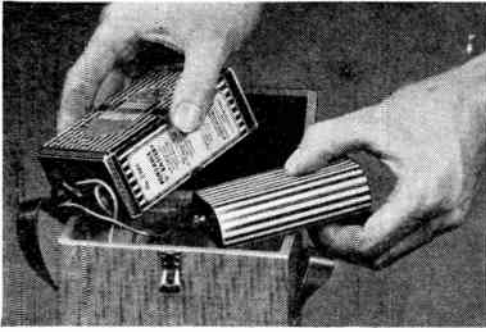

Two small batteries housed in the bottom of the cabinet form the tiny receiver's complete battery supply

in one of the photographs. If desired, a wire from the antenna plug can simply be clipped to the end of the fishing-pole handle. As a matter of fact, the receiver can be used while fishing—the steel rod serving not only to catch fish, but to snare the radio waves. In this case, however, the fishing rod must be one fitted with a cork or other nonconducting handle to insulate the antenna and eliminate body capacity.

In laying out the parts and wiring, follow the photographs and diagram closely. The tubes and coils have been arranged with an eye to compactness and ease in wiring. Be particularly careful in making the connections to the three tube sockets, and follow the socket diagrams to the letter.

LIST OF PARTS FOR CAMPER'S RADIO

Volume control, 500,000 ohms.
 Iron-core antenna coil.
 Iron-core radio-frequency coil.
 Variable condensers, two, .00042 mfd.
 Fixed resistor, 2 megohm, ½ watt.
 Fixed resistor, 1 megohm, ½ watt.
 Fixed resistor, 300,000 ohms, ½ watt.
 Tubular condensers, two, .01 mfd.
 Tubular condenser, .02 mfd.
 Mica condenser, .002 mfd.
 Mica condenser, .0002 mfd.
 Mica condenser, .0005 mfd.

Miscellaneous: Tubes (two XSG, one XY), one 45-volt "B" battery, one 1½-volt midget dry cell, chassis, cabinet, special tube sockets, switches, four insulated plugs and jacks, cabinet, fish-pole, knobs, dials, wire, solder, etc.

HOW TO Install

THE problem of setting up an efficient television antenna for yourself or one of your friends will be greatly simplified if you will follow a few simple rules. First of all, although television antennas may vary in appearance and size, they are basically all alike, consisting of a quarter-wave doublet antenna of predetermined length. A "reflector" antenna, similar in design but from eight to ten inches longer, is mounted beside the doublet when necessary to eliminate "ghosts," or unwanted, out-of-register duplications of the television image on the fluorescent screen. Such ghosts usually are caused by a reflection of the signals from near-by buildings, just as visible light waves—which television waves resemble in many characteristics—reflect from a wall or other surface.

It is advisable to have a helper when setting up the antenna, so that one person can adjust its position while the other tests the operation of the receiver. Locate the antenna in a clear space on the high-



a Television Antenna

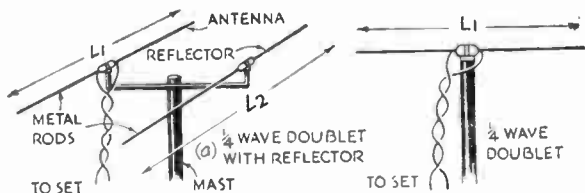

FREQUENCY	L ₁	L ₂
(a) 44-56 MC	122 INCHES	134 INCHES
(b) 66-72 MC	83 INCHES	93 INCHES
(c) 78-90 MC	70 INCHES	80 INCHES
(d) 96-109 MC	58 INCHES	66 INCHES

NOTE: REFLECTOR IS ALWAYS 8 TO 12 INCHES LONGER THAN RECEIVING ANTENNA

est possible part of a building, and on the side toward the transmitter. If the antenna and receiving set are not within easy shouting distance much time can be saved with a two-way, portable telephone system strung up temporarily between the two points.

Television antennas should be mounted on a wooden or an iron mast of substantial design, securely anchored to the building. They are usually furnished properly matched for the 45 to 55-millicycle "vision" transmitters. If your local television station operates on a different frequency, the metal rods must be cut to the overall lengths shown in the accompanying table. Regardless of its design, the antenna will have to be rotated until the maximum signal strength is obtained, which is usually when the quarter-wave rods are at right angles to a line between the antenna and the transmitter. Several commercial antennas are fitted with flexible couplings which simplify this adjustment.

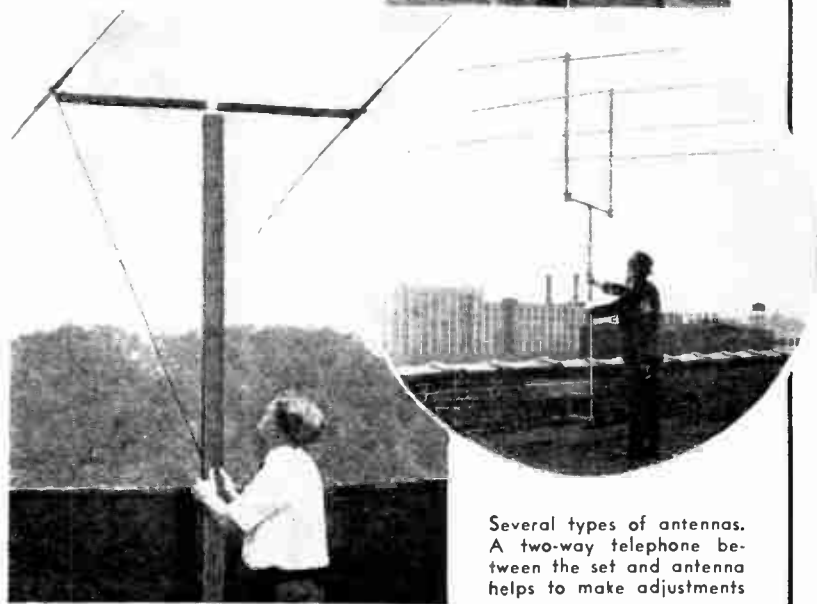

Several types of antennas. A two-way telephone between the set and antenna helps to make adjustments

Universal Power Supply for Battery Receivers

EASILY BUILT UNIT FOR FARMS AND
VACATION CAMPS USES STORAGE
BATTERY OR 110-VOLT HOUSE LINE



The vibrator is mounted on top of the chassis with the transformer, rectifier tube, and 110-volt socket



One six-volt battery is all that is needed. It can be either a storage battery or a dry-cell unit

Operating a battery radio with the power supply

NO MORE worrying about "B" batteries for that battery-operated radio at the summer camp or on the farm if this universal power supply is hooked to the set. One 6-volt battery is all that is needed. And, by simply snapping a switch, the power supply can be converted to operate a battery set on 110-volt A. C.

Easy to build, this vibrator unit steps up the 6-volt power to from 100 to 300 volts for the tube-plate current. It will operate any receiver or amplifier circuit using six-volt tubes where the total B drain is not more than 100 milliamperes.

Four-tube battery receivers with 1.5-volt tubes also may be operated with this unit if the tube filaments are connected in series (4×1.5 volts = 6 volts). However, this may be done only when the vibrator is operated off a 6-volt battery, as the heater voltage is A. C. when the unit is connected to a 110-volt line, and the unit must NOT be used on 110-volt D. C. current.

The pack is built on a steel chassis measuring 2" by 7" by 9". On top are mounted the power transformer, four-prong vibrator, 84 rectifier tube and 110-volt socket. Beneath the chassis are the chokes, resistances, and condensers.

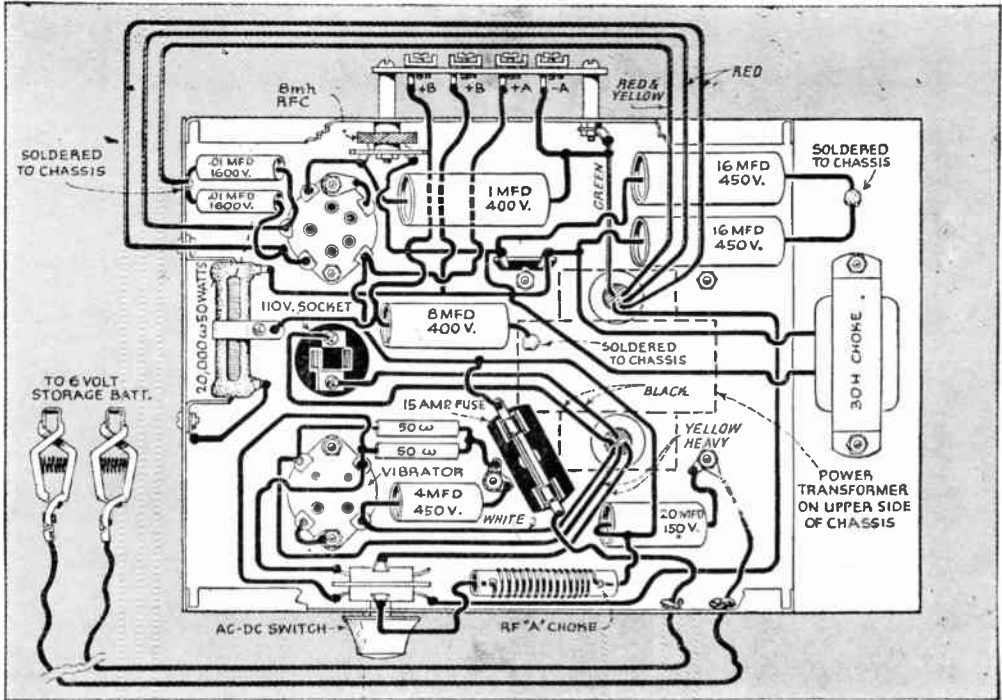

Schematic drawing of power-supply circuit. It will operate a 20-watt CW or 12-watt phone transmitter

The 30-henry filter choke should pass at least 100 milliamperes to avoid overheating and damage to the windings. The 8-milli-henry radio-frequency choke and 1-mfd. bypass paper condenser in the "B —" lead, and the "A" choke and 25-mfd. condenser in the "A —" lead provide the necessary RF filtering to prevent interference with the receiver. The "A" choke can be easily made at home by winding closely 20 turns of No. 14 enam-

eled wire on a bakelite tubing with an outside diameter of $\frac{1}{2}$ ".

A little vibrator static may be experienced when the unit is connected to a 1.5-volt battery receiver, but with 6-volt tubes no hum or vibrator static is noticeable. In each case the power-supply chassis should be connected to a good external ground and the receiver's ground connection disconnected.

The grounded side of the tube heaters

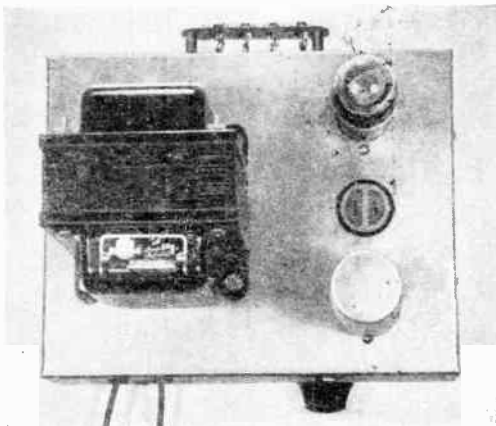

The special power transformer makes it possible to operate a battery set on a 110-volt A.C. supply

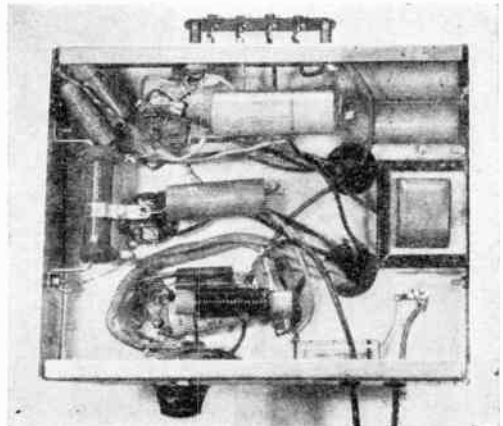

Bottom view of chassis, showing the positions of the various chokes, resistances, and condensers

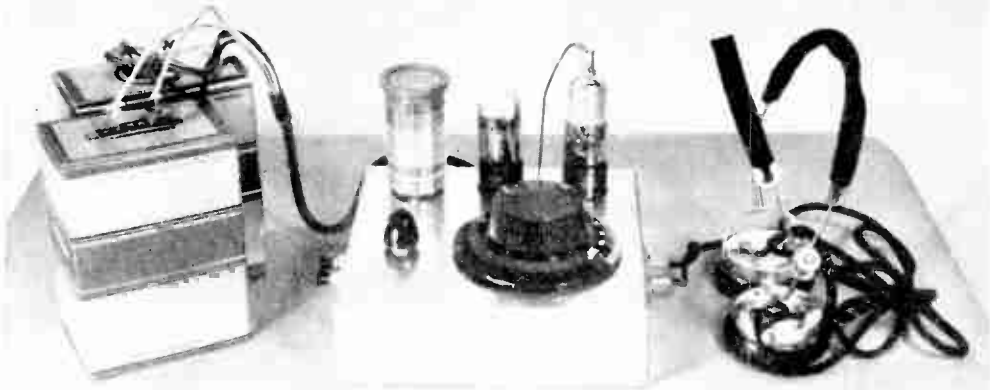

Separate tubes for detection and regeneration give this simple receiver its remarkable efficiency

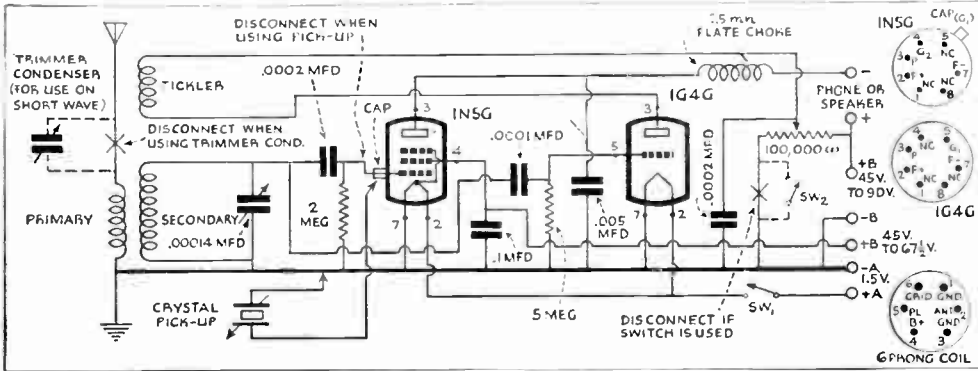

How the circuit is wired. Any good antenna and ground installation may be used with this set

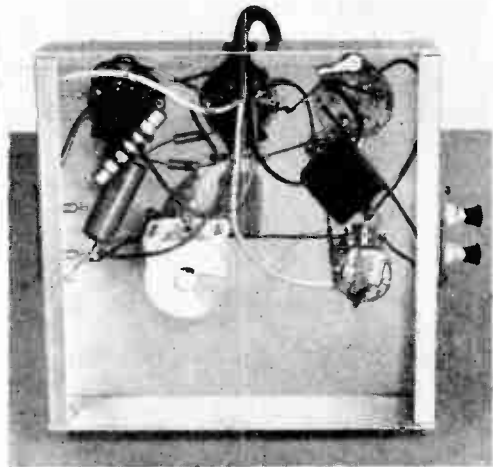
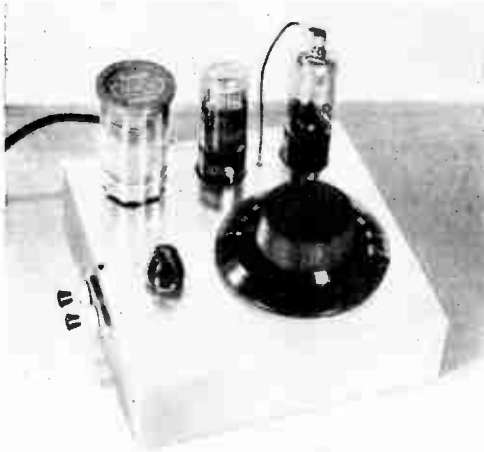

Top and bottom views of chassis. By mounting the controls thus, the metal panel is dispensed with

Portable AC-DC Signal Tester

Oscillator Can Be Used as Wave Meter on Broadcast Band

INEXPENSIVE to build, this portable AC-DC test oscillator recommends itself to present conditions, for it may be used either in the shop or taken out on calls. It operates on both AC and DC current and there is no need to worry about which current a customer might have. The latest tubes are used and the output is a pure, audible sound that can be heard easily through the speaker of the set being tested.

This oscillator will align the I.F. stages of any superheterodyne having a frequency between 300 kc. and 850 kc. Most I.F. stages are peaked at about 456 kc. Additionally it will serve as a wave meter for the broadcast band, enabling one to identify unknown, distant, or local stations. A simple two-tube circuit is used, consisting of a half-wave rectifier (25Z6-GT/G) and a parallel-feed oscillator of the electron-coupled type, (6SK7).

Two coils are needed for this operation,

one to cover the 300-kc. to 850-kc. band and the other the broadcast band (1,750 kc. to 550 kc.). Directions for making these coils are in the accompanying sketch. Before using, the oscillator must be completely inclosed in a steel cabinet. A .05-mfd. condenser grounds the cabinet to the chassis. Do not ground the cabinet directly to the chassis, for there is danger of a short, especially where the oscillator is being used on a DC line. The .02-mfd. condenser must be mica insulated and not paper insulated, unless it is non-inductively wound. The simplest way to calibrate the oscillator for

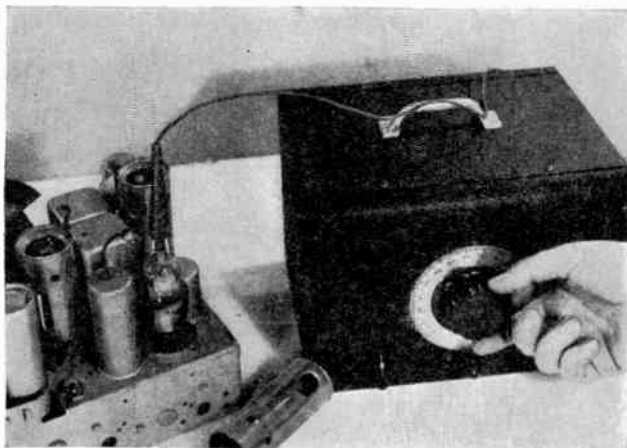

Oscillator shown in use with test prong hooked to screen grid cap

Below, front view of coils on chassis and other parts

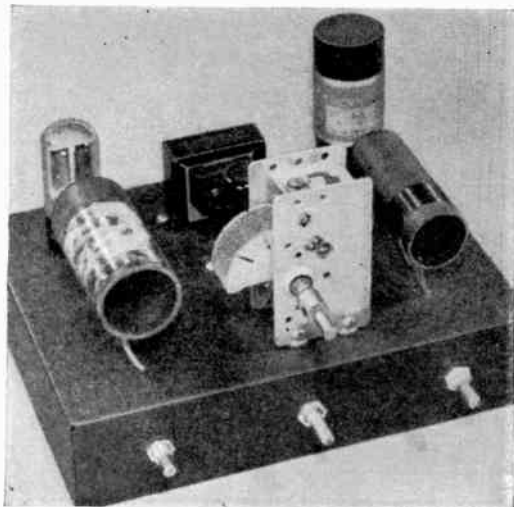

Bottom view of chassis, illustrating wiring of unit

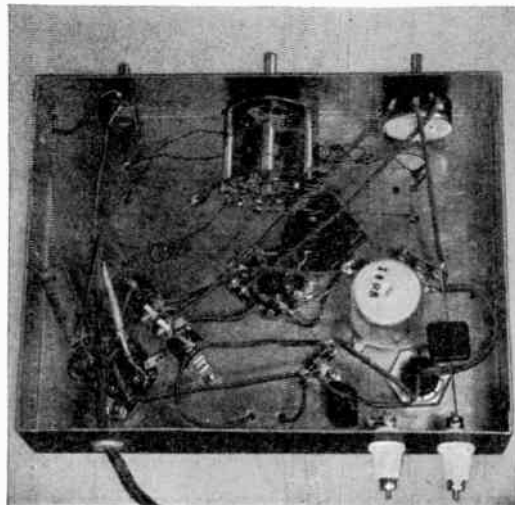

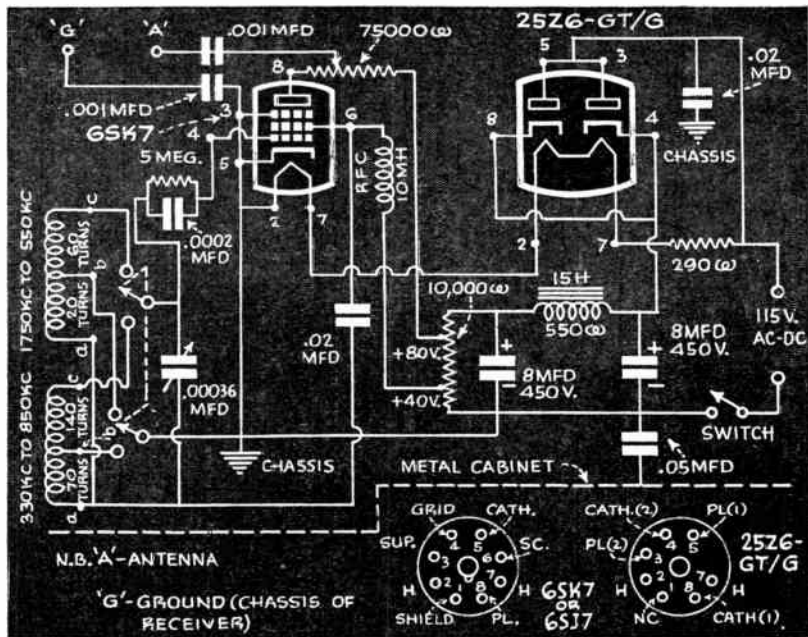
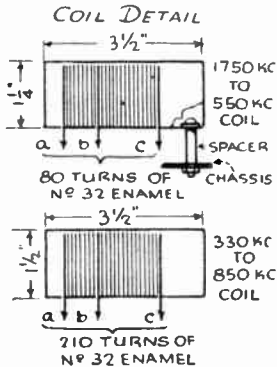
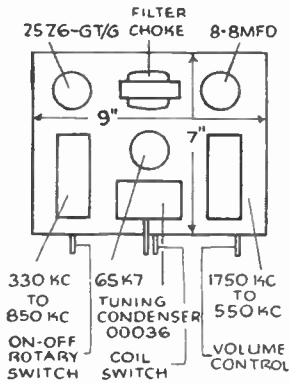

As shown in the wiring diagram, two taps are used on resistor. These can be moved up and down resistor until correct voltages are obtained. Directions for making coils are given in detail at left. Coils are mounted on chassis with a 1/4" machine screw and a 3/4" brass spacer

aligning a superheterodyne is to use a good radio receiver having an I.F. frequency of 456 kc. Then remove the grid clip from the first I.F. tube and connect point "A" on the oscillator to the grid cap of the I.F. tube. Rotate the dial until a signal is heard in the speaker. This point on the dial will corre-

spond to the I.F. frequency of the receiver. In order to align the I.F. stages of other sets, tuned to 456 kc., switch the oscillator on and turn the dial to the correct position for 456 kc. The oscillator is now sending out a note tuned to 456 kc. Next, adjust the trimmers on the I.F. coil cans, until the note is heard.

Cabinet with dial, brass handle, and two self-tapping screws appears below. Note its compactness

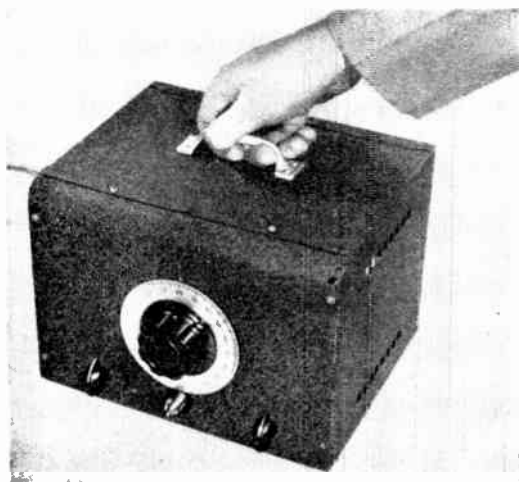

LIST OF PARTS

- Cabinet, 7 1/2" by 8" by 10 1/4". Black wrinkle finish.
- Cadmium-plated chassis, 2" by 7" by 9".
- Tuning condenser, .00036 mfd.
- Coil form, 1 1/2" diameter by 3 3/4" long.
- Coil form, 1 1/4" diameter by 3 1/2" long.
- Filter choke, 15 henrys, 550 ohms.
- Dual electrolytic condenser, 8+8 mfd., 450 volts.
- Octal tube sockets (two).
- Rotary switch, S.P.S.T.
- Variable resistor, 75,000 ohms.
- Wire-wound resistor, 10,000 ohms, 25 watts.
- Porcelain binding posts (two).
- Tubes: 25Z6-GT/G and 6SK7.

Servicing Your Radio

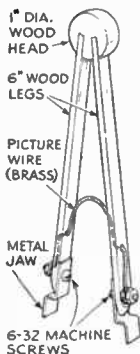
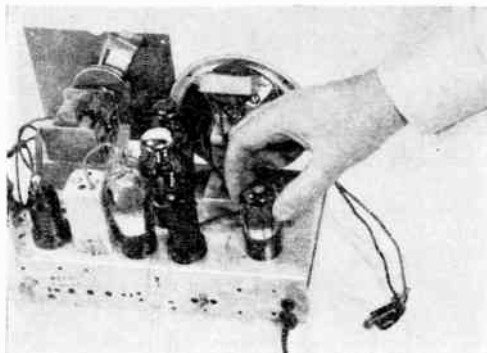

WORK CAN BE SPEEDED UP in servicing old radios with this gadget made from wooden photo tongs, such as is used on wet prints. Switch on the receiver and begin shorting the different fixed resistors. When the defective one is shorted, reception improves.

SOME SERVICEMEN HAVE TROUBLE with the AC-DC receivers that use the 35Z5-GT rectifier tube. This is shown by the pilot bulb blowing out when a new tube is inserted and the set is switched on. When these blowouts occur, the section of the tube's heater—just across the pilot bulb—is defective. As the set is switched on, the pilot bulb carries the load and, of course, blows out. The remedy is to replace the 35Z5-GT.

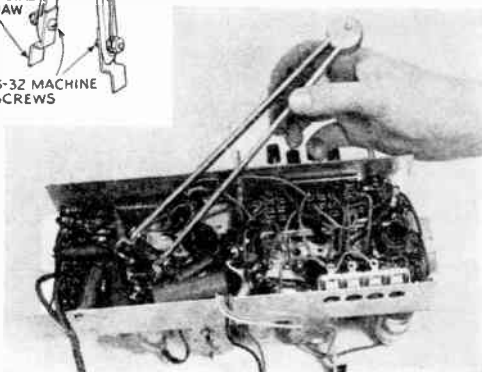
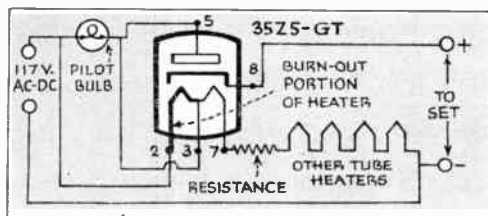

WPB HAS REDUCED TUBE TYPES by some 349 varieties, because they made up only about 1% of the total yearly sales. Smaller GT tubes will replace the larger G types, without loss in output. Sets formerly using a 25Z6-G, or a 25Z6-GT, will now obtain identical results with the 25Z6-GT/G tube.

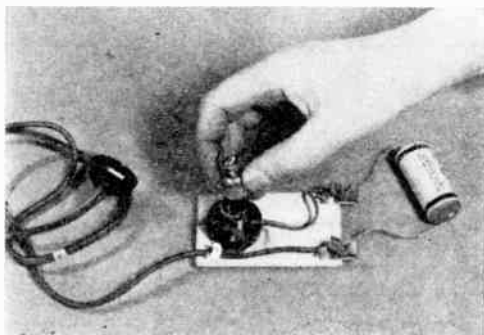

INTERMITTENT AND FADING RECEPTION on some AC-DC receivers and phone combinations is caused by faulty construction of new single-ended tubes, without grid caps. To test for this trouble, tap all tubes with a wooden screwdriver handle, as shown below, and the defective one will induce static. It should be replaced.

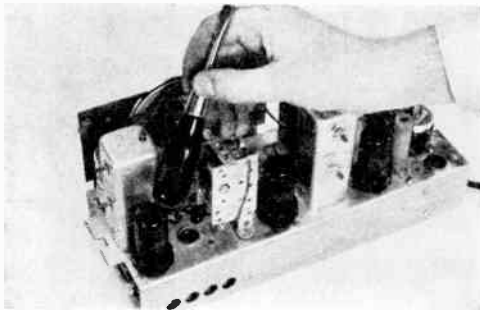

HANDY DEVICE TO HAVE on the workbench is this homemade neon condenser tester. It will work with either paper tubular or mica condensers of any capacity. If the condenser being tested is good, the neon will flash once. But if the condenser is leaky or shorted the neon will glow and sputter, showing it should be replaced. Tester works on DC or 90-v. battery.

Book-Light Radio

MOUNTED on the bracket of a book light, this tiny broadcast receiver will be found extremely useful while reading after you've gone to bed. Earphones, two small batteries, aerial, and ground complete the set. Instead of the usual radio-frequency choke in the plate lead, a 10,000-ohm, half-watt resistor is used, while a padding condenser with a maximum capacity of .0004 mfd. forms the tuning condenser. A similar padding condenser is used as a regeneration control. The tuning coil (L_2) is a midget-type antenna coil such as used in A.C.-D.C. receivers, wound with thirty turns of double-silk-covered wire around the lower end. This unit comprises the ticker coil (L_3).

The cabinet is $\frac{3}{8}$ " thick walnut, $1\frac{1}{2}$ " by $3\frac{1}{2}$ " by $3\frac{3}{4}$ ", glued together and shellacked. Fiber board may be nailed on the back, and the unit fastened to the stem of the book lamp with a single bracket.

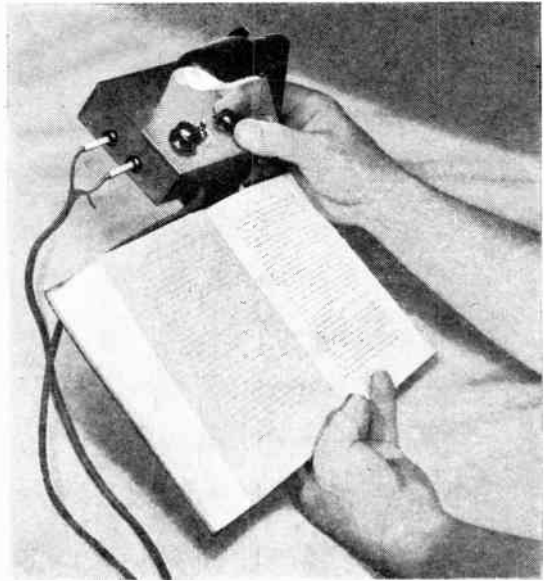

Controls are handy as you read with this radio turned on

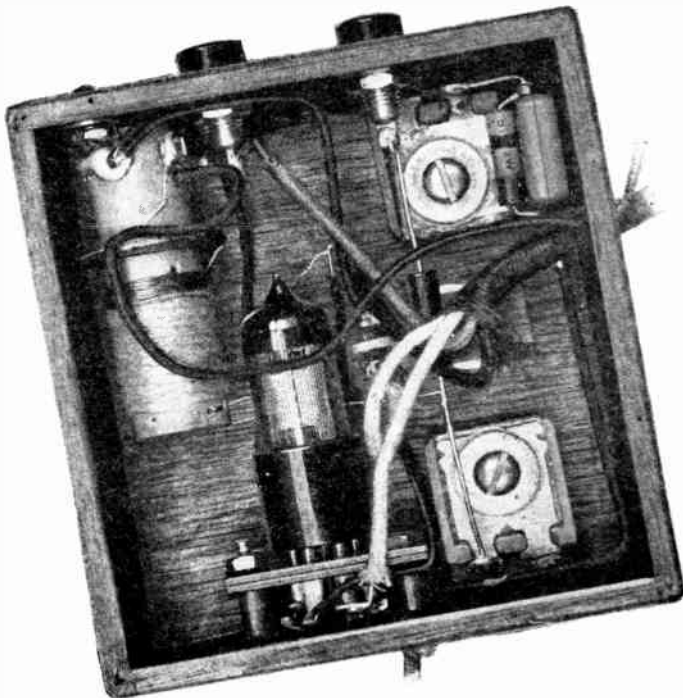

Padding condensers replace the usual-type tuning condensers. Note cabinet details at right

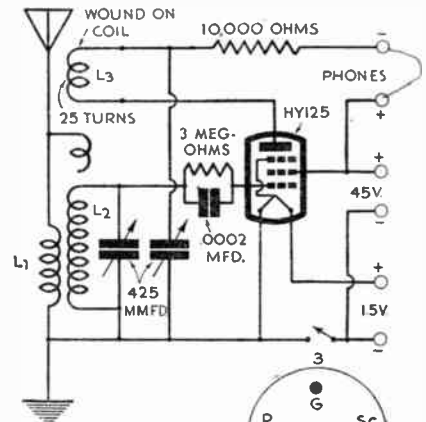

Details of the circuit are shown in diagram. Its tiny $1\frac{1}{2}$ -volt tube uses a 45-volt "B" battery for plate current

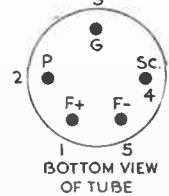

Around-the-World

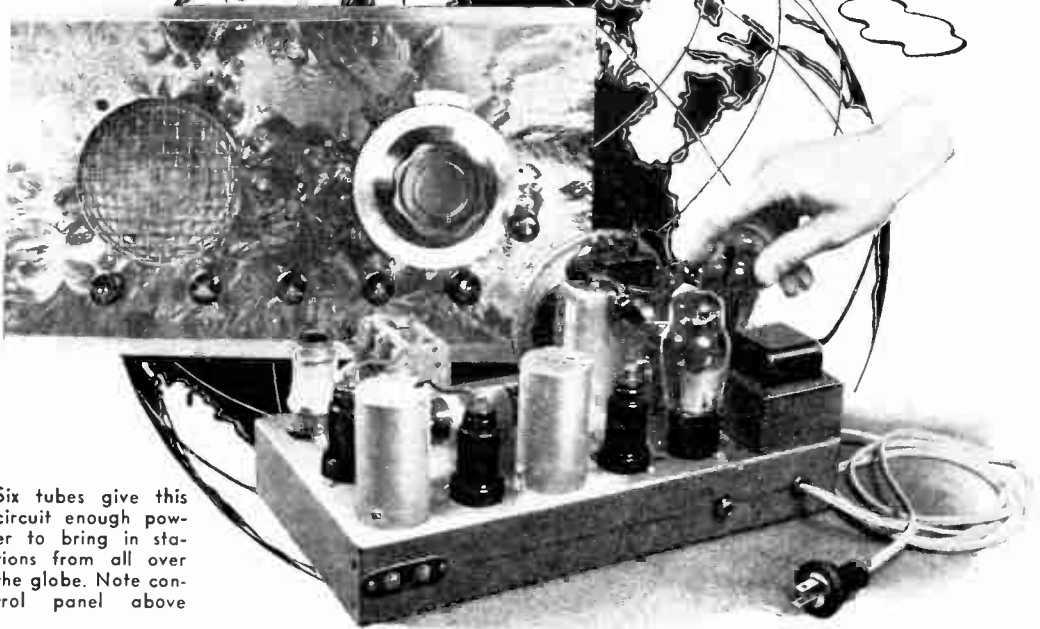

Six tubes give this circuit enough power to bring in stations from all over the globe. Note control panel above

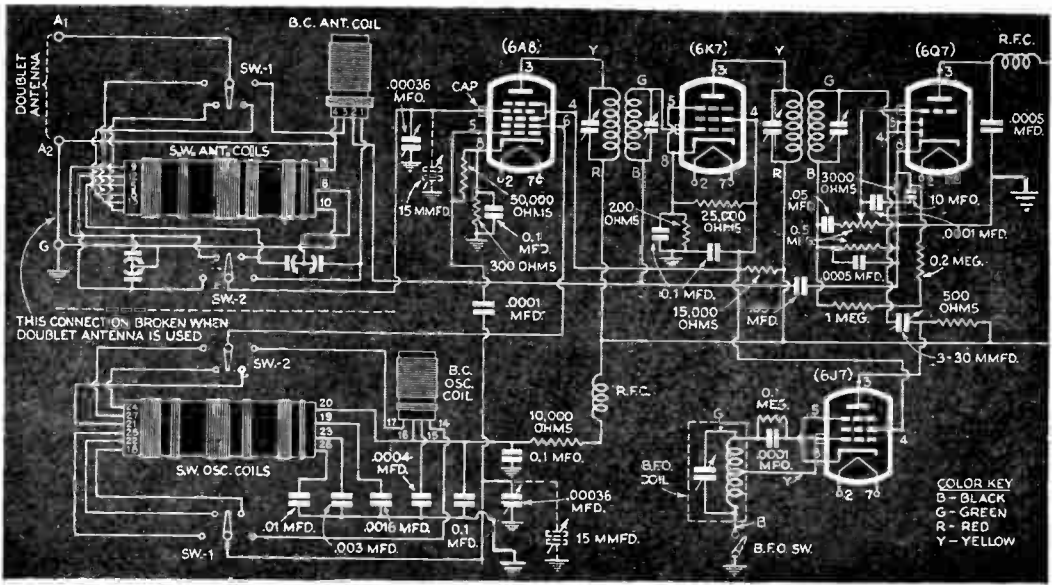

Receiver COSTS \$20 TO BUILD

TWENTY DOLLARS will build this powerful six-tube communications receiver, which includes all the more important features necessary for good all-around reception. Although only six tubes are used, two of these are dual-purpose tubes (the 6A8 which acts as a combined first detector and oscillator, and the 6Q7 which serves as the second detector and first audio amplifier) resulting in eight-tube performance. This set has plenty of power to bring in short-wave stations from any part of the globe.

The circuit covers the entire range from twelve meters up to 550 meters. This range is divided into four bands (550 to 200 meters, 200 to 75 meters, 75 to 35 meters, 35 to 12 meters) by means of a selector-type switch which is noiseless in operation. Among its other features are a sensitive, self-contained dynamic speaker, a stand-by switch, a beat-frequency oscil-



The set includes many of the outstanding features of the latest models

lator with pitch control and on-off switch, automatic volume control, a full-range tone control, and provisions for the use of either a doublet or L-type antenna.

No band spread has been used in the original design as satisfactory results were obtained by the small friction-drive vernier

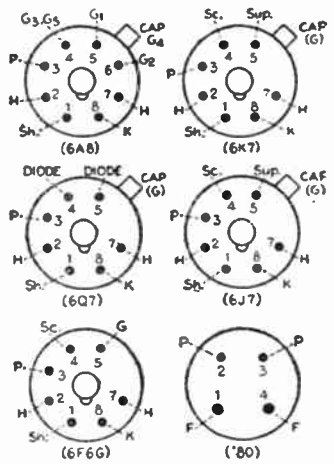
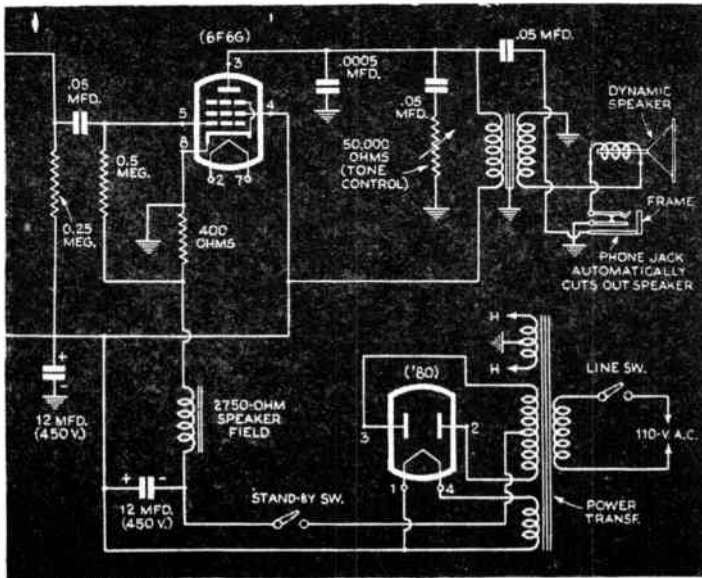

COMPLETE WIRING DATA
for the circuit and the tubes are given in the diagrams at the left and above. A supersensitive band spread is shown in dotted lines

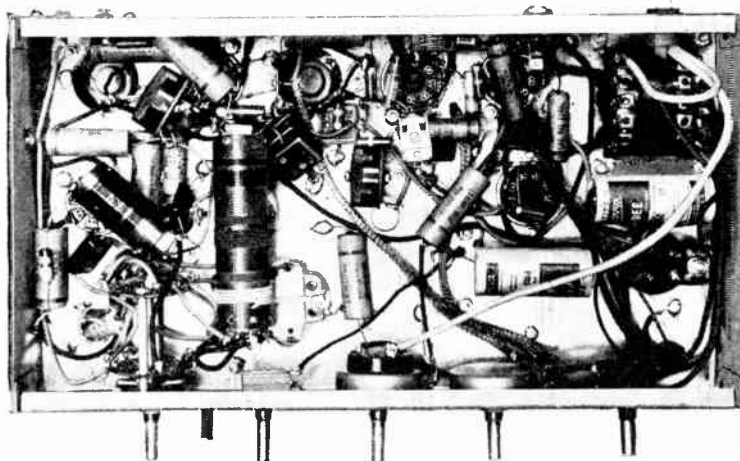
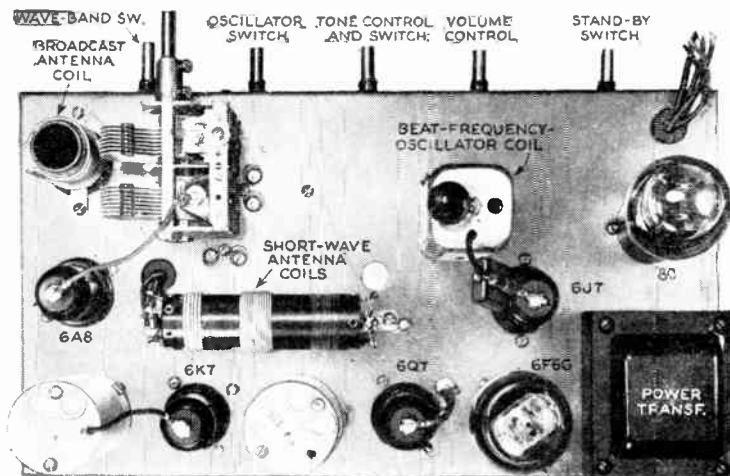

dial shown next to the outer rim of the large tuning dial. Most readers will find this system sufficient for their needs, especially as this vernier control costs only ten cents! However, those who wish to add an electrical band-spread system may do so. It involves only a slight additional cost of from one to two dollars, and consists merely of wiring a two-gang tuning condenser having a very low maximum capacity (approximately fifteen micromicrofarads) across the main two-gang tuning condenser as shown by dotted lines in the diagram. It can be mounted between the speaker and main tuning control. This system is used only for the short-wave bands and becomes inoperative on the broadcast band.

All-metal tubes are used in all stages but the last. In this stage (the output or second audio amplifier) an

PARTS FOR THE COMMUNICATIONS RECEIVER

All-wave coil kit.
Two-gang tuning condenser, .00036 mfd. (two).
Two-gang tuning condenser, 15 mmfd. (two) (see text).
Beat-frequency coil.
One 4-prong and five octal wafer sockets.
Tone control, 50,000 ohm; and switch.
Volume control, 500,000 ohm.
S.P.S.T. rotary stand-by switch.
Five-inch dynamic speaker, 2,750 ohm.
Power transformer.
Two radio-frequency chokes, 2.5 mh.
Padder condenser, 3-30 mmfd.
Two carbon resistors, $\frac{1}{2}$ meg., $\frac{1}{2}$ watt.
Carbon resistor, 1 meg., $\frac{1}{2}$ watt.
Carbon resistor, 250,000 ohm, $\frac{1}{2}$ watt.
Carbon resistor, 200,000 ohm, $\frac{1}{2}$ watt.
Carbon resistor, 100,000 ohm, $\frac{1}{2}$ watt.
Carbon resistor, 50,000 ohm, $\frac{1}{2}$ watt.
Carbon resistor, 25,000 ohm, 1 watt.
Carbon resistor, 10,000 ohm, $\frac{1}{2}$ watt.
Carbon resistor, 15,000 ohm, 1 watt.
Carbon resistor, 3,000 ohm, $\frac{1}{2}$ watt.

Carbon resistor, 500 ohm, $\frac{1}{2}$ watt.
Carbon resistor, 400 ohm, 1 watt.
Carbon resistor, 300 ohm, $\frac{1}{2}$ watt.
Carbon resistor, 200 ohm, $\frac{1}{2}$ watt.
Five tubular condensers, 1 mfd., 400 volts.
Five tubular condensers, .05 mfd., 400 volts.
Tubular condenser, .01 mfd., 400 volts.
Three mica condensers, .0005 mfd.
Three mica condensers, .0001 mfd.
Two electrolytic condensers, 12 mfd., 450 volts.
Electrolytic condenser, 10 mfd., 25 volts.
Mica condensers, .003 mfd., and .0016 mfd. (included in coil kit).
Converter tube 6A8.
Amplifier tube 6K7.
Amplifier tube, 6J7.
Detector-amplifier tube, 6Q7.
Power-amplifier tube, 6F6G.
Rectifier tube, 80.
Dial, 4-inch, with vernier attachment.
Vernier dial, 3-inch (see text).
Miscellaneous: Five dial knobs; aluminum panel and chassis, phone jack; wire.

octal glass tube is used. The same thing applies to the 80, or rectifier, tube.

The purpose of the beat-frequency oscillator is to introduce oscillation into the intermediate-frequency stage so that when tuning to weak or distant stations they will not be missed. With this oscillator in operation, a slight whistle is heard each time a station is passed, much the same as that heard when tuning a one or two-tube receiver with the regeneration control full on.

Another helpful feature is the stand-by

switch. This control cuts out the plate and screen voltages and silences the set but does not disconnect the heaters of the tubes so that the set can be switched back into immediate operation without any waiting for the tubes to heat up.

The intermediate-frequency transformers are of the tuned-grid, tuned-plate type, and are adjusted to the proper frequency before leaving the factory. This adjustment allows for normal stray capacities found in the average receiver, and, unless excessive capacities are introduced such as grid-wire shielding, only a slight touch of the trimmers is necessary to align the intermediate-frequency amplifier. However, an oscillator should be used to align the set on the short waves. This will be done for a nominal sum by your local radio service man.

The cabinet for this set should not cost more than fifty cents and is easily built at home. It is made of white pine three quarters of an inch thick and consists of only four sides, with no front or back. As the aluminum panel overlaps the chassis in length, it will prevent the chassis from sliding in too far, and at the same time provides a means of anchoring the whole set firmly in the cabinet by means of screws at each end of the aluminum panel. The back of the cabinet is left open to provide adequate ventilation for the tubes.

To give a dressier appearance to the control panel, apply a coat of brown, crackle-finish lacquer.

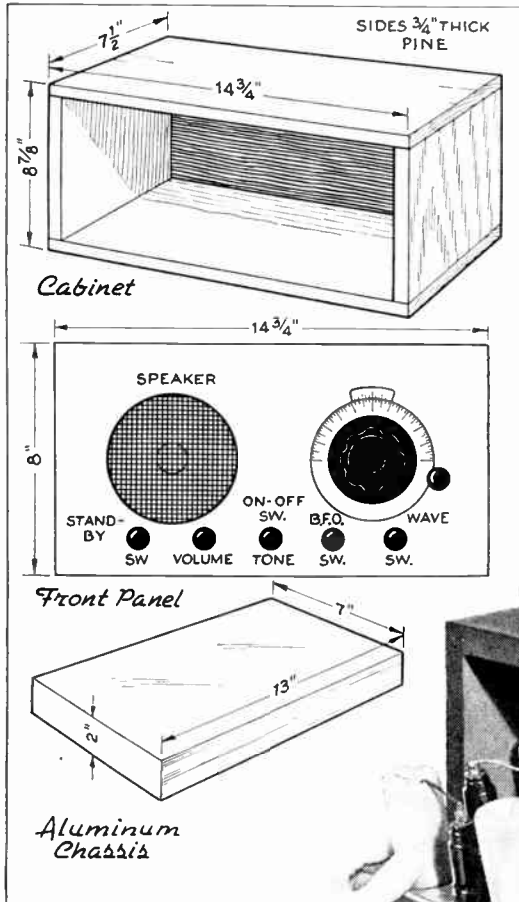

Cabinet, panel, and chassis dimensions and arrangement of controls should be followed closely

The back of the cabinet is left open for ventilation. The chassis is slipped in and held in place by screws



Two-Tube Radio Phonograph



The finished set, ready for use as a radio or phonograph

USING only two tubes, this radio-phonograph combination provides output and quality equal to sets using five tubes or more. It boasts all the features found in combinations using eight tubes, for the two-tube chassis incorporates a variable tone control working on both radio and

records, a volume control (also working on either radio or records), a phonograph switch, and a sensitivity control. The latter is really a regeneration control but differs slightly from the conventional type in that it can be adjusted to below the oscillation point and left in that position while tuning through the entire broadcast band. Usually a regeneration control must be reset as each station is tuned in. Another advantage is that it does not detune the set.

The reader should be able to duplicate this phonograph combination, including the commercial walnut cabinet, for \$27.50. This price includes tubes, pick-up, and phonograph motor.

Fundamentally, the circuit is a tuned radio-frequency receiver using a triode in the detector stage, and a 3:1 shielded transformer in the audio stage. Plug-in coils have been used in both the antenna and radio-frequency circuits. They are tuned by two .000365-mfd., ganged variable condensers. To balance the circuits satisfactorily, the original trimmers on the condensers should be replaced by two others of a slightly higher capacity (3 to 30 mmfd). The coils chosen must have a range of 185 to 360 meters (with a .00014-mfd. condenser). With the .000365-mfd. tuning con-

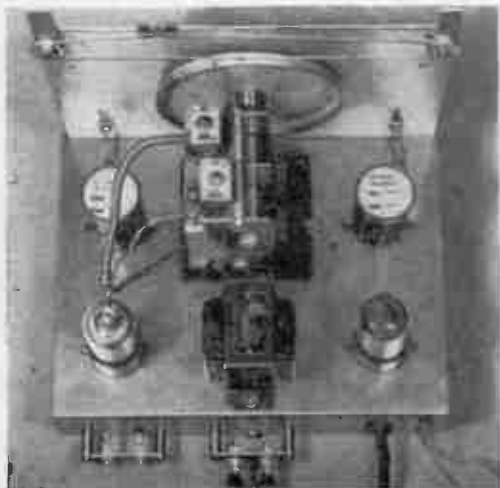

Extreme simplicity marks the layout of the parts on top of the chassis. Coils and tubes are accessible

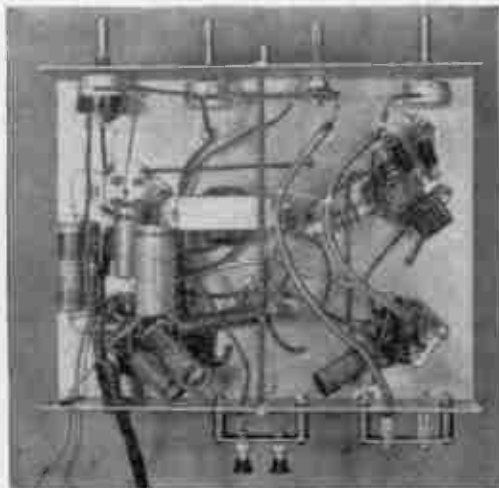

This view of the underside of the chassis will assist the builder in making the various connections

LIST OF PARTS

Six-inch permanent-magnet speaker.

Output transformer.

Radio-phonograph cabinet.

Radio-frequency and detector tube, 12B8GT.

Output and rectifier tube, 32L7GT.

Line cord and resistor, 220 ohm.

Four-prong plug-in coil.

Six-prong plug-in coil.

Two-gang tuning condenser.

Eight-inch slide-rule dial.

Aluminum chassis, 2" by 7" by 9".

Audio transformer, 3:1 ratio.

Variable resistor, 50,000 ohm.

Variable resistor, 100,000 ohm.

Variable resistor, 500,000 ohm.

S.P., D.T. rotary switch.

Filter choke, 13 henry.

Radio-frequency choke, 2.5 mh.

Crystal pick-up.

Phonograph motor.

Trimmer condensers, two, 3—30 mmfd.

Electrolytic condensers, three, 8 mfd.

Tubular paper condensers, two, .1 mfd.

Electrolytic condenser, 25 mfd., 25 volt.

Tubular paper condenser, .05 mfd.

Mica condensers, three, .00015 mfd.

Carbon resistor, $\frac{1}{2}$ watt, 2 meg.

Carbon resistor, 1 watt, 600 ohm.

Carbon resistor, 2 watt, 1,000 ohm.

Mica condenser, .0005 mfd.

Green pilot bulbs, two, 110 volt.

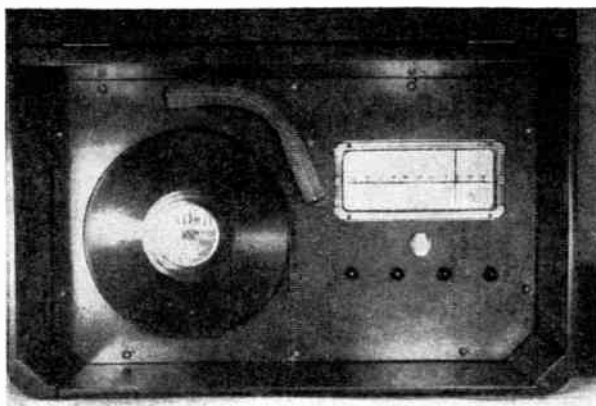

Top view showing phonograph turntable, radio dial, and controls

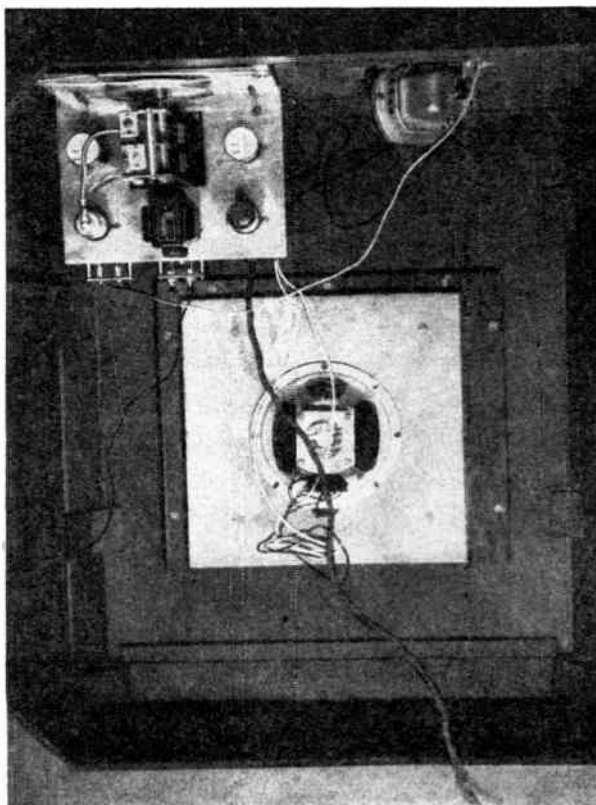

View from behind the set, showing how the ports are mounted

the grid of the output pentode. A single-pole double-throw rotary switch cuts out the secondary of the audio transformer when the pick-up is used. It is important to use a crystal pick-up with this circuit, as a magnetic type will not give sufficient volume.

Three 8-mfd. electrolytic condensers, a 13-henry choke, and a 2-watt, 1,000-ohm resistor, make up the filter network. In the wiring diagram, note that the "B" positive side of the output transformer is connected to a point between the filter choke and the 1,000-ohm resistor.



Built to match the walls, one cabinet holds the phonograph and radio, the other the loudspeaker

Cabinet Ideas for Radio Builders

WITH unmounted radio chassis, home owners handy with tools can build cabinets to harmonize with the decorative scheme of a particular room. Four suggestions are shown in the photographs on this page. At the top, twin cabinets were built of knotty pine, one housing the radio and phonograph and the other the loudspeaker. Other schemes pictured are a unit built into the end of a divan, a modernistic cabinet separating a living room and foyer, and a cabinet for an entrance hall.

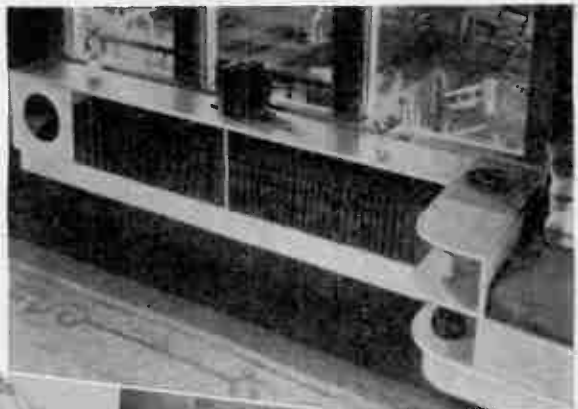

Here are three other methods of adapting the radio to the architectural and decorative scheme of an individual room



SPORTS RADIO Is



CONSISTING of a compact yet powerful battery receiver mounted on a conventional cane-seat which can be purchased for a dollar or two, the radio illustrated forms a handy set for hikers, sports spectators, and campers. The circuit, designed around three of the new American-made midget tubes, consists of a pentode regenerative detector, resistance coupled to a pentode amplifier which in turn is resistance coupled to a second audio-amplifier stage. Regeneration is controlled by a 25,000-ohm potentiometer. Since the commercial type of antenna coil shown in the diagram has no tickler

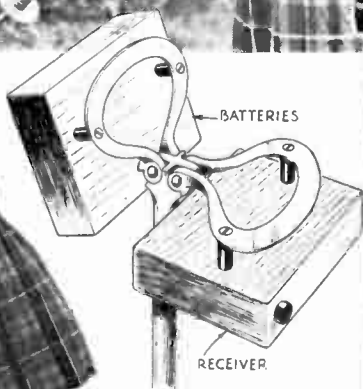

Cabinets mounted on the handles of the cane-seat house the set and batteries

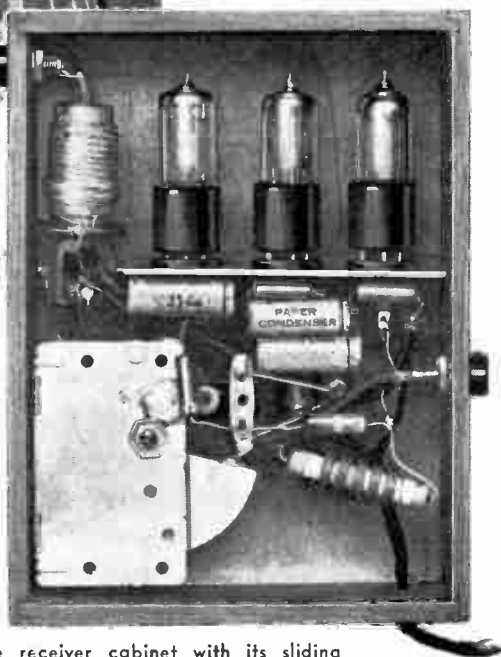

The receiver cabinet with its sliding cover removed to show the three small tubes, tuning condenser, and chassis

Combination Cane and Seat

winding it will be necessary to provide one by winding approximately thirty-five turns of No. 38 double-silk-covered wire around the lower end of the long, flat grid coil.

With the maximum of 45 volts of "B" voltage used, $\frac{1}{2}$ watt, or even $\frac{1}{4}$ watt, resistors can be used, while a maximum rating of 200 volts is sufficient for the .01 mfd. by-pass and coupling condensers. These condensers can be of the paper or tubular type. All other condensers, however, should be of the mica variety.

The receiver and its battery supply are housed in two cabinets each $1\frac{5}{8}$ " by $4\frac{1}{4}$ " by $5\frac{1}{2}$ " and mounted on the handles of the cane. Sliding panels serve as covers and make it an easy matter to change batteries or make repairs. The cabinets are fastened to the aluminum handles by means of long bolts and metal bushings.

Two $1\frac{1}{2}$ -volt cells connected in parallel serve as the "A" battery supply, and may be obtained as a single unit or by breaking open a four-cell "A" battery. The midget

45-volt "B" battery fits snugly beside the "A" cells in the battery cabinet.

For an antenna, a steel fence, the metal cane, or a 35' piece of wire will serve.

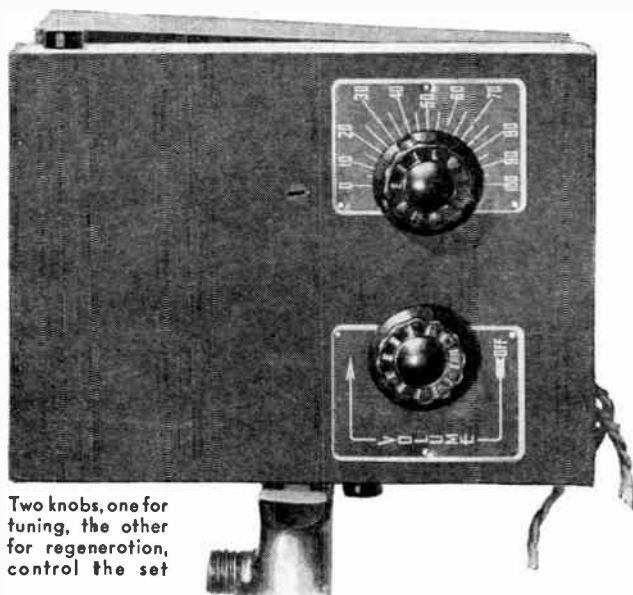

Two knobs, one for tuning, the other for regeneration, control the set

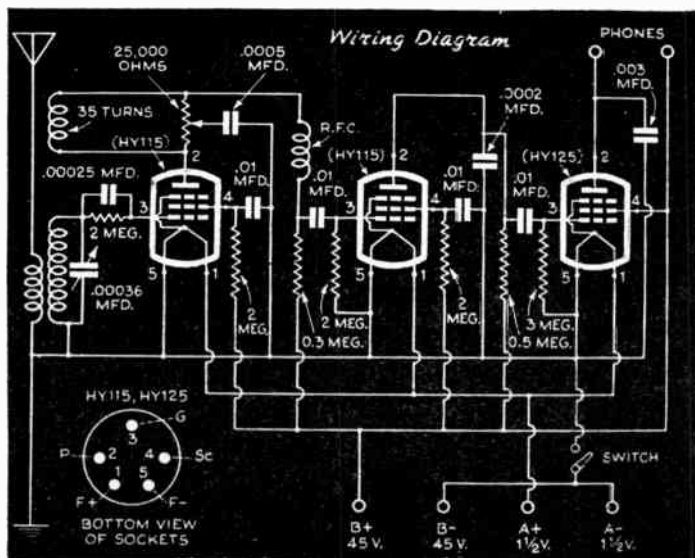

How the circuit should be wired and cabinets and chassis constructed

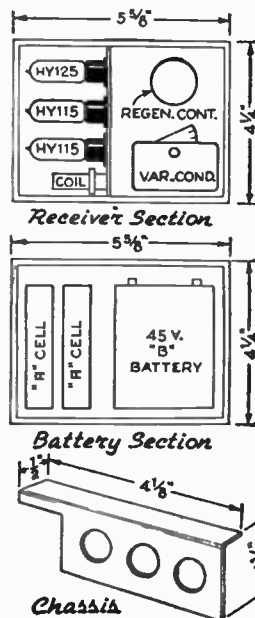



The completed radio, ready to take to vacationland

Midget Portable

FOR YOUR VACATION

FOR SET builders who want a really compact vacation receiver here is the answer. Built around five of the newest midget tubes, the set illustrated requires only two small batteries and weighs only 7¼ pounds complete with loudspeaker and built-in antenna. The superheterodyne circuit is particularly powerful and gives exceptional tone and volume.

The 4¾" by 5¾" by 8¼" cabinet was built up of 3/16" pressed composition wood, although plywood could be used as well. When the top, bottom, and two end pieces have been cut to size and carefully trued up, each of the four joints should be fastened

Careful arranging of the parts and batteries makes it an extremely compact portable set

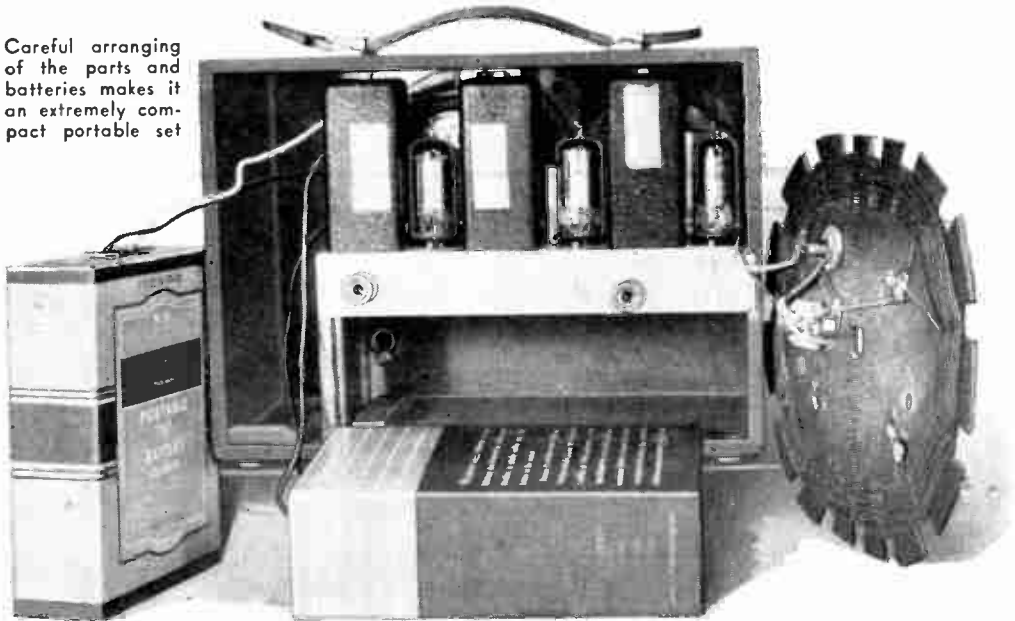

with cellulose cement and two $\frac{1}{4}$ " round-head wood screws. These screws serve mainly to hold the pieces together while the cement dries thoroughly. All holes should be countersunk so the screw heads can be covered with wood putty. As a finish the case can be given two coats of clear lacquer with a sanding before and after the first, and a final rubbing down with pumice and rottenstone after the second, followed with wax.

The receiver itself is built on a 1/16-inch aluminum chassis. The various parts should first be spotted in place and the mounting and connection holes drilled.

A homemade vernier dial is used to drive the

Top and bottom views of the chassis, below, will aid you in building the tiny receiver

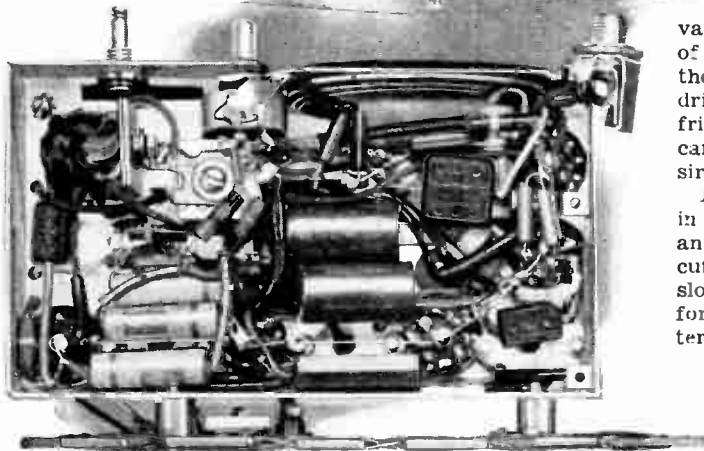
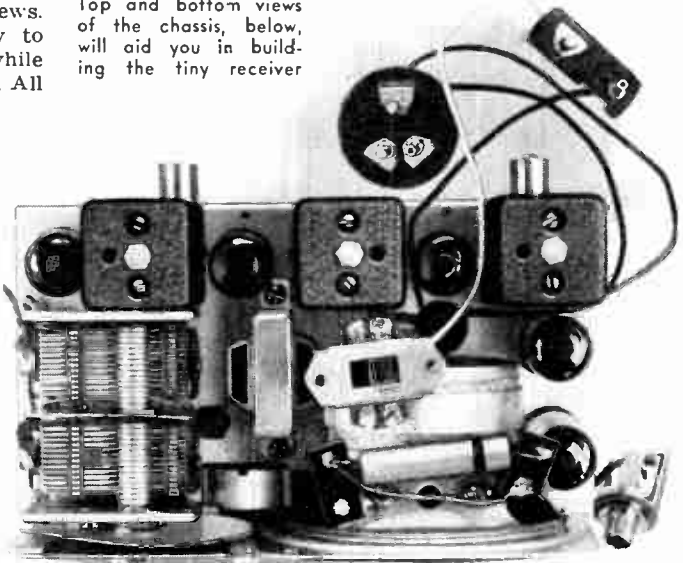

variable condenser. It consists of a celluloid disk fastened to the shaft, and turned by the drive shaft taken from an old friction dial. A regulation dial can be used, of course, if desired.

A fiber form should be used in winding the built-in loop antenna. The tabs should be cut 1" deep all around with the slots $\frac{3}{8}$ " wide. In making the form first mark the $5\frac{1}{2}$ " center line. Then with points A and B as centers, draw semicircles with a $1\frac{5}{8}$ " radius joining them top and bottom. Place the $\frac{3}{8}$ "

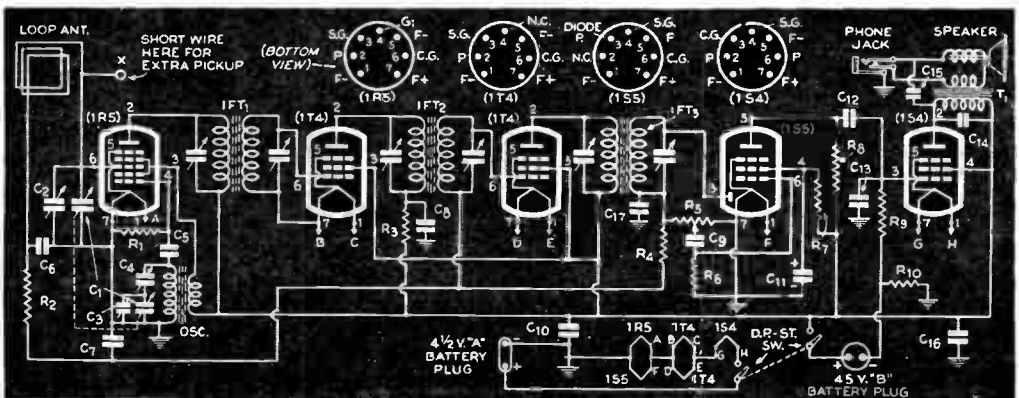

Follow this wiring diagram carefully. The symbols refer to the text and the parts list on the next page

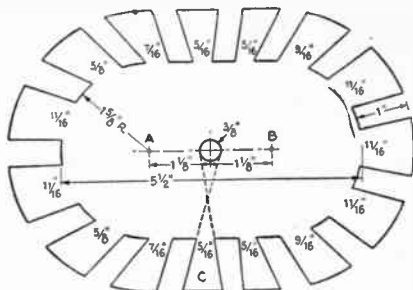
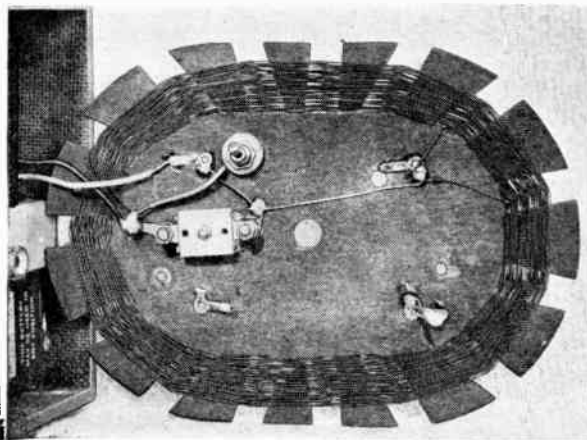

You should have no trouble making this directional loop antenna. Note the extra connection below for attaching a supplementary antenna when desirable

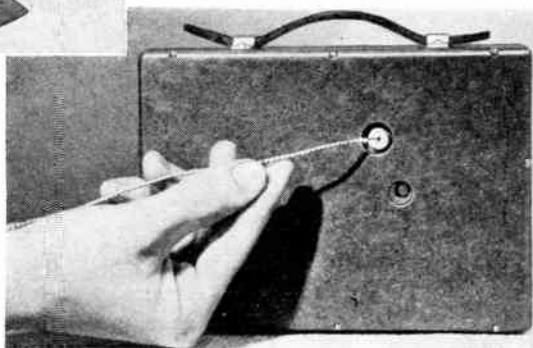
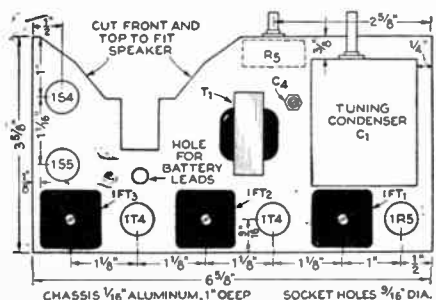

diameter circle at the center of the oval. The figures on each tab show the widths at the inner ends. Starting at tab C, mark the sides by lines such as those shown dotted. Proceed all around the oval in this manner, then cut out the openings. The loop contains 34 turns of No. 24 D.S.C. wire wound on opposite sides of adjacent slots.

A 30-mmfd. trimmer condenser (C_2) should be fastened to the loop form so that it can be reached through a hole drilled in the back of the case. A terminal for the connection of a short wire for extra pick-up in poor localities also should be provided. The loop should be fastened to the rear of the chassis with two screws.

An on-off switch is provided at the top of the case under the handle. For reception of weak signals, or in locations where quiet must prevail, headphones are required. A jack on the front panel is included.

When the set is in use, the loop antenna will be found highly directional, minimum signal pick-up occurring when the plane of the loop is at right angles to the station being received. This minimum, or "null point," can be used for approximate direction finding in the woods or on a boat.

LIST OF PARTS

Condensers: C_1 .—Two-gang variable, 350 mmfd. each section.
 C_2 .—Trimmer, 3-30 mmfd.
 C_3 .—(On C_1).
 C_4 .—Padder, 500 mmfd.
 C_5, C_{17} .—Mica midget, 50 mmfd.
 $C_6, C_7, C_8, C_9, C_{12}$.—Paper, .01 mfd., 400 volt.
 C_{10} .—Paper, domino type, 25mfd., 200 volt.
 C_{11}, C_{16} .—Midget electrolytic, 10 mfd., 50 volt.
 C_{13} .—Mica midget, 100 mmfd.
 C_{14} .—Mica midget, .004 mfd.
 C_{15} .—Paper, .05 mfd.
Resistors: R_1 .—100,000 ohm, $\frac{1}{2}$ watt.
 R_2 .—.25 meg., $\frac{1}{2}$ watt.
 R_3 .—20,000 ohm, $\frac{1}{2}$ watt.
 R_4 .—2 meg., $\frac{1}{2}$ watt.
 R_5 .—Variable, .5 meg.
 R_6 .—10 meg., $\frac{1}{2}$ watt.
 R_7 .—3 meg., $\frac{1}{2}$ watt.
 R_8 .—1 meg., $\frac{1}{2}$ watt.
 R_9 .—.5 meg., $\frac{1}{2}$ watt.
 R_{10} .—200 ohm, $\frac{1}{2}$ watt.

Transformers: T_1 .—Midget, output, 8,000 to 3 ohm.
 IFT_1 .—Iron-core, input, intermediate frequency.
 IFT_2 .—Iron-core, interstage, intermediate frequency.
 IFT_3 .—Iron-core, output, intermediate frequency.

Miscellaneous: Batteries, 3-inch permanent-magnet speaker, five tubes sockets, $\frac{1}{4}$ pound No. 24 D.S.C. wire for loop, case, etc.

Servicing Your Radio



TESTS ON BATTERIES from a portable receiver should always be made with a voltmeter—it is the only testing instrument that will show accurately the effective voltage of a battery. It is risky business to use any other device, including a flashlight bulb or an ammeter, since many of them are likely to affect the life of a battery materially. An ammeter—especially bad to use for this purpose—has a low resistance and will short a battery when placed across it. Invariably it will also give a high reading even when a battery is badly run down.

STRIPS CONNECTING THE LOOP ANTENNA inside the cover of some midget portable receivers are likely to wear and break off near the hinge as a result of frequent opening and closing of the lid. When such a break occurs, reception stops. These metal strips can be repaired, however, with short lengths of twisted metal cord like that used in repairing radio dials. Remove the broken part of the original metal strips at their connection with the two wires inside the set; then solder one end of the cord to each of these wires, and solder the other end to that portion of the strips connected to the antenna.

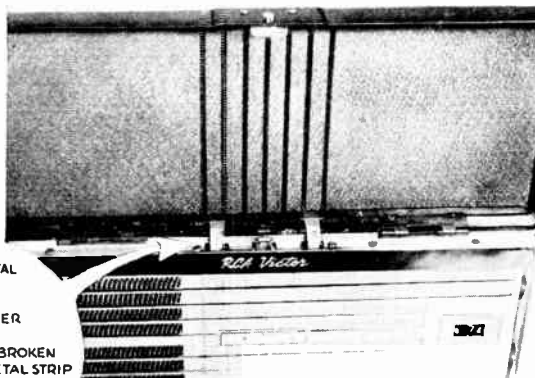
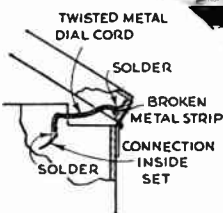

Where a loop-antenna connection is likely to break. Repair it as shown at the left

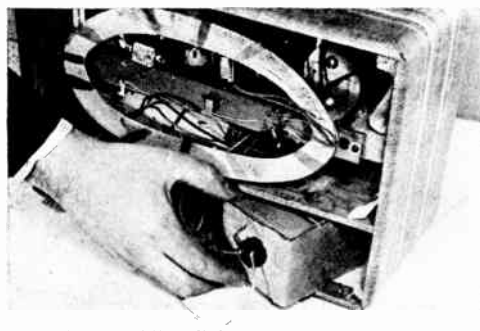

BATTERIES THAT DO NOT FIT TIGHTLY in their compartment will not knock about if wrapped in corrugated cardboard. A round hole cut in one piece of the material will permit insertion of the battery plug. To conserve your battery, turn off the receiver when it is not in actual use. If you have a three-way set, use electric current when possible. Batteries kept outside the case at 60-deg. temperature may last 18 months.

THREE SEPARATE PLUGS can be substituted for a single battery-pack plug, as shown in the drawing below, to permit use of separate "A" and "B" batteries with a portable if a battery pack cannot be obtained. In removing any plug from a battery, always grasp the plug itself. Never tug on the wire, for this may pull the insulation back, and a short caused by wires touching can render a battery useless in 15 minutes.

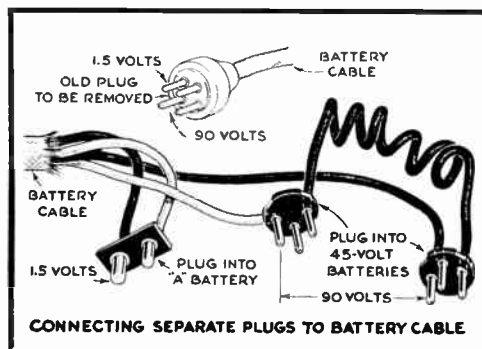



How the electric speaker set fits conveniently on the head of a bed

BED RADIO

CONVENIENTLY hung over the back of a bed, this small radio will bring programs within easy control of late night readers or convalescents. The cabinet and chassis layout have been carefully planned in order to compress the complete set in as small a space as possible without loss of efficiency.

Measuring $7\frac{1}{2}$ " square, and with a depth of only $2\frac{3}{4}$ ", the cabinet houses a powerful tuned-radio-frequency receiver with a radio-frequency detector, and audio and rectifier stages. Yet only two tubes are used—an important factor in reducing the overall size. One tube, the 12B8GT, contains an RF pentode and high-mu triode, which are used for the RF and detector stages, respectively. The other tube, the 25A7GT, contains the pentode output amplifier and the half-wave rectifier.

Instead of these tube types, the reader may use the newer low-drain models, the 25B8GT and the 70L7GT. If these tubes are used, the line-cord resistor will have to be changed to one having a built-in resistance of 135 ohms instead of 220 ohms. Also, the connections to the 70L7GT tube differ slightly. Connections to the 25B8GT are similar to those of the 12B8GT.

No other changes are necessary in the circuit.

A compact two-gang variable condenser tunes the antenna and the RF coils. The antenna coil is unshielded, and is mounted right next to the 12B8GT tube. The RF coil, though shielded, is mounted in an unconventional way—upside down. However, it is still thoroughly shielded and in this new position makes the wiring of the set a lot easier. The small screw on top of the can, which holds the coil in place, is unscrewed and passed through a hole in the chassis to anchor the shielding can and coil securely in place.

Volume is controlled in the conventional manner, by varying the grid bias on the RF tube, using a 50,000-ohm potentiometer between the antenna and cathode of the RF pentode. A 300-ohm, $\frac{1}{2}$ -watt fixed resistor in series with the potentiometer keeps the tube always slightly biased. Ganged with the 50,000-ohm volume control is the S.-P., S.-T. on-and-off switch. To provide greater stability in the RF stage, the screen of the pentode (12B8GT) is decoupled by means of the 5,000-ohm, $\frac{1}{2}$ -watt resistor and the .05-mfd. tubular by-pass condenser.

The cabinet is constructed of pine, with

The wired chassis looks like this before being placed in the cabinet. Careful designing makes it extremely compact

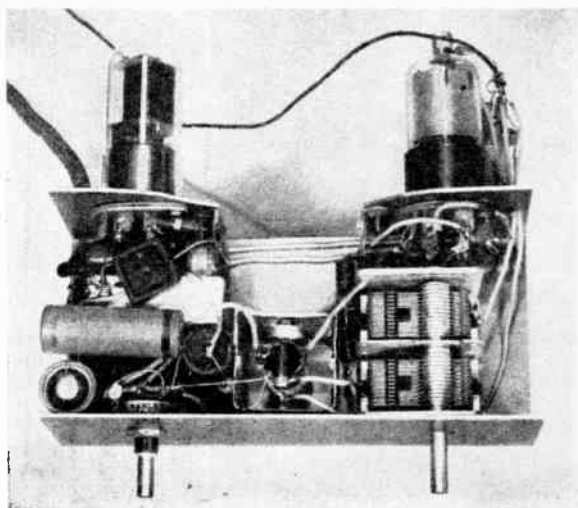

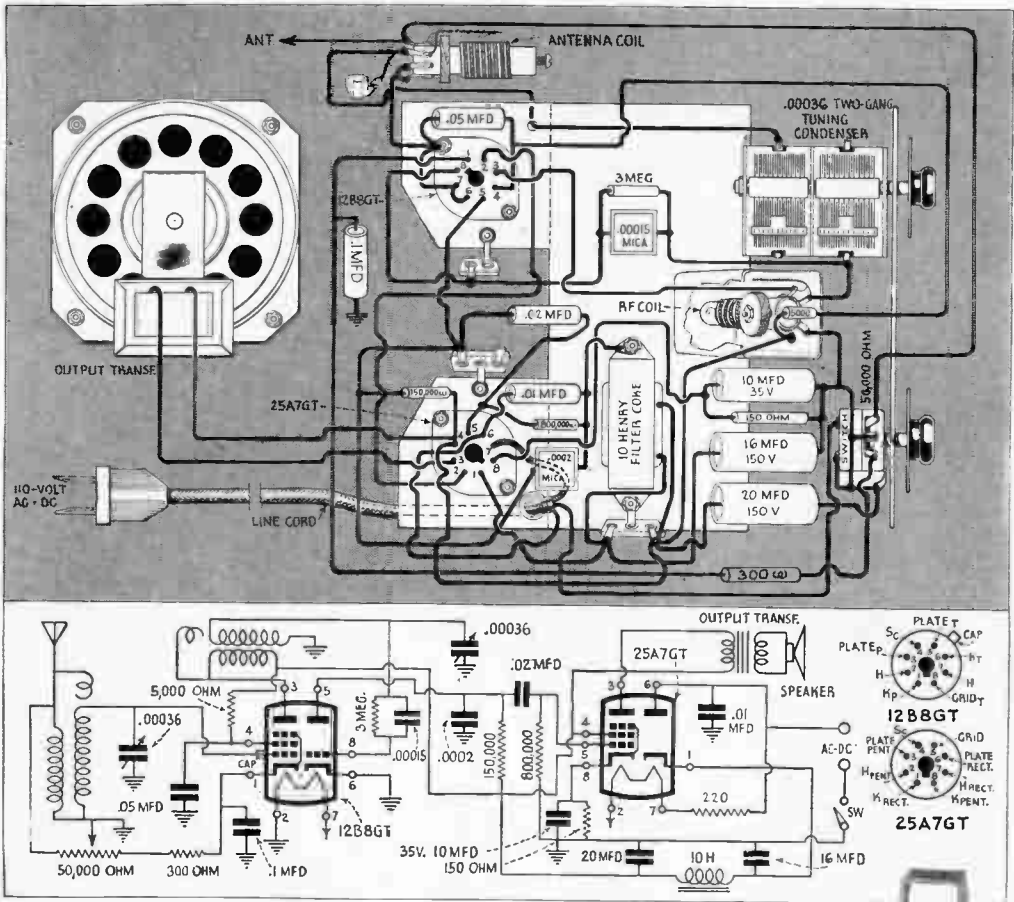

The pictorial diagram above makes it easy to follow the wiring connections

View below shows the cabinet and speaker, with chassis ready to be installed. Right, angle view of the finished set and brackets

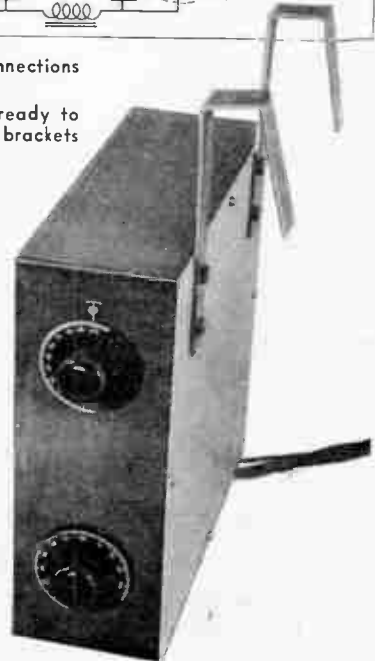
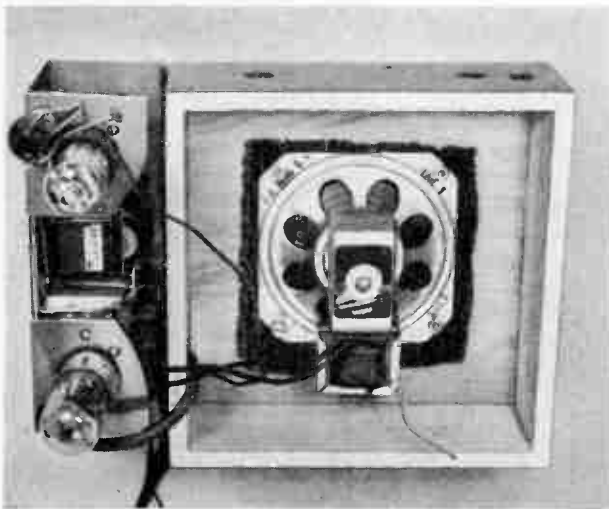

the sides $\frac{3}{8}$ " thick and the front about $\frac{5}{16}$ ". A round hole of $3\frac{5}{8}$ " diameter is cut in front for the speaker and decorated with a round escutcheon from a tuning dial. The escutcheon may be purchased separately at any large radio store. Aluminum $\frac{1}{16}$ " thick is used for the back. To it, two brass strips $\frac{3}{4}$ " wide, previously bent in a vise, are attached—each with two $\frac{6}{32}$ machine screws and hex nuts. The angles shown in the drawing will do for most low-backed beds.

The large ventilator hole on the bottom side of the cabinet prevents the heat generated by the tubes from remaining inside the cabinet and melting the wax insulation on the tubular condensers, or causing damage to the finish on the bed (if wood) by heating up the aluminum back.

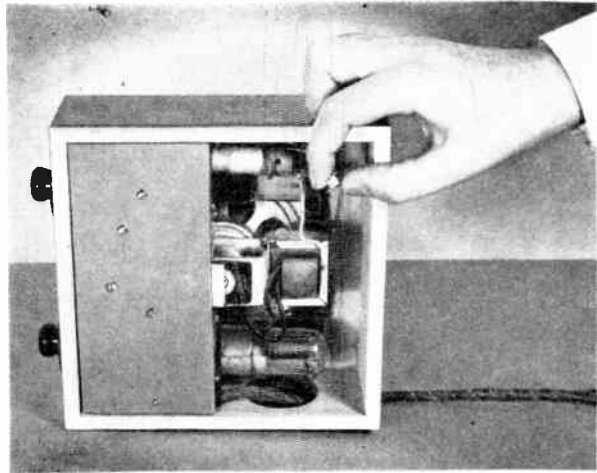

Rear panel before mounting. Chassis and cabinet details below

LIST OF PARTS

- Two-gang tuning condenser, .00036 mfd.
- Antenna coil, unshielded.
- RF coil, shielded.
- Filter choke, 10 henry.
- Line cord, 220 ohm (see text).
- 12B8GT tube (see text).
- 25A7GT tube (see text).
- Permanent-magnet speaker, 4".
- Output transformer.
- Potentiometer, carbon, 50,000 ohm.
- S. P. S. T. switch.
- Octal wafer sockets (two).
- Carbon resistor, 150 ohm, 1 watt.
- Carbon resistor, 300 ohm, $\frac{1}{2}$ watt.
- Carbon resistor, 5,000 ohm, $\frac{1}{2}$ watt.
- Carbon resistor, 150,000 ohm, $\frac{1}{2}$ watt.
- Carbon resistor, 800,000 ohm, $\frac{1}{2}$ watt.
- Carbon resistor, 3 meg., $\frac{1}{2}$ watt.
- Electrolytic condenser, tubular, 10 mfd., 25 volt.
- Electrolytic condenser, tubular, 16 mfd., 150 volt.
- Electrolytic condenser, tubular, 20 mfd., 150 volt.
- Tubular condenser, .1 mfd., 400 volt.
- Tubular condenser, .05 mfd., 400 volt.
- Tubular condenser, .02 mfd., 400 volt.
- Tubular condenser, .01 mfd., 400 volt.
- Mica condenser, .00015 mfd.
- Mica condenser, .0002 mfd.

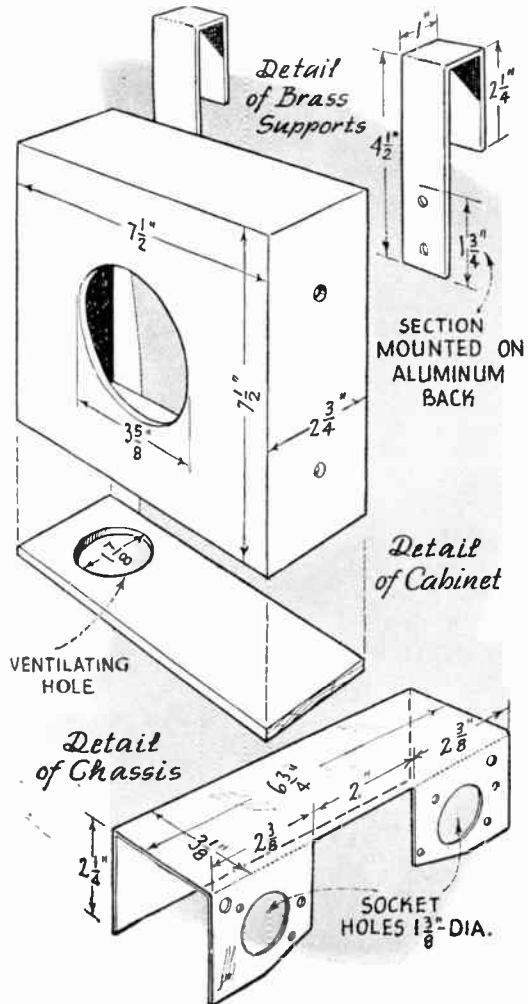

Suppressor Built from Junked Parts Reduces Man-Made Static

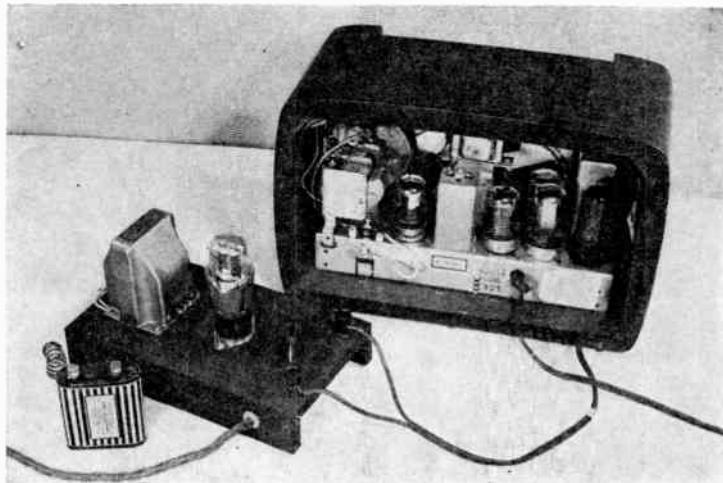

Left, the unit connected to a small AC-DC receiver. It may be used with almost any type of radio

A top view of the unit is shown in the first photo below. Few connections are necessary, as can be seen in second photo. Drawing shows how the static suppressor is hooked up to a receiver

OWNERS of sets ranging all the way from headphone "one-lungers" to 12-tube console models may find good use for this static suppressor. Easily attached across the output circuit, it will in most cases reduce severe man-made static by at least 50 percent. There is a slight loss of volume, but this can be overcome by turning the volume control.

The unit comprises a full-wave rectifier tube (such as the 6X5-GT/G or 50Z7-G), a push-pull output transformer, a 220-ohm line-cord resistor, a S.P.S.T. toggle or rotary switch, and a 4½-volt "C" battery. The secondary of the output transformer must have a high resistance. One of the old output transformers used with magnetic speakers will do admirably, and may be retrieved from the junk box. A class "B" interstage transformer might be tried, but make sure that the primary winding passes enough current. It is useless to attempt to use a transformer with an 8-ohm secondary.

Any kind of chassis, wood or metal, may be employed. The transformer, eight-prong tube socket, and switch are mounted on the top of the chassis. Drill ½" holes in the back for the line cord and the two leads to the "C" battery. The secondary leads of the output transformer (primary side if it is a class "B" interstage transformer) are connected to two plastic binding posts, which provide connections to the set.

Remove the radio chassis from the cabinet. Connections are then made to the plate of the last tube and the B+ lead. The leads from the unit to the radio chassis should not exceed 3' or 4'.

LIST OF PARTS

Chassis, metal or wood	Small "C" battery, 4½ volts
Full-wave rectifier tube	Line-cord resistor, 220 ohms
6X5-GT/G or 50Z7-G	Binding posts (2)
Eight-prong octal wafer socket	Rotary or toggle switch,
Output transformer (see text)	S.P.S.T.

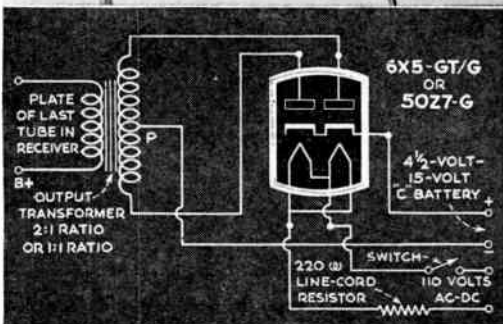
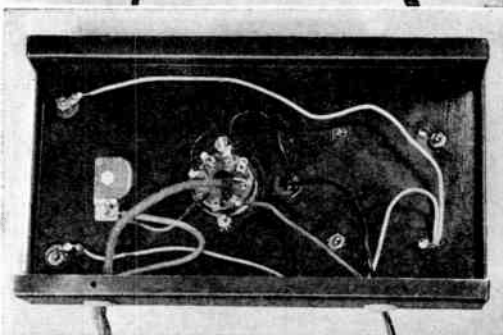
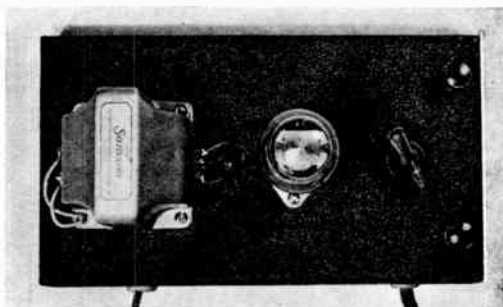

BATTERIES POWER COMPACT EMERGENCY RECEIVER



This portable set, designed for defense organizations, picks up near-by broadcasts without the use of a ground

DESIGNED to meet the requirements of defense organizations, this is a portable emergency short-wave receiver that eliminates the use of bulky "B" batteries without sacrificing power, quality, selectivity, or sensitivity. Instead of the usual 90- to 135-volt "B" batteries, the metal carrying case comfortably encloses, in addition to the usual "A" battery, two small "C" batteries which reduce the plate voltage to eight or nine and cut the filament voltage in half. Since the "emission life" of a tube is greatly lengthened when operating at a reduced voltage, the life of the tubes in this novel receiver may be at least doubled.

The new single-ended, all-metal 6.3-volt AC-DC tubes (6SJ7) or the single-ended glass type 1½-volt battery tubes (1SA6GT) can be interchanged in the set without any rewiring. The choice of either tube depends on whether you want a husky tube that will take more abuse in the field or a tube that will conserve the batteries to their limit. The metal tubes consume more electricity, but they are more robust for portable use and are slightly more sensitive. The glass tubes conserve electricity, but they are not so serviceable in the field.

Filament voltages are extremely critical in both types of tubes and any variation—even as little as 1/10 of a volt—will reduce the power of the receiver. In fact, if the tubes are



Tubes shown here are the new all-metal, 6.3-volt 6SJ7 type, but battery 1SA6GT tubes will serve

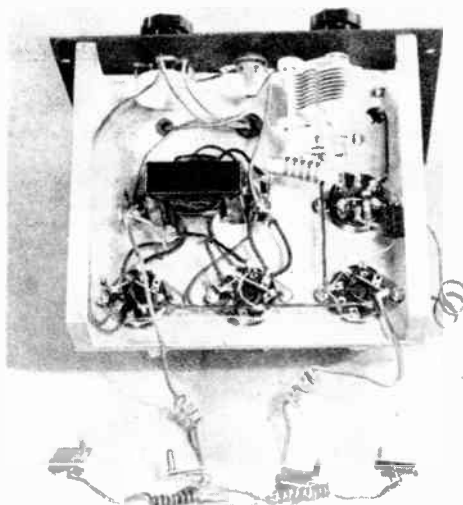

View of the receiver chassis from the underside, showing the wiring and connection to phone clips

operated at their normal voltages, the set will stop functioning. For this reason a voltmeter is placed on the front panel for a visual indication of the "A" batteries' current. The knob directly under the voltmeter operates a 10- to 15-ohm rheostat which controls the filament supply.

But for special tube connections, the set is built with a standard detector plus two audio-frequency amplifying stages. Inter-stage coupling is achieved by means of two unshielded 1:3 audio transformers, one mounted above the chassis and one below. The output of the receiver is fed directly into a pair of magnetic 2,000- to 4,000-ohm headphones. These phones can be plugged into the front of the panel.

Plug-in coils enable an operator to tune in on various wave bands ranging from 16 to 1,000 meters. This includes ship-to-shore, broadcast, aviation, police, foreign, and domestic transmission. If

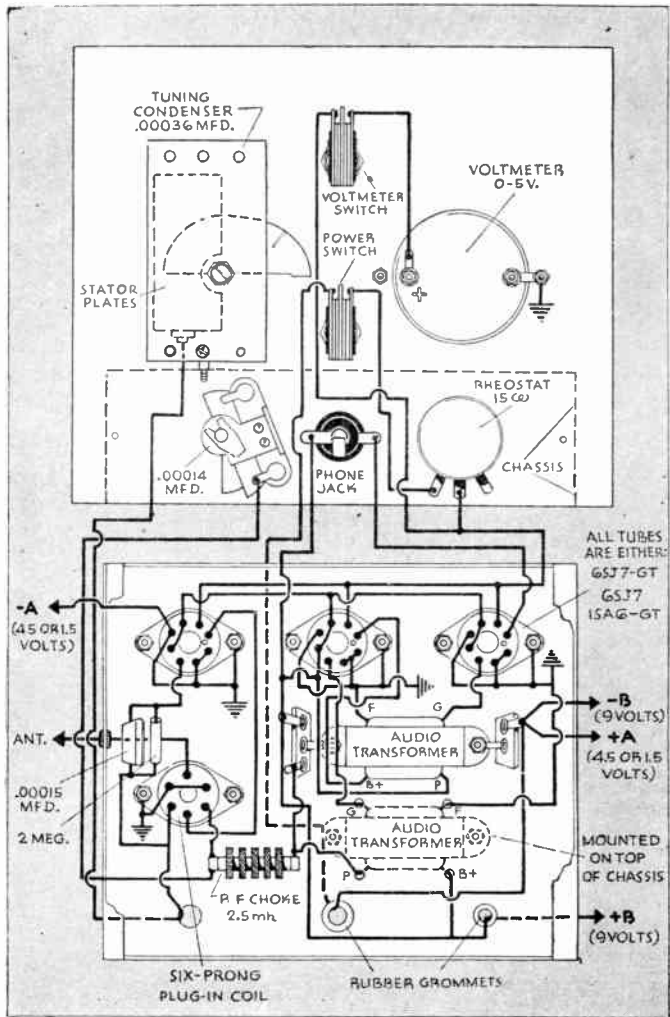

Two midget "C" batteries with low voltage replace the bulky "B" battery, lengthening the "emission life" of the tubes

Pictorial diagram of the compact, portable emergency receiver. This shows in detail the placing of the parts both on the chassis and on the front panel. In making the connections, solder should be used

Below is a complete wiring diagram in simplified form to be followed in making connections. A tickler-winding coil is used in the antenna

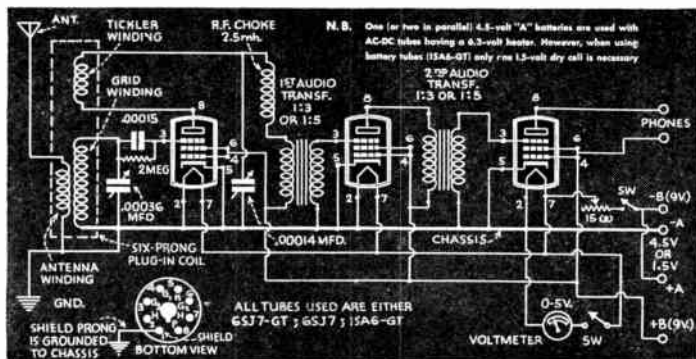
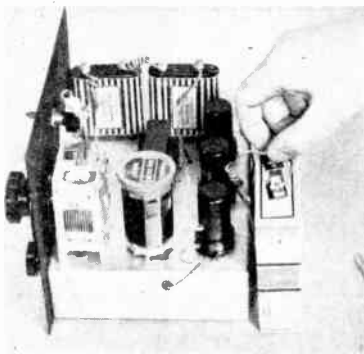

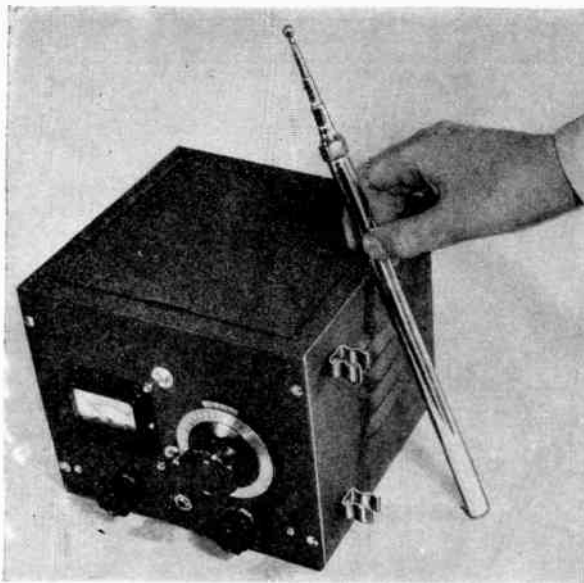

Clips on the cabinet next to the tuning condenser hold the telescopic, metal antenna when the radio is in operation. These clips must be fully insulated from the metal cabinet

the set should fail to oscillate on a particular band, this may be remedied by increasing the capacity of the variable condenser used for regeneration to .00036 or by increasing the number of turns on the tickler winding. It should be noted that the coil specified by the manufacturer for use as the tickler winding is used instead as the antenna winding.

Batteries and headphones can be housed in the metal carrying cabinet. When the operator is ready to use the set, he merely removes the headphones from the case and plugs them into a jack on the front of the panel. Two inexpensive luggage straps, purchased from the five-and-ten-cent store, can be placed around the cabinet for carrying purposes.

The antenna consists of a telescopic metal rod similar to those used on cars. It is clipped to the cabinet next to the tuning condenser when the set is in operation. The clips must be fully insulated from the metal cabinet, which is connected to the ground circuit.

If the receiver is operated within 20 or 30 miles of a transmitter, it will work efficiently without a ground connection. For distant or weak stations, however, a ground must be used. A suitable ground can be made by connecting 5' of insulated wire to a metal rod about 5" long and 1½" in diameter. The wire should be connected to either the front panel or the chassis and the rod inserted in the ground.

The emergency receiver shown in the illustration was constructed for about \$15, but changing conditions in the radio-equipment field make it impossible to give any definite figures on cost. The set has been tested under adverse conditions where reception was faint on similar radios and has given excellent results.

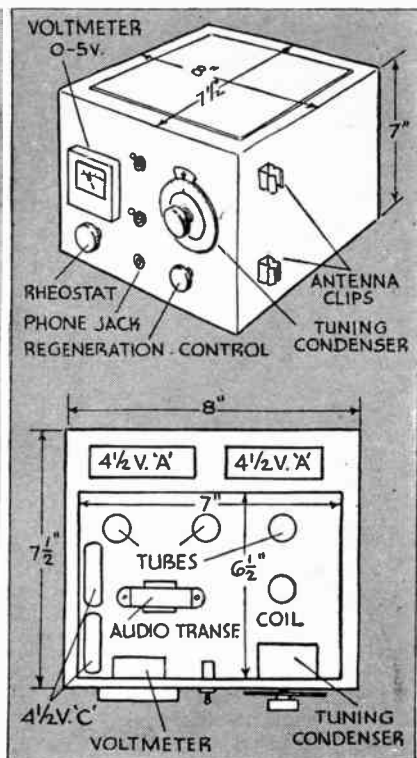

LIST OF PARTS

- Black wrinkled steel cabinet, 7" by 7½" by 8".
- Cadmium-plated steel chassis, 2" by 5½" by 7".
- Telescopic chrome-plated antenna.
- Tuning dial, 2¾" diameter.
- Octal wafer sockets (3).
- Six-prong coil socket.
- Six-prong broadcast and short-wave coils.
- Tuning condenser, .00036 mfd. or .00014 mfd.
- Regeneration condenser, .00014 mfd. or .00036 mfd.
- Audio transformers (2), unshielded, 1:3 or 1:5 ratio.
- Ground clamp and wire.
- RF choke, 2.5 millihenrys.
- Rheostat, 10-15 ohms.
- Voltmeter, 0-5 volts.
- Toggle switches (2).
- Phone jack and plug.
- Mica condenser, .00015 mfd.
- Carbon resistor, 2 megohms, ½ watt.
- Midget "C" batteries (2), 4½ volts.
- "A" battery, 1½ or 4½ volts.
- Pentode amplifier tubes (3), 6SJ7 or 1SA6GT.

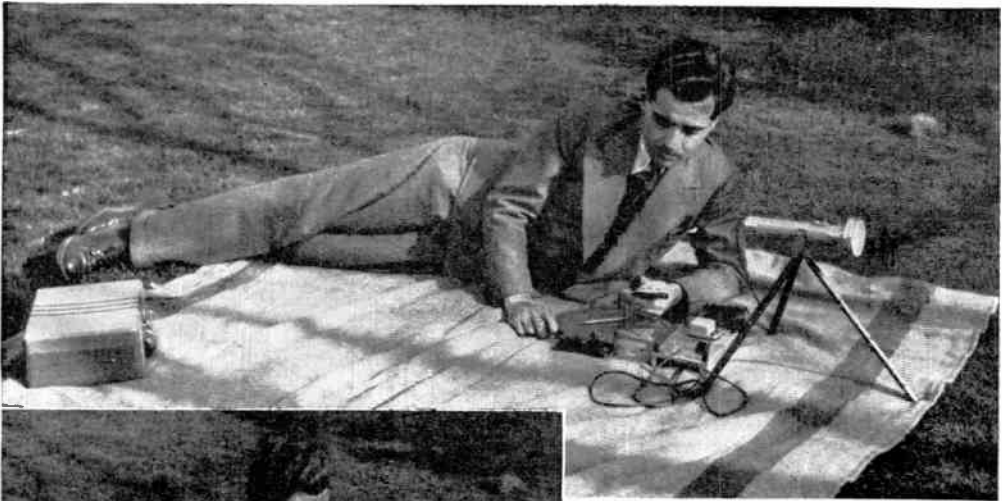

The operator taps out a code message on an ordinary telegraph key. Below he sights along the barrel to aim the flash light

LIGHT-BEAM TRANSMITTER

CODE MESSAGES that can be detected only with a specially built receiver may be sent with this light-beam transmitter. With a 3- or 4-cell flash light, preferably of the type with which the light rays can be focused into a spot, messages can be sent up to 200 feet. By increasing the voltage of the buzzer circuit from $7\frac{1}{2}$ to $22\frac{1}{2}$ volts and using a more powerful light, this range can be increased.

The transmitter works on the same principle as a radio broadcast transmitter. The light waves from the flash light act as the carrier wave, and the code signals tapped

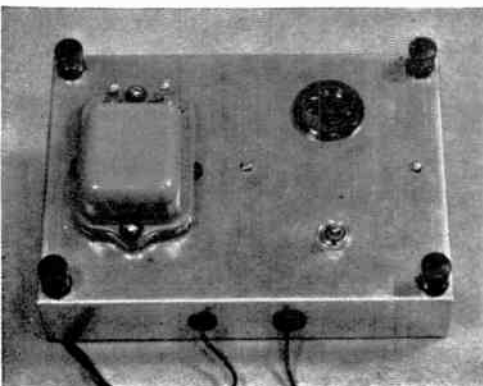

The top of the transmitter. Note rubber grommets

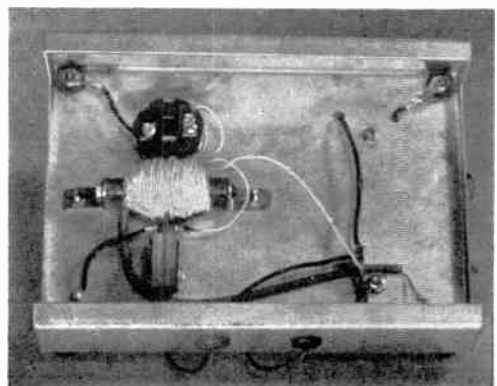

Bottom view shows handmade coupling transformer

The receiver, showing the photo-electric cell shield and the magnifying glass, connected by a black tube

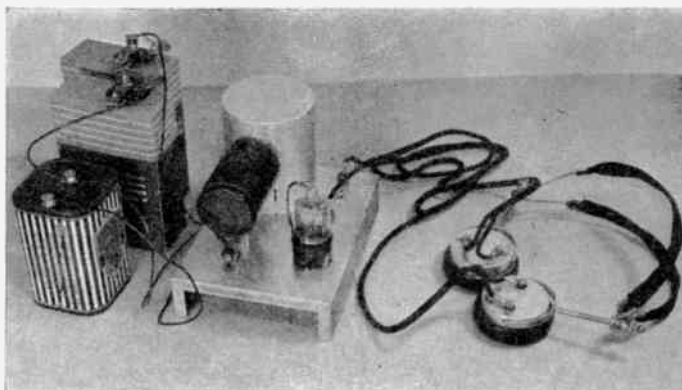

out on the telegraph key are superimposed on this light beam. Light variations forming the message are invisible, and to all appearances the rays from the flash light form a steady beam.

With this device, messages can be sent through windows, foliage, or anything that allows at least part of the light beam to reach the receiver.

A gas-filled photo-electric tube is used as a detector in the receiver, and this is followed by a two-stage, resistance-coupled audio amplifier. The photo cell transforms the modulated light beam into sound which is amplified by the audio stages.

As a matter of fact, any good audio amplifier can be used after the detector stage. Care must be taken, however, to see that the photo tube never has more than 90 volts on its plate, to avoid damaging the tube.

To focus the rays of light from the transmitter, a magnifying glass is placed 4" from the curved cathode inside the photo

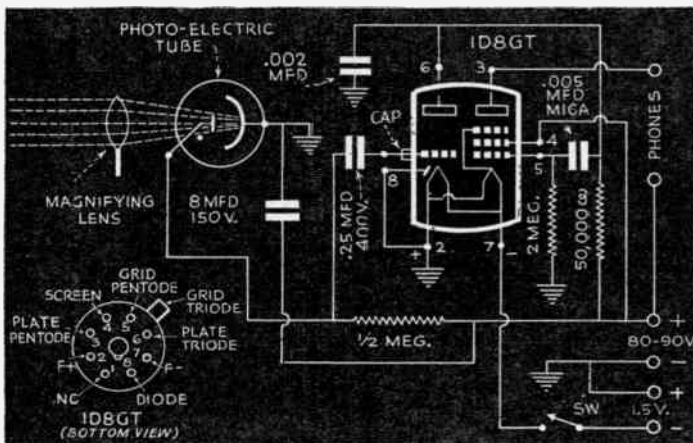

Schematic diagram of the receiver, with a bottom view of the 1D8GT tube

tube. To enable the receiver to work in a lighted room or outdoors (if the sun is not too bright) a black composition tube, 1 3/4" in diameter and 2 1/2" long, is placed between the can and the magnifying lens.

For the amplification a 1D8GT tube with

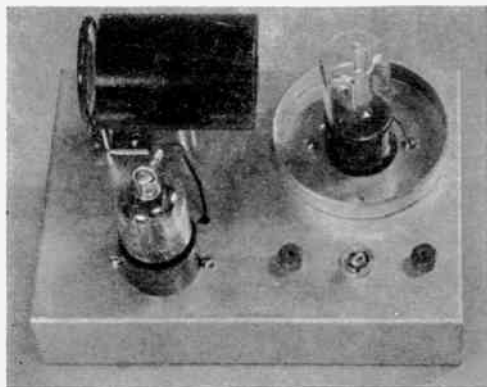

The top of the receiver with the shielding taken off

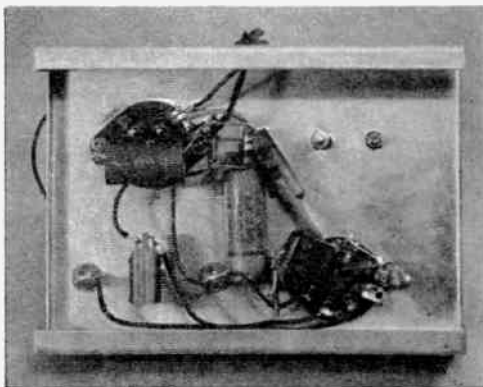

A bottom view, showing the condensers and resistors

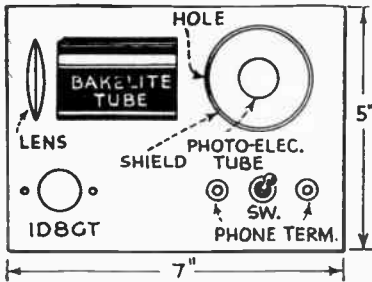

a 1.4-volt filament is used. To operate the receiver, two 45-volt "B" batteries and a 1½-volt "A" battery are needed.

If the photo-electric cell fails to operate during reception of a signal, discharge the .25-mfd. condenser by shorting it.

To make the coupling transformer used in the transmitter, use an iron core made from an old chisel or a hollow iron shaft about ½" in diameter. Around this wind 100 turns of No. 24 d.c.c. wire and then another 150 turns of the same wire to form the primary and secondary windings.

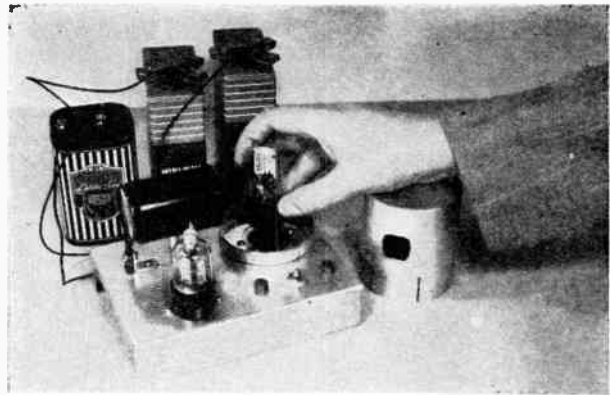
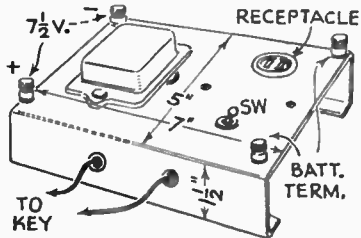

Putting the photo-electric tube in place. Note the hole in the shield. At the left is the detail of the receiver chassis

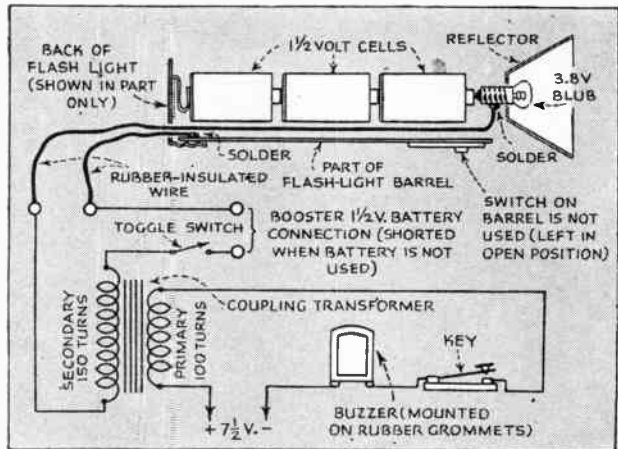

The transmitter circuit. The chassis detail is at the left

LIST OF PARTS FOR THE LIGHT-BEAM SET

Transmitter

Three-cell flash light (with metal barrel)
 Four-section tripod.
 Metal chassis (7" x 5" x 1½").
 Household buzzer.
 7½-volt "C" battery.
 Telegraph key.
 Special coupling transformer.
 S. P. S. T. toggle switch.
 Four insulated binding posts.
 Spool of No. 24 d. c. c. wire.

Receiver

Photo-electric cell, type 923.
 Dual amplifier tube, type 1D8GT.
 Four-prong socket, wafer type.
 Eight-prong socket, wafer type.

Metal chassis (7" x 5" x 1½").
 Coil shield.
 Electrolytic condenser, 8 mfd., 150 v.
 Paper tubular condenser, .25 mfd., 400 v.
 Paper tubular condenser, .002 mfd., 400 v.
 Mica condenser, .005 mfd.
 S. P. S. T. toggle switch.
 Insulated 'phone terminals.
 Carbon resistor, 500,000 ohms, ½ watt.
 Carbon resistor, 50,000 ohms, ½ watt.
 Carbon resistor, 2 megohms, ½ watt.
 Two portable "B", batteries, 45 v.
 Midget "little six" "A" battery, 1½ v.
 Black tubing 2½" long.
 Pair of head 'phones, 2,000 or 4,000 ohms.
 Approximate cost of receiver parts is \$5.84.
 Transmitter, 3.10.
 Batteries for both sets, 1.86.
 Prices include tubes.

BLACKOUT RECEIVER

Battery-Operated Set
with Only Two Tubes
Costs Little to Run



This is a back view of the cabinet shown above at right. The 2" by 7" by 7" chassis is on the left, and the "A" and "B" batteries are seen at the right

Below, a top view of the chassis. Note the small push-pull output transformer behind dial at the left

ALTHOUGH two tubes usually are needed just for the push-pull stage in a receiver, here is one with only two tubes multiplied into an RF stage, a high-mu detector stage, and a push-pull output stage using two pentodes! Powered by dry batteries, this receiver is especially useful in the home in case of a blackout and is extremely economical to operate.

The 3A8-GT tube is a combination RF pentode and a high-mu triode detector, while the 1E7-G tube is a twin pentode. The filaments of the 3A8-GT are connected in series (2.8 volts), and operated straight off a 3-volt "A" supply without a filament re-

Bottom view of the receiver chassis. The wiring is simple and should be an easy job even for a beginner

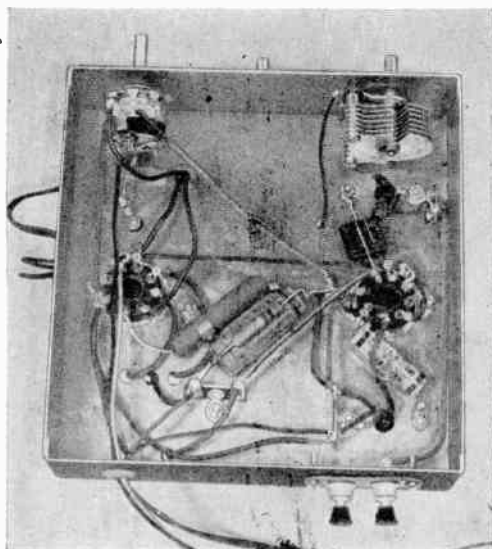
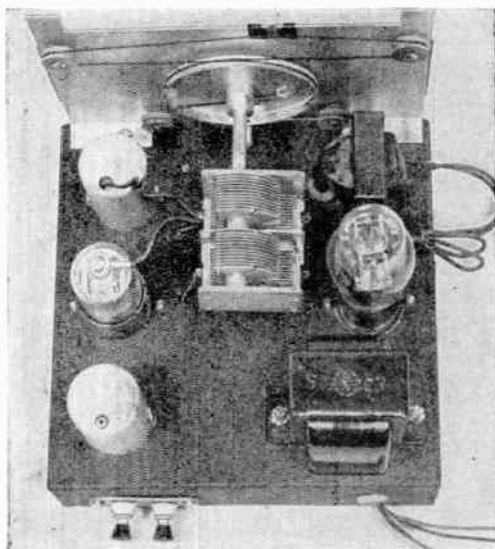

Servicing Your Radio

DIAL troubles often can be corrected easily. Many of the older AC-DC midgets have a direct-drive dial, in which the tuning knob is mounted right on the shaft of the tuning condenser. The only thing that can go wrong with this type is a loosening of the

knob, which is remedied by tightening the set screw. Slightly more complicated are the friction drives using a belt or cord. The photographs below show various troubles encountered on these sets, and how they can be eliminated.

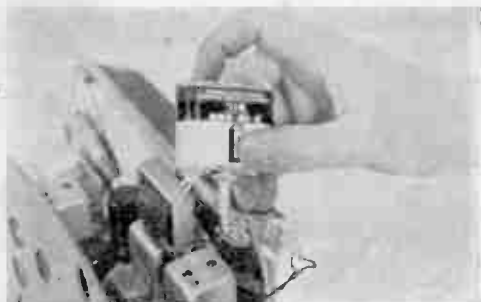

A squeaky slide-rule dial is remedied easily by a little oil on the wheels over which the dial cord runs. Oil very lightly with a light lubricant, being careful not to get any oil on the cord itself



In some friction-drive dials, the cord is kept taut by a spring behind the dial plate as shown above. To tighten the cord, it is necessary only to remove the spring and make another knot in the drive cord



If the pointer is not calibrated properly with the frequency marks on the dial, it is an easy matter to move it to the correct position. Once it is set properly for one station, it will be correct for all

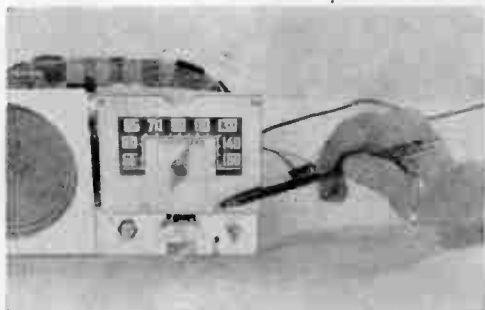

To get at a spring behind the dial plate as shown in the photograph above, it is necessary to take off the plate. To do this, loosen the two hex nuts indicated by the pencil in this illustration

A slipping belt, when it is not too serious, can be remedied by applying a special wax obtainable in stick form. Rubbed lightly on the belt as shown, it usually is found to give a smoother-working dial

If moving plates touch fixed plates in a tuning condenser, loud static is produced whenever the dial is touched. On most condensers this can be corrected by adjusting with a screw and lock nut



Vest-Pocket Receiver

BUILT into a simulated-leather playing-card case, this one-tube receiver is powerful enough to get distant stations. The tube is the new all-glass 45-volt miniature diode pentode (1S5) with the unused diode portion grounded directly to the chassis or "A" minus. A "vest pocket" 45-volt "B" battery should last three or four months and an ordinary flashlight "A" battery will give several hours of use. Padder (compression) condensers less than 1" square are used, one for tuning and one for regeneration. They tune only about half the broadcast band, so the capacity most desirable should be decided before purchasing. An unshielded antenna coil, to which a tickler winding may be added by winding 15 to 20 turns of No. 30 d.c.c. wire to the lower



Really small enough to fit into the vest pocket

portion of the grid winding, is satisfactory. Oscillation may be reduced by decreasing the turns or stepped up by reversing the connections to the tickler coil. No ground is used. The aerial is 20' or 30' of loose insulated wire.

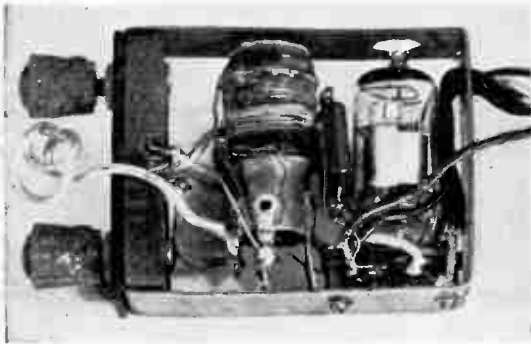

Two padder condensers, one 1S5 glass pentode, an unshielded antenna coil, and two batteries are used. Two Fahnestock clips on the card-case cover connect to phones. No ground is necessary

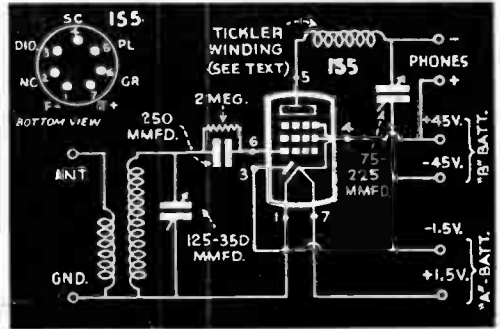
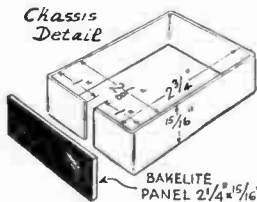

Above, a complete wiring diagram for the one-tube receiver, and below, the radio in its tiny case, showing tuning and regeneration controls, phones hooked up, and (between knobs) antenna connection

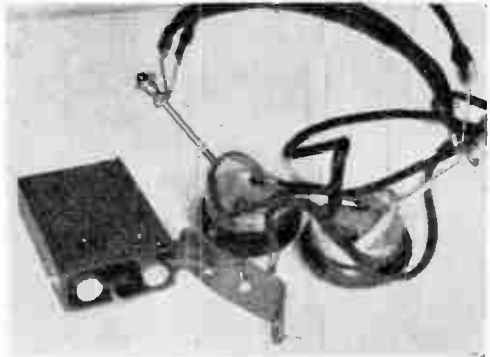
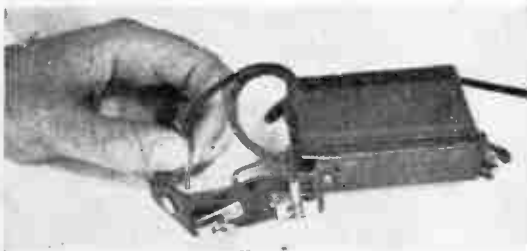

Football-Fan's Radio

WITH THIS COMPACT RECEIVER, YOU CAN LISTEN TO
THE BIG-GAME BROADCASTS AS YOU WATCH THE PLAYS



HOW would you like to hear a play-by-play radio description of the football games you see—while you're seeing them? All you have to do is build the compact radio receiver described on these pages, take it with you to the next big game, and tune in on the radio broadcast of the game while you watch. When the final whistle blows, you'll know a lot more about the plays you saw than will your neighbors in the football stands.

The cabinet of the receiver, designed to look like a vacuum bottle, is compact enough to be carried under the arm, and contains both the receiver circuit and the batteries. Open at one end and closed at the other, it measures $4\frac{1}{2}$ " by

Handy for picnics as well as football games, this compact receiver gives good earphone broadcast reception



Several spectators at a football game can use this receiver at once. Compact and provided with a convenient handle, the receiver has its own built-in battery supply, and operates on a short antenna

5" by 10" and is constructed of pine $\frac{3}{8}$ " thick. Shellac can be used to seal the grain, while a few coats of enamel provide a durable and attractive finish. If desired, the case can be finished in the colors of the builder's favorite school or college.

To complete the realistic appearance of the outfit, the cap from a regular vacuum bottle is fastened to the closed end of the cabinet. This can be bolted permanently in place, or, as was done in the original shown, it can be used to house additional plastic

drinking cups. If this is done, a disk of wood shaped to be a snug fit in the outer cap must be bolted to the cabinet. If a particularly neat job is desired, coarse threads can be cut into the wood disk to take the threads on the inside of the cap.

The circuit chosen is a standard three-tube, tuned-radio-frequency hook-up. However, instead of using 2-volt battery tubes, the author decided to employ the new 1½-volt tubes, because of their extremely low filament consumption. The parts are mounted

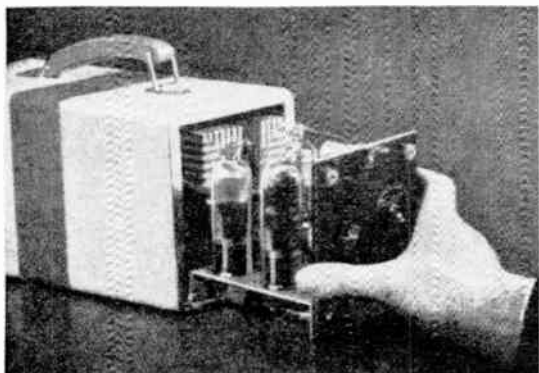

Batteries and circuit are slipped into the open end of the cabinet. The chassis holds the batteries in place

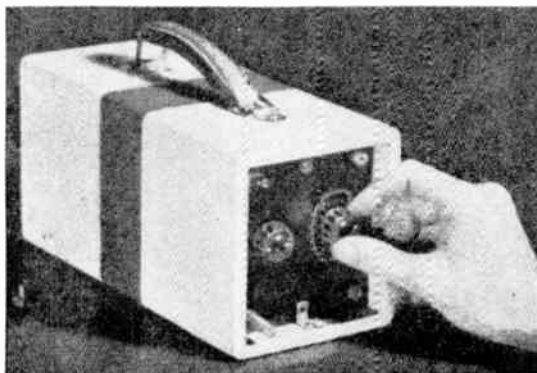

To allow the vacuum-bottle cabinet to stand upright, the control panel should be recessed, as shown above

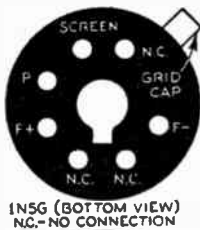

1N5G (BOTTOM VIEW)
N.C.—NO CONNECTION

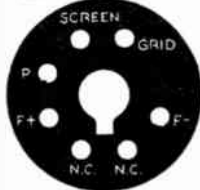

1A5G (BOTTOM VIEW)

Tube-base diagrams showing the connections to be made for the tubes used in the circuit

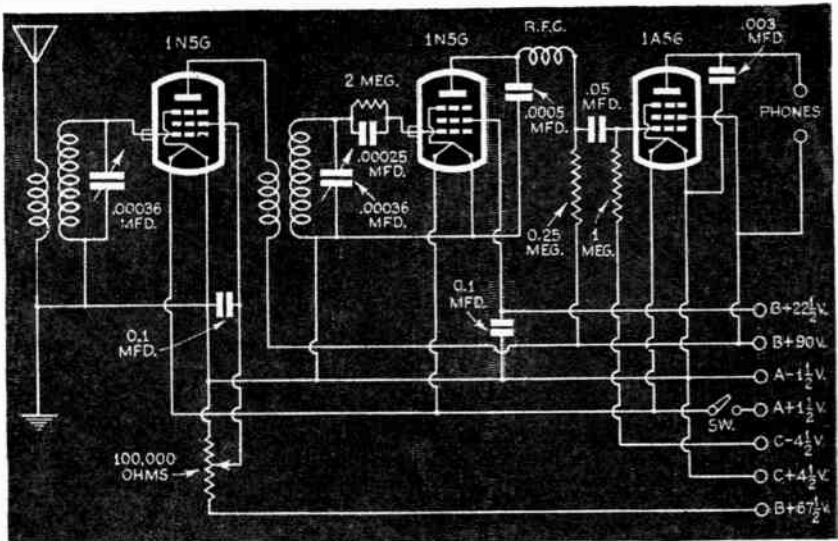

Wire the circuit carefully and make sure that all soldered connections are tight

on a midget aluminum chassis measuring 1" by 4 1/2" by 4 1/2".

A two-gang variable condenser is used to tune the radio-frequency and detector stages, and a small radio-frequency choke in the plate circuit of the detector tube prevents any stray radio-frequency currents from entering the audio-frequency stage and causing distortion. The antenna coil, a regular commercial unit removed from its shielding can, can be mounted directly onto the back of the control panel just above the two-gang tuning condenser. The radio-frequency coil, which should be shielded, is mounted between the two pentode tubes. A 100,000-ohm variable resistor inserted in the screen lead to the radio-frequency tube controls the volume of the receiver by varying the screen voltage to that particular tube.

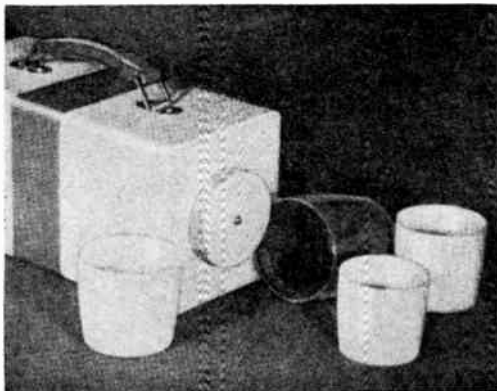

If a wood disk is used to hold the cap in place, additional cups can be carried inside the cap

The "A," "B," and "C" batteries, bound together with a heavy black elastic band, can be slipped into the cabinet after being connected up to the six-way battery cable of the receiver. The set is then placed inside of the cabinet in front of the batteries, and anchored securely in position by four small brackets. Four insulated plugs mounted on the face of the control panel provide connections for the antenna, ground, and phones. A twenty-five-foot antenna, of the type commonly used with small A.C.-D.C. receivers, is recommended.

LIST OF PARTS NEEDED

- Two 1N5G tubes.
- One 1A5G tube.
- Two-gang condenser, .00036 mfd.
- Two tubular condensers, .1 mfd.
- Tubular condenser, .05 mfd.
- Mica condenser, .003 mfd.
- Mica condenser, .0005 mfd.
- Mica condenser, .00025 mfd.
- Resistor, 2 meg., 1/2 watt.
- Resistor, 1 meg., 1/2 watt.
- Resistor, 250,000 ohm, 1/2 watt.
- Radio-frequency choke.
- Radio-frequency coil.
- Antenna coil.
- Three octal sockets.
- Switch and volume control.
- Six-way battery cable.
- Miscellaneous:—Four banana plugs and jacks, dials, knobs, batteries, chassis, cabinet, panel, earphones, etc.

Pocket Radio

BUILT INTO A Notebook

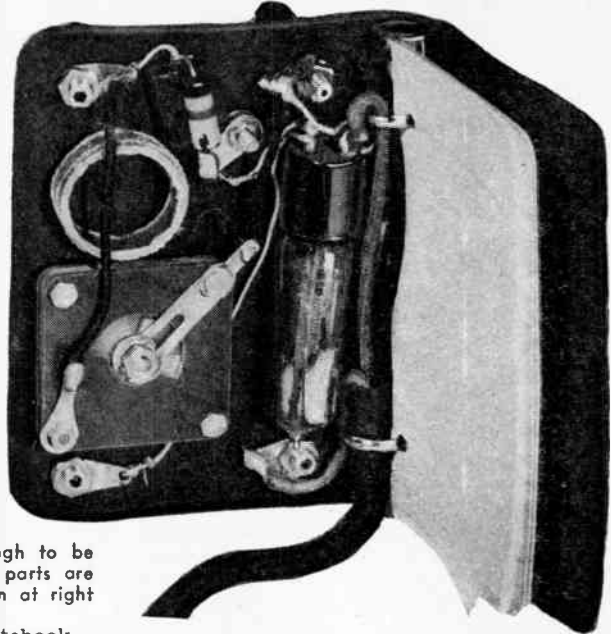

A one-tube receiver that is small enough to be carried in your coat pocket. How the parts are mounted inside the book cover is shown at right

BUILT into a 3" by 4" loose-leaf notebook, this tiny one-tube, earphone radio can be carried easily in your coat pocket. Its single tube, a midget triode measuring less than 3", requires but 3 volts for its filament and 45 volts for its plate.

Because of limited space, no socket is used, connections being soldered directly to the pins at the base, and the tube is sewed to the front cover to hold it in place.

A small, .00042-mfd. insulation-spaced variable condenser tunes the set. It measures 1 1/4" square, and has a depth behind the cover of only 3/8".

The tuning coil is a high-impedance primary coil of the type used to replace burned-out primary windings in standard A.C.-D.C. receivers. However, you must unwind approximately 100 turns to make the coil suitable for receiving stations between 200 and 550 meters.

Current is supplied by the new midget "A" and "B" batteries, also small enough to fit in your coat pocket, and four small jacks provide connections for the antenna, ground, and phones.

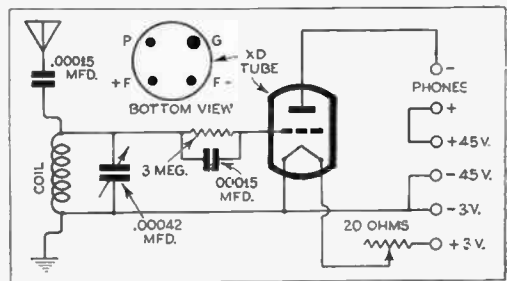

LIST OF PARTS NEEDED

MIDGET tuning condenser, .00042 mfd., paper-spaced instead of air-spaced. High-impedance primary coil. Two mica condensers, .00015 mfd. each. Resistor, 3 meg., 1/2 watt. Midget detector tube (see text). Rheostat, 20 ohms. Midget 45-volt "B" battery. Midget 3-volt "A" battery. Battery cable, three-way, about 3' long. Four jacks and plugs. Five soldering lugs. Small black loose-leaf notebook. Earphones, dial, knob, etc.

NOVEL Lamp Radio

Note steplike chassis that saves space. Shellacked wall paper covers the wooden cabinet

IS EASY TO BUILD

COMBINING a reading light and a broadcast receiver, this Chinese lamp radio will form a useful as well as an attractive addition to a living room, a bedroom, or a den. It is easy to assemble, and the use of a modern dual-purpose tube makes the necessary parts few in number and inexpensive.

You don't even have to be an artist to apply its artistic finish. Select any attractive wall paper of Chinese pattern and simply glue it to the wood cabinet. When the glue dries, apply a coat of thin, colorless shellac. The light fixture can be bought at a hardware store, and a lamp shade to blend with the wall paper can be almost as inexpensive as you wish.

The parts for the compact, two-tube radio cir-

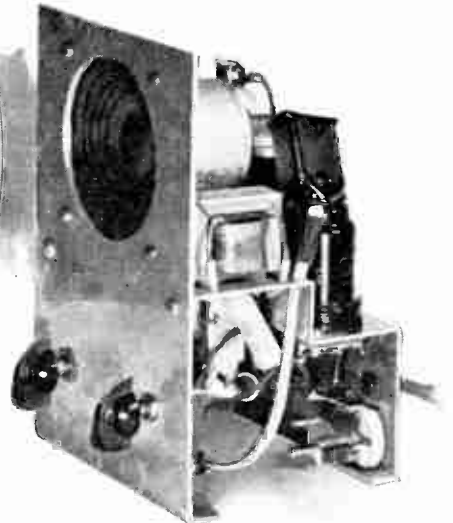
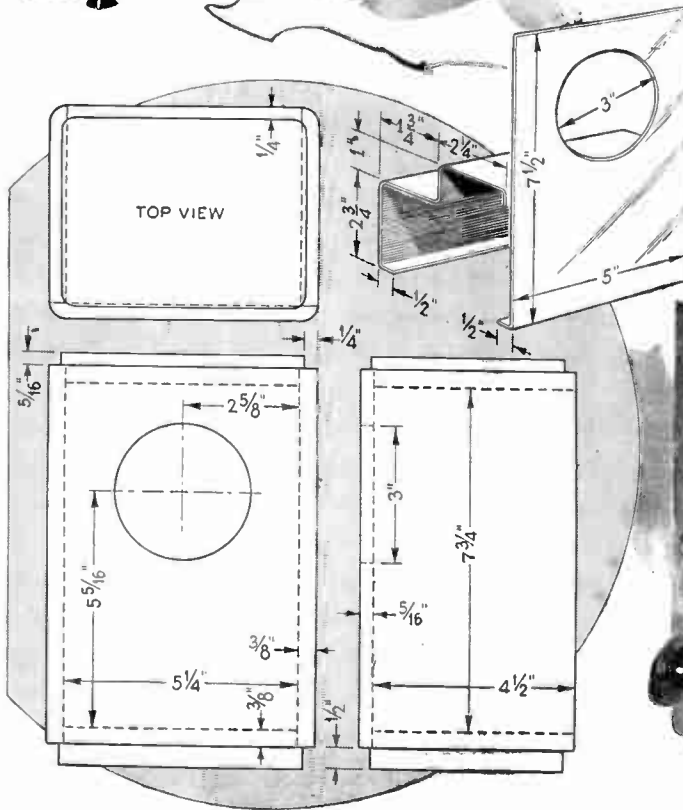

Bottom view of wired set showing arrangement of parts. Below, screw driver points to the two-way connector that permits easy removal of the chassis

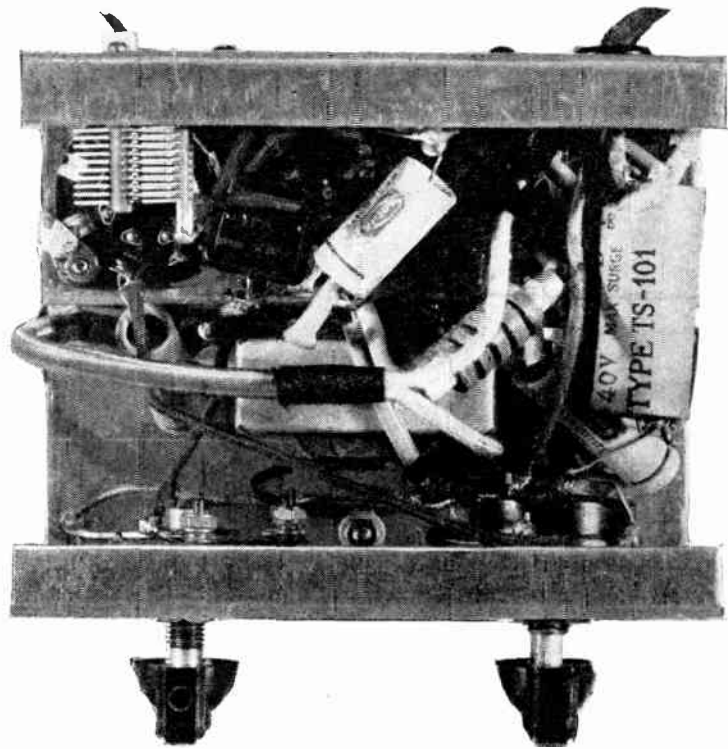
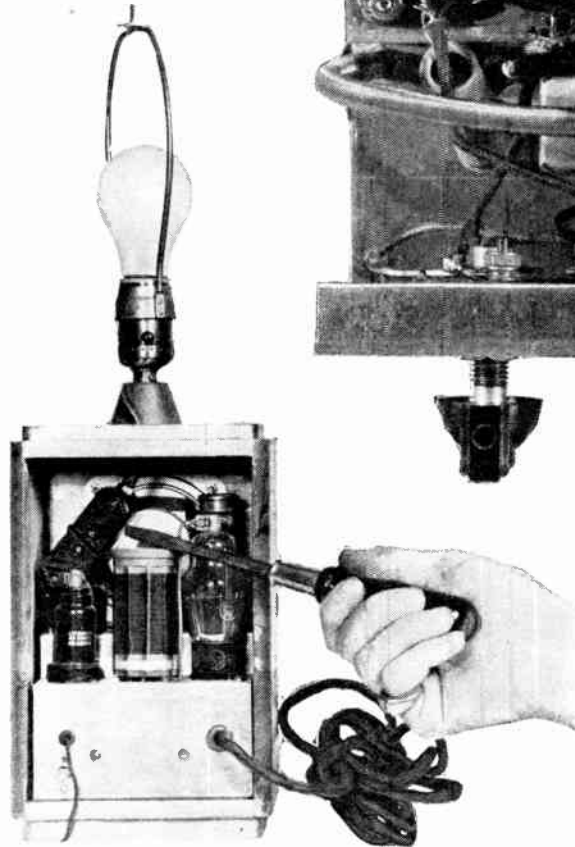

LIST OF PARTS

- | | |
|--|--|
| Line-cord resistor, 310 ohm. | Tubular condensers, .02 (two), and .01 mfd. |
| Midget choke, 15 h. | Plate choke, 2.5 mh. |
| Plug-in coil, 4-prong (see text). | Resistors, 2 meg., $\frac{1}{2}$ watt, and 100,000 ohm, $\frac{1}{2}$ watt. |
| Padding condenser, .000075 mfd. | Resistor, 200,000 ohm, $\frac{1}{2}$ watt. |
| Tuning condenser, .0005 mfd. | Resistor, 750,000 ohm, $\frac{1}{2}$ watt. |
| Dual electrolytic condenser, 8 and 8 mfd. | Wire-wound resistor, 2,000 ohm, 1 watt. |
| Dry electrolytic condenser, 10 mfd., 25 v. | <i>Miscellaneous.</i> —Chassis, midget sockets, output transformer, indoor antenna, speaker, tubes, etc. |
| Volume control and switch, 50,000 ohm. | |
| Mica condensers, .0005, .0003, and .00015 mfd. | |

and dual, 8-mfd. electrolytic condenser. Regeneration and volume are regulated by a 50,000-ohm variable potentiometer, coupled with the switch.

Should the set fail to oscillate over the entire wave band, increase the capacity of the .0005-mfd. fixed condenser connected between the radio-frequency choke and the chassis, by wiring another fixed condenser of .00025-mfd. capacity in parallel. The original model worked well without a ground, but if you wish to try one, connect it through a .02-mfd. condenser as shown by the dotted lines in the circuit diagram. The condenser must be used to insulate the ground from the chassis and protect the tubes, which are also grounded through the chassis to the electric-wiring system.

A two-way plug, placed just above the metal pentode as shown in the photographs, connects the wires from the lamp socket with the current-supply cord leading to the radio, making it easy to disconnect the wiring for removal of the chassis from the set.

