



THE HAMMARLUND "40" CATALOG

HAMMARLUND MANUFACTURING COMPANY, INC.
Factory & Main Offices: 424-438 West 33rd Street, New York



"MC" MIDGET CONDENSERS

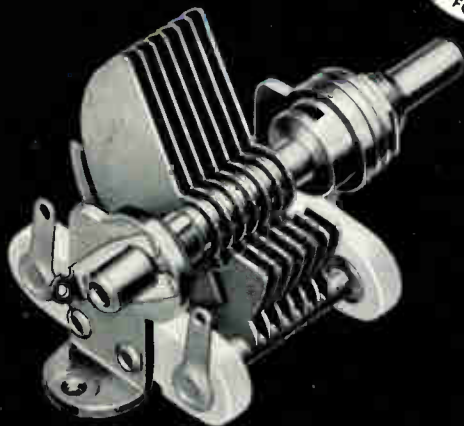

'MC' MIDGET CONDENSER

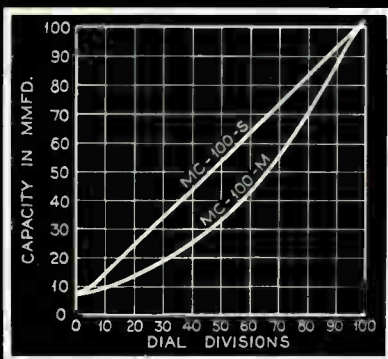

TWENTY-NINE years ago, the first HAMMARLUND variable condensers made their appearance. Their dominant superiority became a byword in laboratories, schools, and homes the world over. Today, specialists continue to show their approval of HAMMARLUND condensers by continually specifying them for use in every conceivable type of radio instrument.

Among the more prominent users of HAMMARLUND products are: General Electric, Westinghouse, R.C.A., Western Electric, Bell Laboratories, U. S. Army, Navy, Coast Guard, Forestry Service, Bureau of Standards, Stromberg-Carlson, Philco, etc. Every HAMMARLUND condenser is designed for peak electrical and mechanical performance. Wide capacity ratios, vibration-proof construction, light weight, quality insulation, selected metals—all with an eye to dependable trouble-free long lasting service.

In high frequency work with frequencies running up to 50 and 60 megacycles, unusual condenser efficiency is demanded. Every detail of HAMMARLUND condensers can be depended on to more than meet these severe demands. The "MC" series uses Isolantite insulation placed outside of electrostatic fields to reduce dielectric losses to minimum and to insure maximum and uniform efficiency under all conditions of temperature and humidity. A wide split-type rear bearing and a wide special bearing at the front provide for perfect contact without objectionable inductive reactance. The type, size and accuracy of these bearings assure long life, quiet operation, and absolute stability of calibration. In addition, a new noiseless silver-plated Beryllium wiping contact is also included in the rear. Thus, strictly noise-free results are assured. Cadmium plated non corrosive soldered brass plates eliminate vibration and effect lowest series resistance.

Greater strength and rigidity are secured through elimination of all screws and nuts—everything being either soldered or riveted. End plates of heavy aluminum. Single hole panel mounting or base mounting.

Because of their vibration-proof construction, the condensers are ideally suited to aircraft, police car, and marine work, as well as for broadcast tuning, wave traps, compensating and vernier condensers, regeneration and neutralizer condensers and for laboratory and test equipment in general.

General Specifications—Plates are .0225" thick with .0245" air gap. Shafts are 1/4" diameter extending 5/16" beyond rear frame to facilitate ganging. Standard condensers include stops and are made to increase capacity by clockwise rotation. Individually tested for breakdown on 500 V., A. C. Quality fully guaranteed. See drawing and table below for dimensions, plates, etc. At left are typical capacity curves.

SPECIAL condensers can be supplied to order. These include condensers of special capacities, spacing, rotation, and shaft extensions; also locking type condensers for fixed frequency work, split stator, balancing condensers, extra compact condensers, etc.

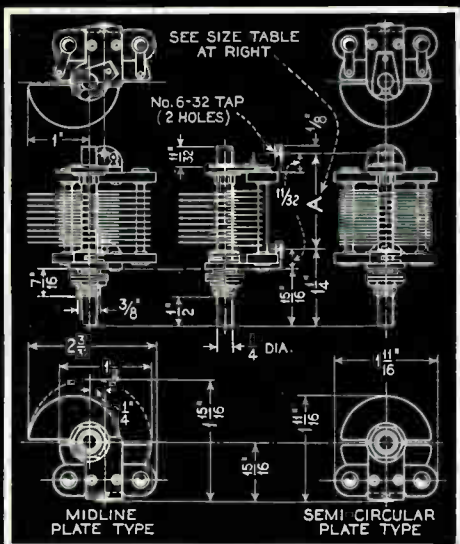

LIST OF STOCK SIZES

Code	Max. Cap.	Min. Cap.	Plates	Dimension "A"	List Price
MC-325-M	320 mmf.	13.5 mmf.	43	2 23/32"	\$3.50
MC-250-M	260 mmf.	12 mmf.	34	2 5/16"	3.00
MC-200-M	200 mmf.	10.3 mmf.	27	2"	2.75
MC-140-M	140 mmf.	9 mmf.	19	1 19/32"	2.50
MC-140-S	140 mmf.	10 mmf.	19	1 19/32"	2.50
MC-100-M	100 mmf.	7.5 mmf.	14	1 13/32"	2.25
MC-100-S	100 mmf.	8.3 mmf.	14	1 13/32"	2.25
MC-75-M	80 mmf.	7.3 mmf.	11	1 7/32"	2.00
MC-75-S	80 mmf.	8 mmf.	11	1 7/32"	2.00
MC-50-M	50 mmf.	6.3 mmf.	7	1 7/32"	1.60
MC-50-S	50 mmf.	6.5 mmf.	7	1 7/32"	1.60
MC-35-S	35 mmf.	6 mmf.	5	1 7/32"	1.50
MC-20-S	20 mmf.	5.5 mmf.	3	1 7/32"	1.40

"M" = Midline Plates "S" = Semi-Circular Plates

"MCD" SPLIT-STATOR CONDENSERS

Like HAMMARLUND single midgets, these duals incorporate rigidity, low losses, and careful construction—every requirement imperative to highest mechanical and electrical efficiency. Entire condenser built on strong Isolantite base including shield plate between stators. Cadmium plated soldered brass plates. New split type rear bearing and noiseless wiping contact of silver plated Beryllium. Single hole panel mount. Other specifications same as for "MC" single midgets.

Code	Max. Cap. Per-Sec.	Min. Cap. Per Sec.	Length Behind Panel	List Price
MCD-140-S	140 mmf.	8.5 mmf.	3 3/8"	\$4.00
MCD-140-M	140 mmf.	7.8 mmf.	3 3/8"	4.00
MCD-100-S	100 mmf.	7 mmf.	3 3/8"	3.50
MCD-100-M	100 mmf.	6.3 mmf.	3 3/8"	3.50
MCD-50-S	50 mmf.	5.5 mmf.	3 3/8"	3.00
MCD-50-M	50 mmf.	5 mmf.	3 3/8"	3.00

"M" = Midline Plates "S" = Semi-Circular Plates.

"MCD-X" DOUBLE-SPACED CONDENSERS

This condenser is specially designed for ultra-high frequency work and laboratory use, for either transmitting or receiving. Wide spacing between plates aids frequency stability. Isolantite insulation. New split type rear bearing and noiseless wiping contact. Cadmium plated non-corrosive soldered brass plates. Actual air gap between plates .0715".

Code	Max. Cap. Per Sec.	Min. Cap. Per Sec.	Length Behind Panel	List Price
MCD-35-MX	31 mmf.	6 mmf.	3 3/8"	\$3.50
MCD-35-SX	31 mmf.	6.8 mmf.	3 3/8"	3.50

"MX" = Midline Plates. "SX" = Semi-Circular Plates.

"MC-X" DOUBLE-SPACED CONDENSERS

An excellent variable condenser for ultra-high frequency receivers and transmitters, particularly compact transmitters. Plates are widely spaced—air gap between plates .0715". New split type rear bearing and noiseless wiping contact. Cadmium plated soldered brass plates. Isolantite insulation.

Code	Max. Cap	Min. Cap.	Length Behind Panel	List Price
MC-100-SX	100 mmf.	16.5 mmf.	4 3/8"	\$3.50
MC-50-SX	50 mmf.	11.5 mmf.	2 7/8"	2.75
MC-50-MX	50 mmf.	10.5 mmf.	2 7/8"	2.75
MC-35-SX	32 mmf.	8.5 mmf.	2 1/8"	2.25
MC-35-MX	32 mmf.	7.8 mmf.	2 1/8"	2.25
MC-20-MX	20 mmf.	6.5 mmf.	1 29/32"	2.00
MC-20-SX	20 mmf.	6.8 mmf.	1 29/32"	2.00

"MX" = Midline Plates. "SX" = Semi-Circular Plates.

"MC-B" BAND SPREAD CONDENSERS

These condensers are designed for use as "band spread" tuning condensers, for short wave receivers and for amateur band frequency meters. The "tank" section can be set and locked at any desired capacity permitting the tuning section to spread narrow frequency ranges over the entire dial regardless of the range of the band or the coils used. Cadmium plated non-corrosive soldered brass plates. Isolantite insulation.

Code	Tank Cap.	Tuning Cap.	Length Behind Panel	List Price
MC-120-B	100 mmf.	20 mmf.	2 5/16"	\$3.00
MC-150-B	100 mmf.	50 mmf.	3 1/8"	3.25

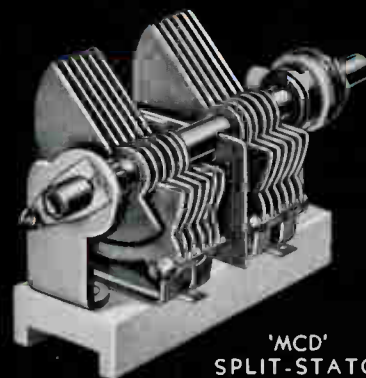

'MCD'
SPLIT-STATOR
CONDENSER



'MCD-X'
DOUBLE-SPACED
SPLIT-STATOR
CONDENSER

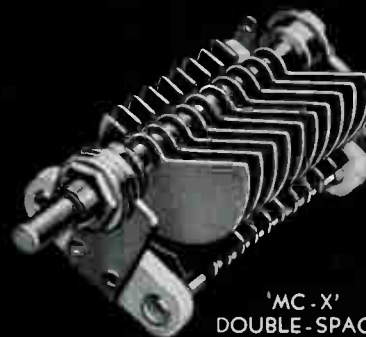

'MC-X'
DOUBLE-SPACED
CONDENSER



'MC-B'
BAND SPREAD
CONDENSER



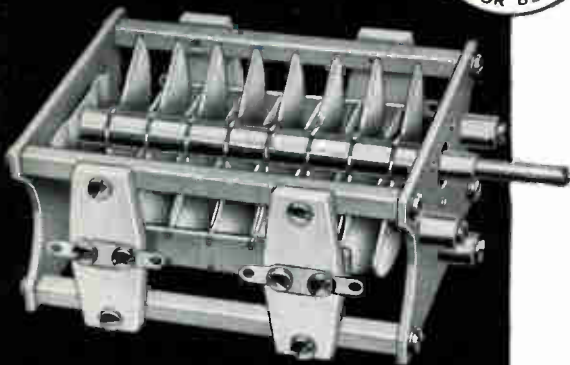

'TC' TRANSMITTING CONDENSER

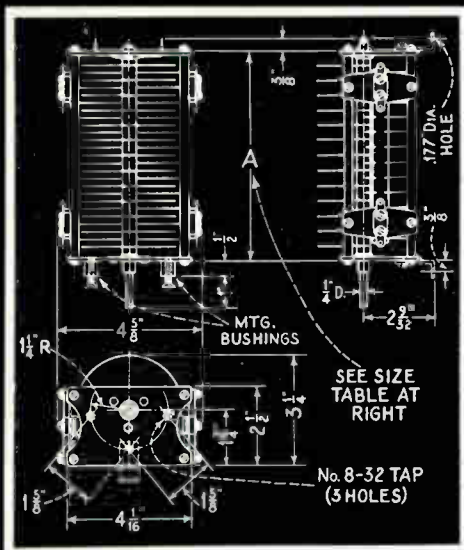
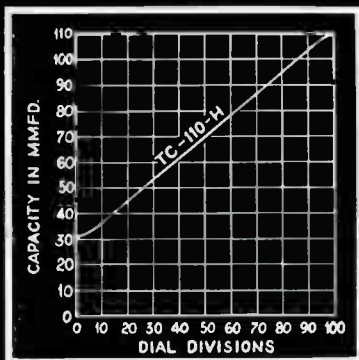

"TC" TRANSMITTING CONDENSERS

THIS new and complete line of "TC" transmitting condensers was recently developed in the HAMMARLUND laboratories. Many outstanding features incorporated in these new condensers are the result of years of careful research in both mechanical and electrical design of variable capacitors. Heavy aluminum end plates for maximum strength are tied together with four 5/16" duraluminum pillars. Both rotor and stator plates are carefully buffed and polished and have rounded edges in order to minimize danger of flash-over. The rotor assembly, which embodies the non-magnetic principle, is an exclusive HAMMARLUND feature. The rotor plates are carefully staked to a non-magnetic shaft. The stainless steel dial shaft does not pass through the rotor assembly. All magnetic material is kept out of the direct field of the condenser—something which is absolutely necessary for the maximum efficiency at high frequency. Special hand fitted full-floating bearings eliminate binding and twisting. The rotor contacts are heavy silver plated Beryllium wipers and of sufficient area to eliminate contact losses. This contact is direct to the rotor shaft and extends through the rear plate of the condenser for soldering. Thus, we do not depend upon metal to metal contacts through the framework. Neither do we depend upon the stainless steel rear ball bearing for electrical contact. This shortens the electrical path and greatly increases efficiency.

General Specifications: Peak voltage ratings for the various types are: 7500 V. for type "F"; 6750 V. type "C"; 6000 V. type "H"; 4250 V. type "J"; 3750 V. type "K"; 2000 V. type "L"; and 1000 V. type "M". The latter is only made in the split stator type as illustrated on page 6. Shaft is 1/4" diameter stainless steel. Isolantite insulation throughout, specially treated against moisture absorption. Three panel mounting bushings for 8/32" screws and also special mounting feet for base or stand-off insulator mounting are packed with each condenser. See drawing and table below for dimensions, plates, air gap etc.

CONDENSERS of special capacities or plate spacing can be supplied to order. Condensers can also be supplied to meet special mounting requirements or equipped with such accessories as rotor locking devices, Isolantite mounting bushings, etc.

LIST OF STOCK SIZES

Code	Capacity	Plates	Plate Spacing	Dimension "A"	List Price
†TC-55-F	60 mmf.	15	.230"	5"	\$8.00
†TC-40-C	46 mmf.	11	.200"	3 3/16"	7.00
†TC-65-C	75 mmf.	17	.200"	5"	8.80
†TC-100-G	110 mmf.	25	.200"	6 5/8"	11.20
†TC-150-G	165 mmf.	37	.200"	9 3/4"	14.80
†TC-25-H	23.5 mmf.	5	.171"	2 1/16"	3.50
†TC-50-H	53 mmf.	11	.171"	3 3/16"	6.00
†TC-110-H	115 mmf.	23	.171"	5 5/8"	9.00
†TC-240-J	250 mmf.	33	.100"	5 5/8"	10.20
†TC-90-K	95 mmf.	11	.084"	2 1/16"	4.50
†TC-165-K	167 mmf.	19	.084"	3 3/16"	6.50
†TC-220-K	222 mmf.	25	.084"	3 3/4"	8.00
†TC-330-K	335 mmf.	37	.084"	5 5/8"	10.00
†TC-220-L	220 mmf.	21	.070"	3 3/16"	4.50
†TC-440-L	465 mmf.	43	.070"	5"	7.70

†Polished round edged plates—.040" thick.

‡Standard type plates—.025" thick.

Plate spacing is actual air gap between adjacent rotor and stator plates.



"TCD" TRANSMITTING CONDENSERS

HAMMARLUND "TCD" split stator transmitting condensers are identical in quality and have the same features found in the "TC" single transmitting condensers. These condensers, while available with wide plate spacing and high capacities, are still within bounds insofar as physical dimensions are concerned and lend themselves readily in the design of modern, compact apparatus. For complete details as to general construction and specifications, see page 4. The following split stator types have all four horizontal tie pillars drilled and tapped to accommodate brackets for mounting the neutralizing condensers and tank coil directly on the tuning condenser: "TCD-55-F", "TCD-40-G", "TCD-75-G", "TCD-50-H", and "TCD-100-H". This feature greatly facilitates construction of the amplifier in which the condenser is used, making a more compact and symmetrical layout.

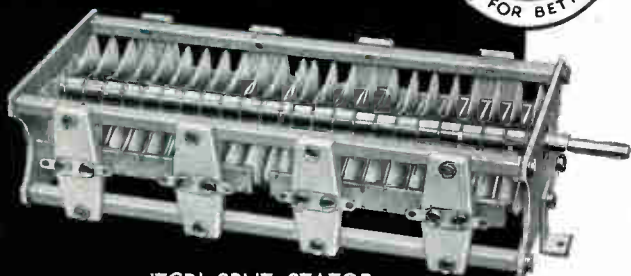

'TCD' SPLIT-STATOR TRANSMITTING CONDENSER

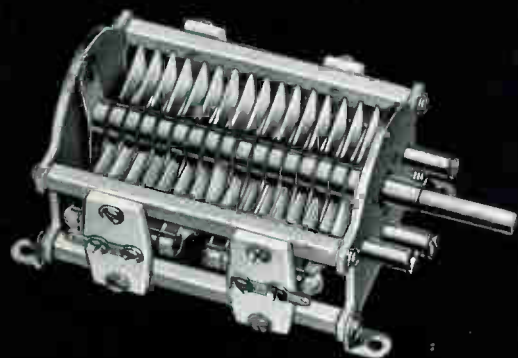
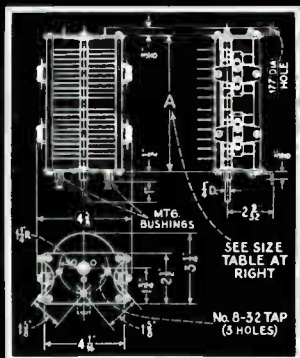

'MTC-D' SPLIT-STATOR TRANSMITTING CONDENSER

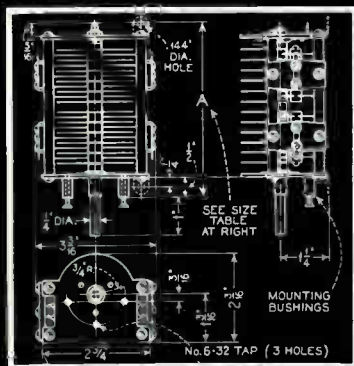

Code	Capacity	Plate Spacing	Plates per sec.	Dimension "A"	List Price
†TCD-55-F	60 mmf.	.230"	15	10 3/16"	\$13.50
†TCD-40-G	46 mmf.	.200"	11	6 5/8"	10.50
†TCD-75-G	85 mmf.	.200"	19	10 3/16"	14.50
†TCD-50-H	53 mmf.	.171"	11	5 5/8"	9.80
†TCD-110-H	115 mmf.	.171"	23	10 3/16"	16.00
†TCD-240-J	250 mmf.	.100"	33	10 3/16"	19.00
†TCD-90-K	95 mmf.	.084"	11	3 3/4"	7.50
†TCD-165-K	167 mmf.	.084"	19	5 5/8"	11.00
†TCD-325-K	335 mmf.	.084"	37	10 3/16"	20.50
‡TCD-80-L	90 mmf.	.070"	9	3 3/16"	5.50
‡TCD-210-L	215 mmf.	.070"	21	5"	8.25
‡TCD-500-M	490 mmf.	.030"	21	3 3/16"	6.50

†Polished round edged plates—.040" thick.
‡Standard type plates—.025" thick.

"MTC-D" TRANSMITTING CONDENSERS

These split-stator condensers have the same characteristics and the same constructional features as the "MTC" singles. Unusually compact and light in weight. Ideal for portable transmitters. Overspaced plates securely held in place. Isolantite insulation. Quality bearings. Noiseless wiping contacts. Provides the same operating advantages outlined in the above description of "TCD" type condensers. See drawing and table for dimensions, plates, air-gaps, etc.

Code	Cap. Per Sec.	Series Cap.	Plates per Sec.	Dimension "A"	List Price
†MTCD-20-B	22 mmf.	10 mmf.	5	3 11/16"	\$5.25
†MTCD-35-B	33 mmf.	18 mmf.	7	3 11/16"	5.75
†MTCD-50-B	50 mmf.	25.5 mmf.	11	3 11/16"	6.50
†MTCD-100-B	100 mmf.	51 mmf.	21	5 13/16"	8.75
‡MTCD-50-C	46 mmf.	25.5 mmf.	5	3 11/16"	4.50
‡MTCD-100-C	105 mmf.	51 mmf.	11	3 11/16"	5.00
‡MTCD-150-C	150 mmf.	77 mmf.	15	3 11/16"	5.25
‡MTCD-250-C	255 mmf.	135 mmf.	25	4 11/16"	6.00

†Polished round edged plates .025" thick—.070" plate spacing.
‡Standard type plates .025" thick—.031" plate spacing.
Plate spacing is actual air gap between adjacent rotor and stator plates.

"HFA" AND "HFB" CONDENSERS

THIS new line of transmitting and receiving condensers departs considerably from the usual condenser design. All parts are brass, cadmium plated, and soldered resulting in a compact, rugged unit. Isolantite end plates insulate the rotor assembly from the mounting brackets. All "HFB" models have insulated control shafts especially designed for circuits where the high voltage is connected directly to the rotor. This permits higher tube voltages for a given condenser plate spacing and results in a less expensive, more compact unit. It also provides greater personal safety to the operator. Model "G" can be used with 2,375 V. to the plates of the tubes, 100% modulated. Model "F", 2,000 V. modulated; Model "E", 1,500 V. modulated. The "HFAD" units are the same in construction as the "HFBD" except that smaller plates are used and the control shaft is not insulated. They are ideal for low power portable transmitters and receivers. "HFAD" like the "HFBD" has opposed rotors and stators for perfect counter-balancing. The "HFA" is a single unit having only one Isolantite end plate. The 100% soldered construction of both the "HFA" and "HFB" types eliminates the danger of losses due to high resistance contacts. Both "HFA" and "HFB" types are available to manufacturers with special shaft lengths and special mounting arrangements. Inquiries are invited.

General Specifications—All shafts are $\frac{1}{4}$ " in diameter. All plates are semi-circular and all rear bearings are single ball thrust. Types "HFB" and "HFBD" have $1\frac{3}{8}$ " shaft extensions; .025" plates thickness; $1\frac{13}{16}$ " Isolantite end plates. Type "HFA" has $\frac{9}{16}$ " shaft extension, $1\frac{13}{16}$ " x $1\frac{1}{32}$ " Isolantite end panel, .020" plate thickness. "HFAD" has $1\frac{3}{8}$ " square front and rear Isolantite panels, $\frac{9}{16}$ " shaft extension, .020" thickness. All types have base mounting brackets and panel mounting bushings. "HFA" and "HFAD" have additional single hole panel mounting feature.

Code	Per Section		Plate Edges	Air Gap	Length "A"	List Price
	Mmf.	No. Plates				
HFBD-35-C	35.	8	Plain	.050"	2 7/16"	\$3.90
HFBD-50-C	50.	11	Plain	.050"	2 7/8"	4.15
HFBD-100-C	100.	23	Plain	.050"	4 5/8"	5.15
HFBD-200-C	200.	43	Plain	.050"	7 11/16"	6.75
HFBD-35-E	35.	11	Rounded	.070"	3 1/4"	5.50
HFBD-65-E	65.	19	Rounded	.070"	4 13/16"	7.00
HFBD-100-E	100.	29	Rounded	.070"	6 11/16"	9.00
HFBD-35-F	35.	14	Rounded	.100"	4 5/8"	6.20
HFBD-65-F	65.	25	Rounded	.100"	7 3/8"	8.25
HFBD-35-G	35.	17	Rounded	.125"	6 3/16"	7.25
HFB-50-C	50.	11	Plain	.050"	1 7/8"	3.20
HFB-100-C	100.	23	Plain	.050"	2 7/8"	3.70
HFB-150-C	150.	33	Plain	.050"	3 9/16"	4.10
HFB-50-E	50.	15	Rounded	.070"	2 7/16"	4.40
HFB-100-E	100.	29	Rounded	.070"	3 13/16"	5.80
HFB-50-F	50.	19	Rounded	.100"	3 3/8"	4.90
HFB-100-F	100.	39	Rounded	.100"	5 7/8"	6.90
HFAD-75-A	75.	15	Plain	.020"	2 3/8"	3.15
HFAD-100-A	100.	19	Plain	.020"	2 23/32"	3.40
HFAD-140-A	140.	27	Plain	.020"	3 3/8"	3.90
HFAD-25-B	25.	7	Plain	.030"	1 29/32"	2.80
HFAD-35-B	35.	9	Plain	.030"	2 3/32"	2.95
HFAD-50-B	50.	13	Plain	.030"	2 1/2"	3.20
HFAD-100-B	100.	27	Plain	.030"	3 29/32"	4.00
HFAD-150-B	150.	39	Plain	.030"	5 3/32"	4.75
HFAD-15-E	15.	9	Plain	.070"	2 23/32"	3.00
HFAD-30-E	30.	17	Plain	.070"	4 3/16"	3.50
HFA-75-A	75.	15	Plain	.020"	1 1/4"	1.80
HFA-100-A	100.	19	Plain	.020"	1 13/32"	1.95
HFA-140-A	140.	27	Plain	.020"	1 3/4"	2.30
HFA-10-B	10.	3	Plain	.030"	25/32"	1.35
HFA-150-B	15.	5	Plain	.030"	7/8"	1.40
HFA-25-B	25.	7	Plain	.030"	31/32"	1.45
HFA-35-B	35.	10	Plain	.030"	1 3/16"	1.55
HFA-50-B	50.	14	Plain	.030"	1 3/8"	1.70
HFA-100-B	100.	27	Plain	.030"	2 11/32"	2.80
HFA-150-B	150.	39	Plain	.030"	2 31/32"	3.20
HFA-15-E	15.	9	Plain	.070"	1 3/8"	1.65
HFA-30-E	30.	17	Plain	.070"	2 1/2"	2.25

A = Overall including Isolantite Panels for types HFB, HFBD and HFAD.

A = Overall length behind mounting nut for HFA.

† Uses rear Isolantite panel.

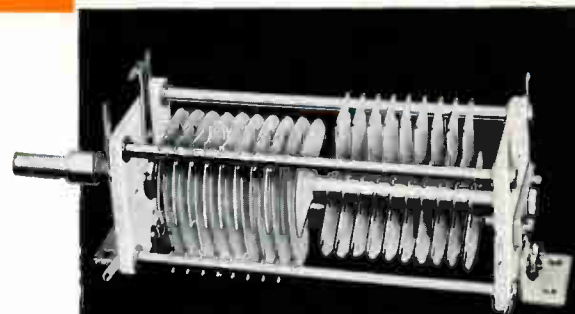

'HFB' SPLIT-STATOR TRANSMITTING CONDENSER

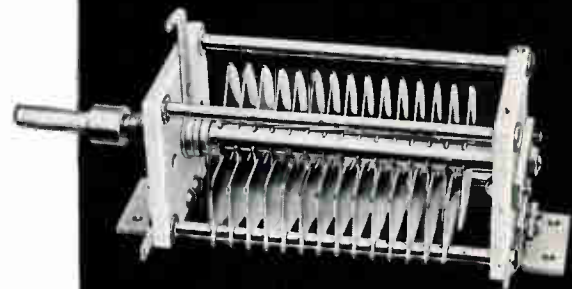

'HFB' TRANSMITTING CONDENSER

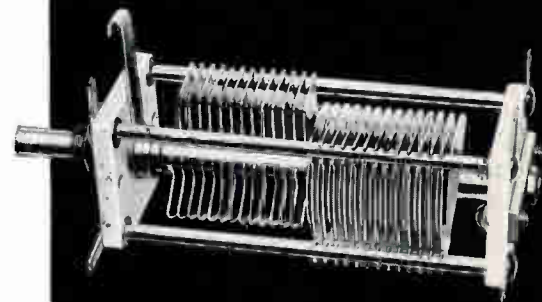

'HFA' SPLIT-STATOR CONDENSER

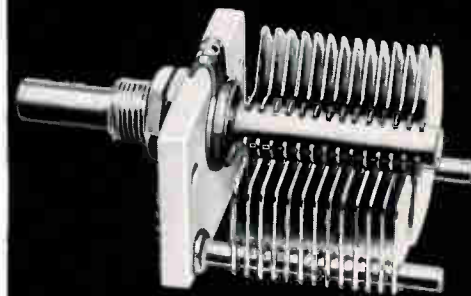

'HFA' MIDGET CONDENSER





'SM' STAR MIDGET CONDENSER



'N-10' NEUTRALIZING CONDENSER



'CS' COIL SHIELD



'TS' TUBE SHIELD

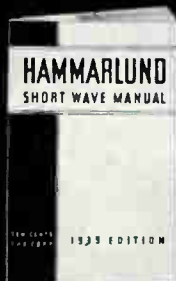

'SW' MANUAL



'FC' COUPLING

"SM" STAR MIDGETS

A very popular low-priced midget variable condenser for set-builders, experimenters, and laboratories. There are types for receiving and transmitting, for short wave tuning, regeneration, antenna coupling, verniers, etc., etc. Intelligent design, accurate manufacture and highest quality materials guarantee perfect operation and long life. Low-loss natural bakelite insulation. Straight line capacity type aluminum plates are accurately spaced on heavy brass tie-bars. A phosphor bronze spring plate affords proper tension for smooth control and also provides for perfect contact.

Single hole mounting. Shaft $\frac{1}{4}$ " diameter. Mounting bushing is $\frac{5}{16}$ " diameter. Size is $1\frac{1}{8}$ " wide by $1\frac{3}{4}$ " high. Depth behind panel from $\frac{1}{8}$ " to $1\frac{1}{8}$ " depending on capacity. Double spaced "X" types have .064" air gap.

Code	Max. Capacity	Min. Capacity	Plates	List Price
SM-15	15 mmf.	3 mmf.	3	\$.85
SM-25	25 mmf.	3.5 mmf.	4	.85
SM-50	50 mmf.	4 mmf.	7	.90
SM-100	100 mmf.	6 mmf.	14	1.00
SM-140	140 mmf.	7 mmf.	19	1.25
SM-35-X	35 mmf.	6.5 mmf.	11	1.00
SM-50-X	50 mmf.	7.5 mmf.	16	1.25

NEUTRALIZING CONDENSERS

A new type high voltage neutralizing condenser, offering the advantages of horizontal adjustment and generally improved both mechanically and electrically. Thick aluminum plates with rounded edges and polished on all surfaces. An oversized fine thread screw provides smooth micrometer adjustment. Lock nut permits permanent setting and a stop prevents shorting—plates can not touch. Special base construction prevents pivoting and insures permanent plate alignment. Isolantite insulation. Overall size: N-10, $2\frac{5}{8}$ " high x $1\frac{1}{8}$ " deep; N-15, $4\frac{1}{8}$ " high x $3\frac{1}{2}$ " deep; N-20, $5\frac{1}{8}$ " high x 4" deep.

Code	Capacity	List
N-10	2.1—10 mmf.	\$3.00
N-15	3.2—14 mmf.	6.00
N-20	3.8—14 mmf.	6.50

COIL AND TUBE SHIELDS

The "CS-3" coil shield is a very effective general purpose shield made of heavy aluminum and slotted to afford easy handling. Diameter—3", height— $3\frac{1}{2}$ ".

The "TS-50" tube shield affords complete isolation and is designed for maximum cooling. Made of heavy aluminum and measures $4\frac{5}{8}$ " high x $1\frac{5}{8}$ " diameter. Mounting centers— $1\frac{27}{32}$ ".

Code	Type	List Price
CS-3	Coil Shield	\$.50
TS-50	Tube Shield	.40

SHORT WAVE MANUAL

A 32-page book containing up-to-the-minute constructional data on short and ultra-short wave receivers, power supplies, transmitters, pre-selectors, converters, tuning hints, and short wave station list. All sets were built in the HAMMARLUND laboratories and thoroughly tested. Profusely illustrated.

Code SWM-39	List Price \$.10
-------------	-------------------

"FC" FLEXIBLE COUPLINGS

This coupling permits tandem operation of any number of independent units without requiring exact shaft alignment. The sides are insulated from each other. Made of bakelized canvas. Brass bushings for $\frac{1}{4}$ " shafts. Four set screws provide against shafts slipping. Overall diameter— $1\frac{1}{2}$ ".

Code FC	List Price \$.60
---------	-------------------

"APC" MICRO CONDENSERS

High quality, air dielectric condensers for use wherever space is at a premium. Will maintain constant capacity under any conditions of temperature, humidity, or vibration. Ideal as air dielectric trimmers for gang condensers, I. F. transformers and for padding r. f. circuits. Isolantite base. Cadmium plated soldered brass rotors and stators. Screw driver adjustment. See drawing and table for dimensions.

Code	Max. Cap.	Min. Cap.	Plates	Dimension "A"	Price List
APC-25	25 mmf.	3.0 mmf.	7	5/16"	\$1.30
APC-50	50 mmf.	3.9 mmf.	14	17/32"	1.50
APC-75	75 mmf.	4.5 mmf.	20	23/32"	1.70
APC-100	100 mmf.	5.5 mmf.	27	29/32"	1.90
APC-140	140 mmf.	6.5 mmf.	37	1 7/32"	2.25

"HF" MICRO CONDENSERS

A new series of ultra-high frequency variable condensers with many advanced features affording highest efficiency in tuning or trimming critical high frequency circuits. Cadmium plated soldered brass plates and Isolantite insulation insure rigidity, stability and lowest losses. Three different mounting methods are provided. Base mounting by means of a bracket. Single hole panel mounting. Panel mounting by means of two insulated spacer bushings. Equipped with special wide front bearing. Noiseless in operation. See drawing and table for dimensions.

Code	Max. Cap.	Min. Cap.	Plates	Dimension "A"	List Price
HF-15	17.5 mmf.	2.8 mmf.	5	1/4"	\$1.25
HF-35	35 mmf.	3.2 mmf.	10	13/32"	1.50
HF-50	50 mmf.	3.7 mmf.	14	17/32"	1.60
HF-100	100 mmf.	5.3 mmf.	27	29/32"	1.90
HF-140	140 mmf.	6.2 mmf.	37	1 7/32"	2.25
*HF-15-X	15 mmf.	3.6 mmf.	10	3/4"	1.60
*HF-30-X	30 mmf.	5.2 mmf.	20	1 5/16"	1.85

*Double Spaced.

"HFD" SPLIT-STATOR MICRO CONDENSERS

Like the "HF" single micro condensers, these duals also incorporate advanced features providing maximum efficiency at ultra-high frequencies. Soldered brass plates are cadmium plated. Aluminum front and rear end plates are mounted on a heavy Isolantite base. A wide front bearing and a special split rear bearing together with individual silver-plated Beryllium wipers for each section assure long life and noiseless efficient operation. Rotor contact can be shifted to three positions to permit shortest possible leads. Single hole panel mount or base mounting. Shield between sections for ground connection. See drawing and table for dimensions.

Code	Max. Cap. Per Sec.	Min. Cap. Per Sec.	Plates Per Sec.	Dimension "A"	List Price
HFD-50	50 mmf.	3.6 mmf.	14	2 5/16"	\$2.75
HFD-100	100 mmf.	5.0 mmf.	27	2 5/16"	3.25
HFD-140	140 mmf.	6.0 mmf.	37	2 15/16"	3.75
*HFD-15-X	16 mmf.	3.8 mmf.	11	2 5/16"	3.00
*HFD-30-X	28.5 mmf.	5.0 mmf.	19	2 15/16"	3.25

*Double Spaced.



'APC' MICRO CONDENSER

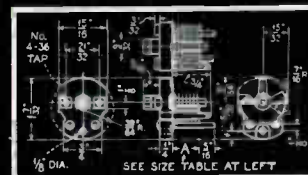

'HF' MICRO CONDENSER

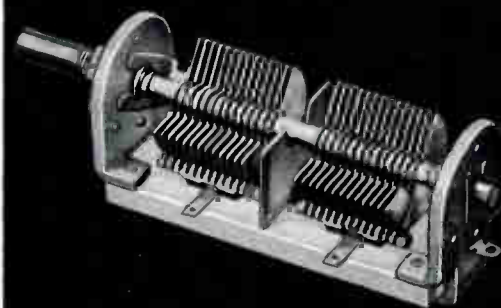
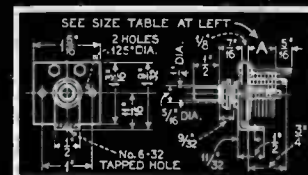

'HFD' SPLIT-STATOR MICRO CONDENSER

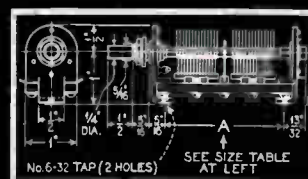



"VT" VARIABLE TRANSFORMERS

These transformers are designed to permit continuous variation of the mutual inductance between primary and secondary throughout a wide range of values without otherwise affecting circuit constants. The approximate range of variation is from 1/3 critical coupling to over 3 times critical coupling. Continuous variation between these limits may be controlled from the receiver panel by means of suitable mechanical arrangements. Where continuous variation is not desired coupling may be adjusted to the desired value and locked at that point via a thumb screw arrangement.

The effect of various coupling values on the transmission characteristics of a single transformer is shown in the graph at left. In a "one stage" I.F. amplifier two transformers are used; so in this case the overall selectivity curve is calculated by squaring the ordinates of the graph. Thus the voltage ratio marked "10" becomes "100", "5" would become "25" etc. Similarly in a "two stage" I.F. amplifier three transformers would be used and the "10" ratio would become "1000" and so on. For panel control of selectivity, several transformers can be mounted in line and their coupling varied simultaneously. For wide band or high fidelity reception, it is desirable to use three transformers; two variable and one fixed (such as the "VTF" which is the same as the "VT" variable type except that the coupling is fixed).

Primaries and secondaries are impregnated three pie Litz windings on Isolantite cores and have the exceptional "Q" of 130. Tuning condensers are the APC air dielectric micro condensers described on Page 7. May be used with any screen grid tubes normally used as I.F. amplifiers. Tuning adjustments are on one side of the 2" x 2" x 5" aluminum shield. All transformers tunable over a range of plus or minus 10 kc.

'VT' VARIABLE COUPLING I.F. TRANSFORMER

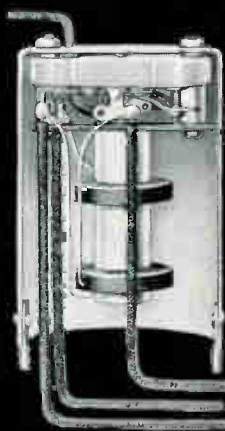
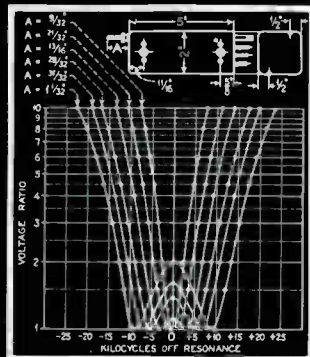
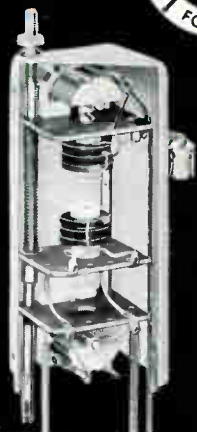

'T' I. F. TRANSFORMER



'ST' I. F. TRANSFORMER

Code	Frequency	Type	Price
VT-465	465 kc.	Variable I. F.	\$5.50
VT-175	175 kc.	Variable I. F.	5.50
VTF-465	465 kc.	Fixed I. F.	4.50
VTF-175	175 kc.	Fixed I. F.	4.50
VTF-465-CT	465 kc.	Fixed I. F. (center-tapped)	4.50
VTF-175-CT	175 kc.	Fixed I. F. (center-tapped)	4.50
VTO-465	465 kc.	Beat Oscillator	4.50
VTC	Variable coupling mechanism for panel control of up to four transformers		2.50

"ST" AND "T" TRANSFORMERS

Type "ST" and "T" I.F. transformers are high grade units designed for experimental work and replacement in standard receivers of all types. Sensitivity, selectivity, and other characteristics are such as to make them equally satisfactory in superheterodynes employing either one or two stages of I.F. in connection with any type of second detector. Made in 10 special types. The 262 kc. "ST" type is specially designed for automobile receivers. All transformers are the tuned grid, tuned plate type with lattice wound coils impregnated to prevent moisture effects. Litz windings are used in the 465 kc. units. Tuning condensers are the highest grade mica compression type mounted on Isolantite and adjustable from the top of the shield can. Leads are RMA color coded and tagged for easy installation. Secondaries are either plain for standard screen grid tubes or center-tapped for tubes requiring split input circuits. Aluminum shield can of type "T" measures 2 1/8" outside diameter and 3 1/8" high. Mounting is by means of threaded lugs on 2" centers. "ST" type is a midget type specially adapted for limited space installations. It measures 2 3/4" high x 1 7/16" square with threaded mounting studs on 1 5/16" centers. All units are individually packed with screen grid cap and mounting nuts. Tunable plus or minus 10 kc.

Code	Frequency	Type	List Price
ST-465 or T-465	465 kc.	Standard	\$1.65
ST-175 or T-175	175 kc.	Standard	1.65
ST-465-CT or T-465-CT	465 kc.	Center-Tapped	1.65
ST-175-CT or T-175-CT	175 kc.	Center-Tapped	1.65
ST-262	262 kc.	Standard	1.65
STBO-465 or TBO-465	465 kc.	Beat Oscillator	1.65

"CH-8" R. F. CHOKES

This R.F. choke is designed particularly for short waves but is equally effective over the broadcast band. Its compactness permits mounting in isolated positions well removed from stray R.F. fields. This, together with its load characteristics specially recommend it as a grid choke for multi-stage transmitters. Isolantite spool is sectionalized with four moisture-proofed windings protected by radio frequency lacquer and a covering of cellophane. Flexible leads and removable brackets permit any desired style of mounting. No metal screw passes through choke to increase losses or distribute capacity. Size is $1\frac{3}{8}$ " x $\frac{7}{8}$ " less brackets.

Code	Inductance	D.C. Res.	Dist. Cap.	Current Cap.	List Price
CH-8	8 mh.	70 ohms	3 mmf.	125 ma.	\$1.10

"CH-500" TRANSMITTING CHOKES

A specially designed choke for parallel feed in high-powered transmitters in the 10-20-40-80- and 160-meter amateur bands. In these bands it has the exceptional equivalent impedance of more than 500,000 ohms and consequently introduces negligible losses. Equally effective from 1500 to 30,000 kc. except between 5300 and 6400 kc. and between 8000 and 9000 kc. Its use within these frequencies is not recommended. Six thin Universal wound pies on an Isolantite core tapped at each end. Brackets removable and choke can be mounted with a single machine screw. Size (without brackets) $1\frac{1}{8}$ " dia. x $2\frac{1}{2}$ " long. Current 500 ma. continuous D.C.

Code	Inductance	D.C. Res.	Dist. Cap.	Current Cap.	List Price
CH-500	2.5 mh.	8 ohms	1.5 mmf.	500 ma.	\$1.75

"CH-X" MIDGET CHOKES

This choke is invaluable for use where space is at a premium. So small in size and light in weight that it can be supported by its own leads. So inexpensive that they may be used generously everywhere where R.F. filtering is desirable. Five universal wound impregnated pies are mounted on a $\frac{1}{4}$ " Isolantite core. Tinned copper wire leads secured to Isolantite core with metal end caps. Size is $\frac{1}{2}$ " diameter x $1\frac{1}{2}$ " long.

Code	Inductance	D.C. Res.	Dist. Cap.	Current Cap.	List Price
CH-X	2.1 mh.	35 ohms	1 mmf.	125 ma.	\$.50

"CH-250" MIDGET CHOKES

The "CH-250" is similar in design to the "CHX" and has a 250 ma. current rating. This higher rating permits us in medium power transmitters where chokes of larger dimensions would take up too much space. The characteristics of the "CH-250" make it suitable for operation on all amateur bands down to 10 meters. Size $\frac{5}{8}$ " diameter and $1\frac{1}{2}$ " long.

Code	Inductance	D.C. Res.	Dist. Cap.	Current Cap.	List Price
CH-250	1 mh.	10 ohms	1 mmf.	250 ma.	\$.50

"RFC" HIGH IMPEDANCE CHOKES

These chokes have been standard in the industry for years. A special process of winding and impregnating provides a very large inductance with a very low distributed capacity, making them very effective in both broadcast and SW receivers. Bakelite case is $1\frac{1}{8}$ " high x $1\frac{1}{8}$ " diameter.

Code	Inductance	D.C. Res.	Dist. Cap.	Current Cap.	List Price
RFC-85	85 mh.	215 ohms	3 mmf.	60 ma.	\$2.00
RFC-250	250 mh.	420 ohms	2 mmf.	60 ma.	2.25

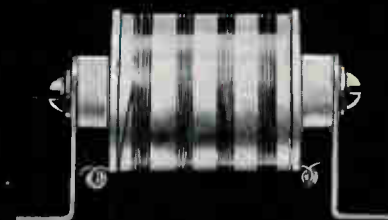

'CH-8' RF CHOKE

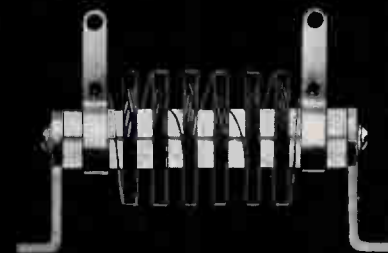

'CH-500' RF CHOKE



'CH-X' RF CHOKE



'CH-250' RF CHOKE



'RFC' RF CHOKE



**"XP-53" PLUG-IN COIL FORMS**

These attractively priced coil forms are made of XP-53 dielectric, the remarkable new low-loss insulating material. Rugged, durable, and most important, extremely effective, for XP-53's power factor is unusually low. Its amber color is natural—no artificial coloring to cause losses. The coil proportions provide a most practical form factor. The forms are groove ribbed for air spaced windings. Flange grips for easy handling. Meter indexes for wave length inscriptions. The form also has a special threaded shelf moulded inside to permit the mounting of "APC" air padding condenser for tuning the coil to a fixed frequency or for band spread arrangements. Winding diameter 1½". Overall length is 2⅞", exclusive of prongs.

Code	Prongs	List Price
SWF-4	4	\$0.35
SWF-5	5	.35
SWF-6	6	.40

"XP-53" PLUG-IN COILS

HAMMARLUND "XP-53" coils provide greater signal strength and greater selectivity on all bands. Extensive laboratory work has resulted in a practically perfect design of the primary, secondary, and tickler coupling and overlap with due regard to the suitability of type and size of wire, number of turns, spacing, form factor, co-efficient of coupling, etc. The frequency ranges covered by each coil were so selected as to provide the most favorable inductance to capacity (L/C) ratio on the important short wave bands. All of the amateur and broadcast short wave bands are thus tunable at the low capacity settings of the tank condensers, affording highest signal voltages. Four coils tuned by a 140 mmf. condenser cover entire range from 17 to 270 meters. A special coil is available for the 10 to 20 meter band, and another special coil is available for the broadcast band. Secondaries of high frequency coils are of heavy silver plated copper wire.

Code	No. of Coils	Prongs	No. of Windings	Wave-Length	List Price
SWK-4	4	4	2	17-270 meters	\$3.00
SWK-6	4	6	3	17-270 meters	3.75
No. 40	1	4	2	10-20 meters	1.00
No. 41	1	4	2	17-41 meters	1.00
No. 42	1	4	2	33-75 meters	1.00
No. 43	1	4	2	66-150 meters	.75
No. 44	1	4	2	135-270 meters	.75
BCC-4	1	4	2	250-560 meters	1.25
No. 60	1	6	3	10-20 meters	1.25
No. 61	1	6	3	17-41 meters	1.25
No. 62	1	6	3	33-75 meters	1.25
No. 63	1	6	3	66-150 meters	1.00
No. 64	1	6	3	135-270 meters	1.00
BCC-6	1	6	3	250-560 meters	1.50

"TCF" TRANSMITTING COIL FORMS

These new giant forms are made of low loss XP-53 dielectric, the same material that is used for the popular SWF type coil forms described above. Forms are groove ribbed to permit air spaced windings. Substantial flange grips for easy handling are another feature. The form may be base mounted by means of a special pair of brackets supplied with each form or mounted in the familiar plug-in coil fashion in the regulation socket. The winding diameter of the form is 2¼". Overall length is 3⅞" exclusive of prongs.

Code	Prongs	List Price
TCF-4	4	\$0.70
TCF-5	5	.70

'APC' IN
SWF
FORM'S W F'
COIL
FORM

'SWK' COIL KIT

'TCF' TRANSMITTING
COIL FORM

"CF" COIL FORMS

The low losses and stability of these forms of extruded Isolantite afford efficient high frequency reception under all conditions. Equipped with convenient recessed black enameled wooden handle in which is inserted a removable paper disc. A celluloid disc protects the paper, a spring ring holding the disc in place. Surface of form is "non-skid", eliminating troubles encountered in winding on slippery surfaces. Numerous holes provided make drilling unnecessary. Form is 1½" in diameter and 2½" long exclusive of knobs and prongs.

Code	Prongs	List Price
CF-4	4	\$1.25
CF-5	5	1.25
CF-6	6	1.25

"CF-M" COIL FORMS

These forms are designed for maximum efficiency at ultra-high frequencies or within the 28 or 56 megacycle band. Being made of Isolantite, and having the correct form factor, high frequency resistance is at a minimum and absolute stability is achieved. The number and location of holes facilitate securing the exact inductance desired and permits of almost any conceivable type of experimental winding. Form is 1½" in diameter and 2" long exclusive of prongs.

Code	Prongs	List Price
CF-5-M	5	\$1.00

"S" ISOLANTITE SOCKETS

An ideal low loss socket affording improved high frequency reception. Constant resistivity and perfect contact eliminate noise. Made of Isolantite, glazed on top and sides and "Ceresin" treated underneath guaranteeing highest surface resistivity. Long leakage paths between rust proofed positive side gripping contacts. Due to a square inset anchorage, HAMMARLUND contacts cannot twist, loosen, or shift position with age or changes in temperature or humidity. A circular "guide groove" makes insertion of tubes easier. Subpanel or base mounting. Size is 2¼" long x 1½" wide. Standard 1 27/32" mounting centers.

Code	Prongs	List Price
S-4	4	\$.60
S-5	5	.60
S-6	6	.60
S-7	7 (large base)	.60
S-7-B	7 (small base)	.60
S-8	8	.75

"S-900" ACORN SOCKETS

HAMMARLUND acorn sockets for ultra-high frequency acorn type tubes, 954 and 955, are a real low loss achievement. Isolantite base with alignment stud. Top, sides, and stud are glazed for highest surface resistivity. Five Double grip, silver plated phosphor-bronze spring clips eyeletted and lipped to base guarantee perfect contact. The prongs cannot twist or shift. Size is 1¾" diameter. Bottom of socket is recessed to insulate contacts and permit flush base mounting. Two mounting holes on 1¾" centers.

Code	Prongs	List Price
S-900	5	\$1.50

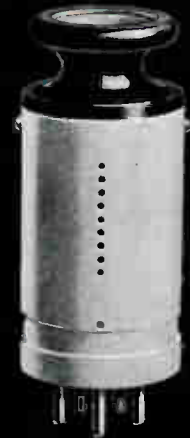

'CF' COIL FORM



'CF-M' COIL FORM

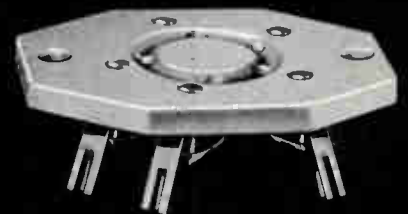

'S' ISOLANTITE SOCKET

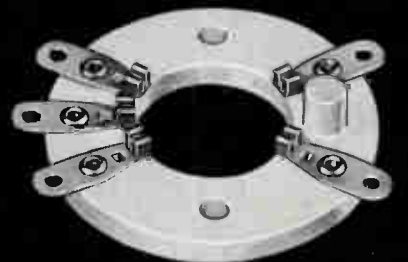

'S-900' ACORN SOCKET





TRIMMING AND PADDING CONDENSERS

HAMMARLUND adjustable mica condensers as now improved are the result of seventeen years of specialization. Quality has been constantly improved through research carried on with the larger electrical laboratories and radio manufacturers in the development of condensers to resist effects of moisture, temperature, vibration and age. Testifying to the accuracy of HAMMARLUND design, processes and material control is the fact that the great majority of radio receiver manufacturers use HAMMARLUND condensers exclusively.

Both the sensitivity and selectivity of superheterodynes are dependent upon the quality of these condensers. It is imperative that the capacity and power factor be maintained as uniform as possible under the constantly varying conditions of temperature, humidity, and vibration, encountered in actual service. Isolantite bases are conditioned to resist moisture and to maintain constant volume and surface resistance. Only the most expensive imported mica is used. The phosphor bronze spring plates are shaped to provide the best possible capacity curve. Easy soldering heat dissipating terminals are employed. Fixed plates are securely anchored. Actual minimums are lower and actual maximums are higher than indicated below. Condensers are tested for capacity, power factor, and for breakdown at 500 volts D.C.

Space does not permit complete description of all the types made. All types are designed with identical accuracy and excellence of materials to meet the exacting purposes for which they have been produced. For I.F. tuning R.F. trimming and for padding or trimming of oscillator and other circuits.

A SPECIAL laboratory is maintained for research and design of trimmers and padders. Our engineers will be glad to give their assistance to all special trimming and padding problems, including special condenser assemblies for automatic tuning devices.

LIST OF STOCK SIZES

Type	Code	Capacity	Size	Mtg. Centers	Base	List Price
"MEX"	MEX-30	3-30 mmf.	5/8"x3/4"	Isol.	\$.30
"EC"	EC-35	3-35 mmf.	1 1/4"x11/16"	Single Hole	Bakelite	.30
.....	EC-80	25-80 mmf.	1 1/4"x11/16"	Single Hole	Bakelite	.40
"MICS"	MICS-70	10-70 mmf.	1"x1 5/8"	1 1/4"	Isol.	.50
.....	MICS-140	70-140 mmf.	1"x1 5/8"	1 1/4"	Isol.	.60
.....	MICS-220	140-220 mmf.	1"x1 5/8"	1 1/4"	Isol.	.70
.....	MICS-1000	500-1000 mmf.	1"x1 5/8"	1 1/4"	Isol.	1.00
"CTD"	CTD-85	25-100 mmf.	1 1/8"x2 1/8"	1 13/16"	Isol.	.80
.....	CTD-160	45-260 mmf.	1 1/8"x2 1/8"	1 13/16"	Isol.	.90
.....	CTD-230	65-350 mmf.	1 1/8"x2 1/8"	1 13/16"	Isol.	.90
"CTS"	CTS-85	25-100 mmf.	1 3/16"x1 1/16"	15/16"	Isol.	.50
.....	CTS-160	45-260 mmf.	1 3/16"x1 1/16"	15/16"	Isol.	.60
.....	CTS-230	65-350 mmf.	1 3/16"x1 1/16"	15/16"	Isol.	.60
.....	CTS-380	175-550 mmf.	1 3/16"x1 1/16"	15/16"	Isol.	.75
.....	CTS-525	230-800 mmf.	1 3/16"x1 1/16"	15/16"	Isol.	.80
"DTD"	DTD-50	8-90 mmf.	1 1/16"x1 3/16"	Single Hole	Isol.	.70
.....	DTD-115	30-175 mmf.	1 1/16"x1 3/16"	Single Hole	Isol.	.80
"DTS"	DTS-50	8-90 mmf.	1/2"x1 1/16"	Isol.	.30
.....	DTS-115	30-175 mmf.	1/2"x1 1/16"	Isol.	.40
"QTD"	QTD-100	20-100 mmf.	1 11/32"x1 11/32"	Single Hole	Isol.	.70
.....	QTD-250	55-250 mmf.	1 11/32"x1 11/32"	Single Hole	Isol.	.80
.....	QTD-450	100-450 mmf.	1 11/32"x1 11/32"	Single Hole	Isol.	.90
.....	QTD-600	170-600 mmf.	1 11/32"x1 11/32"	Single Hole	Isol.	1.00

Isol. = Isolantite



"ETU" EXCITER TUNING UNIT

These handy units are intended for use in multi-band transmitter exciters and lend themselves readily to band switching arrangements. They are used in our exciters shown on page 17. Available unwound or with windings for 10-20-40 and 80 meter bands. Designed to work with 6L6's. Consists of two 25 mmf. double spaced condensers and a 2" x $\frac{7}{8}$ " diameter winding form. "ETU-10" for 10 meters, "ETU-40" for 40 meters, etc.

Code	Size	List Price
ETU	2" x 4" x 1 $\frac{7}{16}$ "	\$4.00
ETU-10-20-40-80	2" x 4" x 1 $\frac{7}{16}$ "	5.50

"PTS" POWER TUBE SHIELD

Designed for use with power tubes of the screen grid type. Increases stability and reduces feedback. Made in two sizes, "PTS" for low powered tubes such as 807, RK-23, etc., and "PTS-H" for large pentodes and tetrodes such as RK-20, 814, etc. Mounting centers 2 $\frac{27}{32}$ ".

Code	Size	List Price
PTS	2 $\frac{1}{4}$ " x 3" high	\$0.40
PTS-H	2 $\frac{1}{4}$ " x 2 $\frac{1}{8}$ " high	.40

"XS-2" CRYSTAL SOCKET

A new crystal socket designed to follow the modern trend toward compact transmitter design. Pure Isolantite with heavy re-inforced contacts to insure perfect connection. Can be mounted above or below base or inside XP-53 coil form. Mounting centers 15/16".

Code	Size	Prongs	List Price
XS-2	1 $\frac{5}{16}$ " diameter	2	\$0.50

ISOLANTITE INSULATORS

Made of pure glazed Isolantite. These heavy duty insulators will not chip or crack as easily as ordinary porcelains. Superior material prevents threads from stripping. Hardware is heavy brass cadmium plated and the terminal lug is thick cadmium plated copper. Available with or without hardware and in either plain or jack tip types. Insulating beads and bushings also Isolantite.

LIST OF STOCK SIZES

Code	Size	List Price
SOS-75	1/2" x 3/4" long	\$0.15
SOS-100	1/2" x 1" long	.20
SOS-150	1/2" x 1 1/2" long	.25
SOS-250	1/2" x 2 1/2" long	.30
SOL-100	3/4" x 1" long	.30
SOL-150	3/4" x 1 1/2" long	.40
SOL-200	3/4" x 2" long	.50
SOL-350	3/4" x 3 1/2" long	.70
SOSP*	Plain tip for 1/2" Dia. Ins.	.10
SOSJ*	Jack tip for 1/2" Dia. Ins.	.15
SOLP*	Plain tip for 3/4" Dia. Ins.	.15
SOLJ*	Jack tip for 3/4" Dia. Ins.	.20
FTB**	Feed Through Bushings	.15 pr.
FCB***	Flexible Connector Beads	.25

* Complete hardware, including tip, screws, lockwashers, cork friction washer, mounting base, etc.

** Packed in pairs in individual envelopes.

*** Packed in envelopes of 25 beads (5 $\frac{1}{2}$ beads per inch).

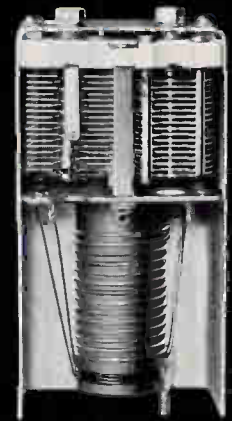

ETU



PTS



XS-2



FCB

FTB

INSULATORS

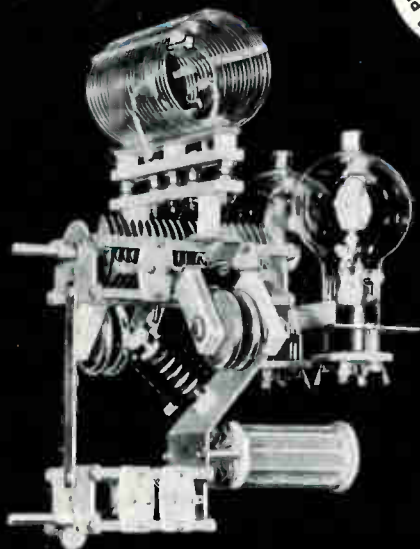

"PA-300" AMPLIFIER

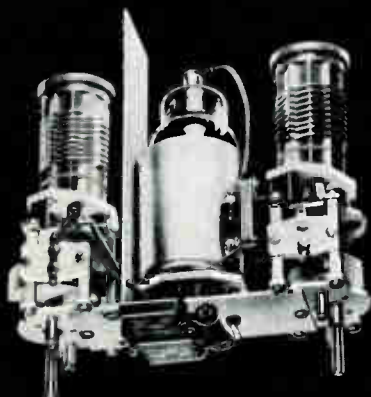

"BD-40" BUFFER-DRIVER

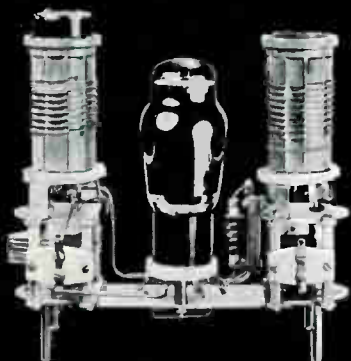

"OD-10" OSCILLATOR-DOUBLER

"PA-300" AMPLIFIER

AMATEURS the world over are expressing their enthusiasm over the new HAMMARLUND method of transmitter construction. It is no longer necessary to build complicated bulky apparatus. These new transmitter foundation units eliminate the usual chassis with its difficult drilling and machining. These units are so simple to assemble that even the most inexperienced person can build a neat, business-like transmitter. All brackets are completely drilled and shaped to fit standard HAMMARLUND parts and can be assembled in only a few minutes time. This unit is suitable for either a low or medium power transmitter. Such tubes as 809's, T-20's, 10's and many others can be used for low power output. For higher output either 808's, RK-37's, T-55's, HK-24 or HK-54 provide excellent results. The plate tuning condenser has .070" spacing. Voltages up to 2000 may be applied to the tubes. The brackets are designed to accommodate standard variable link inductors. Other HAMMARLUND parts used are—1 MTC-100-B; 1 MTC-100-C; 2 N-10; 1 CH-500; 2 S-4; 1 S-5; 4 SWF-4 coil forms. Dimensions 13"x8½"x8".

Code	Description	List Price
PA-300	Includes all brackets, screws, washers, and nuts	\$3.25

"BD-40" BUFFER DRIVER

THE "BD-40" is a buffer-driver-multiplier unit of compact design and can be used in multi-stage transmitters where several multiplier stages are necessary or can be used as the driving unit for the "PA-300". The "BD-40" employs an 807 or similar beam tube and has an output of nearly 40 watts on all bands from 80 to 10 meters. Ideal for beginners desiring to start out with a small inexpensive transmitter. The "BD-40", when used in conjunction with the "OD-10", provides a neat, compact low power transmitter. Other HAMMARLUND parts needed: 2 MTC-100-C; 2 S-4; 1 S-5; 1 CH-X; 8 SWF-4 coil forms. Dimensions 8¼" x 7½" x 3¼".

Code	Description	List Price
BD-40	Includes all brackets, tube shield, screws, washers and nuts	\$3.60

THE three foundation units listed on this page, when used together, form the complete R. F. section of an efficient and compact transmitter suitable for operation on all bands from 80 to 10 meters—phone or CW. Ideal for the beginner and old-timer alike.

"OD-10" OSCILLATOR DOUBLER

THE "OD-10" is a standard tri-tet oscillator-doubler and can be used as a low-power one-tube transmitter or in conjunction with the "BD-40" and "PA-300" in a multi-band transmitter. This unit employs a 6L6-G or similar tube and will operate on two amateur bands with a single crystal. The "XS-2" crystal socket is mounted inside of the cathode coil form so that the coil and crystal can be changed in one operation. Other HAMMARLUND parts needed—2 MTC-100-C; 2 S-4 sockets; 1 S-8 socket; 1 CHX choke; 1 XS-2 socket; 2 SWF-4 forms. Size: 8¼" x 7½" x 3¼".

Code	Description	List Price
OD-10	Includes all brackets, screws, nuts, etc.	\$2.80

"PA-500" AMPLIFIER

THE "PA-500" push-pull power amplifier can be operated with outputs up to 500 watts and over. This unit makes use of tubes such as RK-38, 100-T, 50-T, HK-54, HK-154, and others requiring up to 2,000 or more volts on the plates. "PA-500" uses standard HAMMARLUND "TC" condensers. Either the "TCD-55-F" with a .230" plate spacing, or the "TCD-75-G" with a .200" spacing can be used in the plate circuit and "TCD-50-H" or "TCD-165-K" in the grid circuit. In design, the "PA-500" is similar to the "PA-300." All parts are fastened together with brackets to form a neat and compact unit. All brackets are completely shaped and drilled. The entire unit can be assembled and wired in less than an hour. It is designed to mount directly on the panel—no chassis is required. "PA-500" can be used as a final amplifier in all amateur transmitters from 80 to 10 meters with maximum efficiency. Provisions have been made to accommodate standard, fixed, or variable link coils in both the plate and grid circuits. The "PA-500" and "ED-4" shown below, when used together, constitute the complete R.F. portion of a 500 watt transmitter capable of efficient operation on all bands from 80 to 10 meters — phone or C.W. Other HAMMARLUND parts needed: 2 "S-4" sockets; 2 "N-10" neutralizing condensers; 1 "CH-500"; 1 variable plate condenser; 1 variable grid condenser, (see page 6 for plate spacing and capacities). Dimensions: 15½" high x 10½" wide x 12" deep.

Code	Description	List Price
PA-500	Includes all brackets, nuts, screws, etc.	\$4.25

"ED-4" EXCITER-AMPLIFIER

The "ED-4" is the same as the "EU-4" except that a power amplifier (RK-47, 814, etc.) has been added so that it can be used as a driver for the "PA-500" or as a transmitter with an output of nearly 100 watts. This kit contains the same hardware as the "EU-4" with the addition of a tube shield, bracket for mounting the tube socket, special spring plate connector, and 2 pillars for mounting standard plate coil. When completely assembled and wired, this unit represents an extremely compact and efficient transmitter or driver. Other HAMMARLUND parts needed: Same as EU-4 plus 1 "S-4" socket; 1 "S-5" socket; 1 "MC-100-S" condenser; 1 "MTC-100-B" condenser; 1 "CHX"; 3 "SOS-100" stand-off insulators; 2 "SOSP" insulator hardware; 4 "SWF-4" coil forms. Dimensions: 17" long x 8" deep x 9¼" high. All parts aluminum.

Code	Description	List Price
ED-4	Includes all hardware, drilled and shaped, nuts, screws, 2-switches, etc.	\$13.50

"EU-4" EXCITER UNIT

THE NEW "EU-4" 4-band exciter unit is designed for amateurs who want a really flexible and compact unit covering the 80, 40, 20, and 10 meter amateur bands. There are four stages employing 6L6 tubes. The first is an 80 meter crystal oscillator and the remaining three stages are for frequency multiplication. Band changing is accomplished with a single 4-point rotary switch. This switch, as it is rotated, adds the proper number of multiplier stages to provide the output frequency desired and also connects the output link to the particular stage being used. Link coupling is used on all bands from 80 to 10 meters inclusive. Another switch is provided for metering the four stages. Power output is sufficient for driving small and medium power beam tubes or pentodes and low power triodes requiring only a few watts excitation. Foundation unit includes all hardware for building the "EU-4" and includes the two special rotary switches. Other HAMMARLUND parts needed: 1 "ETU-90"; 1 "ETU-40"; 1 "ETU-20"; 1 "ETU-10"; 1 "XS-2"; 4 "S-3" sockets; 5 "CHX" R.F. chokes. The "EU-4" is 17" long x 8" wide x 2¾" high. All parts are aluminum.

Code	Description	List Price
EU-4	All hardware, nuts, screws, switches, etc.	\$11.50

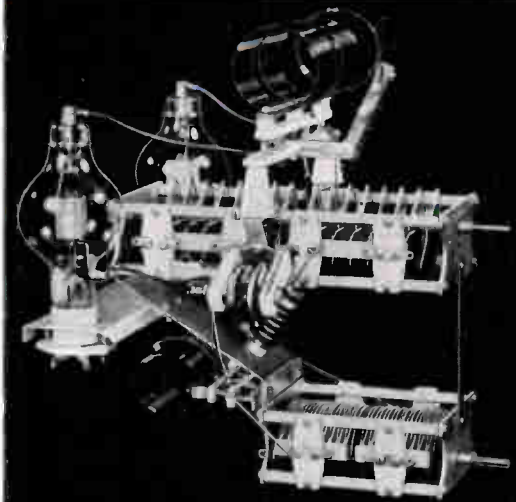

PA-500
PUSH-PULL
POWER AMPLIFIER

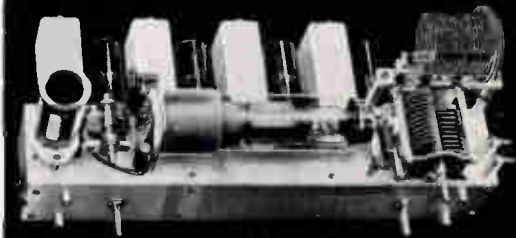

ED-4
COMBINED
BAND-SWITCHING
EXCITER AND AMPLIFIER

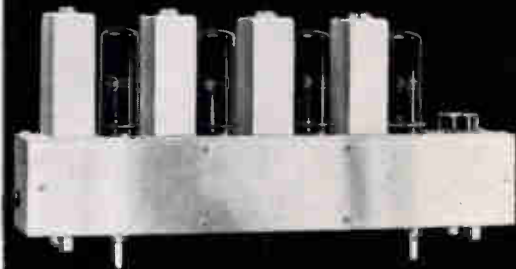

EU-4
BAND-SWITCHING
EXCITER UNIT





"HQ-120-X" RECEIVER

(Licensed under RCA and Hazeltine Patents)



HQ-120-RECEIVER

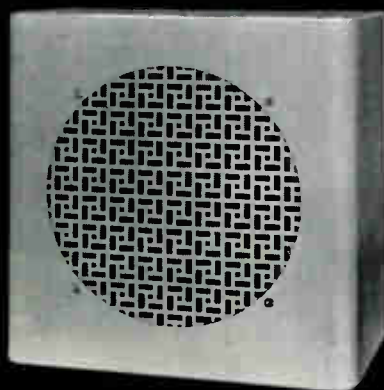

"PM" DYNAMIC SPEAKER

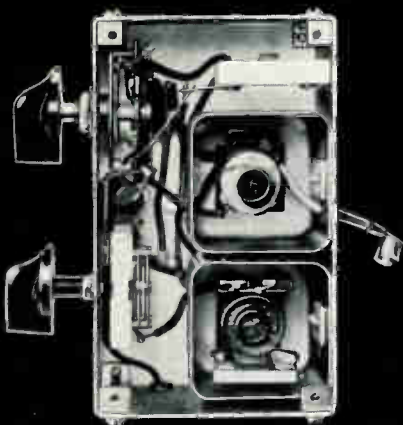

VARIABLE CRYSTAL UNIT

NEVER BEFORE have so many outstanding features been incorporated in a single receiver. This ultra-modern 12-tube receiver covers a range of from 31 to .54 mc. (9.7—555 meters). It is designed to meet the most exacting demands of the amateur and short wave experimenter. This is no ordinary receiver, no redesigned broadcast set, it is especially engineered from start to finish. With the type construction employed in the "HQ-120-X," the inclusion of the broadcast band in no way jeopardizes the efficiency of the receiver at higher frequencies. Although this requires special tuning condenser design, it is the only satisfactory solution.

Many of the features in this remarkable receiver are original HAMMARLUND developments. The new "full range" crystal filter that opens up a new field in radiophone communication; the special high gain R.F. stage with its antenna compensator; uniform sensitivity; three I.F. stages with silvered mica condensers and permeability tuned transformers; exclusive tuning condenser design; calibrated dial; noise limiter, and many others all go to make up a receiver that is already taking the field by storm. The stability, sensitivity, and selectivity of the new "HQ-120-X" are exceptional. The voltage regulated power supply provides constant voltage to the high frequency oscillator. This, together with special oscillator circuit, provided a degree of stability high enough to warrant calibrating the band-spread dial in megacycles for each amateur band from 80 to 10 meters inclusive. This dial has an additional 0—200 scale for calibration at other frequencies. The general coverage dial is also calibrated in megacycles. The high gain R.F. stage, with its antenna compensator control, provides maximum image rejection and highest signal-to-noise ratio with all types of antennas. By special circuit arrangement, the gain of the entire receiver is held relatively constant in all amateur bands and provides accurate "S" meter readings. Another feature directly concerning the accuracy of the "S" meter is the uniform output of the crystal filter.

The specially designed 15-gang tuning condenser in the "HQ-120-X" provides constant band-spread throughout its entire range. There are six sections in the main tuning condenser, and nine sections in the band-spread condenser. The special design of the tuning condenser, combined with an unusual dial arrangement, provides 310 degrees band spread on each amateur band.

The noise limiter on the "HQ-120-X" is designed to effectively remove automobile ignition interference and similar disturbances. It works with or without the A.V.C. system and there are no delicate threshold controls on the panel—merely an "On and Off" switch.

The new crystal filter circuit employed in the "HQ-120-X" is an outstanding HAMMARLUND development. Because of its "full-range" selectivity, this filter is applicable to both phone and C.W. reception. There are six positions on the selectivity switch and these are controlled from the panel. There are three positions for phone reception and the first of these positions provides a band width wide enough to admit fairly good quality music. Two positions in the selectivity range are for single signal C.W. reception. The sixth position cuts the crystal out of the circuit. Equipped with black etched panel and crackle finished metal cabinet with handles. Measures 17 1/8" long x 10" high x 12 1/4" deep. Send for free 16-page booklet. Rack model \$10.00 extra list.

Code	Description	List Price
HQ-120-X	Receiver complete with tubes, crystal filter and 10" P.M. Dynamic speaker, less speaker cabinet	\$230.00
SC-10	Cabinet for 10" P.M. speaker finished to match receiver. Size is 12 1/2" x 12 1/2" x 7".	6.50
HQ-120-XG	With gray cabinet and panel.	235.00
SC-10-C	Gray Speaker cabinet.	7.50

"XU-455" VARIABLE CRYSTAL FILTER

This crystal filter is supplied with a 455 kc. crystal. It can be used with receivers having a 465 kc. I.F. by simply adjusting the transformers of the receiver to the new frequency. Dimensions 2 1/8" wide x 3" deep x 5" high.

Code	Description	List Price
XU-455	Complete with 455 kc. crystal	\$30.00

HAMMARLUND "SUPER-PRO" (Licensed under RCA and Hazeltine Patents)

The new HAMMARLUND 18-tube, Series 200, "Super-Pro" is the last word in communications receiver engineering. Every feature for improved performance has been built into the new "Super-Pro." This new receiver is designed for commercial services where peak performance and unlimited flexibility are paramount. Its full range selectivity from less than 100 cycles to approximately 16 kc. makes it respond to the operator's every wish whether it be for reception of CW telegraph signals in crowded bands or for high fidelity reception for re-broadcasting purposes. This wide range of selectivity permits maximum use of the extreme sensitivity for which the "Super-Pro" has long been famous. Amateur and commercial operators, alike, will find reception of weak, distant stations more reliable because selectivity can be adjusted to suit receiving conditions.

The crystal filter has five ranges of selectivity varying from "single-signal," to 2½ kc. for phone reception. Three of these ranges are especially intended for receiving phone signals. In addition, the overall I. F. selectivity is variable from 3 to 16 kc. by mechanically changing the coupling in the I.F. transformers.

Interference by man-made disturbances has been reduced to a minimum with an efficient and improved noise limiter. Automobile ignition interference, which is most bothersome on 10 and 20 meters is practically eliminated.

The new "Super-Pro" also has an improved "S" meter which is adjustable to conform with the operator's custom of reporting signal strength. Another major feature is the band spread system with a 12-gang band spread condenser which spreads each amateur band over practically the entire dial scale. This band spreading is not restricted to the amateur bands. High frequency broadcast channels are also spread out considerably on the band spread dial. Band spread is available throughout the entire high frequency range of the receiver. The exclusive cam-operated band changing knife switch is noiseless in operation, jar-proof, and trouble-free. Especially designed silver-plated knives mounted on bakelite panels are used. Six silver-plated contact fingers insure dependable low resistance contact for each circuit. No moving part carries current to cause noise or to provide stray coupling. Silver-plated shortcircuiting springs automatically short out the unused coils at all times. The new Series 200 "Super-Pro" receiver is available in two special tuning ranges as listed below. All models, however, include identical features. In addition to the above, the "Super-Pro" has a beat oscillator, AVC, calibrated main tuning dial, two stages of tuned R. F. for image-free reception and high signal-to-noise ratio, 14 watt audio amplifier, separate power supply, relay terminals, ear-phone and phonopick-up connections and a beautiful metal cabinet. Send for illustrated folder containing further details. Receiver measures 21½" long x 15¼" deep x 12¼" high. Power unit 13" x 7⅞" x 8½". Rack model 19" long x 14¾" deep x 10 15/32" high.

Code	Type	Tuning Range	Speaker	List Price
SP-210-X	Crystal	15-560 meters	10" Dynamic	\$465.00
SP-210-SX	Crystal	7½-240 meters	10" Dynamic	465.00
SP-220-X	Crystal	15-560 meters	12" Dynamic	490.00
SP-220-SX	Crystal	7½-240 meters	12" Dynamic	490.00
PSC-10	10" speaker cabinet to match receiver			8.50

Above prices cover 110 volt 60 cycle model including tubes, crystal, speaker and separate power pack. Rack models are available at \$17.50 additional, list. Models covering other tuning ranges and for different line voltages are also available. Prices on request.

"All Prices in This Catalog Subject to Change Without Notice"



STANDARD 'SUPER-PRO'
IN METAL CABINET

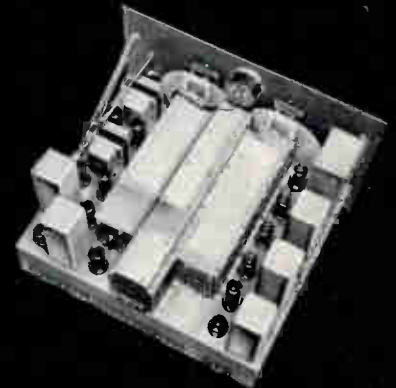

STANDARD 'SUPER-PRO'
RECEIVER CHASSIS

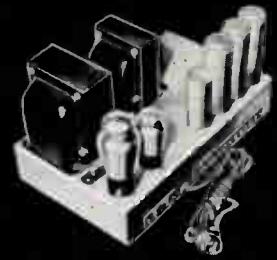

STANDARD 'SUPER-PRO'
POWER SUPPLY CHASSIS



'SUPER-PRO' HI-FIDELITY
12" SPEAKER CHASSIS

Twenty-Ninth YEAR
World Radio History



PAGE NINETEEN



HAMMARLUND PRODUCTS

PRECISION STANDARD, MIDGET AND MICRO VARIABLE CONDENSERS; TRIMMING AND PADDING CONDENSERS; PLUG-IN COILS; COIL FORMS; SOCKETS; I. F. TRANSFORMERS; R. F. CHOKES; COUPLINGS; SHIELDS; PROFESSIONAL RECEIVERS AND SPECIAL LABORATORY EQUIPMENT FOR ULTRA-HIGH FREQUENCY, HIGH FREQUENCY AND BROADCAST RECEIVING AND TRANSMITTING.

SALES OFFICES

BUFFALO, N. Y. . . . 250 Delaware Ave.
PHILADELPHIA, PA. . . . 2324 Ripley St.
CHICAGO, ILL. . . . 540 N. Michigan Ave.
DETROIT, MICH. . . . 153 E. Elizabeth St.
CLEVELAND, OHIO . . . 1400 W. 25th St.
ATLANTA, GA. . . . 289 Peachtree St., N.E.
DALLAS, TEXAS . . . 137 South Montclair
DENVER, COLO. . . . 436 Continental Oil Bldg.
LOS ANGELES, CAL. . . . 945 E. Pico St.
SAN FRANCISCO, CAL. . . . 1264 Folsom St.
PORTLAND, ORE. . . . 917 S. W. Oak St.
HAMILTON, ONT., CAN. . . . 41 W. Ave., N.
EXPORT DEPT. . . . 100 Varick St., N. Y. C.

A COMPACT UNIT-TYPE AMPLIFIER

Push-pull 4K24's Without Conventional Chassis

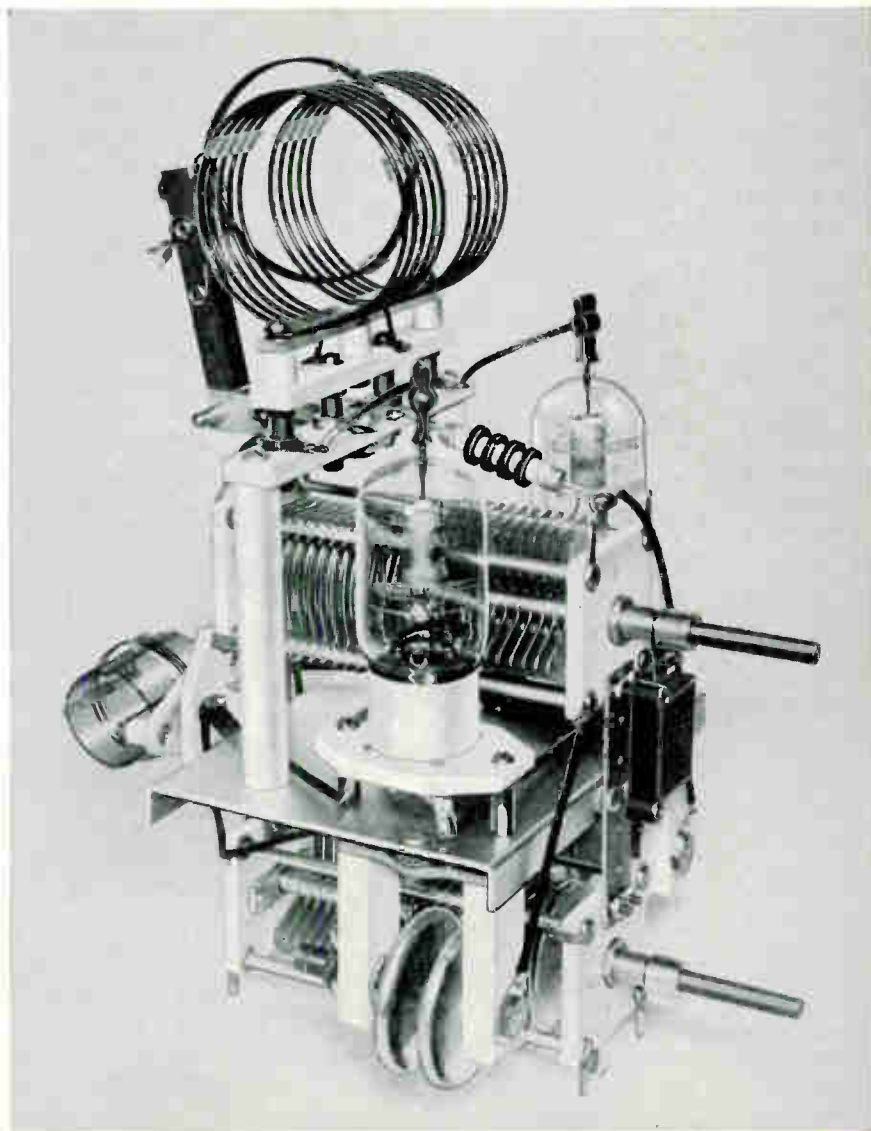

*4K24's
Hammarlund
1205 Lynde
8-1-30*

HAMMARLUND MFG. CO., Inc.
424 W. 33rd ST., N. Y. CITY

TIME was when a rig had to be big in order to be good. Now, with smaller and more efficient tubes as well as other transmitting components, the amateur is striving to build more compact and presentable apparatus. In building the amplifier unit shown in the photograph, no particular effort was made to keep the dimensions small but after it was completed we were quite aware of its compactness and that it might be of interest to other amateurs who like to conserve space. The overall dimensions are 11½ by 8 by 5½ inches, exclusive of shafts which would normally project through the panel.

Considering that this amplifier will deliver approximately 175 watts, it becomes quite a husky little fist-full. The rotor of the plate tuning condenser is connected to the high voltage lead to take the d.c. potential from across the condenser

well as plate spacing and capacity, although a lower-voltage unit could be substituted in the grid circuit. Voltages up to 1000 can be used with plate modulation, or to 2000 volts unmodulated.

The method of assembly is quite evident from the photographs. The two condensers are supported by vertical metal strips attached to the 5½ by 4½-inch sub-base. This sub-base, or platform, not only serves to mount the tubes and coils, but also acts as a shield between the two condensers. Standard Barker & Williamson coils are used in both the plate and grid circuits, and require no pruning. The amplifier is suitable for operation on 80, 40, 20 and 10 meters with the condensers illustrated. Since the series minimum capacity is in the neighborhood of 9 mmfd., there is no difficulty in obtaining resonance throughout the 10-meter band with proper L/C ratios.

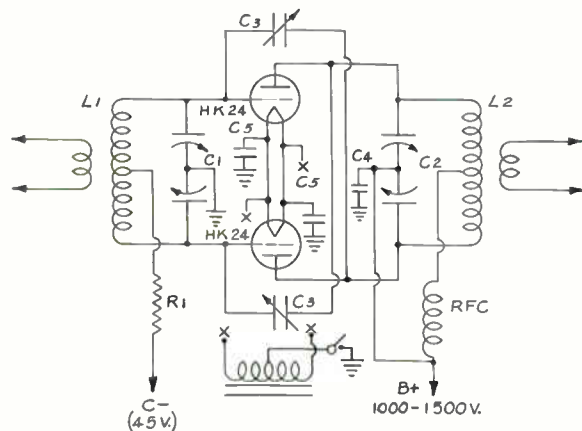

Circuit diagram of complete push-pull amplifier stage built with the "PA-150" foundation unit. The only deviation from standard wiring practice is the B-plus feed connection to the plate circuit. This is arranged so that the B-plus is applied to both the rotors and stators of the condenser.

plates. This method of wiring up the plate circuit of an amplifier was thoroughly discussed in a past issue of QST* and is highly recommended for a number of good reasons. It permits the use of a condenser with smaller plate spacing, and as a result the overall physical dimensions of the condenser can be reduced for a given plate voltage. The only drawback is the fact that the rotor has full d.c. voltage on it, while in the other circuits the rotor is grounded. Because of the design of the condenser used in the amplifier shown here, the danger element due to the high voltage being present on the rotor is reduced considerably, since an insulated shaft extension is an integral part of the condenser, and the rotor is insulated from ground by the Isolantite end plates. For mechanical reasons, the grid and plate condensers in the amplifier have the same physical dimensions as

The excitation requirements for the two 6X4's are quite modest; only some 10 watts are required. An amplifier or oscillator delivering around 15 or 20 watts should do the trick very nicely and provide an ample reserve of power for good regulation in the driving stage.

Slight changes in the amplifier can be made without difficulty. For example, fixed link coils can be used in the plate circuit and other types of tubes requiring from 1000 to 1500 volts on the plate can be substituted.

There is no trick to assembling this amplifier. First, fasten the two strips to the large shelf, then the two condensers are mounted. The standard mounting brackets that come with the condensers are removed and the screws are used when using the new mounting arrangement. Next, mount the tube sockets with the filament terminals to-

* Ferrill, "How Much Condenser Spacing?" Dec., 1938 QST.

Reprinted in part from October, 1939 QST

ward the front of the unit. Then the coil pillars are mounted. These pillars are 3" long and are made up of two insulators for each side of the coil base, consisting of one 2½" insulating and one 1" insulating. The two being held together by a short length of threaded rod. When mounting the two "N-10" neutralizing condensers, the spacers should be placed by the bases and the aluminum shelf so that there is clearance for the nuts used in mounting the sockets. The photos show the neutralizing condensers with their adjusting shafts toward the rear. If, for some reason, it is desired to adjust these condensers from the front, they can be turned around and very easily adjusted through holes in the front panel.

The entire unit should be wired with covered wire as a measure of safety. Number 18 push-back wire is good enough. The filament leads in the power cable should, of course, be heavy where there is any appreciable length to the cable. All

connecting leads in wiring up the unit should be as direct as possible. In the course of wiring up this amplifier it is found that all connections are convenient and in practically every case, the leads are short and direct due to the general design and layout of the unit. Four 1" stand-off insulators are used to fasten the "PA-150" to the front of the panel. These are placed, two on each condenser, one on each side of the shaft. The center distance horizontally for panel mounting is 35/64" each side of the rotor shaft, and the vertical center distance is 4-5/32".

Tuning and adjusting the "PA-150" are identical to any other push-pull amplifier and is thoroughly covered in the several excellent handbooks which are now available. As a driver, the 807 will be found to do the job admirably. If you want four-band operation with band switching, the Hammarlund "ED-4" exciter unit with an 807 in place of the usual 814 or RK-47 is just the thing.

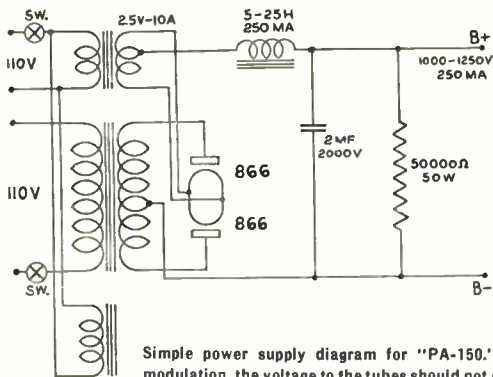

Simple power supply diagram for "PA-150." With plate modulation, the voltage to the tubes should not exceed 1,000.



Hammarlund "PA-150" Parts List

PA-150.....	2.80	List
2 - HFBD-100-C conds.....	5.15 ea.	10.30 List
1 - CH-250.....	.50 ea.	.50 List
1 - S-5.....	.60	List
2 - S-4.....	.60 ea.	1.20 List
2 - N-10 neut. conds.....	3.00 ea.	6.00 List
2 - SOS-250 insul.....	.30 ea.	.60 List
6 - SOS-100 insul.....	.30 ea.	1.80 List

Total \$23.80 List

Amateur Net Total 14.28

Other Parts Required:

- 2 - HK-24's or similar type tubes
- 1 - R₁ 3,000 ohm 10 watt resistor wire wound
- C₅ 0.01 mf. paper condenser, 1,000 V.
- C₄ 500 mmf. mica 5,000 V.
- Grid and plate inductors. See text.