

**DEVELOPMENTS
IN THE
ELECTRICAL INDUSTRY
DURING 1937**



GENERAL  ELECTRIC

**DEVELOPMENTS
IN THE
ELECTRICAL INDUSTRY
DURING 1937**



COPYRIGHT 1938
BY GENERAL ELECTRIC COMPANY

**GENERAL ELECTRIC COMPANY
SCHENECTADY, NEW YORK**

CONTENTS

SUBJECT	PAGE
Power Generation.....	5
Transformers.....	9
Voltage Regulators.....	11
Petersen Coil.....	12
Lightning Arresters.....	12
Fuse Cutouts.....	13
Switchgear.....	13
Meters and Instruments.....	18
Network Analyzer.....	23
Cable.....	24
Steel-tank Mercury-arc Rectifiers.....	24
Electron Tubes.....	25
Carrier Current.....	26
Capacitors.....	27
Electric Transportation.....	27
Marine Equipment.....	31
Aviation.....	32
Motors.....	33
Control Equipment.....	35
Dynamometers.....	37
Welding.....	38
Industrial Heating.....	40
Elevators and Hoists.....	42
Electric Shovels.....	43
Machine-tool Equipment.....	44
Textile Mills.....	44
Paper Mills.....	45
Sugar Mills.....	46
Steel Mills.....	47
Electric Refrigeration.....	47
Air Conditioning.....	48
Appliances.....	50
Radio Equipment.....	53
X-ray and Electromedical Apparatus.....	55
Rural Electrification.....	56
Lighting.....	58
Research.....	63

ELECTRICAL PROGRESS IN 1937

MORE Goods for More People at Less Cost emphatically continued in 1937 as the aim of the electrical industry, whether considering the production, transmission, or use of electricity—in industry, commerce, or the home. Decided advances were made in all directions, and in ways which will have lasting effects in increasing the wealth of the world.

More efficient equipments for both the generation and the utilization of electricity were produced, as in higher-pressure turbine-generators and improved incandescent lamps. Operating losses were further reduced, as exemplified by new transformers. Designs were standardized and simplified, and sizes and weights reduced, as shown by new motors and control equipments. Longer life, greater ease of servicing, and decreased maintenance expense were likewise effected. Few indeed, if any at all, were the products which were not bettered in at least some of these respects.

Not only in improved designs of products were there notable advances. The year was no exception in the succession of those which saw the evolution of new engineering ideas, and the development of equipments extending the application of electricity to the accomplishment of processes heretofore not possible. Specialized equipments, better meeting the requirements of specific applications, were produced, as in the case of a new motor for the textile industry; and limits were extended in the production of equipments of greater capacities and increased speeds.

The most outstanding development of the year in power-generation equipment was the announcement of the proposed use of 2300-lb steam in a 22,500-kw turbine-generator. The pressure will be nearly double that of high-pressure plants now installed in this country. The operating temperature will be 940 F.

The first hydrogen-cooled turbine-generator was put into commercial operation, and by the end of the year more than a million kva of such units were in service or under construction. "Topping" or superposed turbines, decidedly increasing the efficiency of power-generating stations, continued in demand. In both large and small turbines there was a continued tendency for higher average operating pressures and temperatures, with accompanying increased efficiencies.

The first of two 48,000-kva vertical waterwheel-driven generators was about to go into operation at Bonneville Dam. Although of less rating than the 82,500-kva generators at Boulder Dam, they are physically larger since they operate at 75 rpm instead of 180 rpm.

In a new distribution transformer the magnetic circuit, instead of containing hundreds of hand-assembled laminations, consists of a continuous, machine-wound, steel ribbon. The active material is thereby used more effectively, clamping structures are simplified, and size, weight, and total losses reduced. By the end of the year Pyranol had been applied in more than 400,000 kva of transformers, up to 10,000 kva in size. Outstanding among power trans-

formers built during the year were the single-phase 60-cycle water-cooled units for a step-down service at the end of the 230,000-volt Boulder Dam line. They are of core-type, concentric, shielded-winding construction.

Switchgear developments during the year followed the line of more extensive applications of metal-enclosed structures. In midget-type equipments, sizes were increased to include 50,000- as well as 25,000-kva interrupting ratings.

A new single-phase watt-hour meter was produced with a practically flat operating characteristic over a very wide range. Of major importance also was the production of concentric magnet-type instruments for direct-current work, one third lighter, requiring no auxiliary shields to reduce stray-field errors, and measuring currents of half the previously possible magnitudes.

Many new types of electric measuring instruments were produced, and improvements made in other types. Among such new instruments were an inkless-type recording instrument, utilizing a typewriter ribbon; a double photoelectric recorder for simultaneously recording two electrical quantities as low as one microampere full scale; a portable bar-to-bar test set for comparing resistances of coils as measured between adjacent commutator bars; and, for amateur and professional motion- and still-camera photographers, a photoelectric exposure meter of high sensitivity.

Decided progress was made in the rehabilitation of city transportation facilities. In accomplishing this result, three vehicles, the most modern motive power available to city transportation systems, were extensively used. The Presidents' Conference Committee Car is now in service in eight cities; the trolley coach is in use on 44 properties; and the world's first fleet of diesel-electric buses went into service. An electric drive of greatly decreased weight and cost and increased efficiency was developed for these buses and coaches.

In the steam-railroad field, electricity also contributed to the improvement of motive power. Electric equipment was used extensively for additions to existing electrifications, for diesel-electric switching locomotives, and for locomotive equipment on diesel-electric streamlined trains. The 5000-hp steam-electric locomotive for main-line operation on the Union Pacific is now undergoing initial tests. A process for flash butt welding the ends of rails to form one long, continuous rail, with smoother riding for passengers and reduced maintenance for railroad operators, was announced.

The highest steam pressure and temperature yet used on any American-built ship were provided for two turbine-electric-driven tankers, with steam conditions of 600 lb gauge and 825 F. Geared turbines were provided for oil tankers, for cargo vessels with a service speed of 16½ knots, replacing ships operating at 11 knots in Atlantic Coast service, and for new

bulk carriers beginning a replacement fleet for Great Lakes service.

There was a continued trend toward greater use of enclosed motors; and an increased displacement of single-phase commutator-type motors by the simple capacitor motor with squirrel-cage rotor. Much larger wound-rotor and squirrel-cage motors were made for operation at 3600 rpm; there were numerous added examples of the application of motors built into equipment.

Electric heat continued to find new industrial applications as well as greatly extended use in fields in which it was no stranger. A new electric roller-hearth furnace makes it possible to anneal malleable-iron castings in from 12 to 30 hr, instead of the previous 5 to 10 days. Inductive heat was applied in producing hardened bearing surfaces without affecting other parts of the steel, with the hardening accomplished in seconds as compared with the hours required for carburizing or nitriding treatment.

A variable-voltage car-dumper equipment placed in service during the year, the most powerful yet constructed, will handle 50 120-ton or 60 70-ton cars per hour. It is of the lift-and-turnover type. Electric equipment was also provided for the largest, and probably the fastest, a-c mine hoist in America. The load will travel up the steep slope at approximately 41 mph, and only 10 sec will be required in loading or unloading the car.

Among the numerous advances made in the application of electricity to the textile industry were a weft-straightening control correcting the skew in cloth; guider equipment for quick and accurate positioning of tenter rails; the applications of motors to continuous batching in winding cloth; a screenless, open motor, designed for positive lint expulsion; and new drives for ranges and sliver lap winders.

Of particular interest to paper mills were improvements made in the regenerative, adjustable-voltage tension-control winder drive, and the development of a sectional paper-machine drive whereby uniform loading of the dryer motor is assured, thereby preventing difficulties in case of snap-off. An electric motor-driven turbine-governor giving accurate control of speed of mechanical-drive steam turbines over a 24:1 range was found very effective for paper-machine drives.

For sugar-mill applications the trend continued for high-speed centrifugals for high-speed drying of sugar on short duty cycles; larger high-torque two-speed squirrel-cage motors were produced to meet the increased demand on the driving motors. The time required for applying or releasing mechanical brakes on motor-driven high-speed centrifugals was reduced to less than a second by application of gear motors which simultaneously solved a problem of meeting space limitations.

Steel mills again emphasized improved strip mills, and by the end of the year several large hot-strip mills had been placed in service or were under construction. Maximum width of mills was increased, delivery speed was stepped up, and total capacity of main drives attained higher values. A new method of driving runout tables and coolers of wide strip mills was evolved, with appreciable power saving, simpler and smoother control, and saving of substation space. Cold-strip mills were also speeded up, and the use of variable-voltage control for blooming- and slabbing-auxiliaries was further extended.

Hermetically sealed refrigerating units were further improved so that, comparing the machine of today with that of 1928, the cost of operation has been reduced to less than half, the weight in one size reduced from 202 to 120 lb, the Btu per hr rating increased from 337 to 530, and the amount of ice from 0.6 to 2.0 lb per hr.

A new unit room air conditioner cools, dehumidifies, cleans and circulates air, and ventilates. Air circulators, exhausting hot air from the attic and thereby lowering house temperatures, were applied on a large scale. Both oil-fired warm-air conditioners and oil furnaces were made available in units of smaller capacities, and in central-plant air conditioners the flexibility of application was increased by the addition of new heat-transfer elements.

More than 200,000 farms were added to electric power lines during the year, setting a new record, so that today nearly $1\frac{1}{4}$ million farms—a fifth of the total—have power-line service. Added to the ever-increasing list of applications for electricity on the farm were its use for heat and light in the commercial introduction of soil-less agriculture, and in the application of electric motors for small cultivators and tractors.

More than a half billion large incandescent lamps were sold in the United States during the year, establishing a new volume record. Including both large and miniature lamps, a total of 955,000,000, also a record, was indicated.

A new high-efficiency filament, increasing light output of incandescent lamps 10 per cent without using additional current, was announced. A prefocused type of flashlight lamp, a 300-watt small-bulb motion-picture projection lamp, improved lamps for toy projectors, a 300-watt medium-screw-base lamp with short light-center length, and a 5-kw lamp for underwater service were among the several new incandescent lamps developed.

Improved street and highway lighting kept pace with a public determined to minimize the traffic fatalities in city streets and open highways. The San Francisco-Golden Gate bridge was included among the new installations of sodium-vapor luminaires.

Research and engineering continued to record many advances. A developmental oil-immersed x-ray outfit for operation at a half million volts, together with an oil-immersed multisection x-ray tube, was a research announcement. Of shock-proof type and semi-portable, the equipment does not require a special building for housing it. That other oil-immersed units can be built for much higher voltages without excessive increases in volume or weight was indicated by experience with this equipment.

Using a special Boys camera with a rotating film velocity as high as 10,000 ft per min, studies of natural lightning were made from a tall building in New York City. Photographs obtained with the equipment yielded valuable data regarding the nature of lightning.

In the following pages, which review these and many other developments of 1937, all apparatus referred to are products of the General Electric Company and associated companies. These developments cover such a wide range that the references will serve as an indication of the tendencies in design and construction as well as the general progress in the electrical manufacturing industry as a whole.

Developments in the Electrical Industry During 1937

By GUY BARTLETT
General Electric Company

WITH kilowatt-hour consumption in 1937 again setting a new record, and with the production of new current-consuming devices, it followed that there was need for additional generation and transmission equipment. These trends were reflected in many new and improved equipments installed or under construction at the end of the year.

POWER GENERATION

2300-lb-pressure Steam

A record-breaking pressure of 2300 lb per sq in., nearly double that of the most modern high-pressure plants being installed, and a temperature of 940 F,

million kva, already have been installed or are under construction. One of these has two generators.

To the 25,000-kw topping turbine of the Dayton Power & Light Company went the honor of being the first hydrogen-cooled turbine-generator in commercial service. The noncondensing turbine, at 1200 lb gauge and 900 F, drives a 3600-rpm 31,250-kva hydrogen-cooled generator. Hydrogen leakage at the shaft is prevented by oil-shaft sleeves; automatic equipment maintains the purity of the hydrogen within the generator at a pressure slightly above atmosphere. Fin-tube water coolers within the housing cool the hydrogen as it is circulated within the machine by the usual fans on the rotor.

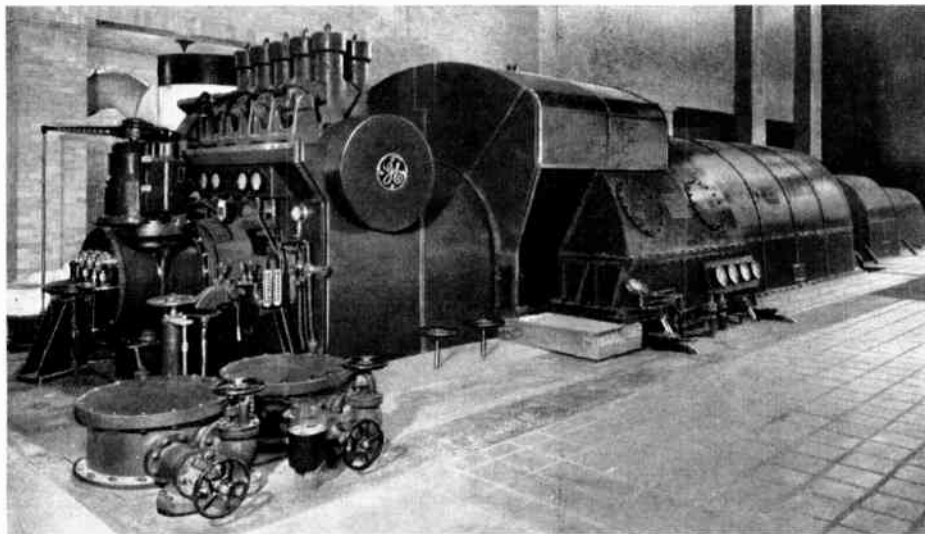

Fig. 1. A 20,000-kw turbine-generator of the compact tandem-compound double-flow design

are features of a turbine-generator under construction for the Indiana & Michigan Electric Company, subsidiary of the American Gas & Electric Company, for an extension of the Twin Branch Plant, Mishawaka (Ind.). The 22,500-kw unit will be cross-compounded with a new 45,000-kw 385-lb-pressure turbine-generator. Although somewhat higher pressures have been used in Europe, no unit has so far been operated on such a large scale and, in addition, forced circulation was required. Natural circulation will be used with the Twin Branch boiler.

Hydrogen-cooled Generators

The first hydrogen-cooled turbine-generator was placed in commercial operation during 1937. Sixteen hydrogen-cooled units, representing more than a

Hydrogen cooling is to be used on the third 110,000-kw vertical-compound turbine-generator under construction for the Ford Motor Company. The set otherwise is like the second unit, already installed, with steam conditions of 1200 lb, 900 F, and 1 in. absolute back pressure.

Hydrogen cooling was provided also for a 150,000-kw triple tandem-compound turbine-generator in the State Line Station of the Chicago District Electric Generating Corporation. The turbine, the largest 1200-lb unit ever built, is designed for use with steam at 825 F total temperature entering the high-pressure turbine—the steam being reheated to 825 F before entering the intermediate section from which it exhausts directly into the double-flow low-pressure element. The generator, shipped as an air-cooled



Fig. 2. The second 60,000-kw single-casing turbine-generator in Connors Creek Station of Detroit Edison Company

machine, has been provided with a hydrogen-tight housing. The inner cage construction of this large generator made it readily adaptable to hydrogen cooling. The 150,000-kw 0.9 power-factor air-cooled turbine-generator set had a generator guaranteed for an output of 132,000 kw at 0.85 power-factor, 155,300 kva. Hydrogen cooling results in a guaranteed output of 150,000 kw at 0.85 power-factor, 176,500 kva, or a gain of 21,200 kva. Also, with hydrogen, there is a reduction of losses of 878 kw at all loads.

Superposed Units

The 2300-lb turbine-generator of the Indiana and Michigan Electric Co., already mentioned, will operate initially as the high-pressure element of a cross-compound machine. Later, when the present 600-lb boilers need to be replaced and additional 2300-lb topping turbines are installed, the high-pressure units will operate superposed on a 400-lb plant.

An example of a topping turbine installed in 1937 was the 25,000-kw 3600-rpm unit for the Monongahela West Penn Public Service Company at Rivesville (W. Va.). This unit has initial steam conditions of 1200 lb and 925 F total temperature exhausting into low-pressure units.

A large topping turbine was also installed for the Appalachian Electric Power Co., Logan (W. Va.).

The 40,000-kw turbine is designed for 1250-lb 925 F steam and exhausts at 200 lb gauge. The 3600-rpm generator is hydrogen-cooled.

A 10,000-kw 3600-rpm topping unit was installed at Battle Creek (Mich.) by the Consumers Power Company. This turbine takes steam at 750 lb and 850 F total temperature, and exhausts into the station mains at 210 lb gauge.

Still another topping unit installed was that of the Nebraska Power Co. at Omaha (Neb.). Here a 10,000-kw 3600-rpm topping

unit uses 1200 lb 900 F, exhausting into the station mains at 200 lb.

Tandem-compound Sets

Three units of the compact tandem-compound double-flow design with fabricated-steel exhaust hoods were installed during the year. The 20,000-kw unit (FIG. 1) of the United Power Manufacturing Company at Davenport (Ia.) is designed for steam conditions of 825 lb, 825 F total temperature, and 1½-in. absolute back pressure; the 25,000-kw unit of the Public Service Company of Colorado is for 350 lb, 675 F, and 1 in. absolute back pressure; and the unit for the New York State Electric & Gas Company, Dresden, is for 650 lb, 825 F, and 1 in. absolute back pressure.

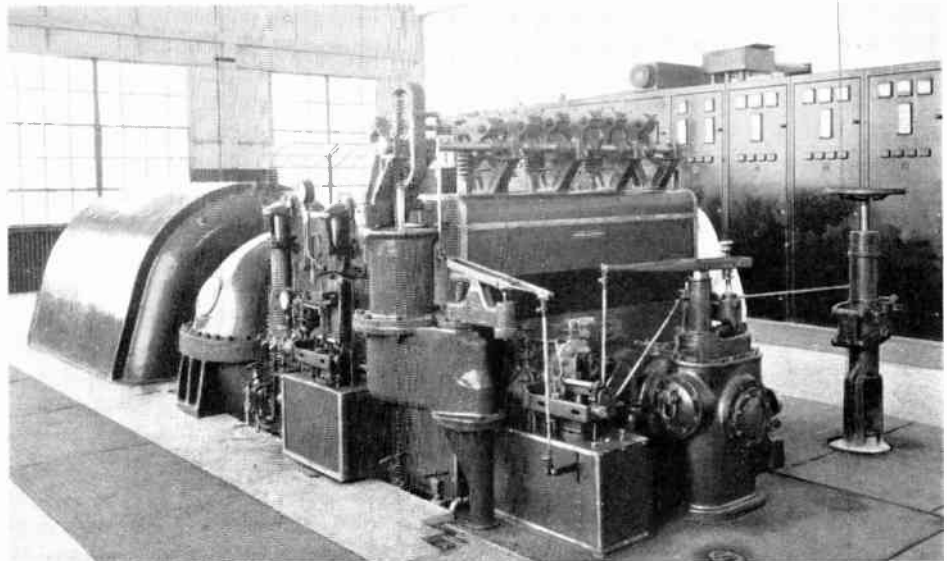

Fig. 3. A double-automatic-extraction 6000-kw condensing turbine-generator in a kraft mill of the Union Bag and Paper Company. It is equipped with a double three-arm lever governor interconnecting both extraction governors with the speed governor

Large Units

In addition to those already mentioned, numerous other large turbines were installed or under construction during the year. For the Delray Station of the Detroit Edison Company, two 75,000-kw single-casing turbines are being built to operate at steam conditions of 815 lb gauge, 900 F total temperature, and 1 in. absolute back pressure. The 1800-rpm generators are rated 0.75 power-factor, 100,000 kva, and are air-cooled. In the Conners Creek Station, a second 60,000-kw single-casing 1800-rpm unit (FIG. 2) was installed,

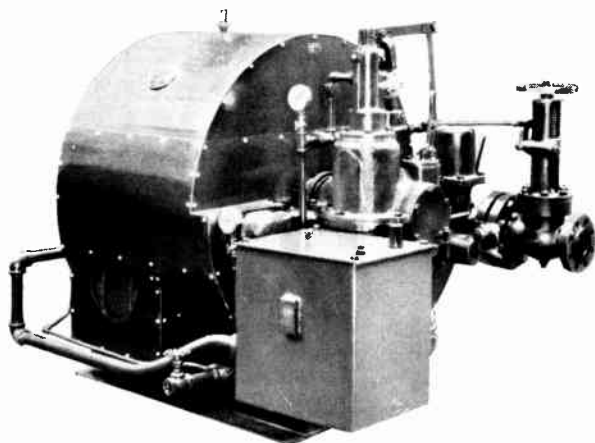

Fig. 4. Oil-relay governor for mechanical-drive turbines

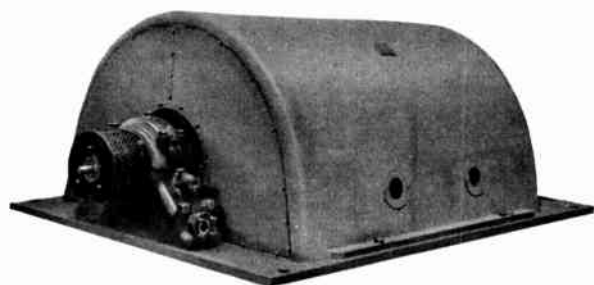

Fig. 5. Functional design applied to generator

and a third, duplicating it, is being built. Steam conditions are 600 lb gauge, 825 F, and 1 in. absolute back pressure.

In the Cahokia plant of the Power Operating Company, St. Louis (Mo.), a 75,000-kw 1800-rpm turbine-generator was installed to operate at steam conditions of 315 lb, 725 F, and 1 in. absolute back pressure.

A 50,000-kw unit for 375 lb, 700 F total temperature steam was constructed for the Cleveland Electric Illuminating Company; a 35,000-kw 0.7 power-factor 1800-rpm unit, for steam at 235 lb, 725 F, and 1½ in. absolute back pressure, was built for the San Diego Consolidated Gas & Electric Company. Two 20,000-kw turbine-generators for the Jones and Laughlin Steel Company, for 25-cycle power, have steam conditions of 410 lb, 675 F, and 1 in. absolute back pressure. The City of Hamilton (Ohio) has a 10,000-kw unit for 325 lb gauge, 630 F, and 1½ in. absolute back pressure.

Smaller Turbines

The continuing upward trend in initial pressure and temperature of smaller turbine-generators is indicated by several turbines under construction. One for the Dow Chemical Company is rated 7500 kw, 1250 lb gauge, 825 F total temp, and 385 lb gauge exhaust. The Tampa Electric Company is obtaining a 6000-kw unit of 835 lb gauge, 800 F total temp, and 210 lb gauge exhaust; the Toledo Edison Company will install a turbine of 5000 kw, 825 lb gauge, 825 F total temp, and 225 lb gauge exhaust.

Industrial-turbine Governors

Governors for industrial turbines have been further improved. A new double three-arm lever governor (FIG. 3) interconnects both the extraction governors of a double automatic extraction turbine with the speed governor.

Mechanical-drive Turbines

As in the case of other turbines, the trend in mechanical-drive turbines has also been toward high pressures and high temperatures. Two units rated 1002 hp at 3730 rpm, now in service, are operating on steam at 1200 lb gauge and 900 F total temp, exhausting at 230 lb gauge back pressure. They are driving boiler-feed pumps in the Millers Ford plant of the Dayton Power & Light Company.

The governor end of mechanical-drive turbines of some larger sizes has been redesigned to use oil-relay governors (FIG. 4), giving a compact, simple, and easily accessible front end. By reason of the compactness, the governor can be applied to smaller turbines than has previously been possible.

Fabrication

True functional design has been achieved to an unusual degree with the smaller generators (FIG. 5) by taking advantage of advances in torch cutting, forming, and welding, to develop a generator having improved appearance, accessibility, and strength. The flush-fitted end shields are a continuation of the smooth contour. Round holes in the sides serve the double purpose of lifting holes and inspection windows.

Small turbine-generators are being furnished mounted on a fabricated structural-steel base (FIG. 6). The unit is not disassembled after being completely assembled and tested at the factory; the entire assembly can be lifted on a freight car, shipped, and placed on the foundation without disassembly. The floor line is at the top of the base. The rating of units of this type is usually limited to 1250 kw or less because of shipping dimensions.

Welding is being used on some high-pressure and high-temperature turbine casings (FIG. 7). The complex cast-steel steam chest with cored passageways is welded to a forged-steel casing to give a strong high-pressure turbine shell of simple design.

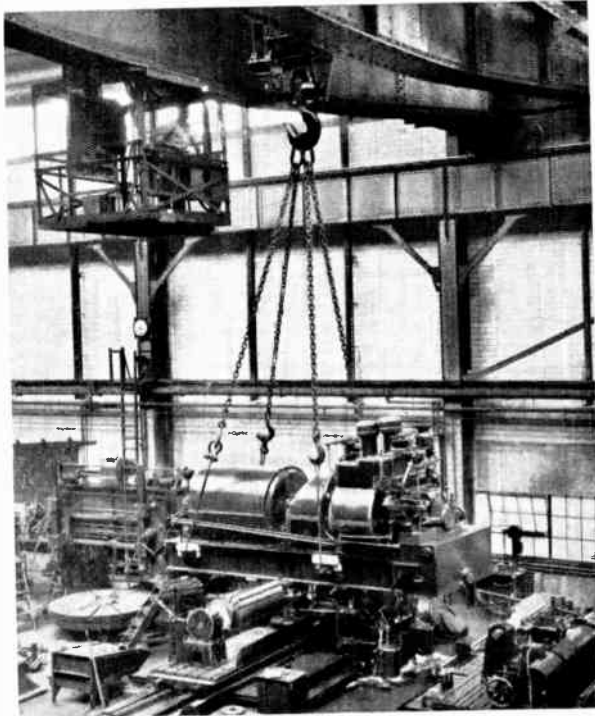

Fig. 6. A fabricated structural-steel base for a small turbine-generator

Waterwheel Generators

The first of two 48,000-kva vertical waterwheel-driven generators (FIG. 8) is about to go into operation at Bonneville Dam. Because of the speed of these machines, 75 rpm, their physical dimensions are great. For example, the diameter over the frame is 40 ft 7 in., as compared with 30 ft 9 in. for the Boulder Dam generators, although the Boulder Dam units have a 72 per cent greater rating. Most waterwheel generators are designed to have safe stresses for approximately 1.8 or 2 times normal speed; these have been designed for safe stresses at 2.88 times normal speed, corresponding to the runaway speed of the waterwheel, so that the rotor parts were designed to safely withstand stresses which are 8.3 times the normal-speed stresses. The thrust bearings of these generators must carry half again as much thrust as any previously manufactured, having been designed to carry 3,000,000 lb under condition of maximum waterwheel thrust.

Early in 1937, the second of the 36,000-kva 85.7-rpm vertical waterwheel-driven generators was installed outdoors at the Joe Wheeler Dam in Alabama.

Another outdoor installation recently placed in service was that of the 9000-kva 138.5-rpm vertical waterwheel-driven generator in the Upper Salmon Plant of the Idaho Power Company.

Diesel-engine Generator

The largest generator for diesel-engine drive employing open self-ventilated type of stator construction and fabricated, instead of cast, rotor construction is being built for 25-cycle operation but with provision being made in the design for quick and low-cost change-over to 60-cycle operation. The generator is rated 6250 kva at 167 rpm.

To accommodate this expected change to 60-cycle operation, the rotor rim is drilled for the necessary poles, and the stator is so designed that a 60-cycle winding can be placed in the same slots now used by the 25-cycle winding. Upon conversion, the change in WR^2 of the rotating parts will be negligible.

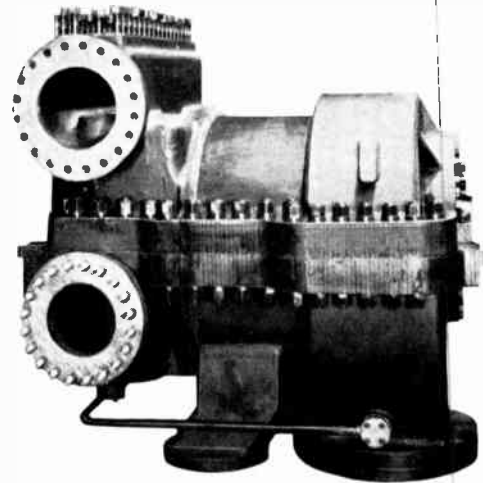

Fig. 7. Welding applied to a high-pressure high-temperature turbine casing

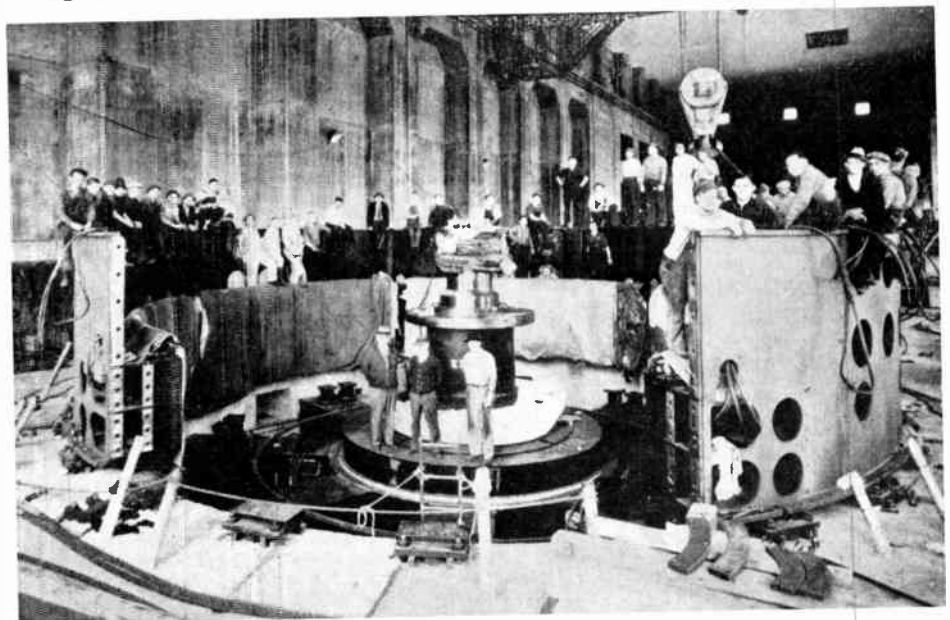

Fig. 8. Installing the first waterwheel-driven generator at Bonneville Dam, showing the lower bearing bracket, shaft, thrust bearings, and five sections of the wound stationary armature in place

TRANSFORMERS

Distribution Transformers

A radically new method of core and winding assembly for distribution transformers (FIG. 9) in 1½- and 3-kva sizes, 7620 volts and below, offers numerous advantages. In the new transformer, known as the wound-core design, the magnetic circuit, instead of containing hundreds of hand-assembled laminations,

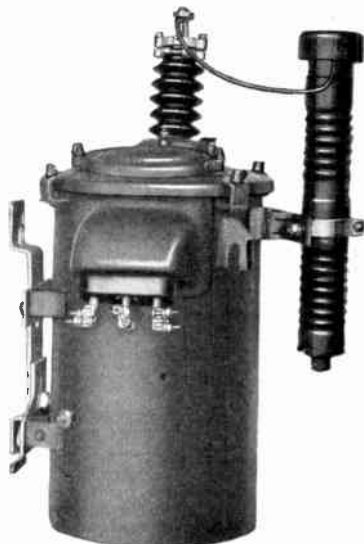

Fig. 9. Distribution transformer, with wound-core interior, for 7200-volt solidly grounded common-neutral system. The transformer is equipped with through-bolt mounting bracket and pellet lightning arrester

consists of a continuous steel ribbon ingeniously machine-wound around the insulated coils (FIG. 10). The use of improved core steel results in more effective use of the active material and this, together with simplified clamping structures, results in smaller average dimensions, lower weights, and lower total losses.

There has been a strong trend toward standardization in network-transformer design during the past

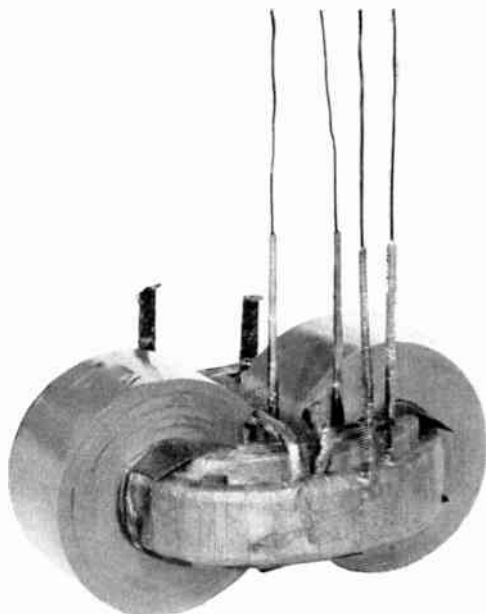

Fig. 10. Core and coil construction of a new wound-core 1½-kva 2400-volt distribution transformer

year, and there are now available standard network transformers of the type illustrated in FIG. 11. The standard transformer is of low-height low-loss design and is equipped on one end with a 3-pole 3-position disconnecting and grounding switch and on the other end with a submersible-type a-c network protector. High- and low-voltage cables are top-connected. Ratio adjusters are externally operated by a single control near the high-voltage end. Accessories, including a liquid-level gauge, thermometer, drain valve, filter-press connection and sampling device, are grouped at the high-voltage end for convenience in inspection and maintenance.

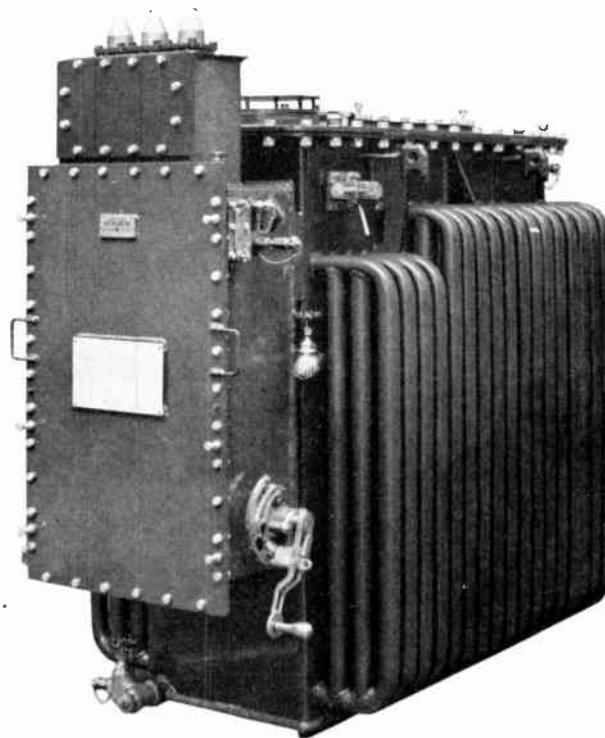

Fig. 11. Standard three-phase 500-kva Pyranol network transformer

Pyranol Transformers

Since 1932 more than 400,000 kva of Pyranol transformers, in over 1400 units ranging from 1½ to 10,000 kva in size, have been placed in service to meet a wide variety of operating conditions. In addition to being nonflammable and nonexplosive, Pyranol has demonstrated the unusually valuable property of marked stability by its freedom from oxidation and its continued high dielectric strength. Service experience indicates that Pyranol requires materially less maintenance, such as filtering, than does transformer oil.

Power Transformers

Outstanding among power transformers built in 1937 were several single-phase 60-cycle water-cooled units (FIG. 12) for the Metropolitan Water District of Southern California, for step-down service at the end of the 230,000-volt line from Boulder Dam. All were of the core-type concentric shielded-winding construction, with 6900-volt secondaries. Included

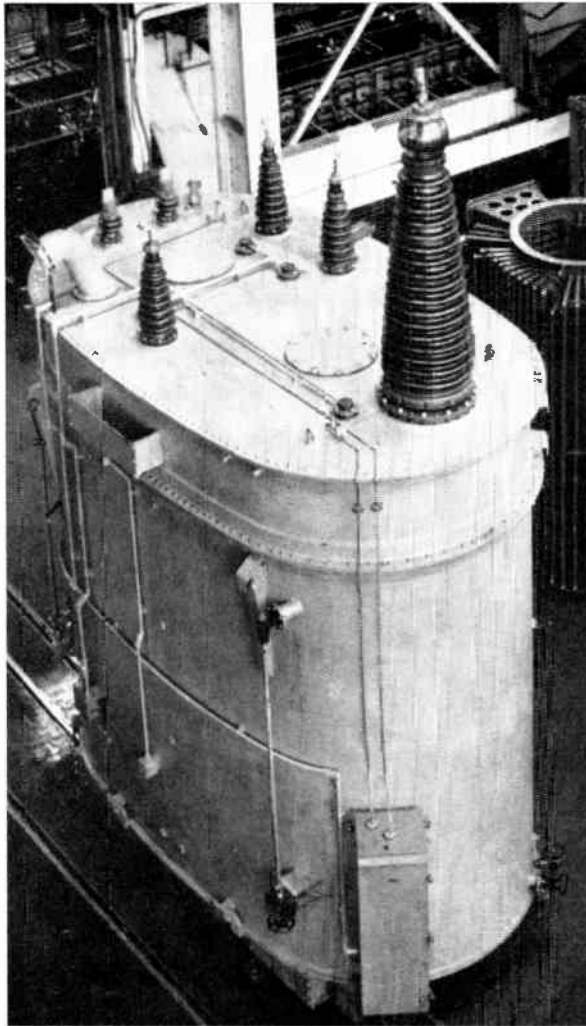

Fig. 12. A single-phase 60-cycle 22,000-kva 230,000 grounded Y-volt water-cooled power transformer

were four 22,000-kva units with 39,800/69,000Y third windings, and seven 15,000-kva and four 5500-kva units.

An outstanding feature of a new line of wedge-type ratio adjusters (FIG. 13), for changing tap connections on power transformers, is the double-line heavy-pressure contact obtained between the sides of a wedge and two adjacent contact tubes. Both wedges and contact tubes are heavily silver-plated to prevent corrosion and minimize contact resistance. By a combination of crank and cam movement, the wedges are gradually wiped in and out of contact position with comparatively little operating torque, effectively removing any possible sludge formation on the rods and making exact positioning of the adjuster unnecessary. Quick dissipation of heat at the lines of contact is assured by the relatively great pressure on the contact wedges and the massive construction of them and of the contact rods. Ratings of 50 and 115 kv, and 150 and 1500 amp are available.

Load-ratio Control

A dynamic-braking scheme for a-c motors has been developed and adopted as standard for a-c-driven

load-ratio-control equipments (FIG. 14), so that now the reliability of this method of braking and the elimination of servicing required by friction brakes are to be had with either a-c or d-c motors in load-ratio-control equipments. In the new scheme the braking effect is accomplished by first removing the applied a-c potential and then applying direct current, derived by means of a rectifier, to the stator windings. This principle can be applied either to motors having rotors of squirrel-cage construction or to commutator motors having means for short-circuiting the rotors. A positive and quick stopping of the rotor is assured, as the d-c field is maintained at its full strength until the motor stops, after which the d-c voltage is removed by a time-delay relay. The basic difference in the dynamic braking of d-c and a-c motors is that, in the d-c motors the d-c field is always available and it is necessary only to maintain it until after the rotor stops, whereas in the a-c motors the d-c field must be created from an a-c source and applied after the a-c potential is removed.

Oil-testing Set

Testing of oil has been made safer by an improved design of portable oil-testing set which automatically

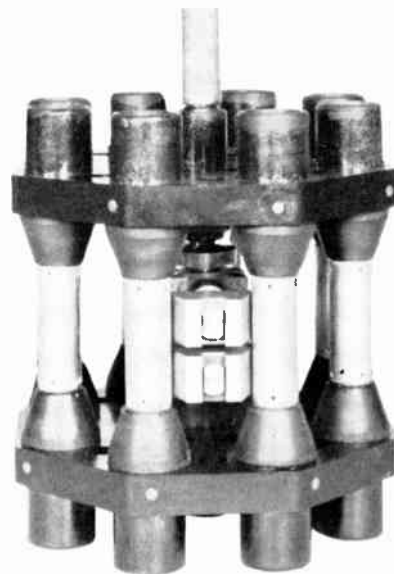

Fig. 13. Wedge-type ratio adjuster for power transformers

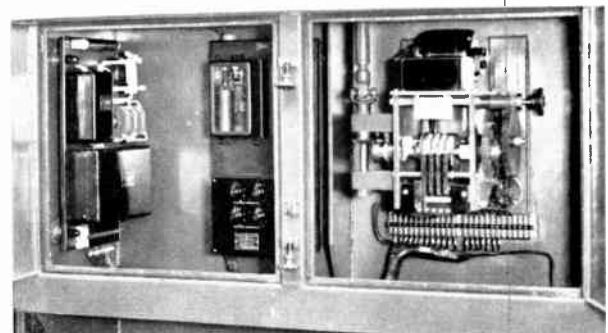

Fig. 14. Load-ratio-control devices and operating mechanism with dynamic braking

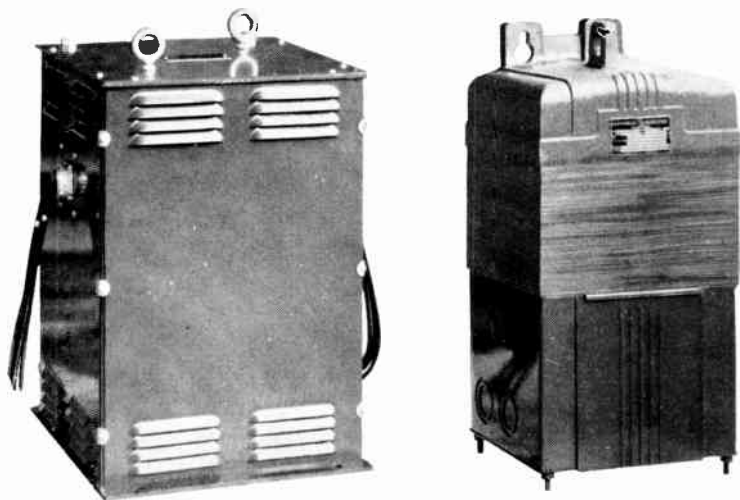

Fig. 15. Comparison of previous 15-kva air-cooled distribution transformer, for indoor use only (left), and new design (right) for either indoor or outdoor use

opens the circuit upon failure of the oil under test. The high-voltage oil-testing receptacle is mounted where it is difficult to touch. Continuously variable voltage is provided by a potentiometer and a voltmeter in the low-voltage circuit.

Specialty Transformers

Only five, instead of nine, standard sizes of parts are required in a new line of air-cooled distribution transformers (FIG. 15), the upper limit being extended from 10 to 15 kva. The conduit compartment has ample room for easy connection of leads, and is provided with multiple concentric knockouts.

For speed control of fractional-horsepower fan and blower motors, an autotransformer with continuously variable voltage has been developed. A brush contact arm moves across the autotransformer conductor turns, from which insulation has been removed at the point of contact, to give continuously variable voltage. The unit is suitable for flush, wall, or floor mounting. The maximum and minimum voltage or speed obtainable may be adjusted.

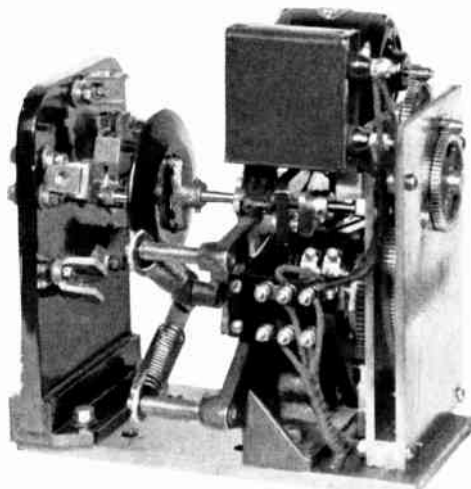

Fig. 16. New switching mechanism for four-step branch-feeder voltage regulators

Oil-burner Transformer

An improvement in radio-interference suppression features a redesigned 10,000-volt ignition transformer for domestic oil burners. One design, with knockouts on the end, bottom, and each side for line-voltage wiring, replaces two of the previous standard units required for the same range of knockouts. A variety of high-voltage bushing terminals and bushing locations, with either universal or concealed mounting, can be supplied.

VOLTAGE REGULATORS

A new switching mechanism (FIG. 16), in which the major insulation between taps and from line to ground consists of wet-process porcelain, has been incorporated in a redesigned line of four-step branch-feeder voltage regulators. The mechanism has a spring drive, actuated by a sturdy capacitor motor

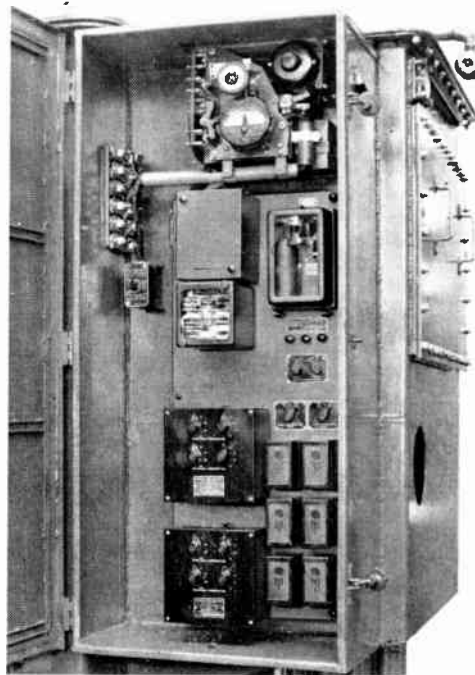

Fig. 17. Operating and control mechanism for voltage-regulating devices with reverse-power control

and gearing, with the gearing providing a time delay between the operations of the contact-making voltmeter and switching mechanism. This time-delay device is automatically reset by auxiliary switches which cause the motor to run back to its original position when a change in voltage is not required.

Another development is a reverse-power control for voltage-regulating devices (FIG. 17). When it is desired to maintain regulated voltage automatically on the output side of a voltage-regulating device, regardless of the direction of power flow, the control circuit must be arranged to reverse the direction in which the regulator functions to raise or lower the

system voltage. The voltage-regulating relay used to control these equipments requires a source of regulated voltage, and it is therefore usually necessary to provide potential transformers connected to both sides of the regulator. By means of a reverse-current relay in combination with auxiliary relays, the regulating relay is automatically transferred to the regulated source, the raising and lowering control circuits are reversed, and, when line-drop compensators are included, the proper phase relation between the current and voltage through the compensator is maintained. Where one compensator cannot be utilized for both directions of power flow, two may be necessary, in which case means are also provided to transfer the control from one to the other.

PETERSEN COIL

Increasing recognition has been given by power companies to the engineering soundness of the Petersen coil (FIG. 18) as a service protective device. Operating experience has shown that, when correctly applied, these coils offer a simple, effective, and rela-

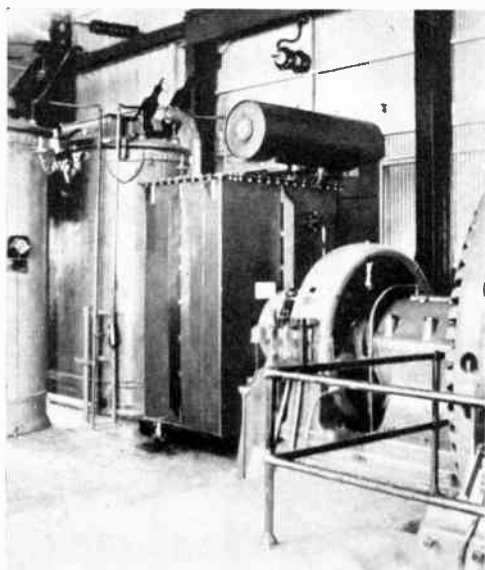

Fig. 18. Petersen coil installed on the 100-kv system of the Public Service Company of Colorado

tively low-cost method of quenching transitory ground faults which, on many systems, constitute a good majority of the total faults. Of 15 coils now in service in this country, 10 were installed in 1937. Of two Petersen coils scheduled for installation in 1938 on the 230-kv Boulder Dam—Chino transmission line of the Southern California Edison Company, the

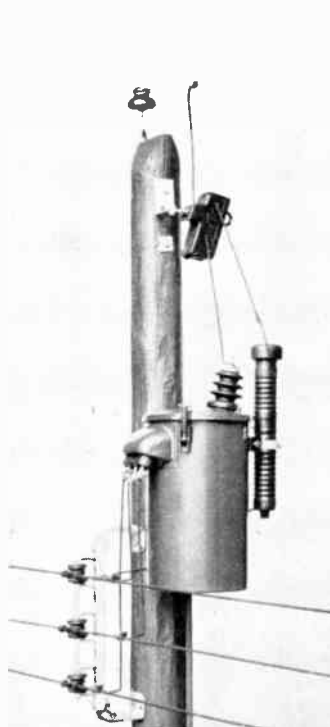

Fig. 20. Combination mounting of arresters, transformers, and cutouts for a rural distribution circuit

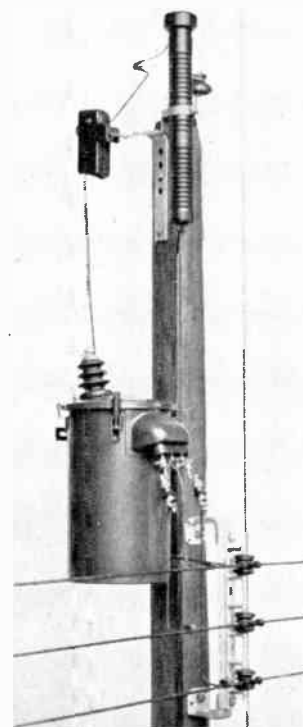

Fig. 21. Combination mounting of arrester and cutout for a rural distribution circuit

one for the Boulder Dam end, with a 42,000-kva 10-min rating, will be the largest iron-core variable reactor ever built.

LIGHTNING ARRESTERS

Line-type Thyrite Arresters

New line-type lightning arresters, with Thyrite valve elements and Thyrite shunted and shielded gaps, embody many improved electrical and mechanical features (FIG. 19). Four standard single-pole units have maximum permissible line-to-ground voltage rating of 20, 25, 30, and 37 kv and are used separately or in series combinations to make complete arresters for application on either grounded or non-grounded circuits from 20 to 73 kv; the previous line

Fig. 19
Line-type Thyrite lightning arresters

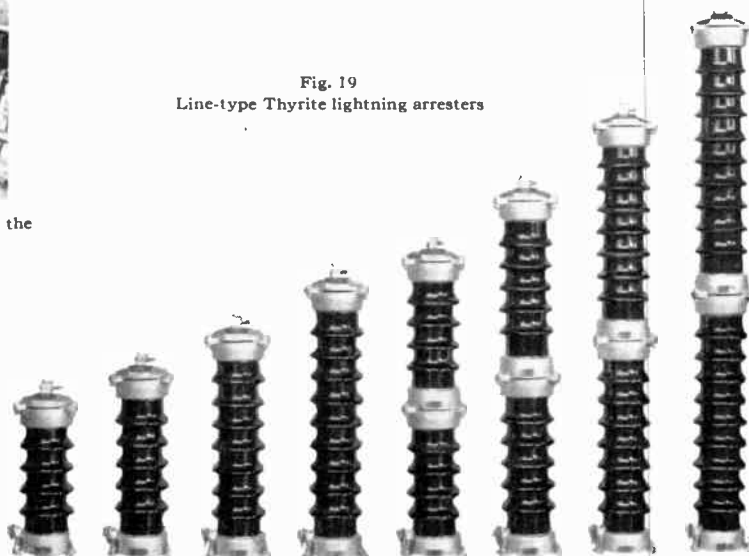

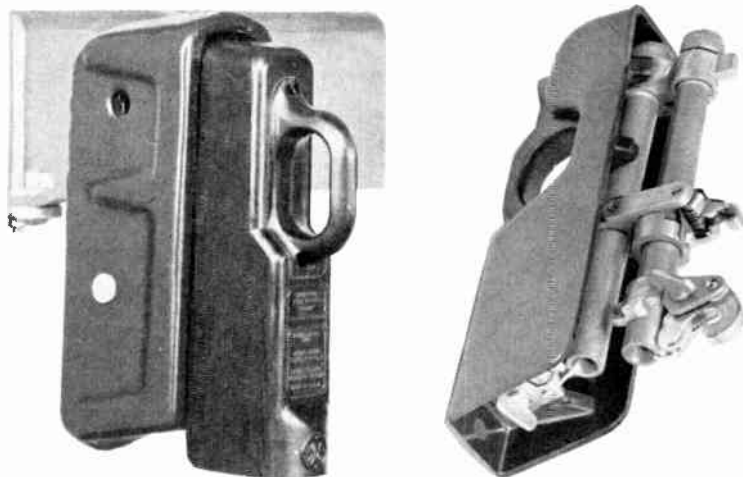

Fig. 22. Porcelain-housed reclosing fuse cutout

was confined to system voltages not exceeding 30 kv. The new single-pole arresters are designed for base, bracket, or suspension mounting.

Equipment for Protecting Rotating Machines

A new line of Pyranol-filled capacitor-type units for lightning protection of a-c rotating machines is suitable for outdoor or indoor service; former units were for indoor use only. The units are enclosed in drawn-steel resistance-welded cases with outdoor bushings and have self-contained discharge resistors. The new line includes a three-phase 3000-volt capacitor unit as well as single-pole units with ratings as high as 15,000 volts.

Rural-transformer Protection

For overvoltage and overcurrent protection on rural distribution circuits, the trend has been toward more economical applications of standard valve-type arresters and fuse cutouts, made possible by mounting as shown in FIG. 20 or by the combination mounting of the cutout and lightning arrester as shown in FIG. 21. The mountings employ the same bolts which secure the pole-top insulator pin to the wood pole. By swinging it on the hinge, the fuseholder may be connected to, or disconnected from, the line. Sound engineering and construction practice, simplicity, complete protection, and good appearance are achieved.

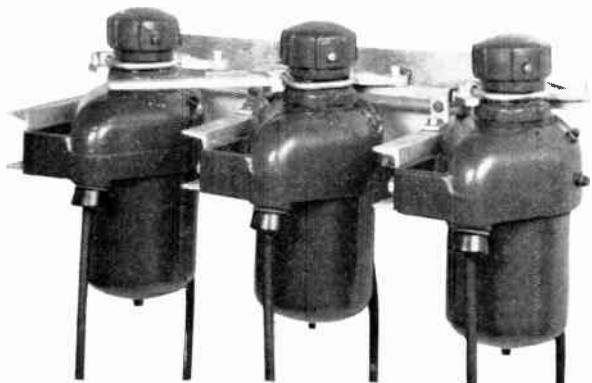

Fig. 23. Three-phase mounting of pole-type oil fuse cutouts showing rack and operating mechanism

FUSE CUTOUTS

A porcelain-housed reclosing fuse cutout with a door (FIG. 22) which may also be substituted for the single-element door on an existing cutout installation makes it economically practicable to extend automatic reclosing service to wider areas, including distribution-transformer installations in many cases. Two fuseholders and a completely enclosed escapement time-delay mechanism located on a recessed door make possible a single-reclosure device by means of which service can be very materially improved at very low cost. The one-second time delay, uniform in different ambient temperatures and atmospheres, makes possible closer co-ordi-

nation between fuse links connected in series at sectionalizing points and relays. The cutout is available in 50-amp rating at 5000 volts and 7500/12,500 grounded Y volts.

Three-phase pole-, subway-, or pothead-type oil fuse cutouts (FIG. 23) capable of repeatedly and simultaneously opening load current on all three phases provide low-cost switching facilities as well as automatic overcurrent protection. Three, or more, standard single-phase cutouts are mounted on a rack which provides for simultaneous operation. Replacement of the fuse links requires only the removal of the fuse carriers, which are automatically uncoupled from the operating mechanism when the fuse carrier is removed or are coupled to it when the fuse carrier is replaced.

SWITCHGEAR

Equipments

Switchgear-equipment developments have followed the line of more extensive applications of metal-enclosed structures. The line of midget-type metal-clad switchgear was enlarged to include oil-blast circuit breakers of 50,000 kva interrupting rating, as well as those of 25,000 kva. These equipments were also improved to include jack-screw, instead of the previous lever-type, lowering and elevating mechanisms, similar to those of the heavier-type metal-clad equipments.

In heavy-duty metal-clad switchgear, improvements include drawout potential-transformer compartments, fabricated potheads for incoming or outgoing cables (FIG. 24), and motor-operated lowering or elevating devices as standard equipment for all units rated 500,000 kva and above (FIG. 25).

A line of low-voltage switchboards, with drawout-type air circuit breakers (FIG. 26) was developed for buildings, industrial plants, and power stations in which attractive appearance and ease of inspection and repair are combined with the same degree of safety possessed by high-voltage metal-clad switchgear. An outstanding feature of these equipments is their sturdiness. As shown in the illustration, the addition of a 265-lb man's weight failed to distort the

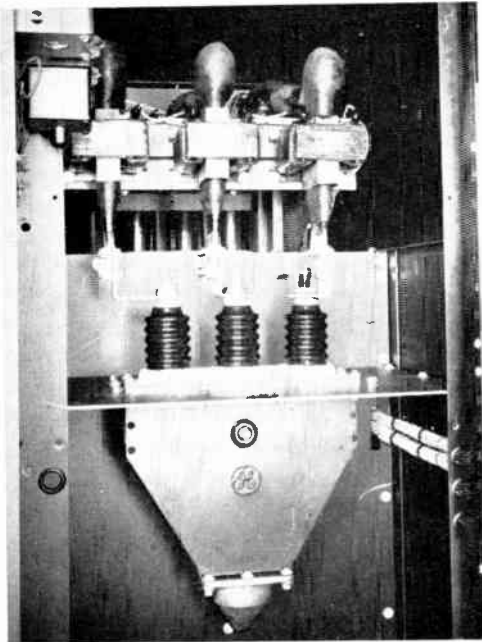

Fig. 24. Fabricated cable pothead in metal-clad switchgear

rollout mechanism. This safety-enclosed low-voltage switchgear is available, with or without the drawout feature, with air circuit breakers of all sizes at voltages up to 600 volts a-c or 750 volts d-c.

Small Oil Circuit Breakers

The line of oil-blast moderate-duty, 50,000-kva interrupting rating circuit breakers not oil-tight in

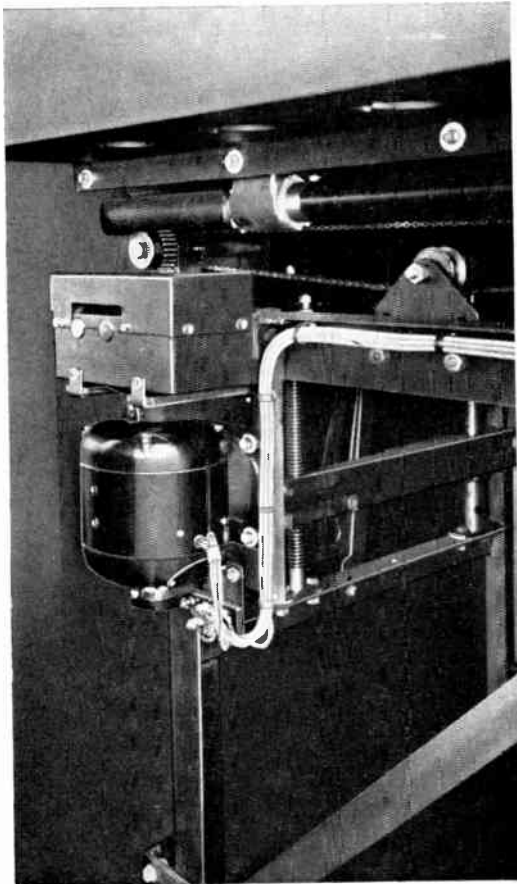

Fig. 25. Motor-operated lowering and elevating mechanism for metal-clad switchgear

design, in ratings of 600 amp, 15,000 volts, and 1200 amp, 7500 volts, was modified to add a separating chamber and improve the oil-tank gasket.

A 75,000-kva breaker, for manual or electrical operation, has been made available in 600-amp 15,000-volt, 1200-amp 7500-volt, and 2000-amp 5000-volt ratings. The breaker (FIG. 27) has a rectangular tank made of heavy plate steel to provide a sturdy construction that makes this breaker especially applicable where heavy duty and small space requirements are desired. A noteworthy feature, in addition to the duplex butt-type contacts, is the unit assembly of the stationary arcing contacts and springs (FIG. 28). The electrically operated solenoid mechanism is of a new high-efficiency pull-down type; the tripping mechanism is a positive stored-energy device with a roller-bearing latch.



Fig. 26. Low-voltage switchboard, with sturdy, drawout air-circuit-breaker units

A new mechanism for remotely mounted, manually operated switchboard oil circuit breakers has an improved toggle arrangement at the breaker to provide the closing force at an expenditure of effort only about two thirds of that previously required. A new crank arrangement at the panel, with the vertical pipe in tension, reduces the strain in the supporting panel to approximately one fourth that of the former design.

Large Oil Circuit Breakers

An improved single-pole impulse circuit breaker, to open in one cycle on a 25-cycle circuit and with an interrupting rating of 65,000 amp rms, was developed for railroad service. Available in single-pole units in outdoor housings, it is rated 1500 amp at 15 kv, but is equipped with 23-kv insulation.

The small-oil-content upward-vertical-break heavy-duty station-type circuit breakers that have been so extensively used throughout the world for nearly 40 years are now equipped with silver-to-silver oil-blast contacts, and have an improved high-speed motor-

operated cam mechanism. The circuit breakers rated 15 kv are provided with 23-kv insulation.

For large oil circuit breakers, indoor or outdoor, a motor-operated cam mechanism (FIG. 29) was developed. This is essentially the same as a trip-free solenoid mechanism except that the cam, rather than a solenoid, provides the closing force. In the sketch the mechanism is shown in the closed position, with the cam in the reset position. As the breaker opens, the larger roller, shown in the linkage between the points marked Mechanism Linkage and Breaker Operating Crank, drops down to the lower face of the cam. In closing, the motor drives the cam counterclockwise

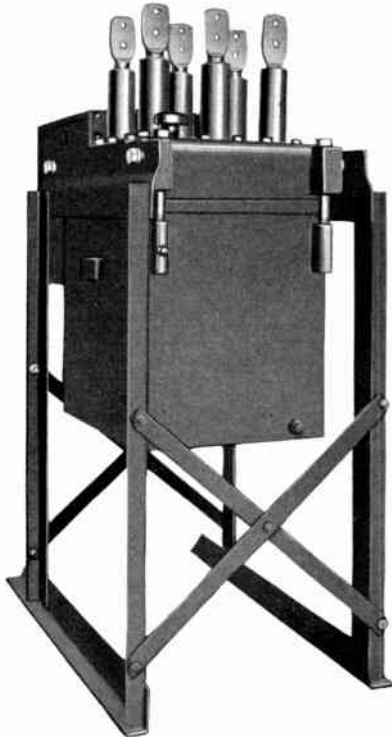

Fig. 27. A frame-mounted 600-amp 15,000-volt 75,000-kva single-throw solenoid-operated, indoor oil circuit breaker

and raises the roller to a closed position. When the cam is rotated to the flat portion, a movement of approximately 270 deg, the breaker is in the fully closed position and the cam is stopped by cutting off the motor current and catching the cam itself on buffers. Immediately after the breaker comes to a closed position by forcing the toggle between the parts marked Mechanism Linkage and Breaker Operating Crank against an over-center stop, the cam is returned to its reset position by springs. This motor-cam mechanism gives a closing time as low as 30 cycles, as compared with 50 to 60 cycles for other kinds of motor mechanisms. Not only is it very fast, but the closing force can be very definitely proportioned to the requirements of closing the breaker, permitting closing at a very high speed without undue banging or overtravel at the end of the stroke.

By adding a system of releasing latches that permits the circuit-breaker mechanism roller to drop for circuit-breaker tripping without releasing the normal

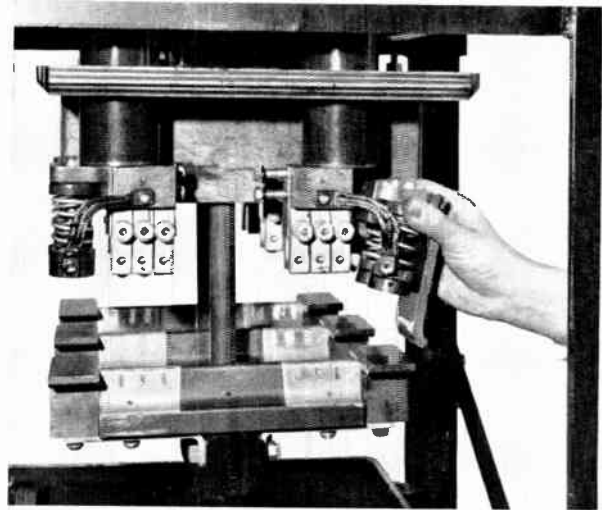

Fig. 28. Contact assembly of 75,000-kva oil circuit breaker, showing easily replaceable duplex butt-type arcing contacts

tripping toggle, an inherently high-speed reclosing mechanism has been provided for large outdoor circuit breakers. Upon the occurrence of a fault, the added release latch falls, and the fast rotating cam immediately picks up the roller to reclose the breaker. Upon fault persistence the normal tripping toggle latch is released and the circuit breaker opens, to be reclosed in the normal manner.

A further modification of the cam mechanism utilizes double power motors that start the closing cam from a predetermined point, before the opening stroke is completed. This gives a super-high-speed reclosure, of the order of 20 cycles from the time of energizing the tripping circuit. Fault persistence will cause a second tripping of the breaker to its fully open position. These mechanisms are available for use with breakers up to 230-kv rating.

Air Circuit Breakers

The line of air circuit breakers, which are particularly adapted to general industrial and central-station auxiliary service and which were formerly available only in electrically operated units, was extended to

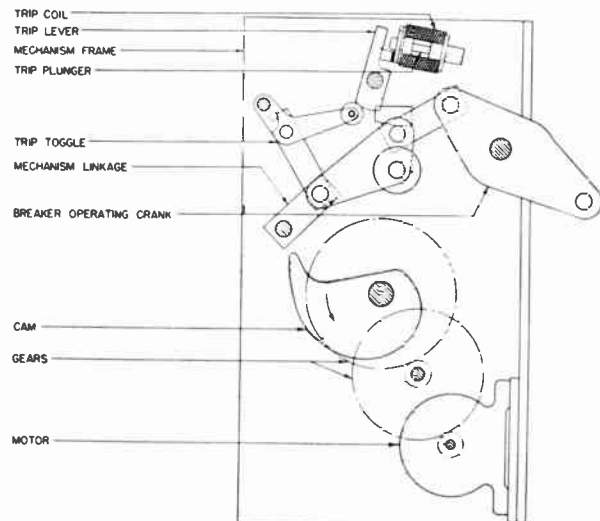

Fig. 29. Cam motor mechanism for high-voltage oil circuit breakers

include manually operated breakers as well. These breakers, capable of operating thousands of times without requiring maintenance, are intended for protection of feeders, machines, and motor-branch circuits where many opening and closing operations are required. Their simplicity and compactness make



Fig. 30. A 600-amp 600-volt triple-pole manually operated air circuit breaker for front-of-board mounting



Fig. 31. High-speed a-c current differential relay with harmonic restraint



Fig. 32. Evolution of polyphase power-directional relay to 6-in. universal case

them especially suitable for mounting in metal enclosures, but they are also available for front-of-board (FIG. 30) and dead-front mounting. Single-, double-, triple-, and four-pole breakers are included in the line.

These breakers can also be equipped with a d-c reverse-current device where service demands it. Upon current reversal the flux shifts from the armature magnetic circuit to the closed magnetic circuit formed by the potential and current circuits, thereby allowing the armature to drop out and trip the breaker.

To make them suitable for service as a-c generator and synchronous-motor field switches, manually and electrically operated air circuit breakers are now available with discharge clips, making the field switch consistent with other air circuit breakers in design and appearance.

Relays

A high-speed overcurrent relay intended primarily for bus-differential protection employs a principle of harmonic restraint to prevent it from operating because of current-transformer transient unbalances. The relay has two tuned circuits in parallel across the secondary of a small current transformer in the relay case. One of these circuits, containing the operating coils of the relay, is tuned to pass current at fundamental frequency and to block the harmonics present in the secondary circuits of current transformers carrying short-circuit or inrush currents. The other of these circuits, including the restraining coils of the relay, is tuned to block the fundamental frequency and to pass all the harmonic and d-c components which cannot flow in the operating coil. For faults external to the protected zone, the restraint provided offsets the effect of whatever current of fundamental frequency flows in the operating coil. For internal faults, the current in the operating coil is many times greater; it overcomes the effect of the restraining-coil current. The relay, a single-phase unit in a 12-inch universal case (FIG. 31), is connected in the differential circuit of the bus or line-current transformers; three units being required for three-phase protection.

The design of the induction-cylinder directional relay has been extended so as to replace many



Fig. 33. Carrier-current pilot-relay equipment with distance and ground-fault backup protection, showing complete equipment for one line end

induction-disk types. FIG. 32 shows to scale the evolution from the early polyphase power-directional relay to the present induction-cylinder device which is contained in a 6-in. universal case. Similar relays are now available for single-phase or ground-directional applications, or combinations of functions such as polyphase directional uses combined with voltage restraint and ground-directional applications.

Inasmuch as the elements required for carrier-current pilot relaying for interphase faults happen to be nearly identical to those present in conventional directional-distance relays, such relays can be used to provide the combined features of distance and carrier-current pilot protection (FIG. 33). Ground backup protection is provided, as usual, by directional relays using both instantaneous and time elements.

The modern trend in the design of protective relays is toward higher-speed operation, but when lines are equipped with expulsion protector tubes the protective relays should have sufficient time delay to permit the gaps to operate, so as not to have undesirable tripping of the oil circuit breakers. This means that the trip coil should not be energized, if at all, until one or two cycles after the fault occurs. Rather than redesign the protective relays to slow them down, it is more satisfactory to add a definite time after the operation of the high-speed relays before actually closing the trip circuit. This is accomplished by an auxiliary relay having an adjustable 1- to 5-cycle time delay. When the protective relay contacts close, a capacitor

begins to charge at a rate depending on the adjustment of a series resistor in the circuit. The auxiliary relay cannot pick up until the capacitor has been charged to the necessary voltage the value of which depends on the relay setting. The time is primarily determined by the relation between the capacitor and the adjustable resistor.

Now included in the line of solenoid control relays is an internal auxiliary element that provides pump-free control offering better protection against overheating in the solenoid closing coil and in the closing rectifier (where rectifiers are used). The auxiliary element, energized by a special switch closing at the end of the closing stroke of the circuit breaker, opens the main coil of the relay and thus promptly de-energizes the solenoid closing coil and the closing rectifier. It also seals itself in around the auxiliary switch, so that no further closures can occur until the controlling circuit has been opened and again closed. The winding of this auxiliary unit may be left connected—as is done with a maintained-closed controlling switch or devices—without harm. The relay is available for operation on a-c or d-c control circuits.

A make-before-break auxiliary relay was developed for use in transferring the current coils of telemeters into current-transformer circuits. In the de-energized position the relay has two contacts open and one closed. When the coil is energized these two contacts close, shunting the coil into the current-transformer secondary before the other contact opens.

A small, single-contact low-energy auxiliary relay was developed for the control or protection of apparatus by means of pilot wires. It operates on less than 0.3 watts and is capable of closing 18 amp at 250 volts.

Balanced-current relays have been improved by the substitution of electric targets (FIG. 34) to replace the mechanical targets formerly used.

A new switchboard-type annunciator (FIG. 35), in a 6-in. universal case, has the same targets as those used in high-speed directional-distance and carrier-current pilot relays. Of shockproof type and high-speed in operation, it is capable of operating on a one-cycle impulse. Targets are reset by an external push button. The annunciator is available in 4-, 8-, and 12-drop models.

Power Switching Equipment

Because silver-to-silver contacts have proved so satisfactory in service on indoor devices—practically eliminating contact maintenance—outdoor switches, except those for rural duty, have been improved by the addition of silver line contacts. Silver line contacts have also been added to the line of indoor knife switches rated 400 amp and above.



Fig. 34. Balanced current relay with electrically operated targets

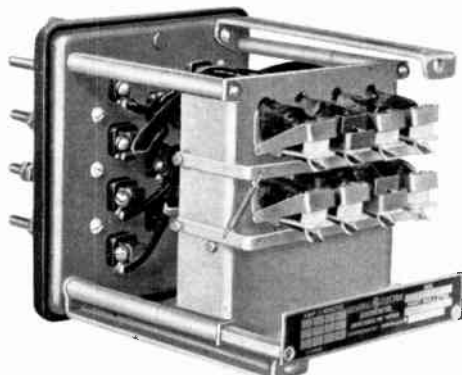

Fig. 35. High-speed switchboard annunciator, in 6-in. universal case with the cover removed

The line of outdoor fuse disconnecting switches was extended to include a 400-amp rating in voltages of 7500 (Fig. 36) and 15,000 volts. The outdoor fuse unit, available in 250-, 300-, and 400-amp ratings, similar to the well-known fuses of lower ampere ratings, is a spring-expulsion fuse that provides rapid operation with high interrupting ability and positive

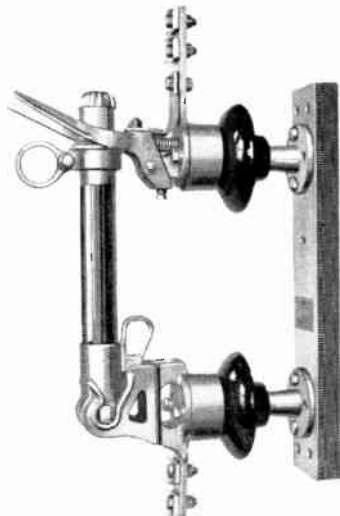

Fig. 36. A 400-amp 7500-volt outdoor expulsion fuse disconnecting switch

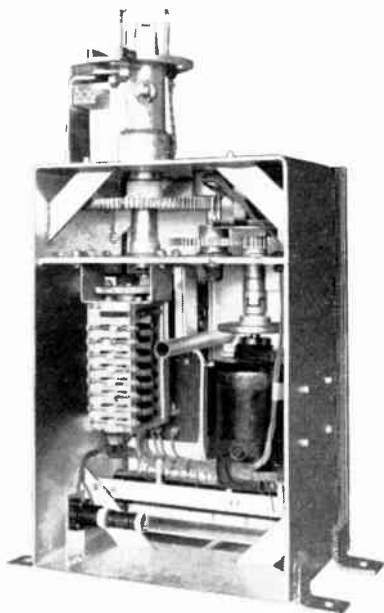

Fig. 37. Motor-operating mechanism for outdoor disconnecting switches with front cover of housing removed to show motor and limit switches

performance for low as well as for high currents. It differs from the unit rated 200 amp and less in that it is enclosed in a fuse holder, to serve as the blade of the fuse disconnecting switch.

A new motor mechanism for the operation of group-operated outdoor disconnecting switches (Fig. 37) is a reversing-type mechanism having adjustable motor-limit and auxiliary switches, magnetic reversing contacts, and a magnetic brake, all mounted in a weatherproof housing. A noteworthy feature of the

limit and auxiliary switch is that each stage is independently adjustable.

METERS AND INSTRUMENTS

Watt-hour Meters

A new single-phase watt-hour meter (Fig. 38) has a practically flat accuracy characteristic. Its ability to meet such a wide range of capacity means a saving to the power company in inventory, and easier provision for increasing loads. For most domestic applications the 15-amp meter, with a practically flat accuracy characteristic from 0.5 to 60 amp, is satisfactory. If load conditions require a lower rating, a 5-amp meter is available; and to handle larger current loads there are a 50-amp meter and a 2.5-amp meter for use with an instrument transformer. They are available for bottom connection, or for socket or plug-in mounting.

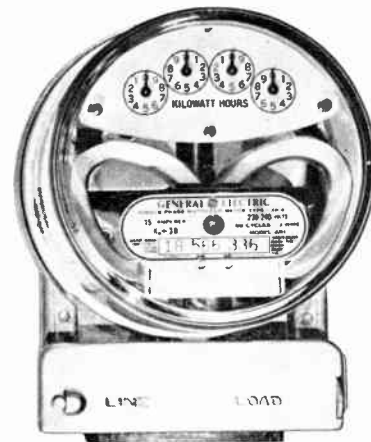

Fig. 38. Single-phase watt-hour meter having practically flat accuracy characteristic

Two features contributing to the wide-limit accuracy are an entirely new driving element with compensating shunt for high and low current values and a new light-load and lag adjustment which is compensated for the effect of temperature variations when loads of less than unity power factor are being registered.

The weight and size of two- and three-phase poly-phase watt-hour meters (Fig. 39) has been materially reduced without sacrifice of mechanical and electrical characteristics. In the two-phase meter the two elements, acting on the same disk, are smaller than heretofore and, because of their low inherent errors and the applied overload compensation, are highly accurate. The disk is novel in that it is constructed for minimum interference and is mounted on an aluminum-alloy shaft. The disk is made up of several radial-slotted laminations, assembled with the slots staggered and separated by very thin insulation. The three-element meter has two electric elements acting on the lower disk and the third element on the upper disk.

Demand Meters

In a new cumulative form of demand register the resetting or accumulating operation is performed manually. One of the major problems in the development of such a mechanism was to make it independent

of the speed at which the meter reader might operate the device; another was to prevent the demand dial train from creeping forward when the operation of accumulating was repeated with no load on the meter. These problems have been solved in a new cumulative-demand register with an ingenious locking mechanism which positively locks the demand gear train during the accumulating operation and then relieves the strains set up in this gear train by that operation before it is unlocked.

A small, completely self-contained, totalizing unit using a standard demand register to give indicated demand has been made available in a small four-circuit totalizer (FIG. 40) designed for operation by two-wire contacts. Outgoing contacts can be mounted

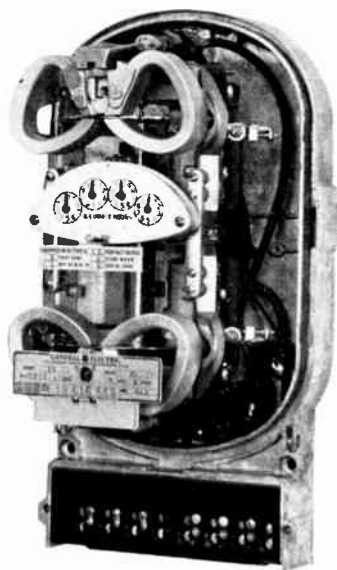

Fig. 39. (Left) Three-element polyphase watt-hour meter, with cover removed; (Right) Two-element polyphase watt-hour meter

conventional types. The new element (FIG. 41), made possible by the use of Alnico steel, consists of two sector-shaped magnets enclosed in a steel ring which serves both as a return path for the flux from the magnets and as a shield from external magnetic fields.

Inkless-type Recording Instrument

The conventional inking system has been replaced by a mechanism utilizing a typewriter ribbon as the marking medium in a new recording instrument (FIG. 42), eliminating such hazards as spillage, evaporation, freezing, clogging of pens, etc. The new instrument also offers such advantages as increased reliability over a wide range of temperature, added accuracy since pen-to-paper friction is reduced, decreased maintenance, and ability to obtain a month's record without servicing.

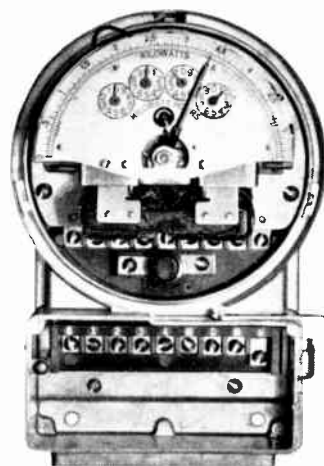

Fig. 40. Small four-circuit totalizer shown with register

on the totalizer in place of the indicating demand register, to operate some standard form of contact-operated demand meter. This arrangement makes it possible to obtain recorded demand where indicated maximum demand may not be sufficient.

Another new a-c totalizer, a two-circuit device, was designed for operation by three-wire contacts. It has better inherent accuracy than the two-wire device, and is suitable for use on larger and more important loads. The totalizer may be used with a standard demand register or with outgoing contacts. The advancing mechanism is new in that Telechron synchronous motors are used to advance the differential gear train.

Concentric-magnet-type Instruments

Considered as one of the most important improvements effected in direct-current instruments in nearly a half century is the concentric-magnet-type instrument—which is one third lighter than previous designs, requires no auxiliary shield to reduce stray-field errors resulting from external magnetic fields, and measures currents of half the magnitude measured by

Small Instruments

For general testing work in which small size and sturdy construction are important, a new line of portable direct-current instruments has been produced. A knife-edge pointer is employed with a three-inch mirror-type scale, permitting accurate readings. The case measures $5\frac{1}{2}$ by $3\frac{1}{2}$ by 2 in.

Incorporating the same elements as those used in round cases, miniature panel instruments having rectangular or fan-shaped cases have been designed to meet the requirements of special applications.

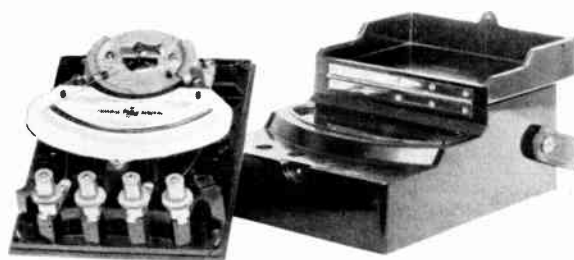

Fig. 41. Element of concentric-magnet-type direct-current instrument and case

Phasing-out Voltmeter

A self-contained voltmeter with ranges up to 15,000 volts has been produced for use in phasing out circuits. The voltage is read directly on a miniature copper-oxide-rectifier instrument, and the presence of voltage is also indicated by a neon lamp. The instrument is contained in a cylinder $3\frac{1}{4}$ in. in diameter. The one for 15,000 volts has a case 22 in. long, and weighs approximately four pounds.

Instrument Transformers

By taking advantage of new magnetic materials and applying new insulation methods and materials, and by covering core and windings that were formerly exposed, there has been developed a 5000-volt



Fig. 42. Inkless-type recording instrument

indoor, current transformer (FIG. 43) which has approximately 50 per cent improvement in accuracy and 15 per cent better insulation strength, without any increase in its dimensions. With primary ratings of from 5 to 800 amp, it is designed for accurate metering service with burdens of one or more watt-hour meters. High accuracy down to 5 per cent of the primary rating is afforded by the compensation method employed. It has good ratio characteristics for relay operation up to 20 times normal current.

High impulse strength, improved accuracy through changed compensating methods, and especially high accuracy in the overload range have been attained in a new line of oil-filled current transformers. Porcelain shells are now used for voltages of 25 to 138 kv.

For use on solidly grounded neutral systems there has been completed a line of porcelain-shell single-bushing potential transformers, the newest being for 69-kv service. For voltages below 69 kv, unit con-

struction is employed; for higher voltages, two or more units are cascade-connected in a single porcelain shell.

Stabilized Amplifier

By changing the method of using an amplifier and by including two stabilizing circuits, a stabilized amplifier which maintains an input-output ratio and a phase angle essentially independent of changes in tube characteristics, plate voltages, etc., has been produced for measurement applications. Tubes can

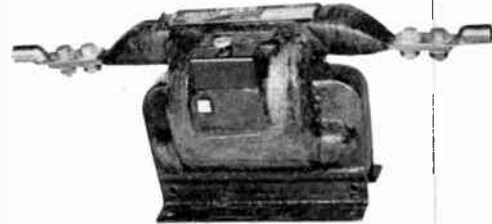

Fig. 43. A 5000-volt indoor current transformer

be freely interchanged without affecting the accuracy, and even line-voltage variations of 20 per cent on the power supply do not change the calibration. Two such amplifiers and their associated instruments, after having been in constant use for eight weeks in the network analyzer that will be described later (p. 23), were found to have a maximum deviation of 0.2 per cent from their original calibration. The use of such stabilized amplifiers may be extended to any application where accurate measurements are required of quantities too small to be measured in any other way.

Double Photoelectric Recorder

The double photoelectric recorder (FIG. 44), recording simultaneously two electrical quantities as low as one microampere full scale, consists of two photoelectric recorders housed in a single case with a standard chart mechanism extended to accommodate a 10-in. chart paper. The new instrument is particularly useful in the study of unusual relations between two variable electrical quantities, such as the measurement of current, voltage, frequency, and illumination.

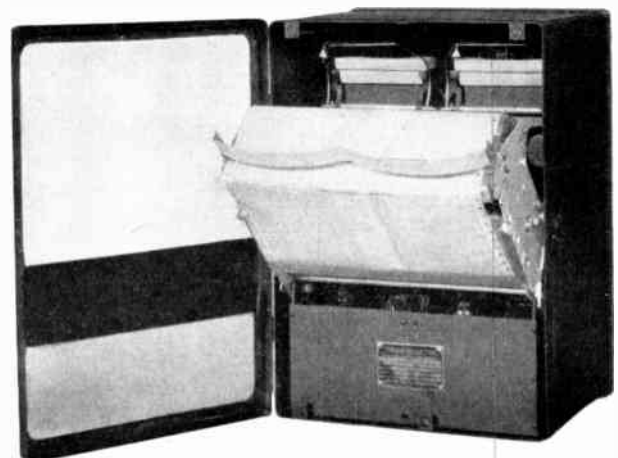

Fig. 44. Double photoelectric recorder with cover open and chart carriage tilted out



Fig. 45. Portable bar-to-bar test set

One application is its use with two electric gauges for measuring and recording surface irregularities of steel strips.

Time Stamp for Automatic Oscillograph

A time stamp has been designed for use with the automatic oscillograph that is used for recording rapid transients in power systems. On the back of each oscillogram it permanently records the date and the hour and minute A.M. or P.M. In addition a fixed stamp can be added, if desired, just above the date line to indicate the name of the company or the station at which the oscillograph is located. Should the a-c source of power which operates the Telechron synchronous-motor mechanism fail during a disturbance, the stamp will still record the time at which the disturbance began.

Portable Bar-to-bar Test Set

Previously it was necessary to take a d-c armature to the testing equipment in order to compare the electrical resistance of coils measured between adjacent commutator bars; a new bar-to-bar test set (FIG. 45) is portable, permitting such a test of an armature to be made anywhere. The instrument is a resistance comparator, and hence is useful wherever

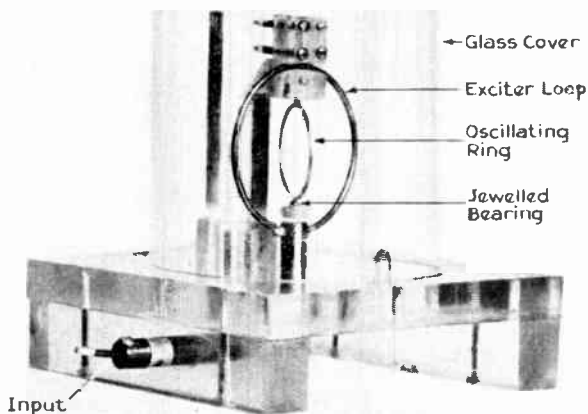

Fig. 46. Electrodynamic ammeter, a standard for current measurement at high frequencies

a comparison of resistance is required. Resistances as low as 0.0002 ohms and as high as 40 ohms can be compared, with an accuracy of about one per cent.

Electrodynamic Ammeter

A new electrodynamic ammeter (FIG. 46) was made available as a standard for current measurement at high frequencies. It can be used with currents of three to six amperes in a frequency range of 5 to 42 megacycles, with an accuracy of readings of plus or minus one per cent. In addition to being ideal for use as a standard for current measurement, the instrument has lower impedance than commercial instruments, and therefore has less effect on the circuit into which it is connected.

Exposure Meter

An exposure meter (FIG. 47) has been designed for the use of photographers in determining the correct exposure time for the various light intensities en-



Fig. 47. Exposure meter for photographers

countered in photographic work. It is universal in application—for both motion and still pictures, with films either fast or slow, and for lenses of all f values.

The instrument has a direct-reading scale which not only reads in foot-candles of illumination but which also, in the case of certain popular film stocks, gives direct readings for shutter speeds and lens openings. On the hood there is a calculator by means of which the correct exposure for any combination of film, shutter speed, and lens opening may be quickly determined. Over the light-sensitive cell is a hinged cover which, when opened, increases the sensitivity by a factor of 10; a further increase in sensitivity is obtained by removing the hood, which is of such shape that it cuts down reception of excessive light from the sky.

Miniature Strain Gauge

The electric strain gauge that has rendered such a good account of itself in the measurements of dynamic strain in locomotive parts, bridge members, rails, and

other mechanical parts, weighs $4\frac{3}{4}$ oz and is $2\frac{1}{4}$ in. long. Now, particularly applicable for the measurement of strain in aircraft structural parts and other members of small sectional area, there is a miniature gauge, fundamentally similar to the larger type but only an inch long and weighing about $\frac{1}{2}$ oz.

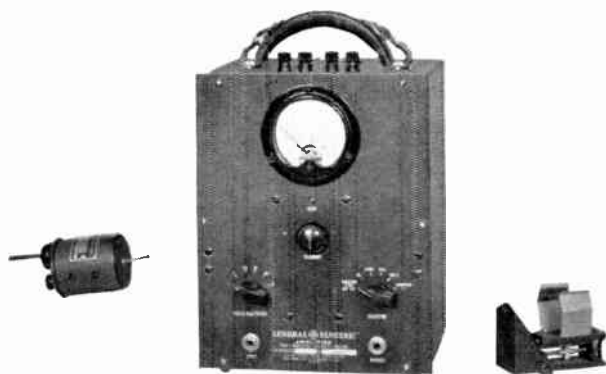

Fig. 48. Meter for measurement of vibration velocity

Vibration-velocity Meter

The vibration-velocity meter—a portable, general-purpose wide-range precision instrument for measuring the velocity of vibration of large or small bodies in a single direction throughout any angle from horizontal to vertical—has been radically redesigned (FIG. 48) to provide a more compact and lighter detector unit. Simultaneously, the former indicating instrument has been supplanted by a portable, battery-operated amplifier unit having greater sensitivity. In addition, a mounting cradle has been provided for permanent installation, if desired, of the velocity unit.

The previous meter had a vibration-velocity range of from 50 to 7,000 mils per second; the range of the new one extends from 1 to 18,000 mils per second. The earlier one had a frequency range of 10 to 1000 vibrations per second; the new one has a range from

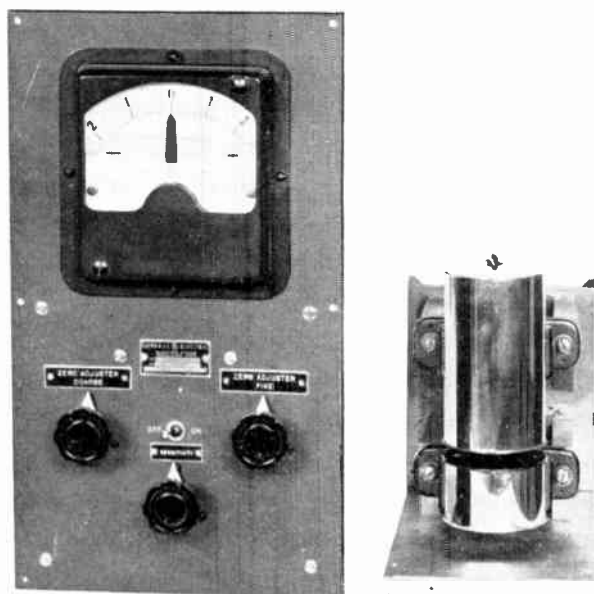

Fig. 49. Foil gauge, with an accuracy of 0.00001 in.

10 to 4000 vibrations per second. The preceding one had a velocity unit loading effect of $3\frac{1}{2}$ oz on the moving body; the new one has a $\frac{1}{2}$ -oz effect.

Electric Foil Gauge

The problem of the continuous measurement of the thickness of thin foils during rolling without touching the foil has been solved in the electric foil gauge (FIG. 49). The foil is passed through an air gap $\frac{3}{8}$ in. wide and the thickness is indicated to an accuracy of 0.00001 in. Eddy currents are induced in the metal foil as it passes through a high-frequency magnetic field and the effect of these currents on the field is measured to determine the thickness of the foil.

Electric Pressure Gauge

An electric pressure-gauge head has been developed to measure and record on an oscillograph the instantaneous pressures in a high-speed steam or diesel-engine cylinder. It consists of a diaphragm having a high natural frequency of approximately 1000 cycles per second; this frequency actuates a sensitive electric gauge. Since the diaphragm displacement is very small, the electric pressure-gauge head will follow accurately harmonics in a pressure wave of the order of 700 cycles per second. This ability gives it a distinct advantage over the ordinary type of mechanical steam-engine indicator, which has too much inertia to record transient pressures, and as a result opens a new field of research.

Light-beam Electrostatic Voltmeter

The many difficulties and inconveniences encountered with the usual electrostatic voltmeter for determining high voltages were overcome in a light-beam electrostatic voltmeter which has excellent response characteristics and a very readable and nearly uniform scale. Use of a light beam instead of the customary heavy pointer is largely responsible for the improved performance.

The instrument consists of a pivot-mounted moving system and stationary pole pieces mounted within a metal case. A mirror on the moving system reflects a light beam upon the scale; dry cells within the case supply current to the lamp. Scale distribution is practically uniform from 20 per cent of the instrument rating to full scale. Full-scale ranges from 2 to 20 kv (ac or dc), with an accuracy or two per cent of full-scale kv, are included.

Magnetic damping permits a responsiveness of four seconds, and effective shielding from stray electrostatic fields is provided by the case. The readable range of the new 20-kv instrument is from 4 to 20 kv; that of the preceding one was from 10 to 20 kv. The new instrument is light in weight, and can be used on alternating current with a capacitance divider to obtain extended ranges without special calibration.

NETWORK ANALYZER

Many new design features have been included in an a-c network analyzer (FIG. 50) recently placed in service at Schenectady for simulating lines and equipment on a utility-company's system in miniature for load, voltage-regulation, and short-circuit studies; investigations in system stability; and network studies involving mutual reactance.

In power systems of the large size and complexity in operation today, many of the component parts are capable of profoundly affecting the successful operation of the system. It has therefore become necessary for engineers to study their systems much more critically. When carried out by longhand methods, calculations which constitute a large part of the work

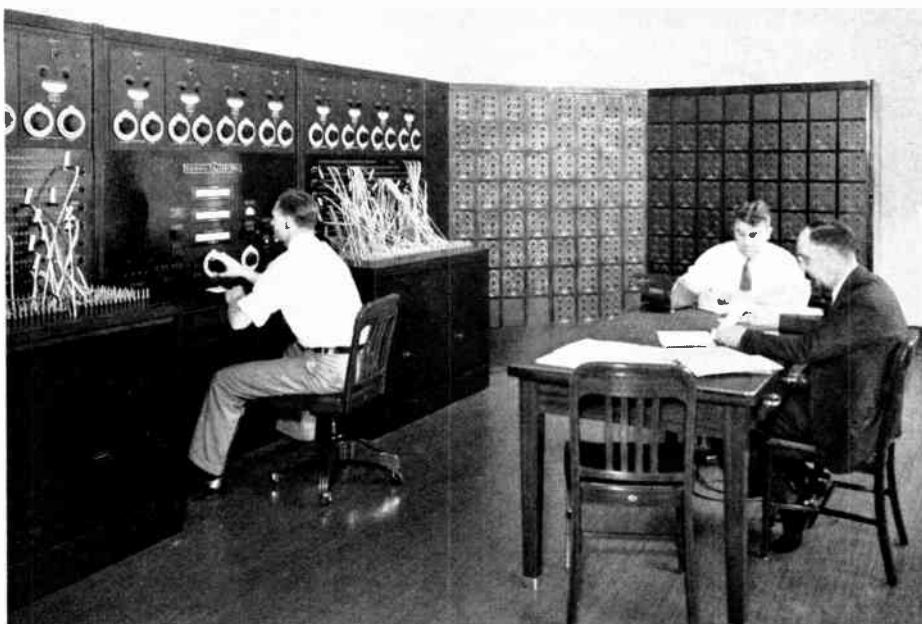

Fig. 50. The a-c network analyzer, showing operator at centralized metering system board and right bank of circuit-unit cabinets

of such critical studies are generally so complicated and laborious that they very frequently curtail the scope of the study and sometimes make analysis altogether impractical. The a-c network analyzer is today a very important engineering tool for simplifying and shortening the work of making such calculations, and in the hands of a competent engineer becomes a valuable aid in analyzing the performance of the most complicated systems and apparatus. It is also a quick and effective means for studying major system disturbances, to determine what probably occurred, and to compare suggested remedies. It is particularly valuable as a means of following, in "slow motion," the individual reproduction of the sequence of events during abnormal system operation. So comprehensive is the analysis given that it is believed that all major changes and additions to power systems involving large expenditures could profitably be studied with such an analyzer.

Assembled symmetrically with respect to the centrally located instrument and control cabinet, the new

analyzer is 26 ft across and 11 ft deep. The 480-cycle power is supplied to the analyzer network from generator units in the upper parts of the three center cabinets. The 3-phase power for operation of these generator units is derived from a remotely located motor-generator set controlled from the analysis instrument cabinet. Each of the 300 network units terminates in jacks and plugs with flexible cords on the connecting cabinets, situated on each side of the instrument cabinet. The desired network is formed by inserting the plugs in the jacks of the vertical jack panels. Mounted on the inclined panel of the central instrument cabinet are telephone-type key switches to connect any circuit unit or jumper circuit of the network to the instrument buses. Direct measurements

may be made of magnitudes or vector components of voltage, current, and power, as well as phase angles in any branch of the network. Master instruments, including ammeter, voltmeter, and wattmeter-varmeter, are of the light-beam type and have moving systems of exceptionally short times of response. Eye strain is reduced to a minimum by the light-beam feature and the 8-in. opalescent-glass scales. Accurate current and voltage amplifiers (see Stabilized Amplifier, p. 20) to supply the necessary instrument power give these instruments very low burdens so that the insertion of the metering

system in the network will produce a negligible effect on the distribution of currents and voltages in the branches of the network. Impedance taps on all circuit units are adjusted to an accuracy of 1 per cent, and the over-all accuracy of the instrument system through the voltage divider and current shunts and amplifiers is better than 0.5 per cent. The high accuracy built into the analyzer eliminates the necessity of using correction tables.

All cabinets are of unit type so that, according to space requirements, different arrangements can be made in other installations. Another analyzer of this type is under construction for a large eastern utility.

Instrument readings of the desired electric quantities can be obtained speedily; as many as 500 readings of voltages, currents, watts, and vars have been taken and recorded in two hours. The high speed is largely the result of the central arrangement of the circuit unit key switches, whereby one operator can conveniently take all readings from the instrument cabinet.

CABLE

Investigations of the processes used in the manufacture of different types of cable, and of the properties of the materials used, led to decided improvements in electrical and mechanical properties of cables, and to the opening of new fields of applications for them. For example, in tellurium-compound cable jackets, for use where abrasion is severe and toughness is required, the tensile strength, modulus, and tear resistance were all further increased. Coronol, a corona-resisting compound, was applied to larger conductor sizes, for higher voltages, and in longer lengths. A new 600-volt mining locomotive cable, having Glyptal cloth insulation with a protective cover of asbestos braid treated with a flame- and moisture-resisting compound, will operate at higher temperatures, and withstand oil and mechanical abuse better than the rubber-insulated cable formerly used.

A new paper-insulating machine was developed and installed. This machine is equipped with special devices to prevent buckling or wrinkling of tapes, and to control tension. Solenoid brakes and thyatron controlled pickup reels are used, thereby eliminating jerking and slipping when the machine is started or stopped, and producing an extremely uniform application of the paper tapes.

A similar machine is being installed for applying varnished-cambic insulation, with the difference that there are only two taping heads per stand instead of four to allow for the use of compound between the tapes as required in this type of insulation.

A new lead pot designed for the lead press completely protects the hot metal against oxidation. This does not supersede the hydrogen process, but rather supplements it. Combination of the hydrogen process and the new lead pot results in a sheath of unusual excellence and is another factor in assuring the quality of the lead sheath.

New equipment was developed for shipping very long lengths of cable for submarine or buried service. This includes movable pickup devices to permit the straight-line winding of the cable on long reels, special steel reels, a special shipping cradle to simplify handling in the field, and special braking equipment for control during laying (FIG. 51). As a result, a 3750-ft length of three-conductor cable weighing 44 tons can be readily handled.

Cable Accessories

A new oil-resisting compound developed for use in solid cable joints has an oil solubility in service

that is practically negligible. Also, it is free from black asphalt which, when dissolved in cable oil and compound, tends to contaminate them somewhat. This feature, usually of minor importance at low voltages, is very desirable at intermediate and higher voltages. The reliability of both the joint and the cable is materially improved at such voltages when the compound is used.

Equipment for the pressure-attachment of insulated cable connectors has been developed. Connector-to-conductor attachments now can be made quickly and entirely satisfactorily without the customary soldering operations which might endanger the oil and solid insulation. The press consists of hydraulically operated rams carrying steel punches which are forced into the connector wall, thus packing the cable strands and surrounding connector. Pressure is developed by a manually operated high-powered oil



Fig. 51. Reel and picking device for handling long lengths of cable

pump. The equipment, readily portable, is applicable to conductor sizes of 2,800,000 cir mils and smaller.

STEEL-TANK MERCURY-ARC RECTIFIERS

Steady progress has been made in the design of steel-tank mercury-arc rectifiers (FIG. 52) and auxiliaries. Several installations involving current limiting and voltage regulation by means of automatic grid control are in successful operation.

Molded Mycalex seals, electrically welded to the rectifier cover wherever current enters the vacuum chamber, eliminate from 20 to 56 bolted vacuum-tight joints, depending on the type and size of the rectifier.

To better withstand mechanical strains set up by temperature changes, the cathode construction has been changed to utilize a steel ring coated with vitreous enamel in place of a ceramic material previously used.

A new vacuum-relief arrangement in the automatically operated shut-off valve of the new rotary vacuum-pump assembly permits a change of the complete motor and pumping unit without loss of vacuum even in the exhaust system. This feature also prevents oil from being drawn back into the pipe line because

of the equalization of pressure on both sides of the mechanical pump when it is idle.

The mercury-condensation vacuum pump has been redesigned to have several times the pumping speed of previous types as well as an increase in back pressure. Proper mercury level in the pump boiler is automatically maintained. The pump itself is provided with removable nozzles, the interior being readily accessible for inspection and cleaning.

The construction of the McLeod vacuum gauge has been improved to eliminate internal, bolted vacuum-tight joints.

A recirculating water system which permits the use of treated water, thereby minimizing corrosion of the water jacket, is now standard equipment for rectifier cooling. The system includes water-to-water or water-to-air heat exchangers.

Mercury-arc rectifiers are widely used in electrolytic work. A unit for this service was placed in operation supplying power to a cell bank for the electrolytic decomposition of salt in chlorine production. The output voltage of this rectifier is closely regulated by means of automatic grid control. Similar equipment may be used to facilitate parallel operation of rectifiers with rotating a-c to d-c conversion equipment.

Automatic grid control was also used to limit the current output of a rectifier supplying power to a railroad. During normal operation the voltage regulation of the rectifier is equivalent to that of a shunt-wound generator, but, if the current rating of the machine is exceeded, the grid control features are automatically brought into operation to limit the output to approximately constant current thus avoiding a complete interruption in the power supply. This type of control is also used to prevent overload-



Fig. 52. Six-anode 1,000-kw metallic-tank mercury-arc rectifier being assembled. The centralized terminal board is shown on the side of the tank.

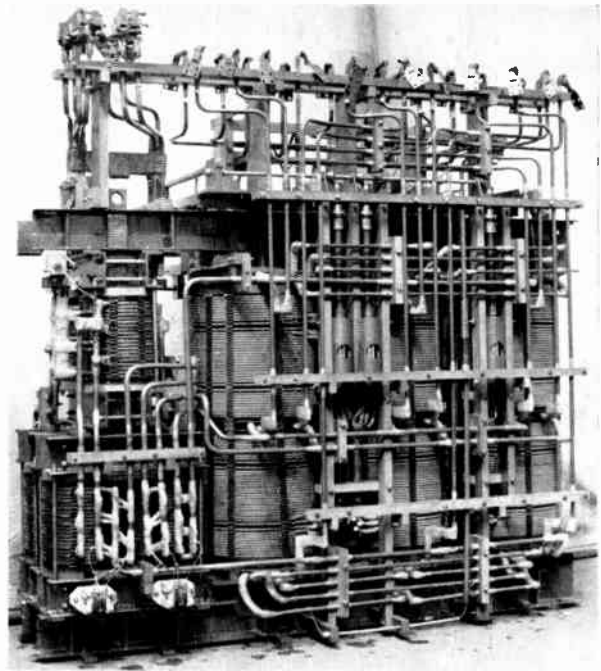

Fig. 53. Assembled core and coils of a transformer for a 24-anode mercury-arc rectifier

ing of the rectifier when substations are being put on the bus after a complete shutdown of a large system.

Rectifier Transformer

The assembled core and coils of a rectifier transformer with a three-phase interphase transformer mounted at one end are shown in FIG. 53. The combined unit was built during 1937 for use with a 24-anode 9000-amp 340-volt mercury-arc rectifier for electrolytic service. The secondary is connected double quadruple zigzag to give 12-phase voltage regulation; Thyrite surge absorbers are connected to the secondary and interphase windings for protection against overvoltages.

ELECTRON TUBES

Low-voltage Rectifier

A new form of metal pool-cathode rectifier tube, utilizing four anodes, can provide d-c power from a three-phase source with a Scott-connected transformer. The tube (FIG. 54) has a d-c rating of approximately 100 amp at 110 volts and is suitable for battery charging and similar needs. It is started immediately by means of an immersed ignitor.

Steel Welder Control

The rating of metal mercury-pool ignitron tubes for welding control has been greatly extended by the use of water cooling in all but the smallest sizes (FIG. 55). Simplicity of design, smaller space requirements and, particularly, lower cost per ampere have been attained.

High-current Rectifier

A new Tungar bulb for high-current applications is particularly adapted for motion-picture projector sets,

battery charging, and low-current arc welding. It was first applied in a low-current arc-welder set, with a maximum output of 80 amp, using four tubes or 20 amp per tube. The use of an overwound thorium-oxide-coated filament increases the emissive area to

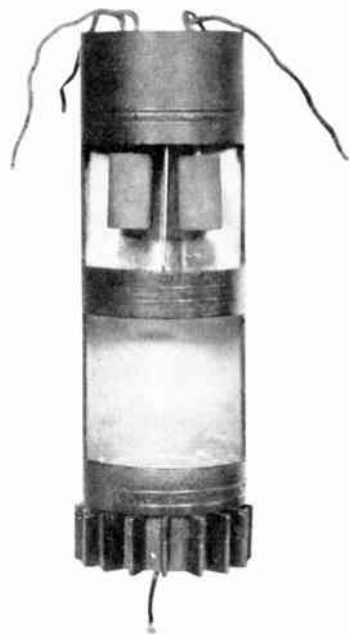

Fig. 54. Cutaway view of metal pool-cathode rectifier tube



Fig. 55. Metal mercury-pool tube for welding control

about five times that of the conventional tungsten filament. This larger area increases the cathode efficiency, allows higher peak-current demands, and results in longer life for the tube. A combination of argon gas and mercury for ionization gives a quick-starting tube with higher inverse voltage rating.

CARRIER CURRENT

The number and variety of carrier-current installations placed in service during the year reached a new peak for both high- and low-frequency applications. The number of low-frequency controllers used for water-heating was more than doubled, and the increase in controller installations for all purposes was more than 60 per cent.

High-frequency Equipment

In the field of communication, the major developmental activity was the general redesign of party-line equipment to increase reliability, ease of maintenance, and adjustment. Three new assemblies were added to provide for simplex operation, using loudspeaker calling, with a carrier output of 10 watts or 100 watts. This increase brings the total number of assemblies to eight. Among the additions there were also a duplex equipment with similar features, and a duplex assembly suitable for use with existing magneto telephone lines and exchanges or operators' turrets.

Improvements made in trunk-line and simplex party-line equipments have resulted in greater reliability and less maintenance of the apparatus itself,

and permit more economical use of such transmitters and receivers as channels for standard-selector supervisory control (FIG. 56), for straight remote control or indication of sectionalizing switches, for telemetering, and for automatic control of tie-line loading, for which applications a number of installations were placed in service during the year.

Improvements in carrier-current equipment used as a channel for pilot relaying of high-voltage lines resulted in increased transmitter power output in both a-c and d-c power-supply models, permitting operation over longer distances with increased signal levels, and resulting in greater margins of safety and further widening of the field of application.

Laboratory and field tests indicated that a new carrier line trap (FIG. 57) is a practical and exceedingly effective aid in improving the performance of power-line carrier applications for communication or other purposes. The use of a grooved porcelain form, carrying a special stranded conductor and fitted with particularly sturdy and noncorrodible hardware resulted in a unit which has a marked mechanical superiority. Increased inductance and a newly developed tuning capacitor provide a greatly improved impedance characteristic for both single-frequency and two-frequency tuning.

Low-frequency Carrier

In the low-frequency field, the standardized line of control transmitters was supplemented by one of lower rating, fully automatic in operation, and arranged to control the water-heating load in unattended substations of 1500 kva or less, in accordance with the total load on the substation bus. Through minor additions the same transmitter equipment also

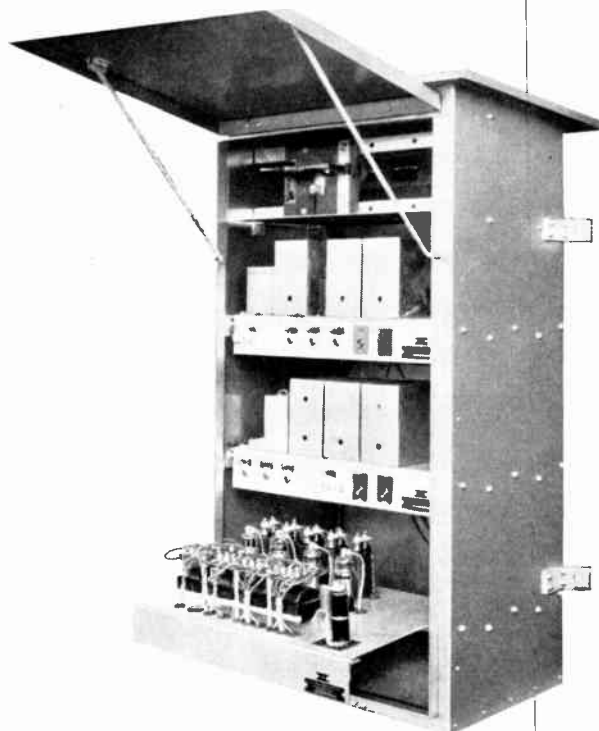

Fig. 56. Carrier-current supervisory control equipment

operates at 480 cycles as well as at 720 cycles, to control street lights on a definite astronomic time schedule.

The number of standard controller arrangements was increased from six to nine, principally to meet the growing needs in water-heating control. The new arrangements include 115- and 230-volt controllers for Type S indoor or outdoor socket mounting (FIG. 58).

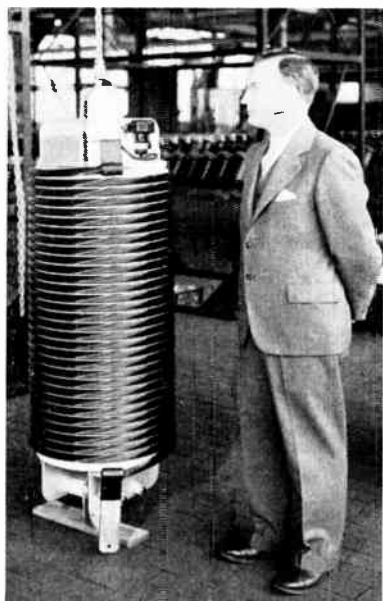

Fig. 57. An 800-amp carrier-current line trap

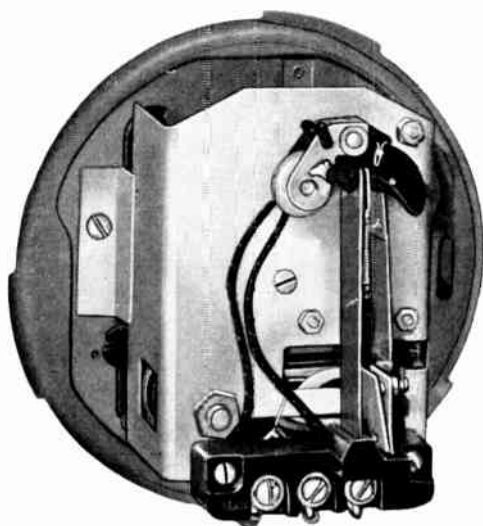

Fig. 58. Carrier-current controller, showing chassis mounted on meter base plate

Controllers for this service include a redesigned thermal-load contactor for 230-volt service, with a new heater, improved thermal material, and a pawl arrangement which greatly increases operating life. Accelerated life tests applied to controllers for water heaters have reached the equivalent of 25 years of regular operation without a single electrical or mechanical failure.

A portable carrier voltmeter, developed to read superimposed carrier voltages on 115- and 230-volt

secondary circuits, was found useful also as an analyzer of harmonics of the fundamental power frequency in general investigations into the sources and effects of harmonics on power-distribution circuits.

CAPACITORS

Meeting the demands of public-utility companies for low-cost power-factor improvement on distribution feeders, and consequent release of system capacity for added load, outdoor pole-mounted Pyranol capacitor units in a comprehensive line of voltage and kva ratings (FIG. 59) have been developed for both

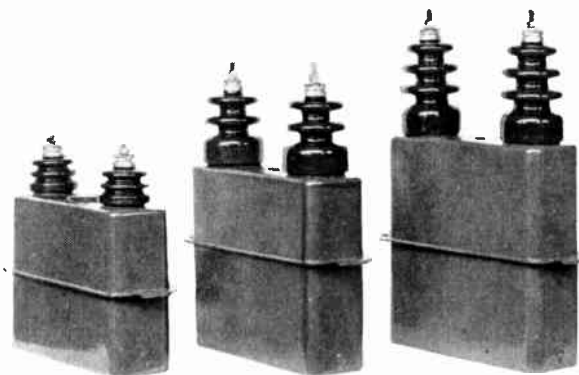

Fig. 59. Pyranol capacitor with welded, drawn-steel case



Fig. 60. New electrolytic capacitor for capacitor motors, about one third the size of previous design

primary and secondary applications. The units have drawn-steel cases with resistance-welded seams, and sturdy compound-filled porcelain bushings with ample flashover values.

Only 36 per cent of the volume of the former design is required in a new design of electrolytic capacitor (FIG. 60) for starting capacitor motors, making the mounting of the capacitor on the motor far less conspicuous. The capacity obtained per unit area of electrode has been greatly increased by the development of etched aluminum-foil electrodes.

ELECTRIC TRANSPORTATION

Urban Equipment

Application of the Presidents' Conference Committee Car, first placed in service about two years ago in Brooklyn (N. Y.), Baltimore (Md.), and Chicago (Ill.), was extended during the past year to Pittsburgh (Pa.), San Diego (Calif.), Los Angeles (Calif.), Boston (Mass.), and Washington (D.C.). Including cars now under construction for some of these properties, there will shortly be in service 640 of these modern street cars. Results obtained from some of the earlier installations, as well as opinions obtained from a large number of riders, give evidence of the popularity of these new cars, both with the operators

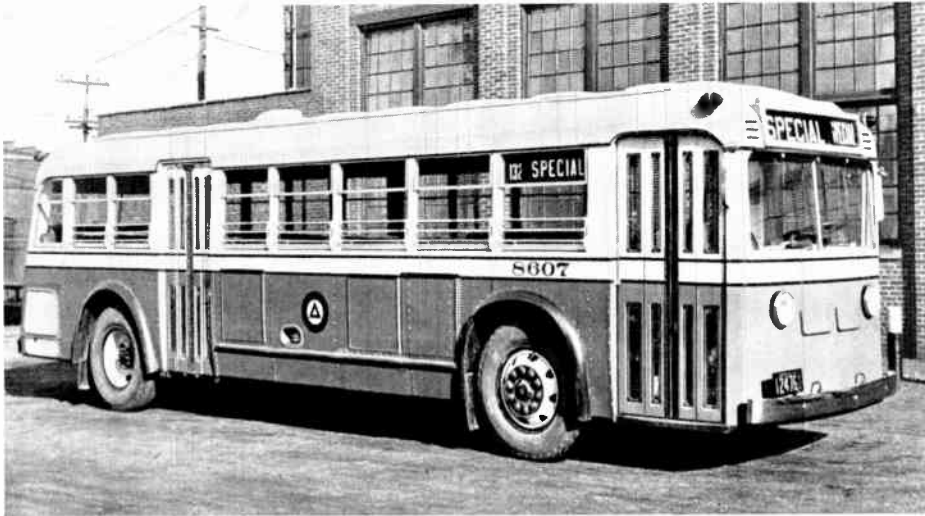

Fig. 61. Diesel-electric bus, Public Service Co-ordinated Transport, Newark (N. J.)

and the riding public. A definite increase in riding, attributable to the new equipment, was indicated.

The popularity of the modern trolley coach, which had its initial trial in 1928 and 1929, continued unabated. More than 1700 of these vehicles are operating on 44 properties. While many of the vehicles delivered during the past year went to properties previously equipped with trolley coaches, a number of new installations was made. Both single-motor and double-motor equipments are being used.

Use of the all-service vehicle, which can be operated either as a trolley coach or as a gas-electric bus, was extended. A large number of these vehicles, including changovers from existing gas-electric buses, are now in use by Public Service Co-ordinated Transport of New Jersey.

During 1937, interest in electric drive for motor buses greatly increased. Based on the experience gained from 2000 gas-electric buses which have operated successfully for 10 years, a new electric drive was developed. Weighing 35 per cent less and costing less, it can be applied directly to a standard single-reduction rear axle, further reducing cost. Also, improved electric design greatly increased the efficiency of power transmission.

The world's first fleet of diesel-electric buses (FIG. 61) went into service on the lines of Public Service Co-ordinated Transport in New Jersey in 1937. During the year every major bus builder began or completed an electric-drive bus for demonstration purposes.

Rapid-transit Equipment

For handling increasing traffic on the municipal lines in New York City, the Board of Transporta-

tion is now receiving a total of 250 new cars, half the electric equipment for which is being built at Erie (Pa.).

Multiple-unit motor-car equipment was supplied for the 3000-volt d-c cars placed in service during the year by the South African Railways.

Substation Equipment

For supplying power to the new lines across the San Francisco-Oakland Bay Bridge, the Pacific Gas and Electric Company is obtaining 20,000 kw of mercury-arc rectifiers, trans-

formers, and switchgear equipment. Included in this apparatus are four 2500-kw 1300-volt d-c mercury-arc rectifiers and transformers for the Southern Pacific lines. Four 2000-kw and two 1000-kw mercury-arc rectifiers delivering 625 volts d-c will be used for the Key System lines.

Other new users of mercury-arc-rectifier substation equipment include the City of Detroit (for the Detroit Street Railways) which is using two 1000-kw 60-cycle 600-volt units, and the Philadelphia Rapid Transit Company in Philadelphia (Pa.) which is installing one new 1000-kw mercury-arc rectifier with transformer and automatic control equipment.

Steam Railroad Equipment

New electric equipment for steam-railroad operation is under construction for both the Pennsylvania Railroad and the New York, New Haven and Hartford. The extension of the main-line electrification of the Pennsylvania from Philadelphia to Harrisburg, including additional freight lines, will require new electric passenger locomotives, 11 of which are being built at the Altoona shops of the railroad company. Electric equipment for 5 is being constructed at Erie (Pa.). The new electric operation involves 315 mi of route and 773 mi of single track. When these lines are electrified the Pennsylvania will be operating electrically a total of 2677 mi. It is expected

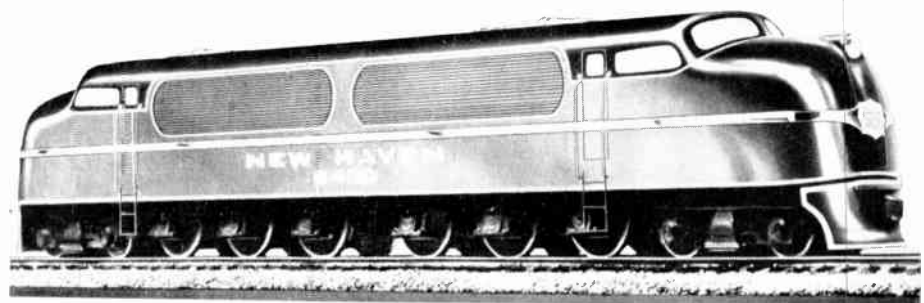

Fig. 62. Model of New Haven streamlined passenger locomotive

that electric operation of these new lines will be inaugurated early in 1938.

For handling high-speed passenger trains between New York and New Haven, six additional electric locomotives (FIG. 62) are under construction. These locomotives will be streamlined, will weigh 215 tons each, and will be capable of handling a 1200-ton passenger train in high-speed service. Provision is made for operation either on the 11,000-volt single-phase lines or on the New York Central 600-volt d-c lines. Maximum speeds of 80 mph will be required in service. These locomotives will exceed in weight and power any of the equipment previously used by this railroad. Each locomotive will be driven by six twin-armature commutator-type motors employing a construction similar to that used on 10 locomotives of the same wheel arrangement (2-C+C-2) but

the same size was also placed in service by the Fort Worth and Denver City Railway for switching and transfer service.

The popularity of the streamlined diesel-electric train for main-line service continued, and new units have been placed in service during the year by the Santa Fe, the Rock Island, and the Union Pacific. The Union Pacific has just completed a 14-car train to be hauled by a 3-cab 5400-hp locomotive for transcontinental service between Chicago and the coast. The Chicago, Rock Island, and Pacific, on the other hand, is adapting a single-cab 1200-hp locomotive to the handling of 3- and 4-car trains on various parts of its system. The Santa Fe has placed in service complete new equipment for its transcontinental train, the "Super Chief," including a 2-cab 3600-hp diesel-electric locomotive and eight light-weight stainless-steel coaches (FIG. 64). This road also has under construction seven 1800-hp single-cab diesel-electric passenger locomotives for some of its lighter trains.

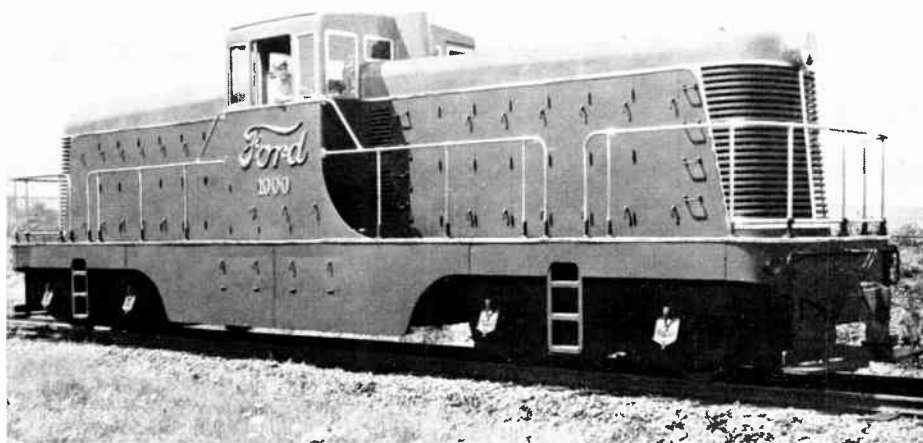

Fig. 63. New Ford streamlined diesel-electric locomotives

with a lower over-all rating, which have been in operation since 1931.

Additional electrification equipment is also being used in a different field to supplement locomotives previously placed in service. The Utah Copper Company, including 20 locomotives recently acquired, now has in service 60 85-ton electric switching locomotives in the pit mine at Bingham (Utah). Industrial locomotives of the straight electric type, in sizes from 60 to 80 tons, have also been furnished for operation in Canada and South America.

Diesel-electric Switchers

A large number of steam railroads and industrial lines acquired diesel-electric locomotives in 600- and 900-hp sizes for yard switching. Nearly 100 such units were delivered during the first nine months of 1937 (according to *Railway Age*). Notable examples of new diesel-electric locomotives in larger sizes are the two 1000-hp streamlined switchers (FIG. 63) placed in service by the Ford Motor Company, and a 1000-hp switching locomotive installed by the Monongahela Connecting Railroad at Pittsburgh. A unit of

Steam-electric Locomotive

One of the most interesting developments of the year was the new 5000-hp steam-electric locomotive which is now undergoing initial tests. This locomotive will be delivered to the Union Pacific Railroad for main-line operation early in 1938.

Welded Rails

Smoother riding for passengers and reduced maintenance for railroad operators result from the introduction of new, mobile equipment for flash butt welding the ends of rails to form one long, continuous rail. The new equipment, recently put into operation by Sperry Rail Service, makes easily possible the use of continuous rails more than a mile in length (FIG. 65). In addition, the new rail-welder is housed in specially built railroad cars and can be readily moved from one location to another, as the job requires.

Although the welding of long rails has been extensively practiced in Europe, the development of the resistance method is comparatively new in this country and comes as the result of considerable research and experimental work with the Delaware & Hudson Railroad and Sperry Products, Inc.

Head-end Power Supply

Diesel-electric high-speed trains demand a light-weight and compact, as well as a reliable and efficient, source of electric power for their car heating, air



Fig. 64. Santa Fe's "Super Chief"

conditioning, fans, lights, kitchen appliances, etc. The requirements are well met in a combined generator and exciter unit (FIG. 66), four of which have been built for use on the new Union Pacific streamlined trains. The generator has one bearing, with a flange forged on the shaft for direct connection to the diesel engine through a flexible coupling. Two units are installed in each train, with amortisseur windings to facilitate paralleling and to avoid hunting.

Railway Lighting

Particularly noteworthy in the lighting of railroad cars has been the lighting of modernized coaches on many prominent lines. In one method, a lighting unit is placed over each seat for reading, and in the center of the ceiling are low-wattage night-lighting fixtures.

Another progressive step in the art of train lighting is represented by the new "Royal Blue" streamlined train recently placed in service by the Baltimore and Ohio Railroad between Washington and New York. The lighting throughout this train is accomplished by continuous lighting troughs, the bottoms of which are equipped with a series of molded plastic transverse louvers. It is believed that this represents the first installation where such louvers have been used in train lighting.

Pyranol Transformers

One of the earliest uses of Pyranol as a liquid cooling and insulating medium was in railway transformers, as its nonexplosive and nonflammable properties made it particularly well adapted for this kind of service. This application is rapidly broadening, Pyranol transformers having been built for locomotives and cars for both freight and passenger service. In the smaller transformers the Pyranol

circulates from transformer to cooler by thermosyphon action, a blast of air being passed through the cooler. The larger ones, for locomotives, are cooled by the forced circulation of Pyranol to a turbulent flow, which is not only a very efficient method of heat transfer, but also results in light weight of transformers and low Pyranol content.

D-c Lightning Arresters

Three new capacitor-type arresters of 750, 2000, and 3900 volts maximum permissible line-to-ground rating have been developed for lightning protection of d-c railway equipment.

The arresters, for either indoor or outdoor service, have clamp-terminal bushings with insulated covers. The Pyranol-filled capacitors are of 4-microfarad capacity and are designed with the discharge resistor enclosed in the case as an integral part of the capacitor.

Lightning-discharge Resistors

A new Thyrite gap discharge resistor, affording a means of using track rails as an additional path for lightning discharge, enables railway-signal power lines to use the highly successful principles of central-station practice. Lightning-arrester grounds are connected through Thyrite disks to the track rails. These resistors are highly resistant to normal track circuit voltage, but under lightning-discharge conditions

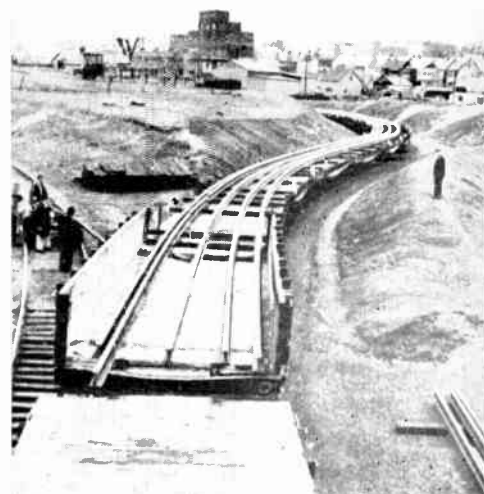

Fig. 65. Mile-long rails, flash butt-welded

become highly conductive and permit the enormous counterpoise effect of the rails to be added to the existing ground connections.

Wheel-tire Oven

Increased axle loading and higher operating speeds have imposed severe service conditions on trailer-wheel tires on steam locomotives, leading to increased use of heat-treated tires having greater strength, hardness, and ductility. Such tires, while being expanded, must be kept below the heat-treating range of temperature. A new electric oven for this work (FIG. 67) has two compartments, each holding two tires. Temperature is maintained below 500 F, and tires can be heated in four hours with unusually low standby loss. The tire-expanding oven also provides a practical way of heating tires for driving wheels having thin wall sections so that heat-treated tires may also be successfully applied to those wheels.

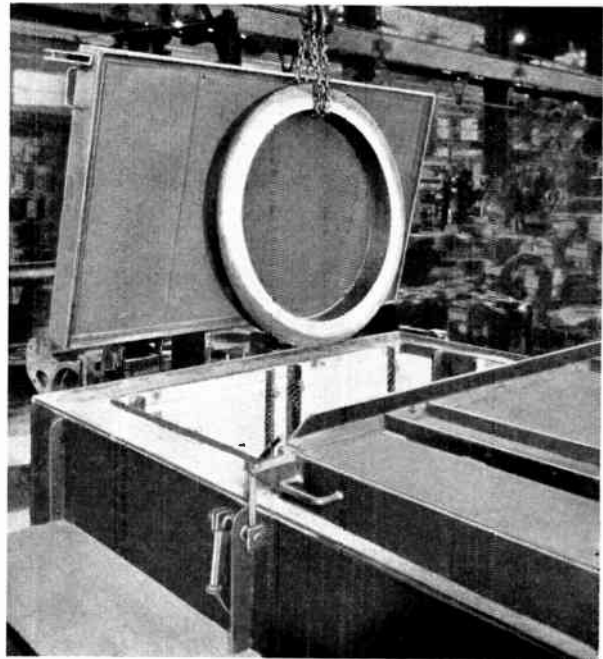

Fig. 67. Electric oven for expanding heat-treated wheel tires

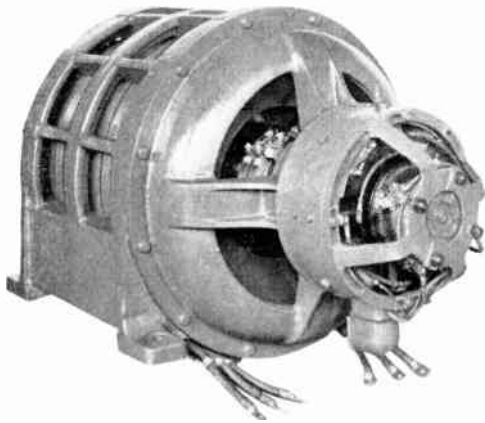

Fig. 66. Combined generator and exciter unit for head-end power supply

MARINE EQUIPMENT

Oil Tankers

Geared turbines were used for the propulsion of two oil tankers, S.S. *Gulfcoast* (FIG. 68) and S.S. *Gulftide*, which have been placed in service by the Gulf Oil Corporation, and duplicate turbine equipments will be used for two duplicate tankers for the same company, built or being built by the Bethlehem Shipbuilding Corporation. The propelling units (FIG. 69) have a normal rating of 2800 hp, 78 rpm, with steam conditions of 375 lb, 700 F total temperature, and 1 $\frac{3}{4}$ -in. absolute back pressure.

The turbine rotors are solid-steel forgings. The design of the turbine is original in that the low-pressure base and lower half of the exhaust casing are in-

tegral and carry the full weight of the condenser shell. Installation is thereby simplified, and liability of stress resulting from rolling and pitching of the vessel is negligible. The exhaust casing for the low-pressure turbine and the supporting platform form a unit of fabricated construction.

The high-speed gears, of cast steel, are 55.82 in. in diameter with a 13-in. active face. They operate with a pitch-line velocity of 10,540 ft per min, practically 2 mi per min. The low-speed gear is of the fabricated type, with forged-steel shaft and web plates for supporting the rim. These plates are welded to the cast-steel hub and rolled-steel rim (FIG. 70). The low-speed gear is 114 $\frac{1}{2}$ in. in diameter and operates at a pitch-line velocity of 2340 ft per min.

The highest pressure and temperature yet used on any ship built in the United States will feature two turbine-electric-drive tankers being built for the Atlantic Refining Company by the Sun Shipbuilding & Dry Dock Company. The first tanker, the S.S. *J. W. Van Dyke*, will have its trial run early in 1938.



Fig. 68. Oil tanker S.S. *Gulfcoast* with geared turbine for propulsion

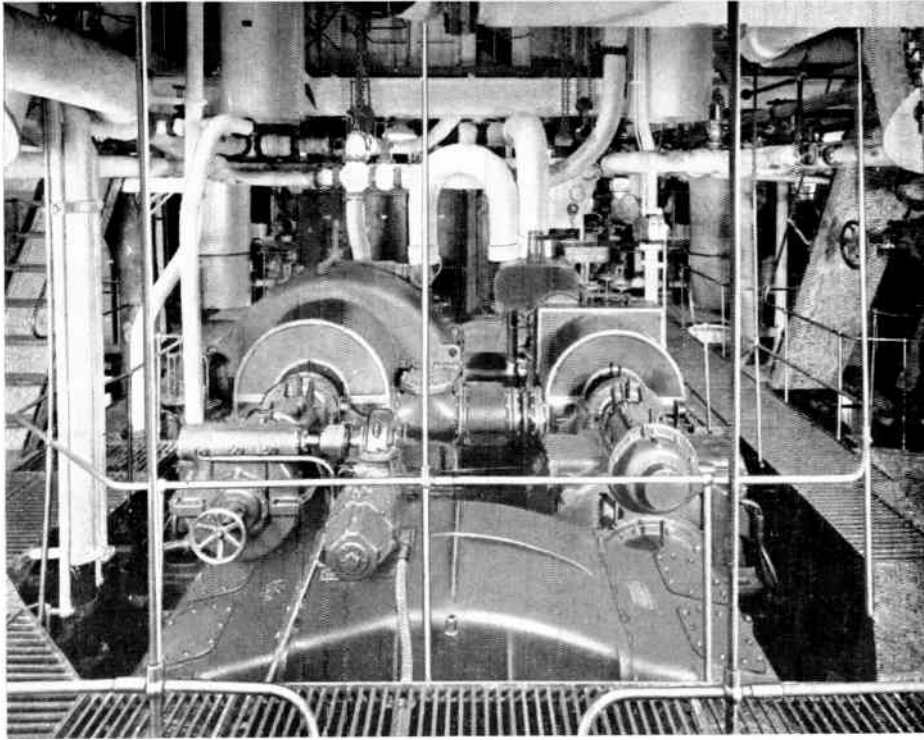

Fig. 69. Main propulsion reduction gear in engine room on S.S. *Gulfcoast*

Steam conditions are 600 lb gauge, 825 F total temperature, and 1½-in. absolute back pressure. The propulsion motor is rated 5000 hp at 90 rpm, and the main 4500-kw turbine generator supplies power not only for the propelling motor but also for the auxiliary motors and lights at sea. Three 300-hp cargo pumps on each tanker are driven by 2300-volt motors of explosion-proof type.

For another oil tanker, being built by the Sun Shipbuilding Company for the Tidewater Associated Oil Company, a geared turbine with normal rating of 3600 hp is being supplied.

High-speed Cargo Vessels

Ships now operating at 11 knots between Philadelphia and Norfolk are to be replaced by two high-speed cargo vessels with a service speed of 16½ knots. The new ships, the first high-speed cargo vessels to be constructed in this country, were designed by Theodore E. Ferris, naval architect, and are being built by the Pusey and Jones Corporation for the Philadelphia and Norfolk Steamship Company. Each will be fitted with a geared turbine, with a normal rating of 4000 hp at 120 rpm, and with a maximum rating of 5000 hp. The

vessels will have an overall length of 292 ft and a displacement of 4200 tons.

Bulk Carriers

In beginning a replacement fleet on the Great Lakes, geared-turbine propulsion equipment is being used. Four new bulk carriers, each more than 600 ft long, are being built for the Pittsburgh Steamship Company, a U.S. Steel Corporation subsidiary. For each of the two being built by the Great Lakes Engineering Works, there is being supplied a 2000-hp geared turbine and two 200-kw turbine-generator sets. To furnish power for the electric auxiliaries when the ship is underway, there will also be a 125-kw generator attached to the main

gears. Steam conditions are to be 375 lb, 725 F total temperature, and 1½-in. absolute back pressure.

AVIATION

Far lighter, less costly, and easier to install than the corresponding a-c units, new aviation instruments (Fig. 71) known as d-c Selsyns are ideally suited for aircraft applications where remote indication is desired. The new instrument elements are so small that four units may be grouped in the standard-size aircraft-instrument case. The instruments accomplish the same results as do the ordinary a-c Selsyns but operate on direct current. Included in the line are instruments for oil pressure, fuel pressure, oil temperature, manifold pressure, carburetor-air temperature, and free-air temperature, as well as position indicators for



Fig. 70. Fabricating the low-speed gear of one of the new Gulf Oil Corporation tankers

retractable-landing-gear position indication and flap-position indication, and for many other uses.

Another interesting aviation development was that of a high-frequency alternator to provide accessory power on large aircraft. The new alternator is driven by a turbine wheel mounted in the exhaust of one of the aircraft engines, the wheel being the same as that employed for certain sizes of exhaust-driven superchargers. Voltage and speed regulation are provided.

Numerous advances have been made in exhaust-driven superchargers. Outstanding among these improvements are new and better alloys for safe operation at 25,000 rpm and at temperatures of 1500 F or higher.



Fig. 71. Aircraft d-c Selsyn landing gear and flap-position indicator

Larger sizes of impellers and diffusers were developed for geared superchargers, meeting the demand of larger aircraft engines. Special forms of cabin superchargers for both military and commercial aircraft, as well as for stratosphere flying, were also produced.

MOTORS

Fractional-horsepower Motors

Outstanding among improvements in fractional-horsepower motors was a new thermal overload switch, built into the motor; previously such a device was mounted on the terminal box of the motor. The switch disconnects the motor from the line only when the windings have reached the limiting temperature for safe operation on running overloads, and acts fast enough so that windings will not be damaged on abnormal currents that occur when the rotor is locked. The device automatically reconnects the motor when the windings are again at a safe temperature. The new switch, which is mounted inside the end flange of the motor, has been given snap

action by the use of a very small Alnico permanent magnet.

A new line of high-torque general-purpose capacitor motors, using a capacitor-start induction-run design that has high efficiency and high maximum output, increases starting and pull-up torques and provides better-balanced performance. For single-phase high-torque applications this line takes the place of both the long- and short-hour capacitor motors previously available.

A new all-service permanent-split capacitor fan motor having a series-parallel winding may be used as a single-speed dual-voltage, two-speed single-voltage, or variable-speed dual-voltage motor. Two-speed operation is obtained by the use of a simple snap-switch, and variable-speed operation by the use of a brush-type transformer controller. The companion d-c fan motors have been modified and may be similarly used for either single- or variable-speed service.

An improved starting switch has fewer parts than the previous design, is more sturdy, and has an average life of over a million operations.

A permanent-split instantly reversible high-torque capacitor motor using a conventional stator design and a cast-aluminum rotor was produced as an automatic tuner motor in the radio field. Available for 25 volts or less and for use at any frequency, the motor is applicable for damper regulators and other intermittent applications.

Synchronous Motors

Two 900-hp synchronous motors produced to drive ball mills in a cement plant have a speed of 720 rpm, considerably higher than that generally used for such a large ball mill.

A synchronous motor built for driving a blower, with a rating of 2200 hp, was unusually large considering its speed of 1200 rpm.

There was an increase in the use of splash-proof synchronous motors (FIG. 72) for Jordan drives in the paper industry and in other similar applications.

Also outstanding in synchronous motors were six enclosed self-ventilated 9,000-hp 400-rpm vertical pump motors (FIG. 73) constructed for the Metropolitan Water District of Southern California.

Direct-current Motors and Generators

An increase in the size of synchronous motor-generator sets for operation at 360 rpm was represented by three 7,000-kw sets, each including a synchronous motor and two 3500-kw d-c generators. The previous largest set of this general speed was of 6,000-kw rating.

During 1937, there was developed and built a double-current d-c a-c 20-kw generator, the d-c end being 125/250 volts, three-wire, and the a-c end 120/-208 volts, three-phase, 60-cycle, four-wire. It was arranged to provide alternating and direct current simultaneously, with extra fields to compensate for change in the a-c load.

Explosion-proof d-c motors suitable for operation in gasoline vapors and under similar atmospheric conditions were made available in several sizes. They bear the Underwriters' Laboratories label for locations designated as Class I, Group D.

Polyphase Induction Motors

Polyphase and single-phase motors with special features were produced for use in sealed refrigerating machines. To withstand the refrigerant atmosphere, which sometimes includes oil fumes, a special insulation treatment was developed, incorporating a synthetic rubber compound.

Meeting the demands for motor-mounted disk brakes for use in explosive gas conditions, enclosures meeting the Underwriters' Laboratories standards

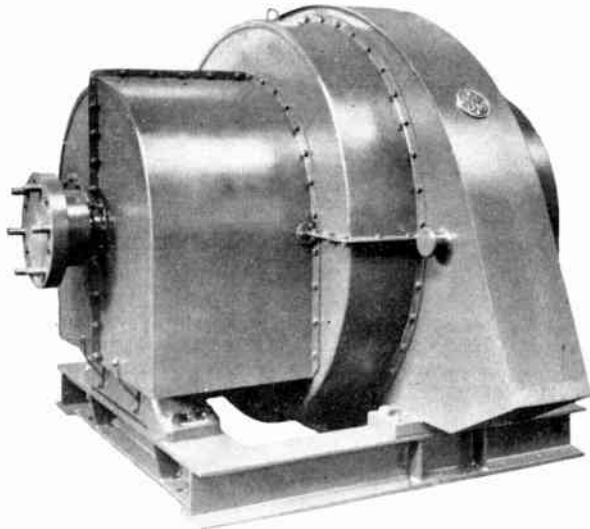

Fig. 72. 225-hp 300-rpm splash-proof synchronous motor

for Class I, Group D hazardous conditions were developed for 8- and 12-in. disk brakes.

The suitability of Class B insulation in explosion-proof motors was determined by tests, and the use of this insulation has made available motors with higher ratings to meet conditions under the Class I, Group D designation, based on a 75 C rise.

Hollow-shaft vertical motors using totally enclosed fan-cooled frames (in some cases designed for explosive atmospheres), were built for deep-well pumping.

Included in large vertical motors for driving pumps used in dewatering mines were some rated 700 hp which were required to support the unusually high thrust loads of 33,000 lb (FIG. 74). They have oil-lubricated bearings, with oil pump-circulated to coolers in the water-pump discharge.

A considerable number of large motors, of both wound-rotor and squirrel-cage types, designed to operate at 3600 rpm, were built for pipe lines, boiler-feed pumps, and similar applications (FIG. 75).

The increased demand for higher horsepower ratings at higher speeds in totally enclosed fan-cooled motors, particularly in those for hazardous gas locations,

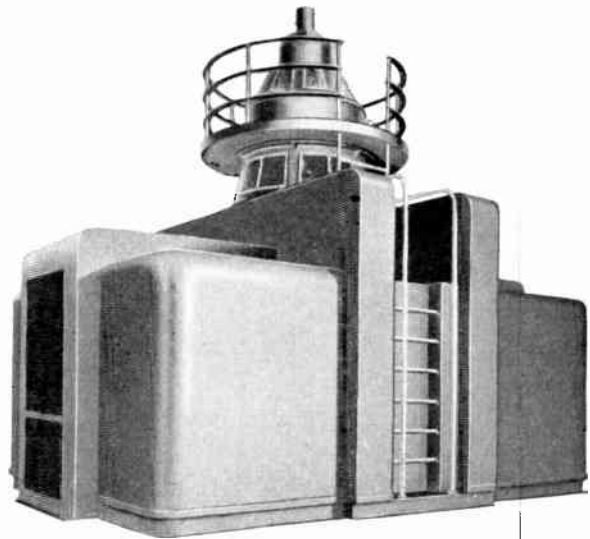

Fig. 73. An enclosed, 9,000-hp self-ventilated vertical pump motor for the Metropolitan Water District of Southern California



Fig. 74. A large vertical motor for mine dewatering

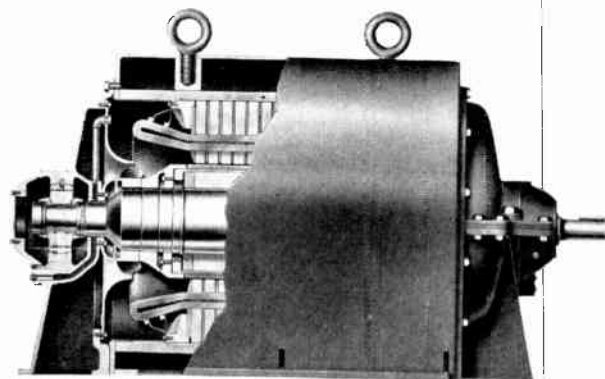

Fig. 75. Cross-section of a 1750-hp 3600-rpm motor

led to many refinements in design—including a special fan and cooling system (FIG. 76) which result in more efficient operation.

To protect the internal parts of a large outdoor motor from dirt, dust, and weather conditions, air filters were provided at the four corners of the base (FIG. 77). Air is drawn through these filters before entering the motor.

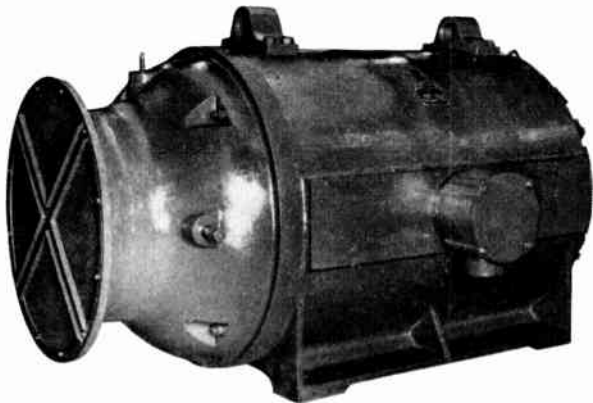

Fig. 76. A 3600-rpm totally enclosed fan-cooled motor

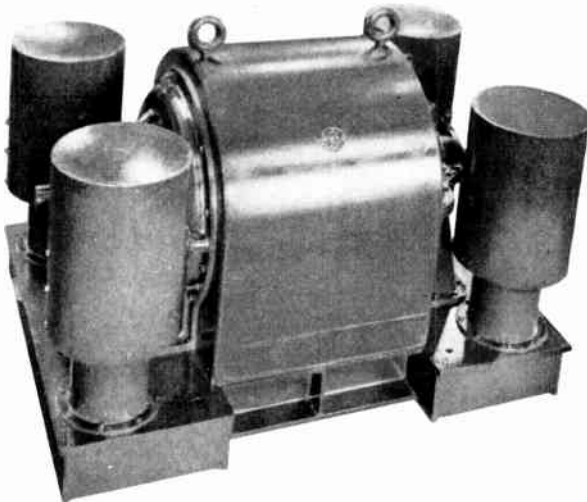

Fig. 77. A base-ventilated motor of large size, having an air filter at each corner of the base

Single-phase Motors

Greatly simplified construction, reduced size and weight, and a speed range of 3:1 have been achieved in single-phase repulsion motors of the brush-shifting type. Frames of standardized dimensions are used.

CONTROL EQUIPMENT

Multipole Contactor

Certain requirements in the machine-tool industry have had an important influence on industrial control equipment by focusing greater attention on compactness, mechanical life, ease of installation, adaptability, and low-cost maintenance.

For example, there has been developed, primarily for machine tools, a small multipole contactor (FIG. 78) rated 1 hp or 10 amp at 600 volts ac, with approximate dimensions of 3 by 2½ by 5¾ in.

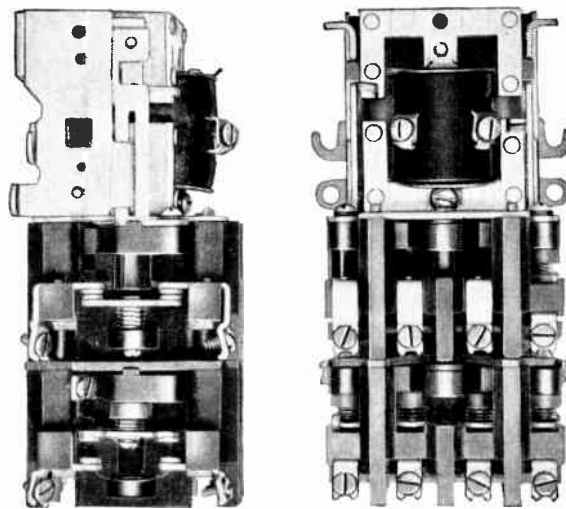

Fig. 78. Small 8-pole contactor for machine tools

in the 8-pole form. The contactor is simple in construction, facilitating wiring and maintenance. Any combination of normally open or normally closed circuits are obtainable in both 4- and 8-pole forms; and a mechanical interlock can be arranged either horizontally or vertically for use with any two forms of contactors.

Limit Switches

Another very compact device is a two-circuit limit-switch unit (FIG. 79). With the required 600-volt clearances and creepages, it is only 2⅞ in. long, and a movement of 7/32 in. operates the contacts. Either circuit may be normally open or normally closed, and no tools are required in making the changeover to the opposite form. Single units may be stacked end to end or one above another to multiply the number of circuits available from a single mechanical motion.

An unusually long mechanical life has been achieved in a new oil-tight heavy-duty reversing-type limit switch (FIG. 80), for use with reciprocating machine tools. An Alnico permanent magnet, producing the snap action, eliminates many of the wearing parts of the usual over-center snap-action mechanism. The switch operates easily, but positively, with an accuracy of ± 0.002 in.

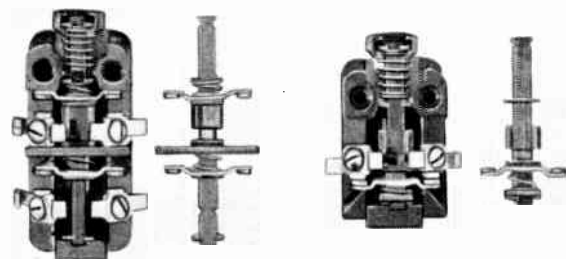

Fig. 79. Two-circuit limit switch: (left) 2-pole normally open; (right) single-pole normally closed

For obtaining precise successive movements by the intermittent operation of a motor such as the feed motor of a planer, a special rotating limit switch (FIG. 81) has been developed. Projecting from the switch is a drive shaft for connection to the motion to be measured. As integral parts of the device there are an indexing mechanism, with a secure locking feature, for a wide range of fine adjustments of motor-operating time, and an automatic resetting mechanism which includes a compactly designed magnetic clutch mounted on the drive shaft.

Punch-press Control

A new control equipment for air-clutch-operated punch presses (FIG. 82) includes numerous safeguards for protection of the operator and consists of a rotating-cam limit switch, control panel, and several oil-proof push buttons—with the push buttons and a selector switch as contributory new developments. The push buttons have cast-iron cases with gasketed covers and seals around large-diameter buttons which, if desired, may be mushroom heads for ease of operation. A built-in locking attachment is also available with these stations. The selector switch is composed of individual 12-position cam units which can be shaft-assembled for any reasonable number of circuits in a selector or continuously rotating cam switch.

Push-button Stations

The separately mounted resistor unit required in the earlier arrangement of an indicating light in a push-button station has been eliminated in a new arrangement employing a 125-volt lamp. For use between 125 and 250 volts, ac or dc, there is a compact resistor; for use between 250 and 600 volts ac, an equally small capacitor is employed. Either the resistor or capacitor combination is mounted in the same space formerly occupied by a lamp and socket, thereby eliminating the need for separate mounting and the wiring of an external resistor.

Panel space is saved and the possibility of error in associating a particular indicating light with the proper push button is eliminated by a new push button (FIG. 83) which has the indicating light mounted within the button. A translucent cap of clear, amber, white, blue, green, or red material is used as the button. A small separately mounted transformer is used for the 6-volt lamp which is operated by an electric interlock on the device controlled by the push button.

Wound Resistors

Superseding a variety of previous forms, a new line of wound resistors covering a series, current-carrying range of about 1 to 50 amp was developed in three forms—smooth-, open-, and edgewise-wound. All have the same basic construction, with from one to five interlocking porcelain insulators, and hence a uniformity of mounting in all capacities. Terminals and

taps are brazed to the resistors, preventing localized heating troubles from contact resistance.

Motor-operated Rheostat

A low-cost motor-operated rheostat (FIG. 84), adaptable to small dial switches and to tube or plate rheostats, has been made possible by a new, compact, enclosed operating head driven by a fractional-horse-power gear-motor.



Fig. 80. Oil-tight heavy-duty reversing-type limit switch

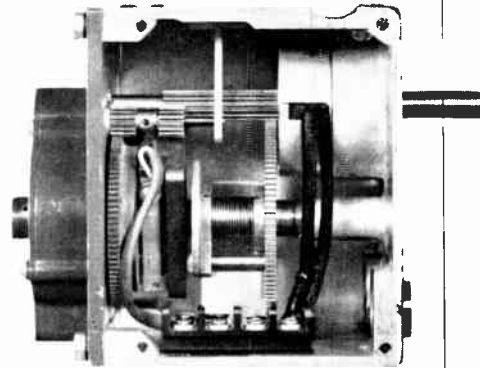

Fig. 81. Rotating limit switch for planer

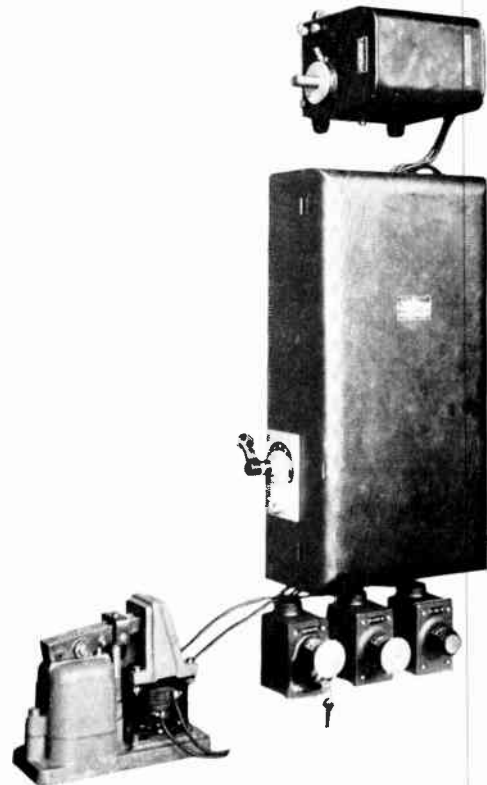

Fig. 82. Control equipment for air-clutch-operated punch press

It can be used with a maximum of three standard 12-in. plate rheostats. An adjustable limit-switch stop with an auxiliary circuit for an indicating light is provided at each end of the travel.

Humless Contactor

For use where noise reduction is important, there is a new line of d-c-operated a-c contactors which will not hum during operation. They are intended particularly for hotels, hospitals, schools, office buildings, theaters and auditoriums, stores, and similar places where magnetic hum is objectionable. The

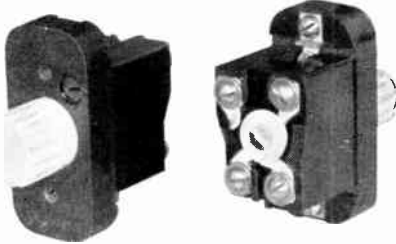

Fig. 83. Illuminated push-button station, partly disassembled

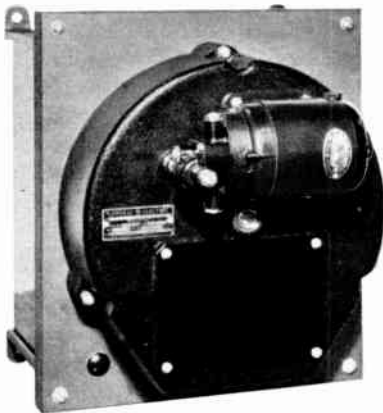

Fig. 84. Gear-motor-operated field rheostat

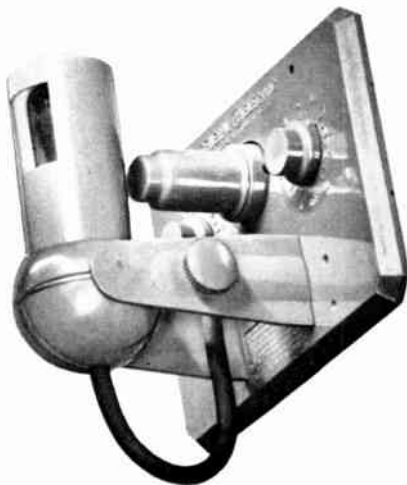

Fig. 85. Photoelectric relay for controlling lights in school-rooms, factories, offices, etc.

contactors require only a small amount of power to hold the circuit closed, are unaffected by normal voltage variations, and are relatively simple in construction. Their current-carrying parts are conservatively rated on an 8-hr basis at 600 volts; they can be used for either ac through rectifiers or directly for dc wherever dc is available.

Automatic Lighting Control

Correct utilization of lights for best results and efficiency, and hence reduction of eye fatigue and strain, results from the use of a new and low-cost automatic, lighting-control relay equipment, particularly suited for use in schoolrooms, factories, offices, etc. The new device turns the lights on automatically when daylight falls to a predetermined minimum, and off when the daylight reaches a similarly predetermined optimum value. This control is turned on or off by a wall switch. The light-sensitive unit (FIG. 85) consists of a molded-plastic base supporting a phototube and holder, a metal radio-amplifier tube, two potentiometer knobs for adjusting the "on" and "off" settings, and, on the back, a small transformer. Finished in neutral gray, it can be mounted flush on a three-gang outlet box, or surface-mounted in an enclosing case. The auxiliary relay and 30-amp contactor panel, also in either a surface-type or flush-mounted enclosing case, can be mounted in a closet or corridor.

DYNAMOMETERS

The line of cradle-type dynamometers, extended two years ago by the addition of a $\frac{1}{2}$ -hp unit, was last year extended in the other direction by a d-c unit capable of absorbing 500 hp over a speed range of 800 to 2000 rpm (FIG. 86). It is designed for precision laboratory testing of modern high-power internal-combustion engines.

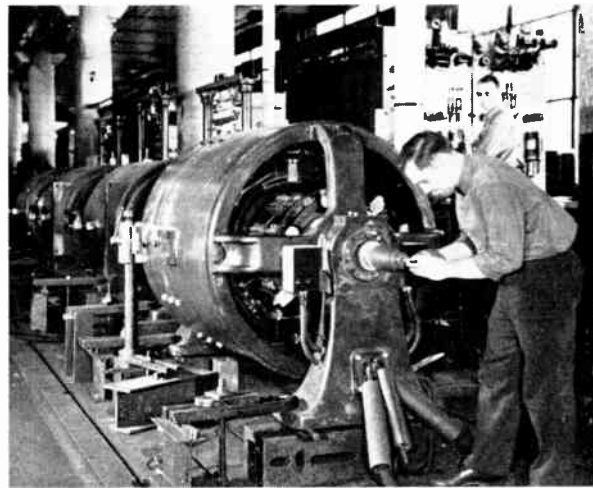

Fig. 86. A 500-hp d-c dynamometer (right) being tested as a motor by loading it on three cradle-type machines connected in tandem

The line has been improved by changes in design, noteworthy among which is the use of a quick-acting cam-type field lock in place of the slower-moving screw-type lock. There has also been an improvement in flexible-lead construction, using a back-connected terminal board and supplying a shield over the flexible leads, thus eliminating any exposed live parts.

There is now being built a hydraulic dynamometer rated 500 hp with a top speed of 8000 rpm which is the highest speed for which hydraulic dynamometers have so far been built.

WELDING

Single-operator Welding Sets

Refinements in design of electric and magnetic circuits of the single-operator d-c arc-welding set (FIG. 87) have made new speed, new case, and new performance available to users of arc welding. Retaining the exclusive cross-field principle of operation,

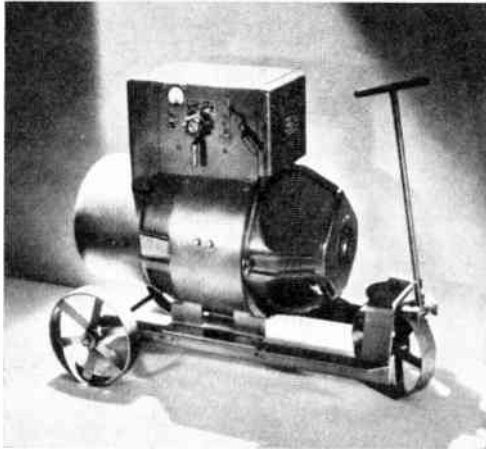

Fig. 87. Single-operator d-c arc-welding motor-generator set

the design not only provides an unusually wide range of welding current but also provides flawless performance throughout that range. Ratings of 200, 300, 400, and 600 amp are available with either a-c or d-c motor drive, with gas-engine drive, or in units designed for belt drive. In addition, a new 150-amp single-operator motor-generator set extends the line into the light-gauge welding field. The small machine (FIG. 88) is arranged for horizontal operation. Electrically, it is similar to those of larger ratings and provides the same type of performance. The welding range is from 45 to 200 amp and the set weighs about 350 lb.

A new gasoline-engine-driven arc welder has also been developed in the 200-amp size (FIG. 89). A compact, economical unit has been obtained by coordinating the new 200-amp (NEMA rating) arc-welding generator with a standard 60-hp Ford V-8 engine. Less than two gallons of fuel per hour are used to operate the machine at full load. Standard parts are used in both engine and generator. The set includes electric self-starter, battery, charging generator, oil-bath air cleaner, fuel pump, 10-gal fuel tank and governor. A two-wheeled pneumatic-tired running gear with trailer hitch is among the optional features. The set is 24 in. wide, 60 in. long, and 43 in. high; it weighs 1250 lb.

Automatic Arc-welding Equipment

A simplified and improved automatic arc-welding head for either d-c or a-c welding was achieved through the use of thyatron control (FIG. 90). Because of the speedy, sensitive action of the control, the arc can be established consistently in approximately one tenth of a second—considerably faster than with

any other available equipment. The desired arc-voltage is automatically maintained within close limits at all speeds so that uniform welding is successfully produced at both high and low speeds.

No changing of gears or feed roll is required in changing the melting rate or the size of electrodes. Electrodes of any size from $\frac{1}{16}$ to $\frac{1}{4}$ in. can be used successfully. The control operates on alternating current so that an auxiliary supply of d-c power is not required regardless of whether welding current is furnished by a single-operator d-c motor-generator set or by an a-c welder.

The welding head embodies two tapered, hardened tool-steel electrode-feed rollers which provide a better grip and higher pull on the electrode than do conventional cylindrical rollers. The rollers are positively driven through a totally enclosed, lubricated, single-reduction gear by a built-in high-torque d-c motor. Full voltage is applied to the motor field at all times. Power for the armature is furnished through two thyatron tubes so connected that one tends to cause rotation in one direction and the second tends to cause rotation in the opposite direction. The amount and direction of the resulting armature torque is

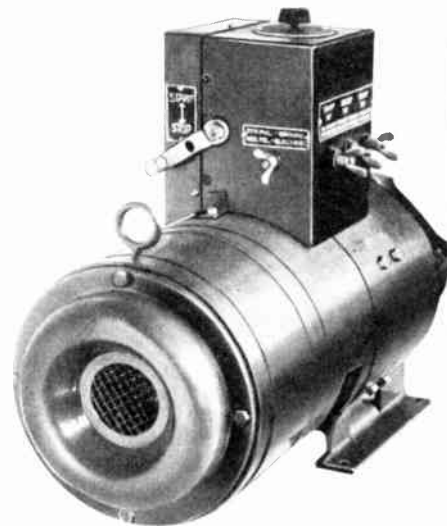

Fig. 88. A 150-amp single-operator motor-generator set for light-gauge welding

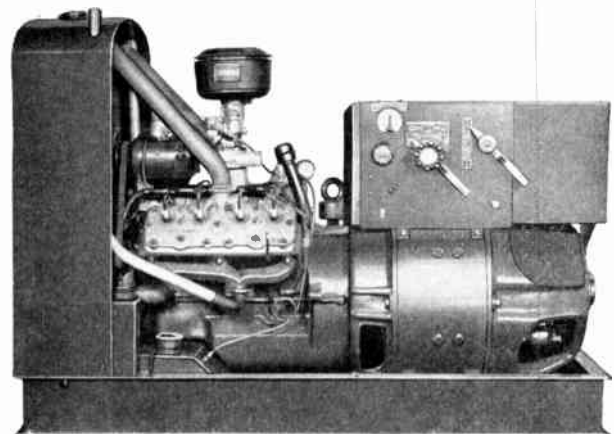

Fig. 89. Single-operator d-c welder driven by a 60-hp automobile engine

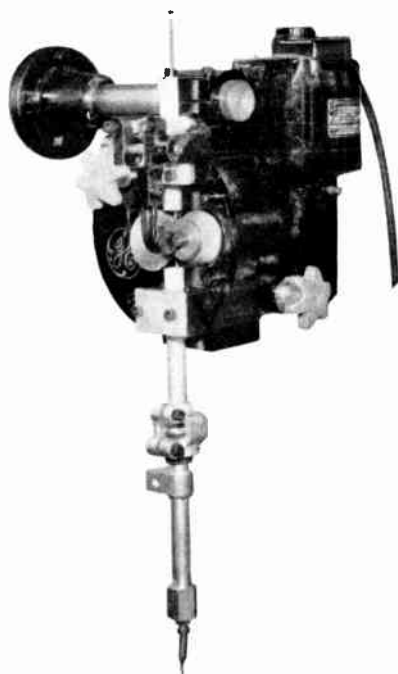

Fig. 90. Thyatron-controlled automatic arc-welding head

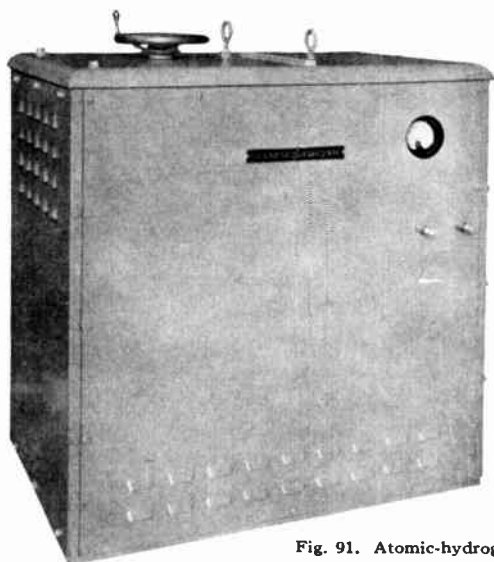

Fig. 91. Atomic-hydrogen arc-welding equipment



Fig. 92. An arc-welding transformer having a self-aligning-mechanism construction is shown with meters

dependent upon how much the arc voltage is above or below the pre-selected value.

Atomic-hydrogen Arc Welding

Improvements in the design of atomic-hydrogen arc-welding equipment have resulted in the achievement of a compact, enclosed unit (FIG. 91) in which everything except the welding torch and hydrogen supply is self-contained. The new design also provides stepless current adjustment, an improvement over the plug-board previously used for regulating output. Any welding current within the range of the unit is obtained by turning the handwheel. Adjustment can be changed during either manual or automatic operation without interrupting the arc. Available in 35- and 75-amp ratings, the new unit weighs 750 lb and measures 39 by 34 by 22 in.

Arc-welding Transformers

The line of arc-welding transformers (FIG. 92) was modified so that all ratings from 300 to 1000 amp have a uniform design, including the new feature of a self-aligning mechanism with an automatic take-up for wear, providing easy control and quiet operation. Fiber-glass insulation is used in coils to resist the temperatures encountered in heavy-duty applications. All are designed for easy application of instruments, automatic voltage-reducing control, and remote-control mechanism. Using the remote-control mechanism, it is possible to install the transformer in a shop balcony, or other remote place, as the operator has automatic control at the touch of a finger.

A new 150-amp arc-welding transformer has a safety, high-efficiency stepless-current control, and freedom from maintenance of the larger units. Instead of a movable magnetic shunt, this unit embodies a movable coil to vary the current adjustment. The current range is 30 to 180 amp, with secondary voltages of 90 and 115. The primary is wound for either 220 or 440 volts but is not reconnectible.

Resistance Welder Control

Improved ignitron starting characteristics, making possible the use of smaller and lower-priced control tubes, have made possible a new line of thyatron controllers for spot and seam resistance welding (FIG. 93). Having the same capacity and characteristics as the previous controls, the new spot-welding units require only one third the space and cost only about half as much. Because of the smaller size and reduced weight, one may be installed beside or above the welder. Heat control by the phase-shifting method, available in some of the units, is obtained by a dial on the panel which permits stepless adjustment of the current over a 20:1 range. Welder transformer taps, autotransformer, and tap-changing switches may be omitted, thereby reducing the cost of the welding machine.

No series transformer or contactor is required for the new seam-welder control, which is contained

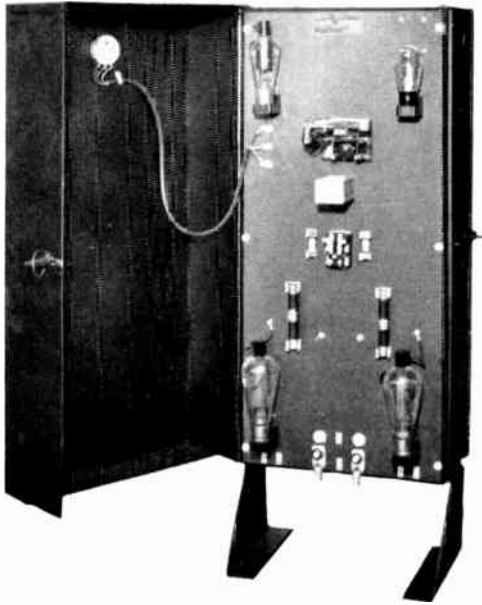

Fig. 93. Front view of new thyatron spot-welder controller, with door open to show control tubes

within one small case and which weighs approximately 800 lb, compared with 3500 lb for the previous controllers with separate series transformer. Cost of installation is reduced and no high-voltage wiring is used.

INDUSTRIAL HEATING

Malleable-iron Annealing

Only from 12 to 30 hr, instead of 5 to 10 days, are required for annealing malleable-iron castings in a new electric roller-hearth furnace (FIG. 94). Its energy consumption is only 305 kw-hr per net ton of castings, with a time cycle of 16 hr and a rate of 34 tons per day. The time depends on the castings and the analysis of the iron. The castings leaving the furnace are scale-free, a protective gas atmosphere being used.

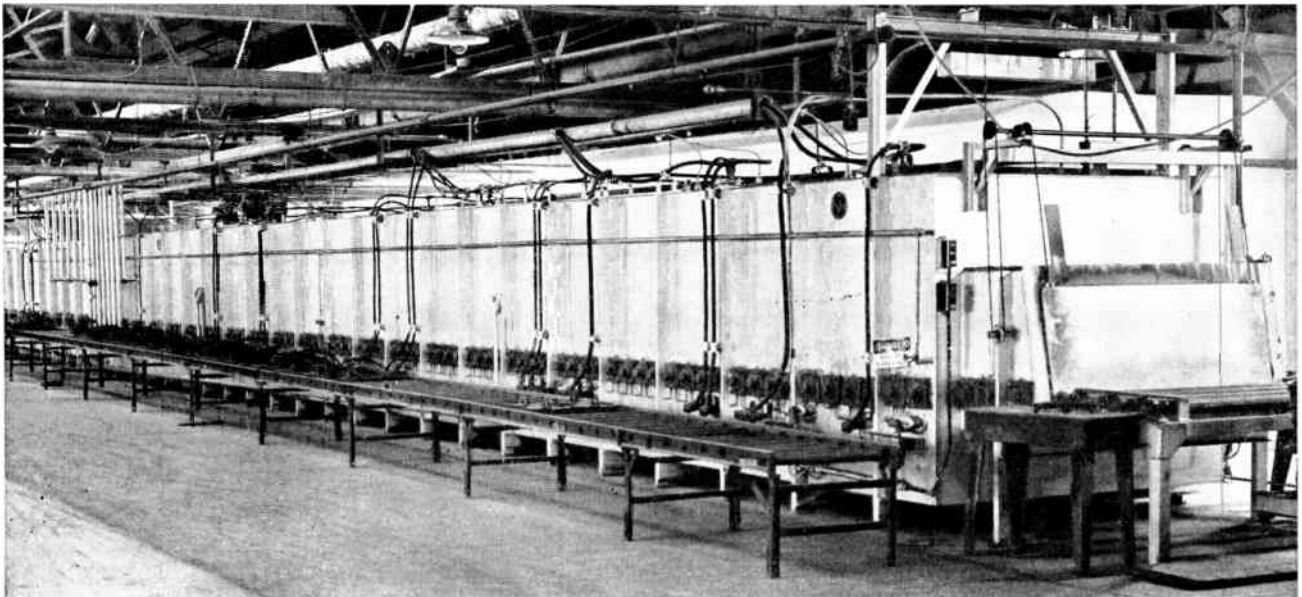

Fig. 94. Large electric roller-hearth furnace used for annealing malleable-iron castings

Scale-free Hardening

The scale-free-hardening conveyor furnace, giving industry a tool for producing higher-quality metal parts at lower cost, has been extended greatly in its applications—as in the hardening of bolts, typewriter parts, chain links, drill-chuck parts, textile-machine parts, etc. A typical furnace (FIG. 95) consists of an electrically heated chamber in which there is a driven conveyor, loading device, quench tank, temperature-control equipment, and an atmosphere controller. Steel parts are uniformly hardened in such a furnace, are free from scale, and require no subsequent cleaning.

Wire Enameling

Meeting the more rigid requirements for enameled copper wire, a new electrically heated wire-enameling oven (FIG. 96) bakes the wire under controlled conditions, with resulting improved quality and increased production.

Inductive Heating

The use of inductive heating in producing hardened bearing surfaces with a tough core and without affecting other parts of the steel is a noteworthy recent development. This process is illustrated in FIG. 97, which shows a crank with hardened bearing surface and a cam section hardened by the Tocco process, developed by The Ohio Crankshaft Company. The heating and quenching operations, producing a hardened surface, are accomplished in seconds as compared with hours required for carburizing or nitriding treatment.

The frequency required for surface heating depends on the dimensions of the piece, the resistivity of the metal, and the desired depth of the hardened zone. Crankshafts and camshafts, for example, have been inductively hardened with 1920 cycles.

Generator equipment developed for this service is of

the inductor type, having a steel rotor without rotating windings (FIG. 98). The largest machine so far built for this service is rated 1000 kva, 1920 cycles, 800 volts, single-phase.

Furnace Transformers

Concentric core-type construction, which has been widely adopted as standard for furnace transformers, gives greater flexibility in obtaining desired transformer characteristics, considering the low-

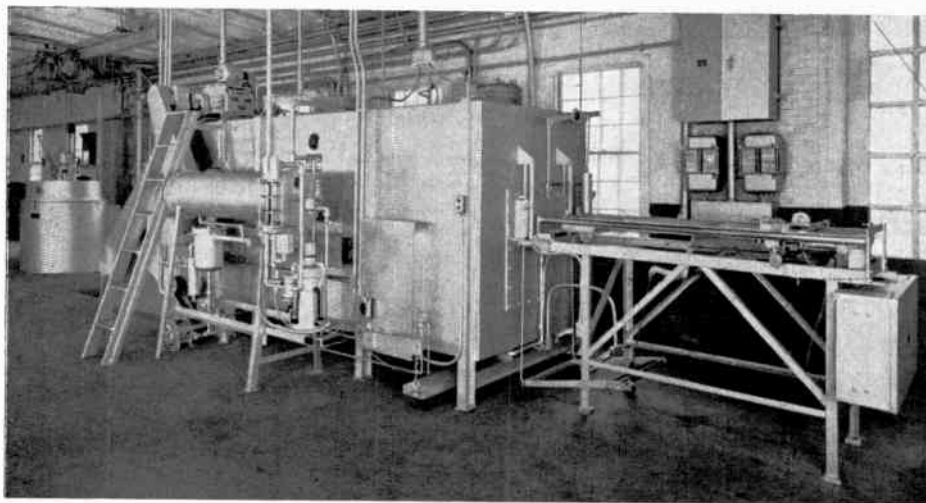

Fig. 95. Typical scale-free-hardening conveyor furnace

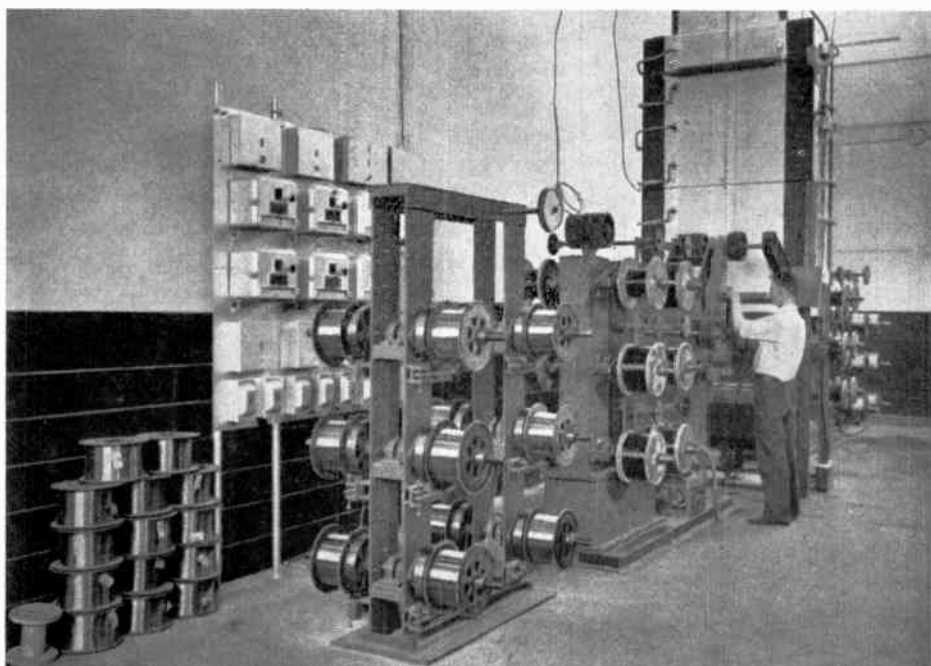

Fig. 96. One of two 2-compartment electric ovens with reel equipment for enameling copper wire. The control shown is for the four compartments



Fig. 97. Section of crankshaft with hardened bearing surface and a cam section hardened by inductive heating

voltage heavy-current secondaries required. These windings are split into parallel paths such that continuous-wound sections can be used with the consequent advantages of fewer joints in the conductors. Bus-bar arrangement is much simplified.

Dew-point Potentiometer

For use in the determination of atmosphere moisture content in industrial metal-heat-treating furnaces, there is a new portable instrument employing the dew-point method. Readings are made by having the gas under test flow through the gas chamber. A mirror within the instrument is allowed

to cool slowly until a spot of dew is formed at its center, where a thermocouple is attached. After balancing the potentiometer the dew-point temperature is read directly on the scale, between -40 and 130 F. Formation of the dew at the center of the mirror is very definite and is easily observed.

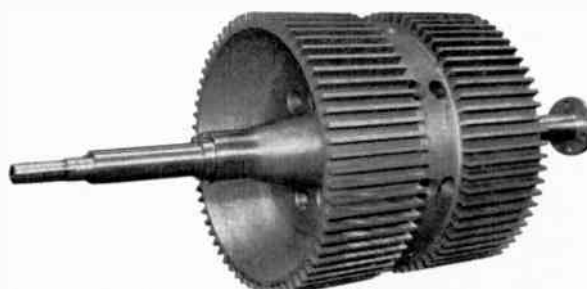

Fig. 98. Rotor without windings, for single-phase high-frequency inductor generator

Convection Heaters

Many applications have been found for the fin-type Calrod heating unit announced two years ago. The unit consists of a steel-sheathed heater around which a steel fin is helically edgewise-wound and copper-brazed. One such application is in a new forced-convection unit heater (FIG. 99) housed in a round case so mounted that the air from the quiet fan may

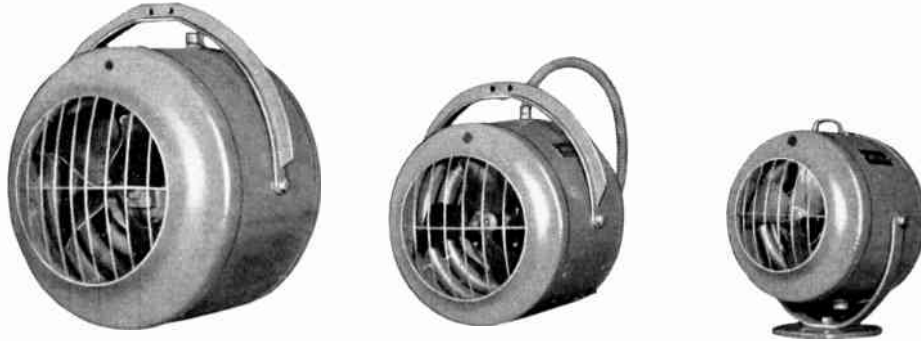

Fig. 99. Convection unit heater with fin-type Calrod heating unit

be directed at different angles by tilting the entire heater. Another type is designed for installation in a shallow wall recess.

Soldering Irons

A high over-all efficiency has been attained in a new type of soldering iron in which the cartridge heating unit has a conducting sleeve of calorized copper to transfer the heat to the tip. Copper-brazing is used exclusively in the construction. Ventilation between parts in the support keeps the handle cool.

Automatic Gluepot

Careful regulation of glue temperature and quick production of workable glue are attained in a new automatic gluepot. The temperature is accurately maintained between 140 and 150 F, the temperature required for best results, by a snap-acting thermostat which is protected against excessive preheating by a thermal-resistant disk.

ELEVATORS AND HOISTS

Elevator Equipment

For the first time, 1800-rpm motor-generator sets have been successfully applied for variable-voltage elevator equipments; noise and vibration previously prevented use of 1800 rpm sets. A novel feature is that the three units of the motor-generator set have only two bearings, the driving motor and exciter both being overhung (FIG. 100). Bearings are of the long-life sealed-in ball type. The sets have all the characteristics required for elevator use, such as stability, high peak overload capacity, and excellent commutation on peak loads.

Rectifiers for Elevators

Small-capacity hot-cathode mercury-arc rectifiers (FIG. 101) have been successfully applied in capacities up to 40 kw at 250 volts, and 50 kw at 550 volts, to supply direct current in districts where a-c

networks have replaced d-c networks. Primarily developed to handle elevator and miscellaneous motor loads such as those encountered in the average small building, the original installation has been in actual service continuously for two years without a tube failure. Such rectifiers operate with a higher power factor and higher efficiency over the entire load range than do induction-motor-driven generators.

Fast Mine Hoist

Electric equipment is being built for the largest, and probably the fastest, a-c mine hoist in America, to be installed at the Wenonah No. 9 mine of the Tennessee Coal, Iron & Railroad Company. More than 6000 ft of rope will be wound around the 18-ft drum in hoisting the unbalanced load of 50,800 lb. The load will travel up the steep slope at 3600 ft per min, or approximately 41 mph. Only 10 seconds will be used in loading or unloading the car. The hoist motor is rated 2500 hp, and the full-magnetic control is reversible. Dynamic braking will be used to control the speed when lowering. The resistor alone will weigh approximately 30,000 lb.

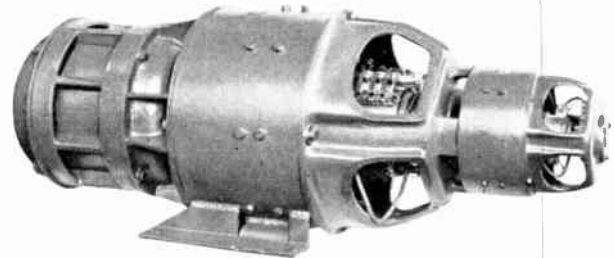

Fig. 100. Three-unit two-bearing 1800-rpm motor-generator set for variable-voltage elevator equipment

D-c Crane-hoist Control

Among features of a new d-c crane-hoist control, using rocker-bearing contactors and magnetic-time relays, are high lowering speeds, excellent speed regulation, precise spotting of the hook, protection of both motor and brake from abuse, and maximum safety for the operating crew. There is regenerative braking for any load requiring 35 per cent, or greater, braking effort; dynamic braking is also available for emergency stops.

Car Dumper

A variable-voltage car-dumper equipment (FIG. 102) built for the Wheeling & Lake Erie Railroad at

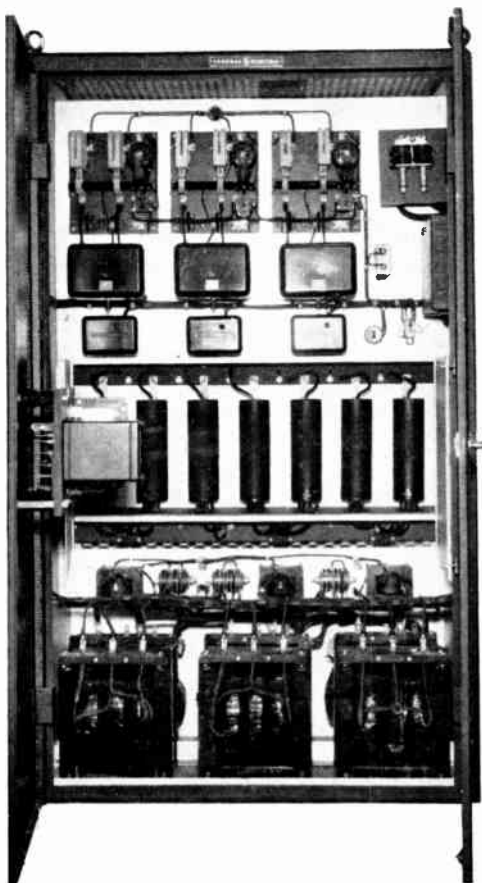

Fig. 101. Phanotron rectifiers for operation of d-c elevators from a-c supply

Huron (O.) is the most powerful yet constructed and is unique in several of its features. Of the lift-and-turnover type, it will handle fifty 120-ton cars or sixty 70-ton cars per hour. The electric equipment is conservatively designed to handle the full capacity

of the dumper on a continuous basis, and is arranged so flexibly that the dumper can still handle the maximum load even though a major piece of electric equipment should fail. Wherever possible, the plant has been made automatic in operation. Two motor-generator sets, each rated 1275 kw at 720 rpm, supply d-c power for the mule and cradle drives, as well as for the auxiliary drives. Adjustable-voltage (Ward Leonard) control is employed on both mule and cradle drives; special Thrustor brakes, each with sufficient capacity to hold the cradle in position, are used on the main drives.

Power for the main drives is supplied by two 4-unit 5-bearing synchronous motor-generator sets, each consisting of two 450-kw adjustable-voltage generators and one 375-kw constant-voltage generator driven by a 2300-volt synchronous motor. The mule and cradle are each driven by two similar 500-hp d-c motors whose armatures are duplicates of those for the 450-kw generators, making it possible to carry only one spare armature for the four generators and four motors used for the main drives. A diversity of loading on the dumper is obtained by having one generator on each of the main sets connected to the mule and the same hook-up used on the cradle which is counterweighted to reduce tower demands. The cradle is coming down light while the mule is handling a loaded car; and, similarly, the load on the mule is light while the cradle is being hoisted under load.

ELECTRIC SHOVELS

Meeting the demand for increased power in the limited space available for the power plant in electric shovels and excavators, motor-generator sets operating at 1800 instead of 1200 rpm have been made

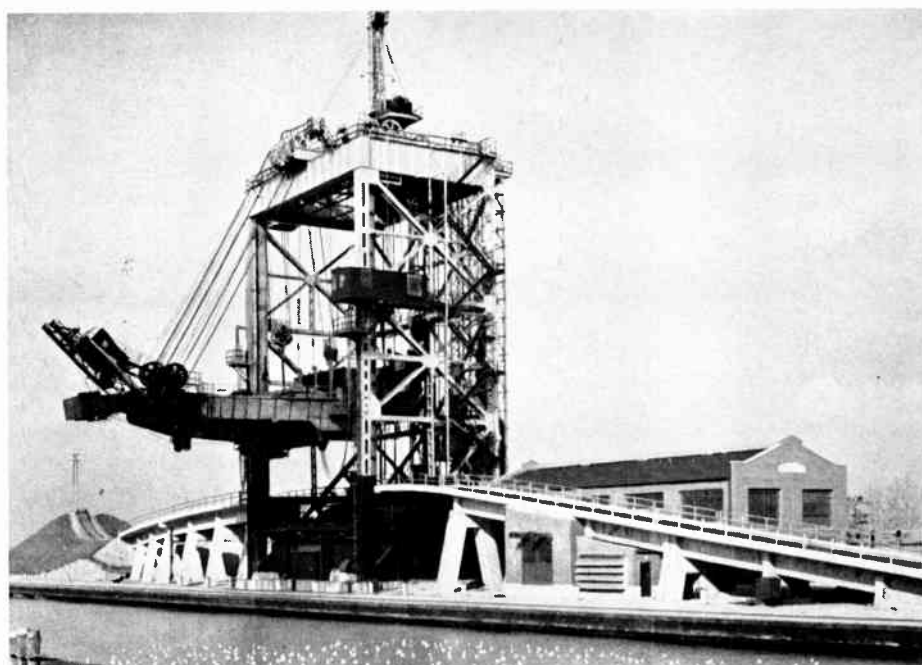

Fig. 102. The most powerful car-dumper equipment, Wheeling and Lake Erie Railroad

available for shovels of larger capacity. FIG. 103 shows such a set developed for shovels of 8 to 14 cu yd capacity. It consists of a 650-hp synchronous motor, two 200-kw hoist generators, a 136-kw split-circuit swing generator, a 68-kw thrust generator,

accurately the motion of the selvedge and to place the tenter rails instantly in proper position. New magnetic reversing switches, utilizing high-speed relays, have proved highly successful in service under actual mill conditions.

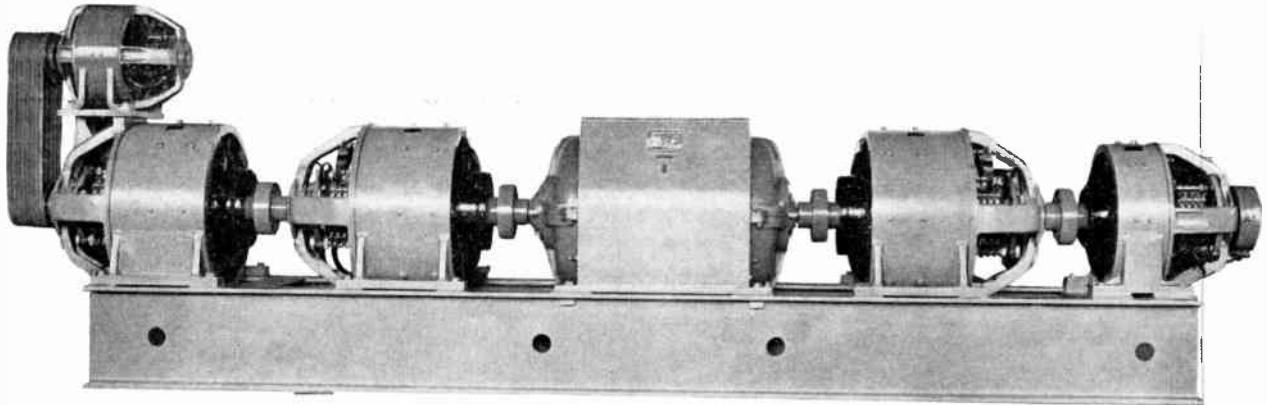

Fig. 103. An 1800-rpm motor-generator set for electric power shovels and excavators of 8 to 14 cu yd capacity

and a 25-kw V-belt-driven exciter. All generators are of the three-field type for variable-voltage control. Ball bearings are used throughout, and alignment is maintained by the self-supporting three-point-support base.

MACHINE-TOOL EQUIPMENT

A special variable-voltage planer equipment, with a total speed range of approximately 30 to 1 has been developed. Of this speed range, that from 1200 rpm (the top speed of the motor) to 750 rpm is used only on the return stroke, and is controlled by varying the motor field. Speeds below 750 rpm are used for the cutting stroke, with control by generator voltage. Output characteristics over the speed range parallel as far as practicable the outputs of contact-voltage equipments, with constant horsepower for cutting above 250 rpm, and constant torque below 250 rpm.

Also of particular interest to designers and users of machine tools are several of the developments in the motor and control equipment fields, as referred to under those headings (pp. 33, 35).

TEXTILE MILLS

Weft-straightening Control

The original weft-straightening control, to detect skew in cloth and utilize this detection as a means of controlling the operation of the straightening motor in terms of skew, was qualitative only. Now the device (FIG. 104) has been made quantitative in that the rate of correcting the skew is proportional to the magnitude of the skew itself, thus greatly increasing the usefulness of the device. Should the control become inoperative for any cause, a signal appears.

Guider Equipment

High cloth speeds, incidental to modern finishing methods, require quick-acting switches to follow

Batcher Motors

The gear torque motor, known to the textile trade as batcher motor, was originally developed for piece batching, to wind cloth under a constant tension, adjustable to suit finish requirements. Now the motor has been applied to continuous batching, winding the cloth without stopping delivery from the tenter.

Screenless Open Motor

A new screenless open motor (FIG. 105) has the ventilating system designed with particular attention to positive lint expulsion. Free lint or dust in the ventilating air is forced through large, unobstructed air passages and is effectively discharged through large openings in the stator frame.

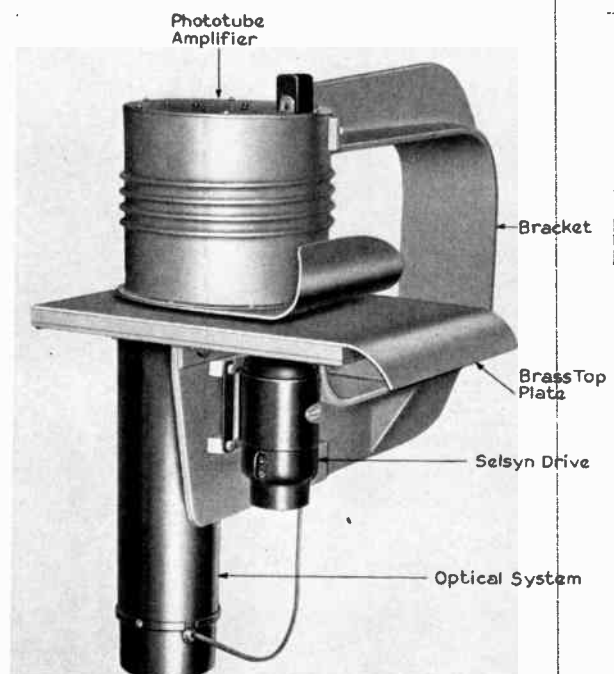

Fig. 104. Weft-straightening control for detecting and correcting skew in cloth

Drive for Sliver Lap Winder

A complete electric drive has replaced belted drive, mechanical brakes, etc., in a sliver lap winder (FIG. 106) produced by the Saco Lowell Shops and used in the preparatory process of the textile industry. The new winder is self-contained, electrically controlled, and has the mechanical and electric parts co-ordinated, with the motors and control built into the framework. Unnecessary parts and sources of mechanical trouble have been eliminated, and appearance and operation have been improved.

Range Drive

In a new scheme of meeting both speed and heating requirements of cloth-finishing units, a turbine-generator set is mechanically connected to the leading or speed-determining unit of the range. The follower units are driven by squirrel-cage induction motors which follow the turbine speed exactly by virtue of the generator frequency. Process steam at the required temperature is provided by the turbine running noncondensing at suitable back pressure. In the conventional set-up, adjustable-speed motors have met the wide-range speed requirements, and the steam has been supplied separately. The steam turbine is particularly well adapted to the service since its speed can be controlled either manually or by automatic governors.

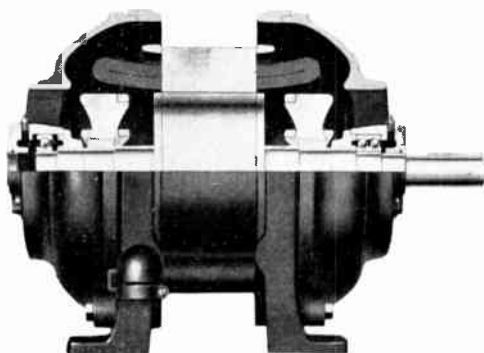

Fig. 105. Cutaway view of screenless open motor, showing fans and air passages

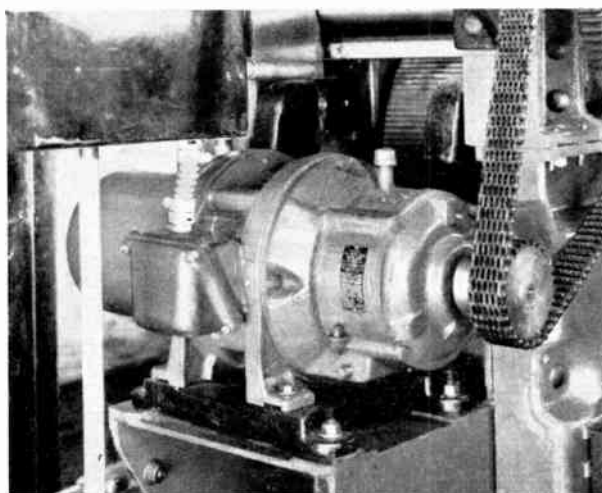

Fig. 106. Sliver lap winder with built-in electric drive



Fig. 107. Typical installation of Pyranol capacitor equipment in textile mill

Resistance Starters

For such applications as on roving machines, which must be started slowly, there is a redesigned three-phase resistance starter of smaller size. It consists of two switch elements with a time-delay station, and three resistors with taps for adjusting for varying torques as required by the machine. The case measures about 17 by 21 by 9 in.

Pyranol Capacitors

Particularly for installation in textile mills, a special design of Pyranol capacitor equipment, enclosing all live parts in a dust-tight enclosure and still providing ventilation for cooling the capacitor units (FIG. 107), was produced.

PAPER MILLS

Winder Drives

Regenerative, adjustable-voltage tension-control winder drive, which has proved so successful, underwent further development in 1937. The braking generator now may be used as a motor during the threading operation and as a generator throughout the entire speed range of the winder during the winding operation. Provision has been made for automatically easing off the sheet tension during acceleration and for automatically increasing the tension during retardation. Dynamic braking is used on both the winder drums and the unwinding roll. Means were also provided during the year for separately driving the rider roll.

Tension Balance

A system was developed for sectional electric paper-machine drives whereby sheet tension is balanced

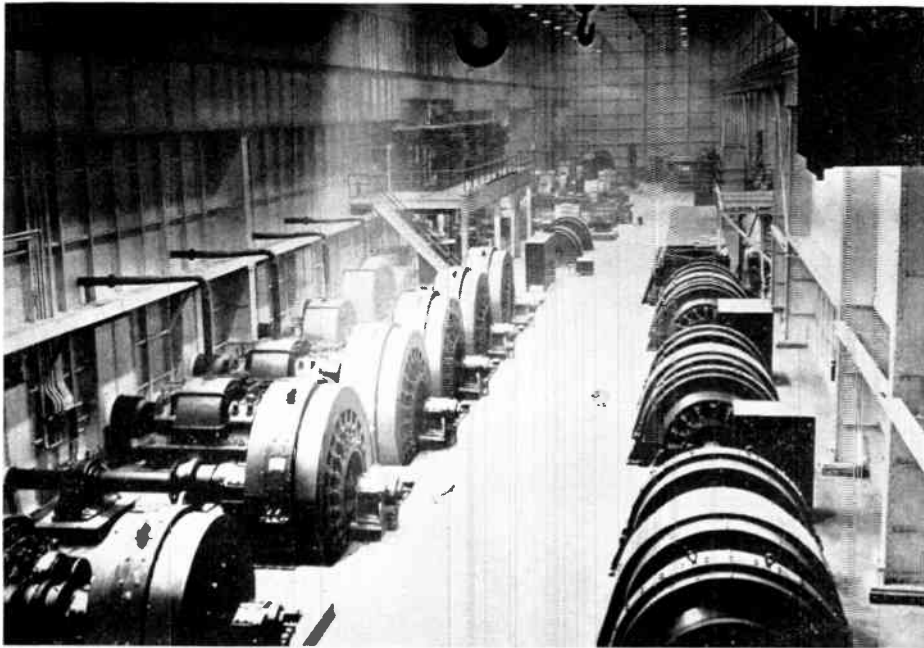

Fig. 108. A hot-strip mill of 96-in. width installed during the year by Jones & Laughlin Steel Corp., Pittsburgh (Pa.). General view of motor room from finishing end

by generated power and the dryer motor is forced to carry the friction load of the dryers at all times. On paper machines making heavy papers and on some machines making special papers, it is possible to unload the dryers partially or completely and actually drive them with the sheet of paper. This has always resulted in difficulties during a snap-off because a loop forms in the sheet immediately ahead of the last dryer section before the dryer motor can assume its load. When a snap-off occurs with the new system, the tension generator immediately drops its load.

Motor-driven Turbine-governor

Mechanical-drive steam turbines, used extensively for driving paper machines, need a considerable speed range to accommodate the various weights of paper that may be made on the machine. A fly-ball governor is a very accurate and satisfactory device up to about 3:1 speed range, but on greater speed ranges the loss of power at low speeds makes this device unsatisfactory. For speed ranges up to 24:1 there is now a motor-driven governor which operates entirely within the 3:1 range but, by means of electric gearing, the turbine speed can cover a span of as much as 24:1 with a high degree of accuracy of control throughout the whole range. The fly-ball governor is driven by a small synchronous motor which is energized by an alternator geared to the turbine. This makes a satisfactory nonslipping connection between the two units. The effect of a gear-shift system is obtained by changing the number of poles in the generator and in the synchronous motor.

SUGAR MILLS

Centrifugal Motors

The development of high-torque two-speed squirrel-cage motors has been extended to those of larger

frames for the purpose of driving 48-in. sugar-centrifugal machines at 1150 rpm. In these motors the rotor resistance is mainly in the end ring, which is built in the form of a blower with a ventilating system separate from the motor's magnetic structure. The trend has been toward high-speed centrifugals for drying high-grade sugar on short duty cycles; this service materially increases the duty on the driving motors. Two-speed wound-rotor motors were formerly employed, but the secondary resistors and attendant wiring were objectionable because of space limitations

and first cost. In addition, the motors must share the duty of braking the machine as, otherwise, the heat and wear on the mechanical brake would be excessive; also, the torque characteristics must be suitable for rapid acceleration, regenerative braking, and plowing. All the requirements are met by the new motors, and a number of installations with full-automatic and timing-control equipments have been made.

Gear-motor-operated Brakes

Ideally meeting the space limitations, gear motors in a new application have reduced to only 6/7 sec the time required for applying or releasing mechanical

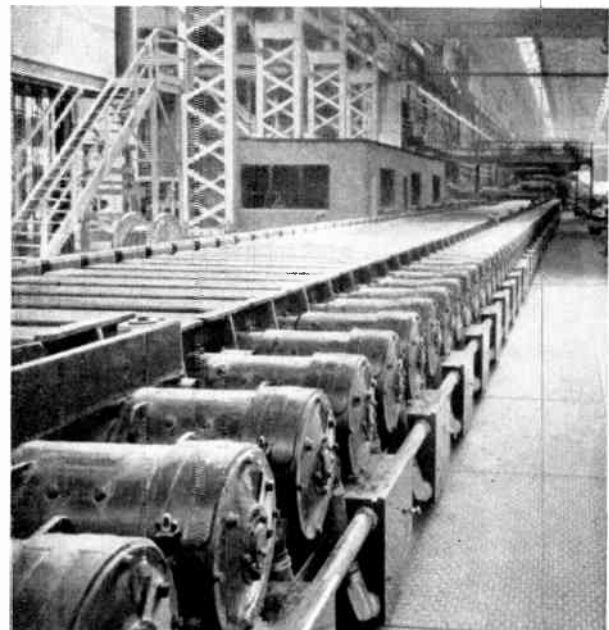

Fig. 109. A runout table, 98 in. wide, installed by the Republic Steel Corp., Cleveland (O.), showing part of the 300 rollers

brakes on motor-driven high-speed centrifugals. Operating on a $2\frac{1}{2}$ -min cycle, the centrifugals are brought to half speed by regenerative braking on the main driving motors and then to rest by the brake motors. In the brake mechanism, designed by the Western States Machine Company, a crank is mounted on the low-speed shaft of a $\frac{1}{6}$ -hp gear motor running at $17\frac{1}{2}$ rpm and is connected by a spring-loaded connecting rod to the brake levers. The brake is applied by a 90-deg rotation of the crank. The preloaded spring prevents excessive side pull on the motor shaft, even though the crank should pass dead center.

STEEL MILLS

New construction in steel mills was again centered around strip mills, as in other recent years. Several

A very interesting and novel rod mill, newly built and electrified, is arranged to finish four strands of rods simultaneously, at a speed close to 4000 ft per min. Nine d-c motors with a very special type of control are employed for driving the mill.

The use of variable-voltage (Ward Leonard with 3-field generators) control for blooming- and slabbing-mill auxiliaries was further increased. In addition to the first equipment of this type, reported a year ago, additional ones are being supplied for three mills under construction. It has been demonstrated in practice that this type of drive reduces not only electrical maintenance but also maintenance of the mechanical equipment it drives.

Factory-assembled control and switchgear apparatus has become a standard for steel-mill applications because of a great saving in installation time.

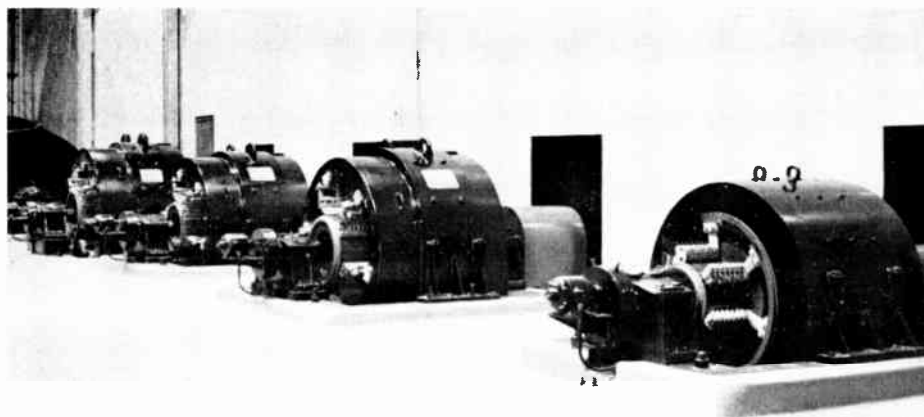

Fig. 110. The electric drive of a cold-strip mill, Republic Steel Corp., Niles (O.)

large hot-strip mills were placed in service or were under construction.

The maximum width of mills was increased to 98 in., the delivery speed was stepped up to 2150 ft per min and the total capacity of main drives on a single hot-strip mill (FIG. 108) reached a value of more than 42,000 hp. The maximum capacity of a single motor for such a mill was increased to 5000 hp.

Appreciable power saving, smoother and simpler control, and saving of substation space are features of a radically new method of driving the runout tables (FIG. 109) and coilers of wide-strip mills. Instead of using squirrel-cage motors and supplying them with adjustable frequency from d-c to a-c motor-generators, the latest three mills employ d-c mill-type motors (one motor per roller or per pair of rollers) furnished with power from one or more adjustable-voltage generators.

The speed of cold rolling of strip has been stepped up in several instances to about 1750 ft per min (FIG. 110), with a 2000-ft per min goal within sight. This requires greatly increased power and a still greater precision of control. The electric tensiometers for indicating and controlling strip tension between stands have been finding a wider use.

ELECTRIC REFRIGERATION

Hermetically sealed refrigerating units have been made available in the 12- and 15-cu ft models for domestic use; previously only the conventional open-type unit was available in those sizes. The complete line now includes every size from 2 to 15 cu ft capacity for domestic use. Recent changes have included new cabinets with such convenience features as full-width sliding shelves which are adjustable in height, and sliding top shelf. A comparison of former hermetically sealed refrigerating machines with those of today shows decided improvements. The cost of operation has been reduced to less than half that of 1928; the weight has been reduced from 202 to 120 lb in one size; the Btu/hr rating has been increased from 337 to 530; and the amount of ice from 0.6 to 2.0 lb per hr.

Conditioned air-cooling units, providing uniform cabinet temperature, rapid cooling, and controlled humidity, are used in the larger models of a new line of 20-, 30-, 40-, and 60-cu ft storage cabinets in the commercial-refrigeration field. The smaller models are self-contained; the larger are designed for use with a remotely installed refrigeration machine.

A new, completely portable beverage cooler

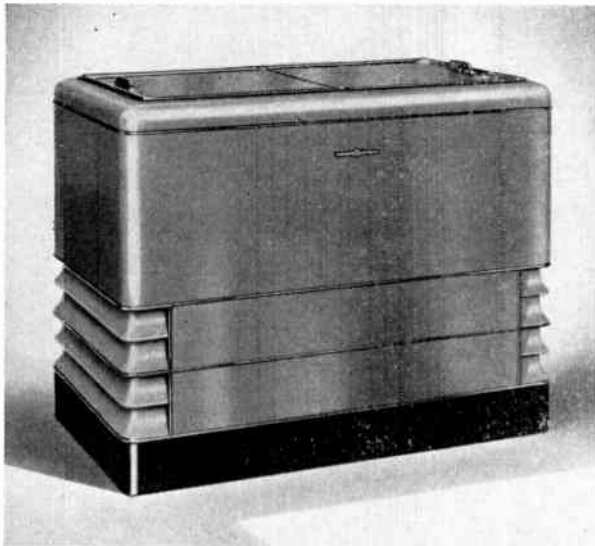

Fig. 111. Portable beverage cooler

(FIG. 111) with a storage capacity of 150 6-oz bottles is designed particularly for drug stores, grocery stores, filling stations, lunch rooms, taverns, etc.

A line of water coolers (FIG. 112) for small offices can be changed readily from bottle type to fountain or faucet type. All will cool $3\frac{1}{2}$ gal of water per hour from 80 down to 50 F.

AIR CONDITIONING

Unit Room Air Conditioners

A new unit room air conditioner (FIG. 113) cools, dehumidifies, cleans, and circulates the air, and ventilates. With all working parts housed in an attractive cabinet, it is designed for residential, office, or similar single-room application. In one arrangement the refrigerant condenser is straight air-cooled, with a capacity of 7400 Btu per hr with 80 F, 50 per cent relative humidity room air and 95 F outdoor air. In another arrangement the refrigerant condenser is

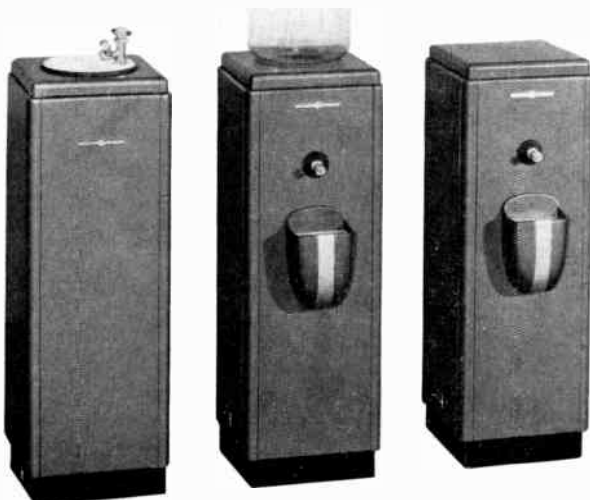

Fig. 112. Water coolers for small offices (left to right) fountain, bottle, and faucet types

cooled evaporatively, with a capacity of 10,100 Btu per hr with the same room conditions and with 75 F outdoor wet-bulb temp. Cooled and dehumidified air is discharged to the room at relatively high velocity, thereby assuring thorough mixing and uniform distribution. The unit is simply set in front of a window and the window duct, which accompanies the unit, is attached; the only special connection required is an electric line for the 1-hp motor. No water connection is required for the air-cooled design; the evaporatively cooled unit employs a $\frac{1}{4}$ -in. water-supply line. No drain connection is required for either design.

Central-plant Air Conditioners

In the smaller sizes of central-plant air conditioners, which incorporate internally mounted belt-



Fig. 113. Unit room air conditioner

driven fans, vibration isolation has been provided by a spring mounting for the fan-motor assembly. Larger sizes use externally mounted fans, selected according to application requirements. The flexibility of application of the entire line, in a range from 900 to 18,000 cu ft per min has been greatly increased by the addition of new heat-transfer elements which include direct-expansion evaporators for Freon in one, two, three, four, and six rows of tubes; water-cooling coils in two, four, and six rows, and heating coils for steam or hot water in two, three, and four rows. Several new combinations have been added, increasing the standard models from 53 to 89, with hundreds of special combinations possible for meeting unusual application requirements.

Oil-fired Warm-air Conditioner

A new oil-fired warm-air conditioner having a capacity of 100,000 Btu per hr has been provided

in addition to the previous size of 133,000 Btu per hr. The combustion chamber and secondary heat-transfer surface are both of welded-steel construction, designed so they may be shipped as one piece.

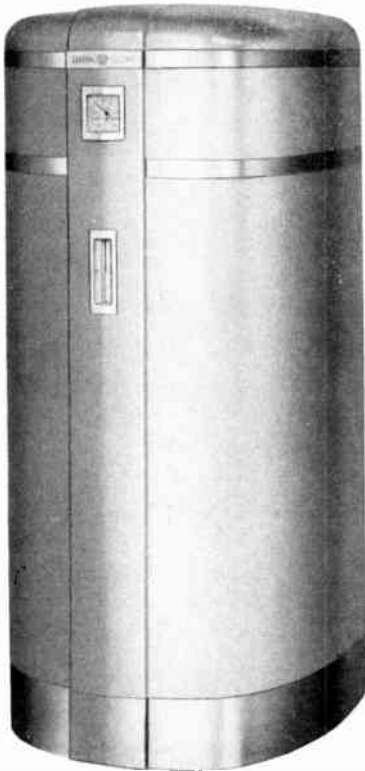

Fig. 114. Oil furnace of smaller capacity

Oil Furnaces

The range of application of oil furnaces has been extended by the addition of a new size (FIG. 114) with a capacity of 100,000 Btu per hr, as compared with 133,000 and 275,000 Btu per hr for the other types. It follows the same general design, using impact-expansion atomization of the fuel, and welded-steel boiler construction. The jacket affords easy access to the working parts and is attractively styled.

Condensing Units

Condensing units, available in sizes from 1 to 50 hp, have been designed to operate at high economy with minimum vibration and noise, and to afford maximum interchangeability of parts. The same cylinder blocks, valve-plate assemblies, cylinder heads, pistons, and connecting rods are used for units of 10 to 50 hp (FIG. 115). The cylinder block has two cylinders. Three crankcase assemblies are used in this range: one, with one cylinder-block and valve-plate assembly for a vertical 2-cylinder compressor; another, with two such assemblies, for a 4-cylinder V-type compressor; and a third, with four such assemblies, for an 8-cylinder V-type compressor. Designs are available for use with evaporatively cooled condensers where this combination affords the greatest overall economy.

Mushroom Air Conditioning

An unusual application of air conditioning has been made on a mushroom farm (FIG. 116). At certain stages of the crop development, close control of temperature and humidity must be maintained.

Portable air-conditioning equipments with combined capacity of 200 tons have proved very successful in such control, with the crops improved in quality and increased in quantity.

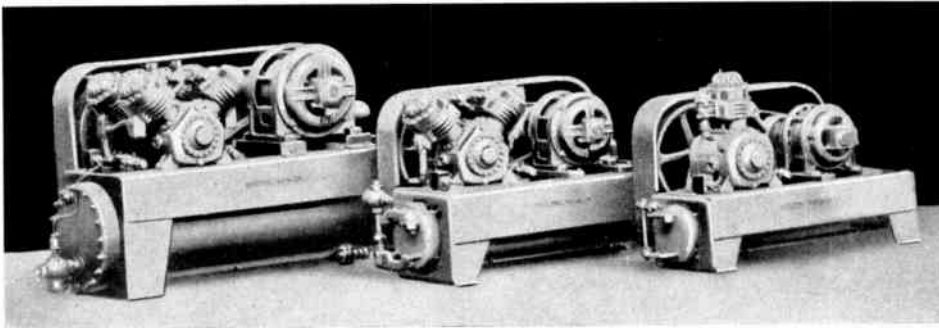

Fig. 115. Water-cooled condensing units rated 50-, 25-, and 10-hp

Air Circulator

Designed to provide comfort during hot weather with a minimum installation cost, a new air circulator (FIG. 117)

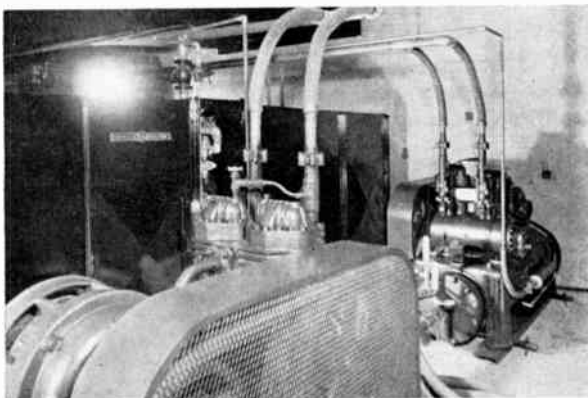

Fig. 116. Interior of equipment room of mushroom-growing houses

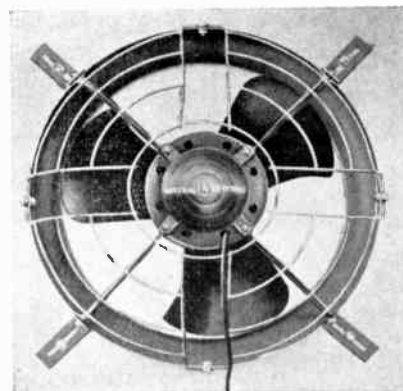

Fig. 117. Air circulator, with wall-bracket mounting for exhaust application in attic ventilation

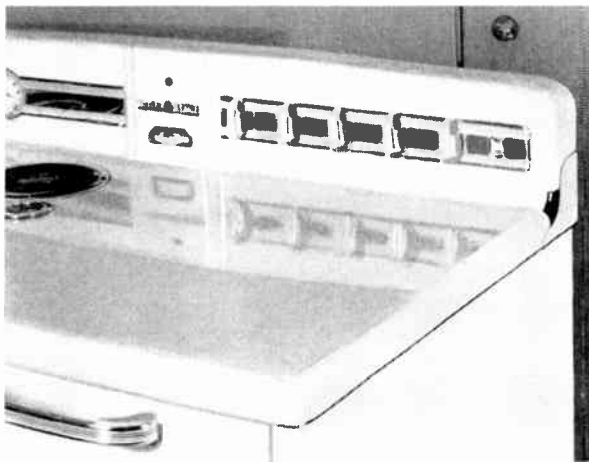

Fig. 118. Unitop construction of electric range

which provide adequate circulation for an average 8- to 10-room house, and by exhausting hot air from the attic will often lower home temperatures from 5 to 10 deg. The large, aponic, axial-flow fan moves a larger volume of air more quietly than preceding types.

APPLIANCES

Electric Ranges

Features included in one line of electric ranges comprise the general adoption of the triple oven, which is really three ovens in one, and seamless construction in producing the top and back splash. Welded body construction was adopted in another line of porcelain-enameled ranges.

The triple oven includes a speed oven for single-shelf cooking, a full-size oven, and a fast broiler in one unit. A removable duplex sheathed heating unit can be placed in either of two terminal blocks



Fig. 119. A 30-gal water heater of table-top design

in the back of the oven. In the upper position there is room for a single shelf above the heating unit, and an economizer sheet below the unit tends to keep the heat in the upper portion of the oven, giving more rapid heating with less current consumption. When used in the lower position the heating unit provides heat for either the full-sized oven or the broiler. The duplex oven unit is really two sheathed units built into a single supporting frame. For average broiling only the center portion of the heating unit is utilized; the outer coil is used for baking.

Cracks have been eliminated, corners have been rounded, and cleaning has been made easier by having the back splash and top of one seamless piece of steel (FIG. 118).

By 100 per cent use of electric welding in the production of a line of range bodies, the entire body is



Fig. 120. Electric sink, including dishwasher and Disposall in one unit

welded into a solid unit, and porcelain-enameled both inside and outside in one operation, resulting in a weight reduction of 34 per cent, greater structural strength, and improved appearance by reason of rounded corners and fewer breaks in the contour of the body. Previously the composite parts of the range were enameled and then fastened to a framework.

Water Heaters

A new 30-gal water heater (FIG. 119), in either a single or a twin unit, has the same seamless top and back-splash construction as that used in the ranges and harmonizes with them. The working surface is acid- and stain-resistant. Use of front connections, both electrical and water, means that the heater can be installed flush with the back wall, thus adding to the harmonious appearance of the kitchen.

Electric Sink

An electric sink (FIG. 120) makes available in a unit assembly the electric dishwasher and the

Disposall unit, for disposing of food waste down the drain. The combination is in various models, to fit the requirements of different homes; the units are also available in individual cabinets or separately for use with sinks of different manufacture.

The new dishwasher unit has simplified control, a detergent cup, and an improved hinge which tightens as the cover is raised. No major changes have been made since the Disposall was announced two years ago; it has been applied in practically all sections of the country, and may also be used with septic tanks.



Fig. 121. New unit kitchen, adaptable to one-wall, U- or L-shaped kitchens

Unit Kitchen

A simplified method of installation, a co-ordination of both electric and nonelectric items, as well as low cost because of prefabrication are features of a new unit kitchen (FIG. 121). It may be adapted to one-wall, L-, or U-shaped kitchens, and is so flexible that as many sections as desired may be utilized. The six basic sections are: range, dishwasher, sink (with or without Disposall), refrigerator, base cabinet, and corner sections. Each has four divisions: top storage cabinet, lighting strip or molding, back-splash wall panel, and base unit of appliance or drawers. Linoleum work surfaces may be used and cabinets may be equipped with interior lights automatically controlled by the doors.

Hot Food Storage

It has been common practice to keep food hot, after it has been cooked, by setting the food pans or jars in openings in the top of a table over a hot water pan. The steam kept all the food at the same tem-

perature, too hot for some foods and tending to continue the cooking. New hot-food storage units (FIG. 122) give the suitable temperatures for each kind of food. The unit consists of an aluminum casting, with cast-in Calrod unit, proportioned to surround the side walls and bottoms of the food pans and

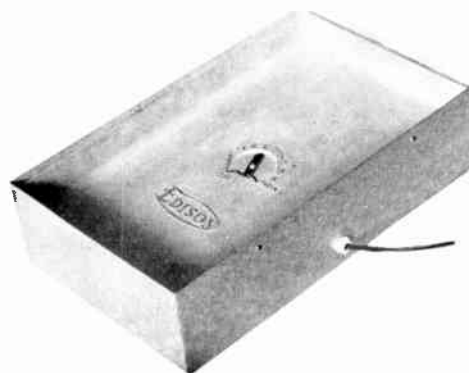

Fig. 122. Hot-food storage unit

jars without actually touching them. An adjustable combination temperature control and "on-off" switch is in the center of the receptacle. The units are incorporated in fixtures built to serve individual customer requirements.

Smaller Home Appliances

Three beaters are provided in a new kitchen mixer (FIG. 123) to give more complete and rapid mixing. With a small bowl, only two of the beaters are used. A wide range of speeds is provided by a special brush-shifting control so located that the speed may be altered at a touch of the thumb even while the mixer is removed from its stand. The mixer may be removed instantly from its stand and, being light in weight, may be used over any bowl, on the stove or elsewhere. The motor is inverted on its stand for juice extraction and other uses.



Fig. 123. Three-beater kitchen mixer having a wide speed range



Fig. 124. Electric floor polisher for scrubbing, waxing, and polishing

An electric floor polisher (FIG. 124) relies on high peripheral brush speeds and high unit weight on the brushes without high total weight to perform its tasks of scrubbing, waxing, and polishing. Brushes are used in scrubbing and waxing, and rubber disks and felt buffers are used for polishing.

An automatic electric roaster for baking, roasting, broiling, frying, boiling, and steaming (FIG. 125) will accommodate a 16-lb turkey and yet is portable, weighing approximately 23 lb—less utensils. Thermostatic control regulates the temperature from 150 to 550 F, with the lower range used to keep food and dishes warm.

A peculiar tail on the trailing tip of the blades for desk and ventilating fans eliminates eddies and thereby increases efficiency and reduces noise. The new design resulted from high-speed-camera studies of air flow around blade tips. For example, in the 20-in. air circulator having the same wattage input as the former type, air delivery has been increased from 3800 to 4200 cu ft and noise level reduced from 67 to 62.5 decibels.

A new heater-cord set for such domestic appliances as flatirons has the cord, attachment plug, strain relief, and heater plug molded together in rubber to form a single unit. The copper conductor and contacts of the heater plug are welded together and permanently sealed in a new heat-resisting rubber compound; the casings of the heater plug are riveted together.

A new type of oil-resisting cord has a synthetic jacket impervious to oil. Bearing the approval of the

Underwriters' Laboratories, it is designed for use in service stations, garages, machine shops, and similar places where the cord actually contacts oils and grease.

A small type of two-conductor No. 18 AWG all-rubber cord for use on portable appliances such as vacuum cleaners, portable mixers, and electric office machinery, has an outside diameter of only $\frac{1}{4}$ in. The single conductors are rubber-covered, twisted together with fillers, and rubber-jacketed.

An enclosed, three-position motor-reversing switch for a-c service is novel in that an interlocking three-position tumbler movement has an intermediate "off" position in the center so that it is impossible to pass from one position to the other without a hesitating movement to unlatch the mechanism. Rated at 20 amp, 250 volts, or 1 hp at 115 volts (2 hp at 230 volts) it is intended for surface mounting or for flush mounting as a separate switch unit, and is arranged for either flexible- or rigid-conduit wiring.

A new wall or baseboard plug (FIG. 126) is molded as one piece with, and at right angles to, the cord. For use with lamps, clocks, and small appliances, it lies close and flat against the wall or baseboard.

Intercommunication System

An inter-office communicating system, consisting of a master unit in combination with as many as four remote units, permits two-way conversations between points up to 2000 ft apart or, with special arrangements, at even greater distances (FIG. 127). An individual at the master station may have two-way conversations with any of the remote stations, or may speak to all of them simultaneously. Only the



Fig. 125. Automatic roaster, thermostatically controlled

master station requires connection for power as the remote stations are energized and controlled from it.

Electric Heat Gun

An electric heater has been attached to the exhaust orifice of a hand vacuum cleaner to produce an electric heat gun for use in service stations and garages. The new device offers a simple method for thawing out transmissions, differentials, carburetors, and radiators, as well as for drying out wet ignition systems. The curved nozzle fits into the differential or transmission case and supports the heater. With the nozzle detached, the heater is used for frozen radiators, gas and oil lines, etc.

RADIO EQUIPMENT

Police Transmitter

A new 1-kw medium-high-frequency radiotelephone transmitter (FIG. 128) was developed for use in the 1500- to 3000-kc police band. With the exception of the speech-input equipment and the antenna-tuning

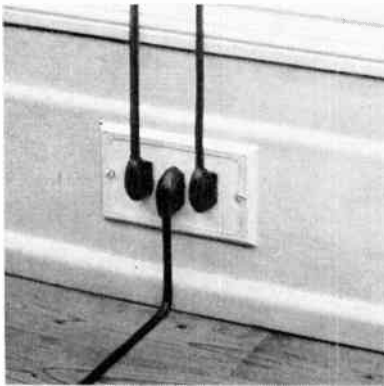

Fig. 126. Molded-rubber angle plug



Fig. 127. Intercommunication system: (upper) master station; (lower) remote speaker-phone station

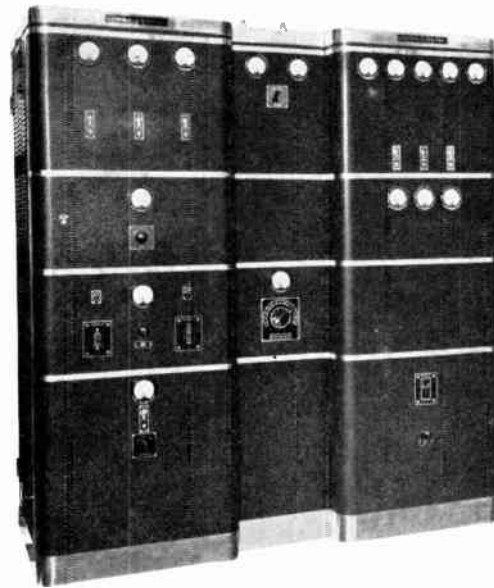

Fig. 128. One-kilowatt, medium-high-frequency radiotelephone transmitter

apparatus, this transmitter is completely self-contained, comprising an exciter unit and a radio-frequency amplifier. Frequency stability is maintained well within plus or minus 50 cycles over a wide range of ambient temperature by a new type of low-temperature-coefficient type of quartz crystal mounted in an improved design of temperature-controlled crystal cell. A transmission-line-terminating and antenna-tuning unit provides means for terminating correctly either the open-wire or concentric-tube type of transmission line and for tuning any conventional antenna. Fidelity equal to broadcast-transmitter quality is obtained.

Fireboat Communication

A new application of radio-communication equipment has been made by the marine division of the New York City Fire Department, which now has two-way radiotelephone communication between each of its nine fireboats and the Manhattan fire-alarm central office. A special filter unit at the main transmitter location permits a single antenna to simultaneously receive ultra-high frequencies from the boats and transmit medium-high frequencies to them. The 500-watt medium-high-frequency transmitter incorporates features usually found only in broadcast equipment.

Motorcycle Receiver

A new ultra-high-frequency receiver for police motorcycles (FIG. 129) employs metal tubes and has many features of the larger ultra-high-frequency receivers, and in addition has the sturdiness, compactness, and light weight required for this difficult service.

Radio Receivers

A unique feature found in 1938 radio receivers is automatic tuning, which requires merely the pressing

of a button to tune-in a desired station. The automatic tuning mechanism (FIG. 130) makes use of a new 6-volt reversible capacitor motor the circuit of which is connected through a relay to push buttons on the front panel of the receiver. When a particular station button is pushed, the motor begins to rotate the tuning condenser. A movable contact rotates on the condenser arm past a series of stationary contacts mounted on a fantail at the rear of the condenser. When the sliding contact reaches the stationary contact corresponding to the button depressed, a relay is energized, breaking the motor circuit and stopping the rotation. The stopping contacts are



Fig. 129. Ultra-high-frequency receiver for police motorcycles

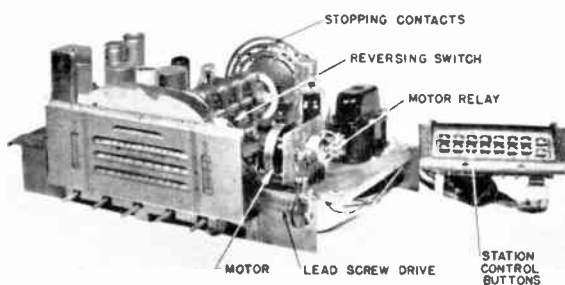

Fig. 130. Automatic tuning applied to 10-tube chassis

preset for desired stations, of which as many as 13 may be set up. The automatic tuning receivers make use of the automatic frequency-control circuits developed the previous year.

Variations in calibration resulting from changes in size as a result of variations in humidity have been eliminated in a new scale for radio receivers by punching them from metal, with the individual scales laid back at an angle (FIG. 130). The printing is done directly on the metal flaps. Addition of band, volume, and tone-control indicators results in added utility to the user.

Decidedly better connections in radio receivers have been achieved by the use of a capacitor welder (FIG. 131) to replace the conventional soldered connections. Welding pliers are used to make the connection, and their use on production lines has reduced the number of poorly made connections to practically zero.

A new radio power transformer (FIG. 132) weighs $5\frac{1}{8}$ instead of $6\frac{5}{8}$ lb, has a core loss approximately 40 per cent less, is free from lamination vibration,

has the leads brought out at chassis level, and has an improved appearance. It measures about $2\frac{7}{8}$ by 5 by $4\frac{7}{8}$ in.

Radio Outlet

A convenient outlet (FIG. 133) for noise-reducing or doublet antennas eliminates the usually unsightly wiring connections characteristic of most radio

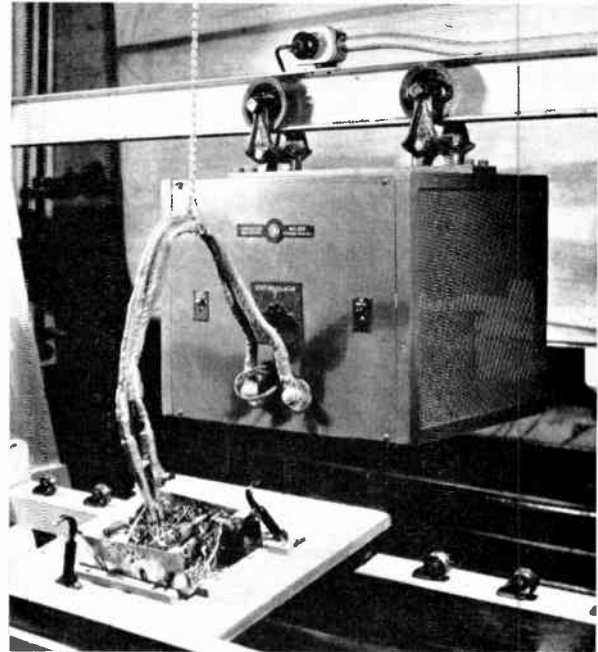

Fig. 131. Capacitor welder on radio receiver production line, for welding of connections

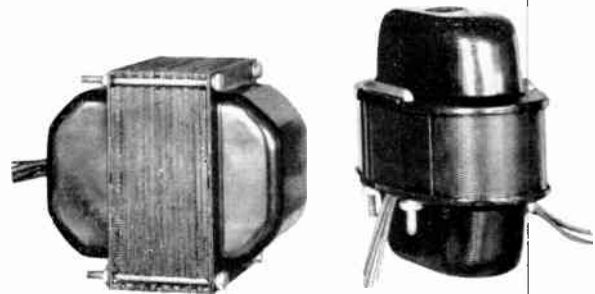

Fig. 132. Improved radio power transformer at right, compared with one of earlier design

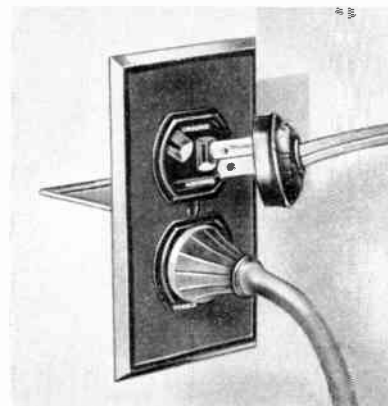

Fig. 133. Radio outlet for doublet antennas

receivers installed in the home. It affords a compact means of separable attachment for ground, antenna, and power leads for a radio set. Lead-in wires are thereby replaced by neat short lengths of cord.

X-RAY AND ELECTROMEDICAL APPARATUS

Medical X-rays

Oil-immersed and self-contained, a new shock-proof type of x-ray therapy equipment (FIG. 134) rated 400 kv peak and 5 ma continuous operation was produced, which occupies only a fraction of the space required for air-insulated apparatus of like rating. The tube-head, a 4,000-lb sealed and grounded tank containing all high-voltage parts, is vertically adjusted over the patient by means of a motor-operated raising and lowering mechanism in the left supporting column. Angular positioning through 180 deg of its



Fig. 134. Oil-immersed, self-contained 400-kv x-ray therapy equipment

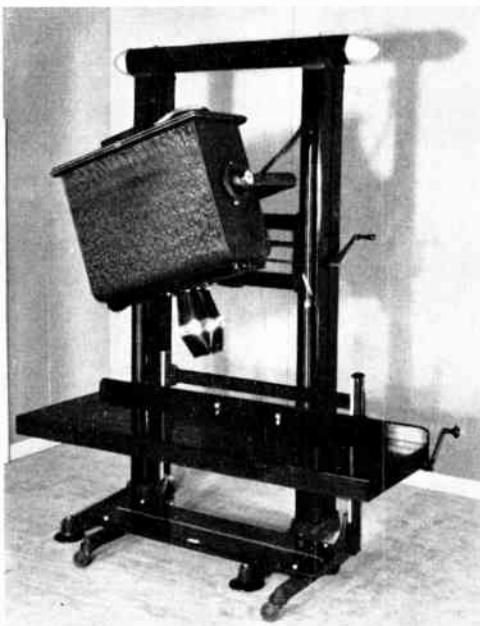

Fig. 135. Oil-immersed 220-kv x-ray therapy equipment



Fig. 136. Biplanar fluoroscope for localization and removal of foreign bodies from food and air passages

long axis is by worm and gear actuated by a hand-operated crank on the other supporting column. Positioning of the patient and directing of the radiation to the treatment area are simplified by these facilities. An oil pump within the housing of the supporting structure maintains a constant flow of oil through the tube anode, removing the heat.

Making it economically possible for practically every community to have x-ray therapy conveniently available is a new apparatus (FIG. 135) designed for 220 kv peak, 15 ma continuous operation, and having a γ -unit output at least equal to many older types of apparatus operating at 25 ma. It has all high-voltage parts similarly oil-immersed in a sealed and grounded tank, and raising and lowering is by means of a manually operated hand crank on the supporting column. With rotation of the tube about two axes, the radiation thus may be directed quickly and accurately to the treatment area. The Coolidge-tube anode is cooled by oil constantly circulated from a remotely installed pumping system.

To aid the surgeon in the quick and efficient localization and removal of foreign bodies from the food and air passages, a biplanar fluoroscope (FIG. 136) was developed. The apparatus consists essentially of two x-ray tubes, energized from the same high-voltage transformer; one tube is for horizontal radiation, the other for vertical radiation. The fluoroscopic screen is so mounted that it may be quickly pivoted from one plane to the other. Variation in the opening of the lead diaphragm for each tube is obtained by motor drive, controlled through individual switches on the control panel. Two self-starting Telechron clocks are used to indicate the time either tube is energized, so the operator may know at a glance whether he is approaching the limit of skin

tolerance to the x-rays. All parts of the high-voltage circuit are enclosed to render operation electrically safe to both patient and operator. The control unit also is enclosed and is grounded. If the door to the high-voltage transformer room is opened, the primary circuit is caused to open automatically. This development has been very much stimulated by the keen interest of Dr. W. Edward Chamberlain, Director of

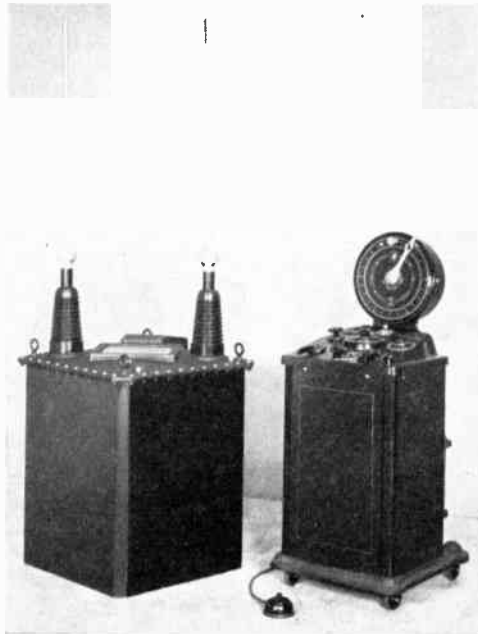

Fig. 137. Autotransformer control for rotating-anode Coolidge tube

Roentgenology at Temple University, Philadelphia, a collaborator of Dr. Chevalier Jackson, long noted for his contributions to this important field in surgery.

To make available to radiologists an x-ray energizing unit with sufficient power to obtain every possible advantage in their use of the rotating-anode Coolidge tube announced last year, a new high-power transformer with greatly improved control was introduced. The 52-button autotransformer control (FIG. 137) offers refinement unprecedented in radiographic equipment. With the unit rated 85 kv peak and 500 ma, each button of the autotransformer control represents a change of 1.8 kv peak; and the voltage value of each step is constant throughout the entire milliamperage range of 10 to 500 ma. Duplication of results can be obtained much more consistently with this equipment. The oil-immersed kenotrons for rectifying the current, of a new type developed specifically for the purpose, are in the transformer tank.

Industrial X-rays

In addition to the important applications x-rays now have industrially, in the inspection of welds, examinations of castings, etc., a new field for their use has been opened in California, where oranges, lemons, and grapefruit were given fluoroscopic examination to insure against packing of fruit that has been frozen or otherwise damaged, so that only

uniformly high quality fruit reaches the market. So successful has been the application, it is felt that wide application of x-rays in the examination of other fruit and agricultural products may be expected.

Electromedical Equipment

Shadowless ultraviolet radiation, covering a larger area at greater intensity, has been attained in an improved lamp employing a cylindrical quartz burner and a reflector of new design.

A new all-metal air-conditioned cabinet (FIG. 138) was developed for use in conjunction with the Inductotherm in the giving of artificial fever treatment. The patient, at rest upon a mattress of live latex within the cabinet, is surrounded by circulating, properly humidified air heated to a temperature in step with that of the body. Fever, produced by the heating of the Inductotherm, is maintained by controlling the environmental temperature within the cabinet.

A heart-rate recorder consisting of an electrocardiograph-type amplifier and a special recorder draws a series of vertical lines the height of which is proportional to the time between beats. Electrodes on the patient's chest pick up the cardiovascular voltage, which is then amplified to operate a thyatron-controlled relay at each beat. This relay controls the start of the stylus across the paper, the stylus always moving at a constant rate.

RURAL ELECTRIFICATION

Since 1923, when the General Electric Company began its pioneer work in rural electrification, more than 1,100,000 farms have been added to electric power lines, from a meager beginning of about 100,000. Today approximately one fifth of the farms of this country are connected to power lines, and during 1937 a new high of 200,000 additions was established. Vast developmental work has been carried on, so that today there are dozens of practical and profitable uses for electricity in the business of farming. Many of the developments mentioned elsewhere in this review are, of course,

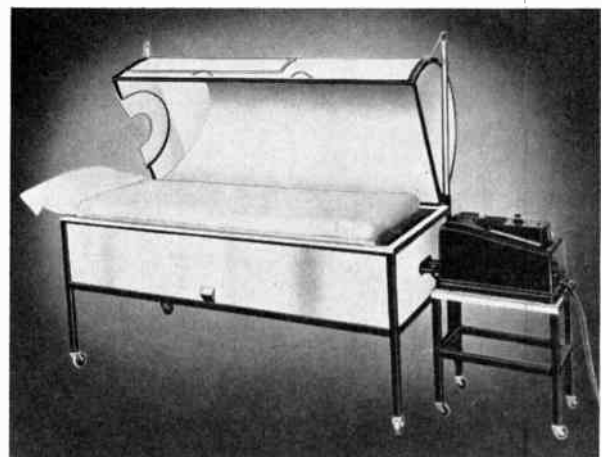

Fig. 138. All-metal air-conditioned cabinet for use with Inductotherm

of interest to the rural customer either in his home or in his business, but there are still others of particular interest to farmers.

Nutrient Solution Culture

"Soil-less" agriculture (FIG. 139) calls for both soil-heating equipment and artificial light in the growing of certain crops without soil. Although the technique of nutrient-solution agriculture is not novel, the use of the principle in the commercial production of certain crops is new. Plant foods are furnished through chemical solutions that are maintained at the proper temperature by electric soil-heating equipment, and the proper light conditions are satisfied through the use of both natural and artificial illumination.

Electric Cultivators

The application of electricity to the operation of field jobs is apparent in the work which has been done with small, motor-operated cultivators and tractors of various types (FIG. 140) which are limited at present to concentrated agriculture such as truck gardening.

Milk Coolers

A choice of wet or dry storage has been made available in a new line of electric milk coolers



Fig. 139. Growing plants without soil

(FIG. 141). Completely self-contained wet-storage types, with deck-mounted refrigeration units ready to plug in and operate, include 2, 3, 4, 6, 8, and 10-can sizes; dry-storage types with deck-mounted refrigeration units include 4- and 6-can sizes, with or without an ice-maker. In addition to these, wet- and dry-storage milk and cream coolers are available with remote installation of the refrigerating unit.

Poultry Equipment

Even distribution of heated fresh air over all the floor covered by the brooder, a minimum variation between floor and brooder ceiling temperatures, and positive ventilation through the forced circulation of



Fig. 140. A motor-operated cultivator for truck gardening and nursery work

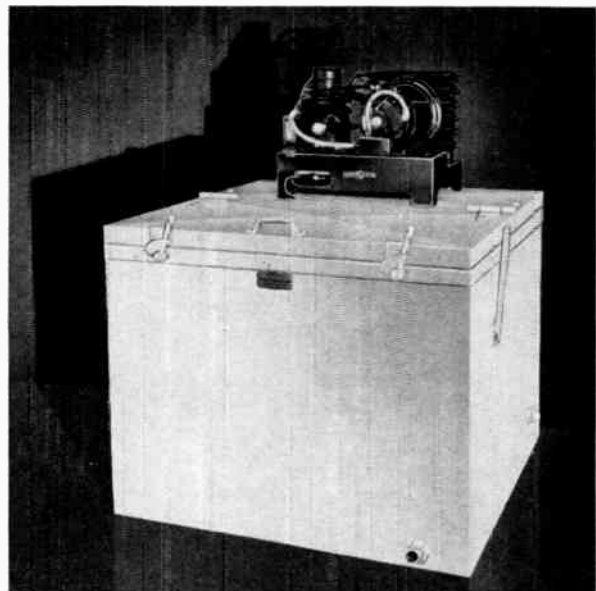

Fig. 141. Electric milk coolers for wet or dry storage

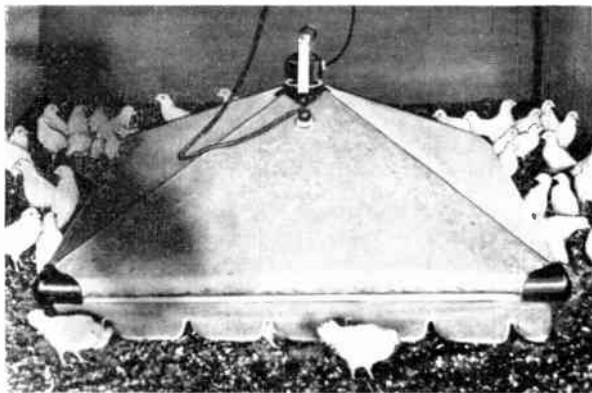

Fig. 142. Electric poultry brooder

fresh air by an electric fan—brooding requirements for maximum chick growth—are features of a new electric brooder (Fig. 142).

For maintaining a water supply not only free from ice but at proper temperature, there is now a thermostatically controlled, poultry water warmer.

LIGHTING

More than a half billion large incandescent lamps were sold in the United States during 1937, establishing a new volume record, it is indicated by a preliminary estimate. A total of 955,000,000 is indicated for both large and miniature lamps, including 515,000,000 large and 440,000,000 miniature lamps (Fig. 143). Each of the totals is the highest ever attained.

High-efficiency Filament

Perfection of a new, high-efficiency tungsten filament (Fig. 144), which increases the light output of incandescent lamps 10 per cent without using additional electric current, was one of the outstanding improvements in the field of lighting during the year. Taking the 60-watt lamp as an example, the tungsten is first drawn into a straight wire 19/10,000ths of an inch in diameter, almost invisible to the naked eye. It is then wound, 335 turns to the inch, around a thin molybdenum wire, or mandrel, leaving the coils 1/1000th of an inch apart. (The coils must be as close together as possible to reduce heat loss but must not touch each other.) The coiled wire is coiled again on another mandrel, 70 turns per inch, with a spacing of 7/1000ths of an inch between the secondary coils. Before the first coiling, the tungsten wire in a filament is 20 in. long. The first coiling compresses

it to a length of 3.4 in. The second coiling compresses it still further to a length of $\frac{5}{8}$ in., with a coil diameter of 310/10,000ths of an inch. Following the second coiling, the mandrels are chemically dissolved. When installed, the filament is mounted as a cross-bar between two lead-in wires, with one support in the center of the filament, instead of being looped around three supports, as was the practice with the older type of coiled filament.

Although the development of the gas-filled lamp in 1913 reduced filament evaporation, it introduced a new problem—the presence of gas inside the bulb gave rise to convection currents, which tended to fan the filament and lower its temperature, thus reducing light output. This loss can be reduced by greater concentration of the filament, particularly in length. Since the effective length of the newly designed filament is only about one half that of the old, there is much less cooling by gas, permitting the lamp to give 10 per cent more light for the same amount of electric current.

New Incandescent Lamps

A new 300-watt incandescent lamp with a medium-screw base has been developed to fill the need for a lamp of this wattage with a short light-center length for use in fixtures now employing the 200-watt lamp.

A prefocused type of flashlight lamp (Fig. 145) is designed to prevent distorted beams, to provide users with brighter spots of light, and to increase materially the seeing range for general flashlight service. It has a flange base instead of the conventional screw base. Atop the bulb is a tip which provides a tiny cavity in the glass to accommodate one end of an elongated filament support. Accurate positioning of the filament with respect to a fixed part of the lamp practically eliminates the possibility of faulty filament positioning.

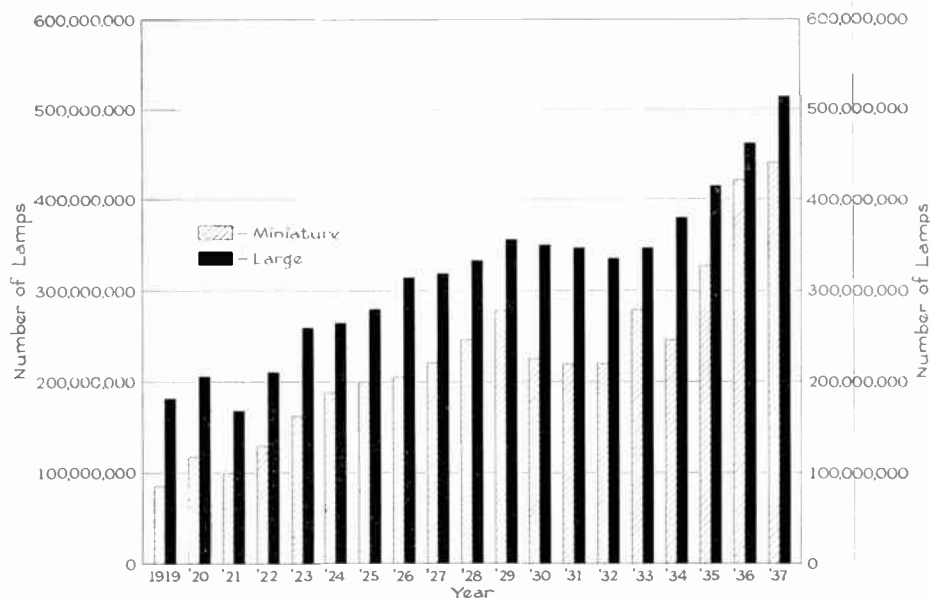

Fig. 143. Incandescent lamps sold in the United States, 1919-1937 (1937 estimated)

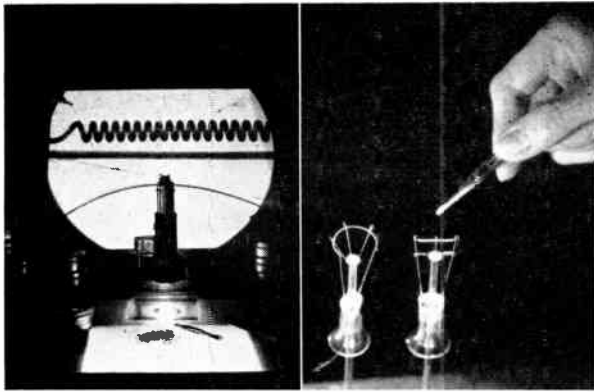

Fig. 144. Enlarged silhouettes of a high-efficiency tungsten filament for 60-watt Mazda lamp with a section of the coiled filament formerly used and a strand of human hair; at right, a comparison of old and new filament mountings

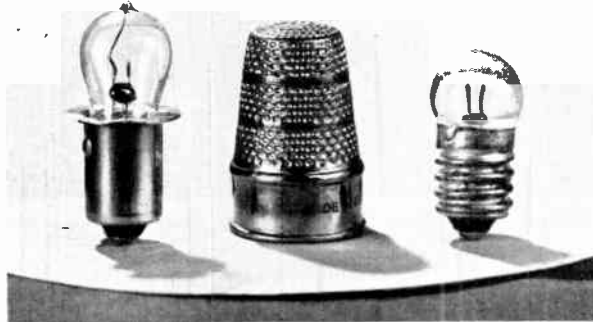

Fig. 145. One of the new prefocused flashlight lamps (left), and one of the older screw-base type with a common thimble to indicate the relative size of each

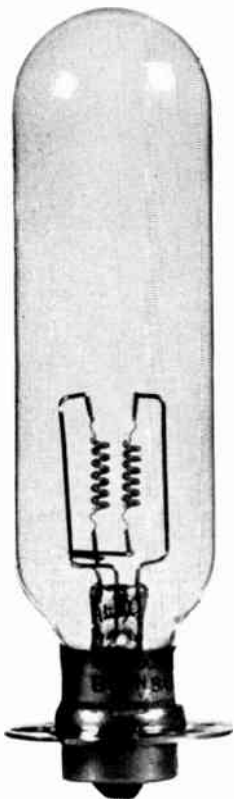

Fig. 146. A 300-watt projection lamp



Fig. 147. A 400-watt (Type H1) mercury lamp, for use with special auxiliaries on a-c only

The 300-watt lamp (FIG. 146) with high-efficiency coiled filament and single-contact prefocused base represents a further development of the small-bulb high-wattage projection lamp. It enables a source of 300 watts to be placed very close to the condensing lens, thus increasing the amount of light entering the optical system. It is intended primarily for 8-mm motion-picture projectors.

The new coiled-filament construction has made possible excellent 50- and 100-watt 115-volt lamps for projectors of the toy classification. The performance of such equipments has been so improved that a large market has been developed for them.

A 5-kw 115-volt lamp capable of withstanding pressures of 300 lb per sq in. was developed for underwater service. A six-inch-diameter hard glass bulb is used in combination with a special water-tight holder and connecting cable. The lamp will be employed in the salvaging of R.M.S. *Lusitania* and for taking pictures of the operation under water.

Flood-flash Lamp

A 100-watt mercury lamp and control mechanism is being developed for photographic use. It is expected to be about as effective as a No. 20 Photoflash lamp but may be flashed many times. The control kit contains the current-limiting reactor and a mechanism for short-circuiting the reactor for a few cycles. When the lamp is flashed in this way, there is a tremendous increase in light output permitting instantaneous exposures. Besides its economy, this new equipment should eliminate much of the customary excessive heat generated by conventional lighting equipment in most studios.

Photomicrographic Lamp

A lamp designed especially for projection use with microscopes is essentially a tungsten arc lamp of the same type as the S-1 sunlight lamp and requires the same special transformer. An arc is established between the ring and the cylindrical electrode, resulting in a small source of light of high, uniform brilliance. The unique design of the ring electrode permits the light from the other electrode to be directed into the optical system of the projection equipment. Another feature of the lamp is the use of the medium bipost base to insure accurate positioning.

Industrial Mercury Lamps

For industrial lighting, the 400-watt mercury lamp has been slightly modified (FIG. 147) in its electrical characteristics to provide increased stability on fluctuating supply lines through an adjustment in the amount of mercury, which is analogous to a change in the specifications of the tungsten filament in an incandescent lamp and so does not affect the external appearance of the lamp. The mounting of the lamp proper in its enclosing bulb has been simplified and improved by the use of K Monel alignment disks. An

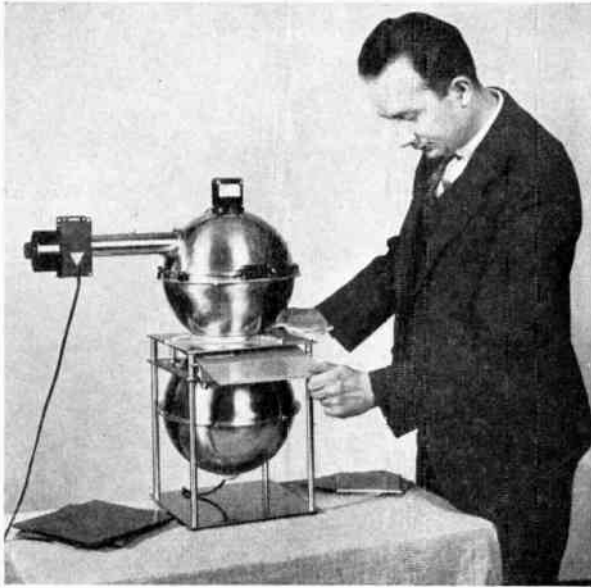

Fig. 148. Measuring the transmission factor of a sample of colored glass with the new light-cell reflectometer

internal starting electrode is now used instead of the external screen electrode used when the lamp was first introduced.

One of the more unusual applications recently found for the 85-watt mercury lamp has been that for the ultraviolet printing of the sound track on film. The lamp is unique in this application because of its intrinsic brilliancy, comparable with that of a ribbon-filament incandescent lamp, and because of its efficiency in the production of 365-millimicron radiation, in excess of that of any previously available mercury arc. To adapt this lamp more satisfactorily to this application, a slight modification has been introduced in that the new lamp is not equipped with the usual external starting electrode but requires an auxiliary source of high voltage for starting.

Portable Brightness Meter

A portable brightness meter with a practicable range from about 0.025 to 50,000 foot-lamberts, or 0.00005 to 110 candles per sq in., meets the need for a small instrument of this type with high accuracy and extreme range. An object as small as one foot wide can be measured at about 500 ft. Using a blue filter, the color of the comparison field is approximately the same as that of the light from a high-wattage tungsten-filament lamp.

Light-cell Reflectometer

The light-cell reflectometer (FIG. 148), a modified Taylor reflectometer for measuring the reflection and transmission factors of flat surfaces, differs

from older types in that it utilizes light-sensitive cells and gives its readings directly on a meter scale. As it does not operate on the principle of visual comparison of brightnesses, experienced observers are not required. The fatigue that resulted from extended measurements with the older types is also eliminated. Since, when measuring reflection factors, the instrument may be operated in any position, it is very convenient for determining the reflecting qualities of materials in actual use as, for example, wall paints.

Flashograph

The flashograph has been developed to trace on a moving film the full-life performance of a photoflash lamp. The lamp is flashed in the conventional Ulbricht sphere which in this case has a photoelectric cell mounted on it. The output of the cell is amplified and the potential, varying directly with the light output, is applied across a small Rochelle-salt crystal oscilloscope. The crystal is deformed by the potential and, in reflecting a beam of light across the aperture of a film drum, traces the candlepower-time relation. This arrangement makes it possible to obtain the type of record which would in past practice require much more costly and less convenient equipment.

High-efficiency Indirect Luminaire

With indirect lighting deservedly growing in popularity, the matter of efficiency of luminaires is becoming increasingly important. It is interesting to note the development of a new silvered-bowl unit which has the surprisingly high efficiency of more than 90 per cent and, at the same time, is generally satisfactory from the standpoint of appearance.

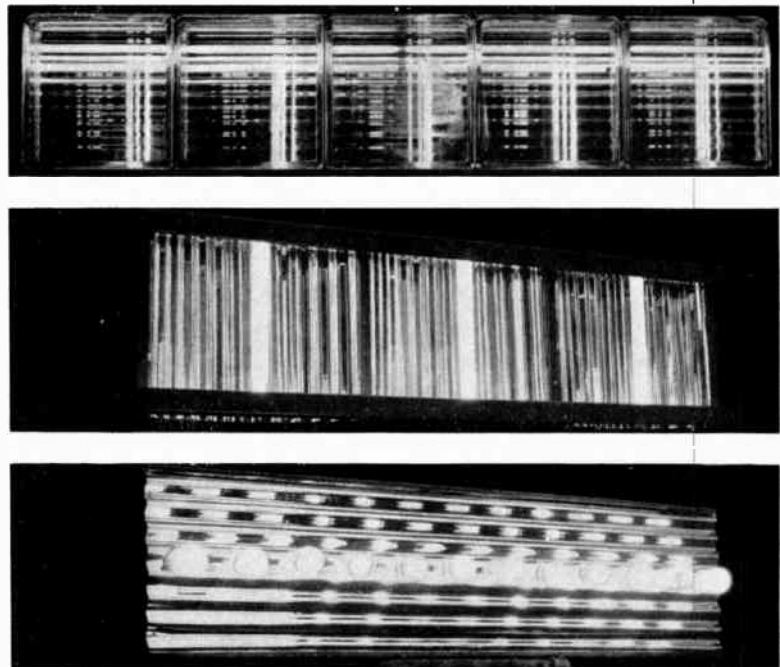

Fig. 149. Top to bottom—Glass bricks lighted from behind; corrugated metal used with Lumiline lamps; corrugated metal used with standard Mazda lamps

Display and Store Lighting

Among the many interesting trends in the rapidly developing field of luminous structures and displays is the use of modern materials with stable reflecting surfaces to multiply the effectiveness of exposed sources. Glass blocks, variously illuminated, and structural sheet glasses of interesting texture and color, some of the tempered variety, are adding new and important values as are metal surfaces (FIG. 149). As a result, theater fronts and commercial buildings are being characterized today by a smartness rarely found in pre-depression days.



Fig. 150. An improved method of triplicate mirror lighting

A wholly adequate, glare-free method of triplicate mirror lighting (FIG. 150) has been developed. The reflector is a parabolic trough made of polished Alcoa lighting sheet with a double-ended socket located so that the light centers are on the focal axis. Since one stands under the reflector, no light sources are in the field of vision. The light from the reflector strikes the mirror at such angles that it is directed to the lower half of the figure, permitting uniformly easy seeing of all details. Diffusely reflected light from the appropriately toned upper wall and soffit amply illuminates the head and shoulders. A variation of this type of parabolic trough is adaptable to triplicate mirrors where it is not feasible to build a niche.

The first application of a louvered direct-lighting unit provides a relatively high level of downlighting, but with a wide distribution suitable for general illumination. The unit is a shallow, semi-spherical, etched, aluminum spinning, recessed flush with the

ceiling. It is equipped with either translucent or opaque concentric ring louvers, with a secondary projecting reflector to direct some light to the surrounding ceiling area for relief of brightness contrast. The unit can use either an inside-frosted lamp with a reflecting cup or a silvered-bowl lamp. This coffer-type unit is meeting with favor among architects where, for decorative reasons, a minimum projection into the room is desired.

Street and Highway Lighting

Improved street and highway lighting has kept apace of a desire on the part of a public determined to minimize the traffic fatalities on city streets and open highways. The National Resources Committee in its recent report to President Roosevelt endorsed highway safety lighting as justifiable on a dollars-and-cents basis alone. Confirmation of this viewpoint is found in actual statistics from many sources. A report issued by L. J. Schrenk, general superintendent of Detroit's Public Lighting Commission, for example, indicates that improved lighting has slashed the rate of fatal night accidents on 31 mi of streets where the death rate was the highest in the city for more than two and a half years. There were 146 night fatalities and 21 day fatalities on these streets in 1934, 1935, and 1936—up to the time improved lighting went into service—or a ratio of seven to one. Since the new lighting has been in operation (covering periods from four to eight months on different sections) there have been only five night fatalities and four day fatalities, or a ratio of 1.25 to 1. Lighting along the 31 mi of streets has been increased from two to five times what it was, and the traffic thoroughfares are now illuminated to an average value of one foot-candle.

The luminaire used in these installations is equipped with 10,000- or 15,000-lumen series lamps in an Alzak aluminum reflector designed to utilize a large percentage of the light flux on the road surface. The design of the housing recognizes the trend among progressive cities toward pleasing appearance in street-lighting equipment.

An interesting section of highway lighting is found on the San Francisco Golden Gate Bridge (FIG. 151). This six-lane automobile highway is illuminated by 214 10,000-lumen sodium-vapor luminaires, 199 of which are installed on the bridge and approaches and the remainder in the Waldo tunnel. The units are approximately 150 ft apart on both sides of the highway and are mounted at a height of approximately 25 ft.

There has been developed an adjustable leveling bar for accurate positioning of the high-visibility incandescent luminaire. With this level, the luminaires can be adjusted easily and quickly at the time they are installed, and no subsequent adjustments at night are required.

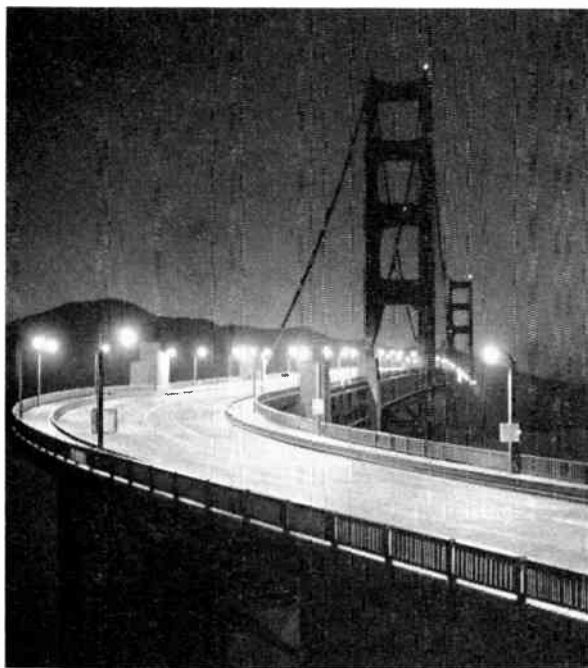

Fig. 151. San Francisco's Golden Gate Bridge

FIG. 152 illustrates four new types of luminaires: (a) one in which ornamentation has been added; (b) a new type developed for post-top mounting, permitting modernization without changing of poles; (c) a large ornamental luminaire, in use on Chicago's outer drive, with an internal Alzak reflector to direct



(a). With ornamentation

(b). For pole-top mounting

(c). Large ornamental luminaire

(d). For gasoline-pump islands

Fig. 152. Four new types of luminaires

the light along the thoroughfare; and (d) a unit developed for lighting gasoline-pump islands, also with an Alzak reflector to direct the light downward.

Maintenance cost is reduced because periodic painting is eliminated in a new all-aluminum bracket and luminaire which has an Alzak reflector mounted on a cast-aluminum hood clamped on the end of a special, aluminum-alloy bracket, which will easily support a 200-lb weight.

Several street-lighting luminaires have been improved by the use of a new type of external wiring that is dust-tight and better insulated. A gland-type bushing clamps a rubber bushing firmly around the wire.

The distinctive color of the sodium-vapor luminaire is now being used as a caution signal for safety-island beacons. An incandescent lamp in the base of the conventional beacon support floodlights the support and abutment. Another sodium-vapor luminaire has been produced for lighting the approach buttresses of loading platforms, giving a concentrated light distribution to provide adequate warning.

A new oil-immersed street-lighting controller includes standard clamp-type terminals and bushings such as those used on distribution transformers, thereby facilitating installation and the stocking of parts, as well as simplifying disconnection for testing or servicing.

Proper life and light output of lamps are insured in a new constant-current transformer by the compound balancing lever which gives a straight-line regulation. The transformer tanks have also been changed to incorporate the clamp-type terminals and bushings as used on distribution transformers and the new controller.

Tunnel Lighting

The lighting of the Tooth Rock Tunnel, on the Columbia River Highway in Oregon, is unique in that attention has been paid to the momentary but hazardous loss of visibility as a motorist enters the tunnel from bright daylight conditions. This contrast is eliminated by providing a relatively high level of illumination with incandescent lamps along a 150-ft section of the tunnel at each portal. A photoelectric relay switches this supplementary entrance lighting

on at dawn and off at dusk. Sodium luminaires, with 10,000-lumen lamps, provide a continuous illumination of approximately four foot-candles in the remainder of the tunnel.

Floodlighting

The largest installations of floodlighting equipment during 1937 were made for illuminating sports and recreational areas. Lexington Field at St. Paul (Minn.) and Nicolett Field at Minneapolis (Minn.), baseball parks, are now equipped with floodlights for night play, thus completing the lighting of all American Association fields. The St. Paul and Minneapolis

(FIG. 153) baseball fields are each equipped with 230 1500-watt floodlights, totaling 345 kw at each field.

RESEARCH

Major developments in the electrical industry can, in general, be attributed to research—of the current year in some cases, but generally to fundamental studies of years before. The many advances made during the past year were no exceptions.

Research continues, and the fundamental studies in progress will probably be reflected in the radically new things of future years. In the realms of pure science and fundamental research, work was being conducted, for example, in such branches as high-voltage, and natural and artificial lightning, investigations; the mechanism of luminosity in vapors and fluorescent materials; ionization decay and other phenomena associated with the operation and failure of electron tubes, secondary electron emission; basic chemical reactions involved in synthesizing resins; fundamentals of dielectric losses and the mechanism of dielectric failure; the explanations of magnetism, relations of stress concentration to fatigue failure of metals and alloys, cathode-spot phenomena in pool-type rectifiers, molecular and atomic films, and the characteristics of arcs in air and other gases.

Lightning Investigation

During the past three years an investigation has been in progress in New York City to determine detail characteristics of lightning strokes. Photographs of many strokes have been obtained and valuable analyses of the strokes made. For this work a special Boys camera was designed with a rotating-film velocity as high as 10,000 fpm (FIG. 154). A suitable light-trap and means for moving the rotating member which carries the photographic film have made it possible to obtain seven successive exposures without changing the film; with the previous Boys camera much time was wasted in stopping the rotating film and again getting it up to speed.

At Roanoke (Va.), an automatic crater-lamp oscillograph has been in operation since 1933 recording the operation of expulsion protector tubes connected to the 132-kv lines terminating at Roanoke. The results obtained have given not only data concerning the operation of the tubes, but also valuable data as to the prevalence of multiple strokes on transmission lines, indicating clearly that multiple strokes occur to transmission lines and cause successive operations of protective devices. As many as twelve, or more, may occur within one second.



Fig. 153. Nicolett Baseball Park, Minneapolis (Minn.)

Alnico Applications

Two years ago there was announced a new magnetic alloy of iron, aluminum, nickel, and cobalt, known as Alnico, about which there are several references in this year's review. As a permanent magnet, Alnico has twice the magnetic strength of the best prior magnets, is much more resistant to mechanical shock and to high temperature, and has equivalent magnetic strength with greatly decreased volume. In relays, measuring instruments, and in special motors, as well as in radio loud-speakers and other devices, it is replacing electromagnets, increasing the simplicity of design, maintaining constant field strength, and eliminating breakdowns resulting from coil failure under severe operating conditions.

Mechanical Investigations

For the production balancing of machine rotors and radial-flow fans there was developed a new dynamic balancing machine which gives measurements of the two necessary corrective weights independent of each other by a new method which eliminates the familiar pivoted cradle and thus makes the machine more readily adaptable to a wider range of weights and shapes to be balanced. Measurements of balance weights are made by balancing the output of an electrodynamic pick-up against that of a small sine-wave

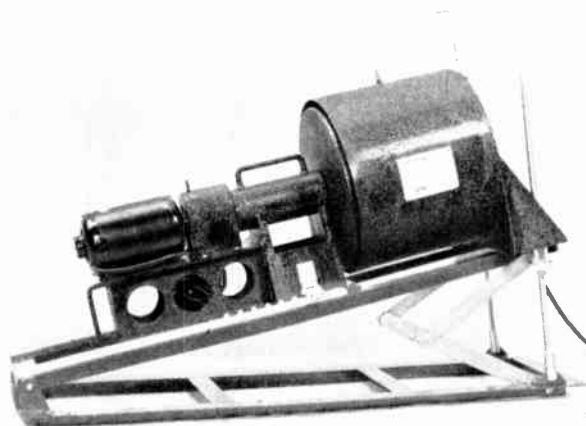

Fig. 154. Special Boys camera with rotating-film velocity as high as 10,000 ft per min, for studying lightning

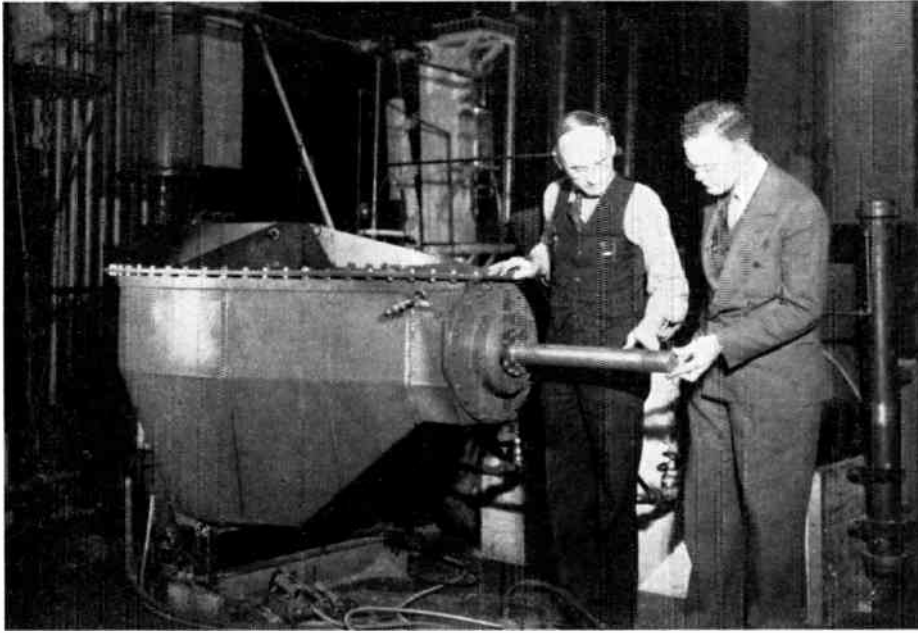

Fig. 155. Oil-immersed x-ray outfit for 500,000-volt operation

alternator. The machine is independent of meter calibrations and small speed changes, and has high sensitivity. The rotor to be balanced needs to be run only once to obtain readings of amounts and positions of both balance weights. The machine will indicate unbalance as small as 0.005 oz at a 6-in. radius on a fan weighing 10 lb.

Many advantages have been found in the combined use of a portable cathode-ray oscillograph and an electric vibration pick-up for general vibration study. Displacement, velocity, and acceleration types of vibration pick-ups have been used. The assembled apparatus has been used in the study of such vibration problems as detection of out-of-round journals and other extraneous causes of vibration when balancing large machines; comparison of the residual sources of vibration in well-balanced ball-bearing high-speed motors; measurement of commutator roughness; and the investigation of high-frequency noise in small single-phase motors.

High-voltage X-rays

During the year there were announced from the Research Laboratory a developmental oil-immersed x-ray outfit (FIG. 155) for 500,000-volt operation and an oil-immersed multisection x-ray tube (FIG. 156).

The outfit is of the shock-proof type, is semi-portable, and does not require a special building to house it. The x-ray target operates at ground potential, simplifying the problem of providing adequate x-ray protection by allowing the protection to be placed nearer the generating source, and permitting the use of tap water for cooling the target. Experience with the outfit indicates that other oil-immersed units can be built for much higher voltages with the same general design, without increasing volume or weight to excessive proportions or requiring special buildings for their instal-

lation. The over-all dimensions of the 500,000-volt outfit are 4 ft wide, 4 ft high, and 6 ft long.

The 500,000-volt multisection x-ray tube has a cathode, anode, and four intermediate electrodes. The insulating portion of the tube has an over-all length of 26 in. and a diameter of 3½ in. The extension chamber is built with a nickel tube 24 in. long and 2 in. in diameter. The tungsten target, backed by nickel, is at the end of the tube, outside the voltage insulating envelope. Compared with tubes for operation in air, the new tube is extremely small.

This article which describes tangible products of research and engineering, such as apparatus and devices, will be followed in our next issue by one in which P. L. Alger reviews intangible products, such as new ideas and new knowledge.—EDITOR

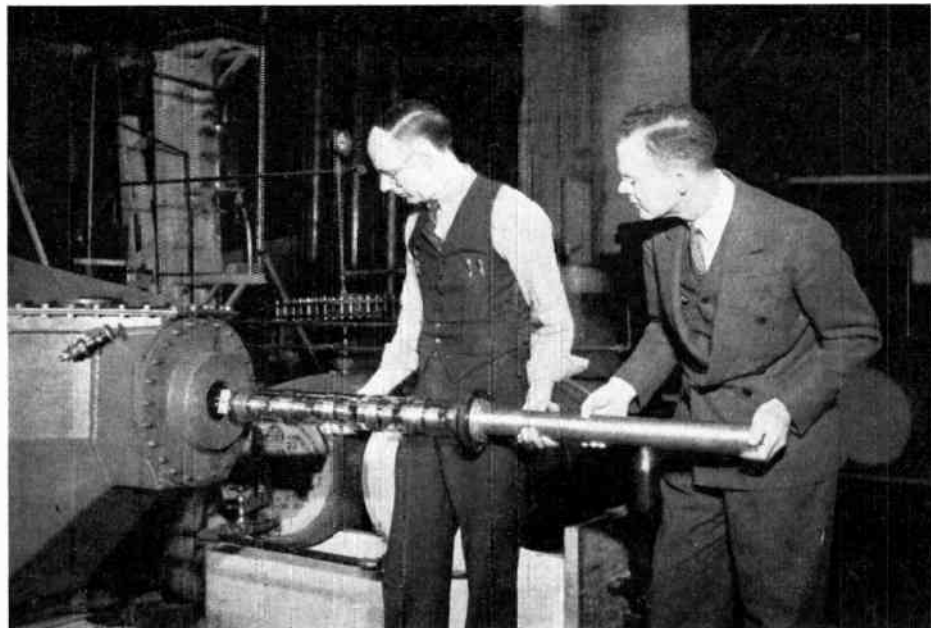

Fig. 156. Oil-immersed multisection x-ray tube

GENERAL  ELECTRIC