

SEPTEMBER 1922

Price 20c

READING RADIO SYMBOLS

VOL. I

NUMBER  
V

# E-Z RADIO

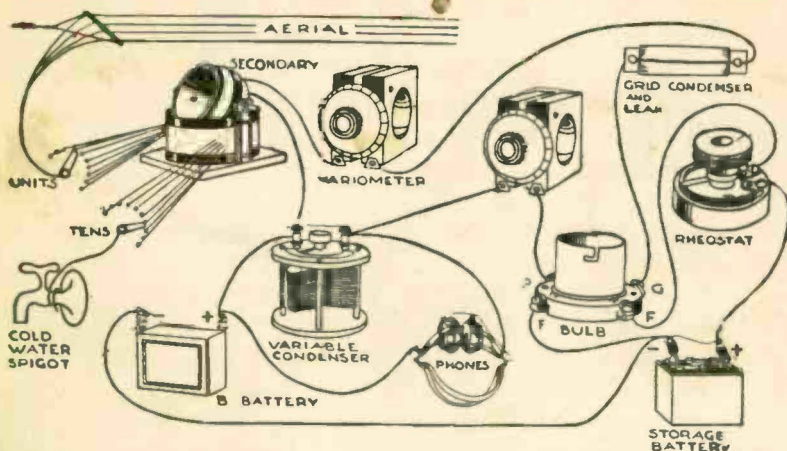

Another Hook-Up for Two Variometers, a Variable Condenser and a Variocoupler

*By Henry M. Neely*

E-Z COMPANY, Inc.

614 ARCH STREET  
PHILADELPHIA

## WE WILL BUY IT FOR YOU.

It's enough to daze any beginner to walk into a radio store these days. During the past year all sorts of companies have sprung up and the making of apparatus has flourished like a plague.

A lot of this apparatus is very fair stuff; some of it is fine, standard high-grade material—and much of it is simply junk.

How is the beginner to know the good from the indifferent and the indifferent from the bad?

The man behind the counter will be free with his advice—but most of the men behind counters in radio stores nowadays, calling themselves "Radio Engineers," aren't radio engineers nor steam shovel engineers. They'd do much better as coffee-urn engineers in the places with the white trimmings and the marble top tables. They pretend they know, but they simply don't, and that's all there is to it.

If you are going to spend money on radio apparatus, and have become interested in some particular make, ask Mr. Neely. He has given the products of most factories pretty thorough tests and he will tell you just what value you can get for the amount of money you have to spend. He makes nothing out of it one way or the other. But, if he serves you, he is making friends for this magazine and that is his business.

If you prefer, tell him how much you can spare for a set, what you expect and he will buy the apparatus for you—all without any advance in price to you and no charge for the service. He can get deliveries where you can't; he knows what your money ought to buy and what kind of results you will get with it. Let him do your shopping for you. Address,

HENRY M. NEELY,  
E-Z Experimental Station,  
Delanco, N. J.

# E-Z RADIO

BY

HENRY M. NEELY

---

---

VOL. I.

SEPTEMBER, 1922

NO. 5

---

---

Entered as second class matter May 26th, 1922 at the Post Office,  
Philadelphia, Pennsylvania, under the act of March 3rd, 1879

---

Copyright 1922 by The E-Z Company, Inc.

---

## CONTENTS

The Storage and B Batteries.....	3
How We Use Batteries.....	4
Storage Battery Needs Attention.....	6
A Loop Aerial Is Easy to Make.....	9
A Hook-up for a Loop Aerial.....	10
Some Ideas on Loop Aerials.....	11
Another Regenerative Hook-up.....	13
The Wave Length of Your Aerial.....	14
Protect Your Aerial Against Wind.....	16
Some Points on Crystal Detectors.....	17
Using a Variometer with the Crystal.....	19
A Costless Variable Condenser.....	21
Another Variable Condenser for You.....	22
Get Ready for Your Amplifier.....	24
Wiring Up Your Transformer.....	25
Getting Used to Radio Symbols.....	27
Some More Electrical Symbols.....	28
The Symbol for the Audion Bulb.....	30
The Symbols for a Modern Hook-up.....	32
The Symbols for a Two-Slide Tuner.....	34
A Glossary of Symbols.....	37
The Workings of a Condenser.....	38

Published monthly by the E-Z Company, Inc., 614 Arch Street, Phila.

Subscription Price Two Dollars The Year.

## SOME IDEAS ON LOOP AERIALS

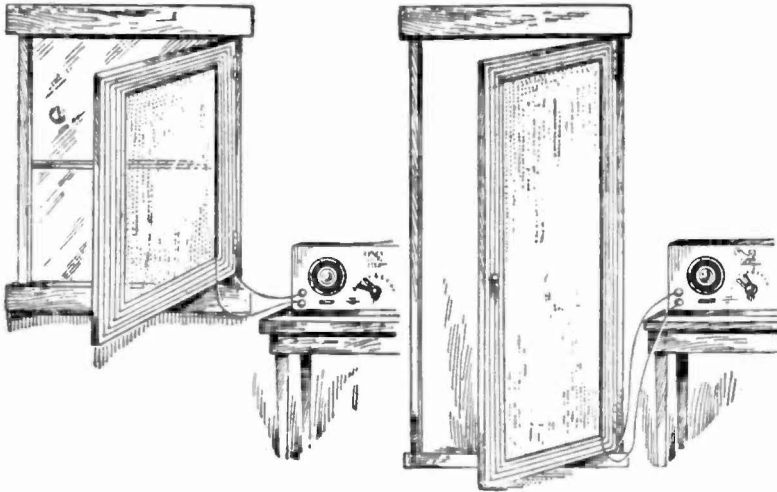

Here are two suggestions for putting up efficient loop aerials without making them an eyesore to the Lady of the House

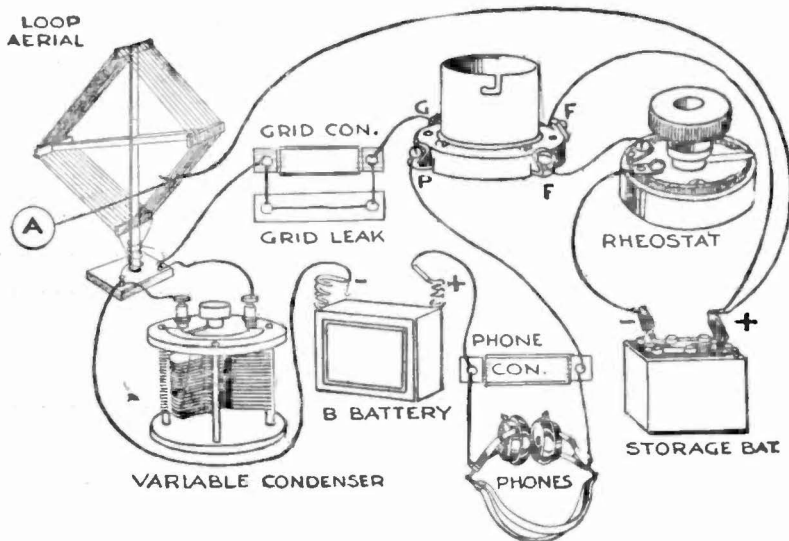

Here is a simple hook-up for the loop aerial and one that is especially good for receiving on the longer wave lengths

## THE "STORAGE" AND THE "B" BATTERIES



1/2 VOLTS 3 AMPERES

To the left the picture illustrates how we can multiply amperage (quantity) without increasing volts (pressure or force). To the right we reverse the process and increase volts (pressure or force) without increasing amperes (quantity).

The stumbling block of most amateurs who contemplate installing an audion bulb set is the high price of the storage battery and the trouble of keeping it constantly charged and in good condition.

"Why can't we use dry cells?" they ask. "Dry cells will light the audion bulb and make it work."

Well, dry cells can be used but, if there were not a very serious objection to them, storage batteries would not be so universally recommended.

"But electricity is electricity," you may say.

That also is true, but there are different kinds of electricity, just as there are different kinds of beans and potatoes and other things in this world. The storage battery is built for one kind of

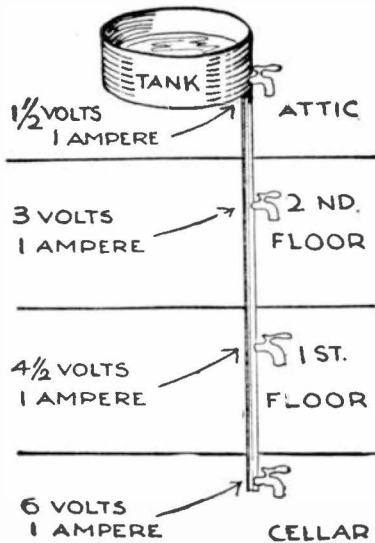

service and the dry cell or the little cell from the pocket flash lamp is built for another kind.

There are two aspects of electrical current which we have to consider in this problem. I am not going to become technical beyond the knowledge of the average novice so it is only necessary to say that these two aspects are known as "volts" and "amperes."

Now roughly, the difference between these two can very well be illustrated by our old friend, the tank of water in the attic and the pipe-line leading from the attic down through the house.

If you have a spigot on the pipe just where it comes out from the tank, and you open this spigot, the water will flow out but will not have a great deal of force to it.

Go downstairs to the floor below and open a spigot there and you will find that the water will flow with greater force than it did in the attic. This is because you

have an added drop of 8 to 10 feet from the tank and the force of gravity always adds force to a falling body the farther that body falls.

Go down two floors below the attic and open a spigot there and you will find that the water will spurt out with decidedly more force than it did from the tank.

Go all the way down into the cellar, open a spigot there and you will find that the water will have force enough to run a small motor or water-wheel.

This is due to what we call the "head" of the water—in other words the height from which it falls. A head of 50 feet will have a great deal more force than a head of 25 feet, and a head of 1 or 2 feet will have very little power behind it.

This head of water is similar to voltage in electricity. Voltage is the power behind the current. We measure it in terms of 1 volt or 6

volts or 100 or 1000 volts, as the case may be just as we measure the head of water in feet.

The other aspect of electricity, amperage, might be likened to the size of the stream which flows from the tank. If you have a 1/2-inch pipe leading down through the house and open the spigot in the cellar, the water will flow with the regular speed of water at that height, but you will not get so much of it in a given time as if you used a pipe 2 inches in diameter. The diameter of the pipe governs the quantity of water and the head governs the force at which it flows, or the pressure behind it.

While the comparison is not strictly accurate, it is sufficient for our purpose to know that amperage is to electricity very much what the diameter of the pipe is to water—that is, more or less roughly, an indication of the quantity.

### HOW WE USE STORAGE AND "B" BATTERIES

In the last article we said that volts in electricity might be likened to the "head" of water in a pipe from a tank—in other words, the distance it falls, which governs the pressure behind it. So volts means pressure of electric force.

Amperage, we said, was like the size of the pipe in the water system, and is, for practical purposes of explanation, a measure of the quantity without reference to the force behind it.

The ordinary dry cell, of which you will find eight in the picture accompanying this article, has a pressure or force of one and a half volts between the positive binding post and the negative binding post.

To use our water-supply illustration, the positive post might be called the tank in the attic and the negative post might be called the spigot from which the water is drawn, and the voltage is like the "head" of the water.

As we have the four dry cells connected in the upper picture—we call this connected in "series"—it might be likened to the water system through the various floors of the house. The first cell gives one and a half volts (force); the second cell, which might be called the floor below, gives another one and a half volts, making three volts at this point. The third cell adds a further force of one and a

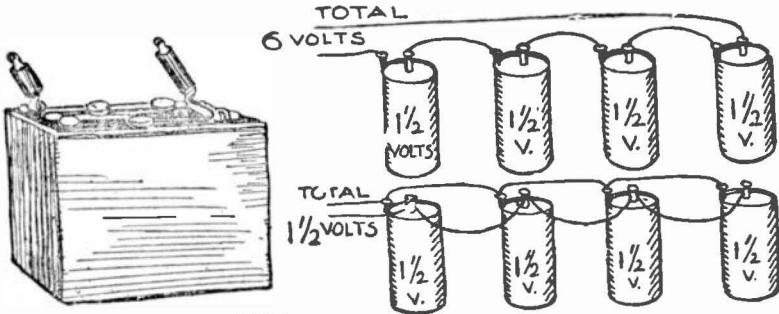

STORAGE BATTERY

Above is a typical storage battery for lighting audion bulbs. To the right, in the upper illustration, are four dry cells connected in "series." Below them are four cells connected in "parallel." Below that to the left is the kind of dry cell used in small pocket flash lamps, and to the right is a typical little "B" battery, made up of a number of these embedded in an insulating substance.

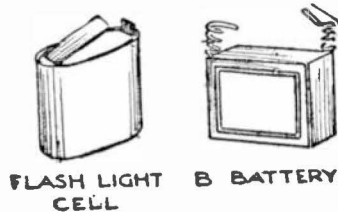

FLASH LIGHT CELL B BATTERY

half volts, making a total force of four and a half volts. And the last cell is the spigot in the cellar, and when we open this we get the full effect of the drop, which, in electrical terms, is six volts.

Each of these cells has a certain amperage. In the ordinary dry cell of this type there are thirty amperes. Connected as the cells are in the upper illustration, the amperage is not affected, but the voltage is added, just as it would be in a water system if the pipe going from the attic through the different floors to the cellar were all one and a half inches in diameter. The stream which came out of the spigot in the cellar would have the full head of the tank, but would still be only one and a half inches in diameter.

Thus connecting electrical batteries in "series" adds the voltage, but does not affect the amperes.

The four cells just below the upper one are connected in what we call "parallel" or "multiple"; that is, all the positive binding posts are connected to each other and all the negative binding posts are connected with each other.

We can illustrate the effect of this by again considering our water system and remembering that in the upper illustration we used each cell to represent one story of the house. Joining them in series gives you the force of all four stories. Joining them in parallel means that we go only one floor below the tank, but, instead of taking all the water through one pipe, we use four pipes and open them all at once. This means that, while the force of water as it leaves the spigots is not very great because it has flowed only one story, we are getting four times as much water because we are using four pipes.

Thus connecting electric batteries in parallel adds the amperage or quantity, but leaves the voltage, or force, the same.

The great difference between a storage battery and a dry cell is that, in the storage battery, the electricity is made by a combining of various chemical elements which are in the solution, and the advantage is that when these elements are all combined and there is no more electricity to be made, we can introduce a charge of electricity from an outside source into the solution, and this breaks the elements up again into their original form until, when the battery is fully charged, all the elements are prepared, when called upon, to start combining all over again, and thus make more electricity.

The usual storage battery has a force or power of six volts, and the different sizes are rated in "ampere-hours"—that is, the number of hours for which the battery will deliver a steady current with the

quantity of one ampere.

Dry cells, which are of about thirty-ampere capacity, will really not deliver an ampere for thirty hours on a steady flow. They are built for frequent periods of short service and, once they are discharged, they cannot be recharged.

So we use a storage battery for the steady lighting of our audion bulb.

The "B" battery is simply a collection of small dry cells usually all mounted into a block of some insulating material. They are connected to the part of the audion bulb known as the plate, and the operation of the plate, while requiring a high voltage requires very little amperage—in fact, only about one-fiftieth of an ampere.

In our water illustration it might almost be likened to a tank placed at the top of the Eiffel Tower, but connected to the ground by a pipe only the size of the tube of a thermometer.

### YOUR STORAGE BATTERY NEEDS ATTENTION

Once you have your "B" battery installed in your set and properly hooked up you will not have to bother much about it so long as the electricity that it gives seems to have plenty of "kick" to it.

When the electricity ceases to be strong enough there is only one thing to do—throw the battery away and buy a new one.

Fortunately, though the plate of your audion bulb requires a powerful current, it uses very little of it and a good "B" battery ought to last you for six months or more.

The storage battery, however, is a very different proposition. Here

we have a piece of chemical mechanism which is called upon to deliver quite a strong current, to give a good deal of it, and to give it steadily in a long service.

The dry cell is not fitted for this strenuous work and, while four dry cells hooked together will give you fairly satisfactory service in lighting your filament for a short time, they very soon reach a point where the service becomes most undependable. Though there may be a good deal of life left in them, it is not the kind of life that will do for this purpose.

Four dry cells at forty cents



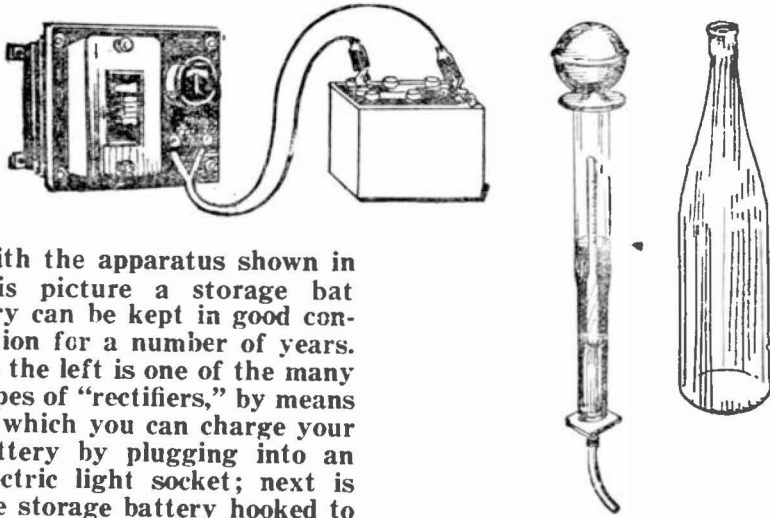

With the apparatus shown in this picture a storage battery can be kept in good condition for a number of years. To the left is one of the many types of "rectifiers," by means of which you can charge your battery by plugging into an electric light socket; next is the storage battery hooked to the charger, next to that is the hydro-meter syringe, which will tell you the condition of your battery at any time, and next to that a bottle of distilled water which should be added to the solution about once a week to keep the plates of the battery immersed.

apiece make \$1.60, and I doubt if they would last more than a week with any efficiency left at the end of that time. It would not take many weeks at this rate to cover the cost of a first-class storage battery.

With the storage battery you will have three very great advantages. First, the current you will draw from it will be steady and just the kind of a current you want for radio purposes; second, it will stand up efficiently many times as long as the dry cell; third, when the charge is exhausted it is an inexpensive matter to have a new charge put into it or put one in yourself by hooking it up with your house lighting current with the

proper apparatus in between and it is ready to begin all over again.

A storage battery requires looking after just as does any other delicate and efficient piece of mechanism.

First, there are certain things you must be careful of in order to cover the requirements of the fire underwriters. They have decreed that the battery must be completely housed so that all live parts are covered. They also demand that you connect the battery to your wires through fuses which will not allow more than ten amperes to pass. This is done so that if two wires come accidentally in contact the fuse will blow out and the current will be stopped before it has a chance to start a fire. They also have ruled that storage batteries which have exposed terminals must be provided with a ventilated cover of such a nature that it will prevent accidental short circuit across the terminals. They insist that the wiring between the storage battery and your radio apparatus be not

less than No. 14 B & S gauge approved rubber covered.

The underwriters say nothing about your eyes and your clothes, but let me warn you not to spill the acid of the battery upon the carpet nor let any part of the battery, which is moist with this acid, touch your clothes. I once had a man carry a storage battery a short distance for me without warning him of it and about an hour afterwards the cloth of his trouser legs, against which it had rubbed, simply fell to pieces.

And above all, after handling any part of the battery, do not touch your eyes. I do not know that this acid would cause blindness, but I do know that it can cause most uncomfortable pain.

Never have a flame near the top of a freshly charged battery. During the process of charging and for some time afterward the solution forms a gas which is highly explosive.

Examine your battery through the filler-caps at least once a week and see that the solution is well above the edges of the plates. If it is not, pour in distilled water or a chemically pure water that you can get from the drug store, until the plates are well covered. If the solution becomes weak it is much better to let a man in charge of the regular battery station do the refilling for you rather than attempt it yourself.

There are many makes of "home chargers" on the market now, all designed to change the alternating current of your house lighting system into a direct current not too strong for the battery and, with one of these, you simply plug into a light socket and the

battery will charge overnight at the expenses of only a few cents for current. These charging devices may seem expensive, but they are well worth while because a battery which is "boosted" a couple of times a week will give two or three times the length of service of one which is used to the limit and then fully recharged.

For a dollar you can get what is known as a "hydrometer syringe," which will give you an unfailing indication of whether your battery needs charging or not.

Inside the glass part of the syringe is a little glass thing that looks like a thermometer tube. When you squeeze the bulb of the syringe and take some of the solution into the glass barrel, this little tube floats and the point on the scale at which it meets the surface of the solution tells you what the "specific gravity" of the solution is.

A fully charged battery will indicate around 1280 on the scale, while a fully discharged one will read about 1125. In actual service you should never let the specific gravity of this solution get below 1200.

Storage batteries are graded according to their "ampere-hour" capacity—that is, the number of hours for which they will steadily deliver a current of one ampere. It is best not to get a battery of less than sixty ampere hours for radio purposes. The average audion bulb will use about one ampere an hour, so that your battery would burn for sixty hours continually. If you are using two amplifiers as well as the detector you will be using three amperes an hour and your battery will last twenty hours.

## A LOOP AERIAL IS EASY TO MAKE

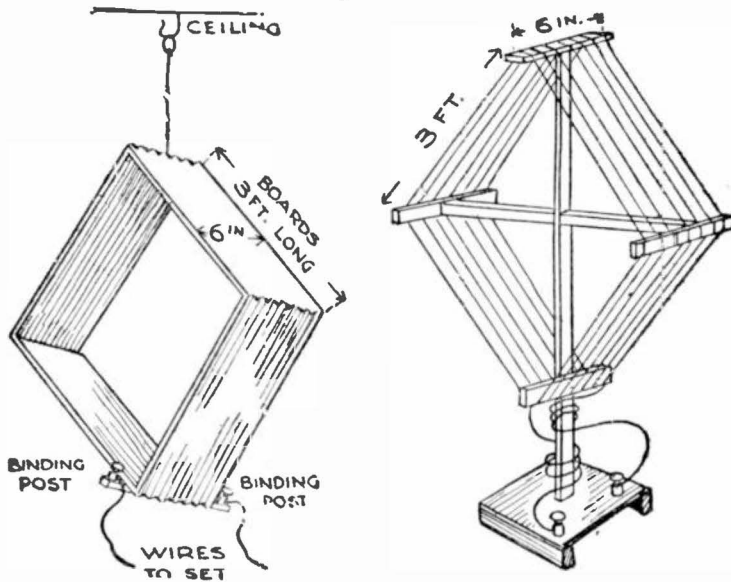

Two forms of frame work for loop aerials. On the left is a simple square of boards notched at the corners to hold the wires in place. On the right is a more elaborate and workman-like frame

A loop aerial is so easy to make that it is worth any one's while trying during the static season just to see what results he gets.

So-called experts in radio will write long and learned dissertations saying that certain things cannot be done, and these dissertations meet with loud laughter from hundreds of school boys all over the country who are actually doing these things.

As a matter of fact, radio is such a new and comparatively little-known miracle that no man ought to say positively that a thing cannot be done. I have seen dozens of articles printed under the names of various leaders in this science, all stating definitely that it is useless to try to use a loop aerial with a crystal detector. I made the same

statement myself in these articles some time ago, and shortly afterward an amateur of my acquaintance, just to see whether I was right or not, hooked a loop aerial to his crystal and quite clearly heard the concert from Schenectady, more than 200 miles away.

This is a freak, of course, but it has always been the freak happenings in radio that have led to discoveries which later made them the ordinary happenings.

I still do not advocate trying a loop aerial with a crystal receiver in spite of my friend's one triumph. But if you have an audion bulb set it is decidedly worth trying. you have any success with it at all you will find it of inestimable value in cutting out interference from other stations and it will also

eliminate a great deal of static.

Very few amateurs will want to use loops that are more than three feet on a side, so that is the size I have given in the illustration. If, however, the lady who bosses you around at home does not object to its appearance, there is no doubt that a four foot loop is more satisfactory.

The simplest—though most unsightly—form of loop aerial is shown in the left-hand picture. It is merely four boards nailed together firmly at the corners and suspended from a hook in the ceiling. The corners of the frame should be notched to receive the wires and insulated wire should be used. A strip of wood should be nailed to the lower corner to receive the binding posts and the two ends of the wire should be attached to them.

In using this aerial, it should be hung a few feet away from the operator and a string should be run from each of the two horizontal corners to the operating table. You then turn the loop around by handling these strings much as you would handle the reins in driving a horse, and when you have the loop pointed in the direction from which you hear the loudest signals you twist the strings around a nail or

a screw on your table and that holds the loop in place.

The frame work on the right makes a much neater-looking job and avoids the necessity of hanging the frame from the ceiling. Such a loop can be stood on the table or the floor and can be turned about either by the strings just mentioned or by a long stick.

Almost any kind of wire will do for these loops, but it is usually best to use an insulated wire. Otherwise there may be dampness in the wood which will permit some of the weak currents to leak across from one turn to another.

Ordinary bell wire is excellent for this purpose or you can use wire as small as number 22 double cotton covered. Theoretically it is best to use a wire consisting of a number of strands twisted together, but this is expensive and I doubt that the advantage is worth the extra money.

It seems impossible to make the average novice give up the impression that he should have his windows open in order to receive signals on a loop or an indoor aerial. This is not necessary at all. You can shut your room up tight and stuff every crack and crevice with sealing wax, and the radio waves will come merrily in just the same.

### A HOOK-UP FOR THE LOOP AERIAL

One of the most interesting hook-ups for an indoor loop that I have tried is given at the bottom of page 2 in this issue. The main point of difference between this and the one given last month is in the fact that there is a wire connecting the positive post of the storage battery to the center wire of the loop. This connection is in-

dicated at the point marked A in the drawing.

Oddly enough, though I have never seen the peculiarity mentioned in any text books, I found during two weeks' experimenting with this set that hooking the battery to the center wire seemed entirely to take away the loop's "directional properties." I could turn

my loop in any direction or lay it flat on the floor or raise it horizontally above my head, and the music came in just as well.

I have often been curious to know whether other experimenters had the same result, but have never been fortunate enough to meet one who has tried this hook-up, so that I am still uncertain as to whether my experience was the result of a freak combination of conditions or whether this hook-up does in reality take away the directional properties from the loop. I should be very much interested to learn any results that you obtain from it.

This hook-up is intended particularly for stations sending on longer wave lengths than those used in broadcasting. The variable condenser, wired up as indicated, increases the wave lengths of the loop, and the connection with the storage battery on the positive side makes the hook-up especially good for what are known as C. W. signals, which, of course, include the concerts.

In the recent article on the construction of loop aerials I spoke of the advantages for certain kinds of work of making a loop with quite a number of turns and arranging it so that the wires from the binding post can be hooked on to any turns desired by means of clips.

### SOME IDEAS ON LOOP AERIALS

The present winter will undoubtedly see most radio enthusiasts concentrating on some form of loop aerial in connection with the new Armstrong super regenerative circuit. Just as soon as we can get this circuit worked down to the point where the beginner can use

This arrangement is especially useful for this hook-up.

This arrangement of instruments has for the novice some advantages over the one given in the article last month. In the first place, it uses less instruments, and is, therefore, cheaper, and as it has less variable parts there are not so many adjustments to make.

But do not forget that it is almost an axiom in radio work that simplicity of operation is always gained at the expense of selective tuning—that is, the fewer parts you have to adjust the less you are able to tune out annoying interference.

For this reason I have found this hook-up to be rather unsatisfactory in a city where there are four or five broadcasting stations, whereas with the hook-up given in the preceding article I have been able to tune out all interference with almost uncanny facility.

Still, I would be almost inclined to say that the novice who has never used a loop had better try this one first merely for the greater ease with which stations are picked up by it, and then after he becomes proficient in its use he can graduate to the more difficult and more expensive but undoubtedly more selective arrangements given in the other article.

it, it, with a neat little loop aerial, will solve the difficulty that confronts the city dweller who finds it impossible to erect an outdoor antenna.

Most amateurs seem to understand the principles of the loop aerial, but nine out of ten, judging

from my letters, are puzzled as to the best way to mount the frame so that it can easily be turned in the direction of the station that you want to receive.

I will admit that the forms of loop aerial given in almost all publications do present difficulties of construction to discourage a man who is not an expert with tools. I have myself found it hard at times to mount a frame as solidly as I wanted it without damaging the furniture or making a contrivance so big and ungainly as to bring forth the disapproval of The Lady Who Bosses Things Around the House.

I want to give here a few hints that will solve your difficulty without sacrificing any efficiency. You will find them illustrated on page 2 of this issue.

The first plan is to take an ordinary mosquito screen frame which you would put on the outside of a window in the summer time and mount it on the inside of the window frame by means of two hinges on one side of it. The loop can then be wound around this screen frame and can be made of ordinary bell wire fastened at each corner by a brad or a tack. You must remember that the insulation on this wire will not prevent the reception of radio signals, but is very desirable in preventing the leakage of electrical currents from wire to wire.

For the average size of window

screen frame, about six or seven turns of wire will be sufficient, but it should have a variable condenser in the circuit connected by the "series-parallel switch" which I have already described in these articles.

A screen swinging on hinges in this way can be turned through an arc of half a circle and, as you will get reception from a station toward which either one of the two sides is pointed, you will get your signals from a complete circle.

In this same way a loop can be wound around a door, only in this case you will require only about four turns of the wire. Opening and closing the door will allow you to swing your loop through a sufficient arc to find the station that you are looking for.

I have also seen loops wound on one panel of a Japanese screen and a friend of mine has one wound upon a fire screen in such a way that it is almost invisible.

In any case connect a variable condenser by means of the series-parallel switch already spoken of and this will compensate for any error in the number of turns of wire that you make.

You can make a close enough estimate of the correct number of turns when you know that for broadcast concerts a loop four feet on each side should contain four turns of wire spaced one-half inch apart.

## ANOTHER REGENERATIVE HOOK-UP

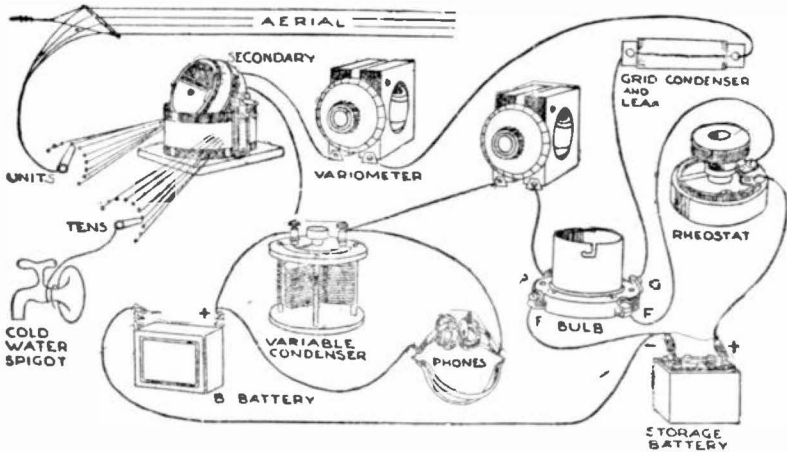

Another hook-up for two variometers, a variable condenser and a vario-coupler

To nine persons out of ten who get well into this radio craze and become what we ordinarily know as "bugs," the mere listening to the broadcasting concerts has very little thrill and the great joy of radio arrives with a tablefull of miscellaneous apparatus, most of it probably home-made and not at all expensive, and a scrapbook made up of a great collection of diagrams of hook-ups gathered from dozens of different sources.

Operating the radio set then becomes a real joy.

Not long ago a friend of mine came to my experimental station four or five times in one month in order to listen to a radio concert, and each time he found me in the midst of unhooking my set preparatory to trying some new arrangement that I had come across.

There is no one hook-up that is best for every purpose and aerial and every location. Whenever you get a set that is designed to receive everything that is flying through the ether, you will know that you have a set which has had to sacri-

fice a certain amount of efficiency somewhere in order to be generally practicable.

These different hook-ups are not, of course, of particular interest to the man who simply wants to hear the broadcast concerts, but, as most of you will inevitably later develop into real bugs, it is just as well at the very beginning to start making a scrapbook of all the hook-ups you find and when your operating room has become cluttered up with so much junk that it looks like the sales room of a dealer in second-hand apparatus, you will enter into the real heaven of the radio fan and get the full joy of this wonderful new science.

One of my most prized possessions is a big bundle of notepaper made up of the data that I have jotted down night after night while trying these different hook-ups. I give each hook-up in my scrapbook a number and when I sit down at my table to test it out, I place this number on the top of each sheet of the notepaper which is on my table, then I rule off columns and lines

and tune in some station. As soon as I get it strongest I make a note in a column headed "audibility" of the strength with which it comes in.

This audibility scale, which I range from 0 to 10, cannot be exact, but it is near enough to be very interesting. Under the 0 classification, I place the station whose call letters I can just barely make out with the aid of my imagination and enough sound in the telephones to enable me to identify it after I have heard it a number of times.

Under the 10 classification I place the signals which come in so strong that they actually make the telephones rattle unpleasantly in the ears. No. 5 is the signal which comes in with fairly good satisfaction. Other intensities of sound are graded in between according to my judgment.

Under other column headings on the record I enter the dial settings of the various parts as they were when I got best results.

Naturally the usefulness of such a system is very largely increased when you acquire sufficient acquaintance with the dot and dash code to enable you to identify the many amateurs and commercial stations which are constantly working with each other through the ether. And let me say right

### THE WAVE LENGTH OF YOUR AERIAL

Every amateur, as he continues the study of radio, becomes curious to know what the "natural wave length" of his aerial is.

There are many formulae for determining this, but those that give really accurate results require measurements and calculations which are beyond the scope of the novice.

here that it is worth all the trouble it requires to learn this code, because then you can get into the long distance work and experience the genuine thrill that comes to you when you first hear a station in Europe or South America.

This hook-up which we give today is not, however, suitable for the reception of stations working on the long commercial wave lengths. It is designed especially for amateur and concert broadcasting waves.

It uses the same instruments which were given in our other two-variometer hook-up, but it places the variable condenser in a different position and many amateurs will find it more satisfactory than the other. I have been using it myself for some time with very good results.

The operating directions given for the other set apply to this one also. After all, such directions merely narrow themselves down to a matter of patiently twisting your knobs until you find what you are after.

But let me again give the caution which is applicable to all hook-ups using an audion bulb. That is, don't put too much storage battery current into your bulb through the rheostat. Always operate the bulb with the filament at minimum brilliancy for strong signals.

It is, however, possible to make a rough estimate of the average aerial and equations for doing this can be found in most books on radio.

These equations use various factors, the principle of which are the length of the aerial, which means the number of feet from one insulator to the other regardless of the



number of wires, the height of the aerial, which means its average height above the earth, the length of the lead-in, which means the number of feet from the place where the lead-in wire joins the aerial to where it joins the instrument and the length of the ground wire, which means the number of feet from the ground binding post on the set all the way to the earth, even though the greater part of this may be your cold-water pipe. In such a case the cold-water pipe is merely a part of the "ground wire" and the "ground" itself is where the pipe goes into the earth.

It would only confuse you if I were to give a number of formulae for calculating your wave length, because you would find different results from each equation. I will only give the approximate natural wave length of the commonest kind of aerials and you can make a fairly close estimate of yours from them.

For a four-wire aerial which takes its lead-in from one end the approximate wave lengths are:

Fifty feet long — Thirty feet high, 98 meters; 40 feet high, 110 meters; 50 feet high, 125 meters; 60 feet high, 140 meters.

Sixty feet long — Thirty feet high, 105 meters; 40 feet high, 115 meters; 50 feet high, 135 meters; 60 feet high, 150 meters.

Seventy feet long—Thirty feet high, 120 meters; 40 feet high, 130 meters; 50 feet high, 145 meters; 60 feet high, 155 meters.

Eighty feet long—Thirty feet high, 135 meters; 40 feet high, 150 meters; 50 feet high, 160 meters; 60 feet high, 175 meters.

Ninety feet long—Thirty feet high, 145 meters; 40 feet high, 155 meters; 50 feet high, 165 meters; 60 feet high, 180 meters.

One hundred feet long—Thirty feet high, 155 meters; 40 feet high, 165 meters; 50 feet high, 180 meters; 60 feet high, 200 meters.

One hundred and ten feet long—Thirty feet high, 175 meters; 40 feet high, 185 meters; 50 feet high, 200 meters; 60 feet high, 215 meters.

If you have only a single wire, pick out your height and length from this and reduce the above wave length by about 15 or 20 per cent.

If you take your lead-in from the middle, reduce above wave lengths by about 50 per cent.

One of the formulae which is most in use is the following:

Add the length to the lead-in, add to this the ground, and if there is more than one wire in the aerial add one-third of the over-all length of the aerial. This is all in feet. Divide this total by two and add the result to the first total. This is said to give the natural wave length in meters.

It is probable that the natural wave length of your aerial will be somewhere about midway between the results given by this formula and the table I have given.

## PROTECT YOUR AERIAL AGAINST WIND

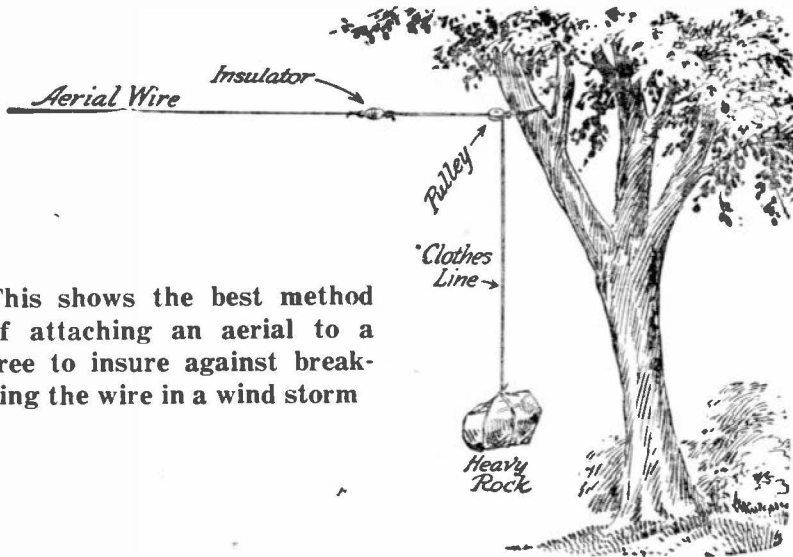

This shows the best method of attaching an aerial to a tree to insure against breaking the wire in a wind storm

It is probable that eight out of ten amateurs, in erecting their aerials, make use of at least one tree in place of a mast and it is equally probable that not one of the aerials so erected fails to break during some heavy gust of wind which strikes its locality.

Many amateurs attach an end of the aerial to a part of the tree trunk that looks perfectly strong and stiff and they find it impossible to realize what has happened when they go out some morning and see their wires trailing pathetically on the ground.

But the "windage" in a tree is considerably greater than you would suppose. A mere twenty-mile wind getting among the luxuriant branches of a healthy tree in summer time, will exert a pressure of a great many hundred pounds and in most cases will start the tree swaying or oscillating so that it gathers added force each time that it swings outward. It does not take long for this swing-

ing force, snapping the wires quickly from very loose to very tight, to break the strands and another radio set is out of commission.

Whenever a tree is used for the support of an aerial this should be provided against and it can be done by a very simple method.

The sketch shows the easiest and probably the most efficient way. You simply take a pulley as high up in the tree as you can get it and lash it fast around a limb. Then you pass a clothes line through the pulley, tie one end of it to your aerial insulator and let the other end drop to the ground.

Meanwhile you must get a large rock or a heavy iron weight or a half dozen bricks and these will be your assurance against a breaking aerial.

Pull your clothes line until your aerial is perfectly tight and then tie the heavy weight on the end of the line just high enough to

allow the weight to swing a foot or two above the ground when the aerial is taut.

Ten or fifteen pounds will do for the weight for the ordinary single wire aerial, but if you have more than one wire with spreaders you must put on more weight. This is a matter that can be decided only by experiment, the object being to have the weight heavy enough to keep the aerial wire perfectly taut.

It does not matter upon which

end of the wire you put this protection. The object is simply to give your aerial a certain amount of elasticity, and this elasticity may be put either at the near or far end.

With this arrangement, when the tree sways away in the wind, the clothes line simply slides through the pulley, lifting the weight slightly higher. When the tree sways back again, the clothes line slides once more, letting the weight drop and the aerial stays at a uniform tension all the time.

### SOME POINTS ON CRYSTAL DETECTORS

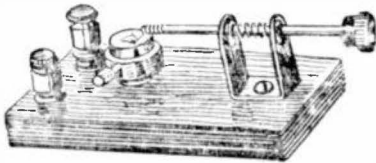

Here are the best types of stands for using a crystal detector. There are many different makers specializing in these types and their advantages are described in the accompanying article.

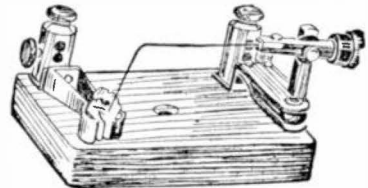
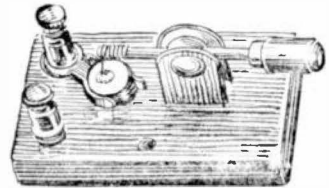

It is a perfectly easy thing to sit down and write an article telling how to make a complete receiving set for a dollar. I have been much amused at a number of such articles I have seen and particularly at the ingenious devices evolved to take the place of the usual crystal detector stand. Most of these devices simply use a twisted wire to make the contact with the crystal and you are directed to find the sensitive spot with it.

Instead of telling you to find the sensitive spot they ought to dare

you to find it. These things are all right for the experienced amateur who knows exactly where and how to locate trouble in his set, but there is nothing that gives the average beginner more bother than finding—and keeping—a sensitive spot on his piece of mineral.

It is astonishing the number of different types of crystal holders that have appeared on the market since this radio broadcasting craze began. I think I must have personally tested fifty of them and these tests have convinced me that

the only type for one who is not skilled in radio is some such apparatus as shown in the illustration. There are many makes on the market using this general principle and the choice may well be left to the one which the purchaser feels fits his hand the best.

This style of stand holds the crystal in a cup or clamp on the base, attached to one binding post. The cat-whisker wire is bent at right angles and is mounted upon a ball and socket joint or a pair of swivels or gimbals or some such arrangement to give it absolutely free play in all directions.

The advantage this type of stand has over all others is due to the fact that a difference of pressure almost of the weight of a feather applied to the catwhisker on the detector will cause a vastly great difference in the clearness and strength of the signals. For this reason, all devices which have a spring pressure are bad and those which depend upon a screw and thread are undesirable because, the moment you go to screw in or out, you are almost certain to take the end of the catwhisker off the sensitive spot and you may have a heap of trouble finding it again.

And this leads me to another point about galena which does not seem to be generally understood by beginners. This is the fact that, while a piece of galena may be a very fine detector, it may have all of this ability stored in one particular spot no bigger than a pin's head and be absolutely dead all over the rest of its surface. Once you get your catwhisker away from this tiny efficient spot you may have your own troubles finding it again.

I have had a number of pieces of galena which had this peculiarity and I have found that in nine cases out of ten, scraping the surface quite deeply with a knife blade would uncover many more sensitive spots and even breaking up the crystal into three or four pieces with a hammer gave me three or four excellent detectors in the place of one, even though these detectors were smaller.

If you do this you may be puzzled as to how to mount these small pieces in the detector stand. This is quite easy. Simply embed them in a ball of tinfoil from a pack of cigarettes or a piece of chocolate and clamp the tinfoil in the detector stand.

I once got excellent results from an experiment I tried with four or five pieces of galena upon which I could not find a single sensitive spot. One of these pieces was mounted in composition in the usual cup so I simply melted the composition away with my soldering blow-torch, replaced the empty cup on the stand, ground up all of the supposedly dead crystals into a fairly fine powder and filled the cup with it. Thereafter I found plenty of sensitive spots and, if there was any difficulty in finding one, I tapped the cup fairly hard with my finger-nail and this usually located what I wanted.

And this search for a sensitive spot leads me to one other phase of the crystal detector which does not amuse me but fairly makes me furious. This is the failure of beginners to use buzzer testers. It reminds me of my first assignment as a ship's operator. I sailed on a molasses tanker for Cuba on an hour's notice and found that the old-fashioned set with which I was

to be ship-mates had no buzzer tester. Two days north of Miami, Fla., the "old man" filed a message for that station and I called them on a powerful two-kilowatt set and listened for an answer, but there was none. It was my first commercial message and I was determined to get it through so I sat up all night calling Miami every fifteen minutes without success. In desperation I spent all of my time in the wireless shack hurling "WST's" through the ether with no result.

Late the next afternoon I heard them answer me and tell me to go ahead. I shot my message, got my receipt and rushed up to the "old man."

"I got it through," I said triumphantly.

He sneered and pointed silently to the Florida shore not five miles west of us. There were the great towers of the Miami station which had been heard regularly all the way across the Atlantic Ocean and I was proud of having heard them five miles! I learned later that they had heard my very first call and had acknowledged it; but having no buzzer tester to tell me that my point was not on a sensitive spot of the detector, I could not hear them and I wasted two whole days and must have interfered with dozens of important messages by my wild calling every fifteen minutes.

By all means put a buzzer tester on your crystal set or, if you don't, don't blame the apparatus.

## USING A VARIOMETER WITH THE CRYSTAL

There is nothing in my correspondence which surprises me more than the number of persons who have bought variometers for tuning devices with a crystal detector. This is a very inefficient way of tuning a crystal set and cannot compare with even the most carelessly made home-built tuning coil, but so long as a great many people seem to have loaded themselves up with variometers I will give a hook-up to enable them to use this instrument and get what satisfaction they can from it.

We all know that the aerial itself has a certain natural wave length. This wave length depends upon the height, length, the number of wires and certain local conditions.

If the natural wave length of your aerial should happen to be 100 meters, and you add to it a tuning device whose range of wave lengths is from fifty to seventy-five meters, you know that the wave length range of aerial and tuning device together is only from 150 to 175 meters.

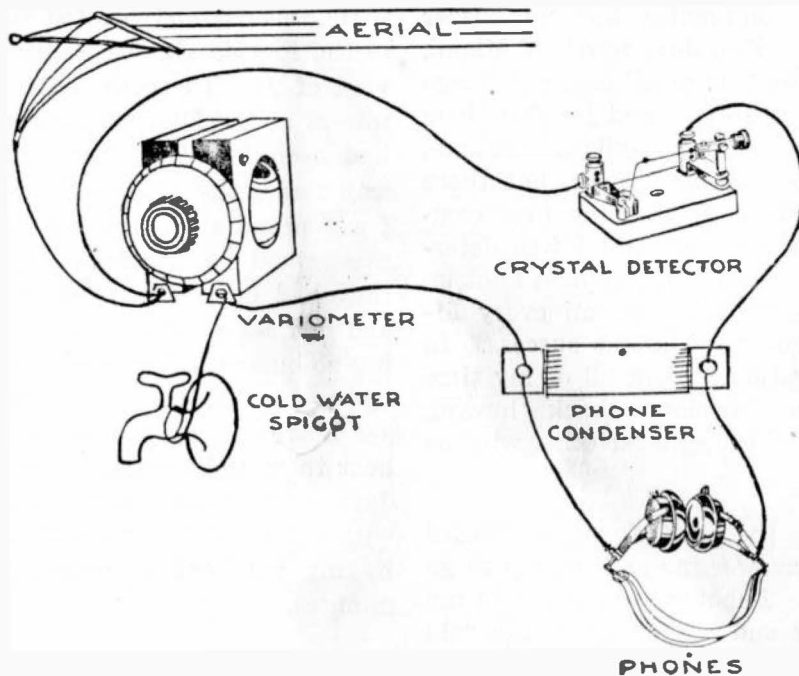

**This is the best hook-up for using a variometer with a crystal detector**

It is because the average amateur aerial has rather a small wave length that we have to provide receiving sets containing tuning devices which have a comparatively wide range of wave length possibilities in order that they may be satisfactorily hooked up to almost any aerial.

The wave length range of a variometer is quite small, and it will not give you satisfaction unless you happen to have the right wave length of aerial to add to it.

The illustration shows the accepted method of hooking up a variometer to your crystal detector. It does not, however, give the

buzzer tester, but I have so frequently insisted upon the necessity of this that I hope that none of my readers would think of installing any kind of crystal set without adding to it the buzzer tester, which has already been so fully described in these articles.

When you have hooked up your variometer as shown in the illustration and find that you do not get signals, no matter which way you turn your knob, the chances are that your wave length is too short. If you have a variable condenser, you can increase the wave length by hooking up the two binding posts of the condenser to the two binding posts on the variometer.

This will give you a much more elastic method of tuning, as you can vary wave length both by means of the condenser and the variometer.

If you have no variable condenser, a grid condenser or a phone condenser hooked up in the same way to the two terminals of your

variometer will increase your wave lengths and may give you the signals you are looking for or else you can put a "loading coil" in the circuit, hooking it between the aerial and the variometer. This loading coil can be a homemade spiderweb or one layer of wire wound tightly around a salt box or oatmeal box and tapped about every ten turns.

### A COSTLESS VARIABLE CONDENSER

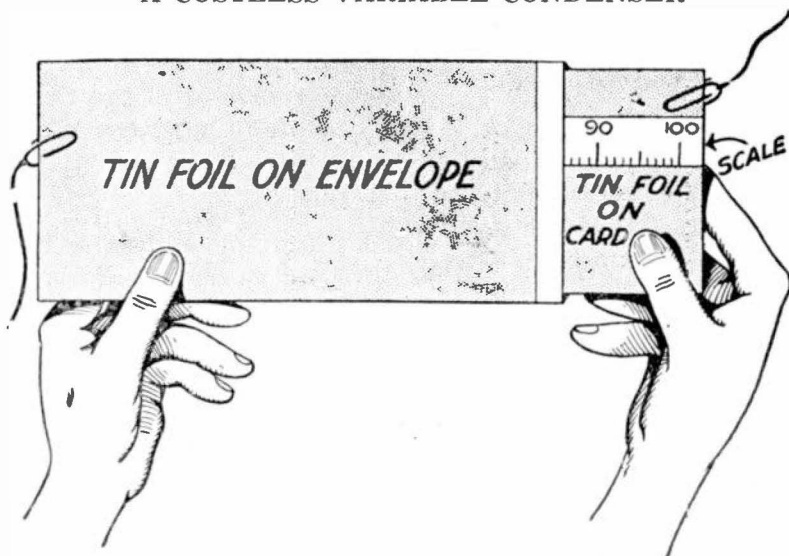

Here is an efficient home-made variable condenser which requires only an envelope, a piece of cardboard, some tin foil and two paper clips

In another effort to combat the high cost of radio I want to describe here one of the neatest and most efficient home-made variable condensers that the novice can construct.

This condenser, built as shown in the picture, will be of about the same capacity as a fifteen-plate

variable, but its dimensions can be very easily changed and it can be enlarged until its capacity equals the forty-three-plate kind.

The best part of this condenser is that it does not cost anything. The necessary material is a large-size business envelope, a piece of cardboard big enough to slide into

it snugly, the tinfoil from several packs of cigarettes or tea or chocolate and two ordinary wire paper clips.

The envelope used to build the condenser shown in the picture was the standard No. 10 envelope used by business houses and measured  $4\frac{1}{8}$  inches by  $9\frac{1}{2}$ . First I sealed the flap and then cut the envelope open at one end. Next I took tinfoil and coated the whole envelope with it with the exception of a narrow margin next the open end.

In attaching the tinfoil to the paper, do not paste it all over or else the envelope will wrinkle badly. Merely attach the corners with a little drop of mucilage.

Next I cut a piece of cardboard so that it would slide easily into this envelope and this cardboard I also covered with tinfoil on both sides.

The next thing to do is to cut a long narrow strip of paper and draw a scale upon it as shown in the illustration. Any kind of scale will do, but it is usual to divide a condenser scale into one hundred equal parts and that is what I did

with this one. The 100 mark should come just at the edge of the envelope when the cardboard is shoved in as far as it will go. The zero mark should come to the edge of the envelope when the tinfoil on the cardboard has been pulled out just beyond the edge of the tinfoil on the envelope.

Next I soldered paper clips to the ends of two pieces of No. 28 cotton-covered wire and one of these clips I shoved over the closed end of the envelope so that it would make contact with the tinfoil and I used the other paper clip in the same way on the end of the cardboard.

In using this condenser it is best to put a piece of board or a book over it or inclose it in a folder of cardboard so as to protect the tinfoil from damage.

The capacity of this condenser is varied by sliding the cardboard in and out of the envelope and, if the capacity is still not sufficient with the cardboard shoved all the way in, it can be increased by putting a book cover over top of it and pressing down on it or putting a heavy weight on it.

### ANOTHER VARIABLE CONDENSER FOR YOU

Get one of your smoking friends to give you the tin foil from a few packages of cigarettes, beg an empty cigar box from the store around the corner; get your wife or your mother to make up a bit of ordinary flour paste, and find a

brass bolt and a nut somewhere and you have spent all the money necessary for a perfectly good variable condenser which will be equal to the ordinary store one having about twenty-three plates.



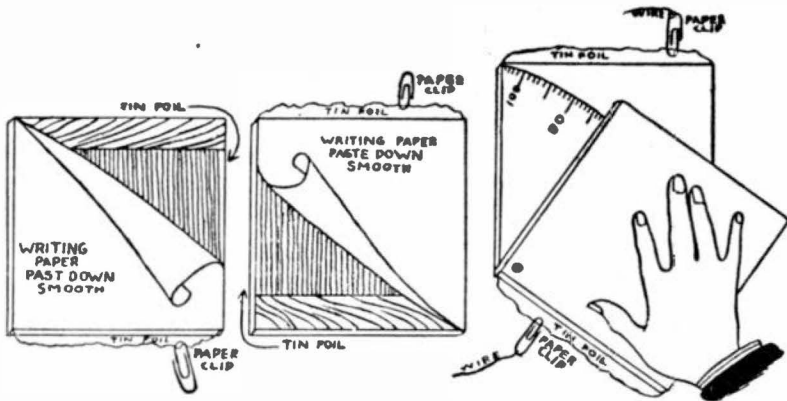

Here is another variable condenser which any one can make without spending a cent

If, however, you want the equal of the forty-three plate kind, you will have to go to the expense of having to ask for more pieces of tin foil from your cigarette-smoking friend and getting two pieces of wood big enough to paste several of these tin-foil sheets on each.

Smooth out the tin-foil as nicely as possible before using, because it is always well to have all radio apparatus neat.

First it will be wise to give each piece of wood a coating of thin glue on one side and let it dry over night. Then, in the morning, give them another coating of glue and lay your tin-foil sheets flat upon them and smooth them down carefully so that the tin foil will stick without wrinkles.

The tin foil should come all the way to and over one edge of each piece of wood, but should be about one-inch away from the opposite

edge and about one-half inch away from the two sides. It does not matter much about the size of the pieces of wood that you get, but you should have at least thirty square inches of tin foil on each. If the tin foil which you get does not cover that amount of surface, you can paste pieces on wherever necessary, but do not paste tin foil to tin foil as the mucilage is an insulator and we want good contact all over the surface of both sheets. In piecing out, paste the tin foil to the wood and let the edge overlap the other piece of tin foil and press down upon it.

With both pieces of wood thus covered with tin foil, you paste an ordinary sheet of writing paper over both surfaces to cover the tin foil. Turn your two pieces of wood so that the paper covers come together and pivot them with the brass bolt in one corner of the side that is free from tin foil.

You can now open and close the boards like a fan, and as you do so you bring more or less of the surfaces of the two tin-foil sheets over each other. Draw an arc on the lower piece of paper and, when the two are opened as far as you can open them, mark a scale running by tens and units just like the scales on the regular dials of radio

sets and, as the edge of the upper one runs along this scale in tuning, you can see exactly at which mark you receive your signals best.

In using this variable condenser let me say that you can considerably increase its capacity by putting a heavy weight of some kind upon the upper board.

### GET READY FOR YOUR AMPLIFIER

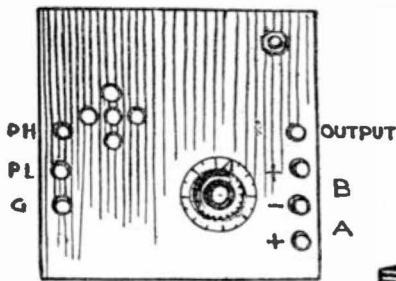

FRONT VIEW

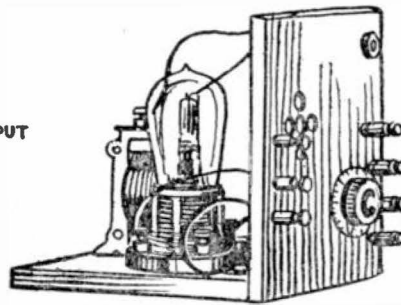

LEFT SIDE VIEW

Here are three views of a change you can make in your audion control panel to prepare yourself for amplification when you can afford the rest of the apparatus

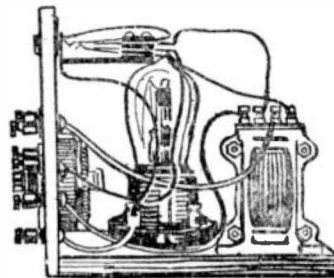

SIDE VIEW

Most radio fans would have at least one stage of amplification on their apparatus if it were not for the fact that when they sit down to make up a list of the various things required the cost staggers them. If they could only buy the stuff on the installment plan they would go into it at once.

My object here is to show you how to get the amplifier, although you cannot use it until it is paid for in full. I am going to tell you

how to mount a detector bulb so that, as the money comes in, you can add amplification, part by part without interfering with the full use of your detector bulb.

I am assuming that you have adopted the 6 by 6 inch panels that I have been advocating, and I am going to tell you of the changes that I have made in several of mine, so that I can put them together either for detector alone or for one, two or three steps of am-

plification. In changing your present detector panel to prepare for your first stage amplifier, the first things to buy are a "double-circuit" jack and a phone plug.

Each one of these will cost you about a dollar and you will never regret the money that you spend on them because the plug and jack system will give you a totally new idea of how conveniently things can be arranged.

I am assuming that you have not yet bought the transformer and am advising you to put in the jack and hook your phones to the plug preparatory to getting the rest of the apparatus.

Later you can get the transformer and mount it as shown in

the picture, and if you can afford to spend \$6 now you can put it together and use your set until you have saved enough money to buy an amplifying bulb, a socket and a rheostat.

If, however, you do not care to buy more than the plug and jack at present, put the jack where it is in the illustration, rearrange your binding posts as shown in the front view, lead a wire from the binding post marked "phones" to one blade of the jack and solder it there, lead another wire from the binding post marked "plus B" on the right to the lower part of the jack and solder it there and then you can use your bulb as a detector and have part of the convenience of the plug and jack system at least.

### WIRING UP YOUR TRANSFORMER

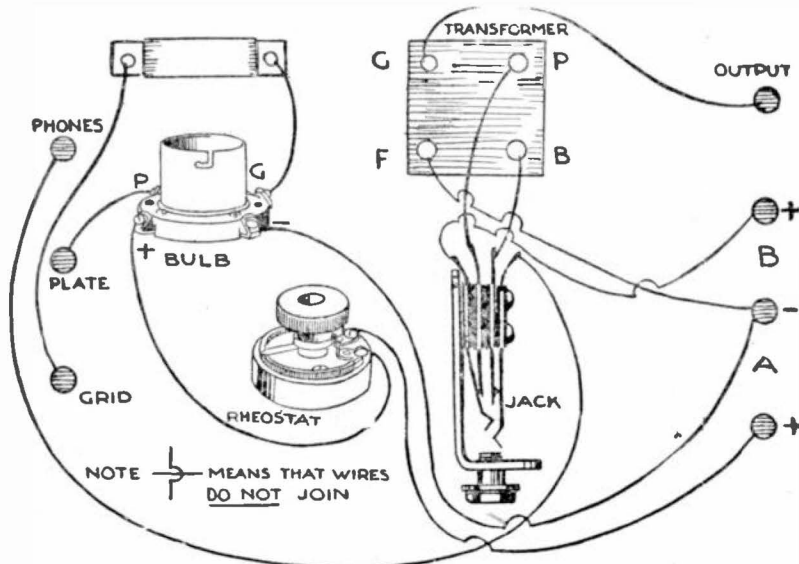

Here is a diagram which shows how to rearrange your detector panel to get ready for an amplifier when you can afford it

Assuming that you have bought a plug and jack and a transformer with the intention of getting your

detector panels ready for amplification, I am giving here a diagram showing how the panel must

be rearranged and wired in order to function as a detector alone or else automatically cut in your amplifying bulb when you get it.

First you will see that I have made a change in the binding posts described before for your detector panel. We have now in the left-hand side three binding posts and on the right four. Some people have five on the right, two for the plus and minus of the storage battery, known as the A, two for the plus and minus of the B battery and one for the "output" which will lead to the grid of the amplifying bulb when you get it.

Personally I use only three binding posts for the two batteries, using the same binding post for the minus side of both batteries as they are virtually always connected.

You can do this wiring from the diagram if you wish, but I find that the average beginner has some difficulty in this, so I am going to give you a list of the wires and their connections and you can work from this list independently of the diagram, checking each wire as you attach it.

First we must designate the four blades which you will find on your phone jack. Let us call the top one A, the second B, the third C and the lowest D. Now get ready to attach your wires and run them as follows:

From phone binding post on left to A blade of jack.

From plate binding post on left to plate connection on the socket.

From grid binding post on the left to one side of the grid condenser and from the other side of

the condenser to grid binding post on the socket.

Now turn to the binding posts the right side.

A wire from "output" binding post to binding post marked "G" on the transformer.

A wire from plus B battery binding post to "B" blade of the jack.

A wire from minus binding post to binding post marked "F" on transformer.

Another wire from that same post to minus binding post on socket.

A wire from plus A binding post to one side of the rheostat and another wire from the other side of rheostat to plus binding post on socket.

A wire from B blade of jack to B binding post on transformer.

A wire from C blade of jack to P binding post of transformer.

It is absolutely essential to solder all connections to the blades of the jack and if you happen to have a particular make of jack whose blades are too close together to work comfortably take a pair of pliers and bend them apart.

You are now ready to hook up your panel to the tuning set and when you insert your phone plug in the jack you are cutting out the transformer entirely and merely using the tube as a detector.

Later I will describe how to hook up another unit like this containing the amplifying bulb, but I am assuming that you do not care to go to the expense just now.

## GETTING USED TO RADIO SYMBOLS

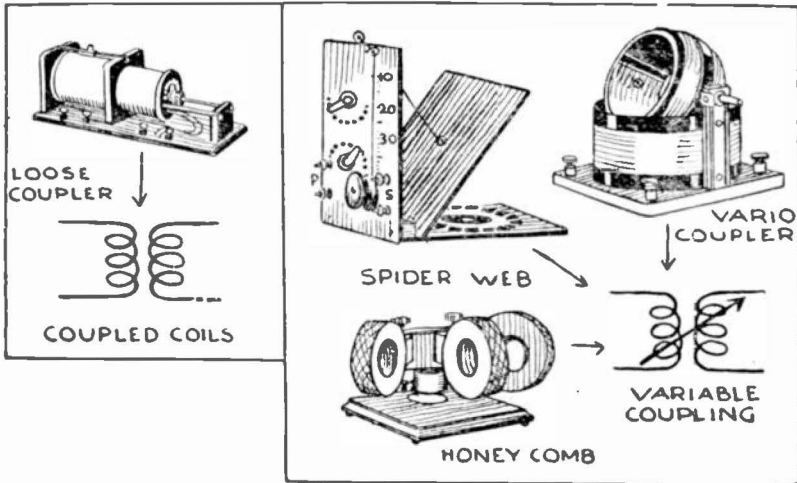

The corkscrew lines in the illustration show two electrical symbols which indicate that two coils of wire are placed so as to have an effect upon each other. In other words, they indicate a coupler and the pictures show different types of couplers all of which are indicated in diagrams by these symbols.

If everybody understood all of the symbols used in the radio hook-ups and explanations given in most of the text books and magazines, it would save our artist a great deal of trouble in drawing the pictures which we use when we give wiring illustrations for apparatus. The symbols are not at all difficult to understand, and it is very convenient to be able to translate them, so it may be worth our while at the present time to take those which are most in use and learn just what they mean.

We have already explained that a "coupler" consists of two coils of wire placed in such a position with relation to each other that a current of electricity flowing in one will create or, to use the technical term, "induce" a current in the other, even though the wire of the two coils is not physically connected.

There are a great many different kinds of couplers.

There is the old-fashioned "loose coupler," which is a coil of wire wound around one cylinder and another coil of wire wound around a smaller cylinder which slides in and out of the first one. This sliding in and out "varies the coupling"—in other words, it changes the influence that the electricity in the first coil has in inducing a current in the second coil. This is extremely important in getting sharp and distinct signals in the phones.

There is the type known as the vario-coupler, in which the first coil is wound around the cylinder and the second coil is wound around a ball-shaped form known as a "rotor." In this case the coupling is varied by turning the rotor around on its axis inside the cylinder.

Two spider-web coils or two honey-comb coils or two coils of any other kind which are used for the same purpose also make a coupler, and changing their position with relation to each other—sliding them apart like a fan or opening and closing them like a book—varies their coupling.

In all radio diagrams you will see lines drawn in a fairly good imitation of a corkscrew. This is merely a graphic representation of a coil. When two of these corkscrews are placed near to each other in the diagram you will know that they are intended to have an effect upon each other, and this effect is known as coupling.

In the illustration you will see two of these symbols representing couplers. One of them has an arrow striking through both coils; the other has no arrow.

Nowadays these two symbols seem to be used to mean the same thing, but in the old days the symbol without the arrow in it would have meant that the two coils were fixed in their positions with relation to each other and that there was no means of varying their coupling. If we wanted to indicate two coils whose coupling could be varied, we put the arrow cutting through both coils. Whenever we saw this arrow on any symbol we knew that it meant "variable."

**SOME MORE ELECTRICAL SYMBOLS**

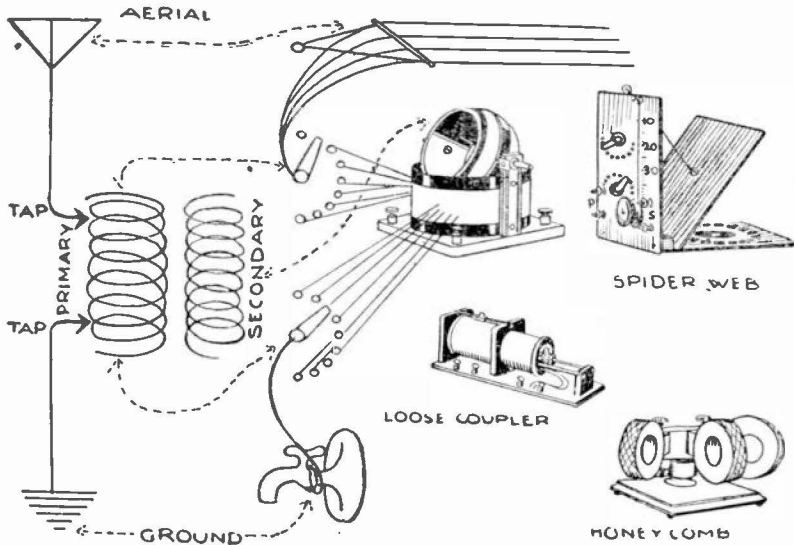

Here are the electrical symbols which indicate the aerial, the lead-in, the variable primary coil, the ground connection and the fixed secondary coil

In our last talk on the symbols used in the regular electrical diagrams of hook-ups we showed the

two corkscrew lines side by side which indicate a coupler.

In the picture which we give

with this article we are using these two symbols again, but attaching to one of the coils, which is called the primary, the other symbols which go to make up what is known as the primary circuit.

It starts at the top with the little inverted triangle, which always means the aerial. Sometimes this is merely a triangle, sometimes a line will be drawn from the middle of the horizontal line down to the lowest point, and sometimes the artist will add to this three little lines jutting upward like the points of three lightning rods.

All of these symbols mean an aerial.

Coming down from the aerial you will see a straight line which indicates your lead-in and which bends sharply at right angles to meet the coil at the arrow point. It has become customary to lay out all electrical diagrams at right angles to avoid confusion of lines, but this does not necessarily mean that the wire itself must actually be bent at a right angle.

In the symbol as we have given it you will notice that the aerial lead-in meets the coil with an arrow point. Whenever you see an arrow in a wiring diagram you will know it means "variable."

In some diagrams you will find this aerial lead-in coming straight down and being twisted at once into the symbol for the coil. That will indicate that it is a fixed coil—one not having any means of varying the number of turns included in the circuit at that particular point.

In this one which we give here the arrow indicates that you can vary the number of turns either by means of a rotating switch like the one shown on the variocoupler in the illustration, or by means of a

slider such as you have on the ordinary tuning coil.

Below the place where the aerial joins the coil you will see another arrow point, which indicates that there is another place at which you can vary the number of turns of the coil included in the circuit. This particular symbol as given here might mean an old-fashioned loose coupler with two sliders on the outer coil, or the modern variocoupler with two switches as shown in the illustration or the two-tapped spider web coil which we have been advocating so strenuously in these articles.

You will see that this lower arrow is on a line which goes straight out to the left and then bends down to an inverted pyramid of horizontal lines. This pyramid of lines indicates the ground connection. It may be the cold water spigot or the steam radiator (though I hope you are not using this for a ground) or it may be anything else that you use to conduct your currents easily into the earth.

The right-hand corkscrew line in the illustration is the symbol for the secondary coil. As it is given here it would indicate the modern variocoupler, because the absence of any arrow points shows that there is no means of varying the number of turns of wire included in the circuit. The rotating ball which holds the secondary of the variocoupler ordinarily has no means for this adjustment and therefore would suit the symbol as given here.

If, however, there had been a line with an arrow point from this coil it would have meant that the particular circuit given required an apparatus which had means of altering the number of turns of wire

used in the secondary coil. This would apply to the usual loose coupler or the tapped spider web coil.

Pick up any radio magazine or any book on radio and look at the diagrams and see how many parts of the symbols you can identify.

### THE SYMBOL FOR THE AUDION BULB

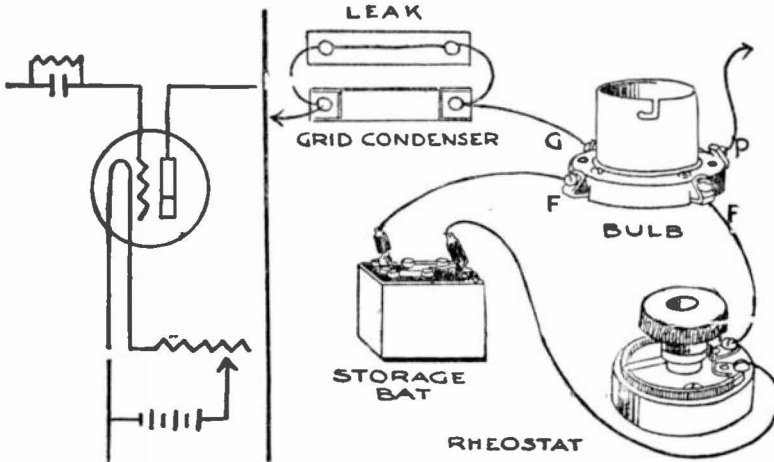

Above you will find some more symbols used in diagrams in radio hook-ups and also pictures of the apparatus which will enable you to translate them

In our past talks on the symbols used in wiring diagrams as given in virtually all radio magazines and text-books, we have learned the meaning of the queer little figures that have been devised to indicate aerial, ground and various kinds of coils. Here we are going to take up a group of symbols which are virtually always found together in every hook-up employing an audion bulb.

I am giving the hook-up first in the form of a diagram and then translating it into pictures of the actual objects as you know them and showing how the wires are connected according to the diagram.

Let us take up the various pieces of apparatus part by part, referring first to the diagram and then to the pictures. In the diagram a

line beginning at the left represents a wire leading to one part of the audion bulb. The wire leads directly to two vertical parallel plates which are not connected.

Whenever you see two lines arranged like that, at right angles to the wire and with an open space between them, you will know that they mean a condenser. If there had been an arrow drawn diagonally across these lines it would mean a variable condenser because arrows mean that that particular piece can be varied. In this case, however, there is no arrow so it cannot be varied. We call that a "fixed" condenser regardless of what size it may be.

From each side of your condenser you will see lines going up and making a bridge with a saw-toothed line connecting them. A



saw-toothed line like this in any electrical diagram means resistance—a piece of apparatus which opposes the flow of electricity until the strength of the current is sufficient to overcome it.

These two symbols together in this particular diagram represent the grid condenser and grid leak, as you will see in the picture.

If you will follow, in imagination, a current of electricity entering at the left you will see that the condenser stops it from flowing straight through.

It builds up a form of energy between the condenser plates until this energy is strong enough to overcome the resistance, when the electricity flows around and gets to the grid.

A grid leak may be either one of the standard kind sold in the stores or you can make it by drawing a fairly heavy pencil line across the paper of your grid condenser, being sure each end of the pencil line makes good connection with the brass eyelets to which you fasten your wires. This pencil line puts a deposit of lead on the paper and this lead resists the flow of electricity that is very weak, but a current of sufficient strength can pass across it.

Next from the grid condenser and leak in the diagram is a figure very familiar in all wiring hook-ups that you will see—the circle and the three little symbols in it which mean the modern audion bulb.

As you know, there is inside the glass tube of the bulb a filament that lights from the current supply of your storage battery. That filament is represented by a hairpin-shaped line which goes into the circle of the symbol.

The zigzag line always means the grid and the little square or oblong means the plate connection. In the pictures, I am giving only the socket because the connecting parts are always mounted on the socket and if you will hook your wires to the proper posts as you will find them marked you will know that the right connection will be made when you insert the bulb in the socket.

You will see the hairpin-shaped line meaning the filament comes out of the circle at two places and these places represent the plus and minus binding posts on your socket.

On one of these, as you will see, there is another saw-toothed line and, as we have already learned, this represents resistance of some kind. You will see that there is an arrow touching this saw-toothed line and we know that an arrow means that the apparatus can be varied. This, then, means a resistance that can be varied—in other words, a rheostat.

Down below this is a little group of short and long lines. Symbols like these always mean a battery. As this battery is connected to the filament and rheostat you will know that it is a storage battery because it is from that you get the current to light your bulb.

It will really pay you to study these two parts of the illustration and to learn step by step which piece of apparatus is represented by each symbol in the diagram because it is almost impossible to find hook-ups in the picture forms I have been giving you, and you may find articles in radio magazines that you would find very interesting if you could translate the symbols.

### THE SYMBOLS FOR A MODERN HOOK-UP

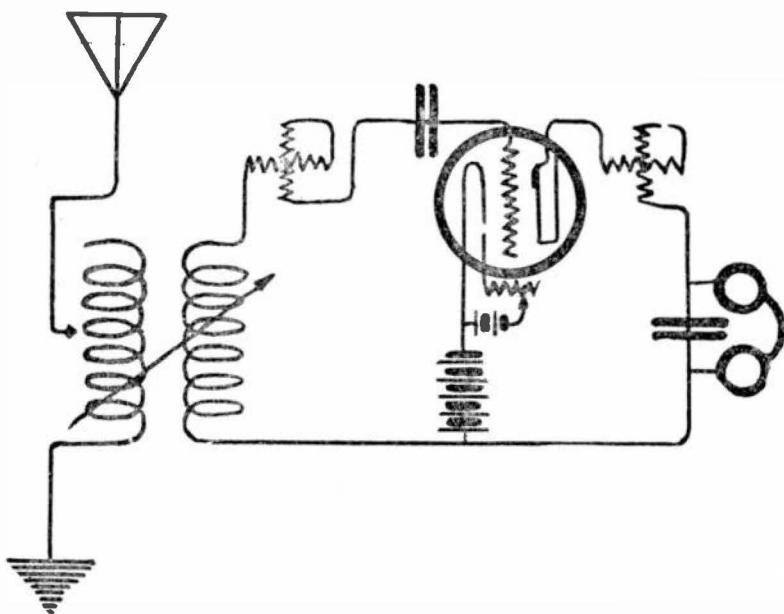

Here is a hook-up given in diagrammatic form and the meaning of the symbols is explained in the accompanying article

We are ready now to try to translate into ordinary terms the symbols used in a complete diagram of a modern radio hook-up.

The one given here shows the method of connecting the instruments for the standard "short-wave regenerative" set, and it contains most of the symbols to be found in any hook-up.

Let us begin at the very beginning and take up each symbol.

In the upper left-hand corner is a triangle with a line drawn through it. This represents the aerial. The line goes down, bends to the left, goes down again and ends in a little arrow point. An arrow point, as we have already learned, means that the apparatus can be varied in some way, and the fact that this hook-up shows the

aerial connected to this variable point would indicate that the wire leading into this instrument goes directly to a shaft holding a switch blade.

The two corkscrew lines set near each other represent two coils of wire and the arrow striking between them shows that the position of these two coils with reference to each other can be varied. This would mean a vario-coupler or a loose coupler or a pair of any kind of coils used as a coupler.

The coil on the left is, of course, the primary and the bottom line of the coil leads down to the inverted pyramid of horizontal lines which is the symbol for the ground connection.

Most vario-couplers have two switch blades, one of them govern-

ing the taps by single turns of wire and the other governing the taps by larger sections and, if that is the kind to be used, the line in the symbols leading to the ground connection, instead of coming directly from the coil, might have had an arrow point on it the same as the line coming from the aerial. But in many such hook-ups an arrow point simply indicates variability, and it makes no difference how the varying is done. It might just as well indicate the sliders on the outside of a loose coupler. The prime object of the symbol is to tell you that the aerial and the ground are to be hooked to one coil of wire, with some means of altering the number of turns of wire that you use, and that this coil is placed near to another coil in such a way that the magnetism of one will affect the other and with some means provided for varying their position with respect to each other, and consequently varying the magnetic effect which one has on the other. This varying position is what we call "coupling."

The second corkscrew line represents the other coil of your coupler and, as there is no arrow point on the lines going out from it, it means that it is not necessary to vary the number of turns used in this particular coil.

The line leading from the top of the second corkscrew curve goes directly to the only unfamiliar symbol that there is in this dia-

gram. This is the cross formed by two saw-toothed lines, and I am giving it here in this form because many publications print it this way, though it is not strictly correct. A cross like this with the ends of two of its arms connected by a line indicates the instrument which we call a variometer.

To be strictly accurate, the two arms of this cross should have been made to look like Mary Pickford's curls. Saw-toothed lines, such as are given in this diagram, ought always to represent some kind of resistance, and a variometer is not a resistance. A variometer is two coils of wire, with the end of the outer coil connected to one end of the inner coil, and I am giving the wrong symbol here deliberately only to point out the fact that it means a variometer as given in many publications whose editors are not sticklers for accuracy.

Beyond this symbol for a variometer we see the two parallel lines with a space between them which we know represents a condenser, and we see that the line from this condenser leads into the circle representing the audion bulb to the jagged line which represents the grid.

In wiring up this part of the diagram we would attach one end of a wire to the secondary of the variometer and the other end to one end of the variometer. We would attach another wire from the other connection of the variometer to

one side of the grid condenser and another wire from the other side of the grid condenser to the binding post marked "G" on the bulb socket.

Let us now turn our attention to the lower end of the corkscrew line in the coupler. This leads directly to the right, to the series of alternate long and short lines, which means a battery. Above this battery you will see another smaller group of these lines connected to the hairpin line running into the audion bulb. This hairpin line represents the filament and, as the smaller group of lines representing a battery is connected to this hairpin line, we know that this smaller battery means the storage battery, because that is the one which lights the filament. The saw-toothed line between the battery and the bulb touched by an arrow point which indicates variability represents the rheostat by which we control the amount of current used to light the bulb.

### THE SYMBOLS FOR A TWO-SLIDE TUNER

It ought to be easy now for any of the readers who have been following these articles to hook up an audion bulb and a two-slide tuner from the diagram given on the next page.

First, we know that the long corkscrew line means a coil and the two arrow points touching it mean that it can be varied at two con-

nections. It will be seen that the two batteries are connected to each other on one side and even when a diagram does not indicate which is the plus and which is the minus side, the beginner is always safe in connecting the two minus sides together. I have seen many hookups giving a connection between the minus side of the B battery and the plus side of the A battery, but I have usually found it improved by connecting the two minus sides.

Going down again to the line leading from the secondary coil, on past your B battery, we see it connects to one side of the telephones and that same side of the telephones connects also to one side of a condenser.

The other side of the telephones connects to the other side of the condenser and also to another of those cross-shaped symbols, meaning a variometer, and the connection from this variometer goes directly to the plate inside the audion bulb.

As one of these connections goes off to one side, leading to the ground, and the other goes off to the side leading to the bulb, we know that these are not merely the tens and units switches of the vario-coupler because those switches only lead between aerial and ground.

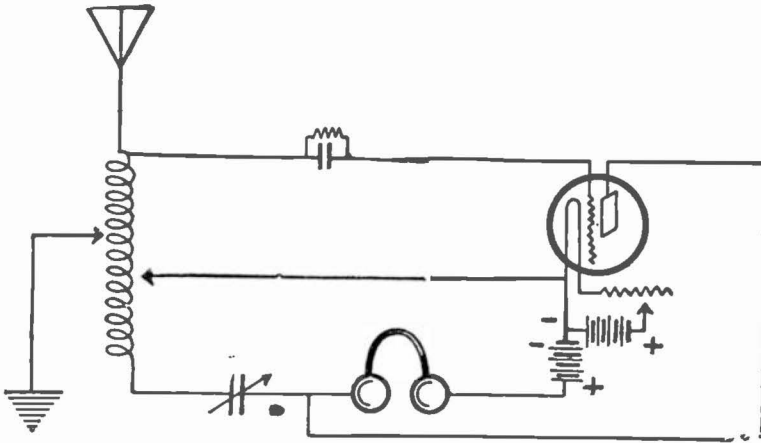

This is the technical diagram representing the hook-up for a two-slide tuner and an audion bulb. The meaning of the symbols and the methods of connections are explained in the accompanying article

This is the two-slide tuner which is the favorite instrument of so many beginners and which is, by the way, a very efficient and easily managed piece of apparatus in this hook-up. Let us read this diagram from the top and see what the connections are.

The triangle at the top means the aerial and the line leading from it to the top of the corkscrew curve shows that the lead-in of the aerial is connected to one end of the two-slide tuner and the line going to the right shows that the same end of the tuner is connected to the grid condenser and leak represented by the two vertical lines with the saw-toothed bridge over them and that the other side of this condenser and leak is connected to the grid binding post on the bulb socket as represented by the saw-toothed line (which means

the grid) inside the circle (representing the bulb).

The first arrow-shaped line leads down to the inverted pyramid of horizontal lines which always represents the ground and this means that one of your sliders should be connected to your cold-water spigot.

The other slider represented by the arrow-point shows a line connecting to the hairpin symbol inside the circle and, as this hairpin line always represents the filament, and you can see by following it that the side to which the slider connects also is connected to the minus sign on the battery, you know that this means that you are to run a wire from the second slider to the binding post marked minus on the bulb socket and that you are to run another wire con-

necting to these two from the minus side of your battery.

This double connection may be made at any place you see fit. It is really a triple connection because you will also see that the minus side of the B battery is in the same circuit. Personally, when I have four or five pieces of apparatus that are connected together in this way, I cut a little strip of tin from a tin can and solder the connections to it making it the common connecting point.

Thus, in this particular instance, I would run a wire from the slider and solder or screw the other end to the piece of tin. I would run another wire in the same way from the minus binding post on the bulb socket to the piece of tin, another wire from the minus side of the storage battery to the piece of tin and still another wire from the minus side of the B battery to the piece of tin.

This idea will be found an extremely useful one and it really makes for efficiency, because, when you put more than one piece of wire around a binding post the thumb screw is almost certain to come loose in time and a loose connection of this sort is the last thing you think of looking for when you are having trouble in getting your signals, though it is wise always to look for loose connections first when anything happens.

The lower end of the two-slide coil is shown connected to another symbol containing two vertical lines with a space between, which we know indicates a condenser, and the arrow striking through it means it is a variable condenser.

There is another line representing a wire running from the variable condenser to one side of the telephones and this line shows still another connection or branch coming off of it and running around to the plate binding post on the bulb socket.

A single branch like this is best made by scraping away the insulation on a part of a wire, twisting the end of the branch wire around the bare place, fixing it with a drop of solder and wrapping the connection with insulated tape or painting it with shellac or hot paraffin.

The other side of the telephones is shown connected to the plus side of the B battery.

The plus side of the storage battery goes up to the arrow point touching the saw-toothed line and, as we know a saw-toothed line like this means resistance and the arrow means that it is variable we know that this symbol represents the rheostat and that it is hooked up between the plus side of the storage battery and the plus binding post on the bulb socket.

## A GLOSSARY OF SYMBOLS

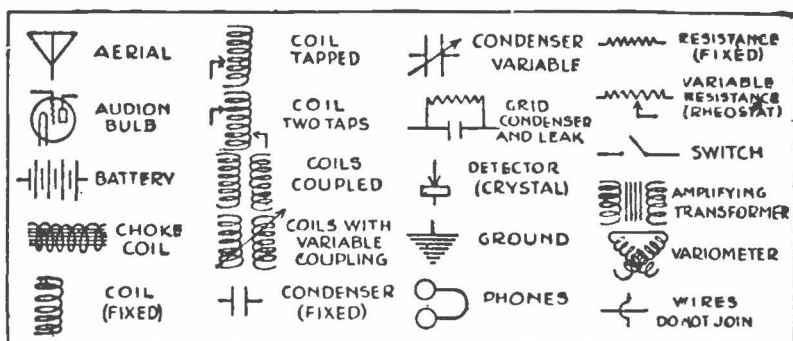

This collection of symbols will enable the amateur to translate and understand any of the ordinary diagrams of radio hook-ups

In our studies of the electrical diagrams used to represent various hook-ups, we have come across most of the symbols which the radio fan will encounter in any book or magazine on the subject.

In this article I want to make a rapid summary of these symbols and I am giving in the illustration the separate signs used to indicate various parts of apparatus.

The symbol representing the aerial is sometimes varied by running two little straight lines upward from the corners of the triangle. Other writers do not use the triangle at all but change it into a square form with two or three uprights like the points of lightning rods. The different variations, however, are easily recognizable and the amateur will find no difficulty in identifying them.

The sign for the audion bulb is the circle with the three little fig-

ures in it. It is most convenient to regard this sign as representing the socket. These sockets are now standardized and have four screws or binding posts on them to which you attach your wires.

One of these screws is marked G and is indicated by the little saw-toothed line in the symbol which represents the grid inside of the bulb. When you screw the bulb in the socket, it automatically makes contact with the binding posts marked G.

There is another binding post marked P and this is indicated by the little square or oblong inside the circle which represents the plate within the bulb.

The hairpin-shaped line represents the filament and, as it comes out of the circle in two places, this shows that there are two binding posts to which it is connected. On some sockets these screws are simply marked plus and minus.

In any electrical diagram you can tell which is which by following the lines down to the symbol which represents the storage battery and seeing to which side of it they are attached.

The choke coil symbol will not be found in the simple forms of diagram but is used in the new Armstrong super-regenerative circuit, in all transmitters, and in some of the more elaborate forms of receivers.

Given as shown in the illustration, it indicates a coil wound around an iron core; without the parallel lines cutting through the curved lines, it means a coil of almost any kind with no core and may be honeycomb, duo-lateral, or a single layer coil.

The illustration gives a number of symbols representing induction coils. The first one is a plain coil with no means of varying the number of turns of wire that you use. The next one, with one arrow point touching it, means that there is a switch or slider by which we change the amount of wire that we include in our circuit. The next one, with two arrow points, means

that there are two such switches or sliders.

The symbol with the two coils placed near each other means that there are two coils in such a position that the magnetism around one creates an electrical effect in the other and this makes what we call "coupled coils."

Strictly speaking, the symbol as given here means that there are no provisions made for changing the coupling—in other words moving one coil farther from and nearer to the other. This ability to change the coupling is illustrated in the next symbol which shows the two coils with an arrow striking through them. But most books and magazines nowadays have dropped this arrow and use the other symbol to represent coils whose coupling can be varied because they are really the only kind of coils that are used in modern sets.

All of the other symbols explain themselves and it will be a perfectly simple matter for the amateur to read almost any diagram by means of this glossary.

### THE WORKINGS OF A CONDENSER

It is so important for the beginner in radio to understand how a condenser acts and why it is used in radio that I am glad to print here a letter from a reader containing one of the clearest illustrations

that I have yet seen. The writer is George T. Prince, a consulting engineer of Omaha, Neb., and a member of the American Society of Civil Engineers. Mr. Prince writes:

"Referring to what you published



relative to condensers, you compare it to a tank storing water, remarking that as soon as the tanks were filled to the overflow pipe the readers are supposed to understand by some method the bottom of the tank is to drop out and the amount of water stored in the tank to be delivered in mass.

"It occurs to me that you would be interested to know of the 'flush tank' which is employed in sewer systems. You will recognize that small branch lines of sewers, particularly when laid on flat grade, will not, as a rule, carry sufficient sewage known as 'dry weather flow' to prevent the pipe from becoming clogged and foul, and to guard against this possibility we place at the head or upper end of such a lateral a device known as a 'flush tank,' which is simply a closed tank usually built of brick and sealed water-tight with cement, which receives water from a service pipe connected with the water main, the flow being regulated by a valve.

"In this tank is placed a vertical pipe extending to the elevation of the maximum water line and when the water reaches this pipe it overflows into the sewer below. Around and over this pipe is placed a pipe of larger size, the bottom of which is placed at elevation of low water mark, within a few inches of the bottom of the tank, the top being closed and extending a few inches above the top of the overflow pipe.

"In operation, the water rises in the annular space between the outer envelope and the discharge pipe until it reaches the top of the discharge pipe and flows downward through the same. Without going into details, suffice it to say that

this downward stream of water exhausts the air within the discharge pipe, setting up a siphonic action that results in discharging the contents of the tank in the fraction of a minute, the usual amount contained in the tank being approximately one hundred gallons.

"This flush of water down the sewer lateral overcomes the tendency of clogging above referred to and these flushings can be made as often as is necessary by regulating the flow of water into the tank by regulating the aforesaid valve. The 'flush tank' is then a good illustration of a fixed condenser.

"I believe there is yet a better illustration by comparing the condenser to the ordinary pile driving apparatus, in which a weight is raised through the leads to any desired height and then tripped.

"During the first operation of driving a pile the weight is raised to the entire height of the leads, where it is automatically tripped, and as the pile reaches the elevation at which it is desired to drive the same, the height to which the weight is raised is decreased so that the effective blow upon the pile will not be sufficient to drive it below the desired elevation. This illustrates a variable condenser.

"In the first instance, potential energy is stored in the 'flush tank' and delivered by the discharge of water; in the second instance, energy is imparted by the falling weight. In the electric condenser, as I understand it, electric energy is imparted by the current falling from a higher to a lower potential. It occurred to me that the above references might be of interest to you."

### YOU MUST LEARN TO CRAWL FIRST.

To the far-seeing man in the radio industry, nothing is more discouraging than the widespread advertising campaign to force the novice to buy the most elaborate and expensive kind of radio apparatus under the impression that it is so simple a child can operate it and so efficient that you and your friends can hear opera and concerts and lectures as plainly as though you were in the hall with performers.

Neither of these assertions is true. The set with three stages of radio frequency amplification, detector, two stages of audio frequency amplification and three five-watt tubes on an electrical loud speaker cannot be operated satisfactorily by the beginner. It takes an experienced and clever man to operate it. And even then it will never give you the illusion that you are actually in the hall with the performers.

Radio hasn't reached that stage yet and this advertising is leading hundreds of buyers into the science through false hopes that are not realized and the buyers quit in disgust.

The beginner must crawl before he can walk. He should start with simple apparatus and with the books that explain it in language understandable by a child. And, as he gradually absorbs the knowledge of the hows and whys of radio, he can add to his apparatus and elaborate upon it and all the time get the fullest measure of satisfaction from it.

E-Z RADIO is intended to teach you to crawl. From the first (May) issue, it has gradually led up from the simplest beginnings to the things you see dealt with in this number. But you will lose half the enjoyment and value of this and succeeding issues unless you start at the very beginning.

Send one dollar to this office for a six months subscription, instructing us to enter it from the May number.

E-Z RADIO,  
614 Arch Street,  
Philadelphia.

## BRING YOUR TROUBLES TO US.

Every beginner in radio runs into a snag in his early days. Something doesn't work and he isn't sufficiently expert in the science to locate the trouble.

Perhaps he buys some advertised goods and, when he gets them, can't find out how to hook them up.

Maybe he has some apparatus and thinks he might improve it by adding a variometer or a variable condenser or changing his hook-up. Maybe—but he isn't sure and he wouldn't know how to go about it if he were.

And so he writes to Mr. Neely.

You who buy this issue of E-Z RADIO have this privilege. We want you to feel that this is a magazine of RADIO SERVICE and, no matter what your problem and no matter whether you are a subscriber or not, write to Mr. Neely and let him do your puzzling for you.

Kindly enclose a stamped, self-addressed envelope for reply. Address,

HENRY M. NEELY,  
E-Z Experimental Station,  
Delanco, N. J.

DEPENDABLE



DIAMOND QUALITY

LINE

ESTABLISHED  
1909

Pioneers in Constructing  
Electrical Instruments

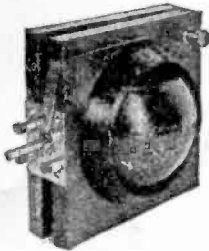

TRANSFORMERS

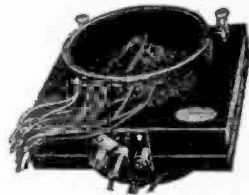

PLATE  
CONDENSERS

No. 41

Precision Variometer  
\$6.50

Panel Mounted, \$8.50

No. 42

Precision Variocoupler  
\$7.00

Panel Mounted, \$11.50

---

*INSIST ON THE "TESCO" LINE OF INSTRUMENTS*

---

Manufactured by

**THE EASTERN SPECIALTY CO.**

3551 N. 5th STREET

PHILADELPHIA