

AUGUST 1922

Price 20c

TWO STAGE AMPLIFIER

VOL. I

NUMBER
IV

E-Z RADIO

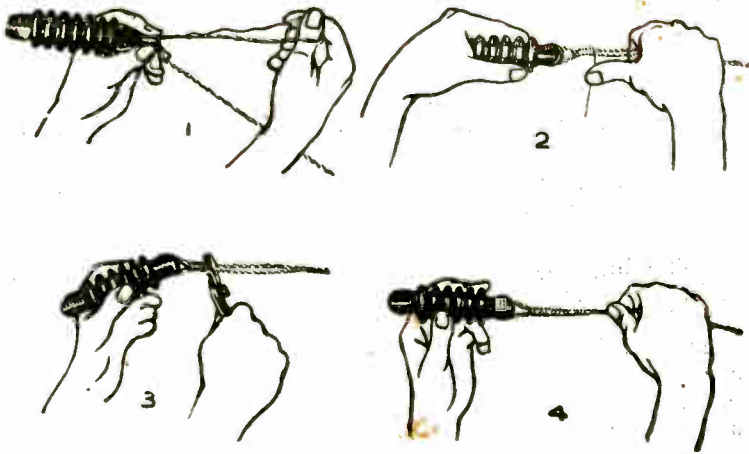

The Way to "Mouse" a Guy Wire

By Henry M. Neely

E-Z COMPANY, Inc.

401 CHESTNUT STREET
PHILADELPHIA

BETTER DAYS ARE COMING.

About the time that you readers of "E-Z RADIO" are getting this issue in your hands, the editor will be borrowing money for lunch and most of the people who are in the business of selling radio supplies will be wondering if they can't swap an audion bulb for a good square meal.

We've had a hard time of it this summer—all of us. You won't get the dealer to admit it but the editor of this publication hasn't sense enough to keep his mouth shut and so he rises right up in meeting and tells the horrible truth.

But the slump ought to have been expected by everybody. It hasn't hit radio only:—It hit the movies and the theatres and the phonograph people and all magazines in general.

Wherever you folks have had daylight saving time, you have had daylight until nine o'clock at night and you have been out in the parks and in the country and in your flivvers and your little putt-putt boats and you have been having a much better time than if you had been sitting at home cussing the static and, bless your hearts, it has probably done you much more good than sitting in a stuffy room with your ears dripping perspiration under the hot phones or reading the dull pages of this stupid little magazine.

We all expect to starve to death this month but you need not worry about that:—a lot of us are used to it.

But wait until next month and then October and then the rest of the winter!

The big boys of radio now have far too much at stake to let the game slump and you can depend upon some wonderful concerts being broadcast next winter and with Major Armstrong's Super Regenerative circuit allowing you all to use indoor aerials and so solving your most annoying problems, all signs point to a boom time and several million happy radio fans all over the country.

To say nothing of regular lunches again for the editor of this magazine.

Go to it!

E-Z RADIO

BY

HENRY M. NEELY

VOL. I.

AUGUST, 1922

NO. 4

Application made for registration as second class mail matter at the Philadelphia Post Office.

Copyright 1922 by The E-Z Company, Inc.

CONTENTS

The Best Aerial Spreader	2
Down the Scale of Wave Lengths	5
What We Mean By "Resonance"	7
The Ideal Amateur Aerial	9
Can You "Mouse a Guy"?	11
Some Pointers on Aerials	13
What the Fire Underwriters Require	14
Is Lightning a Danger?	17
Another Spider Web Idea	19
Demountable Spider Web Outfit	20
Condensers and the Spider Web Coils	22
An Easy Wave Length Changer	24
"Series-Parallel" Switch on a Panel	26
How Plugs and Jacks Are Used	27
A Complete Amplifying Outfit	29
A Detector and Two-Stage Panel	31
Complete Tuner, Detector and Amplifier	32
Those Queer Code Noises You Hear	34
The Dot and Dash is Easy to Learn	36
Good Code Practice For These Summer Evenings	38

Published by The E-Z Company, Inc., 608 Chestnut Street, Philadelphia

Subscription Price Two Dollars The Year.

THE BEST AERIAL SPREADER

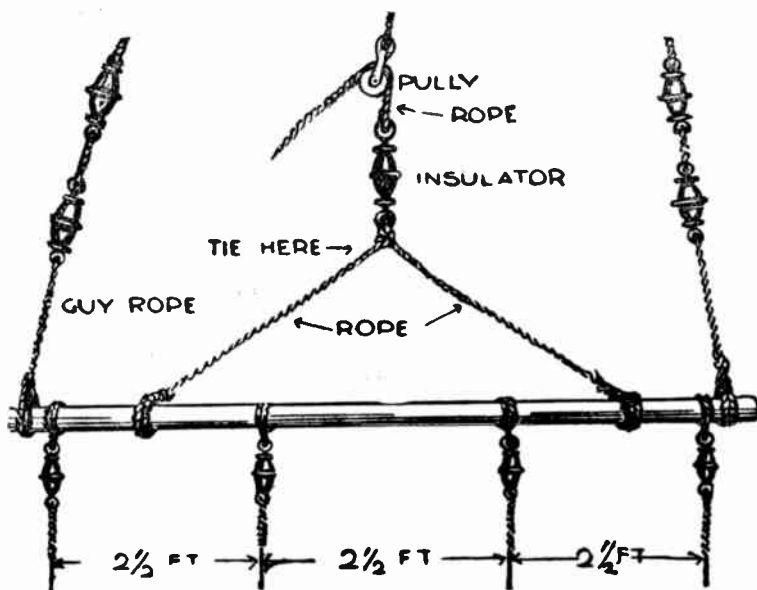

This is a clear working drawing showing how the spreader of an aerial is equipped. The importance of good insulators is explained in the article on page 13

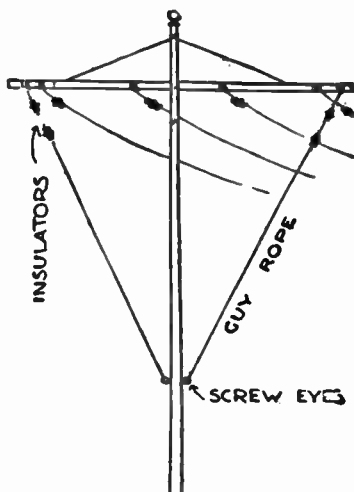

WE LIVE IN A VIBRATING WORLD

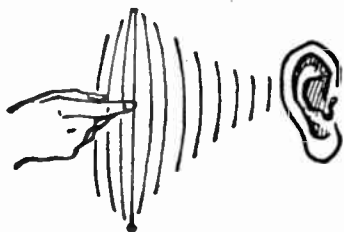

The universe is full of sending and receiving instruments, each with its own range of wave lengths. You pluck a string and you create waves that can be heard by the ear. Put your hand near a fire and the nerves respond to the wave lengths which cause heat. Light is the result of certain wave lengths which the eye can see. There are wave lengths longer and shorter than this, but the eye does not respond to them

The reader who is following these lessons in radio may feel that I am over-emphasizing the importance of studying the subject of vibrations and the matter of wave length, but we are living in a universe whose very existence depends upon vibrations, and all of the joys and all of the sorrows of the world might almost be said to narrow themselves down to a question of the wave length of these vibrations.

You wake up on one of these beautiful summer mornings and see a glorious day of sunshine and you are happy. Why? Scientifically it is because of the vibrations of the particular wave lengths which are having their effect upon you.

With no clouds to interfere there are vibrations with wave lengths of from one-thirty-thousandth to one-sixty-thousandth



of an inch, and that is pure sunlight—the combination of all of the wave lengths within that range. The frequency of these vibrations runs up to trillions of times a second, but you do not stop to count them; you merely know that your eyes receive the glowing sunshine.

That is because the nerves of your eye have tuned themselves to respond to these vibrations.

You turn your eyes away from the heavens and look across the country and you see green fields and the color of the lush brown earth freshly upturned by the plow, or a flash of red or blue or yellow from some bird dashing in and out among the trees or any one of the myriad colors of the flowers.

You do not have to turn any knobs or test any currents or twist any variometers to get the full effect of all this beauty. And yet, as your eye passes from one color to another, nature herself takes care of all this tuning for you and you select the different wave lengths without being conscious of it.

Some day, perhaps, you will be able to work your radio receiver just as quickly and as surely. But the two processes are fundamentally the same; light, whether the white light of the sun or the different colors that you see, is entirely a matter of wave length.

You will see in the advertisements of radio receiving sets such qualifying statements as "wave length range 150 to 450 meters." You may wonder why it is necessary to have limits of this kind placed upon a set.

Remember that, in this vibrating universe in which we live, there are waves so long that they will reach a score of miles from one crest to the other, and there are waves so short that the only way that we can measure them is to put them against the shortest wave we can actually measure and calculate how often these waves interfere with each other. It is not too much to say that we know of waves so small that we could have a billion of them on the head of a pin.

It is beyond possibility for any one piece of mechanism to respond to such a limitless range. The eye responds to waves between one-thirty-thousandth and one-sixty-thousandth of an inch from crest to crest, and these waves, producing what we call light, give the marvelous gift of sight.

There are waves still smaller than these visible ones. We know that they exist because we can make pictures with them upon an ordinary photographic plate even though the eye cannot see them. They are what we term the ultra-violet rays.

As we get to the longest waves that can be seen, producing the sensation which we know as the color red, we begin to be conscious of them through another of our senses, and this is the sense of touch. The vibrations cause what we know as heat.

Thus the human body has a separate receiving set for tuning in these waves of different lengths.

The sensation which we call sound is also entirely a matter of wave length, but there is this important distinction between sound and light; sound waves are produced by vibrations in the air, and will not go through a vacuum, whereas light waves are produced in the ether and will not only go through a vacuum, but through a number of very solid substances, such as glass and quartz.

Just as the different wave lengths in the range which we call light give us the sensation of different colors, so the different wave lengths in the air within the range of sound give us the sensation which we know as pitch.

The high, shrill note of the piccolo or the chirp of a bird is caused by air waves with the shortest wave length. It is possible, by mechanical means, to cause vibrations in the air which can be detected scientifically, but which the human ear cannot hear. Many naturalists believe that some birds and many insects communicate with each other by means of these short waves to which we cannot tune our own receiving instruments.

The great bass notes of a

church organ are produced on long pipes and some organs have pipes as much as thirty-two or even sixty-four feet long, but this is not usual, because very few persons can hear the notes produced by a sixty-four-foot pipe. Yet it is a mathematical certainty that if we make a pipe

128 feet long and use the same mechanical process for creating wave motion in the air in it, we are producing an effect which would be included in the word "sound" if our receiving instruments—the ears—were made to respond to that wave length. But they are not.

DOWN THE SCALE OF WAVE LENGTHS

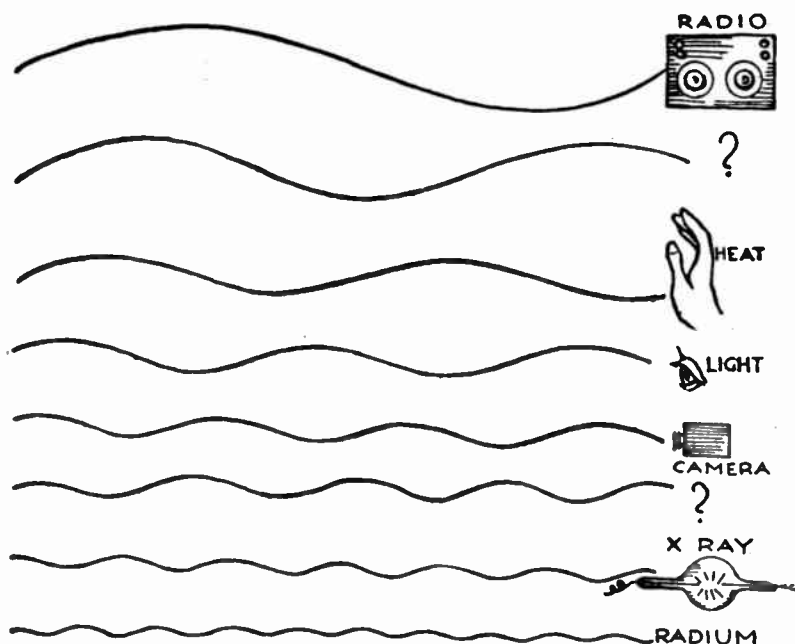

Vibrations in the ether take many forms according to their rapidity and the resultant length of their waves. This illustration represents the change in their nature from the extremely long waves of radio up to the infinitesimal waves of radium

Let us suppose today that we have invented a perfectly marvelous instrument — an instrument that there is no possibility of achieving in practice but which is perfectly easy to establish in an ordinary imagination.

This instrument is merely a wire string like the string of a

mandolin or a guitar and so arranged that, by twisting a key we can stretch it tighter or loosen it without any limits. If we could do this, there would, in imagination at least, be no limit to the slowness or the rapidity with which we could make it vibrate. And we must imagine that, instead of affecting the air,

the string makes vibrations in the ether.

We know that if we cause a million waves a second to pass any given point each of these waves, from crest to crest, would measure only one-millionth the length of waves passing at the rate of only a single one in a second. We can, therefore, put it down as a fact that the faster the vibrations are the shorter the wave length will be.

Let us suppose that we are starting our experiment with the string as loose as we can possibly make it. That will, of course, give us the biggest wave that we can produce. Science has made radio waves 35,000 meters long, but they are not used for practical purposes. Still, it is possible to produce them. Let us now gradually tighten the string while we continue plucking it. When the string vibrates fast enough to produce waves of 10,000 meters, or more than five miles, from crest to crest, we are getting into the band of lengths used for commercial purposes. These very long waves are used by the most powerful long-distance stations but please do not get the idea from this that wave length has anything to do with the distance over which a station can be heard.

As we tighten the string more and more and shorten the length of the waves from crest to crest we get to 2600 meters, which is the length used by the great navy station at Arlington for sending out the time tick at noon and 10 P. M.; we tighten some more and increase the rapidity of vibration, passing through the 600-meter wave of the ordinary commercial station, then the 360-

meter wave of the broadcasting stations and the 200-meter wave used by the amateurs.

So we can go on tightening until we produce waves only about one foot from crest to crest. All of these wave lengths, when they occur in the ether, are what we know as electricity.

As we tighten from this point on we come to a curious phenomenon. We come to a band of wave lengths about which science knows absolutely nothing. We must keep on tightening until the waves which we produce are only about one-tenth of an inch from crest to crest.

Here we begin to be able to detect them again but not by means of any electrical instrument. They have now become of such a length and frequency that the human body itself is conscious of them. As we continue to tighten the string, the hand with which we are plucking it will, in imagination, tell us what is happening. "It is growing warm," we will say. And that will be the fact. We are now producing waves which we know as heat.

Continue to tighten the string, thereby increasing the number of vibrations and making the waves continually smaller and gradually we will see the string beginning to glow. Here we have a curious overlapping of two of our senses just as, in radio work, well-designed sets have a large "overlap" for their various coils.

This overlap is detected from our string by the fact that our hand tells us it is growing hotter and our eye tells us it is beginning to glow. In other words, there is a certain band of wave

lengths between the heat waves and the light waves detectable both to our senses of touch and of sight.

We continue to tighten the string and soon it is blazing with a pure white light. It is incandescent. The longest waves that are both heat and light will produce a red glow. The color red is caused by the longest waves that are visible to the eye, and as we shorten the waves and thus increase the number of vibrations we pass through orange and yellow and green, blue and violet. The violet rays are the shortest which the human eye can respond to. When you know that red, the longest, is caused by waves less than one-millionth of a meter from crest to crest, you can imagine how extremely minute are the rays of violet.

And beyond these are the ultra-

violet, which are really light waves, but which the human eyes cannot detect. They will, however, make photographs and they can be handled scientifically, just as are other light rays.

Here, as our string vibrates still more rapidly we come to another band, which science has not yet been able to detect.

But beyond this blank band we come to X-rays and so to the smallest that we know, the "gamma" waves sent out by radium and other such substances.

And so we see that, in tuning our wireless instruments, we are accomplishing the great marvel of taking ether waves that are inaudible, invisible, insensible, intangible, and making of them a commercially profitable commodity and a means of home entertainment for millions of people throughout the country.

WHAT WE MEAN BY "RESONANCE"

It seems a pity to have to devote so many of these articles to extended definitions of technical words, but, as my object in writing the series is merely to prepare the beginner for further study in case he wants to undertake it, and as virtually all other writers insist upon talking of technical things as easily and glibly as you and I talk about pie and cheese, it is necessary for me to explain some of the most-used terms.

And one of these is "resonance." "We tune our secondary circuit to resonance with the incoming waves," you will read in every book or magazine you pick up. This sounds complicated, but it isn't. Resonance simply means to "sound again."

I remember one night many years ago sitting in the front row of a theatre near the bassoon player. Every time he blew a certain note I could feel my hat vibrating so actively that it tickled the ends of the fingers in which I held it. My hat was "in resonance" with that particular note, and, if it had been possible to make the hat produce a noise by drawing a violin bow across it or tapping it, it would have produced that note or else one of the octaves of it.

In other words, the hat was so constructed that, if it started to vibrate, it would send out waves of a certain particular length from crest to crest, and conversely, it would start vibrating when

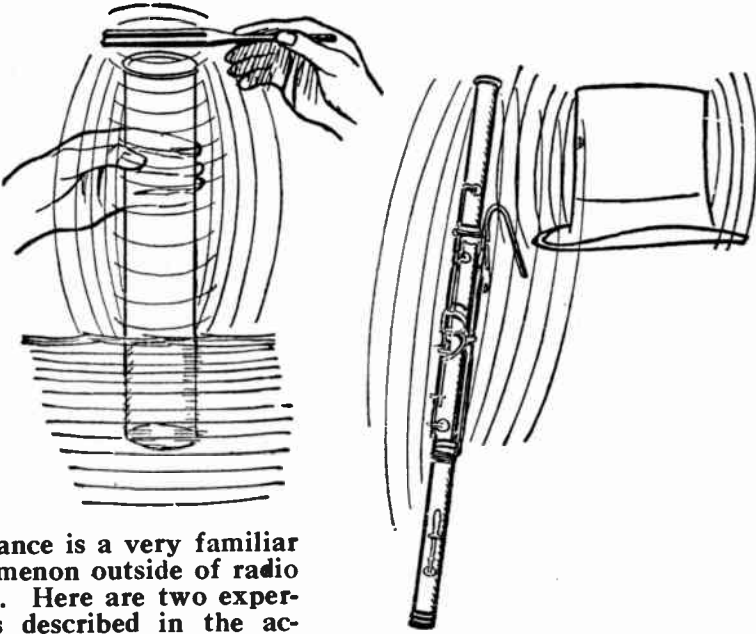

Resonance is a very familiar phenomenon outside of radio circles. Here are two experiments described in the accompanying article, proving resonance and explaining how it works in radio

waves of that particular length struck it.

Every thing in the world that is capable of vibration has this thing that we call its "natural period" or "natural wave length." They have even experimented with the Washington Monument in our national capital and found that its natural wave length is about 800 meters. Theoretically, then, it would be possible, if we could continue to produce 800-meter waves in the nearby air, to make the Washington Monument vibrate so violently as to topple it from its foundation. The monument would have been in resonance with the waves.

In these two instances we have been dealing with waves in the air, but the same principle applies through the ether.

Every aerial has a natural wave length. The average amateur's aerial, we will say, is 150 meters. If we insert a detector, in the line from this aerial to the ground and wire a pair of phones around it, we will hear all signals sent out on a wave length of 150 meters. But such a set would be no good for anything except this particular wave length, and so such an arrangement would be virtually useless for receiving to the radio waves which we send broadcasts unless we were able to construct it with a natural wave length of exactly 360 meters. And a set of such restricted usefulness would have little value.

So, in order to get best results, we put up an aerial with a natural wave length of 150 meters, and, in the line leading to the ground, we insert coils and condensers which have natural wave

lengths of their own and which are so made that we can vary their wave lengths. Thus, with our 150-meter aerial we add fifty meters of coil and condenser to receive the amateurs transmitting on 200 meters, or we use more of the coil and more of the capacity of the condenser, taking 210 meters of their value to add to the 150 meters of our aerial, and so we put our entire apparatus in resonance with the waves of 360 meters which are coming in from the broadcasting stations.

This is what we call "inductance" and "capacity," but these terms will not bother you if you will only remember that, for practical purposes, inductance means length of wire in the form of a coil and capacity means placing more or less of the plates of a condenser surface to surface.

Tuning our set in this way soon makes it vibrate in resonance with the transmitting station, just as my hat vibrated when the bassoon player struck a certain note, only in that case it was the bassooner who did the tuning.

There is a very pretty experiment which you can perform to prove to yourself what resonance is. This experiment is performed with a tuning fork, a lamp chimney and a bowl of water. Hold the lamp chimney over the bowl, strike the tuning fork, and hold it over top of the lamp chimney. The sound will come from the tuning fork alone, with no response from the chimney. But lower the bottom of the chimney gradually into the water, and soon the chimney will be singing as loudly as the tuning fork. It is in resonance. If you continue to hold the chimney so that the water is at the same point and tap it with your finger nail it will give out exactly the same note that the tuning fork gave out. The wave length of the part that is out of the water and free to vibrate is exactly the same as the wave length of the tuning fork.

That is all the highly scientific gentlemen mean when they tell you to tune your set "in resonance with the incoming signal."

THE IDEAL AMATEUR AERIAL

Five out of every ten of my correspondents include somewhere in their letters the question. "What do you consider the ideal amateur aerial?"

I will describe my ideal amateur receiving outfit, but I want to say in the first place that you can get a lot of fun and satisfaction out of an aerial decidedly less expensive and less perfectly constructed. If, however, you have the money to put this one up it will pay you to do it and you will have an outfit which you

can show to your friends with a good deal of pride.

For this aerial I am assuming a straight stretch of 125 feet and am advocating a single wire aerial. As I have said many times before, if you have only seventy-five feet make it a two-wire aerial and if you have much less than that, make it four or six wires. However, I am not so much concerned in this article with the antenna itself as with the masts and supports which are to hold it up and these are usually the prin-

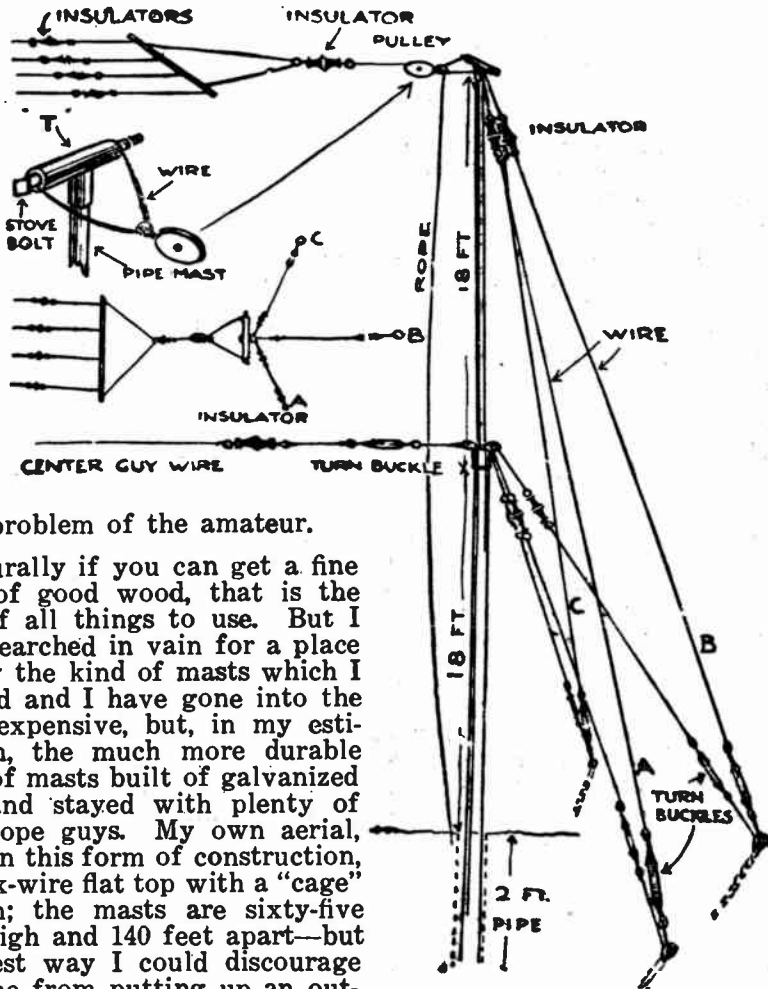

cial problem of the amateur.

Naturally if you can get a fine mast of good wood, that is the best of all things to use. But I have searched in vain for a place to buy the kind of masts which I wanted and I have gone into the more expensive, but, in my estimation, the much more durable form of masts built of galvanized pipe and stayed with plenty of wire rope guys. My own aerial, built in this form of construction, is a six-wire flat top with a "cage" lead-in; the masts are sixty-five feet high and 140 feet apart—but the best way I could discourage any one from putting up an outfit like this would be to show them the bills for it. Incidentally let me say that this is a transmitting aerial and has twelve wire counterpoise and that no such elaborate apparatus is necessary for the simple reception of broadcasting stations.

For the amateur I advocate masts, each one made of two standard eighteen foot lengths of galvanized iron pipe, the lower length being 1½ inch pipe and the upper 1¼ inches, the two being

This is an expensive way of putting up aerial masts, but it makes a very fine job. Construction details and prices are given in the accompanying article

connected by a reducing socket and strongly guyed both back and sides at the place where the socket joins the two and at the top. The top of the mast has a T connection and this holds the guy

wires and the wire to which the aerial pulley is attached. The pulling-apart strain at the tops of the two masts is taken care of by the aerial itself and the pull at the center should be taken care of by a wire with at least three insulators in it so that this wire will not absorb any of the energy from the aerial.

For this type of aerial mast first drive into the ground a two-foot piece of $2\frac{1}{2}$ -inch pipe for the sockets. The "anchors" for the guy wires should be three foot pieces of one-inch galvanized pipe, each topped with a T to pass the guy wires through. These anchors for the side guys should be ten feet from the base of the masts and driven all the way into the ground and for the back guys they should be twenty feet from the mast.

The two pipes should be connected and all the guy wires should be put in place on the masts before the masts are lifted and dropped into the sockets. And just one word of caution; in lifting these masts, have enough men helping you to keep all the guy wires taut as you raise the mast. Otherwise the threads at the connection are likely to snap off.

Insulators in the guy wires should be placed about five feet from the top end of the wire and there should be a turn buckle about five feet from each anchor, so that any slack can be easily taken up.

CAN YOU "MOUSE A GUY"?

The title of this article sounds like slang, but it isn't. It is a perfectly straight question in the technical talk of electrical line-men. "Mousing a guy" in wire-

I am giving below a price list for this apparatus, but this list is based upon prices of new stuff, and second-hand piping is just as good and would be considerably cheaper. Here is the cost:

2 pieces 18 feet long $1\frac{1}{2}$ inch pipe -----	\$9.00
2 pieces 18 feet long $1\frac{1}{2}$ inch pipe -----	7.20
2 reducing sockets at 30c ---	.60
2 $1\frac{1}{2}$ inch T's at 35c -----	.70
2 2-foot pieces $2\frac{1}{2}$ inch for sockets -----	1.80
6 3-foot pieces 1 inch for anchors -----	2.16
6 T's for same at 25c -----	1.50
500 feet galvanized clothes-line wire at 85c per 100 ft.	4.25
17 4-inch insulators, corrugated, at 40c -----	6.80
12 turnbuckles at 50c -----	6.00
2 pulleys for $\frac{1}{2}$ inch rope at 25c -----	.50
200 feet aerial wire at 70c hundred feet -----	1.40
120 feet window sash cord at 2c -----	2.40
Total -----	\$44.31

There is one great advantage in an aerial of this type. If you want to graduate into something still more ambitious, you can take your masts out, put another 18-foot length of the next size larger pipe on the bottom, splice on longer guy wires and raise it still higher. But always be sure that all of your guy wires are kept taut or some cold night in winter when a gale is raging you are likely to have them snap off.

less is more or less what splicing a shroud or stay is aboard a ship. The guy, of course, refers to the guy wires which support your aerial masts and keep them from

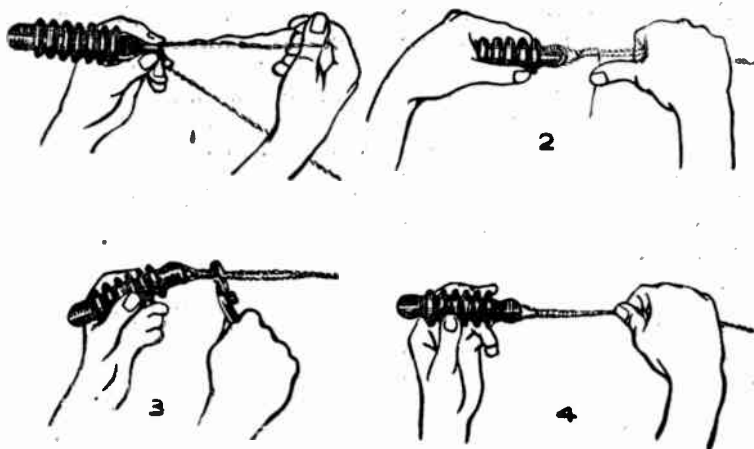

These illustrations show the process of "mousing" a guy wire

falling one way or the other. Mousing is the term applied to the best method of joining two wires or of fastening a wire back on itself after you have taken a turn around the pipe, or through the eye of an insulator or a turn-buckle.

Mousing can only be done with stranded wire—that is, wire rope made up of a number of separate wires twisted around each other. In the article in which we described the ideal aerial and told the reader how to erect the iron pipe masts, we told him to use galvanized iron wire for guys. This iron wire is the kind that is sold in coils of 100 feet for clothesline and it can be bought in any hardware store at a price ranging from sixty to eighty-five cents a hundred feet.

The pictures will probably explain the process of mousing about as well as any text.

You will find in most of the wire sold for clothesline purposes that one wire is much thinner than the others and is perfectly

straight, the others being wound around it. This thin straight wire is the last one that you use in mousing.

When you have passed the end of your wire through the eye of your insulator you bend it back on itself and unravel one strand of the wire back to where the two wires cross. Then twist this one strand around that crossing several times, pulling it as tight as possible with the pliers on each turn. Continue this spiraling of the wires until that strand is all on and twist the end as tightly as possible with the pliers.

Then unravel another of the big strands and wind it in the same way until it is all on and twist it tight.

In this way you do all of the strands, ending up with the thinnest straight one, which simply spirals around the bare wire rope, as all of the other strands have already been twisted on.

This is not only the neatest job that you can do with the guy wire, but it is also much stronger

than any other way of making it fast. If it is properly done and if the loop has been made as tight as possible the wire will break almost anywhere else before the mousing will part. If, however, you let the loop become too loose and you put a heavy strain on the guy afterward, the mousing will have a tendency to pull, though this is so only under such great strain that the insulator would probably break first.

This mousing is also the ideal way for joining two pieces of aerial wire together. First you unravel all seven strands of both ends for about three inches back. Then you fit the two ends together so that the strands of one wire come between the strands of the other alternately.

With all the strands scraped bright and clean, you mouse both ways and then wipe your solder all the way along the mousing. In this way you have a well-soldered joint for all seven strands of wire and you have a job that looks neat, is as strong as it is sible to make it and offers much less electrical resistance than any other way of making a connection.

This may seem a lot of trouble to take, but you must remember that the man who wants to get results out of his radio set must attend carefully to all such little details, for it requires only one bad connection or one faulty piece of insulation in any point in the entire circuit to put your receiving set out of business entirely.

SOME POINTERS ON THE AERIAL

Quite early in this series of articles we discussed various methods of putting up an aerial and I supposed that every one understood the matter by this time. I have been told lately, however, by several of my friends in the radio business that customers constantly come in to them for further information about putting up their antenna and that most of these questions have to do with details of equipping the "spreaders."

This is probably due to the fact that, following the unfortunate spread of the one-wire aerial idea in most of the radio magazines, beginners have tried the single wire without satisfaction and have finally resorted to two or four wires in desperation.

I wish the readers of these articles would get one thing very clearly into their heads, and that

is this: If you have a stretch of seventy-five feet or more for your aerial and can get it thirty feet or more in height, one wire will be perfectly satisfactory. If, however, your stretch of aerial is less than seventy feet or lower than thirty you should have at least two wires and preferably four, and in spite of all the assertions to the contrary made by the learned gentlemen who sign "Radio Engineer" after their names, you WILL get better results (on short stretches and low heights) with multiple-wire aerials than you will with single wires. If you can stretch an aerial a hundred feet or more, your one wire will be the best for you to use as well as the simplest.

In order to meet the questions of the beginners who are puzzled about the rigging up of their spreaders, I am publishing on

Page 2 a fairly large-sized drawing of the standard spreader equipment for a four-wire aerial. This drawing is really self-explanatory, but there are a few pointers which may be taken up.

If you can possibly afford it, buy insulators which are at least six inches long and which have many deep corrugations around them. This may seem a needless expense when you know that a piece of ordinary writing paper is sufficient insulation to prevent the weak currents in the antenna from leaking through. But this is true only when the paper is absolutely dry and unbroken.

An aerial is a great collector of dust and soot, especially in a city, and this dirt, being deposited most thickly on the surface of the insulator, becomes a persistent collector of dampness. Once damp, the moisture forms an excellent conductor and in a short time you will find yourself receiving weaker and weaker signals without knowing why. The explanation is that the current is leaking through the moisture in the dirt on the insulator and is so escaping to the ground. The longer the insulator and the more surface given to it by deep corrugations, the more resistance there

will be to this current and the less likely it will be to escape from your set.

Whatever type of insulators you use, it is a very wise caution, every now and then, to give them a good coating of heavy automobile grease. This has the happy faculty of shedding moisture and it is well worth the trouble.

Be particularly careful of the insulators in your guy ropes. It is really worth while to put two insulators in each guy rope, especially if you wish to receive during or after a shower, a fog or a dewy night. Here the corrugations are especially important; otherwise the moisture will form in drops and will run straight down the guy rope and the electric current will joyously follow the drop of water and escape to the ground. Only deep corrugations will prevent this calamity.

The spreader for a two-wire aerial should be at least three feet, that for a three-wire at least five feet, and that for a four-wire at least eight feet. In other words, you should have your aerial wires about two and a half feet apart and leave about six inches of the spreader sticking out at each end.

WHAT THE FIRE UNDERWRITERS REQUIRE

The laws which apply to the installation of radio-receiving sets in houses are at the present time somewhat confused because the fire underwriters of different cities have not yet had sufficient experience with this new form of public amusement to satisfy themselves as to its dangers to life or property.

Lightning seems to be the principal bugaboo both from the in-

surance and the individual standpoints, but let it be said right here for the benefit of the nervous individual that a properly constructed aerial, properly grounded, is the very best lightning rod in the world, and, so far as I have been able to learn, there has never yet been a case of lightning striking a house so protected. There have been cases where lightning has entered the house

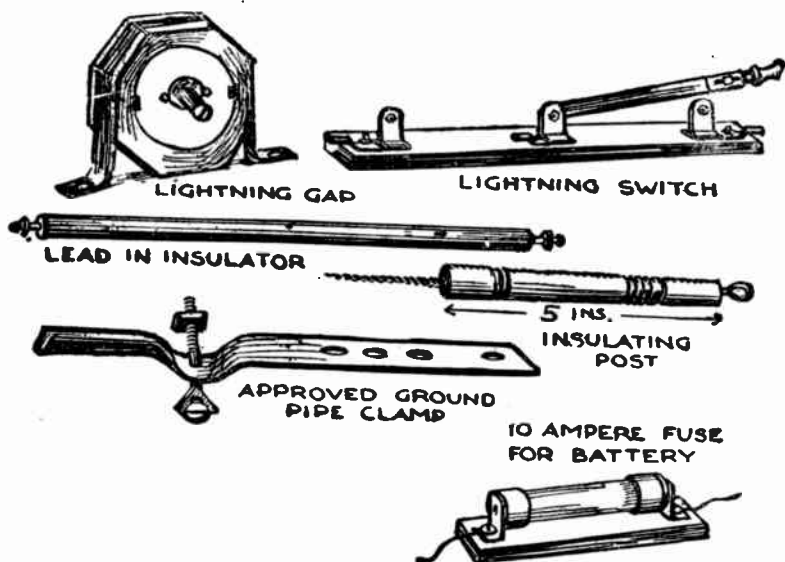

These are some of the standard types of safety appliances required under the National Fire Protection Code. They are described in the accompanying article

when the lightning switch had been carelessly left in the wrong position, but with the switch grounded or with an approved lightning arrester in the circuit the house is as safe as human ingenuity can make it. In fact, it would be good common sense for any one to put up such an aerial merely for protection from lightning, whether they intend to use a radio-receiving set or not.

At the present time almost all cities have adopted the tentative regulations drawn up by a special committee of the National Fire Protection Association.

In the first place all wiring about the set "must conform to the general requirements of the national electrical code for the class of work installed." In addition to this, there are other requirements especially applicable to receiving sets.

Your aerial wire must not cross over or under electric light or power wires, nor must it be so placed that a break in either the aerial or a nearby light or power wire might cause the two to come in contact.

All splices and joints in the aerial span must be soldered unless they are made with approved clamps or splicing devices.

Your lead-in wires must be of copper or of approved copper-clad steel or other approved material that will not corrode, and it must be at least No. 14 in size, except that No. 17 copper-clad steel may be used.

If you bring your lead-in wire along the outside of your building, you must have it mounted on insulating supports, which, in most cities, are required to be of such construction that they will keep the wire at least five inches

from the wall, and you must not let it come nearer than four inches to any light or power wire unless the two are separated by a continuous and firmly fixed weather-proof-non-conductor, and this non-conductor shall be in addition to any insulation on the wires.

Your lead-in wire must be brought into the building through an insulating bushing or tube that is both fire-proof and moisture-proof.

Every lead-in wire must be provided with an approved protective device. This may be located either inside or outside of the building, but it must be as near as possible to the point where the wire enters the building. It is best to get one of the weather-proof devices, of which there are a number on the market, and to mount it outside.

This protective device must be a lightning arrester that has been officially approved by the underwriters.

There is one sentence in these regulations which will surprise most amateurs and which is extremely important to remember. It is this:

"THE USE OF AN ANTENNA GROUNDING SWITCH IS DESIRABLE BUT DOES NOT OBLVIATE THE NECESSITY FOR THE APPROVED PROTECTIVE DEVICE REQUIRED UNDER THIS SECTION."

Let me interpose here a bit of advice which is unofficial. The lightning arrester will protect your house from lightning but only a lightning switch will protect your set from the danger of damage by strong currents induced by the discharge of lightning nearby. By all means have a single-pole

double-throw switch "shunted" around the protective device, and make it a habit to put the blade in the "ground" position when you have finished using your set. The section of the underwriters' requirements here quoted leaves the size of this switch optional with you, but it is well to get as large a one as you can afford, and, as a matter of fact, it is by all means best to get one of the regular lightning switches sold for this purpose, because many inspectors will refuse to pass an installation without it, in spite of this sentence quoted from the code.

The protective ground wire should be entirely separate from the ground wire of your set and must be of copper. The national code says that it shall not be smaller than No. 10, but most cities and most inspectors require that it be at least No. 4, so you had better get the big size and be on the safe side. Preference is given to outside water pipes as ground, and galvanized pipes or plates driven into the earth or buried are approved, but UNDER NO CONDITIONS SHALL A GAS PIPE BE USED as a ground, either for the protective device or for the set.

The ground wire of the set should be copper and at least No. 14 gauge. The wiring between your storage battery and your set must be at least No. 14 and rubber covered, and each of these conductors to your storage battery must be protected by a fuse not greater than ten ampere capacity, these fuses to be installed at the nearest accessible point to the battery.

IS LIGHTNING A DANGER?

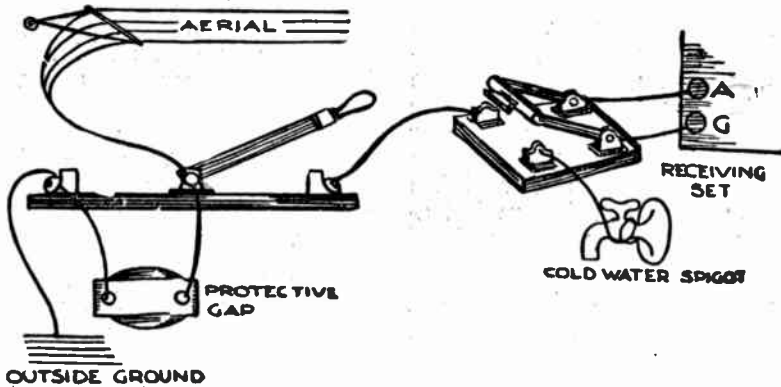

A small two-bladed switch installed on your operating table will protect your set from too strong currents induced by distant lightning discharges

Several short-sighted manufacturers of lightning arrestors have recently been putting out glaring full-page advertisements in the radio magazines, announcing in screaming big letters, "Save your home! Your aerial attracts lightning!"

Of course, in a series of articles like this it is not incumbent upon me to comment on the tendency that such an advertisement has to scare people out of radio and so reduce, rather than increase, the manufacturers' own market. But it is within my province to dispute the truth of these widely spread statements, and I cannot make one fact too strongly emphatic, and that is this:

YOUR AERIAL DOES NOT ATTRACT LIGHTNING. WITH THE STANDARD OUTFIT IT IS THE BEST LIGHTNING PROTECTION THAT YOUR HOME CAN HAVE.

Let us for a few minutes take up this matter of lightning, what it is and what it does, so far as science knows.

We have seen in our studies of radio apparatus that a condenser is a series of metal plates divided into two groups placed near each other, but with no electrical connection between the two groups. We have learned that when the plates of one group are charged with positive electricity and the plates of the other are charged with negative, there occurs a state of strain or tension in the ether between them and that this tension will build up to such an extent that it will break down resistance and discharge itself in the form of electricity.

In radio sets we arrange our circuits in such a way that the electricity caused by the breaking down of this strain is conducted through our wires and used in the production of signals. Just so long as we furnish a path for this electricity to travel on it will pass through the wires harmlessly and give us the music and speech that we want to get.

But if we did not provide this leak, the strain would become so

great that an actual spark would jump across the space between the two sets of plates. If you want to see this actually demonstrated, take one of your variable condensers, hook it up in the place of your spark plug on your automobile, set your timer for a contact and watch your variable condenser give a miniature imitation of an old-fashioned Fourth of July.

During a thunder storm the clouds form one plate and the earth another in a huge condenser. A charge of one kind of electricity will build up in the clouds and a charge of an opposite kind will build up in the earth beneath them.

This causes a state of strain in the ether of the atmosphere between. Just what is the nature of this state of strain we do not know. It is believed that the positive side of the condenser disrupts the atoms nearby, steals from them a lot of their negative particles, which we call electrons, and that these atoms in turn steal from those around in an effort to regain their normal number.

When we change the balance of particles in an atom we cause it to become what we call an ion, and the process is called ionization. When the ionization of the atmosphere has reached a certain degree it forms a path over which a sufficiently strong charge of electricity can pass, and at the very first disruption of this path the whole resistance breaks down and the charge empties itself all at once between the two plates of the condenser and we have what we call lightning.

If, however, we put up into the air between the earth and the clouds a good conductor of elec-

tricity and carefully provide a path for this electricity to travel along the conductor straight into the earth, the ions will be attracted by the conductor and will regain their normal electrical state through the easier path to the earth, and so the state of strain will be relieved and no spark or bolt of lightning will shoot across.

That is what we do when we put up a lightning rod. As you know, the more points there are on a lightning rod the better it is, because we are presenting more surface to attract more ions, and so we prevent the state of strain from taking place over the particular spot protected in this way.

If four or five little metal points such as you find on a lightning rod will protect a house, you can imagine how much better protection you will have through the very much greater conducting surface offered by the wires of a radio aerial. This is true, of course, only when you have your aerial connected directly to the earth during a thunder storm. This is done by putting your lightning switch in the "ground" position. Set in this way, the blade of the switch gives an easy path for the ions and so prevents a state of strain in the ether above.

I am showing in the illustration the best arrangement to take care of this whole matter of lightning. You will notice that, in addition to the required gap and the lightning switch, I am including a small two-bladed switch to be placed on your operating table and connected to your aerial and ground. This is merely to avoid all chance of having your delicate telephone windings injured by

the extremely strong currents which are induced by the discharge of lightning, even though it may be many miles distant. It is a wise precaution to install this

little switch and to make a habit of always opening it when you have finished receiving for the night.

ANOTHER SPIDER WEB IDEA

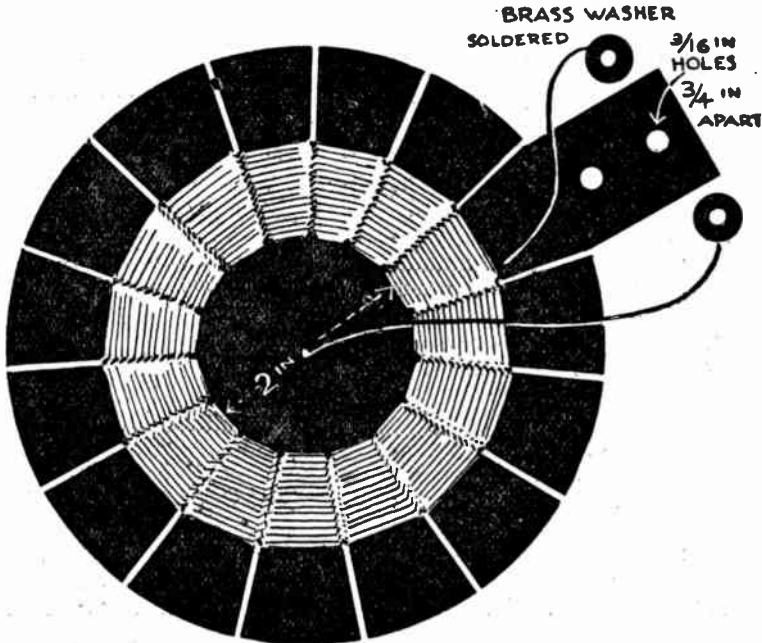

This is a labor-saving variation of the method of winding spiderweb coils for radio receiving. It avoids the trouble of tapping

Judging from my correspondence there seems to be a very great desire on the part of the radio amateur to try the spider web coil which I have been advocating, but I notice that nine out of ten do not want to go to the trouble of tapping their coils. This I can understand and for their benefit I have worked out a scheme by which they can avoid tapping. It involves the use of a variable condenser but the price of these instruments, unmounted, is beginning to get down to the point where anybody can afford them, and there is no question

about it that a variable condenser in a circuit forms the handiest and finest kind of tuning apparatus through the range of wave lengths which it will handle in connection with a definite size of coil is naturally limited.

This new spider web coil mount is, in its essentials, the same as the one which I described in these articles some time ago. The point of difference lies in the extension of one spoke of the form upon which the coil is wound. The picture shows how this spoke is extended. For amateur use the

extreme limit of the long spoke is four inches from the center.

Three inches from the center I bore a hole big enough to take an 8-32 machine screw and three-quarters of an inch further out I bore another similar hole.

I wind coils of various numbers of turns and these different coils are adaptable for receiving different wave lengths. Let us assume that we are winding a coil of fifty turns. By the way, let me correct a mistake which my correspondence proves a number of the readers of these articles are making. I find that many readers, in counting the turns that they have put on a coil, count the wires crossing on one side of the spoke only. They forget that there are an equal number of turns crossing on the other side. Thus, when you have wound a coil which shows twenty-five turns of wire on one side of a spoke, you know that you have altogether fifty turns on the form, for there are twenty-five turns on the other side.

When you have finished winding the fifty turns on the form it is best to solder a small brass washer on the two ends of the

wire. This makes the neatest and most efficient job electrically; but, if you are one of those who do not want to go to the bother of tapping their coils, you will also probably not want to go to the bother of doing any soldering at all. If this is the case, simply scrape the insulation off the ends of the two wires for about three-quarters of an inch, and you will be all right.

I have not room in this article to take up the details of mounting these coils but will do so in the next article and show you how easy it is to put them together in a very convenient and effective form that will give you a lot of satisfaction.

If you want to wind these forms at once, let me say that if you are going to use the hook-up including two variometers, you will need for this variocoupler two coils of fifty turns, each, and these will just about give you the best results for the wave lengths on which concerts are broadcast.

If you are going to use these coils in connection with a crystal detector you had better make one of them sixty turns and the other one eighty.

DEMOUNTABLE SPIDER WEB OUTFIT

In order to use the labor-saving spider web coils without taps, which I described in my last article, it will be necessary to make a slight variation in the panel mounting which we considered some time ago. This variation, however, makes a much easier job and one which any schoolboy can do with the ordinary tools which every family has and with the junk which is found lying about most houses.

I am not going to advocate going to the expense of building this mount with bakelite or formica or hard rubber. Plain, ordinary wood will do very well and an old cigar box will save you a lot of trouble. There are a number of makes of cigars that come in boxes that are almost square and which measure something like six or seven inches on a side. The brand of cigars which made the nickel famous, in the

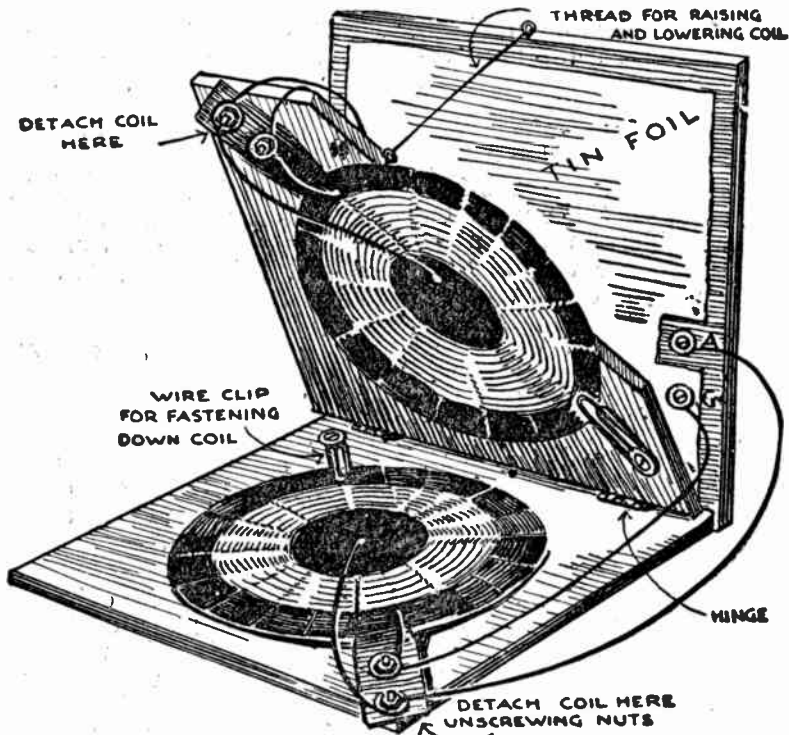

Here is a panel mounting for spiderweb coils that saves a lot of trouble and that is very efficient

old days when a nickel could really buy something still come in a box which is ideal for this coil mount.

With the open end of this box uppermost, decide which side looks best for the front of your panel and then carefully remove the opposite side. This leaves you with a bottom, a front, and two sides all firmly nailed together and saves you a lot of work. Be careful of the side which you have removed, for you are going to use that to mount one of your coils on. In the illustration you will see that the upper coil is mounted on a piece of wood which can be raised or lowered from the lower coil. The side of the cigar box which you have re-

moved should be cut down to take the place of that piece of wood and should be fastened by two small hinges to the base.

The first thing to do is to place two coils center to center and mark these centers and the two holes in the extended spokes upon the base and the piece which raises and lowers.

You will find it necessary to place the coils so that these extended spokes will not come together, for if they did the machine screws by which you mount them would meet and would prevent as close "coupling" of the coils as you will need to receive many of the broadcasting stations.

The picture of this mount is so clear that I do not think any further description is necessary. You will see how the machine screws fit into the holes bored into the extended spokes and how connection is made by screwing down the nuts on the wires. On the left-hand side of the front of the panel there are two binding posts, the upper one for the aerial connection and the lower one for the ground connection. These are permanently wired from the back of the panel to the two machine screws on the base. The aerial binding posts should always be connected to the wire which goes to the inside of the coil, and the wire that comes from the outside should go to the ground binding post. On the right-hand side of the front of the panel there are two other binding posts which are similarly connected to the two machine screws which hold the upper coil in place. This makes the lower coil the "primary" and the upper coil the "secondary."

The paper clips which you see holding the outer edges of both the coils are necessary because, if

either coil trembles even a little bit, you will have an annoying trill or wobble in your signals.

To change coils you simply turn the paper clip one way or the other until it is off the coil, loosen up on the two nuts and remove the whole form. Putting on new coils simply reverses the process.

The coupling, or the distance of the upper coil from the lower, is altered by means of the thread which goes through the screw eye on the top of the panel and down the front to a knob, exactly as described in our other articles on spider web coils.

In winding your coils it is always wise to mark on the hub an arrow pointing in the direction in which the wire is wound. Then when you go to mount them on this stand there are two important things to remember; first, see that the centers come absolutely together and, second, see that the arrows point in the same direction when the coils are closed upon each other.

CONDENSERS AND THE SPIDER WEB COILS

If you use two spider web coils that have not been tapped, or untapped coils of any other kind, you can receive only such signals as are sent on a wave length which equals the wave length of your aerial and ground outfit plus the wave length of your coil. There is no variation possible except a very slight margin offered by the difference in the coupling of the coils—the variation of the distance apart.

It is possible, however, by means of variable condensers to

give yourself quite a large margin because you are able to change the wave length both by means of turning the knob on the variable condenser and by means of hooking it up in different ways.

The variable condensers which are shown in this illustration are those which come already enclosed in cases with neat knobs and dials on them. These are the most expensive but are the handiest for purposes of illustrating the subject of this article. You

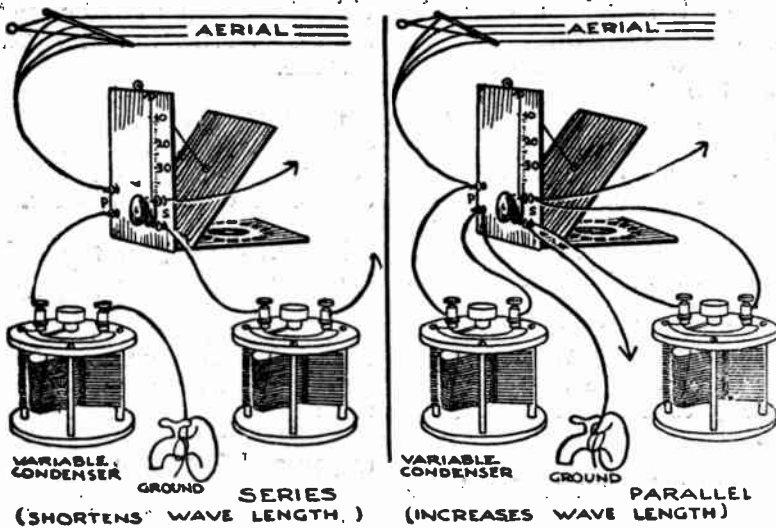

This picture shows the different ways of hooking up variable condensers to fixed spiderweb coils, and the article explains what is accomplished by each connection

can, however, get exactly the same result by buying unmounted condensers, mounting them on panels similar to your coil mount—cigar boxes make excellent things to mount variable condensers in—and you can mark out your own dials on a circular piece of cardboard and make the knob of a tin pot handle or the knobs that the 5 and 10 cent stores sell for bureau drawers.

I am going to assume today that you have made two spider web coils of fifty turns of wire each and that you have two variable condensers. The object of this article is to show you how to use these condensers so that you can either increase or decrease the wave length of your coils. I cannot tell you which you will have to do because it will depend entirely upon the natural length of your aerial, your lead-in and your ground connection. The two methods of connecting condensers are known as “series” and “par-

allel.” Parallel connecting is also known as “shunt.”

There is one rule which you can remember: Series connection shortens wave length; parallel connection increases wave length.

You can use either twenty-three plate or 43 plate condensers but the forty-three plate type is better because it gives a wider range.

The illustration on the left shows both condensers connected in series. If you will follow a radio impulse from the aerial down you will see that it goes in through the upper binding post, all the way around the coil, out of the lower binding post to one side of the variable condenser, through the condenser and so to the spigot. In other words, it traverses the coil before it reaches the condenser.

In the right hand picture, however, the impulse would come

down from the aerial and would divide at the upper binding post. Half of it would go along the wire to the condenser and the other half would go through the wire on the back of the panel and around the coil. The impulse would meet again at the lower binding post after passing through both coil and condenser and would then go to the ground.

When you first try out this fixed coil arrangement, you will have to find out by experiment in which way to connect your condensers.

If you are using an audion bulb with two variometers I advise connecting the first condenser from the aerial as shown in the left-hand picture and the secondary condenser will not be needed. If you do not get signals from

this, change your condenser to the hook-up shown in the right-hand picture.

By means of this process of elimination you will find the correct adjustment either for an audion bulb or for a crystal.

If, however, you are going to use this coil mount in what is called the "single circuit" hook-up, described some time ago in these articles, your secondary condenser must always be connected in parallel as shown in the right-hand picture. This is because the upper coil is then used, not as a secondary, but as a "tickler," and is connected to the "B" battery. The difference lies in the fact that, while radio impulses will go through a condenser, direct current such as the "B" battery produces will not go through it.

AN EASY WAVE LENGTH CHANGER

Now that the price of variable condensers, unmounted, has got down to the point where anybody can afford to buy them I want to show you a very efficient attachment for your radio set which will enable you to make quick changes in wave length and to do extremely sharp tuning as well.

In one of my recent articles I told of the two ways of hooking up a variable condenser to any coil. One of these ways is what we call "series" and the other we call "parallel" or "shunt."

When you attach the condenser in series with the coil you shorten the wave length of your circuit. When you attach the condenser in parallel or, to use another expression, "across" the coil, you

increase the wave length of the coil.

It is a very difficult matter to tell any amateur just what the natural wave length may be of a new coil that he may build or that he may buy.

With a variable condenser, however, hooked up in one of these two ways, he can, by a mere twisting of the knob back and forth, cover the same range of wave lengths as would be covered by three or four points of his switch. The difficulty is to know whether a wave length on which a station is sending is greater or less than the wave length of your coil. If it is greater you will want your condenser hooked up in parallel so as to increase the

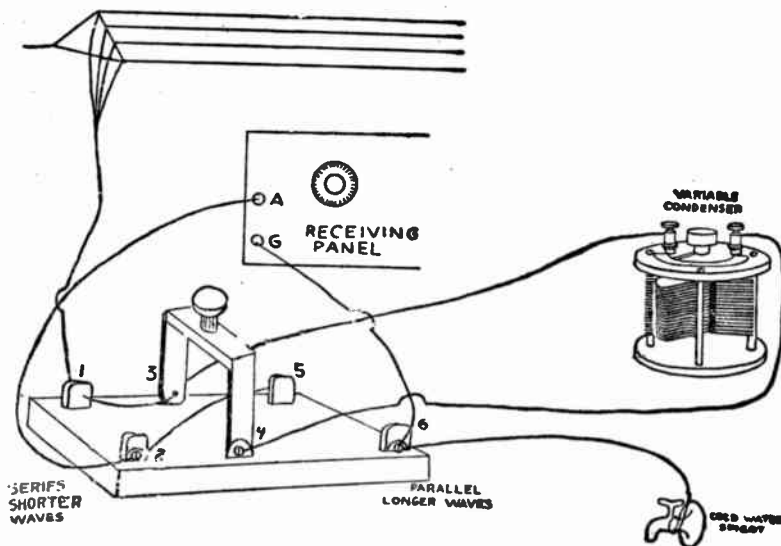

Here is a handy hook-up by which one switch will enable your variable condenser either to decrease or increase the wave lengths of your variocoupler

natural wave length of your coil.

Naturally it is a great deal of trouble to change the hook-up of your condenser from series to parallel, but the addition of the little switch shown in the picture makes it a very easy matter.

When you buy your switch you ask the storekeeper for a "double pole double throw switch." When you take it home and hook it up according to these directions you call it a "series-parallel" switch.

The great advantage of this is that when you throw this handle to the left your condenser is in series, and turning the knob enables you to hunt for a station on the shorter wave lengths, and if you do not hear it there you throw the handle to the right, which immediately connects your condenser in parallel, and turning the knob enables you to hunt for

the station on the longer wave lengths.

Without this arrangement you are forced to go through all of the many adjustments on both your tens and units switches and you are limited to the natural wave lengths included in the coil alone. This arrangement gives you all those wave lengths and in addition the series position gives you shorter ones than you have on your coil, and the parallel position gives you longer ones.

When you are ready to hook up this switch place it in about the same position that you see it in the illustration and wire up according to the numbers given in the picture.

First there are two wires to be connected on the switch itself. A short wire runs from binding post No. 1 to No. 3, and another short wire from No. 2 to No. 5.

Then you detach the aerial lead-in from your cabinet and attach it to No. 1 screw on the switch. You run another wire from No. 2 screw on the switch to the aerial binding post on the cabinet, from which you have just disconnected your lead-in.

You then detach the cold water spigot wire from the "ground" binding post on your cabinet and attach it to No. 6 screw on your switch, running another wire from that same No. 6 screw to the ground binding post. Then you run a wire from the No. 3 screw on the switch to one post on the variable condenser, and another wire from the No. 4 screw on the switch to the other

binding post on the condenser, and you are all set.

In the picture I am using one of the standard mounted variable condensers only because it saves space, but the connections will be the same if you buy an unmounted condenser, and put it on a panel. It is worth while to put a forty-three-plate condenser in this hook-up because it covers a much wider range of wave length than the twenty-three-plate kind, but either one will do.

In operation remember that when your switch handle is thrown to the left it shortens your wave length, and when it is thrown to the right it increases it.

"SERIES-PARALLEL" SWITCH ON A PANEL

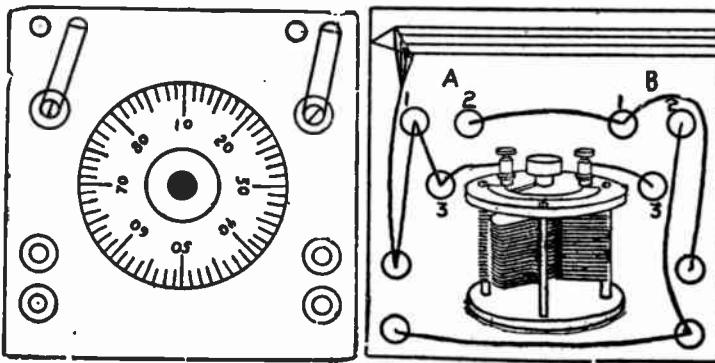

It is easy to mount a "series-parallel switch" on a panel with your variable condenser with the directions given in the accompanying article

Many radio enthusiasts will want to use the "series-parallel" switch which I described the other day, but will not care to have it loose upon their table. It seems to be the desire of most amateurs to have all of their apparatus mounted on panels, and so I am giving here a neat way to put the "series-parallel switch" on the front of the board on

which the variable condenser is mounted.

In this arrangement the switch merely takes the form of two blades, each one passing over two contact points. These blades should be made of brass, but they can be made of two small strips of tin cut from an empty can.

In mounting your variable condenser on a panel as shown in the illustration, you should arrange four binding posts, two on each side. If you so desire, you can put these binding posts on the back of the base board of the panel and do all your wiring there with nothing showing on the front except the condenser knob and dial and the two little switch blades.

The upper binding post on the left is for your aerial lead-in and the lower one is for a wire going to your cold water spigot. The two binding posts to the right are connected to your tuning set, the upper one leading to the aerial binding post on the set and the lower one leading to the ground binding post.

In wiring up this little unit let us consider the left-hand switch blade and the three points as "A" and the right-hand one as "B." Then let us number the three contacts of each one as one, two and three as shown in the picture. The wiring on the back of the panel will then be as follows:

A wire goes from the upper left-hand binding post to A 1; another wire from A 1 to A 3, and a wire from A 3 to one binding post on the condenser.

A wire goes from A 2 to B 1 and another wire from B 1 to the upper right-hand binding post.

A wire goes from B 2 to the lower right-hand binding post and another wire from there to the lower left-hand binding post.

A wire goes from B 3 to the other binding post on the condenser.

You are now ready to use your condenser either to shorten the natural wave length of your tuning apparatus or to make it longer.

With both of the little switch blades placed on the left, you have your variable condenser in series and this will give you the shorter wave lengths.

With the switch blades both moved over to the right-hand contacts, your condenser is in parallel and you will be able to get the longer wave lengths. It will be very easy, from this diagram, to mount all of this on the same panel with the rest of your apparatus, but I still very strongly favor putting each piece of apparatus on its own six-by-six panel and I use my own condensers mounted in this way.

HOW PLUGS AND JACKS ARE USED

No receiving set which has two or more stages of amplification can be considered quite complete and up-to-date unless it is fitted with a system of plugs and jacks. Not only is this the most convenient way to handle a set, but it is really important in increasing the tuning qualities and in getting the best results from the entire outfit.

In the illustration, Figure 1 shows a typical plug. The tip is made of metal and forms one of the contacts and the shaft is also made of metal, forming the other contact and being insulated from the tip by a sleeve which will not permit electricity to pass. You can buy phone cords with these plugs already soldered on them or else you can buy plugs which

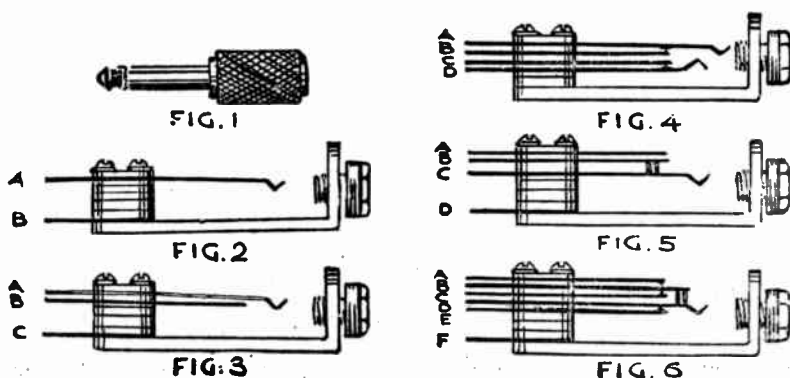

A typical phone plug and various types of jacks the uses of which are explained in the article

contain receptacles for the tips of the phone cords and a screw permits the necessary tightening to assure good contact. This latter type of plug is, of course, considerably larger and more cumbersome, but it serves the purpose very well.

Before describing the action of plugs and jacks it may be well to explain just what they do and how really worth while they are.

We will assume that you have the usual outfit for receiving, containing a detector bulb and two amplifying bulbs. If all of this apparatus is used together and you attempt to tune by having your phones connected to the final stage of amplification you are likely to get signals which sound like the Zoological Gardens at feeding time. It will be almost impossible for you to tell in just what part of the apparatus you have a wrong adjustment and you might twist your knobs for an hour before locating it.

With the plug and jack system, however, you are able to locate the fault by a process of elimination.

You will have three jacks on your panel, each one containing a hole in which you insert your phone plug. First you insert it in the jack which connects your phones at once into the detector bulb alone and cuts out both of the amplifying bulbs. In this position you have only your detector circuit to worry about and you tune that until you get the best response to the signals.

This accomplished, you pull out your plug and insert it in the second jack. This automatically rearranges the entire circuit so that the detector and the first amplifying bulb are connected and the second amplifying bulb is cut out of the circuit.

You have already seen that your detector circuit is functioning properly, so you know that if the signals you get from the second jack are not satisfactory, the fault must be somewhere in the first stage of amplification.

Almost invariably this can be remedied by a proper adjustment of the brilliancy at which the amplifier filament is burning or by a variation in the amount of cur-

rent you are taking from your "B" battery.

With this first stage of amplification adjusted satisfactorily, you plug into your final stage and repeat the process.

The illustration shows side views of various types of jacks provided for different purposes. Figure 2 shows the kind that you would have in your final amplification stage no matter how many stages you have. With one side of the circuit connected at A and the other side at B (both of these lines representing metal strips insulated from each other), you can see that no current would flow because there is no contact between the two strips. But when you insert the phone plug the tip of the plug makes contact with the bend on the end of A and the sleeve of the plug makes contact with the main frame-work of the jack and so to B. This permits the current to flow through the phones and the signals are heard.

In the other two jacks which we have been considering, however, we have a problem just a little more complicated than that. When, for instance, we have a jack between the detector and the first stage of amplification, we must have it so arranged that the current will flow through one winding of the transformer when we want to use the amplifying bulb or will automatically cut out

the transformer and put the phones in its place when we want to tune with the detector.

Figure 4 shows how easily this can be done. We connect the two wires from the detector circuit to A and D and we lead wires from B and C to the primary binding posts on the transformer. Now, when we are using the amplifier, the current flows in at A from the detector, down the little contact to B, from B to the transformer, through the winding and back to C, through the little contact point there to D and so to the rest of the circuit.

Now suppose we want to use the phones there. We push in the plug and the tip forces D down and breaks the contact between C and D while the shaft forces A up and breaks the contact between A and B. This permits the current to flow through the phones, but does not waste any of it by going through the transformer. Such a jack is used between the detector and the first stage of amplification and between the various stages of amplification and the jack shown in Figure 2 is used after the last stage for plugging in either the phones or the loud speaker.

The other illustrations show various types of jacks whose many uses can easily be figured out.

A COMPLETE AMPLIFYING OUTFIT

Since the publication in the last issue of a hook-up for adding two stages of amplification to an audion bulb detector, I have had many requests for a diagram to include detector and two amplifiers and with the whole thing

mounted in one panel to contain the plug and jack system, which I have said was the handiest for tuning.

The hook-up which is given in the illustration here is an excel-

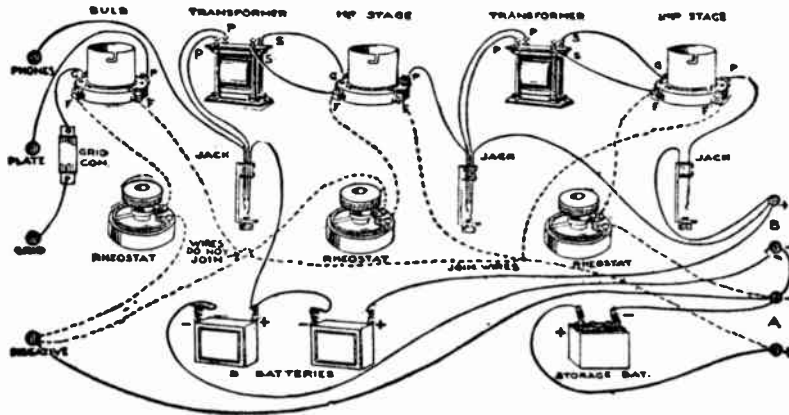

Here is a complete hook-up for use with a panel to contain a detector tube and two stages of amplification, using the plug and jack system

lent one for this purpose and contains all of the instruments necessary. You will notice on the left-hand side of the drawing that there are four binding posts—one for phones, one for plate, one for grid, and one for the negative side of the battery current. With this hook-up it is necessary to have only one negative post, because the minus sides of the storage and "B" batteries are always connected, and this connection can be made to a common binding post.

The best methods of constructing this panel and assembling the set will be taken up later. This diagram is given merely to show clearly the way of connecting the various pieces of apparatus.

Such a panel as this can be hooked up to almost any tuning circuit which you may have, your only problem being to make the proper connections to the four binding posts on the left. With some hook-ups you may not find it necessary to use the binding post for the negative battery current as the connection of the two

batteries on the right-hand side will be sufficient. This is the case with the circuit using a vario-coupler and two variometers which I have already given, and I will later show this circuit connected to this panel.

Many experimenters make one addition to the circuit shown in this panel, and that is to hook an ordinary phone condenser from the negative binding post on the left to the phone binding post above it. This connection, of course, is made on the back of the panel and will not show on the front.

You can get a very clear idea of the usefulness of the plug and jack system from this diagram. Let us suppose that we want to find out first whether the tuning circuit is properly adjusted before we add the amplifying tubes. If you will trace the path of an electric current from the plate of the detector socket, you will see that the wire leads out through the plate binding post on the left, where it would be connected with the plate variometer, the current

would go through the variometer and back to the phone binding post on the panel, would go on down to one side of the jack, through the little contact point to the transformer, through its windings and down to the positive side of the "B" battery.

Now, for tuning the detector bulb alone, we do not want any of the current wasted in the windings of the transformer. If you will, in imagination, insert the phone plug in this first jack, you will see that it will force apart the two levers which have curves in them and will thus break all contact with the transformer, sending the current instead through the phones.

With this circuit tuned to our satisfaction, we take out the phone plug, the curved blades of the jack spring back into place,

once more joining the little contact points, and the current goes through the transformer.

Inserting the phone plug in the second jack does exactly the same thing, and allows us to see that the first amplifying bulb is operating properly.

You will notice that the last jack does not have this double set of contacts. That is because there is no other transformer which we wish to disconnect. This is merely a phone jack, and when we insert the phone plug it makes contact, one side with the curved blade and the other side with the metal framework of the jack, and so our phone, or our loud speaker, if we are using one, is put into the circuit and gets the full volume of sound from all three tubes.

A DETECTOR AND TWO-STAGE PANEL

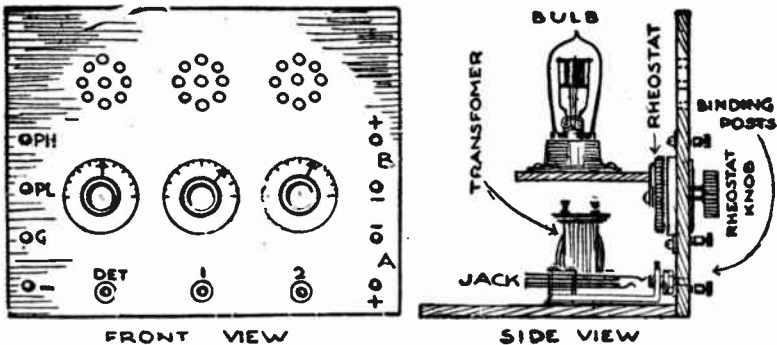

Here are side and front views of the panel to contain a detector tube and two amplifying tubes with plugs and jacks

The hook-up which we gave in the last talk, containing a detector bulb and two amplifying bulbs can be mounted very neatly in a panel and the work of doing this is so simple that nobody of even grammar school age need hesitate to do it.

Personally I always mount each separate stage in one of the 6x6 panels that I have so persistently advocated, but this is because I am constantly trying out new hook-ups and consequently do not want any of my apparatus put together in permanent form.

A very large proportion of the radio fans, however, are not particularly interested in new hook-ups. They want the one that satisfies them and they want it all contained in a cabinet which will be an ornament to their homes. For this purpose this detector and two stage amplifier hook-up mounted in a hardwood cabinet with a panel made of any of the standard panel materials is probably the most satisfactory that the average novice can handle. He can put his tuning circuit in one panel and the three bulbs in another panel to match or else, if he so desires, he can incorporate the whole thing in one cabinet and it will not require any more skill with tools than ninety-nine people out of 100 possess.

There are a number of ways of mounting all of this material on the back of the panel. If you want your panel to be high and not very deep you can put a shelf on the back of it and mount your tubes on this shelf. The rheostats would be mounted directly in front of the tubes, tight against the back of the panel, and the transformers would be on the base underneath the tubes.

If you prefer to have your panel deep but not so high you can mount the rheostats directly on the back of the panel, the tubes

right behind them, and the transformers still farther back and between the tubes. However, you mount the transformers, be sure to put them at right angles to each other. Otherwise the current going around the coil of one transformer is likely to cause a strong field of magnetism which may reach the other transformer and affect its operation.

In the article some time ago in which I described a two-stage amplifier I gave a list of the necessary parts and their cost. The hook-up which we are now considering will add to this cost the price of two "double circuit" jacks, one "telephone" jack, the phone plug and the binding posts. This extra apparatus ought not to total more than \$5. Add to this the cost of whatever kind of cabinet you want to use and the panel of hard rubber, bakelite or formica.

You can use either three or four binding posts on the right hand side to connect to your batteries. Virtually all hook-ups show a connection between the two minus sides and I have found three binding posts generally satisfactory, using the top one as the positive of the storage battery, the bottom one as the positive of the "B" battery and the center one as the common negative.

COMPLETE TUNER, DETECTOR AND AMPLIFIER

The ambition of most radio fans is to have one fine-looking cabinet containing all of their tuning apparatus and enough amplifiers to enable them to put a loud speaker or a phonograph attachment to their radio set and without a complicated looking lot of binding posts on the front

with wires running from one to the other.

I am giving in this article a hook-up which will satisfy this demand and which will also be useful for those who like their bulbs mounted in a cabinet, but who want their tuning apparatus

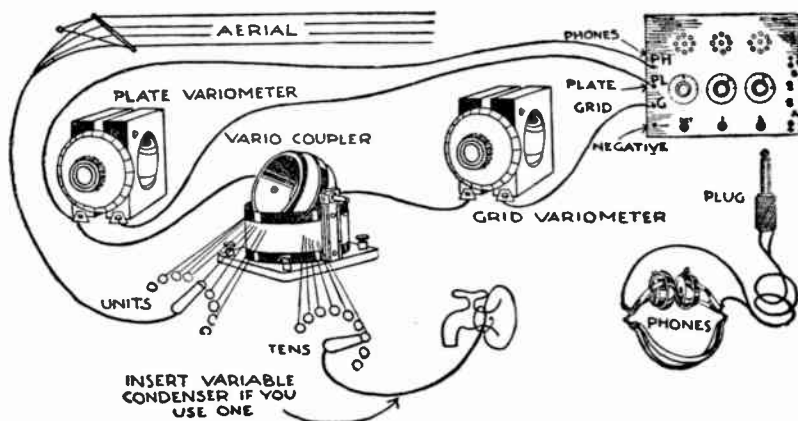

Here is the "short wave regenerative hook-up" attached to the cabinet containing a detector bulb and two amplifying bulbs

to be separate so that they can change their hook-up or add other apparatus as the fancy strikes them. For this latter class the illustration will answer the purpose. It shows the three-bulb cabinet which I have already described, and it gives in addition the correct way to attach to this cabinet the famous "short wave regenerative" hook-up, using a variocoupler and two variometers.

For the man who wants to have the whole thing in one cabinet this illustration will also be adequate. With the instruments placed as shown in the picture, he can easily figure out, with the aid of the other articles which I have printed about this cabinet, how to construct one single panel which will show on the front only the knobs and dials used to operate it and the holes of the three jacks.

For a panel of this kind all the outside connections can be made to the back of the cabinet where they will not show. On the left

would be two binding posts, one for the aerial connection and the other for the ground connection, and on the right would be the binding posts for the storage and "B" batteries. It is a perfectly simple matter to figure out the dimensions of the cabinet so that the "B" batteries can be put inside of the box and then only the storage battery would be connected outside, and that can very easily be put out of sight in a room because its current is strong enough to light the bulbs, even though the battery be ten or fifteen feet away from the set.

In mounting this particular regenerative hook-up on a panel it is customary to place the variocoupler between the two variometers. This is done so that the magnetism caused by the coils of the variometers will not influence each other. The windings of the variocoupler are at right angles to the windings of the variometers and so can be placed comparatively near without having much magnetic effect.

It is customary in mounting this set to have the grid variometer on the right and the plate variometer on the left. This makes the

wiring from coupler to grid as short as possible, which is a great advantage.

THOSE QUEER CODE NOISES YOU HEAR

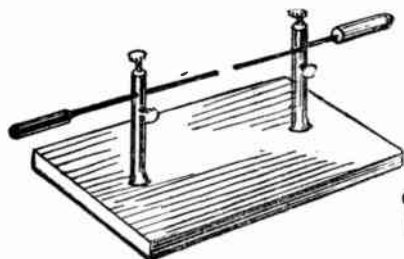

QRM.

Do you know what that means? In these days of radio craze, QRM ought almost to be adopted into our colloquial language. Everybody is being QRM'd.

If you could understand the Continental code used by wireless operators and could listen in and read some of the stuff that is constantly flying through the ether, there would not be a night that you would not hear one of the men send, "Pls rpt QRM."

In ordinary English, that means, "Please repeat. Another station's signals are interfering and I cannot read your message."

QRM means "I am being interfered with." And, with most of the sets now on the market, designed for ease of operation rather than sharpness of tuning, QRM is a constant occurrence.

You will be listening peacefully to the "Samson and Delilah" aria, perhaps, when suddenly it will be broken up by something that sounds like somebody sawing wood or filing iron or perhaps it will be one of those funny little squeaky imitations of a canary

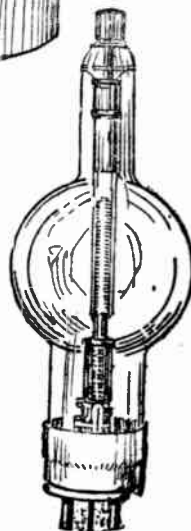
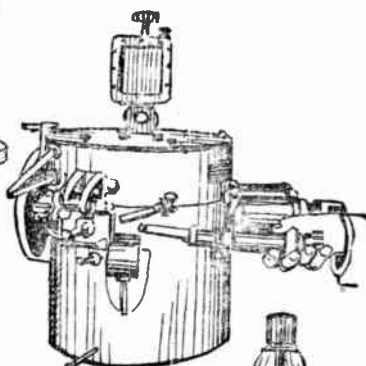

To the left, the spark gap of an amateur spark set. Above, a modern arc transmitter. To the right, a 250-watt vacuum tube by which the concerts are broadcast

bird on a jag or a sort of liquid sing-song, rising and falling rapidly like a whistler practicing a trill.

These are code signals and it is interesting to know the difference between them even though you cannot read the signs.

The rasping, buzzing, usually low-toned notes are "spark" stations. We have already learned how condensers discharge their energy in sudden bunches, vibrating at almost inconceivable rapidity. The spark station uses an apparatus that has a gap or opening in the circuit. When the electric energy piles up in the condenser to a certain strength it suddenly discharges with a powerful surge that is strong enough to make the electric current jump across this gap or opening in the form of a spark.

The current swings first one way and then the other, charging the condenser each time, first with positive, then negative and again positive, alternating thus until the energy dies down, each time sending it in the form of a spark across the gap until the energy used up in the form of the light and heat of the spark entirely empties the condenser.

But these alternations are so inconceivably rapid that there are thousands of them during the time of the shortest little spark that a man's hand can make and perhaps several million of them in a second.

These spark signals use what radio experts call "damped waves"—that is, the original energy sent out by the discharge of the condenser dies down just as the sound of a big bell dies down after it is struck with a hammer until all is silent again. The resistance of the air and the natural

resistance of the metal "damp" the sounds of the bell and you hear the noise gradually trail off into nothing.

So the spark "damps" the electric energy, but it does it several thousand times a second.

The little chirpy, canary-bird noises and the gurgling, liquid-sounding dots and dashes are usually made by what operators call "continuous wave" stations, referred to in all the radio magazines as "C. W."

This form of radio energy is sent out by an audion bulb. The little audion bulb that you use as a detector in your receiving set may be all the time sending out a stream of radio waves while you are listening to a concert. These waves are extremely weak, but, if you had another aerial within a few feet of your own, you would hear them in the form of a steady little hum in the phones.

Radio engineers have developed special forms of bulbs or tubes for sending purposes and these tubes send out radio energy not damped, as the spark signal is damped, but continuous and with radio waves of the same size and power all the time.

The broadcast concerts are sent out in this way. All radio telephone work is done on this "C. W." and it is also used for the Continental code messages by means of special devices in the sending station. "C. W." is a favorite form of radio among skilled amateurs and, by means of it, amateur messages have been sent all the way across the United States and from the United States to Great Britain and the Continent.

Then there is the QRM that sounds like a whistler thrilling. There are two distinct notes, one a "back-slap" like a rubber ball bouncing rapidly between two surfaces.

These are "arc" sending stations. They use a big arc light for power and this light, by means of the great spark that is constantly playing between its points, sends out a steady stream of radio waves. The steady stream is sent, we will say, on a wave length of 450 meters. All the time the sending key is open, this stream of waves remains at 450 meters.

Now, when the operator presses the key, the energy from the arc is diverted through a different part of the apparatus and this part is so constructed that the wave it sends out is only 425 meters.

So the skilled receiving operator who wants to read this message finds it, perhaps, on the steady wave of 450 meters and then "tunes down" to 425 meters and reads only that note, either tuning the 450 note out or else so concentrating on the 425 that he can read the code.

THE DOT-DASH CODE IS EASY TO LEARN

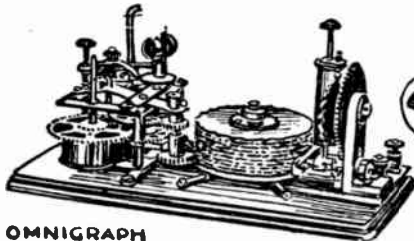

OMNIGRAPH

Here are some teachers to give you skill with the dot-dash code. On the left is an omnigraph, to the right of that is the key and buzzer for giving you practice in sending, and below is the phonograph which can also be made an excellent teacher

You really cannot call yourself a radio amateur until you are sufficiently familiar with the fascinating dot and dash code to be able to sit down and copy one of the weather reports sent out slowly several times a day by the Government radio stations all over the country.

And not only are you not an amateur until you can do this, but you really do not know the per-

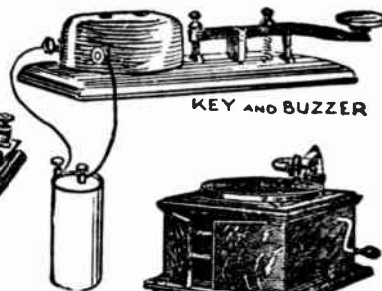

KEY AND BUZZER



PHONOGRAPH

manent joy of radio unless you have acquired this much skill.

There is nothing very mysterious or difficult about this dot-dash language. Any boy from twelve to twenty-one can very readily become quite proficient with about three months' practice, and any man of ordinary intelligence can get a certain amount of skill in the same time, but my own experience leads me to believe that one who begins to learn it after passing thirty will never reach the facility that the younger mind seems to jump to so easily.

Unquestionably the best way to learn radio is to go to one of the regular schools and take a three months' course which will cover both the dot-dash code and the theory of the science as well as the practical knowledge of how best to operate sets.

If you are unable to do this, one of the many correspondence courses is very well worth while. Failing this, there are several mechanical devices which give excellent instruction in receiving the dots and dashes, and there are a great many books which will give you the theory.

Modesty forbids me to suggest that you might get something of value by following these articles regularly.

The best practice in the world is, of course, to have a little receiving set of your own and copy the many messages and calls which are constantly flying through the ether. But most of this stuff comes through at pretty high speed and the beginner simply becomes first bewildered and then discouraged by trying to follow some "hard-boiled ham" who is "chewing the fat" (radio talk meaning gossiping) so fast that it sounds as though he had St. Vitus dance in his fist.

There is a very ingenious little apparatus called the omnigraph which is a very fine teacher of dots and dashes. There are half

a dozen types turned out by various makers, but all of them work on the same principle, and they are so good that the Government stipulates that candidates for sending license shall be examined by means of the omnigraph.

This instrument is run by clockwork and when it runs down you simply wind it up and start all over again. The clockwork turns a pile of metal disks and all along the edges of these disks the letters of the Morse code are cut so that as the disks revolve the raised parts touch a contact, and the current from a dry cell battery works a buzzer.

You can run this machine as slow as five words a minute, which is the speed at which the beginners start, or as fast as forty or fifty words a minute, which is about the limit of the best operator's skill, and every letter and number is sounded with absolute accuracy in its dots and dashes by the buzzer.

When you have run the machine so often that you have become familiar with the sequence of the characters it ceases to give you good practice, so you simply take the disks off their shaft, shuffle them up as you would a pack of cards, put them on the shaft again and you have an entirely new sequence of characters to give you practice.

There is also quite a complete set of phonograph records made

for the purpose of teaching the wireless code. These records start with the alphabet alone. You hear a man's voice saying "a" and a wireless operator in the box sounds a dot and dash twice; the man's voice says "b" and the operator sends a dash and three dots. So it goes through the whole alphabet and the numerals, and you keep working that record until you are sure you know all of them. Then you turn the record over and you get a very slow message. The other records give other messages at different speeds and there is one which has a very fair imitation of the interference caused by static, another

which has two messages going at once so as to give you practice in concentrating on one and ignoring the other and finally a record which gives groups of meaningless code letters so that you cannot possibly anticipate what is to follow.

All of these methods are good until you are able to graduate into the very best practice in the world, and that is by listening in on your own receiving set to the jumble of dots and dashes that make the ether hideous to the man who wants to hear music and speeches, but make it a heaven for the genuine radio bug.

GOOD CODE PRACTICE FOR THESE SUMMER EVENINGS

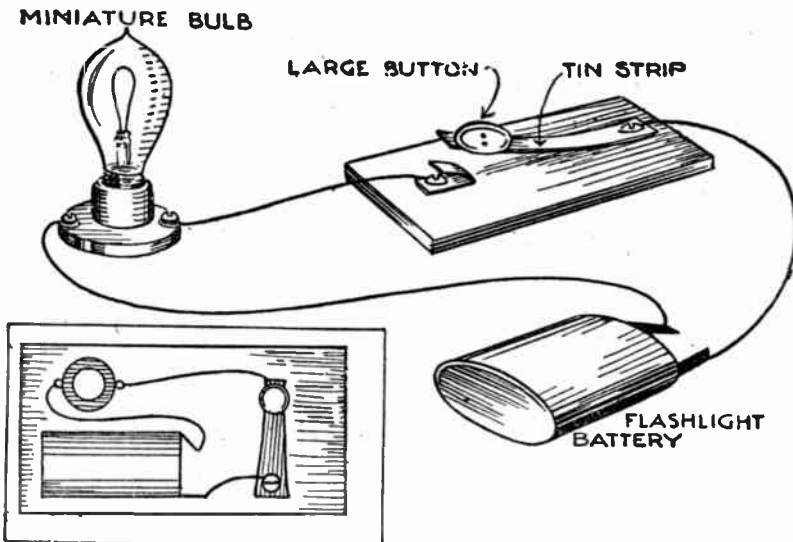

A simple set which any boy can make and by which he can carry on practice conversations in the dot and dash code by means of the blinker light

We can expect to see the streets and the open spaces of the country try blinking brilliantly these summer nights as if with a hun-

dred huge fireflies, but the seeming fireflies will be radio enthusiasts who are trying to learn the fascinating mysteries of the dot and dash code.

The ordinary pocket flashlight or a little blinker light put together as shown in the illustration gives excellent practice in memorizing the dots and dashes which go to make up the letters of the wireless operator's alphabet.

The hand flashlamp will do this fairly well, but its contacts are not altogether dependable and it is likely to cause considerable confusion among those who are merely beginners. It is best to use some such outfit as shown in the picture. These various pieces of simply constructed apparatus can be put together in a few minutes. The light shown is a miniature bulb such as can be bought anywhere and is screwed into a small porcelain base which can be purchased for a few cents.

Any of the standard flashlight batteries will do for this blinker light and it can be mounted upon the board in any way that best pleases the maker.

For the key it is only necessary to cut a strip of tin from a tin can and screw one end of it down to the board with one wire wrapped around the screw for good contact.

First, however, it is wise to mount on the other end a button

or a poker chip or the sawed-off end of a spool or some such device that the fingers will feel comfortable upon when sending.

There should be provided another contact for this free end of the tin strip to press upon. This can be another small piece of tin bent as shown or it can be simply a screw which serves the double purpose of holding the other wire tight and making the contacts for the dots and dashes.

There are only a few points necessary to observe when two persons wish to practice with the blinker light. Each person, of course, must have his own outfit.

Let us suppose that John and Bill are going to practice and have gone some distance apart. John calls up Bill by making a series of six or seven quick flashes which we call dots.

If Bill is ready to receive, he makes a similar series of dots and then the letter K, which is a long flash a short flash and a long flash. The letter K, by the way, is the regular wireless operator's signal which means "go ahead."

John then sends his first word and if Bill has received it correctly Bill makes a dot and John goes ahead, sending his whole message through so long as Bill sends him a dot after every word. This dot, by the way, signifying that a word has been received correctly, is not used in wireless transmis-

sion, but is quite generally used by ships at sea communicating by means of a blinker light.

Any time Bill fails to understand what John is sending, he breaks in by a series of short dots or else he makes the wireless signal for a question mark which is two dots two dashes two dots, and John repeats the word.

At the end of his message John makes a series of dots to signify it is finished and the letter K which means that Bill is to go ahead with his answer. Or else, instead of the series of dots he can make the regular wireless signal, dot-dash-dot-dash-dot, which means "end of message."

The dots and dashes which compose the wireless code can be found in almost any book on radio, but I am going to give them here in the form in which it has been found best for the beginner to learn them. In this form we use the syllable "dit" for a dot and "dah" for a dash. The "dit" should be pronounced as short and sharp as possible and the "dah" should be strongly emphasized and prolonged.

Pronounced in this way, the letters give a very fair imitation of the wireless code and the beginner will find it splendid practice while reading his newspaper, to translate some of it to himself in the "dits" and "dahs" of the code. Two students without any appa-

ratus can also give each other excellent practice by carrying on a dit-dah conversation, even though they will find it rather difficult to be serious while they are doing it. It sounds very silly and childish, but it is extremely valuable to any one who wishes to learn the dot-and-dash language.

Here, then, is the "dit-dah" alphabet:

- A dit-dah
- B dah-dit-dit-dit
- C dah-dit-dah-dit
- D dah-dit-dit
- E dit
- F dit-dit-dah-dit
- G dah-dah-dit
- H dit-dit-dit-dit
- I dit-dit
- J dit-dah-dah-dah
- K dah-dit-dah
- L dit-dah-dit-dit
- M dah-dah
- N dah-dit
- O dah-dah-dah
- P dit-dah-dah-dit
- Q dah-dah-dit-dah
- R dit-dah-dit
- S dit-dit-dit
- T dah
- U dit-dit-dah
- V dit-dit-dit-dah
- W dit-dah-dah
- X dah-dit-dit-dah
- Y dah-dit-dah-dah
- Z dah-dah-dit-dit

Question mark dit-dit-dah-dah-dit-dit.

Period dit-dit, dit-dit, dit-dit.

Wait dit-dah, dit-dit-dit

TREASURES FOR THE NOVICE.

Nothing pleases us more than to learn from our correspondence what a great help this little magazine is proving to all kinds of people.

George T. Prince, a consulting engineer of Omaha, Neb., writes:—"I want to congratulate you upon the very simple and yet effective way which you have adopted in explaining the principles involved in making receiving sets."

W. A. McCubbin, Deputy Director of Pennsylvania Bureau of Plant Industry, writes:—"I like your style in "E-Z RADIO." Please send it to me for six months and include the first three numbers so that I may have the whole series. I enclose the required dollar."

C. D. Richards, of Rochester, N. Y., whose call is "8CQR" writes:—"I am following very closely your radio articles. They are positively the best stuff on the subject that I see anywhere. I made spider webs according to your directions and they work fine."

"E-Z RADIO" does not pretend to be a magazine for the person who knows a good deal about the subject. For that class, Radio News, The Wireless Age, Q. S. T., and such magazines are splendid publications, Radio News being particularly fine with an editor (Mr. Gernsbach) the most vivid writer on radio that we have.

But for the person in the kindergarten stage of radio we feel that this publication fills a very decided need. We are not going to attempt to enter the field so well cared for by the others but we believe that, if you will follow the simple articles in this magazine you will be able to get more value from the pages of the publications which we have named.

You should have your files of "E-Z RADIO" complete. Send a dollar for a six months subscription to this office ordering your subscription to begin with the first (May) issue.

**E-Z RADIO,
608 Chestnut St.,
Philadelphia.**

"IT'S A JOB BUT WE'RE DOING IT."

When we offered to answer by mail any of the questions which readers of "E-Z RADIO" wanted to ask we did not expect such a bombardment as has occurred but, in spite of the increasing number of letters Mr. Neely is keeping up with the job and has not yet asked to be relieved.

It doesn't matter what your trouble is in your radio experiments, if you are stumped send a diagram of your hook-up and let Mr. Neely do your worrying for you. The questions which he is getting cover virtually the whole field of radio and come from boys who are winding coils around salt boxes, men who are constructing well made sets at some expense and who ask help in assembling them, other men who want to know what to buy and where to buy it and seemingly from all other classes attracted by this fascinating game.

Our offer of help still holds good. You need not even be a subscriber to this magazine to take advantage of it. When you buy a copy on the newstands you buy with it the right to use Mr. Neely's knowledge in any way that you see fit and you need not hesitate to ask him to solve your problems.

Kindly enclose a stamped, self-addressed envelope.

ADDRESS—

HENRY M. NEELY,
E-Z Experimental Station
Delanco, N. J.