



A Publication for the
Radio Amateur Worldwide

Especially Covering VHF,
UHF and Microwaves

VHF COMMUNICATIONS

Volume No.28 . Autumn . 3/1996 . £4.50

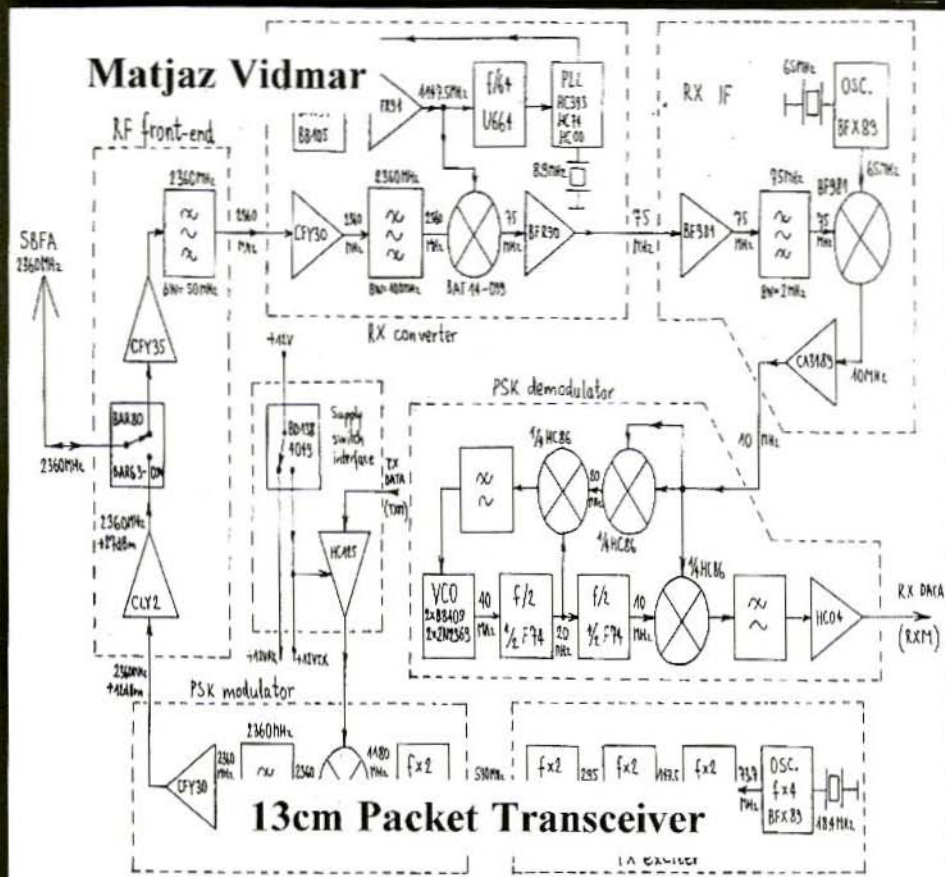

NEW BOOKS FROM NOBLE

Microwave Field Effect Transistors

\$89

By Raymond S. Pengelly

This book covers the use of MESFET devices in microwave circuits such as low noise amplifiers, mixers, oscillators, power amplifiers, switches and multipliers. Included are 703 pages, 470 figures, 356 equations, and 61 tables. This classic reference is a "must buy" for all engineers involved in the development of microwave devices.

Semiconductor theory
Intermetallic compound
Dual gate FET
Schottky barrier
Operation principles
Large signal
Non-linear
Intermodulation
Power FET
FET oscillator
CAD considerations
Power amplifiers
Power combining
GaAs mixing
Image rejection
Noise figure
Signal handling
Dual gate mixer

Induced neg. resistance
S-parameter mapping
Stabilized oscillators
Dielectric resonators
Packages & Sealing
Thermal resistance
Discriminators
Digital circuits
MESFET & MISFET
Monolithic microwave
Freq. multiplication
Freq. upconversion
Preamatched
Phase shifters
FET fabrication
Narrow band
Broadband
Switches



Transceiver System Design for Digital Communications

\$54

By Scott R. Bullock

This system level approach to transceiver system design covers digital communications, building on principles required for military applications and translating those concepts for widely-used commercial applications. Includes 416 pages, 99 figures and 239 equations.

Design principles
Link budget
Receiver specifications
Antenna systems
Transmitter specifications
Frequency conversion
Intermodulation
Dynamic range
Digital signal processing
AGC design
PLL design and analysis
Modulation
Demodulation
Spread spectrum
Pulse theory

Error probability
The eye pattern
Sampling and aliasing
Path characteristics
Multipath analysis
Jamming sources
Jamming resistance
GPS transmissions
GPS code
Time synchronization
Direction finding
Interferometer methods
Pitch and roll conversion
Problems and answers
Index

ORDER BY PHONE, FAX OR MAIL

**BOTH BOOKS
ONLY \$125**

Name _____
Company _____
Address _____
City _____ State _____
ZIP _____ Country _____
Phone _____ FAX _____
Card # _____ Exp _____
Signature _____

Please send the following products

- Both Books \$125
- Microwave Field-Effect \$89
- Transceiver System Design \$54

Shipping & Handling
US \$8, Canada \$20, Intl. Air \$40

Payment Method

- VISA or MasterCard
- EuroCheck
- Bank Check (Must have the name of a US bank on the check)

NOBLE PUBLISHING

TEL (770)908-2320 FAX (770)939-0157
2245 Dillard St., Tucker, GA 30084, USA
editor@noblepub.com www.noblepub.com



Contents

Matjaz Vidmar S53MV	13cm PSK Transceiver for 1.2Mbits/s Packet Radio Part-1	130 - 147
Denys Roussel F6IWF	An Ultra Low-Cost HF SSB/CW Transceiver with 20W Output, an AGC Meter, S-Meter and Audio Filters Part-2 (conclusion)	148 - 156
Dipl.-Ing. Detlef Burchard	Active Reception Antennas: Observations, Calculations and Experiments Part-2 (conclusion)	157 - 164
Wolfgang Schneider DJ8ES	VHF, UHF and SHF Measuring Methods Using a PC Part-1: Essentials of Control Using the PC's Centronics Port	165 - 172
Bernd Kaa DG4RBF	Expansion of the Software for the DB1NV Spectrum Analyser Digital Image Store	173 - 180
Richard A. Formato K1POO	More on the Off-Centre-Fed Dipole	181 - 184
Dr. Ing. Jochen Jirrmann DB1NV	A High-Precision Logarithmic Intermediate-Frequency Amplifier	185 - 188



KM Publications, 5 Ware Orchard, Barby, Rugby, CV23 8UF, UK

Telephone: (0)1788 890365; INT: +44 1788 890365; FAX: (0)1788 891883

INTERNET: vhf-comm@g6iqm.demon.co.uk

WWW <http://www.eolas.co.uk/ag/vhfcomm.htm> & <http://www.clearlight.com/~vhfcomm>

Matjaz Vidmar, S53MV

13cm PSK Transceiver for 1.2Mbit/s Packet Radio Part-1

The choice of a transceiver design for high-speed packet radio is not simple. Is it better to use an apparently simpler FM transceiver or to go for a more sophisticated PSK transceiver? Both choices have their advantages and disadvantages and at this time it is difficult to predict which one will become more practical. However, increasing the transmission speed both the signal bandwidth and the radio range need to be considered.

1. INTRODUCTION

Increasing the data speed beyond about 100kbit/s, the resulting signal bandwidth is only acceptable at microwave frequencies. The transmitter power available at microwave frequencies is small and expensive. Therefore the radio range becomes a limitation even for line-of-sight terrestrial packet-radio links. A PSK transceiver with a coherent

detector offers a radio range that is between 5dB and 15dB larger and a signal bandwidth that is less than half when compared with a FM transceiver.

In packet radio the main problem of a PSK transceiver is the initial RX signal acquisition. The latter is a function of the carrier frequency uncertainty. In a simple biphase PSK (BPSK) system with $0/180^\circ$ modulation, the initial signal acquisition requires a complicated searching loop, if the frequency error exceeds 10% of the bit rate. Quadrature PSK (QPSK) allows a further halving of the signal bandwidth at the expense of a much more sophisticated demodulator design and an even more critical initial signal acquisition.

Therefore PSK becomes simple at high data rates. On the other hand, the signal acquisition of low-Earth orbit amateur packet-radio satellites transmitting at only 1200bit/s PSK is very difficult. This unfortunate PSK design made radio amateurs believe that PSK is not suitable for packet radio, being just an unnecessary complication at low data rates like 1200bit/s.

In this article a successful 13cm BPSK transceiver design will be described. In the 13cm amateur band, the sum of the frequency uncertainties of both receiver and transmitter is at least 10 kHz using top quality temperature-compensated crystal oscillators. A real-world figure is 100 kHz frequency uncertainty that requires a MINIMUM bit rate of about 1Mbit/s!

With the above restriction, a convenient choice is to use 1.2288Mbit/s for packet radio. This figure can easily be obtained with standard baud-rate crystals, being the 32nd multiple of 38.4kbit/s or the 1024th multiple of 1200bit/s. Of course the described transceiver can also be used for other digital data transmissions that require megabit rates, like compressed digital television transmission.

2. 13cm PSK TRANSCEIVER DESIGN

Since the above mentioned PSK modulation is relatively unknown to most radio amateurs, the 13cm PSK transceiver block diagram will be discussed first. The same form of PSK modulation, namely 0/180° BPSK, allows many different transceiver concepts.

For example, a PSK signal may be generated at an IF frequency and then upconverted to the final transmitter frequency. A PSK signal can also be generated directly at the final frequency and even after the transmitter power amplifier. Finally, a PSK signal can also

be fed through frequency multiplier stages, but here one should not forget that the PSK modulation phase angles are multiplied by exactly the same factors as the carrier frequency.

A PSK demodulator may be coherent or non-coherent. A coherent PSK demodulator offers a larger radio range, but requires a local carrier regeneration. A PSK signal is demodulated coherently by multiplication with the regenerated carrier in a balanced mixer. Carrier regeneration requires a non-linear processing of the PSK signal (in the case of BPSK this may be a frequency doubler) and a narrow bandpass filter (usually in the form of a phase-locked loop).

A PSK signal may be demodulated at a convenient IF frequency or directly at the receiver input frequency. A PSK receiver can be designed as a direct-conversion receiver just like a SSB receiver. Carrier regeneration may be performed by a squaring loop (frequency doubler) or by a Costas loop. Just like SSB, all PSK demodulators are very sensitive to small carrier frequency inaccuracies.

The block diagram of the described 13cm PSK transceiver is shown in Fig.1. The transmitter includes a crystal oscillator followed by a multiplier chain. The PSK modulator - - balanced mixer operates at the final transmitter frequency and generates the desired signal directly. Modern semiconductor devices provide high gains per stage.

The mixer is followed by just two amplifier stages at 2.36 GHz to obtain about 0.5W of microwave power.



The oscillator uses a fundamental resonance crystal, since fundamental resonances have a lower Q than overtone resonances. The turn-on delay of the transmitter crystal oscillator can be reduced in this way. The transmitter crystal oscillator is turned off when receiving, since its fourth harmonic could disturb the first IF at 75 MHz. For operation at 2360 MHz, a "computer" crystal for 18.432 MHz can be tuned to the desired frequency with a series capacitive trimmer. Using different crystals for other frequencies, a series inductor L1 may be required in place of the capacitive trimmer.

The oscillator transistor is also used as the first multiplier, since the output circuit (L2 and L3) is tuned to the fourth harmonic of the oscillator frequency. Three additional frequency-doubler stages are required to obtain about 10mW at 590 MHz. The first doubler stage uses air-wound, self-supporting coils L4 and L5, while the remaining two doubler stages use "printed" inductors L6, L7, L8 and L9. The supply voltage for the oscillator and the first doubler stage is stabilised by a 8V2 Zener diode.

The transmitter exciter is built on a single-sided PCB with the dimensions of 40mm x 120mm, as shown in Fig.3. The PCB is made of 0.8mm thick glass-fibre-epoxy laminate to shorten the wire leads of the components and in this way reduce the parasitic inductances. The component location of the transmitter exciter is shown in Fig.4.

L2 and L3 have about 150nH each or 4 turns each of 0.25mm thick copper-enamelled wire. They are wound on

36 MHz (TV IF) coil formers with a central adjustable ferrite screw, plastic cap and 10mm x 10mm square shield. L4 and L5 are self-supporting coils with 4 turns each of 1mm thick copper-enamelled wire, wound on an internal diameter of 4mm. Finally, L6, L7, L8 and L9 are etched on the PCB.

The transmitter exciter is simply tuned for the maximum output power. The individual stages are tuned to obtain the maximum drop of the DC voltage on the base of the next-stage transistor. Of course, the base voltage has to be measured through a RF choke. The base voltage may become negative, but should not exceed -1V. Finally, the crystal oscillator is tuned to the desired frequency with the corresponding capacitive trimmer (or L1).

4.

2360 MHz PSK MODULATOR

The circuit diagram of the 2360 MHz PSK modulator is shown in Fig.5. Except for the modulator (balanced mixer) itself, the module includes the last frequency-doubler stage, bandpass filters for 590 MHz, 1180 MHz and 2360 MHz and an output amplifier stage to boost the signal level to about 15mW. All of the filters and other frequency-selective components are made as micro-strip resonators on a 1.6mm thick glass-fibre-epoxy laminate FR4.

The input resonator (L1) functions as an open circuit for the input frequency (590 MHz) and as a short circuit for the

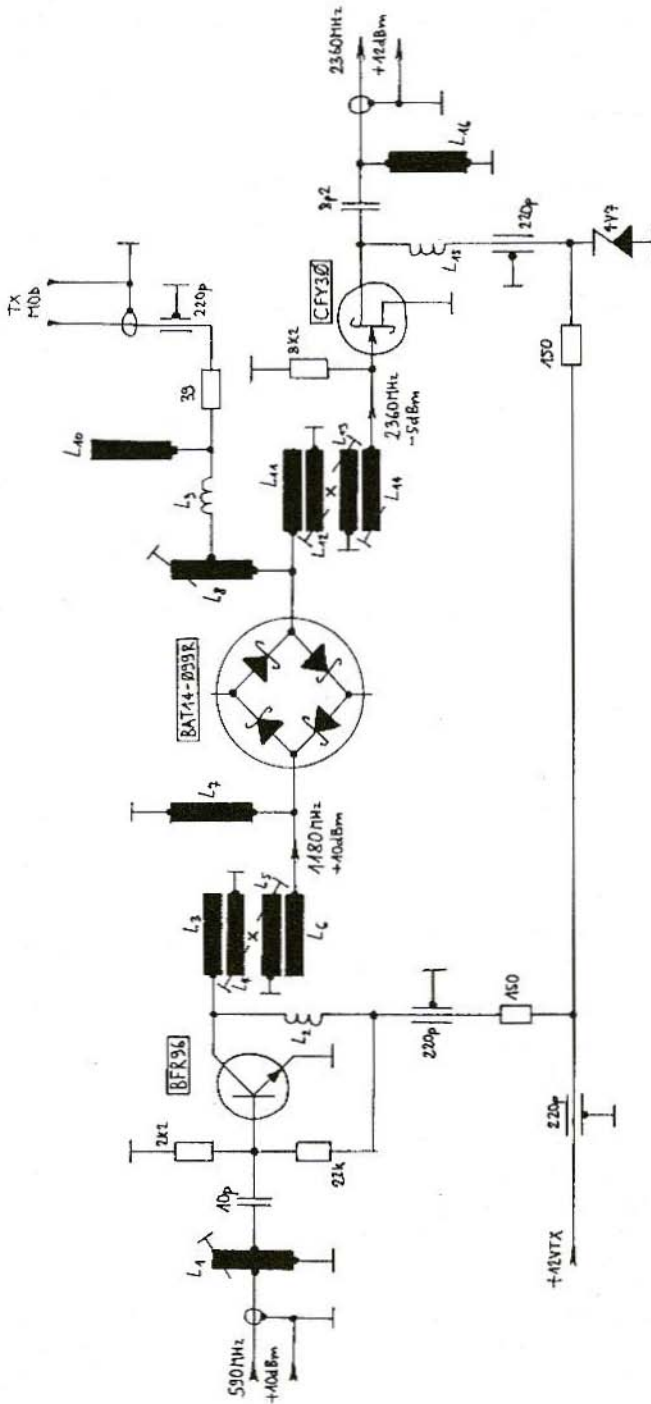

Fig.5: The PSK Modulator

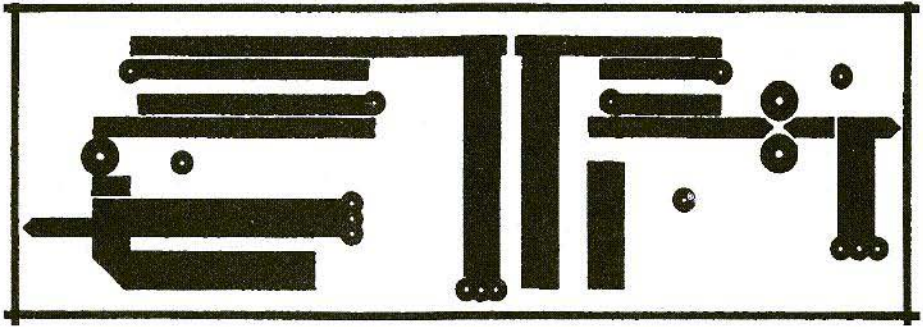

Fig.6: PSK Modulator PCB (double-sided 1.6mm glass-fibre-epoxy, micro-strip circuit with a continuous groundplane).

output frequency (1180 MHz) of the frequency doubler. In this way the operation of the doubler is less sensitive to the exact cable length and output impedance of the exciter. The output bandpass (L3, L4, L5 and L6) should not only suppress the input frequency (590 MHz) but also its fourth harmonic

(2360 MHz) that could disturb the symmetry of balanced mixer resulting in an unsymmetrical, distorted PSK.

A harmonic mixer with antiparallel diodes is used as the PSK modulator, since this circuit provides a reasonable unwanted carrier suppression (25dB) without any special tuning and without

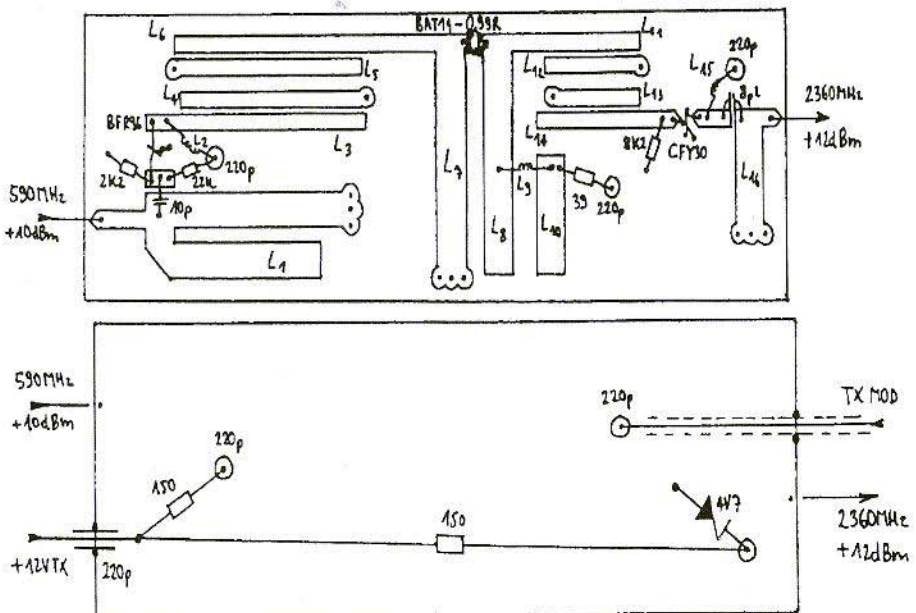

Fig.7: PSK Modulator Component Overlay

access to expensive test equipment (spectrum analyser). The harmonic mixer uses a quad Schottky diode BAT14-099R, since four diodes provide a higher output signal level than just two antiparallel diodes.

The mixer is followed by a bandpass filter for 2360 MHz (L11, L12, L13 and L14) to remove the 1180 MHz driving signal and other unwanted mixing products far away from the 13cm frequency band. The generated PSK signal at 2360 MHz does not require any filtering itself. Since the 2360 MHz signal level is low, about 0.3mW, a GaAsFET amplifier stage (CFY30) is used to raise the signal level to about 15mW.

The PSK modulator is built on a double-sided PCB with the dimensions of 40mm x 120mm. Only the upper side is shown in Fig.6, since the lower side functions as the micro-strip groundplane and is not etched. The PCB is made of 1.6mm thick glass-fibre-epoxy laminate FR4, although this material has substantial RF losses at 2.36 GHz. The component location of the PSK modulator is shown in Fig.7 for both sides of the PCB.

Although most of the transmission lines are etched on the PCB, L2, L9 and L15 are air-wound quarter-wavelength chokes. L2 is a quarter-wavelength choke for 1180 MHz, L15 is a quarter-wavelength choke for 2360 MHz while L9 should be a quarter-wavelength somewhere in the middle (around 1700 MHz), since it has to be effective for both frequencies.

The described PSK modulator can simply be tuned for the maximum output signal level. Besides the 590 MHz

exciter signal, a digital modulating signal is required as well. The latter may be a square wave of the appropriate frequency or better the real digital packet-radio signal. Without any alignment, the PSK modulator will already provide an output of a few milliwatts. After any alignment of the micro-strip resonators one has to check the modulation signal level to find the best operating condition of the harmonic mixer.

5.

2360 MHz RF FRONT-END

The circuit diagram of the 2360 MHz RF front-end is shown in Fig.8. The RF front-end includes the transmitter power amplifier, the receiver low-noise preamplifier and the PIN antenna switch. The RF front-end is the only module including micro-strip circuits, that is built on a low-loss, 0.8mm thick glass-fibre-Felton laminate with a dielectric constant of 2.5.

The circuit of the RF front-end is simplified by using modern SMD semiconductor devices, originally developed for cellular telephones. The transmitter power amplifier uses a single GaAs transistor CLY2 that provides both 15dB gain and more than 500mW of output power at the same time. Just a few years ago, an equivalent circuit would require three or four silicon bipolar transistors. The CLY2 is a low-voltage power GaAsFET that operates at a drain voltage of just 4.5V, while generating its own negative gate

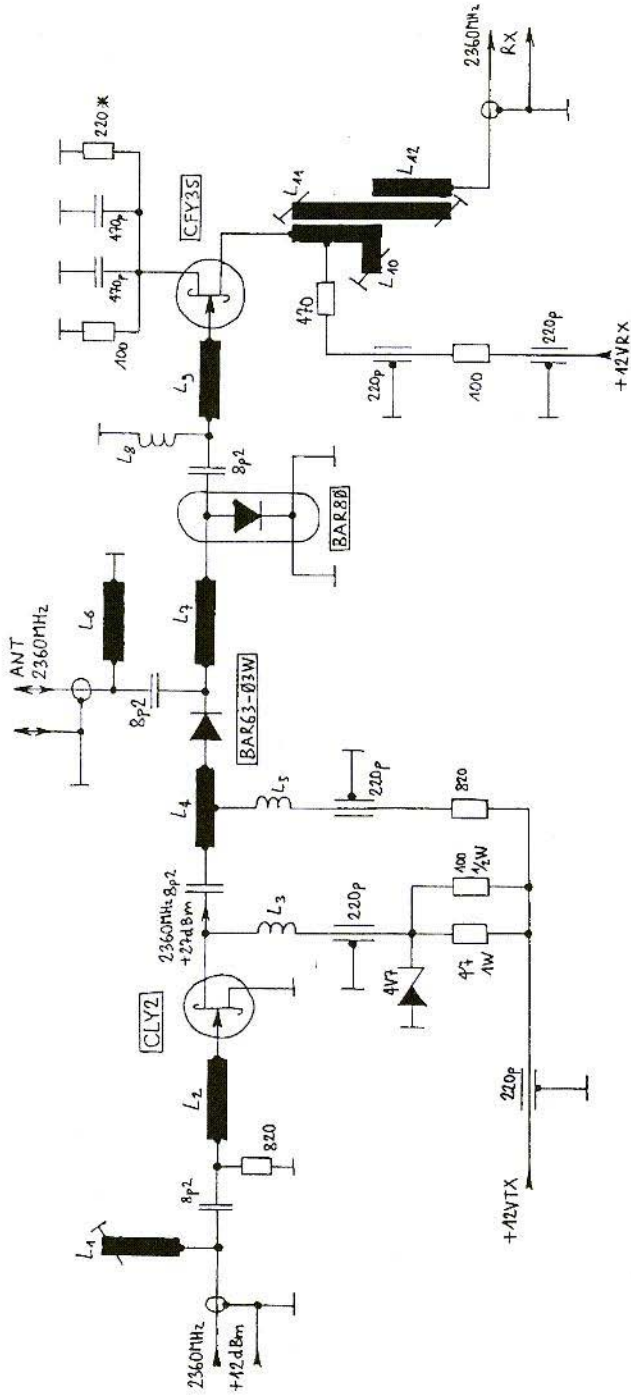

Fig.8: The RF Front-End

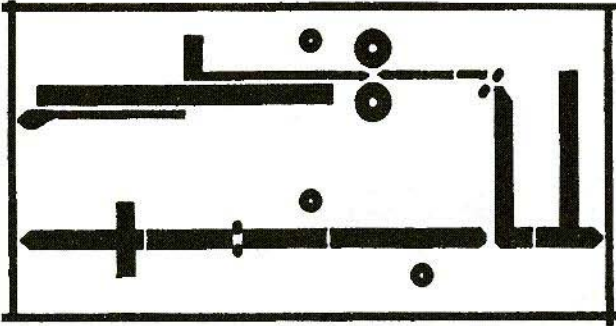

Fig.9: RF front-end PCB (double-sided 0.8mm glass-fibre-Teflon, micro-strip circuit with a continuous groundplane).

The BAR63-03W is built in a standard microwave SMD diode package with a low parasitic capacitance and is used as a series switch. On the other hand, the BAR80 diode is built in a low parasitic inductance package and is used as a shunt switch. Both diodes are turned on while transmitting. The quarter-wavelength line L7 trans-

bias voltage by rectifying the input RF signal.

forms the BAR80 short circuit into an open circuit for the transmitter.

The antenna switch includes two different PIN diodes: BAR63-03W and BAR80. The semiconductor chips of these two diodes are similar, but there is an important difference the packages.

The RF front-end also includes a low-noise receiving preamplifier to improve the sensitivity and image rejection of the receiver. The low-noise preamp uses a CFY35 transistor, followed by a band-

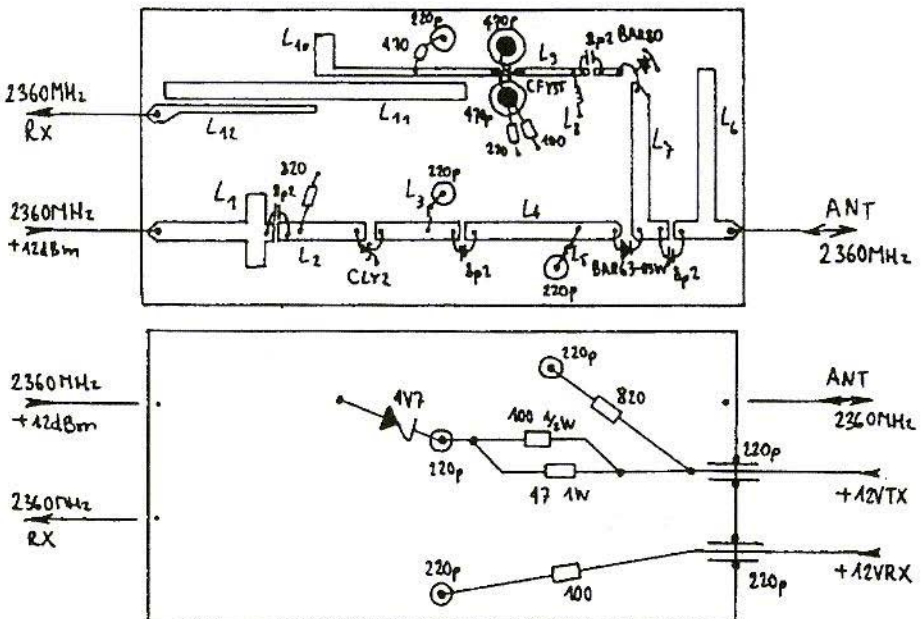

Fig.10: RF Front-End Component Overlay



pass filter. The preamplifier provides a gain of about 11dB including the antenna switch and output filter losses. The bandpass filter is required to attenuate the image response around 2210 MHz.

The RF front-end is built on a double-sided Teflon PCB with the dimensions of 40mm x 80mm. Only the upper side is shown in Fig.9, since the lower side functions as the micro-strip groundplane and is not etched. The PCB is made of 0.8mm thick glass-fibre-Teflon laminate with a dielectric constant of 2.5. The component location of the RF front-end is shown in Fig.10 for both sides of the PCB. Except the printed micro-strip lines, there are three air-wound quarter-wavelength chokes for 2360 MHz: L3, L5 and L8.

Assembling the RF front-end, the most critical item is the correct grounding of the microwave semiconductors CLY2, BAR80 and CFY35. The CLY2 and the BAR80 are grounded through drops of solder, deposited in 2mm diameter holes at the marked positions in the Teflon laminate. On the groundplane side these holes are covered with small pieces of copper sheet that also act as heat sinks for these semiconductors. The CFY35 is grounded through two leadless ceramic disk capacitors installed in 5.5mm diameter holes at the marked positions. The capacitors are connected to the groundplane with small pieces of copper sheet on the other side. Finally, L6 is grounded with a 2.5mm wide strip of copper foil inserted in a slot in the Teflon laminate.

The transmitter power amplifier is simply tuned for the maximum output

power by adding capacity (small pieces of copper foil) to L1. Small sheets of copper foil can also be added in other parts of the circuit, but their influence is usually small when compared to L1. If the specified output power can not be obtained, the cable length between the PSK modulator and RF front-end needs to be changed.

The receiving preamplifier is also tuned for the maximum gain, but here it is more important to bring the bandpass filter to the correct frequency. The latter is adjusted with L11, while L10 only affects the CFY35 output impedance matching. Before making any RF adjustments, the DC operating point of the CFY35 has to be set by selecting appropriate source bias resistors for a V_{ds} of 3-4V.

6. RX CONVERTER WITH PLL LO

To avoid several multiplier stages the receiving converter includes a microwave PLL frequency synthesiser. The converter is built as two separate modules to prevent the digital part from disturbing the low-level analogue circuits. Of course each module is shielded on its own. The described RX converter is derived from a 2400 MHz SSB converter published in [1].

The circuit diagram of the analogue section of the RX converter is shown in Fig.11. The analogue section includes the second RF amplifier stage, the

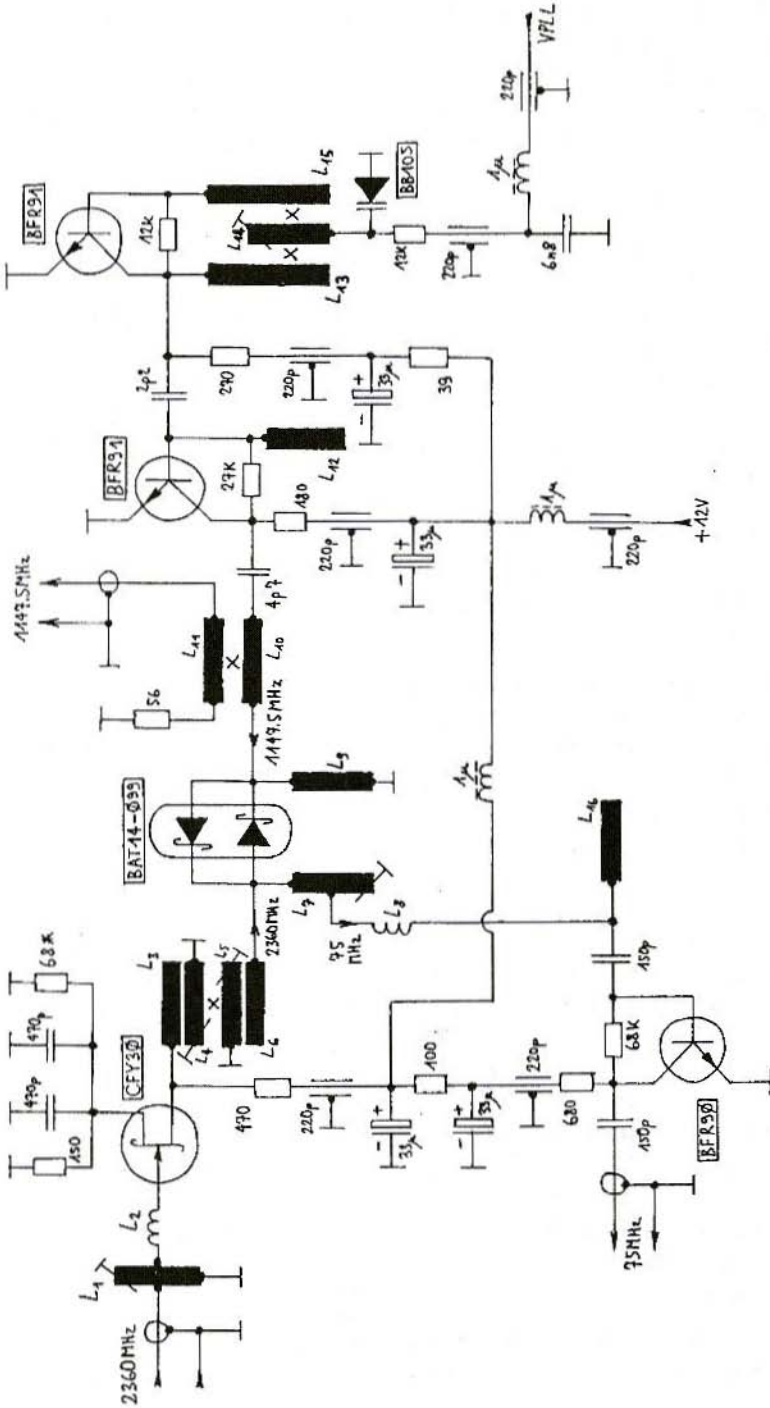

Fig.11: The RX Converter - Analogue Section

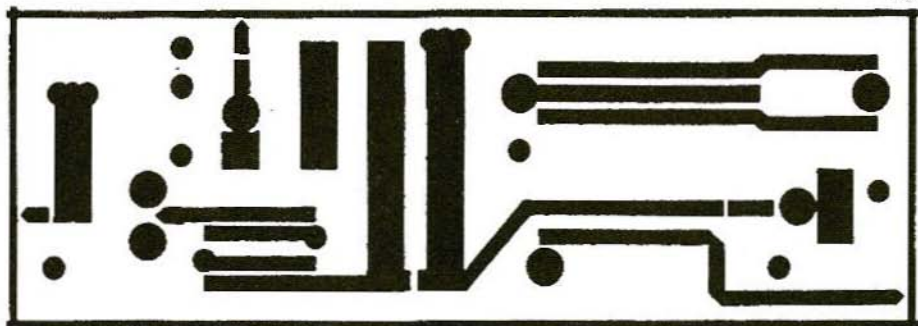

Fig. 12: RX converter, analogue section PCB (double-sided 1.6mm glass-fibre-epoxy, micro-strip circuit with a continuous groundplane).

sub-harmonic mixer, the VCO including a buffer stage and the first 75 MHz IF amplifier. The analogue circuits are built as micro-strip circuits on a 1.6mm thick glass-fibre-epoxy laminate.

The main function of the second RF amplifier is to cover the noise figure of the harmonic mixer. The second RF

amplifier is followed by another band-pass filter (L3, L4, L5 and L6), but unfortunately due to the high substrate losses this filter is unable to provide any significant rejection of the image frequency at 2210 MHz. Its main purpose is to reject far-away interferences like sub-harmonics or even signals at the IF frequency.

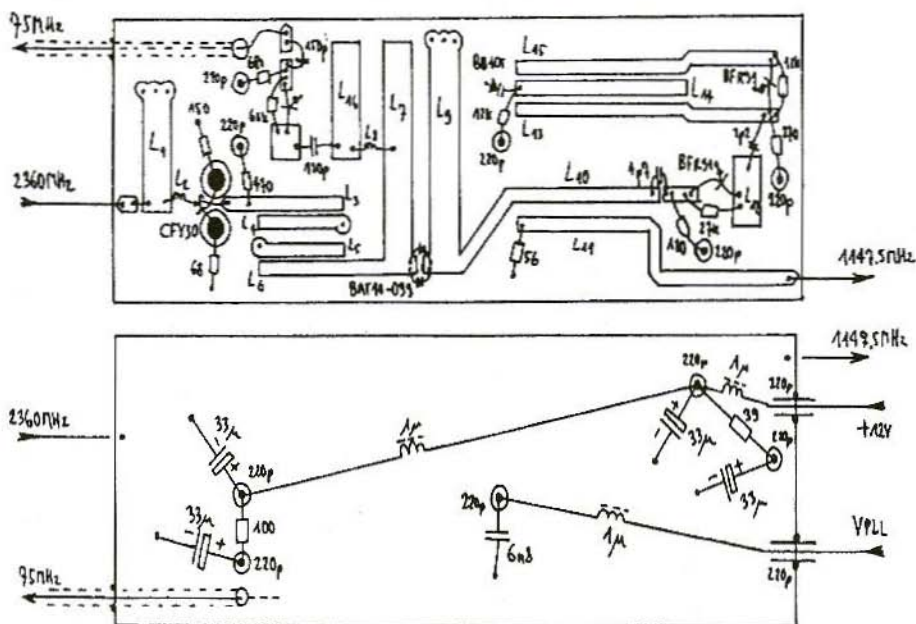

Fig. 13: RX Converter - Analogue Section Component Overlay

The harmonic mixer uses two antiparallel Schottky diodes and is very similar to the PSK modulator. Such a mixer requires a local oscillator at half of the required conversion frequency thus simplifying the design of the PLL synthesiser. The resulting IF signal is amplified immediately to avoid any further degradation of the already poor noise figure.

The VCO uses a micro-strip bandpass filter (L13, L14 and L15) in the feedback network to obtain low phase noise. The tuning range of this VCO is thus restricted to a few percent of the central frequency. The VCO is followed by a buffer stage and part of the buffered VCO signal is coupled by L10, L11 to feed the digital section of the PLL.

The analogue section of the receiving converter is built on a double sided PCB with the dimensions of 40mm x 120mm. Only the upper side is shown in Fig.12, since the lower side functions as the micro-strip groundplane and is not etched. The PCB is made of 1.6mm thick glass-fibre-epoxy laminate FR4, although this material has substantial losses at 2.36 GHz. The component location of the analogue section of the RX converter is shown in Fig.13 for both sides of the PCB.

Although most of the transmission lines are etched on the PCB, there are two discrete inductors in this module. L2 is a wire loop with a 2mm internal diameter made of 0.6mm thick silver-plated copper wire. L2 may need adjustments during the alignment of the complete transceiver. L8 is a quarter-wavelength choke around 1700 MHz to be effective for both the RF and LO frequencies.

Most of the RF active devices (BFR90, BFR91 and BB105) are installed in 6mm diameter holes in the PCB. These holes are afterwards covered on the groundplane side by soldering small pieces of copper foil. The same installation procedure also applies to the two 470pF source bypass capacitors for the CFY30 transistor. The corresponding source bias resistors are adjusted for a V_{ds} of 3-4V.

The alignment of the analogue section should start with bringing the VCO to the desired frequency range by adjusting L14. This is done easily if the PLL is already operating. L14 usually needs to be made slightly longer to obtain a 2.5V PLL control voltage in the locked condition. Then L7 is adjusted for the maximum mixer conversion gain and finally L4 and L5 may need some small adjustments. L1 and L2 should be adjusted to match the RF front-end. If the second RF stage (CFY30) is self-oscillating, the L2 wire loop has to be made shorter.

An alternative solution is to replace the CFY30 GaAsFET with the silicon MMIC INA-03184. The latter has a higher noise figure but offers more gain and does not self oscillate. When using the INA-03184, L2 has to be replaced with a 6.8pF capacitor, the output bias resistor has to be increased from 470 Ω up to 680 Ω and the source bypass capacitors and bias resistors are no longer required, since the two INA-03184 common pins can be grounded in a straightforward way.

The circuit diagram of PLL section of the RX converter is shown in Fig.14. The PLL includes the /64 prescaler

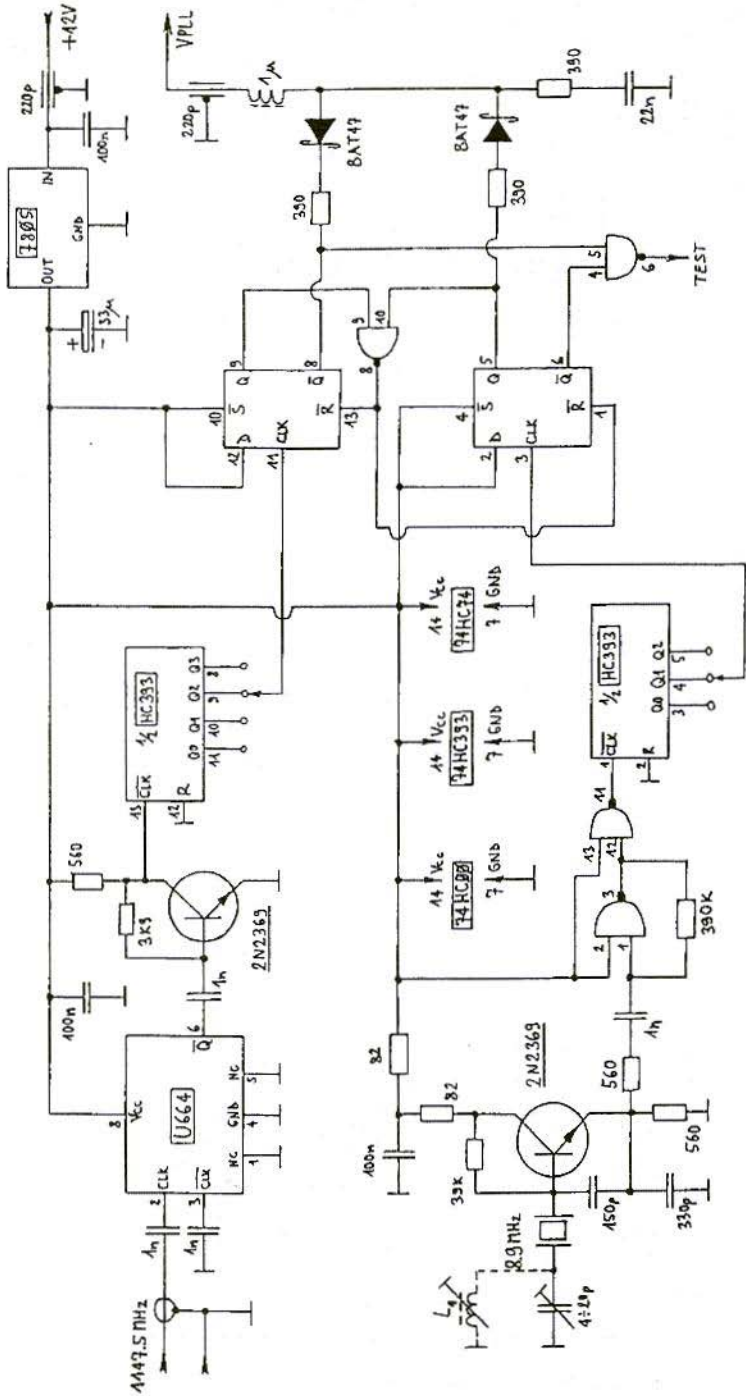

Fig.14: RX Converter PLL Circuit Diagram

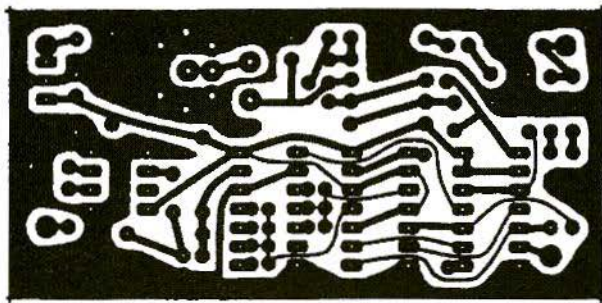

Fig.15: RX converter, PLL PCB (single-sided 0.8mm glass-fibre-epoxy)

(U664), the reference crystal oscillator at about 8.9 MHz, two additional dividers (HC393) and the frequency/phase comparator (HC74 and HC00). The PLL module has its own 5V supply voltage regulator 7805.

The above mentioned PLL is intended to replace a chain of frequency multipliers. Therefore it does not contain variable modulo dividers. The multiplication ratio is fixed to 128 (256 when considering the harmonic mixer) and the crystal frequency has to be selected according to the desired RF channel. In the frequency range around 8.9 MHz, a "CB" crystal can usually be used on its

fundamental resonance. Due to the wide tolerances of CB crystals either a capacitive trimmer or a series inductor L1 may be required to bring the crystal to the desired frequency. For operation at 2360 MHz, the best choice is a crystal for 26.770 MHz (CB channel 22 RX).

The frequency/phase comparator drives a charge-pump output network. The correct operation of such comparators is limited to low frequencies. Therefore both the VCO and reference signals have to be divided down to about 2.2 MHz when using 74HC logic in the frequency/phase comparator. Fast (Schottky) diodes BAT47 are required in the charge-pump network to avoid backlash problems that seriously deteriorate the phase noise of the frequency synthesiser.

The PLL is built on a single-sided PCB with the dimensions of 40mm x 80mm, as shown in Fig.15. The PCB is made of

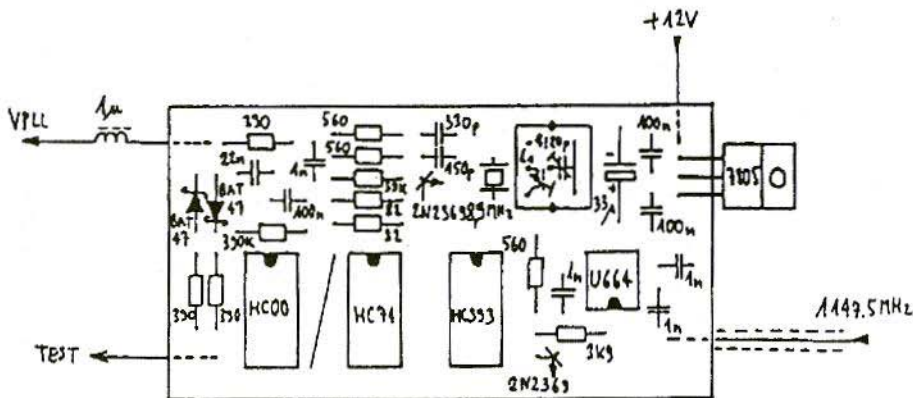

Fig.16 : RX Converter, PLL Component Overlay



0.8mm thick glass-fibre-epoxy laminate. The corresponding component location is shown in Fig.16. The only component installed below the PCB is the JuH choke on the output.

The only adjustment of the PLL is to bring the crystal oscillator to the re-

quired frequency. The PLL lock test point is not brought out of the shielding enclosure since it is only required during the adjustment of the PLL.

To be continued

KM Publications

***in association
with Spira'Web***



SPIRA'WEB

are able to offer World Wide Web space to clients in the UK, Ireland, South Africa & New Zealand at competitive rates

Fast Pentium 200 Servers running UNIX/WEB server NSA
T1 connections to the Internet * Full FTP and Telnet access
CGI-Bin * ImageMaps * Daily Access Stats
E-mail Autoresponder * etc

2M of space £6.60 / month (annual rate)

10M of space £33.00 / month

Full details: <http://www.spiraweb.com/english/>

KM Publications, 5 Ware Orchard, Barby, Nr.Rugby,
CV23 8UF, UK * Tel: (0)1788 890365 * Fax: (0)1788 891883
email: michael.j@g6iqm.demon.co.uk

Denys Roussel, F6IWF

An Ultra Low-Cost HF SSB/CW Transceiver with 20W Output, an AGC Meter, S-Meter and Audio Filters

Part-2

6.7 CW Unit and RX/TX Switching

6.7.1 CW unit:

On modern sets, the transceiver automatically switches to transmit when the key is down. On this small transceiver, this function and wave generation must be realised at lowest cost.

A solution is to use trigger gates. A CMOS 4093 will provide four oscillators or monostables. One of two gated monostables is used for the CW delay, set by P1001. The other monostable (IC 1001B) acts at power ON to prevent unwanted TX switching.

IC 1001C gives the CW AF wave. The frequency must be adjusted exactly to the centre of the receive filter by P1002 (better deviation on the S-Meter/Power indicator level). P1003 sets the CW power level.

6.7.2 RX/TX switching:

The most simple method would have been to use the PU inverter switch with a 4-wire microphone cord, as is used on low cost CB equipment. It is possible, but gives no sound when the mike is disconnected.

I preferred to add two transistors T1101 and T1102 to generate +TX and +RX supplies. L1101 is an interferences cancelling inductor. Its role is to block the local oscillator from leaking onto the AC lines, causing common mode RF hum.

6.8 Filter and Power Amplifier

6.8.1 Band Pass Filter:

The band pass filter protects the mixer from unwanted signals. On 40 meters it is very difficult to protect the mixer

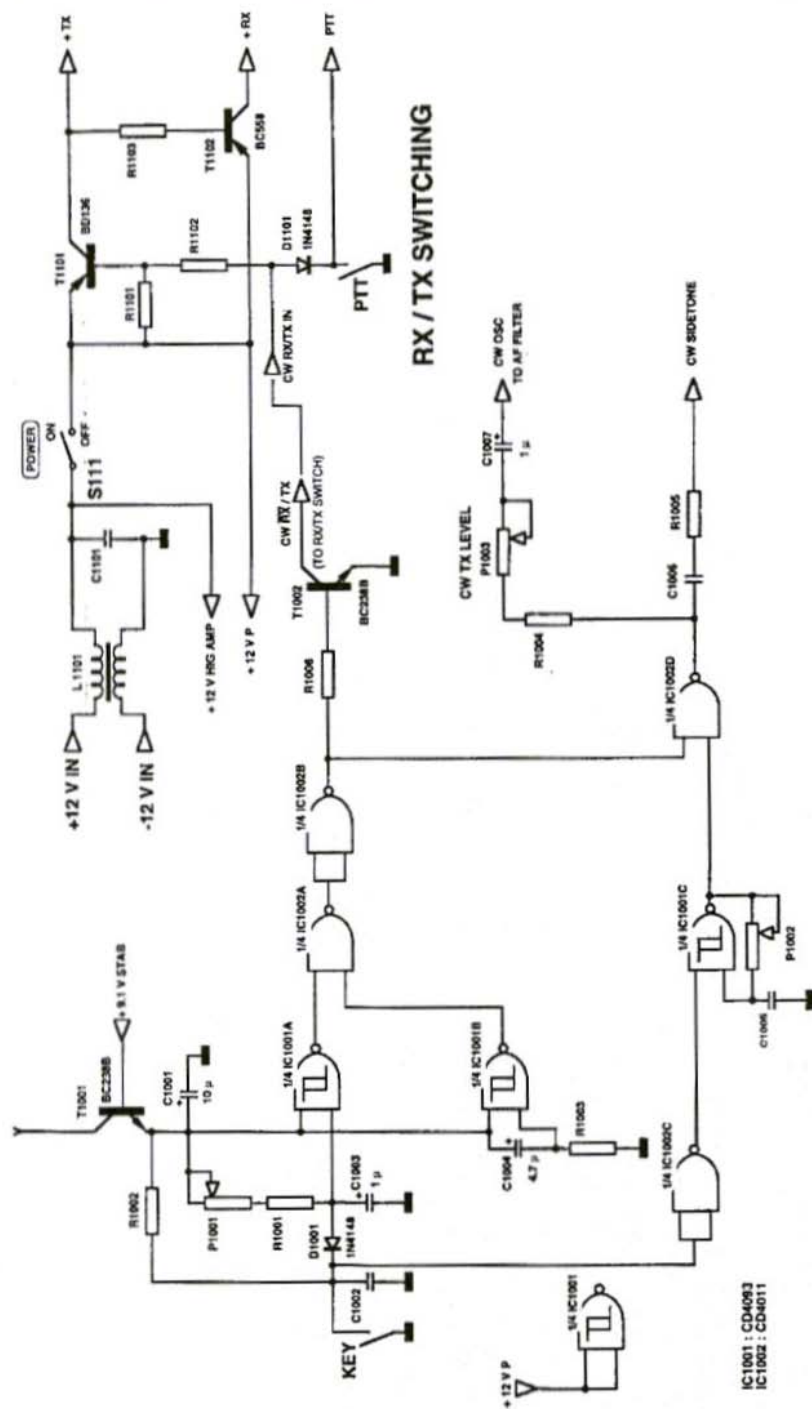

Fig.11: CW Oscillator Unit and RX/TX Switching

because of the proximity of broadcast stations. The best approach should be of course a filter which starts at 7.00 MHz and stops at 7.10!

This component almost exists. For direct subcarrier demodulation in satellite receivers, MURATA designed a ceramic filter at 7.02 MHz. This filter is not convenient alone, but when it is framed by two 100pF capacitors, the bandwidth achieves 7.1 MHz.

Losses are a little bit higher but the

efficiency on broadcast signal rejection is without equivalent.

A test on five sample filters showed a stop frequency between 7.090 MHz to 7.115 MHz (-2dB @ 7.1 MHz) and insertion losses between 4.5 to 7 dB. These losses are still compatible with use on the lower HF bands. In comparison with a two-cell coil BPF this filter exhibits a rejection of more 22dB at 7.2 MHz against only 1dB for the standard one, moreover there is no tuning.

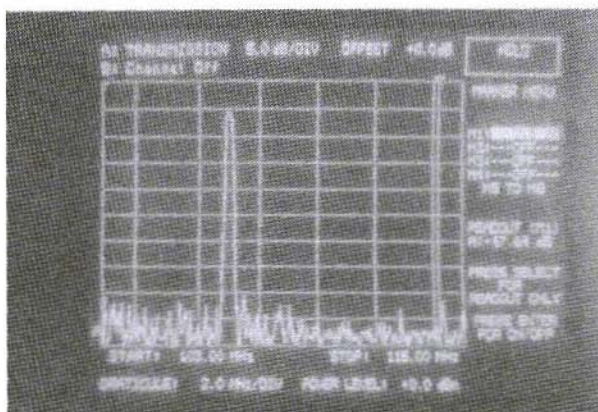

Frequency Response of the 7.02 MHz Ceramic Filter framed by 100pF Capacitors.

Marker = 7.2 MHz

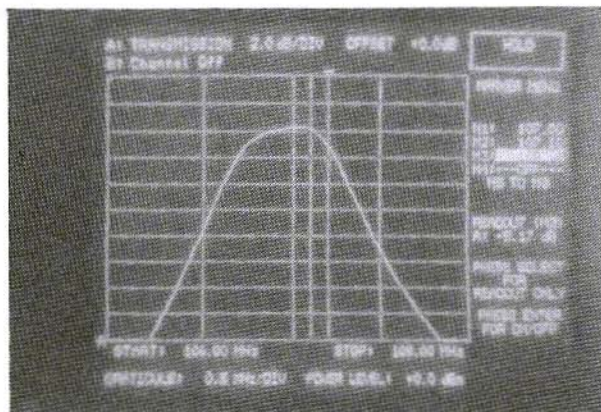

Frequency Response of a standard Two Cells Coil Filter

Marker = 7.2 MHz

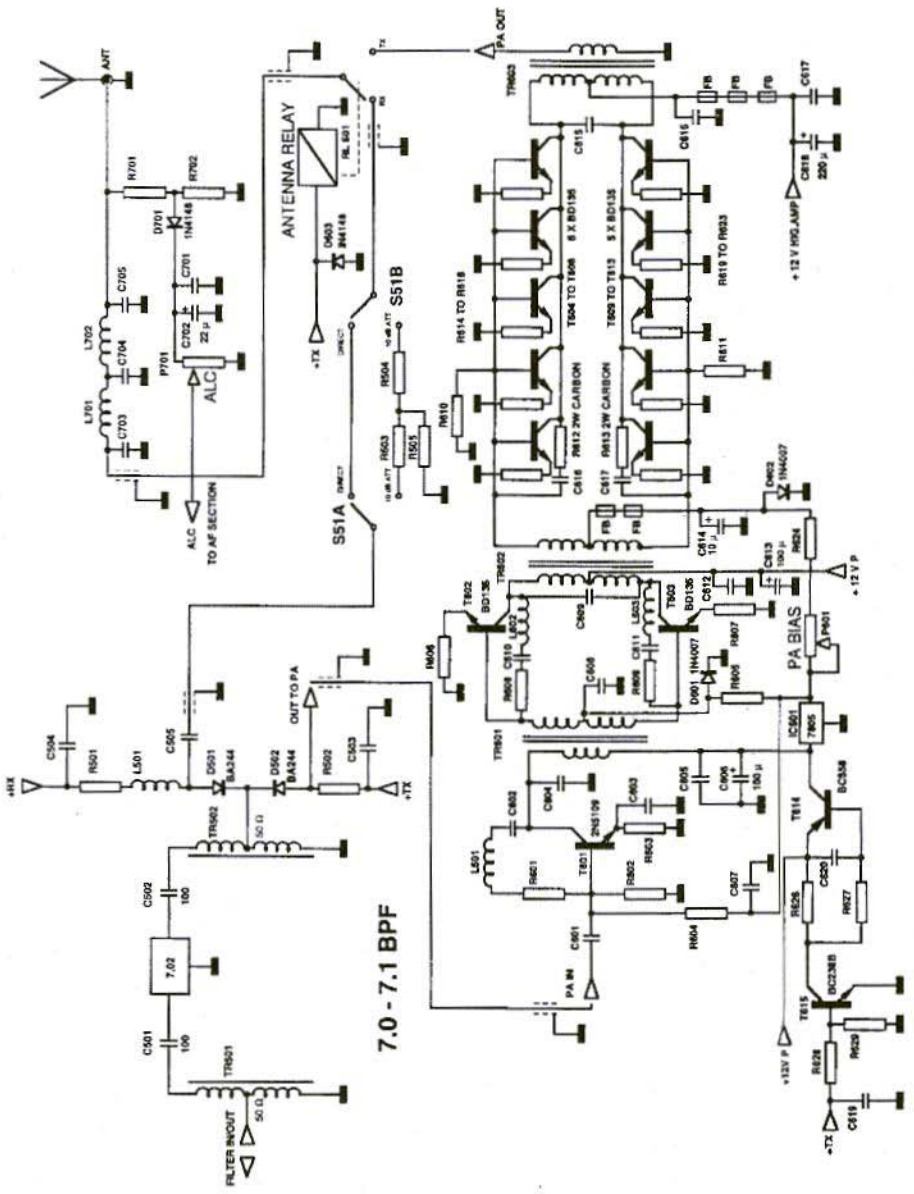

Fig.12: Band Pass Filter, PA, Low Pass Filters and ALC

6.8.2 The Power Amplifier

A power of 20W is already quite expensive. To achieve it two 10W transistors are required which cost of the order of app. £7.00 each. This price is not compatible with the target price of the transceiver.

After several weekends of experimenting with power FET switches, I reverted to bipolar transistors. Power switching MOS devices are not very stable in push-pull configurations and require 24 volts to provide a good power output.

I used a principle described by Mr E.JAMET (FIBAE) 10 years ago. The design uses several low cost transistors wired in parallel. The cost decreases below £3.00!

The input power is about 0.5 to 1mW. For a 20W output, the necessary gain is nearly 46dB. BD135 devices are capable of 10 to 12dB and the pre-driver should amplify by 23 to 26dB. To achieve this gain a 2N5109 is used in the PA input as the pre-driver. This transistor is expensive, but has a important gain at HF and is very linear. L601, C602, R601 and C603 compensate for the slope of the driver and PA stages.

All stages are polarised by a 5V regulator to prevent bias change with supply voltage. There is a separate remote circuit to apply bias in TX operation.

The driver stage is a BD135 push pull to reduce harmonics. The power at TR602 output is about 3 to 4W. The antenna relay is a standard one rated for 2A switching.

The PA is made up from ten BD135

devices in push-pull. The RF power level was measured at 32W on 80M, 26W on 40 and 21W on 20M with a 13V supply. The efficiency is about 50% and the linearity is good.

6.8.3 Low-Pass Filter and ALC

To keep harmonics to an acceptable level a two-cell low pass filter is necessary. To save money, cores are replaced by a section of PVC plumbing PVC pipe.

The ALC detection is very simple but seems sufficient. P701 is set to limit output power to 20 W.

7.

PROTOTYPE PERFORMANCE

7.1 Receiver Performance

- Unwanted side band rejection: The side band rejection at 1 kHz on 7050 kHz was measured at 52dB after optimisation of the AF frequency. On the entire 7 MHz band and from 300 to 3000 Hz, the unwanted side band rejection was better than 45dB.
- AM sensitivity: The AM sensitivity is about 10mV with preamp OFF.
- Intermodulation performance: Not measured. According to mixer testing, the third order input intercept point should be near 30dBm of input (22dBm with 3dB loss in splitter and

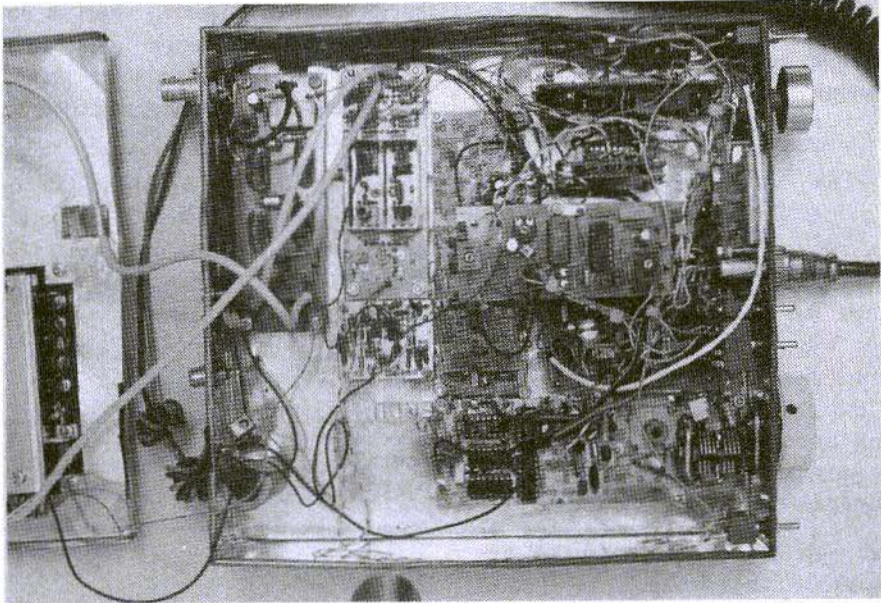

Photograph of the 40/80 m Prototype

6dB loss in the band pass filter). I know that it is very high, but it seems to be the case.

- Noise figure: The noise figure was measured at 27dB without the RF preamp and 16dB with preamp (3 kHz BW). It is not good but sufficient on the lower HF bands. On 14 MHz a low loss band pass filter (1.5dB) should be used to reduce the Noise Figure to a usable level.
- AGC efficiency: The AGC action starts to work on a signal of S7 and keep the audio level at +6dB to near S9+50 dB.
- Selectivity: SSB Wide : 350 to 2800 Hz at -6dB; SSB Narrow : 350 to

1700 Hz at -6dB; CW : 540 to 770 Hz at -6dB.

- AF output: 2W into 8 Ohms at 13 V power supply.
- Consumption: <200mA at 13V power supply.

7.2 Transmitter performances:

- Carrier suppression: about 35dB at 20W output
- Unwanted side band rejection: 30 to 32dB at 20W output (the optimum phase setting is different from in receive mode)
- IM3: Better than 30dB at 20W output



- Harmonic suppression: Better than 40dB at 20W output
- Output power: >20W at 13V power supply.
- Consumption: <5A at 13V power supply.

7.3 Impressions in use

In use this transceiver behaves like a filter one. Practically, opposite side-band stations are completely eliminated by the phasing process. In fact, with 45dB of rejection, opposite side bands are present on very strong stations but covered by QRM or band noise.

The most impressive feature of this receiver is that it is completely free of noise when the antenna is disconnected. There is no transmodulation, even with a normal antenna (dipole) on 40 meters in the evening.

The AGC on AF reminds me of the ATLAS 210. It is impossible when listening to detect that the gain control acts on the AF level. In case of QRM the narrow position is efficient.

In CW, the phasing principle starts to cancel the unwanted side band at "0Hz". With a transceiver only equipped with a SSB filter, the opposite CW side band is not eliminated. Thanks to the CW filter, stations are selected very easily. The transmit frequency is exactly the same as the received one., it is just necessary to push the key down to establish contacts.

In transmitting, the modulation is judged good on the air as well as the CW note. The side band rejection is not really

quite low enough, but at 20W output, the level is only 10mW, which is not detectable under normal conditions. There is no SWR detection to protect the PA, but I did not meet any problem on this side yet.

I have been using a dual band (80/40) version of this transceiver for the past 5 month now, and I have made about 500 QSOs (43 DXCC) mostly on 40m, using a 3 meter whip on a balcony.

8. PRICE CALCULATIONS

Dual Mixer

12 x Ferrite Bead, 2 MKT Capacitor, 2 x LCC Capacitor, 16 x 1N4148, 2 x 25V Capacitor, 3 x 0.25W Resistor: Total 11.65 F.

RF Bidirectional Preamp

9 x Ferrite Bead, 12 x Ceramic Disc Capacitor, 1 x BFR91, 5 x BA244, 7 x 0.25W Resistor: Total 17.75 F.

AF Preamp:

2 x BC549C, 6 x BC238B, 1 x Pot, 2 x 1N4148, 8 x 25V Capacitor, 17 x 0.25W Resistor: 12.75 F.

VFO & RF Phase Shifter

3 x Ferrite Bead, 4 x NPO Capacitor, 1 x J310, 1 x BC238B, 1 x 25V Capacitor, 9 x 0.25W Resistor, 1 x Tantalum Capacitor, 1 x Variable Capacitor, 3 x LCC Capacitor, 1 x Ceramic Capacitor, 1 x VFO Coil, 1 x 74F00, 1 x 74F74: Total 38.15 F.



AF Phase Shifter

2 x CD4053, 2 x TL074, 1 x Pot, 4 25V Capacitor, 8 x 0.25W Resistor, 6 x LCC Capacitor, 6 MKH Capacitor, 18 1% Metal Film Resistor: Total 32.80 F.

AF Section

1 x CD4066, 1 x TL074, 2 x Trimmer Pot, 12 x 25V Capacitor, 12 x LCC Capacitor, 1 x MKT Capacitor, 5 x Ceramic Capacitor, 43 x 0.25W Resistor, 1 x Pot, 1 x S-Meter, 6 x 1N4148, 2 x Switch, 7 x BC238B, 1 x BC549C, 1 x BC558B, 1 x TBA820M, 1 x 1W Loud Speaker, 1 x Zener Diode: Total 94.45 F.

CW Oscillator

2 x LCC Capacitor, 2 x BC238B, 3 x Trimmer Pot, 1 x 1N4148, 4 x 25V Capacitor, 6 x 0.25W Resistor, 1 x Ceramic Capacitor, 1 x CD4093, 1 x CD4011: Total 13.90 F.

RX/TX Switching

1 x LCC Capacitor, 1 x BC558B, 1 x BD136, 1 x 1N4148, 1 x ferrite Core, 3 x 0.25W Resistor, 1 x Ceramic Disc Capacitor, 1 x ON/OFF Switch: Total 12.45 F.

RF Band-Pass Filter

3 x Ferrite Bead, 4 x Ceramic Disc Capacitor, 2 x BA244, 5 x 0.25W Resistor, 1 x Switch, 1 x 7.02 MHz Ceramic Filter: Total 12.45 F.

Low-Pass Filter and ALC

2 x PVC Pipe Sections, 3 x Ceramic Capacitor, 2 x Ceramic Disc Capacitor, 2 x 1N4148, 2 x 0.25W Resistor, 1 x 25V Capacitor, 1 Trimmer Pot: Total 7.10 F.

20W Power Amplifier

10 x Ferrite Bead, 8 x Ceramic Disc Capacitor, 8 x LCC Capacitor, 2 x 25V Capacitor, 1 x 16V Capacitor, 1 x 40V Capacitor, 1 x 1N4147, 2 x 1N4007, 27 x 0.25W Resistor, 2 x 2W resistor, 1 x BC238B, 1 x BC558B, 1 x 2N5109, 12 x BD135, 1 x Trimmer Pot, 1 x 7805, 1 x 4C65 8x14x8 Twin Bead, 2 x 25x8x14 Ferrite Tube, 1 12V/2A Relay: Total 82.35 F.

9.

CONCLUSION AND ACKNOWLEDGEMENTS

A prototype is now working and the price of DM 100 was not so crazy. The total component price reached 335.80 FRF or about DM 96 (app. £45). The remaining 4 DM for the PCB and aluminium plate for the box. It is just a first prototype wired up in a tin plate box and important work is still necessary to describe the construction of this set.

Development must be managed now with reproducibility the aim, a multi-band feature and improvement of transmit performance and noise figure.

This design was registered and protected, commercial use of parts or totality is subject to international rights.

I would like to thanks Messers Rohde, Jamet, Oppelt, Campbell, Jirmann, Hamilton, DeMaw, and many others for their fine articles, Mr Poirrier from SAGEM for 7.02 MHz filter samples, Rene,



F1XR for ferrites, and my friends F9PT, F6AWN and F6CIQ for their help, on-air transceiver testing and patience.

10. LITERATURE

- R.OPPELT DL2NDO (ex DB2NP): The Generation and Demodulation of SSB Signals using the Phasing Method; VHF Communications 2/87 and 3/87.
- R.L.CAMPBELL KK7B: A novel SSB modulator for laboratory signal generators; Application Note, Mini-Circuits. High-Performance Direct-Conversion Receivers; QST 08/1992. High-Performance, Single side band, Direct-Conversion Receivers; QST 01/1993
- N.HAMILTON G4TXG: Improving Direct Conversion Receiver Design; Radio Communication 04/1991
- ARRL Handbook 1993
- J.JIRMANN DBINV: Theory and practice of the frequency synthesiser; VHF Communications 2/93 and 3/93.
- J.JIRMANN DBINV and W. HERCHER DL8MX: Improvement of the Intermodulation of modern Amateur HF receiver; VHF Communications 1/93.
- U.ROHDE DJ2LR: Synthesised high-frequency transceiver; Ham-Radio 03/1978
- E.JAMET F1BAE: Realisations avec des perles ferrite; R.REF 06/1985: Ampli large bande nouveau style; Ondes courtes information 06/1982: Transceiver HF et VHF, compact, performant et de faible prix de revient. R.REF 10/1987 to 02/1988
- A.DEZELUT F6GJO: Les Tores Magnetiques; R.REF 01/1992
- D.DE MAW W1FB: Power-FET Switches as RF Amplifiers; QST 04/1989
- J.MAKHINSON N6NWP: A High-Dynamic-Range MF/HF Receiver Front End; QST 02/1993
- R.C.DAVIS G3TDL: A non-mathematical analysis of the third method; Radio Communication 12/1982
- G.V.ENTWISLE G3MXT: The G3MXT third-method Mk.2 and polyphase Mk.2 SSB generators; Radio Communication 12/1981
- D.LAWSON, WB9CYY: Phasing-type single-signal-detector; Ham-Radio 10/1976
- J.R.HEY G3GTZ: The G3GTZ Phasing Receiver; SPRAT Journal No.71
- J.YOUNG G7BCJ: An 80 Metre Phasing Receiver; SPRAT Journal.
- QST PRODUCT REVIEW: Kenwood TS-8505 160-10 meter transceiver; QST 07/1991
- TECHNICAL TOPICS OF RADIO COMMUNICATION: 03/1978; 02/1981; 09/1988; 2/1989; 06/1991; 09/1991; 08/1984.



Detlef Burchard, Dipl.-Ing., Box 14426, Nairobi, Kenya

Active Reception Antennas - Observations, Calculations and Experiments

Part-2 (Conclusion)

9. MEASUREMENTS UNDER OPERATING CONDITIONS

On the workbench, it could already be established that numerous stations could be heard on all short-wave bands. For comparison with the groundplane antenna recommended in [2], however, the capacitive broad-band active antenna had to be on the roof. There was already

a mast at an appropriate place on the roof of the house (Fig.18), at which a discone antenna had been mounted up till then. The height of the two antenna heads was then the same - 7m above the ground. The expected improvement in reception did not materialise. The short-wave range was crammed with inter-modulation products.

When an oscilloscope was connected using a 50Ω through coupler, this soon made it clear that medium-wave trans-

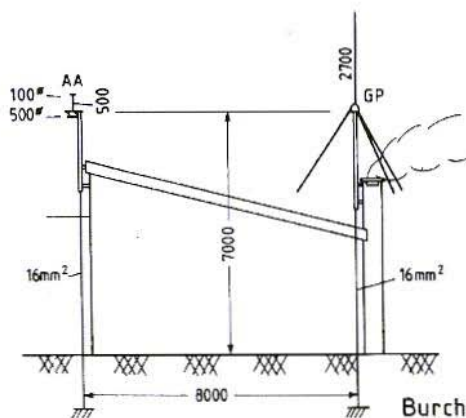

Fig.18:
Configuration of Active Antenna
AA on the House Roof at the same
Height as Ground Plane Antenna
GP, which is otherwise used for
Short-Wave Reception

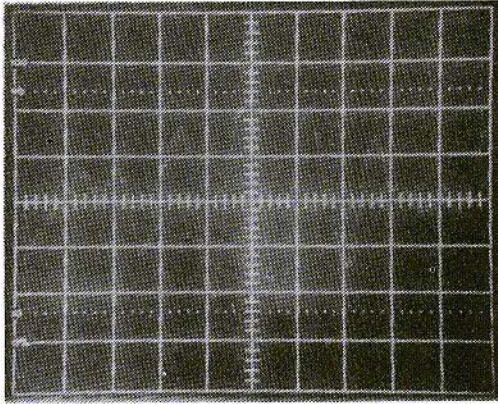
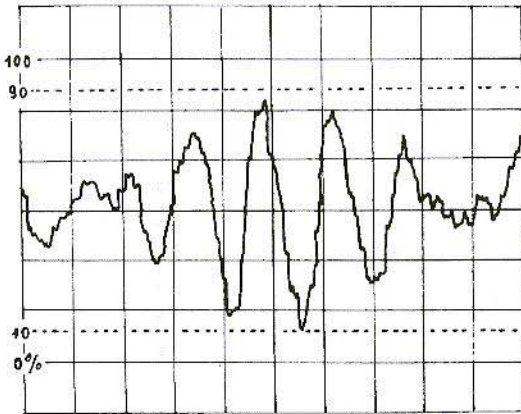

Fig.19:
Reception of two nearby
Medium-Wave Transmitters led
initially to Saturation. The
Image was obtained following
Remedial Measures which are
described in the text:

left) Original Photo from
 Oscillograph Screen

below) Hardcopy drawn from
 Negative

Y: 0.2 V/div; X: 1 μ s/div



mitters were causing saturation. This could only be the two 100kW stations in Nairobi, which are 11 and 17km respectively from the reception point and working at 612 and 747 kHz. The total voltage generated by them was much higher than the maximum swing of the active antenna output. It was estimated that they delivered a field strength of approximately 500mV/m.

What I have done now to remedy the situation is to reduce the input resistance of the amplifier. 10k Ω fixed resistance, together with an antenna capacitance of 5pF, gives high-pass behaviour, with a limiting frequency of 3.2 MHz. The

interfering medium-wave transmitters are damped by more than 12dB, whilst there is scarcely any impairment in the short-wave range. The oscillogram in Fig.19 shows that this was the right thing to do. The curved trace, now unlimited, looks like a beat effect, because the two transmitters are received at about the same field strength. Short-wave transmitters produce the small ripples on the curve. The reason they are so small, although two 250kW stations are operating 39km away, is because their ground waves suffer considerably more attenuation than those of the medium-wave transmitters.



The quality of the screen photo leaves something to be desired. This is due to the fact that once again I was up against the limits of my capabilities. A writing speed of 20 - 30km/s is the best that can be obtained with the oscilloscope ($f = 50$ MHz, $UB = 10kV$), the film used (400ASA), and the maximum focal aperture of the camera (2.8). 50km/s is what was needed here. The hard copy drawn in the dark room, based on the enlarged negative, may be easier to read but does not reproduce all the details faithfully.

Experiments could now be carried out to determine the degree of influence exerted by the top capacity and the ground plate. The result can be seen in Fig.20. A calibration staircase for the rectified voltage in equivalent input power can be seen on the right, to give some idea of the strength of reception. Except for the start and saturation periods, the gradient is 1.8 dB/div. Remember that the dBm reading refers to the power received by the 51Ω resistance in Fig.15. It would be more correct, in physical terms, to have a μV scale or, even better, a $\mu V/m$ scale. Both can be obtained through simple conversion, but this is not something we are concerned with here.

On the basis of transmissions being received from three transmitters in different frequency bands, at different distances and in different directions, it is unambiguously clear that neither the top capacity nor the ground plate have any measurable influence on the reception voltage. The Voice of Germany transmitter from which transmissions were received in the 19m band is in Sri Lanka, 5700km East of here. Radio

Moscow, broadcasting in the 13m band, is 7200km to the North. Finally, the Kenya Broadcasting Corporation's transmitter, from which transmissions were received in the 4m band, is one of those 250kW transmitters already mentioned which are 39km away. This station certainly has the best reception quality, because the ground wave arrives without any selective fading, but it has the greatest fading depth of 45dB. The stress on the AGC is considerable, and the use of logarithmic demodulation in the following receiver, which is here wired up downstream, gives an audible advantage (simply because nothing can be heard of the 45dB signal fluctuation!).

At the time of the day in question, the other two transmitters can be received rather well (The Voice of Germany) and rather badly (Radio Moscow). The fading depth for each of them was only about 30dB.

A few hours later, a comparison was made between the ground plane and the active antenna. The result can be seen in Fig.21. The Voice of Germany is now being received rather more strongly, but inter-modulations can be heard in the field strength troughs. The ground plane certainly supplies 16.5dB volts less on average, so that noise can be heard in the field strength troughs, but no inter-modulation products of any kind can be heard. They may be covered by noise.

The reception of Radio Moscow at this time is poor with both antennae. Frequent disappearance in noise when the ground plane is used can be compared with frequent disappearance in chirping and external modulations with the active

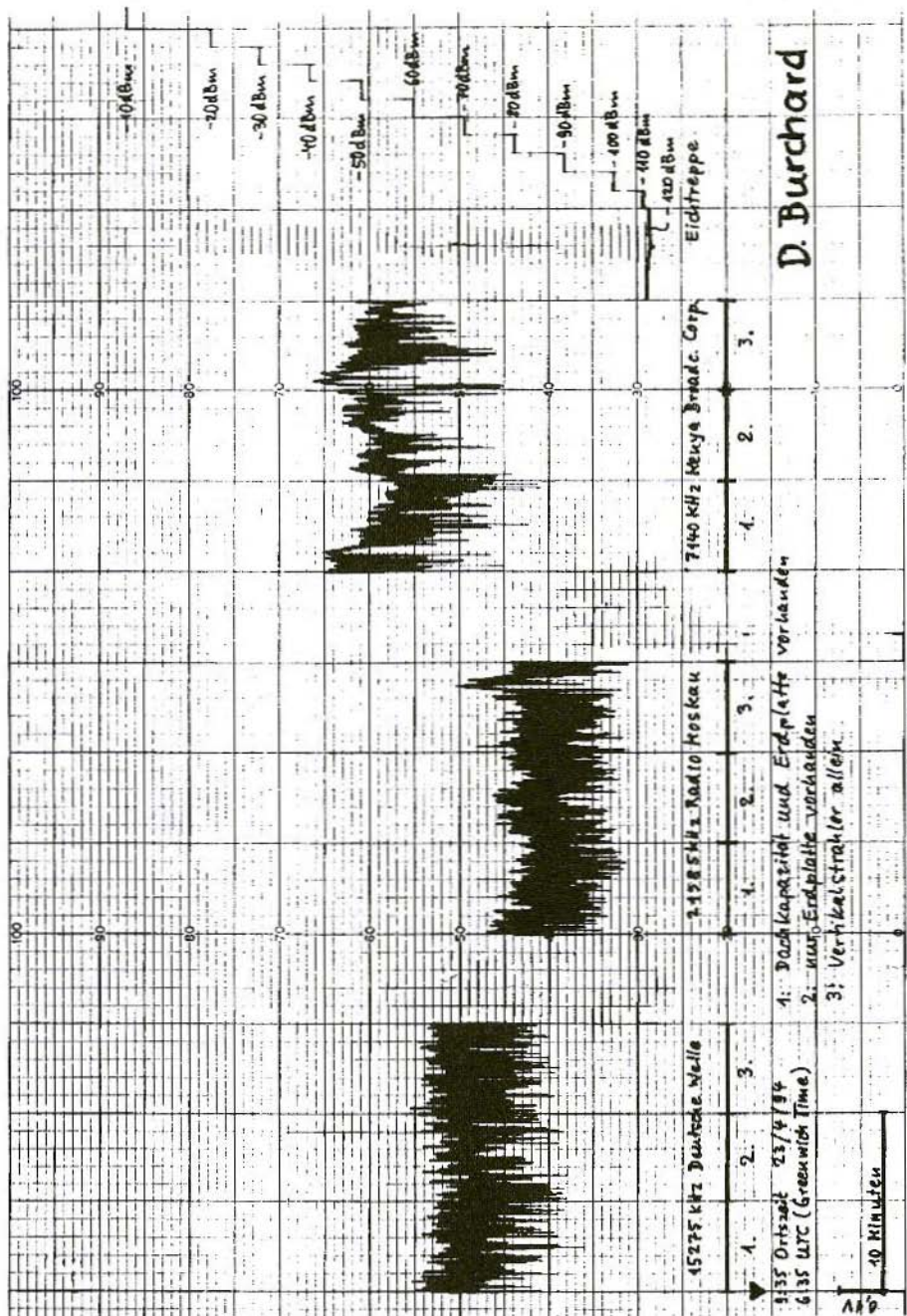

Fig.20: Recording of Rectified Voltage for Reception of Stations with Top Capacity and Ground Plate (1), Ground Plate only (2), Neither (3)

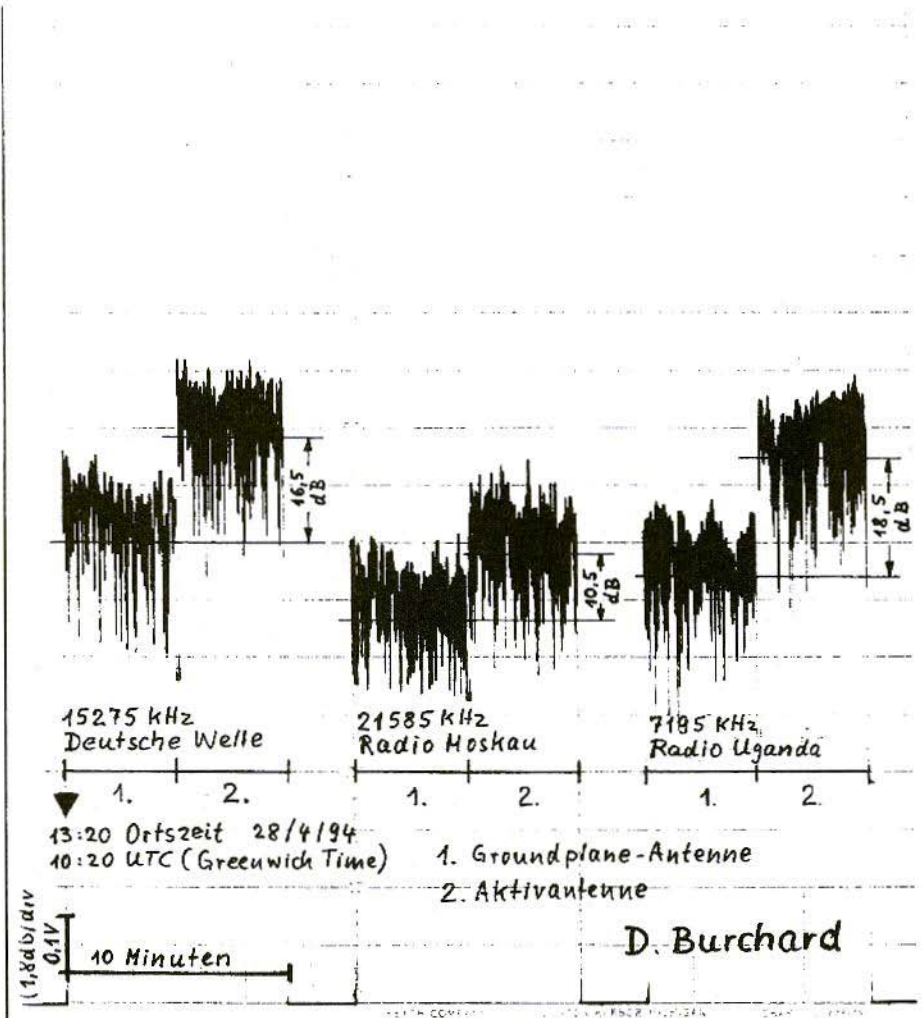

Fig.21: Recording of Rectified Voltage for Reception of Various Transmitters with Ground Plane (1) and Active Antenna (2) using a Configuration as per Fig.18

antenna. The mean level difference is only 10.5dB, and it can be assumed that at the top end of the short-wave range, where the ground plane comes into resonance, the level difference will be rather small.

Since in the meanwhile the Kenya Broadcasting Corporation had switched over to the midday siesta, Radio Uganda (550km West-North-West of here) was now received in the same band. Reception with the active antenna was reasonably good and with the ground plane it was rather poor. The level difference had increased to 18.5dB. In none of the three cases was the gain in reception quality as great as the level difference between the ground plane and the active antenna would lead us to expect. There is little external noise, at this time of day at least. It was thus clear that it is not the internal noise which determines the lowest level of reception, but the dregs from all possible inter-modulations. At night, when the external interference is considerably greater, there are even situations in which the ground plane is superior.

10. SUMMARY

Experience with the medium-wave transmitters shows that the requirement for a compatibility of 1V/m field strength is in no way exaggerated. In Central Europe, it will possibly be necessary to lay down even higher values. But even the 1V/m means that the amplifier

output must be capable of delivering up to 10Vpp into 50Ω, which corresponds to 25mW (+24dBm). The current consumption would go up considerably, to an estimated 150mA.

The IM suppression would have to be increased to 120dB. If work is being carried out with a band width smaller than 7 - 10 kHz, then the demands are even greater! The active antenna described here is still 33dB short of 120dB. Naturally, the characteristics of the subsequent receiver would also have to be better, which might scarcely be possible using broad-band concepts. We know from spectrum analysers that there seems to be a sound barrier at "100dB on the screen", even if it is only a matter of cost. So once again we must think about pre-selection, or at least sub-octave band-pass filters. The further forward they are mounted in the signal path, the better they will work. And for this reason a reduced input resistance of the active antenna is better than a really great filter after it.

These problems can be diminished by using a shorter antenna rod. The signal voltage is then reduced and the internal noise is increased, because the Z_q noise increases.

The rod can also be given a capacitive load. This also reduces the signal voltage and the internal noise too, because the Z_q decreases, even if not to the same extent as the signal. Capacitive loading is equivalent to the omission of the C_e compensation. We can no longer talk of the "harmful" input capacitance. A design without compensation, such as [5], must not be disadvantageous in operation.



Finally, it appears from the external noise behaviour shown in Fig.5 that for shorter rod antennas are sufficient at low frequencies. Instead of shortening, we can impose an Ohmic load on a sufficiently long rod for the short-wave range (0.5m). If the external noise is greater than $500\mu\text{V}$ at 20 kHz, but the internal noise is less than $2\mu\text{V}$, then a load may be imposed such that the input voltage falls to 1/250. The rod could be given a $6\text{k}\Omega$ load, which is very near to the $10\text{k}\Omega$ which I used to reduce the voltage of the medium-wave transmitter.

What comes out of this in the end is that the amplifier input need not be capacitance-free or particularly high-Ohmic for the **purposes of reception**. But both conditions must be fulfilled if the aim is to measure field strengths, for which a constant conversion factor is required, irrespective of the frequency. The circuit given in [3] fulfils its purpose, since the input capacitance there is very low and the frequency range of the amplifier is very wide.

The top capacity and the ground plate have no influence on the reception voltage, and only a slight influence on the internal noise, due to the fact that they increase the capacity. It is better to leave them aside completely.

Apart from a small glow lamp with an ignition voltage of 70V, no measures were taken here in the amplifier to drain any over-voltage on the antenna conductor. True, when operations commenced it was not at all clear whether a serviceable active antenna would even be obtained. And even now I am not at all sure that I want to have one. To my knowledge only such antenna of this

type are secure against a direct lightning strike that have directly earthed antenna conductors. Such constructions are used in passive antennae. And then, I live in an area which has considerably fewer thunderstorms than my previous home in Germany. I would have to wait a very long time for some lightning, or set up a high-voltage laboratory. There is a lightning research institute on San Salvatore near Lake Lugano in Switzerland. Perhaps a radio ham from Switzerland can get some information from them on how to "harden" amplifiers with a FET input?

Perhaps to end with I should again refer to something which has been known for a very long time, i.e. that antennae with restricted band widths also have their advantages. They keep out signals from outside the band, and thus reduce the possibilities of inter-modulation quite considerably.

11. LITERATURE

- [1] Akadern. Verein Hütte (1962)
Metallurgy, IV B, 28th edition
Chapter III - Wave Propagation
Verlag W.Ernst & Sohn, Berlin
- [2] D.Burchard (1989)
Short-Wave Reception Based on
the Thirties Principles;
VHF Communications 1/90,
pp. 23-30 and 2/90, pp. 70-76
- [3] D.Burchard (1992) MES-Fetishism
II; VHF Communications 4/92,
pp. 233-240



- [4] F.R.Connor (1982) Noise, 2nd edition E.Arnold, London
- [5] J.Jirmann (1992) Active Antennae for the Frequency Range from 10 kHz to 50 MHz; VHF Communications 4/92, pp. 226-231
- [6] Meinke & Gundlach (1968) High-Frequency Technology Pocket Book 3rd edition Chapters H and N Springer-Verlag, Berlin
- [7] Meinke & Grundlach (1986) High-Frequency Technology Pocket Book 4th edition Chapters H and N Springer-Verlag, Berlin
- [8] Rothammel & Krischke (1991) Antennae Book 10th edition Franckh-Kosmos-Verlag, Stuttgart
- [9] J.Vastenhoud (1972) Short-Wave Reception Practice Deutsche Philips (publishers) Hamburg
- [10] R.W.Weeks, F.M.Long & J.E.Lindsay (1977) Fish Tracking from the Air Proceed. 1st Int. Conf. Wildlife Biotelemetry pp. 63 - 69 University of Wyoming, Laramie
- [11] NN (1974) Active Aerial AA300 description Standard Radio & Telefon AB, Vällingby

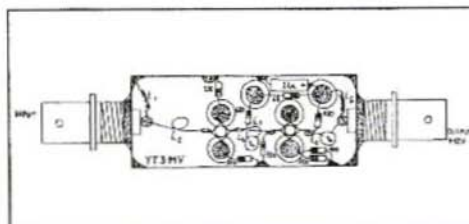

Very low noise aerial amplifier for the L-band as per the YT3MV article on page 90 of VHF Communications 2/92. Kit complete with housing Art No. 6358 £36.55 Orders to KM Publications at the address shown on the inside cover, or to UKW-Berichte direct.

The British Amateur Television Club

The foremost association on the world, for anyone, anywhere in the world, who is interested in Amateur Television.

CQ-TV the quarterly journal of the BATC is recognised as the most professionally produced amateur publication of its kind.

Join the BATC and receive *YOUR* copy of CQ-TV

Membership is *only* £9.00 per year.

BATC, Grenehurst, Pinewood Road, High Wycombe, HP12 4DD



Wolfgang Schneider, DJ 8 ES

VHF, UHF and SHF Measuring Methods Using a PC

Part 1: Essentials of Control Using the PC's Centronics Port

Developing VHF, UHF and SHF measuring methods is an ambitious goal. Radio amateurs can simply not do without measuring methods now, in connection with building their own equipment or even operating their own radio systems. Obtaining the apparatus required for this is not always simple, and is certainly not always inexpensive.

1. INTRODUCTION

There are particularly interesting possibilities for DIY work in the area of measuring methods. Numerous different publications in the relevant amateur radio literature support this opinion. Whether it's a test transmitter, a milliwatt metre or even a spectrum analyser - as Robert Lentz, DL3WR, once wrote in VHF Communications - "state of the art

technology comes to DIY assembly".

All these devices have one thing in common, they should be usable over as wide a range as possible. But it is not sufficient for the milliwatt metre to function well at 23cm alone. It must give readings which are just as precise in the short-wave range, at 2m or 70cm.

And it's precisely here, when we come to deal with wide-band linear operation, that the problems really begin. The computer can help us here to a really miraculous extent. Linearisation of tuning characteristics in the test transmitter, automatic calibration of the wattmeter, zero offset compensation, etc.. The list of possibilities is virtually endless.

Specifically, this series of articles will deal with the themes of input and output units for Centronics interfaces, mW meters, frequency synthesisers, and a computer-controlled measuring position, with additional options for a wobbler and a spectrum analyser.

2. POSSIBLE LINKS TO A PC

However, before this universal measuring position comes into being, the principles must be set out first. This applies, in particular, to the digital world of the personal computer. Computers can now be found in the shacks of the majority of radio amateurs. To start with, we used the C64 or ZX81 for applications which were still "relatively limited".

Now you can find virtually everything in the PC line which is available on the market.

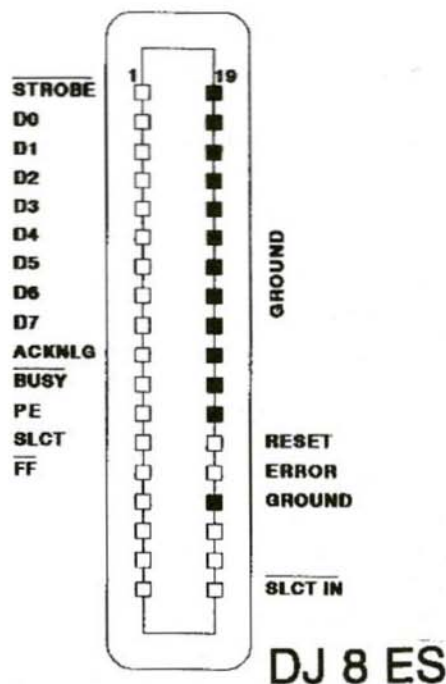

Fig.1: Pin-Assignment for a 36-pin-Centronic Connector

If the computer is to take over control functions, it must be able to communicate with the outside world. That's what interfaces are for.

2.1. Parallel Interfaces

Any commercially available PC has at least one parallel interface as per the Centronics norm as a standard feature, to which the printer is connected - but this interface can do much more!

The data traffic between the PC and the printer is carried on through a minimum of 8 data circuits and 4 control circuits.

When data are transmitted, the transmitter sends the data item on circuits D0 to D7 and checks whether the subscriber is ready to receive data (BUSY).

As soon as the BUSY circuit accepts a logic 0, the transmitter generates a STROBE signal (briefly, a logic 1) and enters the information into the peripheral.

The printer acknowledges using the ACKNLG signal (ACKNOWLEDGE).

The PE circuit (PAPER EMPTY) signals that the printer has run out of paper.

These four control circuits are all that is needed for data transmission.

Many printers have additional¹ control options. I shall not be going into these additional options in greater detail here and now. But they are included in Fig.1, for the sake of completeness.

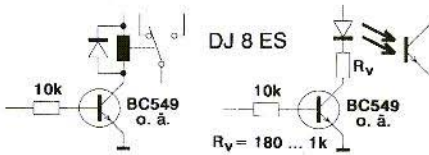

Fig.2: Driver Circuit for Driving Switching Stages

2.2. Control using the Centronics Interface

The circuits referred to above can be used as follows in control technology:

D0 to D7 as exit

STROBE as handover signal

ACKNLG, BUSY, PE as entry

All circuits on the Centronics interface operate at transistor transistor logic level. Switching stages, transducers, etc. can be connected up directly here. Due to the fact that the switchable power is only "low", drivers (e.g. 74LS244 or LS245) should be looped in. They provide multiple amplification for the switching current.

To wire up lamps, motors, etc., relays must sometimes be inserted into the circuits. Optoelectronic couplers are used here too, for de-coupling, and so are electronic load relays.

De-coupling can be recommended, especially for applications using supply voltage (or at higher voltages). Fig.2 shows simple driver circuits for driving switching stages.

2.3. Adapter Cards for Experiments

A simple and easily monitorable adapter card is useful for the first practical tests.

The circuit is shown in Fig.3. It includes the bus driver for the output circuits D0 to D7 and, as an updated status display for all circuits, LED's of various colours.

With this adapter card, we can "see" what's going on in front of us (Fig.4). Fig.5 shows the components plan for the double-sided printed circuit board.

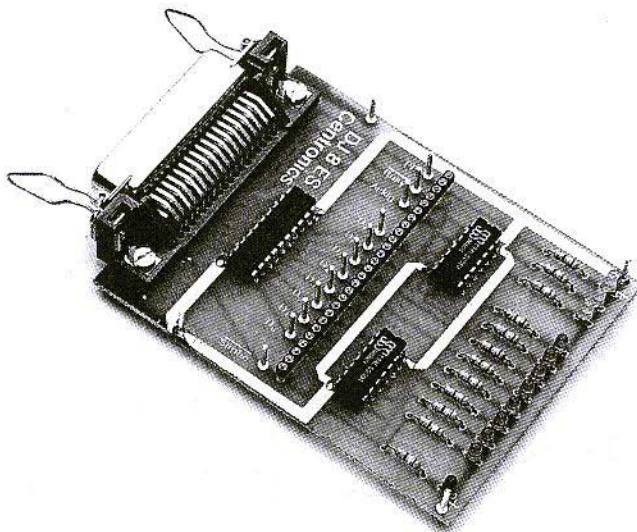

**Fig.3:
The Centronics
Adapter Card
Fully Assembled**

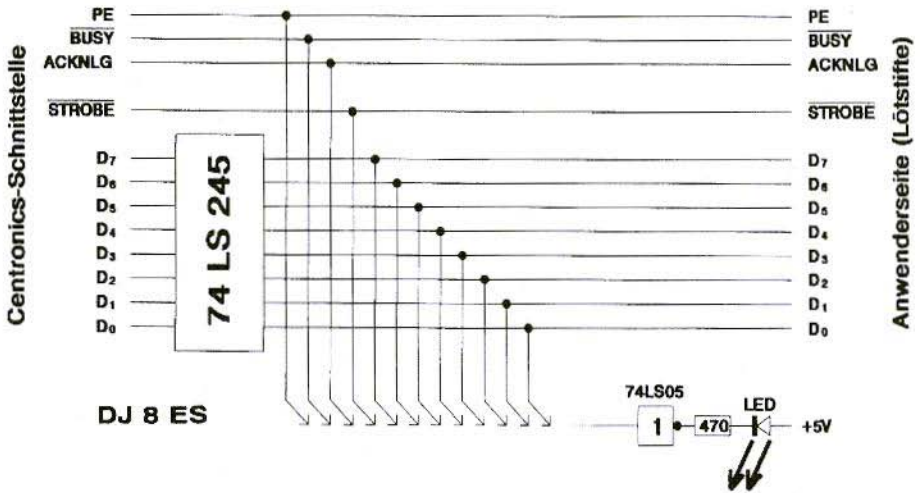

Fig.4: Centronics Adapter Card Circuit: *Schnittstelle* = Interface

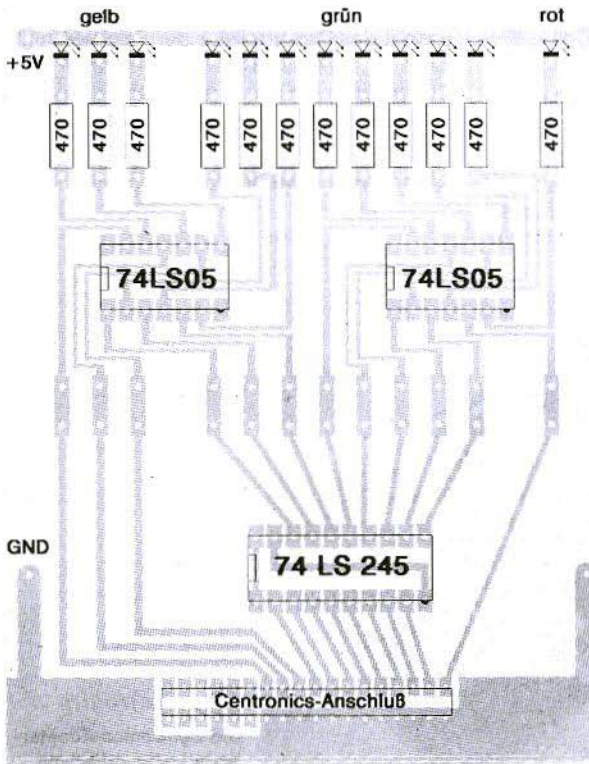

Fig.5:
Components Plan of
Adapter Card

Gelb = Yellow;
Grün = Green;
Rot = Red;
Anschluß = Connection

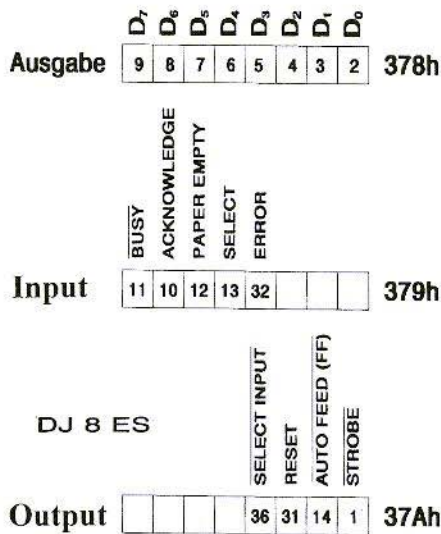

Fig.6: Allocation of Control Signals to corresponding Register

3. ACTUATING THE INTERFACE

The PC must be appropriately programmed so that it can communicate with the outside world.

The logic address(es) of the built-in Centronics interface in the computer is/are important in this context. This is/these are dependent on the hardware configuration:

278h - 27ah

378h - 37Ah or

3BCh - 3BEh

In each case, the first address - 278h, 378h or 3BCh ("h" signifies "option" in hexadecimal) - actuates the data register of the parallel interface. Data can be entered into this 8-bit register by the computer, to be output to the external equipment.

D0 - Pin-2

D1 - Pin-3

up to

D7 - Pin-9

The second address in each case - 279h, 379h or 3BDh - actuates the so-called status register of the interface. Special replies from the printer are deposited in this register, when ACKNOWLEDGE is

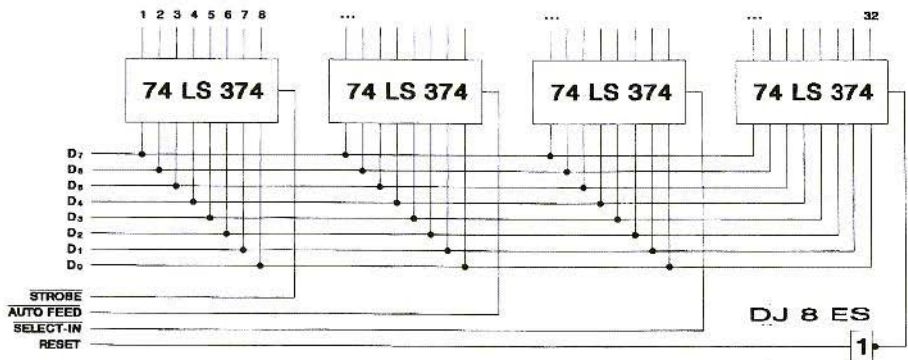

Fig.7: Register as Output for 4 Data Items, each 8 Bits long

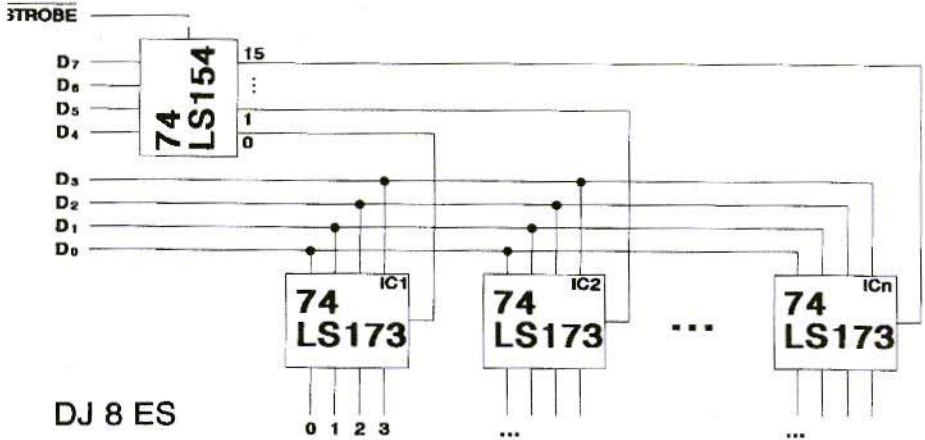

Fig.8: Output Unit organised as 16 x 4 Bits

there on bit 6 (pin-10), BUSY on bit 7 (pin-11) and PAPER END on bit 5 (pin-12). The third address in each case - 27Ah, 37Ah or 3BEh - actuates the control register of the interface. Here we find the STROBE signal on bit 0 (pin-1).

N.B.: The STROBE signal is output in inverted form. For example, if it is desired to output a "1" on the STROBE circuit, a "0" must be entered in bit 0! Various other circuits are also inverted! The signals are correspondingly identified.

Fig.6 shows the allocation of all control signals to the various registers. For example, here we have the contents for the addresses 378h, 379h and 37Ah. The boxes show the relevant pins of the 36-pin-Centronics connector.

3.1. Test Program in BASIC

A simple Basic program checks the functioning of the adapter card. As a first step, a running light is programmed for the output circuits, so that the STROBE flashes. The three input cir-

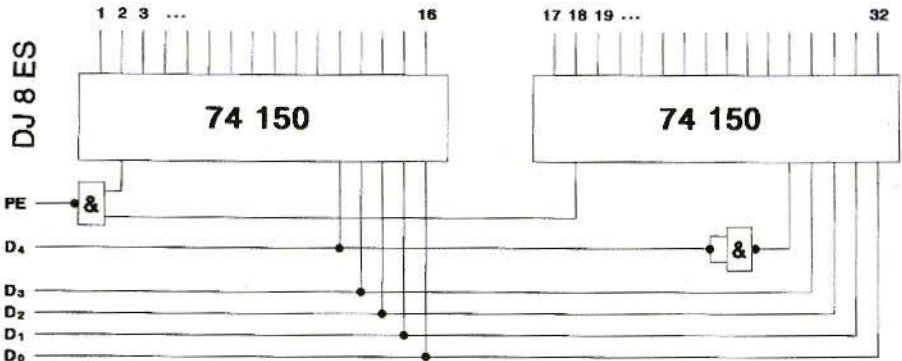

Fig.9: Circuit Proposal for 32-bit Input into Time Multiplex

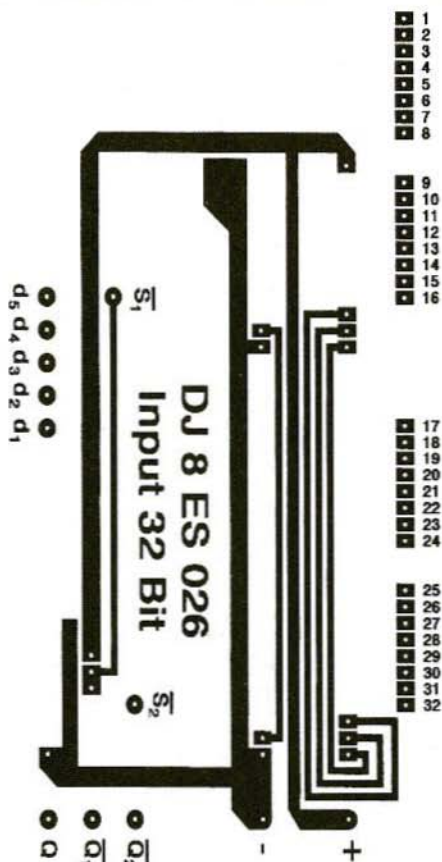

Fig.10: 32-bit Input Unit

circuits already named can then be tested. The updated status is always shown on the corresponding output bit. N.B.: BUSY is inverted!

```

100 REM function test
110 Set REM port "0"
120 REM adr 378h = 888d
130 OUT 888.0
140 OUT 890.1
150 REM running light
160 FOR I = 0 TO 7
170 I = 1.2
180 OUT 888.1
190 FOR J = 0 TO 100
200 NEXT J
210 OUT 890.0
220 FOR J = 0 TO 100
230 NEXT J
240 OUT 890.1
250 NEXT I
260 OUT 888.0
270 REM input test
280 A = INP (889)
290 A = A AND 224
300 OUT 888.A
310 GOTO 270
320 END
    
```

3.2. Output functions

Merely observing flashing LED's is also not satisfactory in the long run.

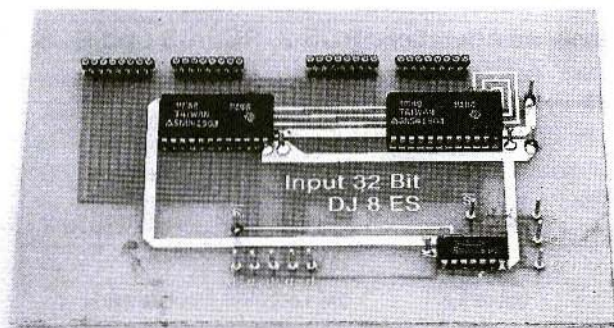

Fig.11: Experimental Setup for 32-bit Input Unit



It certainly looks nice, but my PC is supposed to be controlling something! For the PC to be able to take over this control function, it has to "talk" to the world beyond itself. This leads us directly to one of the most important aspects of the interface, namely the inputting and outputting of data.

The simplest case (8-bit output) can be covered by the Centronics interface immediately and without any expansion of any kind. If applicable, STROBE can be used, in addition to the 8 bits D0 to D7, as an interchange signal for peripherals.

```
100 REM output
110 REM data
120 OUT 888, DATA
130 REM STROBE signal
140 OUT 890,0
150 OUT 890,1
```

A further interesting output option can be implemented in an easily monitorable way using 4 x 8 bits. In addition to STROBE, the circuit shown in Fig.7 also uses the other output signals RESET, SELECT-INPUT and AUTO-FEED (FF) as interchanges, with the data being entered in output latches in 8-bit blocks.

3.3. Data output in time multiplex

It is also possible to output data by means of the time multiplex process. This method considerably increases the number of ports which can be differentiated. Here Fig.8 shows a path for a maximum of 16 x 4 bits. The individual data items for each 4 bits are transmitted sequentially in this system.

```
100 REM output time multiplex
110 REM data + address
120 FOR ADDRESS = 0 TO 15
130 OUT 888, DATA + ADDRESS*16
140 REM STROBE signal
150 OUT 890,0
160 OUT 890,1
170 NEXT ADDRESS
```

3.4. Input function

At first glance, it looks as if even more effort is required for input. And yet there are only 5 input bits there in all. As a rule, this is too few. Only a time multiplex process can be considered for inputting entire data items (1 byte or more).

Fig.9 proposes a circuit for inputting 32 bits. The individual bits are sequentially scanned and read in through the PAPER EMPTY (PE) circuit. For this purpose, the data circuits D0 to D4 select the individual input channels. The desired data formats (e.g. 4 x 8 bits) are then set up internally through software.

```
100 REM input time multiplex
110 FOR ADDRESS = 0 TO 31
120 OUT 888, ADDRESS
130 INPUT = INP (889) AND 32
140 INPUT = INPUT/32
150 PRINT ADDRESS, INPUT
160 NEXT ADDRESS
```

Fig.10 shows one side of the printed circuit board for the 32-bit input unit, which is coated on both sides. The prototype for this experimental printed circuit board can be seen in Fig.11.

And now all the best for your first experiments.

To be continued



Bernd Kaa, DG4RBF

Expansion of the Software for the DB1NV Spectrum Analyser Digital Image Store

The digital image storage unit for spectrum analysis as per DB1NV is a very useful assembly, which can, however, be designed to be more convenient. I describe some improvements and additions below which result in the 2.06 software version.

1. INNOVATIONS

The aim was to be able to call up the additional options in the new software simply by using the number of operating keys already available.

1.1. The Innovations of Version 2.06

- The reference curve can now be printed out as well, shown as a dotted line.
- The reference curve can be switched on and off.

- A title block has been inserted, so that the object measured can be named.
- A dB scale is also printed out; both grids, 8 x 10 and 10 x 10, are taken into account here.
- Switching from 10 dB/div. to 5 dB/div. is possible using a diode; the pre-setting is 10 dB/div. with diode from P1.3 to P3.2. Change to 5 dB/div. = P1.3 - 1 ← P3.2
- Print-out of text elements (-) measurement curve and (-) reference (if available!).
- Incorporation of two additional mean values: the digital mean value is provided by the image storage unit, in which digital technology can display its advantages properly for the first time.

Thus we can recognise very clearly in Figs. 1 to 4 that mean value 2 and mean value 3 again involve a marked reduction in noise. Especially in somewhat unstable conditions - contributed to, for example, by an



Messobjekt: PLL - PMB 2306

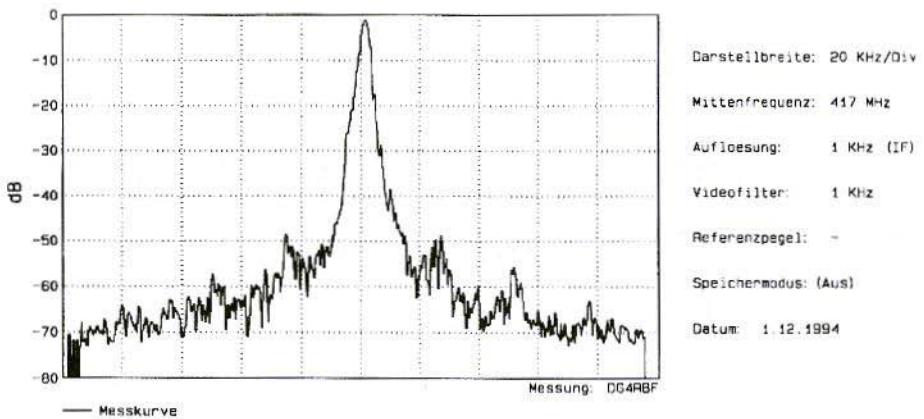

Fig.1: Diagram of Measurement Curve without Mean Value

Messobjekt = Subject of measurement; *Messkurve* = Measurement curve; *Messung* = Measurement; *Darstellbreite* = Image width; *Mittenfrequenz* = Mean frequency; *Auflösung* = Resolution; *Referenzpegel* = Reference level; *Speichermodus* = Storage mode; *Aus* = Out; *Datum* = Date)

Messobjekt: PLL - PMB 2306

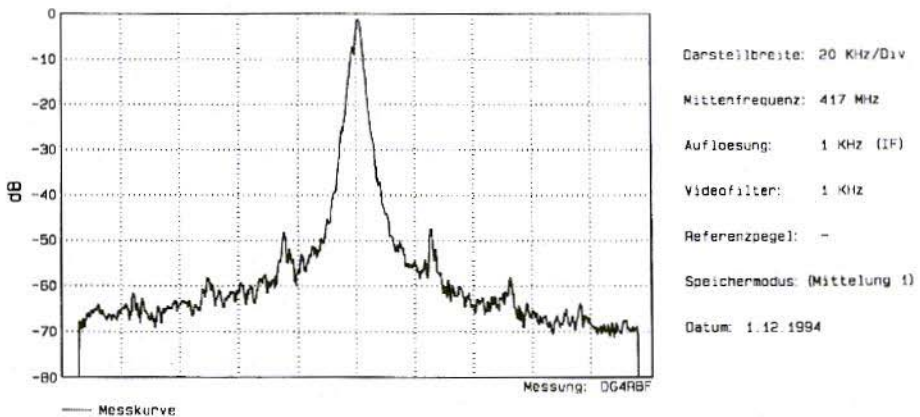

Fig.2: Diagram of Measurement Curve with Mean Value 1

imperfect power supply - the stronger mean values 2 and 3 make a very positive impression.

- Storage mode print-out: off, mean value 1, mean value 2, mean value 3, standardisation.



Messobjekt: PLL - PMB 2306

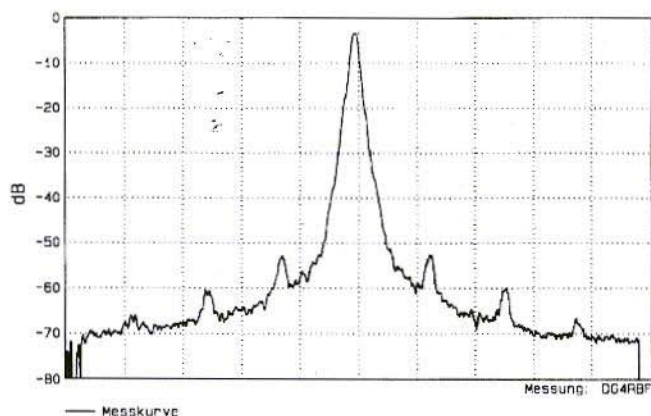

Darstellbreite: 20 KHz/Div
 Mittenfrequenz: 417 MHz
 Auflösung: 1 KHz (IF)
 Videofilter: 1 KHz
 Referenzpegel: -
 Speichermodus: (Mittelung 2)
 Datum: 1.12.1994

Fig.3: Diagram of Measurement Curve with Mean Value 2

Messobjekt: PLL - PMB 2306

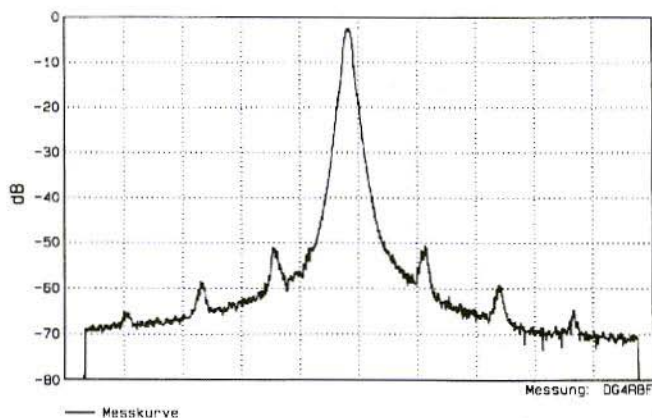

Darstellbreite: 20 KHz/Div
 Mittenfrequenz: 417 MHz
 Auflösung: 1 KHz (IF)
 Videofilter: 1 KHz
 Referenzpegel: -
 Speichermodus: (Mittelung 3)
 Datum: 1.12.1994

Fig.4: Diagram of Measurement Curve with Mean Value 3

The table (Fig.5) gives a summary of the possible settings, broken down by diode.

1.2. Operation of New Functions:

Switching reference curve on and off:

- ☞ REFERENCE key (store ON/OFF)
- ☞ Long pressure (app. 1 sec.) = store

- ☞ Short pressure = ON/OFF for stored curve

Switching on and switching between digital mean values is done as follows:

- ☞ STANDARDISATION/MEAN VALUE key:
- ☞ Long pressure = standardisation on
- ☞ Short pressure = switch over between mean values 1 and 2



Basic setting without Diode	Basic setting with Diode	from Port	to Port
Grid 8x10	Grid 10x10	P1.0 (Pin-1)	P3.2 (Pin-12)
Matrix Printer	HPGL-Plot	P1.1 (Pin-2)	P3.2 (Pin-12)
Epsom Mode	HP-Thinkjet-Mode	P1.2 (Pin-3)	P3.2 (Pin-12)
10dB/div	5dB/div	P1.3 (Pin-4)	P3.2 (Pin-12)
HPGL-Plot	COM-Port	P1.4 (Pin-5)	P3.2 (Pin-12)
Transmission Rate 19200 Baud	Transmission rate 9600 Baud	P1.5 (Pin-6)	P3.2 (pin-12)
dB-Scale	dB-Scale No	P1.6 (Pin-7)	P3.2 (Pin-12)

Fig.5: Table of Basic Settings for Version 2.06

- ☞ Display: 1 x flash, mean value 1
- ☞ 2 x flash, mean value 2
- ☞ RESET + NORM, mean value 3
 - ☞ Mean value 3 is the strong mean value from the old version, but without residual bars at the beginning and without a reference curve.

All additional print-out options have been introduced for HPGL plot only, since only here does the graph show to such good advantage. In any case, I am of the opinion that the future belongs to the laser printers, since these have recently become available for around DM 1,000. The quality of the print-out and the options on offer are worlds better here.

2.

SERIAL INTERFACES FOR IMAGE STORAGE

One interesting new option makes it possible to transfer data from the image storage unit into the PC and submit them to further processing there. This can be done by means of the serial interfaces described below, using the PC-PLOT programs specially written for the purpose.

It thus becomes possible for those radio hams who themselves do not possess a printer with HPGL capacity but who can obtain printing facilities in the club headquarters or from someone they know to obtain an appropriate HPGL print-out using a laser printer or a plotter.



The PC-PLOT program can actually be used to store up to nine plots, which can then be printed out, independently of the spectrum analyser, using a PC connected to a suitable printer.

Beautiful print-outs can also be obtained from PCL printers and matrix printers if the GRAPHICS program has been loaded in advance. GRAPHICS is a constituent part of MS-DOS and supports a large number of printers, so that there should be something suitable in it for any printer.

Moreover, the print-out can also be professionally formatted:

- Set up to three markers (often of assistance for documentation)
- Insert your own call sign (e.g. Measurement: DL1XYZ)
- Print out all subject data. The data is sent from the serial interface to the PC over a simple two-core cable - e.g. telephone or coaxial cable. Even an unscreened two-core cord caused me no problems in the test phase.

The transmission rate here is 19,200 Baud or 9,600 Baud. Even with various 0815 input-output cards, there were no problems at the COM port at 19,200 Baud.

Switching over to the serial output is done as follows:

- Switch HPGL plot over to COM port by means of diode, using a switch, from P1.4 to P3.2
- P1.4 \rightarrow ← P3.2 = data to COM port (only 2 x flashes on RESET)

With a diode between P1.5 and P3.2, the transmission rate is set to 9,600 Baud - no diode = 19,200 Baud

3. SHORT DESCRIPTION OF PC-PLOT

PC-PLOT is a support program which takes data from the image storage unit through a serial interface, and can

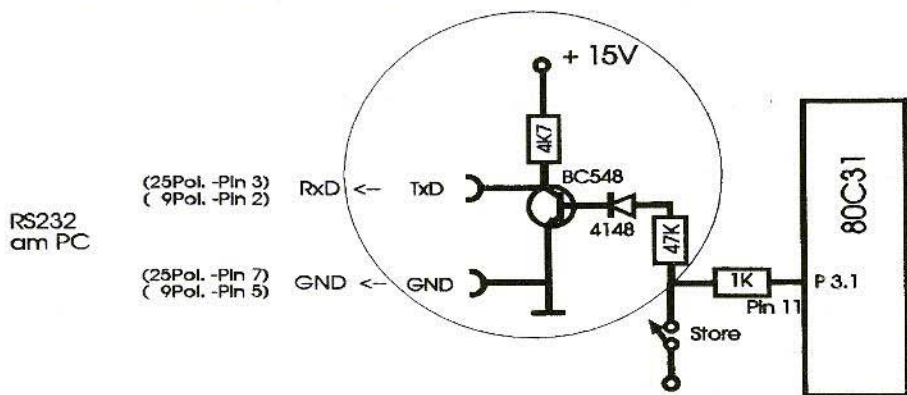

DG4RBF

Fig.6: Serial Interface for Image Storage; *Am* = On



Messobjekt: Trafos im Gehäuse des SA

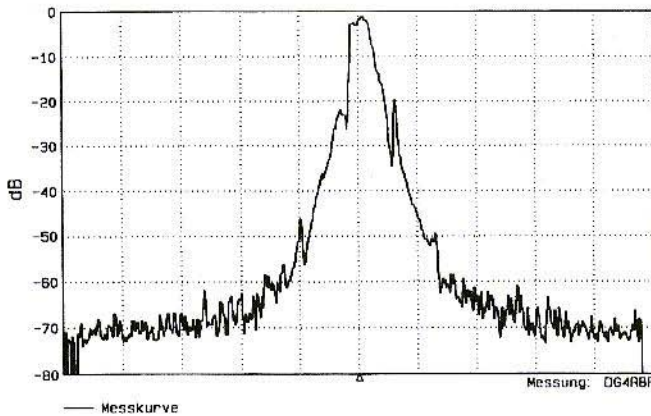

Darstellbreite: 10 KHz/Div

Mittenfrequenz: 0 MHz

Auflösung: 1 KHz (1F)

Videofilter: 1 KHz

Referenzpegel: -

Speichermodus: (Aus)

Datum: 08.11.1994

Messobjekt: keine Trafos im Gehäuse des SA

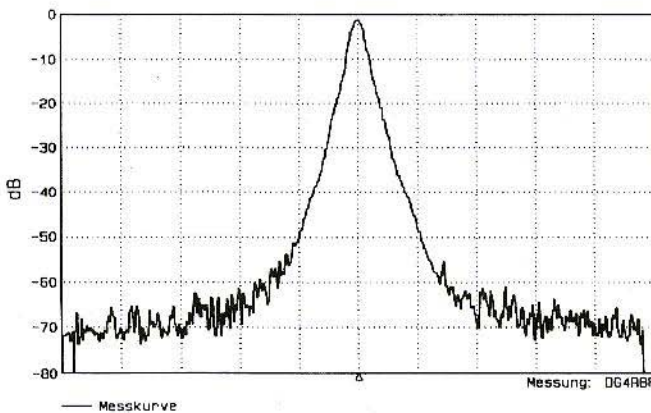

Darstellbreite: 10 KHz/Div

Mittenfrequenz: 0 MHz

Auflösung: 1 KHz (1F)

Videofilter: 1 KHz

Referenzpegel: -

Speichermodus: (Aus)

Datum: 08.11.1994

Figs. 7a & b: Two Sample Print-Outs using PC-PLOT

submit them to further processing in the PC.

Running the program is particularly easy, as the individual initial letters of a command or a process are used.

PC-Plot can store up to nine plots and print them out later, independently of the spectrum analyser.

It is also possible to re-format the print-out:

- Set up to 3 markers (often of assistance for documentation)
- Print out your own name or call sign
- Input and output subject data (subject of measurement, display width, average frequency, resolution, etc.)
- Print out graph as PGHL file

This opens up new possibilities for printing out the measurement curves in

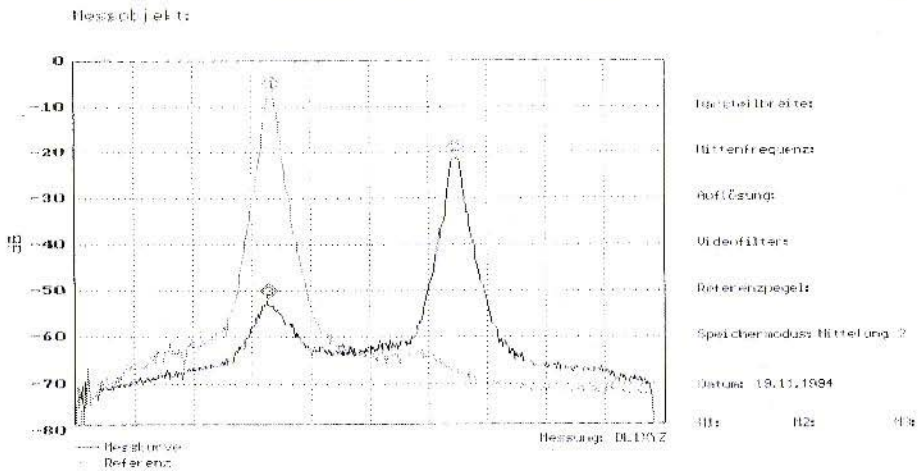

Fig.8: Sample Print-Out from Matrix Printer using PC-Plot

various sizes or inserting them into descriptions or documentation. HPGL files can be read in and submitted to further processing by graphics programs or by good text programs such as, for example, Coral Draw or Microsoft WORD.

3.1. Running PC-PLOT version 1.01

The data is automatically read in if the Plot key is pressed on the spectrum analyser

- Press the S for SAVE key to store the read-in curve in PC-PLOT.DAT.
- Press the R for RESTORE key to call up and display the stored curve.
- Press the K for KURVE (CURVE) key to call up the next stored curve.
- Press the ALT-K key combination to call up the previous curve from the memory.
- Press the N for NEW key to draw the curves new or over the old curve. This is dependent on the position of the Curve NEW switch. N.B.: markers can be set only using Curve NEW.
- Press the O for OBJEKT (SUBJECT) key to open an input window into which the data regarding the subject can be entered.
- Press the H for HPGL key to print out the curve displayed on an HPGL printer.
- Press the P for PLOT key to print out the curve displayed on other printers. GRAPHICS must have been loaded first: for example, for matrix printer [GRAPHICS] or for PCL printer [GRAPHICS DESKJET/, etc.]; see also GRAPHICS.PRO.
- Press F for FILE to switch the HPGL output to the file (data in file).



Call sign		DL1XYZ
LPT port/file	(LPT 1-2) or FILE	LPT 1
COM port	(COM 1-4)	COM 3
Transmission rate	(9600/19200)	19200
Output unit (for HPGL)	(PLOTTER) or (LASER)	PLOTTER
[Switch off pause program or set time!]		WORM = 2000]

- Press L for LPT to switch the HPGL output to the LPT port.
- Press F1 to display the settings. The file name can be changed when the curve is stored, so that there can be several memory files.
- Press the left-hand mouse key to set a marker.
- Press the right-hand mouse key to delete the marker indicated by the mouse arrow.
- Press the ESC key to leave the program.
- The PC-PLOT.CFG file holds data which PC-PLOT calls up when it starts to run (see top of page)

The time before the pause program is switched on can be set in the sixth line. (WORM = 1500) is the basic setting, corresponding to app. 1.5 minutes. Anyone who doesn't like the pause program can switch it off by writing WORM OFF in the sixth line.

If you write FILE in line 2 instead of the LPT port, HPGL-PLOT will send the data into a file instead of to the printer.

The entries can be changed using a text editor. To do this, all entries must be referred to in capitals!

The option of selecting PLOTTER or LASER for the HPGL output was incorporated so that even plotters with

considerably slower drawing speeds (with different data transmission) can operate without problems.

3.2. Necessary modifications

To be able to work with PC-PLOT, the following modifications to the image storage unit must be carried out.

- a Replace crystal previously used with standard 18.432 MHz crystal; this makes it possible to obtain a Baud rate of precisely 9,600 / 19,200 Baud.
- b Incorporate a simple serial interface for data transmission, with a two-wire circuit to the PC. Fig.6 shows how easily and cheaply this can be done.
- c Incorporate a default diode with a switch to select whether the data should go to the HPGL printer or to the serial interface.
- d Insert new EPROM with version 2.06 of image storage software from DG4RBF.
- e Switch on image storage unit and test.

3.3. System pre-requisites

PC-PLOT requires a simple VGA graphics card with 640 x 480 resolution and at least one AT-286 PC.



Richard A. Formato, Ph.D., K1POO

More on the Off-Centre-Fed Dipole

In a the last issue of VHF Communications [1], I suggested that the conventional 1/3-feed used for the off-centre-fed dipole (OCFD) is not the best choice.

This article provides additional performance data for the antenna, and discusses comments made at the end of the previous article.

It is useful to examine first in more detail the SWR data which are the basis of my earlier article. Fig.1 plots comput-

er-modelled free space SWR for the prototype 21.03-meter long, 0.0253-cm-diameter OCFD. SWR for a 200 feed system impedance was calculated at the antenna input terminals every 50 kHz for RF source frequencies from 5 to 30 MHz. Three feed point locations were modelled, 3.65, 6.98 (1/3 feed), and 8.65 meters from the end of the antenna, and the curves are labelled accordingly.

The most important features of the SWR curves are the locations of minima and maxima, and the corresponding SWR.

3.65 m		6.98 m (1/3-feed)		8.65 m		Band	Fc
Freq	SWR	Freq	SWR	Freq	SWR		
6.95	1.27	7.05	2.03	7.05	2.49	40 m	7.15
14.15	1.70	14.05	1.62	14.00	1.61	20 m	14.20
21.20	1.91	---	---	21.15	1.14	15 m	21.20
28.25	1.18	28.30	1.30	28.25	1.41	10 m	28.85

Table 1: SWR MINIMA

3.65 m		6.98 m (1/3-feed)		8.65 m	
Freq	SWR	Freq	SWR	Freq	SWR
10.40	45.76	11.05	19.65	11.60	18.50
18.00	15.71	---	---	17.80	18.03
25.45	11.12	22.75	22.12	24.80	14.06

Table 2: SWR MAXIMA

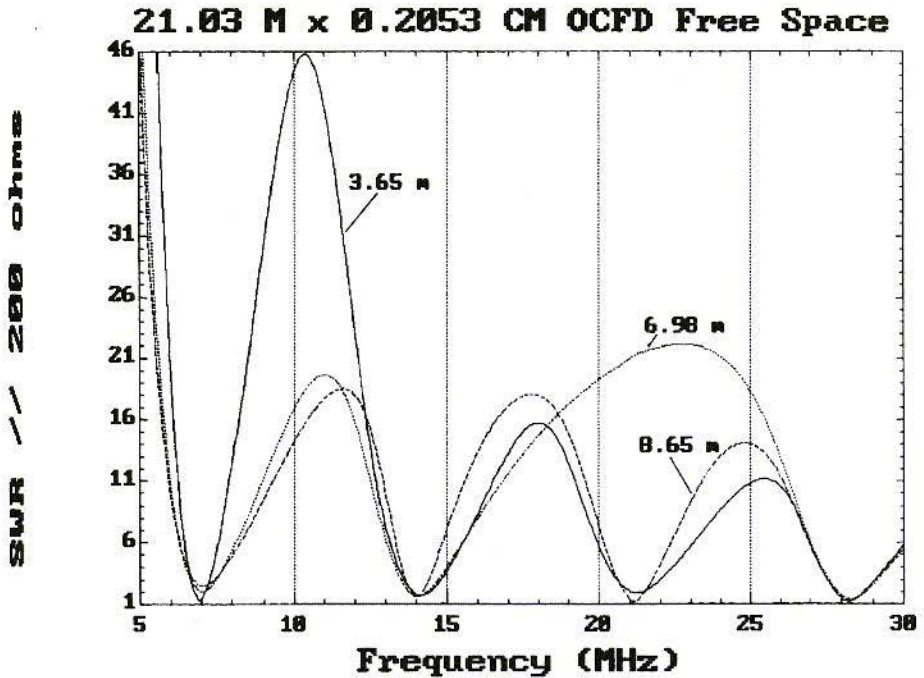

Fig.1: SWR 5 to 30 MHz

Table 1 lists minimum SWRs and the frequencies (MHz) of the minima for the three feed points. For reference, the right hand columns list the corresponding amateur band and its approximate centre frequency. Table 2 provides similar data for the SWR maxima.

The major point of the original article was that the 3.65 and 8.65 meter feeds might permit four-band operation without a matching network, because these feed points each result in four SWR minima between 5 and 30 MHz (see Fig.1). By contrast, the 6.98 meter SWR curve has only three minima in that range. Thus, the 1/3-feed antenna cannot possibly operate on more than three bands without some sort of matching, which is why the G0FAH design [2]

requires two baluns and a specific transmission line length for 15 meters.

How feasible four-band operation is depends only on where the minimum SWRs occur relative to the amateur radio bands, and how low the SWR is across the bands. Table 1 shows that the prototype OCFD has SWR minima very close to the 40, 20, 15 and 10 meter bands. With appropriate on-site adjustment, it is reasonable to expect that this antenna, fed either 3.65 or 8.65 meters from the end, could provide good SWR across all four amateur bands without a matching network.

It should also be noted that the prototype OCFD dimensions were chosen because they correspond to the G0FAH

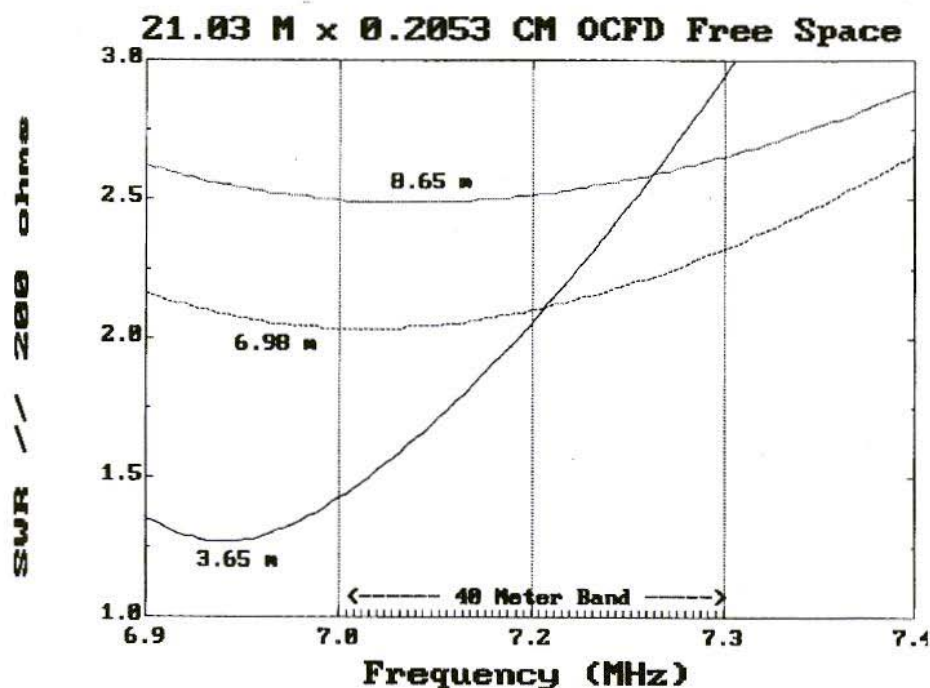

Fig.2: SWR 40 Meter

design, thus permitting direct comparison with that antenna, not because they are optimised in any way. In fact, the prototype dimensions are *not* optimum for a four-band OCFD. In free space, the frequencies at which SWR minima occur, and the depth of the minima, are determined by three parameters: (1) radiating element length and (2) diameter, and (3) feed point location. Changing any one of these changes both the frequencies of the SWR minima and the minimum SWR values. Optimising a four-band, free space OCFD comes down to determining a set of antenna parameters that produces an acceptably low SWR (typically less than 2) across each of the 40, 20, 15, and 10 meter bands. While I have not determined

optimum parameter values, the predicted performance of the prototype antenna, which is quite good, suggests that still better performance is almost certainly achievable.

Turning next to the comments appearing at the end of the original tech note (readers may wish to consult the reference for details), they are addressed as follows:

Variation of SWR across a band: In terms of SWR behaviour, the OCFD is much different from an ordinary centred dipole (CFD). The CFD is intentionally cut (tuned) to place minimum SWR within the band, which is why SWR increases toward the ends of the band (moving away from the minimum). An



OCFD may or may not exhibit this behaviour, depending on where its SWR minima occur. To illustrate, Fig.2 plots the prototype OCFDs SWR from 100 kHz below to 100 kHz above the 40 meter band in 5 kHz steps. The SWR does *not* increase toward each end of the band. If the SWR minimum is either outside or at one end of the band, as it is in Fig.2, the SWR will increase in one direction (up or down band), but decrease in the other, quite unlike an ordinary CFD. The OCFDs SWR will increase at both band edges *only* when its SWR minimum is inside the band, which generally is not the case.

Azimuth pattern: The OCFD does indeed have an asymmetrical azimuth pattern, because the radiating element is not symmetrical about the feed point. But feeding the OCFD 8.65 meters from the end provides a *higher* degree of symmetry than the conventional 1/3-feed. Locating the feed 8.65-m from one end should result in a more symmetrical azimuth pattern than the conventional feed, not less. Of course, feeding the OCFD 3.65-m from the end increases its asymmetry compared to the 1/3-feed, so that the pattern for this implementation would be expected to be less symmetrical. Even so, pattern asymmetry is not necessarily undesirable. Many operators may wish to take advantage of the OCFDs pattern by orienting the antenna to radiate in a preferred direction. This consideration applies to any antenna, even to the single-band CFD, which is an extremely poor radiator in the direction of the antenna axis at low to moderate take-off angles.

Operating the OCFD out-of-band: Regardless of where the feed is placed, or how it is implemented, certainly no attempt should be made to operate a 40-20-15-10 meter OCFD on any other band. High SWR conditions may very well result in balun damage. Of course, this is good advice for any antenna. For example, the free space SWR relative to 50 of a typical 40-meter band CFD (20.4-meters long, 0.2-cm diameter) is 1.44 at 7.15 MHz. But on 20-meters, at 14.2 MHz, the 40-meter antenna has a SWR of 101, which is sure to stress the balun!

The data presented here provide additional insight into the advantages of feeding the OCFD at points other than 1/3 of its length from the end. With computer-models for wire antennas widely available, it should be possible to optimise the OCFD in free space and over typical ground so that four or possibly even five band operation is achievable without a matching network.

References

- [1] Richard A. Formato, K1POO, Improved Feed for the Off-Centre-Fed Dipole, VHF Communications 2/1996, pp. 90-93
- [2] Bill Wright, G0FAH, Four Bands, Off Centre, QST, February 1996, p 65.



Dr. Ing. Jochen Jirmann, DB1NV

A High-Precision Logarithmic Intermediate-Frequency Amplifier

A logarithmic intermediate-frequency amplifier was proposed years ago for the spectrum analyser for 10.7 MHz, with a dynamic range of approximately 70 dB. The circuit's cost was considerable. A better result can now be achieved, for a lower cost, using an integrated module from Analog Devices.

1. INTRODUCTION

About 7 years ago, when the author's spectrum analyser project was entering its final construction phase, it was worth finding the simplest possible logarithmic intermediate-frequency amplifier. The limiting conditions were: 70dB dynamic range, band width at least 200 kHz. The existing solutions at that time were the expensive logarithmic intermediate-frequency amplifier from DL8XZ and a log amplifier using a Plessey integrated circuit, SL521 or SL523. The latter variant can be found in relatively simple

radar equipment for marine navigation, and requires four SL523's. The intermediate-frequency amplifier from DL8XZ was eliminated, in spite of the high precision of measurement and the dynamics, due to the space required and the cost of smoothing.

The author next worked out a variant of the DL8XZ amplifier with differential stages and high-frequency side summation, which was presented in issue 2/1987. It was certainly almost free of smoothing, but the cost of 18 transistors for 70dB dynamics was considerable.

In the second version, therefore, the author used an FM intermediate-frequency circuit with a logarithmic field strength measurement output. The choice fell on the TDA1576 from Philips.

Very little expense is involved and the logarithmic precision is fully sufficient for radio equipment (owners of Japanese radio equipment can only dream of such S-meter precision), but the short waves still stand out in an unpleasant way on a gauge.

FUNCTIONAL BLOCK DIAGRAM

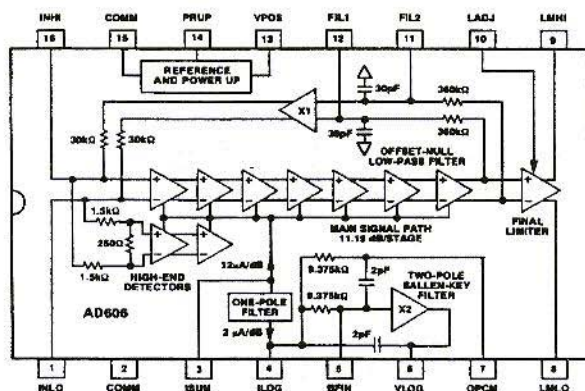

Fig.1:
AD 606 Block Diagram
and Brief Data

FEATURES

Logarithmic Amplifier Performance
 -75dBm to +5dBm Dynamic Range
 $\leq 1.5\text{ nV}/\sqrt{\text{Hz}}$ Input Noise
 Usable to >50 MHz
 37.5mV/dB Voltage Output
 On-Chip Low-Pass Output Filter

Limiter Performance
 $\pm 1\text{ dB}$ O/P Flatness over 80dB Range
 $\pm 3^\circ$ Phase Stability at 10.7 MHz over 80dB Range
 Adjustable Output Amplitude

Low Power
 +5V Single Supply Operation
 65mW Typical Power Consumption
 CMOS Compatible Power-Down to 325 μW typ.
 5 μs Enable/Disable Time

APPLICATIONS

Ultrasound and Sonar Processing Phase-Stable
 Limiting Amplifier to 100 MHz Received Signal
 Strength Indicator (RSSI) Wide Range Signal and
 Power Measurement

2. NEW MODULE

Anyone who would now like to improve the precision of level measurement of

his or her spectrum analyser, or who is planning to build a measurement receiver, can now switch to an integrated logarithmic amplifier from Analog Devices, the AD606. The module is available in a DIL-16 housing or in an SO16 surface-mounted housing. According to information from Sasco, the individual unit costs approximately DM 115 plus VAT.

Fig.1 shows some brief data and a block diagram

Apart from the 80dB dynamics logarithmic amplifier, the AD606 also contains a power-down control using a logic signal (not of any interest here), an integrated low-pass filter, the limiting frequency of which can be adjusted using external capacitors, and an output for the restricted intermediate-frequency signal. The data sheet gives the logarithmic precision at $\pm 1.5\text{ dB}$ max. over the entire level range from -75dBm to +5dBm, with a typical error of $\pm 0.4\text{ dB}$.

As it happens, the output voltage range from 0.5 to 3.5V is perfectly suited to the output level of the TDA1576.

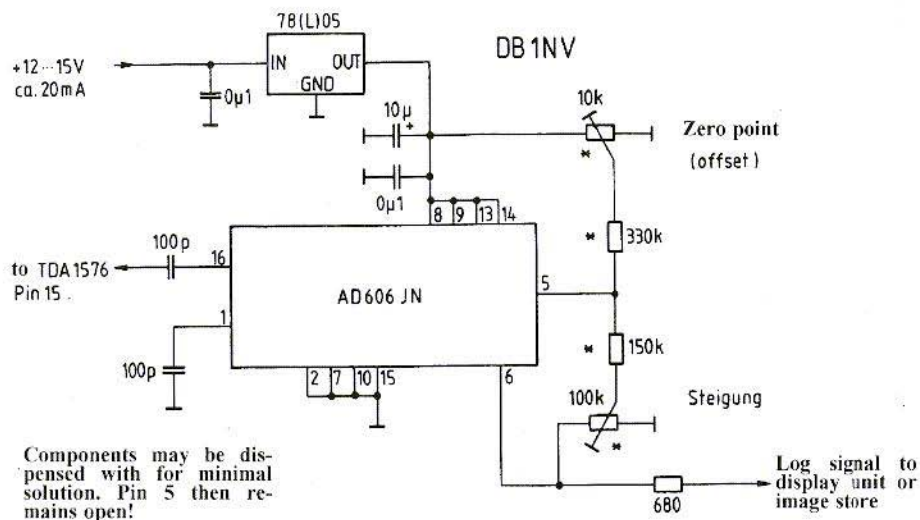

Fig.2: Logarithmic Intermediate-Frequency Amplifier with AD 606

3. SPECIMEN CIRCUIT

As shown in Fig.2, the cost of the external wiring is extremely low. Apart from a few blocking capacitors, only a 5V voltage regulator is used. Anyone who invests in two resistances and two trimming potentiometers can make both the offset and the log characteristic line gradient adjustable.

The small number of components can be assembled on one experimental printed circuit board measuring approximately 30 mm x 40 mm. The assembly can then be fitted, through the TDA1576, into the high-frequency / intermediate-frequency section of the spectrum analyser.

Alternatively, the TDA1576 can also be unsoldered, and the AD606 can be directly hand-wired in, when the old tracks have been removed. In no case may 12 to 15V be fed directly to the

AD606. The maximum supply voltage for it is 9V. The input signal for the AD606 is measured off at pin-15 of the TDA1576.

4. MEASUREMENT ASSEMBLY

To compare the two logarithmic amplifiers, the spectrum analyser was set to 100 MHz and 200 kHz band width, the high-frequency signal being generated by an HP8640A with a downstream precision reference circuit (DPU from R & S). Fig.3 shows the assembly.

A switch installed as an aid makes it possible to connect both video outputs to the display section of the analyser. To plot the characteristics, the analyser worked in measurement receiver mode (zero span), the output voltage from

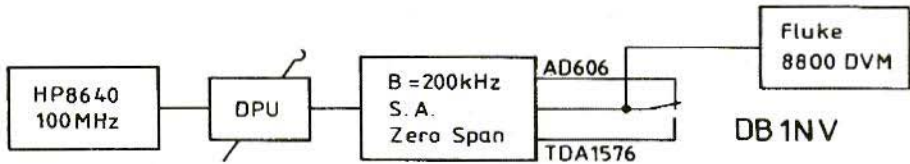

Fig.3: Measurement Assembly for Comparison of two Logarithmic Amplifiers

both log amplifiers being measured by a digital voltmeter (Fluke 8800A).

The improvement in the precision of measurement could be recognised simply by looking at the flanks of the spectrum line: for the AD606, the flanks are smooth, and the slight waves well-known from the TDA1576 are completely absent. A total dynamic range of at least 70 dB can be used with a filter band width of 200 kHz.

Plotting the logarithmic characteristics in Fig.4 confirmed the visual impression. The characteristic of the AD606 is almost a straight line, and does not have the inherent waviness and the non-linearity at high levels of the TDA1576.

5. SUMMARY

Anyone wishing to improve the precision with which levels are measured by the spectrum analyser from DB1NV can obtain almost professional accuracy of measurement by using the AD606. The maximum expenditure involved here is DM 150 - plus a few hours' work.

The AD606 is also interesting with regard to the modernisation of elderly spectrum analysers or measurement receivers, since it is suitable for intermediate frequencies from a few kilohertz up to 50 MHz. It could itself be used as a substitute for the problematic hybrid log amplifier in the 8755 HP scalar analyser, because it can process the 27 kHz intermediate frequency directly.

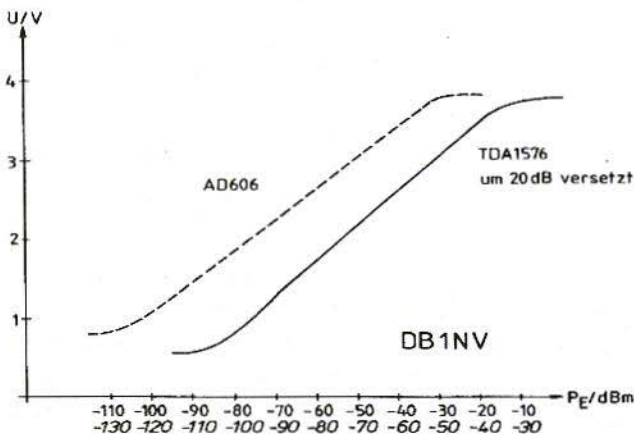

Fig.4: Measurement Curves of Logarithmic Unit;

Um 20dB versetzt =
Offset by 20dB



Shock Wave

THE EUROPEAN COMMUNICATION MAGAZINE

Shockwave is dedicated to communication in Europe. It deals mostly with Telephone communication, Computer communication and Radio Communication. Our aim is to keep you informed of the newest technologies dedicated to the various forms of communication.

Shockwave is to be published in 3 languages every 2 months. Presently, our magazine is available under subscription only, but will soon be made available from bookstands, etc.

The subscription rate is:

1 Year: US \$35.00 (app. £23)

2 Years: US \$60.00 (app. £40)

Our first issue will be available in September and a free copy of it will be available for download from our WWW site.

Telephone Comms * Computer Comms * Radio Comms

Articles and complete investigations on the latest systems. Clearly written in a non-expert language. A magazine widely open to outside writers and other magazines.

SHOCK WAVE

"THE" EUROPEAN COMMUNICATION MAGAZINE

Philippe Cadic - Publication Manager

PO Box 2867

41028 BLOIS CEDEX, FRANCE

TEL: (+33) 54 56 08 76 FAX: (+33) 47 67 03 54

<http://www.spiraweb.com/shockwave>

**COMPLETE KITS****for projects featured in VHF Communications**

KIT	DESCRIPTION	ISSUE	ART No	PRICE
DB1NV-006	Spectrum Analyser IF Amplifier	2/89	06370	£142.00
DB1NV-007	Spectrum Analyser Lo-PLL	2/89	06371	£ 62.00
DB1NV-008	Spectrum Analyser Crystal Filter	3/89	06372	£108.00
DB1NV-009	Spectrum Analyser Sweep Gen	3/89	06373	£ 48.00
DB1NV-010	Spectrum Analyser Digital Store	3&4/91	06378	£132.00
DB1NV-011	Spectrum Analyser Tracking Gen	2/92	06474	£143.00
DB1NV-012	Spectrum Analyser VCO 1450 MHz	4/92	06483	£ 39.00
DB1NV-013	Spectrum Analyser VCO 1900 MHz	4/92	06484	£ 41.00
DB6NT-001	Measuring Amp up to 2.5 GHz	4/93	06382	£ 60.00
DB6NT-002	Frequency Divider to 5.5 GHz	4/93	06383	£100.00
DJ8ES-001	23cm FM ATV Converter	1/91	06347	£ 93.00
DJ8ES-002	Digital Frequency Indicator	1/91	06352	£ 53.00
DJ8ES-003	IF Amplifier	1/91	06355	£ 55.00
DJ8ES-004	Demodulator	1/91	06362	£ 72.00
DJ8ES-019	Transverter 144/28 MHz	4/93	06385	£143.00
DJ8ES-019mod	Transverter 50/28 MHz	2/95	06392	£143.00
DJ8ES-020	Hybrid Amplifier for 144 MHz	1/94	06387	£179.00
DJ8ES-021	13cm FM ATV Exciter	2/94	06388	£ 67.00
DJ8ES-022	28/432 MHz Transverter Oscillator	2/95	06395	£ 59.00
DJ8ES-023	28/432 MHz Transverter Converter	2/95	06396	£114.00
DC8UG-007	5W PA for 13cm	3/94	06938	£286.00

Minimum postage and packing charge is £6.75. Credit Card orders +5%.

KM Publications, 5 Ware Orchard, Barby, Nr.Rugby, CV23 8UF, U.K.

Tel: (0)1788 890365

Fax: (0)1788 891883



PRINTED CIRCUIT BOARDS

for projects featured in VHF Communications

DB1NV	Spectrum Analyser			Art No.
PCB	DB1NV-006	IF Amplifier	Ed.2/89	06997 £ 17.25
PCB	DB1NV-007	Lo-PLL	Ed.2/89	06995 £ 17.25
PCB	DB1NV-008	Crystal Filter	Ed.3/89	06998 £ 17.25
PCB	DB1NV-009	Sweep Generator	Ed.3/89	06996 £ 17.25
PCB	DB1NV-010	Digital Store	Ed.3&4/91	06477 £ 21.15
PCB	DB1NV-011	Tracking Generator	Ed.2/92	06479 £ 15.50
PCB	DB1NV-012	VCO 1450 MHz	Ed.4/92	06480 £ 16.35
PCB	DB1NV-013	VCO 1900 MHz	Ed.4/92	06481 £ 16.35
DB6NT	Measuring Aids for UHF Amateurs		Art No.	ED. 4/93
PCB	DB6NT-001	Measuring Amp up to 2.5 GHz	06379	£ 17.75
PCB	DB6NT-002	Frequency Divider to 5.5 GHz	06381	£ 17.75
DJ8ES	23cm FM-ATV Receiver		Art No.	ED. 1/91
PCB	DJ8ES-001	Converter	06347	£ 10.75
PCB	DJ8ES-002	Digital Frequency Indicator	06350	£ 9.65
PCB	DJ8ES-003	IF Amplifier	06353	£ 7.95
PCB	DJ8ES-004	Demodulator	06356	£ 10.30
DJ8ES	28/144 MHz Transverter		Art No.	ED. 4/93
PCB	DJ8ES-019	Transverter 144/28 MHz	06384	£ 17.75
PCB	DJ8ES-020	Hybrid Amplifier 144 MHz	06386	£ 17.25
DF9PL	High Stability Low Noise PSU		Art No.	ED. 1/93
PCB	DF9PL-001	30 Volt PSU	06378	£ 9.80
PCB	DF9PL-002	Pre-Stabiliser	06376	£ 10.20
PCB	DF9PL-003	Precision Stabiliser	06377	£ 11.20
F61WF	10 GHz FM ATV Transmitter		Art No.	ED. 2/92
PCB	F61WF-001	DRO Oscillator - PTFE	06485	£ 16.20
PCB	F61WF-002	Modulator and Stabiliser	06486	£ 12.00
DC8UG	13cm GaAsFET PA		Art No.	ED. 3/94
PCB	DC8UG-PA	5W PA for 13cm	06936	£ 19.25
PCB	DC8UG-NT	Power Supply for the PA	06937	£ 7.75

Minimum postage and packing charge is £6.75. Credit Card orders +5%.

KM Publications, 5 Ware Orchard, Barby, Nr.Rugby, CV23 8UF, U.K.

Tel: (0)1788 890365

Fax: (0)1788 891883



VHF COMMUNICATIONS

A Publication for the Radio Amateur Worldwide

Especially Covering VHF, UHF and Microwaves

Volume No. 28 Autumn Edition 3/1996

Publishers

KM PUBLICATIONS,
5 Ware Orchard, Barby, Nr. Rugby,
CV23 8UF, United Kingdom
Tel. 01788 890365
Fax: 01788 891883

Internet:
vhf-comm@g6iqm.demon.co.uk
Compuserve: 100441377

Editor

Mike Wooding G6IQM

VHF COMMUNICATIONS

The international edition of the German publication UKW-Berichte is a quarterly amateur radio magazine, especially catering for the VHF/UHF/SHF technology. It is owned and published in the United Kingdom in Spring, Summer, Autumn and Winter by KM PUBLICATIONS.

The 1996 subscription price is £16.00, or national equivalent. Individual copies are available at £4.50, or national equivalent each. Subscriptions should be addressed to the national representative shown in the next column. Orders for individual copies of the magazine, back issues, kits, binders, or any other enquires should be addressed directly to the publishers.

NOTICE: No guarantee is given that the circuits, plans and PCB designs published are free of intellectual property rights. Commercial supply of these designs without the agreement of the Author and Publisher is not allowed. Users should also take notice of all relevant laws and regulations when designing, constructing and operating radio devices.

© KM PUBLICATIONS

All rights reserved. Reprints, translations, or extracts only with the written approval of the publishers

Translated by: Inter-Ling Services,
62 Caldecott Street, Rugby,
CV21 3TH, UK

Printed in the United Kingdom by:
Cramphorn Colour Printers Ltd., 15c
Paynes Lane, Rugby.

AUSTRIA - Verlag UKW-BERICHTE, Terry D Bittan, POB 80,
D-91081 BAIERSDORF, Germany. Tel. (9133) 47-0
Fax: 09733 4747 Telex: 629 887. Postgiro Nbg. 30445-858

AUSTRALIA - W.I.A., P.O. Box 300, SOUTH CAULFIELD,
3162 VIC, Australia. Tel. 528 5962

BELGIUM - UKW-BERICHTE, POB 80, D-91081 BAIERSDORF,
Germany. Tel. (9133) 47-0. Fax: 09733 4747 Telex: 629 887.
Postgiro Nbg. 30445-858

DENMARK - KM PUBLICATIONS, 5 Ware Orchard, Barby,
Nr. RUGBY, CV23 8UF, UK. Tel: +44 788 890365
Fax: +44 788 891883 Email: vhf-comm@g6iqm.demon.co.uk

FRANCE - Christianne Michel F5SM, SM ELECTRONIC, 206is
Avenue des Clairons, F-89000 AUXERRE, France
Tel. (86) 46 96 59

FINLAND - KM PUBLICATIONS, 5 Ware Orchard, Barby,
Nr. RUGBY, CV23 8UF, UK. Tel: +44 788 890365
Fax: +44 788 891883. Email: vhf-comm@g6iqm.demon.co.uk

GERMANY - UKW-BERICHTE, POB 80, D-91081
BAIERSDORF, Germany. Tel. 09133 7798-0
Fax: 09133 779833. Postgiro Nbg. 30445-858

GREECE - C+A ELECTRONIC, P.O. Box 25070, ATHENS
100 26, Greece. Tel: 01 52 42 867. Fax: 01 52 42 537

HOLLAND - KM PUBLICATIONS, 5 Ware Orchard, Barby,
Nr. RUGBY, CV23 8UF, UK. Tel: +44 788 890365
Fax: +44 788 891883. Email: vhf-comm@g6iqm.demon.co.uk

ITALY - ADB ELETTRONICA di Luchesi Fabrizio IWSADB,
Via Vecchia Romana 266, 55100 ANTRACCOLI, (LUCCA), Italy
Tel. 0583 952612. Fax: 0583 91109

NEW ZEALAND - Judith Holland, AUCKLAND VHF GROUP
Inc., P.O. Box 10, AUCKLAND 1030, New Zealand
Tel: 0 9 412 7659

NORWAY - HENNING THEIG RADIO COMMUNICATION
LA4YG, Kjoeloveien 30, 1370 ASKER, Norway
Postgironr: 3 16 00 09

SOUTH AFRICA - HI-TECH BOOKS, P.O. Box 1142,
RANDBURG, Transvaal 2125, South Africa. Tel: (011) 465 3385

SPAIN & PORTUGAL - JULIO A. PRIETO ALONSO EA4CJ,
Donoso Cortes 58 5º -B, MADRID 15, Spain. Tel: 543 83 84

SWEDEN - WAVELINE AB, Box 60224, S-210911 MALMÖ,
Sweden. Tel: 40 16 42 66. Fax: 40 15 05 07. GSM: 0705 16 42 66
Postgiro: 13 78 93 - 4

SWITZERLAND - KM PUBLICATIONS, 5 Ware Orchard, Barby,
Nr. RUGBY, CV23 8UF, UK. Tel: +44 788 890365
Fax: +44 788 891883. Email: vhf-comm@g6iqm.demon.co.uk

UNITED KINGDOM - KM PUBLICATIONS, 5 Ware Orchard,
Barby, Nr. RUGBY, CV23 8UF, UK. Tel: +44 788 890365
Fax: +44 788 891883. Email: vhf-comm@g6iqm.demon.co.uk

U.S.A. - WYMAN RESEARCH Inc., RR#1 Box 95, WALDRON,
Indiana 46182, U.S.A. Tel: (317) 525 6452

- Henry Ruh, ATVQ MAGAZINE, 3 North Court Street,
Crown Point, Indiana 46307, U.S.A. Tel: (219) 662 6395.
Fax: (219) 662 6991

ELSEWHERE - KM PUBLICATIONS, address as for the U.K.

WWW: <http://www.solas.co.uk/ag/vhfcomm.htm>

ISSN 0177-7505

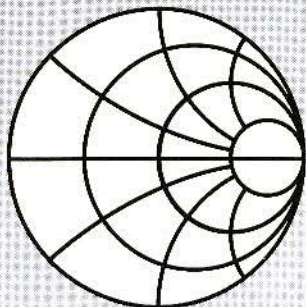

SMITH CHART TOOLSET

\$59

Electronic Applications of the Smith Chart is an updated edition of Phillip H. Smith's original book. This detailed reference is the authoritative work on the Smith Chart.

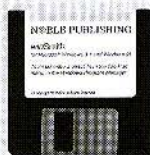
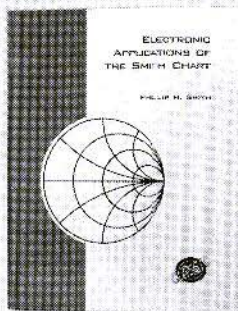

\$79

The winSMITH program which runs on IBM/compatible PCs modernizes the Smith Chart by easily tuning elements and readout of precise values.

\$99

This video is all the instruction you need to start using the Smith Chart to solve all types of matching and transmission line problems.



ORDER BY PHONE, FAX OR MAIL

ALL 3 ONLY \$199
SAVE \$38

Name _____
Company _____
Address _____
City _____ State _____
ZIP _____ Country _____
Phone _____ FAX _____
Card # _____ Exp _____
Signature _____

Please send the following products

- Toolset (includes all three) \$199
- Smith Chart book \$59
- winSMITH software \$79
- Smith Chart video \$99

Shipping & Handling
US \$8, Canada \$20, Intl. Air \$40

Payment Method

- VISA or MasterCard
- EuroCheck
- Bank Check (Must have the name of a US bank on the check)

NOBLE PUBLISHING

TEL (770)908-2320 FAX (770)939-0157
2245 Dillard St., Tucker, GA 30084, USA
editor@noblepub.com www.noblepub.com

EASY-PC Professional XM

Schematic and PCB CAD

From Super Schematics

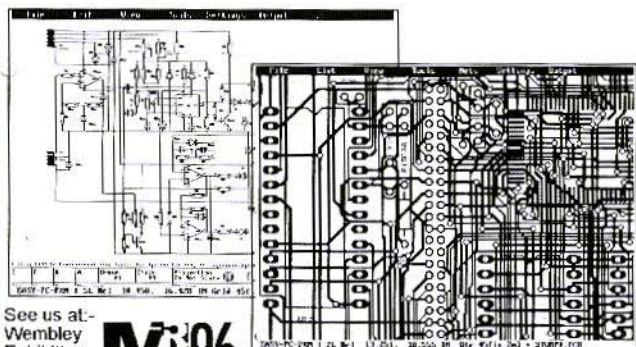

See us at:
Wembley
Exhibition
8-10
October

N:96
Microelectronics and RF

To Perfect PCB's

- Runs on:- PC/ 386/ 486 with VGA display
- Links to PULSAR (logic), ANALYSER III (analogue) & LAYAN (electromagnetic) simulators.
- Design:- Single sided, Double sided and Multi-layer boards.
- Provides full Surface Mount support.
- Standard output includes Dot Matrix / Laser / Ink-jet Printer, Pen Plotter, Photo-plotter and N.C. Drill.
- Optional, powerful, 32 bit Multi-pass, Shape based, Shove Aside, Rip-up and Re-try Autorouter.

Simulation can even include the parasitic effects introduced by the Board Layout

LAYAN - Electro-magnetic Simulation **ONLY £495**

Affordable Electronics CAD

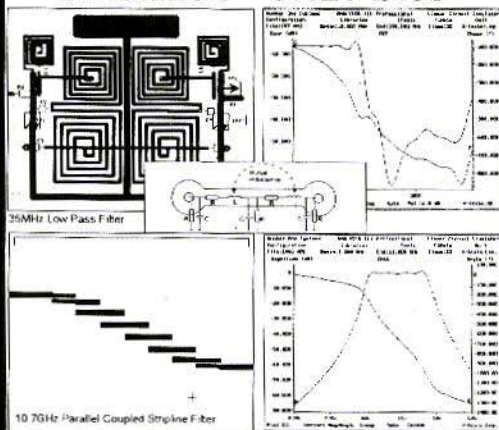

EASY-PC Professional: Schematic Capture and PCB CAD. Links directly to ANALYSER III, LAYAN and PULSAR.	From \$246	£146
MultiRouter: 32bit Multi-pass Autorouter	\$475	£295
LAYAN: Electro-Magnetic PCB Layout Simulator. Include the board parasitics in your Analogue simulations. Links with and requires EASY-PC Professional XM and ANALYSER III Professional	\$950	£495
PULSAR: Digital Circuit Simulator	From \$175	£98
ANALYSER III: Analogue Linear Circuit Simulator	From \$175	£98
FILTECH: Active and Passive Filter Design program	From \$245	£145
STOCKIT: New comprehensive Stock control program for the small or medium sized business	\$245	£145
EASY-PC: Entry level PCB and Schematic CAD	\$135	£75
Z-MATCH: Windows based Smith-Chart program for RF Engineers.	From \$245	£145

We operate a no penalty upgrade policy.
US\$ prices include Post and Packing
Sterling Prices exclude P&P and VAT

For full information and demo disk, please write, phone, fax or email:-

Number One Systems

- TECHNICAL SUPPORT FREE FOR LIFE
- PROGRAMS NOT COPY PROTECTED.
- SPECIAL PRICES FOR EDUCATION.

UK/EEC: Ref. VHF.COM, Harding Way, St Ives, Cambridgeshire., ENGLAND, PE17 4WR.
Telephone UK: 01480 461778 (7 lines) Fax: 01480 494042
USA: Ref. VHF.COM, 126 Smith Creek Drive, Los Gatos, CA 95030
Telephone/Fax: (415) 968-9306

e-mail: sales@numberone.com
International +44 1480 461778

