

J 20 419 F

*A Publication
for the Radio-Amateur
Especially Covering VHF,
UHF and Microwaves*

VHF

communications

Volume No.17 · Summer · 2/1985 · DM 7.00

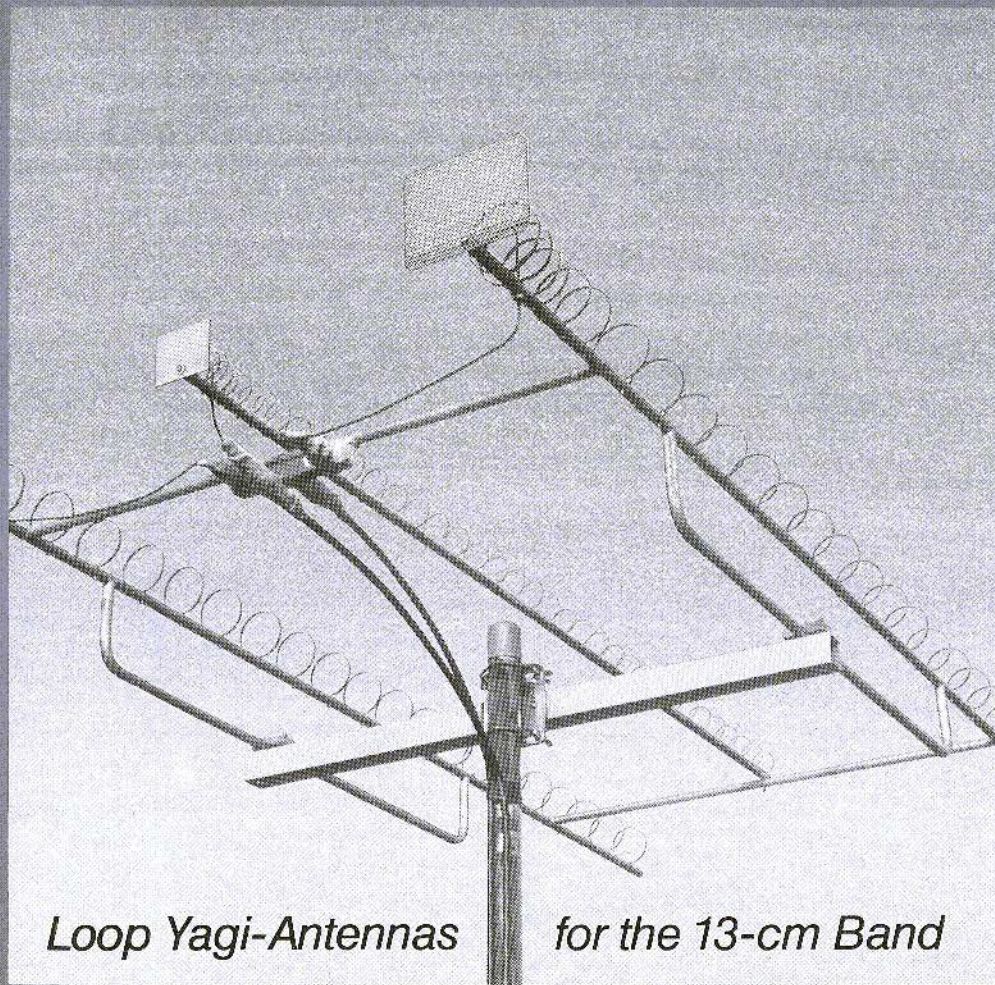

Loop Yagi-Antennas for the 13-cm Band



VHF communications

A Publication for the Radio Amateur
Especially Covering VHF, UHF, and Microwaves

Volume No.17 - Summer - Edition 2/1985

Published by: Verlag UKW-BERICHTE,
Terry Bittan
Jahnstrasse 14
D-8523 BAIERSDORF
Fed. Rep. of Germany
Telephones (91 33) 855, 856.

Publisher: Verlag UKW-TECHNIK
Terry Bittan

Editors: Mrs. Corrie Bittan

Advertising manager: Mrs. Corrie Bittan

VHF COMMUNICATIONS

The international edition of the German publication UKW-BERICHTE, is a quarterly amateur radio magazine especially catering for the VHF/UHF/SHF technology. It is published in Spring, Summer, Autumn, and Winter. The 1985 subscription price is DM 24.00 or national equivalent per year. Individual copies are available at DM 7.00 or equivalent, each. Subscriptions, orders of individual copies, purchase of PC-boards and advertised special components, advertisements and contributions to the magazine should be addressed to the national representative.

All rights reserved. Reprints, translations, or extracts only with the written approval of the publisher.

Printed in the Fed. Rep. of Germany by R. Reichenbach KG, Krelingstr. 39 - 8500 Nuernberg.

We would be grateful if you would address your orders and queries to your representative.

Representatives

Austria
Verlag UKW-BERICHTE, Terry D. Bittan
POB 89, D-8523 Baiersdorf/W. Germany
Creditanstalt Bankverein, WIEN Ko. 17-90-599;
PSchKro WIEN 1, 168, 146

Australia
W. J. A. P. O. Box 300, South Caulfield, 3162 VIC, Phone 5285962

Belgium
HAM INTERNATIONAL, Brusselssteenweg 428, B-9218 GENT,
POR 000-1014257 CCP, Tel. 00-32-91-312111

Denmark
Halskov Electronic, OZ7LX, Sigorated gamle Skole,
DK-4100 RINGSTED, Tel: 00-616162, Giro 7 29 68 00.

France
Christiane Michel, F 5 SM, SM Electronic,
20 bis, Avenue des Clairons, F-89000 AUXERRE
Tel. (86) 46 96 59

Finland
Erkki Heberthal, SF-31400 SOMERO
Joensuu tie 6, Tel. 924-46311

Holland
MECOM, PA 0 APP, Postbus 40, Noordwolvenweg 12,
NL-6780 AA BLEDUM, Tel. 05900-14390.
Post giro 3996163

Israel
Z. Pomer, 4X4KT, PO Box 202, K. MOZKIN 28114
Tel. 00872-4714076

Italy
Franco Armienghi, I 4 LCK, Via Sigonio 2,
I-40137 BOLOGNA, Tel. (051) 31 56 97

Luxembourg
TELECO, Jos. Faber, LX 1 DE, 5-9, Rue de la Fontaine,
ESCH-SUR-ALZETTE, Tel. 53752

New Zealand
E. M. Zimmermann, ZL 1 AGO, PO Box 31-261
Milford, AUCKLAND 9, Phone 492-744

Norway
Henning Theg, LA 4 YG, Postboks 70,
N-1324 LYSAKER, Postgirokonto 3 16 00 09

South Africa
SA Radio Publications, PO Box 2232, JOHANNESBURG 2000, Telephone 011-3378472

Spain + Portugal
Julio A. Prieto Alonso, EA 4 CJ, MADRID-15,
Donoso Cortés 58 5° B, Tel. 243.83.84

Sweden
Carl-Oscar Birse, SM4VIL, Ojtenbacken 12 B
S-17239 SUNDBYBERG, Tel. 08-29 63 22

Switzerland
Terry Bittan, Schweiz, Kreditanstalt ZÜRICH,
Kto. 469.253-41, PSchKro ZÜRICH 89-54.649

USA
UV COMMS, K3RRS
PO Box 432, LANHAM, MD 20706
Tel. 301-458-4924

© Verlag
UKW-BERICHTE
1985



Contents



Wolfgang Guenther, DF 4 UW	Basic Rules for Self-Constructed Equipment	66 - 68
Carsten Vieland, DJ 4 GC	Thermal Power Measurements - yet another look	69 - 71
Josef Grimm, DJ 6 PI	Loop Yagi Antenna Design for 13 cm	72 - 78
Jochen Jirrmann DB 1 NV	Switched Mode Power Supplies (S. M. P. S.) Part 1: Basic Theory	79 - 93
Jochen Jirrmann, DB 1 NV	A 12 Volt Mobile, Switched Mode Power Supply (S. M. P. S.) Part 2	94 - 99
Erich Stadler, DG 7 GK	L- and C-Measurements with Calibrated Transmission Lines	100 - 105
Erich Stadler, DG 7 GK	Impedance Measurements with Calibrated Transmission Lines	106 - 111
Joachim Kestler, DK 1 OF	PLL Oscillators with Delay Lines Part 3: Oscillator Module for the 2-Metre-Band	112 - 120
Guenther Hoch, DL 6 WU	Estimating the Gain of Yagi-Antennas from Chart Data	121 - 124
Siemens	TDA 5660P - A Versatile Modulator Circuit for TV, Video, and Sound Signals in the Range of 48 to 860 MHz	125 - 127





Wolfgang Guenther, DF 4 UW

Basic Rules for Self-Constructed Equipment

Radio amateurs in Germany (DL) still have the privilege of building their own equipment without having to submit it for acceptance testing. A recent exception applies to stations operating/mm aboard German ships (1). In some countries a final acceptance examination by the national communications authority is normal for all transmitting equipment.

It is for this reason that it is to be recommended that all home-made equipment, especially for use above 30 MHz, should be constructed according to the following basic principles which are well known in professional circles. These treat the transmitter and receiver modules with equal importance and in the case of the latter, not just from the standpoint of good selectivity, but that unauthorised radiations can also occur from it. It is these spurious radiations which at all costs, must be avoided in order that the trust given to the amateur by the national authority is not betrayed by a slipshod, open form of construction which permits these emissions on illegal frequencies (2).

A subsequent alteration is very much more

expensive than to construct in a spurious, radiation-free, commercial manner in the first place. The following advice should help in this respect:

- a) Consequent grouping in juxta-position of screened **modules** in accordance with the **circuit frequency plan**, i.e. high-frequency, mixer or intermediate-frequency stages all enclosed within their own screened compartments. This enables both, HF and IF modules to enclose more than one amplifying element together with several tuned circuits (of the same frequency order) in the same box.
- b) The high-frequency proof **screened box** can be fabricated from thin tin-plate in which every attempt should be made to make it "watertight".
- c) Overlapping lid edges of the housing should be uniformly tight fitting or screwed-on flat lids should close onto continuous **finger-strip contacts** which ensure an HF-tight fit (see commercial construction or an old UHF-tuner).
- d) All box and housing edge lap-joints, should be **soldered** "watertight".



e) External connections for supply voltages or relay/electronic controls should in principle, be made via **HF feedthrough ceramics** which have been soldered all around the flange – 10 nF for 9 MHz, 4.7 nF for 29 MHz, 1.5 nF for 145 MHz, 470 pF for 435 MHz and 150 pF for 1260 MHz.

f) All input and output impedances should be about **60 Ω** or transformed up/down if necessary. Internal cabling between modules may be thin 50, 60 or 75 Ω coaxial cable, it does not matter which.

g) Notwithstanding what has been said above, double screened **coaxial cable RG 223U** in particular, is widely employed for connections between modules as the connector receptacles can be directly soldered in a "watertight" fashion to the wall of the module. It is advantageous for every coaxial through-connection to install a suitable soldered socket onto the screened case in order to achieve a good soldered connection possibility together with rigid mechanical stability.

h) Amplifiers tend to exhibit parasitic oscillations in the vicinity of the limiting frequency f_L of its constructional elements. A phase-change of 270° to 360° and onto 450° takes place through these elements from input to output near f_L . The magnitude and the degree of phase-change is dependent upon both the mechanical and electrical construction and the relationship of the working to the limiting frequency.

Single stage circuits avoid these oscillation effects by including "**parasitic stopper resistors**" directly at the collector (or anode). The following are reliable values: 455 kHz – 4.7 k Ω , 9/10.7 MHz – 470 Ω , 29 MHz – 220 Ω , 52 MHz – 100 Ω , 145 MHz – 47 Ω , 435 MHz – 10 Ω . Low inductance types of course, should be used such as the old carbon composition

or modern carbon-film resistors. Metal-film resistors are also suitable but under no circumstances use the carbon-film types with a recessed spiral track.

The values should not be made smaller in order to be on the safe side, as in relationship to the 10 to 100 times greater tuned – circuit dynamic impedance, they cause very little power loss in the amplifier. A smaller value can however be employed which is sufficient to inhibit the spurious oscillator effect in cases where the working frequency is large compared to the limiting frequency.

i) If a multi-stage amplifier tends to self-oscillate (i.e. around the working frequency) then the only measures that will help are radiation and/or current decoupling between the sensitive low level input circuits and the high level output. It is simpler to achieve this through **further division** into "watertight" screened compartments following points a) to g) using in addition HF chokes in the supply lines.

j) Every mixer stage should also be housed in its own screened box and the HF, oscillator, and IF signals connected via coaxial cables. Only very short **coaxial** connections however, should be used to connect high impedance points as the capacitance per unit (1 m) length is: 50 Ω – 100 pF, 60 Ω – 80 pF, 75 Ω – 68 pF and **95 Ω – 47 pF**. For an oscillator/amplifier tuned circuit at 136 MHz with a total circuit capacitance of 15 pF and a 10 pF (mid-value say 6.5 pF) trimmer it makes quite a difference whether the 10 cm coaxial cable has a capacitance of 10 pF or only 4.7 pF.

For this reason and for other diverse reasons it is better to adhere to point f) and transform both sides to 60 Ω . This requires a tuned transformer in each box but not of course if by chance, a FET common-gate amplifier (P 8000) or a low ohm input mixer is being driven.



In order to achieve sufficient signal decoupling between inputs/outputs, preferably double-gate FETs or push-pull circuits also diode ring mixers should be employed where the latter are to be balanced in phase and amplitude. Ready-made modules don't have to be.

If all the points outlined above are diligently carried out, the radio amateur may be sure that he will immediately satisfy at least the **minimum** requirements of the German Federal Post Office (DBP) set out in (3). In the requirements for the implementation of the amateur licensing regulations of March 1967 para 12 it states:

"The amateur radio station must be constructed and maintained according to the current state of the technique. Unwanted emissions are to be limited to the smallest possible values. The attenuation of the unwanted emission relative to the power on the working frequency should be for transmitters of over 25 watt

under 30 MHz at least 40 dB
over 30 MHz at least 60 dB

The radiated interference power from oscillators or harmonic frequencies which fall within the broadcast or television bands must not exceed 4×10^{-9} watt".

If all the components of a transceiver were located on one PCB which was then placed in an unbonded cabinet with holes through it, or even in a plastic case, the above specifications would certainly not be met. The interference emission of diverse oscillators and their amplifiers are in general, very much underestimated.

It is also recognised that with VFO modules possessing little or no screening together with crystal oscillators (particularly with multipliers for VHF and UHF) become even more unstable when amplitude-modulated signals (e.g. from SSB

PA's) are radiated into them. The oscillators exhibit a small frequency-modulation in sympathy with the AF which can lead to unintelligibility of the outgoing signal (Listen to some U stations on the HF bands).

It is not for nothing that the goodness of many HF equipments may still be measured by their weight. Unfortunately, nothing nowadays is given away but when the old basic rules of the HF techniques are followed exactly, success is sure and the home-constructed equipment will exhibit spurious signals - 60 dB rel. full carrier output rating or less than 4×10^{-9} watt when tested by the authorities between 1 and 800 MHz with a spectrum-analyser connected to the antenna.

In cases of interference the amateur is deemed to be at fault if the radiation from the equipment, oscillators, PA's etc. exceeds the following power levels outside the permitted amateur band:

between 30 and 300 MHz = 1.25×10^{-9} W i.e. 31 dB rel. pW
over 300 MHz = 2×10^{-9} W or 2 nano W or 33 dB rel. pW

It cannot be taken for granted that just because the amplifiers and mixer stages are showing no signs of self oscillation that it is not emitting appreciable spurious radiation, see (4).

Literature:

- (1) cq-DL 1/1981, Page 34 and cq-DL 2/1981, Page 81;
- (2) Vw Anw DV-AFuG von 1980, pt. 9, Page 46;
- (3) DV-AFuG vom März 1967, Paragraph 12 (Page 13) and Paragraph 16 (Page 15);
- (4) cq-DL 4/1981, Page 177, Pt. 1 to 5 (Linearstufen-Übersteuerung).



Carsten Vieland, DJ 4 GC

Thermal Power Measurements – yet another look

The construction proposal (1) for a thermal power-meter has evidently been an stimulus for many discussions and home-constructional projects. From the many demands and suggestions, I would like to place a few points forward for discussion.

The optimal design for a bolometer-head (transducer of HF power into DC) is a deciding factor in determining the stability and the attainable limiting frequency of the circuit. Experiments with 1.5 mm thick epoxy-glass PCBs arouse little enthusiasm since as well as the dielectric losses the transition from HF socket to the broad conductor

strip signifies a reflection point at the joint. Even at 1.3 GHz, a return-loss of under 10 dB (SWR = 2:1) was recorded (in **Table 1** last line). A certain reduction in the transition losses of all types of PCB is attained by a ground coating of the conductor track side. Optimum results are achieved when the two surfaces at the PCB's end are soldered together via a U-formed strip of thin copper (**Fig. 1**).

Experiments with cylindrical resistors (metal film) proved to be fruitless because of skin-effects, current in the direction of the return (ground) conductor, led to the resistor's value increasing with frequency.

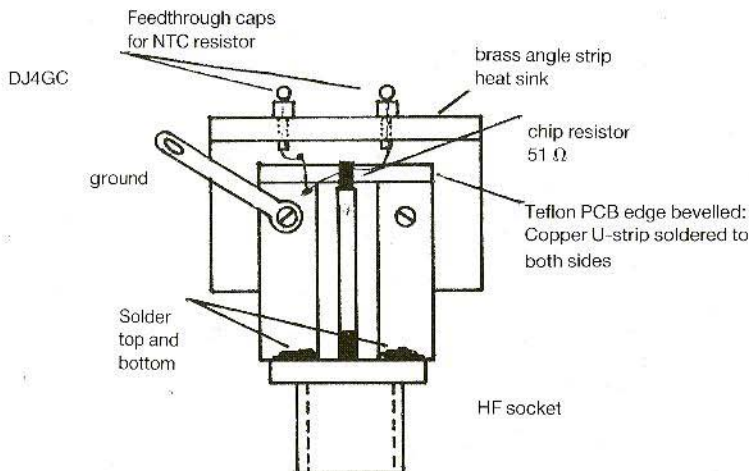

Fig. 1:
Modification of a
bolometer-head

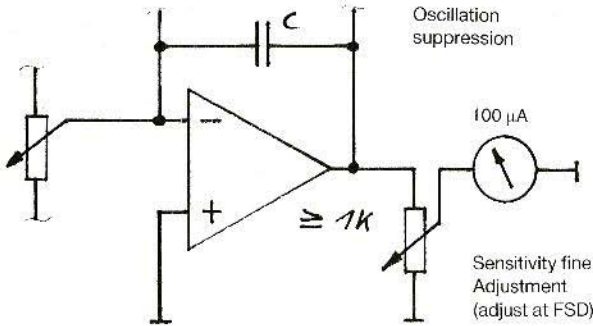

Fig. 2:
Modification of voltage amplifier

The connecting leads of NTC resistors can only be soldered reliably at high temperatures. At solder temperatures under 350°C, they are liable to "glue" together, thereby increasing the risk of developing a thermo-junction.

The bridge-supply voltage can be made potentially isolated with only a small loss of linearity (Fig. 2). The first operational amplifier, with its possible offset-drift problems, may then be dispensed with. This voltage must however, be perfectly stabilised. The drift of the IC 78L05 is very small and only influences the read-out information in a linear fashion but does not disturb the linearity of

the bolometer bridge.

LED displays, as well as power-supplies, should never be placed anywhere near the bolometer, in order that heating effects may be avoided.

The display amplifier is most advantageously provided by the chopper-stabilised operational amplifier ICL 7650 by Intersil (2). Offset-drift and offset-voltage are practically absent. In the circuit of (1) however, two of these op. amps. were required. A point to watch is the very small output current of this C-MOS IC, which necessitates the use of a 100 μ A FSD meter.

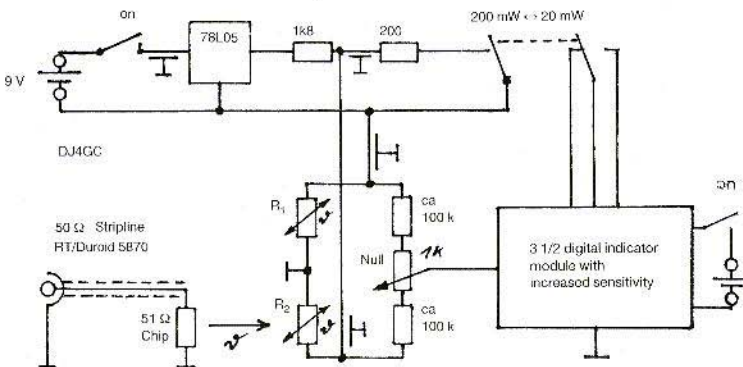

Fig. 3: Complete circuit diagram of a digital display thermal milli-wattmeter
 R_1 = (temperature compensation): micro-NTC resistor ca. 1 M Ω
 R_2 = (bolometer-probe): as R_1



A jumping around of the indicator null-point upon range-switching can usually be attributed to oscillation of the operational amplifier (check with an oscilloscope). One remedy is to bypass and block the supply lines to the IC as near as possible to the pins. Another method is to place a (1 nF – 0.1 μ F) capacitor between the output and the inverted input of the op-amp, which reduces its AC amplification sufficiently to stop the oscillation.

The meter-movement is most advantageously provided with an additional dB-scale. The FSD of about 1 mW, corresponding to 0 dBm, with the graduations descending to a convenient –10 dBm. Upon range-switching in decades, 10 dB can be added to, or subtracted from the indicated value. It is thereby possible to obtain a dBm-scale without having to calculate anything. Amplification or attenuation may be read directly in dB. For the optimal use of this scale a fine-adjustment of the indicator sensitivity is recommended.

A particularly interesting circuit on account of its amazing simplicity, was made by the author in large numbers. It was a thermal power-meter with a digital display which required no output amplifier. The bridge-voltage was simply fed to a 3½ digit LCD multi-meter module.

At a bridge voltage of 5 V the differential voltage was about 60 mV at 20 mW HF input power. The resolution (one digit) then being 10 μ W. Range-switching of 200 mW was carried out simply by division of the bridge voltage supply. The instruments constructed in this manner, exhibited a loss of indicated linearity of only a few percent when measuring input powers of below 200 mW. Interestingly, the sensitivity of the dual-slope converter could be altered from 200 mV for maximum reading by compensating with the multi-turn potentiometer for the requisite HF input.

The employment of a digital display for tuning purposes takes a bit of getting used to, but this however, is the same problem with all digital multi-meters.

Literature

- (1) Carsten Vieland, DJ4GC:
A Sensitive Thermal Power Meter
VHF COMMUNICATIONS Vol. 15, Winter
Ed. 4/1983, Pages 225 – 231
- (2) Dr. Hannes Fuchs:
Messen im Mikrovolt-Bereich (ICL 7650)
Funkschau, Heft 11/1984

	DJ4GC	30 MHz	144 MHz	440 MHz	1.3 GHz	Base material
BNC	Return loss SWR	35 dB 1.03	33 dB 1.04	27 dB 1.09	27 dB 1.09	RT-Duroid 5870
N	Return loss SWR	40 dB 1.02	39 dB 1.02	37 dB 1.03	23 dB 1.15	0,79 mm thick
SMA	Return loss SWR	40 dB 1.02	42 dB 1.02	55 dB 1.00	31 dB 1.06	
N	Return loss SWR	39 dB 1.02	31 dB 1.06	21 dB 1.2	10 dB 2	1,5 mm Epoxy

Table 1: Return loss measurements from bolometer-head Fig. 1



Josef Grimm, DJ 6 PI

Loop Yagi Antenna Design for 13 cm

The following article describes an easily reproducible loop Yagi antenna design for the 13 cm amateur radio band, together with an array of double and quadruple stacked antennas.

1. PRELIMINARY NOTES

With the rising activity in the lower GHz bands, easily reproducible antenna designs are neces-

sary. In [1], a small array with relatively little gain and large beamwidth was described for the 13 cm band, however, because of the high path loss, high-gain antennas are desirable. The prominent characteristics of a parabolic antenna are not disputed, but not everyone is able to accommodate one of these extensive structures upon his roof.

In [2], a small loop Yagi antenna with relatively high gain and small bandwidth was described for the 23 cm band. The author has successfully used this antenna since 1976, at first as a single

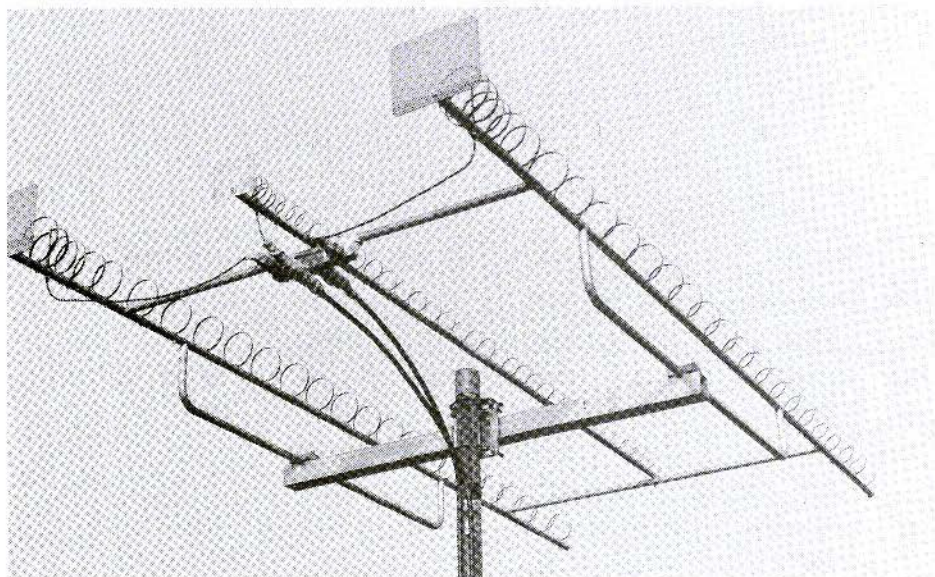

Fig. 1: Loop Yagi antennas for 23 cm (outside) and 13 cm (centre) by DJ6PI



antenna, then later on as a double-array antenna for the 23 cm band (Fig. 1). At the same time the author gave the scaled-down measurements for a 13 cm version, the antenna was described in [3] with 23 elements, and constructed with 37 elements (Fig. 1, centre). The design and construction of loop Yagi antennas has been dealt with in the meantime by many authors [4], [5], [6], [7].

2. LOOP YAGI ANTENNA FOR THE 13 cm BAND

From the 23 cm antenna data in [5], a 13 cm antenna was scaled down. Special care was taken to use materials, easily obtainable in Germany, to the nearest possible measurements so that no correction factors had to be taken into account [5], [6].

1 m lengths of 10 mm \varnothing brass or copper tubing can be bought inexpensively from hobby shops or builders merchants. This makes a boom with enough room for 25 elements. The elements (reflector, radiator and all directors) are formed from 0.4 mm thick brass or copper plate. All the elements are made from 2.5 mm strips cut on a guillotine or with hand shears. Due to the small dimensions, the rings are adequately stable. Next, the positions of the elements can be marked on the boom. In order to avoid cumulative measurement errors, table 1 gives all the element spacings from the reflector screen outwards. The construction is shown in Fig. 2.

Reflector screen	0. mm
Reflector ring R ₁	43.6 mm
Radiator	56.9 mm
Director 1	72.6 mm
Director 2	84.3 mm
Director 3	109.3 mm
Director 4	134.3 mm
Director 5	151.9 mm
Director 6	184.3 mm
Director 7	234.3 mm

Further elements are spaced at 50 mm intervals.

Table 1: Distance of the elements from the reflector screen.

The feed to the radiator is made with semi-rigid cable, via a 3.6 mm hole drilled in the boom directly in front, or behind this element. Next, the elements are cut to the lengths given in Table 2, formed into rings and soldered to the positions marked on the boom.

Reflector ring 1:	135.9 mm
Radiator:	129.7 mm
Director rings 1 – 11:	115.9 mm
Director rings 12 – 22:	112.4 mm

Table 2: Uncoiled length of elements

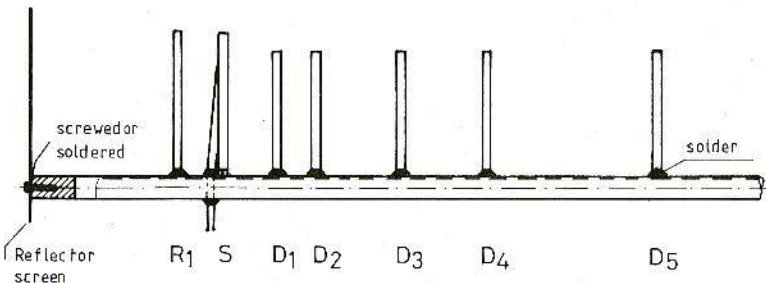

**Fig. 2:
Configuration
of the elements**

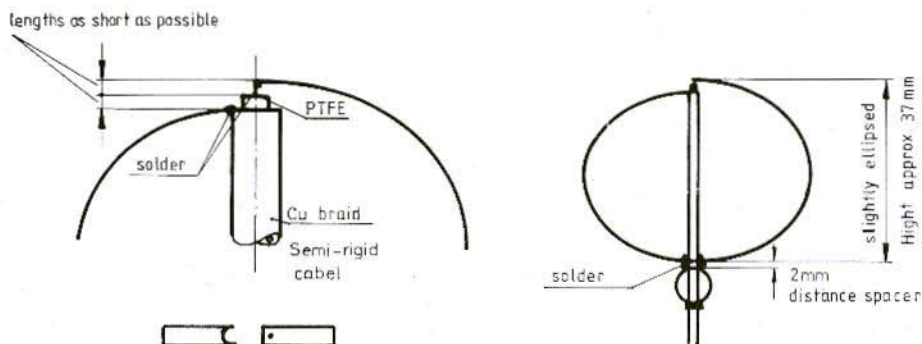

Fig. 3: Construction details of the feeder and radiator element

The radiator element is prepared as in Fig. 3 and soldered to the marked place on the boom. The semi-rigid cable should be fed through the hole in the boom as tightly as possible. Fig. 3 shows how this element should look when the final soldering is completed.

The end of the semi-rigid cable under the boom is fitted with a suitable N-cable socket. Finally, a mesh or flat plate is soldered or screwed to the end of the boom, as shown in Fig. 4.

In order to tune the antenna, connect it via an SHF standing wave bridge to a 13 cm transmitter.

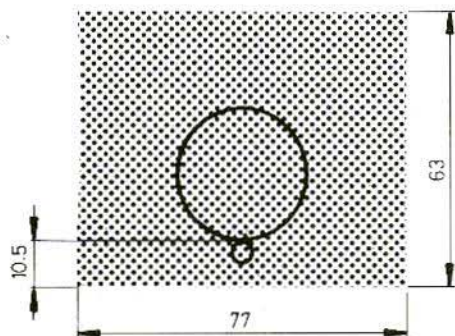

Fig. 4: Reflector screen of mesh or flat plate

First of all, adjust for minimum reflected power by pressing the radiator element together or pulling it apart. The fine tuning is accomplished next, by bending the reflector and the first director ring towards or away from the radiator, the semi-rigid cable can then be soldered at the points of penetration through the boom.

In order to prevent corrosion, the antenna must be weatherproof, eg. by spraying it with waterproof varnish.

The gain of such a loop Yagi antenna with 26 elements for the 23 cm band was determined in [8] to be 16.33 dB_G. Because of the slightly shorter version of the 13 cm antenna a gain of 16 dB_G is to be expected. Both beamwidths are around 20°, the bandwidth is around 3 % (2350 ± 35 MHz). Sidelobes are at least 10 dB weaker than the main lobe.

3. STACKING TO A DOUBLE ANTENNA ARRAY

Adding extra elements to the antenna gives no substantial increase in gain, but stacking in the horizontal or vertical plane does. The gain from stacking two antennas due to unavoidable inter-

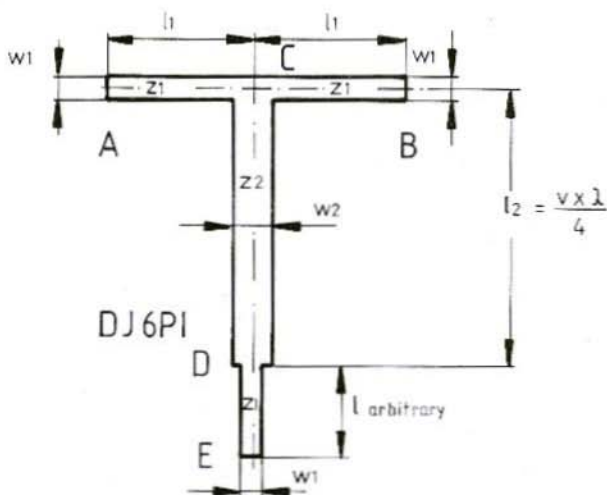

Fig. 5:
Dimensions and
characteristic impedances
of the DUAL divider

action losses amounts to not quite 3 dB. According to [9], the optimum stack spacing should amount to 0.37 m. For the 1.3 GHz band, the stacking distance comes to 0.66 m, for the METEOSAT band 0.5 m, and for the 3.5 GHz band 0.25 m. Power dividers/combiners for the coupling of more antennas are described in [2], [3], and [5]. These refer to complicated arrangements employing air-coaxial techniques.

To simplify matters, the antenna coupling can be achieved by a printed circuit matching section. This was carried out using 0.79 mm thick RT/duroid 5870. Providing the feed in both antennas has been optimized as in Para. 2, one can start from a base impedance of 50 Ω . The semi-rigid cable running to the connecting points A and B (Fig. 5) must be exactly the same length. The micro-strip sections of line L_1 , L_2 may be of any desired length as long as they are equal and with a characteristic impedance of 50 Ω . They serve only to bring forward the antenna leads to the coupling point C. At this point, the impedance is 25 Ω , due to the parallel connection of two 50 Ω impedances.

The actual matching section is between points C and D. At point D an impedance of 50 Ω exists for the connection to the downlead coaxial cable. The length of the microstrip line between points D

and E is arbitrary, the characteristic impedance of this section of line must amount to 50 Ω . The characteristic impedance Z_2 of the matching pad C-D is calculated from

$$\begin{aligned} Z_2 &= \sqrt{Z_C \cdot Z_D} \\ Z_C &= 25 \Omega \\ Z_D &= 50 \Omega \\ Z_2 &= 35,35 \Omega \end{aligned}$$

The length of the matching section (C-D) is: $l_2 = V \cdot \lambda/4$.

The width W_2 of the transformation line, calculated from the known microstripline formula for RT/duroid 5870, comes to 3.7 mm. The velocity factor derived from this formula comes to $V = 0.698$.

The length of l_2 for any frequency is: $l_2 = V \times \lambda/4$.

e.g.

1296 MHz:	40.4 mm
1691 MHz:	30.96 mm
2330 MHz:	22.5 mm
3456 MHz:	15.1 mm

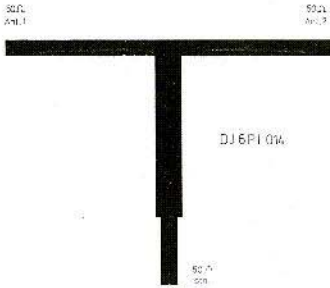

Fig. 6: Layout for the RT/duroid PC-board DJ6PI 014

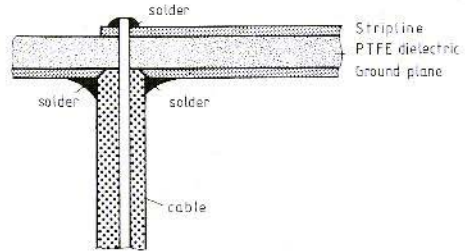

Fig. 7: Soldering coaxial cable and PC-board together

The width W_1 for the $50\ \Omega$ microstripline is uniform for all frequencies, coming to 2.23 mm. Fig. 6 shows the printed circuit layout DJ6PI 014.

The transition of the semi-rigid cables to the antennas at points A and B, as well as the lead-in cable at point E, must be completely free of dent marks. Therefore the inner conductors of the cables are fed through from the ground side of

the printed circuit board. On the ground side of the PCB, some of the metal around the coax. innerconductor holes is removed with a 6 mm drill. The outer conductor of the coaxial cable is soldered to the ground side, as shown in Fig. 7.

The finished soldered power divider/combiner should be sprayed with a waterproof varnish to protect it against corrosion and fitted into a

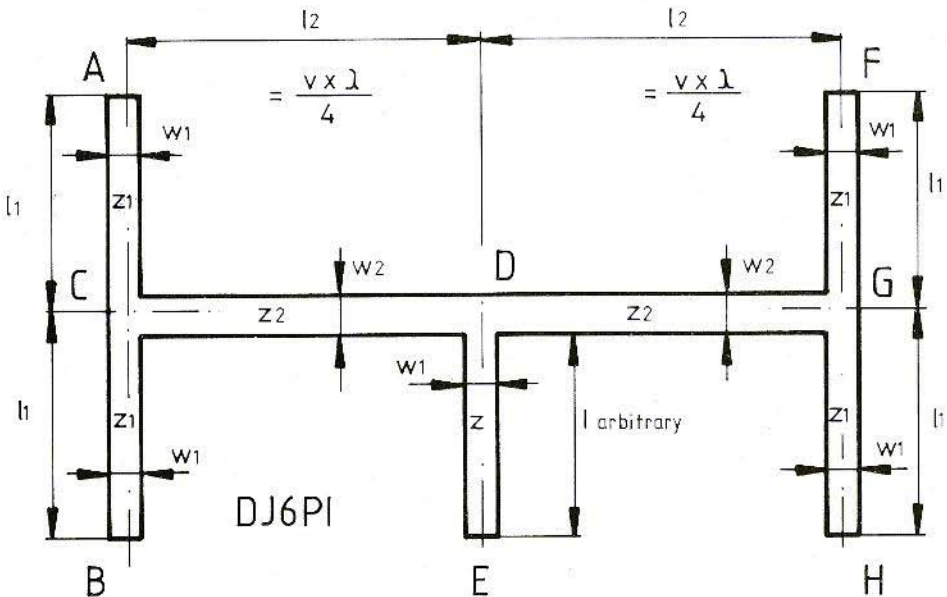

Fig. 8: Dimensions and characteristic impedances of the quad divider



waterproof housing. The cable inlets in the housing are sealed with a malleable filler (e.g. Teroson, Bostik). The gain of this double-bay stacked loopyagi is approx. 18 dB_d.

4. STACKING TO A QUAD ANTENNA ARRAY

An array of 4 Loop-Yagis approaches the gain of a parabolic dish of 0.9 m diameter (approx. 21 dB_d), as mentioned in section 2. Each pair of antennas is stacked horizontally and vertically. The stacking spacing is given in section 3.

The antennas are interconnected by a printed circuit quad-divider as shown in Fig. 8.

Identical lengths of semi-rigid cable from the four antennas terminate at points A, B, F, H. The nominal impedance for each can be assumed to be 50 Ω. The microstriplines AC, BC, FG, HG have a characteristic impedance Z₁ of 50 Ω each. They serve to bring forward the antenna leads to the coupling points C and G. They are all the same length l₁, which is arbitrary. The impedance at these points is 25 Ω owing to the parallel connection of two 50 Ω impedances.

For further transformation one must think of the connection at D as separated into two halves. The characteristic impedance Z₂ of the matching sections CD and GD is calculated from:

$$Z_2 = \sqrt{Z_C \cdot Z_D},$$

and

$$Z_2 = \sqrt{Z_G \cdot Z_{D_2}}$$

In order to obtain an impedance of 50 Ω at point D after joining (connecting in parallel), both halves, Z_{D1} and Z_{D2} must each amount to 100 Ω.

$$Z_{C,G} = 25 \Omega$$

$$Z_{D1,D_2} = 100 \Omega$$

$$Z_2 = 50 \Omega$$

The length of the matching section CD, GD is: l₂ = V · λ/4.

The station lead-in cable DE can be of any length, provided that the characteristic impedance Z, is 50 Ω. Thus, all the microstrip lines of this quad divider/combiner have a uniform characteristic impedance of 50 Ω. The velocity factor V for RT/duroid 5870 and 50 Ω characteristic impedance is: V = 0.71.

Length l₂ for any frequency is:

$$l_2 = V \cdot \lambda/4.$$

From this are obtained the lengths for the following common frequencies:

1296 MHz: 41.08 mm

1691 MHz: 31.49 mm

2330 MHz: 22.85 mm

3456 MHz: 15.4 mm

The printed circuit layout DJ6PI 015 for four 13 cm antennas is shown in Fig. 9.

All further details (soldering the coaxial cables) are, as already described for the double array.



Fig. 9:
Layout for the RT/duroid PC-board DJ6PI 015

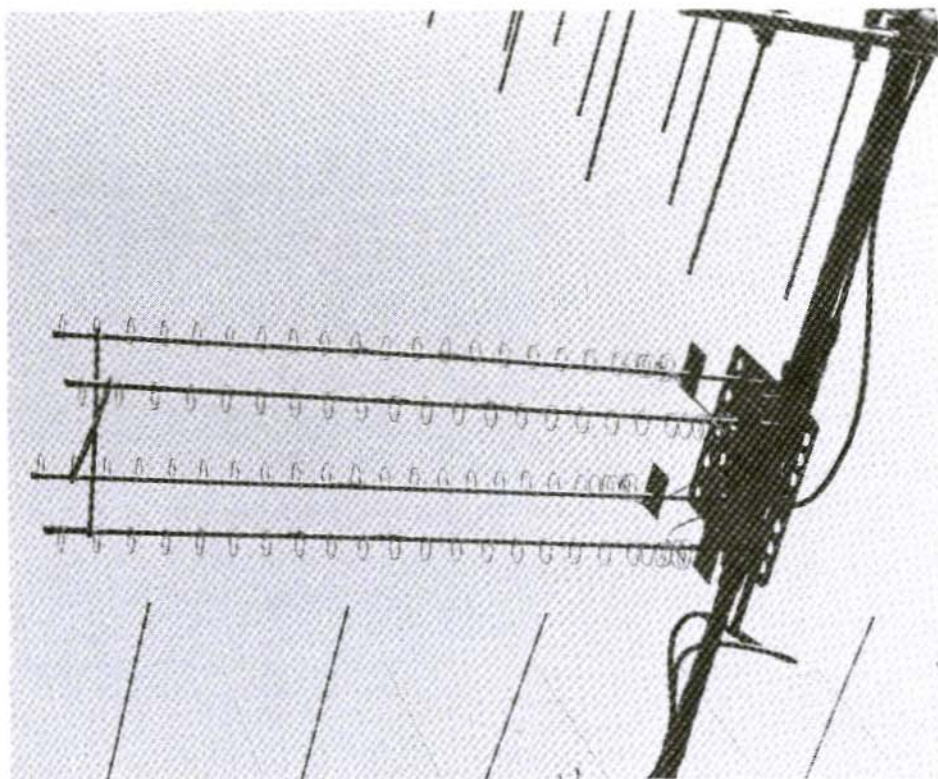

Fig. 10: Example of a quad array antenna as described by DC9MD

The described double and quad power dividers/combiners operate successfully in the B-section omnidirectional antenna array and cavity resonator of the ATV transponder at Tegelberg/Allgäu. Fig. 10 shows finally a four-antenna array operated by DC9MD.

5. REFERENCES

- 1) K. Hupfer: A Colinear Antenna for the 13 cm band
VHF COMMUNICATIONS 7, Ed. 4/75,
Pages 236 – 238
- 2) D.S. Evans, G.R. Jessop: VHF/UHF manual
3rd Edition, Pages 8.47 – 8.49
- 3) UHF-Unterlage Teil III, K. Weiner, 1982,
Subautor J. Grimm,
Pages 572 – 574
- 4) R. Lertz: Loop-Yagi antennas
VHF COMMUNICATIONS 10, Ed. 1/78,
Pages 23 – 29
- 5) G.R. Jessop, VHF/UHF manual, 4th Edition,
Pages 9.59 – 9.60
- 6) W. Ratz: Der TV Amateur 54/1984,
Pages 24 – 26
- 7) UHF-Unterlage Teil IV, K. Weiner, 1984,
Subautor J. Grimm, Pages 724 – 726:
Loopyagi für das 9-cm-Band,
Pages 731 – 733:
Loopyagi für das 70-cm-Band
- 8) G. Schwarzbeck, cq-DL 1/1981, Pages 9 – 20
- 9) G. Hoch: Extremely Long Yagi Antennas
VHF COMMUNICATIONS 14, Ed. 3/82,
Pages 130 – 138



Jochen Jirmann, DB 1 NV

Switched Mode Power Supplies (S.M.P.S.)

Part 1: Basic Theory

Switched mode power supplies have replaced conventional power supplies both in the computer and consumer electronic fields. Apart from the smallest applications, this technique has been hardly used in amateur equipment. Arguments abound, such as, how complicated, difficult involved construction, causes radio interference and prone to failure etc. This article should help to make the s.m.p.s. technique more understandable and to open up more possibilities for its use.

1. HISTORY

History of Development

From the beginnings of electronics it was known that weight and volume in power equipment could be reduced, if the mains supply frequency chosen, was higher than 50 Hz. The volume of a power transformer falls in proportion to $1/f_{\text{Netz}}$ and the smoothing capacitors can also be reduced in size as the ripple frequency increases. An early application of this technique was the 115 V/400 Hz aircraft power equipment which brought down the weight and volume by a factor of 8 – an enormous advantage. For the same reason the mechanical vibrators in road vehicles mostly operated with a frequency of 100 to 200

Hz. Higher switching frequencies were not possible using a mechanical switch.

With the first germanium power-transistors D.C. converters with switching frequencies in the kilohertz-region, and powers in excess of 100 W could be built. Older radio amateurs will remember the first transistor converters used to power valved transceivers in cars or the VHF-FM equipment such as the KFT 160 with two built-in converters.

Nevertheless, before switched mode power supplies could be employed in mains powered equipment, the component manufacturers had to solve many problems:

- Transistors with high voltage ratings capable of being fed directly with rectified 230 VAC had to be developed.
- Ferrite material had to be found which would operate at low loss in pulse, power transformers at around 25 kHz.
- For rectification on the secondary side, fast power diode rectifiers had to be manufactured.
- The control and monitoring was taken over from expensive discrete transistors by integrated circuit solutions.

For a few years now these components have been obtainable at reasonable prices and more and more switched mode power supplies are being used in equipment. Even the choke/starter combination in neon-lamps will be replaced in



new models by a 120 kHz switching regulator. In this application, low weight and higher light radiation with lower power losses are decisive advantages.

2. ADVANTAGES AND DISADVANTAGES OF THE S.M.P.S.

Previously it was stated that an s.m.p.s. could replace a mains transformer/rectifier combination with considerable savings in both space and weight for the same efficiency. Additionally, by interfering with the switching process and controlling, for example the on-time of the power-transistor as a function of the output voltage, a stabilisation against mains and load fluctuations may be achieved. It should be borne in mind however, that each interference in the oscillatory circuit reduces its efficiency. This is particularly so in the partly loaded region (eg. when regulating an increasing output voltage where the efficiency is lower than a series pass regulator, whereas on full steady load a unique efficiency of 80 % is attainable. It may be seen that the main application areas of the s.m.p.s. lie where a fixed output voltage and only a limited fluctuation of the load current is required. It is not meaningful to design a laboratory power supply with wide adjustment ranges for both current and voltage using purely the s.m.p.s. concept. A further deficiency of all switched-regulators is the high level of radio interference (r.f.i.) which can however, with suitable constructional methods, be made compatible with that produced by linear regulators. The anti-r.f.i. measures begin with the choice of switching concept and continues with the P.C.B. layout and component choice until final completion of the equipment.

To summarize: A power supply in the switched-mode technique can be employed to advantage when:

- a fixed output voltage with a steady or slow varying load is required,
- strongly varying mains voltages are to be regulated (a range from 90 to 270 V may be regulated nowadays without range switching).
- short-term mains drop-outs are to be bridged,
- small dimensions and low weight are demanded,
- the small heat loss, makes the use of forced-air cooling unnecessary (very useful in heavily screened enclosures or in extreme ambient temperatures),
- the available energy must be fully utilised in the best possible manner,
- the small residual output voltage ripple is not important,
- several voltages are to be regulated.

A linear voltage regulator is better employed when:

- only small powers (less than 10 W) are required,
- highly sensitive analogue-circuits are to be supplied,
- extremely high regulation reaction time is demanded,
- a large adjustment range of the output voltage is required.

Now the basic circuits for the switched-mode power supplies will be considered.

3. BLOCK DIAGRAM AND APPLICATION POSSIBILITIES

3.1. The Secondary Switching Regulator

The switching concept sketched in **Fig. 1** serves only to replace the loss-intensive series regulator. The mains isolation and transformation of the mains is carried out by a conventional 50 Hz transformer. This means that the power diodes in the regulator are only subjected to low voltages which is a cheaper concept. The only advantage of this circuit is the small loss in the power supply.

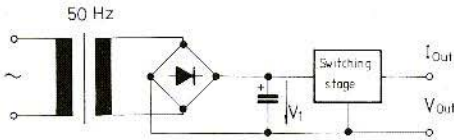

Fig. 1: The secondary switched regulator

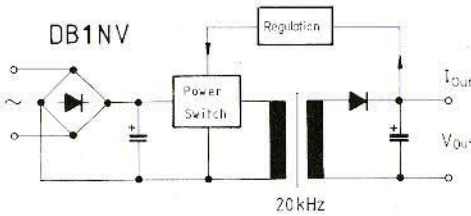

Fig. 2: The primary switched regulator

No savings worth mentioning are apparent in space or weight since as before, a large 50 Hz transformer is necessary.

In many applications (eg. telephone installations) it is an advantage that a suitable choice of V_1 (eg. 24 V) is made in order that a second supply input from a battery to ensure supply continuity during supply failures may be realised. These circuits will not be considered any further as they hardly afford any advantage in amateur applications. Much more interesting are the following concepts.

3.2. The Primary Switching Regulator

As Fig. 2 shows, the mains voltage is directly rectified and with a power-switch transformed into an ultra-sonic frequency 20 – 50 kHz. The power transistor must be capable of working with the rectified mains voltage (about 325 V). Mains isolation and transformation to the required output

voltage is carried out by a small ferrite transformer. Owing to the high ripple frequency the secondary storage capacitor can be much smaller than is possible at 50 Hz. A mains isolated (eg. with an opto-coupler) feedback loop holds the output voltage independent of mains and load fluctuations.

For sensitive applications for which the regulation speed and the residual ripple of a switching regulator are insufficient, another concept comes into question.

3.3. Primary Switching Regulator with Linear Regulator

In the circuit of Fig. 3 the primary converter carries out the volume and weight saving transformation of the mains voltage into the input voltage of the linear regulator. The primary switch can either be unregulated or it regulates only the mains fluctuations. The secondary side linear regulator supplies the desired clean, output voltage. Certainly the efficiency of the circuit is very low owing to the linear regulator, mostly about 50 %.

Now that acquaintance has been made with a few basic circuits the key component, the power transistor will be somewhat closely inspected and then on to two variants, the power-MOSFET and the high speed thyristor (SCR).

4. THE TRANSISTOR AS A POWER SWITCH

Transistors are normally used as oscillators or as switches and characterised by parameters such

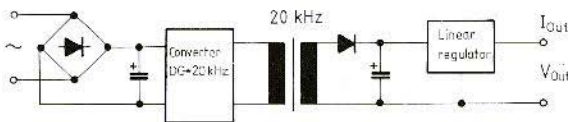

Fig. 3: Combination of primary and linear regulator



as voltage and current ratings, power dissipation, current amplification, transit-time, noise factor together with input and output impedances. These are typical small-signal parameters in a linear application. Since a power switching-transistor hardly ever finds itself in a linear application, other parameters must be found to describe it. Besides ratings of voltage and current in the conducting condition summarized in "Forward-Bias Safe Operating Area" (FBSOA) and the switching times, the behaviour in the moment of switch-off is also of particular importance. For this the "permissible operating region with biased-off base-emitter diode" (PBSOA) is used. In all cases the applied voltages and currents should not be permitted to leave the working region of the transistor!

In switching converters mainly fast bipolar power transistors or power FET's (HEXFET, SIPMOS, TMOS) are used but sometimes also SCR's and GTO's (switch-offable SCR's) are employed.

Of fundamental importance for a low loss and reliable operation of a power transistor at higher switching frequencies are two circuit details:

- the correct drive-circuit,
- a suitable collector (drain) circuitry.

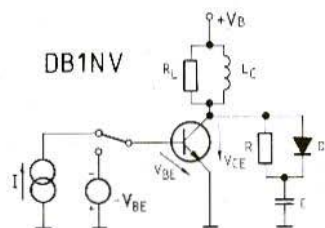

Fig. 4: The transistor as a switch; R_L is the load resistance as transformed into the collector circuit, L_C is the main inductance of the switched converter

4.1. Bipolar Switching Transistors

Turning now to the control and fast transistor circuitry for which Fig. 4 is required:

To switch on the transistor it is necessary to apply only sufficient base current in order that the collector-emitter voltage falls to 1 to 2 volts. This base current is clearly larger than that arrived at from beta and collector current calculations. A still larger base current reduces only marginally the losses in the conducting condition however, the transistor would be driven into saturation. This means that the collector voltage sinks under the base voltage and the collector-base diode conducts forward. In this operating condition many charge-carriers are stored in the transistor which must be cleared upon switch-off. This leads to an unnecessarily long and lossy switch-off phase, therefore saturation of the transistor should be avoided.

Switched mode power supplies of higher powers therefore contain circuits for the automatic base-current matching to the collector current in order that the transistor is always working just on the edge of saturation in the so-called quasi-saturation region.

Additionally, the unsaturated i.e. linear region can be monitored in order that the transistor may be switched off under overload conditions. Such circuits are to be found eg. in "Handbook of Switching Transistors" by Thomson-CSF.

With many power-supply concepts a transitory overcurrent in the collector circuit can occur during the moment of transistor switch-on. Maybe because a fly-wheel diode is still conducting and is still to be blocked. The transistor may be relieved by limiting the current gradient with a small inductance in the collector circuit. The stored energy must naturally, be suitably dissipated at the moment of blocking. This is accomplished most simply, by a series circuit of diode and resistance in parallel with the inductance.



As a basic rule, when the switching loss cannot be reduced any further, it is better to remove it from the transistor and into an uncritical component such as a resistor.

Much more critical than the switch-on and conducting phase is the switch-off transition of the transistor. As the load impedance always has an inductive component, the collector-emitter voltage rises well over the supply voltage as the collector current falls. The transistor momentarily experiences a period of power loss which must always lie inside the permitted working region under cut-off base-emitter-diode conditions, otherwise the transistor will be damaged.

In order to switch the transistor off, it is not sufficient just to interrupt the base current. Owing to the charge carriers stored during the conducting period in the base, the fall time of the collector current takes much too long. The base is switched therefore, from the current source for I_B to a negative voltage source of a few volts to "neutralise" the base charge. This source must supply a current for about a micro-second in the same order of amplitude as I_B and maintain the base voltage of the cut-off transistor at about -5 V .

The following cut-off period for the transistor is not critical. Because the base is biased negatively, the collector-emitter voltage of the transistor may rise above V_{CE0} to the very much higher V_{CEV} without endangering the transistor. Care must be taken that the base falls to a value below V_{CE0} before the next moment of switch-on, otherwise there will be a departure from the FBSOA at the switch-on time.

Summarizing: In order that a power transistor can be switched at high speed and with low loss, it must be supplied with sufficient base current during the conduction period but it must not be allowed to be driven into saturation. For the switch-off, the base is supplied from a low impedance bias source of a few volts.

Whilst the base-control chiefly determines the switching loss, the collector circuitry has the task of diverting the switching loss into non-critical

components. These RCD components at the collector of the switching transistor are known as the slow-rise-network. Most losses occur in the bipolar transistor during the switch-off transition the conducting and cut-off losses on the other hand can be neglected. The switch-on transition losses may be reduced by design features.

Only with FET switches are losses developed in the switch-on resistance R_{DSon} of any real contribution to the total transistor loss.

Now in order to reduce the dominating switch-off transition losses, the rise in the collector-emitter voltage has to be delayed. The transistor has then a smaller collector voltage during the clearance time (of charge carriers) which reduces the switch-off transient power loss greatly.

The simplest method is to place a capacitor in parallel with the collector-emitter. Unfortunately the stored energy will be transformed into heat during the switch-on transition. Quite simply, the transistor is shorting a capacitor charged to several hundred volts at every switch-on transition which would cause additional stress through high peak currents. In addition the capacitor would tend to form a tuned circuit with the leakage inductance of the transformer causing a high voltage overshoot (or ringing) at the collector.

The RCD circuit shown in **Fig. 4** works better, at the moment of switch-off the capacitor ensures the desired slow rise of the voltage. At the switch-on transition, the stored energy discharges into the resistor where it largely dissipated as heat. These networks are best dimensioned experimentally. It is only possible unfortunately, to optimise the network for a certain load and a fixed duty cycle. In power supplies with a variable switching frequency or duty cycle the efficiency may be reduced under partly or unloaded conditions if the network has been optimised for full load.

It is also possible, by careful optimisation of the RCD network, to reduce the losses so much that cheaper, lower voltage transistors may be



employed. The gradient of the collector voltage is delayed above the value of V_{CEO} until the base voltage has gone negative and the transistor may then be subjected to V_{CEV} .

4.2. Field-Effect transistors

Power-MOSFETs such as TMOS from Motorola, SIPMOS from Siemens or HEXFET from International Rectifier are very much easier to control than bipolar transistors. Because the device is voltage controlled there is no requirement for a continuous flow of current into the control electrode. The control voltage source must supply a voltage of about 10 V for conduction and a small negative bias to cut off the device. To change the charge of the gate-source capacitance (several nano-farads) current impulses of about 1 A must be delivered by the driver stage. In a bipolar transistor the minority charge carriers present in the base, must be recombined with the majority charge carriers at the moment of switch-off before the transistor can cut-off. This process is responsible for the storage time of the transistor (about 1 μ s). Since the FET is a purely majority charge carrier device the recombination time does not exist and it can be driven at a much higher switching frequency. At applications above 100 kHz the FET is thereby superior to bipolar transistors. Furthermore, there is no difference with the FET between conduction and cut-off regions. This means that the FET is completely described with a safe working region. The foregoing considerations about the bipolar transistor regarding voltage stability at the moment of switch-off and at switch-on (as long as the base is not biased enough), are superfluous with the FET. This can always be loaded with the maximum drain-source voltage regardless of whether it is working in conduction or cut-off conditions.

But most circuits nowadays are still using bipolar devices having the following advantages apart from price:

- at the normal switching frequencies of 20 – 50 kHz the higher switching losses are not so important,

- power FETs with working voltage of over 500 V have been only recently available, single-transistor circuits for the 230 V mains could not be realised in their absence,
- the switch-on resistance together with the conducting total power loss of a FET rises linearly with applied voltage.

The advantages of power FETs – shorter switching times, simpler base control, and the simpler slow-rise network – are apparent only above 100 kHz switching frequencies. For these and higher frequencies suitable transformer materials, super-fast rectifier and steering circuits are just coming on to the market.

4.3. Fast SCRs and GTOs

It may appear that SCRs have a few advantages to offer when employed as switches in an s.m.p.s.:

- they require only a firing impulse, not a long control pulse,
- they can be manufactured with high working voltages and currents,
- they are more robust than transistors.

These good characteristics however, are more advantageous outside the amateur sector such as, inductive heating, high power motor control, high voltage generators for x-ray machines or other medium frequency generators. In the power range under 500 W they have two overwhelming disadvantages:

- the SCR requires external components to switch it off by returning the anode momentarily to zero volts. With small single-SCR circuits a series tuned circuit is employed which handles considerable power and is therefore very big. Only in push-pull circuits is the commutation easier,
- even high-speed SCRs have a switch-off time of about 10 μ s which is an order slower than transistors.

An improvement is hoped for from "gate turn-off SCRs" (GTOs) which can be cut off with a large negative current impulse, applied to the gate. So far these devices have made very little impact.



5. OTHER COMPONENTS

Besides the switching device, the transformer and the secondary rectifiers are also key elements of an s.m.p.s. This will be made clear in the next section.

5.1. Transformers, Storage and Filter

Chokes

Laminated soft-iron cores for transformers working at frequencies over 10 kHz cannot of course be used but ferrite is suitable. All component manufacturers have developed suitable materials for the power transducer which are characterized by a high magnetic saturation, a high Curie temperature and small losses which decrease with temperature. This enables safe working at temperatures of over 100°C.

Just as important is a core-form which may be wound without problems (also with thick wire), allow a good insulation between primary and secondary (for mains isolation) and has low leakage inductance. They have cores with a rounded centre piece such as RM, PM, ETD and EC core-forms. For low leakage storage and anti-r.f.i. chokes, ring-cores are employed which are wound only by hand or with special machines.

5.2. Electrolytic Capacitors

All charge and filter capacitors which carry current at the switching frequency should be special s.m.p.s. electrolytics possessing low series resistance at about 50 kHz. Normal filter capacitors become too hot and are unable to filter out the switching frequency.

Alternatively, several small capacitors may be paralleled in order to reduce the series resistance and to share the heat loss. In high voltage power supplies only paper/foil capacitors should

be employed for filtering. At low voltages paper/foil capacitors are connected in parallel with the electrolytics to reduce the shunt resistance at HF.

5.3. Diodes

All rectifier diodes, excepting the mains rectifier, should also be special switching types. Experiments with normal 50 Hz diodes such as the 1N4007, are not to be recommended. For middle and higher voltages at small currents, television line-frequency diodes such as BA 159, BYX 55, BY 299, BY 399, BY 201, BY 202 etc. are sufficiently fast.

For smaller voltage rectification Schottky-rectifiers are advantageous. They have a low barrier voltage of typically 0.55 V and a switching-time in the region of nano-seconds. Unfortunately they are available with a maximum voltage of only 50 V and the permitted crystal temperatures are lower than those of PN diodes. The latter disadvantage is balanced by the lower power loss in the diode. A few manufacturers (eg. Motorola) have recently made available ultra high-speed PN-rectifiers for use at high frequencies.

Now that the most important components of the s.m.p.s. have been considered, the next section is devoted to the basic circuits.

6. BASIC CIRCUITS

In the foregoing, consideration is limited to s.m.p.s.'s with mains isolation. Other types, such as those employed in TV's using choke "flyback" circuits without mains isolation, are ignored. The basic circuits may be divided into single-transistor and push-pull, where the former are used in low power s.m.p.s.'s and the latter in the high power range and for special circuits (eg. HV multiple cascades). Taking the single-transistor circuits first, the choke and the "forward" converter circuits.

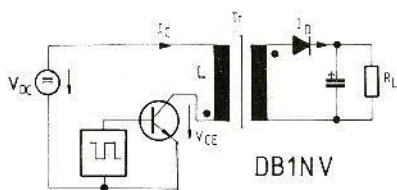

Fig. 5: The choke converter

6.1. The Single-Transistor Choke Converter

This circuit suitable for the power range lying under 100 W is built according to the arrangement of Fig. 5.

The most important component is the choke (transducer) Tr which besides its function as a transformer and mains isolator also serves as an energy store. In order that the necessarily low inductance value with a large ferrite core may be realised, the core has an air-gap of 0.5 to 1 mm. The A_L value is about 250 as opposed to the 3000 of the same sized core without the air-gap.

The manner of its functioning is apparent from Fig. 6. When the transistor is switched into conduction from the control circuit the collector cur-

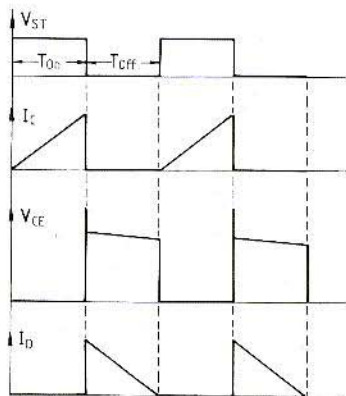

Fig. 6: Choke converter current and voltage waveforms

rent rises linearly through the primary inductance of the transformer. The rise-time is obtained from the equation

$$V_{DC} = L di/dT$$

and the collector peak current to

$$I_C = T_{ON} U_{DC}/L$$

At the switch-off point the energy stored in the primary choke is:

$$W = 1/2 \cdot L I^2 = 1/2 L T_{ON}^2 V_{DC}^2$$

At switch-off the collector voltage rises between two and five times the DC supply voltage depending upon the circuit. At the same time the rectifier diode conducts and passes the current to the load. Only when the whole of energy has been forwarded and the magnetic field is zero can the transistor be switched on again.

The choke converter is used for example in televisions, video-recorders and similar applications. Besides the relatively small circuit outlay the reason for its wide use is as follows: The energy stored in the choke depends upon the square of the transistor conduction time and a large regulation range of the converter is obtained for both mains and load variations. If the on-time is limited, and thereby the stored energy, the circuit can be rendered short-circuit and/or overload proof.

A few disadvantages of the choke converter are with loss power applications not so very serious:

- transistors capable of working at 800 – 1000 volts with collector current with peak values much higher than the RMS value are needed. Mostly TV line output transistors such as the BU 208 are employed in this type of circuit,
- The choke/energy store is slightly larger than in other types of converter,
- when unloaded the output voltage and thereby also the collector voltage rises well over the working voltage if the duty-cycle has not been

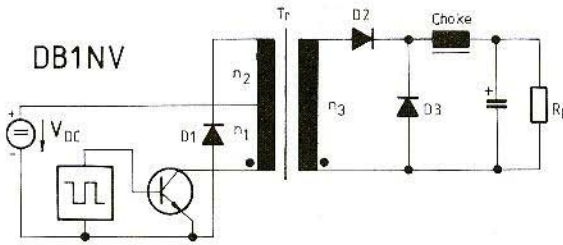

Fig. 7: The forward converter

reduced. In general a choke converter can therefore only be used without regulation under constant load conditions,

- lastly because of the pulsating output current, very large filter electrolytics (and maybe additional filtering) behind the rectifier are necessary.

For larger power outputs the "forward converter" is more suitable and is about to be described.

6.2. The Single-Transistor Forward Converter

The most important hallmarks of the single-transistor forward converter are, that the energy is passed through the secondary during the transistor 'on' period and that the transformer and the energy storage choke are separate components which can be optimised for each other. Fig. 7 shows a typical circuit diagram.

It can be seen that the component complexity is somewhat higher than that of the choke converter but that must be weighed against a few advantages. As the collector current is practically rectangular in form, the transistor is better utilised than that of a choke converter thus enabling it to handle more power for the same sized transistor. The rectifier with choke input ensures minimum ripple even with small output electrolytics. The electrolytic current loading is very small and expensive switching types are mostly not required. One disadvantage of the forward converter is that rectangular current consumption through the mains rectifier requires the fitting of anti-interference filters to the primary side.

But now to the components and the circuit description:

The most important component, the converter transformer is dimensioned as a normal transformer inasmuch that the magnetizing current represents only 5 to 10 % of the rated current – a very big difference to the choke converter!

The second wound component, the storage choke, is in principle not necessary but it reduces the output current ripple so much that it is generally employed.

The method of functioning is explained with the aid of Fig. 8:

When the transistor is conducting, a nearly rectangular current flows through the primary n_1 of the transformer. The secondary winding n_3 is polarized such that a corresponding current ($n_1/n_2 \cdot I_C$) flows through the diode D 2 and the choke to the output.

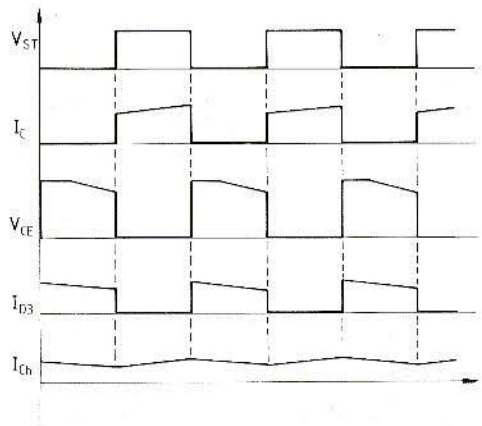

Fig. 8: Forward converter current and voltage waveforms

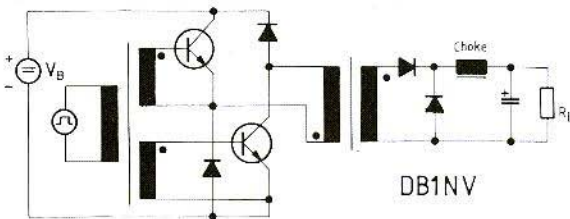

Fig. 9:
forward converter
with two transistors

After the transistor has been cut-off, the collector voltage rises to a very high value as contrary to the choke converter, the secondary diode is now blocked and the transformer is therefore unloaded. The back-energy can be dissipated in an RC network but only in low power converters (eg. a 12 V input requires a few watts). It is better that this energy is fed back into the voltage supply with the aid of a tertiary winding n_2 (same turns as n_1 normally, and tight coupled) and diode D 1 energy recovery diode. It is important that this demagnetisation process is completed before the transistor switches on again.

On the secondary side diode D 3 (choke diode) passes the current following the blocking of D 2 (steering diode). Energy is supplied from the storage choke field to the load which gradually falls to zero. The choke is so dimensioned that the full-load current has triangular form with an alternating component of some 20 % of the direct current.

Single-transistor forward converters are usable up to powers of several kilowatts and are always used to advantage when the output voltage has to be rectified again. For applications in which a

symmetrical alternating output voltage is required (eg. high-voltage generation with multiple stages) the push-pull converter is more suitable. This will be described in the next chapter.

In conclusion another single-transistor forward converter circuit is shown in Fig. 9 which uses two transistors in series. It requires only one primary winding and is particularly suitable for high input voltages (eg. rectified 400 V mains).

Both transistors are driven in-phase and are so connected that each transistor is, at the most, subjected to the full DC input voltage. The diodes are energy recovery diodes which serve also to limit the voltage across the transistors. Otherwise the function is exactly the same as that of the normal forward converter. With this concept, powers of 5 kW at 400 V input voltages can be realised.

6.3. The Push-Pull Forward Converter

The push-pull circuit is probably known to all radio amateurs as a component of mobile power supplies, therefore only a short description will suffice.

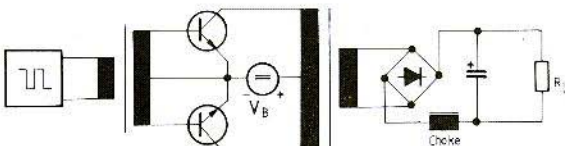

Fig. 10:
Conventional
push-pull circuit



As Fig. 10 shows, the circuit is similar to a transformer-coupled push-pull power amplifier which has been driven with a rectangular input voltage. This concept is used almost exclusively as an unregulated blocking oscillator in power supplies. The reason is, the saturation of the transformer core, which with unsymmetrical drive or different transistor switching times leads to high peak currents in the transformer and consequent destruction of the transistors.

This can be avoided by either over-dimensioning the transformer and by provision of an air-gap, or by a very complex balancing circuit which monitors the switch-on times of the transistors.

If FETs are used as the power transistors, an exact symmetrical drive and other measures are not necessary, as FET switch-on times are both short and quite precise.

No problems are apparent, as already mentioned, under astable working conditions. Here a small saturated driver-transformer is generally for the feedback, which automatically serves to balance the power stage.

A more suitable circuit will now be described known as the "half-bridge" which exhibits no symmetry problems.

6.3.1. The Half-Bridge

A widely used push-pull circuit is the "half-bridge" which is similar to an ironless push-pull

output stage as shown in Fig. 11. Both transistors are driven in anti-phase causing the left end of the primary winding n_1 of the output transformer to alternate between ground and V_B whilst the right end stays at $1/2 V_B$ by means of a capacitive divider. That is, a rectangular voltage of amplitude $1/2 V_B$ is placed across the primary n_1 . Since the capacitive divider admits no DC component into the primary, an unbalanced drive to the transistors will not cause transformer pre-magnetisation with its saturation problems.

A full wave bridge rectifier with choke input is mostly employed on the output of push-pull switching circuits owing to the smaller diode peak currents and also for the better utilisation of both diodes and transistors.

A common or two separate driver stages may be used to drive the power stage, both solutions are of equal merit when the correct design is employed.

An important point has now been reached, the drive and control stages.

7. DRIVE AND CONTROL STAGES

The driving circuits of an s.m.p.s. consists of at least four parts,

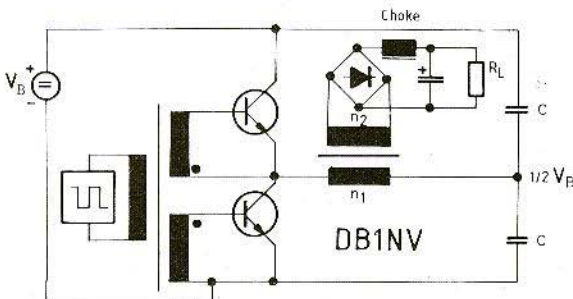

Fig. 11: The half-bridge



- an oscillator for the switching frequency
- a pulse-width modulator,
- a reference voltage source,
- a comparator to compare the output voltage with the nominal voltage.

Other desirable features include,

- a circuit which provides a steadily rising output voltage following the switch-on,
- current limiting, either primary (transistor current) or secondary (load current),
- comparators for the switching-off of the s.m.p.s. during under- and over-voltage conditions of the mains supply,
- PLL integrated circuits for the synchronous operation of several s.m.p.s.'s,
- over-temperature protection,
- remote on/off control.

Whilst these facilities have for years, been provided by operational amplifiers, logic circuits, and discrete semi-conductors, there are now a number of integrated-circuit control stages. Well known series are: the SG 1524 series, the TL 494 with variants TL 495 and TL 496, the TDA 4700 with its successors and the TEA 1001/UAA 4001. A special place is occupied by the TDA 4600 which is used in consumer-electronics for many control applications in astable choke-converters in the power range up to 150 W.

A detailed description of individual integrated-circuits would be out of place here as manufacturers data sheets can supply this information.

The driver stage represents the connecting link between the driver module and the power-switch. It has three tasks, to present the power-transistor with a well proportioned dose of current during the conduction time to ensure that it works in the quase-saturation region, to clear the base of charge carriers at the moment of switch-off, and finally, to bias the base a few volts negative during the following cut-off period. The driver-stage also, in some cases, acts as a potential buffer between control and power electronics.

At first glance, the power FET appears to require only a simple driver as it is a voltage controlled

device. It should be borne in mind however, that the gate-source capacitance is in the order of 1 nF and also that capacitance amplified by the Miller-effect between gate and drain is in parallel with it. This capacitance must be charged/discharged in a few hundred nano-seconds which requires a peak gate current of about an Ampere. The driver for a power-FET is then tailored for high impulse fidelity at high peak currents. In addition, an even larger voltage capacity is necessary than for a bipolar transistor. The only simplification is that there is no requirement for the anti-saturation network.

There are normally three driver-stage circuits variants, direct coupling is used between the driver and the power transistor usually provided by a complementary push-pull circuit shown in Fig. 12. A simple anti-saturation circuit can also be seen.

Should the collector voltage of the power transistor fall under a certain value, the control current of the driver is diverted through diode D_{AS} partly into the collector thus preventing saturation. This circuit also ensures the shortest switching-times and allows the direct supervision of the transistor in respect of saturation and over-current but it does require two auxiliary voltages of 5 to 10 V.

If a potential buffer between control circuits and power stage is necessary it is better employed

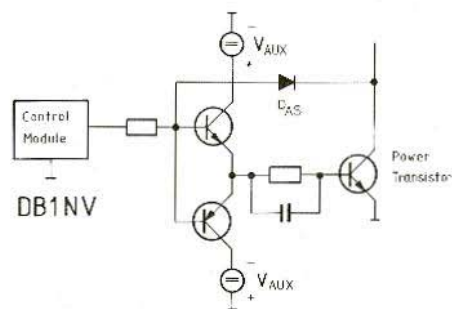

Fig. 12: Direct-coupled driver with anti-saturation network

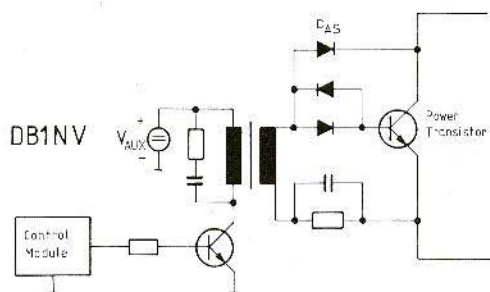

Fig. 13:
DC isolated driver stage
with anti-saturation diodes

between control module and driver (eg. with an opto-coupler). The auxiliary voltages V_{AUX} must then be separately produced for each power transistor and voltage-isolated.

The characteristic of the two other variants, the transformer coupled single-ended driver (Fig. 13) is that the energy for the every transistor drive-phase is stored in the driver transformer. Hence the forward converter driver (the required energy to switch through the power stage is passed directly and the switch-off energy being stored in the transformer) and the choke converter. Both versions are differentiated only by the polarisation of the secondary of the driver transformer (Fig. 13).

Disadvantages are the long switching times and the imprecise control of the power transistors. For the current monitoring and power transistor protection, yet more transducers may be necessary. The transducer coupling ensures a good match between the existing driver supply voltage and the control requirements of the power stage. It can for example, be realised directly from the rectified mains supplied high voltage driver, with a step-down transformer. Furthermore, the voltage isolator can be embodied in the transducer if the poor coupling and higher leakage inductance resulting from the required degree of isolation can be tolerated.

Summarizing, it is possible to say, that in use the directly-coupled driver utilizes the power transistors current and voltage capabilities to the full. The control circuits are arranged then more simply in the primary, the output voltage sample

being taken via an opto-coupler from the isolated secondary to the regulator. Current limiting may be directly sampled from the transistor's current.

If the power transistors are only subjected to the collector-emitter voltage V_{CE0} , the base-drive is not so critical for safe operating control and a single-ended driver with transformer coupling may be used without any problems. The regulation circuits can then be located in the secondary side of the transformer isolated from the mains. This concept on the one hand, allows a direct voltage and current sample from the output terminals but, on the other hand it requires an independent power supply for start-up which takes care of the control and the driver circuits.

The choice of concept depends upon the power to be handled. With large power supplies the extra complexity of several mains isolation windings and an auxiliary power supply does not add greatly to the total cost. The regulating circuit should be arranged to be in the secondary. It would also be advantageous to arrange monitor points for servicing the regulation circuit to obviate the need for earth-free oscilloscopes and isolation transformers.

The control-circuit is arranged on the primary at mains potential where the power transistor can be directly controlled. To start-up, the rectified mains is taken initially via a resistor to the control circuit, the control circuit supply is then switched to a voltage derived from an auxiliary winding of the power transformer. Naturally this only applies to fixed-voltage power supplies where the output



voltage and the driver supply voltage have a fixed relationship and the latter may not be adjustable.

The look-around in a switched-mode-power-supply has now come to an end and an important item for the radio amateur reviewed – the radio-frequency and electro-magnetic interference (r.f.i. and e.m.i.) suppression.

8. SUPPRESSION MEASURES

An s.m.p.s. can influence other electronic equipment in several ways,

- through feedback of the switching frequency and its harmonics into the mains,
- through the residual ripple of the output voltage,
- through the stray electric field from wound components.

The latter two points may be dealt with by constructional measures such as avoiding open magnetic circuits like those present in ferrite rod inductors, also conducting loops with a high proportion of alternating current should be made as small as possible.

Preference should be given to power transistors which can be bolted directly to ground, not isolated thus acting as antennas radiating the switching frequency. Direct radiation may be neglected by using a metal enclosure with well bonded sides in which to house the s.m.p.s.

It is more difficult to prevent the switching frequency from being fed back into the mains. In all cases it is recommended that a good mains filter with a high attenuation above 10 kHz is employed. Foil capacitors of 0.1 to 1 μF may in addition, be connected across the primary-side reservoir electrolytic. With larger powers an input rectifier circuit with an air-gapped choke is used in order that the peak current through the rectifier and reservoir capacitor is reduced without dissipating power in a current limiting resistor. It is here that it is possible with the minimum of circuit

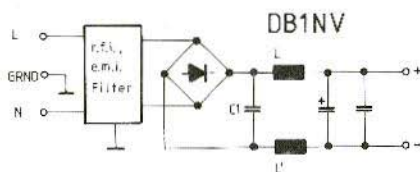

Fig. 14: A possibility for mains suppression

alteration, to effect a large decrease in the level of mains interference. The chokes are split into two parts, as in Fig. 14, and a paper/foil capacitor is shunted across the rectifier serving as an HF short-circuit. Under some circumstances only two Y capacitors are then required at the mains input for suppression purposes.

Another important point here – use only suppression capacitors which have been constructed for this requirement and are in good condition together with the appropriate country's test-mark (eg. VDE, SEV, UL). Furthermore the maximum leakage current between phase and ground/chassis should not exceed a limit of 1 mA. In cases of doubt the appropriate regulations should be consulted.

The residual ripple on the output voltage should, in the interests of interference free operation of the supplied equipment, be as small as possible. It is good practice to include behind the secondary smoothing capacitor an LC filter consisting of a ferrite ring core with a few windings and a parallel combination of electrolytic and foil capacitors. The important thing is, that the load current does not drive this inductor into saturation!

The secondary ripple is also highly dependent upon the switching concept. A choke converter which charges its output capacitor with short current surges has a higher ripple than say a forward or a push-pull converter with storage chokes.

High frequency spectral components can also originate from the secondary side rectifiers if the parallel damping, mostly an RC network, has not been correctly dimensioned. In all cases recti-



fiers with the "soft recovery" characteristic are easier to suppress and should be given preference.

With these measures it is possible to suppress an s.m.p.s. such that it can work directly in the vicinity of an amateur installation. Further measures require a large outlay in test-equipment in order that their efficacy may be determined.

Following this article, the attentive reader should be in a position to classify switched-mode-power-supplies and to judge their data and characteristics. Later articles will deal with practical modern s.m.p.s.' for construction. This will occur in an easy sequence, so far an 80 W computer power supply and two 12 V supplies with 8 and 20 Ampere capacity are being planned and in test-trials respectively.

9. FURTHER LITERATURE

- Motorola:
Linear/Switchmode Voltage Regulator Handbook
- Siemens:
Schriftenreihe Schaltnetzteil I-V (Grundlagen)
- Siemens:
Applikationen für TDA 4600, TDA 4700 und TDA 4718
- Thomson-CSF:
Handbuch Schalltransistoren
- Thomson-CSF:
Handbuch II Transistoren in der Leistungselektronik
- Thomson-CSF:
Applikationen für TEA 1001SP und UAA 4001 DP

Which Volumes of VHF COMMUNICATIONS are missing from your library?

As you know, the publishers continue to reprint back copies of VHF COMMUNICATIONS. Since they are full technical articles and little news or advertising, they contain a great deal of non-again information that is just as valid today. Many of our readers will also have lent out copies of VHF COMMUNICATIONS and never received them back. All editions available can be obtained from your representative or from the publishers.

Subscription to VHF COMMUNICATIONS 1985	DM 24.00
VHF COMMUNICATIONS – Volume 1983/1984	each DM 22.00
VHF COMMUNICATIONS – Volume 1981/1982	each DM 20.00
VHF COMMUNICATIONS – Volume 1979/1980	each DM 18.00
VHF COMMUNICATIONS – Volume 1976, 1977, and 1978	each DM 16.00
VHF COMMUNICATIONS – Volume 1975	DM 14.00
VHF COMMUNICATIONS – Individual copies 1982	each DM 6.00
VHF COMMUNICATIONS – Individual copies 1981	each DM 5.50
VHF COMMUNICATIONS – Individual copies 1979/1980	each DM 4.50
VHF COMMUNICATIONS – Individual copies 1975, 1976, 1977, 1978	DM 4.00
Individual copies out of order, incomplete volumes, as long as stock lasts:	
1/1970, 2/1970, 2/1971, 1/1972, 2/1972, 4/1972	each DM 3.00
2/1973, 4/1973, 1/1974, 2/1974, 3/1974	each DM 3.00
VHF COMMUNICATIONS – Discount price for any 3 volumes including 1 binder:	
VHF COMMUNICATIONS – Volumes 1975 – 1977	DM 47.00
VHF COMMUNICATIONS – Volumes 1976 – 1978	DM 48.00
VHF COMMUNICATIONS – Volumes 1977 – 1979	DM 50.00
VHF COMMUNICATIONS – Volumes 1978 – 1980	DM 52.00
VHF COMMUNICATIONS – Volumes 1979 – 1981	DM 56.00
VHF COMMUNICATIONS – Volumes 1980 – 1982	DM 59.00
VHF COMMUNICATIONS – Volumes 1981 – 1983	DM 62.00
VHF COMMUNICATIONS – Volumes 1982 – 1984	DM 68.00
VHF COMMUNICATIONS – Volumes 1983 – 1985	DM 72.00
Plastic binder for 3 volumes	DM 8.00





Jochen Jirmann, DB 1 NV

A 12 Volt Mobile, Switched Mode Power Supply (S.M.P.S.)

Part 2

Modern mobile transceivers are in no way inferior to those of fixed station design but they are much more compact. For this reason, many radio amateurs tend to use them temporarily or exclusively for fixed station use. The usual problem when using them for fixed station use is the 12 V power supply which for a 10 W UHF transceiver requires a current of 3 A and for a 100 W HF transceiver requires a current of 20 A. A floating car battery or a conventional series regulator power supply with its unavoidable heat loss and weight, are not the ideal solutions to the problem.

An ideal mobile transceiver power supply for fixed station use should fulfil the following requirements:

- Output voltage 13 to 14 V. The stabilisation between these limits is of little importance as mobile transceivers are (or should be) designed with this in mind.
- A steady load current of 10 A indefinitely, intermittent 20 A.
- Current limiting, preferably with foldback characteristics.
- Output over-voltage protection at about 15 to 16 V.

- Convection cooling (i.e. no noisy forced-air requirements)
- Low switch-on surge (no blown house fuses)
- High conversion efficiency and low quiescent current.
- Unaffected by HF fields and causes no radio hash (r.f.i.)
- As small and light as possible.

There are two circuit principles with which the above requirements may be met: Either a conventional power supply but with SCR's and filtering, or with a switched-mode power supply. The weight advantage of the switched-mode power supply decisively over-rides its disadvantage of high filtering requirements over the SCR type.

1. CONCEPT AND BLOCK DIAGRAM

From the maximum output requirements of 14 V at 20 A, a power of almost 300 W is obtained. A single transistor forward converter circuit with output storage choke recommends itself in this circuit. A fly-back converter would be possible but the transducer would be much too large (at least

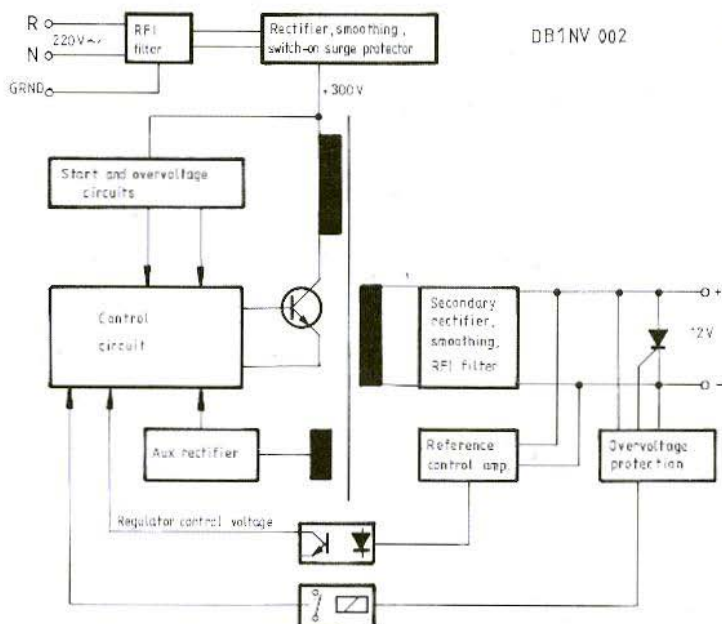

DB1NV 002

Fig. 1:
The 300 W switched mode power supply with single transistor switch and storage choke

EE-55 core) whilst the push-pull forward converter would involve too much complication.

Further, a fixed-voltage power supply for the control circuit can be taken directly from an auxiliary winding on the power transformer. If the control circuit is arranged to be on the primary side, its power may be supplied initially with the rectified mains and then switched over to the auxiliary transformer winding. By this means, a separate 50 Hz power supply for the control circuit is rendered unnecessary. There are two circuits isolated from the mains, namely the power transformer and an opto-coupler which passes the error-voltage from the 12 V output. For the protection circuit, to be described later, a further isolated circuit using a reed relay is necessary.

A block diagram may be evolved from this conception, as in Fig. 1, where a bi-polar transistor is shown as the switch. It will be seen later that a power MOSFET may also be used.

2. CIRCUIT DETAILS

With the aid of the block-diagram of Fig. 1 and the detailed circuit schematic Fig. 2, the somewhat involved – because as yet – unknown manner of operation will be explained. The mains supply is fed via two fuses and the thermistor surge limiter to the fullwave bridge rectifier. Two Y₂ capacitors carry out a rough filtering and a SIOV-Varistor 'caps' the dangerous peaks from the mains supply voltage. The electrolytics of together 440 μ F are fed with the rectified mains voltage via choke L 1. The choke increases the current flow angle in the rectifier and reduces thereby the peak current taken from the mains (to the pleasure of the electric power plant) and together with C₄ prevents a voltage at the switching frequency from being fed back into the mains.

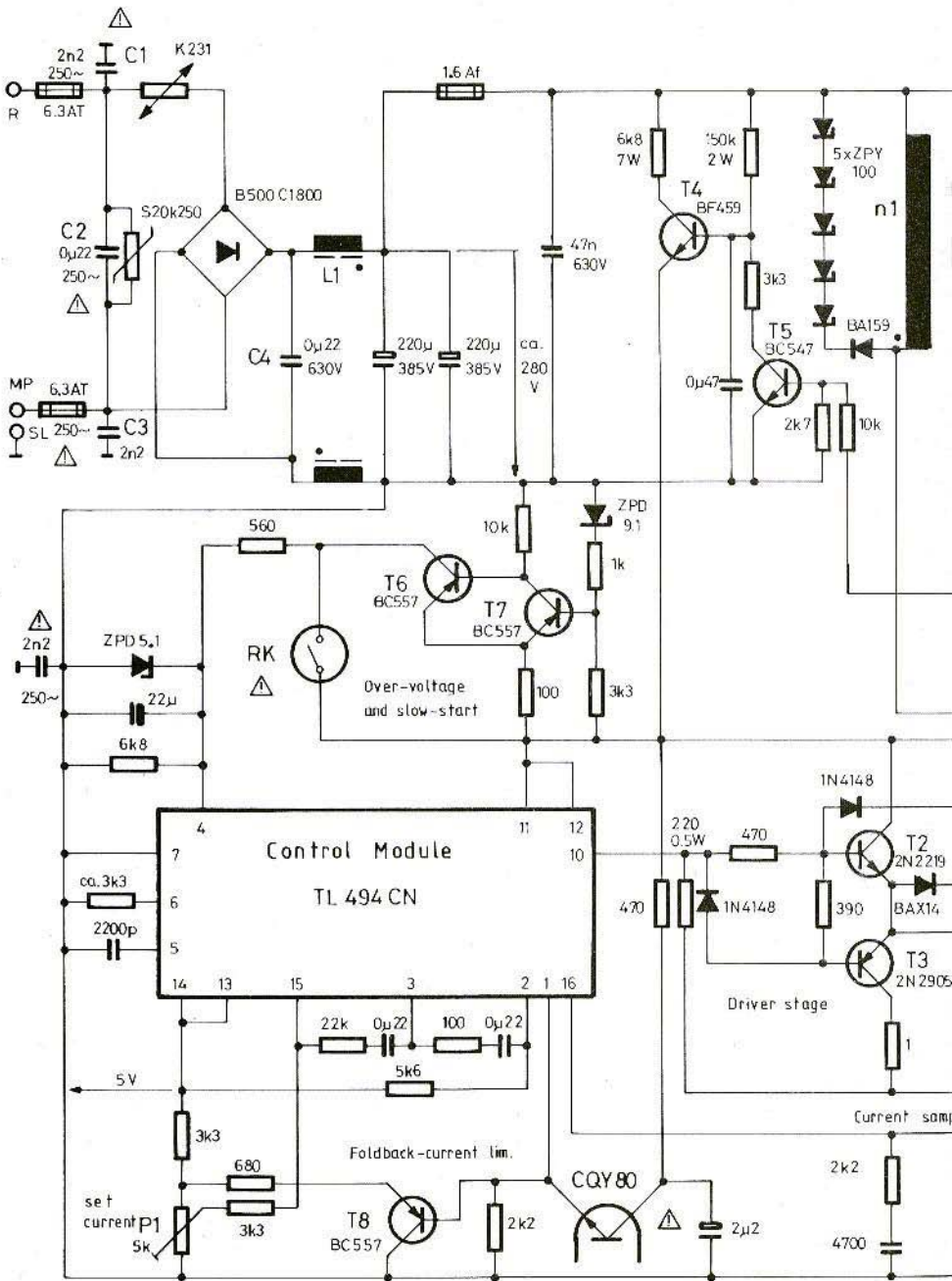

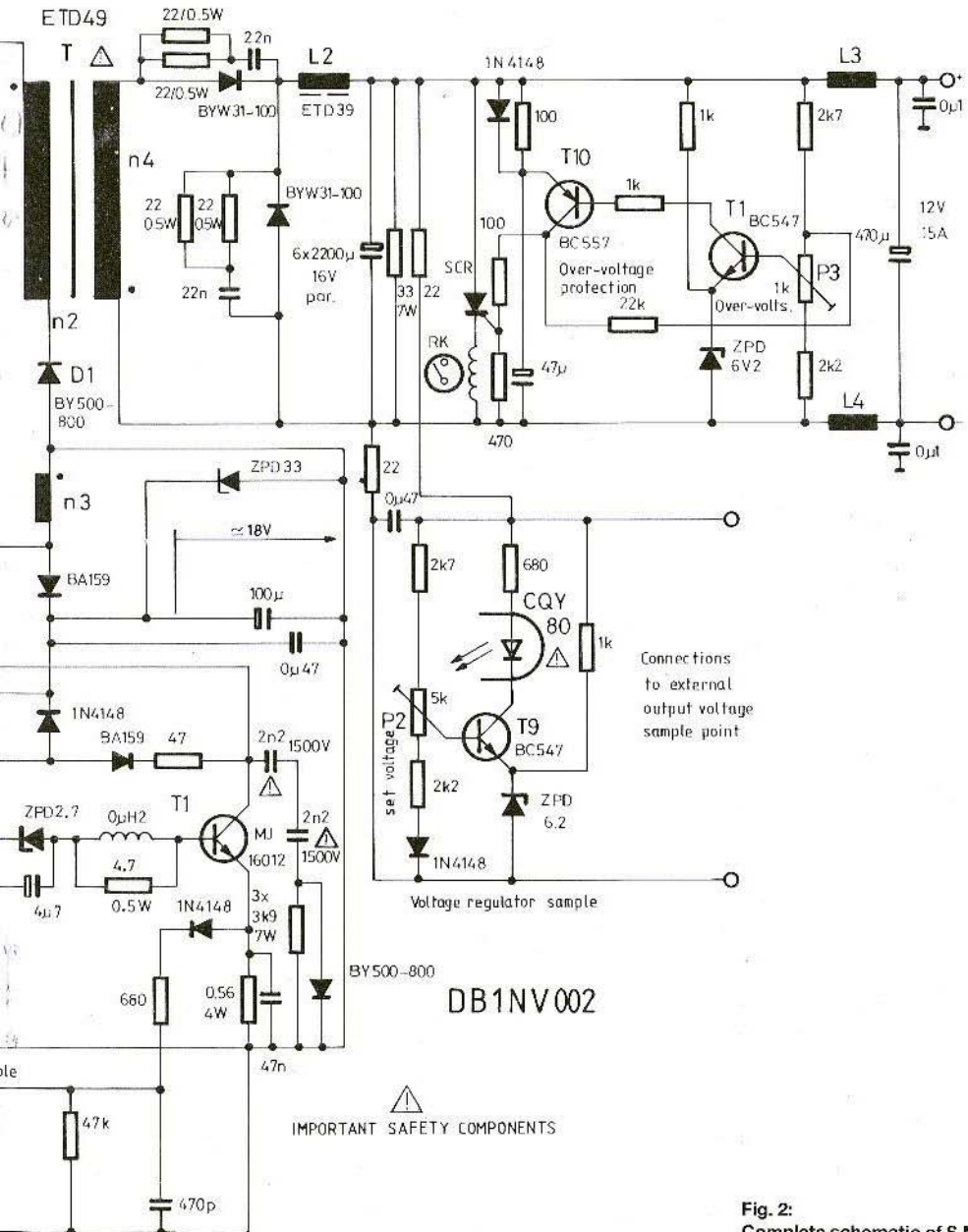

Fig. 2:
Complete schematic of S.M.P.S.
DB1NV002

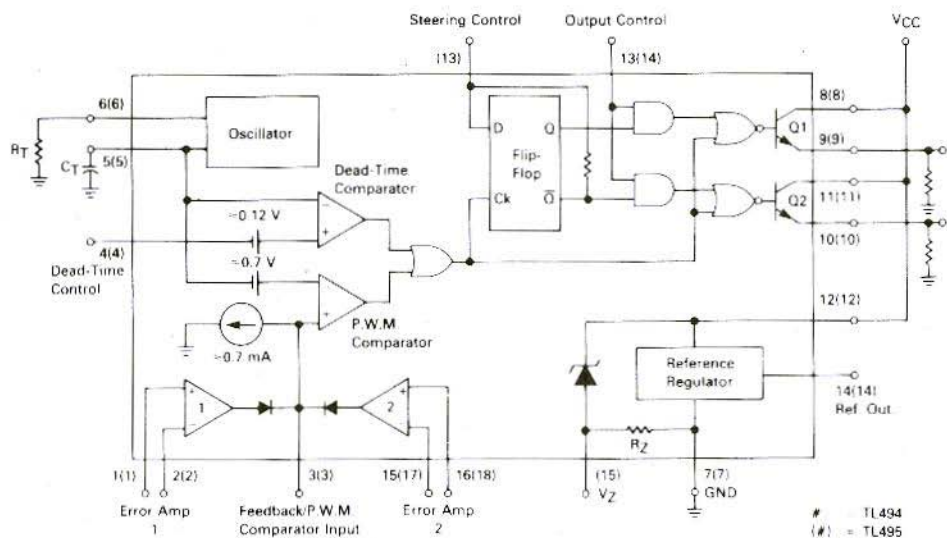

Fig. 3: The integrated S.M.P.S.-control circuit TL 494

The 280 VDC supplies a conventional single-transistor forward-switching converter. It consists of the power transistor T 1, the transformer T, the energy recovery diode D 1 and the RCD slow-rise network on the collector of T 1, working at a switching frequency of 50 kHz.

A self-regulating driver stage comprising T 2 and T 3 together with associated components controls the power transistor T 1, driving it into quasi-saturation. The energy required for the switch-off is stored in the base electrolytic capacitor 4.7 μ F, no negative bias being necessary to cut off the transistor.

The supply voltage, about 18 V, for the driver stage and the control circuit IC TL 494 is derived from the winding N 3 of the power transformer. For starting, the circuit assembly comprising T 4

and T 5 switches the rectified mains voltage via a heavy-load resistor onto the 18 V line. The TL 494 is switched off for the time-being and its current consumption therefore very low (approx. 10 mA). When a voltage of about 12 V is reached, the Schmitt-trigger comprising T 6, T 7 gives an impulse for the slow start to pin 4 of the TL 494 and the power transistor is controlled with a steadily increasing duty cycle. The winding N 3 then takes over the supply of the control circuit and the start-up circuit is switched off.

Upon switch-off the action is opposite: When the power transistor voltage falls to 10 V, it will be switched off via pin 4 of the TL 494.

For short circuit protection, a small resistor is included in the emitter of the power transistor. The voltage across it is rectified and passed via a two time-constant RC network to the TL 494.



All the important parts of the control circuit are embodied in the integrated circuit TL 494. As Fig. 3 shows, the IC contains a 5 V reference diode, an oscillator, the frequency of which is determined by the resistor at pin 6 and the capacitor at pin 5, a pulse-width modulator, a bistable (flip-flop), and two driver stages.

The pulse-width modulator may be influenced in three ways: A bias at pin 4 will reduce the duty-cycle from maximum. No voltage at pin 4 results in maximum duty-cycle (5 % off-time) and 5 V at pin 4 will suppress the output pulse completely. This facility is used for the slow start-up, the full running and the shut-down of the power transistor. In addition, each of the two operational-amplifiers can reduce the pulse width to the required extent. One is used for voltage regulation and the other for current limiting. The common output of the operational amplifiers (pin 3) connected to RC-links is used to stabilize the regulation circuit during start-up. There is also a possibility available to flip-over the bistable, thereby obtaining a duty-cycle greater than 50 %. This function is not used here since a duty-cycle of 50 % could lead to the magnetization of the power transformer.

It may be seen that the sample voltage for the current overload is fed directly to the operational amplifier whilst the error voltage of the voltage regulator is fed via an opto-coupler from the mains-isolated, secondary side.

In addition, a portion of the error voltage is tapped-off and taken via an emitter follower T 8 to the reference input of the current amplifier. By this means, a fold-back current limiting characteristic is obtained which results in an output short-circuit current flow of only 7 A, thus limiting the power dissipation of the output diodes.

The secondary winding feeds a half-wave rectifier with a storage choke and fly-wheel diode. The storage capacitance consists of six parallel 2200 μF electrolytic capacitors. This circuit delivers an output containing a very small ripple.

A 33 Ω wire-wound resistor imposes a minimum load in order that there is no instability such as the induction of control pulses back into the tertiary winding N 3 under no-load conditions.

A portion of the output voltage is compared with a 6.2 V zener diode and the transistor T 9 influences, via the opto-coupler CQY 80, the duty-cycle in the requisite manner.

Transistors T 10 and 11 are a Schmitt-trigger and with the S.C.R. form an over-voltage protection. When the output voltage rises above that set by P 3, the S.C.R. short-circuits the output. In order that the S.C.R. may be reset and also to reduce its dissipation (it is uncooled), a coil with 5 turns and a reed-contact within is connected in series with the S.C.R. cathode. The peak short-circuit current of the storage capacitor closes the reed contact which leads to a shut-down of the power supply followed by the slow start-up. The SCR is thus reset. The over-voltage protection is effective for both internal faults and for externally applied over-voltages to the output.

After an output voltage possessing minimal ripple has been achieved, only simple means are required to minimize the radio hash (rfi): Two ferrite tubes (25 x 5 mm), each with 5 windings of enamelled copper wire 2.5 mm dia., form, together with a 470 μF electrolytic and two 0.1 μF capacitors, an rfi filter.

The rfi-measures at the mains side, however, require an external filter for completion. Particularly practical is the mains filter which is encapsulated together with a mains switch and socket.

The following chapters will appear in edition 3/1985:

3. Power Supply Construction
4. Commissioning
5. Installation and Operation
6. Alternative Employment of Power-FET
7. Measured Values and Users' Experience



Erich Stadler, DG 7 GK

L- and C-Measurements with Calibrated Transmission Lines

Two pole measurements by means of a reflectometer or a directional coupler may allow the VSWR/reflection coefficient to be determined with reference to a specific characteristic impedance but no information is given by which the reactive component of the item-under-test (IUT) may be determined. The special properties of a high frequency test transmission line should not be neglected, by means of which, the reactive component of a two-pole network may be determined.

This is carried out by measurement of the standing waves using the familiar "node displacement method". This article will deal with the construction of a simple decimetre band calibrated transmission line. Simple formulae will be given with which L and C may be calculated from the node displacement providing that the test-item possesses no appreciable real component. There follows finally, a few observations about the particularities of the waveguide slotted-line as a measurement device.

1. CONSTRUCTION OF A TEST TRANSMISSION LINE

Fig. 1 shows a demonstration test transmission line using a stripline, which has been used for

years in a school, for the measurement of standing-waves, matching etc. in the UHF and the decimetre band. The 2 mm (approx.) narrow strip running down the centre forms the "hot" conductor whilst the underside of the board is the ground plane.

The two broad strips to the left and right of the actual conductor run, are also both at ground potential. They are not actually, absolutely necessary. They were useful for school work in order that the probe's tip and ground connections (not shown in Fig.) could conveniently contact both conductors of the stripline simultaneously. The photograph shows a double-sided printed circuit board upon the top surface of which a strip-conductor has been formed by etching.

The material employed is glass fibre epoxy. The length of the board is about 1 m, and the width about 80 mm. The relatively long length was required in order to work with signal generators in the 100 MHz range. The velocity factor of the conductor is close to 0.6. It is important that the velocity factor is not arrived at by calculations based upon the dielectric constant of the PCB material as the actual dielectric constant is smaller. This is, because a portion of the electric field passes through air, since the strip is only screened on one side.

Such a test-line for the two-metre band requires a length of 60 cm and for the 70 cm band only 20 to 30 cm. It is sufficient to confine the length to

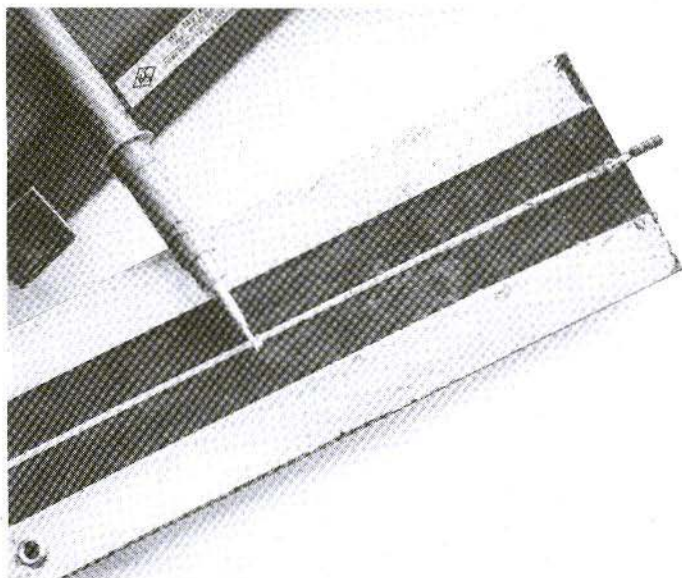

Fig. 1a:
Home-made
test transmission
line

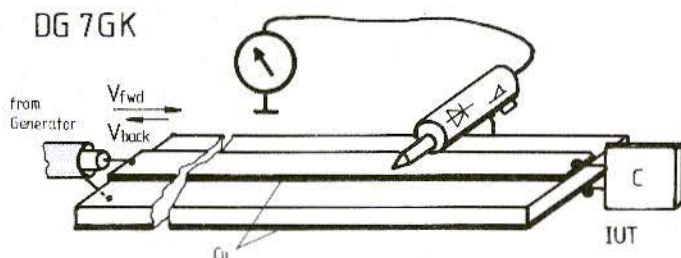

Fig. 1b:
Strip-line as a
test transmission line

just sufficient to allow an electrical half-wave-length as this makes the problems of etching much smaller. The test-line in the sketch has the test-item connected to soldering tags located on the strip and directly beneath on the ground plane (not visible in photo).

On the other end of the test-line a short length of RG 58 cable $Z_0 = 50 \Omega$ (Fig. 1b) has been soldered in order to provide a flexible connection to the signal generator. The width of the centre strip is calculated for a characteristic impedance

of 50Ω . The PCB's dielectric constant and its thickness are very important quantities to determine the characteristic impedance. If the etching process is too long the etchant will creep under the resist thus reducing the strip width and raising the characteristic impedance. Uneven etching will lead to a varying width over the test-line's length which of course, must be avoided as the object is, to achieve a uniform characteristic impedance. It is therefore recommended that the impedance of the test-line be measured.

2. MEASURING THE CHARACTERISTIC IMPEDANCE

This may be accomplished as follows: The test-line is terminated in $R = Z_0$ using short, direct leads. The termination must be non-inductive – do not use wire-wound resistors! Composition resistors are also unsuitable because their resistance is noticeable higher with increasing current. A metal-film resistor is the most suitable.

Connect the signal-generator and contact the strip with the diode-probe tip. If the termination resistor and the characteristic impedance are equal then there will be no standing waves on the line. If the impedance of the line is too great, there will be a voltage minimum across the termination and a small voltage maximum along the length. The characteristic impedance Z_0 of the line is calculated from:

$$Z_0 = VSWR \times R$$

If on the other hand the line impedance is too small (because for example the strip is too broad) then a voltage maximum would be present across the termination and a voltage minimum along the length of the line. The VSWR obtained from the voltage ratio serves again to calculate Z_0 but this time as follows:

$$Z_0 = R/VSWR!$$

The probe must be of high resistance relative to the characteristic impedance. If the resulting Z_0

differs from the desired value, a new etching attempt must be made.

3. STRIP-CONDUCTOR AS AN ALTERNATIVE

The etching of the strip may be avoided by sawing off a strip of double-sided PCB and placing it on a metal base-plate (e.g. soldering). The strip conductor is simply sawn from the PCB and by placing it on a metal base-plate, it makes a kind of one-sided screened strip-conductor the cross-section of which is shown in Fig. 2b. The approximate requisite width calculation is carried out from the strip conductor's physical properties.

The problem of fabrication nevertheless, lies in the clean sawing from the hard glass-fibre material. Such an arrangement however, is not as favourable from the point of view of side-radiation as may be surmised from the cross-sectional sketch in Fig. 2a. The placing on the base-plate is required in order that the line may be asymmetrically driven. The strip-line itself is of course symmetrical.

4. MEASUREMENT OF L

According to the frequency of measurement meaningful measurements of a coil's inductance

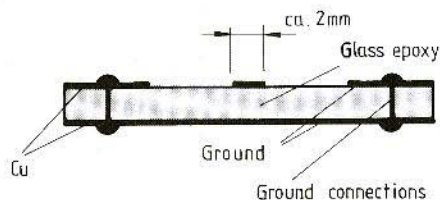

Fig. 2a: Cross-section of a test-line constructed in accordance with Fig. 1

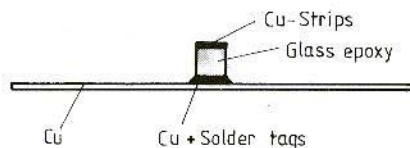

Fig. 2b: Cross-section of a proposed method of test-line construction



from ten to a hundred nano-Henry can be carried out. Firstly, a suitable measurement reference plane (a voltage node) along the line must be found. This is done by shorting the test-line end with a short soldered connection between top and bottom conductors. The signal-generator is adjusted to the frequency of measurement 145 MHz or 433 MHz according to the application band of the test-item.

The consequence of total reflection is the generation of standing waves. With the probe, the positions of the nodes (minimum) and the anti-nodes (maximum) along the line are found. The maxima are equal to the undiminished output of the signal generator and the minima zero volts owing to the total reflection. If the nodes are not zero volts at least the two following major causes must be eliminated.

1. The output resistance of the signal generator is not compatible with the Z_0 of the test-line: If this is the case, an attenuator is required between generator and test-line to define Z_0 .
2. The generator could have a high harmonic output? Harmonics are also totally reflected and

could produce maxima just at the points where fundamental nodes are expected. A 20 dB harmonic to fundamental difference could indicate an apparent VSWR of 10 whereas it is actually infinite.

From the distance between neighbouring nodes the halfwavelength is measured and thereby λ_D determined.

Following these preparations, a suitable node is selected for the reference plane from which the distance x i.e. the displacement Δx may be determined. The short-circuit is then removed and replaced by the test-inductance (Fig. 3a). This reactive element causes another phase displacement in the reflected wave which consequently causes the node to move in a certain distance in the direction of the test inductance. The greater the inductance the greater Δx will be! Δx can only however, at the most, equal a quarter wavelength i.e. $\lambda_D/4$. This would be the case when the test inductance tends to limit. (The test-line would be practically open circuit with a voltage anti-node at its end).

With the aid of the measured Δx the inductance

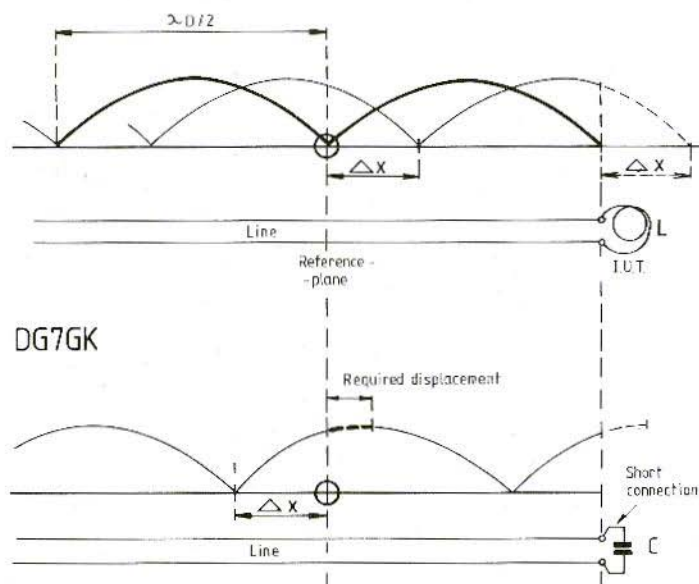

Fig. 3:
Node displacement
a) with L
b) with C
The reference-plane in both cases:
A voltage node under short-circuit condition

can now be measured according to the following formula:

$$L = \frac{Z}{2\pi f} \cdot \tan(360^\circ \cdot \Delta x / \lambda_D)$$

where Z_0 is the test-line characteristic impedance (e.g. 50 Ω), f is the frequency of measurement and λ_D is the wavelength of the test-line. (Suffix "D" for dielectric because it is a prerequisite that the test-line has a dielectric which is not unity. Commercial "test-lines" in general, have an air dielectric, $\epsilon_r = 1$).

Example:

At $f = 145$ MHz a "coil" with a winding of 100 mm was connected as the test-item. Δx was measured as 20 cm. With an initial node separation measurement of 60 cm i.e. $\lambda_D = 2 \times 60 \text{ cm} = 120 \text{ cm}$, what is the test item's inductance? ($Z_0 = 50 \Omega$).

Solution:

$$L = \frac{50 \Omega}{2\pi \cdot 145 \cdot 10^6 \text{ Hz}} \cdot \tan(360^\circ \cdot \frac{20 \text{ cm}}{120 \text{ cm}}) \\ \approx 95 \text{ nH}$$

5. MEASUREMENT OF C

The initial measurements (wavelength, reference plane) are carried out as for the case of the L measurement. For the C-measurement, it is possible to choose the position of the reference plane node under short-circuit conditions. On the formula for the calculation of C however, the difference ($\lambda_D/4 - \Delta x$) is the pertinent displacement. The Δx is taken as in Fig. 3b and C is calculated as follows:

$$C = \frac{1}{2\pi f \cdot Z} \cdot \tan[360^\circ (\lambda_D/4 - \Delta x) / \lambda_D]$$

Meaningful measurements of test-items occur with C between a few pF and about 100 pF. Extreme cases are $C \rightarrow 0$ and $C \rightarrow \infty$. When $C \rightarrow \infty$,

this means the same as if the test-line was short-circuited with the capacitance. Δx tends to zero and the standing wave pattern remains the same as the initial short-circuit condition. When $C \rightarrow 0$, the strip-line is working in a practically unloaded condition with a standing wave pattern possessing a voltage anti-node at its end.

The Advantage of Measuring at Nodal Points:

The voltage measurements can of course, be carried out at voltage anti-nodes (the reference plane would be accordingly different). The choice of the voltage node has the advantage that the measurement may be carried out much more accurately:

1. The voltage node is much sharper than the "broad" transition of the voltage anti-node as the half sine-wave pattern of the standing wave (at total reflection) indicates.
2. The loading which can occur – with probes having not high enough resistance – have negligible effect at the voltage nodes at total reflection!

6. THE WAVEGUIDE SLOTTED-LINE

The data given for the test-line may also be used for the wave-guide slotted-line (Fig. 4) by substituting the wavelength of the slotted-line λ_D for λ_H . As this also does not accord with the wavelength of free space, it must be measured beforehand along the whole length of the slotted-line. The distance between two nodes represents a half wavelength as before.

With the slotted-line it is even more important than by the strip-line, to use the standing wave pattern as a reference under short-circuit conditions. A short-circuit can easily be realised with the slotted-line (with a careful contact at the flange), but an open-circuit does not occur easily. An open flange does not represent an open-cir-

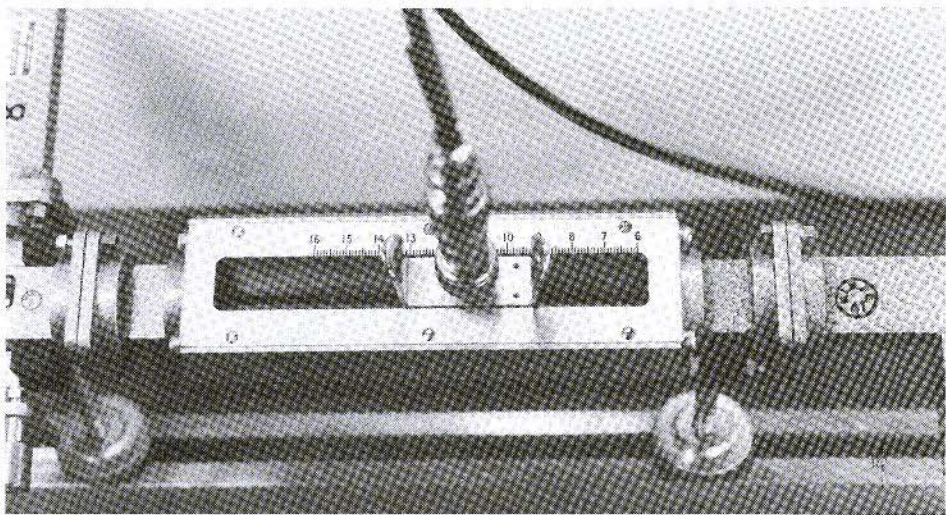

Fig. 4: Wave-guide slotted-line

cuit since it radiates energy and thereby forms a resistance. The flange acts as an antenna with a real resistance, this being the radiation resistance!

Furthermore, it should be pointed out, that pure L and C in the waveguide techniques, only occur under special conditions e.g. at the end of a short-circuited wave-guide of a determined length. The wave-guide appears mostly as a four-pole network and the quantities to be measured contain real and reactive components. Under these conditions simple formulae do not apply and the standing-wave patterns are more suitably diagnosed with the complex reflection coefficient or a Smith-chart. This cannot be the subject of this treatise however.

Finally it should be mentioned, that the given formulae for pure L or C cannot be used with the wave-guides because the Z_0 occurring in them cannot be adequately expressed. The field distribution in the wave-guide has the consequence that the characteristic impedance over the wave-guide cross-section is not simple to define. If then, the inductive or capacitive effect of a wave-guide bipole is to be described, it is expedient to express this in the form of a normalised inductive or capacitive reactance (or conductance).

Normalised inductive reactance:

$$X'_L = \frac{X_L}{Z} = \tan \left(360^\circ \cdot \frac{\Delta x}{\lambda_H} \right).$$

Normalised capacitive reactance:

$$X'_C = \frac{X_C}{Z} = \cot \left[360^\circ \cdot \left(\frac{\lambda_H}{4} - \Delta x \right) / \lambda_H \right].$$

7. LITERATURE

- Karl Rothammel:
Antennenbuch, Telekosmos-Verlag
Herter/Röcker/Lörcher:
Nachrichtentechnik, Hanser-Verlag
E. Stadler:
Hochfrequenztechnik
Vogel-Verlag (Würzburg)
Stadler/Hartmannsgruber:
Grundgebiete in der Meßtechnik der Informati-
onselektronik,
Senn-Verlag, Tettnang (in Vorbereitung)



Erich Stadler, DG 7 GK

Impedance Measurements with Calibrated Transmission Lines

Impedances are measured in commercial measurement technology with network analyzers, vector voltmeters, impedance bridges or sometimes by means of impulse reflectometry. The amateur is assisted often by the grid-dip meter or resonance methods. The excellent characteristics of the transmission line as a measurement aid however, should not be allowed to slip into obscurity. It is suitable not only in the 2 m and 70 cm bands but also in the GHz range where the dip-meter is no longer usable.

Inductance and capacitance measurements by means of calibrated transmission lines (test-lines) have already been discussed in the same edition. As this method resolves the impedance into its real and reactive components it is a little more involved. The determination of impedance from the reflection-coefficient by means of a Smith-chart is relatively easy if the indirect method of a calculator programme is to be avoided.

1. TEST-LINE CONSTRUCTION

For the 2 m and 70 cm bands a stripline grounded on one side with a characteristic impedance of say 50Ω can be used (Fig. 1). The dimensions can be determined from the table in Fig. 2. It must be observed that the effective dielectric constant

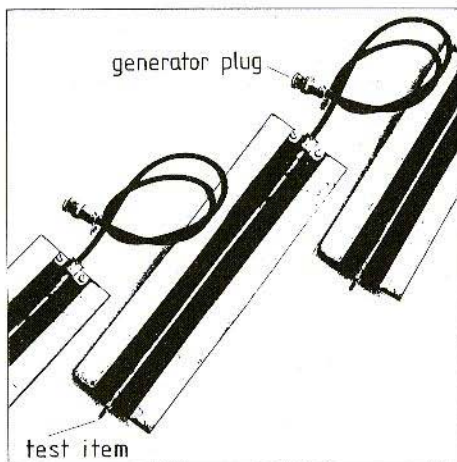
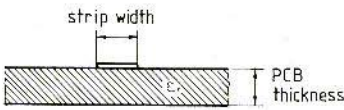

Fig. 1: Strip-line as a test-line

of the stripline is not that of the material chosen for its construction. This comes about because the electrical field around the conductor passes through air on its top side, thereby reducing the field intensity in the dielectric. For the GHz range either the strip-line can be used or a slotted-line (Figs. 3 and 4). The latter are not really suitable for home construction as the mechanical requirements (an accurate slide with a capacitive probe) are stringent. In any case, a signal-generator, of the same internal resistance as the Z_0 of the test-line and which exhibits low harmonic output, is required.



Line $Z_0 = \text{free-space } Z_0: \sqrt{\epsilon_r}$

Fig. 2: Table for the determination of the Z_0 of unsymmetrical screened strip-lines for three types of base material: $\epsilon_r = 4$, $\epsilon_r = 5$ and $\epsilon_r = 6$ (from "Microwaves" 3/68)

strip to PCB thickness ratio	3:1	2:1	1:1	0,5:1	
freespace Z_0	70 Ω	90 Ω	125 Ω	166 Ω	
effective dielectric constant	3,2	3,1	2,9	2,8	at $\epsilon_r = 4$
" ϵ_r'	3,9	3,7	3,5	3,4	at $\epsilon_r = 5$
" ϵ_r'	4,6	4,4	4,3	4,0	at $\epsilon_r = 6$

2. METHOD OF MEASUREMENT

2.1. Determination of Reference Points

The impedance measurement is made indirectly from a measurement of the magnitude and phase

angle of the reflection coefficient. The reflection coefficient magnitude $|P|$ may vary between zero and unity according to the load matching. With a perfect match it is zero and with total reflection it is unity. All other load values giving intermediary results. Before beginning the actual determination of the impedance a couple of voltage measurements along the line must be undertaken.

a) **Matching check.** This test checks that the Z_0

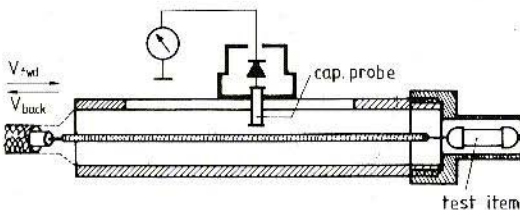

Fig. 3: Principle of the coaxial slotted-line

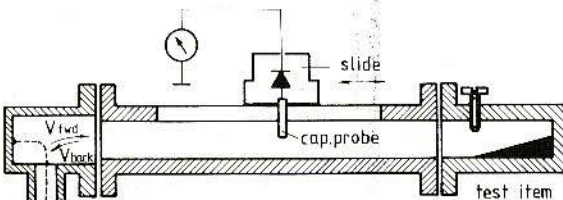

Fig. 4: Principle of the waveguide slotted-line

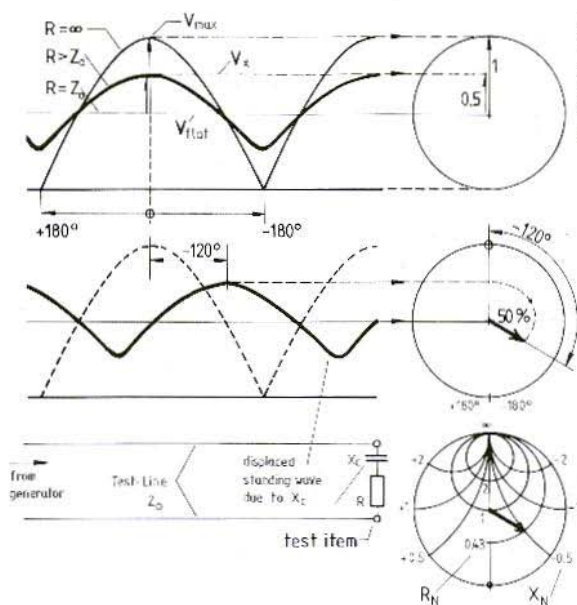

Fig. 5: Standing waves along the test-line and evaluation; co-ordinate representation of the reflection coefficient, Smith-chart for impedance components

of the test-line is compatible with the resistance of the terminating resistor. Use short direct connections to terminate the end of the test-line with the metal-film (preferably) resistor. When using coaxial or waveguide slotted-lines, a suitable lead absorber termination (50Ω) should be available. The check consists of running the probe along the test-line under terminated conditions to ensure that the voltage is equal at all points along the line (i.e. no VSWR) and to note this voltage V_{flat} for reference purposes.

b) **Total reflection test.** The end of the test-line should be either short-circuited or open-circuited for this test. This produces the well-known standing waves along the line. An open circuit condition is depicted in Fig. 5 top. Theoretically an open-circuit would also produce the required total reflection but in practice an open-circuit is very difficult to achieve owing to the fact that the radiation from the end of the transmission line constitutes a resistance – the radiation resistance.

The effect is more prevalent when using slotted lines where the short-circuit termination should

always be used to produce the total reflection. If a sliding short-circuit termination is available with the waveguide slotted line then this of course, could be used to create a true open-circuit at the end of the line by means of the $\lambda/4$ transformation effect. The standing waves are displaced by $\lambda/4$ relative to the short-circuit condition and this should be taken into account whatever method is used to produce total reflection. At total reflection the voltage at the nodal points is zero and at the anti-nodes the voltage is the maximum available from the generator at open-circuit output. Having ensured that total reflection exists, the voltage V_{max} should be noted. The range between the matched voltage V_{flat} and the voltage at total reflection V_{max} corresponds to the reflection coefficient at unity.

2.2. Determination of Reflection Coefficient Magnitude $|P|$ at any Termination Impedance

The two voltages V_{flat} and V_{max} have been determined and the test-impedance connected to the



end of the test-line. The voltage anti-nodes now lie **between** the reference V_{flat} and V_{max} , although its position on the line may now have been displaced owing to the reactive component of the item-under-test (I.U.T.). To determine the magnitude (only) of the reflection coefficient of the I.U.T. this displacement is of no consequence. According to the degree of reflection the voltage standing wave anti-node assumes a voltage V_x above the reference line V_{flat} . The distance $V_x - V_{\text{flat}}$ being an indication of the magnitude of the reflection coefficient. This may be expressed as a fraction of the maximum distance $V_{\text{max}} - V_{\text{flat}}$ which results in the value for the reflection coefficient.

Example: $V_{\text{flat}} = 0,8 \text{ V}$ and $V_{\text{max}} = 1,6 \text{ V}$. The voltage anti-node was measured at $V_x = 1,2 \text{ V}$. What is the magnitude of the reflection coefficient (see Fig. 5)?

Solution: $V_{\text{max}} - V_{\text{flat}} = 1,6 \text{ V} - 0,8 \text{ V} = 0,8 \text{ V}$
 $V_x - V_{\text{flat}} = 1,2 \text{ V} - 0,8 \text{ V} = 0,4 \text{ V}$
 $|P| = 0,4 \text{ V} / 0,8 \text{ V} = 0,5$

Note: This is a relative measurement and the absolute voltage is not strictly required. It is important however, that the measurement system is working linearly between the range V_{flat} and V_{max} . The output from the signal generator should be high enough to overcome the barrier voltage of the probe diodes, i.e. in the region of a few volts as in the example above.

2.3. Determination of the Reference Line for the Reflection Coefficient Angle

The reactive component of the load impedance is of great importance for the **angle** of the reflection coefficient. Before the angle measurement can begin, a reference must be established at total reflection. The reflection coefficient angle is zero degrees when the line is terminated with a pure

resistance R which is greater than the characteristic impedance of the line. This of course is just as true if the line is "terminated" in an open-circuit, i.e. when R is infinitely great. This case is represented in Fig. 5. It is possible to count the angle from the position on the line of the anti-node. A quarter-wavelength equals a reflection coefficient angle at 180° .

2.4. Determination of the Reflection Coefficient's Angle at any Terminating Impedance

After connecting the test impedance a standing wave system will be developed whose anti-node will be between V_{flat} and V_{max} . The magnitude however, is of no importance for the measurement of the angle but its position, in relationship to the anti-node at open-circuit, is. When the test-load has a **capacitive** reactive component the standing wave system is displaced relative to that at open-circuit **towards the load**.

This displacement can amount to a maximum of a quarter wavelength when the load capacitive reactance X_C tends towards zero (high capacitance) and the real component R is smaller than the line's characteristic impedance. In this extreme case the reflection coefficient's angle is -180° . The minus sign indicates that the reactance is capacitive. The degree graduations are linear with distance.

If the load impedance contains an **inductive** reactive component, the standing wave pattern is displaced relative to that at open-circuit by a maximum of a quarter wavelength i.e. $+180^\circ$ **towards the generator**. This maximum displacement occurs when the inductive reactance X_C tends to zero (very low inductance) and the resistance of the load is much smaller than the characteristic impedance of the line. The degree graduations are also linear. The plus-sign indicates that the reactive component is inductive (see para 4e for measurement pitfall).

Example: In Fig. 5 (lower) upon termination of the line the standing wave pattern has been displaced $2/3$ of a quarter wavelength in the direction of the load. This amounts to an angle of -120° caused by a capacitive reactance.

2.5. Polar-coordinates: Representation of the Reflection Coefficient

It is worthwhile now to regard the reflection coefficient as a phasor in a polar co-ordinate plane. The reflection factor magnitude is represented by the radius where the greatest radius is unity, i.e. full reflection. This case is represented by the top right-hand circle in **Fig. 5**, whereby the second radius represents a reflection coefficient of 0,5 both at angle 0° . The lines of projection show how the phasor may be obtained from the standing wave pattern ($V_{\max} - V_{\min}$ must represent unity with a linear scale between).

For demonstration purposes the circles are drawn with the 0° direction upwards instead of the usual right-hand orientation. A standing wave displacement due to load reactive components causes the phasor to turn clockwise or anti-clockwise according to the nature of the reactance. A negative reactance is represented by a clockwise phasor movement and a positive reactance by an anti-clockwise movement. In the **example of Fig. 5**, middle circle, the phasor has turned clockwise -120° owing to the capacitive reactive component. The length of the phasor is half of the outer radius which represents the reflection coefficient of 0,5.

2.6. Determination of Real and Reactive Components of the Load

The third circle in **Fig.5** contains the Smith-Chart in a suitable position (0° upwards). The outer circle radius accords to full reflection as in the polar diagrams. The phasor is now drawn in the same position onto the Smith-Chart. The phasor rotates about a point "1", the middle of the diagram. From the coordinates lying at the point of the phasor, the real and the reactive components of the load may be read off in **normalised** form. The normalised form is simply the actual impedance, resistance or reactance divided by the Z_0 of the line (50Ω) so that unity represents Z_0 (50Ω mostly) and lies in the centre of the circle. It follows then that any quantity finally read off the normalised Smith-Chart must be multiplied by Z_0 in order to find the actual value.

Note for use of waveguide slotted-line: This normalisation is not valid for the W/G slotted-line owing to the fact, that there is no definite characteristic impedance data possible because of the completely different field distribution as opposed to that of the coaxial slotted-line and strip test-line.

3. EXAMPLE

The test-item is a series combination of R and C and causes a reflection coefficient of 0,5 and angle -120° . After plotting these quantities onto the Smith-Chart (see **Fig. 5** bottom right), the **phasor tip** is seen to be located at the co-ordinate intersection of $R_N = 0,43$ and $X_N = -0,5$. The characteristic impedance is 50Ω and the measurement frequency 145 MHz. What are the actual components of the load?

Solution:

$$R_N = 0,43 \times 50 \Omega = 21,5 \Omega$$

$$X_N = -0,5 \times 50 \Omega = -25 \Omega$$

The minus sign indicates a capacitive reactive component which at 145 MHz has a capacitance of 44 pF.

4. MEASUREMENT PITFALLS

a) Signal generator harmonics: are reflected in the same manner as the fundamental. As they form standing wave patterns which are closer together, they could cause confusion by distorting both amplitude and phase of the fundamental standing wave.



b) Generator internal impedance R_i not equal to the Z_0 of the test-line:

multiple reflections distort the main standing wave pattern.

c) Probe: Signals small enough to fall into the non-linear region of the diode.

Remedy: increase signal generator output.

d) Loading of line by probe: avoid this by using capacitive coupling or a high impedance probe relative to the Z_0 of the test-line.

e) The location of the maxima: owing to the broad anti-node transition it is difficult to locate the exact point of maximum voltage nodes to assess the pattern displacements. The displacement angle is shown in Fig. 5 as being with reference to the anti-node for the clarity's sake, but in reality the nodes should be used to locate the point

exactly. The required displacement then being the difference between reference and test nodes.

5. REFERENCES

E. Stadler: Using Smith Diagrams (Charts).
VHF COMMUNICATIONS, Vol.16, 1/1984,
Pages 23 – 28

Colour ATV-Transmissions are no problem for our new ATV-7011

The **ATV-7011** is a professional quality ATV transmitter for the 70 cm band. It is only necessary to connect a camera (monochrome or colour), antenna and microphone. Can be operated from 220 V AC or 12 V DC. The standard unit operates according to CCIR, but other standards are available on request.

The **ATV-7011** is a further development of our reliable ATV-7010 with better specifications, newer design, and smaller dimensions. It uses a new system of video-sound combination and modulation. It is also suitable for mobile operation from 12 V DC or for fixed operation on 220 V AC.

Price DM 2750.00

The ATV-7011 is also available for broadcasting use between 470 MHz and 500 MHz, and a number of such units are in continuous operation in Africa.



Specifications:

Frequencies, crystal-controlled:
Video 434.25 MHz, Sound 439.75 MHz
IM-products (3rd order): better than - 30 dB
Suppression of osc.freq. and image:
better than - 55 dB
Power-output, unmodulated: typ. 10 W
Delivery: ex. stock to 8 weeks (standard model)



UKWberichte

Terry D. Bittan · Jahnstr. 14 · Postfach 80 · D-8523 Baiersdorf

Tel. West Germany 9133-855. For Representatives see cover page 2

Joachim Kestler, DK 1 OF

PLL Oscillators with Delay Lines

Part 3: Oscillator Module for the 2-Metre-Band

In (1) Michael Martin, DJ7VY, introduced a VHF Oscillator with outstanding characteristics with regard to low noise and short term stability. The oscillator to be described employs the same oscillatory circuit with a low noise doubler for use in 2 m receivers or transceivers with either a 10.7 or 9 MHz IF. In order to achieve the necessary long-term stability however, the PLL principle with delay lines (2, 3) will be employed. In this manner the not uncritical DAFC together with temperature compensation measures can be dispensed with.

5. AN OSCILLATOR MODULE FOR THE 2-METRE BAND

5.1. The Resonant Circuit

As this is the most important and critical part of every oscillator circuit, a short account of the Stettner ceramic inductor used in (1) will now be undertaken.

A Vector-Impedance-Meter HP 4815 A was used (as by DJ7VY) to determine the circuit Q in two ways:

- Measurement of R_0 , the resistance at resonance ($Q = R_0/\omega L$)
- Measurement of the 45° frequencies f_1 and f_2 :
 $Q = f/(f_2 - f_1)$

Care should be taken when soldering connections to the coil, that as little tinning solder is used as possible. The connections should be cleaned with trichloroethylene to remove the flux residue. The tuning capacitor of 12 pF together with the probe capacity resulted in a resonant frequency of between 65 and 70 MHz.

Results (measurements of b in brackets)

- Coil without screening and without tuning diode: $Q = 633$ (613)
- Coil in PCB enclosure, size 45x45x30 mm without tuning diode: $Q > 700$ (922)
- As above but with 2xBB209 (tapped 1 wdg, $V_D = 15$ V) $Q = 611$ (709)
- As above but $V_D = 7.5$ V $Q = 570$ (648)
- As above but $V_D = 5$ V $Q = 500$ (517)
- 1 (module) lid of tin-plate without diode: $Q = 421$ (482)
- 2 covers of tin-plate without diode: $Q = 284$ (305)

It may be seen that the coil Q when screened (not by tin-plate) is improved as it avoids loss through

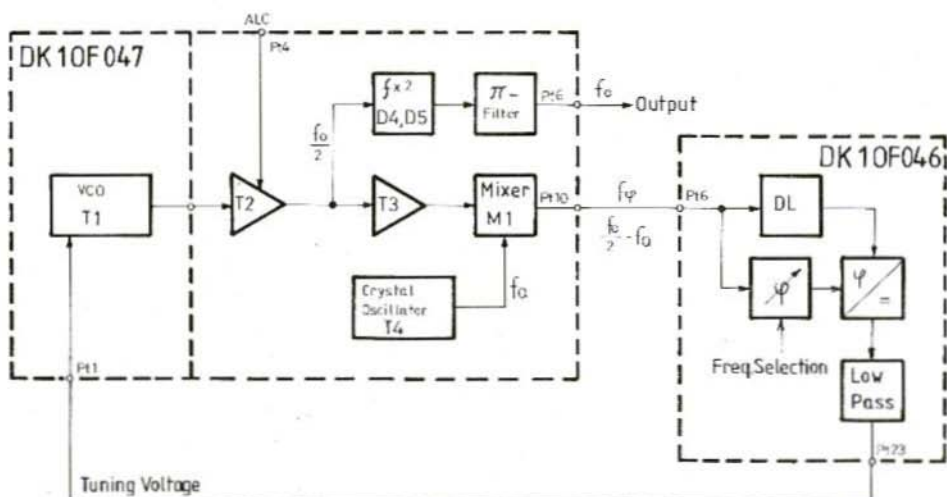

Fig. 26: VHF oscillator block diagram

radiation. The influence of the tuning diode is noticeable but tolerable as long as the tuning voltage remains above 5 V. With $V_D = 0$ the Q-factor is only 120.

5.2. Circuit Description

Fig. 26 shows the block schematic of the VHF oscillator. The VCO oscillates at half the output frequency, its signal being buffered by T 2 and fed to a frequency doubler with filter to the output. The buffered oscillator signal is also fed to a further buffer stage (T 3) on to the mixer. The mixer is also supplied with a crystal oscillator signal resulting in a difference output frequency of $f_{\phi} = f_o/2 - f_o$. This is fed to the module with the delay line, phase-shifter and comparator described in (3) the resulting tuning voltage being used to tune the VCO. Buffer T 2 can be used to provide ALC by means of an external voltage.

The choice of difference frequency is not critical but it must however, lie in the passband of the

delay line (3–7 MHz). It is advisable to avoid sub-harmonics of the difference frequency in order to prevent spurious signals. An example built by the author has the following frequency plan:

IF = 10.7 MHz, output frequency 133.3 to 135.3 MHz, crystal frequency 62.9 MHz, $f_{\phi} = 3.75$ to 4.75 MHz. Using a IF of 9 MHz one requires an oscillator signal of 135 to 137 MHz. Choosing a crystal frequency of 62.5 MHz, f_{ϕ} results in between 5 and 6 MHz and again, no IF spurs are to be anticipated.

The detailed schematic of the oscillator module is shown in Fig. 27. The part of the circuit with T 1 (VCO), T 2 (buffer) and D 4/5 (doubler) has already been exhaustively treated in (1), so here only a few particulars should be mentioned. The VCO supply voltage is fed via Pt 3. It is recommended that this voltage be produced by a separate regulator (e.g. 7815, 0.2 A) and filtered with an RC combination of 100 Ω /1000 μ F. The ALC voltage to Pt.4 influences the capacitive divider C 10/D 3 hence the control of T 2 and the input to the doubler, thereby the output may be varied. The same

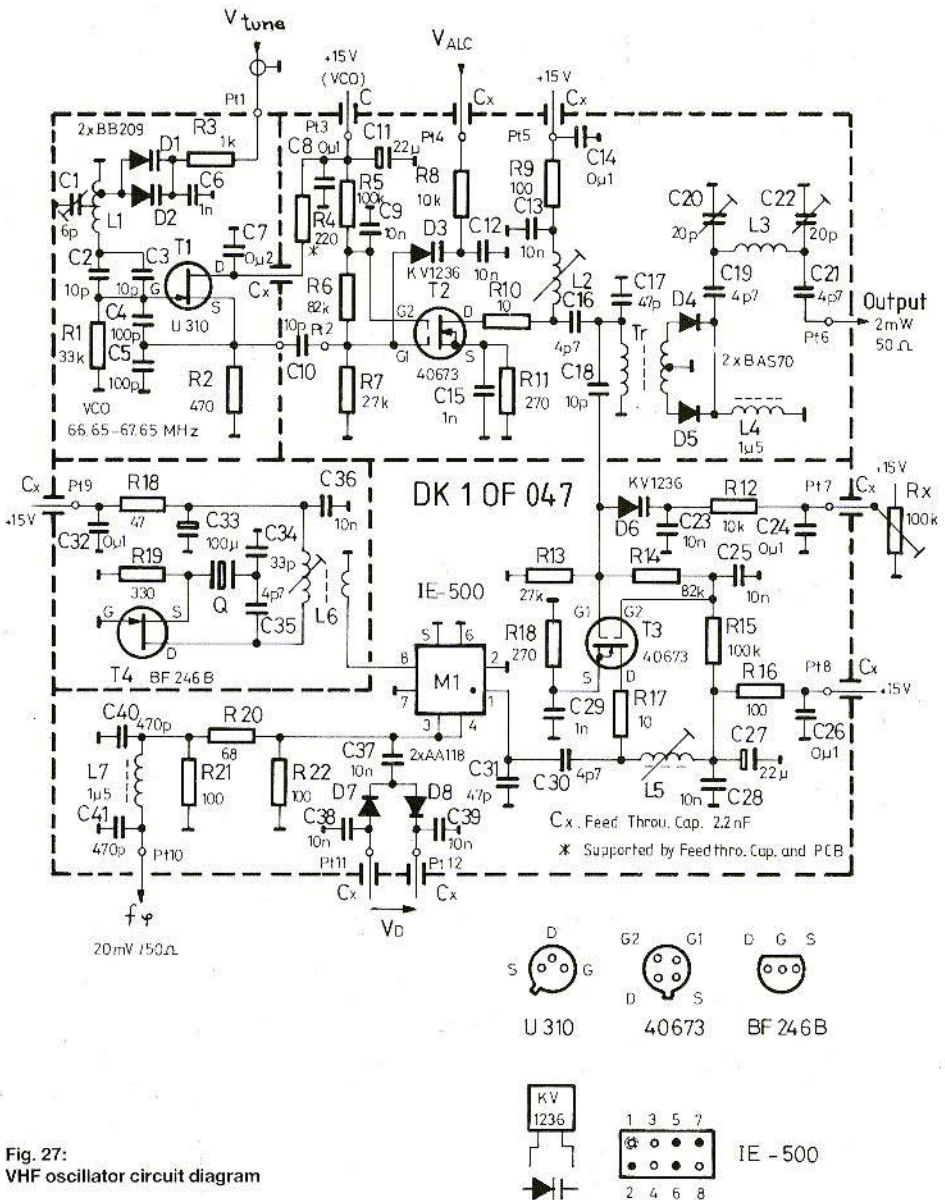

Fig. 27: VHF oscillator circuit diagram

circuit is used on the input to the buffer T3 (C 18/ D 6); thus it is possible to adjust, by means of a control voltage applied to Pt 7, the output of the ring mixer M 1 and the level of the difference fre-

quency signals at Pt 10. A barrier layer FET (T 4) is used for the crystal oscillator. The relatively low frequency (approx. 60 MHz) used here, obviates the requirement for compensation of the static



crystal capacitance with inductance allowing the crystal to oscillate at its nominal frequency.

The difference frequency, developed in the ring mixer, is fed to a low pass filter C 40/L 7/C 41 suppressing undesired higher order mixing products before going to the output at Pt 10. The 10 dB pad (R 20, R 21, R 22) serves as a broadband, 50 Ω termination for the mixer. The DC voltage between Pt 11 and Pt 12, which are test-points, indicating the amplitude of the output signal at Pt 10. This will be mentioned during alignment and testing.

5.3. Hints for Construction

In order to ease construction a double-sided through-plated etched PCB has been developed. It measures 110 x 72.5 mm and carries the inscription DK10F 047. The VCO does not

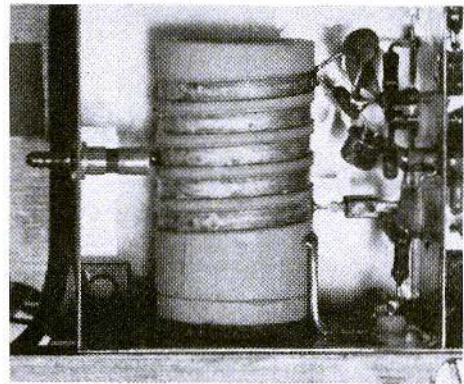

Fig. 28: The ceramic coilformer with C 1 (left) and the selfsupporting oscillator circuit (right)

use a PCB in order that short connections to the coil are used and to minimise the solder connections (Circuit Q).

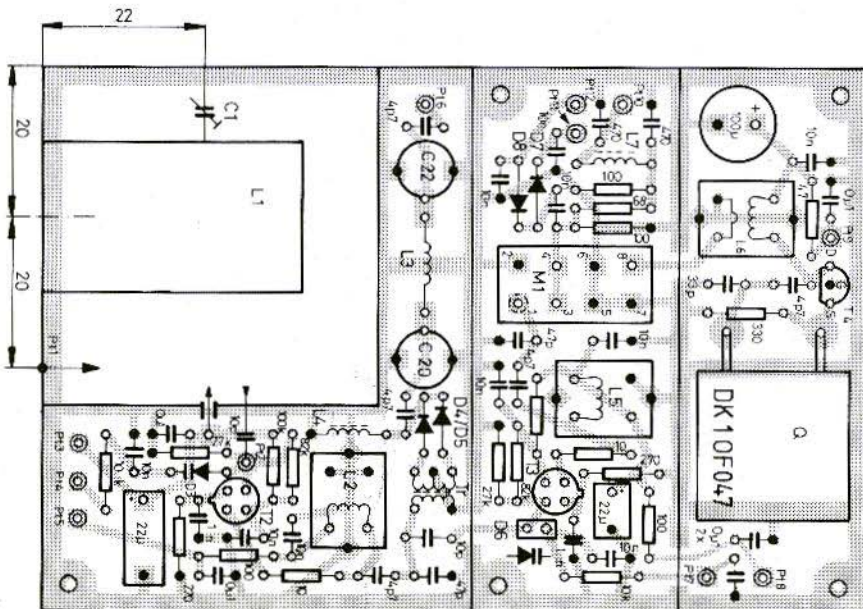

Fig. 29: The trough contact PCB is 110 x 72.5 mm

The following sequence is recommended for the construction:

- File the PCB to the exact size.
- Provide a cut-out for the VCO.
- Cut surrounding screen (30 mm high) and bore for the feed-through capacitors at Pt 3, 4, 5, 7, 8, 9, 11, 12 and feed-through solder terminals at Pt 1, 2, 10 also for a Mini-BNC coax. receptacle (or feed-through terminals) for Pt 6. Fit to the PCB and solder the screen both sides of the PCB.
- Cut out the 2 tin-plate divider screens (20 mm high and with no holes) and solder to the PCB.
- Complete the VCO screened enclosure with holes for the two through connections capacitor and terminal. Do not use tin-plate but rather 0.5 mm brass (preferably silvered) or PCB. Copper plate is unsuitable owing to its high heat conductivity making it difficult to solder.

Before mounting the VCO inductor with nylon screws M 3 and paxolin washers, the tuning

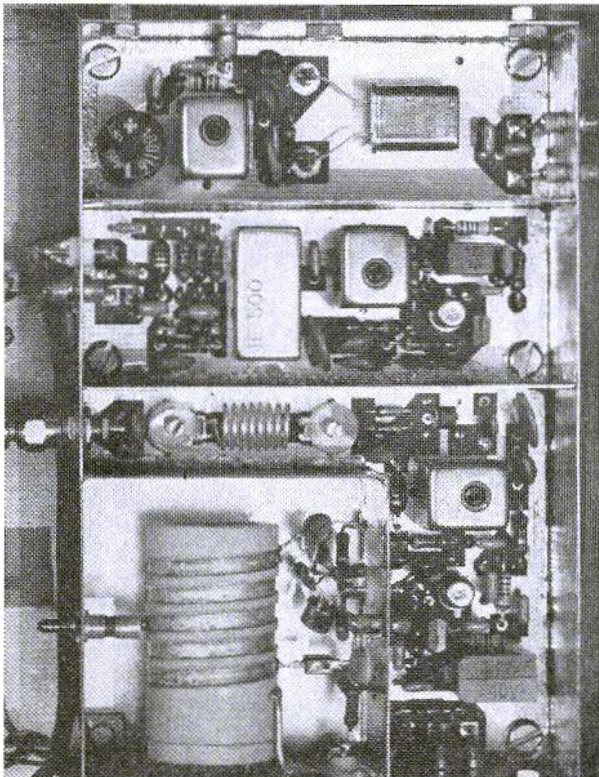

Fig. 30:
The finished module DK10F 047



diode should be soldered one winding from the earth and using as little solder as possible. The rest of the VCO components follow, supported by the inductor, the feed-thru. terminals Pt 1 and Pt 2, the feed-thru. capacitor and the screen. The arrangement may be seen in **Fig. 28**. The PCB can now be fitted with the rest of the components according to the plan in **Fig. 29**. A photo of the finished module is shown in **Fig. 30**. The flux residue is then removed from all soldered joints with a solvent, but do not soak the PCB in solvent as some components wouldn't like it! This measure is not a cleanliness fetish, but avoids the possibility that moisture absorbed into the flux causes electrical leakages and corrosion.

5.4. Special Components

- T1: U310 (Siliconex)
 T2, T3: 40673 or 40841 (RCA)
 T4: BF246B, P8000 or P8002 (Texas Instr.)
 D1, D2: BB209
 D3, D6: KV1236 (Componex Duesseldorf)
 D4, D5: BAS70 (Siemens) or HP2800
 D7, D8: AA118 or similar Ge diodes
 M1: IE-500, SRA-1 or SRA-3 (mini-circuits)
 Q: IF = 10.7 MHz : 62.9 MHz
 IF = 9 MHz : 62.5 MHz
 Series resonant, 3rd overtone, holder HC-18/U or HC-6/U e.g. XS 6204 (KVG)
 L1: Ceramic inductor type 87-6228 (Stettner) tapped one wdg from earthy end for tuning diode
 L2, L5: 13 Wdg. 0.15 mm copper-laquer-(silk) wire on Vogt coil kit 514 04
 L3: 8 Wdg. 0.8 mm silvered wire (self supported) 5.5 mm inside dia
 L4, 7: Ferrite choke 1.5 NH (Siemens, Jahre)
 L6: As L 2, but with coupling Wdg. of insulated wire on earthy end
 C1: Ceramic coaxial trimmer 6 pF, 3 mm dia.
 C2, C3: Ceramic disc cap. 10 pF, don't use brown ones ('S'-ceramic has greater loss)
 C4, C5: Ceramic (multi-layer) cap. 100 pF

- C11: Tantalum cap. 22 NF/40 V 10 mm mounting
 C27: Tantalum cap. 22 NF/16 V 5 mm mtg
 C33: Tantalum cap. 100 NF/16 V 5 mm mtg
 CX: Feed-thru. cap. 2.2 nF/30 V (solder flange)
 C20: Foil trimmer 20 pF 7.5 mm dia.
 C22: (Valvo: green)

The remaining capacitors are ceramic disc 30 V, 5 mm mounting. All resistors are 10 mm mounting.

- Tr: 4+2x4 Wdg 0.1 mm CuL in 2 hole bead B 62152-A8-X17 (Siemens)

5.5. Setting-up and Adjustment

After the connection of supply voltages to Pt 3, Pt 5, Pt 8 and Pt 9 check the drain current of all transistors by measuring the voltage drop across the drain resistors. A value of 10 mA is optimum, 6 to 15 mA tolerable. Outside these limits the FET should be replaced. The two oscillators (T 1 and T 4) are measured in the non-oscillatory condition: T 1 Gate to earth via 100 Ω and T 4 by taking out the crystal or C 35. Following that, connect a temporary adjustable voltage to Pt 1 taken from the supply voltage via a 10 k Ω (approx.) potentiometer. Pt 3 is supplied directly with 15 V. Fit the VCO enclosure provisionally with the cover and obtain the tuning characteristics shown in **Fig. 31**. Trimmer C 1 is adjusted so that the upper band limit is attained with a potential of 12 V. If this is not achieved with C 1 fully out replace C 2 or C 3 with a smaller value (say 8.2 pF), likewise increase C 2 or C 3 if the band limit is not reached at 12 V with C 1 fully in. The frequency counter may be connected either by coax cable across C 17 or remove the screen from L 2 and use a single-turn inductive coupling. Naturally, only half the output frequency will be measured at these points.

The lower band limit should be attained with about 8 V (6 to 9 V). If this is not the case (maybe another tuning diode has been used) the diode tap on L 1 must be adjusted.

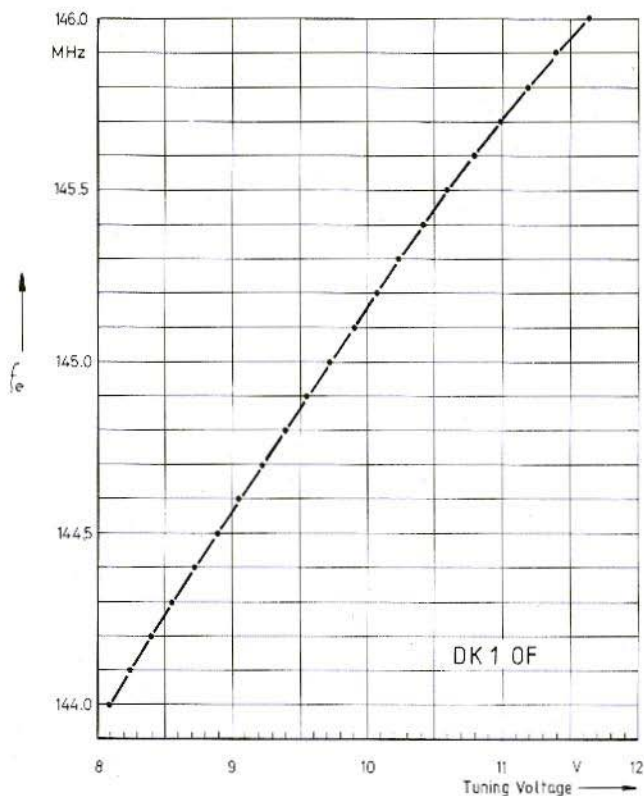

Fig. 31:
The VCO tuning curve

Next the crystal oscillator is checked the counter being connected inductively to L 6 or a coax. cable to pin 8 of the ringmixer. The adjustment is limited to adjusting the core of L 6 exactly to the crystal frequency. If the crystal refuses to oscillate (e.g. with old or "tired" crystals) reduce C 34 to 27 or 22 pF.

The given difference frequency at Pt 10 may be checked easily with an oscilloscope (freq \approx 10 MHz) with the input terminated in 50 ohms.

Turn the preset RX at Pt 7 to maximum and tune L 2 and L 5 for max. amplitude at Pt 10. The VCO should be set to mid-band (provisional voltage at

Pt 1 about 10 V). About 300 mV peak-to-peak (approx. 100 mVRMS) should be displayed. This drops to 60 mVp.p. (20 mV RMS) with RX at 20 mV. A high impedance (100 kohms) voltmeter should read 0.1 V between Pt 11 and Pt 12.

Bandfilter trimmers C 20 and C 22 following the doubler are iterated several times to achieve the maximum output. Should a high-frequency levelmeter not be available, use a test circuit of 50 Ω resistor a Germanium diode and a 1 nF reservoir capacitor across a normal multimeter.

After adjustment the VCO cover should be fitted and soldered. The tuning curve is then re-



checked and, if necessary, C 1 corrected. The connections to the PLL part DK1OF 046 are shown in Fig. 26. The VCO of the PLL part will not be needed but may be used to check unit 046 on its own. Screened cable should be used for the connection Pt 1 to Pt 23 to avoid pick-up voltages on the VCO tuning line. This is not too critical as the tuning line is a relatively low impedance of 100Ω (R 55 see Fig. 19 part 2). Also low frequency pick-up (hum) is nulled by the action of the phase loop. The supply voltage should of course, be well regulated and filtered.

5.6. Test Values

In the following table is set forth the data which was obtained from measurements on the prototype. The instruments used were:

Vector Analyser (Pegelmesser) ZPV Rohde & Schwarz

Spectrum Analyser HP 141 T with plug-in modules 8552 and 8554

Frequency Counter (home made, 8 digit, DCF 77 locked).

DATA:

Frequency range 133,3 – 135,3 MHz
(IF = 10,7 MHz)

135,0 – 137,0 MHz
(IF = 9 MHz)

Output power + 4 dBm midband
+ 3 dBm bandlimits

Sub-harmonics $f_0/2, 3/2 f_0$:
< - 30 dBm

Harmonics $2 f_0, 4 f_0$:
< - 40 dBm

$3 f_0, 5 f_0$:
< - 60 dBm

Switch on drift < 200 Hz)

Long term drift < 20 Hz/hour)

Sensitivity to supply voltage changes: < 1 kHz/V)

Supply: + 15 V, 40 mA)

) together with PLL-DL-Module DK1OF 046.

Naturally the data are not complete without carrier noise being assessed but unfortunately suitable test equipment was not to hand. In the next edition of VHF COMMUNICATIONS a receiver input stage suitable for use with this oscillator module will be described which will of course, consider the question of front-end overloading.

5.7. A 70 cm Version

Those who wish to make their first steps on a higher frequency band will do well to construct

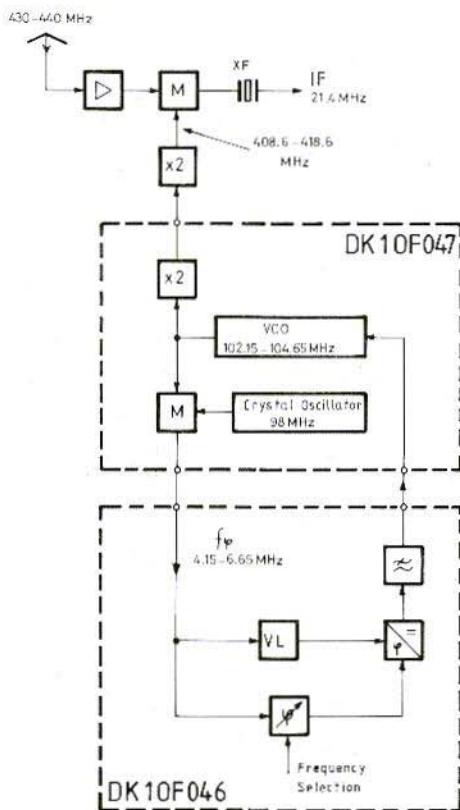

Fig. 32: Block diagram of a 70 cm single conversion super



the converter first and test it with an available, good receiver. In this manner and without a great outlay, one can gain experience in high frequency techniques and with unfamiliar components and circuits. Results may not approach those of the state of the art with regard to input overloading and IF spurious specifications, an optimal solution being the concept of a narrow band, fixed IF. This trend is to be seen on the 435 MHz band but for the 2 m band it is already the norm.

Fig. 32 shows how the described oscillator module may be used in a 70 cm receiver (or transceiver). The VCO oscillates at 103 MHz, its signal being doubled twice before being passed to the mixer. It is suggested that an IF of 21.4 MHz is used, as crystal filters exist at this frequency but the choice is not binding.

With more attention to the preselection filter in order to facilitate image performance, an IF of 10.7 or 9 MHz may be used. Anyway, image interference is not so unpleasant as overloading effects as only a single frequency suffers whereas overloading could make the whole band unusable.

The question is interesting, whether the often mentioned Stettner ceramic inductor is suitable for a 103 MHz VCO. Measurements as in 5.1 but at 103 MHz, gave a circuit Q of 460 (C = 6 pF, coil in enclosure, diode voltage 10 V) i.e. not much less than at 67 MHz.

The following table indicates which components in **Fig. 27** are to be changed:

D1:	BB 505
D2:	redundant
Q:	IF = 21.4 MHz: 98.0 MHz IF = 10.7 MHz: 101.0 MHz Series resonance, 5TH overtone holder HC-18/U or HC-6/U e.q. XS 6306 (KVG)
L2, L5:	8 Wdg. 0.25 mm silvered copper wire Vogt kit 514-04
L3:	7 Wdg. 0.8 mm silvered, self supporting coil, int. dia 5.5 mm
L6:	As L 2 but with one coupling loop

C1:	ceramic cylindrical trimmer 3 pF, 3 mm dia
C2:	ceramic disc, 4.7 pF
C3:	redundant
C4, C5:	ceramic disc 39 pF
C17, C31:	ceramic disc 10 pF
C20, C22:	foiltrimmer 10 pF

All other components as listed in 5.4.

Construction and operation are as described in 5.3. and 5.5. This version also, did not need inductive compensation for the static crystal. The output capacitance power at Pt 6 was 1 mW (0 dBm) in the mid-band falling to - 2 dBm at the band extremes - somewhat lower than the 2 m version.

Owing to the frequency doubling, the drift rates were also doubled. One revolution of the phase-shifters will now result in a frequency interval of $4 \times 15.625 \text{ kHz} = 62,5 \text{ kHz}$.

A 70 cm receiver front end (IF = 10.7 MHz) is now in the process of construction; if the expectations match projected specifications, publication in this magazine is intended.

Literature:

- 1) Martin, M.: Low noise VHF-Oscillator with Diode Tuning
VHF-COMM. 2/1981,
Pages 66 - 82
- 2) Kestler, J.: PLL-Oscillators with Delay Lines
Part 1, VHF-COMM. 4/84,
Pages 211 - 220
- 3) Kestler, J.: PLL-Oscillators with Delay Lines
Part 2, VHF-COMM. 1/85,
Pages 46 - 54



Guenter Hoch, DL 6 WU

Estimating the Gain of Yagi-Antennas from Chart Data

The author has described in (1) how the gain reduction due to sidelobes can be estimated for an antenna with a nearly rotational symmetrical polar diagram. The comparison with practical measurements on a yagi antenna leads to a diagram, which with easily obtainable values, gives a close approximation to the available gain.

1. BASIC THEORY

The familiar Kraus formula for antenna gain

$$G_i \approx \frac{4\pi}{\Phi_E \cdot \Phi_H} \quad [1]$$

or for the angle in degrees and with reference to a dipole

$$G_d \approx \frac{25200}{\Phi_E \cdot \Phi_H} \quad [2]$$

yields for an antenna whose half power or beam-width Φ_E and Φ_H for both polarization planes are known, an upper limit for the gain. When the diagram has sidelobes suitable deductions are to be made.

In general, the main lobes and sidelobes are different for both diagram planes, the amateur is however, only interested in the directional characteristics of one plane, for horizontal polarization this is the E plane (the plane of the elements).

For a few types of antenna the relationship between E and H diagrams is known. One of these is the yagi antenna, superimposing (multiplication) the H diagram with a dipole characteristic results in a good approximation of the E diagram. The latter causes null points at $\pm 90^\circ$ which in turn causes extensive cancelling of the sidelobes in the area of the null position; this leads to, for short and medium length antennas, a certain narrowing of the main lobe (from this it is clear that the often stated front/side ratio for the E plane is nonsense: a radiation in the direction of the elements can only arise from current in the boom or cable).

2. APPLICATION

From the previous basics it follows, that for a yagi antenna it is sufficient to know the important data characteristics of the diagram of one plane in order to determine the gain.

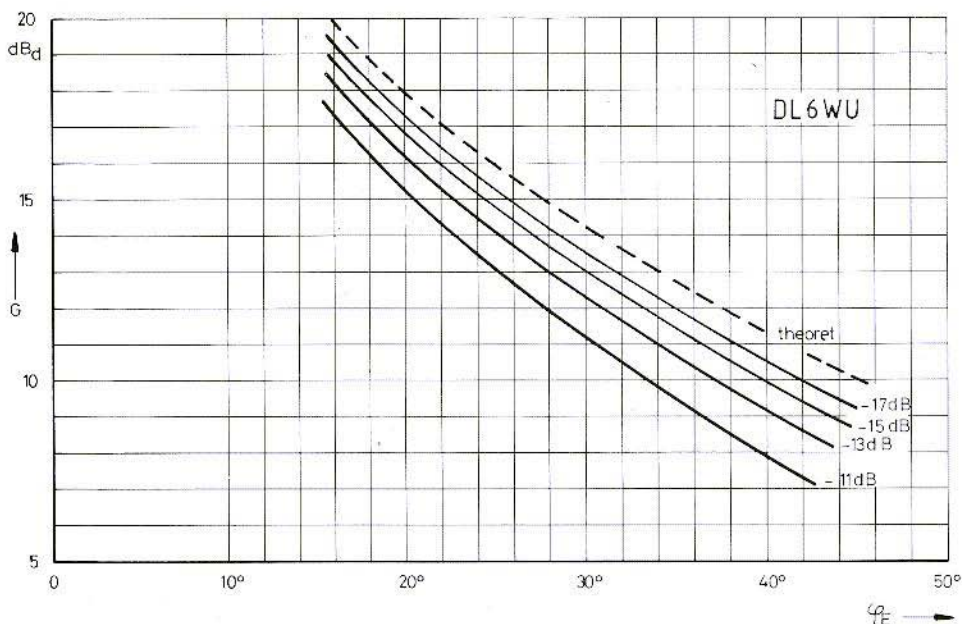

Fig. 1: Gain of yagi-antennas as a function of beamwidth (ϕ_E) of the E plane and sidelobe damping

Fig. 1 shows dotted the theoretical gain of a loss free, sidelobe free antenna, as a function of the E beamwidth. The solid lines show the practical gains as a function of beamwidth for various degrees of sidelobe damping.

From this, the conclusion should not be drawn that an antenna with weak sidelobes generally has higher gain. For the same length of antenna decreasing the sidelobes increases the beamwidth of the main lobe. The gain remains nearly constant over a wide range. In spite of this it is normally preferable to choose the antenna with the least peaky sidelobes.

From Fig. 1, someone, able to measure dB's and angle degrees, can obtain a good estimate of the gain.

It must be stressed, that the diagram is only valid for single yagi antennas; not for arrays etc., since for these, completely different standards apply.

Corrections for ohmic loss (skin effect) are normally unnecessary. The bases for this has been derived from test data, as well as from actual antennas. It goes without saying that drastic mismatching, unsymmetrical feeds etc. falsify the result. The almost amazing accuracy of the procedures has been confirmed by G. Schwarzbeck, DL1BU in (2).

3. PRACTICAL PROCEDURES

The antenna to be measured is aligned to a sufficiently strong and constant incoming signal (beacon), than the beamwidth is determined by rotating the antenna until the -3 dB-point is found, then rotate the antenna in the opposite direction

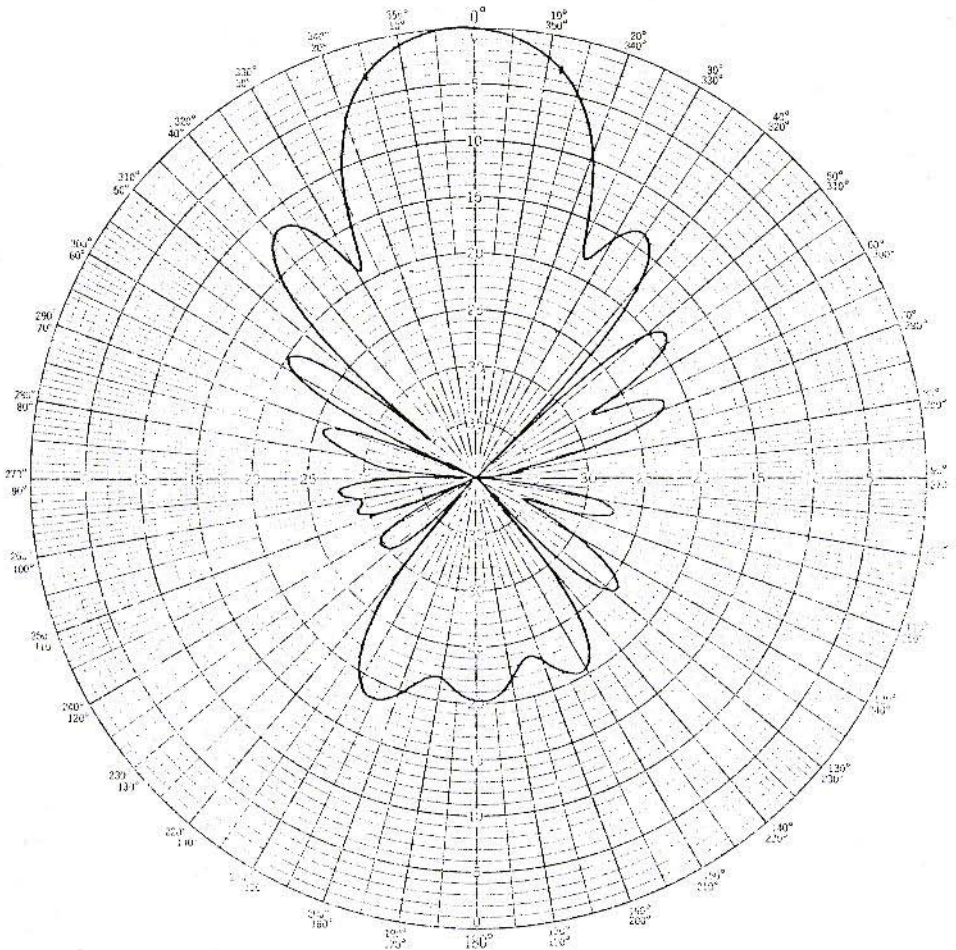

Fig. 2: Polar diagram of an 18 element yagi antenna measured on 1.10.1981 at 432.5 MHz

until the other -3 dB-point is found; the angle between these points is the required beamwidth. On the other side of the -3 dB-point the signal must quickly decrease, run through a pronounced minimum, then climb to a value usually lying 10 to 20 dB's under the maximum value. The signal difference is equal to the sidelobe attenuation.

All the following sidelobes must be smaller, at $\pm 90^\circ$ there will be a deep null point. All backward lobes should be many dB's below the maximum

gain of the antenna. An antenna with 14 dB gain must have at least 16 dB front to back ratio.

If the right and left sidelobes are very different, the field disturbance is caused either through reflection from buildings or the feed is unsymmetrical, eg. from the construction or the cable lead-in; small differences are averaged out.

When an exactly calibrated S meter is not available, a switched attenuator can be inserted in the



signal path, and adjust for the same level. It is not possible to go below a certain minimum attenuator value, otherwise mismatching will falsify the results.

The found half power angle can now be easily examined: it is never bigger than half the angle Φ_{m1} , which is the angle between the first two minima. For shorter antennas it is noticeably smaller (0.47 – 0.48 Φ_{m1} in order of 2λ long), from around 6λ long is almost exactly $0.5\Phi_{m1}$.

4. EXAMPLE

Fig. 2 shows the diagram of an 18 element antenna (Parabeam PBM18). The -3 dB-points lie at $+12^\circ$ and -15° , that means $\Phi_E = 27^\circ$. The first minima lie at $+27^\circ$ and -29° , that means $\Phi_{m1} = 56^\circ$. The first sidelobes have sunk to around 12 dB and 14 dB respectively, the average sidelobe

attenuation is therefore 13 dB. The front/back ratio comes to 19 dB. With these values imposed to Fig. 1, it gives a gain of 13.3 dB_d, the measured gain was 13.4 dB_d (dB_d gain ref. dipole).

The author has employed the diagram for many years to verify gain measurements and it immediately revealed any obvious errors in measurement.

5. LITERATURE

- (1) Hoch, G.: YAGI-ANTENNAS-Principle of Operation and Optimum Design Criteria. VHF COMMUNICATIONS Vol.9 Autumn 3/1977 · Pages 157 – 166
- (2) Schwarzbeck, G.: Streifzug durch den Antennenwald cq-DL 52 (1981), H.3, S. 126 – 130

New Interdigital Bandpass Filters

4-stage, sealed bandpass filters for
1152 MHz, 1255 MHz, 1288 MHz or 1297 MHz
centre frequencies.

3 dB bandwidth:	12 MHz
Passband insertion loss:	1.5 dB
Attenuation at ± 24 MHz:	40 dB
Attenuation at ± 33 MHz:	60 dB
Return loss:	20 dB
Dimensions (mm):	140 x 70 x 26

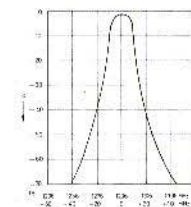
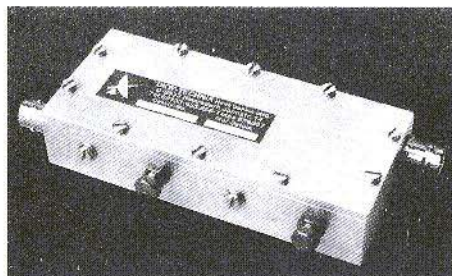

Price: DM 178.—

Please list required centre frequency on ordering.



UKWberichte Terry D. Bittan · Jahnstr. 14 · Postfach 80 · D-8523 Baiersdorf
Tel. West Germany 9133-855. For Representatives see cover page 2



TDA 5660P – A Versatile Modulator Circuit for TV, Video, and Sound Signals in the Range of 48 to 860 MHz

The new, bipolar integrated modulator **TDA 5660P** was developed for use in TV and video equipment, and also for other electronic equipment with video and sound requirements. This integrated circuit contains all functional circuits that are required for the modulation and conversion of video and sound signals to VHF/UHF in the frequency range of 48 MHz to 860 MHz. A few examples of the versatility of the circuit are:

- TV and video equipment
- Cable and TV converters
- Video generators
- Video surveillance systems
- Amateur TV, or
- Personal Computers.

The versatility of this integrated circuit can be increased further with the aid of a number of external connections for adjustment etc.

It is possible, for instance, for the sound signal to be either amplitude or frequency modulated (e. g. FM-sound IF 5.5 MHz). The video input is able to process frequencies of between 0 and 5 MHz, and the sound input between 0 and 20 kHz. The sound oscillator operates between 4 and 7 MHz, and the output carrier frequency (sound and video information) can be in the range between 48 and 860 MHz. The following functions can be adjusted externally: The video-sound carrier spacing, the AM-depth of modulation, negative or positive video modulation, and suppression of the residual carrier.

Functional Description and Special Features of the TDA 5660P

● AM-sound modulator, FM-sound modulator; AM-depth of modulation and preemphasis are ex-

ternally adjustable.

- Sound oscillator (4 to 7 MHz) with a high frequency stability.
- High frequency stability of the balanced VHF/UHF main oscillator.
- Synch. level blanking circuit for the video signal.
- Control circuit for peak white and a control circuit for the video amplitude (compensation for fluctuations of up to 6 dB).
- Continuous adjustment of the depth of modulation of both positive or negative modulation.
- Alignment possibilities for compensating the dynamic unbalance of the mixer (at high output frequencies), and thus for minimizing the dynamic residual carrier.
- Variable video-sound carrier spacing.
- Balanced mixer output (48 to 860 MHz) with buffer.
- Low interference spectrum.
- Very stable, internal reference voltage of 7.5 V.

Circuit Description (Figure 1)

The sound signal (AF) is connected capacitively to connection 1 in the case of frequency modulation. The preemphasis can be provided by use of an external R-C circuit. This signal is fed to a mixer (AM-sound modulator), which is dependent on the AM-modulator input (connection 16). If a voltage is present at pin 16 that differs from the internal reference voltage, it is possible for the video-sound carrier spacing to be adjusted. If the sound carrier is not to be frequency modulated, but amplitude modulated, it is necessary for pin 1 to be connected to pin 2 and for the AF-signal to be fed capacitively to pin 16. The internally set

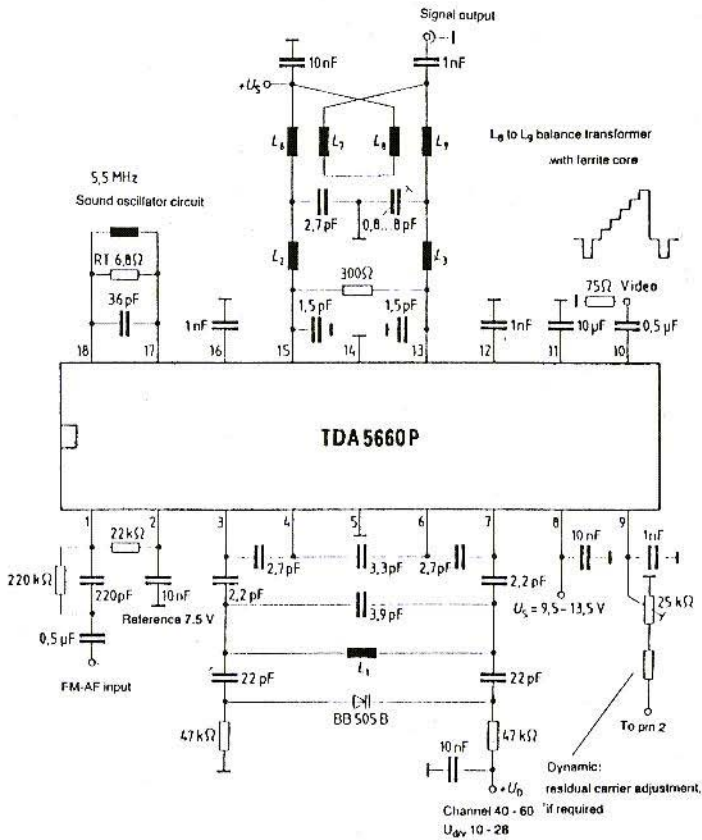

Fig. 1:
Application circuit
of the TDA 5660P

depth of modulation can be adjusted by providing an additional, external DC-voltage to pin 16.

The FM or AM sound carrier is added to the video signal in the VHF/UHF mixer with the aid of the local oscillator signal. The parallel resonant circuit of the sound carrier oscillator is connected between pins 17 and 18.

An additional alignment of the cross talk is required to avoid sound interference to the image when using AM-sound. Due to the lack of free connections, the DIP-18 case does not provide any possibilities for this. For this reason, a 20-pin case is being prepared.

The video signal with negative-going synchronizing level is connected capacitively to pin 10. The blanking circuit blanks the signal to synchronizing level.

Fluctuations of the video signal of up to 6 dB are compensated for in the control circuit and brought to peak-white level. The VHF/UHF mixer will therefore receive a constant video level from the video buffer.

If pin 12 is grounded, the IC will be switched from negative to positive modulation. The modulation depth can be varied by using a variable resistor connected to pin 12 ($R = \infty$ to $R = 0$).

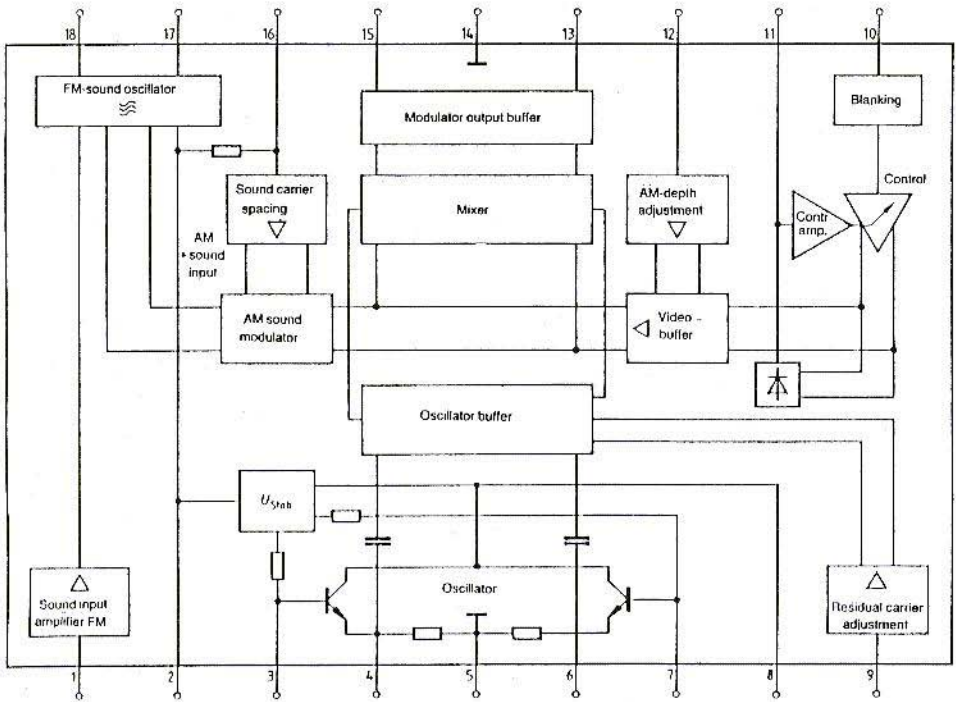

Fig. 2: Block circuit diagram of the TDA 5660P

The internal reference voltage should be bypassed at pin 2. The balanced amplifier of the VHF/UHF oscillator (ECO-circuit) is available at pins 3 to 7. When operating at higher frequencies in excess of 300 MHz, it is possible that a dynamic unbalance of the VHF/UHF mixer must be compensated in order to suppress the residual carrier. This can be made via pin 9.

The ground of the oscillator resonant circuit should also be connected to pin 5. An external oscillator signal can be injected via pins 3 and 7 both inductively and capacitively.

The construction of the PC-board should be made so that a sufficient screening attenuation of approximately 80 dB is present between the oscillator pins 3 to 7 and the modulator outputs 13 to 15.

In order to obtain the best residual carrier suppression, the balanced mixer output (pins 13 and 15) should be connected to a wideband balance transformer having a good phase accuracy. Furthermore, an L-C lowpass filter is required at the output, whose cutoff frequency must be in excess of the maximum operating frequency.

Editorial note:

If this interesting IC is to be used in amateur TV-transmitters, it is necessary for a vestigial sideband filter to be provided. It is not possible to use the well-known IF vestigial filter DJ6PI 004 or OFW 369, since a VHF/UHF filter is required. The editors would be interested to hear from readers who constructed circuits based on this IC.

**MATERIAL PRICE LIST OF EQUIPMENT**

described in edition 2/85 of VHF COMMUNICATIONS

DJ6PI			Loop Yagi Antenna Design for 13 cm.	Art.No.	Ed. 2/1985
PC-board	DJ6PI 014	RT/duroid 5870/0.79mm, 45 x 40		6911	DM 33.—
PC-board	DJ6PI 015	RT/duroid 5870/0.79mm, 65 x 30		6912	DM 34.—
Semi-rigid cable		SR-3		0392 p. cm	DM 0.50
N-connector for cable		SR-3		0426	DM 24.—
Loop yagi antenna for 13 cm, ready-to-operate, with N-connector and mast clamp				0094	DM 195.—
DK10F			PLL Oscillators with Delay Lines. Oscillator Module for the 2-metre-band.		Ed. 2/1985
PC-board	DK10F 047	double-sided etched with thro-contacts		6906	DM 33.—
Components	DK10F 047	2 FET, 2 DG-FET, 4C-diodes 2 Schottky-diodes, 2 Ge diodes 1 ringmixer, 1 Stettner-ceramic coil, 3 coil kits, 2 chokes, 1 two-hole bead, p. 1 m wire 0.15 Ø / 0.8 Ø / 0.1 Ø, 1 coax. trimmer, 2 foil trimmers, 14 ceram. caps., 21 by-pass caps., 3 tantalum caps., 9 feed-thru. caps., 22 resistors		6907	DM 271.—
Crystal	62.5 MHz	XS 6204, HC-43/U		6908	DM 32.—
Crystal	62.9 MHz	XS 6204, HC-43/U		6909	DM 32.—
Kit	DK10F 047	complete, with 1 crystal (mention please!)		6910	DM 329.—

It is now possible for you to order magazines, kits etc. using your **VISA Credit Card!**

To do so, please state your credit-card number and the validity date, and sign your order.

Yours - UKW-BERICHTE/VHF COMMUNICATIONS



UKWtechnik Terry D. Bittan · Jahnstr. 14 · Postfach 80 · D-8523 Baiersdorf

Tel.: West Germany 9133 / 855 · For representatives see cover page 2

Space and Astronomical Slides

Informative and Impressive

VHF COMMUNICATIONS now offers sets of fantastic slides made during the Gemini, Apollo, Mariner, and Voyager missions, as well as slides from leading observatories. These are standard size 5 cm x 5 cm slides which are framed and annotated.

Prices plus DM 3.00 for post and packing.

Sets of 5 NASA-slides DM 8.50 per set

Set 8103	Apollo 11: Earth and Moon
Set 8104	Apollo 11: Man of the Moon
Set 8105	Apollo 9 and 10: Moon Rehearsal
Set 8106	From California to Cap Canaveral
Set 8107	Apollo 12: Moon Revisited
Set 8108	Gemini Earth Views
Set 8109	Apollo 15: Roving Hadley Rille
Set 8110	Apollo 16: Into the Highlands
Set 8111	Apollo 17: Last voyage to the moon
Set 8112	Apollo 17: Last Moon Walks
Set 8113	Mariner 10: Mercury and Venus

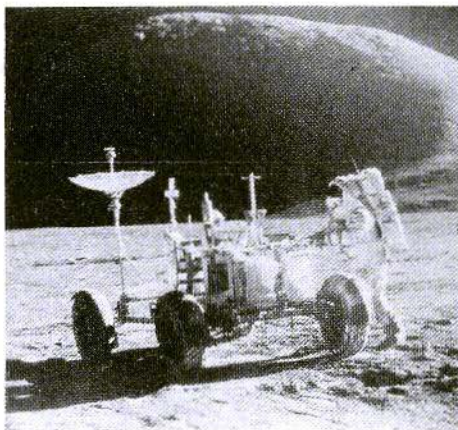

Set 8147 »Jupiter encountered« 20 slides of VOYAGER 1 & 2 DM 35.00

1. Jupiter and 3 satellites 2. The giant planet 3. Jupiter, Io and Europa 4. The Red spot 5. The Red spot in detail 6. The swirling clouds 7. Io and a white oval 8. The neighbourhood of the Red spot 9. The rings of Jupiter 10. The Galilean satellites 11. Amalthea 12. Callisto 13. Impact feature on Callisto 14. Eruption on Io 15. Io full disc 16. Europa close-up 17. Europa distant view 18. Ganymede close-up 19. A distant Ganymede 20. The Iovian system

Set 8100 »Saturn encountered«, 20 VOYAGER-1 slides DM 35.00

1. Saturn and 6 of its moons 2. Saturn from 11 mio miles 3. Saturn from 8 mio miles 4. Saturn from 1 mio miles 5. Saturn and rings from 900.000 miles 6. Saturn's Red spot 7. Cloud belts in detail 8. Dions against Saturn 9. Drone close-up 10. Rhea 11. Craters of Rhea 12. Titan - night side 13. Titan - atmospheric bands 14. Huge crater on Mimas 15. Other side of Mimas 16. Approaching the rings 17. Under the rings 18. Below the rings 19. »Braided« F ring 20. Iapetus

Set 8148 »VOYAGER 2 at Saturn«, 20 VOYAGER-2 slides DM 35.00

1. VOYAGER 2 approaches 2. Clouds & rings 3. Storms & satellites 4. Cyclones, spots & jet streams 5. Convective regions 6. Atmospheric disturbance 7. Rings & shadows 8. The »C« ring 9. Ring details 10. The »A« ring 11. Looking back on Saturn 12. Titan - night side 13. Titan - atmospheric bands 14. The »F« ring 15. Hyperion close-up 16. Iapetus revealed 17. Enceladus explored 18. The Tethys canyon 19. The »F« ring structure 20. Within the Enke division

Set 8102 »The Solar System«, 20 NASA/JPL slides DM 35.00

1. Solar System 2. Formation of the Planets 3. The Sun 4. Mercury 5. Crescent Venus 6. Clouds of Venus 7. Earth 8. Full Moon 9. Mars 10. Mars: Olympus Mons 11. Mars: Grand Canyon 12. Mars: Sinuous Channel 13. Phobos 14. Jupiter with Moons 15. Jupiter Red Spot 16. Saturn 17. Saturn Rings 18. Uranus and Neptune 19. Pluto 20. Comet Ikeya-Seki.

Set 8149 »The Sun in action«, 20 NASA/JPL slides DM 35.00

1. Sun in He light 2. Total Solar eclipse 3. Outer corona 4. Corona from SMM satellite 5. Corona close-up 6. Solar magnetogram 7. Active regions in X-radiation 8. X-ray corona 9. A coronal hole 10. Solar flare 11. Active Sun 12. Eruptive prominence 13. Gargantuan prominence 14. Eruptive prominence 15. Huge Solar explosion 16. Prominence in action 17. Sun in action 18. Magnetic field loops 19. Prominence close-up 20. Chromospheric spray

Set 8144 »Space shuttle«, 12 first-flight slides DM 24.00

1. STS-1 heads aloft 2. View from the tower 3. Tower clear 4. Launch profile 5. Payload bay open 6. STS control Houston 7. In orbit, earth seen through the windows 8. Bob Crippen in mid-deck 9. John Young 10. Approaching touchdown 11. After 54.5 hours in space Columbia returns to Earth 12. Astronauts Crippen and Young emerge after the successful mission

Set 8150 »Stars and Galaxies«, 30 astro color slides, AAT 1977 - 1982, DM 46.00

1. The Anglo-Australian 3.9 m Telescope (AAT) 2. AAT Dome 3. Telescope Control Console 4. An Observer at the Prime Focus 5. Star Trails in the SW 6. Circumpolar Star Trails 7. Centaurus A, NGC 5128 8. The Spiral Galaxy M83 (NGC 5236) 9. The Eta Carinae Nebula 10. An open Cluster of Stars NGC 3293 11. A Planetary Nebula, NGC 6302 12. The Trifid Nebula M20 (NGC 6514) 13. The Cone Nebula 14. S Monoceros and NGC 2264 15. The Helix Nebula, NGC 7293 16. A Wolf-Rayet Star in NGC 2359 17. A Spiral Galaxy, NGC 2997 18. Messier 16 (NGC 6611) 19. The Orion Nebula 20. Dust and Gas in Sagittarius, NGC 6589-90 21. NGC 6164/5, The Nebulosity Around HD 148937 22. Dust Cloud and Open Cluster NGC 6520 23. The Spiral Galaxy NGC 253 24. A Mass-Loss Star, IC 2220 25. The Jewel Box NGC 4755 26. Local Group Galaxy NGC 6922 27. Central Regions of NGC 5128 28. Towards the Galactic Centre 29. The Trapezium 30. The Trifid Stars



UKWberichte Terry D. Bittan · Jahnstr. 14 · Postfach 80 · D-8523 Baiersdorf

Tel. West Germany 9133-855. For Representatives see cover page 2

OUR GREATEST now with reduced dimensions !

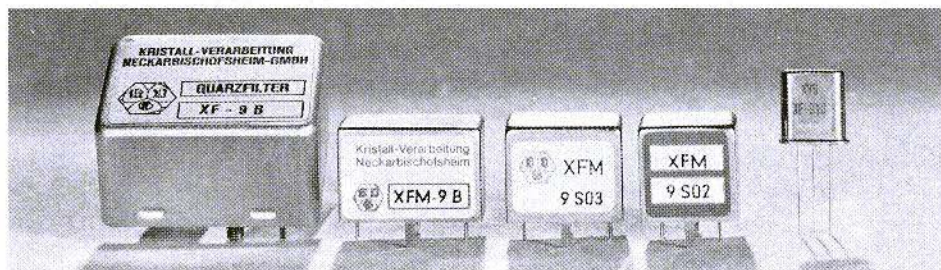

Case: 1 15 14 13 17

DISCRETE CRYSTAL FILTER	Application	MONOLITHIC EQUIVALENT						
		with impedance transformation			without impedance transformation			
		Type	Termination	Case	Type	Termination	Case	
XF-9A	SSB	XFM-9A	500 Ω 30 pF	15	XFM-9S02	1.8 kΩ 3 pF	13	
XF-9B	SSB	XFM-9B	500 Ω 30 pF	15	XFM-9S03	1.8 kΩ 3 pF	14	
XF-9C	AM	XFM-9C	500 Ω 30 pF	15	XFM-9S04	2.7 kΩ 2 pF	14	
XF-9D	AM	XFM-9D	500 Ω 30 pF	15	XFM-9S01	3.3 kΩ 2 pF	14	
XF-9E	FM	XFM-9E	1.2 kΩ 30 pF	15	XFM-9S05	8.2 kΩ 0 pF	14	
XF-9B01	LSB	XFM-9B01	500 Ω 30 pF	15	XFM-9S06	1.8 kΩ 3 pF	14	
XF-9B02	USB	XFM-9B02	500 Ω 30 pF	15	XFM-9S07	1.8 kΩ 3 pF	14	
XF-9B10*	SSB	—	—	—	XFM-9S08	1.8 kΩ 3 pF	15	

* New: 10-Pole SSB-filter, shape factor 60 dB : 6 dB 1.5

Dual (monolithic twopole)

XF-910; Bandwidth 15 kHz, $R_T = 6 \text{ k}\Omega$, Case 17

Matched dual pair (four pole)

XF-920; Bandwidth 15 kHz, $R_T = 6 \text{ k}\Omega$, Case 2 x 17

DISCRIMINATOR DUALS (see VHF COMMUNICATIONS 1/1979, page 45)

for NBFM

XF-909

Peak separation 28 kHz

for FSK/RTTY

XF-919

Peak separation 2 kHz

CW-Filters – still in discrete technology:

Type	6 dB Bandwidth	Crystals	Shape-Factor	Termination	Case
XF-9M	500 Hz	4	60 dB : 6 dB 4.4	500 Ω 30 pF	2
XF-9NB	500 Hz	8	60 dB : 6 dB 2.2	500 Ω 30 pF	1
XF-9P*	250 Hz	8	60 dB : 6 dB 2.2	500 Ω 30 pF	1

* New !

KRISTALLVERARBEITUNG NECKARBISCHOFSHAIM GMBH

D-6924 Neckarbischofsheim · Postfach 61 · Tel. 07263 / 6301

