

October 1965

60 Cents

QST

devoted to the interests of

amateurs

radio



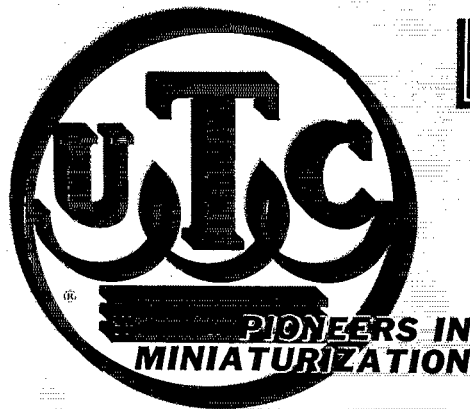

LINEAR STANDARD AUDIO TRANSFORMERS

For over 30 years UTC has been the leader in advancing the art and technology of iron core inductance devices . . . The Linear Standard (LS type) units are the highest quality, non-hermetic, high fidelity transformers of their type. This series includes transformers designed for tube, transistor, hybrid, modulation and matching applications.

With the ever increasing use of wide range equipment, the point has been reached where the major limiting factor is the frequency range of the transformers employed. These LS components represent the closest approach to the ideal transformer from the standpoint of uniform frequency response, low wave form distortion, high efficiency, thorough shielding, and dependability.

LS SERIES

TRANSFORMER TYPES	Pri. Range Ω	Sec. Range Ω	Freq. Range ± 1 db	Max. Level Range
Low Imped. to Grid and Mixing and Matching	2.5 to 5,000	50 to 120,000	7 \sim to 50 KC	+ 15 dbm to + 23 dbm
Interstage and Driver	5,000 to 30,000	50,000 to 135,000	10 \sim to 20 KC	100 mw to 40 W
Hybrid and Repeat Coils	150 to 600	150 to 600	20 \sim to 40 KC	+ 15 dbm to + 18 dbm
Plate, Crystal, Photocell, and Bridging to Line	4,000 to 30,000	50 to 600	7 \sim to 50 KC	200 mw to 400 mw
High Level Matching	50 to 600	1.2 to 600	10 \sim to 40 KC	20 W to 40 W
Output to Line and Voice Coil	8 to 10K	500 to 1.2	7 \sim to 50 KC	20 W to 60 W
Modulation	3K to 10.4K	6000 to 1.2	10 \sim to 50 KC	20 W to 2500 W

BROADCAST HI-FIDELITY HAM COMMERCIAL

IMMEDIATE DELIVERY
From Stock

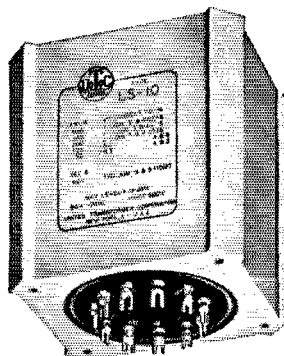

LINEAR STANDARD
HIGH SHIELDING
DIE CAST CASES
TOP & BOTTOM MTG.

LS-1 CASE

Length 3 $\frac{3}{8}$ "
Width 2 $\frac{1}{4}$ "
Height 3 $\frac{1}{4}$ "
Mounting 1 $\frac{1}{4}$ " x 2 $\frac{1}{4}$ "
Screws 6-32
Cutout 1 $\frac{1}{4}$ " dia.
Unit Weight 3 lbs.

Write for latest catalog of over 1,300 STOCK ITEMS with UTC high reliability

UNITED TRANSFORMER CORP.

150 VARICK STREET, NEW YORK 13, N. Y.

PACIFIC MFG. DIVISION: 3630 EASTHAM DRIVE, CULVER CITY, CALIF.

EXPORT DIVISION: 13 EAST 40th STREET, NEW YORK 16, N. Y.

CABLE: "ARLAB"

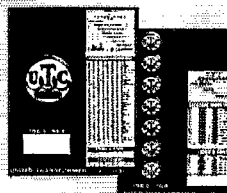

hallicrafters
has harnessed
500 watts of
brute power
for only \$395.



NEW SR-500
Jornado

tri-band transceiver!

Own your own private tornado—500 watts worth of sheer power for the big, effortless signal you've always wanted in a transceiver. And that's just the beginning! You get:

Exclusive Hallicrafters AALC (Amplified Automatic Level Control) providing up to 12 db. of effective compression • RIT (Receiver Incremental Tuning) with ± 3 kc. for superior net and CW operation • A superbly designed crystal lattice filter which makes the most of the desirable SSB transmission characteristics • A built-in changeover relay permits direct operation with the HT-45 or other linear amplifier • Sensitivity is less than $1 \mu\text{v}$ for 20 db. S+N/N ratio • Receiver employs a separate AVC amplifier providing a figure of merit of 100 db. • Price: \$395.00 less power supplies and mobile mounting kit.

Get the full story from your distributor or write for complete specifications today.

"Quality through Craftsmanship"

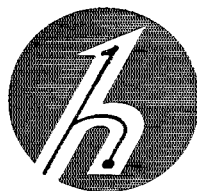

hallicrafters

5th & Kostner Aves., Chicago, Ill. 60624
Export: International Div., Hallicrafters
Canada: Gould Sales Co., Montreal, P.Q.

Winner's Circle

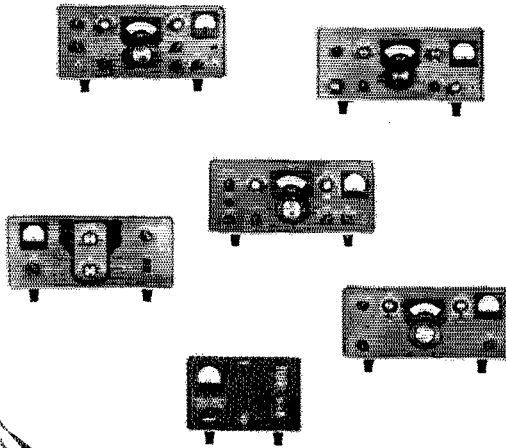

How come so many top DX'ers use Collins S/Line equipment? To say nothing of all those sweepstake winners, RTTY winners, Field Day winners, traffic men, top amateurs everywhere. Collins users already know the answer because they're the winners we're talking about. Collins equipment offers more features than any other. Complete station compatibility; light weight; simplicity and styling; frequency stability; frequency calibration; more QSO's per kilocycle; mechanical filters; dual or single PTO control; automatic load control; negative R-F feedback. Today, some of these once-exclusive features have been incorporated as standard in all amateur rigs. But Collins is still the only equipment which offers *all* these features — and is still unexcelled in any of them. Join the winner's circle. A demonstration of S/Line equipment at your Collins distributor's can be very convincing. And don't forget to check those resale values. You'll be surprised to find out how little it costs to own the finest.



PUBLISHED MONTHLY, AS ITS OFFICIAL ORGAN, BY THE AMERICAN RADIO RELAY LEAGUE, INC. NEWINGTON, CONN., U. S. A.: OFFICIAL ORGAN OF THE INTERNATIONAL AMATEUR RADIO UNION

STAFF

JOHN HUNTOON, WILVQ
Editor

E. LAIRD CAMPBELL, WICUT
Managing Editor

GEORGE GRAMMER, WIDF
Technical Editor

DONALD H. MIX, WITS
BYRON GOODMAN, WIDX
DOUG DE MAW, WICER
Assistant Technical Editors

EDWARD P. TILTON, WIHQD
V.H.F. Editor

LEWIS G. MCCOY, WIICP
Beginner and Novice

DOUGLAS A. BLAKESLEE, WIKLK
Technical Departments

ROD NEWKIRK, W9BRD
SAM HARRIS, W1FZJ
HELEN HARRIS, WIHOY
JEAN PEACOR, K1HV
JOHN TROSTER, W6ISQ
Contributing Editors

MARJORIE B. FORAN
Editorial Assistant

LORENTZ A. MORROW, W1VG
Advertising Manager

EDGAR D. COLLINS
Advertising Assistant

J. A. MOSKEY, W1JMY
Circulation Manager

R. J. RINALDI, KIAFC
Assistant Circulation Manager

OFFICES

225 Main Street
Newington, Connecticut 06111
TEL.: 686-1541
Area Code 203

Subscription rate in United States and Possessions, \$6.00 per year, postpaid; \$6.50 in Canada, \$7.00 in all other countries. Single copies, 60 cents. Foreign remittances should be by international postal or express money order or bank draft negotiable in the U. S. and for an equivalent amount in U. S. funds.

Second-class postage paid at Hartford, Conn. and at additional mailing offices.

Copyright 1965 by the American Radio Relay League, Inc. Title registered at U.S. Patent Office. International copyright secured. All rights reserved. *Quedan reservados todos los derechos* Printed in U.S.A.

INDEXED BY

Applied Science and Technology
Index
Library of Congress Catalog
Card No.: 21-9421

- CONTENTS -

TECHNICAL —

HBR Developments.....	Ted Crosby, W6TC	11
Improved Break-In Keying for Crystal-Controlled Cathode-Keyed Transmitters	Arthur C. Erdman, W8VWX	19
RTTY Indicator Systems.....	Irvin M. Hoff, K8DKC	21
R9/S1.....	Victor D. Poor, K3NIO	33
A "Top-Band" Grounded-Grid Linear Amplifier	Robert Sutherland, W6UOV, and Harold Barber, W6GQK	40
Recent Equipment:		
The Alltronics-Howard Model L RTTY Converter....		51
The Racal RA-71 Receiver.....		52
DynaLab Three-Band Conversion Kit.....		54
A Transistor Preamplifier For 432 Mc.	J. W. Brannin, K6JC	62
The Multimilliammeter	Lawrence F. Shannon, K2KVS	86
New Apparatus:		
Antenna Baluns.....		101

BEGINNER AND NOVICE —

3 + 3 = 4 (?) !.....	Lewis G. McCoy, WIICP	46
----------------------	-----------------------	----

MOBILE —

Improved Vertical Antenna for 2-Meter Mobile	Vern Epp, VE7ABK	32
--	------------------	----

OPERATING —

Fifth World-Wide RTTY Sweepstakes.....		26
Emergency Drill, Deluxe Style	Stephen E. McCallum, K4URX	27
1965 Simulated Emergency Test Announcement.....		30
More Down the Flagpole.....		58
Results — 1965 ARRL DX Competition	Ellen White, WIYYM	64
Armed Forces Day — 1965.....		104

GENERAL —

The Challenge of Milliwatt Power	J. W. Dreher, W2TKG	56	
A Tale of Tornadoes.....	George Hart, WINJM	88	
A DX Vertical With Space Age Features	Percy T. Booth, W7FTA	99	
ARPS.....	58	"It Seems to Us . . .".....	9
Coming Conventions.....	10	Operating News.....	120
Correspondence From Members	49	Operator of the Month.....	123
Hamfest Calendar.....	50	Our Cover.....	10
Happenings of the Month.....	38	Silent Keys.....	176
Hints & Kinks.....	94	Station Activities.....	126
How's DX?.....	107	World Above 50 Mc.....	112
Index to Advertisers.....	190	YL News and Views.....	117
IARU News.....	96	25 Years Ago in QST.....	98

EIMAC salutes W6DNG: first across the Atlantic on 144 Mcs!

On April 11, 1964, W6DNG of Long Beach, California and OH1NL of Nakkila, Finland established two-way 144 Mcs contact via moon-bounce! This record-breaking communication was the result of years of patient effort and experiment. The difficult earth-moon-earth path was successfully conquered by a combination of radio amateur "know-how," enthusiasm, and state-of-the art equipment. High gain antennas, low noise narrow-band receivers and a reliable kilowatt transmitter using Eimac 4CX250B's joined with VHF experience to break the VHF communication barrier between Europe and North America. Eimac joins the A.R.R.L. and all radio amateurs in saluting W6DNG and OH1NL: two radio amateur pioneers, blazing a trail of achievement in long distance VHF communication. EIMAC—a division of Varian Associates, San Carlos, California.

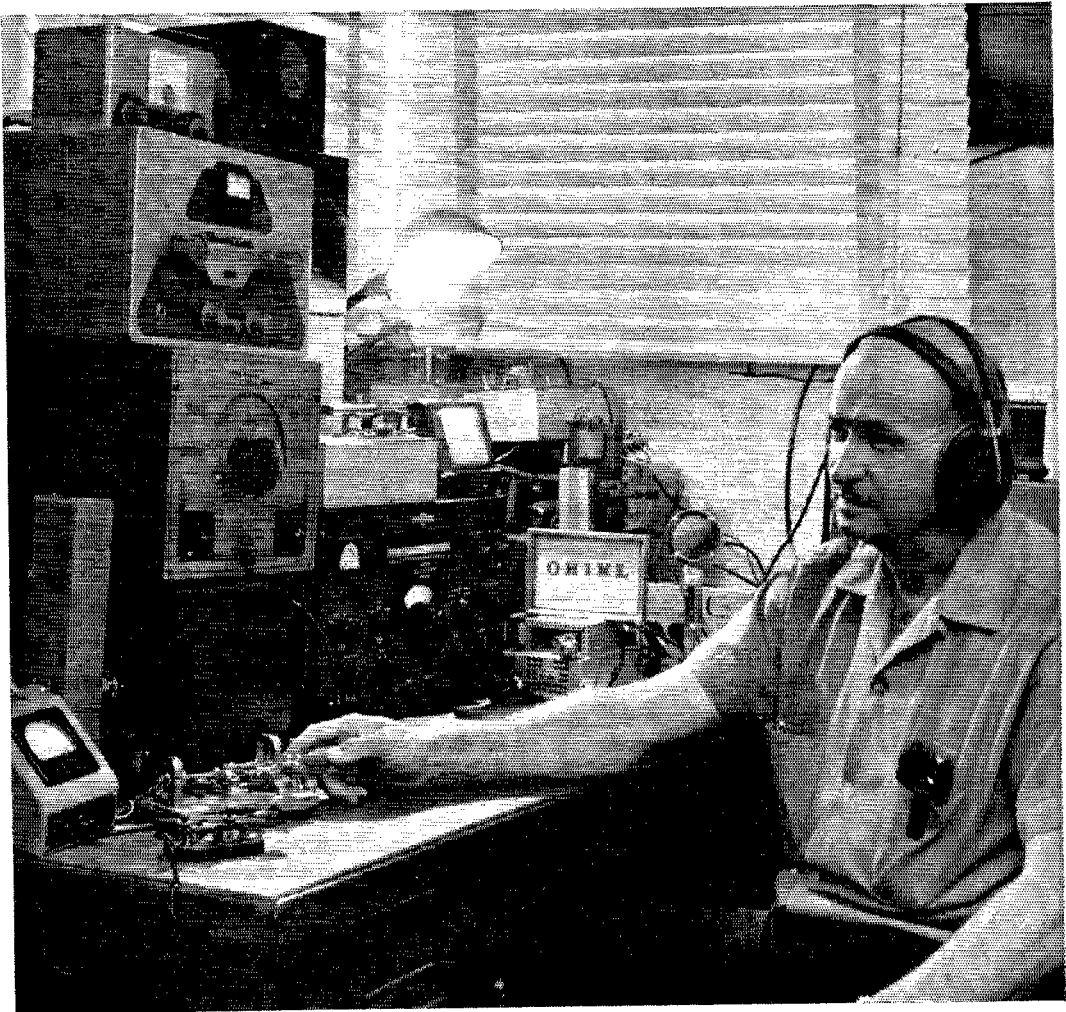

Short on real estate?

18HT

Want maximum multi-band performance on DX as well as short haul communications? Get a

18AVQ



HF VERTICAL

5 models to choose from...

The Incomparable HY-TOWER for 10 thru 80 Meters

By any standard of measurement, the Hy-Tower is unquestionably the finest all-band vertical antenna system on the market today. Delivers outstanding omnidirectional performance on DX as well as short haul contacts. Takes maximum legal power. Feeds with 52 ohm coax. SWR less than 2:1 on all bands. Positive action automatic band selection is provided by unique stub decoupling system that effectively isolates various sections of the antenna so that an electrical 1/2 wavelength (or odd multiple of a 1/4 wavelength) exists on all bands. Structurally, the self-supporting Hy-Tower is built to last a lifetime...withstands 100 MPH gales. If you want the finest, you'll want a Hy-Tower. Model 18HT\$139.50 Net

The New Model 18AVQ. A high-performance all-band vertical for under \$50.00

You asked for it...Hy-Gain built it. A high-performance automatic band switching all-band vertical at a modest price. Features individually tuned Hy-Q traps that provide peaked performance on each band. Takes maximum legal power. Feeds with 52 ohm coax. SWR less than 2:1 on all bands. Simple to install on ground or rooftop - withstands 100 MPH winds when properly guyed. The biggest value all-band vertical available. Model 18AVQ \$49.95 Net
Roof Mounting Kit for Model 18AVQ. Includes adjustable roof saddle, guy wires, hardware and complete instructions for installing. Model 18RMQ \$13.95 Net

The New Model 14AVQ for 10 thru 40 Meters

Improved successor to Hy-Gain's Model 14AVS...the world's most popular automatic band switching vertical for 10 thru 40 meters. Outstanding omnidirectional performance on DX as well as short haul contacts. Features individually tuned Hy-Q traps that provide peaked performance on each band. Takes maximum legal power. Feeds with 52 ohm coax. SWR less than 2:1 on all bands. Easy to install on ground or rooftop - withstands 100 MPH winds when properly guyed. Terrific for portable as well as permanent applications. Model 14AVQ \$29.95 Net
Roof Mounting Kit for Model 14AVQ - Includes adjustable roof saddle, guy wires, hardware and complete instructions for installing. Model 14RMQ \$11.95 Net

The New Model 12AVQ for 10, 15, 20 Meters

A new companion antenna to the Model 14AVQ. Outstanding omnidirectional performance on 10, 15 and 20 meters. Individually tuned Hy-Q traps provide peaked performance on each band. Takes maximum legal power. Feeds with 52 ohm coax. SWR less than 2:1 on all bands. Easy to install on ground or rooftop - withstands 100 MPH winds when properly guyed. Model 12AVQ \$21.95 Net
Roof Mounting Kit for Model 12AVQ - Adjustable roof saddle, guy wires, hardware and complete instructions for installing. Model 12RMQ \$9.50 Net

Economy All-Band 18V

A high performance trapless vertical for 10 thru 80 meters. Tunes to any band by simple adjustment of feedpoint on base matching inductor. Feeds with 52 ohm coax. Heavy gauge aluminum construction - mounts on ground, roof or tower. Exceptional portability. Model 18V \$16.95 Net

Available from your Hy-Gain Distributor or Write

HY-GAIN ELECTRONICS CORPORATION

8400 N.E. Highway 6 - Lincoln, Nebraska 68501

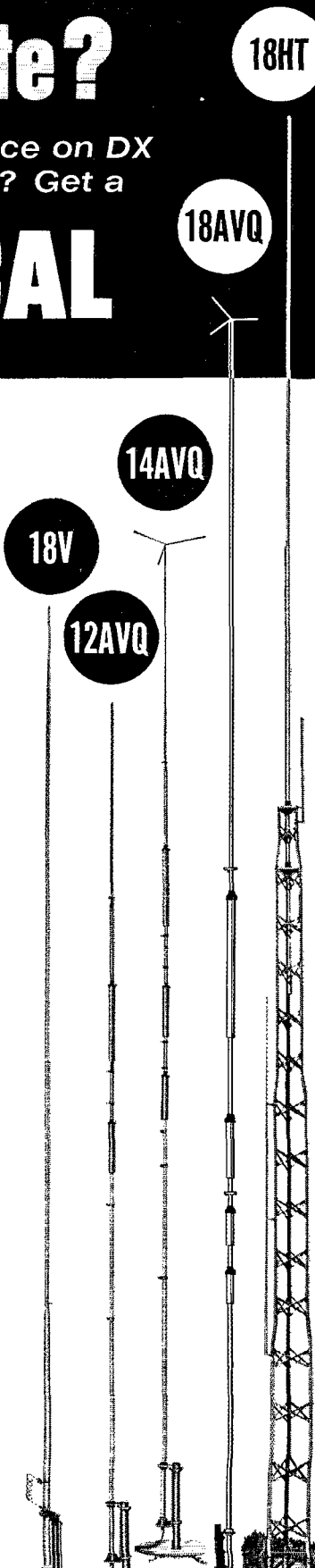

Section Communications Managers of the ARRL Communications Department

Reports Invited. All amateurs, especially League members, are invited to report station activities on the first of each month (for preceding month) direct to the SCM, the administrative ARRL official elected by members in each Section. Radio club reports are also desired by SCMs for inclusion in *QST*. **ARRL Field Organization station appointments** are available in areas shown to qualified League members. General or Conditional Class licensees or higher may be appointed OBS, OES, OPS, OO and OBS. Technicians may be appointed OES, OBS or V.H.F. PAM. Novices may be appointed OES. SCMs desire application leadership posts of SEC, EC, RM and PAM where vacancies exist.

ATLANTIC DIVISION			
Delaware	W31YE	Roy A. Belair	415 Brighton Rd. Wilmington 19809
Eastern Pennsylvania	W3ZRQ	Allen R. Breiner	212 Race St. Tamaqua 18252
Maryland D. C.	W3QA	Bruce Boyd	415 Wickham Rd. Baltimore, Md. 21229
Southern New Jersey	W2BPHV	Albert E. Hankinson	2309 Raymond Drive Northfield 08225
Western New York	K2HUK	Charles T. Hansen	211 Rosemont Drive Buffalo 26
Western Pennsylvania	W3GJY	John F. Wojtkiewicz	1400 Chaplin St. Conway
CENTRAL DIVISION			
Illinois	W9PRN	Edmond A. Metzger	1520 South 4th St. Springfield 62703
Indiana	K91VG	M. Roberta Kroulik	401 El Portal Drive Michigan City
Wisconsin	K9GSC	Keuneth A. Ebneter	822 Wauona Trail Portage 53901
DAKOTA DIVISION			
Minnesota	W0TCK	Herman R. Kopschke, Jr.	RFD 2 Jancville 56048
North Dakota	W0DM	Harold L. Sheets	21 Euclid Ave. Grand Forks
South Dakota	K0TXW	Seward P. Holt	Box 88 Clear Lake
DELTA DIVISION			
Arkansas	W6DTR	Curtis R. Williams	Route 3, Box 230 Little Rock 72205
Louisiana	W5PAL	J. Allen Swanson, Jr.	RFD 1, Box 354-E Covington
Mississippi	W5EMM	S. H. Halston	2321-27th Ave. Meridian
Tennessee	W4UVP	William Scott	115 East Holston Ave. Johnson City 37601
GREAT LAKES DIVISION			
Kentucky	W44KFO	Lawrence F. Jeffrey	1605 Antler Ave. Owensboro 42301
Michigan	W8FX	Ralph P. Thetreau	27209 W. Six Mile Road Detroit 48240
Ohio	W8AL	Wilson E. Weckel	1317 Logan Ave., N.W. Canton 44703
HUDSON DIVISION			
Eastern New York	W2EFU	George W. Tracy	1138 North Country Club Drive Schenectady
N. Y. C. & Long Island	K2HDB	Blaine S. Johnson	266 Cypress St. Massapequa Park, L. I.
Northern New Jersey	W2CVV	Edward F. Erickson	13 Robert Circle South Amboy 08879
MIDWEST DIVISION			
Iowa	W0NTB	Dennis Burke	1418 Douglas Ave. Ames 50010
Kansas	K0BXP	Robert M. Summers	1125 N. 50th Pl. Kansas City 66102
Missouri	W3TPK	Alfred E. Schwaneke	Edgar Star Ate Rolla 65401
Nebraska	W0GGP	Frank Allen	Box 272 Clering 69341
NEW ENGLAND DIVISION			
Connecticut	K1GGG	Fred Tamm	485 Romanock Rd. Fairfield 06432
Eastern Massachusetts	W1ALR	Walter L. Baker, Jr.	85 Solat Ave. Saratoga 02185
Maine	K1DYG	Herbert A. Davis	Lakes Ln. Ellsworth Falls 04634
New Hampshire	W1SWX	Robert Mitchell	Box 137-A, RFD Chestor
Rhode Island	K1AAV	John E. Johnson	30 Fruit St. Pawtucket 02860
Vermont	K1MPN	E. Reginald Murray	3 Hillcrest Drive Montpelier 05601
Western Massachusetts	W1BYR	Percy C. Noble	8 St. Dennis St. Westfield 01085
NORTHWESTERN DIVISION			
Alaska *	KL7ENT	Daniel R. Wright	3206 Wyoming Drive Spennard, 99503
Idaho	K7HLLR	Raymond V. Evans	Route 3 Twin Falls 83301
Montana	W7TYN	Joseph A. D'Arcy	1416 Hagan Ave. Anaconda
Oregon	W7AJN	Everett H. France	3335 S. 15 1/2 Ave. Portland 97266
Washington	W7HMJQ	Iverett E. Young	2217 Fifth St., S.E. Puyallup
PACIFIC DIVISION			
East Bay	K6LRN	Richard Wilson	107 Cordova Way Concord
Hawaii	KH6BZF	Lee R. Wical	45-601 Luluku Rd. Kaneohe 96744
Nevada	W7PBV	Leonard M. Norman	652 Utah St. Boulder City 89005
Sacramento Valley	W6AJUT	John F. Minke, III	4613 Rustic Rd. Carmichael 95608
San Francisco	W6ABAUD	Hugh Cassidy	77 Coleman Drive San Rafael 94901
San Joaquin Valley	W6JFU	Ralph Saroyan	6234 E. Townsend Ave. Fresno
Santa Clara Valley	W6ZRJ	Jenn A. Gredin	10835 Willowbrook Way Cupertino
ROANOKE DIVISION			
North Carolina	W4BNU	Barnett S. Dodd	420 West Franklin St. Salsbury 28144
South Carolina	W4PLD	Charles N. Wright	711 Merrweather Dr. North Augusta 20841
Virginia	W4SHJ	H. J. Hopkins	8600 Hammett Ave. Norfolk 23503
West Virginia	W8JM	Donald B. Morris	1136 Morningsstar Lane Fairmont 26554
ROCKY MOUNTAIN DIVISION			
Colorado	07TBK	Donald Ray Crumpton	P. O. Box 223 Alamosa
New Mexico	WA5FLG	Bill Farley	1306 Spruce Alamogordo
Utah	W7MWR/W7OAD	Marvin C. Zitting	P. O. Box 1813 Salt Lake City 84110
Wyoming	W7CQL	Wayne M. Moore	142 South Montana Ave. Casper 82601
SOUTHEASTERN DIVISION			
Alabama	K4KJD	William S. Crafts	Route 3, Box 233 Athens 35611
Canal Zone	KZ5TD	Thomas B. DeMels	P. O. Box 1111 Balboa
Eastern Florida	K4SJJ	A. L. Hamel	220 N.E. 25th St. Pompano Beach 33064
Georgia	W4RZL	Howard L. Schonher	P. O. Box 1902 Columbus 31902
West Indies (P.R.-V.I.)	K14JH	Jose E. Saldaña	Box 222 Hato Rey, P.R.
Western Florida	W4RKH	Frank M. Butler, Jr.	404 Elliott Rd. Fort Walton Beach 32548
SOUTHWESTERN DIVISION			
Arizona	W7FKK	Floyd C. Colyar	3411 West Pierson St. Phoenix 85017
Los Angeles	W6BHG	H. G. Gaman	3732 Chabwin Ave. Long Beach 90808
Orange	W6DEY	Roy R. Maxson	1434 South Olive st. Santa Ana 92707
San Diego	W6LRU	Don Stansifer	4427 Pescadero San Diego 92107
Santa Barbara	W6OKN	Cecil D. Hinson	1933 Coventry Court Thousand Oaks
WEST GULF DIVISION			
Northern Texas	W5BNG	L. L. Harbin	4515 Calmont Fort Worth 76107
Oklahoma	K5KTW	Bill F. Lund	1220 S. Owasso Tulsa 74120
Southern Texas	W5AIR	G. D. Jerry Sears	5634 Eskridge St. Houston
CANADIAN DIVISION			
Alberta	VE6TG	Harry Harrold	1834-6th Ave. N. Lethbridge, Alta.
British Columbia	VE7FB	H. E. Savage	4553 West 12th Ave. Vancouver 8, B. C.
Manitoba	VE4JT	John Thomas Stacey	19 Cottonwood Cres. Brandon
Maritime	VE1WB	D. E. Weeks	Harvey Station, N. B.
Ontario	VE3NG	Richard W. Roberts	Willowdale, Toronto, Ont.
Quebec	VE2DR	C. W. Skarstedt	Pointe Claire, Montreal 33, P. Q.
Saskatchewan	VE5QC	Mel Mills	P.O. Box 801 Saskatoon

* Official appointed to act temporarily in the absence of a regular official

INTERNATIONAL FREQUENCY METERS

 *designed for servicing!*

Equip your lab or service bench with the finest . . .
Discover new operating convenience.

FM-5000 FREQUENCY METER 25 MC to 470 MC

The FM-5000 is a beat frequency measuring device incorporating a transistor counter circuit, low RF output for receiver checking, transmitter keying circuit, audio oscillator, self contained batteries, plug-in oscillators with heating circuits covering frequencies from 100 kc to 60 mc. Stability: $\pm .00025\%$ $+85^{\circ}$ to $+95^{\circ}$ F, $\pm .0005\%$ $+50^{\circ}$ to $+100^{\circ}$ F, $\pm .001\%$ $+32^{\circ}$ to $+120^{\circ}$ F. A separate oscillator (FO-2410) housing 24 crystals and a heater circuit is available. Dimensions: FM-5000, $10" \times 8" \times 7\frac{1}{2}"$.

FM-5000 with batteries, accessories and complete instruction manual, less oscillators, and crystals. Shipping weight: 18 lbs. Cat. No. 620-103 \$375.00
 Plug-in oscillators with crystal \$16.00 to \$50.00

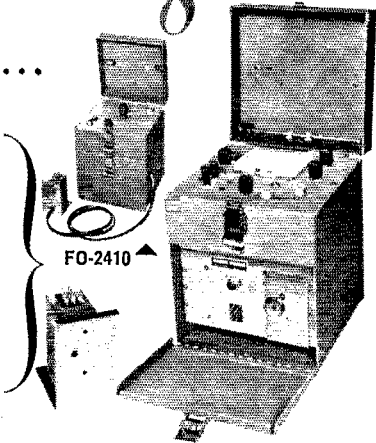

FO-2410

C-12B FREQUENCY METER For Citizens Band Servicing

This extremely portable secondary frequency standard is a self contained unit for servicing radio transmitters and receivers used in the 27 mc Citizens Band. The meter is capable of holding 24 crystals and comes with 23 crystals installed. The 23 crystals cover Channel 1 through 23. The frequency stability of the C-12B is $\pm .0025\%$ 32° to 125° F, $.0015\%$ 50° to 100° F. Other features include a transistorized frequency counter circuit, AM percentage modulation checker and power output meter.

C-12B complete with PK (pick-off) box, dummy load and connecting cable, crystals and batteries. Shipping weight: 9 lbs. Cat. No. 620-101 \$300.00

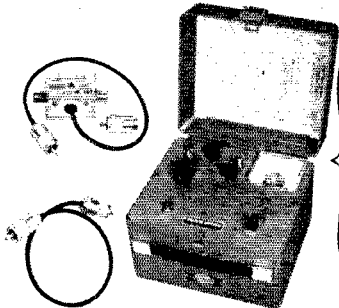

C-12 CRYSTAL CONTROLLED ALIGNMENT OSCILLATOR

The International C-12 alignment oscillator provides a standard for alignment of IF and RF circuits 200 kc to 60 mc. It makes the 12 most used frequencies instantly available through 12 crystal positions 200 kc to 15,000 kc. Special oscillators are available for use at the higher frequencies to 60 mc. Maximum output .6 volt. Power requirements: 115 vac.

C-12 complete, but less crystals. Shipping weight: 9 lbs. Cat. No. 620-100 . . \$69.50

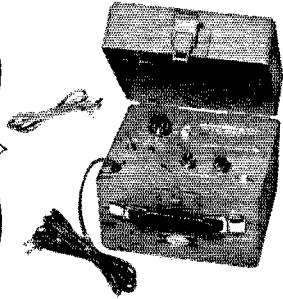

C-12M FREQUENCY METER For Marine Band Servicing

The International C-12M is a portable secondary standard for servicing radio transmitters and receivers used in the 2 mc to 15 mc range. The meter has sockets for 24 crystals. The frequency stability is $\pm .0025\%$ 32° to 125° F, $\pm .0015\%$ 50° to 100° F. The C-12M has a built-in transistorized frequency counter circuit, AM percentage modulation checker and modulation carrier and relative percentage field strength.

C-12M complete with PK (pick-off) box and connecting cable, batteries, but less crystals. Shipping weight: 9 lbs. Cat. No. 620-104 \$235.00
 Crystals for C-12M (specify frequency) \$5.00 ea.

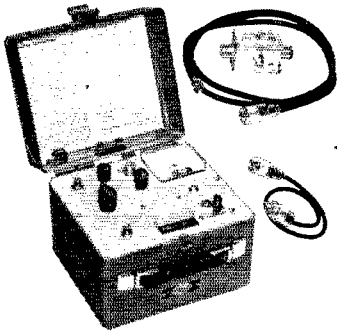

KEEPING YOU ON FREQUENCY IS OUR BUSINESS...

Write today for our FREE 1965 CATALOG



18 NORTH LEE OKLAHOMA CITY, OKLAHOMA

THE AMERICAN RADIO RELAY LEAGUE, INC.,

is a noncommercial association of radio amateurs, bonded for the promotion of interest in amateur radio communication and experimentation, for the relaying of messages by radio, for the advancement of the radio art and of the public welfare, for the representation of the radio amateur in legislative matters, and for the maintenance of fraternalism and a high standard of conduct.

It is an incorporated association without capital stock, chartered under the laws of Connecticut. Its affairs are governed by a Board of Directors, elected every two years by the general membership. The officers are elected or appointed by the Directors. The League is noncommercial and no one commercially engaged in the manufacture, sale or rental of radio apparatus is eligible to membership on its board.

"Of, by and for the amateur." It numbers within its ranks practically every worth-while amateur in the nation and has a history of glorious achievement as the standard-bearer in amateur affairs.

Inquiries regarding membership are solicited. A bona fide interest in amateur radio is the only essential qualification; ownership of a transmitting station and knowledge of the code are not prerequisite, although full voting membership is granted only to licensed amateurs.

All general correspondence should be addressed to the administrative headquarters at Newington, Connecticut.



Past Presidents

HIRAM PERCY MAXIM, W1AW, 1914-1936
EUGENE C. WOODRUFF, W8CMP, 1936-1940
GEORGE W. BAILEY, W2KH, 1940-1952
GOODWIN L. DOSLAND, W8TSN, 1952-1962
(President Emeritus)

Officers

President HERBERT HOOVER, JR., W6ZH
900 Wilshire Blvd., Los Angeles, California 90017

First Vice-President WAYLAND M. GROVES, W5NW
1406 West 12th Street, Odessa, Texas 79761

Vice-President FRANCIS E. HANDY, W1BDI
225 Main St., Newington, Connecticut 06111

Vice-President ALEX REID, VE2BE
240 Logan Ave., St. Lambert, P. Q., Canada

Secretary JOHN HUNTOON, W1LWQ

Treasurer DAVID H. HOUGHTON
225 Main St., Newington, Connecticut 06111

Secretary & General Manager Emeritus, A. L. BUDLONG, W1BUD

General Manager JOHN HUNTOON, W1LWQ

Communications Manager FRANCIS E. HANDY, W1BDI

Technical Director GEORGE GRAMMER, W1DF

Assistant General Manager RICHARD L. BALDWIN, W1IKE

Assistant Secretaries PERRY F. WILLIAMS, W1UED
GARY L. FOSKETT, W1ECH
225 Main St., Newington, Connecticut 06111

General Counsel ROBERT M. BOOTH, JR., W3PS
1100 Vermont Avenue, N. W., Washington, D. C. 20005

Associate Counsel ARTHUR K. MEEN, VE3RX
Suite 2212, 44 King St. West, Toronto 1, Ont.

DIRECTORS

Canada

NOEL B. EATON VE3CJ
R.E. 3 Burlington, Ontario

Vice-Director: Colin C. Dumbrille VE2BK
116 Oak Ridge Drive, Bale d'Orfee, Quebec

Atlantic Division

GILBERT L. CROSSLEY W3YA
734 West Poster Avenue, State College, Pa. 16801

Vice-Director: Edwin S. Van Dousen W3FCP
3711 McKinley St., N.W., Washington, D.C. 20015

Central Division

PHILIP E. HALLER W9HFG
6000 S. Tripp Ave., Chicago, Ill. 60629

Vice-Director: Edmond A. Metzger W9PRN
1520 South Fourth St., Springfield, Illinois 62703

Dakota Division

CHARLES G. COMPTON W0BUO
1011 Fairmount Ave., St. Paul, Minn. 55105

Vice-Director: Charles M. Bove W0MXC
1611 1/2 East Lake St., Minneapolis, Minn. 55407

Delta Division

PHILIP P. SPENCER W5LDH/W5LXX
29 Snipe St., Lake Vista, New Orleans, La. 70124

Vice-Director: Franklin Cassen W4WBF
925 North Trezevant St., Memphis, Tenn. 38108

Great Lakes Division

DANA E. CARTWRIGHT WRUPB
2979 Observatory Ave., Cincinnati, Ohio 45208

Vice-Director: Charles C. Miller W8JSU
4872 Calvin Drive, Columbus, Ohio 43227

Hudson Division

HARRY J. DANNALS W2TUK
RFD 1, Arbor Lane, Dix Hills, Huntington,
N. Y. 11743

Vice-Director: Stan Zak K2SJO
13 Jennifer Lane, Port Chester, New York 10573

Midwest Division

ROBERT W. DENNISTON W0NWX
Box 73, Newton, Iowa 50208

Vice-Director: Sumner H. Foster W0GQ
2315 Linden Dr., S.E., Cedar Rapids, Iowa 52403

New England Division

ROBERT YORK CHAPMAN W1QV
28 South Road, Groton, Conn. 06340

Vice-Director: Rigelow Green W1EAE
236 Marlboro St., Boston, Mass. 02116

Northwestern Division

ROBERT B. THURSTON W7PGY
7700 31st Ave., N.E., Seattle, Wash. 98115

Vice-Director: R. Rex Roberts W7CZY
837 Park Hill Drive, Billings, Mont. 59102

Pacific Division

HARRY M. ENGWICHT W6HC
770 Chapman, San Jose, Calif. 95126

Vice-Director: Ronald G. Martin W6ZFF
1573 Baywood Lane, Napa, Calif. 94558

Ranoke Division

P. LANIER ANDERSON, JR. W4MWH
428 Maple Lane, Danville, Va. 24541

Vice-Director: Joseph F. Abernethy W4AKC
764 Colonial Drive, Rock Hill, S.C. 29730

Rocky Mountain Division

CARL L. SMITH W0BWW
1070 Locust St., Denver, Colo. 80220

Vice-Director: John H. Sampson, Jr. W7OCX
3618 Mount Ogden Drive, Ogden, Utah 84403

Southeastern Division

THOMAS M. MOSS W4HYW
P.O. Box 578, East Point, Ga. 30044

Vice-Director: Charles J. Bolvin W4LVV
2210 S.W. 27th Lane, Miami, Fla. 33133

Southwestern Division

HOWARD F. SHEPHERD, JR. W6QJW
127 South Citrus Avenue, Los Angeles, Calif. 90036

Vice-Director: John F. Martin W8ECP
1135 Crest Drive, Encinitas, Calif. 92024

West Gulf Division

ROEMER O. BEST W5QKF
P.O. Box 1656, Corpus Christi, Texas 78403

Vice-Director: Ray K. Bryan W5UYQ
2117 S.W. 61st Terrace, Oklahoma City, Okla.
73159

"It Seems to Us..."

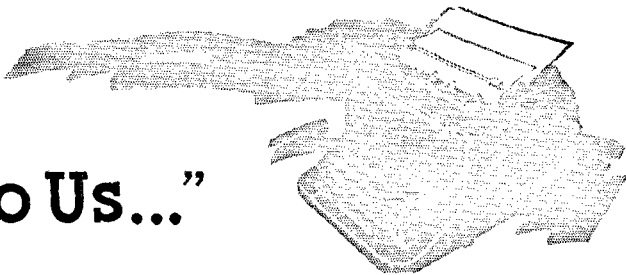

EMERGENCY COMMUNICATION

In 1913 one of the first recorded instances of amateur emergency communication took place in a middle west area left isolated by windstorm. Since that time amateur radio has often been the first, and sometimes the only, means of communication between stricken areas and the outside world. Among our outstanding performances have been the 1936 floods in the northeast, the Louisiana hurricane disaster of 1957, the Alaskan earthquake of 1964. In each of these, hams by the thousands manned their equipment around the clock, providing vital links for government and relief agencies efforts to save lives and property.

The position of the amateur in the general field of disaster communications has changed considerably in recent years. Police, fire, utilities, taxicab and similar radio facilities, once almost non-existent, today can and do furnish a considerable portion of emergency needs. Even CB gets into the act, and when intelligently operated can be a useful adjunct. In real emergency, the aim is to achieve communications through whatever facility is available and — if there is a choice — most useful.

While organized amateur units, particularly AREC, still maintain a high state of communications readiness, there has been a noticeable drop of individual interest in recent years. Perhaps it's apathy. Perhaps it's an erroneous feeling that hams can't be as useful as in the past. We'd like to make a few comments and offer a few reminders.

Amateur radio exists because it functions in the "public interest, convenience or necessity." Unfortunately every amateur is not required to prove his own personal performance in this area; we are judged as a group, over-all. Thus we have some free-loaders riding on the public service efforts of the rest of us. But the broad record of achievement must still remain high.

Possibly many of us do not realize the extent to which we, particularly in Canada and the U.S., have the *opportunity* to provide emergency communications. Many amateurs in other parts of the world are denied such privileges. There have been instances in Europe, in the past, when officials at the scene of a critical emergency refused offers by amateurs, and insisted upon waiting for the

delayed arrival of a government communications mobile unit! In another case, an amateur was convicted and fined for handling traffic for relief agencies in a serious emergency, on the charge he had violated rules against third-party traffic! Count your blessings, VEs and W/Ks.

Emergency work is the most important form of public service because it is the most direct. While technical developments, special communications projects, enhancing international good-will or advancing to a higher grade of license all serve to increase our stature, there is nothing like direct contact with the public interest in emergency communication to put us over. And emergency communication is a field all of us can prepare for.

The League's Amateur Radio Emergency Corps., a division of ARPS, is the vehicle precisely tailored to this objective. Another in its series of nation-wide tests is scheduled this month (see pp. 30).

We can't say enough in praise for volunteer field workers — particularly SECs and ECs — who devote so much of their personal time to organize and plan the local and sectional groups for maximum performance when the flood or hurricane or tornado strikes. They need more of your help and cooperation — and participation. Regular drills and meetings admittedly sometimes get boring after a while, but continuing familiarity and practice is essential in preparing to do a good job. (Can you imagine the status of our country's defense if the Strategic Air Command crews let themselves get bored and indifferent in their daily drill missions and flights?) Yes, we're volunteers, but in a good cause — personal satisfaction, the knowledge that we are contributing to our community, and — equally important — to our beloved amateur radio, in improving its record of public service readiness and performance.

Participation in an emergency group is far from being all work and no play, all duty and responsibility and no fun. There is just no substitute for the camaraderie and cohesiveness and spontaneous enthusiasm of a group of hams who are proud of themselves and proud of each other — and know that what they are doing is the greatest thing in amateur radio. So don't stay out of it because it's "no fun." It's the greatest sport there is!

Would you know what to do when disaster strikes? How could you best help? What frequency or band would be most appropriate? Who is your local Emergency Coordinator? What plans exist for group endeavor?

If not, start learning and doing today! Inquire of your local club officers for first contact. If that fails to put you in touch with the EC, write the appropriate SEC (page 31 this issue), the SCM listed on page 6 of this and every issue of *QST*, or to Hq. Enlist in

the AREC and cooperate with your EC. Should you find there is none at the moment, get together with other hams in the area and select a candidate for recommendation to the SCM.

There is still plenty of opportunity for the amateur service to show its mettle in the field of emergency communication. To achieve this end, and further accomplish the long-term preservation of amateur radio, the League needs your support.

QST

COMING A.R.R.L. CONVENTIONS

October 1-3 — Ontario Province, Sudbury

January 22-23, 1966 — Southeastern Division, Miami, Florida

March 19-20, 1966 — Michigan State, Saginaw

April 22-24, 1966 — ARRL National, Boston, Massachusetts

May 28-29, 1966 — Roanoke Division, Natural Bridge, Virginia

May 27-29, 1966 — Southwestern Division, Anaheim, California



Winners of the Pennsylvania Junior Academy of Science State Congress this year include several radio amateurs. K3ZDR took second place and WA3CZJ received honorable mention, both in physics. It was their second year representing the center of the state at the competition. Other hams participating in the affair were K3PMC and KN3TXW.

We regret to report the death by electrocution of another radio amateur. After an evening of operating, 9M4GT reached over and switched off his desk lamp and was electrocuted. Shock was not from the high voltage in the radio equipment, but from the a.c. mains current. This is a tragic reminder to ground *all* equipment, even the desk lamp. Switch to Safety.

On June 21, 150 Science-Fair winners from all over the U. S. were given a one-week cruise aboard a U. S. Navy ship at Norfolk, Va. Among the Science Fair "crew" were K3UEM, K3YYJ, K3QVA, KN3BPD, WA4QMP, WA4DMC, WN4VUF, KN4WNT, WA5MLF, WA8LEI, WA9IHT, WN9POA, WA9IZR, and K0FCW.

John Spooner, K2JCG, Plant Manager of RCA's Somerville (New Jersey) semiconductor plant, recently received the U. S. Air Force Zero Defects Program Participation Award on behalf of RCA employees. The award is part of a program to achieve greater efficiency by encouraging and motivating people to do their jobs right the first time. The plant has shown better than a 20-per cent improvement in over-all quality levels, in spite of a substantial increase in production schedules. The Somerville plant manufactures and engineers many types of transistors and semiconductor devices.

Northern California hams are invited to tune in to a new program on amateur radio presented each Sunday at 10:15 A.M. on KPFA (94.1 Mc. f.m.). Gene Bergman, WB6LBU, prepares the weekly program which covers all aspects of amateur radio.

K9LQE sends in these "key twisters" for practice on your hand or bug key: Horses possess horseshoes; pisces horoscope prophesies cheer es hope; specs es eyepieces espy eyesores; sorcerers choose error es oppress psychos; spicy sez she es poohpooh es heresy sez he; roscoe and rose ross cherish irish roses es choose Ohio or Hoosier poppies.

K9CRP/5, 1600 Bernard St., Denton, Texas 76201, would like to hear from other radio amateurs interested in pyrotechnics and amateur rocketry.

The Post Office Department promises faster mail service with the new Zip codes. Use yours when you write League Headquarters. Use ours, too. It's 06111.

Father Raoul Lapointe, VE2AHW, has published a "Little Dictionary for Listeners of the Short Waves." The dictionary is basically English-to-French and contains technical, operating and general-term words and phrases. Single copies are 50¢. Any profits from the sale of the dictionary will be used to assist missions in Haiti. Order directly from VE2AHW, c.p. 700, Bagetville, P. Q., CANADA.

OUR COVER

Starting on page 64 of this issue is the full report of the 1965 ARRL International DX Competition. A few of the active participants in this popular ARRL contest are shown on our cover. They are: Top row (L to R), PY2SO, 2nd high PY c.w. and top YL score; CR4BB, Cape Verde c.w. leader; VK2EO, third high VK c.w. Second row, VP3HAG, British Guiana phone score of over 250,000; YV5BKA, 2nd high YV c.w. Third row FG7XL (and XYL), top single-operator phone in North America; DM4YPL (now DM2-CZL), top German c.w. Fourth row, EP2RC (K1KOM), top Iran c.w.; EA4GZ, top European phone single operator; PJ3CD, 2nd high phone in Netherlands Antilles.

HBR Developments

Improved Selectivity and Tuning Ease

BY TED CROSBY,* W6TC

A good basic design can live on indefinitely, with the help of occasional modernization and improvement. Such has been the history of W6TC's series of HBR receivers. Here are the latest of indefatigable Ted's refinements, most of them incorporated in the HBR-13C illustrated. The receiver itself is the handiwork of WA4ZNI.

I AM reminded of the fellow who had the bear by the tail and couldn't let go. Substitute "HBR Receiver" for "bear" and you'll have my predicament exactly!

Little did I realize what I was getting into when the HBR-14 communications receiver was described in the July 1957 issue of *QST*. Over the intervening years that original design has been progressively modified and refined, with the popularity of the HBR receivers snowballing all the while. Somewhere along the line one would think that finally there would come a time when the subject matter would have been covered sufficiently and the project could be allowed to live or die on its own merits, but always there remain some loose ends.

Primarily this will be a manuscript covering such "loose ends," and not a detailed description of the HBR-13C which graces the pages of this article. This particular receiver is rather complex and is not recommended as a suitable

project for the inexperienced, but it will serve admirably as an example of some of the loose ends to be discussed subsequently. Many of its circuit modifications and refinements are easily adaptable to its less pretentious predecessors.

In large part, the HBR-13C is the brain child of my good friend and collaborator, Alex Stewart, WA4ZNI. In his approach to me for any worthwhile suggestions for this, his third HBR receiver, Alex had two primary thoughts in mind: first, the receiver must be built with standard and easily obtainable parts; second, the 898 Eddystone dial must be centrally located. As for the circuitry and chassis layout, he was wide open to any and all suggestions.

The transformer-coupled 1610-kc. first-i.f. amplifier stage, back-to-back 100-kc. transformer-coupled second-i.f. input stage, and 6BC5 first mixer, plus some additional minor modifications, had proved satisfactory in some of my own equipment and the circuits were passed along to Alex, together with some suggestions for a workable chassis layout. He took it from

*23901 Crosby Drive, Sun City, California 92381.

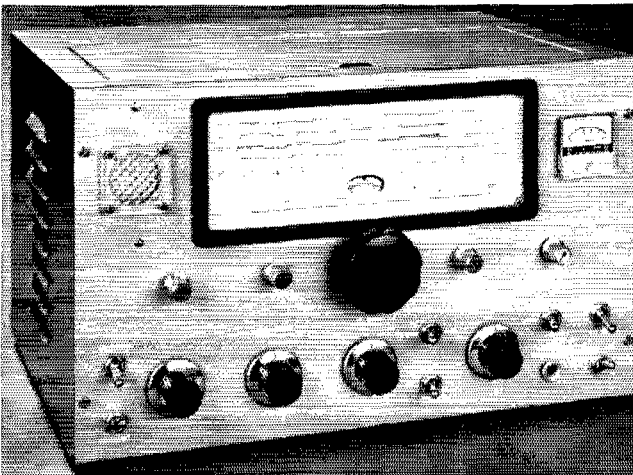

The HBR-13C, built by Alexander Stewart, WA4ZNI, is the basic HBR-11 or HBR-12 plus the additions and modifications described in the text. Major electrical changes are the addition of an amplifier stage at the first intermediate frequency (1610 kc.) and one more transformer in the 100-kc. second-i.f. amplifier. The mechanical arrangement permits centering the large Eddystone dial.

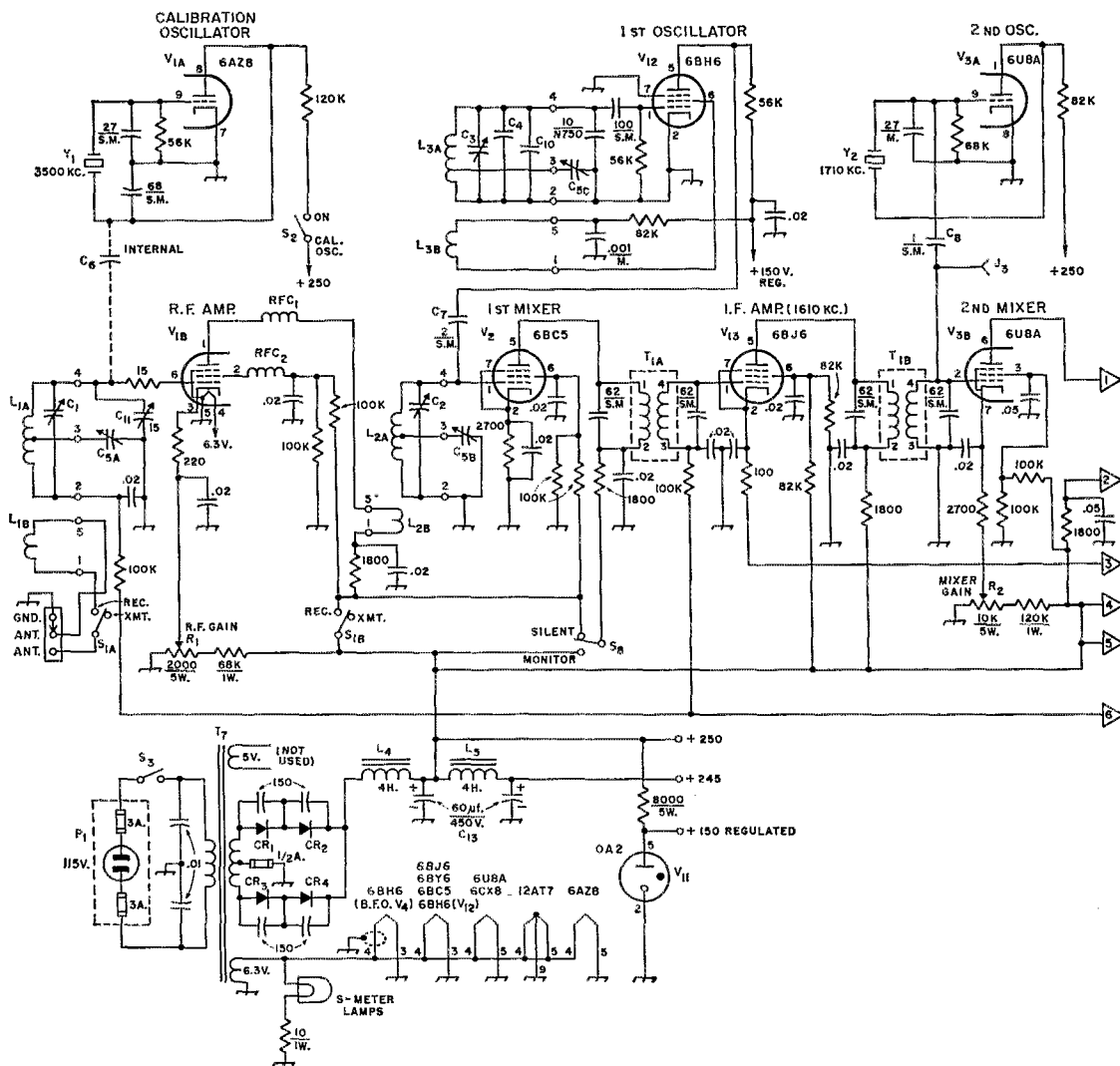

Fig. 1—Circuit diagram of the HBR-13C. Fixed resistors are $\frac{1}{2}$ -watt composition unless otherwise indicated. Fixed capacitors are ceramic except M = mica, SM = silver mica, P = paper or Mylar.

C₁, C₂, C₃, C₄, C₁₀—See coil tables.

C₅—3-section variable, 5.5-23 pf. per section (Miller 2102).

C₆—Internal tube capacitance; external capacitance not required.

C₇—2-pf. dipped silver mica.

C₈—1-pf. dipped silver mica.

C₉—10-pf. variable, screwdriver adjustment (Hammarlund MAPC-15, cut down to two rotor and two stator plates).

C₁₁—15-pf. variable (Hammarlund MAPC-15B).

C₁₂—50-pf. variable (Hammarlund MAPC-50B).

C₁₃—Dual electrolytic, 60 μ f. per section, 450 volts (Sprague TUL-2772 or equivalent).

CR₁—CR₄, inc.—Silicon, 600 volts p.i.v. (International Rectifier type 1N1096, or equivalent).

CR₅—High back-resistance diode (1N54 or equivalent).

J₁, J₂—Open-circuit phone jack.

J₃, J₄—Pin jack (insulated type).

L₁, L₂, L₃—See tables.

there, adding some ideas of his own. The appearance of the finished product speaks for itself, while the receiver's performance actually is superior to its eye appeal.

Those readers who have followed this *QST* series and possess the necessary background and skill will find the construction of an HBR-13C

relatively simple. For the newly interested, the June 1961 *QST* article, in which the need for the reasonably large cabinet and subchassis-mounted front end was explained, if the large No. 898 Eddystone dial is to be employed, would be mandatory reading. Of equal importance, the March, 1963, April, 1963, April, 1964,

EXCEPT AS INDICATED, DECIMAL VALUES OF CAPACITANCE ARE IN MICROFARADS (μf .); OTHERS ARE IN PICOFARADS (pf. OR $\mu\mu\text{f}$.); RESISTANCES ARE IN OHMS; $K = 1000$

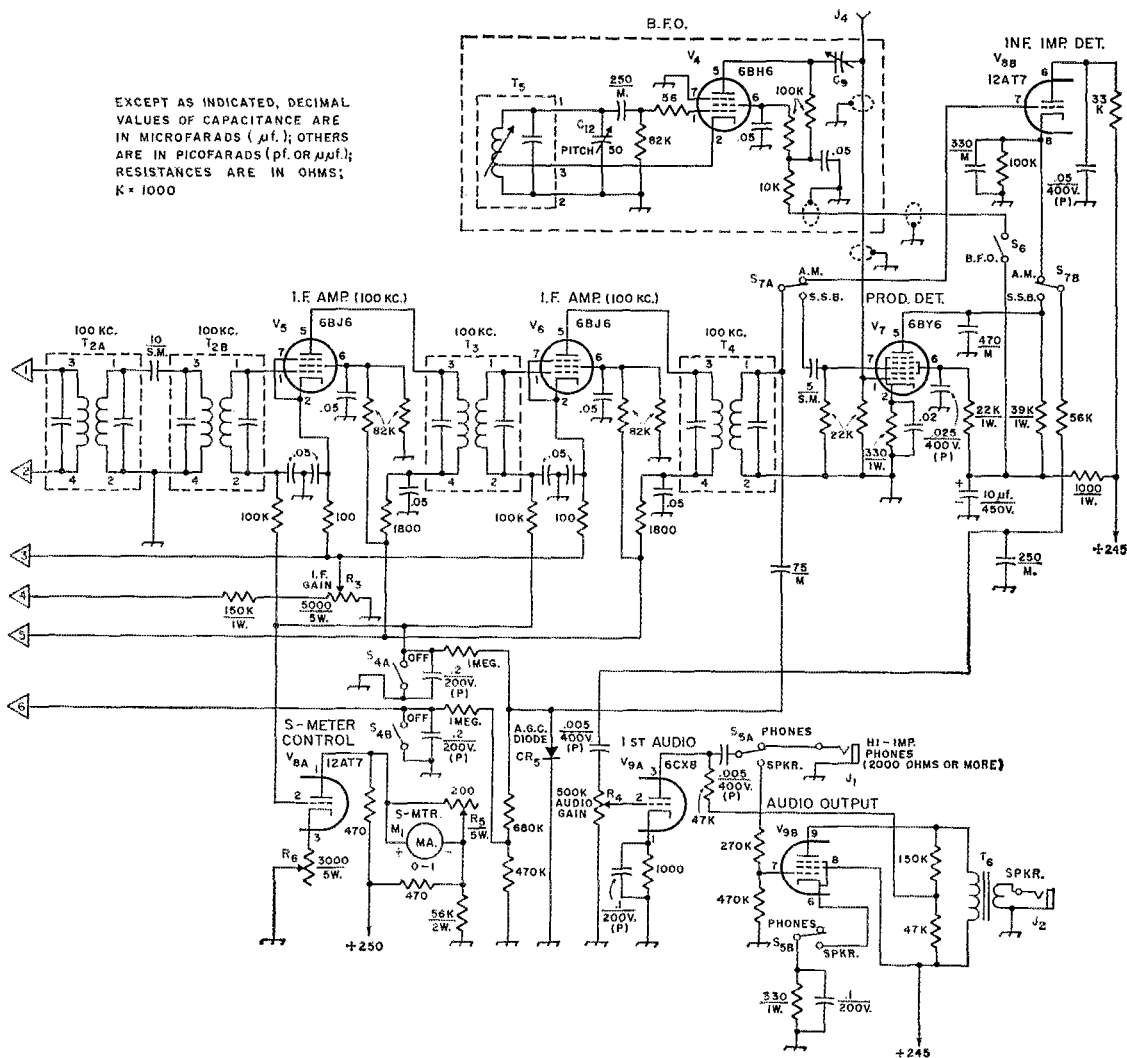

- L₄, L₅—4 henrys, 90 ma. (Triad C-9X).
- M₁—0-1 d.c. milliammeter (Lafayette 99-2513 or equivalent).
- P₁—Fused line plug for type 3AG fuses.
- R₁, R₂, R₃, R₅, R₆—Wire-wound control, not over 1/4 inch in diameter (Centratub WW or equivalent).
- R₄—0.5-megohm control, audio taper.
- RFC₁—22 turns No. 22 enamel, close-wound, inside diameter 1/8 inch, self-supporting.
- RFC₂—12 turns No. 22 enamel, close-wound, inside diameter 1/8 inch, self-supporting.
- S₁, S₄—D.p.s.t. toggle (must be small 3-amp. type).
- S₂, S₃, S₆—S.p.s.t. toggle (must be small 3-amp. type).
- S₅, S₇—D.p.d.t. toggle (must be small 3-amp. type).

- S₈—S.p.d.t. toggle (Must be small 3-amp. type).
- T_{1A}, T_{1B}—1800-kc. i.f. transformer, slug-tuned (Miller 1730); padded with 62-pf. silver-mica capacitors and tuned to 1610 kc.
- T_{2A}, T_{2B}, T₃, T₄—100-kc. i.f. transformers, slug-tuned (Miller 1709 or 1710; see text).
- T₅—100-kc. b.f.o. coil, slug-tuned (Miller 1711).
- T₆—Audio output; 7000/4 ohms, 40 ma. primary (Triad S-7X or Stancor A3878).
- T₇—Power transformer; 520 to 550 volts c.t., 90-110 ma.; 6.3 volts, 4-5 amp. (Stancor PC-8420 or Triad R-12A).
- Y₁—3500-kc. crystal.
- Y₂—1710-kc. crystal.

and July, 1964, issues of *QST* contained articles covering the general constructional and alignment procedures applicable to all HBR receivers. With this material almost any amateur of average background and building experience should be able to take it from there. It has always been my aim to keep the design

of an HBR receiver as simple and straightforward as possible, although never overlooking the fact that the receiver must do a first-class job. The several modifications to be discussed were made with that thought in mind; to be most effective as to results, but not difficult in application.

The Transformer-Coupled First-I.F. Amplifier

This modification provides two additional tuned circuits at this point in the circuit for improved nearby-channel selectivity, as well as an appreciable increase in gain.

My own HBR-12 was modified by mounting the 6BH6 electron-coupled first oscillator atop the chassis alongside the 6U8A pentode first mixer, as suggested in the April 1964 *QST* article. This modification — which works perfectly and is recommended — left an unused 7-pin miniature tube socket centered immediately below the L_3 coil socket at the lower edge of the rear chassis wall. It was easy to discard the two 1731 link-coupled first-i.f. coils, mount the two 1730 i.f. transformers on either side of the 7-pin socket, and rewire the first-i.f. amplifier stage as shown in the HBR-13C schematic, Fig. 1. The improved performance is well worth the time and effort.

When padded with the specified 62-pf. silver-mica capacitors, the 1730 transformer is resonant at 1610 kc. when the lower slug is approximately 4 turns in and the upper slug is about 7 turns in from the two extreme outer ends of the shield can. The two transformers will extend about 1 inch beyond the rear wall of the Wyco No. 7723 cabinet, and a suitably located cutout in the rear wall of the cabinet will be required.

I will warn those who make this modification to an existing HBR-12 that as there is now an amplifier tube with manual gain control located between the first- and second-mixer tubes, there will appear to be less gain at a retarded setting of the i.f. gain control as compared to the gain at this same setting when the wide-open coupling of the 1731s was used. The bias voltage provided by the original 10,000-ohm i.f. gain control is such that the 6BJ6, V_{13} , is nearly inoperative with the gain control fully retarded. It is for this reason that the 5000-ohm i.f. gain control is specified in the HBR-13C circuit. Not that this is of real concern, since the 6BJ6 "does its stuff" equally well when the i.f. gain control is advanced: the difference is only a matter of the degree of rotation.

The 6BC5 first mixer in the HBR-13C is no better nor worse than the 6U8A mixer at this spot: it was substituted because it requires less chassis space and is lower priced. Furthermore, if Pins 2 and 7 of the first-mixer socket are connected together externally, as called for in Fig. 1, a 6AG5, 6CB6, or 6DE6 can be used with equally good results. The operating characteristics of individual tubes of any one type are not necessarily identical. If several tubes are available, try them. Some work better than others as mixers.

Back-to-Back 100-Kc. I.F. Transformers

The objective here is improved skirt selectivity for the over-all receiver. Because of the much lower frequency employed in the second i.f. amplifier, this modification is more effective in

Table I
Tuned Circuit Data

All coils wound with enameled wire on 1½-inch diameter polystyrene 5-pin plug-in forms (Amphenol 24-5P). Taps are counted from "cold" end of coil.

On "A" coils, turns should be evenly spaced to length specified; "B" coils are close-wound. "A" and "B" coils wound in same direction.

3.5 Mc.	<p>L_{1A}, L_{2A}: 29 turns No. 26, close-wound, then $3\frac{1}{2}$ turns spaced $\frac{1}{16}$ inch, then 4 turns close-wound, tapped at $31\frac{1}{2}$ turns; (total $36\frac{1}{2}$ turns).</p> <p>L_{3A}: 15 turns No. 22, close-wound, then $3\frac{1}{2}$ turns space-wound over $\frac{3}{16}$ inch; tapped at $18\frac{1}{2}$ turns (total $18\frac{1}{2}$ turns).</p> <p>C_1, C_2 — 50-pf. air padder. C_3 — 75-pf. air padder. C_4 — None. C_{10} — 5-pf. N750 ceramic.</p>	<p>L_{1B}: $5\frac{1}{2}$ turns No. 26, spaced $\frac{3}{8}$ inch from L_{1A}.</p> <p>L_{2B}: $9\frac{1}{2}$ turns No. 26, spaced $\frac{3}{16}$ inch from L_{2A}.</p> <p>L_{3B}: $11\frac{1}{2}$ turns No. 26, spaced $\frac{3}{16}$ inch from L_{3A}.</p>
7 Mc.	<p>L_{1A}, L_{2A}: $6\frac{1}{2}$ turns No. 22, close-wound, then 16 turns space-wound to an over-all length of 1 inch; tapped at $9\frac{3}{4}$ turns (total $22\frac{1}{2}$ turns).</p> <p>L_{3A}: $6\frac{1}{2}$ turns No. 22, close-wound, then 7 turns space-wound to an over-all length of $\frac{9}{16}$ inch; tapped at $13\frac{1}{4}$ turns (total $13\frac{1}{4}$ turns).</p> <p>C_1, C_2 — 50-pf. air padder. C_3 — 50-pf. air padder. C_4 — 6M-pf. silver mica. C_{10} — 10-pf. N750 ceramic.</p>	<p>L_{1B}: $2\frac{1}{4}$ turns No. 26, spaced $\frac{1}{16}$ inch from L_{1A}.</p> <p>L_{2B}: $3\frac{1}{4}$ turns No. 26, spaced $\frac{3}{8}$ inch from L_{2A}.</p> <p>L_{3B}: $10\frac{3}{4}$ turns No. 26, spaced $\frac{3}{16}$ inch from L_{3A}.</p>
14 Mc.	<p>L_{1A}, L_{2A}: $11\frac{1}{2}$ turns No. 22, length $\frac{9}{16}$ inch; tapped at $4\frac{1}{4}$ turns.</p> <p>L_{3A}: $8\frac{1}{2}$ turns No. 22, length $\frac{1}{2}$ inch; tapped at $8\frac{1}{4}$ turns.</p> <p>C_1, C_2 — 25-pf. air padder. C_3 — 50-pf. air padder. C_4 — 180-pf. silver mica. C_{10} — 15-pf. N750 ceramic.</p>	<p>L_{1B}: $3\frac{3}{4}$ turns No. 26, spaced $\frac{3}{16}$ inch from L_{1A}.</p> <p>L_{2B}: $3\frac{1}{4}$ turns No. 26, spaced $\frac{3}{16}$ inch from L_{2A}.</p> <p>L_{3B}: $11\frac{1}{2}$ turns No. 26, spaced $\frac{1}{8}$ inch from L_{3A}.</p>
21 Mc.	<p>L_{1A}, L_{2A}: $8\frac{1}{2}$ turns No. 22, length $\frac{7}{8}$ inch; tapped at $2\frac{1}{4}$ turns.</p> <p>L_{3A}: $5\frac{1}{2}$ turns No. 22, length $\frac{3}{8}$ inch; tapped at $4\frac{1}{4}$ turns.</p> <p>C_1, C_2 — 25-pf. air padder. C_3 — 50-pf. air padder. C_4 — 130-pf. silver mica. C_{10} — 10-pf. N750 ceramic.</p>	<p>L_{1B}: $3\frac{1}{4}$ turns No. 26, spaced $\frac{3}{16}$ inch from L_{1A}.</p> <p>L_{2B}: $3\frac{1}{4}$ turns No. 26, spaced $\frac{3}{16}$ inch from L_{2A}.</p> <p>L_{3B}: $8\frac{1}{2}$ turns No. 26, spaced $\frac{3}{16}$ inch from L_{3A}.</p>
28 Mc.	<p>L_{1A}, L_{2A}: $5\frac{1}{2}$ turns No. 22, length $\frac{15}{16}$ inch; tapped at $2\frac{3}{8}$ turns.</p> <p>L_{3A}: $5\frac{1}{2}$ turns No. 22, length $\frac{1}{2}$ inch; tapped at $5\frac{1}{4}$ turns.</p> <p>C_1, C_2 — 25-pf. air padder. C_3 — 50 pf. air padder. C_4 — 47-pf. silver mica. C_{10} — 10-pf. N750 ceramic.</p>	<p>L_{1B}: $3\frac{1}{8}$ turns No. 26, spaced $\frac{3}{16}$ inch from L_{1A}.</p> <p>L_{2B}: $3\frac{1}{4}$ turns No. 26, spaced $\frac{3}{8}$ inch from L_{2A}.</p> <p>L_{3B}: $8\frac{1}{4}$ turns No. 26, spaced $\frac{3}{8}$ inch from L_{3A}.</p>

Note: Use coil socket pin arrangement shown in Fig. 1.

this respect than is the first-i.f. modification. When both modifications are completed the passband of the receiver will be just about as narrow as can be satisfactorily employed for s.s.b. reception. By the same token the single-

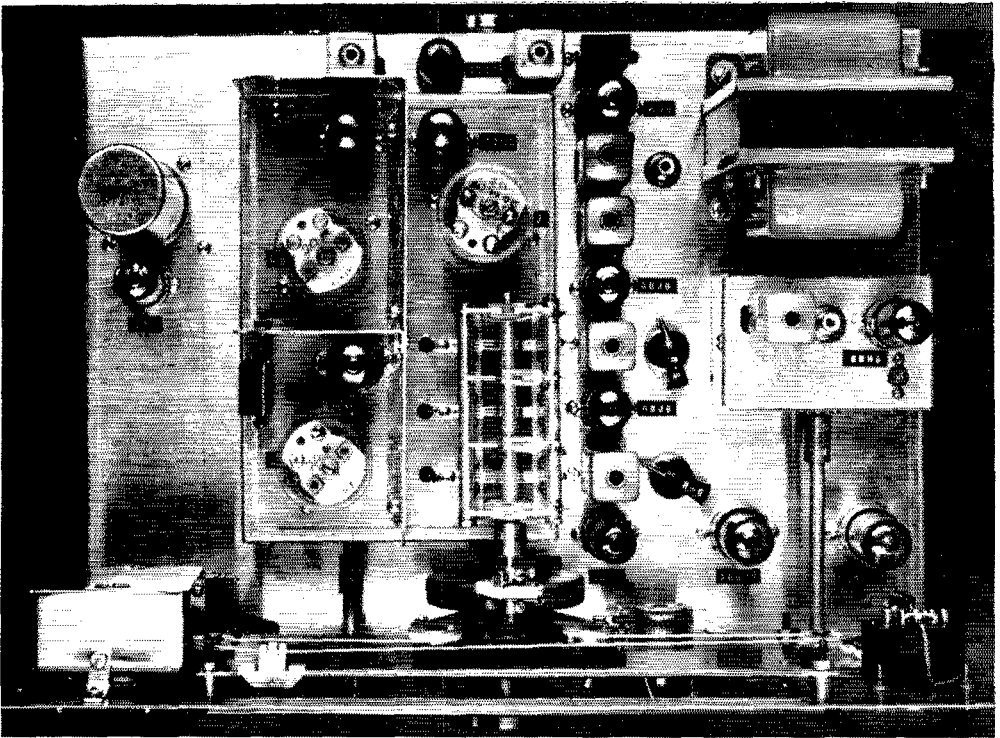

Plan view of the receiver. The plug-in coils are in separate compartments, with the r.f. stage at the left front mixer directly behind, and the h.f. oscillator to the rear of the three-gang tuning capacitor. The i.f. systems parallel the front-end compartment; the 1st i.f. behind and the 2nd i.f. to the right (as viewed from the panel). The b.f.o. is in a separate shield box at the right.

Table II
General-Coverage Coil Data

All coils wound on 1¼-inch diameter 5-prong forms (Amphenol 24-5P). All coils wound in the same direction.

14-17 Mc.	<p>L_{1A}, L_{2A}: $8\frac{1}{2}$ turns No. 22 enamel, space-wound to a length of $\frac{5}{8}$ inch, tapped at $8\frac{1}{2}$ turns.</p> <p>L_{3A}: $6\frac{1}{2}$ turns No. 22 enamel, space-wound to a length of $\frac{3}{8}$ inch, tapped at $6\frac{1}{2}$ turns.</p> <p>C_1, C_2: 25-pf. APC air padder.</p> <p>C_3: 25-pf. APC air padder.</p> <p>C_4: None used.</p> <p>C_{10}: None used.</p>	<p>L_{1B}: $2\frac{1}{4}$ turns No. 26 enamel, close-wound, spaced $\frac{5}{16}$ inch from L_{1A}.</p> <p>L_{2B}: $2\frac{1}{4}$ turns No. 26 enamel, close-wound, space $\frac{5}{16}$ inch from L_{2A}.</p> <p>L_{3B}: $5\frac{3}{8}$ turns No. 26 enamel, close-wound, spaced $\frac{3}{16}$ inch from L_{3A}.</p>
9-10.8 Mc.	<p>L_{1A}, L_{2A}: 8 turns No. 22 enamel, close-wound, followed by $5\frac{1}{2}$ turns space-wound, to a total coil length of $\frac{3}{8}$ inch (total $13\frac{1}{2}$ turns), tapped at $13\frac{1}{2}$ turns.</p> <p>L_{3A}: $10\frac{1}{2}$ turns No. 22 enamel, space-wound to a length of $\frac{3}{8}$ inch, tapped at $10\frac{1}{2}$ turns.</p> <p>C_1, C_2: 25-pf. APC air padder.</p> <p>C_3: 25-pf. APC air padder.</p> <p>C_4: None used.</p> <p>C_{10}: None used.</p>	<p>L_{1B}: $2\frac{1}{4}$ turns No. 26 enamel, close-wound, spaced $3\frac{1}{8}$ inch from L_{1A}.</p> <p>L_{2B}: $3\frac{7}{8}$ turns No. 26 enamel, close-wound, spaced $\frac{3}{16}$ inch from L_{2A}.</p> <p>L_{3B}: $6\frac{1}{4}$ turns No. 26 enamel, close-wound, spaced $\frac{1}{16}$ inch from L_{3A}.</p>

signal c.w. performance also will be noticeably improved.

With this back-to-back arrangement the gain is slightly less than when a single transformer is employed, but again this is of no real concern since a correctly-functioning HBR has more gain than ever is needed. Also, the additional gain provided by the 6BJ6 first-i.f. amplifier more than takes care of this insertion loss.

T_{2B} can be a Miller 1710 transformer, as specified for the original HBR-12 receiver, but Bill Courtney, K6GEK, chief engineer for the J. W. Miller Co., recently came up with an improved and sharper-tuning version designated the 1709. The 1709 and 1710 are physically interchangeable. Electrically, the 1709 is definitely the better performer, and when used in the HBR-13C circuit will provide c.w. and s.s.b. performance excelled by very few communications receivers. The 1709 is resonant at 100 kc. when both the upper and lower tuning slugs are 2 to 3 turns in from the two ends of the shield can, as compared to the 5 or 6 turns required for the 1710.

This back-to-back 100-kc. i.f. transformer idea can be enlarged upon, of course, to the point of using the arrangement throughout the second i.f. amplifier, provided that allowance is made for the progressively narrower passband and loss of gain as transformers are added. Six 1709 transformers in a two-stage second-i.f. amplifier will provide superlative c.w. performance,

but would be much too sharp for phone, even of the s.s.b. variety. Five 1709s, with double transformers employed for T_2 and T_3 , but with a single 1709 at T_4 , will provide a similar type of performance, and can be used for s.s.b. provided the b.f.o. frequency is kept not more than 500 cycles from the center of the passband, and provided considerable clipping of the audio-frequency response can be tolerated. The four-transformer arrangement used in the HBR-13C is the recommended one for general use.

Most HBR-12 builders used McCartney's silicon-diode rectifiers (April 1963 *QST*) and then mounted the dual 60- μ f. filter capacitor in the spot I specified for the 5V4 rectifier tube. This leaves chassis space for mounting the T_{2B} 100-kc. transformer immediately to the right of the original T_2 unit. In my own HBR-12 the silicon diodes were mounted underneath the power transformer as an afterthought. The 5V4 tube socket then was removed and the filter capacitor reinstalled at that location. The filter-capacitor original mounting hole was covered with an aluminum plate, secured to the chassis with self-threading metal screws, and the T_{2B} transformer then was mounted immediately to the right of the original T_2 input transformer.

The New Miller 2102 "Polar" Tuning Capacitor

Many readers will have seen the "New Apparatus" item on Polar tuning capacitors which

appeared on page 16 of August 1964 *QST*. I will agree 100 per cent with everything said except the possible use of the then-available C28-143 model in an HBR receiver front end. For several reasons this recommendation was in error. A considerable exchange of correspondence between Col. F. D. Harris of British Radio-Electronics and myself followed immediately, and the manufacturer has since made available a special three-section tuning capacitor designed specifically for use in the front end of HBR receivers, provided it is used with the coils specified in March 1963 *QST* and listed here in Table I.¹ The J. W. Miller Co. is distributing the capacitor in the U. S. as Miller type 2102.

This special Polar capacitor employs an off-set-plate arrangement similar to that used in the Miller 1461-BS capacitor, and provides an almost identical near-linear tuning characteristic with the tapped coils used in the HBR front end. The 2102 is almost identical to the 1461-BS in width and length and is easily substituted for it. Because of its extremely low torque and immunity to mechanical backlash, the 2102 definitely is recommended over the 1461-BS, regardless of its somewhat higher cost.

Two threaded bolts 1 $\frac{1}{4}$ inches long, with six matching nuts, are supplied with each 2102. The bolt heads must be hacksawed off, leaving two studs approximately 1 inch long. These

¹ See coil-sketch correction in April 1964 *QST*.

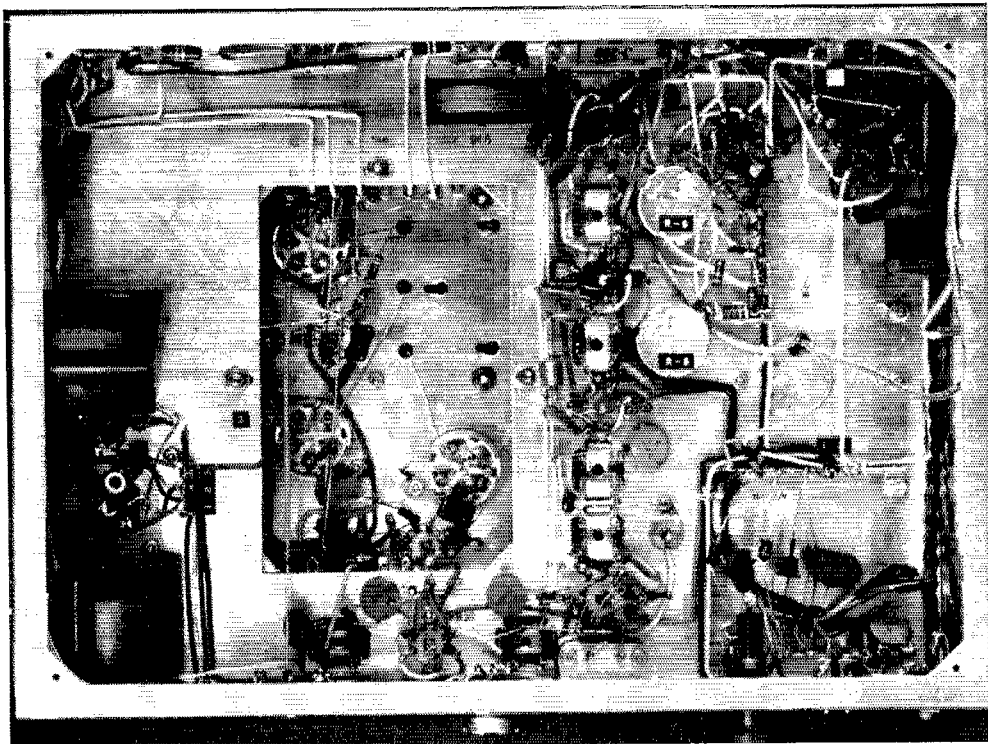

The rectangular chassis cutout gives access to the bottom of the front-end section, which is on a separate chassis of its own. The i.f. section is to the bottom and right of the cutout in this view. Power-supply components are at the lower left.

studs are threaded into the mounting holes at the two ends of the capacitor frame and locked in place with nuts. The capacitor then can be mounted above the chassis at the required height and locked into position with nuts placed above and below the chassis top, as described on page 15, March 1963 *QST*. It is extremely important that the capacitor shaft and dial-drive head be almost perfectly aligned, both vertically and horizontally, and that a Millen 39006 flexible coupling be used at this point. Otherwise drag, bind and mechanical backlash quite likely will be present.

Equally important is the selection of the correct end of the double-ended Polar shaft. The narrower cut-out end of the stator plates must appear at the left-hand side of the capacitor frame, as viewed from the front or panel end of the unit, when the capacitor is correctly mounted. If the capacitor is reversed, the frequency coverage will be nonlinear in the extreme.

There is a likelihood of v.h.f. parasitic oscillations in the r.f. amplifier stage when this low-loss capacitor is used with the coils and short leads employed in an HBR front end. This explains the two homemade parasitic-suppressor chokes in the plate and screen circuits of the 6AZ8 r.f. amplifier tube. The two chokes should be separated by the maximum possible distance to reduce stray coupling to the minimum.

Note that in the HBR-13C schematic, Fig. 1, the original connections to the primary of L_2 have been reversed, with the 6AZ8 plate now connected to Pin 5 of the L_2 coil socket rather than to Pin 1. This change results in a more stable r.f. amplifier stage at both the normal operating frequency and the parasitic frequencies as well, especially the latter. This is a "must" when the 2102 is substituted for the 1461-BS. In some instances one less turn in the primary coil (L_{2A}) also will be required as an r.f.-stage stability measure when the 2102 is employed.

Miscellaneous HBR-13 Modifications

Note the s.p.d.t. toggle switch, S_8 , which Alex incorporated into his HBR-13C receiver. Those who work both c.w. and phone can have the choice of either monitoring of the local transmitter's c.w. signal, or a muted receiver during phone transmissions. It is not necessary that S_8 be panel-mounted. HBR-12 owners can use most any vacant spot on the chassis, pre-setting S_8 to the position desired during any particular operating session. With the decoupling resistors and bypass capacitors mounted directly at the related circuit components, the dress and length of the S_8 leads are not critical.

The HBR-13C a.g.c. circuit uses a single germanium diode and separate buses to the r.f. and first-i.f. stages. By eliminating the delay voltage previously used, difficulties from diodes with subnormal back-resistance characteristics are eliminated. However, any diode which shows less than 3 megohms back resistance on the $R \times 10,000$ scale of a 20,000-ohms-per-volt ohmmeter should be discarded on general principles.

(In passing, here's a useful tip: When the ohmmeter leads are properly connected to indicate the back resistance of the diode, the *positive* lead of the ohmmeter will be connected to the *cathode* of the diode. It is this end of CR_5 which goes to chassis ground in Fig. 1. The same checking procedure will identify the cathodes of $CR_1 - CR_4$, inclusive.)

The revised a.g.c. circuit applies only partial a.g.c. voltage to the r.f. and first-i.f. amplifier stages, which tends to improve the weak-signal response of the receiver when a.g.c. is used. Which reminds me to mention something: It is not too well known that the effective input capacitance of an r.f. amplifier tube decreases with an increase in negative grid-bias voltage. If the r.f.-i.f. gain controls are sufficiently advanced so that a.g.c. bias voltage is developed — as indicated by the action of the S meter — the effective capacitance across L_{1A} will be decreased slightly because of this phenomenon. To compensate, the capacitance of the antenna trimmer, C_{11} , must be increased slightly, resonance being indicated by maximum reading of the S meter. If the a.g.c. now is turned off, the r.f.-stage grid circuit will be thrown out of resonance because of the removal of the a.g.c. bias, and the over-all gain of the receiver in some instances actually will be less with the a.g.c. off than on. It follows that the correct method of checking the effectiveness of the a.g.c. is to be certain that the antenna trimmer is tuned to resonance in the off as well as the on position of the a.g.c. switch.²

The small speaker mounted in the upper-left corner of the HBR-13C shouldn't be taken too seriously. Alex placed it there mostly for visually balancing the S meter. It will serve in a pinch when nothing better is available. However, for c.w., its almost complete lack of low-frequency response is an asset rather than a liability. If it did have adequate low-frequency response, the inevitable mechanical vibrations would set up microphonic problems — always to be expected from this type of construction.

A Potpourri of Loose Ends

Often I'm queried about front-end coils for the broadcast and 160-meter bands. Sorry, but these are impracticable; the range of the tuning capacitor is too small for the required frequency coverage at these relatively low frequencies. Also, in both instances the frequencies are too close to the receiver's first i.f. for trouble-free operation.

There have been numerous requests for information concerning general-coverage coils for some particular frequency range, or the magic formula for figuring out the specifications for such general-coverage coils. Again my reply of necessity is a rather negative one. The relatively small range of the tuning capacitor is the limit—

²This detuning effect is most pronounced when the first stage is operated in the highly-regenerative condition that results when the coils are adjusted as described in earlier articles by W6TC, and when a low- C grid tuned circuit is used. — Editor.

ing factor insofar as the general-coverage capabilities of an HBR receiver are concerned. And a magic formula for the lumped-capacitance tapped-inductance type of coil used in an HBR front end appears in no reference book to my knowledge.

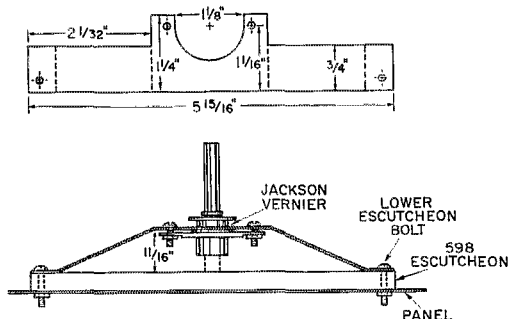

Fig. 2—Scale drawing of mounting plate for vernier drive. Exact locations for escutcheon mounting holes can be determined by temporarily mounting the vernier drive and plate on the 598 dial shaft. In the complete assembly the recessed dial knob covers the vernier. Use a $1/8$ inch socket punch to form the center cut-out.

However, two sets of general-coverage coils have been built, and data on them are given in Table II. The 14–17-Mc. coils were designed for use with crystal-controlled v.h.f. converters which have 14-Mc. output, while the 9–10.8-Mc. coils cover a very active segment of the spectrum, including the many short-wave broadcasting stations around 9.5 Mc. and the 10-Mc. signals of WWV. I am aware that 14 to 18-Mc. coverage would have been desirable for the first set, but we are stymied due to the limitations of the tuning capacitor. Even so, most of the activity on a v.h.f. band will be covered by the 3-Mc. range of these coils.

The trick to obtaining maximum frequency coverage with either set of coils is to adjust the turn spacing of the first-oscillator coil, L_{3A} , so the APC bandset capacitor is just *slightly* meshed at the lower-frequency end of the specified range. The primary-secondary coupling and tracking adjustments of the L_1 and L_2 coils duplicate the regular procedures.

The fourth harmonic of the 3500-kc. calibration oscillator is used to spot the 14-Mc. resonant point at 2 on the 598 dial scale in the first instance, while the third harmonic of this oscillator provides a 10.5-Mc. check point which should be spotted at approximately 75 on the scale in the second case.

A Tuning-Mechanism Modification

The only drawback to the 598 Eddystone vernier dial is that its tuning ratio is no more than 10 to 1, which leaves something to be desired insofar as accurate tuning of an s.s.b. signal is concerned. An externally-mounted 6-to-1 Jackson vernier drive supplies the solution in a most satisfactory fashion, and at low cost.

Despite its extremely small dimensions, this little gadget possesses the same smoothness and lack of backlash inherent in the Eddystone dial. In tandem, the two vernier drives provide a "solid-as-a-rock" 60-to-1 tuning ratio which, in my opinion, leaves nothing to be desired. When used with the correctly aligned drive shaft of a 2102 capacitor the $2\frac{1}{2}$ -inch-diameter Eddystone knob can be spun from one end of the dial scale to the other in a matter of seconds, and with a single finger.

The approximate size and shape of the externally-mounted aluminum supporting member is given in Fig. 2. If all of the mounting holes are slightly oversized, there will be no difficulty in getting a perfect mechanical fit, which would not be the case if the aluminum support were forced into position at one or more points. It is imperative that the Jackson drive socket exert no inward pressure on the tuning-capacitor shaft, because binding and dragging would be the inevitable result. The aluminum support should be given several coats of quick-drying black spray enamel prior to its installation.

For the moment at least, these comments bring things pretty much up to date. If there are any reasonable questions I will continue to try to answer them to the best of my ability. However, again I would remind some of the more thoughtless that I shouldn't be required to pay for the privilege. A stamped, self-addressed envelope in every instance, please! **QST**

Many of the *QST* issues named by W6TC are out of print and are no longer available from ARRL Headquarters. However, a large schematic, scale drilling templates of the panel and chassis, and 8×10 prints of the photographs appearing in this article, together with data on the construction of the HBR-13C, are available at a nominal price covering the cost of reproduction. Particulars can be obtained by writing Alexander Steward, WA4ZNI, 916 Croton Drive, Alexandria, Va. 22308.



Hq. has received a few complaints about loosening pages in the new v.h.f. book. Any press run involving thousands of books is bound to produce a sub-standard copy now and then, but investigation this time shows a portion of the run may have been with deficient binding. If you have this difficulty, please return the book to us for replacement.

Stolen Equipment

A Collins KWM-2A transceiver (serial number 12683) and power supply (serial number 14333) were stolen from the Air Force MARS station at Sheppard Air Force Base, Wichita Falls, Texas. Also taken was an Electro-Voice microphone. Anyone with information should contact Chester Ludlam, WA5CMC, 2309 Bullington St., Wichita Falls, Texas 76301.

Crystal-oscillator keying problems are avoided through the use of an unkeyed "silent" transistor crystal oscillator that plugs into the transmitter crystal socket.

Improved Break-In Keying for Crystal-Controlled Cathode-Keyed Transmitters

BY ARTHUR C. ERDMAN,* W8VWX

THE author operates a modified Knight T-150 transmitter in which all exciter stages, including the crystal oscillator when it is used, are keyed in the common cathode lead. As with most keyed crystal oscillators, rather critical adjustment of the plate tuning is necessary to obtain good keying characteristics. Unfortunately, an adjustment found satisfactory for one crystal is not likely to hold for other crystals, and it becomes a nuisance to have to make the necessary readjustment each time frequency is changed.

The author's solution to this difficulty is the simple adapter unit shown in the photographs. This adapter consists of a transistor crystal oscillator, complete with its own power supply. This unit, when plugged into the crystal socket of the transmitter, drives the original crystal-oscillator tube as a buffer amplifier. Keying problems are avoided by allowing the adapter oscillator to run continuously. Because of the complete shielding of the unit and the low power level, the signal cannot normally be heard in the receiver, so the break-in feature is not sacrificed.

Circuit

The circuit of the adapter is shown in Fig. 1. The oscillator is a Pierce type. It draws about 1

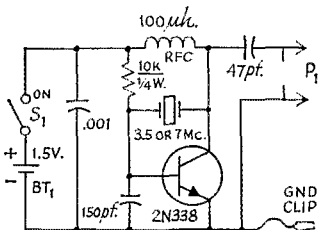

Fig. 1—Circuit of the crystal-oscillator adapter. Capacitors are mica. BT_1 is a penlight cell. P_1 is a plug to fit the transmitter's crystal socket (see text). S_1 is a miniature slide switch.

ma. from the 1.5-volt battery. Since the output circuit is untuned, it is not necessary to neutralize the oscillator circuit in the transmitter to use it as a buffer amplifier.

The original crystal-oscillator circuit in the T-150 is a Pierce in which the screen of the 6CL6 oscillator tube serves as the plate, as shown in Fig. 2. This makes it necessary to ground the side of the transmitter's crystal socket which goes to the screen through a blocking capacitor. I made this connection by simply attaching a short lead, terminated in a grounding clip, to the case of the unit. When the unit is plugged into the transmitter's crystal socket, this lead is clipped onto a convenient point on the transmitter chassis. The adapter must be plugged into the crystal socket so that the grounded side of the adapter is connected to the socket terminal that goes to the screen blocking capacitor, of course.

Construction

The unit is constructed in a $1\frac{5}{8} \times 2\frac{1}{8} \times 2\frac{3}{4}$ -inch Bud Minibox (type CU-2100A), as shown in the photographs. The plug by which the unit is plugged into the transmitter's crystal socket is a Mosley type 343-PK. This plug, originally designed as a termination for 300-ohm ribbon, fits into a standard crystal socket ($\frac{1}{2}$ -inch pin spacing) when the central locating pin is removed. Two holes are drilled through the plug so that it may be fastened against one end surface of the box with No. 4 machine screws and nuts after drilling clearance holes for the pins. The battery

* 241 Garden Road, Columbus, Ohio 43214.

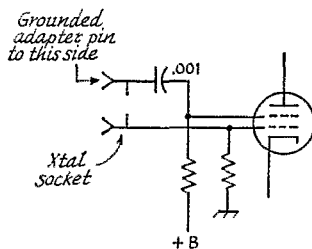
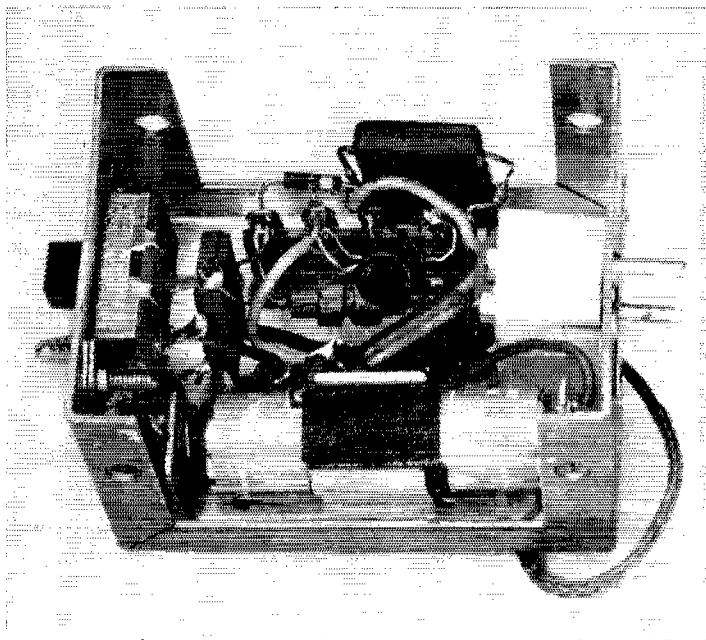

Fig. 2—In transmitters using modified Pierce oscillators, the adapter should be plugged into the transmitter crystal socket in such a direction that the grounded side of the adapter connects to the screen blocking capacitor, as indicated here.

Interior view of the crystal adapter, showing the penlight battery in the foreground, power switch on the left, and the adapter plug at the right. The transistor and other small components are mounted on a soldering-lug strip at top center



switch is mounted in the opposite end of the box, and the crystal socket (Millen 33102) on the back wall. A 5-terminal soldering-lug strip serves as a mounting for the remainder of the components

with the exception of the battery which is held in place with a clip mounting.

Some sort of shielding should be provided for the crystal to minimize radiation. I used an old octal tube shield that I found in my junk box. An old i.f. can may be cut down to serve the same purpose. A soldering lug under one of the crystal-socket mounting screws is bent so that it bears against the inside of the shield can to ground it.

When used with the T-150, the adapter provides slightly more drive to the final than the original crystal oscillator. In the author's installation, the adapter signal can be heard very weakly if an indoor receiving antenna is used. When an outdoor antenna with transmission line is used, the signal is below the noise level.

Other Transmitters

It is probable that a similar unit could be used with other transmitters in which oscillator keying is a problem, provided that there is at least one amplifier stage between the original crystal oscillator and the final, and that all stages are cathode-keyed. Unless all stages following the adapter are cut off, the oscillator signal may leak through.

Some alteration of the transmitter crystal-oscillator circuit may be necessary. In transmitters using the grid-plate oscillator circuit, for instance, the capacitive feedback network would probably have to be disconnected, and the cathode bypassed to ground. The ground clip lead would not be required.

If the unit pictured will not fit into the area allowed for the original crystal, a different mechanical configuration may be necessary. On the other hand, if plenty of space is available, one might find it desirable to include crystal switching in the adapter unit.

QST

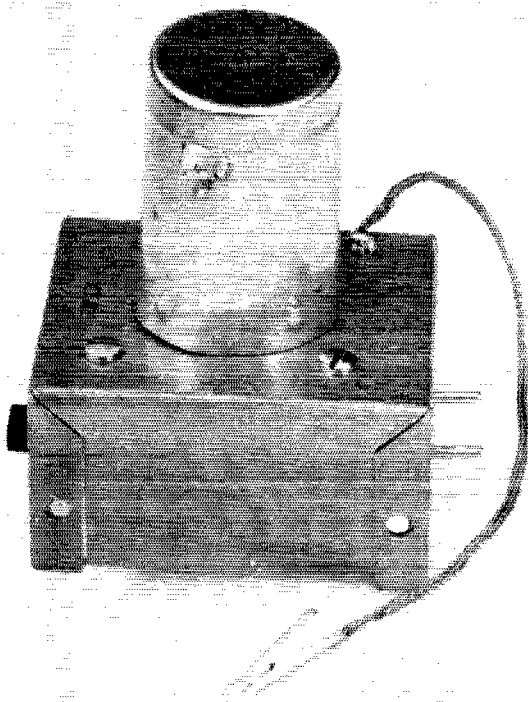

The plug-in transistor crystal oscillator with grounding clip.

RTTY Indicator Systems

Aids to Accurate Tuning of Incoming Signals

BY IRVIN M. HOFF,* K8DKC

IN regular c.w. reception, the beat-frequency oscillator can be adjusted for any tone that is pleasing to the ear. RTTY, however, involves filters in the demodulators that are designed for specific audio tones for optimum reception. Since RTTY demodulators work best when the mark and space frequencies correctly match these filters, some means is needed for tuning the receiver to the optimum tones. Most indicators rely on human eyesight to make a visual comparison between mark and space signals, but aural comparison of the mark tone with a standard reference can be quite simple, inexpensive and yet accurate.

Tuning by Ear

Some copy will be printed if the receiver is merely tuned until the printer *does* work. After some experience in listening to the audio tones which are required, an adept operator can tune the receiver fairly well by "guessing." However, this seldom gives better than second-rate results with a demodulator that does not incorporate a threshold corrector such as is used in the TT/L demodulator.¹

With the threshold corrector in the TT/L, automatic balance is maintained for mark and space voltages at the slicer input. This feature allows great latitude in tuning accuracy (or for drift tolerance). Without this feature few demodulators can tolerate *any* mistuning without introducing bias into the post-detector signal.

* 1733 West Huron River Drive, Ann Arbor, Michigan 48103

¹ Hoff, "The Mainline TT/L F.S.K. Demodulator," *QST*, August, 1965.

In this article, the eighth of the series on RTTY by K8DKC, various types of tuning indicators, both visual and aural, are discussed. It is possible, as the author points out, to get *some* copy from the Teletype machine with guesswork tuning, but some type of tuning aid is a necessity for reliable reception.

Of course the printer can handle a surprisingly high amount of bias, if in proper adjustment, so the typical operator is seldom aware that he is probably getting less than optimum results if there is no tuning indicator to show otherwise. It is ironic that the units requiring the most precise tuning — those without some type of automatic threshold correction — are often those with the least suitable tuning indicators.

Indicating Lamps

Some demodulators (usually quite simple types) use neon bulbs as triggering devices. These normally have one bulb for mark and another for space. If these bulbs are panel-mounted, they provide a means for tuning the incoming signal to *some* extent. The W2PAT demodulator² is an example of this type of circuit. (The Mainline TT/L demodulator uses several neon bulbs — two in the autostart circuit and one in the slicer output — but these have a much different function.)

Sometimes neon bulbs are used in the mark and space channels merely to indicate which channel the signal is coming from at the moment. Some commercial units offer these bulbs in addition to a more precise indicator; their use assists in rapid tuning and in quickly identifying "upside-down" copy.

"Eye" Tubes

Quite often the outputs of the mark and space channels are sampled and then combined in some visual type of indicator. While the cathode-ray oscilloscope is most often used by the advanced enthusiast, the 6AF6G electron-ray tube is a much cheaper and more simple arrangement. This tube indicates visually, by means of two shadows on the fluorescent target, the effects of changes in the controlling voltages. A typical circuit for a 6AF6G tube is shown in Fig. 1.

This type of indicator is viewed from the end and looks something like Fig. 2A. The upper and lower shadows alternately open and shut as the signal goes from mark to space, and the

² Recent copies of *The Radio Amateur's Handbook*; Blakeslee, "RTTY Reception for Beginners," *QST*, March, 1965.

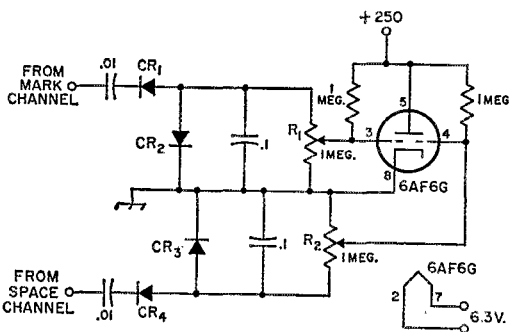

Fig. 1—"Magic-eye" tuning indicator circuit. The display is similar to Fig. 2A when the receiver is properly tuned. Capacitances are in μf ; capacitors may be paper or mylar as convenient. Resistances are in ohms; fixed resistors are $\frac{1}{2}$ -watt.

CR₁-CR₄, inc.—Silicon, 100 volts p.i.v. or more (Sarkes-Tarzian F4 suitable).

R₁, R₂—Audio-taper control.

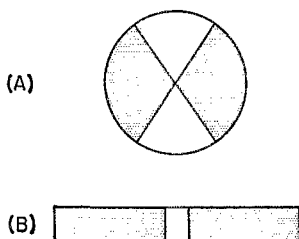

Fig. 2—"Eye"-tube displays. (A) is typical of the 6AF6G tube; (B) is the bar pattern of the 6FG6.

receiver is tuned to the signal so this alternating pattern results. With some experience, most operators are able to get good results with this type of indicator. If the shift does not closely match the filter tones, the indicator becomes increasingly difficult to use with accuracy since the relative size of the openings diminishes as the shift narrows. The 6AF6G is seldom used any longer except in the most simple demodulators, as other indicators are now available that give superior results.

Newer types of dual-shadow eye tubes have been developed, and the original Mainline f.s.k. converter designed by WSSDZ and the author in 1963³ used the Telefunken EMM-801 tube, which is a bar-type fluorescent indicating tube with two targets, amounting to a dual 6FG6 in one envelope, and viewed the length of the tube rather than through the end. (The 6FG6 is currently used in many f.m. tuners in hi-fi installations and exhibits a pattern of the type shown in Fig. 2B.) The EMM-801 has parallel-bar patterns, and one was used for mark and the other for space, providing a nice comparison for best tuning.

The TT/L Eye Tube

In the past, eye tubes have not been very popular with the serious enthusiast, and for good reason. When receiving a steady carrier, the pattern was steady and it was possible to tune the receiver quickly and accurately. However, when the f.s.k. RTTY signal was received and mark would alternate with space, the eye tube would flicker so rapidly, because of the short retention time of the phosphors used in the manufacture of the tube, that accurate tuning at best was difficult. The 6AF6G is also somewhat hard to see satisfactorily in a well-lighted room.

The indicator system introduced for the first time in the Mainline TT/L Demodulator is unique since it uses a single display pattern for both mark and space signals. In all other indicator systems known to the author, it is necessary to compare two different displays and then make some correction to bring these into agreement with each other for optimum reception.

In the TT/L, a dual-detector scheme is used so that both mark and space present voltages

of the same polarity to the indicator. Since mark alternates with space, the indicator will not flicker when the mark voltage is the same as the space voltage which replaces it as the f.s.k. signal is received. Thus rapid and highly accurate tuning is possible. Tuning becomes increasingly easy as the correct frequencies are approached, as the flicker will completely stop at the optimum point.

This system is particularly outstanding when receiving shifts other than normal. Most other indicator systems fail to give displays that can be easily interpreted when the shift is substantially less than normal, because of the interaction of the filters at the point at which the displays are sampled. In the TT/L, the dual-detector system automatically back-biases the opposite channel to eliminate this problem. The single-bar electron-ray tube used in the TT/L (a 6FG6) becomes a very precise means of tuning quite narrow shifts, giving a usable display down to less than 10 c.p.s. shift while using the TV-coil discriminator intended for 850-c.p.s. shift. (The operator should keep in mind that for such extraordinary shifts, minor readjustment of the cathode bias pot on the slicer stage might be needed for normal printing.) Actually it will be quite unusual for the operator to encounter transmissions of less than 170 c.p.s., since the very narrow shifts fall in the realm of experimentation and have very little practical use at the present time.

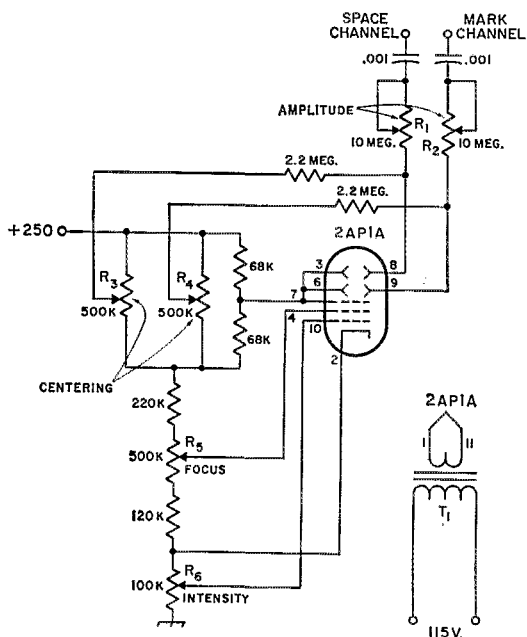

Fig. 3—Oscilloscope indicator circuit. Resistances are in ohms (K = 1000); fixed resistors are 1/2-watt. Capacitances are in μ f.

R₁, R₂—Audio-taper control.

R₃, R₄, R₅, R₆—Linear-taper control.

T₁—Filament transformer, 6.3 volts, 0.6 amp. (Stanco P-6465).

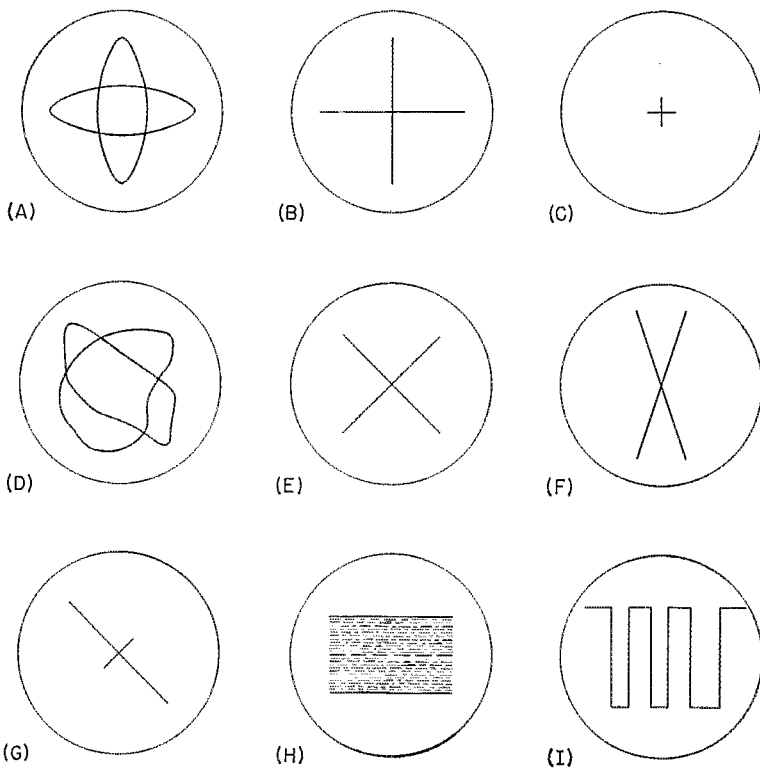

Fig. 4—Scope displays of various types for RTTY signals. See text for explanation.

Oscilloscope Patterns

The cathode-ray oscilloscope offers an excellent means of correctly tuning the RTTY signal, and many different types of patterns have been in use. The most common is the standard “+” display, where the mark channel is presented horizontally and the space channel is presented vertically (some systems use the opposite configuration; either is equally acceptable).

A typical oscilloscope hookup is shown in Fig. 3. R_1 and R_2 are independently adjusted for equal deflection in the mark and space channels when the input voltages are correct for the demodulator. In the case of the TT/L demodulator, the pickup points for such a scope arrangement would be on the secondaries of the step-up transformers in the plate circuits of V_1 just prior to the diodes in the detector.

If simple filters are used, the oscilloscope pattern might look something like Fig. 4A. This merely indicates that the channel separation in the filters is quite moderate.

With multisection filters exhibiting sharp skirt selectivity, the pattern becomes more like Fig. 4B.

If a narrow-shift signal is tuned between these sharper filters, the pattern may look more like Fig. 4C, but if the same signal is tuned on the broader filters, it may have a quite distorted

appearance as in Fig. 4D, which is of little value for tuning purposes.

However, we should mention that the more simple filters actually would work much better, in most cases, on these narrower-than-normal shifts than the patterns would suggest, and even though the oscilloscope pattern appears to be worthless, it does not mean that the demodulator cannot copy those signals. It just means a different indicator should be used. The primary value of the “+” pattern, then, is for copying normal shifts and using high-quality multisection filters.

For a good display on narrow shift while using the “+” scope pattern, the operator would need to switch filter systems to one appropriate for narrow shift. The limitations of the “+” pattern have led many operators to conclude that their demodulators were not adaptable to copying narrow shifts, while in many instances this was not the true picture.

Some operators have added sharp filters just to the scope input to get a pattern resembling Fig. 4B, while retaining broad filters in the actual demodulator. This again gives a somewhat erroneous presentation of the capabilities of the demodulator although “improving” the scope display. Other displays than the “+” type would be more useful over a greater range of f.s.k. shifts.

The "phase-shift" display (which resembles an "X" pattern) is occasionally used. Regular 850-c.p.s. shift might look like Fig. 4E. Narrow shift when properly tuned might then look like Fig. 4F and normal shifts incorrectly tuned might look like Fig. 4G. The phase-shift display is much better than the "+" display for tuning less-than-normal shifts. However, it requires additional circuitry over the oscilloscope hook-up in Fig. 3, which already is fairly complex and expensive. The inexpensive and simple circuit in the TT/L makes any scope pattern appear to be complex and high-priced when the cost of components and their combined space on the chassis are considered. The TT/L indicator also gives results that in most instances are actually easier to interpret accurately than the common scope patterns. Consequently, detailed circuit information for the phase-shift unit will not be included at this time.

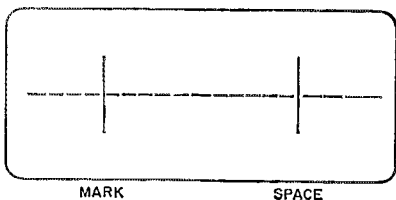

Fig. 5—The "audio-spectrum-analyzer" scope display.

Another type of oscilloscope display which offers excellent potential is often used on military equipment, and might be called the "flipping line" display (Fig. 4H). A d.c.-coupled scope is used and connected to the output of the detector stage. A mark signal will cause the line on the scope to go up and a space voltage will cause this same line to go down. Proper tuning will keep this line equally above and below the center of the scope as an f.s.k. signal is received. One of the big advantages of such an arrangement is that the gain of the scope may be increased as the operator tunes shifts less than 850 c.p.s. The author has accurately copied signals of less than 4 c.p.s. using such a display.

However, the cost of the d.c. scope would prohibit all but the most enthusiastic from buying or building such a circuit, particularly when the results are compared with the inexpensive display on the TT/L, which is equally good to at least 10-20 c.p.s. shift.

If the sweep on the d.c. scope is slowed to around 6 c.p.s. the pulse formation of the various characters can be studied as in Fig. 4I. If the same character is repeated a few times, bias and other problems can be quickly isolated.

The d.c. scope could be connected to the "minus-minus" line on the TT/L, and then rather than being displaced downward for space, the line will appear to stand still as mark and space are tuned correctly. However, this would be a needless duplication of the 6FG6 circuit in the TT/L.

Other scope patterns are possible also, but again the associated circuitry is complex and expensive besides taking a disproportionate amount of chassis space. One such display, shown in Fig. 5, is a panoramic display of the audio spectrum from the receiver. As the mark signal is tuned a vertical pip moves along the base line, becoming the highest at the point of optimum tuning. The same occurs for the space signal. The height then shows optimum tuning and the distance between indicates the shift. The tube used is rectangular in shape. The primary application for such a display is in commercial transmissions using "Twinplex" where there are actually four signals being transmitted at one time. Conventional displays would be useless in this case.

Meter Displays

Some operators have used meters for tuning the f.s.k. signal rather than more costly and complex scope patterns. Such meters have normally been a center-zero type that would swing one direction for mark and the opposite for space, when hooked to the detector output. Supposedly, when receiving f.s.k. signals, the meter would hover around mid-scale. At best this was doubtful, as most RTTY signals favor mark to some extent, even at machine speed. However, if the operator would send "RYRYRYRYRYRYRY" at machine speed the meter would be reasonably accurate. Such an arrangement is of little value for the customary amateur conversation, which is invariably at moderately slow hand-speed typing.

However, such a meter has a very definite advantage that to our knowledge has not been pointed out before — in tuning the b.f.o. on the receiver for best noise balance.

The receiver is tuned to a "no-signal" frequency and then the b.f.o. (or pass band tuning) is adjusted until the meter hovers around mid-scale. The receiver is then correctly tuned as far as the b.f.o. or passband tuning is concerned. If a zero-reading meter is not used for this purpose, the operator otherwise can spend a great amount of time trying to determine the optimum setting of the b.f.o. or passband tuning, and still be uncertain whether the setting is optimum for the demodulator.

However, one need not install such a meter permanently, nor need a zero-center meter be used for setting the b.f.o. An ordinary d.c. meter can be used and then turned to "normal" or "reverse" until the b.f.o. or passband tuning is adjusted satisfactorily — that is, to where the pointer will hover around the bottom of the meter scale. Such a system is an excellent means of tuning the b.f.o. quickly and accurately. A pencil mark could be placed on the receiver so the proper setting could be quickly selected once again should the control be changed for any reason.

A similar check could then be made for the most narrow position of the receiver — such as the 500-cycle position, if the receiver has one —

that might be used for 170-shift copy, and an additional mark placed for that filter position.

With the TT/L "minus-minus" system, a meter can be used in lieu of the 6FG6 indicator; when the signal is optimum tuned, the meter would be at maximum and would not flicker as the signal changed from mark to space. As this is a high impedance point in the circuit, either a d.c. v.t.v.m. or a 20,000-ohms/volt multimeter should be used. Inexpensive meters having greater than 100-microampere movements should not be used at that point. Such a meter would give an excellent idea of the shift that was being copied, as 170-c.p.s. shift would give only about 20 per cent as much meter reading as 850-c.p.s. shift.

Limitless Reception

In limitless reception the operator is going to have some difficulty no matter what visual system he uses, since the indicator amplitude will change because of the varying signal strength, in addition to changing because of the frequency of the signal. This makes it impossible for the operator to be certain whether the signal has drifted or faded. Since the mark and space signals often fade at independent rates (selective fading) the tuning is made more difficult by this as well. Thus the visual indicator systems require an operator to be quite alert.

Many operators solve the problem indirectly by turning the limiter on momentarily until correct tuning is assured and then turning it off once more to take advantage of the limitless features of the demodulator.

To compound the problem further, most serious advocates of limitless copy have obtained quite narrow channel filters, and here again even a little drift will quickly make a noticeable change in the indicator presentation. Also, with filters of this type mistuning can quickly produce unacceptable levels of distortion.

Thus for limitless reception some method in addition to visual indicators should be used, although this is somewhat a new concept in amateur reception.

Tuning by Tone Comparison

We have now made the full circle back to "tuning by ear" once more. However, the system to be described is a far cry from "guessing" by ear. It can be an extremely accurate means of assuring oneself that the signal is correctly tuned whether for limitless reception or for normal use of the limiter.

All that is needed is some means of generating an audio tone that matches the mark filter frequency. An audio oscillator such as is found in many amateur stations for test purposes can be put to work (one way to get your money out of the thing at last!) or tuning forks can be obtained. Some musical instruments, such as mouth organs, will work very nicely.

The system is simplicity itself, and merely compares the incoming signal against a standard reference tone that has been adjusted to that of

the mark filter. The operator just sets the tuning so the mark signal agrees with the standard tone.

This system works very well for normal shifts, but is not very easy to use on narrow shift as it is hard to pick out the exact mark pitch from the space tone for comparison purposes. (This is one reason why narrow-shift transmissions are seldom bothered with c.w. interference — the c.w. operator finds it difficult to isolate the tone he needs from the others.) The average operator will not be using narrow shift very often, so the system presents no particular drawbacks from that standpoint.

At some time prior to receiving an incoming signal, the receiver is tuned to a crystal-calibrator spot on the dial (or the transmitter is turned on to give a steady carrier) and then adjusted to give maximum output from the mark detector while looking at a meter or the tuning indicator. The audio oscillator is then adjusted to equal that tone in pitch.

While receiving an f.s.k. RTTY signal, the receiver is merely tuned until the mark tone matches the pitch of the audio reference tone. This can be done with extreme rapidity and with exceptional accuracy when compared with normal visual indicators such as the "+" scope pattern.

One of the advantages of such a system is that the operator need not continuously look at the indicator to see if any readjustment is necessary — he can hear when the signal differs in pitch from the standard tone. This is quite nice, particularly for contest work where limitless copy with very narrow filters gives an important edge over other participants.

Since the operator is listening and not looking, the system works equally well with or without the limiter.

It may be that the incoming signal shift is not 850 c.p.s. exactly, and in this case perhaps the standard audio tone is not the best. A simple adjustment can be quickly made: the limiter is turned on and the signal tuned normally by visual reference to the indicator. Then the audio oscillator is adjusted to match this mark tone and the limiter can be turned back off. As mark and space are separated by 850 cycles, it is normally not difficult for the average operator to pick out the mark pitch even while the signal is "in motion" from mark to space and back again.

The primary disadvantage in using this type of tuning aid is that it is necessary to hear the incoming signal as well as the standard tone source at the same time. Many operators do not care to listen to the receiver at any time while on RTTY, but this is the opposite extreme. Others prefer to listen not only to their own signal but the incoming signal as well. Both techniques have some merit, but it would seem that monitoring the signal by ear has much merit.

The audio comparison method has an important fringe benefit — it is very simple to match the local transmitter to the incoming signal quickly and accurately. Thus for breaking into a contact the frequency can be set "right on the

money" in an instant, and if it is not correct that fact becomes immediately evident. Again this requires that the operator be able to hear the signal while transmitting. It would seem that a bypass switch across the speaker could be easily installed for this purpose, so it would operate during transmissions. There is no need to kill the receiver during transmission as the demodulator standby switch makes that unnecessary. Having the receiver operate during transmission will also enable the operator to observe the tuning of the local station to compare its frequency with the incoming signal for accuracy. From listening to amateur RTTY contacts it would seem that very few operators pay any attention to their own frequency while transmitting, for how else could they be so far off the station they are talking with?

Summary

Some means should be used to tune the receiver to the audio frequencies that the demodulator needs for optimum copy. In the past, systems have ranged from the simple neon bulbs in the W2PAT circuit to the audio-spectrum display of certain commercial units. Most amateur enthusiasts have come to rely on the "+" oscilloscope pattern, but it has severe drawbacks from a general operating viewpoint. The new indicator for the Mainline IT/L Demodulator is not only a very accurate indicator that works quite satisfactorily for tuning any shift but also is small, simple and inexpensive. For limiterless reception and rapid tuning, aural comparison of the mark tone with a standard audio tone of the same frequency presents an excellent means of keeping the signal accurately tuned. **QST**

(The next article in this series on RTTY will appear in an early issue. — Editor)

Fifth World-Wide RTTY Sweepstakes

October 16-18

1) This is a competition between all stations throughout the world to determine their ability to exchange messages via two-way radio teleprinter.

2) *Contest period:* 0200 GMT, Oct. 16, to 0200 GMT, Oct. 8, 1965.

3) *Bands:* This test will be conducted in the 3.5, 7.0, 14.0, 21.0, and 28.0 Mc. amateur bands.

4) Stations may not be contacted more than once on any one band. Additional contacts may be made with the same station if a different band is used. To encourage multi-band DX operation, the same country may be claimed more than once if contacted on different bands. The same state worked on more than one band may only be claimed once.

5) *Country status:* For the purpose of this contest, KH6, KL7, and VO will be considered separate countries, in addition to the ARRL Countries List.

6) Stations will exchange messages consisting of message

number, check (RST), time in GMT, and state or foreign country.

7) *Points:* (a) All two-way RTTY contacts by North and South American countries (including KH6) will earn two (2) points. (b) All two-way RTTY contacts by countries other than in (a) above will receive ten (10) points. (c) All stations receive 200 points per country worked, not including their own.

8) *Scoring for all stations:* (a) Two-way exchange points times total states worked. (b) Total country points per band times number of continents worked. (c) Add item (a) and (b) above, for your *FINAL SCORE*.

9) Follow the sample score sheet and log form shown. Log the state only once, the first time contacted. Log the country the first time contacted on each band. To qualify, logs and score sheet should be received by RTTY, Inc., 372 Warren Way, Arcadia, California, 91007, by November 27, 1965. **QST**

LOG, FOURTH WORLD-WIDE RTTY SWEEPSTAKES

Station log of W6TPJ (call) My state or country Calif. Date 16, Oct. 1965

NR Sent	RST Sent	Time Sent	Band	Station	NR Rcvd.	RST Rcvd.	Time Rcvd.	State or Country	Exchange Points
1	589	0205	14	W6CG	2	589	0204	CALIF.	2-
2	569	0230	14	VK3KF	6	579	0231	AUSTRALIA	2
3	?	?	14	W6NRAI	4	359	0240	---	0
4	599	0300	14	W2JAV	7	599	0259	NEW JERSEY	2
5	579	0514	7	VK3KF	22	569	0514	AUSTRALIA	2

CLAIMED SCORE: (a) Exchange points 8 × 2 States = 16

(b) Country points 400 × 2 Continents = 800
(2 × 200)

Add (a) and (b) = 816

FINAL SCORE

This log is correct and true to the best of my knowledge.

Signature

The annual ARPSA Simulated Emergency Test is scheduled for Oct. 9-10. Some of the boys have a lot of trouble thinking up something to simulate. Here's a simulated emergency test put on by the Daviess County, Ky., AREC, which added spice and realism to a drill which, without exercise of a vigorous imagination and implementation through written instructions, might have been dry and humdrum.

EMERGENCY DRILL, DELUXE STYLE

A Kentucky Simulated Emergency Test by Envelope

BY STEPHEN E. McCALLUM*, K4URX

JOHN Morehead, WA4MYH, had just settled down to start operations as a major net control for a special emergency operation organized by George Wilson, W4OYI, assistant EC for Daviess County, Ky. According to plan, he opened an envelope marked "No. 1" and read, to his dismay:

"Stop transmitting, NOW! Even if you are in mid-sentence. Shut off the rig; it just blew up. This is to test how long it will take to get the 6-meter link in operation, how badly it's overloaded, and the efficiency of the operators. After a 30-minute layoff, assume you get the rig fixed, resume operations and try to pick up the pieces."

This shocker came shortly after operations had been set in motion and amateurs had been alerted by telephone and by a broadcast on the Owensboro, Ky., radio stations to monitor 50.5 Mc. and 3965 kc.

The Plan of Operation

Schmutz's First Law of radio engineering¹ ("If anything can go wrong, it will.") applies to emergency operations as well as construction projects. W4OYI based the test on this tenet

* Section Emergency Coordinator, Kentucky, 8910 Eastern Parkway, Owensboro, Ky.

¹ Sometimes referred to as "Murphy's Law."



of contrariness in outlining an imaginary tornado situation and gave the amateurs in this Ohio River Valley area some kicks they hadn't expected. The basic theme had been to assume that the civil defense director of Daviess County had received several reports of a tornado striking somewhere on the outskirts of the city. He called amateurs to action and planned to send out mobile units to suspected locations which could not be contacted by land line.

In planning the drill two weeks before this, W4OYI had laid out the path of a hypothetical tornado and imagined some serious consequences. Then he prepared five sets of sealed and numbered envelopes. As the mobile units reported to NCS on the appointed day, each operator was handed a set of five envelopes, told where to go and when to open the first envelope.

The Situation Unfolds

Mobilcer Reginald W. Taylor, W4MMY, dispatched to Mosleyville, six miles south of Owensboro, opened his No. 1 envelope and was stunned to find that: "A panic-stricken drunk has hit and overturned a school bus full of kids. Five are hurt. A few people are around assisting. A doctor has happened by and says the injured can await transportation to the hospital. Send for ambulances. The bus completely blocks the road: you can't get through. Figure out another way to get to Mosleyville. When you get there, open envelope No. 2."

Meanwhile, Darrell Richards, K4EQR, on his way to Petit in the same general direction, complicated W4MMY's situation with a request to relay traffic to the NCS after finding this problem outlined in his first envelope:

1) You see three houses destroyed. The only person in view is a little girl who runs up as you stop, face bleeding, and tells you 'Mommy is crying under our house.' Locate the moaning woman: she's hurt and you can't get her out. Call for help. Then wait three minutes.

"WHAT DO YOU DO?"



2) Now you see a fire has started in the second house. Call for help. Wait five minutes.

3) A man runs up from the third house. He and his wife and five children have no place to go and no transportation. Ask for advice. When you get it, open envelope No. 2."

When the third mobile, operated by C. S. Clayton, W4UDZ, headed east to Thruston, Ky., via the conventional route he found on opening his first envelope that: "The road right ahead is blocked completely with rubble. You can't get around it. Find another route and when you get to Thruston open envelope No. 2."

Zane Carlisle, WA4FAG, the fourth mobile, ran into this hairy imaginary situation when he opened his first instruction at a railroad crossing: "The tornado has caused railroad signals to fail. As a result, a special train full of college kids has run into a heavily loaded freight train. There is mass confusion, with 2 dead and 17 injured in varying degrees. Several of the injured need immediate medical attention. Nearly 200 persons must be transported and cared for. Report the situation, await instructions; when received, open your next envelope."

As the headquarters operators were trying to unravel these situations, a call came from mobile No. 5 (W4SUD) which had been proceeding peacefully westward to Stanley, Ky., until he found this startling revelation in his first envelope: "There has been an intersection collision between a farm truck loaded with cattle and a military vehicle. The farmer took off, trying to round up the scattered cattle. The military truck driver gasped, 'Top secret . . . radioactive!' and fell unconscious. His injuries appear most serious. There is a yellow, sticky fluid dripping from the sealed back end of the truck. What do you do?"

With reports like these pouring into the base station, the three operators there were in a near-disaster situation themselves. They were trying simultaneously to operate the priority-packed 6-meter mobile net, relay via a 40-meter link to the courthouse where the c.d. director sat, and maintain a 75-meter tie-in with state c.d. in Lexington, some 150 miles distant.

SNAFU

It was a gala day for Schmutz's Law. Messages from mobiles omitted vital details (like the location of a fire!). NCS operators, under pressure,

failed to note such lapses and passed incomplete messages on to c.d. headquarters: the c.d. director thus was forced to message back for the missing information before he could make his imaginary decisions. When much-needed assistance arrived for the snowed-under 6-meter NCS, the new man on the job made a false assumption which caused several relay messages to reverse the locations of the first and second mobiles; as a result, an imaginary fire truck was sent to the school bus accident at Mosleyville and an ambulance to the fire at Petit.

Pursuing realism throughout the exercise, W4OYI scheduled various amateurs to be called into the action periodically, presumably as they were located and available to participate. Thus by the end of the drill, about 30 amateurs were active in one capacity or another and things were smoothing out. All in all, the exercise took about four hours, as opposed to the conventional half-hour or so of lip-service most of the gang had expected.

"Believe me, it was a sweat," said Allen Haase, W4PFQ, EC for Kentucky's five-county District 4. Al operated 6 and 40 meters from his automobile parked outside the courthouse end of the command link, employing Boy Scout runners between his station and the c.d. director inside.

The exercise was deliberately planned to overload the existing c.d. communications system, to dramatize the need for better communications facilities, and to tax the ability of the operators. In these objectives, the operation succeeded to a superb degree.

Critique

In a critique a week later, WA4KFO, an officer of the Owensboro Amateur Radio Club, made the following observations:

1) The magnitude of the exercise was sufficient to thoroughly point out deficiencies of our organization. It also showed certain areas of excellence.

2) Our equipment is badly in need of checking out.

3) Our operators, particularly myself, need drilling.

4) V.h.f. coverage of the county is good.

5) We should be getting more of the younger hams active in this work.

Concurring with these comments, W4OYI started immediately with EC W4PFQ to draw up a program for acquiring more suitable space and equipment for emergency communications. The plan was adopted by the c.d. director and is being implemented.

At the close of the exercise it was estimated that 120 simulated emergency messages were handled in the realistically-simulated first four hours of this "tornado."

Further Situation Developments

Just to give you an idea how fully simulated some of these situations were, after encountering the overturned school bus and complying with the instructions in his first envelope, W4MMY

found the following in subsequent envelopes: "Did you think to ask for someone to get the bus off the road? If not, do it. You find Mosleyville in ruins but deserted except for some hoods looting. Don't try to stop them yourself, send for help. You hear the tornado came from the direction of Panther. Go there. If signals are weak, ask NCS to send a car mid-way to relay. At Panther there are 9 dead, 12 hurt bad and no doctor. People crowd around for instructions. Get them from c.d. headquarters. While you are waiting for instructions, you hear there are 23 men, 36 women (three of them invalids) and 50 children homeless. There is no transportation. Get instructions. When you've got them, return to headquarters, your job is finished."

K4EQR, after encountering the bleeding little girl, the fire and the homeless family in Petit, is told that the tornado headed toward Masonville. "Report you're going there and get started. Go three miles. The next house on your left is a shambles, four people standing around dazed, no place to go and no transportation. Get instructions regarding them. Now you hear that Masonville wasn't hit after all. Ask NCS for instructions."

K4UDZ's previously mentioned situation at Thruston was only the beginning for him. When he opened his subsequent envelopes he found that: "Houses are destroyed. The Thruston school is somewhat damaged but usable. Fires are threatening other houses. Report the situation and call for help. Did you remember to report the blocked road you had to go around? If not, do it now. There has been heavy rain and people are standing around shivering, with

person and is blocking the only exit from the schoolhouse (window, door or what have you). Inside are children and teachers, in panic. You have warned them to be calm and stay put. They are doing the latter, but the panic continues and you are worried someone might try to make a break for it. Report and ask for instructions."

W4AFAG, at the train wreck, finds that: "Near the wreck there has been substantial property damage. A fire is threatening some LP gas storage tanks. Report it. Four tank cars full of liquid ammonia have been derailed and are broken open. Fumes are endangering all in the area. Report it. The train wreck has blocked the track 200 yards to the west and a half mile to the east of the crossing. Report this, then proceed to Yelvington, but don't forget you have to find a way around the wreck. At Yelvington there is no direct damage, but some refugees have come from Thruston. Residents have no power and no water because pumps aren't working, and they ask you to find out how long the power will be off. Find out what to tell them."

After handling the farm truck and military vehicle collision, W4SUD proceeded onward to Stanley and opened his next envelope and found that: "The town is undamaged, but high winds have broken power lines. Two live wires thrash about near the railroad, and traffic on the main east-west route is backed up both ways. Get instructions." Later envelopes revealed that: "A light plane has been forced down in a pasture. The plane looks somewhat damaged but the two occupants are unhurt. They ask you to have a truck sent out to dismantle and haul back the aircraft. Make report and request, then proceed to Sorgho. No one hurt here, but a house is afire. It's beyond help, but there is definite danger of its spreading. Request assistance."

Conclusions

This horrendous afternoon in the clutches of Schmutz's Law brought amateurs sharply face to face with the fact that they have to be top-notch communicators. These small unincorporated communities, ranging from 5 to 15 miles outside of the metropolitan Owensboro area, have few if any officials that amateurs can contact. Instructions have to come over the air. In effect, then, the mobile amateurs represent constituted c.d. authority. They have to examine situations and exercise judgment in making reports. As the resulting messages coming into the control center are mostly of the informal type, communications personnel at that point have to be sure that information is complete before relaying it, in writing, to c.d. headquarters.

Two vital conclusions emerged from this drill:

1) Amateurs must make every effort to draw up accurate and comprehensive reports. This calls for careful observation and for caution in reporting unsubstantiated rumors, making sure that every bit of information is categorized as fact or hearsay, according to its source and authentication.

(Continued on page 180)

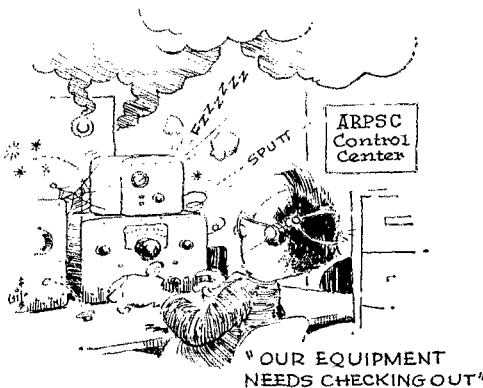

no food or transportation, with more homeless filtering into town all the time, wandering about helpless and confused. Ask for instructions. You hear the tornado funnel left the ground after it hit here but that it came from the direction of Dermont. Go there. When you get there, you find at least five dead, 12 hurt and no doctor. The homeless are being taken care of by friends. Two of the injured obviously need ambulances. The rest appear able to be moved but you're not sure, you're no doctor. Get instructions. Now you see a live wire sputtering and whipping about. It has already killed one

Announcing 1965 Annual ARRL Simulated Emergency Test

October 9-10, 1965

An emergency plan that is never tested stands a good chance of not working when the emergency occurs. Once each year, we test our emergency plans on a nationwide scale. This occurs in October and is known as the Simulated Emergency Test or, more familiarly to those who take part, as the SET. It is not a contest, but a true test of emergency plans, facilities and personnel, including both divisions of the Amateur Radio Public Service Corps: The National Traffic System (NTS) and the Amateur Radio Emergency Corps (AREC). The Radio Amateur Civil Emergency Service (RACES) comes in for some activity, but this is not primarily a civil defense exercise. The SET is of and by amateurs as amateurs for public service, however this may be accomplished.

The SET is at once both an introspective look at ourselves as we really are and a public demonstration of our capabilities, in this order of importance. We don't want to demonstrate anything we aren't really capable of, and therefore we first determine what we can do, then call in the publicity media to *show* 'em.

There are two parts to the SET, separate and yet connected. At the local level, each ARRL emergency coordinator gets his AREC members together and conducts a test or drill simulating a communications emergency condition. Some of these are strictly local, some are dovetailed with a Section-wide drill being conducted by the Section emergency coordinator. Some simulate emergencies which have occurred in the past, some are based on what could or might occur — including enemy action, where civil defense is a part of the picture.

During the test, each AREC member originates a message, in standard ARRL form, to his Section emergency coordinator. Emergency coordinators and Section emergency coordinators send message-form reports to headquarters. Local emergency coordinators obtain messages from their Red Cross and civil defense officials to their respective headquarters. Various other civic officials are induced to originate traffic. In addition, an innovation this year, we are asking participants to originate more traffic, simulating disaster inquiries, to their friends and relatives in other parts of the country, and if possible get answers back. These messages would receive a "test priority" rating and would simulate the high number of such messages that would be floating around in a real emergency.

This, too, will "load" the National Traffic System, which will be conducting extra sessions as it would in a real emergency, except that we are not asking NTS people to burn too much midnight oil. We hope in this way to eliminate one of the principal complaints received last year — not enough traffic.

ARPS officials have each received a bulletin with details, but here in brief is a rundown of the procedure:

- 1) Local ECs notify AREC personnel of the impending emergency. Most of them conduct "surprise" exercises, with only the approximate time of the drill pre-announced.
- 2) Certain members of the AREC group are designated as liaison to National Traffic System nets to handle "outside" traffic.
- 3) The EC originates a "test P" message to headquarters giving results of the test.

(Continued on page 182)

NATIONAL CALLING AND EMERGENCY FREQUENCIES (Kc.)

During the SET, all NCEFs will be operated on a full-time basis, from 2300 GMT Oct. 9 to 0700 GMT Oct. 11, just as though this was a period of actual emergency. The following are the most-used frequencies:

3550	7100
3875	7250

Other NCEFs which can be used during the SET are:

14,050	28,100
14,225	29,640
21,050	50,550
21,400	145,350

The procedure: In case of simulated emergency, call "TEST QRRR" on one of the c.w. NCEFs, or "CQ Test Emergency" on one of the phone NCEFs. When contact is made, move off the frequency to handle any traffic.

For clearing regular traffic, call CQ followed by the destination of your traffic. When contact is made, move off the frequency to clear it.

Do not call CQ or make any but a *real* emergency call on any of the NCEFs during the first five minutes of any hour!

Section Emergency Coordinators of the Amateur Radio Emergency Corps

The Section Emergency Coordinator is appointed by the SCM to take charge of the promotion of the Amateur Radio Emergency Corps organization throughout the Section. He acts as the SCM's executive in the furthering of provisions for emergency amateur radio communications in every community likely to suffer in case of a communications emergency. One of the duties of the SEC is to recommend the appointment of Emergency Coordinators for the various communities in his Section. Does your town have an EC? If not, recommend the name of a likely prospect to the SEC. The SEC invites your questions concerning the status of the AREC in your Section.

ATLANTIC DIVISION				
Delaware	K3NYG	John L. Fenrod	Eagle Nest Road RFD #1 Blackbird 4607 Convent Ave. 7512 Foster St., SE So. Johnson St. 1144 Grover Rd. 8242 Heberton Drive	Townsend, 19734 Philadelphia, 19114 District Heights 20028 Carnegie Point 08069 East Aurora, 14052 Verona, 15147
Eastern Pennsylvania Maryland-D.C. Southern New Jersey Western New York Western Pennsylvania	W3ELI W3CVE K2ARY W2ZRC K3ZMLH	George S. Van Dyke Conan W. B. Barger Norris J. Mundell Daniel C. Clark Oliver C. Karpathy		
CENTRAL DIVISION				
Illinois Indiana Wisconsin	W9RYU K9WET K9ZFP	Harry Studer Ralph L. Piercy Bernard E. Tower	705 Hillcrest Rd. RFD 1 6921 W. Bennett St.	Milan, 61264 Walton, 46994 Milwaukee, 53219
DAKOTA DIVISION				
Minnesota North Dakota South Dakota	WA0BZG WA0AYL W0SCT	Asa H. Spicer David E. Beach Lester R. Lauritzen	716-3rd Ave., W. Apt. 7 1116-19th Ave. S. R. 3, Box 32	Grand Rapids 55744 Grand Forks, 58201 Centerville 57014
DELTA DIVISION				
Arkansas Louisiana Mississippi Tennessee	W5NPM W5BUK W5JDF W4RRV	Samuel M. Meeke John L. Robertson Charles E. Boone Sanford B. DeHart	1917 B 5th St. 2609 Halsey Drive 707 High Extension St. 227 S. Purdue Ave.	Blountville AFB 72317 New Orleans, 70114 Aberdeen, 39730 Oak Ridge, 37830
GREAT LAKES DIVISION				
Kentucky Michigan Ohio	K4URX K8GOU W8HNP	Stephen McCallum Donald R. Van Sickle Arlington A. Garn	2910 Eastern Parkway 20295 Westpointe Court 5034 Oak Ridge Drive	Owensboro Southfield 48076 Toledo, 43623
HUDSON DIVISION				
Eastern New York N.Y.C. & Long Island Northern New Jersey	W2KGC K2OVN K2ZFI	William L. Stahl John S. Brandau John W. Banke	Shirley Avenue 1659 E. 46th St. Main Rd., Box 177	Fishkill, 12524 Brooklyn, 11234 Towaco, 07082
MIDWEST DIVISION				
Iowa Kansas Missouri Nebraska	K0BRE K0BXF W0BUL K0JXN	Vertin B. Rowley Robert M. Summers Charles O. Gosch Larry Abbott	1008 So. Third St. 1125 N. 50th Place 711 South Oakland Abbott Ranch	Fairfield Kansas City, 66102 Webb City, 64870 Almeria, 68711
NEW ENGLAND DIVISION				
Connecticut Eastern Massachusetts Maine New Hampshire Rhode Island Vermont Western Massachusetts	W1EKJ W1AOG K1QIG W1ALB/ W1TNO W1YNE W1VSA	Vernal G. Charles Donald F. Gupilli Cliff Stowers Edward F. Everett Gordon F. Fox Harry A. Preston, Jr.	216 Clement Road 17 Park St. Court 35 West Street RFD #4 151 Whipple Road Box 26	East Hartford 06118 Medford, 02255 Fairfield, 04937 Concord, 03301 Esmond, 02917 Charlotte, 05445
NORTHWESTERN DIVISION				
Alaska Idaho Montana Oregon Washington	W7RZY W7HMQ	Harry Roylance Everett E. Young	P.O. Box 621 2217 5th St., SE	Harlowton, 59036 Puyallup, 98371
PACIFIC DIVISION				
East Bay Hawaii Nevada Sacramento Valley San Francisco San Joaquin Valley Santa Clara Valley	WA6OLF KH6CCL W7JU/ K7JU W6KZF WA6HVN	Jack M. Palmatier Ernest J. Kurlansky Ray T. Warner Bill Ray Harold L. Whitfield	4135 Porter St. 748 Kil St. 539 Birch St. 52 Matilda Ave. 3148 Jenkins St.	Oakland, 94619 Honolulu, 96821 Boulder City 89005 Mill Valley San Jose
ROANOKE DIVISION				
North Carolina South Carolina Virginia West Virginia	W4MFK WA4ECJ W48HJ W88SA	James W. Boisford Richard F. Miller Harry J. Hopkins Jr., E. K. Chambers	P.O. Box 452 7C Woodward Apartments 3600 Hammett Avenue P.O. Box 62	Hillsboro 27278 Beaufort Norfolk, 23503 Bluefield
ROCKY MOUNTAIN DIVISION				
Colorado New Mexico Utah Wyoming	W08IN K5QIN W7WKF W7YWE	Charles M. Cotterell Robert E. Cowan McCarroll Peterson Frederick L. Hildebrand	430 South Swadley St. 1466B 45th Street 1180 E. Whitlock Ave. Box 143	Denver, 80228 Los Alamos, 87544 Salt Lake City 84106 Douglas, 82633
SOUTHEASTERN DIVISION				
Alabama Canal Zone Eastern Florida Georgia West Indies (P.R.-V.L.) Western Florida	W4NML K760C W41YT W48AZ W4MLE	William C. Gann Eugene D. Gasset Andrew C. Clark Tom Donan George L. Thurston	2115 Brookline Drive Box 917 41 Lenape Drive P.O. Box 206 2116 Gibbs Drive	Huntsville Howard AFB Miami Springs 33166 Acworth, 30101 Tallahassee 32303
SOUTHWESTERN DIVISION				
Arizona Los Angeles Orange San Diego Santa Barbara	K7N1Y W6BNX W6SK WB6NDP	George Mezey John A. Vaidean J. D. Campbell Bob Weaver	P.O. Box 73 6271 Dayman St. 3235 Idlewild 5575 Somersel Drive	Sun City, 85351 Long Beach, 90815 San Diego, 92117 Santa Barbara 93105
WEST GULF DIVISION				
Northern Texas Oklahoma Southern Texas	W5PYI K5DLP K5RDP	James M. Cotten William B. Pierce A. Gene Henry	208 East Oak 901 Bell Avenue 206 Riverwood St.	Weatherford 76086 Lawton Houston, 77022
CANADIAN DIVISION				
Alberta British Columbia Manitoba Maritime Ontario Quebec Saskatchewan	VE6FK VE7OM VE4OL VE1HJ VE3EUM VE2AAH VE5CU	Don Sutherland W. C. Orchard John H. Bell, Jr. F. R. Fraser Harry Walker Laval Duquet W. H. Parker	444-25th Ave., N.E. 13733-62nd Ave. 453 Rita St. 12 Albert St. 956 Beach Blvd. 1575 Stanley St. 1008 10th St., E.	Calgary North Surrey Winnipeg 12 Dartmouth, N. S. Hamilton Sainte Foy, P. Q. Saskatoon

Improved Vertical Antenna for 2-Meter Mobile

Adapting the 5/8-Wave Vertical to Amateur V.h.f. Service

BY VERN EPP,* VE7ABK

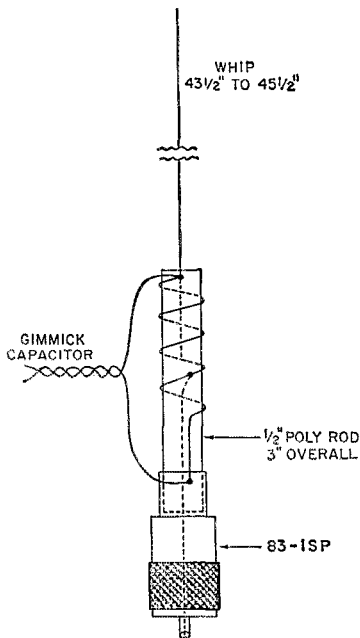

Fig. 1—The 5/8-wave 2-meter whip mounts in a poly rod, inserted in the top of a coaxial plug. Impedance matching coil is wound on the rod, and the line to the transmitter is tapped up one turn from the bottom end. The coil is tuned with a "gimmick" capacitor.

OBSERVING the excellent results obtained in commercial v.h.f. communications with 5/8-wave vertical antennas, I decided to try an inexpensive adaptation of these antennas in our 2-meter f.m. work. There are several types of these antennas available commercially, but all are quite expensive. The construction shown here

* 203 View St., Nelson, B.C.

costs very little. The antenna is easy to make, and the original has been in use for several months, demonstrating that it is rugged enough for amateur service. Best of all, it has shown an average improvement of 3 db. over the quarter-wave vertical whips formerly used.

Construction

As shown in Fig. 1, the whip is inserted in the top of a polystyrene rod, which is threaded into the sleeve of a standard coaxial plug (PL-259 or S3-1SP). The whip is 1/8-inch welding rod, 44 inches long. This is not critical, as the tuning capacitance can be varied for different antenna lengths. The impedance of the 5/8-wave whip is quite high, so a matching device must be used. A coil wound on the poly rod is in series with the whip and the sleeve of the plug. The coaxline and center pin tap up on the coil about 1 turn from the grounded end. The coil is resonated with a "gimmick" capacitor, or a small trimmer.

The rod is 3 inches long. It is drilled about 1 1/2 inches deep, with a drill somewhat smaller than the whip stock. The end of the whip is then heated and forced into the hole slowly. A hole is drilled up from the other end of the rod, and a similar one into the side, at a point near where the tap will be. A wire may then be run into this to make the tap connection, or a thread may be tapped into the side hole and a screw threaded into it to make contact with the wire that runs down to the coaxial connector center pin. The end of the poly rod can be threaded into the plug if the latter is heated with a torch. An alternative is to turn or file the rod down just enough so that it can be forced into the threaded portion of the plug.

The coil is 4 turns of No. 14 wire, with the top end soldered to the whip. The bottom is soldered to the connector sleeve. The tap is one turn up from the bottom. The gimmick capacitor was made from a twisted pair of hookup wires, about 8 inches long. This can be cemented alongside the coil after adjustment has been completed.

Tuning and Use

The system can be resonated by adjusting the length or twist of the gimmick capacitor, checking resonance with a grid-dip meter coupled to the coil. To do the best job, put a 50-ohm resistor across the coaxial line at the point where the antenna is plugged into it, when the resonance check is made. Any variable capacitor could be substituted for the gimmick and replaced with a fixed capacitor of equivalent value when adjustment is completed.

Performance of this antenna was checked by calibrating the receiver's limiter grid current with a signal generator, and then comparing the 5/8 and 3/4-wave whips. They were originally installed on a rear fender, where results were consistently better, transmitting and receiving, with the 5/8-wave whip. Still better results were obtained when the 5/8-wave whip was installed in the middle of the car roof. QST

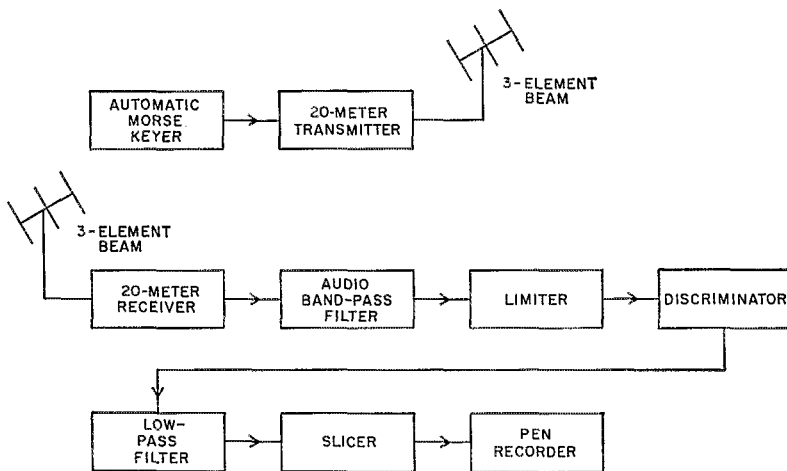

Fig. 1—Block diagram of the weak-signal slow-speed c.w. communication system.

way somewhat analogous to the limit placed on receiver sensitivity by external noise.

The receiver bandwidth referred to above is the *pre-detection* bandwidth—that is to say, the bandwidth achieved with the i.f. filter or an audio filter. (Some may argue that an audio filter is *post-detection*, but this is not the case since the “detector” and b.f.o. are simply serving to translate the signal from i.f. frequency to audio frequency. If the audio is listened to by an operator, then detection in the sense used here is actually accomplished in the operator’s head! In the remainder of this article, detection means what is usually called “envelope detection”: Rectification of an a.c. signal to produce a proportional d.c. signal.)

A Detection Scheme

The first thing we are going to do to implement our new technique is to borrow an idea from

RTTY practice and ask the transmitting station to use frequency-shift keying (f.s.k.) rather than on-off keying.¹ With this system the transmitting station will have his carrier on continuously and not just when the key is down. The receiver will be tuned to a frequency half-way between the key-up and key-down frequencies and the audio output from the receiver will be applied to an audio band-pass filter just wide enough to include both frequencies. In the tests run by the author, a frequency shift of 170 cycles was used and the audio filter was about 250 cycles wide. The output of the audio filter is applied to a limiter/discriminator much like you would find in an f.m. set except, of course, that it works with an audio-frequency carrier. Again, we may borrow from the RTTY gang use of one of the limiter/

¹ For a complete discussion of f.s.k. see the current RTTY series in *QST* by K8DKC, specifically the March and May 1965 issues.

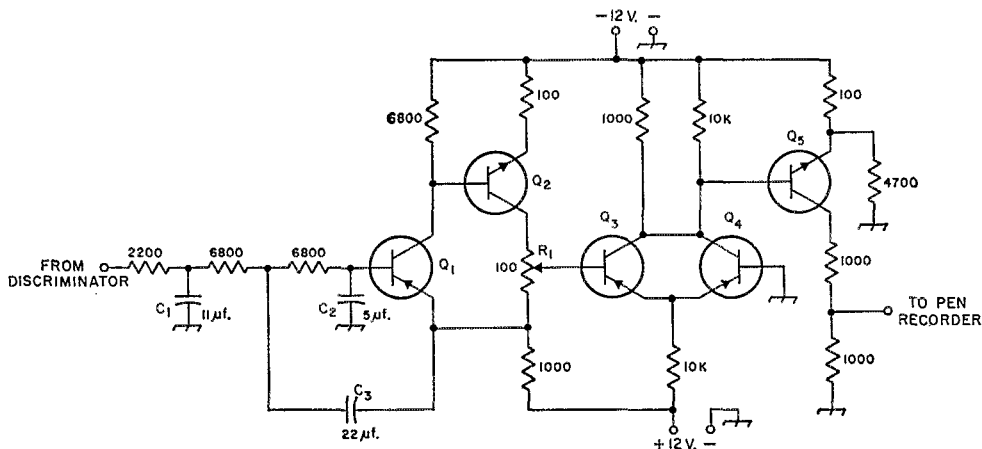

Fig. 2—Circuit of the low-pass filter and slicer. Resistances are in ohms; fixed resistors are ½ watt composition. C₁, C₂, C₃—Good-quality paper; see text. Q₁, Q₃, Q₄—2N404. Q₂, Q₅—2N1302.

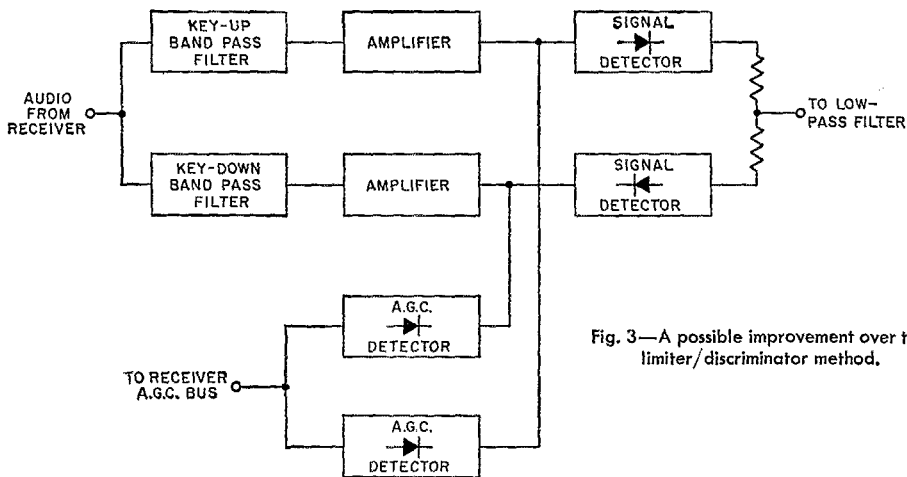

Fig. 3—A possible improvement over the limiter/discriminator method.

discriminator converters developed for RTTY use.²

The output of the discriminator is a detected form of the received signal. The discriminator output is a d.c. voltage proportional to the instantaneous frequency of the input to the limiter. If the discriminator is designed in the usual manner, the output will be zero volts at center frequency and will vary above and below ground as the input signal varies above and below center frequency. Thus, with a good signal, the d.c. output of the discriminator will vary above and below ground with the keying of the transmitter. As the received signal falls into the noise, it becomes more and more difficult to detect the exact frequency of the signal, with the result that the d.c. output from the discriminator develops substantial fluctuation. On the average, however, the discriminator output will favor the frequency of the received signal even if it is below the noise level. A circuit that will average the discriminator

output for us and give us a smooth d.c. result must follow the discriminator.

The Low-Pass Filter

Following the discriminator we introduce a low-pass filter (l.p.f.) to do the averaging job for us. The l.p.f. simply integrates the output of the discriminator over a period of time (determined by the cutoff frequency of the filter) and gives us a d.c. average. If there is a secret to the whole process, this is it. In order to detect weaker and weaker signals, you simply use a lower and lower cutoff frequency in the l.p.f., thus averaging the discriminator output over a longer and longer period of time. Not only does this illustrate the secret of the system but it also illustrates the limitation. The weaker the signal you want to detect, the longer you must average and therefore the slower the transmitter must be keyed. In other words, you have a simple trade-off of transmitting speed and signal strength.

It is necessary to go through one more step to complete the system. A circuit is required to sense whether the d.c. output of the l.p.f. is

² The best circuit published so far is incorporated in the TT/L converter. See August 1965 QST.

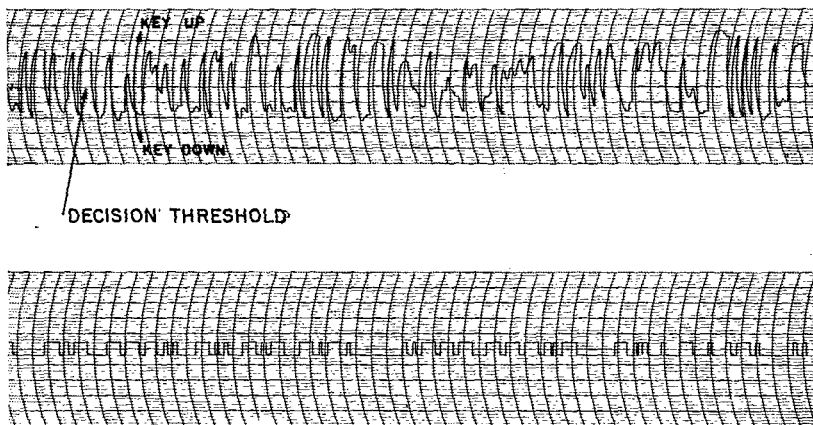

Fig. 4—Pen-recorder tracings showing low-pass filter output (upper) and slicer output.

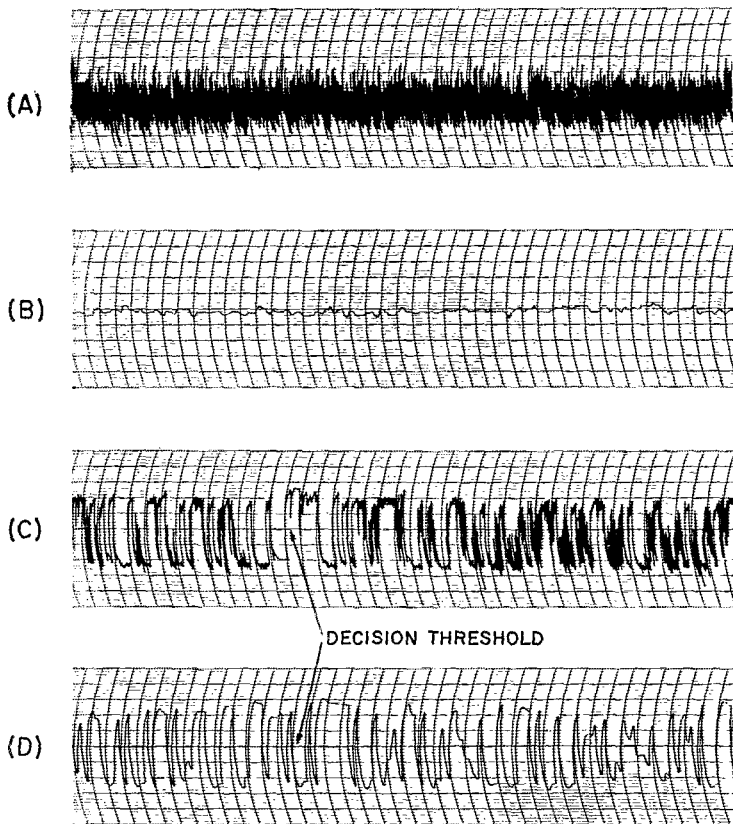

Fig. 5—Typical recordings with two low-pass filter bandwidths. (A) 50-c.p.s. cutoff, noise only (no signal present). (B) 2-c.p.s. cutoff, same conditions as A. (C) 50-c.p.s. cutoff, noise and weak forward-scatter signal. (D) 2 c.p.s. cutoff, same conditions as C.

above or below ground. This is what is called the "decision process". This circuit, called a "slicer", is in effect a very high gain d.c. amplifier. The gain is so high that if the input is just slightly positive, the output saturates in one direction and if it is just slightly negative, it saturates in the other. The plus and minus swing of the slicer output will (hopefully) follow the key-up/key-down keying of the transmitter. Since the keying will probably be very slow, some sort of automatic recording means will probably be desired on the output. The author has available to him a pen recorder operating at slow speed as well as a device that converts Morse signals to TTY signals automatically. Since the average amateur seldom has such exotic equipment at hand, some other ways might be tried. A tape recorder might be

used in which the slicer output keys a tone into the recorder and then the whole thing played back at a higher speed for copy by ear.

A Typical System

In order to test the ideas presented here the author, with assistance of K8DKC, built a system and tried it on 20 meters. Even though 20 was used, it applies equally to the higher frequencies. After all, when 20 is dead it is not much different from a v.h.f. band! The 20-meter band was used simply because the gear was available.

The set-up consisted of an automatic Morse keyer modified to operate at very low speeds, a kilowatt 20-meter f.s.k. transmitter, and a three-element beam on the transmitting end.

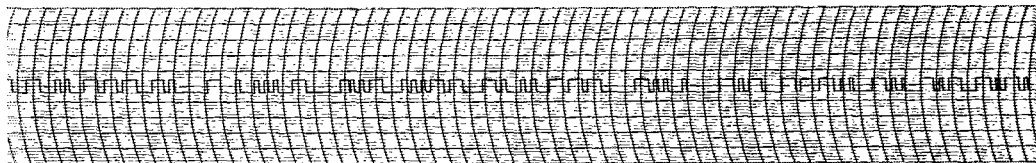

Fig. 6—Slicer output on weak scatter signal, using 2-c.p.s.-cutoff

The receiving set-up included a three-element beam, a crystal-controlled receiver, and the detector as outlined above. The transmitter and receiver were separated by about 500 miles (Ann Arbor, Michigan to Frederick, Md.)

Both the transmitter and receiver are set exactly on frequency by using a crystal calibrator that is zeroed on WWV. There can be no compromise on this — frequency control must be precise. A total frequency error of only 30 cycles was found to degrade performance noticeably. Since this kind of stability is required, paths exhibiting Doppler shift — satellites, moonbounce — do not seem to apply here.

A little experimenting showed that a keying speed of three words per minute gave good performance. For this keying speed, the optimum cutoff for the l.p.f. was just under 2 c.p.s. (For those who may doubt the effectiveness of the l.p.f., see Fig. 5. Notice the several times reduction in noise output and the improvement of signal quality with the narrower filter.) Data provided by Villard and Peterson³ indicates this keying speed should work well to a range of over 1000 miles for this power, frequency, and antenna size. At the present time I have no sure way of extrapolating the keying speed possible at other frequencies and power levels. Only experience will tell.

One of the more surprising aspects of the tests was the amount of QRM encountered on a dead band! On several occasions weak signals were detected even as late as midnight when the band had closed up hours before. In most cases there was no way to identify the signals since the keying was much too fast and the audio much too weak. This does serve to illustrate the possibilities of this method, though. Had any of the stations heard been using the right kind of modulation, contact could have been established. Another point to consider also — the receiver was fixed-tuned with a bandwidth of only 250 cycles. Think how many more signals must have been present and detectable over the 100 kc. or so that makes up the active c.w. portion of 20 meters.

Some Circuit Details

A filter with a two c.p.s. cutoff frequency and an effective slicer circuit are two circuits amateurs are not normally familiar with. When building l.p.f.'s at such low frequencies, the use of inductors is not very practical since very huge values of inductance would be required.

³ Villard and Peterson, "Meteor Scatter", *QST*, April, 1953.

By using a capacitor in a feedback network, it is possible to simulate an inductor and have the equivalent of an *LC* filter without using any *L*. Fig. 2 illustrates such a circuit. The circuit consists of an *RC* network and a unity gain amplifier consisting of Q_1 and Q_2 . The feedback from the emitter of Q_1 through the 22- μ f. capacitor simulates a large inductor, providing us with the equivalent of a pi network. The three capacitors determine the cutoff frequency of the filter and may be varied in inverse proportion to frequency to obtain other cutoff values. High-quality capacitors must be used — no electrolytics! The input to the l.p.f. should be kept to about ± 5 volts for good operation.

The slicer is the circuit containing Q_3 , Q_4 , and Q_5 . The 100-ohm pot, R_1 , may be adjusted to set the slicing or decision level exactly at ground (this can be used to cancel any d.c. bias that may have crept into the system).

An Area for Improvement

One of the limitations in the present method has to do with the limiter and the way it works. A limiter exhibits a "capture" effect such that when the received signal is above the noise it tends to capture the limiter, enhancing the signal to noise ratio. However, when the signal falls below the noise, the noise tends to capture the limiter, suppressing the signal even further. Fig. 3 is a block diagram of an approach that should overcome this problem. Rather than a single bandpass filter following the receiver, two are used. One is centered on the key-up frequency, and the other is centered on the key-down frequency. The outputs of the two filters are amplified and applied to two sets of detectors. One set generates an a.g.c. voltage that feeds back to the receiver so that the peak output from the amplifiers is constant. (A very fast a.g.c. would be required to follow very rapid signal fluctuations.) The other set of detectors provides opposite-polarity outputs which are summed and applied to the l.p.f. A signal present in one or the other of the band-pass filters would unbalance the output from the detectors in favor of the signal even if the signal is below the noise level. Again, as before, you need only to average it long enough to tell which way it is unbalanced.

The values given for frequency shift, band-pass filter bandwidths, and other such details are by no means the last word. On the higher frequencies, wider shifts and pre-detection filters may be needed from frequency-stability considerations alone. A great deal of interesting work remains for the enterprising amateur. QST

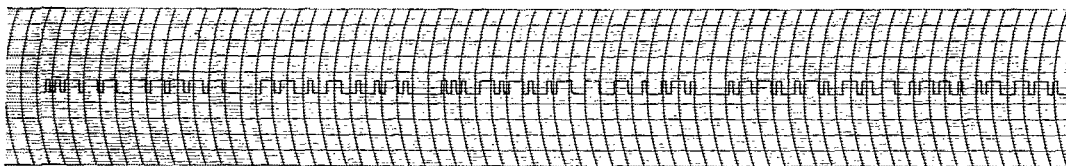

low-pass filter (conditions similar to filter output shown in Fig. 5D).

Happenings of the Month

DAVID H. HOUGHTON RETIRES

On April 10, 1922, a new man climbed the rickety stairs to the third floor of a building at 1045 Main Street, joining twelve others in the three rooms then serving as headquarters for the American Radio Relay League. His job, with the help of two clerks and a hand-cranked addressing machine, was to manage the circulation of *QST*, (then running 23,000 copies per month, of which 8000 were by direct mail to members).

On August 31, 1965, the same man, still brisk of step and purposeful of stride, retired from his job as Circulation Manager. One could hardly recognize the organization as the same. Now its headquarters was a modern office building comprising 26,000 square feet of floor space, its magazine's circulation exceeded 110,000 copies per month (100,000 of them to members) and its David H. Houghton supervised the work of some 25 employees. Under his watchful eye, the first five thousand copies of the first *Radio Amateur's Handbook* ventured into the world in 1926 — to be followed by 3½ million others since then. Nearly two million *License Manuals*, a million *How to Become* and hundreds of thousands of other books bearing the familiar ARRL diamond have gone into distribution.

Throughout these intervening 43-plus years, the integrity and devotion to duty of David H. Houghton, his conscientiousness and ability to keep watch over details important to individual members as well as over-all basic League policies and functions, have been in a large measure responsible for the growth and progress of ARRL, and contributed much to the League's stature. His bold signature, reproduced under his



David Houghton

picture, is known from Afghanistan to Zambia, and he has made hundreds of close friends, many of whom (as in ham radio) he has never met. He has been our skilled hirer of help, the competent orderer of publications and supplies, and since 1941 the keeper of the League's money as Treasurer — in which office he continues to serve. As credit manager, he screened for quality the outlets handling League publications, yet ever increasing their number and volume. His promotion of ARRL publications has even led him on trips to South America and thus to production of *The Radio Amateur's Handbook en Castellano* from Argentina. He's been keeper of the copyrights and astute investor of the surplus, the latter in cooperation with the Finance Committee of the Board.

For all his efficiency, Dave is known to the staff as a warm friend and real person, whether it is as a mainstay in time of personal trouble, or as umpire of softball games at the annual office picnic. A devoted family man, Dave can well be (and is!) proud of his children and grandchildren.

The Board of Directors, at its meeting in May, summed up his career succinctly in these terms:

"On motion of Mr. Anderson, the following resolution was unanimously ADOPTED (by a rising vote with applause):

WHEREAS, David H. Houghton, has served the American Radio Relay League faithfully and well as Circulation Manager for nearly 44 years; and WHEREAS he has been throughout that time an example of integrity and devotion to duty and thereby has contributed much to the growth and stature of the League; and WHEREAS he is to retire from the League staff in 1965; and WHEREAS he has served for almost 25 years in the additional post of Treasurer, in which office he continues to make available to the League his wise counsel and long experience,

NOW, THEREFORE, BE IT RESOLVED, that the Board of Directors of the American Radio Relay League, Inc., in annual meeting assembled, do hereby express to:

DAVID H. HOUGHTON

their deep appreciation of his long and diligent service to the League and its membership."

CANADIAN RULES CHANGES

Several changes — most of them requested by Canadian officials of ARRL — have been made in the amateur regulations by the Department of Transport.

The frequencies 50.0 to 50.05 and 141.0-141.1 Mc. are restricted to type A-1 emission only.

An amateur transmitter may now be permitted to run 1000 watts input. Specifically, the new regulation reads:

"... The (d.c.) power input to the anode circuit of the final radio frequency stage of a transmitter shall not exceed 750 watts, except

Massachusetts Governor John Volpe (4th from left), Ted Gurnaras, Deputy Registrar of Motor Vehicles, (2nd from left) and happy hams.



that the power may be increased so as not to exceed 1000 watts where interference referred to in Section 48 will not result from that increase."

Wideband f.m. (i.e., with a frequency swing of plus or minus 15 kc.) is now permitted in 52-54 Mc., 146-148 Mc. and higher frequency bands.

Maritime mobile operation within Canadian territorial waters is permitted on vessels not registered in the name of the licensee. Authority to operate /mm outside Canadian waters may now be obtained from Regional Offices instead of applying to Ottawa. Amateurs operating maritime mobile outside Canadian waters may use the entire bands 14.0-14.35, 21.0-21.45 and 28.0-29.7 Mc. In addition, maritimers within ITU Region II (roughly, the Western Hemisphere) may use the whole forty-meter band.

These changes were contained in the *Canada Gazette*, August 11, 1965. Copies may be ordered from the Queen's Printer, Ottawa; ask for SOR/65-347, the price of which is 25¢.

U.S. AMATEURS IN GREENLAND

Effective in August, the calls of U.S. amateurs stationed in Greenland have been changed, and the prefix KG1 will no longer be used there. The stations of individual American amateurs have been assigned calls beginning with OX4 and OX5; such stations are not permitted to handle third-party traffic. Two special group stations connected with MARS have the calls XP1AA and XP1AB. Only these two stations are permitted to handle communications on behalf of third parties between Greenland and the U.S. (Other third-party areas are listed in the IARU News column.)

AUSTRALIA AND LUXEMBOURG RECIPROCITY

Agreements for reciprocal operating privileges have been signed by the U.S. with Australia, Luxembourg, Peru and Sierra Leone. Other such agreements pursuant to Public Law 88-313 are being negotiated, and successes will be re-

ported on W1AW bulletin schedules. The full list to date can be found in the IARU column.

MASSACHUSETTS PLATES ISSUED

In April the Massachusetts Registrar of Motor Vehicles announced that amateur call-letter plates would be available, presumably for 1966. On June 2, W1E9Z, chairman of the license plate committee, was informed that the Registrar was going to make the amateur plates available in 1965. Could the committee please furnish a list of the interested amateurs by June 15? Oh, yes, and could the committee refrain from newspaper publicity in so doing? Quite an order—but it was done, appropriately enough, by ham radio, with QNCs on all Massachusetts nets and club ragchewing skeds. The state expected 700 to 800 names; the committee furnished 2,018! Among the amateurs present at State House ceremonies August 3 were K1N9V and W1E9L, brothers of the Governor; K1EMO, Deputy Governor and Commissioner of Administration; and W1H7K, known around the world as the "earthquake priest." Only two states are now without plates, New Jersey and Kentucky.

RENUMBERING OF RESIDENCES

Where an amateur's address has been changed by government edict, and the amateur has not actually moved his station, a superseding authorization will be issued by FCC without formal application and without the payment of a fee. Portions of an FCC letter to W9BCC setting forth the policy and procedures are quoted:

"The request for a superseding authorization should be made by letter and include the amateur call sign, name, address, and other details on your present license and also specify the new address and be sure to state that the change of address was ordered by city ordinance or government edict. Do not submit your present license or file an application for modification of your license. The letter request may be mailed to the

(Continued on page 178)

A "Top-Band" Grounded-Grid Linear Amplifier

Maximum-Power Unit for

C.W., S.S.B., and A.M. on 160

BY ROBERT SUTHERLAND,* W6UOV,

AND HAROLD BARBER,** W6GQK

BEFORE World War II, the 160-meter amateur band was one of the most popular and heavily-populated bands, and is remembered to this day with nostalgia by old timers. In spite of today's Loran QRM and decimated segments, the "top band" (as it is called in G-land) still has its avid supporters. The recent expansion of 160-meter segments in the United States has renewed interest in "one-sixty," and the band has been "hot" with unusual DX during the recent sunspot-cycle minimum.

Unhappily, much commercial equipment used by amateurs makes no provision for 160 meters. This is a mixed blessing, to be sure, as it leaves the 160 band a haven for "do-it-yourselfers" and confirmed equipment builders. Much of the gear operating on this band is homemade, or is designed around the few commercial excitors that cover this portion of the spectrum. Most of the units are low-powered, of the single 6146 variety, and not capable of running the maximum power limits allowed in various parts of the United States.

The 160-meter grounded-grid linear amplifier described in this article may be used with excitors capable of meeting the modest drive level of 20 watts. This amplifier makes use of a single 4-125A and illustrates an inexpensive and uncomplicated package that will operate at the maximum nighttime power limit (200 watts) and, by increasing plate voltage, will come within a few decibels of reaching the maximum daytime power limit (500 watts) allowed in some parts of the country. The unit is designed for c.w., a.m., and s.s.b. operation. While this am-

*% Eitel-McCullough, Inc., 301 Industrial Way, San Carlos, California.

** 45 Sherwood Court, Millbrae, California.

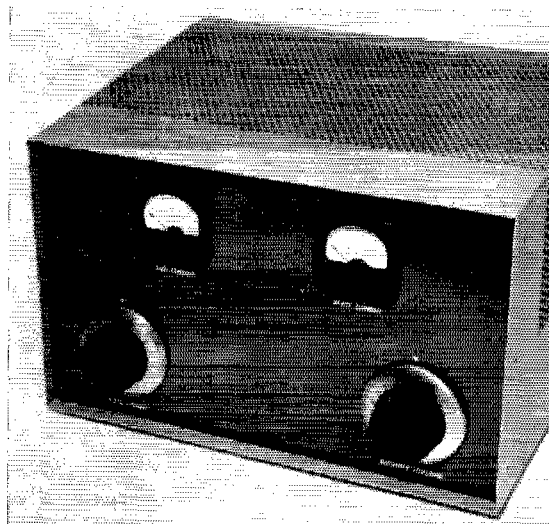

The "Top-Band" linear amplifier. Capable of 200-watt "night" and 345-watt "day" power levels, this compact linear amplifier is suitable for c.w., a.m., and s.s.b. service on 160 meters. The receiver-size wrap-around cabinet is homemade. Cabinet and panel are sprayed with aerosol paint, followed by a coat of clear Krylon enamel.

plifier is designed for the 160-meter band, by proper choice of tuned circuits the design may be used on any amateur band up to 10 meters. With careful attention paid to layout and choice of components, there is no reason why it would not work on 50 Mc. To the one-band low-power ham, the single-band grounded-grid amplifier is an attractive and inexpensive means of achieving a sizeable increase in output.

The Plate Circuit

The little single-band linear amplifier is simplicity itself. A 4-125A tetrode is connected as a grounded-grid high- μ triode in the cathode-driven circuit shown in Fig. 1. At a plate potential of 2000 volts, it is capable of an input of over 200 watts. The screen and control grid of the 4-125A tetrode are grounded directly at the socket. The grounded-grid circuitry eliminates the need for expensive screen and bias supplies, and neutralization is unnecessary. The necessary grid and plate-current metering is done in the negative power leads. This technique excludes the meters from high-potential circuitry. Notice that negative high voltage is slightly above chassis ground; therefore the negative power-supply terminal must not be grounded.¹

¹ This means that the chassis of a conventional supply, in which the negative is connected to chassis, cannot be grounded. From the consideration of safety, it would be preferable to insulate the entire negative side (not just the negative terminal) of the power supply from the power-supply chassis, mount the 50-ohm 10-watt resistor in the power-supply chassis, and connect it from the insulated negative to the chassis. An insulated output terminal should then be provided for the connection to the negative terminal of the meter, as shown in the inset of Fig. 1. This permits grounding both power-supply and amplifier chassis to earth. — Editor.

This design "swims against the tide" in that it incorporates a high-impedance plate circuit requiring relatively-high plate voltage and low plate current. This has some decided advantages at 160 meters that are often overlooked. The plate impedance of the 4-125A under these conditions is about 10,500 ohms. Using a loaded plate-circuit Q of 12, the required plate tuning capacitance is only 88 pf. for resonance at 1.8 Mc.² If the plate impedance were of the order of 2000 ohms (a common value in low-voltage, high-current circuits) the same value of loaded Q would require a plate tuning capacitance of over 460 pf. Worse still, if a pi network were used, the output loading capacitor would be approximately 2800 pf.! The relatively-high plate impedance shrinks the size of the plate-

circuit capacitor, and the substitution of a double-tuned, inductively-coupled output circuit for the more common pi network eliminates the costly and bulky loading capacitor.³ It may be heresy in these days of the pi-network circuit to employ an alternative design, but the simple circuit used in this amplifier is effective, provides excellent harmonic rejection, and is certainly familiar to most pre-1950 amateurs.

The plate and antenna inductors are cut from commercial coil stock and the tank circuit is

² On the other hand, this feature may present a problem in avoiding an excessively-high- Q tank, if the circuit is modified for operation at higher frequencies as suggested earlier. — Editor.

³ Since the maximum transformation ratio in a pi network is limited to the plate load resistance divided by the square of the tank Q , a Q of about 15 would be required to transform 10,500 ohms to 50 ohms if a pi network were used. Even so, for the 10,500-ohm plate load resistance, the required output capacitance would be only approximately 500 pf. Since the voltage across this capacitor would be less than the voltage appearing across the series tuning capacitor of the inductively-coupled circuit, the physical sizes of the two output capacitors could be about the same. — Editor.

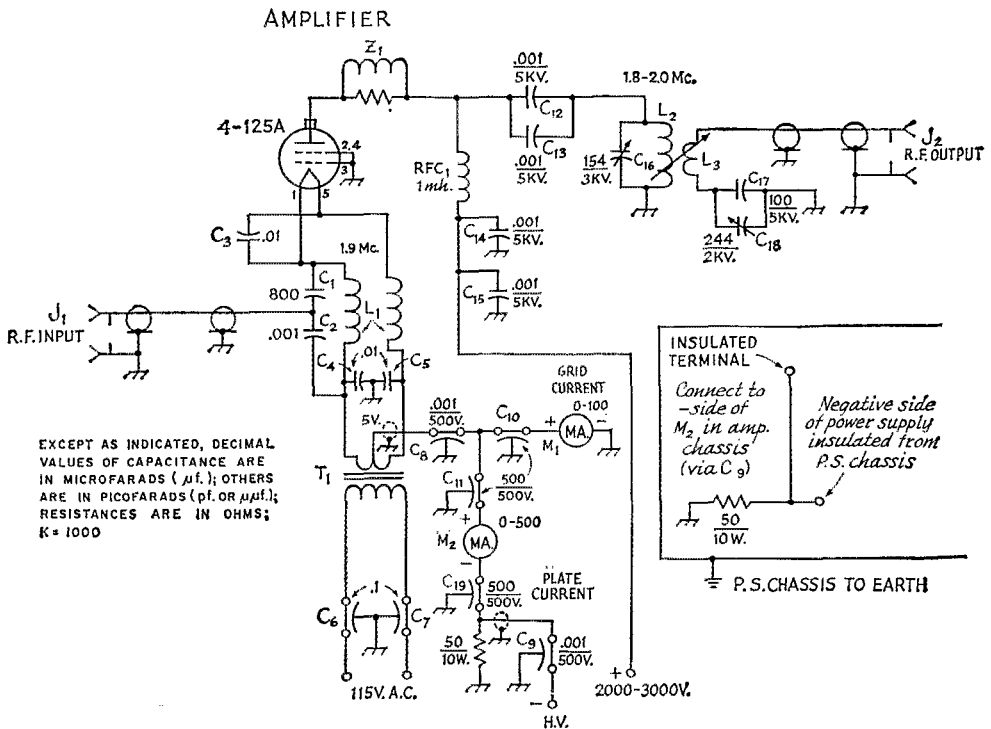
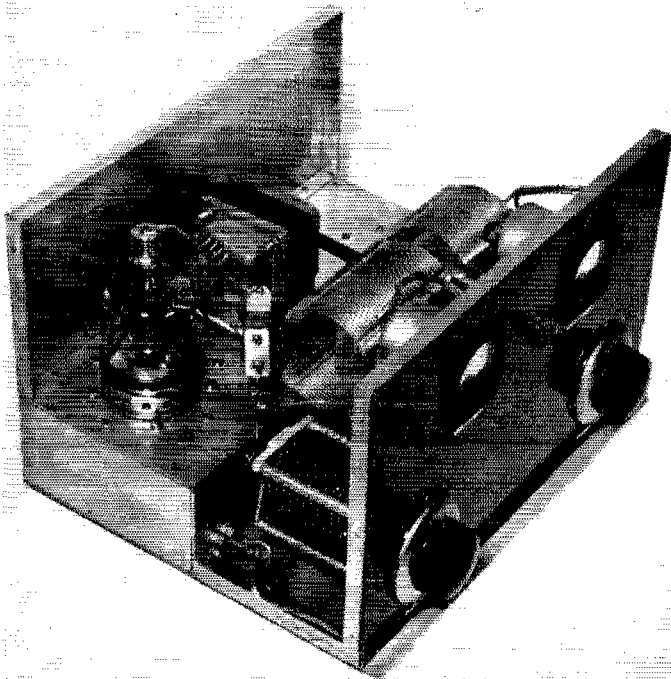

Fig. 1—Circuit of the 160-meter grounded-grid amplifier.

- C₁, C₂—1200-volt (min.) transmitting-type mica (see Footnote 5)
- C₃, C₄, C₅—500-volt mica or silver mica.
- C₆, C₇—Feedthrough type (Sprague Hypass 80P3).
- C₈, C₉—Feedthrough type (Erie 327X5U102M or Centralab FT-1000).
- C₁₀, C₁₁, C₁₉—Feedthrough type (Centralab MFT-500).
- C₁₂, C₁₃, C₁₄, C₁₅—Transmitting ceramic (Centralab 858S-1000).
- C₁₆—3000-volt variable (Johnson 154-8).
- C₁₇—Transmitting ceramic (Centralab 858S-100N).
- C₁₈—2000-volt variable (Johnson 154-1).

- J₁, J₂—Chassis-mounting coaxial receptacle.
- L₁—38 turns (each coil) No. 12 Formvar wire, close-bifilar-wound on 2-inch diam. form, winding length approx. 6½ inches (see text).
- L₂—70 μh: 40 turns No. 14, 10 turns per inch, 3-inch diam. (Illuminetics Air Dux 2410T)
- L₃—45 μh: 27 turns, same as L₂.
- M₁, M₂—2-inch square d.c. meter.
- RFC₁—600-ma. r.f. choke (National R-154U).
- T₁—5.0-volt 6.5-amp, filament transformer (Triad F-9A.)
- Z₁—4 turns No. 14, ½-inch diam., ¾ inch long, shunted by three 82-ohm 1-watt carbon resistors in parallel.



Left-oblique view of the amplifier. The plate-coupling capacitors are supported from the top of the plate choke by a small aluminum bracket. Meter leads are shielded and pass into the subchassis via feedthrough capacitors visible in foreground. The perforated area in the back panel is for a possible addition of a blower, and substitution of a 4-250A at a later date.

proportioned to match a reasonably flat 50-ohm antenna load. The plate of the 4-125A is shunted so that d.c. plate voltage does not appear on the tuned circuit. This configuration requires a good transmitting-type r.f. choke, but allows the use of a compact, inexpensive tuning capacitor having minimum spacing between the plates.

The Cathode Circuit

As this is a single-band design, the cathode input circuit is fixed-tuned to a nominal frequency of 1.9 Mc. The circuit accomplishes three things: First, it matches the 50-ohm input impedance to the 4-125A cathode impedance; second, it provides a suitable impedance across which the drive voltage is developed; and third, it provides a resonant circuit having a Q of about 2 which preserves the waveform of the driving voltage as the Class B 4-125A loads the input circuit on alternate half-cycles.⁴

The cathode inductor L_1 is a bifilar coil of No. 12 Formvar-insulated wire, wound on a 2-inch-diameter section of plastic tube of the type used for electrical conduit and water piping. The r.f.-input point is the junction of two series capacitors and provides a driver load impedance of approximately 50 ohms when the amplifier is properly adjusted. The input circuit is broadly resonant, covering the entire 160-meter range without adjustment. The cathode impedance of the 4-125A is about 340 ohms, so an impedance step-up of approximately 1:6 is achieved in this simple circuit. Transmitting-style mica capacitors

are required, as small ceramic or mica capacitors will not stand the r.f. current flowing in this circuit.⁵

The Amplifier Assembly

The amplifier is housed in a homemade cabinet built of 0.063-inch aluminum sheet and $\frac{1}{2}$ -inch aluminum angle. The housing is $8\frac{3}{4}$ inches high by 14 inches wide by 12 inches deep. Perforated screen for the top cover may be cut from screen stock found where do-it-yourself supplies are sold. The screen used in this amplifier was punched to our requirements.⁶

The subchassis, upon which most of the components are mounted, is a standard $3 \times 6 \times 14$ -inch aluminum chassis. Under this chassis are mounted the tube socket, the bifilar filament coil, and various auxiliary components. Atop the chassis are the filament transformer, the plate r.f. choke and the two plate bypass capacitors.

The two meters, the plate-tuning capacitor and the antenna-tuning capacitor are mounted on the front panel, as are the two large coils. The coils are slid over a $\frac{1}{2}$ -inch-thick piece of Rexolite⁷ sheet measuring 3 by 6 inches. Two polystyrene pillars, $3\frac{3}{4}$ inches long, support the

⁵ Transmitting mica capacitors are not widely distributed these days. An abbreviated assortment is available from Walter Ashe Radio Co., 1125 Pine St., St. Louis, Mo. The required values can be made up from parallel combinations, if necessary. Capacitors of this type are sometimes found in surplus, e.g., Standard Radio-Electrical Products, 86 Franklin St., New York. The use of two 0.001- μ f. capacitors will increase the impedance seen by the line by about 30% — probably not enough to affect the operation significantly.

⁶ Editor.

⁷ California Perforating Screen Co., 345 Folsom St., San Francisco, California.

⁴ Orr, Rinaldo, Sutherland, "The Grounded-Grid Linear Amplifier," *QST*, August, 1961.

coil assembly from the panel. Antenna coupling is set by sliding the antenna coil back and forth on the support plate until proper degree of coupling is achieved.

While the 4-125A does not require forced air, convection cooling is necessary to remove the heat from the enclosure. Accordingly, a series of $\frac{1}{4}$ -inch holes was drilled in a 3-inch square area in the bottom plate of the cabinet, just under the tube socket. Air passes through these holes, up via the socket and tube base, and over the glass envelope of the tube. The amplifier cabinet is mounted on rubber feet to provide space under the cabinet to admit the cooling air.

The use of aluminum meter shields,⁸ feed-

⁷ Lucite, polystyrene, or other such material may be substituted.

⁸ Meter shields are obtainable from California Chassis Co., 5445 East Century Blvd., Lynwood, Calif., type MSA-2 for 2-inch meters, or type MSA-3 for 3-inch meters.

through capacitors, and shielded wiring contribute to amplifier stability and freedom from TVI — important matters even at the most “d.c.” of all “d.c.” bands!

Preliminary Amplifier Tuning and Adjustment

The bifilar input circuit requires no adjustment if the values specified in the schematic are used. The resonant frequency may be verified with a grid-dip meter, and should fall near 1.9 Mc. The plate tank circuit and antenna circuit should be checked at the intended frequency of operation with the grid-dip meter. During this check, the antenna circuit should be completed by shorting the antenna coaxial receptacle with a bit of wire. Finally, the amplifier should be checked for parasitic oscillation. Full plate voltage is applied without excitation and without antenna load. No grid current should be observed at any

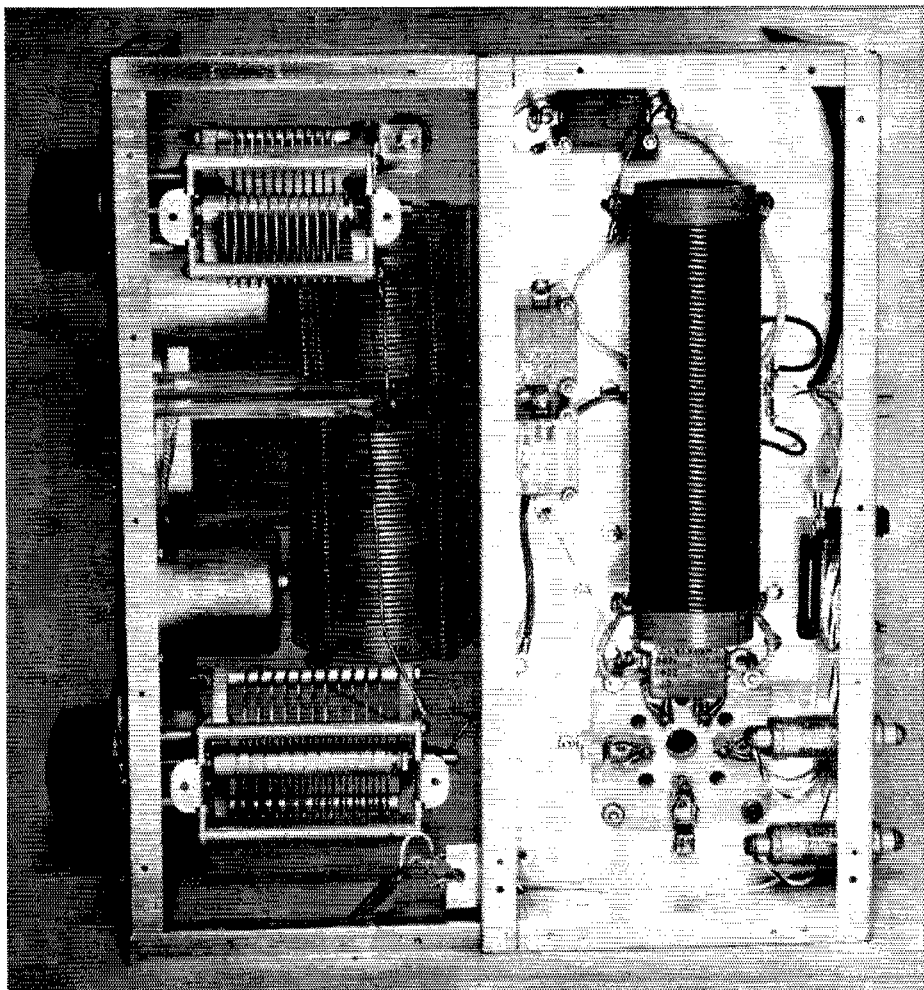

A bottom view of the linear amplifier. Removal of the bottom plate exposes the bifilar coil at the right. The series-connected mica input-tuning capacitors are to the left of the coil. The bottom plate encloses the input area, shielding it from the plate-circuit components. Ventilation holes are drilled in the bottom plate, encompassing the area around the tube socket.

TABLE I
4-125A Typical Operating Conditions Grounded-Grid Amplifier

C.W. and S.S.B. Conditions

D.C. plate voltage	2000	2500	3000	volts
Zero-signal d.c. plate current	10	15	20	ma.
Single-tone d.c. plate current	100	110	115	ma.
Single-tone d.c. total grid current	85	85	85	ma.
Single-tone driving power	16	16	16	watts
Driving impedance (4-125A)	340	340	340	ohms
Plate load impedance	10,500	13,500	15,700	ohms
Plate input power	200	275	345	watts
Plate output power	145	190	240	watts

A.M. Linear Carrier Conditions

D.C. plate voltage	2000	2500	3000	volts
D.C. plate current	54	55	57	ma.
D.C. grid current	28	28	28	ma.
Driving power	4	4	4	watts
Driving impedance (4-125A)	340	340	340	ohms
Plate load impedance	10,500	13,500	15,700	ohms
Plate input power	108	137	171	watts
Plate output power	36	47	60	watts

setting of the controls, and plate current should not change from its zero-signal value. No difficulty is anticipated with this test.

Preliminary adjustments may be made with full plate voltage but with reduced drive. Full excitation should *never* be applied to any grounded-grid amplifier without plate voltage, or damage to

the tube may result. Once plate circuit resonance has been established, the antenna circuit is tuned to resonance, indicated by a rise in plate current. Loading may be varied by altering the spacing between the antenna coil and the plate coil. Once the approximate spacing for proper loading has been found, fine adjustment may be accom-

The meter shields (with feed-through capacitor terminals C_{10} , C_{11} and C_{19} set in) and the plate parasitic suppressor are visible in this oblique view. Plate-circuit coils are suspended from the panel by means of insulating supports attached to a plastic strip within the coils. The antenna-tuning capacitor, with shunting capacitor attached, is in the foreground. A short length of RG-8/U coaxial line connects the antenna receptacle to the antenna tuned circuit. The outer shield of the line is grounded to the chassis at both ends.

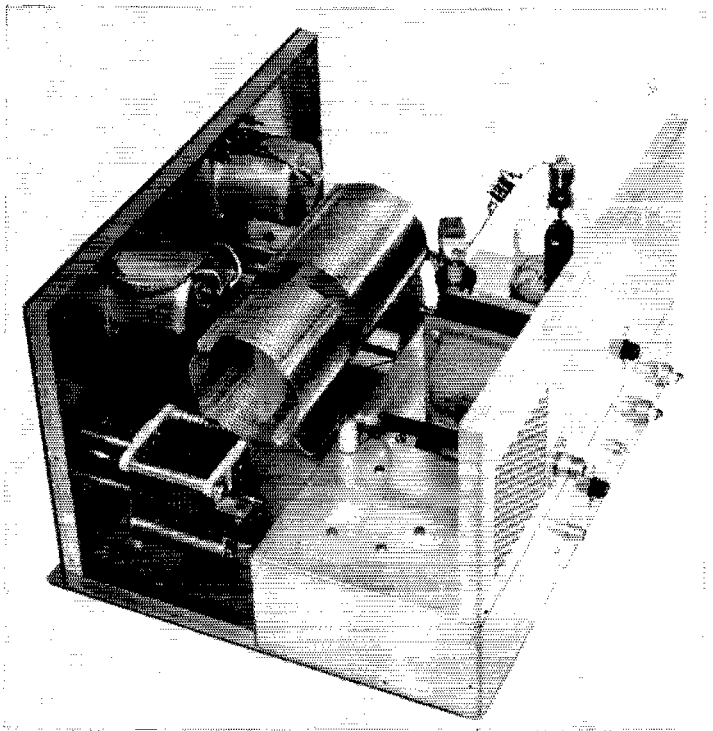

plished with the antenna-tuning capacitor. Do not attempt to make large loading changes by drastic detuning of the antenna circuit.

As with all linear amplifiers, the proper ratio between drive power and antenna loading must be achieved. Proper grid and plate currents are indicated in the operating chart. If grid current is excessive, plate loading is too light. Conversely, if grid current is low, the coupling should be reduced a bit by increasing the spacing between the coils, accompanied by an increase in drive level. As a final check of proper loading, the r.f. output (as observed by an r.f. indicator in the antenna line) should increase in direct proportion to the excitation level.

Adjustment for A.M. Service

The adjustments for a.m. linear service are accomplished in the same manner as described above for c.w. and s.s.b. operation. The drive power and antenna loading must be adjusted until the conditions outlined in the table are met. When the amplifier is properly adjusted, the drive power will be one fourth that required for c.w. and s.s.b. operation. This allows the driver to be modulated 100 per cent, reaching four times the

driver-carrier power level. The p.e.p. plate input of the 4-125A for 100 per cent a.m. drive modulation will be the same as the single-tone input power for either the c.w. or s.s.b. operation condition.

Driven from a low-power exciter stage using a plate-and-screen-modulated 6V6, the linear amplifier delivers a fine 45-watt fully-modulated carrier. Used in s.s.b. service, the maximum tube capability is attained for a 250-watt input p.e.p. signal that really "bores a hole" in the band. Results have been so good that the builders are toying with the idea of a "brace" of single-band linear amplifiers, covering the ham bands like a blanket! But that's another story!

This amplifier operates in the Class B mode and, as such, is not suited to Class C plate-modulated service. It would be possible to add grid-leak bias, drive the amplifier harder into the Class C operating region and modulate it. However, modulation of a grounded-grid stage may introduce problems (involving modulation of the driver) and, for the time being, the idea of plate modulation has been shelved until additional time allows the subject to be fully investigated. QST

Strays



The biggest hazard to a model airplane enthusiast is the loss of an airplane, especially in the free-flight division. During the National Model Airplane Championships at the U. S. Naval Air Station, Willow Grove, Pa., the Phil-Mont Mobile Radio Club volunteered its services to recover and track model planes by using mobile stations linked with a spotter aircraft and a communications-center van. Shown in the photograph are two members of the club going over a map of the area. The communications van is in the background. Nearly 200 planes were recovered this year, often in time for their owners to enter the next event! Twenty members participated in the recovery operation. The Phil-Mont club has had plenty of experience along these lines; they are old hands at providing emergency communications during floods and heavy storms. The club holds monthly meetings at the Franklin Institute in Philadelphia. (Official U.S. Navy Photo)

Bill Richardson, K6VVM, (left) accepts from Ray Meyers, W6MLZ, the 1964 grant of sideband equipment presented by the Single Sideband Amateur Radio Association to the Braille Institute of America in Los Angeles. The equipment will be used at the Institute's club station, WA6GLN. Special braille markings are on all dials and controls. The SSBARA was commended in a resolution passed by the Los Angeles City Council for "its generous gesture in making available to blind persons this important equipment which will greatly enhance the radio training program at the institute."



• Beginner and Novice

3 + 3 = 4 (?)!

Two Three-Element 145-Mc. Quads for Four Dollars.

BY LEWIS G. McCOY*, W1ICP

QUOTING from the antenna chapter of the ARRL's new *V.H.F. Manual*¹: "Though it has not been used to any great extent in v.h.f. work, the quad antenna has very interesting possibilities. It can be built from very inexpensive materials, yet its performance should be at least equal to other arrays of its size." Thinking along these lines, we decided to try a 3-element quad to see how economically and easily one could be built. As it turned out, the materials were so cheap that we ended up with two 3-element quads, stacked, complete with feed line for less than four dollars.

For those hams who like to experiment with different types of antennas — and this seems to be a favorite pastime with many v.h.f. men — the antenna described in this article can be built in a few hours. The four-dollar figure is based on all new materials. Many hams have enough

* Beginner and Novice Editor.

¹ *The Radio Amateur's V.H.F. Manual.*

"junk" lying around to make the cost considerably less.

How about performance of quads versus other types of arrays on 2-meters? Doug De Maw of the ARRL Technical Department staff used a quad array over a two-year period. One noticeable difference with the quad as compared with a Yagi was that the quad exhibited less fading, particularly in receiving over long paths. The quad also showed excellent front-to-back and front-to-side-ratios. Put it this way: This antenna is easy to make and you should have fun trying one out.

Each three-element beam has a director, driven element, and reflector. The two beams are stacked vertically, one wavelength apart. The feed system used differs slightly from the conventional method of feeding quads. Fig. 2 shows the two driven elements, one for each beam. Two half-wavelength sections of 300-ohm twin lead are tapped on impedance-matching stubs on each of the elements. The tap position for each line is at a 600-ohm point on the stub. With the two half-wave sections of line in parallel, the point where the feed line is attached is 300-ohms, a match for 300-ohm line. At the station end, a conventional 4 to 1 balun is installed to go from the 300-ohm balanced to 70-ohm coax unbalanced. This assumes that unbalanced (coax) output is used at the rig. If the transmitter tank circuit uses balanced output, as some 2-meter rigs do, the balun can be dispensed with.

In the event the reader wants to build only a single three-element Quad, the 300-ohm feed line would be tapped on the stub four inches from the bottom of the driven element. More about this later.

Materials Needed

The Quads are mounted on a wooden framework constructed from 1 × 1-inch lumber. You'll need the following lengths for two three-element beams with one wavelength separation:

Booms — (Two required) —	32 inches
Ref. — " " —	22 "
Direct. — " " —	20 "
Driven — " " —	21 "
Stacking Mast	
(One required)	— 61 "

Details for making up the wooden supports are shown in Fig. 1. The Quad elements are made from No. 8 aluminum ground wire. This

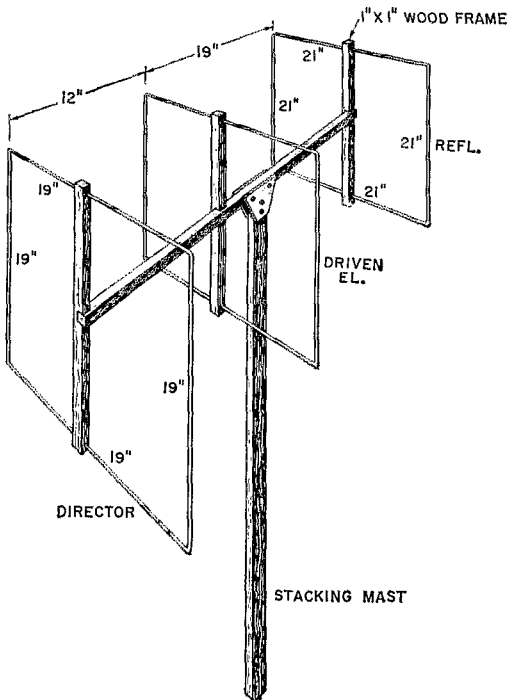

Fig. 1—Drawing of one of the three-element quads. Both antennas are identical.

There have been plenty of constructional articles for quads for low frequencies but few for v.h.f. Here is a simple antenna consisting of two three-element quads, stacked, for 2-meters. The antenna can be built in a few hours and the cost is low.

type of wire is easy to bend but still stiff enough to hold its form. As aluminum is difficult to solder, the easiest way to make connections is with home-made clips. A small piece of perforated aluminum stock, a few inches square, will provide enough material for all the clips and clamps required. Aside from some nuts and bolts to hold the assembly together, plus the feed line, that's all the material needed.

Constructional Information

Make up the booms and supporting members first. We mortised out a small section of each supporting member where it fitted to the boom; in addition, a hole was drilled through the boom and supporting member and the two pieces further secured by a nut and bolt.

The best way to make the aluminum elements is to cut off sufficient wire from the roll equal to the total element length. For example, the reflectors are 21 inches to a side or a total of 84 inches. When cutting off the wire allow another inch for connecting the element ends together. The clamps for connecting the element loop can be made by bending a piece of perforated aluminum, about $\frac{1}{2} \times 1$ inch, around the two ends of the element where they meet. Then run a $\frac{1}{2}$ -inch long No. 6 machine screw through the perforated holes and tighten up the screw and nut. This makes an effective clamp.

The wire for the directors should be 76 inches long, plus an inch for connections. The driven element wire is 118 inches long. The stubs, 19 inches long, should be taped at the top and bottom of the element support. The taps for the phasing line can be made from the perforated aluminum with a soldering lug mounted under the same screw used to tighten the clamp. When installing the elements, we cut the wires to the above lengths, drilled holes at the top and bottom of the element supports and then fed the wires through holes, forming the element to the correct dimensions.

The stacking mast is 61 inches long and when the booms are mounted at each end the distance between the edges of the elements equals a half wavelength. The two phasing lines made from 300-ohm twin-lead are each 31 inches long.

Tune-Up and Adjustments

The figures given in Figs. 1 and 2 can be used as shown and you can have reasonable assurance that you'll be getting the most out of the antenna. However, you may want to adjust the matching section, so the method we used may be of interest as it applies to other antennas as well as this one.

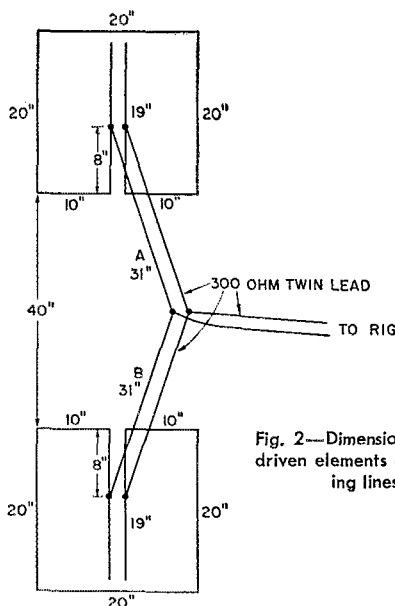

Fig. 2—Dimensions for the driven elements and phasing lines.

Matching coax fed antennas is usually no problem because it is simply a matter of putting a Monimatch in the feed line and then adjusting the matching device at the antenna until a matched condition is achieved. However, if the feed line is 300-ohm twin lead or open-wire line, it isn't quite that simple. In our case, we had to find a 600-ohm point on the driven element stub. The idea here was to have each driven element fed through half-wavelength sections of 300-ohm twin lead that could be connected in parallel. The point where the phasing sections were connected together and fed with 300-ohm line must of course be a 300-ohm impedance point. In a half wavelength of line, the load or impedance at one end of the line is duplicated at the other end. If we could have 600-ohms at each end and then connect the phasing lines in parallel, the load or impedance would be halved, or 300 ohms. The problem is finding out when you have 600-ohms at the stub, or for that matter, 300-ohms at the feed-line end of the phasing section. Actually, this isn't as difficult as it sounds.

All that is required to do this type of matching is a transmitter, some coax, a Monimatch, a transmatch that tunes to 144 Mc., plus a 600-ohm dummy load. Fig. 3 shows this type of setup. Nearly every ham has all of the above with the possible exception of the transmatch. However, this is a simple device and details for construct-

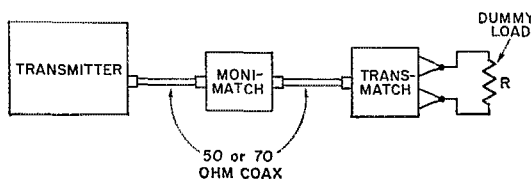

Fig. 3—This set-up is used for matching when balanced lines are used to feed an antenna. The value of R will depend on the match required; see text.

ing one, and also a v.h.f. Monimatch are given in the *V.H.F. Manual*.²

Let's assume we want to find the 600-ohm impedance point on the stub. First, you need a 600-ohm dummy load. This can be made up from two 1-watt, 1200-ohm carbon or composition type resistors connected in parallel. Because we are working at v.h.f., the lead lengths on the resistors should be kept as short as possible to reduce stray inductances and capacitances. With the setup shown in Fig. 3, the 600-ohm resistor load is connected across the output side of the transmatch. Enough power is fed to the load to give an indication on the Monimatch. The transmatch is then adjusted so that a 1 to 1 s.w.r., or match, exists on the coax line between the transmitter and transmatch. Next, without changing the settings of the transmatch, remove the resistor load and connect the 300-ohm line from the driven element to the same connection points on the transmatch as the resistor occupied. The length of 300-ohm line from the driven element must be a half wavelength long, or a multiple of a half wavelength. The next step is to move the connections on the stub on the driven element up or down until the Monimatch

shows a match. When it does, you know you have the phasing line connected at the 600-ohm point on the stub.

If a 300-ohm resistor—or for that matter any value you needed to match—is attached to the transmatch and the transmatch adjusted for a match on the connecting coax line, you can adjust the matching point at the antenna to correspond to the impedance of the dummy load. However, keep in mind that an electrical half wavelength, or multiple, must be used for the connecting line between the antenna and transmatch. When figuring the length of a half wavelength of line the velocity factor of the line must be considered. For example, the velocity factor of 300-ohm twin lead is 0.82.³ Assuming that a half wavelength at 145 Mc. is approximately 41 inches, 41 inches is multiplied by 0.82 to obtain the line length equivalent to an electrical half wavelength, or just slightly more than 32 inches. Velocity factors for the feed lines commonly used by amateurs can be found in the *V.H.F. Manual*. QST—

² *The Radio Amateur's V.H.F. Manual*, pages 188 and 284.

³ This velocity factor is for line made by reliable manufacturers. The "unnamed" brands of line should be avoided.

Strays

According to a report in the National Academy of Sciences *IG Bulletin*, the evidence now in shows that the sunspot cycle passed through its minimum in the summer of 1964. An interesting feature is that there were apparently two minima, one in July and one in September of last year. The upswing is now under way, so we can look forward to increasing "openings" in the 21- and 28-Mc. bands in the next year or two, along with more hours of DX propagation on 14 Mc.

Stolen Equipment

The following items were stolen from the Keesler ARC on August 8: Hallierafter SR-160 transceiver (serial No. 416001-418013), Hallierafters PS-150-120 power supply (serial No. 715001-449027), Hallierafters S-120 receiver, and a Clegg 99er transceiver (serial No. 612-077). Please contact Joseph J. Zelezniak, K3SFC, Keesler ARC, OMR Box 488, Keesler AFB, Miss.

A late report from the Tektronix Employees' Radio Amateur club shows the results of fine club interest in the June ARRL VHF QSO Party. One of the club groups, K7AUO/7, went to 6300 ft. Pine Mt. in central Oregon with the intention of working DX. The photo shows this group preparing to erect the 144 Mc. antenna. Their 220 and 432 Mc. antennas were just as ambitious (gain approaching 18 db.). Although a widespread cold front almost completely quashed their DX efforts, K7AUO/7 worked five bands for 135 QSOs and a multiplier of 30, an impressive 23 sections on 6 meters! Total score 4290 points. The W7QF/7 group went to 3500 ft. South Saddle Mt. in the coast range working well into the Willamette Valley and Puget Sound areas, racking up 4389 points in a four band effort, 221 QSOs and a multiplier of 19.

If you happen to be in Manila (Philippines) and want to meet some of the Philippine amateur radio gang, drop in to their weekly luncheon which is held every Wednesday at noon at the Selecta Restaurant on Roxas Blvd.

On July 24, W8NSJ lost all of his amateur radio equipment, records, and QSL cards due to a fire caused by lightning. He would appreciate it if other stations would check their logs and send him duplicate QSLs. It's a long road to DXCC and WAS from scratch again!

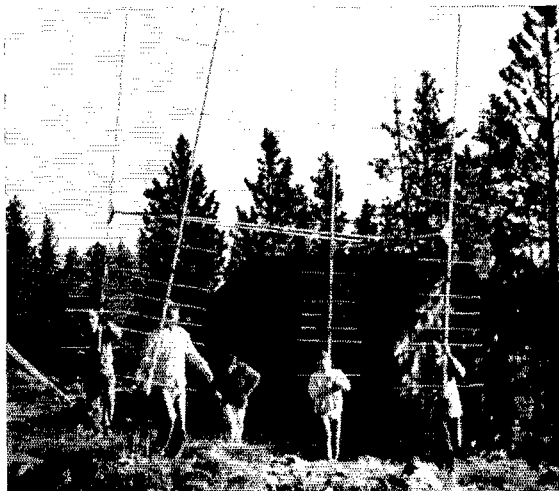



Correspondence From Members -

The publishers of *QST* assume no responsibility for statements made herein by correspondents.

CODE TYPEWRITER

☐ It looks like the code typewriter described in W2QYW's article, "Perfect Code at Your Fingertips" in August *QST* is my next major project. I built the sideband package a few years ago and it is responsible for my present position on the Phone DXCC Honor Roll. I think that this was one of the best construction articles ever published in *QST* . . . —W3KT

☐ This is the first project I will have undertaken for some time and I am anxious to tackle the job . . . —W2RGD

☐ I was quite impressed with the pulse-technique code typewriter article. Since this represents basic computer techniques on a scale of practicality well-suited for instructions, I am interested in obtaining the core modules for construction of a keyer by several of my maintenance technicians who are also hams. In addition to the educational opportunity we of course plan to use it in our ham operations! . . . —W8HSL

☐ Congratulations on the successful conclusion of such an ambitious technical project and on the well-written results of that project.

As an electronics design engineer myself (Medical Electronic Instruments) I can more than appreciate the time and effort that went into this impressive keyer . . . —W1VVA

ANNUAL REPORTS

☐ The annual reports of the officers and directors of the ARRL is truly worthwhile for any radio amateur. This volume should get more publicity. —WA2QJU

[Interested members should check with their club secretaries, who have been offered a copy without charge; or obtain a personal copy at the cost price of 75 cents. —EDITOR]

BAD SIGNALS

☐ It used to be pretty easy to spot DX by listening for weak signals with maybe a little chirp or a little hum. We all realize that it is hard to keep gear running well in some locations, due to lack of parts, etc.

But every time I copied one of these signals, and some of them had more than a little chirp, the call hanging on the end was de W — or K, WA, or WB. I found just as many old timers with faulty signals as newcomers.

The same idea applies to some of the fists I heard. I admit that my own fist and signal are not perfect, but I do make it a point to always strive to improve both. These things should be a matter of personal pride with the c.w. ops.

The League is doing an excellent job with its campaign for better signals and operating practices, but let's not leave good ol' c.w. out of the picture. We've had articles on checking and improving phone signals — how about one on c.w.? —K7OLZ

A NOVICE SPEAKS

☐ A member of your fraternity, but not yet a full-fledged amateur, I don't feel entirely qualified to voice an opinion in your widely-read journal. I guess we Novices aren't capable of doing anything right, be it on the high bands or low, so I'd better not say anything downright specific for fear of being buried up to my neck in angry letters. It's those angry letters in *QST* lately that I'm afraid of, especially those concerned with the incentive licensing proposals. All I've got to say is that if an institution of ARRL's strength and size has something in mind, that item has to be in the best interests of its amateur members. There'll always be some squawkers, but the ARRL, something entirely devoted to a single cause, must know what's best for all of us. Thank you for existing. —W1N2UO

THE EXTRA EXAM

☐ The article by Lathrop, W4PR, in July *QST* is excellent, but having recently successfully passed the Extra Class exam, I would like to amplify several areas.

To begin with, roughly 50% of the questions I had were not in any Q & A manual. The question material came from the ARRL *Handbook*. The 1955 edition covers the material a little better. It is suggested that the following areas be studied: receiver theory with emphasis on operation and theory of xtal filters and Q multipliers, transmitter theory, s.s.b. theory and operation. This means ARRL's sideband handbook is a must. Next, radio wave propagation, especially v.h.f., and then parasitic antenna theory and operation. Don't overlook antennas such as end-fire and broadside types.

Next, one should purchase a copy of the FCC *Radiotelephone First Class Q & A* manual. There's one available for \$1.25. Yes, my exam had half a dozen questions from same. The ARRL *License Manual* is a must. One should study all classes of licenses and be thoroughly familiar with the privileges of all types of licenses. Know what types of emission are permitted on all amateur bands. Know what countries allow third-party amateur traffic. Know the formula for calculating radar average power when given the peak power, pulse width and pulse repetition rate. Yes, I had one question on figuring the average power.

The best code practice is available on 4015 kc. and 8015 kc. NPG sends 25 w.p.m. five-letter code groups every evening. Thirty minutes a day for two months will prepare anyone for 20 w.p.m. plain language and you can "tighten up" if you are just barely getting 20.

Last, be sure to practice all schematic diagrams in the above license manuals. My exam had approximately 20 of such. These were not fill-ins, but complete diagrams. —W6EBT

THERE OUGHT TO BE A LAW AGAINST IT.

☞ Yes sir, all these big shot a.m. and single sidebanders cluttering up the c.w. bands with their five words a minute trying to brush up on their code so they can get an Extra Class ticket — first time most of them have had a key in their fist in a long time. If I had my way I'd relegate the whole bunch of them to the Novice bands until they could receive 15 w.p.m.

Yes sir, there ought to be a law against it. — *W3PN*

LID OF THE YEAR

☞ You can never imagine the anger and chagrin experienced here when I was edged out of first place for "Lid of the Year." I was so sure I'd made the grade until I heard a CQ one morning that lasted 22 minutes with nary a "k". I do have to work to support my hobby of hamming so went to the mill. That night I was getting ready to QRM the 3555 transmission from W1AW when a "foreign" v.f.o. swooped in and spent some time in tuning up right there, spoiling my fun. How can I ever earn this award, which is so rightfully mine, when some clod like this makes me a real bumpkin?

Seriously, I can't see why these practices are required. Maybe you fellas should add to your sentence, "Send in step with W1AW (but off the air!)" — *K1FSY*

HAM HELPS

☞ Thank you for your great help in making me ready to take, first, the Novice test (which I passed the first time), and today, the General test, which I also passed the first time. When I decided to become a ham I already had learned most of the Novice theory. The only obstacle in the way of my ticket was the code, which appeared to be beyond the scope of my learning capabilities. Then I bought a copy of your book, *Learning the Radiotelegraph Code*, which helped me learn the code in about 2 weeks. I made use of the W1AW code practice sessions,

which quickly raised my speed to 7.5 w.p.m. Soon after I received my ticket I bought a copy of your *License Manual* and 1965 *Handbook*, and began studying for the General and deciding which transmitter to build. I built the 75-watt 1625/807 transmitter, and used it with my existing long-wire antenna with 300-ohm twinlead feed, no matchbox. I made a few local contacts, then built a good antenna, an 80/40 trap dipole, which I constructed in inverted-vee. I now plan to build the v.f.o. described in the '65 *Handbook* and design and build a k.w. linear amplifier using 1625s. In closing: Thanks For Everything! — *W2SYW*

COSTLY OMISSION

☞ I wish to compliment ARRL, and W1HDQ in particular, for the thoughtful review in the July issue of *QST* on the SR-42 and SR-46 v.h.f. transceivers wherein it was specifically pointed out that these units do not operate on c.w., the simplest mode of communication. It would have been even better had the last paragraph been in bold type for additional emphasis. This type of review is a major step forward in liberating the Technician Class licensee from being frustratingly trapped at that level. Code proficiency is required to up-grade to General Class and unless all equipment is capable of "on the air" practice, or possibility of using c.w., there is little opportunity to develop this ability. Anyone can talk on phone, whether or not they can say something intelligent, but additional communication skills are required for c.w. The c.w. transmitter is exceedingly simple compared to phone and failure of any manufacturer to include key terminals and a "click filter" is inexcusable.

Had the original reviews on the Communicators, the TWOers, and other widely used v.h.f. gear been more critical I'm sure that the amateur ranks today would not be supporting 30% of its population (Novices and Technicians) in a code-deficient and frustrated category.

Let's have more critical reviews for the benefit of developing the whole amateur. — *W3LUL*



California — The tenth-anniversary RAMS Dinner Dance will be held October 9.

California — The fourth annual Greater Bay Area Hamfest will be held at the Peacock Gap Country Club in San Rafael on October 16 and 17. Write Box 113, Hayward, California for details.

Connecticut — The Tri-City Radio Club, Inc., 18th annual hamfest will be held on October 9, 1965, at the Crocker House Hotel, State Street, New London, Connecticut. Tickets are \$5.99 each which includes a steak dinner and registration. Activities include technical talks, swap and shop table, and visits to local military activities. Registration and information available from General Chairman Robert York Chapman, W1QV, 28 South Road, Groton, Connecticut 06340.

Illinois — The Joliet Amateur Radio Society will observe its 25th anniversary with a banquet October 2 at the Blue Willow Restaurant in Lockport, Illinois. Principal speaker will be Staber W. Reece, Sr., W9DOO, of Madison, Wis., official photographer for the Wisconsin Conservation Department.

Illinois — The annual meeting of the Chicago Amateur Teleprinter Society will take place in Chicago at McCormick

Place, meeting room 7, starting at 10:00 A.M. A banquet will be held at 6:30 P.M. Reservations should be obtained prior to October 10 from Robert E. Paucal, 1327 N. Hamlin Ave., Chicago, Illinois.

Massachusetts — The New England DXCC will hold its 15th annual dinner meeting October 2, at the Motel 128, Dedham, Massachusetts, at the intersection of Routes 1 and 128. A roast top sirloin dinner will be served. Festivities will start at 2 P.M., dinner at 7 P.M. Members and guests are invited. Tickets are \$5.75. For reservations write, and make checks payable to Robert York Chapman, W1QV, 28 South Road, Groton, Connecticut 06340.

Pennsylvania — The Western Pennsylvania Mobile-Radio Club is planning its ninth annual Fall Roundup Hamfest for October 22. For information write Richard B. Wilson, K3IXN, 714 Jane Street, Pittsburgh, Pa. 15239.

Pennsylvania — The fall meeting of the Tri-State Sideband Group of the Pittsburgh area has been scheduled for October 16 and will be held at the Warrendale Holiday Inn located on Route 19 just off the Penna.-Tpke. interchange No. 3. Dinner will be served at 6:30 P.M. Tickets are \$6.00 and may be obtained from T. Tompson, WA3BYS, RR 1, Box 197-M, Greensburg, Pa.

Texas — The 8th Annual Houston Area Hamfest will be held on October 30 at the HARC building and October 31 at Spring Creek Park. Registration will be \$2.50. For further information contact Jim Shotwell, WA5BUV, 315 1st, Humble, Texas.

• Recent Equipment —

The Alltronics-Howard Model L RTTY Converter

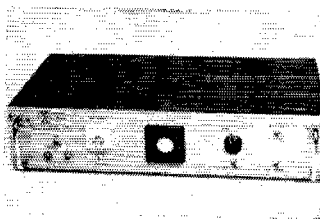

ALLTRONICS-Howard has, over the years, produced a series of receiving demodulators (or converters) for RTTY; the Model L is the latest of this line. With the growing interest in amateur Teletype, many hams will, no doubt, find this moderately priced unit attractive. The Model L is a very versatile unit that is adaptable to about any receiving condition. For signals in the presence of noise, f.m.-type reception with a limiter/discriminator can be used. When one or the other of the transmitter frequencies has QRM, the receiver Q multiplier or crystal filter is used to notch out one channel and only the clear frequency is copied. In this case the limiter in the converter is switched out. For a signal in which the mark and space signals are fading independently, best copy is usually obtained by switching out the limiter and switching in the axis restorer provided in the Model L.

The Model L will mount in a standard 19-inch rack, but a separate cabinet also is available. Jacks for the page printer and keyboard of the Teletype machine are located on the front panel for easy access. The converter provides a d.c. local loop for machine operation.

The input impedance of the Alltronics is 600 ohms, so amateur receivers with only a 3.2-ohm audio output will require a step-up transformer. When the limiter is selected, the audio is fed through a 12AX7 limiter-amplifier. This limiter has the advantage of being symmetrical; that is, the positive and negative excursions of the received pulses are held at the same relative level. A 6AQ5 functions as an audio amplifier following the limiter, or as the first stage when the limiter is switched out. The output of this amplifier

is transformer coupled to the two tuned circuits of the discriminator. The converter is normally supplied with discriminator coils for the standard RTTY frequencies of 2125 and 2975 c.p.s., although other plug-in units are available to accommodate shifts from 100 to 850 c.p.s. A balance control is used to equalize the output of the two tuned circuits. A reversing switch is used to facilitate tuning of inverted (mark and space reversed) transmissions.

The signal is passed either through or around the axis restorer (a bridge of diodes) depending on the position of the axis restorer cutout switch, and is then rectified by one half of a diode-connected 12AX7. The second half of this tube is used as an amplifier and driver for the 6W6 d.c. control tube. The page printer and keyboard magnets are keyed directly by the control tube. A polar relay may be plugged into the local loop circuit so in transmitting the page printer will copy what is being typed on the keyboard while the polar relay keys the transmitter f.s.k. unit. A meter on the front panel monitors the loop current. The local loop current is adjusted by means of a control which varies the screen voltage of the 6W6.

Monitoring of the received signal is accomplished by either an "eye" tube or miniature oscilloscope, depending on the model purchased. For the electron-ray-tube indicator, pulses from the discriminator are rectified, amplified by a 12AX7, and applied to the grids of the 6AF6 "eye" tube. One side of the "eye" will show the mark channel and the other side the space. The gain of both channels is adjustable to provide a balanced visual indication.

Our test unit had the 1-inch oscilloscope for monitoring. The scope will give the operator more information than is possible with the "eye" indicator; one can see the strengths of the mark and space signals and determine whether the receiver tuning and frequency shift of the received signal are correct for the discriminator in use.

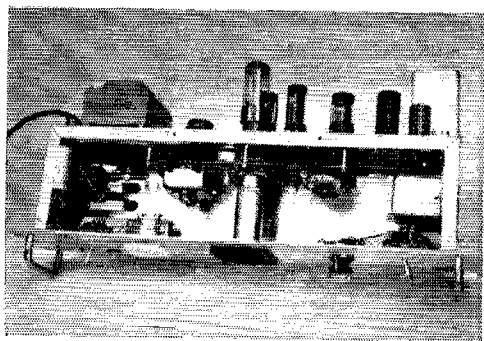

Top view of the Model L receiving demodulator. The limiter, amplifier, and control circuits are constructed on a printed board which is mounted on the rear apron. The oscilloscope circuits are on another printed board mounted on standoffs at the center of the unit. The toroid coils to the right of the scope tube are the filters used in the plate circuits of the scope amplifiers.

The scope indicator receives the mark and space pulses from the discriminator, which are in turn amplified by a 12AX7. The plate circuits of these stages have additional tuned circuits to give the scope a sharper characteristic than the converter. Signals from these two tuned circuits are capacity-coupled to the deflection plates of the scope tube. The result is a cross-hair presentation when the RTTY signal is properly tuned.

Using the Model L is simplicity itself. The receiver is tuned (with b.f.o. on) across the RTTY signal. When the proper scope or "eye" presentation is obtained the converter is switched from hold to print, and the RTTY machine starts. The hold print switch is a useful feature because it prevents the RTTY machine from

"running open" when no signals are received or while tuning the receiver. — *WIKLK*

Alltronics-Howard Model L Receiving Demodulator

Height: 4 inches.

Width: 19 inches.

Depth: 8 inches.

Power Requirements: 115 volts, 50-60 cycles, 50 watts.

Price Class: Model L with "eye" indicator, \$200; Model L with oscilloscope indicator, \$280.

Manufacturer: Alltronics-Howard Co., Box 19, Boston 1, Mass.

The Racal RA-71

RACAL Electronics Limited, an English receiver manufacturer, now has a factory in Silver Springs, Maryland. The American branch assembles and markets several of the Racal products, including the RA-71 communications receiver.

The 71 is a commercial-grade, triple-conversion communications receiver covering 0.5 to 30 Mc. in 30 ranges. The Racal uses a novel tuning system that was described in *QST* some years ago

sight unseen,¹ so we were happy to see a working model. The receiver has all the features one would expect in an expensive set, so we will concentrate on a description of the tuning system.

The unusual features of the RA-71 become immediately apparent when the front panel is examined. The frequency indicator dial looks something like the one used on the Collins 75A receivers, except that on the Racal the small window indicates megacycles, and the slide-rule indicator kilocycles. The pointer on the kilocycle dial is stationary; the scale behind it moves. This scale is a 60-inch piece of 35-mm. film which has a calibration mark every kilocycle. The large knob at the right sets the megacycle range desired, and then the kilocycle knob — the large one at the left — tunes the receiver 1000 kc. Thus, to tune 80 meters, the megacycle knob would be set to 3, and then the kilocycle knob would tune the receiver from 3 to 4 Mc.

The setting of the megacycle knob is not critical, even though it controls a v.h.f. oscillator that performs the bandswitch functions for this receiver. The block diagram, Fig. 1, will be a help in understanding how the Racal bandswitch works.

The 1st v.f.o. (V_5), the megacycle control, has a range of 40.5 to 69.5 Mc. The output of this v.f.o. is coupled to mixers V_7 and V_4 . Mixer V_4 also receives a spectrum of 1-Mc. signals from a 1-Mc. crystal oscillator-harmonic generator. If you were receiving, for example, 4 Mc., the 1st v.f.o. would be set to about 44.5 Mc. The v.f.o. output would mix with the seventh harmonic of the 1-Mc. crystal oscillator, and give

¹ Goodman, "A New Receiver Tuning Principle," *QST*, March, 1958.

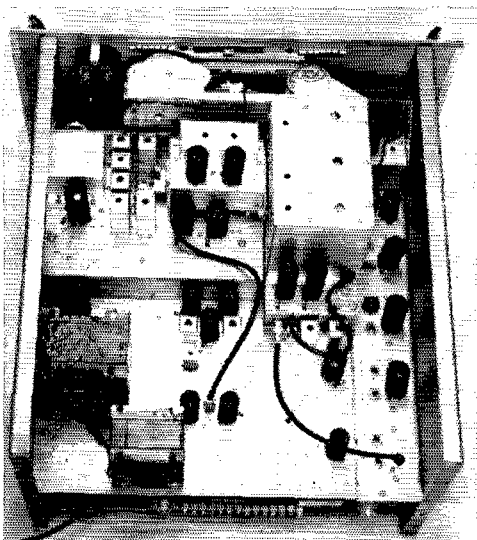

The r.f. stage, first mixers, and the megacycle oscillator are located on the large subchassis to the left. The other large subchassis, at the right, contains the 2-3-Mc. tuner.

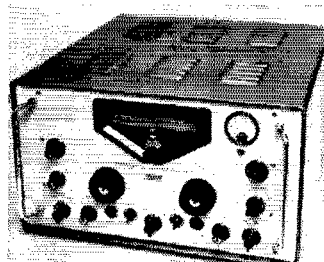

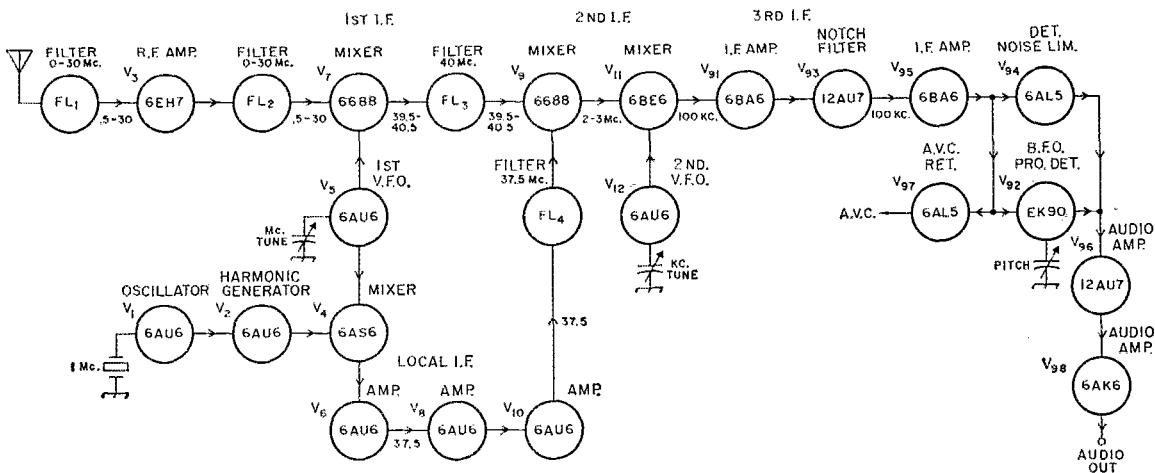

Fig. 1—Block diagram of the Racal RA-71.

an output of 37.5 Mc., the local i.f. frequency. The 37.5-Mc. signal is amplified by V_6 , V_8 , and V_{10} , and then passed through a 300-ke. bandwidth filter, FL_4 . The received signal on 4 Mc., after amplification in the r.f. stage, is mixed with the 1st v.f.o. frequency of 44.5 Mc. giving an output from V_7 of 40.5 Mc., the 1st i.f. frequency. This i.f. signal then goes through a 1300-ke. bandwidth filter, FL_3 , which has a center frequency of 40 Mc.

The first i.f. signal of 40.5 Mc. and the local i.f. of 37.5 Mc. are combined in mixer V_9 , which has an output in this case of 3 Mc. The rest of the receiver is, in effect, a 2-3 Mc. tuner. For any receiver range, the output of the second mixer will be 2-3 Mc.

Confused? Let's take another example. To listen to 14.5 Mc., the 1st v.f.o. would be set to 54.5 Mc., the 17th harmonic of the crystal oscillator would mix with the 54.5 Mc. giving the local i.f. frequency of 37.5 Mc. The incoming 14.5 Mc. would mix with 54.5 giving 40.0 Mc., and the 1st. i.f. of 40.0 Mc. minus the local i.f. of 37.5 Mc. will give 2.5 Mc., the middle of the 2-3-Mc. tuner's range.

An oscillator running between 40 and 60 Mc. is not likely to be very stable, but in this case it doesn't need to be. Consider what would happen if, in the example above, the 1st v.f.o. drifted to 54.6 Mc. A drift of 100 ke. is a lot, but it won't matter. 54.6 Mc. from the v.f.o. would give 37.6 Mc. in the local i.f. and 40.1 Mc. in the 1st i.f., and the two subtracted would again equal 2.5 Mc. Obviously the setting of the 1st v.f.o. is not going to be critical — as you tune this control the receiver will receive one band after another, with each popping in and out with about a quarter turn on the knob. The advantage of this system to a v.h.f. man who wants to cover a number of megacycles as a tunable i.f. for his converters is apparent.

This system of conversion uses v.h.f. frequencies, so you won't find many beats ending up back in the tuning range. Listening on the RA-71 is a

pleasure because it is so "clean." An experienced builder could, no doubt, duplicate the circuit, but the design of the bandpass filters and adequate filtering and shielding during construction make it no simple project.

The r.f. stage uses either a broadband network that covers the entire frequency range of the receiver without tuning, or a six-range preselector for extra r.f. selectivity. If the preselector is used, it must be re-peaked for each range.

The RA-71's selectivity is obtained in the third i.f. at 100 kc.; three steps of selectivity are provided, 8, 2.5, and 0.5 ke. for a.m., s.s.b., and c.w. respectively. A notch filter is also available to null interfering carriers. Either long or short a.g.c. time constants may be selected. The short a.g.c. has a discharge time of 200 milliseconds,

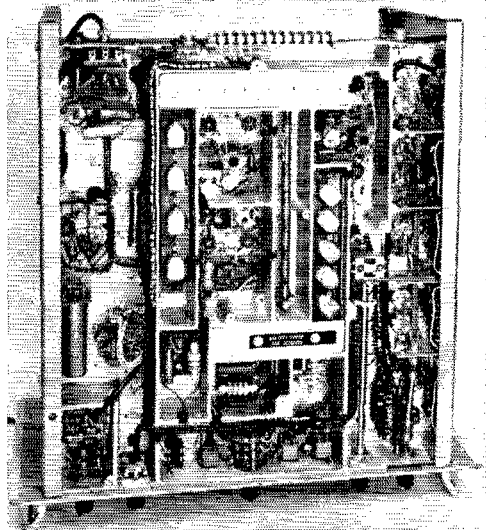

The bottom view of the Racal resembles an English garden maze. The heart of the receiver, the i.f. bandpass filters, are located in the narrow channels at the center.

and the long about 1 second. For s.s.b. and c.w. reception a self-excited product detector is used, while for a.m. a diode detector is selected. The 100-ke. crystal oscillator used in the front end also provides calibration markers for the receiver. The kilocycle dial is calibrated by moving the dial pointer.

The Racal is extremely rugged. The main chassis is an aluminum casting, with channels that crisscross the bottom side providing inter-stage shielding and extra rigidity. The v.f.o. sub-chassis is also a cast piece. The front-panel layout is clean and functional. Some operators may find the tuning rate of the Racal somewhat fast

for easy s.s.b. tuning, for the kilocycle-change knob covers 100 kc. per revolution. — *WIKLK*

Racal RA-71 Receiver

Height: 12 inches.

Width: 20½ inches.

Depth: 21¼ inches.

Weight: 90 pounds.

Price class: \$1200.

Manufacturer: Racal Communications Inc., 3440 Second Avenue, Silver Springs, Maryland.



Dynalab Three-Band Conversion Kit

SOMEONE finally had to do it — make a kit to modify a kit! The Dynalab Co. has produced a kit that can be used to modify the HW-12, HW-22, or HW-32 Heathkit single-band transceivers so each will cover the phone portions of the 80-, 40-, and 20-meter bands. Dynalab supplies all the necessary components, plus an extremely detailed step-by-step conversion manual. The conversion consists of adding the coils, crystals, and other components needed for covering the other two bands with any given model.

In the modification, the coils for the receiving r.f. amplifier and the transmitter driver input and output are switch-selected for each band, plus another switching arrangement is added to the heterodyne oscillator and final amplifier. The final-amplifier switch changes coil taps and adds the required tuning and loading capacitors. As the front panel view shows, a symmetrical panel arrangement is maintained, and only two additional holes are required in the panel.

In order to make room for the additional band switches, the VOX sensitivity control is removed from the panel and mounted behind it. The audio gain control is then moved over to the position formerly occupied by the VOX control, to make room for the switch that changes the receiving r.f. amplifier and transmitter driver coils. The r.f. gain control is removed and mounted above and to one side of the amplifier tuning control. The switch for changing the heterodyne oscillator mixer coils and crystals is then installed in the spot formerly occupied by the r.f. gain control. Appropriate control and band labels are included for labeling the new and changed controls.

The "stickiest" job in the conversion is removing the shielded coils L_2 and L_3 from the

printed circuit board. These must be removed and mounted with the added coils near the band switches. A handy tool for getting the solder out of the holes can be made from a rubber syringe and a short length of Teflon tubing.

The connection is first heated to the melting point of the solder, which is then sucked out with the syringe and tubing. Without such a tool, the coil can must be pried up from the top

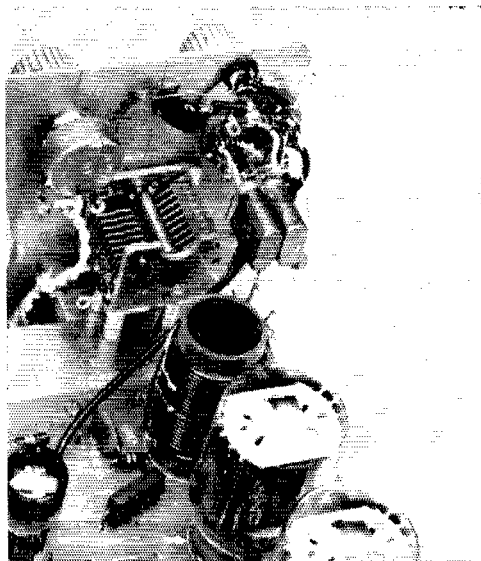

(Top view) The changes in the final amplifier for band switching. The band switch and remounted r.f. gain control are on the panel.

(Bottom view) At the left, behind the separating wall, are the receiver r.f. amplifier and transmitter driver coils with their band switch. On the far right are the coils and crystals for the heterodyne oscillator-mixer.

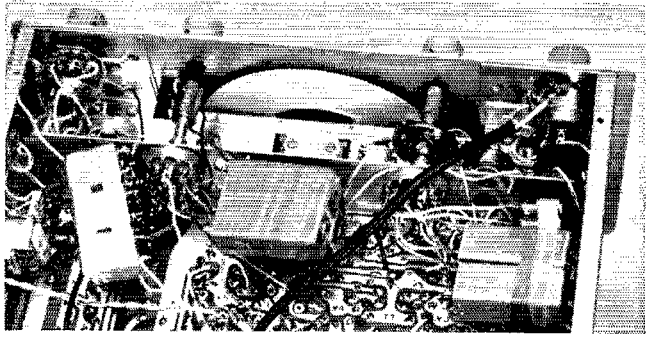

of the board while unsoldering from the bottom. The remaining conversion work is simple, involving only changing and adding connections. The total conversion takes between three and

four hours and alignment another hour or two. The kit is manufactured by the Dynalab Co., 215-28 Spencer Ave., Queens Village, N.Y. 11427. Price Class: \$50. — *WIICP*

Strays



Several hundred licensed Boy Scouts, Explorers, and adult leaders of the Boy Scouts of America will take part in the eighth Jamboree-on-the-Air over the weekend of October 16 and 17. The object of the Jamboree-on-the-Air is to introduce Scouts to amateur radio and to electronics, generally by letting them talk or listen to other Scouts. A participation certificate will be issued to anyone who reports his activity as a radio amateur, a listener, or a visitor to a ham station jamboree program. Reports from the U. S. may be sent to VE3WSB, the Boy Scouts World Bureau, 77 Metcalfe Street, Ottawa 4, Canada, or to K2BFW, the Boy Scouts of America national station in the Johnston Historical Museum at New Brunswick, N. J. 08903. The Jamboree-on-the-Air begins at 0001 GMT, Saturday October 16, and ends at 2359 GMT Sunday, October 17. Scouts and former Scouts, hams or not, may participate. The photograph shows a group of Scouts and Explorers of Atlantic City, N. J., area watching John Gronlund as he operates K2BFW.

In the "25 Years Ago" column in *QST* for May, mention was made of the article, "A 56-Megacycle Mobile Station," by Art Lynch, W2DKJ. Art, now W4DKJ, saw the note and sent in the accompanying photograph showing the actual equipment in use over 25 years ago. The gear was mounted in one of the wheelchairs used for transportation about the New York World's Fair back in 1939. The simple quarterwave antenna is mounted on the rod normally used to hold an umbrella (the umbrella in the background isn't part of the mobile rig). Art worked a large number of 5-meter stations in New York City, Brooklyn, Long Island, Staten Island, New Jersey, Connecticut and, on one occasion, W3FGN located in the City Hall in Philadelphia where Tony was using a somewhat similar rig. However, W3FGN's antenna was poked up through the hat of William Penn's statue atop the building!





The Challenge of milliwatt Power

BY J. W. DREHER,* W2TKG

A good many amateurs will recall the "good old days" of the '45 Hartley or '10 + PTC when inputs of 10 to 25 watts were common. Back then, competition was on a fairly even basis and a pair of 03As only showed up once in a while. But as we're all aware, high power comes much easier today, so much so that inputs of 100 watts and less are considered by some as QRP!

To even suggest, therefore, the use of powers at less than one watt seems completely out of character with present day hamming. But should not the entire gamut of communication be explored? The photographs show a two-transistor transmitter which, with its forerunners, has made possible contacts with 23 states, VE1s, 2s, and 3s and 3.5 Mc.

My first real attempt at QRP operation — since keying the antenna of a '57 detector and '56 audio receiver more than a score of years ago — began with a transistorized 7-Mc. crystal controlled transmitter.¹ Fourteen states and Canada were worked with 250 milliwatts input — including a few QSOs during evening hours at the very low end of the band where common sense says one shouldn't be. Statistically, however, the use of this rig was unsuccessful since the ratio of QSOs to calls was only 10%. I could do much better with 150 watts!

It was North's² article that prompted me to reconsider low-power work. Convinced, as a result of my 7 Mc. work, that if ever frequency maneuverability was needed, it was needed for QRP work. A transmitter, very similar to the one shown, was developed using the oscillator described by North as a v.f.o. Eighty meters was chosen because it was assumed that the stability of the band would provide better measurement. Reliable communication was the goal; DX, if any, would be a bonus.

The results have been more than satisfactory. In only a few instances have the QSOs been of a report-swapping variety. In only one of the 23 states worked (California) did I depend upon the "big rig" for the initial contact. Contacts up to 200 miles are extremely consistent. Not only was my goal accomplished, but DX added "topping to the cake".

In an experience that closely resembles being that rare DX station that you always want to be, I was on the receiving end of calls and QSOs from W8NBK (Ohio-449), W8CKX (WVa-4/5 5/6 9), W9WJB (Ill-339), W8ELL (Ohio-449), and W9SZR (Wis-539), in that order, after an initial contact with K3EKO (Md-5 6/7 9) on the very low end of 3.5 Mc. Power input on these occasions was *only* 75 milliwatts!

I'm sure that a large measure of my success is because of the fine operators with whom I make

* 1 MacArthur Road, Baldwinsville, N. Y. 13027

¹ Todd, "All Transistor Ham Rig", *Electronics Illustrated*, October, 1958.

² North, "Practical Ham Shack Transistor Application", *QST*, December, 1961.

Have you ever QSO'd with real low power — say 100 milliwatts, or less? This is a success story about operating at milliwatt power levels and is written with the hope of encouraging amateurs to explore the potential of communications with inputs of less than one watt. Although the application may not be limitless, communication at these levels should have its place, particularly in emergency situations. Aside from this there is the real opportunity to prove the reliability of good communication with little more than the proverbial "peanut whistle", not to mention what it would do for the QRM situation.

contact — those rugged individuals who have no fear of copying an $S5 \pm 2$ signal. I have an idea that quite a few stations have missed QSOs because the r.f. gain was never turned up sufficiently to copy anything less than an $S7-8$ signal. This is rather unfortunate because with ham radio being as sophisticated as it is today, it is only through the unusual or unexpected that you experience that extra "something." Working QRP will do it regardless of which end of the QSO you're on.

But operating practices at inputs of 100 milliwatts are different; you just don't plow your way through.³ Care in whom and when to call must be taken. Needless to say, an operator's proficiency will improve.

For those interested in QRP, the following rules used at W2TKG might prove helpful:

Determine when conditions are suitable for QRP operation. I have learned that I have better than a 50-50 chance of raising a station being received at the $S8$ level from within my own or adjacent call area. They are always prime targets. I have had much less success with signal strengths at less than $S7$ unless I'm aware that they also are QRP.

³ Campbell, "CQ TR", *QST*, March 1956.

Call the station on his frequency. As common as this practice is today it merits special mention for QRP operation. The reason, simply stated, is that you're more apt to be heard since the operator being called will first monitor his own frequency. I have, however, been surprised at the number of off-frequency calls that are made on 80 meters.

Listen before calling. This is one that has been preached for years but not practiced enough. A QRP rig in the 100-milliwatt range is (probably) not going to compete with 99% of the stations on the air. Before calling a station, be sure no one else is.

Patience, obviously, is a factor. By following these simple rules, however, in my normal 45-minute operating period each morning, two QSOs are a common occurrence — as common as those with 1000 times the power.

Too few contacts have been made with other stations using power inputs in the milliwatt range. Of particular interest, however, is the fact that very frequent consistent contacts are made with W2UUV, Fishkill, New York (160 miles). His extremely sophisticated set-up allows

(Continued on page 186)

Inside view of W2TKG's milliwatt transistor transmitter. The circuit is from the General Electric Transistor Manual, 7th edition, 1964.

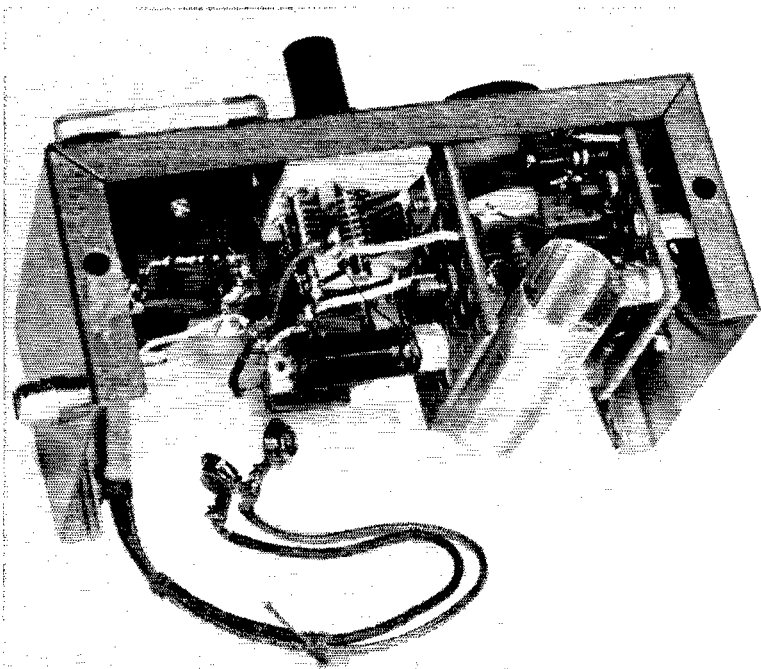

AMATEUR RADIO PUBLIC SERVICE CORPS

CONDUCTED BY GEORGE HART,* WINJM

More Down the Flagpole

Sorry we ran out of room on this subject last month. You will recall that of the five flags discussed, only #4 received a positive reaction, and this was washed out by a heavy negative reaction by SCMs and SECs. So, nothing very conclusive so far. We know that those who especially espoused one or more of those first five flags will be disappointed, perhaps even bitter; but this, as the saying goes, is the way the ball bounces.

Let us hasten to assure you, however, that this does not necessarily end the matter. All it does is introduce an element of caution into any impending implementation.

To continue with the remaining six flags:

(6) *Endorsement stickers for NTS certificates.* In favor: eight. Opposed: five. Indeterminate: one.

Comments: "Would simplify SCM's paper activities. How about a gold sticker for an outstanding year's activity?" "This would just add paper work for the SCM. Why not issue certificates for five- or ten-year membership?" "Regular traffic handlers need neither certificates nor endorsements. Let's not make more work for the SCMs." "Our net hasn't even issued certificates." "OK, if they are earned." "Don't see the point unless you are trying to economize on certificates." "It would take a load off the SCM. Same should be done for all certificates." "This is a good idea. The present system, or rather lack of one, results in a hodge-podge condition." "The net manager should be

* National Emergency Coordinator.

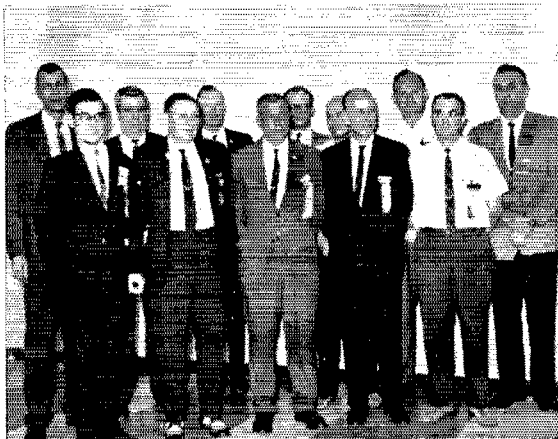

At the Georgia State convention, some of the big brass from the East Coast got together too. In the front row (l. to r.) we have: W4MLE (SEC W. Fla.); W4BNU (SCM N.C.); W4RZL (SCM Ga.); WA4ECJ (SEC S.C.); W4PED (SCM S.C.). In the back row (l. to r.) W4MFK (SEC N.C.); W4HYW (Dir. S.E. Div.); W3PS (ARRL General Council); W1LVQ; (ARRL Gen. Mgr.); W4SAZ (SEC Ga.); W4UVP (SCM Tenn.); W1KUX/6 (EC).

mainly concerned with certificates for the new members; the old ones have them."

(7) *Revise the ARL message list.* In favor: ten. Opposed: two. Indeterminate: four.

Comments: "Long overdue." "Most of them are quite suitable as is, but we might add some for service message texts." "Seems like this should be reviewed every two or three years." "More texts would only complicate the list. OK to eliminate those seldom or never used." "OK, but don't re-use numbers of those eliminated." "I don't go for numbered texts to begin with." "I have no quarrel with present list, but occasional review is a good thing." "More seasonal greetings should be added, and texts from U.S. Training Centers should be ARL'd." "The texts numbered one to nineteen could be revised."

(8) *Re-name the BPL.* In favor: five. Opposed: seven. Indeterminate: three.

Comments: "BPL nomenclature still has the appeal." "This would be like trying to re-name Washington, D. C." "Never heard of such a thing." "C.w.'s high-volume traffic practitioners should have the particular distinctions BPL confers." "What did you have in mind? How about 'Fast And Torrid Handlers of Emergency And Distress Services'?" "Good point! However, the requirement here is a matter of education and not reorganization." "Anyone who doesn't know that phone traffic is eligible for BPL doesn't handle much traffic." "That's like renaming ARRL American Radio Amateur League." "No! If they don't know they're eligible, let 'em read as well as yak on phone." "I like it the way it is, but will go along if we find a suitable name." "Might be hard to find a name."

(9) *Monthly reporting forms for RMs and PAMs.* In favor: four. Opposed: one. Indeterminate: three. Most had no opinion on this one.

Comments: "No reason why they couldn't be made similar to the EC reports." "Seems like a good way to simplify things and eliminate some paperwork." "A common reporting system would help to dissolve differences in appointments." "Absolute necessity!" "What would they report?" "This is definitely needed, immediately." "Forms are handy for routine reports." "If it's a change for the better, FBI!" "We have enough reporting to do."

(10) *Add a CFM (confirm) line to standard message procedure.* In favor: three. Opposed: fourteen. Indeterminate: three. This one was "shot down."

Comments: "More complications." "We should get it right the first time, but words missed can be repeated." "The receiving operator knows what he needs confirmed." "Competent transmitting operators counterbalance the opportunity for guessing by repeating difficult words or groups." "For unattended RTTY it might be a big help. Where an operator can ask for fills, it seems unnecessary." "I think it would be a waste of time." "I like it, sounds like a professional touch." "Isn't it just as possible to mess up the CFM line as the original message?" "Any message handled properly in the first place needs no confirm line." "No, dogzoit, no. This is fine for RTTY, but responsible phone or c.w. ops should not require unsolicited confirmations." "My feeling is: copy it right the first time and ask for fills." "Good idea for special instances, but do we want to create a dogma regarding this?" "Would be superfluous and time consuming." "Why? A CFM line can be loused up as good as the message in the first place." "Not needed. It's quicker to get a fill." "Let's keep our procedure as

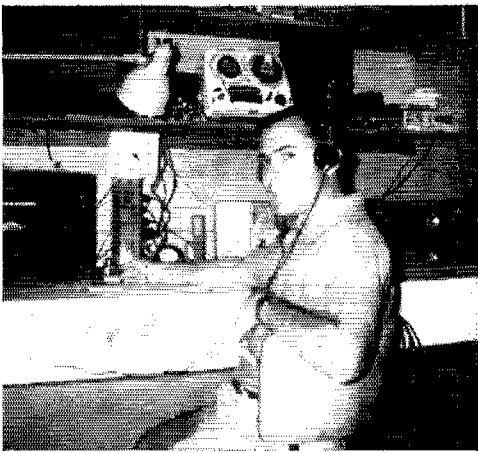

A prominent traffic man and past PAN manager is WA6ROF. Jerry is presently active at all NTS levels and maintains several TCC skeds.

simple as possible; it's complicated enough now." "OK for RTTY, has no place on c.w. and phone." "This may prevent or reduce garbles."

(11) *Open the NCEFs to unlimited calling.* In favor: seven. Opposed: four. Indeterminate: three.

Comments: "A long felt need." "There is plenty of room on the band for other calls. The NCEFs should be kept restricted." "We should establish as much as possible a feeling that these frequencies are sort of sacrosanct." "Good idea, makes more efficient use of a well-known frequency." "First you ought to subject the present NCEFs to a careful scrutiny." "This would defeat the purpose of the calling frequencies." "It may cause some surge in interest, but the caller should indicate the purpose of his call." "I suppose this would be OK, but who uses the NCEFs now?" "Why not? I doubt if it will catch on, though." "No sense keeping a frequency open for emergencies that seldom happen." "If we are going to have NCEFs, let's keep them the way they are."

An interesting analysis, especially in view of the wide divergence of opinion on these matters. We kept all letters pertaining to this in a separate folder, and we want to express our thanks to those who commented at length. We have not identified any of them above, although nobody asked us to refrain from doing so, because we did not want anybody to be swayed for this reason. We do wish, however, to list those who responded to our request for comment, at the same time we refrain from revealing who said what or in just what words (we took the liberty of paraphrasing some of the "quotes"). Our specific thanks, then, to W1JYH, K1TPK, WB2JWB, WA2QJU, K2SIL, W3QCW, K3YVG, W4BNU, WA4IBZ, K4KDN, K4KNP, WA4TNH, WA6CXB, WB6JUH, K6YCX, W8DAE, K8DIU, WA8HFI, W9SNQ, W0SIN, VE3BZB, VE3GI, VE6FK.

And now what, you ask? Well, we can't see that any special mandates have been handed down by the membership, except for revision of the ARL list. But a lot of food for thought has been generated. This is mainly what we were after. We were particularly impressed that we received a minimum of straight "yes" or

"no" answers, and that much thoughtful comment accompanied almost every letter. There are at least two, and sometimes many more, sides to every question. Your hired help at headquarters are active, operating amateurs with personal opinions of their own. We *know* what we think, but in order properly to do our jobs we have to consider first what is in the best interest of public service and second what will be acceptable to the fraternity. Before we can do that, we have to know what *you* think.

Many thanks for telling us, and you can be sure that the net result will affect the course of action taken. — WINJAM.

National Traffic System

To increase interest in NTS and to build our NTS nets we need an increase in traffic. I've never heard of stations becoming discontent with net operations because of overwork. Usually, it's because there's not *enough* traffic.

What's to do about it? Complain because there's not enough traffic for us to handle? Is handling messages more important than *originating* them? I doubt it. Not often, anyway. It would help immeasurably if we all did our part in *originating* and *delivering*. This usually is best accomplished at the section net level.

The *quality* of traffic is also important. By this is meant proper message form, correct word count, etc. Also, a message should be just what the word indicates: a *message*. Sure, we could all just send each other a "message" in correct form saying just "Seventy-three" or something else meaningless, but is that a message? Would you feel that your evening's work on NTS had fulfilled a public service after handling or delivering that type of message?

Originating a message you can be proud of is not difficult. Just give the addressee a little news — perhaps of a mutual friend, or about some new ham gear, or maybe about someone who graduated, moved, had a new baby or went on vacation. Messages that contain news are always welcome at the other end, and when you deliver it there's always the opportunity to ask the recipient for a reply, also news-studded. Neglecting to do this is a common failing among us; some of us don't even give our name or phone number to the addressee.

Delivery of the message is the contact amateur radio has with the general public, and here's one of the best day-in day-out methods to enhance our public image. *Deliver the message the way you would want one you originated to be delivered.*

Occasionally we hear a complaint of a message that was never delivered. This should not be tolerated. If the sender



At the National Convention last July, W4MLE was able to get most of the members of the Pacific Area Staff together for this pix. (L. to r.) W7DZX, TCC Director Pacific Area; WB6JUH, PAN Manager; K7NHL, TWN manager; W6HC, PAS Chairman and ARRL Director; WB6BBO, RN6 manager; K7JHA, RN7 manager.

tells you the message he asked you to send was never delivered, send a "trace" message along the same route. If we all do this, I believe we can put an end to wastebasket deliveries. But be sure on each message you handle to put the date, time and station from which received and relayed, so that if you receive a "trace" request you will be able to honor it. — K5IBZ.

—

I've discovered the difference between a traffic operator and the average, normal amateur. When conditions are bad and what is called QSB is like a solid wall, the casual QSO-type amateur shuts down in disgust. He *knows* he can't get anywhere. The traffic operator hasn't learned that it's hopeless, so he hits that wall until he finds a hole somewhere, and amazingly enough he always finds one. He may have to clear short haul traffic via a long haul relay, but he clears it. He may be cussing the rig, the ionosphere, "Murphy," the other guy and life in general, but he has never been taught to quit while the hook is full. Maybe that's why we can't get recruits, sometimes. They are afraid they might catch the same disease. — W7BBBO.

July reports:

Net	Ses- sions	Traf- fic	Aver- age Rate	Represen- tation (%)
EAN	31	1553	.969	50.1
CAN	31	1390	.889	44.8
PAN	31	964	.673	31.9
1RN	62	469	.275	7.6
2RN	62	652	.791	10.5
3RN	62	598	.430	9.7
4RN	56	548	.345	9.8
RN5	62	810	.352	13.1
RN6	62	750	.610	12.7
RN7	31	270	.280	8.7
8RN	62	400	.308	6.5
9RN	31	597	.697	19.3
TEN	60	491	.363	8.0
ECN	28	128	.229	4.6
Sections ²	1208	5482		
TCC Eastern	124 ¹	822		
TCC Central	93 ¹	957		
TCC Pacific	124 ¹	1026		
Totals	1849	17,907	EAN 8.1	CAN
Records	1918	20,658	1,267 15.2	100

¹ TCC functions not counted as net sessions.

² Section nets reporting (41): CN (Conn.); NCNL, NCN (N.C.); NCN (Calif.); SCN, SCEN (S.C.); PTFN (Pa.); BUN (Utah); GBN (Ont.); NJPTN, NJNN (N.J.); NSN (Nev.); MTN (Man.); OSSBN (Ohio); TN, TSSBN, TPN, ETPN, TSN (Tenn.); AENB, AENH, AENM, AENP

(morn.), AENP (eve.), AENT (Ala.); VSN, VSBN (1) (Va.); NYCLIPN, NLS, NYCLIVHF, NLI (N.Y.C.-L.I.); OQN (Ont.-Que.); MIWN, QMN (Mich.); VTNH (Vt.-N.H.); RIN, RISPN (R.I.); MSPN (e.), MSPN (noon), MSN (Minn.).

³ Representation based on one or less sessions per day.

Well, summer is half gone, and we are in the midst of the usual summer slump. No new records this month, but special mention should be made of the new record CAN has set with one year of 100% representation. Nice going, gang!

K1WJD comments that all's quiet on the home front. W9DYG is proud of the whole CAN gang for the fine representation job they have been doing and sends special congrats to W9QLW, K5IBZ and W9LGG. A CAN certificate was issued to WLBWG, WB6JUH sez this was the worst month PAN has had since he took over as manager. Traffic has hit bottom while the QRN and poor condx have hit new heights. WA2GQZ is awaiting the annual shuffle which is due to take place in the next few weeks when the schools open, the summer boys exit and the old standbys come back from vacation. K3MVO kept his typewriter busy by issuing 3RN certificates to: W3s AXA EEB EML KUN LOS MFB NEM PQ PYS QDW, K3s FHR HNP JY'Z KTH PIE TJE URZ VHS YQI YZF, W4s AIZ and CKA. K7JIA reports a general drop in all statistics which he blames on lack of traffic. W8CHT is pleased with the way 8RN ran itself when he was away the last two weeks of July. The same goes for W9LGG and TEN.

Transcontinental Corps: W5PPE remarks that QRN has been taking its toll in knocking off skeds. Jim is resigning as TCC director as of Oct. 1, and W4ZJY will take over at that time. W7DZX sez some of the skeds were missed because so many of the crew went to the National Convention, but things are getting back to normal now.

July report:

Area	Func- tions	% Suc- cessful	Traffic	Out-of-Net Traffic
Eastern	124	86.2	1862	822
Central	93	87.1	1936	957
Pacific	124	86.3	2052	1026
Summary	341	86.2	5850	2905

TCC roster: Eastern Area (W3EML, Dir.) — W1s BGD EFW FMG NJAL, K1s SSH YKT, W4s BLV RUE, UFI, W7s AEJ HWB, W3s EML NEM, K3s FHR MVO, W4DVT, K4s EHY/1 VDL, WA4PDS, W8CHT, K8s NJW KMQ QKY, Central Area (W5PPE, Dir.) — W4s OGG ZJY, WA4AVM, W5PPE, W9s JOZ DYG ZYK VAY, WA9B9W, W0EJL, K0G5Y, Pacific Area (W7DZX, Dir.) — W6s AGR EOT HC VNO, W4s BRG ROF, K6DYX, WB6CRC, W7s DZX AAF GMC.

THE AMERICAN RADIO RELAY LEAGUE

RADIOGRAM

VIA AMATEUR RADIO

NUMBER	PRECEDENCE	NO.	STATION OF ORIGIN	DATE	PLACE OF ORIGIN	TIME FILED	DATE
1	H	5	WINJM	12	NEWINGTON CONN.	0100Z	AUG 20
To		<p>GEORGE THURSTON WAMLE 2116 GIBBS DRIVE TALLAHASSEE FLA</p>					
To		<p>THIS RADIO MESSAGE WAS RECEIVED AT:</p>					
To		<p>STATION ADDRESS:</p>					
To		<p>CITY:</p>					
To		<p>STREET ADDRESS:</p>					
To		<p>STATE:</p>					
To		<p>ZIP CODE:</p>					
<p>PROOFREADING NOW COMPLETED X THINK WE HAVE A GOOD</p> <p>MANUAL X 75</p> <p>QSO WINJM</p>							
REC'D	WINJM	8-20	0115Z	SENT	WASHI	8-20	0145Z
<p>THIS MESSAGE MAY BE REPRODUCED OR TRANSMITTED IN ANY MANNER WITHOUT PERMISSION OF THE AMERICAN RADIO RELAY LEAGUE. THE MESSAGE IS THE PROPERTY OF THE AMERICAN RADIO RELAY LEAGUE AND IS NOT TO BE REPRODUCED OR TRANSMITTED IN ANY MANNER WITHOUT PERMISSION OF THE AMERICAN RADIO RELAY LEAGUE. THE MESSAGE IS THE PROPERTY OF THE AMERICAN RADIO RELAY LEAGUE AND IS NOT TO BE REPRODUCED OR TRANSMITTED IN ANY MANNER WITHOUT PERMISSION OF THE AMERICAN RADIO RELAY LEAGUE. THE MESSAGE IS THE PROPERTY OF THE AMERICAN RADIO RELAY LEAGUE AND IS NOT TO BE REPRODUCED OR TRANSMITTED IN ANY MANNER WITHOUT PERMISSION OF THE AMERICAN RADIO RELAY LEAGUE.</p>							

We have a new message blank! Note that the standard ARRL blank now includes (1) a place for the precedence, (2) a place for handling instructions, when used, and (3) more information of interest to a non-amateur addressee. To make room for the latter, we have eliminated the location of stations in the servicing data and put these data on the same line. Like them?

<i>Net reports:</i>			
<i>Net</i>	<i>Sessions</i>	<i>Traffic</i>	<i>Check-ins</i>
North American SSB	27	489	641
20 Meter SSB	31	824	301
75 Meter SSB	31	250	841
11BN	31	620	438
7290	44	505	1141

Diary of the AREC

A forest fire that completely destroyed almost 10,000 acres of woodland and an undetermined amount of grassland raged through the Halsey National Forest near Halsey, Nebr. on May 5. KØBJA, Loop Co. c.d. director, and KØHPT, state c.d. communications officer, activated the Nebraska AREC Net from the underground c.d. headquarters in Lincoln. WØFIG drove to the disaster area and relayed reports, through various stations, to c.d. headquarters on the progress of the fire and the needs of the fire fighters until about midnight when the fire was brought under control. KØULQ, WAØKGN and KØHNT acted as NCS at various times and assisted in keeping the frequency clear of casual operating during the emergency. — KØJXN, *SEC Nbr.*

After giving Colorado a good soaking, the flood waters moved into western Nebraska on June 20, causing rather severe flooding of low level lands in and near Big Springs. ECs WØCXH and WØLOD immediately began emergency operations on 75 meters until the crest had safely passed, some 2½ days later. The net provided direct reports to c.d. officials in Lincoln, and mobile units patrolled the flooded areas. — KØJXN, *SEC Nbr.*

On July 11, EC VE7BJV received a call for assistance in locating a missing child. A call on 2 meters brought out three mobile units, as requested, and the search began with VE7s BJV and BSP in one car, VE7s EP and AFX in another and VE7s BDJ and BBJ in the third. A short time after the search began, VE7EP found the little girl, a few miles from home and no worse for the hike. — VE7FB, *SCM B.C.*

On June 25, an explosion in a shopping center in Melrose, Mass., completely demolished a number of buildings. EC W1JVZ, after receiving a call from the Red Cross, supplied emergency communications from the disaster site to Red Cross headquarters. — W1AOG, *SEC E. Mass.*

An emergency call for type A negative blood was put out by the United Hospital in Port Chester, N. Y. on Aug. 8. The Mamaroneck fire department was called and K2IES, who was at the fire department, called Westchester Co. EC K2SJJN. K2SJJN immediately activated the AREC net, with K2EBX as NCS, and notified the All Service Net, WA2GPT NCS, WA2NIJ and Bronx Co. EC, WA2QAO. Within an hour and a half, the hospital had all the donors necessary. — K2SJJN, *EC Westchester Co., N. Y.*

At the suggestion of Alberta SEC VE6FK, a watch was instituted for the flood that threatened the Winnipeg area on Apr. 16-18. Nine amateurs operated in six-hour shifts, listening to news reports and checking the amateur bands. Sufficient stations were alerted to handle any emergency traffic, but fortunately the flood situation was not serious enough to require amateur activity. — VE6SA, *EC Winnipeg, Alta.*

On June 11, W4DKT, Meteorologist at the U.S. Weather Bureau, Tallahassee, Fla., requested the aid of amateur radio in obtaining wind direction and velocity and tide data for points along the Gulf Coast between Pensacola and Cedar Key. Tornado activity had been reported, with two or three of them in the Florida panhandle. The twisters did no damage, having touched down in the rural areas of North Florida. SEC W4MLE alerted Leon Co. EC WA4EOQ, Bay Co. EC WA4NRP and Escambia Co. Asst. EC K4BDF. WA4EOQ was to receive reports from other points and make delivery by phone to the weather bureau. — W4MLE, *SEC W. Fla.*

On June 26 and 27, WA6HYU, W6UOI and K6LGI maintained communication with K6YON/mm, aboard a yacht enroute to Honolulu during a severe storm. The yacht's position and other pertinent information were

relayed to the Coast Guard, just in case the yacht needed any assistance. — WA6HYU.

Well, we finally got another break in the emergency and alert reports, and we will try to catch up on the non-emergency activities. Thanks, fellows, for being so patient.

Dec. 24 — K6MDD and WB6DBB played Santa and Mrs. S. Claus for the children of the members of the Eight Ball Traffic Net in Calif.

Dec. 30 — Members of the Phila. Co., Pa., AREC provided communication to the Shriners Hospital for crippled children, permitting the families of the children in the hospital to speak with them. Fifteen amateurs participated.

Jan. 17 — AREC members in Torrington, Wyo., staged their own SET, which included the local hospital and civil defense. The "disaster" was in the form of an explosion and fire with approximately 20 persons injured.

Feb. 27 — AREC members from Winnipeg, Man., provided communication for a 50 mile snowshoe race held by St. John's Boys' School in Selkirk.

Apr. 3 — Members of the Amateur Radio Club of Southwest Louisiana provided communication for the Jean Lafitte National Sports Car Races. Ten stations were set up at various points around the track and at the start/finish line. Fourteen amateurs participated.

Mar. 20 — Montreal, Que., AREC members assisted in providing communications for a car rally. Several mobile units and two fixed stations were used to relay the positions of the cars to the finish line. Sixteen amateurs participated in this 14-hour operation.

Mar. 20 — AREC members from the Glens Falls, N. Y., area participated in their own SET. They simulated a tornado-like windstorm, handled messages for the Red Cross and other local agencies and assisted the power company locating "downed" lines.

Apr. 3 — Calgary, Alta., AREC members held a training exercise, using some of the equipment from the Southern Institute of Technology. About 20 mobile units positioned themselves at various shopping centers and reported the traffic conditions.

Apr. 10 — A simulated air crash was the problem facing Calhoun Co., Mich., AREC members for their local emergency test. Liaison was maintained with all the local hospitals, and mobile units served as road blocks and provided communication where no telephone service existed.

Apr. 24 — A 20-mile portion of the original trail followed by Gen. John Forbes in 1758 in the capture of Fort Duquesne was dedicated by over 3,000 Boy and Girl Scouts and others who hiked the trail. Members of the Wilkesburg (Pa.) Emergency Net provided communication during the hike, setting up six mobile units along the trail and one base station. Eight amateurs participated.

Apr. 24 — Calgary, Alta., AREC members were called into service to provide communications for the Salvation Army's Centennial parade. Three mobile units were placed within the parade group and the parade marshal was able to keep abreast of the progress the marchers were making.

May 9 — A preplanned check of emergency equipment was staged by York Co., Nebr., AREC members. Mobile units were sent out and communication was maintained between the mobiles and the temporary base station that was set up. The test proved to be satisfactory in every respect.

May 17 — A simulated tornado disaster kept Harris Co., Texas, AREC members busy relaying disaster reports, requests for medical supplies to the Red Cross and liaison to Dallas. Two meters was used for local communication and 75 for long haul.

May 22 — AREC members in Northern New Jersey held their annual "Pre-SET" which took the form of a hurricane this year. Activity was good and Section officials were pleased with the operation.

May 31 — Members of the Westchester Co., N. Y., AREC, RACES and Communications Club of New Rochelle provided communication for the annual Memorial Day Parade. Two base stations and seven mobile units were used, the mobiles staying with the parade and reporting its progress to the base stations.

On June 5, members of the Owensboro Amateur Radio Club and the AREC group participated in the canoe race sponsored by the local Boy Scouts. The amateurs provided

(Continued on page 174)

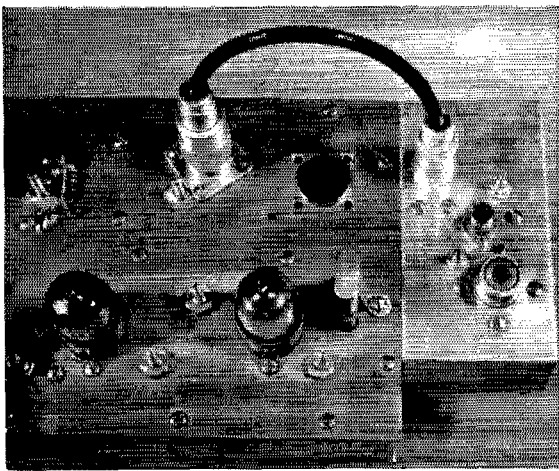

Fig. 1—Top view of the 432-Mc. preamplifier showing fit attached to the converter as a subassembly.

A Transistor Preamplifier For 432 Mc.

BY J. W. BRANNIN,* K6JC

THE desire to improve the sensitivity of my 432-Mc. converter reached a peak a few months ago. The big question was: Tube or transistor to do the job? The subject was discussed with the local 432-Mc. gang. I was urged by W6SV and W6PBC to use Philco's 2N2398 transistor, which later proved to be a wise choice.¹ The results obtained with this transistor, as an amplifier at 432 Mc., were well worth the few dollars expense, and the effort required to build the preamplifier.

The circuit, shown in Fig. 2, is conventional. The input circuit is capacity-coupled to the emitter, tapping the antenna down quite low on coil L_1 in order to secure a match at 50 ohms. The output connection is tapped down on L_2

* 225 Park Street, Redwood City, California.

¹ Difficulty may be experienced in securing the Philco 2N2398 transistor. An RCA 2N3478 unit may be substituted by reversing the battery polarity.

in a similar fashion, providing a correct match to 50 ohms.

Construction

The unit is built on a $4 \times 2 \times 1\frac{1}{4}$ -inch aluminum Minibox. A brass shield is notched to fit across the transistor socket, so that the input and output circuits are well isolated. Care should be taken while installing the shield to prevent solder from flowing between the transistor socket terminals and the shield. The shield should extend out to the sides of the Minibox so there will be as little clearance as possible between the ends of the shield and the sides of the cover when the box is closed.

The use of a transistor socket (as opposed to direct circuit connection), adds to the length of the emitter and collector leads, but permits substitution of other transistors for purposes of experimentation.

Tune-up and Operation

The third harmonic from my 2-meter transmitter was used as a signal source during initial adjustments to the unit. Final tuning can be carried out by tuning in a weak signal on 432 Mc. and adjusting coils L_1 and L_2 . The input tap on L_1 was moved toward ground, $\frac{1}{8}$ inch per step, until optimum signal-to-noise ratio (s.n.r.) was achieved. This can best be done with a calibrated noise generator but I obtained satisfactory results by observing my receiver's S-meter while making these adjustments. The tap position on L_1 did not seem to be too critical.

The input and output circuits were stagger-tuned to provide a flat response of approximately 1 Mc. with 432 Mc. as a center frequency. Coil L_1 was tuned slightly below 432 Mc. while the output coil, L_2 , was set just above this frequency. This band-pass was more than adequate for the type of activity in this area and did not impair the sensitivity of the amplifier materially. The preamplifier operates smoothly, with no indication of instability. In fact, no sign of regeneration was apparent when the antenna was disconnected and the unit was operated without a load.

Slightly more gain was secured with a 12-volt supply attached to it, but 9 volts seems to be adequate. The supply voltage to the preamplifier is applied through a set of contacts on a 10-ma. relay, activated by the B-plus line in the converter. Other switching arrangements may occur to the builder, depending upon the station set-up. A voltage-divider network could be added to the converter and used to provide 9 or 10 volts to power the preamplifier.

No special protective measures were taken by the author to prevent damage to the transistor during transmit periods. My transmitter operates at 100 watts input, with a conventional coax-relay for change over. The sensitivity of the unit has not changed during several months of operation.

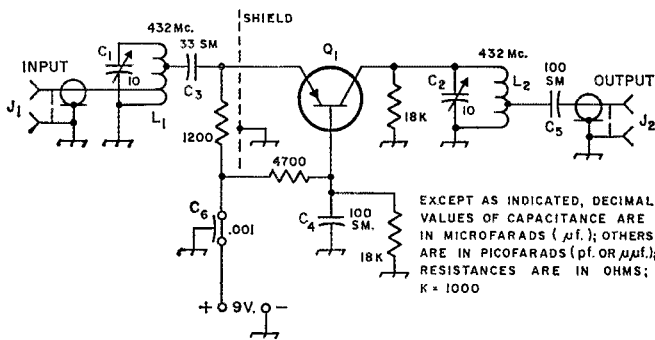

Fig. 2—Schematic diagram of the 432-Mc. preamplifier. 5 M indicates silver mica. Resistors are ¼ watt, carbon.

C₁, C₂—2-10 pf. piston trimmer.

C₃-C₅—Silver-mica capacitors.

C₆—Feedthrough capacitor.

J₁—Coax-connector. (Amphenol SO-239)

J₂—Coax-connector. (Type BNC)

L₁—4 turns No. 18 wire; ¼-inch dia.; ⅝-inch long. Antenna

tap 1½ turns above ground. Emitter tap 2½ turns above ground.

L₂—3½ turns No. 18 wire; ¼-inch dia.; ½-inch length. Tap 1½ turns above ground.

Q₁—Philco 2N2398 transistor. (RCA 2N3478 usable with polarity of circuit reversed.)

Results

The preamplifier is used ahead of the "All Nuvistor Converter," described in an excellent article by W2VCG.² The results have been gratifying and show a signal gain, over noise, of 1 S-unit. Recent tests with a signal generator and calibrated attenuator were made, showing similar results. A 0.25-microvolt signal provided 10 decibels of quieting when applied directly to the converter input. A 0.125-microvolt signal provided the same amount of quieting with the preamplifier connected between the generator and the converter. Incidentally, the sensitivity seemed a trifle low in both cases, indicating the possibility of incorrect calibration of the signal generator's output-level reading. The 6-decibel improve-

² Kaiser, "An All-Nuvistor Converter for 420 Mc.," *QST*, January, 1963, p. 11.

ment is not being questioned however, since the attenuator calibration seems to be accurate.

W6FZA, who is 200 miles away and beyond several mountains, has been received several times with signals that were well over S9. A considerable increase in the level of ignition noise has also been noticed since the preamplifier has been in operation, indicating increased sensitivity.

The cost of the unit is nominal since the transistor sells for \$3.75 at most outlets. The balance of the parts, if purchased new, will range between 3 and 4 dollars. This unit should materially improve the performance of most vacuum-tube converters, if care is taken in the construction and adjustment of the preamplifier described in this text. Does your receiving set-up need a boost?

QST

Fig. 3—Bottom view of 432-Mc. preamplifier showing placement of components shield.

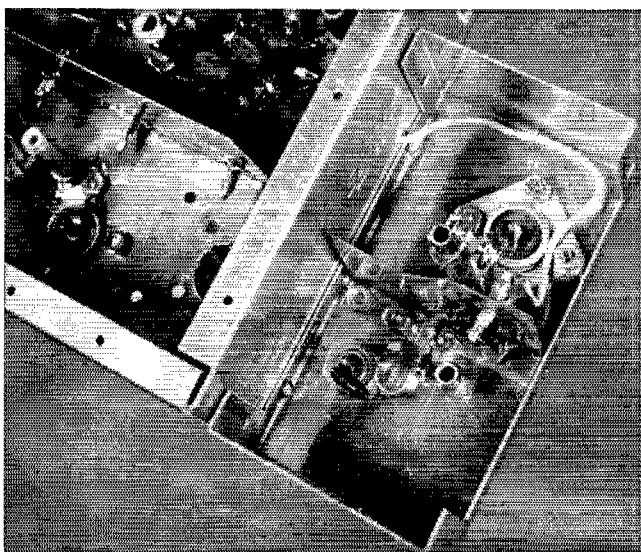

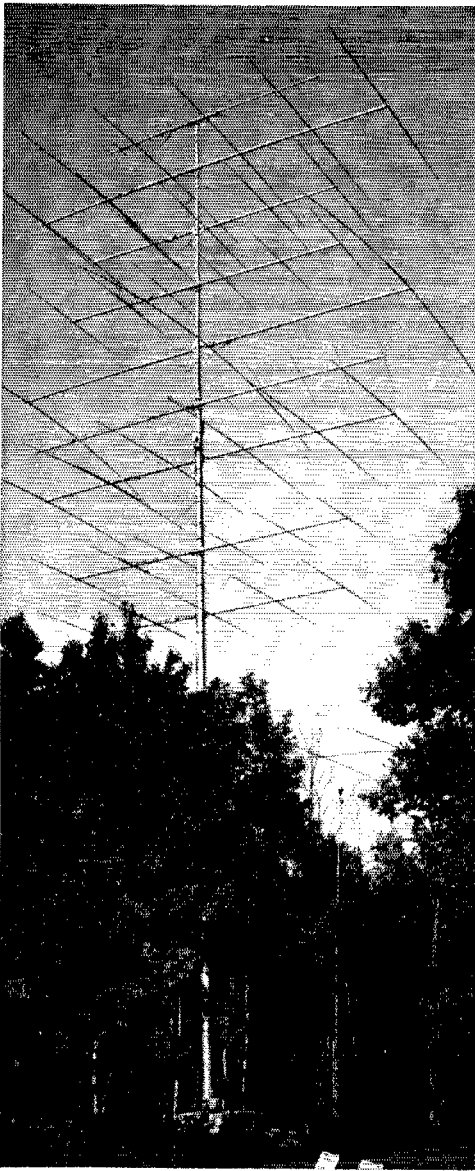

This is the "Big Bertha" used by W2VCZ operating K2HLB for top single-operator W/VE phone score in this DX Competition; stacked yagis on all bands, three elements on 40 and a phased ground plane on 75.

Results—

1965 ARRL DX Competition

COMPILED BY ELLEN WHITE,* W1YYM

It's all over but the shouting and it looks like lots to shout about this year. As we prepare this resume of the 1965 ARRL International DX Competition we're struck inescapably with the conclusion that *this* was the phone year. Sideband exponents both domestic and overseas presented formidable totals in this year of less than ideal h.f. conditions. The numerous charts and breakdowns accompanying this report are the pictures to substitute for a million words of description for all single operator, multiple-operator single-transmitter and the big multi-operator multi-transmitter groups. Recording the 1965 results of the February and March 13-14, 27-28 weekends statistically, we find 1700 logs received, both modes, from W/VE and DX stations in 116 countries, an impressive 15.3% increase in entries over the 1964 results. A foretaste of things to come, perhaps, when conditions *really* become good.

What can be done with a fine location, superb equipment and top-notch operators was demonstrated by the crew at W3MSK. The outstanding almost one-and-a-half-million point phone score resulted from 5 bands of simultaneous operation, topped by 122 different countries on 20. Seven element arrays were used on 10, 15 and 20, 4 elements on 40 and 2 on 75! Kilowatts on all bands piloted around by K1ANV, K3EST W3TMZ W3ZKH and W6HOH. Final figures include 142 DL/DJ stations, 78 G's, 48 VK's, 44 I's etc. on 20 sideband, with 15 phone producing among the 90 multipliers 51 DL/DJ, 61 I's, 34 PY's and 32 G's. A score such as this is an all-out multi-transmitter effort which literally wrings the band dry. Quotas and all, the e.w. effort by the W3MSK code contingent (which included K3EST, W3s FYS TMZ ZKH EIS and W6HOH) was a knock-out; six bands which included 10 multipliers on 160 and 18 on ten meters.

Scores of the W/VE group registering over the 500-K mark are as follows, single-operator stations are shown in bold-face type. *Phone:* W3MSK 1,481,430; **K2HLB 656,760**; K6EVR 548,580; **W4BVV 501,739**. *C.W.:* W3MSK 1,299,072; W4KXV 1,026,018; K4LIQ 850,338; W4BVV 754,924; **W4KFC 684,000**; WB2APG 660,042, W8FGX 649,955; W3GRF 639,738; **W2VJN 593,895**; W6RW 590,424; W3VKD 586,080; W3LOE 549,712; W8VSK 547,815; W6ITA 534,594; **W3BES 534,060**; W1BPW 521,451.

Mid-October is the target date for certificate mailings. As you plan ahead for 1966 note that new forms are now available for recording your efforts in a simplified fashion.

* Asst. Communications Mgr., ARRL.

1966 ARRL DX COMPETITION

Phone: February 12-13, March 12-13

C.W.: February 26-27, March 26-27

The Clubs

A total of thirty-five clubs qualify for the box listing for the 1965 test, up three over the past year. Top ranking this go around is the Potomac Valley Radio Club, reaching for that 10-million mark. Perhaps the most significant factor in this total is that close to four million of these points represent the work of just three multioperator stations, W3MSK both phone and c.w. and W4KXV c.w. Another engraved coco bolo gavel will soon go to the PVRC group. Again this year W3BES takes both phone and c.w. certificates for the famous Frankford Radio Club, "place" position with 9,136,628 points. Both the Northern and Southern California DX Clubs added a million-plus points to their 1964 totals for third and fourth slots—both indicating teamwork and club enthusiasm. New to the rolls this year and already in the top echelons is the 128 Contest Club, founded to promote and stimulate activity in the Eastern Massachusetts area. Just three members participated, in both modes, and presented a one and a quarter million point score with W1BPW taking the club c.w. award and K1DIR the phone certificate.

A rundown of numerous club claims indicates various reasons for score reductions: a club claim by the secretary, but not indicated on the member's log (and vice versa); no club letter; a club letter indicating just calls of members, without a breakdown as called for in the rules. To be fair to yourselves in future competitions, observe the rules closely.

Nice going by all the clubs in '65 — f.b.!

SOAPBOX — C.W.

"Worked two new ones for 225 total." — W2FYI. . . . "After 30 years of hamming heard and worked my first EU on 80 for WAC on this band." — W6LDD. . . . "Conditions were terrific on 80 both weekends." — W3TGF. . . . "The new 5-element 20 on a 50-foot boom sure paid off this year." — W6UED. . . . "Crabbed six new ones towards DXCC." — W45HJK. . . . "I don't know how I'll ever work EU on 80 if the test is shortened." — W5WZQ. . . . "Hats off to OD5AX and EL2AE for outstanding signals and top-notch operating." — W420JD. . . . "My choice for the most efficient operator is OA4PF with a consistent 20 w.p.m., he wouldn't allow tail-ending and signed his call and the call of the station worked at the beginning and end of each QSO." — W8DGP. . . . "VK4TE was a new one." — W3PZW. . . . "Enjoyed working H18XAL and HP11E 160 through 10." — W3MSK. . . . "Handicapped by a burned out transformer in the rotor control box, low power, and only two crystals. Most of the

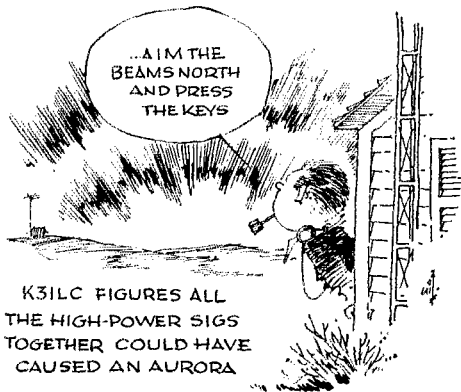

time was spent in switching from one frequency to the other." — VE8BB. . . . "Found conditions poor the first weekend from the east coast with a lack of Asia and Oceania. Operated the second weekend from California and found conditions better geographically, even though EU was fairly hard to work." — K1CTQ. . . . "My 40th year of ham radio and I still enjoy the DX Contest rat race." — VE8DBB. . . . "I put my model 'T' on the DX highway this year for a short bumpy run in order to be listed in QST. In the first few amazed moments I thought of settling for W.O.S. (Worked One Station). It is abundantly clear, however, that the thrill is not the score. The big thrill is being numbered among those alert progressive world citizens pursuing the world's greatest hobby." — W2ADP. . . . "Conditions were quite good throughout,

Left, c.w. contest regular G13OTV; center, PY2BJO top phone in Brazil with over 1200 exchanges; right, PJ2CR leading Netherlands Antilles vocal participants with 262-K.



Single-Operator DX, over 200-K

HP1IE.....	666,540	YV5BTK.....	276,396
H8XAL.....	612,128	OA4PF.....	272,160
YV1DP.....	588,840	YV5AGD*.....	269,640
YP2VL.....	473,325	PY2BGL.....	268,185
KG4AM.....	454,656	PJ2CR*.....	261,765
HK3RQ*.....	339,264	CHCP.....	259,700
PG7XL*.....	334,950	VP3HAG*.....	252,831
H8XAL*.....	334,908	VK2GW.....	245,676
HK4EB*.....	331,931	TG9EL*.....	239,928
OA4KY*.....	317,238	EA4GZ*.....	232,800
YV5KA.....	313,479	PY2SO.....	228,900
HB9JG.....	311,166	HK3RQ.....	220,476
KG4AM*.....	310,242	KP4BJU.....	219,393
VK5ZP.....	307,758	DJ6QT*.....	214,491
G3OQR.....	290,730	PY2BJO*.....	213,287
	JA1VX.....		202,076

* Phone

compared with recent years at K6CTV." — W44NGO. . . . "Our biggest handicap was the fact that we had to climb the tower every time we wanted to rotate the 40/20 meter beam. With the temperature near zero it was a bit uncomfortable." — W8SH. . . . "The 80-meter ground plane really paid off." — W3GHS. . . . "Tripled my score from last year." — W7NPV. . . . "My first opportunity in quite a few years to spend an appreciable time in the DX Test and I enjoyed it immensely, working several new countries. It brought back memories of the 1931 ARRL Test in which I had the thrill of exchanging messages with VS6AH using only small homemade equipment, a 25-watt transmitter and the receiver a simple regenerative detector without even a single stage of r.f. amplification." — W2CKR. . . . "Fifteen proved the most exciting to use. I filled my quota of DLs there in less than 10 minutes, while VKs required 17 minutes. Competition with both east and west coasts is fantastic. Power just doesn't make up for operating skill." — W5LZG. . . . "Got #91 (CR4BB) on 80 for my 5-band DXCC." — K2CPR. . . . "I compliment PY1MCC for a fine signal and operating ability." — W6EUV. . . . "Still maintain my record of never working a new country during an ARRL DX Test hi!" — W6ATGY. . . . "I suggest 24-hour periods only." — W6SC. . . . "It takes two weekends to take advantage of a full range of conditions so leave the DX Contest time allotment as it is." — W3KT. . . . "Some of these operators are really good, but when I heard a WB2 calling and working FN8AA I got the shivers." — W8ZCQ. . . . "If this is what things are like at the bottom of the sunspot cycle, WOW in another few years." — K1ZND. . . . "Biggest thrill was nailing 9M4LP on 40, the biggest disappointment not being able to raise him on 80 when he was a nice steady 459." — W1EVT. . . . "Most enjoyable test ever in six tries from two continents, 80 the star this year. We may have experienced the best conditions on that band in a lifetime." — W6BCKS. . . . "A job with the Wouff Hong should be awarded to a certain W1 who undoubtedly holds the long call record on 80. A 3 by 3 is certainly plenty to raise any station." — W1W LZ.

. . . "Up here in VE country we are hampered by aurora and just can't work into Europe and Asia as consistently as the Ws. From the DXers point of view there are so few VEs in the test that their chances of getting those multipliers are very small with a one weekend test. Let's stick to two weekends and give the VEs a chance." — VE2AYU. . . . "My craziest experience was hearing VU2KV calling CQ for over a period of ten minutes and no takers. Finally called him to let him know he was getting out and then the band caught fire." — W8KMD. . . . "My first year of real contesting and I really enjoyed it. Thanks to W8VSK and W8DGP for tips. My only regret is that I didn't have the necessary experience and savvy to bring home a big score on 10." — W4SCZH. . . . "I've been working the contest since the 1930's. Leave the times as they are. The 96-hour period also gives some of the average contestants a better chance for a contact after the big guns have worked their quotas." — W4DXI. . . . "My high point was working 6 VK/ZLs in one hour on 80 with 150 watts." — W2HUG. . . . "My first Asia on 80, ODSAX." — K1RQE. . . . "First test from my new QTH. It sure is nice to be shielded from those L.A. k.w.s. by the hills." — W6GEB. . . . "With only 100 watts plus simple antennas I often wonder why I kept at this in my 71st year, competing against those who are loaded. It's great fun though." — W2JB. . . . "It may already have been suggested and I'm probably behind the times but I think we need another award for: 'Worked KG4AM/KP4AXM/HP1IE/YV1DP/G3EYN/DL1JW each one per band in a single DX contest.'" — W2NEP. . . . "Boy, in some of those pileups I would have given an arm and a leg for a kw., but after squeezing out a good one with 90 watts, I would have junked it if I had one." — W8ZFIT. . . . "Noise S9 plus 20 db for three months before I tracked it down to a defective heating pad two blocks away. The little old lady left the thing on 24 hours a day! Bought her a new one the Friday before the last weekend of the contest and now everybody is happy." — W6KFK. . . . "My first entry in a DX Contest and all are new for me. Enjoyed immensely QSOing such friendly amateurs and look forward to the QSLs." — W2OBT. . . . "A 51-minute WAC on 20 Saturday afternoon might mean 20 is on the way back." — W2RFT.

SOAPBOX — PHONE

"I don't believe an EU station was worked or heard on 15 from the west coast." — K8EYR. . . . "Got excited on a 10-meter opening and worked PJ2CR with the antenna system grounded. That's 10 meters for you!" — W6AJY. . . . "I think more phone than c.w. stations are using full break in." — W2GKZ. . . . "My kudos to 9M4LX and VK3ATN who said they would work near their frequency, but not on it." — W6FET. . . . "Conditions were unusually good, particularly into southeast and central Asia." — W2GBC. . . . "Spent 2 hours in the middle of the night in the tree repairing the mast for my 75-meter inverted vee." — VE5FIE. . . . "Operated from a railroad boxcar 6 feet underground which served as a bomb shelter." — W44ART. . . . "Conditions greatly improved over last year." — W6YMY. . . . "Two big thrills here in this test, one working VK3MO long path in the morning, the other working ZD8HL on 10 meters." — W1RF. . . . "Fabulous opening to Asia on 20 the second weekend and completed DXCC on phone." — K3JCT. . . . "Best contact of the contest was with 606BW on 75 phone." — W3MSK. . . . "Wish more stations had checked 10 the second weekend. There was a beautiful opening, apparently world-wide at 1900Z both days. At one point, I had KS6BO and 5H3JR hearing each other and both S7 here in Pensacola." — K4ZJP. . . . "What was EA4GZ running? He was 5-9 here around the clock even when the band was dead to EU." — W4OEMS. . . . "Got four new ones in the phone section but only one new one in the c.w. portion."

W4KFC, top single-operator c.w. in Virginia, Roanoke Division and amongst the W/VE competitors, says he removed all correspondence, QSLs, etc. to take this photo as shown. In addition to 3-L on 10, 15 and 20, Vic uses a 40-meter groundplane and a 700-ft. longwire. Yes, the 4-400s final uses plug-in coils.

QST for





Specialists all! On the left Alabama's phone topper W4RLS with activity on all bands, and a specially fine showing on 20. In the center is top-band specialist W2EQS. Charlie spent his time on 160 coming up with 25 exchanges in 13 countries. On the right, Nova Scotia c.w. specialist VE1ZZ with 140 two-ways and 60 multipliers on 80!

Minimum Number of Countries					Minimum Number of Countries					Minimum Number of Countries					Minimum Number of Countries									
Band	75	40	20	15	10	Band	75	40	20	15	10	Band	75	40	20	15	10	Band	75	40	20	15	10	
W1BFA			54			K3BNS			61			WA4PXP	18					W8EVZ				82		
W1BGD	9					W3CGS			69			W4RLS			99	60	14	K8HIR	5	25	85	51		
W1BPW	8					WA3COJ			53			WA4SUR	5			54	10	W8JIN	9	26	65			
K1DIR	27	28	86	57		W3DBX	19	20				WA4SVO	8					W8NGO*	10	34	84	52		
W1FJJ	9					W3ECR			51			K4JZF	8	61	54	12		W8NGU*	6					
W1JYH	24		93			W3EQA	7					K4ZYS*	18	68	52			W8NWO*	27	39	95	63	10	
W1MRQ			50			W3GHM*			64			W5AJY	11		55			W8RXY				55		
K1OSY	5					W3GRH*			50			WA5ALB		20		15		K8UZA/4	7	20	76			
W1QAK	15	23	60			W3GRS			58			K5JZY	11			50	13	W9BCY				55		
W1RF				63	15	W3HA			66			W5KTR	14	21	52	51	15	K9BTU				51		
K1RQE				59	50	W3IYE*	9		59			W5LGG				61	24	W9CTY				61		
W1SEA*	5					K3JCT*	11	21	70			WA5LJU			59			W9DPI*				52		
W1ZFV			96			W3KFO			66			K5MDX	10	37	57	55		W9EWC	18	20	73		10	
WB2APG*	27	27	92	59	10	K3KMO	7				K6AHV	14	20	65			W9GIL				53			
W12BLV	5					W3KT			76			K6BPR	22					W9QQN				59		
W52CKS	8					W3LOE	20	91	51			W6BSY			53			W9WKU				73		
W2EXH			95			W3MCG		23	52			K6CEO			21			W0CU	8					
W2GBC			74			W3MSK*	45	45	122	90	17	WA6EPQ	11		57			W0LBS	10			51		
K2GDP	16					W3MWC*	6					K6ERV	11		59			W0QU*	15	78				
W2GKZ	5		58			K3NHL	5	27	77			K6EVR*	26	28	110		12	VE2ANK	8			71		
K2GXI			119			W3NML	5					WA6EYP			62			VE2BV				57		
K2HLB	29	32	114	71	14	W3PHL	46					WA6GLD			51			VE2UX	23			70		
WB2IQB			54			W3PZV			90			W6GVM			54			VE2WA	11			74		
WA2IZS	9		64			W3QMZ			52			W6ITA*	16	25	84	13		VE2WY				69		
K2JMY			57			W3TLN	11	78	51	11		W6LCX	9		60			VE3FIE	6					
K2KFP	8					KCTPL			70	50		W6LDA			63	11		VE3BHS				56		
K2LWR	27					W3WPG	21	24	64			W6LDD	10		57	10		VE3ES				69		
WB2MFX	24	26	68			W3ZVJ			74			K6OHJ*	12		89	10		VE3UX	7			69		
WA2OJD				12		WA4ARV			61			W6RKP			75			VE4IM				62		
K2PZF			58			W4BCV	15	26	80	64		WA6SBO	9	23	86			VE4MP				61		
W2SSC	16					W4BVV	27	31	105	59		K6SEN	19	20	82	11		VE4XO	8			69		
K2SUX	6		61			W4FRO			53			W6UMI*			54			VE6AAV				62		
W2TQR	15		78			W4HKJ	11	61	55	12		W6WX	5		63			VE6AKR				60		
WA2WGN			58			K4HIF*	8			10		W6YMV			57			VE6BR				65		
W2WZ			55			W4KXV*	7		55			W7DQM			52			VE6VK				72		
W3AXW	9					W4LVV	8					W7QPK			54			VE7ANW				60		
W3AXD	10	24	88	14		WA4NGO	9	22	60	60		WA8AJT*			95			VE8ML*	7			67		
WA3BAS	6					W4NJF	7		89			W8BF			82									
W3BES	27	24	69	51	12	W4OM			80			WA8CZH	14	25	62									
WA3BHY			61			W4OPM			71	13		W8DGP	17	21	61	10								

* Multi-operator Station



— *W1PLJ*. . . . "Pileups on 15 were unbelievable." — *K5ZYP*. . . . "I've been trying for two years for an Asian contact on phone. During the contest I made TWO, 4X4 and OD5." — *WB2FOV*. . . . "I've always heard of the fabulous stuff on sideband, but never believed it before this test." — *W4FRO*. . . . "My biggest thrill was working 5X5U after calling for three hours." — *WA5IPM*. . . . "Wish those nice EU multipliers were a little louder on 40. Nice though to hear so many JA signals on 40 phone with good sideband signals." — *K6CEO*. . . . "SSB has sure helped phone participation in the NCDXC. It's not the tough grind as back on a.m." — *K6OHJ*. . . . "The highest phone score I've been able to run up. Guess the call letter handicap didn't hurt too much after all. Used to hold K1RTB." — *WB2MFX*. . . . "Propagation conditions incredibly similar to corresponding weekends last year, but the MUFs were slightly lower; giving lower 15 and 10 meter country totals. Is JA1CG really running 50 watts?" — *W5KTR*. . . . "Imagine finding ZD8HL calling CQ on 10 meters at 1600Z Sunday March 14th. A beautiful African opening followed for the next few hours." — *W2VCZ*, *opr. K2HLB*. . . . "Never heard EU and AF stations so loud." — *W5EDX*. . . . "This test taught me how to listen and tune for DX." — *K1FNQ*. . . . "Enjoyed working KS6BO through the west coast with my ground plane on 15." — *K1ZVU*. . . . "I've a pipeline to JA from this location." — *W6PAN/KH6*. . . . "At least this year I had no problems with the table falling apart." — *W1BPW*. . . . "Nice to hear 10 open." — *K6HOR*. . . . In 95% of the cases, if you didn't call or answer on your

Michigan c.w. champ W8VSK put in 73 hours and came up with 547,815. Joe's log, comments and statistics make interesting reading though he concludes that with the same QTH, equipment and operator he's reached stagnation and will not enter again seriously until he can show improvement. Please don't give up, Joe, yours was the most interesting log we received!

frequency, there was no QSO for you — probably due to the advent of transceivers." — *W2WZ*. . . . "I defy anyone to beat my score while also taking care of my two harmonics age 5½ and 11 months." — *W8LXU*. . . . "First time out and interesting to see what can be done with a small rig on sideband." — *W1TKG*. . . . "Got a thrill when H18XAL called me by my handle. Later found out he used to be NCS on traffic nets." — *W9ACW*. . . . "Should have been more XE stations on." — *W40ITY*. . . . "How do the phone boys do it?" — *W4KFC*.

PHONE HIGHLIGHTS

AF Honest reporter *CRAAJ* worked 493 stations on 20 and 15 and found just one adjudged to be 5-9 plus. *W6ITA! E89AY* on a.m. proved to be a good catch on 15 for 82 alert operators. Antonio uses parallel 6146's, an NC-300 and Windom antenna. The crew at *ETSUSA* found conditions fair to good but the unavailability of operators impeded complete coverage during the phone weekends. *ZD8HL* found the bands in good shape and topped 114-K though missing the first weekend enroute from the Bahamas. The high point of his weekend was a QSO with *KH6FQ* on 10 meters. We note to an encouraging 108 two-ways on that band! Though operating a relatively short period of time *ZE1AC* was working them at about 50 an hour. Working four bands, *ZS6PN* found 21 Mc. his best, topping the 300-QSO figure. Two-ways were also achieved on 75 with *KH6FIZ* and *W9EWC*. African log *par excellence* was submitted by Uganda's *5X5IU*. Bob's best band was 20, with the continental high QSO figure for that band, an imposing 551. The 2nd, 8th and 4th call areas were his best for contacts. The dependable *606BW* reports that he missed only *KL7* to complete all call areas on 14 Mc. Bee found it good to work *W3MSK* for the sole QSO on 75. To sum it up he found it a very good test, less QSOs this year, but seven more multipliers. *9Q5AA*, ex-*OQ5EP*, used a KWM-2 to good advantage along with a rhombic for a better-than-500-K sum.

CLUB SCORES

	Agregate	Entries	C.W. Winner	Phone Winner
Potomac Valley Radio Club	9,668,687	47	W4KFC	W4BVV
Frankford Radio Club	8,714,369	76	W3BES	W3BES
Northern California DX Club	4,269,053	62	K6OHJ	K6AIV
Southern California DX Club	3,618,220	38	W6TZO	K6SRN
128 Contest Club (Mass.)	2,125,503	6	W1BFW	K1DTR
Virginia Century Club	1,463,189	11	W4FOAE	W4JTF
Ohio Valley Amateur Radio Assn.	1,461,126	8	W2PCJ	W8JIN
Order of Boiled Owls of New York	973,376	15	WB2MFX	WB2MFX
Rochester DX Assn. (N. Y.)	970,986	4	W4MCM	
Southeastern DX Club (Ga.)	807,162	5		
Florida DX Club, Winter Haven DX & Contest Club Branch	663,843	3		
Louisville's Active Radio Operators (Ky.)	568,965	13	K1ZND	K1PNS
Tri-City Amateur Radio Club (Conn.)	517,939	14	W2DAJ	W2DAJ
South Jersey Radio Assn.	483,077	7	W1BIH	W2EXH
Connecticut Wireless Assn.	312,558	8	K2CHQ	W2GKZ
Lake Success Radio Club (N. Y.)	299,724	5	W8ZCO	
Suffolk County Radio Club (N. Y.)	285,246	11	W8YPT	W8BF
Order of Boiled Owls of Ohio	260,763	3		
West Park Radlops (Ohio)	246,630	6	W8RXY	W8RXY
Seven-Eleven Amateur Radio Club of Northern New Jersey	235,786	4		
Central Michigan Amateur Radio Club	176,799	6		
Orange County DX Century Club (Calif.)	160,356	5	W8CK	W8AXO
Amateur Radio League of Manitoba	145,419	4	W9EQS	
Order of Boiled Owls of New Mexico	87,753	4	W9EEQ	
Amateur Radio Club of Savannah (Ga.)	66,657	7		
Four Lakes Amateur Radio Club (Wisc.)	54,261	3	K7UCH	
Horseshoe Radio Club (Pa.)	53,616	3		
York Radio Club (Ill.)	52,046	3		
Willamette Valley DX Club (Ore.)	48,120	3		
TBLCO Amateur Radio Club of Manhattan	29,402	5		
Columbus Amateur Radio Assn. (Ohio)	15,888	5		
Richmond Radio Club (Calif.)	5584	3		
Wheaton Community Radio Amateurs (Ill.)	5226	3		
Northwest St. Louis Amateur Radio Club				
Chicago Suburban Radio Assn.				

1 K6VVA, opr.

ASIA "My first contest," comments *K7VGF* manning *BY1USG* who advises interested readers that they finally got permission from the host government allowing operation of the entire 20-meter band. The Taipei Air Station Base club hopes to help out a lot of the fellows still needing Formosa contacts. Another contest first reports *HL9TT*. George comments on a March 13 opening on 20 where the band stayed open four hours longer than usual. He heard the first, eighth and ninth areas, called without success. Sum total; first VE from Korea, five new states and two Canadian Provinces, *HL9TT* QSLs 100% on initial contact. *HL9US* reports single operator single band is tough when all the offered help doesn't appear to help! Another big twenty-meter effort by *KA5RC* raised 510 stations in 15 states/provinces. Bob plans additional effort on 40, 15 and on 10 in '66. *JA1CG* with a home brew sideband exciter and just 50 watts plus a 3-element fixed quad 35 feet high worked 711 stations on 4 bands in a great showing. Haruo's big band was 20, accounting for over 600 exchanges. *OD5AX* (*W3ACE*) is no stranger to contests and wound up his stay in Lebanon with activity in both modes. On phone Hank edged over the 700 QSO figure topping 300 exchange on both 20 and 15. Top Asiatic Russian S.F.S.R. vocal showing was by *UA0EH*, well over 200 contacts on four bands. Toly runs 200 watts input and uses ground-plane antennas. The popular *9M4LP* missed over two-thirds of the first weekend although reporting good conditions on 40 and 75. Bob was pleased to work *W1BU* on 75 and *W2GWE* on 40 for "firsts" on those bands on sideband. *W1BU* was the only station able to break through the QRM/QRN. The second weekend found poorer conditions but two-ways concluded with *W3BES* and *W4BYV* on 40 for "firsts."

used *G3KFX*), a great total of over 1600 QSOs. *GW3s DIX* and *NW7* multi-operating *GW3NWV* found that high operating standards were maintained and rather more all band activity noted than previously. The fellows at *11RB* (*11s OLI* and *RB*) report a staggering number of vocal exchanges, just under 2000 in a magnificent 4-band try. *11BAF* finds this one a lot of fun every time. Mino mentions 4 locals within a mile operating, himself *11ZIX 11RB* and *11ZEG!* Next year he hopes for better antennas plus a better location. *11ZZZ* worked his first *KL7*. *KH6* and first *W7*. *Ragnar*, *LA5HE* applauds the improved quantity of VEs. *OE2EGL* had hoped to reach his summer place

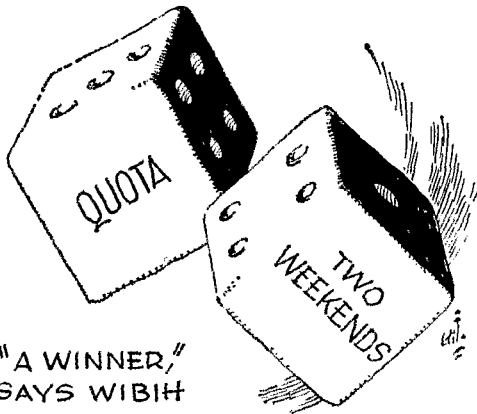

EU *DJ4XE* in a first-time try at the International DX Competition worked twenty meters for well over the 600-QSO mark. *DL1LK* comments on the very excellent ham spirit by American stations. *DJ3GI* operated approximately 13 hours and managed 618 exchanges on 20. Dieter bemoans the absence of South Dakota. *DL3MC* reports good discipline from the stateside boys and Helmut hopes to get returns to his 100% QSL'ing. *DJ6QT* reports an impressive four-band effort with over 1300 QSOs. One of the largest single-operator scores from EU (and a big emphasis on 20), with 1432 exchanges was submitted by *EA4GZ*. Operating was from Madrid with a modest 100 watts/HQ-170/TA-33 combination, results were great—over 230-K. *EA4AK* sums up the situation with a question—"What would the DX operator do these past few years without 20 meters?" *G2QT* finds phone easier. *GS4AZ* found the A-3 affair excellent and was amazed at the performance of his barefoot HT-37 on sideband. John said Sir Winston might well have said "Never in the realms of Amateur Radio have so many been packed into so few." *GSs JUC KFX TUZ* put the East Anglian Contest Club on the air with the special call of *GB2DX* (last year they

Minimum Number of Countries						Minimum Number of Countries					
	30	50	80	60	10		30	50	80	60	10
Band	80	40	20	15	10	Band	80	40	20	15	10
W1BPW	43	53	104	62		W4KFC	46	68	113	65	12
K1DR	46	61	88			W4KXV*	60	81	119	82	
W1ECH	39					K4LIQ*	71	93	112	71	15
W1EVT	45	63				W4LVV			90		
W1ICP*	37	50	80			W4MCM		60	86		
W1JYH	34	58	102			WA4NGO		54	94	68	
W1SWX	45					WA4OAE	35	55			
W1WLZ	49					W4YGY			81		
W1WPO			85			W4ZYQ*				63	
K1ZVU			81			W5BRR					10
WB2APG*	61	70	98	64	10	W5CKY		59			10
W2BOK			104			W5DWT		55			11
K2CHQ	31					W5LGG	32		91	70	20
WB2CKS	44	51	80			W5WZQ		70	84		10
K2DCA	36	57	80	63		K6AHV		50			
W2GGL	31					W6AAM					
K2GUN	38					W6CYV				83	
K2KFP	28					K6EVR					
K2LWR	58					W6FSJ		65			
WB2MTX	30	56				W6IOC				80	
W4AZJD	35					W6IBD		63			
W2PFI	34		87			W6LTA*		74	111		15
W2PXR*	31					W6KG					10
W2TQR	22		83			W6LDD					10
W2VJN	47	66	100	70		K6OHJ				82	13
W4ZZEZ				63		W6ONZ				94	
W3AFM			111			WA6QGW			80		10
W3BES	38	63	95	66		W6RW*	30	77	101		19
W3BIP	30					W6UED			114		
K3EKO	36					W6WB					10
W3GHM*	38	55	91			W6WX			82		11
W3GRF	46	68	97	69	11	KH6JF					15
W3GRS	30		84			W8FGX	45	78	103	70	
W3HHK	30					W8JIN		53			
K3JCT**	33	55				W8JSU				100	
W3LOE	45	63	94	67		W8KMD				84	
W3MCG		53				W8SH*			58	88	
W3MFW	48	50				K8TIG			50	82	
W3MSK*	61	87	131	91	18	W8VSK			97	103	78
W3MSR			94			W8ZCQ				90	
W3MWC*	32					W8ZJM	31				
K3NHL	33	54	86			W9ERU	33	51	88		
W3PZW	39		116	65		W9GIL			81		
W3VKD*		52	99	86		W9IOP	34	56	91	64	
W3WJD*						W9YYG		62			
W4BCV			84			W6A1H		57	80		
W4BRB			80			W8YTTQ			90		
W4BYV*	50	68	115	68		VE1ZZ		60			
W4DVT	40					VE2NZ		50			
W4DXI	30					VE2WA				84	
K4EZ	41		81								

* Multi-operator Station

Over 300 QSO/band — DX

	80	40	2	15		80	40	20	15	10
CR4AJ ¹			368			OA4KY ¹		903	355	
CX1OP			333			OA4PF		579	792	
DL1JW			426			OD5AX		331		
DL1UD ¹			447			OD5AX ¹		355	329	
DJ2IB			428			OE3TL ²	370	862		
DJ2QZ ¹			614			OH1XX		468		
DJ3GI ¹			618			OH2AM ²		917		
DJ4XE ¹			653			OH2FC		394		
DM4YPL			666			OK2KOJ ²	330	549		
DL5AO ¹			929			OK3OM		367		
DJ6QT ¹			945			ON4UQ ²		692		
DJ6TS			672			ON4VS ¹		752		
DT7AA			743			OZ1W		432		
DL7BQ			436			OZ5DX		626		
DJ8IF			382			OZ7X		432		
EA4GZ ¹			1432			OZ7YH		844		
ET4AK ¹			588			OZ8LA		806		
EI9J			434			PA8LOU		439		
EL2AE ²		630	1342	610		PJ2CR ¹		453	716	
F2MO ¹				422		PJ3CD ¹		476		
F3TZ			303			PY1BLG		434	669	
F8VJ			621			PY1MCC		823	302	
F9MS ¹			737			PY1NO ²			309	
FG7XL ²			545	885		PY2BGL		773	694	
FO8BL ¹			705			PY2BJO ¹		838		
G2DC			352	302		PY2SO	329	593	547	
GB2DX ^{1,2}			1225			PY3AHJ ¹		407		
G2QT			509			PY7AKQ	429		441	
G2RO			549			SM5BVF		300		
G3SSO ²			511			SM5CCE		385		
G4CP			1148			SM6BCG ^{1,2}		970		
G6RJ ¹			472			SM6BCG ^{1,2}		926		
G6VC ²			831			SM6BJI ²		1076		
G8FC ¹			114			SP6AT		644		
G13OQR			1135			SP6AKK		404		
G13OTV			300			TF3AB		356		
GW3FSP			479			TG9EL ¹	446	756	304	
GW3ITZ ²			460			UA1KED ²		513		
GW3JI			672			UA2AC		496		
GW3NWX ^{1,2}			588	300		UA2KAW ²		559		
HA1KSA			666			UA0KAE ²		902		
HA5KBB ²			611			UA0KFG ²	312	681		
HA7PJ			326			UA0KKB ²		375		
HB9JG			918	469		UB5KJE ²		517		
HC1EW ¹				341		UB5WF		714		
HC5CRC ^{1,2}			1379	496		UP2KBC		652		
HI8XAL	460	392	899	970		UP2KCF ²		312		
HI8XAL ¹			517	722		VK2APK		473		
HK3AFB ¹			407	451		VK2APK ¹		336		
HK3ASJ		314				VK2EO	402	823		
HK3RQ			856			VK2GW	517	395	402	
HK3RQ ¹			1053	541		VK5ZP	651	571		
HK4EB ¹			814	362		VP1GFQ ^{1,2}	387	681	300	
HK4RCA ^{1,2}			617			VP2KR ¹		447	318	
HK6LR ²			411			VP3HAG ¹		683		
HL9KB			444			VP6WR ¹		970		
HL9US			421			VP7CC		402	381	
HL9US ¹			236			W5IUW/VP9	356	391		
HM5BF			393			XE2AAG	340			
HP1IE	326	649	944	771		YSIRFE		1530		
HR3JP			427			YU1BCD ²		319		
HR9EB ¹				691		YV1DP	421	1100	971	
IBAF ¹			447			YV3KV ^{1,2}		542	341	
IIPPI			313			YV5AGD ¹		443	319	
IRB ^{1,2}			1660			YV5BKA		1021		
JA1CG ¹			622			YV5BPG ¹		335		
JA1VX		346	873			YV5BTK	541	622		
KA2KS ²		518	581			ZD8HL		337	402	
KA5RC ¹			510			ZL1AFW		381		
KG4AM		508	970	770		ZS6FN ¹			317	
KG4AM ¹			800	800		4U1ITU ^{1,2}		316		
K3YMP/KM6 ²			355			4U1ITU ²		951		
KP4AXM ²	346		642	575		5A3TX			437	
KP4AXM ^{1,2}		366	691	908		5X5IU		300		
KP1BJU		319	340	379		5X5IU ¹			551	
KZ5EX ¹			1191			6O6BW		330		
KZ5TD				511		6O6BW ¹		437		
LA1K ²			474			9M4LP		327		
LA5HE ¹			507			9Q5AA ¹			365	
LA7VE ¹			378			9Q6PA			300	

¹ Phone

² Multioperator Station

Top EU c.w. score was posted by H89JG at 311-K. Five bands of operation included 8 contacts and 5 multipliers on 160. The station equipment includes a modified S-Line, quad and groundplane.

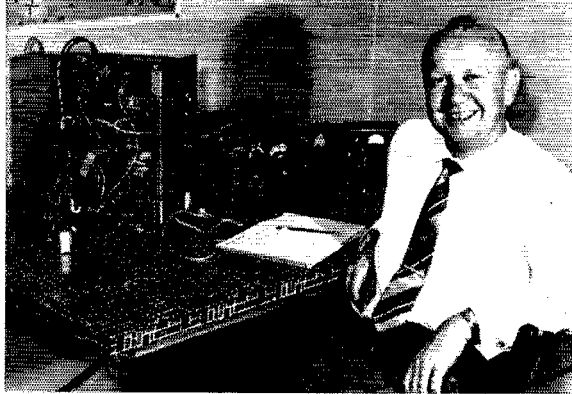

about 11 miles northeast of Salzburg but the strong winter prohibited this. Next year Gene hopes to be there using his quad. *OKIMP* had his time restricted due to the world hockey championship meets and heavy TVI. "Jeep", *ONAVS* had a great time and appreciated the kindness and gentlemanly operation of the great majority of *W/VE* operators — principal operation was on 20, for 752 QSOs. *OZ9SL* made over 1000 QSOs but not a single Vermont. Svend suggests an expedition to Vermont for '66! *SM6BCG* used the abilities of *SM6s BCG CED OKU* for a 3-band effort and 1139 exchanges. This was their first ARRL contest and they enjoyed competing with *SM6BGG*, the technical high school in Gothenburg. The six operators at *AU1TU* didn't quite achieve their '64 score due to Oscar III activity.

NA *FG7XL* enjoyed his first ARRL test very much and thanks participants for their patience and indulgence with his poor english. (A *very fine* first try for 335-K points!) In spite of an active social life (4 cocktail parties the first weekend and 2 the second) *H18XAL* managed 43 hours in which to amass 1772 contacts, 63 multipliers and 334,908 points. Fred found 75 surprisingly good. Doing it the hard way, with low power a.m., *HR9EB* totaled up 830 two-ways, with operation concentrated mainly on 15. *K0UDQ* handled the honors at *KG4AM* and found conditions good on all bands but 75, though skip on ten meters was too long from Guantanamo to the east coast. Thanks says Steve to all who patiently waited for a contact. *W2LEJ/KP4* operated at 1500' above sea level in the hills south of San Juan. Dick was helped (?) by Murphy; only able to operate one weekend, failure of meter circuits involved taking the transmitter apart three times, local power failure for 3 hours during the peak of Saturday evening. *KZ5EX* with a 20-meter only performance — and a knockout it was too with 1191 exchanges — found the sunset periods terrific, averaging about 100/hour at that time. *PJ3CD* found conditions good and wishes we'd run the affair twice a year (HALP!). Jonas is still looking for Montana for his WAS. *TG9EL* showed one of the best performances of all for forty phone and summed up 1538 in the entire phone section for almost 24,000 points. Ellis applauds the participants for their courteous operation and expects to be back in the U. S. as *WA4PTE* prior to this report. One of the phone highlights surely was the 18-hour stint by the crew at *VP1GFQ*; *WA5ATM*, *W5LDH*, *KOGHK*, *VP1AB* and *W0FGQ*. On three bands they bettered three hundred QSOs and made an excellent 75-meter showing with 150 in 13. The always reliable *VP3HAG* came up with excellent totals on five bands (which included 89 exchanges on 10) for a better

than 250-K showing with 1187 contacts. He reports happily that after 16 years of operating he worked *W7P5O*, Wyoming. An excellent single band effort by *VP6WR* amassed 970 contacts with 19 multiplier in just 29 hours of operation, quite a rate! Whenever good activity appears in the Leeward group it's welcomed. This year was no exception with the appearance of *VP2KR* on St. Kitts, 813 exchanges, big band 20. *XE2RE* appeared looking for Vermont and thanks all participants for their QSOs.

O Oceania phone activity was highlighted by the 20-meter activity of *FORBL* working over 700 participants in *W2-WO*, *KL7*, *KHG*, *VE4* and *VE7*. *VK4LT* found conditions erratic with 20 better in February than in March. 7 Mc. was good and he was amazed at the level of the east coast Wa. 75 meter conditions of QRN made copy impossible. *VK2APK* turned in the largest VK phone score, four bands for 64-K points. In New Zealand activity did result in scores, *ZLIAGO* found 406 to exchange reports with for almost 60-K.

SA *HC1EW*, familiar last year as *TI2EW*, topped 172-K while operating 75 through 10. Best band was 15 with a fine showing too on 75 and 10. He found very little operation on 40 and 20 the second weekend although 15 was good at that time. The Cuenca Radio Club, *HC5-CRC*, was ably manned by *HC5s EJ MP NW* for almost 2000-QSOs worth of vocal effort. Bravo! The full 96 hours was employed with 20 once again bearing the brunt, 1379 exchanges. Bill *HK3RQ* is still recovering from the test after operating his own station vocally for 31 hours. *HK6LR* the first c.w. and *HK3LR* the second c.w. weekends — all told 4000 QSOs to log! Bill's QSO rate was approximately one-a-minute for the period he put his *HK3RQ* station through its' paces. *HK3AFB* worked all states in his 998 total, QSLing 100% via manager *K8VDV*. Elie looks forward to '66 and the opportunity once again to be real rare DX. *HK4EB* (Photo in March '65 *QST*, p. 81) topped the 331-K mark with 1519 QSOs and 73 multipliers. Gustavo's beautifully typed log is a joy to behold. Total time on was 45 hours with a "try harder" effort scheduled for '66. *OAKY* joins with dozens of other DX stations in expressing his admiration of the operating abilities of the *W/VE* group. John's main gripe concerns the carelessness

Americans abroad: left, *K0UDQ* operating *KG4AM* for well over 300-K phone and close to a half-million c.w.; center, *H18XAL* (*W9SZR*) with the 2nd high score in the test, over 610-K c.w. and an additional 335-K vocally; right, *DL5AO* with a fine single-band 20-meter phone showing, 929 contacts with a multiplier of 20.

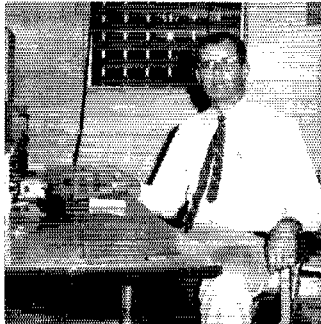

of stations working him as a duplicate or even triplicate. Good conditions says he and good results show in his log; 1429 exchanges with 74 multipliers for over 317-K points. One of the highest ten-meter reports is shown by *PJ2CR* of Curacao, 261 on that band with enough others to come close to 1400 two-ways. *PY2BJO* in Sao Paulo had a great time running up a 1247 contact figure for 213,237 points. *PY3AIJ* specialized on 20 and almost made WAS but for Vermont. *YV5BPG* has reason to be proud, almost 600 exchanges in a one-rig, one-person setup with time off for work, traffic and a good rest. Tony, *YV5AGD*, hit the Venezuela high and over-one-thousand figure; 5 bands of effort for a wallowing 269,640 points! The multipl. *YV3KY* performance was strictly a family affair by *YV3KY* (father) and *YV3KX* (son), over 1000 QSOs, five bands, over 200-K.

C. W. HIGHLIGHTS

AF After a death of c.w. CR4-activity over the years, two appeared to entice the W/VE gang this test. *CR4BB* appeared on 5 bands for a total of 594 exchanges. In spite of this activity from Dias, *CR4AE* (Flavio) found time asking for his exchange during the second portion of the contest. *CR7LU* tried 80 and Lucia says she heard a few W stations between 0300-0400 GMT (especially *W3LOE* and *W4KFC* with good signals) but claims her power and antenna just couldn't make it. Nicest surprise was a QSO with *KL7P1* on 40. *E9AY* was a good multiplier on 80-15 though sparing with his 8-9 reports. Antonio worked 495 stations for 66-K points and issued a scant ten 599 reports, see if you can find a familiar call or two in this list: *W2HTI* *W4ZJBY* *W3LOE* *W3GRF* *W3MSK* *W4KFC* *W5BRW* *W8FGX* *W910P* and *W0FRX*. How do you work over 2500 stations? Well you take a place like west Africa, run multipl with *EL2s AD AE AM AP* — all manning *EL2AE*, put in 96 hours and — well, that's it. The crew at *EL2AE* broke the half-million mark doing this and just missed Alaska for WAS during the test. Consensus: U. S. hams are courteous and cooperative; biggest complaint was duplicate QSOs. Here's a tip from the crew: considerable postage can be saved by QSLing *EL2AE* via Monrovia Dept. of State, Wash., D. C. 20521, using surface postage. The operators of the Kagnew Station ARC *ET3USA* found their portable location at Cheren poor, surrounded by mountains. All told 301 stations on 3 bands. *5A5TX* asks us to leave the contest as is, Carl put in 55 hours and a good show totalling 939 ex-

changes, more than doubling his performance of last year. Unfortunately the second weekend of the test coincided with the last weekend of the big game hunting season in Somalia, so *606BW* went hunting some real rare ones. 10 Hours of the first "go" for Bee netted 429 and a multiplier of 38. *9LITL* was another good catch for over 300 on 40-20-15. *9Q5QR* specialized in a single-band 20-meter effort and managed to snag all 21 multipliers, f.b. Tony, *9Q5TJ* reminds interested parties to address all correspondence to his manager, *DJ40P*.

ASIA Both *DU1OR* and *DU9FB* worked 40 and 20 and found no dearth of takers. *EP2RC* comments on the first weekend being a complete waste, he just couldn't hear the W/VEs. Dick reports that the west coast echo coinciding with the east coast skip is something to write home about, especially with about a dozen from each area calling at the same time. *HM5BF* topped the HL/HM tabulation with 530 exchanges. Kim runs 100 watts input and uses a quad for 15 and doublets for the lower band. Kim's receiver also is a home brew 17-tube dual conversion affair. *HL9TT* worked all U. S. call areas except W9; three Canadian area and found both 80 and 40-meter QRM terrific. *HL9KA* and *KB* worked both 40 and 20 with good results. *K1MEG/W44JYV* manned *HL9US* and feels 40 leaves much to be desired. Not so 20, however, a total of 513 on 40-20-15 . . . one contact alone on 15, *W461PY*. When *JA1VX* appears it's always with a big signal; so testify 1389 who exchanged reports with Mitsu. A big hand by your reporter for all the JA stations submitting logs. The crew at *KA2KS* all had a great time and regret not operating 80. The fellows feel the 550' leg Vee Beam made the difference, especially on 10. They're the only JA/KA stations reporting QSOs with the mainland U.S.A. on 28 Mc. during the test. *JA1VX* joined them in working reliable *KH6IJ* on that band. A real effort by *OD5AX* winding up a stint in Lebanon topped the 100-K mark with 758 exchanges on four bands. *OD5LX* was on hand briefly to dispense 117 exchanges (in just 3¼ hours!). Tremendous efforts by Asiatic Russian S. F. S. R. multipl stations brought forth big totals in contacts and points. *UA0KKB* manned by *UA0-29108* and *UB5-4031/UA0* worked almost 800 of the W/VE participants on four bands for almost 90-K points. *UA0KAE* lays down a big signal from Asia during most of the band openings. Three operators manned this station both periods and totalled well over 1000 QSOs! *UA0KFG* keyed by *UA0s EH FK FM* tried four bands and found them great, 1080 exchanges.

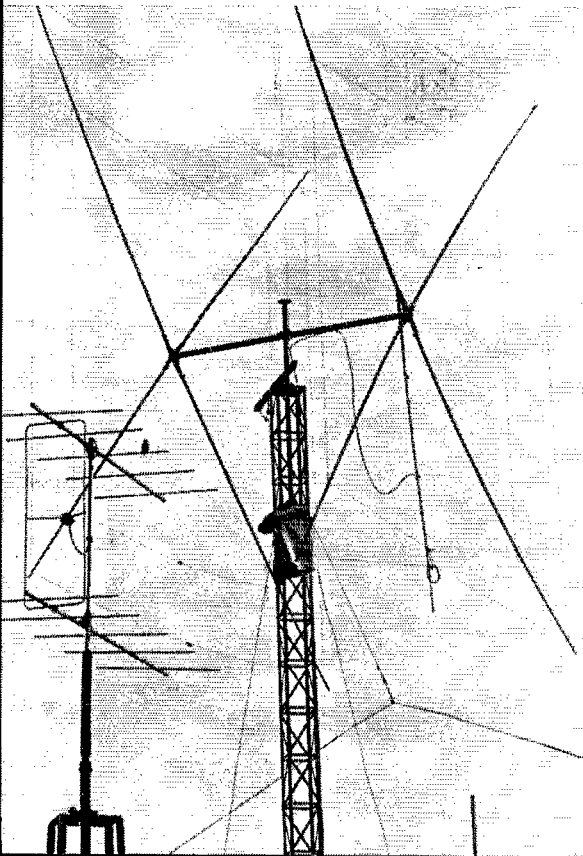

ZL1AFW, top ZL c.w. is a versatile ham by any standard. Doug's antenna system includes a two-band cubex quad and a skeleton slop for 2 in the foreground, both towers are home made at 30 and 40 ft. heights. ZL1AFW is the principal hospital technologist on the Auckland Hospital Board and will be doing a trip around the world in 1966 for the New Zealand Health Department. We all look forward to an eyeball QSO at that time.



LA5HE, Norway phone leader, totalled 559 with a multiplier of 30 for over 50-K. Ragnar found 40 poor but commends the improved numbers of VE's.

VU2GW, known as Ranga to his many DX friends, put in one hour for his first ARRL Competition and promises to be back next time, perhaps with a better directional antenna.

EU Perennially popular *DL7AA* found conditions poorer than last year with 160 impossible due to heavy QRM/QRN. *DL9PU* find this the most interesting contest and totalled three times the points that he did in 1964. *DM4YPL*, topped the listing for Germany with a 4-band effort, 948 exchanges with a multiplier of 66! *DL1JW* feels that the KL7 fellows have all traded in their keyers for microphones. *DJ6TS* had fun on 7-14-21 Mc., tried 80 unsuccessfully. Erwin used a specially made Swiss quad with great results on 14 Mc., 672 exchanges. *DL6VP* reports his first Montana QSO in 14 years. The Youthcentre at Essen *DL9JZ* was operated by *DL8FS* and *DJ6AC* in an effort to encourage local newcomers to get their licenses. The fellows thank the U.S. stations for QSLing so promptly in answer to their airmail confirmations. *EA2DT* reports enjoying the two weekends and looks forward to 1966. *E19J* also asks for status quo on the test periods. His 5-band effort included 22 exchanges on 160 in 5 call areas, f.b.! *E18H* compliments some of the W6/W7 contingent for really fine signals and first-class operating technique. In his 21st ARRL DX Competition *F8VJ* submits better than 171-K on four bands, his highlight was an 80-meter QSO with *W6YY*. Lucien has been active since 1927, a member of REF since that time and a member of ARRL since 1935 (with the exception of the war years) *G6VC* multipl'd by *G3s LEW JLB NZR PZX* and *G6VC* operated about 92 hours for well over the 2000 exchanges. A good show on 4 bands. Vic reports no signals heard on 10 or 15. *G4CP* with close to 260-K feels that that 2000-QSO figure will just have to wait until 10 opens up. Ron claims that one W3 must have got a big thrill out of working him three times on 20. *G2QT* suggests we use consecutive serial numbers for the DX exchange. *G2DC* submitted an immaculate log, completely typed reporting his 936 exchanges. The ubiquitous Bob Roberts *G2RO* claims this was the tough year of the sunspot cycle making the work rather hard at times, but more activity than ever. *G13OQR* with a tremendous report (1762 in 55 for 290,730) found the test most enjoyable and found it wonderful to hear the f.b. signals from the OT's. *G13OTV* pleads that we leave the contest periods as is as he prefers this test to all others. *GW3FSP* submitted a fine first attempt with 814 two-ways on 160-15. He found February conditions better than in March. *GW8JI* sent in a line notebook entry with activity on 1.8-21 Mc. Bob topped 162-K and found it a pleasure to participate. *HA1KSA* once again lead Hungary single operators with 178-K, putting in 57 hours of single operating. *HA8-703*, *HA2MJ*, *HA8DM* and *HA8WH* put *HA8KBB* through the paces on four bands to the tune of 1125 exchanges, best band 20 (what else?). An all around f.b. turnout by the HA operators. In Switzerland *HB9JG* found both 160 and 80 unproductive in W/VE QSOs, but seemed to make up the difference on 40-20-15, totalling 1761 for better than 310-K. An interesting sidelight of the '65 Test certainly was the reported activity by two Sardinia stations, *IS1FIC* and *IS1VEA*. Multiop. *LA1K* found conditions fair on the low frequency bands and promises a photo next go around. *LX3BD* got on three bands briefly and was an extra added attraction for some of the more alert east coast ops. *OE8TL* aided by *OE3LI* and *OU1ND* put in 74 hours for better than 1500 exchanges. Excellent Finnish participation noted this year — a full-time solo effort by *OH2BBR* for 829 QSOs; *OH2s BH BQ BS QV SB* manning *OH2AM* for a f.b. 94-K; *OH2FS* with close to 40/hour for a 34-hour stint; *OH1XX* with 468 on 20, etc. Probably the top numbers reporting/country in Europe are the OK's. *OK1GT* topped 100-K; *OK3OM* concentrated on 20 for 367 contacts; *OK2s BGH BGS* keyed *OK2KOJ* to well over 175-K in a fine four-band effort; with one transmitter and several operators the crew at *OK1KTL* ran up 1334 exchanges for close to 200-K points. The Antwerp C.W. DX Club, manned by *ON4s UQ NM GK QX BK WD* and *ON6s AX AZ* worked 793



and call this the "King of Contests." Denmark activity was plentiful, led by the multiband activity of *OZ3FL* and faithful *OZ7s YH XG OZ1W* and *OZ5DX*. Perennial *PA0LOU* finds less time to operate but pleads that the times remain the same so he and others could have at least one weekend in which to exchange numbers with W/V friends should time curtail their entire operation. Louis's 28 hours netted 553 QSOs and he feels this entire test is a major incentive to better the station and his operation to do better than average in score. EU multiops were the fashion too in Sweden where *SM6s BJ1 BGG BSK CKV* and *AOE* keyed 1388 exchanges for close to 200-K. Ye Olde QST Reporter of years ago (*W4IA* now *SV0WAA*) was the only log report from Greece. Ev reports not enough W/VEs were on to take it out of the dogfight category and that there should be an even higher ratio of W/VEs to foreign stations. One of your reporter's EU highlights is the neatly presented log report from popular Franz Josef Land. Three operators manned

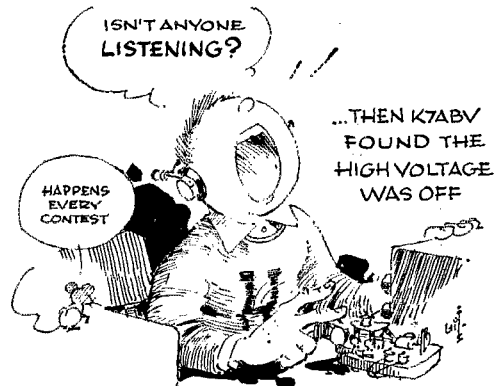

UA1KED supplying a new one for 513 on 20 and 44 on 40. The sixth call area received the only 589 reports in the 7 Mc. log. Kaliningradsk was made very available by the two multiops. *UA2KBD* and *UA2KAW*. *UA2KAW* dispensed 614 in 27 and *UA2KBD* handed out numbers to 426 in 32. An impressive performance from the Ukraine by *UB5WF* and a meticulous log too recording 1076 exchanges. Another unusually outstanding effort was submitted by "Henris" single-operating the *UP2KBC* club station on four bands, score topping 65-K. . . . another superlative log in clarity, neatness and exactness. Dependable *YO2BI* led the single operator YO stations with better than 400 exchanges and looks forward to 1966. A fine showing of logs from Romania. Another of the thousand-QSO reports came from the group manning *4U11TU*; *WA6QUA G300H DL1YJ* and *HB9UD*, four bands of effort in 43 hours.

NA The fine typed log from *FG7XX* itemizes 436 reports with W/VEs on 7-14-21. Maurice found it an enjoyable event. Missed Dominican Republic? Impossible! *H18s RVD LC* and *XAL* handed out over 3700 numbers to the eager W/VE contingent. *H18V'D* worked 557 in 24 and *H18LC* traded numbers with 393 for 38-K.



W3LOE, Western Pennsylvania leader on both modes, used a ground-plane on 75/80, a rotary dipole on 40; 4 elements on 20 and 3 on 15. One of the neatest entries received for this test.

H18XAL's prodigious effort netted 2758 in 62 hours, which includes three exchanges on 10 and 34 on 160. Fred reports his only six-bander was with the crew at W3MSK. All first-time contest QSOs were QSL'd air-mail direct. Same old home-brew rig, same old receiver but something new has happened to the operator at HP11E. Pete found the combination and topped his 1964 effort by a goodly margin and wound up with 2645 exchanges on 6 bands and over 666,500 points. Conditions notwithstanding Pete found 79 to QSO on 28 Mc.! HR5JP, ex-K4WVX, W5NSE, specialized on 20 and found 427 takers, KQ4AM operated by K0UDQ concentrated on four bands and managed 2368 exchanges thanks to the patient U.S.A. c.w. ops. Send all cards to his home call K0UDQ. The crew at KP4AXM, WA1DYZ WA4YUH and KP4s BFB BRY suggest a one weekend test after two weekends of keying and 1724 exchanges. An excellent 80-meter showing, KP4BJU prior to going off to college put in a brisk 40-hours for almost 220-K. Randy tried ten several times, without luck. Midwest Director W0NWX, the contesters, contestman, had fun at VP2VL handing out new multipliers and new countries to well over 2100 of the W/VE audience. Bob said he didn't expect to get that many so he didn't go all-out. W5IUF/VP9 didn't find that unwieldy call much of a hindrance in totalling over 1000 from Bermuda. Al suggests a lower power level for the stateside group. Just licensed since July of 1964, VP9FT noted an immediate improvement in his copying ability and enjoyed the test very much. XE2AAG and XE1NL were welcome signals from south of the border as was Managua's YN1AA. What can you do in a FIRST contest? YSIRFE answered this in a great big way with a 20-meter only effort, 1530 exchanges in 19 areas! — 29 beautifully typed pages itemizing his progress.

Out in the Pacific, W7PQP teamed up with K3YMP to operate K3YMP/KM6 for the benefit of 893 stations. Four lucky sites got a multiplier on 10 meters from the Midway crew. A delight this year to note the reports of many of the Australia actives, topped by old regular VK5ZP. Jeff found the conditions great fun as usual with better conditions the second weekend. His biggest kicks came from picking up tailenders on 80 and hearing signals once again on 10 meters. VK2GW of Gordon, N.S.W., turned in sizeable totals on five bands for close to 250-K. Home-brew VK2EO worked a total of 49 multipliers in 48 hours. Dave is justly proud of having worked all U.S.A. states during the test. Unusually good showings too from VK2APK with 1129 exchanges as well as others. VK2VN reports that the most outstanding signal heard was from W3CRA (so what else is new?). VK5KO's log comments re 160 making excellent reading: "When I logged W1HGT answering my first CQ DX Test at 1010Z he was so strong that I felt really annoyed as I was sure some VK5 was calling me. W1BB/1 was just slightly weaker but lasted longer. I'm sure the peak to W1 passed about 1012Z . . . ZL5OX reported later that Channels 2 and 7 TV from Melbourne were being well received at his home while I was in 160-meter QSO with W1HGT W1BB/1 and W1BU. ZL1AFW topped ZL c.w. reports. Doug too has numerous interesting comments: "I got the CRPLD predictions from the U.S.A. and they clearly showed that 10 would be open. It was, and I had done nothing about it, I've several gripes. Could you suggest that the middle of the contest is not the time to get the best reply to 'pse QSL.' An ex-

traordinary number came back for duplicate contacts. There was a lot of unnecessary calling (shades of W6ISQ — 'I like him'.) When the band is erupting the really cunning ones give it to me once or twice *real slow* and there is no further trouble. Signal quality good. A certain amount of rudeness. When I call a specific BK W7A7, I don't expect any one else to reply as this is in answer to a 449 and it doesn't help to have a W6 clobber one. Thanks for the fun."

SA South Americans not only type well, they perform outstandingly when it comes to our test. CX1OP totalled 393, which includes just one contact on 40, W6ITA. HK3RQ worked his own station as well as with HK6LR and in spite of just putting 21 hours from home, Bill wound up with the top single-operator score from Colombia, over 60 an hour for 21 hours. Bill's total of 220,476 is obviously a superlative keying job. HK4LE participated for the first time this year and picked up a new state, Wyoming. W7ABO pse QSL says Rod! He also wonders if there are active hams in Nevada and South Dakota. His 75-watts surprised him by bringing in fine reports, more than 70% over S-7. Rod says, "I worked 80-40-20 and 15 with only one dipole fed with 75-ohm coax. I got the idea from Gus, HK4EB and it works f.b. I call it the S4B trap dipole (special 4-bands trap dipole). HK6LR manned by HK1QQ and HK3RQ ground out 920 in 24 hours running just 100 watts to a pair of 6146s and an elaborate antenna system — dipoles ten feet high! LU7AU found conditions generally poor. It must be the coffee (or something) because the PY group all added together account for 6874 exchanges! Aeh, PY2BGL led the group with a 64-hour operation and 1578 exchanges on four bands. He says the entire bunch of Brazilian DXers went wild over the test this year. Last year he finished first with a mere 30-K. Kudos to the W/VE gang — no matter what the outcome he feels it will always be a most gratifying pleasure to work such an educated ham group. Almost 1600 contacts and not a single breach of discipline and courtesy. PY2SO, well known for both her c.w. and phone DXing, turned over two daughters to OM Joe PY2CQ, and put in an excellent 50 hours of operation for close to 1500 exchanges. F.B. Sonia! PY7AKQ scored over 1100, and PY1MCC rattled off 1126 on two bands. Bravo all! VP4VU very newly licensed found it fun and is a good one to look for in '65. The Venezuelans know how to go at it in the ARRL Test. The three c.w. entries shown in the tabulation are great. Imagine working almost 1500 and coming in third! Top score was the five-band show by Gregorio, YV1DP, 195 on 80 and 117 on 10 in addition to the totals shown on the chart. YV5BK4 scored just 1962 points in the last contest, and wound up with 313,479 in this! YV5BTK too did great, a multiplier of 62 on 5 bands for a final score of 273,396.

Disqualifications

The calls listed in this paragraph are all deemed ineligible for score listings or awards. Under contest rules 13 and 14, the following have been disqualified because of log discrepancies in their entries: C.w. — W3WJD (K3JJG, W3WJD ops.), W6AM (W9WNV, opr.), K6EVR. In each of the following cases disqualification was under contest rule 14 in view of non-observance of FCC rules as reported by at least two accredited Official Observers, or by a single FCC citation. Such violations as out of band operation, key clicks, spurious emissions, etc. were the criteria for these disqualifications: C.w. — WB2EDH, WA3COJ, W3QPF, W3WPG (W3s SQX WPG, ops.), K4CK, WA4SVO, W6CBE, K6KA, W6LC, W6RGG, W8YGR, W9EVX, W9KXX and W8GNX.

Thirty-First ARRL International DX Competition

Operator of the station first listed in each section and country is winner for that area. . . . The multiplier used by each station in determining score is given with the score — in the case of U.S.-Canada this is the total of the countries worked on each frequency-band used; in the case of non-W/K/KH6/KL7/VE/VO entries it is the total of the U.S.-Canadian districts worked on each band. . . . The total number of contacts is listed next. . . . The letters A, B, and C approximate the input to the final stage at each station; A indicates power up to and including 150 watts; B indicates over 150 watts, up to and including 500 watts; C indicates over 500 watts. . . . The total operating time to the nearest hour is given for each station and is the last figure following the score. . . . Examples of listings: K3NHL. . . . 299,268-204-499-C-70, or final score 299,268 multiplier 204; 499 contacts; power over 500 watts; total operating time 70 hours. . . . Stations manned by more than one operator are grouped in order of score following single-operator listings in each section or country tabulation; calls or numbers of participants at multi-operator stations are listed in parentheses. . . . In sections or countries where three or more multiple-operator entries appear, the top-scoring station is being awarded a certificate.

C. W. SCORES

ATLANTIC DIVISION

<i>Delaware</i>	
K3NHL. . . . 299,268-204-499-	C-70
W3IYE. . . . 274,800-200-458-	C- -
W3DRD. . . . 48,804- 98-166-	C-28
<i>Eastern Pennsylvania</i>	
W3BES. . . . 534,060-270-660-	C-75
W3MFW. . . . 349,590-215-542-	C-80
W3BIP. . . . 218,400-182-400-	C-52

W3KT. . . . 209,664-168-416-	C- -
W3GHS. . . . 196,716-169-388-	C-50
W3KDF. . . . 194,133-163-387-	C-50
W3KFF. . . . 184,140-165-372-	C- -
W3HHK. . . . 178,524-171-348-	C-42
W3GRS. . . . 165,006-178-309-	C-32
W3BGN. . . . 163,350-150-363-	C-70
W3CGS. . . . 159,456-151-352-	C-50
W3EQA. . . . 123,950-134-310-	C-43
W3QMZ. . . . 118,008-132-299-	C-51
W3TGF. . . . 109,668-122-298-	C-80

W3ECR. . . . 93,666-134-233-	B-40	W3ABAS. . . . 101,304-126-268-	C-65
K3MCO. . . . 86,655-109-265-	B-55	W3AXW. . . . 87,500-125-234-	C-48
W3INH. . . . 67,344-122-184-	C-15	W3RNY. . . . 72,522-102-237-	C-10
K3RZF. . . . 61,194- 94-217-	A-75	W3ZQ. . . . 57,600-100-192-	C- -
W3BYX. . . . 56,376- 87-216-	B-68	W3KDP. . . . 35,490- 70-169-	C- -
K3YQJ. . . . 53,103- 93-191-	A-32	W3FBE. . . . 18,762- 59-107-	B-20
W3CCH. . . . 45,504- 79-192-	A-35	K3GUR. . . . 12,300- 50- 82-	B-15
W3EVW. . . . 34,020- 60-189-	C-30	K3KMA. . . . 8040- 40- 67-	A-35
K3MBF. . . . 33,534- 69-182-	C-12	K3BYV. . . . 7216- 39- 63-	- -
W3ISE. . . . 33,480- 72-155-	A-28	K3EKO. . . . 6156- 36- 57-	C-11
W3NML. . . . 30,730- 70-147-	C-25	W3LMZ. . . . 5738- 38- 51-	A- -
W3QLW. . . . 30,096- 66-152-	B-32	W3ZNB. . . . 4935- 35- 47-	C-24
W3PN. . . . 25,920- 72-120-	C- 9	W3NJV. . . . 4002- 29- 46-	B-20
K3HTZ. . . . 24,747- 73-113-	A-30	K3ZTV. . . . 2648- 8- 11-	A- 3
W3CBF. . . . 19,845- 63-105-	B-32	K3QDD. . . . 390- 10- 13-	A- 1
K3NVC. . . . 17,490- 55-106-	B-55	K3YZ. . . . 270- 10- 10-	B- 3
W3EER. . . . 14,820- 52- 95-	A-32	W3MSK (7 oprs.)	1,299,072-398-1088-AC-96
W3UVH. . . . 11,970- 42- 95-	- -		
K3BNS. . . . 9828- 42- 78-	B-21		
K3JGJ. . . . 9348- 41- 76-	B-15		
W3NCW. . . . 8925- 35- 85-	A-17		
W3GHD. . . . 8760- 40- 73-	B- -		
W3DAO. . . . 6195- 35- 59-	A- -		
K3RFB. . . . 1734- 17- 34-	B-16		
W3ADZ. . . . 450- 10- 15-	C- 1		
W3GHM (W3s GHM NOH)	404,595-244-556-	C-70	
K3JCT (K2UWC, K3JCT)	360,591-223-539-	C-88	
W3MWC (K3JLL, W3MWC)	303,666-214-473-	C-80	
W3HNI (W3HNI, K3YUA)	43,875- 75-195-	C-39	
K3WNT (K3s VJA WNT)	5310- 30- 61-	A-21	

Southern New Jersey

K2DCA. . . . 421,155-245-573-	C-65	
W3GGL. . . . 144,450-150-321-	C-61	
W2BJV. . . . 138,618-153-302-	C-40	
W3DAJ. . . . 126,228-134-314-	C-40	
W3QDY. . . . 52,992- 92-192-	B- -	
W2HDW. . . . 52,020- 85-204-	A-20	
W3QKJ. . . . 18,954- 54-117-	B-30	
K3QEA. . . . 18,135- 68- 93-	A- 8	
K3IBO. . . . 17,136- 56-102-	C-30	
K3BG. . . . 15,120- 48-105-	B-20	
K2SQM. . . . 10,185- 35- 97-	B-30	
K2CFE. . . . 5760- 40- 48-	B- 8	
W2ZLS. . . . 5550- 37- 50-	C- -	
W2SDB. . . . 2970- 22- 45-	C- 5	
W2VUM. . . . 1914- 22- 29-	B- 8	
W2HSP. . . . 960- 16- 20-	B- 5	
K2EJV. . . . 462- 11- 14-	A- 7	
WB2APG (WB2APG, W3DQG)	660,042-306-719-	C- -

Western New York

W2MFX. . . . 324,339-219-495-	C-88
W2FVL. . . . 220,528-179-412-	B-76
W2TJR. . . . 166,374-158-351-	C- -
W2UJM. . . . 108,537-121-299-	- -
W2LJX. . . . 85,347-109-261-	B-60

DX-type antennas include, left to right: top VPI GFQ F9MS and G3CAZ; bottom DM4YPL G2QT and PJ3CD.

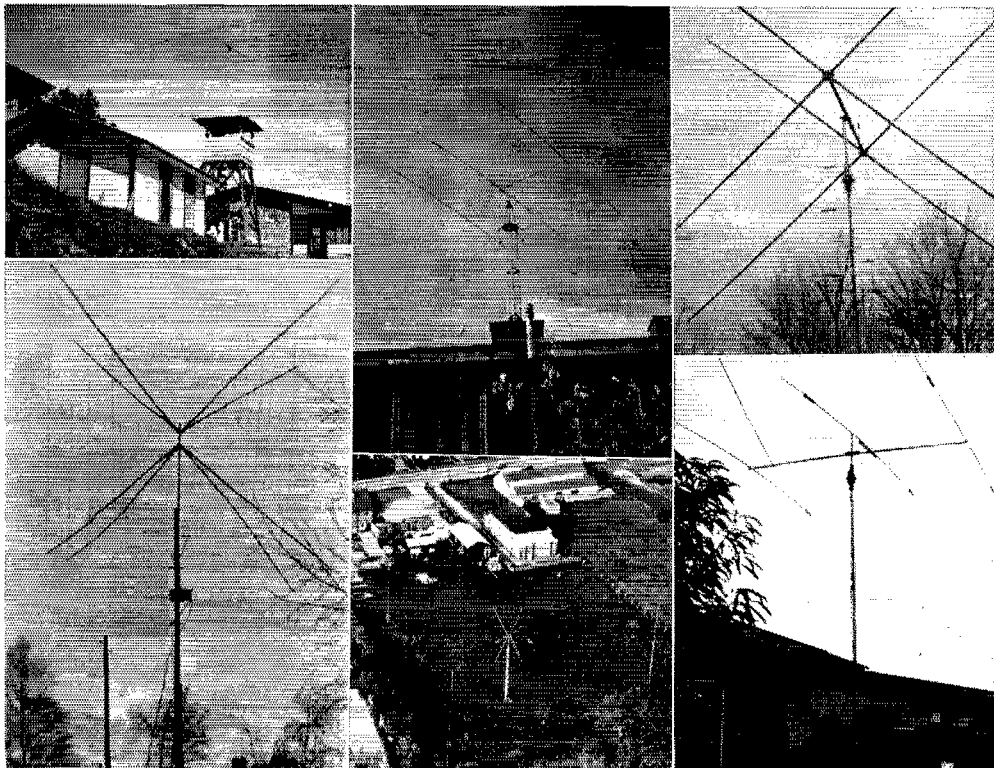

W2BJH	72,594-109-222	C-48
K2TQC	70,632-108-218	B-24
K2VFR	40,320-70-132	B-12
WA2NPFY	17,727-57-105	A-30
K2LWR	12,180-58-70	C-25
W2LFF	7524-38-66	A-28
WA2HUV	6232-38-65	A-7
K2OUS	4868-36-48	C-30
W2DOD	4050-30-45	B-7
W2YXA	3054-29-42	A-26
WA2PCW	2046-22-31	B-7

Western Pennsylvania

W3LOE	549,712-272-675	C-79
W3VEQ	52,920-98-180	C-47
K3ILC	42,735-77-185	B-4
K3ZMH	29,949-67-149	A-38
W3LW	15,345-55-33	C-31
K3VCH	9477-39-85	C-16
W3KQD	3120-26-40	A-4
W3LPP	1728-18-32	B-3
W3VKD (4 ops.)	586,080-264-740	C-76

CENTRAL DIVISION

Illinois

W9ERU	333,831-223-502	C-80
W9JGV	109,056-128-284	C-62
W9WIO	11,085-88-165	C-19
W9BUD	57,131-98-197	C-53
W9YYB	26,532-66-134	C-15
W9YYG	24,552-62-132	C-23
WA9AXX	18,150-55-110	C-17
W9EUI	16,995-55-103	C-14
W9QQG	11,868-46-88	B-23
W9QM	11,352-44-86	C-30
W9WKU	9588-47-68	C-14
W9NHT	7200-40-61	A-22
WA9LZA	5106-37-46	A-37
WA9DCN	4185-31-45	A-13
WA9HJM	4032-32-42	A-55
W9DGM	3510-26-45	A-32
K9ZSY	300-10-10	B-10
K9IWS	216-8-9	B-10
K9YRA	147-7-7	B-6
WA9NOI	27-3-3	A-3
K9GSD (K9GSD, WA9KWN)	5106-37-46	B-20
WA9KWN (K9GSD, WA9KWN)	3024-28-36	AB-20

Indiana

W9JOP	428,505-245-583	C-4
K9VQK	4896-32-51	A-29
W9UC	1587-23-23	C-7
K9FIC	1528-11-16	A-20

Wisconsin

W9QYW	163,680-155-352	C-56
W9GIL	148,050-150-329	C-4
W9IHN	50,058-81-206	B-4
W9RHL	48,060-90-179	C-41
W9VZP	44,589-89-167	C-26
W9SCZ	43,143-73-197	A-35
K9YBC	30,024-72-139	B-20
W9FEI	24,180-62-130	C-48
W9OW	22,794-58-131	-
W9NLJ	22,140-60-123	B-10
W9RBI	18,639-57-109	C-12
K9KKU	16,650-50-111	C-34
W9YTW (W9MLO, K9ZMS, WA9LAW)	23,247-63-123	C-19

South Dakota

W0BLZ	11,538-86-161	C-4
-------	---------------	-----

DELTA DIVISION

Arkansas

K5TYW	21,645-65-111	C-19
W5DRW	18,144-38-96	B-23
W5GFT	3741-29-43	B-18

Louisiana

W5KC	157,887-159-337	C-55
W5HJK	5814-38-51	A-24
W5GZR	2997-27-37	A-6

Michigan

W8VSK	547,815-295-619	C-73
K8TIG	302,247-213-473	C-74
WA8CZA	224,466-179-418	AC-96
W8DRW	224,200-186-100	AC-60
W8RXY	88,245-111-265	C-47
W8CUT	78,140-104-245	C-42
W8EW	55,875-95-195	C-29
W8VPC	48,504-86-188	C-25
WA8HDM	31,725-75-141	A-77
W8GJY	23,200-70-120	-
W8TIQ	20,862-61-114	A-46
W8KC	16,686-64-103	C-32
W8TRN	8190-42-65	B-11
WA8LKI	3219-29-37	C-6
WA8MAM	306-9-12	A-7
WA8MQE	168-7-8	A-4
W8SH (5 ops.)	353,001-223-529	AC-80
W8DUS (W8 CRD DUS)	31,680-80-132	-20

Ohio

W8FGX	649,955-305-711	AC-86
W8ZJM	252,144-204-412	C-55
W8JIN	173,628-182-318	C-42
W8ZCQ	173,010-158-365	C-59
W8CJN	81,360-120-226	C-4
W8YPT	63,000-100-210	B-34
W8JSU	62,700-100-209	C-4
W8KMD	56,070-89-210	C-47
W8GQU	51,128-83-206	BC-47
W8BOJ	33,540-86-130	C-10
WA8FAE	24,360-70-116	B-52
K8NMG	23,760-72-110	AB-4
W8NPF	22,968-66-116	C-30
W8DWP	20,352-64-106	B-24
WA8FDL	11,319-49-77	A-24
WA8GYX	10,800-48-75	B-21
W8GMC	9588-47-68	B-12
W8ILC	8319-47-69	B-15
WA8ETX	6264-36-58	A-6
WA8FCH	5742-33-58	A-34
W8KMF	4743-31-61	B-7
W4KAT	3856-41-72	A-26
W8BLF	3429-27-43	B-18
WA8ADJ	3240-30-36	A-20
K8DWQ	3096-24-43	C-10
WA8DZS	2856-28-34	A-11
WA8AZA	2730-26-36	A-20
WA8KPO	2553-23-37	C-20
WA8EZW	2511-27-31	C-10
W8VZE	1170-15-26	B-9

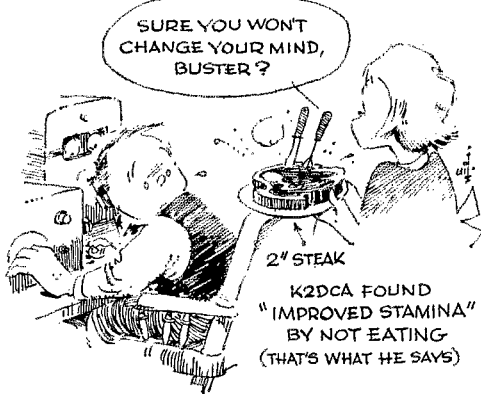

DAKOTA DIVISION

Minnesota

W0AIH	200,025-175-381	AC-45
W9GRW	47,214-86-183	B-56
W9YCR	39,840-83-160	C-40
W9QMD	32,604-76-143	C-16
W9UEI	13,104-42-104	C-4
W9JSN	12,087-51-79	A-30
W9RXL	1056-16-22	C-12
WA9KDI	3060-30-34	B-21
WA9HMW	108-6-6	A-3

North Dakota

W0EOZ	1575-21-25	C-5
-------	------------	-----

Mississippi

W5CKY	235,710-194-405	C-45
WA5HEU	858-13-22	A-14

Tennessee

WA4CGA	57,452-106-181	B-44
W4KAT	3856-41-72	A-26
W4ZWW	5022-31-51	B-48
K4SXZ	2825-25-35	A-6

GREAT LAKES DIVISION

Kentucky

W4BCV	332,424-216-513	C-71
-------	-----------------	------

The fabulous c.w. and phone totals amassed by the W3MSK crew become less of a mystery when conditions, equipment, location and operators are tops. The photo on the left shows W3TMZ and the boss W3MSK in the foreground, Charlie W6HOH left center and K1ANV and K3EST in the rear. On the right is K1ANV logging for W3ZKH. Rotary charters include 7 elements on 20, 15 and 10, 4 on 40 and 2 on 80!



WIJYH is well known in both DXCC and contest circles. Roger took part in both portions of the test adding three-quarters of a million points to the 128 Contest Club aggregate. Both the photo and the final in the upper right (4-UE572As) are by his son Dave, K1QFC.

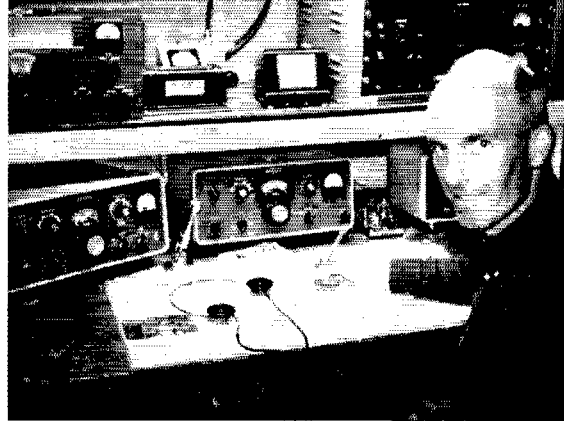

- W1ZBL/8.....429- 11- 13- A- 8
 W8AJW.....297- 9- 11- A- -
 WA8NQC.....102- 6- 6- B- 10
 WA8HVR.....27- 3- 3- A- 1
 WA8PLZ (6 oprs.)
 28,350- 70-135- C-50
 W8DJJD (W8s BQV DJD)
 16,758- 57- 98- C-35
 WA8HLI (WA8s FCD HLL)
 4320- 30- 48-AH-70

HUDSON DIVISION

Eastern New York

- WA2OJD.....381,864-208-511- C-67
 W2HO.....202,890-161-420- C-50
 K2GDP.....87,453-123-237- C-29
 W2AWF.....64,505- 95-227- C-55
 W2RRT.....38,070- 94-135- C-20
 WA2HLH.....37,146- 82-151- A- -
 K2IBW.....30,056- 66-172- C-26
 WB2DXL.....1620- 18- 30- A- 4
 WB2JYV.....1425- 19- 25- A- 10

N. Y. C. — L. J.

- W2PCJ.....352,044-231-508- C-80
 WB2CKS.....346,500-225-516- C-68
 W2IRV.....218,022-179-406- B-58
 W2LXK.....214,542-174-436- B-72
 K2CHQ.....202,104-168-402- C-58
 W2YCW.....168,300-170-330- C-57
 W2GKZ.....150,024-152-320- C-27
 W2WZ.....125,760-131-320- C-21
 K2YOR.....118,656-128-309- C-51
 W2AZS.....86,184-114-252- C-40
 WA2KSD4.....52,461- 87-201-B-20
 WA2ZJK.....47,232- 96-164- C-20
 WA2TJA.....42,804- 87-164-B-17
 W2RDD.....24,522- 67-122- C-12
 K2HVN.....22,644- 74-102- A- 20
 WA2UWA.....17,316- 82-111- B-18
 WA2EFN.....9546- 43- 74- C- 7
 W2JB.....8970- 46- 65- A-29
 W2ZV.....8733- 41- 71- A- 40
 W2EQG.....8237- 33- 63- B-14
 WB2IQM.....5040- 30- 56- B-15
 WB2FAJ.....4785- 29- 55- B- 7
 W2OBU.....4293- 27- 53- B- 7
 WA2TGL.....4032- 32- 42- A-11
 W2CKR.....3726- 23- 54- C-34
 K2DDK.....2250- 25- 30- A-13
 WB2DXM.....900- 15- 20- B- 4
 W2ASE.....900- 15- 20-B-11
 WB2OTT.....546- 13- 15- A- 10
 WB2ENW.....408- 8- 17- A- 7
 WB2EWG.....378- 9- 14- C- 6
 K2CSH.....133- 7- 7- B- 1
 W2AFM.....126- 6- 21- A- 11
 W2NHH.....126- 6- 7- A-16
 WA2ZXL (WA2s RJZ ZXL,
 WB2BJG)
 100,368-123-273- B- -

Northern New Jersey

- W2VJN.....593,895-289-685- C-66
 K2GUN.....309,444-214-482- C- -
 W2BOK.....187,118-161-346- C-40
 WB2FIT.....92,565-121-255- A-70
 W2HUG.....82,185,117-235- A-45
 WB2CZJ.....76,041-119-213- B-42
 W2HL.....59,328- 96-206- C-14
 W2EHN.....50,290- 94-179- B-40
 WB2MWU.....28,721- 77-125- A-44
 W2NEP.....26,775- 75-119- A-24
 K2MH.....26,675- 55-161- C-58
 WA2YRV.....26,208- 78-110- B-22
 WA2ZEZ.....25,326- 63-134- B-38
 W2LQP.....15,753- 59- 89- A- 8
 WB2KXG.....14,193- 57- 83- B-23
 W21WP.....7800- 40- 65- B-22
 WB2NOE.....3888- 27- 48- A-46
 W2ADP.....3726- 27- 46- A-30
 W2EQS.....1224- 17- 29- -
 W2DOV.....564- 12- 17- A- 8
 WB2NLH.....260- 10- 10- A-10
 WB2OHS.....75- 5- 5- B-14
 W2PXR (6 oprs.)
 198,229-167-396- C-84
 K2KFP (5 oprs.)
 183,162-178-343- C-57

MIDWEST DIVISION

Iowa

- W0Y7Q.....270,600-205-442- C-78
 W0HNA.....92,958-122-253- C-78
 W0CXN.....33,165- 67-165- C-27
 W0LBS.....30,620- 71-140- C-30
 W0FDL.....21,105- 67-105- C-12
 W0BSY.....2262- 26- 29- A-23
 WA0JUS.....429- 11- 13- A-34
 WA0HXW (5 oprs.)
 13,260- 52- 85- C-12

Kansas

- W0VBQ.....34,410- 74-155- C-23
 WA0ITY.....210- 7- 10- A-10
 K0MHZ/0 (W0s HLZ, IPV,
 K0MHZ)
 19,530- 62-106- B-40

Missouri

- WA0EMS.....79,134-109-242-A-C-48
 W0LBS.....48,024- 87-184- C-46
 W0GVV.....31,374- 83-126- C-38
 W0CZQ.....24,633- 69-119- C-45
 K0GSV.....3828- 29- 44- A-10
 W0FLN.....1425- 19- 25- A- 8
 K0YIP.....1449- 21- 23- A- 7
 WA0LLQ.....378- 7- 18- A- 2
 K0PFC.....147- 7- 7- A- 4

Nebraska

- WA0GVJ.....1071- 17- 21- A- 1

NEW ENGLAND DIVISION

Connecticut

- W1WPO.....221,613-173-427- C-60
 K1ZVU.....149,742-141-354- C-52
 W1BWH.....143,286-143-334- C-22
 K1ZND.....128,652-142-302- A-55
 W1ECH.....128,454-158-271- B-45
 W1TX.....109,908-129-284-ABC- -
 WA1W7.....100,068-124-269- C- -
 W1WHQ.....85,956-116-247- A-40
 W1BGD.....55,929-103-181- C-30
 WA1AH.....55,149- 93-199- C-57
 W1QAK.....41,118- 89-154- C-20
 K1ZXA.....37,422- 81-154- A-48
 W1BHV.....23,848- 64-119- B-24
 K1LMS.....20,700- 50- 38- A-39
 W1QV.....19,968- 61-104- C-12
 K1YXK.....21,840- 56-130- A-35
 W1FTX.....7869- 43- 61- B- -
 W1BDP.....3645- 27- 45- B- 4
 K1PNS.....4284- 28- 51- C- 8
 W1WY.....2989- 29- 38- B-10
 K1WJB.....2706- 22- 41- B-20
 K1QFV.....2520- 28- 30- A-14

- K1PNU.....1140- 19- 20- B- 3
 WA1BMM.....73- 4- 6- A- 3
 W1FTM.....27- 3- 3- -
 W1ICP (W1s ICP YNP)
 255,780-196-435- C- -

Eastern Massachusetts

- W1BPW.....521,451-267-651- C-76
 W1JYH.....468,344-254-612- C-58
 K1DIR.....456,456-247-616- C-72
 W1EVT.....455,490-241-638-B-72
 W1WLZ.....257,277-191-449- C-62
 W1AXA.....189,336-161-392- C-60
 K1YKT.....103,296-128-289-AB-37
 K1SOP.....84,180-115-244- C-60
 W1EHT.....77,112-102-252- B-47
 W1CSP.....33,930- 78-145- A-39
 W1KXP.....31,005- 65-159- A-25
 W1FJJ.....13,320- 60- 74- C- 4
 K1ZHS.....27,051- 71-127- A- -
 WA1CNY.....19,188- 82-123- A-40
 W1MRQ.....16,692- 52-107- C- -
 WA1CTN.....14,691- 69- 83- C-50
 W1BVP.....4758- 26- 61- A- -
 W1BB.....2125- 17- 39- -
 W1PLJ.....2112- 22- 32- B-11
 W1RWU.....2052- 18- 38- B- 7
 WA1CRK.....1188- 18- 22- C- 2
 W1BLP.....302- 9- 16- C- 1
 W1TKG.....20- 3- 4- A- 3
 K1WJD (W1BGD, K1WJD)
 13,272- 56- 79-AC- 9

Maine

- K1RQE.....180,441-163-369- C-55
 W1BFA.....59,085-101-195- C-58
 W1UOT.....10,212- 46- 74- B- -
 W1EM.....1700- 20- 29- B- 8

New Hampshire

- W1FZ.....102,582-123-278- C- -
 W1PEG.....31,169- 71-149- B-55
 W1SWX.....11,790- 45- 88- C-29
 K1CTQ (WA6OJM, W8AZA)
 7884- 36- 73- A-10

Rhode Island

- W1GOG.....160,083-147-363- B-62
 W1RQ.....21,960- 60-122- B-15
 W1AWE.....15,870- 46-115- - -
 K1EWD.....15,066- 54- 93- A-16
 K1USD.....4200- 25- 56- A- 6
 W1YRC.....14,940- 60- 83- C-13
 K2KMF/1.....756- 12- 21- A-15

Vermont

- W1WTE.....38,016- 72-176- B-30
 K1YRB.....1653- 19- 29- A- 6

Western Massachusetts

- W1AEW.....106,812-129-276- C- -
 W1UUK.....87,792-124-236- B-47
 W1EOB.....28,137- 83-113- C-14
 K1OOV.....8775- 45- 65-A-C-28
 K1LUU.....8160- 40- 68- A- 8

NORTHWESTERN DIVISION

Idaho

- K7CPC.....1872- 28- 58- A-20

Montana

- K7ABV.....15,552- 54- 96- C-12
 W1QB.....3510- 30- 39- A-19
 W7SVF.....240- 8- 10- B-11

Oregon

- K7UCH.....44,064- 72-204- C-45
 W7ABW.....12,972- 47- 92- A-50
 W7DLS.....1872- 29- 56- A- -
 W7QY.....4680- 26- 60- - -
 WA7COB.....1536- 16- 32- A-13
 W7JRI.....522- 6- 29- A- -

Washington

- W7MX.....59,787- 91-219- C-68
 W7LVI.....58,394- 86-227- C-51
 K7VAL.....28,143- 59-159- C-54
 K7QXL.....6831- 34- 67-B-22
 W7VRO.....5940- 33- 60- C- 6

DIVISION LEADERS

C.W.

Phone

Single Operator	Multioperator		Single Operator	Multioperator
W3GRF	W3MISK	Atlantic	W3AZD	W8AISK
W9IOP	W9YTF	Central	W9EWC	WA9GCM
W0AII	Dakota	W0JWL	W0QUU
W5CKY	Delta	K5MDX
W8FGX	W8SH	Great Lakes	W4BCV	W8NWO
W2VJN	W2PXR	Hudson	K2HLB
W0Y7Q	K0MHZ/0	Midwest	W0CU	W0FLN
W1BPW	W1ICP	New England	K1DTR	W1SEA
W7XN	W7ASM	Northwestern	W7DQM
K6OHJ	W6UMI	Pacific	K6AHV	K6OHJ
W4KFC	W4KXV	Roanoke	W4BVV	W4HXV
W6CDP	W6EZO	Rocky Mountain	W0EZO
WA4NGO	W4ZYQ	Southeastern	W4RLS	W4ZYS
W6TZZ	W6RW	Southwestern	WA6SHO	K6FVR
W5LGG	West Gulf	W5KTR	WA5MAV
VE2NV	VE3DFM	Canadian	VE2UX	VE8ML

W7IPX.....1785-17-35-B-16
 W7HDM.....210-5-14-A-6
 WA7ASM (WA7SM, W7SFF)
 1920-16-40-B-25

PACIFIC DIVISION

East Bay

W6LDD.....21,953-183-397-C-85
 W6KQ.....208,560-176-395-C-90
 W6BSY.....112,608-138-272-C-70
 K6AHV.....104,394-137-254-C-35
 W6PQW.....77,490-105-248-A-
 W6AUIS.....60,543-93-217-C-45
 W6KEK.....33,180-79-40-C-35
 W6AVT.....21,917-59-121-AC-
 W6KJS.....21,411-61-119-C-
 W6LPT.....21,000-20-45-C-12
 W6RLLH.....1785-17-35-A-10
 W6EJA.....552-8-23-B-
 W6BBC.....270-6-15-A-8
 W6BETV.....245-7-12-A-10
 W6RIZV.....234-6-13-B-5
 K6LRN.....18-2-3-A-2

Hawaii

KH6LI.....107,682-131-274-C-
 KH6FIE.....348-10-58-B-
 KH6FMF.....1089-11-33-B-6
 W6PAN/KH6.570-10-19-B-6

Sacramento Valley

W6GRX.....133,653-149-299-C-70
 W6EOU.....48,992-88-178-C-70
 W6SLA.....45,900-90-170-B-36
 W6ONZ.....34,843-91-91-C-36
 W6BIL.....20,196-68-99-C-37

San Francisco

W6MSM.....130,416-143-304-C-63
 W6WB.....130,284-141-308-C-70
 W6CYV.....51,294-83-206-C-26
 W6AIVM.....32,232-68-158-C-42
 W6ERS.....61,838-98-211-C-60
 K6LXS.....16,677-51-109-A-10
 K6PJT.....3780-28-45-B-C-15

San Joaquin Valley

W6BVM.....113,919-127-299-C-55
 W6KTW.....94,017-121-259-C-80
 W6WWD.....56,745-97-195-C-30
 W6AFH.....4860-30-54-C-20

Santa Clara Valley

K6OHJ.....288,420-209-460-C-
 W6AQQW.....239,841-189-423-C-72
 W6WV.....197,046-178-369-C-60
 K6ERV.....178,974-163-366-C-50
 W6HOC.....171,150-163-350-C-60
 W6UJ.....150,381-147-341-C-70
 W6SC.....138,570-149-310-C-60
 W6ZMV.....96,285-131-245-C-49
 K6BWX.....90,405-123-245-C-68
 W6ATO.....85,470-110-259-C-76
 K6HOR.....81,396-114-238-C-
 W6GQK.....46,314-83-186-C-35
 K6EBB.....44,376-86-172-C-35
 W6LJ.....44,118-86-171-C-35
 W6BEP.....43,344-84-172-B-75
 W6LXJ.....41,820-82-170-C-50
 W6ISQ.....30,456-72-141-C-20

W6GYM.....30,096-76-132-C-72
 W6HRS.....23,625-63-125-ABC-40
 W6HVN.....22,080-64-116-C-28
 W6KHS.....20,412-63-108-B-
 W6RTV.....13,515-53-85-C-8
 W6RFF.....12,144-46-88-C-
 W6PYM.....6498-38-57-C-10
 W6BLEL.....5210-30-59-A-35
 W6JWD.....1305-15-29-C-4
 K6OZY.....294-7-14-C-6
 W6CLZ.....870-10-29-B-5
 W6UMI (W6s TQK UMI)
 76,518-117-218-C-
 W4ZM.....34,362-83-138-C-10
 W4RKV.....30,876-62-166-C-35
 W41F.....23,532-53-148-B-
 W4YZO.....20,928-64-109-C-10
 W4AMP.....17,700-59-100-B-32
 W4MXU.....11,826-54-73-C-12
 W4JUK.....8505-35-83-C-34
 W4KMS.....5940-33-60-B-14
 W4VKG.....2850-25-38-C-8
 K8UZA/4.....2775-25-37-C-10
 W4QAR.....2184-24-31-C-7
 K4WUM.....1887-17-37-B-5
 W4HVC.....1425-19-25-A-4
 K4OYJ.....1360-16-29-A-10

Utah
 W7NPU.....67,008-96-234-C-76
 W7POU.....5130-30-57-A-29

Wyoming
 W7PSO.....26,334-66-133-C-40
 W7ABO.....20,502-51-134-C-27

SOUTHEASTERN DIVISION

Alabama
 K4NMN.....31,960-68-157-AB-50
 W4AKXC.....3780-30-42-B-
 W4KVC.....3441-31-37-B-10

Eastern Florida

W4ANGO.....421,968-236-596-C-67
 W4SUR.....121,800-145-280-C-72
 K4RQE.....82,482-118-235-BC-
 W4LVV.....68,310-90-270-C-
 K4THA.....58,032-104-188-A-50
 W4VYJ.....43,771-91-161-A-31
 W4ACDN.....43,095-85-169-B-39
 W4NTE.....27,744-68-136-A-48
 W4HKJ.....24,150-70-115-C-12
 W4BRB.....18,880-80-80-A-20
 W4QPV.....15,921-61-87-AC-25
 K4OMR.....13,780-52-89-BC-25
 W4WFO.....7655-35-51-C-6
 W4EEO.....432-12-12-A-10
 W4ZOK.....390-10-13-B-8
 W4ZYQ (W4s ZYQ ZYS)
 217,161-189-421-C-90

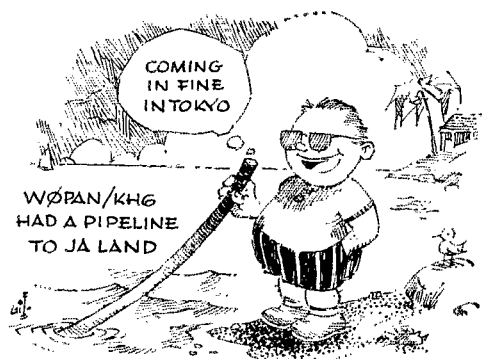

ROANOKE DIVISION

North Carolina
 WA4TLL.....40,128-88-152-B-30
 W6GXQ/4.....29,640-76-130-B-45
 WA4PHA.....20,520-60-114-C-18
 W4OMW.....14,904-64-96-B-14
 WA4OKU.....10,632-48-70-B-17
 WA4HIG.....3042-26-39-B-12
 WA4KFW.....312-8-13-A-2
 WA4SR8.....297-9-11-A-8

W4NXE.....1105-13-29-A-19
 WA4MKG.....65-5-5-B-1
 W4KXV (8 ops.)
 1,026,018-357-958-AC-96
 K4LJQ (K4s LJQ SXT)
 850,338-362-783-C-89
 W4BVV (4 ops.)
 754,924-316-797-AC-96

South Carolina

WA4IKU.....186,972-172-363-C-71
 WA4TLB.....20,460-62-110-A-36
 K4YYL.....648-12-18-C-3

Virginia

W4KFC.....684,000-304-752-C-77
 WA4OAE.....585,000-225-571-C-78
 W4JAT.....137,592-147-312-C-52
 W4YCY.....134,298-134-334-B-38
 W4DYV.....119,472-152-262-C-43
 W4OPM.....112,716-124-305-C-50
 W4LRN.....94,122-126-249-C-24
 W4GF.....81,510-114-239-C-
 W4PTB.....68,904-116-198-C-
 W4CQI.....56,916-93-204-B-31
 W4OPM.....49,020-86-190-C-
 W4ZSH.....48,960-96-170-C-31
 W4WBC.....43,497-81-179-B-36
 WA4DUS.....39,044-86-154-A-44

West Virginia

K8QYG.....232-8-11-A-8

ROCKY MOUNTAIN DIVISION

Colorado
 W8CDP.....131,417-143-313-C-37
 W8GDX.....55,476-92-201-C-25
 WA8CVS.....34,362-83-138-B-30
 WA8DDX.....702-13-18-B-10
 K8VFN.....468-12-13-B-4
 W8EZO (W8EZO, WA8BAD)
 45,360-84-180-C-40

New Mexico

W5CK.....68,052-107-212-C-43
 W5GUZ.....34,524-84-137-C-38
 K5STL.....26,838-71-126-B-36
 W5DWB.....12,816-48-89-C-17
 W5LEF.....450-10-15-C-3

Georgia

W4MCM.....343,335-235-487-C-88
 K4EZ.....324,658-219-494-BC-60
 WA4BJL.....13-2-3-B-1
 W4DXI.....237,888-192-415-ABC-80
 K4TKM.....65,205-115-189-A-23
 K4JJS.....34,860-83-140-C-12
 WA4EPM.....2277-23-33-A-12
 W4HOS (W4s PRO HOS)
 118,170-310-303-B-77

SOUTHWESTERN DIVISION

Arizona

W7IMA.....59,280-104-190-B-
 W7ATV.....17,856-64-93-C-18
 W6BFHE/7
 11,454-46-83-A-20
 W7ENA.....10,935-45-81-A-23
 W7AYY.....7560-36-70-C-6
 K7TEB.....1125-15-25-B-17
 K7TLP.....144-6-8-B-7

Los Angeles

W6TZD.....112,005-131-285-C-40
 W6UED.....104,994-114-307-C-63
 W6NJU.....104,328-126-276-C-56
 W6LDA.....94,248-126-250-C-59
 W6NKR.....87,962-122-241-C-50
 K6KJL.....71,505-105-227-C-40
 W6NEX.....57,310-94-206-C-48
 W6FET.....44,571-84-179-C-40
 WA6TLL.....41,574-82-169-A-72
 W6PQT.....35,424-82-144-C-25
 W6TBD.....29,376-68-144-C-65
 W6RCV.....27,531-69-133-B-38
 W6FSJ.....25,935-65-133-C-
 W6WVQ.....23,532-74-106-C-58
 W6BAKZ.....21,888-64-114-C-15
 W6AGLD.....17,934-61-98-C-20
 W6APH.....13,884-52-89-BC-35
 W6AKHK.....10,414-44-86-A-28
 W6AMWG.....10,062-43-78-C-
 W6BMEQ.....5568-29-64-A-33
 W6UOQ.....4872-28-58-C-6
 W6BKOZ.....3915-29-45-B-
 W6FCM.....2662-22-41-C-13
 K6BPR.....2646-21-42-C-
 W6BCNO.....1748-19-31-A-12
 W6BFCV.....1386-21-22-A-8
 W6LVO.....672-14-16-C-
 K6INH.....432-9-16-C-6
 WA6ZMR.....240-8-10-A-8
 W6RW (6 ops.)
 590,427-289-681-C-96
 W6ITA (4 ops.)
 534,504-278-641-C-96
 W6ANN (W6s ANN DFY)
 155,775-155-335-C-74

HC5CRC, the Cuenca Radio Club, led all S. A. multioperators in the phone portion with close to 2000 QSOs. Shown in the photo are (left to right) HC5NW HC5EJ and HC5MP.



<i>San Diego</i>		<i>Angola</i>	
WA6SBO.....	80,811-123-219- C-20	CR6HG.....	16,416- 19-288- A- -
W6KNE.....	71,508-101-236- C-48	CR6GS.....	2112- 11- 64- A- -
W6PLK.....	48,330- 90-179- C-70	<i>Mozambique</i>	
W6SRF.....	34,155- 69-165- C-40	CR7LU.....	35,598- 34-354- A- -
W6CWD.....	47,472- 92-172- C-40	CR7IZ.....	22,569- 27-279- A- -
WA6LBP.....	10,325- 59-122- - -	<i>Spanish Morocco</i>	
WA6DNM.....	2223- 19- 39- B-20	EA9AY.....	66,015- 45-495- A-20
W3GAL/6.....	1152- 12- 32- B-12	<i>Liberia</i>	
W6BEX.....	990- 15- 22- A-17	EL2AE (4 ops.)	501,732-63-2678-AC-96
W6BTFM.....	162- 6- 9- - -	<i>Ethiopia</i>	
WA6WPG (WB6GPF, WA6WPG)	1751- 17- 35- A- 7	ET3USA (6 ops.)	22,880- 26-301- A-48

<i>Santa Barbara</i>	
WA6OJJ.....	39,342- 79-166- B-70
W6GEB.....	7665- 35- 73- A- 9
WB6DPV.....	420- 7- 20- A-10

WEST GULF DIVISION

<i>Northern Texas</i>	
W5DWT.....	281,865-215-439- C-49
W5KTR.....	115,642-134-290- C-61
K5VBL.....	111,339-139-267- B-68
W5UGS.....	87,399-117-249- C-32
K5QMC.....	32,412- 73-148- C-70
K5FXG.....	24,360- 70-116- B-28
W5MSG.....	147- 7- 2- A- 4

<i>Oklahoma</i>	
K5COX.....	15,105- 53- 95- A-22
K5JVF.....	1953- 21- 31- B-30
W4SKI/5.....	507- 13- 16- A-20
K5VTA.....	324- 9- 12- A- 5

<i>Southern Texas</i>	
W5LGG.....	387,042-257-502- C-69
W5WZQ.....	331,975-245-452- C-74
W5BRR.....	227,290-191-398- C- -
W5LZG.....	110,040-140-282- C-51
W5LJT.....	44,880- 88-170- C-28
WA5HEP.....	10,260- 45- 78- B-72
W5KTW.....	5217- 37- 47- C-14
WA5IPM.....	2376- 24- 33- B-13
WA5ENK.....	3376- 24- 33- A-15
WA5BXC.....	2178- 22- 33- A- -
WA5GZX.....	12- 2- 2- A- 1

CANADIAN DIVISION

<i>Maritime</i>	
VE1RB.....	185,136-152-406- - -
VE1ZZ.....	56,871- 89-213- C-45
VE1EK.....	18,816- 56-112- A-20
VO1AW.....	13,464- 44-102- A-13
VE1DB.....	5160- 58- 30- B- 8
VE1AE.....	2460- 20- 41- A- -

<i>Quebec</i>	
VE2NV.....	226,320-184-410- C-75
VE2WA.....	162,545-145-374- C-40
VE2BV.....	48,822- 79-206- B-32
VE2AYU.....	30,192- 68- 48- B-70
VE2BVD.....	1776- 16- 37- A-10

<i>Ontario</i>	
VE3ES.....	42,372- 66-214- B-28
VE3DBB.....	40,581- 81-167- B-56
VE3BTQ.....	14,256- 44-108- C-37
VE3FIE.....	6100- 34- 50- A-30
VE3DFM (VE3S DAM DFM)	449- 21- 23- A-35

<i>Manitoba</i>	
VE4MF.....	64,206- 87-246- B-65
VE4XU.....	45,123- 89-169- C-20
VE4IM.....	3184- 44- 62- B-16
VE4ZX.....	6237- 33- 63-BC- -

<i>Saskatchewan</i>	
VE5PM.....	3864- 28- 46- B-15

<i>Alberta</i>	
VE6AAV.....	5175- 25- 69- C- 8

<i>British Columbia</i>	
VE7BDJ.....	18,880- 59-107- B-37

<i>Yukon-N.W.T.</i>	
VE8BB.....	1599- 13- 41- A-22

AFRICA

<i>Cape Verde Islands</i>	
CR4BB.....	87,269- 49-594- A-71
CR4AL.....	8148- 28- 97- A- -

<i>Ascension Island</i>	
ZD8HL.....	1575- 15- 35- A- -
<i>Rhodesia</i>	
ZE1BL.....	2580- 10- 88- A- -
<i>South Africa</i>	
Z86FN.....	51,156- 40-348- A-14
ZS10.....	1014- 13- 26- A- -
<i>Libya</i>	
5A3TX.....	137,494- 40-939- A-55
<i>Uganda</i>	
5X5IU.....	29,088- 24-401- A- -
<i>Somali Republic</i>	
606BW.....	48,906- 38-429- C-10
<i>Algeria</i>	
7X2RW.....	2604- 14- 62- A- -
<i>Sierra Leone</i>	
9L1TL.....	30,195- 33-305- A-13
<i>Republic of Congo</i>	
9Q5PA.....	19,404- 21-308- A- -
9Q5QR.....	18,711- 21-297- B- -
9Q5TJ.....	17,332- 28-221- A- -

<i>ASIA</i>	
<i>Philippine Islands</i>	
DUIOR.....	19,200- 16-400- B- -
DUIFB.....	3690- 10-123- A- -
<i>Iran</i>	
EP2RC.....	24,700- 26-318- A-42
<i>Korea</i>	
HM5BF.....	55,650- 35-530- A-29
HL9US.....	32,319- 21-513- A-32
HL9KA.....	19,845- 27-245- A-12
HL9KB.....	12,900- 20-215- A- -
HL9TT.....	7123- 17-141- A-21
<i>Japan</i>	
JA1VX.....	202,076-49-1389- C-55
JA1ADN.....	87,080- 40-559- A-71
JA1FDU.....	20,861- 23-304- A-34
JA8GR.....	5892- 12-164- A-28
JA1DFQ.....	5430- 15-121- A- -
JA1LW.....	4293- 9-159- A- -
JA2XI.....	1617- 11- 49- A- 4
JA1LYZ.....	1221- 11- 38- A-10
JA1AIU.....	756- 7- 36- A- -
JA8BB.....	741- 13- 19- B- -
JA8AJM.....	609- 7- 29- A- -
JA7BP.....	518- 7- 25- A- -
JA6TU.....	336- 4- 28- A-11
JA2AHT.....	195- 5- 13- A- -
JA1EL.....	96- 4- 8- A- -
JA1JQY.....	63- 3- 7- A- -
JA1CUM.....	54- 2- 9- A- -
JA9KA.....	45- 3- 5- A- 3
JA2BSD.....	9- 1- 3- A- 1
KA2KS (6 ops.)	152,766-41-1242- C-82
JA7BJL (JA7S BJJ CUA)	546- 7- 26- A-39

<i>Republic of Congo</i>	
9Q5PA.....	19,404- 21-308- A- -
9Q5QR.....	18,711- 21-297- B- -
9Q5TJ.....	17,332- 28-221- A- -
<i>ASIA</i>	
<i>Philippine Islands</i>	
DUIOR.....	19,200- 16-400- B- -
DUIFB.....	3690- 10-123- A- -
<i>Iran</i>	
EP2RC.....	24,700- 26-318- A-42
<i>Korea</i>	
HM5BF.....	55,650- 35-530- A-29
HL9US.....	32,319- 21-513- A-32
HL9KA.....	19,845- 27-245- A-12
HL9KB.....	12,900- 20-215- A- -
HL9TT.....	7123- 17-141- A-21
<i>Japan</i>	
JA1VX.....	202,076-49-1389- C-55
JA1ADN.....	87,080- 40-559- A-71
JA1FDU.....	20,861- 23-304- A-34
JA8GR.....	5892- 12-164- A-28
JA1DFQ.....	5430- 15-121- A- -
JA1LW.....	4293- 9-159- A- -
JA2XI.....	1617- 11- 49- A- 4
JA1LYZ.....	1221- 11- 38- A-10
JA1AIU.....	756- 7- 36- A- -
JA8BB.....	741- 13- 19- B- -
JA8AJM.....	609- 7- 29- A- -
JA7BP.....	518- 7- 25- A- -
JA6TU.....	336- 4- 28- A-11
JA2AHT.....	195- 5- 13- A- -
JA1EL.....	96- 4- 8- A- -
JA1JQY.....	63- 3- 7- A- -
JA1CUM.....	54- 2- 9- A- -
JA9KA.....	45- 3- 5- A- 3
JA2BSD.....	9- 1- 3- A- 1
KA2KS (6 ops.)	152,766-41-1242- C-82
JA7BJL (JA7S BJJ CUA)	546- 7- 26- A-39

<i>Lebanon</i>	
OD5AX.....	100,054- 44-758- B-50
<i>Astoric Russian S. F. S. R.</i>	
UA6QR.....	16,836- 23-244- A- -

TOP TEN W/VE High Scorers
Under 150 Watts Only

C.W.		Phone	
K1ZND.....	128,652	WA5ALB.....	47,880
WB2FIT.....	92,565	WA2GSO.....	45,090
W1WHI.....	85,956	VE2BV.....	42,660
W2HUW.....	82,485	VE3BHS.....	36,828
W6PQW.....	77,490	WA9LL.....	34,839
K4TKM.....	65,205	WB2FON.....	34,425
K3RZF.....	61,194	WA8HXR.....	34,398
K4THA.....	58,032	K1PNS.....	22,692
K3YQJ.....	53,103	K4THA.....	17,695
W2HDW.....	52,020	VE3DYB.....	17,787

<i>East Malaysia</i>	
9M6LX.....	9576- 19-168- - -
EUROPE	
<i>Germany</i>	
DM4YPL.....	187,704- 66-948- A- -
DL7AA.....	164,346-49-1122- B-80
DL1JW.....	127,204- 49-869- B-36
DJ6TS.....	84,888- 36-786- A-75
DL9PU.....	80,976- 42-667- B-38
DL7BQ.....	54,705- 35-522- B- -
DL8CM.....	46,890- 30-526- A- -
DJ6ZM.....	11,876- 38-371- A-28
DJ8IF.....	23,056- 28-245- A-27
DJ2IB.....	17,128- 34-708- B-31
DJ7LQ.....	15,164- 17-298- B-16
DJ2XP.....	14,832- 24-206- B- -
DL6VP.....	9478- 14-226- B-32
DJ6HE.....	4290- 15- 96- B- -
DJ4HR.....	3906- 14- 93- A-14
DL1TH.....	2664- 12- 74-AB-30
DJ2SR.....	1386- 11- 42-AB- 6
DL1JC.....	640- 8- 28- A- -
DL0JZ (DL3FS, DJ6AC)	8257- 23-120- A-83
<i>Spain</i>	
EA3KT.....	34,432- 32-363- A-45
EA2CR.....	13,020- 20-223- A- -
EA2DT.....	12,558- 23-184- A-20
EA7LY.....	2520- 14- 60- A- -
<i>Republic of Ireland</i>	
EI9J.....	103,439- 49-707- A-21
EI8H.....	57,936- 34-568- A- -
EI9F.....	7890- 15-176- A-22
EI5F.....	1876- 14- 46- A- -
<i>France</i>	
F8VJ.....	171,050-50-1143- A-47
F8CS.....	69,174- 54-247- A- -
F3TZ.....	41,715- 27-515- A- -
F8ZF.....	21,866- 29-262- A-30
F9OE.....	16,592- 16-345- A- -
F3JL.....	8487- 23-123- A- -
F8TM.....	4080- 17- 80- A- 7
F2VD.....	1107- 9- 42- A- -

<i>Turkoman</i>	
UI8BO.....	270- 5- 18- B- -
<i>Kazakh</i>	
UL7IP.....	390- 5- 26- A- -
UL7IR.....	336- 6- 19- A- -
UL7CT.....	36- 2- 6- A- -
<i>Kirghiz</i>	
UM8FM.....	2142- 14- 51- A- -
UM8KAA.....	1890- 14- 45- B- -
<i>India</i>	
VU2GW.....	150- 5- 10- A- 1
<i>West Malaysia</i>	
9M4LP.....	76,160- 40-645- A-38



DJ6QT, top German phone score, came up with almost 215-K, contacting 1349 W/VEs. Walter's best band was 20, followed by 15 then 75 and 40.

(Z2DC.....148-824- 53-936- A- -
 (Z2QT.....118,800- 50-792- A- -
 (Z2RO..... 92,928- 44-716- A-48
 (ZAPN.....19,032- 26-244- A-40
 (6VC (5 oprs.)
 229,680-60-1270- A-92
 (ZSSO (5 oprs.)
 96,449-43- 749- A-48

Northern Ireland

(H3OQR.....290,730-55-1762- A-52
 (H3OTV.... 37,530-30- 419- A-40

Scotland

GM2HCZ... 1400-22- 68- A- 4

Wales

(W3JL.....162,333-51-1061- A-80
 (W3FSP. 131,868-54- 814- A-47
 (W3ITZ (6 oprs.)
 69,444-36- 643- A- -

Hungary

HA1KSA.....178,368-48-1256- B-57
 HA5KFR..... 85,008-42- 676- B- -
 HA7PJ..... 35,148-29- 404- A- -
 HA5DJ.....26,005-35- 249- A-54
 HA1VE.....21,000-25- 279- A- -
 HA5BI.....19,410-13- 138- A- -
 HA9KOF..... 3278-14- 78- A-56
 HA3MB.....1938-17- 38- A- -
 HA5KFP.....1220-10- 41- A- -
 HA9LC..... 423- 9- 47- A- -
 HA5KBB (4 oprs.)
 168,861-51-1125- C-89

Switzerland

HB9JG.....311,166-59-1761- B-48
 HB9KC.....84,672-42- 672-A-B-26
 HB9ZY.....11,256-28- 134- B- -

Italy

IT1AGA.....28,116-33- 284- A-47
 IT1PL.....13,965-15- 313- A-28
 IT1SF..... 7866-19- 138- A- 6
 IT1HL.....3528-14- 84- A- -
 IT1ER.....1785-15- 40-A-B-15
 ITVAB (11s EVJ VAB)
 14,014-26-182- A-36

Sardinia

IS1VEA.....1584-12- 48- A- -
 IS1FIC..... 648- 9- 21- A- 1

Norway

LA6U.....10,672-23- 155- A- -
 LA7H..... 2544-16- 53- A- -
 LA2Q.....1265-11- 39- A- -
 LA1T.....1170-10- 39- A- -
 LA1K (LA1EE, LA3LJ, LA6LH)
 37,275-25- 497- A-60

Lucembourg

LX3BD.....5054-14-122- A- -

Bulgaria

LZ1KAA.....4185-15- 95- A- -

LZ1KKZ (2 oprs.)
 3960-15- 88- B- -
 LZ2KST (2 oprs.)
 2220-10- 74- A- -
 Austria
 OE3TL (OE3s LI TL, 601ND)
 226,542-51-1506- B-74
 OK2OI.....1071- 7- 51- A- -
 OK2BZR.....858-11- 26- A- -
 OK1KOR..... 792- 8- 33- A- -
 OK2BCI.....792-11- 24- B- -
 OK2KOO.....560- 8- 24- A- -
 OK2QR.....408- 6- 24- B- -
 OK2LN..... 54- 3- 6- B- -
 OK1NK..... 3- 1- 1- A- -

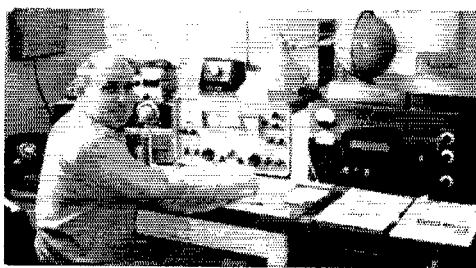

Shown above is W7DQM, top single-operator phone in Washington and the Northwest Division. Jim uses a dipole on 75, three half-waves in phase for N-S switching on a double extended zepp for E-W on 40 and a two-element triband quad up 55 ft. for 10, 15 and 20 meters.

Finland

OH3AH10.....74,610-30- 829- A- -
 OH1XX..... 37,726-26- 486- B- -
 OH2ES..... 22,458-19-1182- B-34
 OH5UX.....13,500-18- 250- A- -
 OH5UQ..... 6912-18- 128- B- -
 OH3XZ.....2530-11- 77- A- -
 OH2BS.....2311-11- 67- B- -
 OH5PT.....1320-10- 44- A- -
 OH5OI..... 448- 7- 22- A- -
 OH7NW..... 356- 8- 14- A- -
 OH2YL..... 324- 9- 12- B-10
 OH3NE.....215- 5- 15- A- -
 OH3YL.....210- 7- 10- A- -
 OH1SH.....112- 2- 2- B- -
 OH2AM (5 oprs.)
 94,314-33- 953- B- -
 OH2AC (OHs DT MM)
 1781-13- 46- A-10

Czechoslovakia

OK1GT.....102,432-48- 718- B- -
 OK1BV..... 33,480-30- 372- B-24
 OK1LY..... 32,508-36- 301- A- -
 OK3UL.....27,000-30- 300- A- -
 OK3SK.....21,147-29- 281- B- -
 OK3OM.....19,818-18- 367- B-31
 OK1AHZ.....18,008-28- 227- A- -
 OK1NL.....13,980-20- 236- A- -
 OK2KG.....11,421-27- 141- A- -
 OK1ADM.....8280-23- 120- A- -
 OK1AGQ..... 6867-21- 109- A- -
 OK3CC..... 6480-20- 108- A- -
 OK3KGI..... 3318-14- 79- A- -
 OK1US..... 2856- 8- 119- B- -

OK1KTL (multiopr.)
 191,198-49-1334- B- -
 OK2KOJ (OK2s BGH BG8)
 176,755-53-1114- A- -
 OK2KAG (3 oprs.)
 19,166-37- 173- A- -
 OK1KDT (2 oprs.)
 3012-12- 84- A- -
 OK2KMB (3 oprs.)
 2880-10- 96- A- -
 ON4UQ (8 oprs.)
 72,500-34- 793- A-89

Faroo Islands

OY7ML.....963- 9- 38- A- -
 OY7H..... 300- 5- 20- A- -
 OY7X.....147- 7- 7- A- 2

Denmark

OZ3FL.....116,748-47- 828- A- -
 OZ7YH..... 98,309-37- 886- B- -
 OZ7X..... 59,319-30- 511- A-87
 OZ1W..... 58,788-36- 545- A-47
 OZ5DX..... 35,568-19- 626- B- -
 OZ7G.....14,331-17- 282- A- -
 OZ4DX..... 456- 8- 19- A- -

Netherlands

PA6LOU.....59,400-36- 553- A-28
 PA6VB.....24,360-29- 280- A- -
 PA6F1X.....21,750-30- 242- A-39
 PA6WAC.....2982-14- 71- A-12

Sweden

SM5CCF..... 32,136-26- 412- B-17
 SM5DKH.....22,825-25- 310- B- -
 SM5BVF.....18,180-20- 304- B- -
 SM3TW.....13,725-25- 189- B- -
 SM6UG..... 9072-14- 216- A- -
 SM5PDS.....8086-13- 211- B- 8
 SM5COL.....5418-11- 133- B- -
 SM7EH..... 3737-14- 89- B- -
 SM6CKU.....3726-18- 69- B- 7
 SM5XX..... 3120-13- 80- A-20
 SM7AUO.....1562-11- 48- B- 7
 SM5BOE.....1068-12- 89- A- -
 SM5OJ.....1050-10- 35- A- -
 SM4CHM..... 990-11- 90- A- -
 SM6AFH..... 306- 6- 17- A- -
 SM16CMR.....162- 6- 9- A- -
 SM5BDY..... 27- 3- 3- A- -
 SM6BJT (5 oprs.)
 194,256-48-1388- B-60

Poland

SP6AAT.....106,840-40- 908- B-57
 SP6AKK..... 67,076-31- 558- A-33
 SP8MJ..... 25,844-26- 332- B-37
 SP9ZD.....5166-14- 11- A- -
 SP2IU.....2958-17- 58- B-10
 SP9PT.....2562-14- 61- A- -
 SP6PH.....1056- 8- 44- A- -
 SP9AGS..... 918- 9- 34- A- -
 SP6HR..... 900-12- 25- A- -
 SP5AHW..... 630- 7- 30- A- -
 SP6TQ..... 592- 8- 74- A- -
 SP3AOT.....459- 9- 17- A- -
 SP9PY..... 420- 5- 28- A- -
 SP6MB..... 54- 3- 6- A- -

Greece

SV0WAA.....23,296-28- 278- A-34

Iceland

TF3AB.....20,520-19- 360- A- -
 TF2W1O.....687-14- 163- A- -
 TF3KB..... 76- 4- 7- A- -

Franz Josef Land

UA1KED (3 oprs.)
 45,091-21- 557- A- -

European Russian S. F. S. R.

UA3FD.....3672-17- 72- B- -
 UA1DI..... 3150-13- 75- B- -
 UA1KAL.....2640-11- 80- B- -
 UA3RM.....2412-12- 67- B- -
 UA3KWB.....1026- 9- 38- B- -
 UA4YY..... 990-10- 33- B- -
 UA3TA..... 736- 8- 31- A- 4
 UA4AZ..... 621- 9- 23- A- -
 UA3KTK.....416- 8- 18- A- -
 UW4HW..... 370- 5- 18- A- -
 UV3TP.....240- 6- 20- A- 4
 UA4ZA.....18- 2- 3- A- -
 UA3KHA..... 9- 1- 3- B- -
 UA3KWA (UA3s XN YI,
 UW3XN) 12,432-16- 259- B- -
 UA1KUA (4 oprs.)
 7266-14- 173- B- -

African specialists this year are, left to right: 9Q5PA leading his country on c.w.; EA9AY a fine multiplier on phone; 9Q5QR (ON4QR) a close second for honors on c.w. from the Republique du Congo.



W3GRF of the PVRC needs little introduction to contest knowledgeable. This year Len wound up with 2nd high c.w. at 639,738 and tremendous country totals on 5 bands. His antenna farm atop a hill includes rotaries way up on 40 through 10, a longwire on 80 and vertical on 160.



UA3KAO (2 oprs.)	5382-13- 138- B-	YO2KAB (multiopr.)	7260-20- 125- B-
UA1KBA (3 oprs.)	4342-13- 112- B-	YO6KBM (YO6s DH SD UV)	960- 8- 40- B-
	0 2-10- 112- B-		
UA6KAF (3 oprs.)	3780-14- 90- A-	<i>Yugoslavia</i>	
UA1KBA (3 oprs.)	2618-11- 80- B-	YU1BCD (3 oprs.)	71,914-39- 615- A-76
UA1KAQ (3 oprs.)	1950-13- 50- A-	<i>I. T. U., Geneva</i>	
UA1KAQ (2 oprs.)	990-10- 33- A-	4U1PTU (4 oprs.)	117,364-37-1060- C-43

NORTH AMERICA

<i>Kaliningradsk</i>		<i>Cuba</i>	
UA2AC.....	24,106-17-496-B-	CO2JB.....	27,450-25-366-A-
UA2BZ.....	3276-14- 78- A- 6	CO7AI.....	75- 5- 5-A-
UA2KAW (3 oprs.)	49,734-27- 614- A-	<i>Guadeloupe</i>	
UA2KBD (UA2s C'D W A WJ)	40,896-32- 426- A-	FG7XX.....	44,472-34- 436- A-

<i>Ukraine</i>		<i>Dominican Republic</i>	
UB5VF.....	161,400-50-1076- B-	HI8XAL.....	612,128-74-2758- A-62
UT5DG.....	16,500-20- 275- A-	HI8RVD.....	40,056-24- 557- A-
UB5KDS.....	7488-16- 156- B-	HI8LC.....	37,632-32- 393- B-19
UB5TR.....	5130-15- 114- A-		
UB5YW.....	4845-19- 85- A-	<i>Panama</i>	
UB5QB.....	3900-13- 100- A-	HP1HE.....	666,510-84-2645- A-
UT5PB.....	2290-10- 76- A-	HP1AC.....	16,632-21- 264- A-
UB5KZA.....	1620-10- 54- A-		
UT5HX.....	798- 7- 38- B-	<i>Honduras</i>	
UB5TU.....	757-11- 23- B-	HR3JP.....	17,766-14- 427- A-12
UB5HN.....	144- 6- 8- A-		
UT5FP.....	120- 5- 8- A-	<i>Guantanamo Bay</i>	
UB5QA.....	18- 2- 3- A-	KG4AMR.....	454,656-64-2368-A-40
UB5KJE (3 oprs.)	61,560-30- 684- A-		

UB5KAI (3 oprs.)	21,384-32- 254- B-	KP4BJU.....	219,393-57-1283- B-40
UB5KGL (3 oprs.)	17,928-24- 249- B-	KP4AXM (4 oprs.)	277,938-54-1724- C-96
UB5KED (2 oprs.)	14,234-22- 221- B-		
UB5KFF (3 oprs.)	1560-10- 52- A-	<i>Virgin Islands</i>	
		KV4DB.....	2184-13- 56- A-

<i>White Russian S. F. S. R.</i>		<i>Canal Zone</i>	
UC2KAA.....	7826-13- 206- B-	KZ5TD.....	130,662-51- 854- A-
UC2WVP.....	5382-13- 138- A-	KZ5RD.....	13,440-21- 215- B-20
UC2KAC.....	3366-11- 102- B-	KZ5BA.....	12,903-23- 187- A-7
		KZ5FC (KZ5s EX RD)	9128-23- 221- B-20

<i>Azerbaijan</i>		<i>Antigua</i>	
UD6BZ.....	2013-11- 61- A-	VP2AX.....	7128-24- 99- A-
UD6KAR (UD6s BQ C'C)	1020-10- 34- B-		
<i>Moldavia</i>		<i>St. Kitts, Nevis</i>	
UO5BM.....	5586-14- 133- A-3	VP2KR.....	36,856-34- 362- A-15
<i>Lithuania</i>		<i>British Virgin Islands</i>	
UP2KBC.....	65,070-30- 723- B-	VP2VL.....	473,325-75-2107-A-
UP2NK.....	9168-16- 191- A-		
UP2KDA.....	4578-14- 109- A-	<i>Barbados</i>	
UP2OM.....	3636-12- 101- A-	VP6BW.....	600- 8- 25- A-
UP2KFC (2 oprs.)	26,676-26- 342- A-	<i>Bermudas</i>	
		W5HW/VP9	154,350-49-1050- A-59
<i>Latvia</i>		VP9FT.....	26,598-31- 312- A-30
UQ2GA.....	11,904-16- 238- B-		
UQ2GQ.....	8217-11- 249- A-		

<i>Estonia</i>			
UR2FD.....	1590-10- 53- A-		
<i>Rumania</i>			
YO2BI.....	46,170-38- 407- B-		
YO5KAU ⁴	18,018-22- 273- B-		
YO3RF.....	9150-25- 122- B-		
YO8FZ.....	6804-14- 162- A-		
YO8KGC.....	2343-11- 71- A-		
YO3RH.....	2394-12- 64- B-		
YO9HH.....	1116-12- 31- A-		
YO8SD.....	450- 5- 30- A-		
YO9IH.....	294- 7- 14- A-		
YO9HI.....	36- 3- 4- A-		
YO3KAA (YO3s AV JW)	48,544-37- 438- B-		

<i>Mexico</i>		<i>SOUTH AMERICA</i>	
XE1NL.....	96,052-44- 735- A-30	<i>Chile</i>	
XE2AAG.....	85,428-42- 681- B-33	CE6EF.....	90- 5- 6- A- 6
		<i>Bolivia</i>	
<i>Nicaragua</i>		CP3CD.....	9045-15- 201- A-
YN1AA.....	130,455-65- 669- A-21	<i>Uruguay</i>	
		CX1OP.....	36,549-31- 393- A-
<i>Salvador</i>		<i>Ecuador</i>	
YS1RFE.....	87,210-19-1530- A-	HC1EW.....	5307-29- 61- B- 8

<i>OCEANIA</i>		<i>Colombia</i>	
<i>Midway Islands</i>		HK3RQ.....	220,476-57-1294-A-21
K3YMP/KM6 (K3 YMP, W7PQP)	160,560-60- 893- B-42	HK4AXY.....	52,332-42- 441- A-33
		HK4ALE.....	35,840-35- 344- A-24
<i>Australia</i>		HK3ANJ.....	12,246-13- 314- A-
VK5ZP.....	307,758-66-1561- A-50	BK4EB.....	3010-14- 72- A-3
VK2GW.....	245,676-59-1388- A-65	HK6LR (HKs 1QQ 3RQ)	134,456-49- 920- A-24
VK2EO.....	190,512-49-1296- A-18		
VK2APK.....	186,285-55-1129- A-	<i>Argentina</i>	
VK3AXK.....	58,212-33- 588- A-32	LU2DAW.....	131,418-49- 894- A-
VK5KO.....	58,035-53- 367- A-28	LU7AU.....	79,672-46- 578- A-40
VK2YN.....	30,780-45- 228- A-9	LU8BAJ.....	71,280-40- 595- B-20
VK2QK.....	29,580-34- 290- A-	LU5DON.....	1440- 8- 60- B-
VK3XB.....	5286-12- 146- A-4		



Above WB2MFX (ex-K1RTB) is shown running up his highest phone score to date. His W. N. Y. effort netted 228-K with a fine showing on five bands. In addition to the contest awards he earned the Rochester DX Assn. phone certificate.

DX CONTINENTAL CHAMPIONS

C.W.		Phone	
<i>Single Operator</i>	<i>Multioperator</i>	<i>Single Operator</i>	<i>Multioperator</i>
5A3TX	EL2AE	ZD8HL	ET3USA
JA1VX	KA2KS	JA1CG
HB9JG	G6VC	EA4CG	I1RB
HP1IE	KP4AXM	FG7XL	KP4AXM
VK5ZP	K3YMP/KM6	VE2APK
YV1DP	HK6LR	HK3RQ	HC5CRC

PY1ADA... 50,856-39-440- B-10
 PY2BDZ... 50,796-34-500- A-30
 PY1BLG... 44,916-38-394- B-26
 PY1NO (PY1s NO RG)
 71,675-47-517- A-53

British Guiana

VP3YG... 13,986-21-223- A-8

Trinidad

VP4VU... 15,140-20-259- A-22

Venezuela

YV1DP... 588,840-70-2804- B-70
 YV5BK A... 313,479-61-1713-AB-58
 YVBT K... 276,396-62-1486- B-56

Paraguay

ZP5EC... 2040-10- 68- A- -

W2QKJ... 19,602-54-121- C-60
 WA2BLV... 14,355-55-88- C-20
 W2ORA... 13,248-46-96- A-24
 W2QDY... 12,555-45-93- B-8
 K2OEA... 7,955-41-65- A-8
 WB2EDH... 7,437-37-67- A-10
 K2SQM... 3,969-27-49- B-36
 W2ZX... 15,410-11-48- C-1
 W2LVW... 432-12-12- -
 WB2APG (WB2APG, W2VJN)
 448,275-215-695- C- -

Western New York

WB2MFX 228,025-175-435- C-85
 W2TQR... 78,477-101-259- C-28
 K2GXI... 61,716-123-168- C-70
 W2SNI... 26,331-67-132- C-48
 WA2CYQ... 14,400-48-100- C-25
 W2MG... 8,410-40-67- C-10
 WA2WVL... 5,588-38-49- C- -
 W2FZJ... 4356-33-44- B- -

PHONE SCORES

ATLANTIC DIVISION

Delaware

K3NHL... 216,972-164-441- C-70
 K3QVU... 19,320-56-115- C-18
 W3DRD... 1209-13-31- C-5
 W3IYE (W3s IYE 'UGF)
 102,300-124-275- C-45

Eastern Pennsylvania

W3BES... 258,602-182-137- C-80
 W3WPG... 155,730-145-355- C-82
 W3RFQ... 121,125-128-323- C-37
 W3BCR... 117,000-130-300- B-47
 W3CGS... 97,584-107-304- C-48
 K2TPL... 90,624-128-236- C-46
 K3BNS... 84,666-103-274- B-44
 W3GRS... 78,540-119-220- C-25
 W3KT... 77,760-108-240- C- -
 W3DRX... 76,908-116-221- B- -
 W3HRK... 71,997-103-233- C-36
 W3QNZ... 69,690-101-230- C-51
 W3QQA... 54,777-95-187- C-35
 W3KDF... 42,705-73-195- C-30
 W3NAM... 41,230-70-187- C-44
 W3HA... 40,788-66-206- C-25
 K3PSW... 32,106-61-115- C-36
 WA3COJ... 20,082-53-152-

WA3BAS... 17,934-61-98- B-24
 K3KMO... 9720-45-72- B-5
 W3KMY... 4371-31-47- A-21
 W3ZNB... 3906-31-42- C-23
 K3ZYP... 300-10-10- A-2
 K3QDD... 6-1-2- A-1
 W3MSK (6 oprs.)
 1,481,436-310-1548-C-96



Single-operator high on both c.w. and phone from Colombia (as well as contributing towards the HK6LR c.w. total) was the well-known HK3RQ. Bill can run up to a KW and uses a 75S3/TH4.

W3GRF (W3s GRF TMZ)
 46,458-87-178- C-30
 K3UXJ (WA3AIY, K3UXJ)
 15,288-49-104- C-28
 K3LCH (K3s JYZ LCH)
 3120-26-40- B-10
 W3RNY (K3QDD, W3RNY)
 1767-19-31- A-9

Southern New Jersey

WA2IZS... 123,624-136-303- C- -
 W2DAJ... 90,405-105-287- B-40
 K2PZF... 74,358-102-243- C-68
 WA2GSO... 45,090-90-167- A-28

K2LWR... 3240-27-40- C-24
 K2VFR... 2622-23-38- B- -
 WA2EOQ... 1062-18-23- C-40
 W2SSC... 912-16-19- C-6
 WA2VSO... 27-3-3- B-3

Western Pennsylvania

W3LOE... 209,745-177-397- C-61
 WA3BHY... 20,790-77-90- C-45
 K3SIQ... 20,544-64-107- C-36
 W3LIV... 11,421-47-81- A-17
 W3ZVA... 9804-43-76- C-30
 K3ELL... 6405-35-61- A-11
 W3KQD... 18-2-3- A-1

K9ZBL... 32,076-81-132- B-31
 W9ZTL... 31,047-79-131- B-33
 W9CTY... 21,117-69-131- C-21
 K9BTU... 21,945-55-133- C-40
 K9ZJV... 16,416-57-96- C-80
 WA9HJM... 15,390-57-90- B-54
 W9GOW... 13,674-53-86- A-16
 W9QQN... 11,900-59-69- C-40
 WA9BHH... 7626-41-62- A-22
 K9JLR... 4350-29-50- B-16
 W9EU... 3150-30-35- C-6
 WA9CCQ... 1500-20-25- A-9
 WA9GCM (4 oprs.)
 22,914-67-114- A-75

WA9JXT (K9GSD, WA9KWN)
 2825-25-35- B-8

Indiana

W9CWO... 14,820-65-114- B-14
 K9GEL... 3240-24-45- C-14
 W9AQW... 1741-13-19- C-9
 K9FIC... 714-14-17- B-25
 W9DPI (W9s DPI OH, K9TZJ)
 19,110-58-110- C-47

Wisconsin

W9EWC... 197,505-165-399- C-65
 W9GIL... 98,580-111-260- C- -
 W9BCY... 77,589-111-233- C-67
 W9KXK... 41,730-46-85- C-17
 W9AOW... 1440-20-24- C-8
 W9YT (4 oprs.)
 10,481-47-75- C-18

DAKOTA DIVISION

Minnesota

W9UJM... 147-7-7- A- -
 W9QUU (W9s NGF QUU)
 137,241-153-299- C-77

North Dakota

W9JWL... 17,995-59-102- B-34

DELTA DIVISION

Arkansas

K5HYB/5... 5635-35-54- B-14
 W5DRW... 1296-18-24- C- -

Louisiana

W5AJY... 105,264-136-258-AC-48
 W5KCC... 60,768-96-216- C-60

Mississippi

K5MDX... 154,548-162-318-AB-40
 WA5LJU... 70,632-109-216- C-57

Tennessee

WA4CGA... 21,970-65-113- B-33
 WA4TXD... 1932-23-28- C-6

GREAT LAKES DIVISION

Kentucky

W4BCV... 298,533-191-521- C-70
 K4RZK... 24,453-57-143- C-42
 W4CVL... 396-11-12- A-3
 W4LDL... 12-2-2- B-1

Michigan

W4HIR... 203,988-178-382- C-53

CENTRAL DIVISION

Illinois

W9WKU... 83,603-109-257- B-56
 WA9LIJ... 34,839-79-147- A- -

1 K3TEJ, opr. 2 W4TFX, opr. 3 W8RCQ, opr. 4 WA2KMV, opr. 5 K9YR, opr. 6 Hq. staff, not eligible for award, 7 W1WTR, opr. 8 K6VVA, opr. 9 K1MEG, opr. 10 OH3BBR, opr. 11 Y05DH, opr. 12 K0TUDQ, opr. 13 W0NWX, opr.

On the left is K2GXI concentrating on 20 phone (after losing both 40 and 75 meter antennas in the week preceding the test). Bob's 5-L beam paid off with well over a DXCC's worth of countries on that band. On the right we have W5AJY, Louisiana phone leader with over 100-K, in a 48-hour only "go." Dick worked 55 countries on 15 and an assortment of 9 on 10 meters.



VYIDP, top S. A. single-operator c.w., third highest DX score takes his hat off to the W/VE gang—thousands and thousands of good operator helping his 588,840 total. Gregorio's log is easily the neatest submitted this test clearly itemizing 2804 exchanges on four bands, results of a fine operator using a KWS-1/75A-4/Dipoles/TA-36.



W8DGP...137,556-152-301-A-C-65
W8ACZH...110,559-137-269-AB-80
W8RYX...70,632-108-218-C-41
K8AJK...21,700-62-117-BC-20
K8OVK...14,036-44-107-B-28
W8EW...9243-39-79-C-12
W8TIQ...27-3-3-A-2
W8NWO (5 oprs.)
125,412-234-606-C-96
W8NGO (5 oprs.)
265,064-184-482-B-88

W8WYC (W8 TJQ WYC)
18,360-60-102-C-20
K8TIG (W8 QN FAW)
6396-41-52-B-8

Ohio
W8JIN...121,176-153-264-C-40
W8BF...113,040-120-314-C-36
W8JZ...45,045-91-165-C-50
W8WUO...41,328-82-168-C-30
W8EVZ...40,344-82-164-B-35
W8AHR...34,398-78-147-A-54
W8LXU...29,748-74-134-B-45
K8AXG...18,753-47-133-B-26
W8NK...15,525-45-115-B-23
W8AHAX...10,080-35-96-A-26
W8BMX...8640-45-64-B-23
W8BOJ...8448-44-64-C-6
W8GDS...7878-39-68-B-17
W8CEX...6888-41-56-C-12
K8DWQ...5856-32-61-C-22
W8NPF...4800-32-50-C-15
W8GMK...3780-30-42-B-9
W8YGR...1512-21-24-A-4
W8AETX...1326-17-27-A-2
W8AFCH...1020-17-20-A-17
W8AETW...300-10-10-A-1
W8AJJ...189-7-9-A-3
W8AMQE...12-2-2-A-1
W8AJJ (K8YUR, W8AJJ)
77,520-95-272-C-67
W8NGU (5 oprs.)
52,380-97-180-C-59

NEW ENGLAND DIVISION
Connecticut
W1OAK...118,875-125-317-C-1
K1ZVU...32,815-65-117-C-16
K1PNS...22,692-62-22-A-27
K1OSY...14,310-53-90-C-4
K1QPV...2706-21-41-A-9
W1BHV...1479-17-29-B-10
W1WHQ...1305-15-29-A-5
W1BGD...798-14-19-C-5
W1BUS...462-11-14-C-1
K1UPL...75-5-5-A-4

Eastern Massachusetts
K1DIR...383,670-203-630-C-70
W1YJH...285,274-185-514-C-52
W1MRQ...45,018-82-183-C-19
W1R3J...23,310-74-105-C-11
W1BPW...12,312-54-76-C-8
W1PLJ...2325-25-31-B-11
W1TRQ...1296-18-24-A-8
K1WJD...486-9-18-A-2
K1LMD...126-6-7-B-2
W1CSP...90-5-6-A-1
W1SEA (K1GCZ, W1SEA YQF)
29,172-68-143-A-45

HUDSON DIVISION
Eastern New York
W420JD...107,061-127-281-C-59
W2GBC...60,162-74-271-C-33
K2GDP...48,870-90-181-B-20
K2JMY...33,858-57-198-C-34
W2RFT...20,130-61-110-B-18
W2TCS...2482-23-36-B-6

Northern New Jersey
K2HLB...656,760-260-842-C-84
K2SUX...83,430-103-286-C-60
W2FFQ...53,180-70-158-B-43
W2AGM...16,377-53-103-C-26
W2IUV...14,805-47-105-A-23
W2IQP...7137-39-61-A-8
K2OIX...3600-30-42-C-13
K2KFP...1560-20-26-C-7
W2MNV...370-10-13-A-14

N. Y. C.-L. I.
W2EXH...114,945-97-395-C-40
W2GKZ...113,826-122-311-C-31
W2TQB...70,632-108-218-C-48
W2WZ...61,698-91-226-C-27
W4WGN...53,562-79-226-C-51
W2FON...34,425-75-153-A-32
W2FSK...27,720-66-140-B-29
W2BCKS...15,912-68-78-C-11
K2DGI...9729-47-69-C-15
W2FOV...5550-37-50-A-15
K2CHS...390-10-13-A-3
K2CHQ...248-8-11-B-3
W2GSL...168-7-8-A-2
W2JB...162-6-9-A-2
W2BMDH...108-6-6-A-1
K2YOR...27-3-C-1
W2BOLN...12-2-A-1
W2BDXM...3-1-A-1

MIDWEST DIVISION
Iowa
W0LBS...48,060-89-180-C-60
W0HXW (5 oprs.)
5100-34-50-C-13

Kansas
W0TTY...715-11-22-A-16
W0JUV...232-8-10-C-3
K0TTF...27-3-3-A-2

Missouri
W0CU...56,700-100-189-C-1
W0LBB...41,952-92-152-C-56
W0EMS...29,540-76-130-B-27
K0TFL...6594-35-61-B-14
K0YIP...6396-41-52-A-17
K0GIV...307-9-11-A-4
W0UCK...231-7-11-A-8
W0PLN (6 oprs.)
18,270-58-105-A-62

Nebraska
W0ZR...4872-24-69-C-24
W0HSX...714-14-17-A-14

NEW ENGLAND DIVISION
Connecticut
W1OAK...118,875-125-317-C-1
K1ZVU...32,815-65-117-C-16
K1PNS...22,692-62-22-A-27
K1OSY...14,310-53-90-C-4
K1QPV...2706-21-41-A-9
W1BHV...1479-17-29-B-10
W1WHQ...1305-15-29-A-5
W1BGD...798-14-19-C-5
W1BUS...462-11-14-C-1
K1UPL...75-5-5-A-4

Western Massachusetts
W1RF...128,506-137-321-C-33

NORTHWEST DIVISION
Idaho
K5CIT/7...42,600-71-200-C-34

Montana
W7QPK...23,166-54-143-C-48

Oregon
K7VYU...16,366-49-112-C-30

Washington
W7DQM...60,078-93-216-C-50
K7QWI...28,152-68-138-C-44

PACIFIC DIVISION
East Bay
K6AHV...148,044-146-338-C-80
W6LDD...130,074-133-326-C-75
W6BSY...32,680-108-260-C-60
K7DDB/6...31,824-68-156-C-53
W6RGG...21,504-64-112-C-40
W6PQW...10,185-35-97-C-1



Top Canadian c.w. single-operator VE2NV topped 226-K without exceeding 185 watts. Jack found 80 particularly good totalling 50 countries on that band. Equipment in use included a TX-1, 32S-3; BC-348, 2-B, 75S3-B, TH-4, ground plane, single and phased verticals.

Maine
K1RQE...110,166-122-301-C-50
W1BFA...52,560-90-197-C-35

New Hampshire
W1FZ...38,394-79-162-C-1
K1FNQ...2754-18-51-B-17
W1SWX...3-1-1-B-1

Rhode Island
W1ZFV...121,632-96-428-C-63
W1YRC...23,625-63-125-C-16
K1VJSJ...12,792-104-41-C-29
W1AWE...1260-14-30--
W1GOG...60-4-5-B-2

Western Massachusetts
W1RF...128,506-137-321-C-33

NORTHWEST DIVISION
Idaho
K5CIT/7...42,600-71-200-C-34

Montana
W7QPK...23,166-54-143-C-48

Oregon
K7VYU...16,366-49-112-C-30

Washington
W7DQM...60,078-93-216-C-50
K7QWI...28,152-68-138-C-44

PACIFIC DIVISION
East Bay
K6AHV...148,044-146-338-C-80
W6LDD...130,074-133-326-C-75
W6BSY...32,680-108-260-C-60
K7DDB/6...31,824-68-156-C-53
W6RGG...21,504-64-112-C-40
W6PQW...10,185-35-97-C-1

California
W6ILH...5670-27-70-A-18
W6UUS...900-12-25-C-10
W6KG...243-9-9-C-1
W6KEK...75-5-5--
W6AVAT...18-2-3-A--
W6BAPK...12-2-2-B--

Hawaii
KH6LJ...107,328-86-416-C-72
W5NXP/KH6
8640-36-80-A--
W0PAN/KH6
1155-11-35-B-5

Sacramento Valley
W6GEX...49,104-88-186-C-54
W6GVM...23,760-66-120-C-1
W6UMI (W6UMI, W6ATQK)
54,144-94-192-C--

San Francisco
W6WB...21,924-63-116-C-20
W6ERS...3150-25-42-C-30
K6LXS...1620-18-30-A-7

Santa Clara Valley
W6WX...133,575-137-325-C-56
K6ERV...114,680-122-314-C-67
W6KJV...14,266-54-88-C-30
W6VUW...9288-43-72-B-16
W6HOC...6612-29-76-B-20
K6UXV...5445-33-55-B-14
K6HOR...4794-34-47-C-16
W6BKHG...2484-32-36-C-1
W6AQW...2232-24-31-C-1
W6ATGY...270-15-16-A-2
W6ISQ...388-8-12-C-1
W6FYM...180-5-12-B-2
K6OHJ (K5OHJ, W7WJB)
190,650-155-410-C-68

ROANOKE DIVISION
North Carolina
W44TLI...15,264-53-96-B-24
W44HIG...2575-25-35-B-15
W44SRS...261-9-11-A-10

South Carolina
K4YYL...29,988-68-147-C-32
W44PWQ...14,256-44-109-BC-30

Virginia
W4BVV...501,739-229-733-BC-82
W4NJF...197,067-163-404-C-51
W40M...149,319-141-353-C-1
W40PM...138,276-138-334-C-60
K8UZA/4...103,296-128-269-C-55
K4VUM...26,838-63-142-B-31
W4LRN...19,032-61-104-C-12
W4WBC...15,759-51-103-B-32
W4AKQ...10,440-40-87-B-35
W4BVQ...9126-39-78-C-5
W44VKG...3936-32-41-C-11
W4KFC...2550-25-34-A-3
W4WSF...1224-17-24-B-4
W4GF...546-13-14--
W4KXV (4 oprs.)
92,214-109-282-C-50

California
W6ILH...5670-27-70-A-18
W6UUS...900-12-25-C-10
W6KG...243-9-9-C-1
W6KEK...75-5-5--
W6AVAT...18-2-3-A--
W6BAPK...12-2-2-B--

Hawaii
KH6LJ...107,328-86-416-C-72
W5NXP/KH6
8640-36-80-A--
W0PAN/KH6
1155-11-35-B-5

Sacramento Valley
W6GEX...49,104-88-186-C-54
W6GVM...23,760-66-120-C-1
W6UMI (W6UMI, W6ATQK)
54,144-94-192-C--

San Francisco
W6WB...21,924-63-116-C-20
W6ERS...3150-25-42-C-30
K6LXS...1620-18-30-A-7

Santa Clara Valley
W6WX...133,575-137-325-C-56
K6ERV...114,680-122-314-C-67
W6KJV...14,266-54-88-C-30
W6VUW...9288-43-72-B-16
W6HOC...6612-29-76-B-20
K6UXV...5445-33-55-B-14
K6HOR...4794-34-47-C-16
W6BKHG...2484-32-36-C-1
W6AQW...2232-24-31-C-1
W6ATGY...270-15-16-A-2
W6ISQ...388-8-12-C-1
W6FYM...180-5-12-B-2
K6OHJ (K5OHJ, W7WJB)
190,650-155-410-C-68

ROANOKE DIVISION
North Carolina
W44TLI...15,264-53-96-B-24
W44HIG...2575-25-35-B-15
W44SRS...261-9-11-A-10

South Carolina
K4YYL...29,988-68-147-C-32
W44PWQ...14,256-44-109-BC-30

Virginia
W4BVV...501,739-229-733-BC-82
W4NJF...197,067-163-404-C-51
W40M...149,319-141-353-C-1
W40PM...138,276-138-334-C-60
K8UZA/4...103,296-128-269-C-55
K4VUM...26,838-63-142-B-31
W4LRN...19,032-61-104-C-12
W4WBC...15,759-51-103-B-32
W4AKQ...10,440-40-87-B-35
W4BVQ...9126-39-78-C-5
W44VKG...3936-32-41-C-11
W4KFC...2550-25-34-A-3
W4WSF...1224-17-24-B-4
W4GF...546-13-14--
W4KXV (4 oprs.)
92,214-109-282-C-50

West Virginia
W8AIN...6930-33-70-B-18
K8WVWY...4860-30-54-B-25

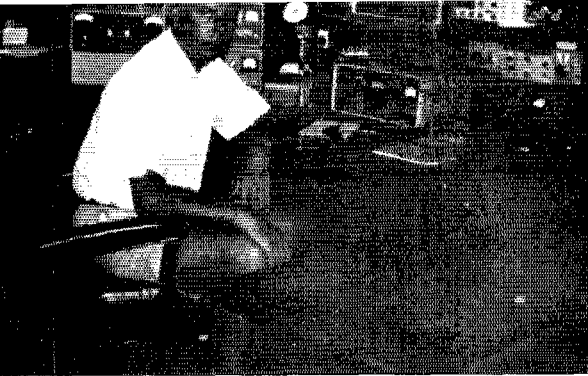

Both phone and c.w. activity from W6ITA multioperated by some of the savvy Los Angeles crew highlighted this year's tests. Gordon's station runs a KW and he goes in for a fine array of radiators; 4-L on 10 and 15, 5-L on 20, 3-L on 40 and a half-wave on 80. On phone assistance was rendered by W6VPH and on c.w. by W6s ENV LEB VPH and K6JIC. Well over 800-K towards the SCDXC club aggregate score.

ROCKY MOUNTAIN DIVISION

Colorado

W0EZO... 50,760-94-180- B-39
 W0CDP... 1560-20-26- C-6

New Mexico

WSLEF... 30,492-77-132- C-25

Wyoming

W7PSO... 1296-16-27- C-5

SOUTHEASTERN DIVISION

Alabama

W4RLS... 349,976-194-602- C-64

Eastern Florida

WA4NGO 233,208-158-492- C-66
 W4HKJ... 168,969-151-373- C-52
 W44SR... 35,895-119-235- C-52
 WA1XP... 56,238-103-182- C-56
 W4LYV... 43,032-88-163- B-36
 WA4SV... 37,191-77-161- C-96
 K4TFA... 19,695-65-101- A-25
 WA4JPC... 2175-25-29- C-4
 WA4JFW... 1480-20-25- A-7
 W4EEO... 216-8-9- - -
 W4ZYS (W4s ZYQ ZYS) 168,063-159-360- C-90

Georgia

WA4ARV 102,660-118-200- C-75
 K4J8V... 47,376-9-168- B-25
 K4J8V... 47,376-9-168- B-25
 W4FRO... 24,960-64-130- B-24

Western Florida

K4ZJF... 150,192-149-336- C-58
 K6ZQB/4... 2664-24-37- B-7

SOUTHWESTERN DIVISION

Arizona

W7LBN... 1368-19-24- C- -

K7TLP... 480-10-16- A-15
 W7ENA... 324-9-12- A-5

Los Angeles

K6SEN... 194,535-165-393- C-90
 WA6EPQ... 113,634-118-321- C-48
 W6LDA... 104,532-124-280- C-56
 W6TZD... 28,152-69-136- C- -
 W6WVQ... 26,418-74-119- C-72
 WA6GLD... 18,639-57-109- B-20
 W6NJT... 14,688-48-102- C-36
 WA6MWG... 13,083-49-89- C-1
 K6SOK... 10,434-37-94- C-20
 W6FFT... 7104-37-64- C-22
 K6KA... 6552-39-60- B-30
 K6CEO... 3780-21-60- C-28
 K6BPR... 2574-22-39- C-21
 WB6FRP... 1080-18-20- B-6
 WB6FCE... 390-10-13- A-9
 K6EVR (4 oprs.) 548,580-223-824- C-96

Santa Barbara

W6ITA (W6s ITA VPH) 293,739-179-547- C-83

Santa Barbara

WA6SBO... 256,473-161-535- C-62
 W6LCX... 116,487-129-301- C-51
 W6YMY... 60,424-104-195- C-64
 W6RKP... 42,075-75-187- B-43
 W6ZKR... 16,800-56-100- B-29
 WB6FCR... 13,150-50-89- C- -
 W6SRF... 11,685-41-95- C-40
 W6KNE... 7826-31-82- C-30
 W6NAT... 6554-23-76- B-18
 W6PLK... 3828-29-44- C-24
 WA6WPG... 1674-18-31- A-11
 WB6FYW (W6s CWD FYW) 27,900-62-150- C- -

Santa Barbara

WA6EYP... 56,430-95-202-AC-46
 WA6OJJ... 14,800-50-99- B-28
 WB8DVO... 72-4-6- B-1

WEST GULF DIVISION

Northern Texas

W5KTR... 160,038-153-350- C-75

WA5ALB... 47,880-95-168- A-40
 K5BXG... 16,992-59-96- B-25
 W5IPH... 11,613-49-79- C-14
 W5MSG... 5-1-1- A-3
 WA5MAV (10 oprs.) 22,791-71-107- C-72

Southern Texas

W5LGG... 140,615-159-295- B-57
 K5JZY... 106,500-125-284-BC-69
 W5LZG... 17,520-60-98- B-21
 W5EDX... 5658-41-46- C-25
 WA51PM... 1476-18-23- A-19
 W5ELN... 342-9-13- A-19
 W5LJT... 324-9-12- C-1
 WA5GZU... 108-6-6- A-3

CANADIAN DIVISION

Quebec

VE2UX... 172,050-130-383- C-66
 VE2WA... 84,910-116-244- C-40
 VE2ANK... 80,184-104-257- C- -
 VE2WY... 47,499-71-223- C-40
 VE2BV... 42,680-79-184- A-22
 VE2WM... 21,777-61-119- C-20

Ontario

VE3UX... 127,872-128-333- C-48
 VE3ES... 59,537-60-191- B-28
 VE3BH... 36,828-66-186- A-36
 VE3DYB... 17,737-49-121- A-33
 VE3FUP... 14,736-48-103- B-20
 VE3CLK... 12,722-42-101- B-14
 VE3FIE... 11,178-46-81- A-50

Manitoba

VE4XO... 57,210-102-285- C-50
 VE4MP... 41,780-87-160- C-34
 VE4HM... 24,180-62-130- B-24
 VE4SK... 8028-36-227- A-12
 VE4AB... 7437-37-67- B-12

Saskatchewan

VE5JU... 6327-37-57- A-24
 VE5DP... 4437-29-51- A-17
 VE5GF... 3161-29-37- B-25

Alberta

VE6VK... 49,176-72-228- B-29
 VE6BR... 38,415-65-197- B-45
 VE6AKR... 26,460-60-147- B-50
 VE6AAV... 26,040-62-140- C-24
 VE6MF... 19,992-56-119- B-30
 VE6HO... 9360-40-78- B-12
 VE6AKV... 4860-27-60- B-19

British Columbia

VE7ANW... 58,905-85-231- B-53
 VE7CE... 19,824-69-112- C-17
 VE7BHW... 2775-25-37- A-7

Vukon-N.W.T.

VE8ML (5 oprs.) 92,416-76-406- C-72

AFRICA

Morocco

CN8AW... 5760-12-160- A- -

Cape Verde Islands

CR4AJ... 39,933-27-493- A-20

Spanish Morocco

EA9AY... 1968-8-83- A-7

Ethiopia

ET3USA (3 oprs.) 546-6-31- A-8

Ascension Island

ZD8HL... 114,750-45-850- A-26

Rhodesia

ZE1AC... 18,473-29-214- A-4

South Africa

ZS6FN... 53,046-42-421- A- -
 ZS4JB... 9360-16-195- A- -

Libya

5A3TX... 4884-11-148- A-5

Niger Republic

5U7AG... 3663-11-111- A- -

Uganda

5X5IU... 49,686-26-637- A- -

Somali Republic

606BW... 57,132-36-529- B-13

Republic of the Congo

9Q5AA... 32,868-22-512- B- -

ASIA

Formosa

BV1USG/A... 5712-14-136- B-8

Philippine Islands

DU9FB... 1728-9-64- B- -

Korea

HL9US... 16,128-16-336- A-10
 HL9TT... 5324-11-162- A-14

Japan

JA1CG... 73,150-33-711- A-44
 KA8RC... 22,950-16-510- B-18
 JA6AF... 1260-10-42- A- -
 JA1FFX... 230-4-21- A- -
 JA5BJM... 9-1-3- A-2

Ryukyus

KR80J... 31,992-31-344- B- -

Lebanon

OD5AX... 63,090-30-701- B-29
 OD5BZ... 2730-10-91- A-5

Asiatic Russian S. F. S. R.

UA9EH... 14,175-21-225- B- -
 UA9KB... 36-3-5- B- -

Turkoman

UH8BO... 92-4-9- B- -

Israel

4X4HW... 10,864-14-259- A- -

West Malaysia

9M4LP... 37,928-34-366- A-27
 9M2BR... 36-4-12- B- -

EUROPE

Portugal

CT1LN... 1488-8-62- A- -
 CT1UO... 1152-9-48- A-13

Germany

DJ6QT... 214,491-53-1349- B- -
 DL1LK... 71,800-40-601- B-34
 DL5AO... 57,740-20-929- B-30
 DL1UD... 43,335-27-538- B-21
 DJ2QJ... 36,520-20-614- A- -
 DJ3GL... 35,036-19-618- B-13
 DJ4XE... 35,028-18-653- B-32
 DL7BQ... 11,799-23-171- B- -
 DJ2IB... 9232-16-196- B-9
 DL9MC... 6100-16-134- A-13
 DJ1SX... 4472-13-119- A-6
 DL6VP... 3302-13-85- B-8
 DJ2SR... 240-8-10- B-4
 DL9GZ (DL3FS, DJ6AC oprs.) 11,952-18-222- A-81

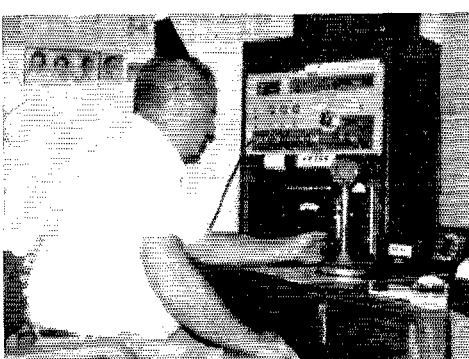

VP7CC (W4GZD) talked up 787 exchanges from the Bahamas during the test and asks that all those interested QSL via K6UTO.

<i>Spain</i>		SM5BL...11,304-18-209- B-
EA4GZ...	232,800-50-1552- A-68	SM1CXE...3672-17-72- B-5
<i>Republic of Ireland</i>		SM5BDS...2519-11-78- B-4
EI4AK...	82,310-31-670- A-20	SM4CHM...1782-11-54- A-
<i>France</i>		SM7CAB...1110-10-37- B-4
F9MS...	84,780-30-942- A-31	SM6BGG (5 oprs.) 132,680-40-1108- B-48
F2MO...	48,825-31-525- A-	SM6BCG (SM6s BCG CED CKU) 126,429-37-1139- B-35
F2YS...	3861-11-117- A-	
<i>England</i>		<i>Poland</i>
G2QJ...	41,940-30-466- A-	SP5AR...12,560-20-213- B-20
G6RJ...	56,336-28-271- A-25	SP5HS...682-11-21- A-
G8FC7...	53,116-36-510-BC-18	<i>Dodecanese</i>
G2QT...	41,940-30-466- A-	SV0WF...1113-7-62- C-5
G3CAZ...	35,640-30-396- A-40	<i>European Russian S. F. S. R.</i>
G82DX (G3s JOC KFX TUZ)	235,104-48-1643- B-90	UW3BV...11,880-20-198- A-
G3LDI (G3s IOR LDI MPN)	8160-17-164- A-24	<i>Kaliningradsk</i>
G3TWW (G3s TWW TWX)	3825-17-75- A-12	UA2KAK (2 oprs.) 5814-17-130- B-8
<i>Wales</i>		<i>Ukraine</i>
GW3NW (GW3s DIX NWV)	147,441-49-1003- B-78	UB5WF...6981-13-179- B-
<i>Hungary</i>		<i>Azerbaijan</i>
HA5KBB (6 oprs.)	15,525-25-208- C-28	UD6KAR (UD6s BQ CC) 3276-14-78- B-
<i>Italy</i>		<i>L. T. U., Geneva</i>
11BAF...	46,700-28-550-AB-15	4U1ITU (6 oprs.) 31,650-30-355- C-18
11LCK...	13,860-21-220- -	NORTH AMERICA
11ZZZ...	12,075-25-161- A-22	<i>Cuba</i>
11LCF...	2619-9-97- A-	CO8RA...31,815-35-303- A-26
11AT...	1980-10-66- A-20	<i>Guadeloupe</i>
11RB (11s OLI RB)	348,800-60-1930- B-67	FG7XL...334,950-66-1601-B-75
<i>Norway</i>		<i>Dominican Republic</i>
LA5HE...	50,310-30-559- A-	H18XAL...334,908-63-1772-A-43
LA7VE...	40,740-28-485- A-26	<i>Panama</i>
LA7WI...	930-10-31- B-	HP1JC...43,660-37-394-AB-14
LA6U...	192-4-48- A-	<i>Honduras</i>
<i>Austria</i>		HR0EB...133,218-54-830- A-44
OE2EGL...	1080-8-45- B-11	<i>Guantanamo Bay</i>
<i>Finland</i>		KG4AM*...310,242-58-1783-C-30
OH2TIS...	10,035-15-223- B-	<i>Puerto Rico</i>
OH2BS...	210-7-10- B-	W2LEJ/KP4 53,808-38-472- B-22
OH3WZ...	108-6-6- A-	KP4AXM- (8 oprs.) 341,495-55-2076-C-96
<i>Aland Islands</i>		<i>Canal Zone</i>
OH0NI...	9361-10-173- B-15	KZ5EX...60,673-17-1191-A-60
<i>Czechoslovakia</i>		<i>Guatemala</i>
OK1MP...	5015-17-99- B-15	TG9EL...239,928-52-1538- B-
<i>Belgium</i>		<i>British Honduras</i>
ON4VS...	59,358-26-769- A-29	VP1GFQ (5 oprs.) 261,522-58-1518-B-
ON5PD...	14,960-20-252- A-6	<i>Antigua</i>
<i>Denmark</i>		VP2AX...3024-16-63- A-
OZ9SL...	99,072-32-1032- A-	<i>St. Kitts, Nevis</i>
OZ38K...	16,470-18-305- A-36	VP2KR...90,206-37-813- A-31
OZART...	7920-23-120- A-	<i>Barbados</i>
OZ9QW...	4680-15-104- A-	VP6WR...55,290-19-970- A-29
OZ1TE...	72-4-6- A-	<i>Bahamas</i>
OZ4DX...	3-1-1- A-	VP7CC...82,635-35-787- A-44
<i>Netherlands</i>		
PA0HBO...	33,179-37-389- B-	
PA0GMU...	9063-19-159- A-	
PA0PRF...	7467-19-131- B-	
PA0LOU...	756-12-21- A-2	
<i>Sweden</i>		
SM4ATA...	17,160-20-286- B-	



WA6SBO led San Diego on phone totalling over a quarter of a million ticks with 535 exchanges and a multiplier of 161. Though sick the 2nd weekend with the flu he still managed to work his country #300 (VU2NRA). Bill's fine Spring Valley location houses an HT-32/SX-101/beams and a vee.

<i>Bermudas</i>	VP9BY...88,704-48-616- A-12	<i>Colombia</i>	HK3RQ 339,264-62-1834-ABC-31
<i>Mexico</i>	XE2RE...67,295-43-527- C-15	HK4EB...531,931-73-1519-B-45	HK3AFB...122,713-41-998- A-
XE2JZ...	24,750-33-251- A-9	HK5JS...210-7-10- A-	HK4RCA (HK4s JO KL) 179,436-57-1053-A-75
<i>Nicaragua</i>	YN1TP...39,780-36-376- A-40	<i>Argentina</i>	LU7DGM...36,348-26-466- - -
OCEANIA		<i>Peru</i>	OA4KY...317,238-74-1429-C-36
<i>French Oceania</i>	FO8HL...27,495-13-705- B-	OA1W...69,072-48-481- A-24	<i>Netherlands Antilles</i>
<i>Australia</i>	VK2APK...63,756-42-506- A-	PJ3CR...261,765-63-1385-B-30	PJ3CD...97,236-37-876- A-58
VK3ATN...	41,595-47-295- A-10	<i>Brazil</i>	PY2BJO...213,237-57-1247- B-20
VK4LT...	11,934-26-154- A-	PY3BAD...32,340-33-336-A-C-12	PY3AQD...31,392-36-296- C-13
VK3XB...	1242-9-96- A-4	PY3AHJ...23,658-19-407- B-9	PY2BGO...23,625-27-292- C-19
VK2PN...	342-6-19- A-2	PY1NO...570-6-33- A-7	<i>British Guiana</i>
<i>New Zealand</i>	ZL1AGO...59,633-49-406- A-2	VP3HAG...252,831-71-1187-A-27	<i>Venezuela</i>
ZL4ML...	9378-18-174- A-9	YV5AGD...269,640-84-1070-BC-58	YV5BFG...87,122-49-597-AB-
SOUTH AMERICA		YV5BFJ...27,072-32-282- B-	YV3KV (YV3s KV KX) 202,616-62-1090-B-34
<i>Chile</i>	CE8CG...18,444-29-216- B-15	<i>Uruguay</i>	CX3BH...2849-17-50- B-
CE4HP...	3762-18-70- A-20	<i>Ecuador</i>	HCEW...172,830-70-823- A-22
<i>Uruguay</i>	HC5CRC (HC5s EJ MP NW) 331,520-56-1978-ABC-96		

* W2VCZ, opr. * Hq. staff, not eligible for award. * WA1AQZ, opr. * K7VGV, opr. * W6WQU, opr. * WA9JSX, opr. * G3GJQ, opr. * OH3PC, opr. * K8UDQ, opr.

ARRL thanks the following amateurs for submitting check logs (LW.—WA1ABW WINI KIUDU W2s EGI GRA MNW OPT, W2GFF W3s CBY EPR, K1s BD FH, W6s BGF EHZ/6 OMR, W8s DJD HA, WA8DXW WA8GQI VE8FGV VE5GH VE6VO HB9J OH2s AF PM, OK1s AFO DK, OK2s BEC KJO, PA0PUR SM6BUT SM7DVF SP2AEL SP5s YC ZA, UB6KIX UC2BF XE1KD ZE3JJ; Phone—W1s FDL PC'D, WA2HOK K3s FFW RFB, W4s GQL QD, W5OHE W6JZG KL7CG W8KYY W6s DJV GUV, VE2SL VE3s CEA RQ, VE6SB G3OQB OH1TM OH2AF OK1ADM SM5ARQ SM6BZE/5 UC2BF YV5BIG.

VE2UX led Quebec and Canadian phones with a fine showing of 172-K. Roger managed 23 countries on 75 and 70 on 20. Look for him in 1966 from VE1.



A COMMON piece of equipment in the ham shack, and a most useful one, is some kind of test meter. This is usually in the form of a volt-ohmmeter or vacuum-tube voltmeter, the latter being preferred for most applications because of its high input impedance. But the usual v.t.v.m. has one serious disadvantage, often overlooked — you can't measure current with it. Sure, you can measure the voltage drop across a resistor, but then you have to know the value of the resistance accurately. You may also have to raise the v.t.v.m. case above ground, and the insertion of appreciable resistance to measure small currents may change operating conditions. A simple wide-range instrument to measure d.c. current should therefore be a useful adjunct to the v.t.v.m.

Shunting Methods

A conventional method of shunting a 1-ma. meter to provide several higher-current ranges is shown in Fig. 1. A separate resistor is required for each range and, if only one switch

* 227 Burgard Place, Buffalo, New York 14211.

The Multimilliammeter

A Handy Instrument for D. C. Current Measurement

BY LAWRENCE F. SHANNON,* K2KVS

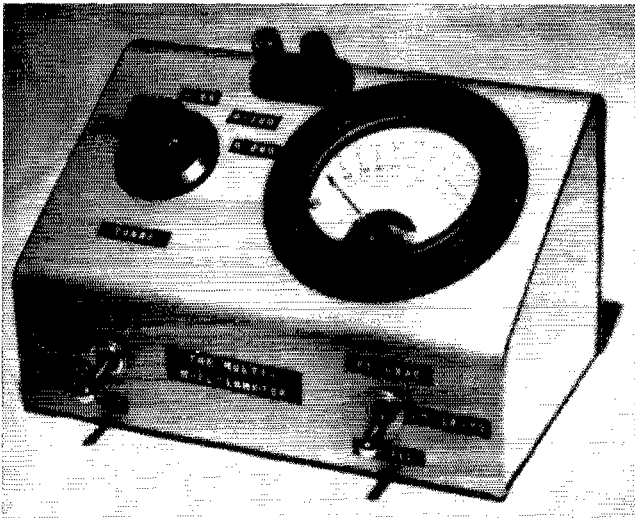

The completed Multimilliammeter. On the sloping panel are the range switch, input terminals and meter. Below are the range-doubling and polarity-reversing switches. The labels are embossed tape. The meter scale was recalibrated with India ink.

section is used, it must be of the "shorting" type (make before break) to avoid damaging the meter. If one of the shunts should open up, it could easily take the meter with it.

The circuit used by the author is shown in Fig. 2. In this arrangement, the shunting resistances (R_4 through R_7) are progressively connected in parallel. If one resistor opens up, those remaining in the circuit will still be in shunt with the meter, and thus reduce the possibility of damage to the instrument.

Additional Features

S_1 and S_2 serve functions that will be found quite handy. R_3 is a shunt that may be switched in, by means to double the current range for any position of S_3 . Besides providing additional ranges of 2 of S_2 , 10, 50, 200 and 500 ma., if these ranges are desired, this switch will be found convenient when using the primary ranges in equipment adjustments that start to run the meter off scale. Flipping the toggle switch is much faster than turning the rotary switch (possibly in the wrong direction in a panic situation). R_1 maintains the original resistance as seen by the multiplier shunts when R_3 shunts the meter, thereby preserving the original multiplying factors. The "short" position of S_3 protects the meter when the meter is not in use.

S_1 is a polarity-reversing switch which makes it unnecessary to interchange prods when going from one polarity to the other.

R_2 is a resistance which may be used to increase the effective meter resistance to a round-figure value to facilitate the calculation of shunt-resistance values, as will be explained later.

Multiplying Resistors

The general formula for determining the shunting resistance required for any desired multiplying factor for the circuit of Fig. 2 is:

$$R_s = \frac{R_M}{n_2 - n_1}$$

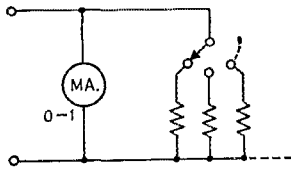

Fig. 1—Conventional method of shunting a 1-ma. d.c. meter to measure higher currents.

where R_M is the resistance of the meter, n_2 is the desired multiplying factor, and n_1 is the multiplying factor at the preceding switch position. In the case of the first shunt, n_1 is 1 (the unshunted meter having a multiplying factor of 1).

As an example, assume that the desired multiplying factor is 100, the multiplying factor at the preceding switch position is 25, and the meter resistance is 100 ohms. Then the required shunting resistance is:

$$R_S = \frac{100}{100 - 25} = \frac{100}{75} = 1\frac{1}{3} \text{ ohms.}$$

It will be seen that the individual shunting resistances are not as small as those required in the circuit of Fig. 1. Also, the divisors are usually multiples of 5 or 10, which make computation easier.

Table I shows circuit resistance values based on a meter resistance of 100 ohms. If your R_M is some other value, (R'_M), multiply the values shown in the table by $\frac{R'_M}{100}$.

Table I

Resistance Values for Circuit of Fig. 2

The following resistance values (in ohms) are based on a meter resistance (or meter resistance plus R_2) of 100 ohms. If your meter resistance (or $R_M + R_2$) is some other value, R'_M , multiply values shown by $\frac{R'_M}{100}$.

R_1	R_2	R_3	R_4	R_5	R_6	R_7
50	See text	100	25	5	1 $\frac{1}{3}$	$\frac{2}{3}$

Meter Resistance

Since the multiplier resistances are based on the resistance of the meter used, it is important that the meter resistance be determined as accurately as possible. In the method used by the author, the current through the meter is first adjusted for full-scale deflection by connecting a variable resistance of about 2500 ohms maximum and a 1.5-volt dry cell in series with the meter. Turn the variable resistor to maximum resistance before connecting the battery, and then gradually reduce the resistance until full-scale deflection is obtained. Call this current (1 ma.) I_1 . Then, without changing the setting of the variable resistor, shunt the meter with a 1 per-cent, or better, precision resistor (plentiful in surplus) of a known value in the range from 50 to 100 ohms, and read the current. Call this current I_2 . Then the meter resistance can be obtained from:

$$R_M = \frac{I_1 - I_2}{I_2} \times R_S,$$

where R_S is the value of the resistor.

If the value R_M doesn't turn out to be a round number, the effective resistance of the meter can be increased to a value more convenient for shunt calculations by adding resistance at R_2 . In this case, multiplier values must, of course, be based on the sum of R_M and R_2 .

There is another, and perhaps better, method of arriving at suitable shunt values. In this method, only the approximate value of meter resistance is needed (the manufacturer's nominal rated value will be close enough, if you know it or can find it in the meter literature). In my case, this approximate resistance was 130 ohms. Then select the minimum value above this approximate figure that is a multiple of 25, 50 or 75 (150 in my case). Now assume that the meter resistance is this latter value, and proceed to calculate the multiplier values.

Instead of a fixed resistor at R_2 , use a variable resistor with enough resistance to make up the difference between the estimated meter resistance and the round-number figure on which the multiplier shunts have been based. (Since the difference in my case is about 20 ohms, a variable resistor of 100 ohms or less would be suitable.) After the unit has been completely assembled, set both S_2 and S_3 to the 1-ma. positions, and set R_2 for minimum resistance. Using a variable series resistor and battery as described earlier, adjust the current for full-scale deflection. Now throw S_2 to the doubling position, and adjust R_2 for exactly half-scale deflection. This adjustment should serve to match the meter resistance to the calculated shunt values for the correct multiplying factors.

Experimental Shunt Adjustment

I used 1-per-cent resistors (combinations when necessary) that I obtained from a surplus house

(Continued on page 180)

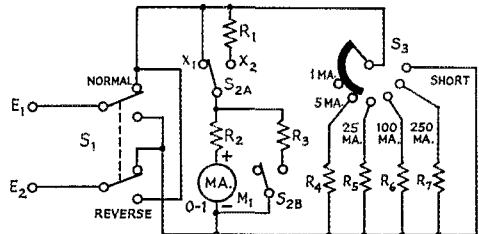

Fig. 2—Circuit of the Multimilliammeter.

E_1, E_2 —Five-way binding post.

M_1 —0.1-ma. d.c. meter, D'Arsonval movement.

$$R_1 = \frac{R_M + R_2}{2}$$

R_2 —See text.

$$R_3 = R_M + R_2.$$

R_4, R_5, R_6, R_7 —See text and Table I.

S_1, S_2 —D.p.d.f. toggle switch.

S_3 —Single-section single-pole 6-position progressively-shorting rotary switch (Centralab PA2042, 3 positions not used).



This was all that was left of WA9MJL's trailer home when a tornado tore up a trailer court in Elkhart. Several people were killed, but all WA9MJL lost were his physical possessions.

A TALE OF TORNADOES

Amateurs Rise to the Need for Extensive Emergency Communication in Storm-ravaged Midwest Areas

COMPILED BY GEORGE HART,* WINJM

ATORNADO is one manifestation of nature's fury when unequal atmospheric conditions exist. Nature abhors such differences, between cold air and hot air, high pressure and low pressure, wet air and dry air, and hurries to equalize them. When she does so, various degrees of havoc are wrought by the winds and the precipitation and the electricity generated.

In early April, such a combination of unequal conditions began to develop in the near midwest, and on the 10th began to take the form of violent thunderstorms throughout the area as hot moist air collided with cold dry air causing heavy cloud formations, high winds, and rain which was thrust upward into the cold air, froze, fell again to pick up more moisture, and was blown up into the cold again. There another layer of ice formed around each droplet — a procedure repeated a number of times until the ice particles became heavy enough to overcome the upward thrust of the winds and fell to earth, sometimes as large as golf balls.

The violent upthrust of the hot air caused whirling winds of tremendous force over limited areas, a type of storm known as a tornado. Given

the proper conditions, one never knows when a tornado funnel will appear, how far its path will go, when another one will appear, or exactly what form and destructive intensity it will have. When the funnel touches the ground, it literally explodes everything it touches.

Conditions favorable to generate such monsters occurred all over considerable areas of Indiana, Michigan, Ohio, Illinois and Wisconsin on April 11, and tornado funnels were numerous. Where they occurred in the open country, damage to man-made structures was slight. Where they occurred in towns and cities, it was terrific. Electric and telephone lines were blown out of existence and large areas found themselves completely without electric power or any means of communications. Into this breach stepped thousands of radio amateurs with mobile and portable equipment and with portable generators maintained for just such purposes.

Indiana

The Hoosier state was hardest hit. Destructive tornadoes all but razed sections of Elkhart, Kokomo, Dunlap, Goshen, Russiaville, Arcadia, Marion, Milan, Wyatt, and Lakeville.

* National Emergency Coordinator, ARRL

Let's split these up into two principal areas, not very far apart. The first area centers about the Elkhart vicinity in far northern Indiana. Towns in this area affected were Goshen, Dunlap, Lakeville and Wyatt. K9VTN tells us that a tornado struck Elkhart on April 11 at 1840, knocking out all power and communications. The police department asked for assistance from the amateurs, who furnished a number of six-meter mobiles. Red Cross requested contact be made with state and area Red Cross headquarters, which the amateurs also accomplished. Traffic handled dealt with medical and blood supplies, transportation for the wounded and dead, information on supplies, food, clothing, and just plain health and welfare, for three and a half days until landlines and power could be partially restored. Traffic was handled to all states and several foreign countries.

Health and Welfare traffic became so heavy that K9HDH, the Elkhart club station sponsored by the Red Cross, simply checked names and addresses against casualty lists, because there was no time to handle formal messages.

At the peak of the emergency there were separate nets for Goshen, Elkhart and Kokomo, ranging from 3906 to 3810 kc. and from 3925 to 3960 kc., which ran from April 11 thru April 14. WA9FDQ reports the going was tough, with lots of break-in stations and most of the time was taken up just listing the traffic. The Indiana Traffic Net, Q1N, operated almost the entire evening every evening of the emergency, and there were 150 Health and welfare messages listed on CAN on April 14. Local standouts were K9s IVG CRS RHU/8, W9s EGQ YXX FZW QLW and WA9BWX, all of whom were control stations. Most active on Q1N were K9s WWJ HYV DNC, W9s QLW ZYK, WA9s BWY AVT FDQ.

WA9BCJ is prominently mentioned for his work from Goshen, which was hit at 1815 Sunday, April 11. He was on the air by 2005 sending emergency traffic, the first of which was a request for help from the local Red Cross director to national headquarters. He was then swamped with traffic so that he had to start refusing to accept health and welfare traffic and handle only full priority. By 0500 he was through this stack and started working on the welfare traffic, which kept him busy until 1000. He managed to get some sleep for a few hours, then was back on the job handling traffic, giving death notices and arranging for funerals, and more of the ubiquitous welfare type. Altogether, he sent 637 messages and received 489, and by Thursday things were back to normal. "Fellows," says WA9BCJ, "now I know why we have the motto: 'Amateur Radio exists because of the service it renders.'"

WA9CQE says that less than an hour after the first tornado struck, an emergency six-meter a.m. net was in operation with K9LNU as NCS. A portable and three mobiles were sent to the area and the Elkhart Club-Red Cross station K9HDH was on the air. All communications to Goshen and South Bend were by two-meter and six-meter f.m. EC W9FQN operated from home, relaying

We are not especially noted for clairvoyance, but if John Hamm's imaginary emergency condition had been spotted just a little to the east, it would have been almost a harbinger of what occurred in wide areas of Indiana, Michigan, Ohio, Illinois and Wisconsin on April 11, Palm Sunday, 1965. There was nothing imaginary about this one, and the emergency work described as having been done by amateurs was real.

to Goshen and more distant points. W9WQX was the first to reach K9HDH and get it on the air. Operations continued until early Monday, then closed down until daylight. Next day stations in Goshen and Elkhart linked Red Cross facilities and helped compile a list of dead and injured. K9HDH handled various inquiries, and Red Cross health and welfare inquiries, on the Indiana Sideband Net. Operations closed Wednesday, except for emergency traffic.

WA9CJR says that three six-meter f.m. and two six-meter a.m. mobiles were dispatched variously to Wyatt, Lakeville, Dunlap and Goshen disaster areas to check conditions and furnish communications to the Red Cross. The South Bend Amateur Radio Club's station K9YFG went into operation from Mishawaka for the balance of the night and handled much emergency traffic with the mobiles. W9CJR set up to supplement telephone service from Wyatt to Red Cross in Mishawaka and the Goshen, Elkhart and Dunlap disaster area. Much important traffic was handled; for example, the Goshen Hospital needed vaccine, blankets, towels, wash rags and other medical supplies. W8EEI/9 originated the message and contact was made with K9YFG who contacted local hospitals and the supplies were immediately dispatched by truck. A request from the Wyatt Red Cross for blankets, splints and relief workers was relayed via WA9CJR/9 to K9YFG and supplied within 45 minutes. Many welfare inquiries were also handled through the Mishawaka Red Cross by K9YFG.

K9DHN reports that the Purdue Amateur Radio Club station, W9YB, relayed messages from the 75-meter s.s.b. nets to disaster areas on v.h.f., also cleared welfare traffic out of these areas by relaying from v.h.f. to s.s.b. A total of 109 messages were handled by six operators.

W9BNI reports that a number of amateurs set up a communications center at Red Cross headquarters in Dunlap under K8MET/9 in the Ind. Sideband Net and WA9NTO on two meters. Operations began on April 12 and terminated Apr. 14 after having handled over 200 messages, some priority but mostly health & welfare. Two-meter RTTY was used to good effect. K9WJU handled approximately 150 messages. W9TRN worked with the Goshen Red Cross.

Cleanup operations in the Elkhart area commenced on April 17 and continued through April 20, with amateurs still supplying communications. Mobile units from Fulton, Marshall and St. Joseph Counties and from Niles, Mich., supplied communications for the Red Cross which was riding herd on approximately 3000 volunteer workers in the Wyatt area. Greatest use of communications was to order and dispatch food for Red Cross mobile kitchens, but there were three emergency calls for medical assistance, one when a boy stepped on a nail, another when a boy's foot was run over by a tractor, and still another when an old gent on the back trails was found to be badly in need of insulin. All these were handled promptly thru K9YFG, set up at Wyatt Red Cross headquarters.

WA9ELY sat on 3905 kc. and was a clearing house for amateurs seeking information regarding the welfare of people in the disaster areas. Armed with a copy of the Indianapolis newspaper which contained casualty lists, he thus forestalled much incoming inquiry traffic. He also handled traffic for South Bend, Goshen and Michigan City.

In the Kokomo area, it seems that W9FHU was first active on April 11 from Russiaville, making contact with W9URS in Frankfort, who then proceeded to spread the word. A 5-k.v.a. generator and 40-foot retractable tower were set up in 17 minutes in the Russiaville area and operated primarily by WA9DXY. The Howard County C.D. Emergency Net was manned by K9PVW, K9IMD and WA9GLS until the early hours of April 12. Mobiles assisting were W9DKR and a number of MARS stations. K9IOO and K9SIH spent considerable time on the Miami County C.D. Net assisting in local and nationwide traffic handling. Early Monday, April 12, the MARS station at Bunker Hill AFB worked with the amateurs handling nationwide traffic. Most amateurs were off the air because of electric failure, but the few who had their own emergency power did a great deal of operating.



"Outstanding" is about the only word to describe the activities of WA9BCJ in the aftermath of the tornado that hit his home town of Goshen, Ind. This young man, from this modest station, handled over 1100 high-precedence messages in 61 hours of semi-continuous operation.

This included K9s LZN MWC ZSM, W9s FFW TTA GIB MXG and WA9AXU.

The Delaware Amateur Radio Assn. combined forces with c.d. following the April 11 tornadoes in Central Indiana. Amateurs were alerted at 1900 by the DARA alerting system and NCS was set up at the c.d. operations center, with other control stations in Muncie City Hall and the SARA club house, through which all communications were channeled. Mobiles and base stations in the area checked into the net and were dispatched as needed. On the reported destruction in the south end of Marion, with no power or communications, mobiles carrying portable equipment and portable generators were dispatched from Muncie, where they set up a power plant for the police, who used it four days. One mobile was sent to Marion General Hospital and an emergency NCS set up near the disaster scene, others were sent to a main shopping center and the Veterans Hospital. Hundreds of welfare reports were handled for the Red Cross, supplementing overloaded wire lines. About 24 amateurs participated.

W9MM reports that K9HMC handled traffic into Marion, Gas City and Jonesboro Monday morning. W9DCX was on for Kokomo starting at 2200 Monday, W9MM from noon Monday on for Marion, Gas City and Kokomo until W9DCX showed up. Over 400 messages were handled in this section of the Indiana Sideband Net which operated about 45 hours. K9GEW and W9RSL assisted operations from W9MM to the tune of about 100 messages.

At 0830 Monday, WA9ESN says he started receiving traffic on six meter f.m. Traffic received by W9MM and K9s ZLB JIR and MGW on 75 meters was routed into the area via this net, mostly health and welfare and local telephone service information. Mobiles were sent into the area to check on persons. About 300 messages were so handled.

K9SXM says the Howard County Six Meter F.M. Net started April 11 at 1945, operating for c.d. and the Red Cross with ten amateurs. A six-meter f.m. station was set up at the police tower and c.d. building in Kokomo, with WA9ESN handling over 200 messages.

The Cass County Radio Club station, W9VMW, operated on April 12 and 13 to handle traffic into and out of the tornado stricken area, securing at 0700Z April 13. Nine amateurs worked in shifts to keep things going.

W9BUQ was on stand by, taking traffic for the stricken area on 80 and 6. He reports principal stations operating were W9s YYX EGQ, K9RHU/8 and K9JIR. W9YTP was NCS on the Indiana Sideband Net on Monday, sends in a long list of stations who checked in.

WA9BWY reports that QIN operated 15 hours from April 12 thru April 16, handled 196 messages, used up six different NCS's and had a total QNT (stations reporting in) of 89.

On April 17 amateurs assisted in the cleanup operation in Johnson County. According to K9QJT, 18 amateurs assembled at Indianapolis

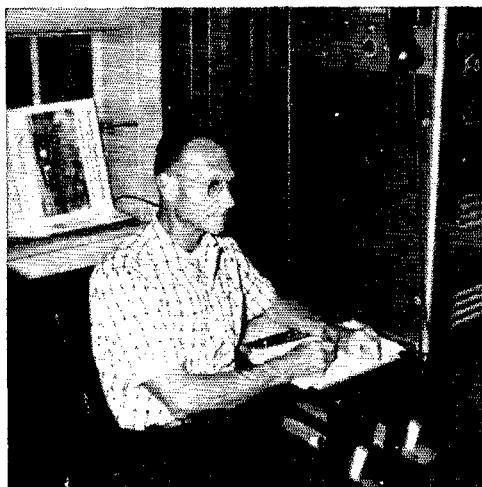
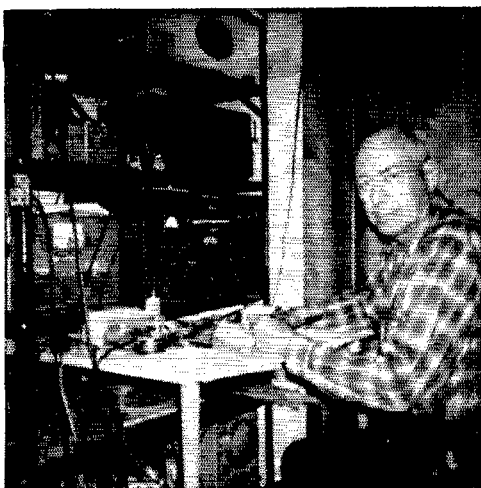

Quite a stir was caused on April 11 when W3CU, Annapolis, Md. (right), intercepted a SOS call from K8JID in Coldwater Lake, Mich., as a tornado funnel was bearing down on the latter. No contact was made between the two, but W3CU notified the FBI, which notified the FCC, which contacted the Coldwater Police Department who thus received the first word that Coldwater Lake was hit. The frequency of the SOS was first 3660 and then 3655 kc.; apparently it was the second call that W3CU heard. K8JID says that in the excitement it never occurred to him to use QRRR or 3550 kc.

with a convoy of fifteen city trucks and drove to Arcadia's devastated area. Upon arrival, K9CVB took over as net control of the mobiles, later relieved by W9FXC on six-meter f.m. Mobiles were dispatched to various sections of the devastated area, some carrying handy-talkies. Mobiles were also assigned to the e.d. directors of both Marion and Hamilton Counties. No other communication was available, but because of the amateurs' efficiency the operation was completed in a single day. These amateurs were from Johnson, Morgan and Marion Counties.

K9RHU/8 reports in detail on operation of the Indiana Sideband Net, which was bogged down with health and welfare traffic on April 12 on 3910 kc. In order to cope with the situation, the net was divided into three divisions, including nets on 3905 and 3925 kc. K9RHU operated on 3925 for over 13 hours, handled 441 inquiries with 347 stations. Many of the inquiries were just an addressee, whose welfare was to be checked out. K9HMC and K9KCQ deserve special mention; the former was the only outlet from Marion until the afternoon of the 12th, and he operated continuously the whole period and long afterward. K9KCQ was the sole contact with Russiaville, which was almost completely demolished; later he traveled to Greentown and attempted to set up communications at that point. Special commendation also go to K9s SWL IVG, W9s UGH and MM.

As a windup to the Indiana tornado operations, we have a summary report from SCM W9YYX on the operation of the Indiana Emergency Net, which was activated on 3910 kc. on April 12 and was operated almost continuously thru April 15. Health and welfare traffic was diverted to alternate frequencies, leaving this net to handle priority traffic to and from the disaster

areas. Thousands of messages were handled, involving Red Cross and civil defense official communications and personals. Disaster area stations participating included K9s HDH FHQ WJU, WA9BCJ and K8MET/9. Many other stations, both in and outside the affected areas, assisted on alternate frequencies on the 75-, 6- and 2-meter bands. The Kentucky Phone Net suspended operation for several regular sessions in order to assist in the emergency. Indiana's QIN net held several lengthy sessions on 3656 kc. The sacrifice of sleep and personal needs to maintain communications reflects the dedication to public service inherent in so many amateurs, says W9YYX.

Sound like a lot of doings in Indiana? There was, brother, there was! Let no one take away from them the magnificent job they did.

Michigan

Damage in Michigan seems to have been limited to parts of Monroe County, north of Toledo and south of Detroit. EC W8NDM alerted the county AREC on Sunday evening, and W8TZZ started monitoring weather stations. At 2115 the Red Cross advised that a tornado had struck Milan, so the net was activated and the communications center WA8MTX at the Red Cross building in Monroe was put on the air. K8WXO/mobile was sent to Milan with a Red Cross volunteer. W8NDM/mobile later took off for Carleton to investigate report of another tornado. Two AREC mobiles worked in Milan for some time, as power and telephone lines were down; then operations were moved to Lost Peninsula, which was hit even harder. The AREC was active from that point until 0500, providing communications for the Red Cross and the Sheriff's Office. W8TZZ

was in charge at W8MTX, and KSAMU did relay work. KSENY handled 12 record messages, all other traffic was of a "command" nature. Seventeen amateurs were involved in 7½ hours of operating.

The U. S. Weather Bureau in Lansing asked KSACO for weather information, as their TWX system had failed. He reported into the Wolverine Net and obtained the required info from W8CTG, W8FLL and KSBMU. Other stations also giving weather information and providing information for local authorities included K8s SAF LQN JHA, W8s EJR EGK and KTJ. W9CUS provided liaison between Michigan and Indiana points. Operations continued for three days. W8EGR handled 25 health and welfare reports. The Michigan BR Net and the Post Office Net also handled much disaster relief traffic. Wayne and Oakland County AREC 2-Meter F.M. Nets were on standby. Grand Rapids, Kalamazoo, Jackson and Flint were also active.

The Southern Michigan 6 and 2 Meter Net was in session from 1810 to 0115, April 11-12, with 49 amateurs participating, handling weather information to the sheriff, city police, civil defense, and much traffic to and from the disaster area at Coldwater Lake. KSWPO and K8NKP were dispatched to the disaster area. K8UCQ and K8UCY were mobile at the radio station feeding info on the storm's progress, then moved to the Sheriff's Department and put up a portable rig for weather information and messages until 0115. K8OWM was assisting at the Sheriff's Department.

Ohio

Widely affected areas of Ohio seem to have included Toledo, Wellington, and Westfield, the latter small towns or settlements in Lorain and Morrow counties respectively.

W8CJP advises that as soon as she was notified about the disaster in Westfield, she (now, get *this!*) constructed a communications sign with lipstick, mobilized to Westfield from her home in Ashley, and was in business. Most traffic handled was personal, but she did a lot of driving around staying in contact with her base station, relaying information. Three other amateurs were active in the area (W8s GZO CJO IJD), all on a spontaneous basis.

K8MZT was alerted at 0800 April 12 and started the Ohio Red Cross Mutual Aid Net simultaneously with the Ohio Emergency S.S.B. Net and the Ohio S.S.B. Traffic Net. Skip conditions required some outside contact to make connections, but by 1100Z communications were normal. K8MZT operated until 1750, checking in 110 stations and handling 45 messages, 25 from the Canton Red Cross, all answered within two hours because the Indiana Phone Net was so well organized. The log shows operation from W8MZS and K8MZT during periods of April 12, 13 and 14. K8MZT offers kudos to 1FN under K9IVG.

All emergency nets in the Toledo area were

activated when a tornado struck on April 11. EC K8TVW was in charge. The Toledo Red Cross station W8FO was manned and mobiles on 6, 10 and 160 meters were dispatched into disaster areas. Other mobiles were sent to hospitals to compile lists of injured and answer inquiries. Amateur mobiles also assisted with transportation for treated persons, who were released from the hospital but had no way home. They also kept Red Cross headquarters informed and even hauled materials. Several fixed stations were set up to be used as relays for more distant mobiles and to serve as liaison with communities under alert. Telephones into Toledo were plugged for days by anxious callers, so amateur radio was called upon to handle over 200 inquiries, both thru direct contact and through the National Traffic system if needed. Some 60 amateurs participated in the Toledo area.

W8GDQ was awakened at 0400 Monday by visitors from Lorain who said there was no communication with Wellington, so he fired up the rig and operated until Tuesday afternoon handling traffic for Western Union, civil defense and individuals. K8CLE and W8SOAB, who dragged him out of bed, assisted in the operation.

The Ohio SSB Net operated 24 hours per day from April 11 to April 14, with check-ins from "all over." W8NAL and W8FSM handled traffic from the Massillon Red Cross. W8VBO, W8CXY and W8TV kept links open with various Indiana nets operating on 75 and 20 meters. The traffic count, says W8NAL, was high.

W8BUL, EC for Seneca County, reports that K8DHF operated 46 hours from 2300 to 0300 (Apr. 11-12) then throughout the remaining week as the Ohio SSB Red Cross Emergency and Mutual Aid Net handled traffic on 75 meters. W8BUL was on for three hours. K8YWF handled the two-meter net and W8CUZ handled contact with the sheriff.

Illinois

Reports seem to indicate that "high winds" hit Crystal Lake, in the northern part of the state, although activity elsewhere hints that there were other trouble spots, too.

K9WMP says there was little property damage at Crystal Lake, but telephone lines were damaged and communications were needed, so he drove there in his mobile, talked his way through road blocks and went to the operations center near the high school. There he contacted Red Cross officials and handled traffic with W9LDU and K9BQQ on Monday, Tuesday and Wednesday.

W9HDF says he was acting as net control of the Chicago Emergency Net on 2 meters, and that he and nine others handled emergency traffic.

W9VEY says that K9AXS was in liaison with the local Red Cross and centralized all health and welfare messages originating in Montgomery, Bond, Macoupin and Christian counties, relaying them the best way possible. K9YMZ and W9VWJ also handled some.

(Continued on page 17#)

Strays



Herbert Rippe, Jr., WA8DCH, is twelve years old and a holder of a General Class License, which proves that you don't have to be an engineer to get a ham ticket! Herb is active on 20-meter c.w. and s.s.b. His father is W8BQH and, yes you guessed it, his mother is a ham too, W8HDB.



The Lafayette Amateur Radio Club set up a booth at the Blackham Coliseum in Lafayette, La. during the annual Sports Show. A two-station setup with certificates, awards, and equipment was on display. Shown manning the booth are, from left to right: Steve Broussard, K5DPH, Mike Comeaux, and K5QXJ.



The accompanying photograph shows an amateur radio class in session at the Anchorage Community Center. The Novice Amateur Radio Club meets each Tuesday night and the course consists of 16 weeks of training in amateur radio theory and code practice. To date, 12 students have passed the Novice class license. The photograph shows Brian Umstead, K0CSJ/KL7, discussing the ARRL License Manual. Brian is a radioman 1st class in the USNR. John Trent, KL7DG, a lieutenant in the USNR, organized the classes as an extension of community service by the Naval Reserve Composite Company 17-1, of Anchorage.

Gillette State Hospital for Crippled Children, St. Paul, has its own amateur radio station WA0GBQ, thanks to three Twin Cities area men, the Sperry Rand Corporation's UNIVAC Division, and the Paul Light Christmas Fund of the St. Paul Pioneer Press. Gillette patients have been using radio equipment donated by UNIVAC, the Light fund and various Twin Cities hams for two years. George J. Selin, seated at the station's console, Ray Maurstad, and H. A. (Mick) Alsop, right, have voluntarily taught radio and electronics classes to patients every Monday night for two years. Showing interest are current patients (left to right) Larry Oster, Little Falls, Minn.; Andrew Roy, Minneapolis; John-dale Koopman, Hendricks, Minn.; and Ray Desrocher, Verndale, Minn.





Hints and Kinks

For the Experimenter



SHOCK MOUNTING

AMAT URS occasionally have to protect various electronic circuits, but potting chemicals sold for the purpose are very expensive. An easy and inexpensive shock mounting can be made from cellulose artificial sponges, the ones that are hard and stiff when dry and become soft and pliable when wet. Cut the sponge into small cubes about one inch on a side. Wet the cubes and squeeze out the excess moisture. Stuff the cubes in the space between the container walls and the object to be protected. When the sponges dry they will form a solid mass that has good thermal and shock-insulating properties and the object will be firmly encapsulated. — *Melvin Leibowitz, W3KET.*

JUNK-BOX ZENERS

RECENTLY I was in need of a low-voltage Zener diode and decided to check out all the transistors I had in my junk box. Some types worked fine; you even get two Zener voltages with one transistor as the Zener point of the base-collector junction is different from the base-emitter junction. A handful of transistors will provide quite a range of Zener voltages, but on most types the current through the transistor can only be a small value. It should follow that the high-wattage transistors can be utilized in a like manner for high-wattage Zeners, but I have not tried them. — *Cal Enix, W8ZVC.*

DIPOLE CENTER INSULATOR

A combination of Series 83 coax connectors can be used to make an excellent center insulator for coax-fed dipoles. Fig. 1 shows the assembly of the connectors. The PL-259 on side A has its inner shell sawn off. The antenna wire is run through the cone feedthrough and soldered to the center pin. Side B has the center pin of the PL-259 removed. A type 83-168 adapter is used to reduce the inside diameter of the connector. The antenna wire on this side is folded over, inserted, and soldered. Once assembled, the entire unit is given a coat of Scotch-Kote, or similar protective compound, to prevent moisture seepage.

At first glance, it would appear that the solder joint on side A would not be strong enough to support long dipoles. This has not proven true, for no difficulty has arisen in several years of supporting an 80-meter dipole with a long run of RG-8 feed line. — *Kenneth G. Kopp, WA4HAA*

COMPACT COIL FORMS

INEXPENSIVE double-slug TV-type i.f. coil forms may be halved to provide single-slug forms for compact construction. — *Bela V. Foldesy, W6HCI*

MAKING MOUNTING BOARDS

THE use of terminal boards for mounting resistors and capacitors makes construction easier and appearance neater. It is easy and inexpensive to roll your own, and the completed board has the advantage of being transparent so there is no hidden circuitry. These boards are made by pouring some resin into a plastic container of appropriate size; the resin can be obtained from any marine dealer for about a dollar a quart. It is normally used for coating the fiberglass-cloth covering on boats. The boards are removed after hardening and drilled with the holes required. Press-in terminals are then mounted if required. — *Robert Coviello, K1WNK*

CONE INSULATOR EXTENDER

EVER paw through the junkbox trying to find the right length of cone insulator for the job at hand? Who hasn't?

A simple solution to this universal problem is the use of wood doweling, sawed to the desired length, drilled through, and mounted under the standoff. This approach has several advantages. You can make your insulator any desired height. The insulating quality is not impaired because the cone still does the insulating. And, by no means least important, the wood provides a cushion that prevents cracking the insulator when the mounting screw is pulled up tight. — *WICER*

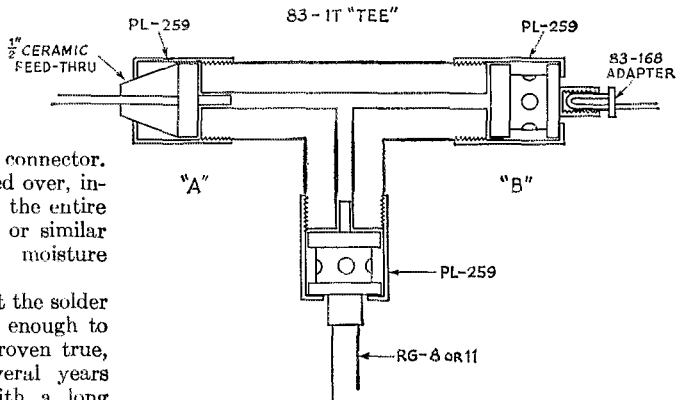

Fig. 1—Assembly of the center insulator constructed from coax connectors.

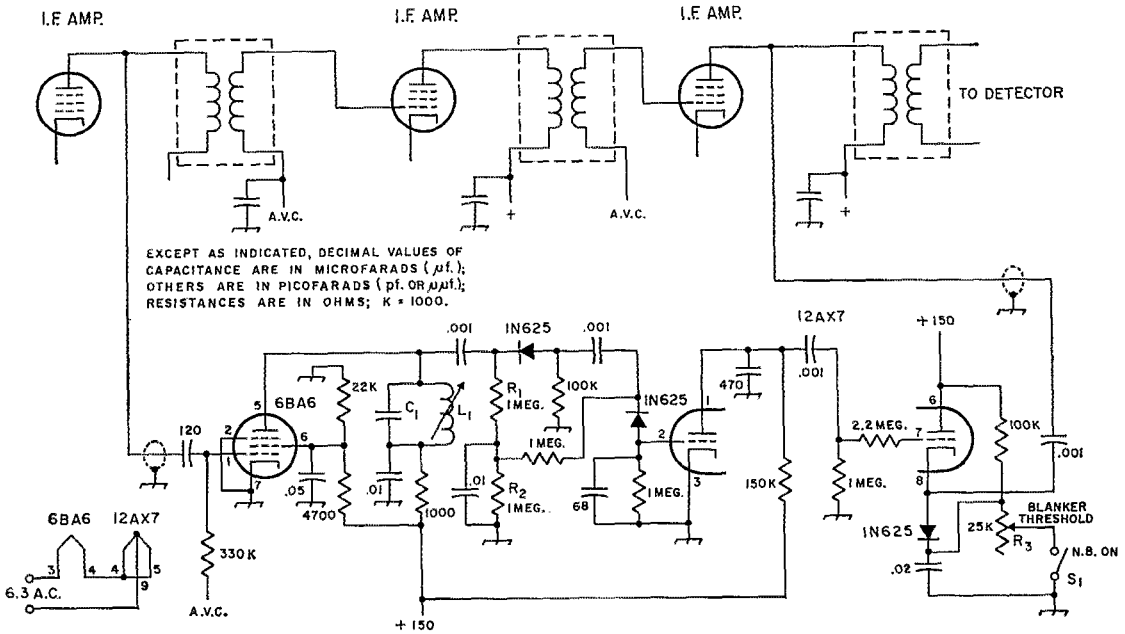

Fig. 2—Schematic diagram of the Drake noise blanker. Capacitors are disk ceramics, and resistors are 1/2-watt.

C₁—Capacitor contained in the i.f. transformer used for L₁.
L₁—One section of a 455-kc. i.f. transformer (detune the other section).

R₁, R₂—1-megohm, 1/2-watt resistor.
R₃—25,000-ohm linear taper control.
S₁—S.p.s.t. toggle switch.

USING THE DRAKE NOISE BLANKER

AFTER trying several noise-blanker circuits, I tried the one used by Drake in the R4 receiver—this one really works. The circuit shown in Fig. 2 was built into my home-constructed receiver.

The blanking pulse was first connected to the first i.f. stage, but the circuit did not work well. Connecting the blanking pulse to the last i.f. stage made the unit perform as it should.

The noise is amplified in the 6BA6 amplifier, and rectified by the 1N625 pulse detector. A noise pulse causes a negative pulse to appear on the grid of the first half of the 12AX7, which cuts this stage off, while the resulting positive pulse in the plate circuit causes the second section to conduct. The plate of the last i.f. stage is grounded for r.f. during the time the second half of the 12AX7 is conducting, through the diode in the 12AX7's cathode circuit. The 25,000-ohm control applies positive bias voltage to the cathode of the second half of the 12AX7 for threshold control.

The blanker is connected to the receiver by short lengths of RG-58/U cable. The i.f. stages must be realigned to compensate for the capacitance of the cables. Then a v.t.v.m. is connected to the junction of R₁ and R₂ and L₁ is adjusted for maximum. The threshold control is set for best blanking action without distortion of the audio. — Jim Brannin, K6JC.

CRYSTAL OSCILLATOR FOR THE 32V

THIS crystal oscillator was designed for use on TMARS and traffic frequencies when using the Collins 32V series transmitters, which are normally v.f.o. control only. Novices may also make use of this adapter if the transmitter power input is held to 75 watts. The unit is constructed on a small chassis which is placed inside the 32V. When crystal operation is desired, the 6SJ7GT in the p.t.o. is removed and placed in the crystal-oscillator circuit. P₁ is then placed in the p.t.o. tube socket. To change back to v.f.o. operation, P₁ is removed and the 6SJ7GT moved back to the p.t.o. — Peter Kimball, K1YER.

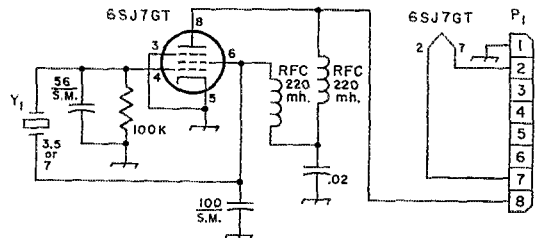

Fig. 3—Circuit for a crystal-oscillator adapter for Collins 32V series transmitters. Resistances are in ohms (K = 1000); decimal values of capacitance are in microfarads (μf.), others are in picofarads (pf.). SM indicates silver mica capacitors. P₁ is an octal plug.

I.A.R.U. News



AUSTRALIAN AMATEUR LICENSING

Although many member nations have long amateur radio traditions of their own, the effects of the United Kingdom licensing system are felt throughout the commonwealth. The cooperative result has been that amateur radio licenses issued by the various governments and their telecommunications authorities are generally accorded reciprocity. A U.K. licensee who moves to Australia, for instance, has no difficulty exchanging his G for a VK call. He will find, however, that he is now operating under different regulations with different frequencies. Our thanks to the Wireless Institute of Australia for the following data.

In Australia two separate 1-year renewable amateur radio licenses are issued to British subjects, and some non-citizens, by the Postmaster-General's Department. The non-citizen may secure an amateur license only with special permission, but the authorities have been rather generous in the past. In addition, effective June 25 of this year, U.S. amateurs became eligible for operating privileges under the provisions of a reciprocal operating agreement.

The principal license is the Amateur Operator's Certificate of Proficiency (A.O.C.P.) which entitles the holder to all amateur privileges. There is also the Amateur Operator's Limited Certificate of Proficiency (A.O.L.C.P.) which limits the holder to phone and only to frequencies above 52 Mc. Thus it is similar to the W Technician Class.

Examinations are held on the third Tuesday in January, April, July, and October of each year by the Superintendent, Radio Branch, at each state

capital city and at any town at which a District Radio Inspector is stationed.

To be eligible an applicant must be 16 years or more, a British subject, and supply a copy of his birth certificate. A fee of the U.S. equivalent of roughly \$2 covers both the application and the cost of the operator's certificate. Successful candidates must supply a statutory declaration concerning the secrecy of wireless communications, a physical description (height, etc.) for identification, and a head-and-shoulders photograph autographed on the front.

A.O.C.P. applicants must pass a 14-w.p.m. Morse sending and receiving code test, a half-hour written examination consisting of operating questions based on a syllabus by the PMG, and a two-and-one-half hour written examination on radio and electrical theory. The written examination is the same for the A.O.L.C.P. Renewals are at the same rate as the application fee and may be paid on the due date at the nearest post office.

The A.O.C.P. licensees may use up to 150 watts input on all available bands with voluntary subbands as follows: 3500-3535 kc., c.w. only; 3535-3700, phone or c.w.; 7000-7030, c.w. only; 7030-7150, phone and c.w.; 14.00-14.10 Mc., c.w. only; 14.10-14.35, phone and c.w.; 21.00-21.15, c.w. only; 21.15-21.45, phone and c.w.; 28.00-28.20, c.w. only; 28.20-29.70, phone and c.w. No subbands are recognized on the v.h.f. or u.h.f. assignments which include 52-54 Mc., 144-148, 432-436, 575-585, 1215-1300, 2300-2450, 3300-3500, 5650-5850, 10,000-10.500, and 21,000-22,000 Mc. Mode usage includes c.w., a.m., s.s.b., and n.b.f.m. on all bands; amplitude tone-modulated telegraphy, fre-

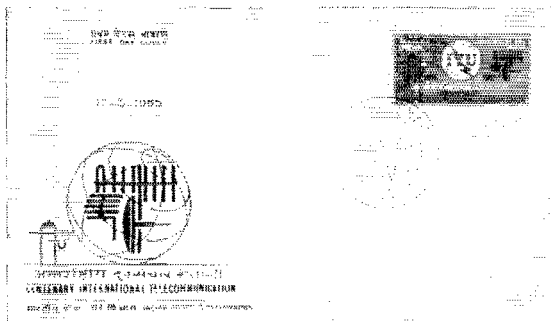

The amateur Radio Society of India, the Indian government, and other agencies celebrated the Centenary year of the International Telecommunications Union with three days of celebrations and exhibitions centered around the 17th of May. A special commemorative stamp was issued as shown above. Also pictured is part of the ARSI amateur radio exhibition with VU2ITU in operation.

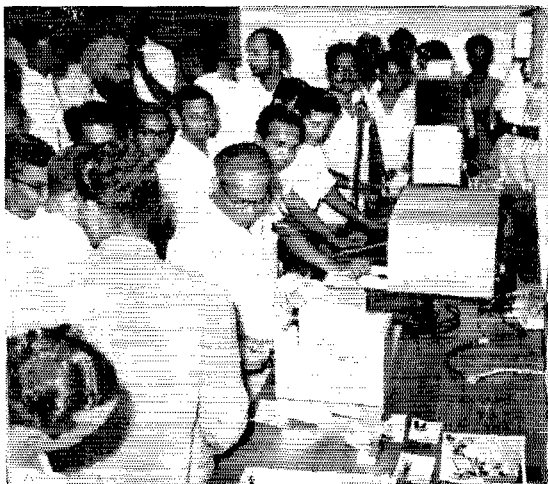



The Korean Amateur League recently opened a new headquarters station, HM0HQ, with equipment donated by Lt. General T. J. Conway, HL9KA, and Franklin Holmes, HL9KC. Shown at the donation ceremonies are officers of the KARL, representatives from the Ministry of Communication, with General Conway at the center of the photograph.

quency tone-modulated telegraphy, and frequency modulated telephony on all bands above 52 Mc.: steady unmodulated pure carrier above 144 Mc.: and, television, amplitude, width, or phase-modulated pulse on the Ultra High and Super High frequencies. Break-in may be employed as long as the station identification requirements are met. Third-party traffic is not permitted, but Hq. station VK3WIA is granted some leeway for traffic on inter-society matters.

Australian amateur stations must be operated in such a manner as not to cause interference to any other service. Should such interference occur the amateur is primarily responsible. The licensee also must accept full responsibility for any infringement of regulations or instructions caused by another Australian licensee operating his station. The station may not be operated in the absence of the owner unless he can prove to the District Radio Inspector that such operation is for the purpose of conducting legitimate experiments. The licensee may also permit unlicensed persons to talk over his equipment provided only that: he signify his presence by announcing call signs in accordance with proper procedure, he maintain personal supervision over the emissions, the transmission is conducted with decorum, and the subject matter is not that which should reasonably be conducted over a public communication system. Portable and mobile operation is freely permitted, after notice.

A log book must be maintained with entries covering the chronological record of all transmissions, the d.c. plate input to the final, the frequency or frequencies used, and, a brief description of the experiments and tests undertaken including the matter transmitted. The logbook must be made available at all reasonable times for inspectors. Inspectors may also visit stations from time to time to test equipment. Official monitors have amateur transmitters and use -AA suffix call signs to notify amateurs on the air of any discrepancies. A volunteer observ-

ing system is also in operation, similar to ARRL's official observers.

Call signs are issued systematically by states and territories using the digits zero through nine preceded by VK and followed by either two or three letters. As a consequence Antarctica uses 0, Australian Capital Territory uses 1, New South Wales 2, Victoria 3, Queensland 4, South Australia 5, West Australia 6, Tasmania 7, Northern Territory 8, and Papua-New Guinea and the other islands use 9. A.O.L.C.P. stations have 3 letter Z suffixes. Call signs are allotted to an amateur station for use only as a station identification for communication purposes. Use as an advertisement on business premises, or business letterheads, or in any way in association with business activities or interests is, therefore, prohibited, and the call may be revoked for misuse.

All calling must be kept to a minimum to eliminate unnecessary use and congestion of the amateur frequencies and a dummy antenna must be used for loading purposes. The call must be sent after each transmission along with the call of the contact. TV identifications must be both visual as well as oral. Transmissions must



A view of some of the donated equipment inside the new Korean Amateur League headquarters station. General Conway, HL9KA (left) is shown with one of the KARL officers.

DX OPERATING NOTES

(**Bold face** indicates changes since the most recent *QST* listing.)

United States Reciprocal Operating Agreements currently exist *only* with: Australia, Belgium, Bolivia, Canada, Costa Rica, Dominican Republic, Ecuador, Luxembourg, Peru, Portugal, and Sierra Leone. Several other foreign countries grant FCC licensees amateur radio operating privileges on a courtesy basis: write headquarters for details concerning a particular place.

Third-Party Restrictions

Messages and other communications — and then only if not important enough to justify use of the regular international communications facilities — may be handled by U.S. radio amateurs on behalf of third parties *only* with amateurs in the following countries: Bolivia, Brazil, Canada, Chile, Colombia, Costa Rica, Cuba, Dominican Republic, Ecuador, El Salvador, Greenland (XP calls only), Haiti, Honduras, Israel, Liberia, Mexico, Nicaragua, Panama, Paraguay, Peru, and Venezuela. Permissible prefixes are: CE CM CO CP EL HC HH HI HK HP HR OA PY TI VE VO XE XP YN YS YV ZP and 4X. **Canadian** radio amateurs may handle these relatively unimportant third-party messages with amateurs in Bolivia, Chile, Costa Rica, El Salvador, Honduras, Mexico, Peru, U.S., and Venezuela. Permissible prefixes are: CE CP HR K OA TI W XE YS and YV.

DX Restrictions

United States amateur licensees are warned that international communications are limited by the following notifications of foreign countries made to the International Telecommunications Union under the provisions in Article 41 of the Geneva (1959) conference.

Cambodia, Indonesia (including West New Guinea), Thailand and Viet Nam forbid radio communication between their amateur stations and amateur stations in other countries. U.S. amateurs should not work HS XU 3W8 or 8F. **Canadian** amateurs may not communicate with Cambodia, Indonesia, Laos, Thailand, Viet Nam and Jordan. Prefixes to be avoided are HS JY XU XW8 3W8 and 8F.

cease immediately upon hearing any distress call. Licensees must receive all requests for assistance and convey these to the appropriate authorities. They may answer distress calls only if no interference will be caused to another station dealing with the emergency.

In the event of an emergency Australian amateurs must make their equipment available to authorized agents of the Postmaster-General. If the equipment is not returned, compensation will be paid for its use. Australian stations registered in emergency networks must confine their operations to emergency work for the duration of the emergency or until released by the government.

There are currently 4869 amateur stations in Australia with 2454 licensees belonging to the Wireless Institute of Australia, the national amateur radio organization. Anyone interested in further information on Australian licensing should write to Mr. A. Seedsman, Business Manager, W.I.A., Box 2611-W, GPO, Melbourne, Australia. 



October 1940

. . . The cover and lead story this month concerned a practical amateur television project. "Television Camera-Modulator Design for practical Amateur Operation" by James Lamb, W1AL, described an economical, compact, tripod-mounted TV assembly that used the just-introduced 1847 Iconoscope . . . Don Mix, W1TS, described "An E.C.O. Exciter with 20-watts Output" — a unit which delivered power comparable to that of a power crystal oscillator and which was designed for output on 160, 80, or 40 meters . . . Donald Greek's, "A Complete Oscilloscope Using the 902" had all the trimmings to make practically any kind of measurement these handy gadgets could possibly make . . . An interesting circuit for low-power fans could be found in an article by Herbert Gordon, W1BY, "A Midget 1.75- and 3.5-Mc. 'Phone Transmitter." Self-contained, except for microphone and antenna, the rig could easily be adapted to portable work from a.c. mains . . . A portable rig was described by Wilson Jennings, W1MGK. "A Sailor's Five-Tube Station" had a two-tube transmitter and a regenerative receiver . . . For the beginner, Veru Chambers, W1JEQ, described "A One-Tube Five-Band Converter" that provided reception between 1.75 and 28 Mc. . . . A five-band exciter with push-button control was the subject of an article by Lew Bellem, W1BES, "Magnetic Bandswitching." . . . A technical story by C. V. Clarke, Jr., W5FQS, telling how to shunt-feed almost any vertical metal structure entitled "Shunt-Excited Antennas for Amateur Use." . . . Public service was reported in this issue under the title "Atlantic Coast Amateurs Render Emergency Service." Amateurs provided communications during a South Carolina-Georgia hurricane and during Virginia floods.

. . . For the second month in a row, *QST* contained "Predictions of Useful Distances for Amateur Radio Communications."

. . . The Communications Department article contest winner for this month was Dick Nebel, W2DBQ. The provocative title of his article could give amateurs of today some food for thought. "What Do You Do 'In the Public Interest' to Justify Your F.C.C. License?" 

A DX Vertical With Space Age Features

BY PERCY T. BOOTH,* W7FTA

IT WAS A RAINY AFTERNOON a couple of years ago when my friend and mentor, Dave, and I were talking in his shack. He sat back and lit up his pipe, a stack of rare-DX QSLs at his elbow. Some were strewn around the desk top, and he musingly picked one up, and replaced it, and swung around to face me.

"I never told you about the vertical I built shortly after I got back on the air after the war," he began. I noticed it was a statement, not a question.

"Nope," I said, "didn't it work?"

"Oh, it worked great! In fact, I've wished many times since that it didn't work so well."

That was a statement as confusing as the double-stacked QSO going on on the receiver in the background, so I waited for him to continue.

"You remember how it was along about that time; everybody who worked DX got vertical conscious and went nuts burying radials and bragging about how many feet of copper wire he had wagonwheeled under his antennas."

"I remember," I said. "Is that what you did too?"

"Well, not exactly," he answered, waving his hands at the cards on the table, "but here is plenty of proof of results, anyway."

He picked up the same card again and gave it another silent stare. The receiver droned on. The last two guys who had moved onto the first two were complaining about guys who couldn't find a spot without moving on top of somebody.

"All of this started with me deciding to build one of those verticals that *QST* had been plugging. There was this one they called a beercan vertical, which was a little dopey sounding, but I figured getting the material would be the easiest part of the project. This all happened before you got back on the air," Dave continued, "and while we still lived out at the old place."

* 2305 Dowell Road, Grants Pass, Oregon

As he went on, he talked a shade faster than normal and his voice seemed to be touched with excitement. I got the feeling that he was going to tell me something that he had long held in secret and was relieved that he had made up his mind to do so.

"Like I said, getting the materials together was the easiest part. It didn't take me long to find out that everybody dropping in for a visit was real eager to be cooperative by helping to empty cans.

"Laying the ends together and running a seam of solder around the rims was easy enough. I cut the tops and bottoms out of the cans to make them lighter and easier to clean. As I assembled a section on the bench about seven feet long, I decided it would be good construction to end each section with a solid can to add strength and provide a beefed-up point for some guy wires."

Dave picked up his cup and sipped at his coffee. Except for the receiver we sat in silence. Another guy had tuned up and was testing on top of the other four, who were still attempting their separate QSOs.

"I worked on the vertical in my spare time," Dave recounted, what with my job and all the other chores around the place. I built a base for it to rest on, against the side of the shack, near a window, so it would be easy to feed. Then I set a completed section on the base and climbed on the roof to survey guying points and to visualize how the finished product would look.

"While on the roof I noticed the gobs of tar and mastic I had used during past winters to stop leaks and made a mental note to pick up enough roofing paper to put on a new roof. The kids helped me some with the roof job, but it took a couple of weeks of my spare time before it was finished and I had a chance to get any more work done on the vertical. During this time the first section I had set up for a check rested in place on its base."

It was nearly dark now. Dave switched on the lights, shook a cigarette out of a pack toward me, took one for himself and I lit them both. I still couldn't figure what there was about this vertical story that made it so special and different. After a few thoughtful puffs he leaned back and continued.

"Well, after making two more sections, then joining all three, I had my twenty-one-foot vertical. It didn't weigh much and a trial showed I could raise it with one hand. I admired its neat slimness, but I figured it needed something on top to give it a finished look. Rummaging around in junk boxes I found a defunct round, copper float ball. When it was fastened in place on the top can and the entire vertical painted with a couple of coats of aluminum paint, it looked real nice. I fed it with co-ax and a tuner, at the base, and it loaded just fine, even though I hadn't as yet put down a radial ground system. That thing was really hot with r.f.!" The push-pull-parallel, out-of-phase QSO on the frequency had come to an end and an assortment of feedback, hum and

squeals, accompanied by the inevitable one-two-three-four, had taken its place.

"Conditions were good," Dave went on, "and I began to work DX right away, with good reports. Then, on a warm June evening a few days after the antenna was completed, I was on twenty c.w. I had worked several good DX catches, when the band opened up for UAs. I had worked two of them and was in QSO with a third. Signals were strong and steady and this fellow was a good operator and seemed to understand English real well. I had just started the fourth exchange, and was describing my antenna, when a blinding flash filled the shack, followed by an explosive roar. I collapsed back in my chair, at the same time instinctively slapping down the high-voltage switch. Trailing the flash and explosion was an odd tinkling sound and my nostrils filled with a peculiar odor. I sat there stunned for an instant; then my shocked senses began to recover. 'Fire!' I thought, as I leaped to my feet and dashed behind the transmitter. Something fell out of my hair and my feet crunched it on the floor. I jerked the door of the rig open, but the smoke and fire I expected to see wasn't there. Everything looked normal. Still trembling, I came back to the front of the rig and as I did so, I realized I was walking on broken glass and that it had been glass that had fallen out of my hair. The window behind my chair at the operating position was shattered. Only small pieces of glass remained hanging in the splintered sash. I ran my hands over my neck and face expecting to see blood, but there was none."

Dave stopped, fished out another cigarette and snapped his lighter at it. He was so deliberately slow getting it lit, that I realized he was watching me intently through the puffs of smoke. I guess surprise and astonishment were showing on my face, as I realized I was sitting stiffly erect, with my mouth hanging open.

"What happened, what was it?" I exclaimed, the words tumbling out in my bewilderment at this wild series of events. He took a couple of long drags from his cigarette and blew the smoke across the glowing end. I noticed that as he spoke his voice had returned to its natural pitch and tone.

"I went to the window and looked out. There in place of my vertical stood a seared and blackened pipe with its top hanging in shreds and the copper ball missing. That vertical had exploded!

Now, I had heard lots of lies and weird stories swapped back and forth, on the air and in and out of ham shacks, but this topped them all. An antenna blowing up? Before I could put another question, Dave continued.

"As I stood there, still shaking with excitement and looking at what was intended to be a simple DX vertical, I smelt that same odor drifting through the window, into my face. Then I realized what it was — the smell of burnt gasoline fumes, mixed with seared paint."

"But Dave," I cried, "If it wasn't lightning, what was it?"

He allowed a faint smile to touch his lips, at

my eagerness. "Let me tell you the rest of the story," he replied.

"You can imagine how well shook up I was by the whole business, so I shut everything down and went to the house. Fortunately for me, Betty and the kids were in town. I just didn't feel like trying to explain something that I couldn't explain to myself. I kept it quiet that night and the next morning. I wanted time to think out an answer — and think I did, all the next day at work. I had to force myself to admit that my vertical had actually exploded, but I just couldn't figure out a logical reason why.

"That afternoon as I drove home from work and entered the lane to our place, I slowed to pass three boys walking along the side of the road. As I pulled abreast of them I noticed one had carried a strange looking but familiar object in his hand. I hit the brakes to a full stop as I recognized the flattened and battered thing as the copper ball that had rested ornamentally on top of my vertical. The boys, puzzled at my sudden stop, looked at me questioningly.

"Knowing full well what it was, I nodded at the sad remains of the ball and asked, 'what you got there son?'

"'We don't know for sure,' he replied, 'we found it down the road a-ways.'

"'Where, down the road?' I asked.

"'Right near the grange hall' the kid answered turning it over with new interest, as he reexamined the piece of junk. 'Is it yours?'

"'Nope,' I lied, 'it's not mine,' as the sinking thought raced through my mind that the grange hall was nearly a half-mile from my place.

"When I got home the cat was out of the bag. My kids had discovered the scorched and shattered vertical and had told their mother.

"I tried to minimize the whole thing and stumbled through an explanation the best I could. I kept quiet about the copper ball rocketing nearly a half-mile — I felt sheepish and guilty enough, as it was.

"Looking the thing over that evening, I had to admit to myself that in some mysterious manner gasoline had gotten inside that vertical and the gas and its fumes exploded from an r.f. arc-over at the feedpoint. Then in a flash I remembered the can of gasoline I had on the roof for cleaning tools, when I did the roofing job.

"Well, that was it," Dave explained, "the kids admitted being guilty and pouring gasoline into the bottom section of the vertical."

So, what had been intended as nothing more than a low-angle vertical for DX, had actually become an unintentional but successful rocket launching. I supposed that was the end of Dave's weird story, but before I could open my mouth to comment, he held up a palm toward me and went on.

"I went back to the old two half waves in phase for twenty. DX conditions were still good and I made a lot of contacts. The second evening after the demise of my vertical, I heard the same UA calling me, that I had been working at the very time of the explosion.

"I gave him a call and he explained that he had been puzzled as to what had happened that evening, because my sigs had been so solid and had stopped so abruptly. I described what had happened and gave him a brief rundown on how the vertical had been built.

"The next evening he was on the same frequency and we carried on for nearly an hour, mostly about my vertical. He asked a lot of questions and seemed keenly interested.

"The next evening and the next after that, we made contacts and I began to get the feeling that he was waiting for me on the frequency. By that time I had given him every detail, from the first soldered seam, to the finding of the copper ball. Then our contacts ended. But later on, I did get a nice QSL card from him."

Dave laid a finger on the receiver tuning knob and carefully peaked the incoming signal, although I knew by the distant look on his face he wasn't hearing a word of what was being said.

I felt he had something more to add to his story, but I was at a complete loss to understand what more he could possibly add to this puzzling chain of events. He turned and stared silently at

a point on the wall, over my head. I waited for him to continue.

"You remember," he finally went on, "when Russia put their first satellite into orbit? That was in 1957."

"Well," he measured his words slowly, "as I read the newspapers and listened to the news accounts, there was a vague and elusive something that kept bothering me. I got the odd feeling that I knew something about their orbital launching that had not been mentioned in the news items. Then one evening, listening to a commentator talley off the number of orbits, it flashed through my mind like an arc-over — the connection I had been searching for.

"I leaped from my chair, dashed to the shack and drug out my box of DX QSLs. My hands were shaking as I shuffled through the cards, until the one I was searching for, came to the top. There it was, just as I knew it would be!"

Dave picked up the same card he had toyed with and held it out for me to read, with his finger pointing to the lower right hand corner. The card was a plain one-color one — a UAB. My eyes followed his pointing finger. There in the usual place, I read 'Stn. op. Ivan Igor Sputnik.' 

• New Apparatus

Antenna Baluns

SEVERAL weeks ago a local amateur called Headquarters with a problem: when he tried to tape the coax feed line from his two-element tri-band beam to his tower, his s.w.r. would go from 1.2:1 up to nearly 8:1. Also, he noticed the antenna had little or no front-to-back ratio. He was feeding the beam directly with 52-ohm coax, so it seemed a good bet that r.f. currents flowing on the outside of his coax were upsetting the tuning of the beam. This seemed a good chance to test theory, so a balun was installed to provide a proper balanced feed for the driven element. Sure enough, the balun solved the problem, for taping the coax to the tower now had no effect at all on the s.w.r., and the front-to-back ratio became something like it should be.

Feed-line radiation can not only make the transmitter hard to load, but will also upset the radiation pattern of the antenna.¹ In the past amateurs have had to live with these problems, because a broad-band balun constructed from coil stock heavy enough to handle power was a large item — hard to mount on a beam, and almost impossible to support at the center of a dipole. Resonant coax baluns are easy to use at v.h.f., but for the lower frequencies their length is often nearly as great as that of the feed line itself. Furthermore, they are good for only one band, which prohibits their use with multi-band antennas.

Recently, toroid cores have become available that will handle large r.f. powers, making it possible to construct physically small broad-band baluns. These baluns can be wound to provide either a 1:1 or 1:1 configuration for transforming unbalanced feed to balanced, or for impedance matching.²

W2AU Baluns

W2AU's baluns are constructed so they may be used directly to replace the center insulator of a dipole. There are two models, one to match 50- or 70-ohm coax to 50- or 70-ohm balanced loads, and the other to match 50- or

¹ AlCoCo, "When Is A Feed Line Not A Feed Line?" *QST*, August, 1965.

² Turrin, "Broad-Band Balun Transformers," *QST*, August, 1964.

70-ohm coax to 200- or 300-ohm balanced loads. The coax feed line is connected to the bottom of the balun unit with a standard 80-230 coax connector.

The toroid transformer is mounted in a heavy-duty plastic case rated to take 650 lbs. of pull on the two eye-hooks that hold the antenna wires. A third hook is provided to support the center of the antenna. Two holes at the bottom of the balun provide "breathers" so moisture that forms inside the unit can evaporate. If this balun is to be used with a beam, it should be mounted so these breather holes are correctly oriented. All the hardware is stainless steel, and the strap that runs the length of the unit is for

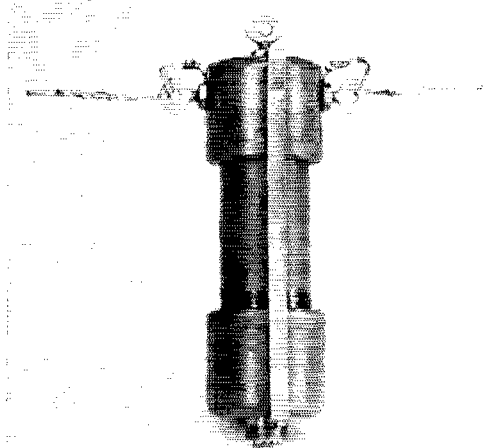

The W2AU balun. The antenna wires are fed through the eye bolts for mechanical support and then soldered to the lugs for electrical connection.

lightning protection. The lightning gaps are factory adjusted so any static electricity that builds up on the antenna is passed to the braid of the coax feed line. To insure proper operation of the arrester the coax braid must be grounded before it enters the shack. The manufacturer is Unadilla Radiation Products, Unadilla, New York, and the price class for either unit is \$13.00.

The Fugle Tenna-Bals

Fugle's antenna baluns are by far the smallest units we have seen — a cylinder only $1\frac{1}{4}$ inches in diameter and 4 inches long — yet they are rated for a full kilowatt. The Tenna-Bals are available in two models which take 52- or 72-ohm coax and provide either a 1:1 or 4:1 impedance ratio.

The frequency range of both models is 3-30 Mcs. Terminal studs are used for attaching the feed line and antenna. The price class for either unit is \$10, and the manufacturer is Fugle Labs, 1835 Watchung Ave., Plainfield, N. J.

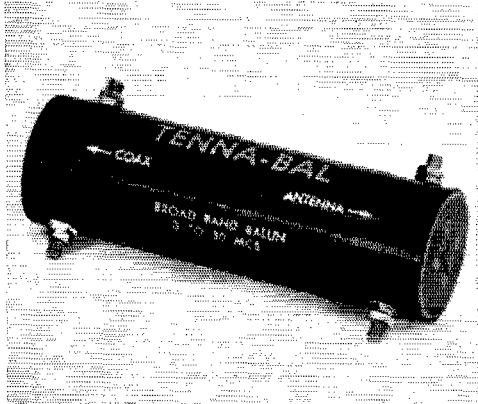

The 4-ounce one-kilowatt balun by Fugle Labs.

Hy-Gain Baluns

The Hy-Gain baluns are all 1:1 transformer types rated for 2-k.w.p.e.p. and intended to be used with 53-ohm coax. The BN-12 and BN-24 baluns are for use with beams and are constructed in a 4-inch-diameter cylindrical container that mounts directly on the boom. An SO-239 coax receptacle is used for the feed-line connection, and bolt terminals connect the balun to the drive element. Short connections should be used when connecting the balun to the antenna as these

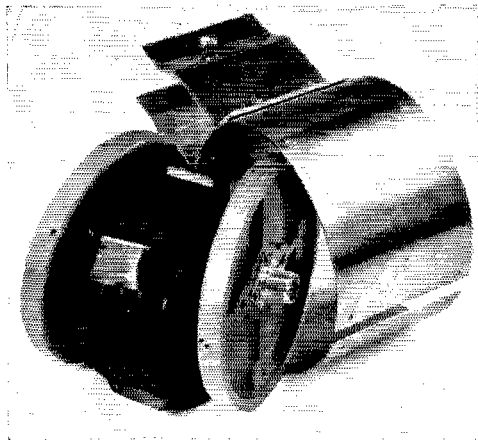

The Hy-Gain BN-24 balun for use with beams, disassembled to show construction.

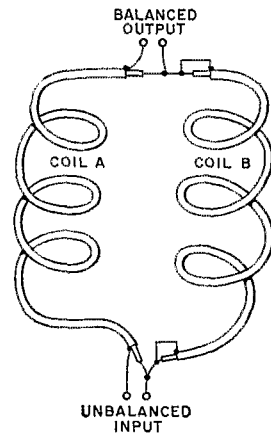

Fig. 1—Two tightly-coupled coils of coax connected to provide an unbalanced to balanced transformation.

leads become part of the driven element. In some cases the element length may have to be readjusted for proper operation. The BN-12 is used for frequencies between 13-30 Mc. and the BN-24 for 7-15 Mc.

Another balun, the BN-48, is available for use with dipoles. It is used as the center insulator of the dipole on any frequency from 3 to 30 Mc. Eyebolts are used for connecting the antenna wires to the balun itself. This balun is constructed differently from the beam-type unit shown in the photograph. The coils of coax in this model hang below the insulator, with the ends terminated inside the insulator block.

The Hy-Gain baluns differ from the other two described in that non-resonant lengths of coax are used rather than toroid transformers. The coax is connected as shown in Fig. 1. The r.f. flowing in the shield of coil A forms a magnetic field that is opposite in polarity to the field of coil B. The two coils are tightly coupled together so the fields cancel, and the shield braid of the feed line receives no r.f. currents. The coils are not resonant so, they will cover a range of frequencies.

The price classes are: BN-12 and BN-24 \$14.00, and the BN-48 \$16.00; they are made by Hy-Gain Electronics Corporation, Lincoln, Nebraska.

— W1KLLK

Strays

Stolen Equipment

Project Oscar reports that during the first weeks of August, thieves broke into the Project Oscar Hq. building at Foothill College, Los Altos Hills, California. Reported missing is a digital-tuned R-391/URR receiver, serial number 087. Any information as to the whereabouts of the equipment should be reported to Project Oscar, or to the local office of the F.B.I.

Important postal changes in handling second-class mail matter are now in effect. Please advise us direct of any changes of address. Four weeks notice is required to effect change of address. When notifying, please give old as well as new address. Your promptness will help you, the postal service and us. Thanks.

The Last Cruise of "Big Mamie"

Amateur Radio Aboard the USS Massachusetts

BY STIRLING OLBERG,* WISNN

DURING the week of June 7 to June 12, 1965, the *USS Massachusetts*, BB59, a decommissioned World War II battleship, made a cruise to its final resting place in Fall River, Mass., where it will be used as a memorial and museum honoring World War II comrades who have fallen.

"Big Mamie" was back in Massachusetts through the efforts of some of the original crew and the help of Massachusetts school children. Mr. Edward Palmer, a former crew member who started the move to save the ship from the scrap heap, was on board and we saw his efforts realized when he was given custody of the ship at the Portsmouth Naval Shipyard.

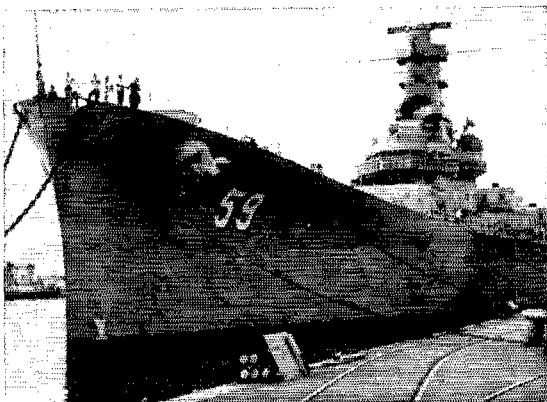

The *USS Massachusetts*, BB59. During World War II, "Big Mamie" had a crew of 2400 men; 26 men handled her during her final voyage. (Photo by K1HYI)

A crew of 26 was selected and was made up of memorial-committee members and some of the former crew. All were warned that it would not be a joy ride, hard work had to be done during the five-day cruise. Originally Big Mamie was powered by 4 turbo-electric engines which delivered 78,000 horsepower each. However, for the homeward journey only the muscle of our crew would do since the ship was totally dead and had to be towed all the way. Cooks, signal men, former officers all turned to and handled lines, painted, and did general work.

Before leaving Portsmouth I hauled aboard my amateur radio gear; an HIT-30, Drake 2-B and a 1200-watt alternator. I immediately set about assembling the station which entailed hoisting antennas on the signal halvyards. I ended up with a questionable variety of inverted Vees with the centers up over a hundred feet! The surrounding steel super structure didn't seem to interfere with my signals.

* 54 Linda Avenue, Framingham, Mass. 01706

The author was assigned to the battleship *Massachusetts* during her construction in 1942. Here he describes amateur radio activities, the only communications aboard, during the ship's final voyage from Portsmouth, Virginia to Fall River, Mass.

A second station, K1HYI (Sheldon Titcomb) also operated aboard the ship during the cruise and we shared the business of traffic and contacts. Schedules were kept with K1CQO, W1NXY and WA1BKQ, and we handled ship's traffic, liaison with the military, and kept the crew in contact with their families and the captain in constant communication with the Memorial Committee at Fall River. W3AWS and W2GB did a great job maintaining a clear channel for us. In fact, it was a pleasure to watch the cooperative spirit of ham radio at work in this regard. It made quite a favorable impression on the press, TV, and radio, all of which were monitoring and reporting on the operation.

We closed down the radio stations for the last time by including in our sign-off the ship's now-silent call, NEPL. All those who contacted the ship will receive special QSL cards made from original naval-log sheets which were printed on the *Massachusetts* during the war years.

Special thanks go to the Air Force State Mars Director (Mass.) John Szretter, K1NAY who, along with K1FWA, provided much of the equipment for the trip.

QST



The author, W1SNN, operating aboard the battleship, *Massachusetts*. The crew really roughed it as water was for drinking only during the 5-day cruise! (Photo by K1HYI)



NSS guest operators and active duty Navy personnel gather together for a group picture at the close of the Armed Forces Day Communication Tests.

Armed Forces Day—1965

Communication Test Results

THE annual Armed Forces Day communication tests conducted by the Army, Navy and Air Force on 15 May 1965, were evaluated as being highly successful.

Four military radio stations, WAR (Army), NSS (Navy) and AIR (Air Force) located in the Washington, D. C. area and NPG (Navy—San Francisco) participated in the communication tests which included military-to-amateur crossband operations and receiving contests for both c.w. and RTTY modes of operation.

Crossband Results

WAR, NSS, NPG and AIR had a combined total of 8431 contacts during the twelve hours and forty-five minutes devoted to the military-to-amateur crossband portion of the communication tests. Commemorative QSL cards have been mailed to all contacts that could be identified in the Spring 1965 issue of the *Callbook*. Any amateur who has not received a QSL card confirming his contact should address a request for clarification to the Armed Forces Day Contest, Room 5B960, the Pentagon, Washington, D. C. 20315. This request must include the amateur's call sign, the station worked, time of contact and the frequency utilized by the military station.

C.W. Receiving Contest Results

There were 632 perfect entries for the 25-w.p.m. c.w.-broadcast message originated by the Secretary of Defense. The complete text of the 25 word-per-minute Morse Code Message is printed below followed by the call signs or names of individuals who received a Certificate of Merit for submitting a perfect contest entry:

ARMED FORCES DAY OBSERVANCE PROVIDE THE DEPARTMENT OF DEFENSE AN ANNUAL OPPORTUNITY TO REPORT TO THE NATION AND THE PEOPLE OF THE WORLD THE DEFENSE CAPABILITIES AND READINESS OF OUR ARMED FORCES PD THESE OBSERVANCES ARE A DYNAMIC DEMONSTRATION OF THE UNITY CMM INTERDEPENDENCE AND CLOSE WORKING RELATIONSHIPS WHICH EXIST IN THE ARMED FORCES CMM THEIR RESERVE COMPONENTS AND AUXILIARY ORGANIZATIONS AT ALL ECHELONS PD THE PRODUCTIVE

EFFORTS OF RADIO AMATEURS IN THE FIELDS OF RESEARCH AND DEVELOPMENT CMM EMERGENCY COMMUNICATIONS CMM AFFILIATION WITH ARMED FORCES TRAINING PROGRAMS CMM AND FURTHERANCE OF INTERNATIONAL UNDERSTANDING CMM ARE TANGIBLE AND VALUED CONTRIBUTIONS TO THE SPIRIT OF UNITY AND PREPAREDNESS WHICH COMPLEMENTS AND EXPANDS OUR TOTAL RESOURCES FOR PEACE PD AS SECRETARY OF DEFENSE I AM PLEASED TO ACKNOWLEDGE THE ACCOMPLISHMENTS OF RADIO AMATEURS WORKING TOGETHER THROUGHOUT THE FREE WORLD CMM AND TO WELCOME YOUR PARTICIPATION IN THESE 16TH ANNUAL ARMED FORCES DAY ACTIVITIES Sgd ROBERT S. MCNAMARA CMM SECRETARY OF DEFENSE"

C.W. Certificate Winners:

K1AAA, W1A1GT, W1AJJ, K1AKK, W1BDI, W1BKQ, W1RXH, W1C8T, W1CRK, K1CUE, W1DMD, W1EYP, K1GGG, W1GQY, W1GZQ, W1HJP, W1HIB, W1IWX, W1JNA, W1LZL, W1MCC, W1MEG, K1NOW, W1OMN, K1QDN, W1QHP, W1QKX, W1RAN, W1RST, K1RTM, W1SAD, W1SGU, W1SRM, W1TO, W1UPF, W1UPG, W1WFF, W1ZLX, K1ZND, WA2ALZ, W2AMG/4, W2AAAH, W2AVK, K2BDI, W2BVE, K2BVS, W2BZA, W2CDJ, WA2CKL, WB2DLW/4, W2EAF, K2EQP, WB2EUH, WB2EVA, WA2EXP, WB2FGQ, WB2FHH, WB2FFG, W2FWQ, WA2GDZ, W2GKM, W2GMM, W2GOR, W2QQN, W2HGY, WB2ILQ, WB2ILY, WA2IOG, K2ISX, W2LXB, WA2JAN, WB2JMY, WB2JWC, W2JZG, W2KLD, W2KRK, K2KSH, WA2LGX, WA2LHV, W2LRW, W2LYH, W2MTA, W2MIZB, WB2NDI, WA2NGP, WB2NYK, WB2ODX, K2OFV, WB2OJM, WA2PHH, K2QDC, W2RJ, W2RN, K2RQT, W2RUK, K2SEN, WB2SXX, WA2TNT, W2TSD, K2UGZ, WA2UPC, W2VEH, WA2VSQ, WA2VYS, K2YQR, W2ZMK, WA2ZQH, W2ZUX, W3ABZ, W3AEA, WB3AEJ, W3AEL, W3AG, W3BFF, WA3CGE, W3DZL, W3EFH, W3ELL, K3EMA, W3EOV, W3ENK, W3FKG, K3GOH, W3GRB, W3GUS, W3GVR, W3HTZ, W3IDO, W3IRS, W3JFT, W3JHR, K3JQB, W3KSL, W3LYV, W3MCO, K3MQE, W3MWF, K3NAS/6, W3NHX, K3ODA, W3OY, W3RDF, W3RMI, W3UQX, K3USH, W3UVV, W3VWH, K3WNL, W3WZC, K3ZMH, W4A1Y, K4AO, K4AWY, W4AX, W4ABAW, W4BBZ, W4BP, W4BZW, W4CAL, K4CBV, W4CCC, W4CH, W4CTD, W4CXY, W4CZ, W4DAP, W4DDQ, K4DNZ, W4DRD, W4ERH, W4EFV, W4EJU, K4EOF, WA4ESL, K4FEC, K4FZM, W4HAM, K4HOE, W4HOS, W4IFI, K4IFB, WA4IIG, W4IMC, WA4IWO, W4IYT,

W4JJU, K4JJZ, W4JRA, W4JRU, K4JXG, WA4JWV, K4KCS, W4KFC, WA4KFN, K4KH, W4KIS, W4KR, W4MHW, W4MIU, W4MISS, K4INC, W4NPG, W4NTE, W4NVD, W4NZP, K4OLG, W4ONC, W4OSC, W4OZB, WA4PWF, W4PRC, W4RHZ, W4RQB, W4RXC, W4SCF, W4SLJ, WA4TFS, W4UGG, W4UHA, W4UUI, K4VDL, WA4VKG, WA4VPO, WA4VWY, WA4VYZ, K4YSJ, WN4WCJ, K4WH, W4WHF, K4ZCH, W5AHC, W5AJG, W5AQN, W5ARK, K5AVR, W5BCF, W5BUE, K5CAT, W5CCF, W5CEZ, W5ACTW, W5CFE, W5DKD, W5EDM, W5EJV, W5AEQQ, W5EWF, W5FIU, W5GRT, W5HFN, K5HYR, WA5JDR, W5JGK, K5JGZ, W5JPC, W5KR, W5KYM, W5MCX, W5MFX, W5MIIB, W5NDV, W5NFC, W5NNA, W5NXZ, W5OVJ, K5PEV, W5PVE, W5RCF, W5RIH, K5SGX, W5SM, W5USA, W5PY, W5WD, W5YAX, K5YKS, W5ZU, W6AAQ, W6AEE, W6AGO, W6AHZ, W6AGQ, W6AXV, W6BGF, W6BHG, K6BHI, W6BZY, K6CB, K6CIO, W6CGJ, W6CKU, W6CLB, K6CME, W6CUF, W6CWR, W6BDPV, W6BDY, K6DV, W6DVD, K6DYX, K6EA, K6EPT, W6EY, W6FB, W6FHI, K6FL, W6FLW, W6FNG, W6GFM, W6GFA, W6FYW, W6FZC, K6GCD, W6GCG, K6GN, K6GS, W6GYH, W6HPZ, K6HOR, W6HIO, K6HJ, W6INI, W6INV, W6IQ, W6IWS, W6JSA, W6JXK, W6KF, W6KGG, W6KZI, W6LMC, W6LWQ, K6MBP, W6MFI, K6MIH, W6MLZ/4, W6AMQZ, W6MNR, W6MIY, W6MXX, W6NJI, W6NRK, W6BGO, W6OET, K6OGE, W6BOJC, W6OJW, W6OKC, W6OWP, W6PCP, W6PLS, W6QFE, W6QIL, W6QQ, W6QWQ, W6RDK, W6RFF, W6RMI, W6ROU, W6RT, K6RXK, W6RXT, W6SAW, W6SCQ, K6SHZ, K6SKT, W6SLU, K6TWE, W6TZD, W6UWV, W6VEB, W6VMD, W6VPV, W6VUE, K6VAH, W6WAW, W6WIL, W6WLL, W6WNG, W6WNZ, W6WFF, W6YDK, K6YKG, W6A9QS, W6A9ZA, W6ZPX, W7ADY, WA7AFQ, W7AGA, W7ARS, W7BAJ, WA7BEV, W7BJY, K7BKN, K7BPT, W7CO, W6CWN, W7CZY, W7DKB, W7ECC, W7EYF, W7FLX, W7FOS, W7GVG, K7GXO, K7HFT, W7HVL, W7HWD, W7JLU, W7JMH, W7JX, W7KQV, K7KYG, W7KYY, W7LFA, W7LPM, W7LZJ, W7MAE, W7MIC, W7MKW, W7MME, W7NWG, K7NWA, W7CEB, W7OCX, W7PUL, W7VPF, K7QBI, W7RDE, W7SMR, W7TSM, K7YDQ, K7VJU, W7VM, W7YDP, K7ZMR, K8ANV, W8AQ, W8BAG, W8BQK, W8BTW, W8CBN, W8CHT, K8COU, W8CX, W8CYN, W8DAE, W8DGP, K8DIU, W8DJD, W8DSX, W8DYY, K8EQN, W8FFK, W8FLA, W8GLX, K8GVY, W8HCR, K8HKU, W8HSW, W8HZA, W8IBB, W8JLV, W8IRN, W8JG, W8JUE, W8KIR, W8LV, W8JBQ, W8KJP, W8KKD/5, W8KPO, W8LEX, W8NEM, W8OMY, W8PHM, W8QLL, W8QMI, W8RLR, K8RYU, W8SQU, W8SRU, W8SS, W8TIF, W8TZO, K8VWN, K8VER, W8VMP, W8VZ, W8ZCW, K9ALH, W9AJF, W9AVO, W9BCJ, W9BML, K9BRL, W9CF, W9CHD, W9DGA, WA9DHI, K9DML, W9EGR, W9ECC, W9EEP, W9ERW, W9FKH, W9GCX, K9GDF, W9GFF, W9HJM, W9HUZ, W9HTO, W9HVP, W9IDO, W9IDY, W9IYO, W9JOT, W9KID, WA9KJJ, WA9LOI, WN9MIY, W9NXG, W9ONI,

W9OVF, W9PDK, W9TGB, W9VHD, K9WAP, W9WNB, W9YPO, WA0AAL, WA0AYL, W0BHA, WA0BIT, WA0BPE, WA0BSE, W0CUC, W0DDV, W0DVJ, W0ECE, W0FA, W0FDJ, WA0GDW, W0GRW, W0HXB, WA0IFI, W0IH, W0JHS, W0JHY, K0JPJ, W0KIS, WA0KWE, K0OJQ, W0QVA, W0RGS, W0TBL, W0TKX, W0USL, W0VBK, K0WMD, W0WVI, K0VWL, K0YTA, W0ZWK, DI4OS, KG6CG, KH6AO, KH6AX, KH6BGW, KH6DQW, KH6ELW, KH6ET, KH6EWA, KH6FX, KL7DG, VE2ZK, VE7BV.

Archer, F. O., Sr.; Aylsworth, Richard L.; Bean, Joseph R.; Call, Brian; Castleman, O. R.; Chenoweth, C. E.; Coen, John; Criswell, B. J.; Daniel, D. L.; Easter, A. D.; Ellis, B. G.; Farmer, M. W.; Faulk, G. R.; Feltz, J. E.; Ferguson, Don P.; Fisher, James F.; Ford, G. L.; Frye, J. L.; Gibson, J. V. C.; Grimes, B. L.; Hadfield, J. Jr.; Harris, Frederick; Hinkel, John; Holmes, H. R.; Ilunepohl, J. L.; Johnson, Jerrey; Joiner, Robert J.; Kelley, J. E.; King, M. H.; Lambert, R. N.; McLamb, W. B.; Miller, J. D.; Moses, E. S.; Patrick, Walter A.; Pfeiffer, L. K.; Probst, D. L.; Radio Gang USS Permit (SSN-594); Radio Gang USS Tattnell (DDG-119); Rice, C. R.; Rosenberger, Jerome D.; Rylant, H. D.; Scherek, J. P.; Schupp, Donald F.; Stetz, H.; Stewart, J. E.; Swearingen, Richard J.; Syriac, Richard; Thompson, R. L.; Prowbridge, O. H.; USS Shangri-La (VA-38); White, T. P.; Wood, J. B.; Woodard, M.; Communications Officer HQ GP 100, Civil Air Patrol, Wallingford, Pa.; 16th Special Forces Group, 1st Special Forces, Charleston, W. Va. (SFC Douglas T. Davis).

RTTY Receiving Contest Results

There were 422 perfect entries for the 60 w.p.m. RTTY Broadcast Message originated by the Secretary of Defense. The complete text of the 60 word per minute radioteletypewriter message is printed below followed by the call signs or names of the successful participants who received a Certificate of Merit for submitting a perfect contest entry:

"THE WHOLEHEARTED SUPPORT OF THE AMERICAN PEOPLE IS BASIC TO A STRONG DEPARTMENT OF DEFENSE. SUCH SUPPORT REQUIRED KNOWLEDGE AND UNDERSTANDING OF WHAT THE DEPARTMENT IS DOING AND WHY IT IS DOING IT. ANNUAL ARMED FORCES DAY OBSERVANCES FILL THIS REQUIREMENT IN THE FORM OF A REPORT TO THE NATION AND THE PEOPLE OF THE WORLD ON THE ARMED FORCES DEFENSE CAPABILITIES AND READINESS. THESE ANNUAL OBSERVANCES DEMONSTRATE THE UNITY, INTERDEPENDENCE AND CLOSE WORKING RELATIONSHIP EXISTING IN THE ARMED FORCES, THEIR RESERVE COMPONENTS AND AUXILIARY ORGANIZATIONS AT ALL ECHELONS.

RADIO AMATEURS THROUGH THEIR PRODUCTIVE EFFORTS IN THE FIELDS OF RESEARCH AND DEVELOPMENT, EMERGENCY COMMUNICATIONS, AFFILIATION

This is the combined group of Army and Air Force operators who manned WAR and AIR networks from the Headquarters, MARS, station on the Concourse of the Pentagon. Front row (l to r): WN4YNG, W8JUW, SMGT Leon Sarkesain, A2C Robert McKenna, W3TMM, K4KNV, W4IYR, W4DIN, K4GFM, A2C Angel Rodriguez-Jimenez, SSgt. David Riley, WA2KGN, Sgt. David Hunt, W4PTI, Second row: SSgt. Aron Scott, W3MVB, WN4YST, W8PAC, WN4YZL, WN4YZV, PFC Richard Baker, WN4YNG, WA5HKG, PFC Kenneth Green, SSgt. George Mondichak, Jr., Sp/4 Mario Sasso, KH6EGS. Assisting in the operation but not pictured were W4LWG, Mrs. Ruth Mills, Jackie Johnson, SFC Roy Snyder, and Robert Mervis. (All of the photographs in this article are Official U. S. Navy Photographs by D. S. Peterson, Ph1, USN.)





Manning the NSS RTTY position is ARRL President Herbert Hoover, Jr., W6ZH (seated left) and Ed Clammer, K3GIF. Looking on is Captain W. D. Owen (standing left), Commanding Officer of Naval Communication Station, Washington, D. C. and Captain John R. Wadleigh, Director of Naval Communications.

WITH ARMED FORCES TRAINING PROGRAMS, AND FURTHERANCE OF INTERNATIONAL UNDERSTANDING, HAVE MADE TANGIBLE CONTRIBUTIONS TO THE SPIRIT OF UNITY AND PREPAREDNESS WHICH STRENGTHEN OUR RESOURCES FOR PEACE.

AS SECRETARY OF DEFENSE I AM PLEASED TO ACKNOWLEDGE THE ACCOMPLISHMENTS OF RADIO AMATEURS WORKING TOGETHER THROUGHOUT THE FREE WORLD, AND TO WELCOME YOUR PARTICIPATION IN THESE 16TH ANNUAL ARMED FORCES DAY ACTIVITIES, SIGNED ROBERT S. MCNAMARA, SECRETARY OF DEFENSE."

RTTY Certificate Winners:

K1AAA, WA1AGT, K1BIM, W1HJP, K1HNN, K1KOT, W1MCG, K1OCS, W1OMN, K1OOZ, K1OQC, W1QKX, K1QLO, WA2ASM/4, K2AXM, W2BGA, W2BLV, W2BVE, W2BXXW, K2BZK, K2DAC, W2DLT, WB2ERO, WA2EXP, WB2FNG, W2GOR, W2GQN, K2GYX, W2ISK, W2JAV, W2KCK, WA2KND, W2KQZ, W2LBO, WA2LKF, W2LKP, W2LNP, W2LRW, W2LVW, K2MWN, W2MIZB, WA2NQR, W2NRY, W2OKO, W2ORX, K2RJJ, K2SBD, K2SQL, W2SUH, W2SUR, W2TAM, K2VAM, K2VRK, K2YQK, WA2YZN, W2ZSJ, K3ADS, W3AVQ, K3BHK, W3CRO, W3DJZ, W3DNN, K3ECF, W3EOV, K3GBV, W3HID, K3HJJ, W3ILL, K3JDF, W3LLI, K3LTI, K3LVJ, W3MHD, K3MMA, K3MNC, W3MWV, K3MYM, K3NKL, W3NNV, W3NSI, K3NYA, K3RCM, W3RDF, W3RTR, W3SFF, W3TDU, K3TZY, W3NUCY, W3UQX, K3UWJ, K3UWL, K3VIK, K3WEE, W3WUX, K3YGS, W3ZIV, W3ZVJ, W4AKB, W4AWY, W4BCO, W4BOC, W4CAL, W4CCC, K4CHE/6, W4CQI, K4CUW, WA4DQ, K4DSI, W4DYE, W4EBH, K4EBQ, WA4EHAL, WA4EPZ, K4FEC, W4GJI, K4GJV, W4GWF, W4HHH, W4HHI, W4IBI, W4IMZ, W4IPL, K4ITB, W4JUJ, K4JXG, K4CKS, W4KH, K4KKZ, W4KR, W4KSA, W4KZL, K4KZR, WA4LDJ, WA4LFW, W4LPR, K4LRY, K4LVA, W4MGT, K4MKO, WA4MSS, WA4NLA, W4NZP, K4OHL, WA4OOR, W4OZB, K4PAN, K4PEQ, WA4PNJ, W4RQB, W4RSE, W4RWM, W4RXE, W4SCF, WA4THS, WA4TLM/2, WA4TPT, W4TQD, K4UMK, W4UWH, W4VBD, K4YDM, WA4YYZ, W4WRN, W4WUX, W4YOA, W4YSU, W5AGS, W5APM, W5ARK, W5BUT, WA5BPM, K5BVS, K5BYF, WA5CON, W5EDZ, W5PEM, K5GEI, W5GIQ, W5GMM, K5GNE, K5GVV, W5HFN, K5JQC, K5JNW, W5JPC, K5LEP, K5MBA, W5NFC, K5OLU, W5PPB, W5QJD, W5RCF, K5SDM, K5SGX, K5TUP, W5UNK, W5USA, K5UTE, W5VJ,

W5YAX, W5YIJ, W6AEE, WA6AGA, WB6AGM, W6AJJ, WB6AQR, K6ARR, WA6BBL, W6BHG, W6BIG, W6BIK, K6BPT, W6CBF, WA6CDV, WB6CYP, W6DOU, WB6DRY, K6DYX, WA6ECE, W6EGZ, K6EPT, W6EYZ, K6FL, W6FLW, K6GKX, W6GGW, W6GYH, WB6HAW, W6HTO, WB6HZH, W6JDN, W6JYZ, WB6KCH, W6LFF, W6LVQ, K6MDD, WB6MHO, WA6MSN, W6MTJ, WA6NDZ, WB6NJH, W6NRK, W6NSS, K6OBM, K6OEH, W6OEN, W6OJF, W6OQI, W6OWP, W6PDD, WB6PDJ, W6QIF, W6QKN, WA6RBT, W6RCR, K6SBL, W6SCQ, K6SEA, K6SHZ, W6TFH, W6VGE, W6VUE, WA6VVR, K6WBC, W6WLL, W6WOC, W6YDK, WA6YSE, W6ZEY, W6ZFN, W6ZFT, W7ARS, W7BEG, W7BSW, W7CTK, W7EQ, W7GVG, W7IGW, W7IGY, K7IND, W7JFU, W7JMH, K7KBS, W7LPM, W7MAE, W7MCU, W7MEV, K7NHO, W7PHG, K7PLR, W7PRG, W7TCT, W7TMA, W7TYR, K7UHO, W7VKO, W7VPH, K7WTC, WA8BOT, W8BTW, W8CJD, W8CXD/4, W8DBR, K8ECK, W8FEU, W8GKN, W8GUL, K8GVY, W8HYX, W8LJV, W8IMK, WA8IMY, W8IOV, K8IPN, K8IUD, WA8JGE, W8JGI, W8KJK, W8LEX, K8LGI, W8MBB, K8MYF, W8OEM, W8OMY, W8REE/4, W8SWC, W8TZO, K8UYM, W8VMP, K8WGJ, K8YJQ, W8ZEP, K8ZDR, K8ZPR, W8ZYW, W9AZW, K9BPO, K9BRL, W9DGA, W9DGV, K9DXB, W9EPT, K9EWJ, K9HEL, W9HRH, WA9KEJ, K9OUN, K9QYY, W9RDJ, W9ZCG, K9AAR, W9BHA, K9BRS, WA9BSZ, K9CGP, W9DEL, WA9FOV, WA9GTT, K9CXL, W9HHS, K9HZO, K9IAY, K9QVY, K9HTF, K9HPQ, K9IQR, K9JAY, W9JHY, W9KIS, K9KTM, K9LFL, W9LQV, K9MAL, K9PHD, W9QHB, W9RX, W9TBL, W9WMI, W9YPT, F3PI, KG4CG, KH6EM, KL7BIL, TG9AD, VE3BNV, VE3IR, Benner, K. J.; Bloom, B. M.; Call, B. D.; Cieslik, Roger N.; Doud, Martin; Ely, H. O., Jr.; Fariella, D., Jr.; Geisler, Martin; Goodman, David J.; Griffith, Carl T.; Hadfield, J., Jr.; Harris, Frederick; Holland, Earl W.; Holt, R. V.; Hughes, W. L.; James, P. N.; Johnson, John A.; Kimerer, Glen; Kisch, R. A.; Ledbetter, Robert P.; McGuil, F. A.; Menadier, P. T.; Murphy, R. L.; Patchel, F. L., Jr.; Peters, R. G.; Radio Gang, USS Tatnall (DDG-19); Rice, C. R.; Sandquist, Harry N.; Siehra, J. N.; Tyndall, Billy K.; USNRTC, Bangor, Maine; USS Coates (DE-65); USS Shangri-La (CVA-38); USS Orion (AS-18); U. S. Naval Reserve Surface Div., Redding, Calif.; 16th Spec. Forces Group, 1st Spec. Forces, Charleston, W. Va. (SFC Douglas T. Davis).



Harold Wilcox, W4OP (left) and Karl Medrow, W3MCG operate NSS c.w. positions as guest operators.

How's DX?

CONDUCTED BY ROD NEWKIRK,* W9BRD

How?

Yes, conditions *must* be rapidly improving with the increasing sunspot count because those DX casuals are flocking back. . . .

Workers of DX may be divided into two general classifications: casuals and diggers. DX diggers are chaps who rarely work anything else. Years of poor short-wave conditions hardly faze them. They're always found scrounging around in the noise level under the umpteenth QRM layer whatever the propagation situation may be. They stick with the hunt under any circumstances from handpicked mountaintop locations to cellar shacks with indoor-antenna restrictions.

Casuals, on the other hand, show up in force only when DX conditions are favorable. When strengthening DX signals start to interrupt their rag-chews and answer their routine CQs they find themselves suddenly worrying about tardy QSLs like the rest of us. Some of these innocents will become addicted diggers themselves in time, mortally jabbed by the DX bug.

The "How's" mailsack confirms that DX casuals are making another comeback. They're bringing with them the usual questions that occur to lads who log their first batches of Europeans plus a rarer catch or two. Might be a good idea to try to anticipate some of their problems and inquiries here and now. A few random but important considerations any W/K DX worker should have in mind:

Keep appropriate self-addressed stamped envelopes on file with your call area ARRL QSL Bureau Manager. He's listed in most QST's.

Don't expect a DX station to QSL you direct, even if you QSL him direct, unless you defray his cost of mailing (by providing International Reply Coupons, etc.). There are simply too many of you and too few of him.

When QSLing overseas stations direct, deal in two-way airmail only. Surface (ship) mail transit time is usually excessive.

You will find that overseas stations sometimes have their QSLing handled through other stations by voluntary arrangement. Unless specifically waived, the usual s.a.s.e., etc., courtesies apply.

Due to organized mailing schedules, QSL swapping via bureaus, while sure, is leisurely. If you work a bunch of Europeans today, don't expect their QSLs to start showing up in your bureau envelopes for two or three months. Some, of course, will make faster connections.

Use only GMT, Greenwich Mean Time, in your logging and QSLing. "EDST" means little to a non-U.S.A. ham. Even if he takes time to search, he may fail to find your QSO in a GMT log crammed with other W/K contacts.

Keep armed at all times with the very latest *Callbook*. Its DX editions contain a wealth of information every worker of DX should have at hand. No other publication has the opportunity to duplicate all such changeable data so regularly.

In the *Callbook*, and also available direct from ARRL's Communications Department, you will find the League's

recommended DX Operating Code. Adherence thereto is bound to help more DXers work more DX.

Give meaningful signal reports but don't be devastatingly critical of the quality of some of the signals you hear from overseas. Many foreign amateurs must work their DX under handicaps that would keep less capable hams off the air.

Just a feet-wetting on the subject to be sure, but it may help. It goes without saying, too, that the amateur radio DXer's capacity toward international good will is a basic factor underlying our FCC licensing privileges. We must continue to discharge this responsibility effectively. Welcome to the team, you new DX hunters! Have fun, but remember your ambassadorial manners.

What?

A little more like it, eh? DX bands up and down the line are showing flashes of old-time form as we bid a rather stinky summer unfond adieu. Twenty and forty held up reasonably well through the hot season up our way but the other bands folded frequently, generally and quite thoroughly. It's equinox time now, so things will be different — delightfully so, we trust. Time for a 14-Mc. tour on the "How's" Bandwagon this month. . . .

20 c.w., as we remarked, turned in its usual reliable DX performance, satisfying Ws 1BD1 1BGD 1ECH 1TS 1YNE 1YYM 3HNK 7DUJ 7VR0 8TRN 8YGR 8ZCQ, Ks 38SL 4WVT 5AIIH 6OZL 6STZ 9UTN 0RHK, WAs 2WJ1 2WOR 3BAE 4CZM 4KXC 4QBX 4RPK 5E1D 5HJK 5IIS 5IPM 5JEY 6J1T 6VAT 7BOA 7BOB 8MAT 8MQE 9AQE 9BKG 9FMQ 9IBT 9HYG. WBs 2DZZ 2LNH 2LSV 2NLH 6CWD 6ESW 6FRP 6ILH 6ITM 6KPN 6MEQ 6MWW 6NBU 6NXX, VE6AJC, DL5JJ and I1ER with the likes of APs 2AR (14,070 kc.) 1500-1600 GMT, 5HQ (29) 15, BV1USA, BYs 3NA 98X, CEs 1AV 2CR, CN8s CF LK MZ (56) 19, COs 2AP 19, 2BB 2CO 2JB 2JP 2LW 6AH (54) 18, CPs 1EA (30) 1, 5AB (70) 1, 5AQ (55) 1-3, 5EZ (31) 1, 8AM, CRs 3AD 4RB (32) 1, 4BC 6CA (58) 23, 6BX 6FW 7IZ (25), 8AF (78) 9-12, 8BH (40) 13-14, 9AH, CTs 1AU (40) 22, 11K 11T (35) 23, 10Z (130) 5, 1UT 3AQ, CXs 2CO 3AN, DMs 2AUD (13) 19, 3RZO 3SUO 3XED (23) 14, 3XVD 3XVO 4YF, DUs 1AA (57) 13-14, 1OR (85) 7, 1RB (24) 8, 1RBB 3PAR 7SV 9FB, EA6BD, EIs 3L 8H 9J (43) 23, 9N, ELS 2AD 2AE 2AJ 2AQ 8X (40) 17, EP2s AS (10) 18, RC RV,



* 7862-B West Lawrence Ave., Chicago, Ill. 60656.

FG7s XS (42) 22, XX (53) 0, FK8s AH (35) 8, AT (45) 8, BE BG (72) 6, FL8AC (15) 20, FM7s WH WP (40) 19, FO8s AI (45) 0-1, BI BJ (35) 1, FR7ZD, FU8AG (40) 7, FY7YJ, GD3s (QR) (15) 12, TNS (69), HAs 2AIE 3GF (35) 21, 5BI 5DD 5DJ 5FW 5KFR 6VK 7PJ 8KUC 0LL (28) 22, HC2SB, HIs 3RJ 8XAL, HK0AI (19) 23-0, HL9s KB (9) 14, US 7, HMs 1AB (40) 6, 1AQ 1AZ 1BB 3CG 5BF (40) 14, 5CP, HP1s AC BR IE (13) 12, PV (80) 22, HRs (CGT HZY) (20) 0, 3JP 2, HSLFJ, HZ1AB, ISIs TAI (46) 21, VEA (15) 11, ITIs AGA AL, JAs 1AAP 1AHO 1BN 1CIB 1CJO 1CJF 1CSL 1EFG 1E2P/3 1FDU 1FGW 1FHF 1HHM 1HFS 1JDX 1KFN 1KFQ 1KVG 1LYZ 1MDK 1OA 1OAY 1OJD 1PTI 1PTX 1ZZ 2DO 2CIR 2HO 2HT 2JW 2XI 3BIP 3CHQ 3JM 3ZP 4BJO 4BUT 5ACF 5AJQ 5CF 5FQ 6AA 6ACZ 6BZJ 7DY 7JI 7KW 8BB 8BF 8BFI 8BY 8QA 8ADY 8AZE, JT1s AD AE AG AJ (40) 16, KAE, K3SWW/KG6, KA2s JG JH (61) 14, JR RG TP (58) 13, USE (57) 7, KB6CY, 5, KGs 1RT 1BX 6AAV (31) 6, 6AIG (52) 13, 6AOX (75) 1, 6IG 6IJ, KH6EDY (61) 23, KJ6BZ, KM6s CE (25) 7, DJ, KR6 6BQ 6HJ (6) 14, 6JZ (22) 22, 6NT (69) 13, 6QC (58) 7, 6QW 8FX, K56BO (25) 11-12, KV4AA (15) 13, KX6BU, KZ5s AY BC (27) 2, CU, LAs 2QJ/p (83) 23-0, 2QP/p (50) 22, 5CL/p (9) 23, 8FG/p, LJ2T of Norway, LZs 1BC 1BZ 1FF 1KJZ 1KKZ 1KPW 1KSV 1SP 2AW (32) 3, 2KSK, MP4s BEU (5) 19, TBO (56) 23-0, OAs 4AO 4BR 6AI, OD5s EE (80) 3, LX, OH0VF (40) 11, OX3s AB (57) 23-0, KI, OYs 1R 22-23, 2H (33) 23, 2J (20) 22, 7AIL (29) 15, PIIRE of Holland, PJs 2AA (24) 1, 2CZ (36) 12, 2NE 2MI 3AH 4AA (85) 23, PZIs AM (78) 0, CM (29) 3, RAEM (2) 3 of Moscow, SLs 5AB (18) 22, 6AL of Sweden, SVs 1BK (24) 2, 0VAA (4) 19, 0WR (38) 22 of Rhodes, TAs 1DB 2BK 160 1-2, 3AS, TF2WJ, TL2s PZ (3) 12, WD/8 (52) 21, TN8AF 15, UAs 1KED (13) 0-1 of F.J.L., 2AK 2BY (38) 1, 2KAP 2KAW 9AT 9CE 9, 9ES 9FI 2, 9FO 9FW 9GO 9JS 9HZ 9KAG 9KCF 9KOR 9KYB 9MS 9OC 9PG 9PP 9TC 9UC 9V (59) 3, 9VJ 9WR 9WS (13) 3, 9WY 9XB 9XP 9YO 9YT 9AT 9EL 9EW 9FC 9FL 9IE 9IK (31) 6, 9JC 9KAE 9KC 9KCU 9KIA 9KIB 9KIN (23) 6, 9KKK 9KUE 9KZB 9KZD 9KZW 9LH 9LS 9MA 9MJC 9MX 9QR 9RD 9RV 9SD 9SK 9SL 9TD 9UT 9YR, UB5s DJE 1V DS EP GE HS ID IF IN JY KAA KBA KDS KJG KLA KTL LU ML MV MT OE TR VE VR WK XO, UC2s AZ 4KAZ WJ (25) 21, WP (24) 21, U6Gs AM BV BZ (7) 2, U6Gs BD KAM (43) 12, KPA KPZ (25) 0, LA (24) 3, VA, U6Gs AD (5) 21, AG AV (29) 22, UH8s AA (30) 3, AE (17) 12, BI (55) 2, BK BO (30) 2, FZ DC (30) 4, KBA, UIRs AI AX (60) 3, BW (12), LC (34) 21, MI (96) 4, UJ8s AH (54) 2, KAA (43) 15, UL7s AA (15) 2, AG (32) 2-3, BF CG (20) 3, KAR KDM KDT (13) 3, LK (63) 2, ND (63) 3, PS RR (57) 6, UM8s AP (16) 2-3, DZ (30) 2, FM (70), IE (32) 3, KAA, UN1s AE (12) 3, BN, UO5s AR (32) 19, GW KAA, UP2s BP BZ CT (25) 6, DU (26) 22, KBC KCF KION NR, UO2s AN CC GA HT (15) 7, KAX KBE (36) 22, UR2s DE (50) 6, DZ FF FU (20) 14, IM (63) 22, IP (65) 7, KAC KAN, UT5s AL AV 8L BV (33) 23, BL BY (33) 23, CC EH (63) 3, FI OF (29) 21, LN NA PX RS XW (38) 5, UVs 3TC 3TP (7) 4, 9US 3C 3DR 3FG 3FR 3TE 3ZA 3HW (42) 2, 9CC 9CP 9DP 9EF 9FF 9KAK 9KWN 9OA 9OY (50) 4, 9OP 9PP 9PT 9WB 9FK 9FM 9IK 9TW 9IX (98) 7, 9JJ, UY5LC (30) 22, VS8s BU 0K ML RZ (88), VKs 8WT (21) 7, 7GK 6, 7GV 7SM 8KK (110) 7, 9CJ (50), 9CC 9TG 9TL 9WE, VOs 1HP 2NA, VPs 1TA 3, 2AO 13, 2AV 2AX 2OR 4VT 5SG (35), 6BW 7VQ (20) 23, 7NS 9BY 9EP 9EU 9FU, VQ8AI (45) 13, VRs 1A 6, 1B (35), 1S (45) 6, 2BZ 2DK (16) 12, 2ED 2ER (85) 6, 4CR (45) 7, 4ED 6, VSs 5PH 7-8, 6FE 4-5, 6FF (50) 12, 6FK 6FO (57) 13, 9ASP (60) 23, 9AB (13) 0, 9OC (90), 9OSC, VU2s AJ CY (70), CQ (52) 2, GW (22), LE WC (90), WA7CAQ/KL7, WB2PXZ/VF9, XEs 1AX (10) 16, 1EK (120) 21, 1OE 1-0, 1TH (15) 20, 1TQ (3) 17, 1XK 2PMX, YA4A (102) 3, YN3KM, YS1RFE, many YVs, ZB2s A 9, AK (25) 19, AM (51) 22, ZC4s GB TX (17) 23, ZDs 7IP (17) 19, 8BC (40) 16, 8LP (13) 20, ZEs 1BA 3JO, ZM6C, ZPs 5LS (29), 6BB, 3As 0K (7) 20, DL (5) 18, 4S7s DA EC RN WP, 4U1TU (8) 20, 4X4s BH FU (80) 20, MZ QA (27) 3, QR TP (60) 21, 5A3TZ (75) 22-23, 5R8CQ, 5W1AZ (95) 6, 5Z4s ERR (50) 19, GT (21) 5, JY (30) 17-18, 6O6BW (20) 20, 6W8BF (5) 20, 6V5AL, 7GJQ (28) 20, 7Xs 2AP 2AH (55) 23, 3CT, 7Z3s AA AB, 8F1BB (14), 9G1s FK (10) 22, FQ (18) 20, FY (60) 20, 9H1s A AB (25) 22, 9J2s AB (73) 20, VB W, 9K2AN (85) 21-22, 9Ms 2AA 2AN 2FZ 2GJ 2LN (40) 16, 2OV 4JW 4LF 4MT (30) 15, 4RS (53) 12, 4US (41) 14, 6JW (30) 12, SKS SRS (60) 13, 9N1MM (66) 16, 9Q5JY and 9X5MH.

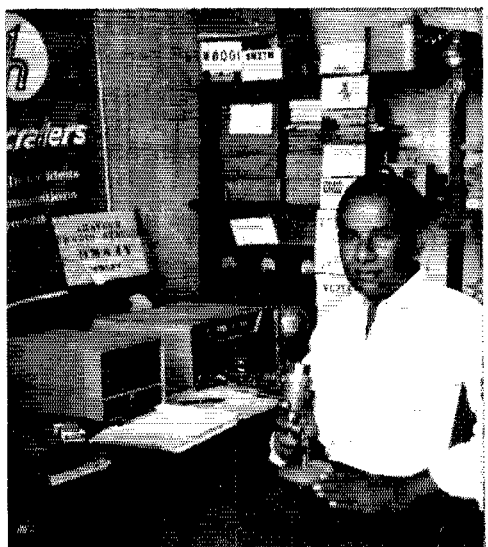

9M4JY handles QSLs for the 9M4-6-8 gang and has a well-heard cubical quad hitched to his SR-150. He's been a professional radioman for fifteen years.

9AAK 9AAU, DMs 2AEC (235) 8, 3HE 3RZO, DUs 1FD (233) 13, 1SA 1VA 6EL 6TY 12, 7SV (110) 12, 9FB KAs 8CJ (150) 0, 9AX*, EIs 4AN* 7AL, ELs 2AF 2AG (200) 20, 3C 4A, EPs 1P (142) 20, 2AX 2BQ 18-19, 2BX 2DS 2KC 2RW 3AA 3AM, ET3USA, F9UC/FC, FG7s XL XT 14, XS, FH8CD, FK8s AC AU BB/p 4-7, BF, FM7WQ 21, FO8s 4W (270) 2, 7, AG (130) 4, FR7ZD 21, FY7s YF 23-0, YL 22, GC2XU, GD6IA, HCs 1DS 1DX 2JT 3LE 5AP 8FM (255) 4, 8FN 8IG (109) 0, HIs 4HD 4XEC 8FD 8RBG (115) 22, 8XAL (109) 2, 8XFS (300) 19, HK8AT 3, ILLs KB KG KO (270) 7, KT (277) 6, KVV (233) 12, 1TY TK (280) 7, TP TO TO (252) 12, US (261) 12, 13, HP1s AA JC PV PW SH, HRs 15O 2ABC 2SC, HS1s RD F HS SD still off limits for W/K/VE/VO types, HV1CN, HZs 1AB 3TA 0-3, ITTAL JAs 1AV 1BK 1BRV 1 BX 1CG 1CRR 1 DM 1HK IUT 2AB 2AEV 2AY 2AN 2AN 2EAN 3BN 3BUO 4AO 4BZO 4OI 5AF 5HT 6AD 6BEE 6DCE 6EK 6KS 6NP 7ARJ 7FK 7FM 7FS 8ADQ 8IK 8KF 9NN, JTICA, JY1AU, K3SWW/KG6 (255) 11, Kas 2EB 2JH 2L 2NY 12, 2RJ (150) 12, 3DG 7CB 9FH (304) 7, 9AB (250) 14, KB6s EBQ (300) 11-12, BPN (266) 2-3, K6Gs AA (235) 12, BO (287) 7-12, BY (280) 9, FMI PE (282) 6, KGs 1BM 1BU 1BX 8, 1CF 1CF 0, LET 1FF 1FR 1FS 4AA 4CA 4UN 4DI 6AIG 13, 6AJI (287) 7, 6AJQ (248) 4, 6APJ 6APK 6APQ 6IG (200) 6-7, 6L (240) 13, K16s BZ 9, DA, KL7s CGE FCH, KM6s BJ (24) 12, CE (27) 7, DJ (20) 12, DZ, KR6s BJ (217) 12, BO (232) 3, BP (270) 10, CA 12, BO (245) 11, FQ (285) 21, GF 0T, GO (206) 14, JW KS 1AB 14, LL (259) 8, RN (266) 12, SB UA UD (238) 12, ULU UO (239) 12, K6s AW (270) 4, BK (259) 5, BP (270) 11, BQ 13, BX, KY4CF, KW6s EB 12, EJ (230) 14, KX6s BQ (310) 23, BU (220) 1, BW (250) 13, DX (310) 11, KZ5s AW 1R 22, LC PW (145) 1, TD, LAs 2QJ/p 5AJ/p 8FI/p, LXIs CO LE* PD* MP4s 8BA (234) 18-19, BBL (240) 19, KCC BEO TBM (120) 17, OAs 1AJ AJ DG EAI IF KH KY OF OS, OD5s AA 21, AI (117) 20, BV BZ 19, CN DZ EE LX 3, OHOs AA (113) 15, AB PZ NF NI, OX3s HM* JV LP, OY7AL, PI1PT 20, PJs 2AA (182) 22, 2CR (110) 3, 2AI (140) 23, 3CD, PZIs AG AX BI BM 12, SLs 3AG 5AB 16, 7CA, SVs 1AA 4, 0WBW (110) 4, 0WF 5, 0VGG (245) 19, 9WPP (128) 22, 0WR (252) 20, TPs 2WJF 22, 3EA 5TP, TG9s EP GZ KJ 0, 1P 0O RJ RR 4, YAs* TIs 2AT* 2CHV 2DX 2EV 2KR 2PI 2SS 2USA 3VI 2VMB* 3CL, TJ1AC (295) 20-21, TL8SW, TN8AA 23-0, TU2s AA (250) 20, AB, UAs 1KED 8, 2KAK* 9EU 9HA (260) 17, 9KCE 9KTE 9TK 9XR 3, 0BY 6EH 0EK 0KWA 0XK 0YA, UB5s K1E* LV (110) 1, UC2s BF (260) 5, DN, UD6B 3, UF6UB, UG6s AG AU 2 UH8s AE BO (104) 2, UI8FQ 2, UI8KAA, UL7s FA JA LK 3-4, NI, 0M8FZ 2, UN1BK (120) 4, UO5s BT 4, PK 3-4, RO (110) 1, WS, UP2AN 20, UO2s AN CS HT, KFG PD, UR2s AR 2, AS GZ (135) 3, IP KAA 1, MS 6, UT5LE (130) 3 4, UV3TP 5, UWs 3BJ (130) 3, 3BV 3TF 3TP 5, 9CC (125) 2, 0IN (126) 18-19, VEs 3CVL/SU 8AA 8AH (261) 9, 8BY 8CO 8MC 8MD 8ML 8ZC 8MB* 0NE, VKs 6ES 6ZS 7CK 7DS 5, 8AV (282) 10, 8KK

(275) 5-8, 9AG 12-13, 9CR 14-16, 9DR 9ND 12, 9NT 12-13, 9TG (235) 13, VPs 1HB (140) 3, 1LB 1LP IRP 2AX* 2RN 2SK 2SM (142) 22, 2SY 3AA 21, 3HAG 0, 3JR 3YG 4LR 4VP 22, 5GC 0, 5LV 5NF (242) 5, 5SG* 6JC (108) 5, 6LK 6WR (245) 21, 7BL 7CC 7DI 7DL (140) 1, 7NS 9FK 9FR (124) 23, 9VB, VCs 1B 11-13, 1S (248) 7, 2EK 2EQ 2ET (255) 6, 6TC, VCs 6AJ (96) 12-19, 6AZ 9ADD 9AE 9AWR 9MB 9OC, VU2s CK (126) 1-2, CQ, XEs 1BC 1DE 1FN 1IL 1KKV 2AI* 2I 2YP 3EB, XW8s AL (115) 14, AS AX AY (233), AZ (115) 16, YAs 1AG 3TNC (100) 15, 4A, YNs 1BN 3FP 3IA 9JUL, YOs 3LB 3ZA 9CN (245) 21, YUs 1AB 1FSE 1JG 10 18RD 2SAG 2SAR (105) 2, YUs 1AA 3AT 3LB 23, YVs en mass, ZBs 2A 9, AK AO 18-19, ZC4s CZ PC* PG*, ZDs 5E 15, 5R (258) 12, 7GP (275) 9, 8BC 8JL 8LT 8PI (27) 12, 8TM 8WZ, ZEs 1AE 1BI 4JS (230) 20-21, ZK1AR (246) 6, ZPs 3AB 3AL 5JK 5KT 23, 5OG 6BB 7BM (115) 1, 9AY, ZS3s B E, 3A2s BF CP 20, 4S7IW, 4U1s 1TU (130) 23, SU, 4Ws 1C 1J 2AA, 4X4s AK AS BF 20-21, BL (150) 21, DK 22, LQ 20, IX (110) 20, JU UT, 5As 1TK 22, 1TJ 1FK 1TQ (338) 21, 1TS 1TT 4TH 17, 4TC, 5H3s JJ JR (257) 21, KR (257) 20, 8N2s FAIT* JEB, 5T5AD, 5U7s AG AU, 5W1AC, 5X5IU (142) 21, 5Z4s FB JX (115) 18, LF RF (137) 15, 6W8AG, 6Y5s LK MJ UC RA, 7Q7s GS (100) 16, PBD (130) 19, PM, 7Xs 2AH 2CT 17, 2MD (127) 4-5, 3HT, 9G1s CC DY EC EW, 9H1s AD M W, 9I2s AB DT* FK (115) 15, VB, 9K2s AAI 22, AN 21, 9L1s JR MJ*, 9Ms 2AA 13, 2CF, 2CR 2EE 2EF (140), 2JR (241) 8-9, 2KW/m 2OV 2SR (277) 6, 4JR 4JY 4LX (210) 19, 4MB (320) 14-15, 4ME 4MF 6AB 6AC 11, 6BM 8DR 8EB 15-16, 8ED 8KZ (256) 8, 8RS, 9N1MM (114) 15-16, 9Q5s AG/m DL DO HW, 9X5s CE and ME, the lonesome asterisks denoting non-s.s.b. signals.

Next month we expect to scout other bands with the help of (15 c.w.) W3NHK, K3TEML, WAs 2WJ 7BOB 9BGK, WB6NXX, WNSKHM, 11ER, Mr. Kilroy; (15 phone) Ws 3HNK 8YGR, WAs 2FUL 4RPK 8AAT 9BGK 9IBT, WBS 2DZZ 6CUU/5; (40 c.w.) Ws 1YNE 3HNK, WAs 4CZM 5RDL 9B6K 9ALYS, WB2DZZ, WNs 4WWT 5KHM; (10 phone) W5BRV, WA4RPK; (80 c.w.) W7DJU and DL5JJ — these plus other reporters now filing data. Hop you aboard, chillun.

Where:

ASIA — AP8B writes, "Our Lahore Amateur Radio Society QSL Bureau so far has distributed more than 5000 cards received for amateurs in both East and West Pakistan. We also receive a number of QSLs for one AP5B but no such station exists." W4LRN regrettably reports, "I'm unable to get confirmation or logs from AP5HQ. Cards on hand are being returned to senders with suggestion to QSL AP5HQ direct." When WA0ITX gets his 4X4 call for a year's Israel sojourn, WA0DXZ will act as Stateside QSL liaison "I QSL'd all stations contacted," declares ex-K4TRD, "but anyone who did not receive his confirmation can reapply to me as K6ARE." "QSLs for my activity at MP4BEQ and 5A3CJ should be sent only direct to me," clarifies Steve Gibbs, still awaiting 5Y4 papers in Nairobi. His latest address appears in the listings to follow "Got snowed with HM1AB's QSLing when John took a recent two-month vacation," remarks W7YRO. Dick expected to have things caught up by this time.

AFRICA — "ZDSWZ will QSL 100 per cent through me," A promises W4TVQ, reminding clients that cards not accompanied by self-addressed stamped envelopes will get less prompt shipment CN8AW, noting CN8MH's mention as c.w. active, informs us that the King hasn't QSO'd in code for years. Miscopy or misappropriation suffix-wise SU1IM reiterates to K6OZL that 1964 activity by one SU1IM/9K2 was purely honorary VE2NV apprises ARRL Assistant Secretary W1ECH that former VQ8AM/VQ8AMR answers to the address F. Dumont, 119 Bell Lane, Enfield, Middlesex, England. However, at any time now France is scheduled to move to 33 Buckingham Close, Enfield, Middlesex.

OCEANIA — Hint from K9UTN: "KG6IG of the Bonins says it's wise to include only self-sealing envelopes when QSLing Oceania stations direct." Pacific humidity usually renders ordinary gummed s.a.s.e. unusable in short order KH6FJL, now a Californian, states, "I tried very hard to get into your 'QSLers of the Month' by QSLing every contact promptly. Unfortunately nobody nominated me — lol!" "I have all KS6BN logs and will answer QSLs promptly through my Canton address," assures KB6CY, specifying s.a.s.e. from W/K applicants

4S7NE manned the mike to arouse plenty of ham spirit in Ceylon during the recent international Boy Scout Jamboree-on-the-Air. Nelson and the lads succeeded in hooking up with 25 other Jamboree stations world wide. (Photo via W5AI/W5YA)

. K3OQF, formerly of KG6AAY, dwells on that club station's QSL debits: "There's a backlog there, all right, and I cannot say if the cards ever will be answered. Those who QSL'd for my own QSOs from KG6AAY were sent cards in return. The last hundred went out in late July." Walt also vouches for the QSL rectitude of KG6AAY ops W9FTO, K7SXF and WA8ALJZ. "If it were not for W9FTO there would be no KG6AAY. Because of him the station was kept operating and some of the QSL logjam did get answered."

EUROPE — OY7ML communicates, "Our Faeroe amateur society, F.R.A. runs a QSL bureau now for faster service. The address: OY QSL Bureau, Box 184, Torshavn, Faeroe Islands." EA3OT's QSOs from EA6AR may be confirmed through Hammarlund DXpedition, Box 7388, GPO, New York, N. Y., 10001, according to the DXpress of VERON K2BKU, formerly ON4UQ, points out that many envelopes supplied by W/Ks as s.a.e. are too small for the average European QSL card. "QSLs over there are larger than our standard size mostly due to a difference in standards resulting from our not using the metric system. I sent my own ON4UQ cards via bureaus except in cases where large enough s.a.e. were provided." K2BKU stands ready for inquiries from those who may not have received their deserved ON4UQ pasteboards "Have logs on hand from SM1GAMD for QSOs up to August," reports W1YNE. "All cards received for those contacts have been answered." There have been no legitimate 1B9US QSOs since July 14, 1965, despite spurious indications to the contrary. Furthermore, Werner probably won't be active again until late in '66 "Seems to me most UAs are good QSLers," observes WB6MPEQ. "In fact many of them confirm second QSOs." DL7CW tells W1WPO of Hq. that his QSL returns from the U.S.A. are running only about thirty per cent. Was it loose?

SOUTH AMERICA — Highlights of PJ2CZ's successful quest for ARRL's WAS diploma: "Made many friends with whom I now regularly rag-chew. Tried to obtain all 50 QSLs in GMT but some have EST, CST, etc. Worked 671 U.S. stations before confirming all states. Received 327 QSLs including the necessary 50. Surprised quite a few W/Ks by calling them." Herman feels he has answered all who QSL'd PJ2CZ but he's willing to re-mail, urging a check first with one's local QSL bureau branch, and specifying that QSOs should be at least six months old. PJ2CZ reminds us that PJ5 calls are usually signed by tourist hams, mostly W/Ks. He recommends as must reading for all DXers "The Art of QSLing" by KZ6SW, p. 61, October 1963 QST WA2CBB, taking up duties as QSL aide for VP4VU, understands that VP4s may become 9Y4s ere long. Notice the upsurge in Trinidad ham activity lately? VP4DS responded promptly to W4TRN's second QSL request, reporting nonreceipt of John's first letter. W4TRN thus comments that a certain percentage of overseas mail goes astray for a variety of reasons, so we shouldn't be too quick to condemn DX operators as non-QSLers.

HEREABOUTS — CE0XA, CX2GAI, G3OIZ, HP1AC, HR1HZY, KA2JR, KS6BO, SMs 5BYG 6AEK, SV0WJ, UB5JR, UW0LK, VK7SM, VPs 4DS 6BW, VU2GW, YA4A, ZL2GX, ZP9AY and 4X4TP are current "QSLers of the Month" nominated by "How's" spotters W8YGR, Ks 7LGU 8ECC, WAs 4CWA 4CZM 7BOA 7BOB 8GUA and WB6MEQ for pasteborder production pronto. Also commended are QSL agents Ws 2CTN 2BCT, Ks 4KMX 4TWE 8ZBY, WAs 4KXC 5CNP, WB2FSW and VE3ACD. Any quick QSLers you'd like to see saluted here? Halp! The following italicized colleagues would appreciate QSL/QTH tips on hold-overs listed: W7T8O, ZK1s AA BW; W8GQU, CR4AE '64, EK1AO '51, FM7VF '50, TF8s 1L KB '64, VK6FZ '61, ZD6LA '64; W3TRN, CR6FW, VPs 2VL 6BW, G06BW; K1TMY, KZ5FP, OK1BY, PY7s ABV AMX TX, all '63; K4WTT, FY7YJ '64, HH2AID '62, VP4TK '63; K8BCA, FM7WA, TAIIR, YI3D, all '64; K8RDE, AP2NK '63, FM7WA '63, GD3UB '63, ZD9AD, 9AM2UF '63; W8MAT, K9LNG/VP4 K0QC2, WAs 4TLI 5ENK 8GUA and WB6IEK offer their services as





OA4KY's multiband beam loftily overlooks picturesque Lima. Juan also employs a 40/80-meter trap dipole and an inverted Vee, hunting his DX on single-sideband or straight a.m.

Stateside QSL agents for DX stations requiring such assistance H18XAL discloses, "Due to events here in the D.R. some 850 QSLs for QSOs between March 1 and May 1, 1965, have been delayed. I urge those who worked me during this period to be patient. If not received by the end of this year, K9WIE will by then have most of my logs and may be able to help. Right now it will do no good to follow up initial QSL requests. Meanwhile, W/K/VE QSOs after May 1, 1965, can be confirmed through K9WIE, non-W/K/VEs through the HI bureau." K9ECG wants to nominate ARRL Hq. as a QSLer of the Month due to especially swift correspondence exchange. Done! Use only QSL tips from VE3EUU, VP2SK's QSL charge: Use only GMT/GMD, always spell out the month, send only Canadian postage or International Reply Coupons with self-addressed envelopes to Canadian QSL managers, and don't complicate things by enclosing currency. "I'm now QSL manager for KZ5AY," writes K6CYG, "primarily to aid DX stations that appear to be clamoring for KZ5 confirmations, but also for W/K QSOs. The usual s.a.s.e., or s.a.e. plus IRCs (and GMT!) of course." Here comes our parade of individual specifics. Remember each recommendation is necessarily neither accurate, complete nor "official." G'luck. . . .

AP2MT, Tufail, c/o Telephone Industry of Pakistan, Haripur, Hazara, Pakistan
 AP2ZR, Zubair Ahmed, c/o Telephone Factory, Haripur, Hazara, Pakistan
 AP5CP, Tiger A.R.C., Dacca Signals, Dacca 6, Pakistan
 AP5HQ (see preceding text)
 CE3OX, Box 1250, Santiago, Chile
 CR3AD, O. Vicente, Box 205, Bissau, Portuguese Guinea
 DJ4EK/TA/YA (via DL3RK)
 DJ6NG (via RCV of Venezuela)
 DL4VJ (July-August '65 QSOs via WB2EEJ)
 DL5JJ, 33rd Sta. Hosp., APO, New York, N. Y., 09069
 DM2CZL, Sig. Schlettig, 8245, P.O. Box 65, Glashutte, E. Germany
 ex-EL8E, Bill Mueller, Houston, Mo., 65483
 EP2LD (via WA1DEY)
 F0AO/m (via REF)
 F0BB (to ON4FU)
 FP8CV (to W2GKZ)
 GB3MAA (via G3SXX)
 HC8JG (via HC2GRC)
 H18XAL (see preceding text)
 HR1FHM, U.S. Embassy, Tegucigalpa, Honduras
 JA3GBH/mm, Masahiro Fujiwara, 196 Kyokaido, Miyazu City, Kyoto-fu, Japan
 K1ZBR/mm, USS *Calcaterra* (DER-390), FPO, New York, N. Y., 09501
 ex-KA7DR, R. Randall, K6ARE, 206 Gregory St., Fairfield, Calif., 94533
 KB6CY, R. York, Bendix Field Eng. Corp., 3131 Nimitz Hwy., Suite 210, Honolulu, Hawaii, 96819
 KB6EPO, 3131 Nimitz Hwy., Suite 210, Honolulu, Hawaii, 96819
 KG6AA Y (see preceding text)
 KG6IF, C. Brown, APO, San Francisco, Calif., 96315
 KH6EOX/M1, Box 400, Verona, Italy
 KH6FJL, J. Fail, 6170 Downey Av., Long Beach, Calif.
 KP4BPG, J. Parker, Box 649, Middlefield, Ohio
 KS6BN (to KB6CY)
 KV4CF (via K3AHN)
 KX6BW, Box 65, APO, San Francisco, Calif., 96555
 KZ5AY (via K6CYG)
 ex-MP4BEQ-5A3CJ, S. Gibbs, P.O. Box 14401, Nairobi, Kenya
 MP4DAN (via DJ4AB)
 OH1SUF (via SRAL)
 OH6AA, P.O. Box 1, Mariehamn, Alands, Finland
 OH6FZ (via DJ4SO)

ON4NM/LX, Box 331, Antwerp, Belgium
 OY9FRA, OY QSL Bureau, Box 181, Torshavn, Faeroe Islands
 PX1EO (via DL9JL or DARC)
 SM6CKU/mm (via SM6CED)
 SV0WJ, R. McIntyre (K4BNI), U.S. Embassy, APO, New York, N. Y., 09223
 UA3FG (via KH6FJL/6)
 UA9EH, T. Glotko, P.O. Box 102, Yushno-Sakhalinsk, Sakhalin Island, U.S.S.R.
 VP2GL (to WA5KQF)
 VP2SK (via VE3EUU)
 VP4RS, Union Village, Claxton Bay, Trinidad
 VP4VU (via WA2CBB)
 VP5GC, F. Stallend, Bodden Town, Grand Cayman Island
 ex-VQ8AM-VQ8AMR (see preceding text)
 VS5PH (via DL3RK)
 VU2EV, Miss K. Shanta, 187 Shradananda Bhavan Rd., Visveswarapuram, B-4, India
 VU2VT, S. Tampi, 6 Eighth Cross, Jayamahal Ext., Bangalore 6, India
 W6BGR/KW6 (to W6BGR)
 W6BGT/KJ6 (via W6BPI)
 W8TNC/KW6, P.O. Box 505, Wake Island
 W0HPM/KG6, c/o Dir., Joint Typhoon Warning Center, APO, San Francisco, Calif., 96334
 WB6PZK/KJ6, Box 803, APO, San Francisco, Calif., 96305
 YA-II, Hammarlund DXpedition, Box 7388, GPO, New York, N. Y., 10001
 YJ8WW (via W4ECD)
 YJ8XX (to VK2AEY)
 YV1OT, Casilla 791, Maracaibo, Venezuela
 ZD8WZ (via W4TVQ)
 ZE4JS (via W3HNK)
 3A8DL (to ON4FU)
 4W1C (via W2CTN)
 4W1J (to HB9AFP via USKA)
 4W2AA (to HB9AET)
 5U7AU (to W8HML)
 5W1AD (via W4ECI)
 9J2AB (via W6BAF)
 9M8KS (to G3GPE)

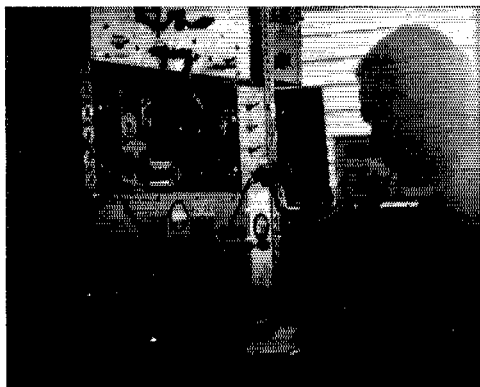

FG7XK scans for fellow rare ones in the quiet dawn on Guadeloupe. Georges enjoys experimenting with that home-brew rack layout. (Photo via W1YYM)

Donors of this directory are Ws 1BD1 1BGD 1YYM 6RDB 7NLB 7UVR 7VRO 8GQU 8YGR 8ZCQ, Ks 2BKU 3TEM 6OZL 8RDE 9VFA 0EGC, Was 4CWA 4CZM 4RPK 5E1D 51PM 8MQE 9IBT, WB2LSV, VE2NV, Columbus Amateur Radio Association *CARAScope* (W8ZCQ), DARC's *D-X-MB* (DLs 3RK 9PF), DX Club of Puerto Rico *D-Xer* (KP4RK), Florida DX Club *DX Report* (W4LVV), International Short Wave League *Monitor* (12 Gladwell Rd., London N8, England), Japan DX Radio Club *Bulletin* (JA1DM), Long Island DX Association *DX Bulletin* (W2FGD), Newark News Radio Club *Bulletin* (L. Waite, 39 Hannum St., Ballston Spa, N. Y.), North Eastern DX Association *DX Bulletin* (K1IMP), Northern California DX Club *D-Xer* (Box 608, Menlo Park, Calif.), Ontario DX Association (VE3FXR), Puerto Rico Amateur Radio Club *Ground Wave* (KP4DV), VERON's *D-Xpress* (PA9s FX LOU VDV WWP) and West Gulf DX Club *Bulletin* (W5IGJ). 'Tis more blessed to help than be helped, OM — QTC QTH? K!

Whence:

OCEANIA — This month NZART (New Zealand) and WIA (Australia) invite amateurs throughout the world to frolic in the 1965 VK/ZL/Oceania DX Contest to be held (phone) from 1000 GMT the 2nd to 1000 the 3rd, and (c.w.) the 9th-10th, same times. Exchanging the usual RS- or RST001, RST002, etc., serials, non-Oceania participants earn a point for each non-VK/ZL Oceanian worked per band, 2 points for each VK/ZL captured, and for final score multiply this total by the number of VK/ZL band-call areas accumulated. (Oceania contestants outside VK/ZL work both sides of the fence at 1 point per non-Oceania and 2 points per VK/ZL, same multipliers.) Your log should clearly indicate date, GMT, call of station contacted, band, serials sent and received, and each new VK/ZL call area as worked per band (separate sheets for each band). Include a summary sheet showing your call, name, address, equipment description, and designate multi- or monoband entry classification. Then whisk the works off to Federal Contest Committee, WIA, Box N1002, GPO, Perth, W.A., Australia, postmarked on or before January 15, 1966, to be eligible for possible certifications of outstanding test performance. Propagation conditions for this one should be noticeably improved over last year — have fun! — WA6SLU had a memorable ragchew with VK2ADC's 2nd op, Ray, when it transpired that George and Ray are both 21, both study E.E. in college, both are coin collectors and photography bugs, and both have worked on the staffs of student newspapers. WA6SLU forgot to ask Ray if he's also 6'3" tall — YL K6QPG's OM, W6PEU, works on Japant isle in the Marshalls where hamming is taboo, KX6BQ's s.s.b. helps keep the two in touch — KH6FJL moves to the mainland after a DXCC's worth of Hawaiian DX fun in ten months — "I expect to be very active on 40 through 10 meters, possibly on 80," states KB6CY, ex-KS6BN, a strictly-c.w. guy — When K3OQF left KG8AA in July that multiplier station was using an HT-32B, Warrior, HQ-170, SP-600, triband rotary and 200-ft. long-wire — Ex-VR30 is now operator Martin on the KX6BQ staff — W9WNV's initial DX-peditionary stops as 5WIAD and YJRWV went off well in August, Don's collaborator, K7LAIU, was elsewhere hopping red tape for future rare activations in Oceania and Asia. Indonesia and mainland China are prime objectives. Frequencies to watch are (c.w.) 7000-7010, 14,015-14,055, 21,045-21,055; (s.s.b.) 7090-7100, 14,100-14,110 and 21,400 kc.

ASIA — ARSI (India) and RSC (Ceylon) invite your participation in the 2nd VU2/487 DX Contest to be held (c.w.) from 0600 GMT October 30 to 0600 the 31st, and (phone) November 6-7, same times. Note the date change from the previous announcement. The usual RS or RST001, RST1002, etc., serials will be exchanged, everybody working everybody. Non-VU2/487s earn 2 points for each QSO with a VU2/487 per band, 1 point per contact per band with stations in the rest of the world. Logs showing date, GMT, calls of stations worked, band, serials swapped — separate tabulations for each band — accompanied by a summary sheet indicating your own call, name, address, equipment description, total score, and a signed declaration that rules and regulations were observed, must be mailed no later than November 30, 1965, to Radio Society of Ceylon, Contest Committee, P.O. Box 907, Colombo, Ceylon, to qualify for possible certifications of meritorious performance — 4X4HW hunts W/K/VEs each week end around 2000 GMT near 14,250 kc., according to W2CES, and WA0DXZ's friend WA0ITX enters college in Israel where he hopes to attain 4X4 status — After W4BED's whirlwind YA and 4X4 doings, W5YGR dubs him Gus-a-Go-Go — AP8B writes, "Lahore Amateur Radio Society was started January 1, 1965, with a membership of thirteen amateurs. Most of us use war-surplus equipment or homebrew rigs constructed from war-surplus parts now in short supply. Club stations active in Pakistan are APs 2AC 5AC 5CP 5HQ 5JA 5SS, all military, and technical institute stations AP5s DC and KC."

AFRICA — Chafing at the DX bit, ex-MP4BEQ-5A3CJ A pens, "Although I've been in Kenya for six months now I have not been able to get a license due to a hold-up in issuances to new 5Z4 applicants. We're hoping it won't be much longer before things are sorted out." — OM-XYL EL8s E and D expect to return to Liberia after a year in Missouri — ZE4J's 14,230-kc. activity at 2000-2300 GMT keeps QSL manager W3HNK at the grindstone — CN8AW welcomed WINTH to the Yanks-in-Morocco gang — CR7GF, VE7PH, VK2s CO and XT recently teamed up to secure emergency medicine that saved the life of a Mozambique woman. So goes a dispatch in the Hartford, Conn., *Courant* — ZD8HL says ZD9BC should continue available on 20 c.w. and phone for another year or two — CR7GF hopes to help energize Portuguese Guinea and Sao Thome now and then as CRs 3GF and 5GF — W8HMI of TU2AU-5U7AU-etc. fame anticipates Upper Volta XT2 emanations about now or sooner.

EUROPE — Faeroes facts courtesy OY7ML: "There are 16 new licensees here within a year making a total of 32 OYs. This coming winter our PRA society will hold another ham license course. Soon OYs will not be rare ones! Most active here are OYs 2J 3B and 7X. Watch out for OY7X who is going to be DX champion of the Faeroes, a fine operator who will surely beat us all. OY7ML is the only s.s.b. station here. OYs 2Z and 5S use straight a.m., and all others are c.w. hounds. W2GHK may visit me this month to work sideband from my station for a few days. We do not have reciprocal licensing as yet; soon, perhaps."



9M6s AB and AC, known back home as WA0GWQ and K9OAD, enjoy DX sessions in Jesselton, Sabah, when Peace Corps duties permit. A 30-ft.-high 14-Mc. quad is hooked to their HX-20 and HQ-145. (Photo via W7PHO)

DL7CW writes WIWPO of the ARRL DXCC Desk about the handy DX booklet issued gratis (no s.a.s.e. needed) by Blaupunkt-Werke GmbH, 32 Hildesheim, Robert-Bosch-Str. 200, Germany. It includes convenient check-off lists for major DX certifications including DXCC, WAS, WAE and DLD (Deutschland Diploma). You may be seeing a lot of these around — "We had to stop our July Luxembourg DXpedition after 36 hours because of ON5DI's illness," regrets ON4NM/LX, promising another effort soon — Remember that E. Germany's WADM test comes off on the 2nd and 3rd of this month as detailed in September's "How's!" — I'm on 20 c.w. almost daily," notices SV0WJ (K4BNI) of Athens, "at 1800-2000 and 0400-0500 week days, and almost any old time on week ends." — K6BHM says UA4QA hunts Vermont and Wyoming to finish his WAS at 0100-0500 and 2100-2300 GMT near 14,020 kc. — Roumania's CCSR schedules a YO DX Contest on the first week end of each August but failed to inform us in time for 1965 QST mention. At least two months in advance of issue, fellows, please — UA1KED of Franz Josef Land is expected to employ UR2KAA's contributed single-sideband rig DXtensively henceforth.

SOUTH AMERICA — VP4RS tells WA9BGK that Trinidad actives include VP4s LE LF LH LQ LR RS VT VU and VV. Most of the lads prefer 21-Mc. a.u. — Brazilian DX Club offers the BDX certification for proof of QSOs with certain numbers of members since September 1, 1964. Check with CBDX, Box 842, Recife, Brazil, for details — WIBDI of Hq. finds K1ZBR/mm, USS *Calcaterra*, due for a nine-month picket voyage in antarctic regions. Several operators will use the call

(Continued on page 132)



CONDUCTED BY SAM HARRIS,* W1FZJ

Solar QRN?

ONE of the most popular questions in the Moonbounce and Oscar mailbag is "How much sun noise should I get?" I must admit that the answer, if any, is always evasive. Everyone agrees that you should be able to measure some sun noise but nobody wants to make any firm statements about how much. In the first place, the sun has a nasty habit of varying its temperature. Not the little squiggles and bursts that occur during a given measurement but an average variation over a month's time of maybe 2 to 1 in apparent temperature at 432 Mc. This variation, as the sun rotates, is not only not dependable, it isn't even predictable. You can predict that it will vary as it rotates but not when it will be maximum or minimum. If you are willing to settle for an answer starting with a 2:1 error and pick a band like 420 Mc., you can ascertain that the sun looks like a 500,000-degree K source when quiet and 1,000,000 K or so when noisy. Now the problem is to determine how much of this noise temperature is seen by your antenna. If we continue to take liberties with facts we can say that the sun looks like a noise source of a half a degree in diameter. Assuming your beam width is a half a degree or more, the noise temperature you will see at your antenna terminals is the result of dividing the sun temperature by the square of twice your beam width and multiplying by your antenna efficiency. This assumes, among other things, that your antenna beam is approximately the same width in both planes. An example might be a 17-foot parabola with a diameter-to-focal length ratio of 0.5. A beam width of 9 degrees and an efficiency of 50 per cent. The square of twice the beam width is (18×18) 324. 500,000 degree K, sun temperature at 432 Mc. divided by 324 equals 1543 degrees K times antenna efficiency of 50 per cent which equals 771.5 degrees K at your antenna terminals. If your feedline-converter-antenna temperature looks like 771.5 degrees you should see an increase in receiver noise of 3 db. when the sun passes the center of your beam (or more, depending on the condition of the sun).

Now if your receiver, feedline and antenna look like a 771 degrees K system and your antenna is aimed 20 degrees or more above the horizon you can assume that the antenna contribution is 20 degrees K. (assuming you are not pointing at the galactic plane. See "Sky Temperature Behind the Moon," *QST*, October 1964). So your receiver-feedline temperature now looks like 751 degrees K and could be the result of a 5.5 db. noise

figure receiver with 0.1 db. feedline loss or a 1 db. noise figure receiver with a 3 db. feedline loss.

The hypothetical antenna in the preceding example has a gain of 24.9 db. A 3 db. increase in antenna gain will produce 3 db. more sun-noise power. Likewise 3 db. less antenna gain will reduce the sun-noise power by 3 db. or a noise temperature at the antenna terminals of around 380 degrees K. Using the same feedline-receiver combination and assuming no significant degradation in back or side lobes, the receiver-noise output should increase approximately 1.8 db. as the sun passes the center of the beam.

From the foregoing you should deduce that a poor feedline is your worst enemy. If you add 3 db. of feedline loss (60 feet of RG8/U) to your 5.5 db. receiver you would have to increase your 17 foot dish to 28 feet to get the same 3 db. increase in receiver noise from the sun. You should also take note that your antenna beamwidth is not a measure of performance without a statement of efficiency. An antenna with a 9-degree beamwidth could have a gain of anything from 21 to 27 db., depending on its efficiency. Parabolic type antennas are generally assumed to have an efficiency of from 50 to 55 per cent when built with a F/D of 0.5 or so.

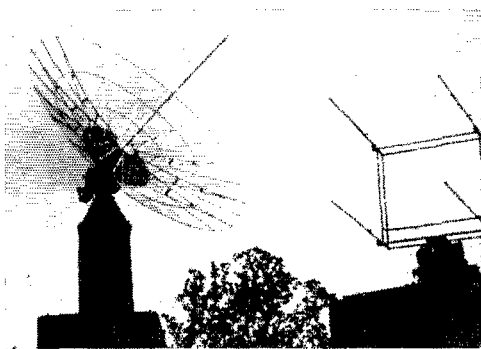

20-foot parabolic reflector used by OZ8EME during his 432-Mc. Moonbounce contacts with KP4BPZ.

W6GDO and W6NLZ Work on 432 Mc.

What is probably the best DX yet worked between home stations in the western part of the country was a contact made on schedule at 0400 GMT August 31. W6GDO had just raised his 32-element extended-expanded collinear to 70 feet, and this was the second day of use. Initial contact was made on c.w., and W6GDO switched to s.s.b. in the latter part of the QSO, with signals still readable. From Rio Linda to Palos Verdes Estates is about 385 miles, over just about every kind of terrain. The path is marginal on 144 Mc.

* P.O. Box 1738, Arecibo, Puerto Rico 00613.

V.H.F., Canadian Style

Although we don't hear too frequently from our Canadian ham friends, this month we've practically hit the jackpot. VE2LI at Montreal, Quebec (first 432-Mc. Moonbounce contact in Canada for (KP4BPZ) writes that activity on 432-Mc. is "pathetic," and the only signal heard at his QTH is that of Dick, W1QWJ in Massachusetts. George suggests a 432-Mc. contest to be held once a month and lasting four or five hours. How about it, fellows! Activity on this band has grown by leaps and bounds all over the country so we'd like to have the opinion of some of you bounders (?) concerning this type of contest.

From Toronto, Ontario, Les Weir, VE3AIB sez: "On July 5 and 6 we finally had a good opening on 432 Mc. from this area to the west. On July 5, starting about 2145 EDST, VE3BQN and I both worked W9ZIH, WA9HUV and W8YIO. Signals from Illinois were quite steady S7 to S9 for at least three hours. No other DX signals were heard here. The following night, July 6, conditions appeared to be good and I culled many CQs on 432 Mc. between 2130 and 2300 without hearing anyone. However, after calling VE3DSU in London, Ontario, on two meters I got him to switch to 432 Mc. with his very low-power rig (about 1 watt out) and he was S6 to S7 on 432 Mc. After we signed I heard W8JLQ in Toledo, Ohio and worked him with good S8 signals, then worked W8HCC (Sandusky, Ohio), W8RQI (Toledo, Ohio), K8OXZ (Cleveland, Ohio), and W8FWF (Garden City, Michigan). Les is running approximately 50 watts input and can use a.m., f.m. or c.w. The antenna is a sixteen-element collinear about 50 feet up. He also tells us that he recently completed a major rebuilding job incorporating transmitters and crystal controlled converters for 50, 144, 220 and 432 Mc. into a new rack to enable rapid and convenient band changing. However, he's beginning to wonder if the 220-Mc. gear will ever be used. Only one local heard this year on 220 and that during a contest.

VE4RE/4 at Winnipeg, Manitoba, sez that although a number of the VE4s made an unsuccessful attempt (as a group) to monitor KP4BPZ on July 24th, they will probably stay on the band for tests and experiments with WØPHD at Warren, Minnesota. Russ is presently working on a 50-Mc. s.s.b. transmitter and sez that VE4HA is very active via this mode on 50.110 Mc. having worked KP4, VP6 and other such delectables this summer. There has been excellent sporadic E and some aurora into Winnipeg during July on 50 Mc., and 144 Mc. came up with some temperature inversion into the north central states on July 22nd.

VE8BY at Yellowknife, N.W.T., sez. "This year has been very bad for v.h.f. at this QTH with just a few openings to Winnipeg and Brandon, Manitoba. It's not for the want of trying though, my receiver has never been off and I can't count the number of times I've checked the front end, just in case. I had a problem with Oscar. I can't track my antenna because of the cold, and on Oscar III my coax cracked and I ended up using a ground plane. At times the temperature was 30 to 40 degrees below zero and the coax can't take it. I hope they put the next one up during the warm weather. This place would seem to be a good one for moonbounce. The moon is in sight all day during the winter. Maybe I should try 432 Mc. if I can find something for an antenna. My frequency on six is 50.103 s.s.b. and 50.05 for c.w. Two meters is 144.100 c.w. Antennas, 5 over 5 on 50 Mc. and 10 over 10 on 144 Mc. Coax

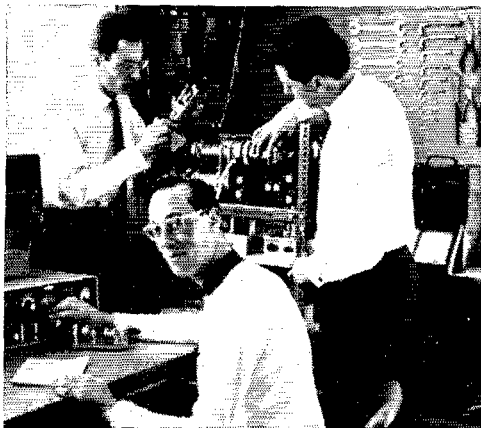

From left to right: F8OX, F8GB (seated) K2KK. Final tune-up before the EME tests with KP4BPZ.

is RG17 in both cases. All this for three or four contacts a year!"

144 Mc. and Up

From Detroit, Michigan, W8WNX advises us that K8AIY and W8JLQ made the first two-way contact on 1296 Mc. over a path of fifty miles; and at Galion, Ohio, K8ZES is still working on his 1296-Mc. transmitter and finishing up the 4X150 for 220 Mc. New Mexico is now being heard on 220.050 Mc. via K5TQP who is still "tied down the gear and making minor improvements." That 220.050-Mc. frequency is the one on which Fred will be making tests with WØEYE but his regular frequency is 220.300 Mc. Transmitter output is 200 watts to a sixteen-element collinear.

K2ACQ writes that he has sked with VE3AIB every night at 10:00 p.m. EDST on 432 Mc. Don has worked 4 states and 3 call areas on this band with maximum distance about 275 miles. During a two-week period in July stations were worked in Cleveland (200 miles), Pittsburgh (210 miles), Sandusky and Detroit (240 miles), and Toledo (270 miles). The stations located at 240 and 270 miles were those most frequently worked so perhaps Don has that certain necessary "something" for 432 Mc. Kentland, Maryland will soon be well represented on 432 Mc. by WN3DKQ and two of his buddies. Tim sez that initial plans call for get-togethers every Wednesday at 0030Z and anyone interested should contact him at 2854 75th Avenue, Kentland, Maryland 20785. Keep an eye out for Delaware on 432 Mc. W3BDP has completed construction of a 32-element collinear for this band and should have it tuned up and on the air by the time you read this. 432-Mc. activity in Florida is nothing to be sneezed at either. W4MVB at Jacksonville Beach has worked K4PZW, WA4JKY, K4NSG and W4UWH in Florida plus W4BCL in Georgia. Jesse is up-grading his equipment by building a final 432-Mc. amplifier consisting of a pair of 4X150As and four five-element beams will soon be going up. Another "bigger one" is being built by W6ARQ who will soon be erecting a new 24-element beam for 432-Mc. Out in Cedar Rapids, WØLDY sez that: "Good tropo conditions existed to the east and southeast on July 12. After my regular Monday night 432-Mc. sked with WA9HUV in Chicago, I noticed several c.w. stations in Ohio and Michigan calling me. After working W8RQI in Toledo and

W8FWF near Detroit. I found W4HJQ in Kentucky calling CQ. He came right back to my call and so I picked up state number 9 on 432 Mc. Still hoping to work W5JWL in Arkansas before the weather goes sour. Understand that K0CER can now receive on 432 Mc. so there is a chance that there may be some activity in South Dakota yet. I would be very interested in hearing from any active c.w. 432-Mc. stations in Missouri, Kansas or Nebraska."

From Portland, Maine, K1MTJ writes that c.w. activity is increasing in New England on two meters. Joel has worked a number of stations via that mode in Connecticut, New Jersey and New York, one in Rhode Island (K1ABR) with W1AZK and W1JSM being about the only ones active on c.w. in New Hampshire and Massachusetts. Joel has m.s. skeds with W0DQY, W8PT and K9SGD for the Perseids (August 10 to 14) plus nightly skeds with K30BU. Tuesday, Wednesday and Thursday are pretty well occupied with skeds with K9ZUP and a weekly one is kept on Sunday mornings with W8PT. Seems like this boy really means it! An opening on two meters is reported by WB2JKU for the night of July 2 when he worked W3DOG (Delaware), K3FYL (Pennsylvania), WB2JEP (New Jersey) W4OLK and W4GI both of Virginia. Other 4s were heard but not worked. Rig used at WB2JKU was a Clegg 22er into eleven elements at 40 feet. Skeds are continuing on two meters between W2IYR, K1RPB and W1STR. Although the skeds were very good during the winter and the boys say that the summer thunder showers are spoiling results. Hard to get on any band, Delaware, has another active 144-Mc. station running 400-watts a.m. and 900-watts c.w. The station is W3BDP, ole Sam King, formerly K4EUS, who moved to Wilmington not too long ago from Richmond. He's now building an exciter driver for 144-Mc. s.s.b. Sam observes that on July 2 the band was good to the northeast when he worked W1MEH on phone, on the 21st when W1AZK was worked via c.w., on the 24th when K4QWZ/1 was worked in Connecticut on c.w. and on the 30th when WA1SR in Virginia was worked on phone. Glad to see that you're up to your old tricks, Sam! K30BU, also of Wilmington, mentions several good openings on 144 Mc. during July. W1s in Connecticut were worked on phone and two-s.s.b. stations in Virginia both had good signals into Wilmington on July 14. Joe states that s.s.b. activity in general is falling off on the east coast and he believes it's 'cause the "big guns" of last year's activity have fallen by the wayside themselves. I'm sure that you can find some of them on 432 Mc., Joe. A number of skeds have been made by K30BU for the Perseids and others which are just plain m.s. skeds. Hope you let us know how they turn out. Shelby Ennis, W4WNH, writes to let us know the outcome of skeds being held with W4AWS. 7 m.s. QSOs in 10 days! He sez: "We decided to try the two-daylight showers during June with skeds at 1300 and 1700 GMT. In general there were more and must stronger pings at 1300 but there were more usable pings and shorts bursts at 1700, although they were all very weak." Shelby also tells of the tropo opening of June 16 to Texas when he worked K5WXZ, K5KXD, W5AJG and W5PZ in Oklahoma. All signals were weak but steady. "The first tropo sigs I ever heard from Texas (all before this via m.s.)." That's what I say! Always something new and different to be discovered on the v.h.f.! W5JWL sends news from Arkansas concerning the 144-Mc. opening of July 12. Jay sez that states heard included Illinois, Michigan, Ohio, Kentucky and one Canadian station, VE3DSU.

2-METER STANDINGS

W1JSM	...26	7	1330	W5WAX	...11	5	735
W1AJR	...25	7	1130	W5BEP	...9	3	1000
W1MEH	...24	6	1000	W5EDZ	...8	5	1375
W1MNF	...22	8	1200	W5YYO	...7	4	1330
W1AFO	...19	6	920				
K1ABR	...18	7	1120	W6WSU	...15	5	1390
W2BLV	...36	8	1020	K6HMS	...9	5	1240
K2GGJ	...35	8	1365	W6KAP	...5	3	1300
K2LMG	...32	9	1710				
K2GEL	...25	8	1200	K7NII	...11	5	1230
W7PUY	...24	8	1150	W7LHL	...10	4	1170
W2ALR	...24	8	1100	K7ICW	...10	5	1236
W2PZE	...23	7	1200				
W2LWI	...23	7	1050	W8PT	...40	9	1260
W2FEX	...21	6	750	W8KAY	...39	9	1210
W2UTH	...20	7	880	W8IFX	...39	8	1225
W2EMA	...19	6	1010	W8SDJ	...37	8	1220
W2PZE	...18	6	750	K8AXU	...34	9	1275
W2ZYX	...17	6	720	W8LOP	...34	8	1060
K2OEL	...16	6	1010	W8MVF	...33	9	1155
W2CCO	...16	6	780	W8YVO	...32	8	1270
K2JWT	...16	6	550	W8NOH	...31	8	1000
				W8EHW	...31	8	890
W8LST	...22	6	800	K1CRQ/8	...30	9	850
K30BU	...19	7	930	W8WNM	...25	8	900
W3MFT	...19	6	600				
K30BU	...17	7	930	W9WOK	...42	9	1170
K3EJA	...17	6	600	W9LFE	...41	8	1150
W3HHG	...16	6	550	K9AAJ	...36	9	1200
W4HJQ	...39	9	1150	W9AAG	...35	9	1050
W4HHK	...38	9	1280	K9SGD	...33	9	1100
W4WNH	...35	9	1350	W9OIL	...32	8	890
W4MRJ	...34	8	1149	W9PBP	...28	8	820
W4MNT	...30	8	1225	W9OJF	...27	9	910
K4QLF	...29	8	1000	W9IFA	...26	6	1000
K4XC	...29	8	1255	W9CUX	...24	7	1000
W4FJ	...27	8	1050	W9WDD	...23	7	900
W4RFR	...24	9	820				
W4TLT	...23	7	1000	W0BFE	...43	9	1350
W4DMU	...21	7	080	W0BFE	...33	8	1040
K4YYJ	...20	6	720	W0BNC	...30	7	1250
W4LNG	...19	7	1080	W0DQY	...27	8	1100
K4MHS	...20	5	800	W0MOX	...23	6	1160
K4VWH	...18	6	590	W0IC	...22	7	1360
				K0TFE	...21	6	940
W8RCI	...39	9	1280	W0LAF	...19	7	1130
W5AJG	...33	9	1360	K0CER	...17	6	1225
W5FYZ	...33	9	1275				
W5JWL	...33	7	1150	VEICL	...8	5	800
W5DFU	...29	9	1300	VEEDR	...37	9	1300
W5FZ	...28	8	1300	VE3ATR	...28	8	1340
W5RQ	...24	8	1150	VE3BP	...25	7	950
K5TQP	...22	7	1250	VE3BN	...23	7	1180
K5WXZ	...22	5	1000	VE3HW	...17	7	1350
W5SWY	...20	5	960	VE6HO	...1	1	915
W5UGO	...16	4	1050	KE6UK	...2	2	2540
W5KTU	...15	5	1360				

The figures after each call refer to states, call area and mileage of best DX.

The two-meter sked between K5TQP and K5WXZ (New Mexico and Texas) over a 570-mile path has turned out to be practically an everyday affair. It isn't quite that simple but out of the three skeds the boys had three contacts with good copy at both ends each time. Fred tells us that his new 70-foot tower is installed at the home QTH in Tijeras, New Mexico and hopefully the two- and six-meter beams have been installed by this reading. Al, K5WXZ, also wrote us about the above-mentioned contact and then went on to tell us of his "doings" on June 16, 17 and 19. On the 16th, Al worked 15 stations in 9 states with 5 new states worked. The 17th brought forth W0EMS and K0DOM in Nebraska plus a number of others in Ø land, but the contact with WA0FDY in Minnesota brought his states up one more notch. On the 19th, W8PT and WA9DOT (Michigan and Wisconsin) brought Al's states worked on 144 Mc. up to 22. He sez that his 4CX250's and four 8-element yagis at 60 feet made the difference. Most of the stations heard were not too strong but they were the boys running a little power and reasonable beams at a reasonable height. Al is on every night at 144.085 listening and calling from 0315 GMT until 0505 GMT. W5FAG is now operational with his high power-s.s.b rig on the low end of two meters. Hub was reading K7NII on his sked with K5TQP and hopes to QSO Tom during August. From New Orleans, Louisiana, W5JFB writes of excitement in that neighborhood when W2OKF aero mobile called into the two meter net. Walt was over

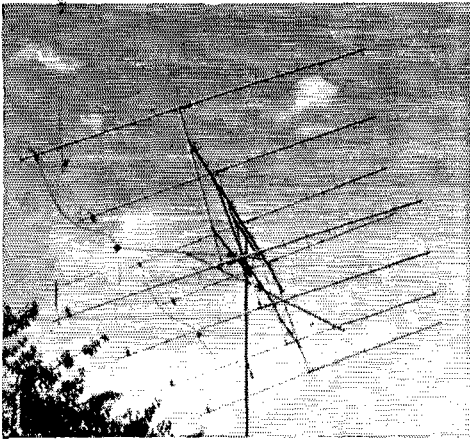

432-Mc. antenna used at F8GB during the July tests.

Jackson, Mississippi at an altitude of 25,000 feet. He was Q5 into New Orleans and gave W5ABD, net control a 5-9 report and W5JFB received a 3-3 report on his twoer and skewed wheel. Sounds like a great time was had by all.

The Californians are ready for 144-Mc. skeds! K6JYO writes that his 32-element colinear and s.s.b. mixer are checked out and ready to go. Bruce hopes to resume skeds with K7NII in the near future on 144 Mc. At San Francisco WA6NDZ sez: "Have an AN/TXC-1 Facsimile transceiver in operation. Have been making picture from press and navy weather maps. Still having a problem in transmitting a picture. Will be putting this on two meters or 220 Mc. in the near future. I understand that there are three stations on two meters with FAX in the Bay area. I'd like to arrange skeds." WB6FGM is trying to start m.c.w. on 144 Mc. in the Sacramento Valley area. He'd like to hear from anyone interested. A final scheduler from 6 land is WA6STS who would like skeds in Santa Barbara, Bakersfield and Fresno. Glen has a new 20-element spiral array on 144 Mc. (that shows about 10 db. increase over his previous 5-element beam) and his kw. linear for 144 Mc. has been completed. WB6CKT is back on two-meter s.s.b. running a 829B with 50 watts out. Regular skeds have been set up between W7AYY at Tempe, Arizona, and K7VAB at Tucson to see how often the path is usable for 144-Mc. contacts. Power at K7VAB is 60 watts with a DB-62 at 40 feet. Power at W7AYY is 10 watts with a similar antenna at 25 feet. K7NII remarks that is interesting to note that K5WXZ puts a signal into Scottsdale, Arizona everytime he is on the air. K6QKL/7 at Tacoma, Washington, writes that WB6KAP and KH6CMM are running scheds twice daily on two meters. No two-way success reported thus far. Chuck suggests that: "It would pay anyone interested in band openings to KH6 to monitor 131.9 and to become familiar with latitude and longitude position plotting."

WA8MHW in South Euclid, Ohio, wants to emphasize a point. "You don't need much power on two meters, just a good antenna system! I am reporting that my station made contact with K2KGN in Bemus Point, New York, VE3DWL in Welland, Ontario, and K9YGGZ in New Berlin, Wisconsin on July 5. My rig is a Twoer and a ten-element beam. So who needs power?" We agree Rick, but—who do you suppose you missed?

Reports have it that WA8KJJ has 4 seven-element beams on an H frame nearly ready to raise on 144 Mc. He also is building a camera to supplement his flying spot scanner. From Ypsilanti, Michigan, K8PBA writes us that 144 Mc. was open to Iowa on July 7 and 23 and to Kentucky every night between the 23rd and 31st. Bob missed the opening into Texas and Arkansas 'cause he was on vacation. Sometimes it seems like vacations just aren't worth it! A two-meter f.m.-repeater for the S.W. side of Chicago is now in the works. WA9AHZ, K9FVB, WA9MED, W9YVP and W9RSV are all involved in the project. WA9JLD has a Model 26 in operation on both 2- and 6-meter RTTY.

One of those "times to remember" is reported by W0LCN. "I was out of town on June 17 and didn't get on 144 Mc. until about 2220 CDST. There being not a sound I suspected that everyone was holding his breath and I called CQ. WA0FDY came back and informed me that he had worked K5WXZ in Garland, Texas (boy he's cropping up all over the place) just a few minutes earlier. It seems that K0CER in South Dakota had worked the Texan at about the same time the previous night and tipped off FDY. At 2220 all was dead. I listened for a while, then turned on my carrier. At the conclusion of my CQ I heard FDY calling K5WXZ on phone and presently heard a nice Texas accent (Al's from southern Ohio, Clair!) on NFM. At the conclusion of that contact I eked out a 5-1-9 from Al while he was 5-5-9 at my QTH but steadily going down. K5WXZ, W5AJG and W5PZ were heard and called during the next half hour and then they were gone. The following night WA0FDY had a contact with W5PZ in Oklahoma but things were about over here." More fun! K0FPC is chortling away 'cause he has an electrical rotation system for his antenna after two and a half years. Now watch it, Bob. That running back and forth was good for the waistline you know. He also advises that the Cass County Net at 144.35 Mc. (0400Z Saturdays) has as many as 16 check-ins and that the group is inviting anyone else who'd like to check-in. Of the nine hams in Harrisonville, Missouri, six of them are on 144 Mc. and of course K0FPC is one of 'em. From the state of South Dakota and K0CER we hear that Bill brought his states worked on 144 Mc. up to 15 when he worked K5WXZ in Texas and W5JWL in Arkansas. For South Dakota I'd say that was going some. Congratulations, Bill!

50 Mc.

From Guam, KG6APJ writes that weak sporadic E was heard from JA land at 0800 GMT on July 2. Weak carriers were observed but no signals were identified. George says that most of the JAs run 3 to 8 watts but need power in excess of 100 watts for reliable operation. He also tells us that he and VK8AV started 50-Mc. experiments on July 19. Hope you let us know how things come along, George. Another of the exotic call areas we heard from this month is KZ5 land. Sunday, KZ5EX (K1MWX) says: "At present all things are extremely tentative, but I am hoping to have some six-meter equipment in operation in about three months. It is beginning to line up as a 4-400A to a ten-element beam on a 50-foot boom, all homebrew, and all situated on top of a hill, one of the highest on the Pacific side of the Canal Zone. I am attempting to get a special license granted for twenty-four hour operation, as a beacon station, until I can determine best likelihoods of openings and probabilities of working the States. KZ5AY also sez that he has a converter for his KWM-2

220- and 420 Mc. STANDINGS

#20 Mc.		
W1AJR.....12	4	480
W1BU.....14	5	600
W1HDQ.....12	5	450
K1JIX.....11	4	615
W2AOC.....15	5	530
K2AXQ.....9	3	240
WA2BAH.....4	2	187
K2CBA.....16	7	660
K2PZM.....12	5	400
K2ISA.....11	4	300
K2ITP.....10	5	265
K2ITQ.....11	5	265
K2JWT.....6	3	214
K2KIB.....12	4	400
W2LWI.....12	4	400
W2SEU.....12	5	450
K2OUR.....6	3	210
W3FEY.....11	5	350
K3IUV.....9	3	310
W3JYL.....3	4	295
W3JZI.....4	3	250
W3LCC.....10	5	300
W3RUE.....10	5	480
W4TLC.....5	1	315
K7ICW.....4	2	250
W7AGO.....2	1	160
K8AXU.....11	5	1050
W9JCS.....6	2	340
VE3BPR.....3	3	300
420 Mc.		
W1AJR.....12	4	410
W1BU.....11	3	390
W1HDQ.....10	3	250
K1JIX.....9	3	230
W1OOP.....11	3	390
W1UWJ.....10	3	230
W1UHE.....10	4	430
K2CBA.....8	4	220
W2ADT.....6	3	200
K2JZM.....10	4	390
WB2EGZ.....9	4	260
W2EUS.....7	3	130
K2GGA.....1	4	383
WA2HQE.....8	4	280
K2HQJ.....8	4	250
W2JTA.....10	4	340
K2UUL.....9	3	280
W2VCG.....9	4	280
W2YPM.....6	3	300
WA2TOV.....5	3	140
W3RUE.....9	5	470
K3CLK.....9	4	400
W3FEY.....8	4	296
K3IUV.....8	3	310
W3LCC.....5	2	300
W3SD.....5	4	300
W3MIV.....5	3	240
W3UJG.....4	3	350
W4HHK.....9	4	550
W4TIV.....6	2	500
W4RFB.....5	2	665
W4TIV.....4	2	500
K4QIF.....3	1	210
W5RCI.....16	5	725
W5AJG.....6	2	685
W5HIZ.....5	3	440
W5WV.....7	3	525
W5UKQ.....3	2	200
W6FZA.....1	1	280
K6GTG.....1	1	180
W8PT.....11	5	400
W8TYY.....9	5	580
W8YIO.....9	5	450
W8IFX.....8	5	470
K8AXU.....5	3	660
W8JLQ.....6	3	275
W8BQJ.....6	3	270
W8HJL.....3	3	25
W9OJI.....6	3	330
K9AAJ.....9	5	425
K9IUF.....9	5	390
W9AAJ.....8	4	325
W9GAB.....9	4	608
WA9HUV.....7	4	450
W9OJI.....6	3	330
WA9NKT.....4	4	275
W6IDY.....9	5	560
K6ITF.....3	2	158
VE3AIB.....5	4	450
VE3BQN.....5	4	447

The figures after each call refer to states, call area and mileage of best DX.

and we'll try a little s.s.b., if we meet with any success." The whole gang will be happy to learn of your efforts, Sunday, and hope to be one of your many contacts when you do get going. WB2JHK writes that skip did not measure up to last year's conditions although all call areas were heard and Canada and Mexico on occasion. Dave is presently working on a s.s.b. transmitter. From Burt, New York, WB2DMU writes about openings of nine different days during July, during which he worked stations in 13 States plus VP7NX and VE4MB.

Very interesting news received from Al, K3CZI who writes: "I wish to report hearing KH6ABU on Wednesday July 7 at 12:18 p.m. EDT. (1618 GMT) on 50.115 Mc. K1MUE and W2REB also heard the signal at the same time. We all agree that KH6ABU was the correct call. I've written to KH6ABU requesting information on his operating on 50.115 at that time from his home QTH. I was in QSO with K1MUE at that time on s.s.b. when I heard KH6ABU calling CQ on frequency on a.m. I immediately called him on s.s.b. but no reply. He then faded out. W2REB heard him again at 1:00 p.m. EDT at 50.22 calling CQ at which time a W4 called him but no contact." Sure sounds good, Al. Wonder if you've had any reply to your letter. Be sure to let us know. The boys in Florida all agree that the band is beginning to slow down as far as openings are concerned although there were still a number of them during July. WA4EEZ mentions the two-way s.s.b. contact he had with KP4JM on the 18th plus a number of other openings. W4FP

also noted openings but has this to add to his report: "The use of the band above 50.5 Mc. for general contact and skip contacts is practically nil. All during the band openings most of the stations seem to be in the neighborhood of 50.1 to 50.5 Mc. I have repeatedly moved up to 51 and 52 Mc. and called CQ and had no difficulty in getting replies. All the stations contacted said they were very glad to get out of the QRM." You're right of course, Tom, but if you get answers at 51 and 52 Mc. then you are in an unusual situation. Believe me in most of the country it's almost an impossibility to get contacts at these frequencies without schedules. Maybe the boys will take heart again after reading your comment, and move up there once in a while. From Hollywood, Florida, WA4STJ sez that his total confirmed 2-way 50-Mc. s.s.b. contacts are now up to 33 states and 3 countries. The boys in Tennessee have a difference of opinion concerning 50-Mc. skip sessions. W4WQZ sez that although the band has been open to some extent almost every day (during June) most of the openings were to Texas only, while WA4NUJ and K4KYL heard at least 32 states plus VE2, VE3, VP7, CO2 and KP4 during that same month. Big story for the month of June was received from W2UZN/4 at Norfolk, Virginia who was told by K4RVU that he (K4RVU) had heard an EA0 on 50 Mc. during the VHF-Contest weekend???? No details! WA5MGP and WA5FBM are having a lot of fun experimenting with low-power transistor rigs on 50 Mc. Don sez the little rigs are in the 50- to 100-milliwatt class. Some of their tests have been conducted from Scenic Drive on Mount Franklin as well as down in the valley near their QTH. Ray Clark, K5ZMS, back from Turkey and once again on six meters is running about 20 watts of input on s.s.b. and doing pretty good with it. In one month's operating he's worked 26 states on s.s.b. plus hearing or working stations in VP7, VE4, KP4, CO5, XE1 and FG7. Ray was told by K3RHO that he had heard a station in Copenhagen, Denmark during this opening (June 6). Another juicy item heard by Ray was that a KP4 had heard a 5U7 (this on July 5). Seems like there's an abnormal number of these rumors going around. Wish someone would either confirm 'em or sketch 'em for us. Out in 6 land W6ARQ observed openings into 7 land on July 11 and 23, and on the 20th he heard 0s but was unable to identify or work them. W7AYY caught an opening on July 18th and worked stations in Texas and California. He sez: "During the opening into Texas, Channel 2 in Houston came through but even more remarkable than this was the fact that by careful adjustment of the Rabbit Ears it was possible to receive Corpus Christi, Texas on Channel 3 despite the fact that a local station in Phoenix is on the same channel." Just had to be a good night for 50 Mc., Don. What were you doing wasting any of that valuable time fooling with the TV? From Michigan, K8AQA writes that six meters seemed to reach its peak for the year about the first of July with conditions dropping off fast after that time. 50.525 Mc. seems to be a popular one in Minnesota. WA0IDB writes us that southern Minnesota now has stations on that frequency in Mankato, Janesville, Waseca, Madison Lake, Minnesota Lake, Worthington, Winnebago and some rural communities. Al was delighted with a couple of contacts he had on July 13 with WB2BBP and WB2ADC in New York when he worked them from his mobile rig. WA0AMO tells us that during one opening he worked 7 stations from 2, 4, 5 and 8 lands in one hour and twenty-eight minutes and was the first Missouri contact for all seven. (That's fun!) QST

YL news and views

CONDUCTED BY JEAN PEACOR,* K1JIV

DXCC Can be Yours

If you can jump out of a warm bed at 3 A.M.! If you're a good listener! If you can manage to be in the right place at the right time! It's true, DXCC can be yours.

Excitement unequalled can be found by tuning your receiver across the 20-meter band and hearing it open to the world. If your DX stories fall into the fish story category (you wouldn't believe the ones that have gotten away), perhaps the comments that follow about some of the leading DX YLs will spur you onward to that first 100 countries.

The number of YLs who are active on the DX bands is surprisingly large, as the following list will show. At the top of the list, with 314 countries confirmed, is Maria de Dantiacq, LU4DMG, of Buenos Aires.

But, can anyone top a 624 confirmed DX total? This is the total shared by Maxine and Ed Willis, W6UHA and W6TS, both leading DXers. Maxine's share of the grand total is 304. Ed, licensed since 1922 as a high school boy, was the first radio amateur to work across the U. S. on 20 and 40 meters (with 1XAM and 2MU) in 1925. Since obtaining her license in 1941, Maxine has specialized in DXing, and together, she and Ed have made countless friendships throughout the world. She's found it to be very true that distance lends added enchantment to any contact. Maxine is a charter member of The Southern Calif. DX Club, also, the Los Angeles YL Club, and Custodian of DX YL certificate for YLRL.

Sally Mary Ryden, KSONV, of Birmingham, Michigan, has been licensed since 1959 and an avid DX hound ever since. Her goal to reach 300 countries confirmed was attained on May 12 when MP4MAH's QSL arrived. Mary has been QSL manager for several DXpeditions and the entire Ryden family had the pleasure to operate as DX in 1963 using the call VP2MM in Montserrat. DXers all, Mary's OM is Ken, KSOHG, and their two daughters are Sally, KSONW, who is 21 and studying to be a doctor at the Univ. of Mich., and Alicia, KSRBB, a 17-year-old senior in high school and holder of DXCC since she was 13.

About six months after Dorothy Strauber, K2MGE, passed her General exam in 1956, her OM, Irv, K2HEA, had the foresight to install s.s.b. gear. That was in the days when, on 20

meters, they often had to arrange an s.s.b. sked via the land line in order to find someone to talk to. In those days, conditions on 10, 15, and 20 were excellent and ragchewing roundtables were being carried on with stations all over the world. Following her early start as a sidebander, Dorothy went on to become one of the best-known sideband DXers through not only her many QSOs, but as a result of her assistance to Irv in editing *The Sidebander* and as s.s.b. editors for *CQ Magazine*. She is an active member of the SSB Amateur Radio Association and the Long Island DX Association. Dorothy has rarely missed a day on the air in ten years and has probably worked more DX on two-way sideband (296/300) than any other YL in the world.

Libby Auer, K0MAS; Helene Leonard, W6QOG; Ellen White, W1YYM; and Lucia Da Silva Tome, CR7LU; are all well over the 200 countries confirmed mark, as the list shows. Libby has managed to attain these totals and yet raises orchids, makes jewelry and works on the side. Helene, licensed since 1938, has earned WAZ and WAC YL and mentions the fun there is in being considered "one of the boys" in a pile-up. Ellen, who has also held the calls W6YYM, KH6QI and W2RBU, is a past SCM for the San



Shown at the National Convention at San Jose, California, are Herbert Hoover, Jr., W6ZH, Pres. of ARRL, and Martha Edwards, W6QYL, Pres. of YLRL. (Photo courtesy of W6DEY)

*YL Editor, QST. Please send all news notes to K1JIV's home address: 139 Cooley St., Springfield, Mass.



Diego section and is known to all as ARRL's Contest Administrator.

Every one of these top notch DXing YLs readily attest to the great pleasures to be found through this aspect of amateur radio. DJ3FP recently wrote: "OMs are good friends all over the world and do not know any border." YL activity on the DX bands adds to the proof of this statement for all.

DXCC YLS

CW/Phone DX total shown only if endorsement since Oct. 1, 1963.

Cert. No.	Issued	Call	Total
393	Feb., 1949	W2NFR	
399	Mar., 1949	W6UHA	
750	Oct., 1949	G3ACC	
829	Jan., 1950	W1FTJ	
870	Mar., 1950	ZS6KK	
1269	June, 1951	ZS2EC	
2024	Oct., 1954	W1RYJ	
2138	May, 1955	KZ5DG	
2171	July, 1955	W3WUW	
2204	Aug., 1955	ZS6WJ	
2347	Mar., 1956	KZ5KA	
2388	Apr., 1956	W7QGF	
2516	July, 1956	CR7LU	209
2630	Oct., 1956	W1VFK	
2651	Nov., 1956	W1YYM	230
2700	Nov., 1956	W6CXC	
2805	Feb., 1957	K5AHZ	
2819	Mar., 1957	W9MPX	
2850	Mar., 1957	W1YYR	
3048	Aug., 1957	W9OMZ	
3058	Aug., 1957	W4VCB/3	
3061	Aug., 1957	K6OWQ	171
3111	Sept., 1957	W8OKB	
3119	Sept., 1957	DJ2YL	
3253	Dec., 1957	VE3DKY	
3476	Apr., 1958	W5DRI	
3756	Aug., 1958	KH6AUJ	
3812	Sept., 1958	K0BFS	
3966	Dec., 1958	K6IAP	
4029	Jan., 1959	W9MLE	
4113	Feb., 1959	K5BEU	
4173	Mar., 1959	K2UKQ	
4413	July, 1959	W7IKK	
4417	July, 1959	ZF7JY	
4443	July, 1959	DL6YQ	
4483	Aug., 1959	ZS1NQ	191
4774	Jan., 1960	G6YL	
4796	Feb., 1960	SM5AE	
4832	Mar., 1960	ZL2JO	192
4848	Mar., 1960	W1ICV	
5096	July, 1960	OA4HK	
5174	Aug., 1960	VE7ADR	
5310	Nov., 1960	K8ONV	300
5372	Dec., 1960	W1YPH	155
5411	Jan., 1961	W5JCY	
5439	Feb., 1961	KH6DLL	

5493	Mar., 1961	K0IKL	
5526	Mar., 1961	W7QKU	
5503	May, 1961	K6RNZ	
5626	May, 1961	K6QPG/KW6	
5656	June, 1961	W4UF	140
5667	June, 1961	W8HPS	
5690	July, 1961	K0MAS	210
5709	July, 1961	K5TXQ	
5813	Oct., 1961	K4ICA	
5980	Feb., 1962	W4VCB/KL7	
5990	Feb., 1962	K9AMD	120
5998	Feb., 1962	K2INQ	
6021	Mar., 1962	W5DVV	189
6050	Mar., 1962	K8RBB	152
6087	Apr., 1962	W1TIW	
6188	June, 1962	W4BWR	156
6425	Nov., 1962	K8ONW	120
6440	Dec., 1962	K7EQM	130
6478	Dec., 1962	K1PZB	142
6847	Sept., 1963	K3PKI	
6864	Oct., 1963	K5SGJ	120
6884	Oct., 1963	K9JJS	133
7107	Mar., 1964	H45FQ	100
7118	Mar., 1964	VE6ABP	160
	Apr., 1965	W80MM	101

DXCC YLS

Phone DX total shown only if endorsement since Oct. 1, 1963.

Cert. No.	Issued	Call	Total
18	Apr., 1948	W1MCW	
222	Apr., 1950	W8BFQ	
290	Sept., 1950	LU4MG	314
504	June, 1953	LU4DMG	314
547	Jan., 1954	C02BK	
637	May, 1955	KZ5DG	
662	July, 1955	W9QLH	
737	May, 1956	W6QOG	243
772	July, 1956	W1VFK	140
849	Dec., 1956	K5BEU	
861	Jan., 1957	W1RYJ	
897	Apr., 1957	W6CXC	
985	Aug., 1957	W3BIW	
1011	Sept., 1957	ZE1JE	
1059	Nov., 1957	W5HWK	
1080	Dec., 1957	KL7ALZ	
1113	Jan., 1958	W4VCB/3	
1119	Feb., 1958	K0ACC	
1171	Mar., 1958	W5HWX	
1188	Apr., 1958	K4CYF	
1224	May, 1958	K3GEN	
1283	Aug., 1958	W7TGG	
1306	Sept., 1958	KL7BAE	
1329	Oct., 1958	PY5QZ	
1361	Nov., 1958	K2MGE	295
1459	Mar., 1959	W1SGD	
1480	Apr., 1959	W0MRJ	174
1494	Apr., 1959	VE7IT	
1581	Aug., 1959	CR7LU	145
1705	Dec., 1959	KR6HI	
1795	Apr., 1960	K9KKR	
1920	Sept., 1960	K9LUI	



Top Notch DXers All! Some of the fine YL operators behind many of the terrific DX scores are (l. to r.): Maxine Willis W6UHA, Dorothy Strauber, K2MGE, Sally Mary Ryden, K8ONV, Libby Auer, K0MAS, Helene Leonard, W6QOG, and Ellen White, W1YYM. (Left): Lucia Da Tome, CR7LU.



Moonbounce History's First YL

In July, a newspaper in Lancaster, Pa. headlined a front page article "Hams Bounce a Signal off Moon." The hams — Oliver Smith III, K3MAW, and Bertram Flick, K3HEC, worked the controls while Oliver's XYL, Livy, K3HOC, operated the key as their moonbounce signal successfully contacted KP4BPZ in Arecibo, Puerto Rico.

You've no doubt seen the cover and inside story in *QST* for September, 1965, which relates the tremendous success of recent tests conducted at Cornell's Arecibo Ionospheric Observatory. Any radio amateur who successfully contacted this station, KP4BPZ, would have been elated. Add to that the thrill of learning you're the first YL to accomplish such a feat and you can imagine how Livy, K3HOC, must have felt.

For six weeks, K3MAW and K3HEC had been intensively working on their equipment preparing for the great day. The morning of the test found them up at dawn. At 7 a.m. they heard the first call of CQ Moonbounce from KP4BPZ as it began its three-hour period of communications. Livy answered every QRZ for the entire three-hour period

(Continued on page 156)

1969	Dec., 1960	K0MAS	210
1970	Dec., 1960	DJ3YL	
2006	Feb., 1961	K2SHE	
2018	Mar., 1961	K0EPE	
2029	Mar., 1961	W1YPT	
2038	Mar., 1961	W7QKU	
2049	Apr., 1961	K1AEY	
2088	June, 1961	W9UNG	
2094	June, 1961	KH6DLL	
2121	Aug., 1961	K4GEF/exW1MCW	
2165	Oct., 1961	K8ONV	300
2171	Nov., 1961	K5LXA	
2179	Nov., 1961	CT1YE	
2182	Nov., 1961	W2OWL	159
2199	Dec., 1961	KP4CL	200
2208	Jan., 1962	W4GMAZ	165
2221	Jan., 1962	D14ZW	100
2234	Feb., 1962	W4VCB/KL	111
2254	Mar., 1962	K9WUR	
2257	Mar., 1962	W5DVV	178
2322	June, 1962	UA3CG	
2332	July, 1962	K1OYM	
2358	July, 1962	W4BWA	144
2375	Aug., 1962	YF3CT	
2395	Sept., 1962	VE6RP	
2427	Nov., 1962	K6KCI	104
2441	Nov., 1962	W4UF	112
2444	Dec., 1962	K5OPT	131
2468	Feb., 1963	ZS1TZ	106
2514	May, 1963	YV5ALC	106
2523	May, 1963	K9TRP	120
2538	June, 1963	K0WEN	101
2728	Mar., 1964	K4RHL	111
2758	May, 1964	VE6ABP	108
2948	Apr., 1965	WA6OET	104

To determine how many YLs are presently included in the DXCC listings appeared to be impossible until Ellen White, W1YYM and Asst. Communications Manager at ARRL, offered her assistance. Ellen devoted many lunch hours to this challenge, and it is only with her help that the list is presented. If an OM or two are included, or a YL or two omitted, it is entirely accidental. Corrections will be welcome.



In July, Livy Smith, K3HOC, of Lancaster, Pa., made YL-moonbounce history by successfully contacting KP4BPZ in Puerto Rico. (Photo courtesy of Lancaster, Pa., New Era.)



Operating News



F. E. HANDY, WIBDI, Communications Mgr.

LILLIAN M. SALTER, WIZJE, Administrative Aide GEORGE HART, WINJIM, National Emergency Coordinator

ROBERT L. WHITE, WIWPO, DXCC Awards

ELLEN WHITE, WIYYM, Ass't. Communications Mgr.

GERALD PINARD, Club Training Aids

PETER CHAMALIAN, WIBGD, Communications Asst.

W1AW's General Operating Schedule.

We're pleased to present this month, a chart indicating the appropriate times using various frequency bands and modes, to try for a contact between your home station and W1AW. (See p. 124.) This sked will be varied from time to time by further notices in *QST*. Such will be necessary to meet seasonal changes in skip-performance of the different amateur bands; also our ratio of available hours for operating afternoon and evening will change considerably with the change from daylight time to standard time. We're still installing and making some changes in the equipment setup. As reported last month, in addition to visitor responsibilities we have added to the number of code-practice transmissions. We have a new item this season, our RTTY bulletins, supplementing twice daily bulletin coverage on c.w. and voice "to all amateurs" all days of the week. More than ever, W1AW is "all things to all amateurs"! Note the specific frequencies and times W1AW will use in each band and mode elsewhere in these columns.

Don't Miss the 32nd ARRL SS! Is it for you (1) a chance to pick up needed states and counties to complete a showing for awards? (2) A new antenna to be checked out? (3) A new QTH? (4) Station performance to be tried on a new band? (5) Your *operating* performance with your regular equipment? (6) Competitive standing with other hams in your ARRL section? or (7) Just some top-operating fun? Whatever your SS interest, get those station improvements finished. This one is coming up fast. Plan to get on the air for those November weekends of the

13th (phone) or 20th (c.w.) and give it your best!

New SS Bonus Points . . . Extra Score Available for Starting a Message (on your SS Results) via NTS/Local Net. There's no change from recent years in the form of making or crediting SS exchanges. We do have a new easy-logging form (on request). You operate merely following the pattern suggested for noting exchanges and crediting multipliers as indicated, see November *QST*. But something has been added, a possible credit of twenty-five (25) points before multiplier for participants who act in the Monday-through Friday (five days) *immediately after* the "SS" periods *originate by radio*, in proper form, through a net in your area (or by NCEF's) one message reporting your SS results to your SCM. For the extra credit you must attach a copy of this radiogram, with the handling data, calls and time-date receipted for, with your SS report and claimed score sent Hq. See the box in the SS announcement this *QST*, for details.

Readers may be interested in the background for "bonus points." A survey of SCM-SEC opinion, last May, examined a number of operational matters. On the matter of encouraging (by bonus) in contests the principles of message relaying some 87% of the official responses were in favor. We have therefore worked out a way to make an "extra" possible. There's no obligation to go after a "bonus" but adding a little credit for thus telling your SCM you are active and familiar with the technique of putting a real message into net channels may be good. This is so since any amateur may sometime need to do it in public service work in a disaster! Your

32nd ARRL Sweepstakes—Nov. 13-15 (phone), 20-22 (c.w.) All W/VE Amateurs Invited To Participate

The highlight of Fall activity, the 32nd ARRL Sweepstakes, will soon be here. As is our usual custom, this early announcement is for the benefit of those amateurs in remote ARRL sections who may not receive their November issues in time for the test. The rules remain the same with one exception. The contest period will run a full 30 hours from 2100 GMT Saturday night until 0300 GMT Monday morning on each of the weekends. Only 24 hours of participation will be permitted, however. Time-out periods may not be taken in less than half-hour increments. This will permit a *maximum* of twelve off periods of a half hour apiece or six off-periods of one hour, etc. See the rules in November 1964 *QST* concerning the message exchange. The November 1965 rules will also carry a brief announcement (see also above) of a way to earn bonus points *following* the S.S. Note too that brand-new convenient reporting forms are ready for your request. Write early to the ARRL Communications Department, 225 Main St., Newington, Conn. 06111.

JULY CD PARTIES

elected SCMs looked at it that traffic and emergency service requires experienced know-how, also practice with net operating *before*, and not after, an emergency. Unpracticed operators can barge into a net and foul things up. Some operators, too, are bashful or reluctant to enter a net the first time for fear they may show inexperience. But it's fun to do it when many others do. Suggested means to improve knowledge and familiarize more amateurs with objective messaging were discussed at meetings in the Roanoke and Midwest and the "bonus" procedure as a reward for the contestant radio-reporting right after a given activity. We hope this will serve the good purpose to help more operators find the operating frequencies of their section net or how to use the NCEFs! Our early SS went *beyond* a bonus and required writing and exchanging full message texts with each station in a full nine-day continuous exercise, up through the sixth "SS" in '35. Let's see how many will be interested in earning the easy bonus. A suggestion to put the message on a net right during the contest was made; this was believed impractical though, since an SS of today's dimensions would result in a high state of traffic congestion if everyone tried to work into the same net at the same time!

We hope we can grant 100% SS bonuses to 100% of the participants in this year's Sweepstakes!

ARRL Observers Honored. The prime mission to be accomplished by the League's Official Observers is to keep radio amateurs out of FCC difficulty. For the fifth consecutive calendar year OOs sent and reported well over 20,000 cooperative notices. Such advisory service is accomplished unobtrusively by their mail efforts. As a result of their tips of signal and other deficiencies, operating conditions in the different bands are bettered for all amateurs. We have here compiled some information to honor publically some hundreds of OOs assisting as a group in this effort. Also we want to give special commendation to those who were leaders in sending the advisory form cards that the League provides to assist such SCM appointees.

Honor Roll

Call Area Leaders			Over 300 Notices Sent		
W1FZJ	W2BLP	W3NNC	W4NTO	K8RFU	W3NNC
W5FFW	K6ER	W7HDL	W2BLP	K8NYN	W8EMD
K4VWL	K9YRA	W0PFG	K8YBK	K9YRA	W4VWL
K8RFU			W2TPJ	W0PFG	W8CQN
			W7HDL	K3HNP	W1FZJ
			K6ER	K0TDO	

Pre-SET Action. The Simulated Emergency Test (Annual) takes place October 9th and 10th. This is a spot exercise to be originated by local ARRL Emergency Coordinators who at all times have the fullest information on local disaster plans and who will or should announce this running of the SET as a local exercise. You should aim to belong to the Amateur Radio

(Continued next page)

As K3QDD aptly put it, "If that wasn't the highest-scoring most active CD Party yet, it sure was close." Comparatively speaking we had 53 topping 100-K e.w. (vs. 49 in July of 1964); for phone, 45 broke 5-K (vs. 27 the past year). In fact, fellas, for the comparative effort involved it seems logical at this time to up the minimum figure for phones to 10-K for QST listing. Highlights? The new phone record by K5MDX, over 67-K; W1JYH pulling a 4-hour 100-K bit *a la* W4KFC; the tremendous activity the first four hours; the dearth of it during the day Sunday; the appearance of two KH6s, 2 Utah and 3 Idaho stations.

The following are high-claimed scores, number of QSOs and sections with final corrected results to appear in the October CD Bulletin.

— W1YYM

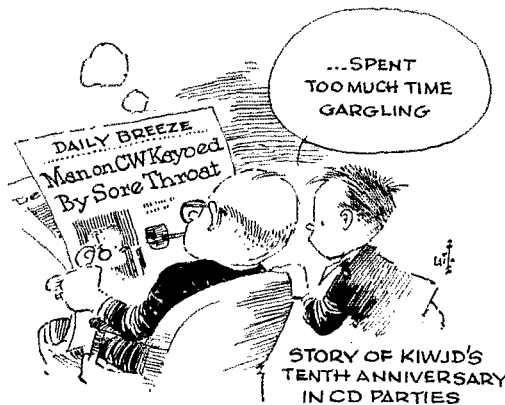

C.W.	W4USM	PHONE
K1WJD.....208,890-626-66103,530-350-58	K5MDX.....67,200-240-56
K8HLR.....207,740-604-64	W1DYB.....100,650-325-61	W0EWC.....56,350-221-49
W1BGD.....194,350-591-65	K1EWL.....100,650-323-61	WINJL.....40,205-180-43
W9YYG.....186,560-578-64	W8AJZ.....100,340-339-58	W1JH.....32,185-150-41
K4VFY.....186,225-567-65	W9YTH.....100,200-328-60	W4TFL/4.....31,000-155-40
K1YKT.....182,400-564-64	W1JYH.....190,160-306-64	W1BGD.....23,580-124-36
K4BYD.....181,675-552-65	W2AJR.....100,130-323-62	K2EU/5.....19,080-99-36
K3QDD.....180,800-550-64	W8VPC (K8MFO, W8VPC).....210,045-620-67	W4MXU.....18,720-110-32
W2ZRC.....177,600-548-64	W1AW (K1DQC, W1WPR).....130,095-406-63	K3JPL.....18,530-104-34
K4ZRA.....176,715-555-63		K1ZHS.....18,180-91-36
K9DHN.....175,360-543-64		K0LGG.....17,655-107-33
W2WLN.....170,625-518-65		W9NPC.....17,280-102-32
K1ZHS.....169-325-514-65		W2UWA.....16,960-106-32
K7CHC.....166,975-477-65		W5VZO/4.....15,190-94-31
K4TKM.....163,600-473-64		K0YIP.....15,035-90-31
W1SWX.....153,400-465-65		W4JJK.....14,550-97-30
W9LNG.....145,485-472-61		W6TYM.....14,355-82-33
W0WYJ.....144,900-453-63		K4PTN.....14,250-95-30
W4TFL/4.....143,640-456-63		W2EDU.....12,040-86-28
K2EU/5.....142,500-448-60		K4ZRA.....12,015-83-27
W3EIS.....142,065-445-63		W2AHP.....11,620-78-28
K8TIG.....134,505-435-61		K9IVG.....11,600-78-29
K3HNP.....133,250-405-65		W0EGQ.....11,020-69-29
W8CFJ.....129,310-386-67		K4BYD.....10,790-76-26
K4RIN/4.....123,965-409-61		K1WJD.....10,665-72-27
W9AUM.....123,380-392-62		W3KJJ.....10,640-70-28
W9BWW.....121,200-400-60		K9DHN.....10,010-72-26
W2KXG.....120,000-370-64		W2ZRC (W2s EUP ZRC, K2STL).....12,180-155-38
K1ZND.....118,645-382-61		K8HLR (K8HLR, W8KYJ).....10,640-69-28
K9JPL.....118,200-389-60		
W2FFIT.....116,250-375-62		
W9QQQ.....115,800-379-60		
K2QDT.....114,240-353-64		
W2UFI.....111,935-360-61		
W2PIL.....108,160-331-64		
WTECH.....107,880-341-62		
W2ZVW.....107,380-357-59		
W4ICU.....106,495-355-59		
K4SD.....106,140-360-58		
K3QFG.....105,610-352-59		
W6TYM.....104,100-342-60		
K0AZJ.....104,050-366-57		
W2MHT.....104,220-386-54		
W4HRG/4.....103,635-324-63		

¹ W4HMC, opr. ² K2SIL, opr. ³ W8FAW, opr. ⁴ K9ELT, opr. ⁵ W2UWA, opr.

Emergency Corps (AREC) so you can be written into plans for use and deployment of stations and operators come any call or opportunity for public demonstrations or use of amateur facilities. Every operator-reader of these pages should find a way to have a part in the SET activity. We'll leave it to you to get the information on local SET plans from your EC . . . contact him to ask about details or *how you can register in AREC*. Emergency Units Placards and AREC decals are available from your EC for AREC members for those who register (or re-register and will be active in tests or on a stand-by basis). All amateurs are invited to identify with this Public Service Corps (ARPS) group or to be signed up in RACES and collaborating in such tests as the October SET to point this up. The test activation of mobiles, use of emergency power at fixed stations and giving a current meaning to your AREC by taking part in a workout that simulates specific conditions that might arise is worth all we can give it!

New List of SECs. This month we list in these pages the current addresses of all Section Emergency Coordinators. The SEC and SCM can put you in touch with your local or county EC. If you don't already know him, get in touch to update or initiate steps to get a new and current AREC membership card. For any community or parish having no SCM-appointed Emergency Coordinator, amateurs should recommend suitable candidates, so action can be taken, if new action is necessary, to provide such leader-appointments.

Op. Aid 9A a Guide to Traffic Form. When the chips are down in actual disaster work much important communication must be by record-type traffic. Every amateur should know the proper order of parts of messages and how to handle and receipt for them. Operating Aid No. 9A, giving such information explicitly, has just been issued by ARRL. This is one more reference tool which each amateur may detach (from Aug. '65. *QST*, page 64A) and keep in his shack. Headed "Amateur Message Form" there are examples to be followed, whether for voice work, c.w., or RTTY . . . Vital information on precedences (emergency, priority, and routine) is given. The listing of abbreviations and procedure signs should smoothe the path, so even the newest amateur can originate and handle traffic.

Before the SET why not try starting a message on your Section Net! To be a truly capable communicator, able to work in the best traditions of the amateur, in emergency or every-day, we suggest that readers new to message-handling do a bit of snooping on the local c.w. or phone net and out this procedure.

For two years now we have had the indications for precedences. How many readers can put a message in proper form and correctly indicate a precedence? How many receiving operators, taking a bunch, will promptly shuffle them to put the higher precedence on top and look around

for a way to move such messages with top speed? A brief perusal of our new Op. Aid No. 9A should enable any amateur to do it. Don't wait for the SET to try this out. In the Simulated Emergency Test this October be ready, signed up in AREC and active in some radio capacity in your EC's test plans. It's of top importance to each licensed person who reads these columns and for the bright image of our Amateur Service that every amateur not only have the know-how of dealing with traffic and emergency problems but be identified with the recognized provisions, and especially with the plans and procedures for amateur communications work and disasters. AREC, RACES, NTS, certification of your ARPS connections, the satisfaction that comes from taking an operational part. These are the things to which we direct your best attention in October! — F. E. H.

BRASS POUNDERS LEAGUE

Winners of BPL Certificate for July Traffic:

Call	Ordn.	Recd.	Rel.	Del.	Total
W3CUL	257	2089	1637	377	4360
K6BPL	72	1882	1904	82	4044
K9ONK	115	987	976	15	2093
WA2RUE	64	894	794	46	1798
W1PEX	108	570	494	64	1236
W7BA	11	565	508	52	1136
W9LGC	13	556	516	26	1111
W9ICZ	31	517	513	4	1065
K6EPT	77	451	188	263	979
W6VNO	18	303	630	18	969
W3EML	18	504	393	8	923
K6YYN	6	440	399	36	881
W6OHL	28	391	387	4	810
WA4RQR/9	22	395	369	1	787
K2KQC	8	369	349	8	734
WA2UFT	26	359	326	15	726
W9HRB	10	356	353	3	722
W6JUH	28	342	305	37	712
W6ZJB	19	326	315	11	671
WA9CCP	15	341	380	11	647
K4Y8N	10	312	303	3	628
WA4LEK/4	23	304	300	0	627
W5NAR/0	24	297	290	6	617
W6BBO	75	277	246	10	608
W9CJU	18	252	195	25	590
K6IWW	10	288	255	33	586
W1BGD	35	270	193	82	580
WA4BMC	356	79	116	5	556
K9KZB	22	267	259	8	556
W3VR	54	249	229	11	543
W6WFF	20	241	211	23	542
W8DXM	75	247	195	24	541
W7DZX	4	285	237	11	537
K9IVG	12	275	233	1	521
K3ZYP	197	167	72	75	511
Late Reports:					
W3CUL/4 (June)	36	296	261	9	602
K4CSH (June)	0	300	175	125	600

More-Than-One-Operator Stations

W6IAR	824	1876	1471	405	4576
W6YDK	2156	673	368	305	3502
W4LEV	43	1338	1271	76	2728
W6MCA	30	707	666	33	1436
VE2XT	292	166	0	166	624
K80DL	386	100	32	72	590

BPL for 100 or more ordinations-plus-deliveries

W8SYD 203	WA4PDM 125	K2AAS 107
W8SYD 0 193	W9NZH 125	WN2SLI 106
W4BAZ 189	W4RHA 121	W7APS 106
WA8IMY 174	W6RSY 121	WA9FAB 102
W6GJM 161	WA5FC 117	WA4VCL 101
W3AKD/VE8 137	WA3QLZ 116	W6FHH 101
K4VWE 137	WA5QKN 112	WA9IZR 100
W2OE 129	W5GHP 108	Late Reports:
WA6JKT 129		K8GOU (June) 105

More-Than-One-Operator Stations

KR6MB 317	K6WAH 213	KR6MH 159
-----------	-----------	-----------

BPL medallions (see Aug. 1954, p. 64) have been awarded to the following amateurs since last month's listing: W6LRU, W7WST/6.

The BPL is open to all amateurs in the United States, Canada, and U.S. Possessions who report to their SCM a message total of 500 or a sum of origination and delivery points of 100 or more for any calendar month. All messages must be handled on amateur frequencies within 48 hours of receipt in standard ARRL form.

ELECTION NOTICE

To all ARRL members residing in the Sections listed below:

You are hereby notified that an election for Section Communications Manager is about to be held in your respective Sections. This notice supersedes previous notices.

Nominating petitions are solicited. The signatures of five or more ARRL full members of the Section concerned, in good standing, are required on each petition. No member shall sign more than one petition.

Each candidate for Section Communications Manager must have been a licensed amateur for at least two years and similarly a full member of the League for at least one continuous year immediately prior to his nomination.

Petitions must be received at ARRL on or before 4:30 P.M. on the closing dates specified. In cases where no valid nominating petitions were received in response to previous notices, the closing dates are set ahead to the dates given herewith. The complete name, address, and station call of the candidate should be included with the petition. It is advisable that eight or ten full-member signatures be obtained, since on checking names against Headquarters files, with no time to return invalid petitions for additions, a petition may be found invalid by reasons of expiring memberships, individual signers uncertain or ignorant of their membership status, etc.

The following nominating form is suggested. (Signers will please add city and street addresses to facilitate checking membership.)

Communications Manager, ARRL [place and date]
 225 Main St., Newington, Conn. 06111
 We, the undersigned full members of the
 ARRL Section of the
 Division, hereby nominate
 as candidate for Section Communications Manager for
 this Section for the next two-year term of office.

Elections will take place immediately after the closing dates specified for receipt of nominating petitions. The ballots mailed from Headquarters to full members will list in alphabetical sequence the names of all eligible candidates.

You are urged to take the initiative and file nominating petitions immediately. This is your opportunity to put the man of your choice in office.

— F. E. Handy, Communications Manager

Section	Closing Date	SCM	Present Term Ends
Idaho	Oct. 11, 1965	Raymond V. Evans	Apr. 10, 1965
Oklahoma	Oct. 11, 1965	Bill F. Lund	Aug. 9, 1965
Wisconsin	Oct. 11, 1965	Kenneth A. Ebneter	Dec. 10, 1965
Illinois	Oct. 11, 1965	Edmond A. Metzger	Dec. 15, 1965
Western Florida	Oct. 11, 1965	Frank M. Butler, Jr.	Dec. 15, 1965
Saskatchewan	Oct. 11, 1965	Mel Mills	Dec. 17, 1965
N.Y.C.-L.I.	Oct. 11, 1965	Blaine S. Johnson	Jan. 2, 1966
Virginia	Oct. 11, 1965	Robert J. Follmar	Resigned
East Bay	Nov. 10, 1965	Richard Wilson	Jan. 10, 1966
E.N.Y.	Dec. 10, 1965	George W. Tracy	Feb. 10, 1966
Georgia	Jan. 10, 1966	Howard L. Schonher	Mar. 26, 1966
Ohio	Jan. 10, 1966	Wilson E. Weckel	Mar. 23, 1966

ELECTION RESULTS

Valid petitions nominating a single candidate as Section Manager were filed by members in the following Sections, completing their election in accordance with regular League policy, each term of office starting on the date given.

New Mexico	Billy Joe Farley WA5FLG	Aug. 16, 1965
Northern New Jersey	Edward F. Erickson, W2CVW	Aug. 21, 1965
Rhode Island	John E. Johnson, K1AAV	Oct. 12, 1965
Indiana	M. Roberta Kroulik, K9IVG	Oct. 14, 1965

In the Iowa Section of the Midwest Division, Mr. Dennis Burke, W0NTB, and Mr. Owen G. Hill, W0BDZ, were nominated. Mr. Burke received 278 votes and Mr. Hill, received 270 votes. Mr. Burke's term of office began July 26, 1965.

In the Kansas Section of the Midwest Division, Mr. Robert M. Summers, K0BXF, and Mr. John W. Shope, K0TRG, were nominated. Mr. Summers received 338 votes and Mr. Shope received 101 votes. Mr. Summers' term of

office began Aug. 18, 1965.

In the West Virginia Section of the Roanoke Division, Mr. Donald B. Morris, W8JM, and Mr. Michael W. Babb, WA8FIC, were nominated. Mr. Morris received 219 votes, and Mr. Babb received 67 votes. Mr. Morris' term of office began Sept. 18, 1965.

OPERATOR OF THE MONTH

Have you thought back over the past month and picked out your nomination for "operator of the month?" Considerations to bear in mind include a clean signal, good keying, careful enunciation, correct procedure, judgment and courtesy. The League's Operating Aid No. 11 lists further examples. Send your vote for "Operator of the Month" to the ARRL Communications Department.

During August the following additional amateurs were nominated in recognition of their extra skills and courtesies:

K1ESG	K4RNS
W1NJM	W5TAO
K2AGJ	W6ZYY
K2ISA	W8PQQ
W3BFF	W9BJH
K4BSS/4	DU9FB
K4KA	G3OHG



A.R.R.L. ACTIVITIES CALENDAR

(Dates shown are per GMT)

- Oct. 7: CP Qualifying Run — W6OWP
- Oct. 9-10: Simulated Emergency Test
- Oct. 16-18: CD Party (phone)
- Oct. 16: CP Qualifying Run — W1AW
- Oct. 23-25: CD Party (c.w.)
- Nov. 5: CP Qualifying Run — W6OWP
- Nov. 16: CP Qualifying Run — W1AW
- Nov. 13-15: Sweepstakes Contest (phone)
- Nov. 20-22: Sweepstakes Contest (c.w.)

OTHER ACTIVITIES

The following lists date, name, sponsor, and page reference of QST issue in which more details appear.

- Oct. 2-3: WADM (p. 102, last month).
- Oct. 2-3: Massachusetts QSO Party, M.I.T. Radio Society (p. 132, last month).
- Oct. 2-3, 9-10: VK/ZL Oceania DX Contest, W1A-NZART (p. 111, this issue).
- Oct. 2-4: Tenth Delaware QSO Party, Delaware ARC (p. 126, this issue).
- Oct. 16-18: Fifth World-Wide RTTY Sweepstakes, RTTY, Inc. (p. 26, this issue).
- Oct. 20-21, Nov. 3-4: 26th YLRL Anniversary Party, YLRL (p. 97, last month).
- Oct. 30-31: New Hampshire QSO Party, Concord Brasspounders (p. 146, this issue).
- Oct. 30-31, Nov. 6-7: VU2/4S7 Contest, Amateur Radio Society of India (p. 111, this issue).

C. D. ARTICLE CONTEST

A Communications Department article contest, a continuation of the very successful QST Article Contest during the 1964 anniversary year, needs your best ideas (in 800-1200 words) relating to League organization, clubs, training exercises, and operating techniques. Periodically, the best articles submitted for the "CD Contest" will be chosen to appear, with the winner electing to receive (a) a bound 1965 Handbook or (b) a QST binder, League emblem and the ARRL DX map.

SUGGESTED OPERATING FREQUENCIES

RTTY 3620, 7040, 14,090, 21,090 kc.
WIDE-BAND F.M. 52.525 146.94 Mc.

GMT CONVERSION

To convert to local times subtract the following hours:

ADST -3, AST -4, EDST -4, EST -5, CDST -5, CST -6, MDST -6, MST -7, PDST -7, PST -8, Hawaiian -10, Central Alaska -10.

A convenient conversion card is available, free of charge, from the ARRL Communications Department, 225 Main St., Newington, Conn. 06111.

15 20 25 30 and 35 w.p.m.; on Monday, Wednesday, Friday and Sunday, speeds are 5 7½ 10 13 20 and 25 w.p.m. For practice purposes, the order of words in each line may be reversed during the 5 through 13 w.p.m. tests. At 2330 GMT daily, speeds are 10 13 and 15 w.p.m. The 0130-0220 GMT runs are omitted four times each year, on designated nights when Frequency Measuring Tests are made in this period. To permit improving your list by sending *in step with W1AW* (but not on the air!) and to allow checking strict accuracy of your copy on certain tapes note the GMT dates and texts to be sent in the 0130-0220 GMT practice on those dates:

- | | |
|----------|--|
| Date | Subject of Practice Text |
| Oct. 4: | <i>It Seems to Us</i> , p. 9 |
| Oct. 12: | <i>Perfect Code at your Fingertips</i> , p. 11 |
| Oct. 15: | <i>A Slow-Scan Vidicon Camera</i> , p. 24 |
| Oct. 21: | <i>The Mainline TT/L P.S.K. Demodulator</i> , p. 27 |
| Date | Subject of Practice Text from <i>Understanding Amateur Radio</i> , First Edition |
| Oct. 25: | <i>Grid Power</i> , p. 34 |
| Oct. 27: | <i>Distortion</i> , p. 34 |

CODE PROFICIENCY PROGRAM

Twice each month special transmissions are made to enable you to qualify for the ARRL Code Proficiency Certificate. The next qualifying run from W1AW will be made Oct. 16 at 0130 GMT. Identical tests will be sent simultaneously by transmitters on c.w. listed frequencies. The next qualifying run from W6OWP only will be transmitted Oct. 7 at 0400 Greenwich Mean Time on 3590 and 7129 kc. **CAUTION!** Note that since the dates are given per Greenwich Mean Time, Code Proficiency Qualifying Runs in the United States and Canada actually fall on the evening previous to the date given. *Example:* In converting, 0130 GMT Oct. 16 becomes 2130 EDST Oct. 15.

Any person can apply. Neither ARRL membership nor an amateur license is required. Send copies of all qualifying runs to ARRL for grading, stating the call of the station you copied. If you qualify at one of the six speeds transmitted, 10 through 35 w.p.m., you will receive a certificate. If your initial qualification is for a speed below 35 w.p.m. you may try later for endorsement stickers.

Code practice is sent daily by W1AW at 0130 and 2330 GMT, simultaneously on all listed c.w. frequencies. At 0130 GMT Tuesday, Thursday and Saturday, speeds are

DXCC Notes

Announcement is hereby made of a change in the ARRL Countries List regarding DXCC credits for contacts with stations located in Singapore. This change will be as follows: Contacts made with stations located in Singapore before September 16, 1963 and after August 8, 1965 will be credited as Singapore. Contacts made with stations located in Singapore September 16, 1963 to August 8, 1965, inclusive, will be credited as West Malaysia. This change will remove Singapore from the deleted countries. Honor Roll totals will be adjusted in accordance with this change in the November issue. This change is neither an addition nor a deletion. Confirmations for Singapore credit may be submitted at any time.

W1AW SCHEDULE, OCTOBER 1965

The ARRL Maxim Memorial Station welcomes visitors. Operating-visiting hours are Monday through Friday 7 P.M.-1 A.M. EDST, Saturday 7 P.M.-2:30 A.M. EDST and Sunday 3 P.M.-10.00 P.M. EDST. The station address is 225 Main St., Newington, Conn., about 7 miles south of Hartford. A map showing local street detail will be sent upon request.

GMT	Sunday	Monday	Tuesday	Wednesday	Thursday	Friday	Saturday
0000	C.W. OBS ¹	C.W. OBS ¹	C.W. OBS ¹	C.W. OBS ¹	C.W. OBS ¹	C.W. OBS ¹
0100	Phone OBS ²	Phone OBS ²	Phone OBS ²	Phone OBS ²	Phone OBS ²	Phone OBS ²
0115	RTTY OBS ³	RTTY OBS ³	RTTY OBS ³	RTTY OBS ³	RTTY OBS ³	RTTY OBS ³
0130	Daily code practice ⁴ : 15-35 w.p.m. TThSat; 5-25 w.p.m. MWFSun.					
0230-0315 ⁴	3945	3555 ⁵	3945	3555 ⁵	3945	3555
0330	Phone OBS ²	Phone OBS ²	Phone OBS ²	Phone OBS ²	Phone OBS ²	Phone OBS ²
0345	RTTY OBS ³	RTTY OBS ³	RTTY OBS ³	RTTY OBS ³	RTTY OBS ³	RTTY OBS ³
0400	C.W. OBS ¹	C.W. OBS ¹	C.W. OBS ¹	C.W. OBS ¹	C.W. OBS ¹	C.W. OBS ¹
1900-2000	14,280	14,100	14,280	14,100	14,280
2000-2100	7/21 Mc. ⁶	7/21 Mc. ⁶	7/21 Mc. ⁶	7/21 Mc. ⁶	7/21 Mc. ⁶
2330	Daily code practice ⁴ at 10, 13 and 15 w.p.m.					

¹ C.W. OBS and code practice on 1805 3555 7080 14,100 kc., 50.7 145.6 Mc.

² Phone OBS on 1820 3945 7255 14,280 kc., 50.7 145.6 Mc.

³ RTTY OBS on 14,095 kc, MWFSat, at 0115, Wed, at 0345; 3625 kc, TTh at 0115; TThFSat at 0345.

⁴ Starting time approximate. Operating period follows conclusion of code practice.

⁵ Operation will be on one of the following frequencies: 7080 7150⁶ 7255 21,075 21,100⁶ 21,410 kc.

⁶ W1AW will listen for Novices on band indicated before looking for other contacts.

Station Staff: W1QIS, W1WPR, K1QNF.



DX CENTURY CLUB AWARDS



Honor Roll

W1FH... 313/339	W2BIH... 312/336	KV4AA... 310/334	W3RNO... 308/326	W9GIL... 306/323
W4DOH... 313/337	W2ZCX... 312/331	W2DEC... 310/326	W2FZY... 308/321	ON4DM... 306/325
CX2CO... 313/334	W8KIA... 312/336	W1MPE... 310/333	W4PLL... 308/323	VK3KB... 306/329
W2ACW... 313/337	W3XUM... 312/339	OK1BK... 310/332	DJ2BE... 310/327	DJ3BK... 305/323
W3GHD... 313/337	W8DKA... 312/334	K2DCA... 310/327	K6EVR... 308/325	W1MYY... 305/322
W1GKK... 313/338	W3GAU... 312/335	W5ABY... 310/327	11AMU... 308/327	W6WWO... 305/322
4X4DK... 313/331	W6AM... 312/337	W9BFB... 310/328	K6ENX... 308/325	W2YTH... 305/323
W8PQO... 313/330	W0VOZ... 312/333	W0ELA... 310/333	W3FTC... 307/330	W3NKM... 305/322
C2PL... 313/336	W4AIT... 312/335	5Z4AO... 310/328	W2FXN... 307/321	K6CF... 305/317
W9RBI... 313/358	K3UPG... 312/336	VE7ZM... 310/334	W8IRN... 307/325	W5KRU... 305/323
W2TCG... 313/332	G4CP... 311/335	W4OPM... 310/325	W4CFB... 307/323	W3CGS... 305/324
W8BRA... 313/336	G3AAM... 311/335	W4LYV... 310/330	G3FXB... 307/325	G3AAE... 305/325
W8UAS... 313/334	W8DMD... 311/333	K2BZT... 309/326	W3VGH... 307/322	K5BGB... 305/318
W8JIN... 313/338	W5LMA... 311/333	G8KS... 309/327	K2LWR... 307/320	W6BZE... 305/325
W6OUO... 313/338	W2SUC... 311/328	W4TMM... 309/331	K4AIM... 307/321	W6EPZ... 305/326
W7GVU... 313/336	W5BOK... 311/328	W2GGB... 309/325	W5OLG... 307/328	W6TZD... 305/326
W8EWS... 313/337	DJ1BZ... 311/329	W0GDF... 309/326	W4MR... 307/327	K2GPO... 304/325
PY2CK... 313/336	DJ3LL... 311/327	W2QKM... 309/327	DJ6EN... 307/322	W5ADZ... 304/326
W8HGW... 313/338	CE3AG... 311/335	W4VPM... 309/326	W2SSC... 307/323	G3YF... 304/326
HB9J... 313/337	W1CLX... 311/334	W2LAX... 309/326	W2HTI... 307/322	W2HMJ... 304/324
W4GD... 313/334	W5MML... 311/332	W2WZ... 309/332	W0QGI... 307/323	K2OEA... 304/320
W1JYH... 313/336	W9LNM... 311/334	K4LNM... 309/323	DJ7BA... 307/324	W9OKK... 304/328
W2LV... 312/331	W8KML... 311/332	W2LE... 309/327	W4COM... 307/329	K4RID... 304/318
W2JT... 312/331	W8JRI... 311/330	W2AYJ... 309/328	W1HX... 307/327	W2PCJ... 304/321
W2BXA... 312/336	W4ML... 311/331	W9AMU... 309/326	PA9FX... 307/327	W2SAW... 304/321
W2LPE... 312/333	W3JNN... 311/335	W2TP... 309/318	W1WZ... 306/323	K2UVU... 304/317
W8BF... 312/333	LU6DJ... 311/333	W6GYV... 309/327	W8NGO... 306/323	W6OSU... 304/316
W3KT... 312/336	W9AIW... 311/334	W3ECR... 309/326	W2GUM... 306/328	W6KEV... 304/326
W9HRZ... 312/332	W5KC... 311/334	WONTA... 309/329	W8PUD... 306/323	W5OK... 304/315
W8MPW... 312/332	W5CKY... 311/330	W2TVR... 308/326	W9PGL... 306/321	W4Z7R... 304/310
W6YJ... 312/332	W8LKH... 311/331	W8DAW... 308/332	W7AC... 306/330	W2DOD... 304/322
W9NDA... 312/336	W6EGB... 311/336	W1HZ... 308/326	HB9MO... 306/323	K4TJL... 304/313
W9YFV... 312/336	W6GPB... 311/332	W7ENW... 308/332	W2NUT... 306/322	W9AJU... 304/318
W7PHO... 312/330	W5AFX... 311/336	W5U&... 308/323	DL1IN... 306/322	W9WHM... 304/320
W4QCW... 312/329	W7GBW... 311/335	W9SYK... 308/326	WAZIZ... 306/323	K4RPK... 304/313

Radiotelephone

CX2CO... 313/334	W7PHO... 312/336	W2JT... 310/324	W4QCW... 306/319	DL3LL... 304/320
W3RIS... 313/338	W4DOH... 312/334	W9JFJ... 310/327	ON4DM... 306/325	G8KS... 304/318
PY2CK... 313/336	W7ZCX... 312/331	W3JNN... 310/331	G3KMK... 306/320	K2BZT... 308/322
W8HGW... 313/338	5Z4AR... 310/328	W8PPO... 309/326	G2P... 306/326	K4TJL... 304/313
W9RBI... 312/335	W6YY... 311/331	W8PQO... 309/326	TJ2HP... 305/327	W0QVZ... 303/318
W8BF... 312/333	PY4TK... 311/328	W2BXA... 309/331	WONDA... 304/324	W2HTI... 303/318
4X4DK... 312/330	W8KML... 310/331	W6AM... 307/331	K4AIM... 304/318	W9WHM... 303/319
W8GZ... 312/335	W1FH... 310/331	11AMU... 307/326		

New Members

From July 1, through July 31, 1965, DXCC Certificates and Endorsements based on contacts with 100-or-more countries have been issued by the ARRL Communications Department to the amateurs listed below.

W2PTM... 273	W4SCH... 122	VE3EYV... 110	K7NEQ... 103	WA1ABW... 100	K7JGA... 100
W0NVZ... 260	I1TIC... 121	DJ4XQ... 110	W1YRC... 102	K1QCC... 100	W7REV... 100
W4SEFL... 205	W3KJ... 120	D06TY... 109	K3TJE... 102	W4ZLR... 100	W0REU... 100
W5LZG... 169	W9EB... 119	W5EBJ... 109	W8MEE... 102	K2MGM... 100	DJ1HL... 100
SM6CAS... 168	VE3DKE... 117	DJ5BW... 108	W4HZI... 101	W3MFR... 100	G3SGH... 100
V12CG... 139	VP8HJ... 117	J4DCE... 106	W4SEW... 101	K3TCY... 100	OK1NH... 100
OK1CA... 135	DL1IW... 112	W9EXE... 104	W4BCHL... 101	WA4LXX... 100	YU3BVU... 100
ON4QU... 123	W9LKI... 110	K5BXG... 103	SM4CHM... 101	W4ZXL... 100	

Radiotelephone

W21OT... 200	DL8CM... 130	VE2AJV... 109	W7UVR... 106	W9PUY... 103	W3UJ... 101
W0NVZ... 217	W3CES... 124	EA3BI... 109	CT1LN... 106	W6BGV... 103	SM6BAS... 101
I1TRC... 163	I1TIC... 115	LU8DB... 107	HLKPV... 106	K9WTS... 102	VE7BEA... 100
DJ9GD... 161	W6WKJ... 109				

Endorsements

W6WX... 301	SM5KV... 271	K6POC... 231	K7UCH... 200	WA2MNQ... 161	W9FJX... 130
W3MWC... 300	K2YXY... 270	W5AL... 230	SM17TQ... 199	W4ZBR1... 160	K0QYD... 130
W4AFY... 300	K8WOT... 270	W0QK... 230	W1AH... 198	K3LJZ... 160	Y5FBNR... 129
VE3REJ... 300	W3WPG... 260	SM5AJU... 230	W2MOP... 190	VE3AVV... 160	W9HRW1... 128
W9TAX... 300	W9TQL... 260	ZS6IW... 226	K4CEB... 190	CR6AU... 158	W8BGX... 126
W4EEE... 296	PY7YS... 256	W7UVR... 225	K7BJE... 190	W4CJY... 157	W6CZP... 122
W1VG... 294	W9KMN... 255	W2YCW... 222	W0CAW... 190	W1WLZ... 155	W0PFG... 122
J1ABK... 293	OZ3Y... 254	DL1TA... 222	W4JFW... 180	JARADQ... 152	K4ZJF... 121
K4HXL... 293	W1TX... 252	W21OT... 221	CRRH... 180	VE3ACD... 151	W4BVA... 121
W2MJL... 290	W8HBI... 251	W8DX... 221	ON4ZY... 180	VE3MZ... 151	W8IRN... 120
W3AFM... 290	W8TJZ... 251	W1DGG... 220	OZ5DX... 176	W2JX... 150	VE2AJV... 120
W6KUT... 290	W4ZRLQ... 250	HB9PL... 220	W4ASUR... 175	W2RMP... 150	K9VY... 115
W1UOP... 288	K4TKM... 250	W4BWWG... 215	W3CBY... 174	K5AEU... 150	WB2BEV... 112
K1SHN... 287	W4GLD... 250	C3OZU... 214	DL1LD... 173	SP6HJ... 150	W6WKG... 112
K4SCT... 282	I1AGA... 243	GM3BCE... 211	SM7KCB... 173	WA2KXC... 141	K6OZL/KP4... 112
W1ORB... 281	W6ZY... 241	WTECH... 210	W0GNX... 171	W7FPL... 140	ZL2AQV... 112
W9TKD... 281	K7ADL... 241	W2HXD... 210	VE6ABP... 171	W9AFX... 140	K1JFF... 110
W2PDB... 280	YV5BZ... 240	K9JFL... 210	WB2APG... 170	OZ6RL... 140	WA4HTW... 110
W3PN... 280	DL8CM... 239	W3AHX... 202	W6GSV... 170	K1VKY... 139	K4JSZ... 110
KP4RK... 280	11BAF... 238	W4OET... 201	DL2ZX... 167	W5HTM... 133	WA4RAK... 110
ZP4S... 280	W9LDA... 238	W0CU... 201	W6CVZ... 166	W9CVZ... 133	W4LWB... 110
W2GZG... 273	K1IMP... 232	O68KI... 201	K4PVZ... 164	DJ4XA... 132	K7PJJ... 110
W5TIZ... 271	W1AW... 231	W1BPY... 200	W8EDB... 163	W1MRQ... 130	K9QVB... 110
	W4VMS... 231	W3PVZ... 200	W2KXL... 162	W2RKC... 130	OZ6HS... 110

Radiotelephone

W1BAN... 310	K1SHN... 245	K1DPI... 203	K1CAH... 181	VE3ACD... 141	WA4SUR... 125
K9KYP... 300	W6BYN... 245	K1TDP... 200	SM5CZY... 180	W3PZ... 140	W2PFL... 124
EZ1AX... 300	PY7YS... 245	W9TLD... 200	W5KX... 170	W0LNB... 140	W1GPN... 124
W4EEE... 295	11BAF... 238	W6WX... 197	W6TGP... 170	K8IKB... 139	WA2OJD... 121
K9ECE... 289	T1ZP1... 236	W6LDA... 196	VE6ABP... 167	I1TRA... 138	K4ZJF... 121
W1UOP... 288	OZ3Y... 234	W4VMS... 191	K1IMP... 166	W62EPG... 137	W4GLD... 121
W7ADS... 280	W2GKZ... 226	K6HZP... 190	W7MKI... 160	SM7CAB... 137	W3KJ... 120
W1ORV... 271	VP2WY... 222	DJ5LA... 189	W9JLT... 160	W0BAM... 136	W45RK... 120
DL3RK... 260	W9LDA... 238	W0CEFL... 185	W1GFB... 160	W1GFB... 135	W4LWB... 110
W5TIZ... 251	OA4KY... 220	DJ7ZG... 182	CR6AU... 155	W2PDB... 130	W9WFS... 112
W6REH... 250	W1WQC... 209	PA0EEM... 182	W8EDB... 164	W9KXK... 130	W46WVG... 110
W8LJZ... 250	GM3BCL... 204	W2HXD... 181	W2JX... 149	4X4HW... 128	K3CNN... 110
1RB... 247					

ATLANTIC DIVISION

DELAWARE—SCM, Roy A. Belair, W3IYE—SEC: K3NYG. PAM: W3CFA. V.H.F. PAM: K3OBU. RM: W3EEB. DEPN meets Sat. on 3905 kc. at 1800 local time. DSMN meets Tue. on 50.4 Mc. at 2100 local time. Dover 6 & 2 Net meets Wed. on 50.4 Mc. at 2100 local time. KCEN meets Sun. on 3905 kc. at 1300 local time. Gov. Charles L. Terry, Jr., issued a statement in observance of "Delaware Amateur Radio Week" Aug. 9-15, 1965. W8GLC operated from Dover AFB July 10-24. K3YHR is mate on the fishing boat *Sea Spray* and caught 7 marlin this year. Traffic: K3YZF 59, W8GLC/3 49, K3YHR/3 10, W3IYE 1.

• All operating amateurs are invited to report to the SCM on the first of each month, covering station activities for the preceding month. Radio Club news is also desired by SCMs for inclusion in these columns. The addresses of all SCMs will be found on page 6.

TENTH DELAWARE QSO PARTY

October 2-4

The Delaware Amateur Radio Club of Wilmington announces its 10th Delaware QSO Party and invites all amateurs to participate. Delaware hams are urged to work as many out-of-state stations as possible, so that those interested can earn credit toward WAS and the W-DEL certificate. Here are the details:

(1) Time: 30-hour period from 2200 GMT Oct. 2 to 0400 GMT Oct. 4.

(2) No time limit and no power restrictions.

(3) Scoring: *Delaware stations*: 1 point per contact and multiply total by the number of states, Canadian provinces and foreign countries worked during the contest period. *Outside stations*: 5 points for each Delaware station worked and multiply total by the number of counties in Delaware worked during the contest period.

(4) Credit for contacts with the same station on other band will be given.

(5) A certificate will be awarded to the highest-scoring station in each state, Canadian Province and foreign country (with 3 or more contacts) and to the highest-scoring station in each Delaware county. In addition, a W-DEL certificate will be sent to any station working all 3 Delaware counties. Party logs showing required data will be accepted in lieu of QSLs.

(6) *Suggested freqs.*: A.m.: 3825, 7225, 14,225, 21,325, 29,000 kc. C.w.: 3525, 7025, 14,025, 21,025, 28,025 kc. S.s.b.: 3975, 7275, 14,325, 21,425, 28,650 kc. V.h.f.: 50, 50.4 and 144 Mc.

(7) General call: "CQ DEL." Delaware c.w. stations should identify themselves by signing *de (call) DEL K*. Phones say, "Delaware calling."

(8) Contact information required: Delaware stations send number of QSO, RS(T) and county (New Castle, Kent or Sussex). All others send number of QSO, RS(T) report, and state, province, or county.

(9) Logs and scores must be postmarked not later than Oct. 30, 1965, and should be sent to the Delaware Amateur Radio Club, c/o J. E. McCartery, K3NMY, P.O. Box 201, Newark, Delaware. Applications for the W-DEL certificate should also be addressed there.

EASTERN PENNSYLVANIA—SCM, Allen R. Breiner, W3ZRQ—SEC: W3ELI. RMs: W3EML, K3YVG, K3MYO. PAMs: W3SAO, K3LSV. The EPA C.W. Net meets nightly 2330Z on 3610 kc. It had a QNI of 348 and QTC of 329 for July. The PTTN Training Net meets nightly on 3610 kc. at 2230Z. Watch for a change in time next month. The EPA Emergency Phone and Traffic Net meets nightly on 3915 kc. at 2200Z. All amateurs are invited to join any or all of these nets. W3BBI is in the midst of remodeling the shack. W3BJI kept the pill peddlers QRL and W3ELI away from the Netters' picnic. W3ELI noticed the lack of

traffic originations and plans to get the Christmas card list out and start early with his greetings. While W3-RTD is on vacation, K3PBU is baby-sitting with the 5-kw. local broadcast station transmitter. K3MNT, K3-FIV and K3RZE are all enjoying vacation trips. If this report looks skimpy, it's because your editor got it out early and also enjoyed the first vacation in 7 years. K3WVZ/3 is radio instructor and counsellor at summer camp in the Poconos, New Gear Dept.: K3ZUN added a Vibroplex bug and attained CP-25 award. A new microphone and VOM meter was added to K3VAX. K3-DJE has a new NCX-5. K3OJA added a 10-meter walkie-talkie. K3CEE is busy figuring out the Philmont Mobile FD logs. K3KKO is ORS and WA3BYH is OPS. K3OMP has been added to the list of active OOs. K3YVG added a new 200-watt s.s.b.-c.w. rig for his traffic work load. On behalf of the Netters' Picnic committee K3YVG, W3EML and W3ZRQ we want to thank all who attended and assisted in the program which added to its success. Net certificates have been issued to these stations in the EPA based on past participation and net performance: W3AIZ, WA3BHN, K3FIV, K3KKO, W3MXP, K3ZYT, K3ZUN. The SET (Simulated Emergency Test) details found elsewhere in this issue, will be one of our traffic net's 24-hour activities. All ECs please note: Let's make a special effort this year and send your compiled reports to our SEC. Let's get that AREG active in your county. Traffic: W3CUL 4360, W3EML 923, W3VR 543, K3MVO 306, K3MYS 220, K3ZUN 207, W3AIZ 182, K3YVG 145, K3FIV 112, W3ZRQ 110, K3OMP 89, K3PIE 76, K3PWM 73, W3ELI 64, K3ZYT 62, K3ZSK 61, K3RZE 57, W3-VAP 50, K3YQL 49, WA3BYV 47, K3MHD 46, W3JKX 34, K3HKW 31, K3FWZ/3. 26, K3KKO 26, W3BFT 22, W3RV 19, K3RLO 16, W3CBH 14, W3OY 11, K3VAX 4, W3PV 3, W3KJ 2, K3MNT 2, K3PBU 1.

MARYLAND-DISTRICT OF COLUMBIA—SCM, Bruce Boyd, W3QA—SEC: W3CVE. RMs: K3JYZ, W3-QCW, W3UE, W3ZWN. PAMs: W3JZY, K3LFD.

Net	Freq.	Time	Days	Sess.	QTC	Ave.
MDD	3643	0000Z	Daily	31	361	11.6
MDDS	28200	0130Z	Daily			
MEPN	3820	2200Z	M-W-F			
MEPN	3820	1700Z	S-S			
MSTN	50150	0100Z	Daily	29	16	.06

W3TMZ handled traffic from San Domingo. W3MCG took a well-earned vacation from QSP. Good to hear from K3QFG who has been QRL school since Sept. '64. K3PKY is a new and enthusiastic adherent of MDD while K3ZSX left 6 meters long enough to QNI twice in MDD. W3PQ is moving to Congress Heights. W3QDD made a high score in the CD Party in spite of various types of non-radio QRM. K3URZ worked his first KH6. W3NDWN reports malicious QRM on 80 by a 2nd district station, K3CYA (W3CYA last month—sorry) reports on non-ham stations in our bands. K3IPX/3 kept MSTN going but had trouble with his new Swan. New s.w.r. bridge at WA3AZI, says his antennas have got to go. *Far Away Dept.*: W3HQE was in Spain for three weeks. K3JYZ spent ten days in California; K3-CXX is working this summer in Los Alamos, N.M.; K3QFG will be in West Virginia later; K3GUR was on the West Coast for 3 weeks; W3AKD/VEE reports by radio from Baffin Island. *Gear, Old and New*: K3-LFD's tower is progressing slowly. K3NCQ is putting a 2-meter corner reflector on his new tower. WA3BJP is rockbound on 50.68 Mc. Tune up there for him. He also needs help with his converter. W3RMI has been QRP to 5 watts. W3QCW is the proud owner of an HRO-50T which he says is great for c.w. K3DNO finds

lo-mu triodes (2A3s) superior to many beam tubes for audio applications. K3FKY is using a KC-610 and an HRO Jr. K3GUR has a new kw. final. WA3AJR has a new 6-meter transmitter and runs a 2-meter EC net. K3LLR's stand-by TCS is running wide his regular transmitter is out of order. General: W3FOV has numerals 73-88 on his auto tags and just received the same numerals for registration on his new cabin cruiser. K3-ZYP is taking a judo course. K3TJE added a radio-telephone first to his amateur extra and made DXCC besides. K3CXX has his M.S. degree from Harvard. W3JZY has been busy working in his garden. W3CDQ is becoming more active on the air since her retirement from NBS. W3ECP reports that A3VJ has been transferred from Philadelphia Naval Hospital to V.A. Hospital at Wilmington and is recovering slowly. Van also says W3GNQ builds guitars and teaches music at the Bethesda Music and Art Center. Traffic: (July) K3ZYP 511, W3AKD/V88 168, K3TJE 130, W3PQ 109, K3JYZ 90, K3QFG 77, W3EOV 72, K3URZ 59, W3RMI 51, K3-QDD 47, K3OAE 45, K3CZK 43, W3HQE 39, W3QCW 36, W3ECP 39, K3LLR 24, WA3AJR 23, K3ZSX 20, K3-IPX/8 19, K3FKY 13, K3LFD 7, W3RKK/3 8, W3CDG 5, W3MCG 2, W3CXY 1. (June) K3JYZ 132, K3TJE 54, K3VHS 30, W3ZNV 16, K3NCQ 7, K3URZ 7.

SOUTHERN NEW JERSEY—SCM, Herbert C. Brooks, K2BC—SEC: K2ARY. PAM: W2ZI RM; W2BLV. With regret we report the passing of K3EH, Levittown, Pa. Harry was one of the founders of the SJRA, which has its 50th anniversary in 1968. WA2KIP, Trenton, expects to have a new beam on 20 soon. N.J. Phone and Traffic Net totals for July: 31 sessions, QNI 493, traffic 129. SJRA's president, W2ORA, reports very fine club activity in the recent PD exercises. We wish W2PTM a speedy recovery from his recent operation. K2PI, W. Collingwood, SJRA's *Harmonics* editor, is retiring from that post. WN2SBD, Monroeville, is quite active on 80-meter c.w. K2JJC and WB2NB are new members in the Gloucester County ARC. We hope W2LY has fully recovered from his recent illness. Holders of OPS and ORS appointments are required to report monthly to the SCM. Eleven stations this month did not report. Vacation time no doubt has reduced the time available for operating. This will be my last monthly section report, having now completed 12 years in this capacity. I appreciate the help received from members of this section and hope they will cooperate fully with the new SCM. Several areas are not represented in this month's report. To have your club and county activities known, reports must reach your SCM during the first week of each month. For those who may not know, this section consists of the following counties: Atlantic, Burlington, Camden, Cape May, Cumberland, Gloucester, Mercer and Salem. Traffic: W2ZPJ 118, W2RG 88, W2ZI 21, W2GIW 16, K2GIO 4, W2BZJ 2, WA2KAP 2.

WESTERN NEW YORK—SCM, Charles T. Hansen, K2HUK—SEC: W2ZRC. PAM: W2PVT. RMs: W2RUF, W2EZB and W2FEB. NYS C.W. meets on 3870 kc. at 1900, ESS on 3590 kc. at 1800, NYSPTEN on 3925 kc. at 2200 GMT, NYS C.D. on 3510.5 kc. and 3993 kc. (s.s.b.) at 0900 Sun, and 3510.5 kc. at 1930 Wed. PCPN 2nd Call Area on 3970 kc. at 0045 and 2345 GMT. NYS County Net on 3510 kc. Sun. at 1000 and 3670 kc. at 1700 Sat. Appointment: W2KDE as OO, Endorsements: WA2GLA as OPS; W2QHQ and W2EMW as ORSs. The West Seneca Central School ARC elected WB2JFP, pres.; WN2QWR, vice-pres.; Andrea Zubricky, secy.; WN2RGU, treas. The club will have an exhibit and radio station at the Erie County Fair. The Lockport ARA held an FB picnic at the Lakeside QTH of W2-RU1 and K2ECQ. The 2-meter f.m. group in the K2-HUK repeater area held a picnic at the QTH of W2ISO in Eagle. WB2NWE, K2LGG, W2EUP and K2HUK now have hand-carried portables on 146.94 Mc. (wide-band f.m.). They can hit the repeater and therefore enjoy 100-mile-plus range. The NFDXA held a picnic at the QTH of K2LWR. Very sorry to report that W2QQ has become a Silent Key. Win was licensed in 1915 and was well known as a conscientious OO and DX man in the Buffalo area. Ex-W2PYU also has joined the Silent Keys. The S.W. N.Y. V.H.F. Assn. held its picnic at the Great Valley Fire Tower. WB2NZA is mobile with an NCX-5. He goes to Northeastern U. in the fall. The Chemung County AREC furnished communications for the soaring meet held over the July 4 week end. Participants were K2DNN, W2FJJ, W2FKA, W2-HFL, W2RCQ, W2TCZ and W2ZBD. Other amateurs from the Binghamton area also pitched in. The GRAMS have a new Gram Shack in Batavia and it sounds real nice. W2IY, PC for Steuben County, has appointed assistants as follows: K2UMY, Corning Area; WB2GYF, Bath (Central); K2EBD, Hornell. K2UMY is Net mgr. for the AREC nets. K2UIT is alternate RO for Hornell, W2GYF Asst. RO for Centra and K2UMY Asst. RO for Corning. W2SEI reports

that RAGS is making a documentary film and also is planning its annual exhibit at the N.Y. State Exposition. The club also is planning an antique wireless show and banquet on Nov. 6 in Syracuse. Congratulations to BPLers K2KQC, WA2UFI and W2OE. Traffic: K2KQC 734, WA2UFI 726, W2OE 357, W2RUF 328, W2LYG 131, WB2NZA 113, WB2GAL 88, WB2HLV 65, K2JBX 62, WB2FPG 53, W2FCG 41, W2FEB 41, K2DNN 40, WB2-ERK 31, K2IMI 31, W2RFQ 31, K2OFY 24, K2HOH 17, WN2FOJ 11, K2QDT 11, K2BWK 6, WB2DMU 2, WA2-GLA 2, W2PNW 2, W2PVI 2, W2EMW 1, WA2PZO 1.

WESTERN PENNSYLVANIA—SCM, John F. Wojtkiewicz, W3GJY—Asst. SCM; Robert E. Gawryla, W3-NEM. SEC: K3ZMH. PAMs: W3TOC, K3VPI (v.h.f.). RMs: W3KUN, W3MFB, K3OOU, W3UHN. Traffic nets: WPA: 3585 kc. 0000 GMT Mon. through Sun. KSSN, 3585 kc. 2330 GMT Mon. through Fri. The Keystone Slow Speed C.W. Traffic Net opens up Oct. 1. Handom extends its sympathy to the family of W3-CKL, who passed away from a heart attack. The Nittany ARC provided communications for the Fireman's Convention Parade at State College. K3RMO returned to the W. Pa. section. WA3BHV had a nice write-up in a Connelville newspaper. W3IDO is busy on MARS frequencies. W3ZRQ/3 operated on 6 meters in Clinton County over the July 4 week end. K3ZGI passed the General Class test. W3GJY visited K2US and W1AW while on vacation. W3YCD is act. mgr. for the Foot-hills Radio Club. K3MIUB and K3QKC assist. New officers of the Brezeshooters are K3RKW, pres.; K3-UTQ, vice-pres.; K3NJZ, treas.; W3SR, W3TVW and W3VZA, windragers. This column also regretfully re-cords the passing of WA3BAH, W3YA ran across former W3WRE at the San Jose National Convention. W3SDV obtained his private pilot's license. W3SHF has been hospitalized. W3KPI and W3NKM were elected pres. and treas., respectively, of the Western Penna. DX Society. WN3DWZ is a new licensee in McKean County. The McKean County ARC has six gasoline-driven engines for its emergency work. WA3CXN is a new "Tech." K3PLW purchased an Elmac AP-67 and W3-TTV a new Collins 75S-3B receiver. WA3CXQ has a new beam on 6. K3WVP became an A-1 Operator. A tip of the hat to the following club secretaries for bulletins: Nittany ARC, the Etna Radio Club, Erie V.H.F. Society, South Hills Brass Pounders & Modulators, Coke Center ARC, Foothills Radio Club, McKean County ARC, the Steel City ARC, Two Rivers ARC, Cumberland Valley ARC. New appointments: WA3-AKH as ORS, Endorsements: W3SMV, K3PYS, W3-LOD, W3LMM, W3KNQ, and W3KQD as ORSs; W3-TOC as PAM/OPS; W3WFR and W3RSB as OPSs; W3QYG and W3LMM as OOs; W3KUN as RM/ORs; K3EDO as OBS. Does your license expire soon? Traffic: (July) W3NEM 275, K3PYS 181, K3OOU 180, W3KUN 102, W3LOS 83, W3HJG 34, K3ZMH 23, W3GJY 24, W3-IYI 21, W3LOD 21, W3ZRQ/3 15, W3ORO 8, K3SMB 8, W3UHN 6, K3EDO 4, K3SOH 4, K3EXE 2. (June) K2-PYS 112, K3OOU 61, W3KPI 40, W3AUD 16.

CENTRAL DIVISION

ILLINOIS—SCM, Edmond A. Metzger, W6PRN—Asst. SCM: George J. Neshed, W9LQE. SEC: W9RYU. RM: W9EVJ. PAMs: W9WJ, WA9CCP and WA9KLB (v.h.f.). Cook County EC: W9HPG. Net reports:

Net	Freq.	Time	Days	Tfc.
11N	3515	1900	CST	M-Sat.
III PON	3925	1700	CST	M-F
III PON	3925	0830	CST	Sun
III PON	3545	0930	CST	Sun
No. Cent. Phone Net	3915	0800	CST	M-Sat.
No. Cent. Phone Net	3915	1300	CST	M-Sat.
IEN	3940	0900	CST	Sun.

} no report
} 346
} no report

W9YIX, former SCM, of Illinois, is hospitalized in Chicago and we wish him a speedy recovery. W9RSV, WA9AHZ, WA9MED, K9FZB, W9YVP and WA9BYF are active on 2-meter f.m. 146.8 Mc. Our sympathy to the families and friends of WA9AGO and WA9AYM, who recently passed away; also to W9QLZ, who suffered the loss of his wife after a short illness. W9GNA is in the Army at Fort Chaffee, Ark. WA9IBT has a new TA-31 on a 325-ft. tower, and hopes to bring in the rare DX. WA9GCM has a new SB-400. The Worth Township ARC held an emergency preparedness demonstration for the public at the First National Bank in Evergreen Park. W9NLF is back from the hospital and in FB condition. The 75-Meter S.S.B. Net had a traffic count of 250 for the month of July, according to the net manager. WA9IPX is now operating HL9ITH and can be heard on 14.230 between 100Z to 1300Z. W9RRF has a new linear on 2 meters. W9FXF has a new au-

tenna and tower. W0EEP has a new Swan and also a new car to go with it. A new ham in the Rockford area is W0OZG. The new officers of the Northwestern University Amateur Radio Society are K9WEH and W9ICE. The Six Meter Club of Chicago had a very successful picnic and many eyeball QSOs were held. W9DOD and W9DDU recently were married. W9JUV/K9OSO is now sales manager of Mark Products (Heliwhip). The CRTA held a party for W9KA who has departed for W4-Land with a new call, W4RM. The Sangamon Valley Radio Club, Inc., sponsored a Radio Exhibit at the Illinois State Fair Exposition which attracted hundreds of amateurs from many states. K9UOV has received his WAC and WAS certificates. New appointments include W9MFS as ORS and W9YFX as OO, W9ACCP and K9KZB are recipients of the BPL Award this month. Traffic: W9ACPR 647, K9KZB 556, W9ACNV 312, W9EVJ 114, W9AXR 70, K9RQO 58, W9AGUM 54, K9BTE 45, K9WAP 43, W9DCQ 34, W9LUG 32, W9MFS 24, W9HOT 22, W9JXV 21, K9UOV 19, K9HSF 12, K9CYZ 9, W9LNQ 6, W9PRN 6, W9IDY 4, K9UAR 3, W9AJF 2, K9RAS 2, K9UTY 2.

INDIANA—SCM, Ernest L. Nichols, W9YFX—Asst. SEC: Donald Holt, W9FWH, SEC: K9WET.

Net	Freq.	Time	Aug. Tfc.	Mgr.	
1FN	3910	1330Z daily	2300	AL-F 214	K9IVG
1SN	3910	0000Z daily	2130	M-Sat. 347	K9CRS
QIN	3650	0000Z daily			193 W9ABWY
RFN	3656	1300Z Sun.			75 W9AIZR

K9GLL, PAM of Hoosier V.I.F. nets, reports July traffic of 57. BPL winners: W9JOZ, W4RQR/9, W9HRB, K9IVG, W9AIZR and W9NZZ. QIN Honor Roll: K9HYV, W9ACYG, W9PJR, W9AIZR, W9HRB, W9ABWY, K9WVJ and K9VHY. W9BZ1, of Muncie, was presented the Indiana Outstanding Amateur Award by the IRCC at the Annual Picnic at Brown County State Park. Bloomington ARC is compiling a directory of Monroe Co. amateurs. New officers of the Columbus ARC are W9LGM, pres.; W9LEE, vice-pres.; W9YDP sec.; K9VXZ, treas. The South Bend ARC completed a very successful class for study for Novice exams with W9CJR, W9CJS and K9UIY as instructors. *Amateur radio exists because of the service it renders.* Traffic: (July) W9JOZ 1065, W4RQR/9 787, W9HRB 722, K9IVG 521, W9AIZR 395, W9BFWY 345, W9QLW 233, W9NZZ 227, W9ACYG 202, K9DEN 120, K9HYV 118, W9FDQ 99, K9CRS 66, W9BUQ 61, W9PJR 55, K9ZLB 49, W9YFX 48, K9RWQ 42, K9GLL 38, W9M1A 35, W9ACJR 23, W9SNQ 23, W9RTH 23, W9FZW 21, K9VHY 21, W9DGA 19, K9EFP 19, K9WVJ 17, K9ILK 14, W9BZ1 13, W9CC 12, W9BPD 11, K9KTL 11, W9DOK 10, W9FWH 9, K9BSL 8, K9VZQ 7, W9CPW 6, W9DZC 5, K9UEO 5. (June) W9VAY 118, W9AJUM 45, W9PJR 23, K9EFP 24, W9BWT 18, W9HWR 14, K9FPA 13, W9PJI 11, W9URJ 11, K9DEJ 9, K9UHQ 8, K9IVV 7, W9WZJ 7, K9PNP 6, K9VZQ 6, W9TKH 5, K9RFW 3, K9SUH 3, K9GHN 2, K9YKE 2, W9MBZ 1, K9RAA 1.

WISCONSIN—SCM, Kenneth A. Ebnetter, K9GSC—SEC: K9ZPP. PAMs: W9NRP, K9IMR, K9HJS and W9AEZT. RM: Still looking. Net reports:

Net	Freq.	Time	Sess.	QNI QTC	Mgr.
BEN AM	3985 kc.	1200Z	Mon.-Sat.	28 186 156	W9NRP
BEN N	3985 kc.	1700Z	Daily	30 591 140	K9HJS
WSBN	3985 kc.	2215Z	Daily	31 993 329	K9IMR
WIN	3535 kc.	2345Z	Daily		5 W9AEZT
SWRN	30.4 Mc.	0200Z	Mon.-Sat.	25 229	

A net certificate went to W9AFAB for BEN. New appointments: K9YPW as EC for Barron County, K9MCK as OO, W9LWJ as OPS. Renewed appointments: W9SIZ and K9GDE as ORSs, W9FMQ as OPS, W9AXS as EC. W9KZZ spoke to the Racine Club on traffic-handling. W9VSO led the OOs with 12 notices sent. W9AMIO is having fun working DX and trying for WAS. Milwaukee County AREC assisted with the Circus Train and the Fourth of July Day in the Old Milwaukee Parade. The Sauk County AREC helped with Parades in Baraboo and North Freedom. W9MIWQ has a new trap doublet for his station. Other stations are reporting the usual summer lull in operating. W9AFAB and W9CGJU made the BPL in July. Traffic: (July) W9CGJU 590, W9AFAB 348, W9DYG 184, K9IMR 109, W9LWJ 80, K9ZPP 70, W9NRP 59, W9CBE 48, W9KQB 26, W9HWQ 20, K9GSC 19, K9RCK 15, W9AIRG 12, K9ITQ 12, W9WJH 12, W9YT 11, W9AEDZ 5, W9MIWQ 5, W9AMIO 5. (June) W9NRP 63.

DAKOTA DIVISION

MINNESOTA—SCM, Herman R. Kopschke, Jr., W0TCK—SEC: W9OBZG. RMs: W0ISJ, W9JDG.

PAMs: K0FLT, K0VPI, W0HEN, W9CQG, MSPN meets M-Sat. on 3820 kc. at 1805Z and 2400Z, Sun and holidays at 1500Z. MSSB Net meets M-F on 3820 kc. at 1730Z and on 3812 kc. at 0045Z. MSN meets daily on 3595 kc. at 0030Z. MJN (slow speed c.w.) meets on 3595 kc. at 0010Z. Novices check in on 3725 kc. when called for. MSTN meets S-F at 0430Z and Sat. at 0200Z on 50.4 Mc. Appointments endorsed: W9OJU, K0SNP, W0LUP and W0FIT as ECs, K0ZZR and W0HEN as OOs, K0ZRD as OPS, K0OK as ORS, W0HEN and W0FLK as OBSs. W9AIIH was appointed as OO and the new moon MSPN is K0QBL. Thanks to K0VPI, who served as PAM the past two years, W0KJZ sends code practice at 10 p.m. on 3625 kc. MSN and MJN held their annual meeting and picnic July 11 at Waseca. MJN will listen for Novice members to check in on 3725 kc. If it is impossible for you to operate this frequency inform the RM or NCS of your frequency and they will try to pick you up there. Here is an opportunity for you to get into traffic work. PICONET members voted at their annual meeting to unite with AREC. Your SCM and Director also enjoyed attending the Grand Rapids, Mankato and Duluth Picnics. W0UNX built and debugged a 7 diode, 7 transistor electronic keyer of his own design. W0AGL was appointed by his friend President Johnson to be chairman of the National Advisory Committee on Selective Service. Mankato ARC members provided communications for the annual parade at Tetonka, Iowa. Traffic operators were busy in July with 2350 traffic totals reported and W5NAR/O, W9AJKT, W0SYD and W0SYD/O making the BPL. Traffic: (July) W5NAR/O 617, W9AJKT 313, W0SYD 312, W0SYD/O 286, W9AIIH 110, W9ACAT 107, K0ZZR 100, K0UXQ 66, K0ZRD 52, W0HEN 48, W9OQY 27, W9EPX 36, K0FLT 36, W0KJZ 31, W9AFDN 25, K0VPI 23, W9AIO 21, W9DVK 19, K0SRK 19, W0UMX 18, W9OBZG 17, K0IGZ 10, W0MXC 8, K0ICG 7, W9AIIJ 7, W9AKQ 7, W9AIOJ 5, W0KJZ 5, W9ADEF 4, K0PZ 4. (June) W9ACI 11, W9CQG 10, W0KJZ 8, K0ZRD 8.

NORTH DAKOTA—SCM, Harold L. Sheets, W0DM—SEC: W9AYL. PAM: W9CAQ. OBS: W0PQW. W9AYL went east for his annual vacation to Ohio and Long Island working 20 meters mobile back home. K0FUP will be on his honeymoon on the West Coast by the time this gets into print. W0ORV, W0NVV, W9OGRX and W9OMN keep 3996 kc. busy during the morning with gossip, family doings, etc. W0DM took the HW-12 along and worked portable while in Burke Co. W0ORV finished her 53rd. Vacation time took W0VBE and W9OGRX out to the West Coast while W9AYA, W0NVV, W0EJF and W9OMN were down in the Detroit Lakes area. The GFAB has some new mobiles, W4GKZ/O and K0SIA have new Swan 240 while K0JTL has an HW-12. K0RSA still is swapping and now has a new SB-34. W0EJF caught a nice bunch of fish so held a fish fry for the husbands and wives of that gossip net. W0PHH and W9AYA were able to get in on that one. The same group gathered to celebrate another milestone for W0PHH on his birthday. W0CDO, NC of the Goose River 160-Meter Net, reports 80 check-ins, one message handled and 2 informals. This net meets Sun. at 9 p.m. CST on 1990 kc. W0HZM put a new SB-34 in the car and took off with W0MQA for a trip to Michigan. W9AIIJ has a new HX-20. Despite vacations, farm work and summer recreation, the RACES Net has been operating regularly at 6:30 p.m. CST. W9BIT, W9AYL and W9CYW share the net control duties. K0TTP leads the group with traffic every month. Traffic: K0TTP 59, W0DM 5, W9GRX 1.

SOUTH DAKOTA—SCM, Seward P. Holt, K0TXW—SEC: W0SCT. RM: W9AOY. K0FKJ worked Maine on 6 meters for No. 42 WAS on six. W9AOY has accepted appointment as RM, relieving K0G5Y who has done an exemplary job despite the pressure of his other duties. Let's give Don a lot of help. New calls are W9OKEM and W9OKCC in Mitchell and W9OMXE in Sioux Falls. K0VYV is on the air with an s.s.b. rig, making all modes available in his net activity. The Sioux Falls Two-Meter Net started operation Sept. 12 at 0200Z and weekly thereafter. K0SJI has a new SB300-400, K0TXW and XYL and granddaughter stopped en route to Omaha at Centerville and discussed AREC matters with SEC W0SCT and visited briefly with W0LXD. Traffic: K0G5Y 231, W9AOY 68, K0VYV 56, W0SCT 53, W0DIY 18, K0ZBJ 8, W9OGLH 4, W0DJO 3, K0TPF 2, W0ZAL 2.

DELTA DIVISION

ARKANSAS—SCM, Curtis R. Williams, W5DTR—SEC: W5NPM. PAM: W5GPO. RM: K5TYW. NMs: W5IHS, K5LPS, W5HNN. With 1500 hams in Arkansas it seems that more than 5 to 7 would report into

the Arkansas C.W. Net per night. If an emergency came along, I would bet that at least 50 would want to help but that those 50 only ten could do a real efficient job. However, there is no cause for alarm because an emergency just could not possibly happen in Arkansas! Besides chasing DX and ragchewing is more fun anyway. The editor of *The Grid Drive*, excellent monthly bulletin of the Southeast Arkansas Amateur Radio Club, has threatened to drop me from his mailing list unless I publish something in this column from his paper but it is difficult to condense six pages of excellent news material into our allotted space. Net reports for July:

Net	Freq.	Time	Days	Sess.	QTC	QNI	Ave. T/c.
OZK	3790	0100Z	Daily	31	?	?	?
RN	3815	0001Z	Daily	31	58	468	1.9
APN	3885	1200Z	Mon.-Sat.	?	?	?	?

Congratulations to W5VFW, North Little Rock, the new Pulaski EC. K5ABE's EC appointment has been renewed for another year. A new SCM soon will take the reins in Arkansas. Please give him your support so his job will be as easy as mine has been. Traffic: (July) W5NPM 445, W5HNN 303, W5OBD 199, W5MJO 117, W5IIS 97, K5TCR 60, W5JTR 28, W5AGPO 25, W5KON/5 25, K5HYB/5 8, W5AKUD 6, W5BBS 2, K5TYW 1. (Late) W5MJO 182, W5ACBL 35, W5AKUD 2.

LOUISIANA—SCM, J. Allen Swanson, Jr., W5PM—SEC, W5BUEK, PAM: W5TAV, RM: W5CEZ, V.H.F. PAMs: W5UQR and W5AKHE, W5AKQN enjoys reporting into nets and handling traffic. W5JLV reports many openings into the north and northeast on 6 meters. He worked Arizona and Mexico. The GNOARC meets every Wed. at 0200 GMT on 50.25 Mc. W5ZJO reports a good opening on 2 meters between Baton Rouge and St. Clair, Mo. K5MEI is on 2 meters using s.s.b. with an SB-33 and mixer. K5FFI is preparing to build a preamplifier to boost his 2-meter activities. W5EID, whose only activity is traffic on LAN, is busy building a kw. for 40 and 80. The Grand Island area, extending as far east as New Orleans and north to Baton Rouge, is covered by a nice net on 146.94 Mc. f.m. At present it includes W5MCC, W5GYR, W5HFAO, W5HAP, K5KDR, K5ZJQ and W5VUY. W5CEZ spent the month of August in New York and other parts of Yankeealand. W5FNB still is pushing traffic. W5HGX says that K5MVG has a new Galaxy V. W5HGX has a new TA-33 Jr. and likes to use W5LWK's new Drake 4. Navy MARS is growing by leaps and bounds in Louisiana. Listen on 4010 any morning at 1245 GMT. K5FYI completed his 2000 p.e.p. rig. W5BLO has had to curtail his activity because of work hours. W5FA says he is just letting the hot weather go by! W5ZJO spends his time in technical discussions, construction and local club work. W5JFB says the Westside Radio Club has a 2-meter net going every Mon. at 0130 GMT on 145.8 Mc. with W5ABD as NCS. W5GHP still is pushing traffic but finds lots of QRML. K5OKL, the Queen of LAN, has a nice traffic total every month. W5AKHE established his first 2-meter contact with the Alexandria area from Natchitoches. He reports W5RVU is going 2 meters. The Central La. ABC had over 200 attending its annual hamfest. W5KIV went to Dallas for a month but operated portable. K5MOJ enlisted in the Navy. W5MXQ reports heavy vandalism to equipment in the Jefferson RC. W5EJD is taking a cruise on the USS *Wasp* but before going made WAC. W5UQR still is looking for Utah on 6 meters for his 48th state. I regret to pass the word that K5BIB has joined the ranks of Silent Keys. W5PM, of all things, joined Navy MARS! W5BUEK is recovering from major surgery. Traffic: W5GHP 433, W5CEZ 279, W5AKQN 139, W5FNB 71, W5EID 43, K5OKR 38, W5EA 20, W5MXQ 19, K5FYI 8, W5HGX 5, W5AKIV 2.

MISSISSIPPI—SIM, S. H. Hairston, W3EMM—SEC: W5JDF, The Jackson ARC really put on a fine hamfest under the leadership of W5MUG. The Pascagoula Club has reorganized using the club call W5WA. New officers are: W5ADVV, pres.; W5BCM, vice-pres.; K5HUW, secy.-treas. The club operated 80 through 6 meters on Field Day. K5TJG has moved to Tupelo and has added 6 and 2 meters to his station. K5JCT is back in Greenwood with HW-12 mobile and has added an SB-200 linear for fixed operation. W5CTU has a new beam that he can lower and raise on his tower. W5JDF arranged for K5VBA to act as Asst. RM while he is off the air. Congratulations to K5YBA on passing the Amateur Extra Class exam. K5MDX made top score in the Venezuelan Independence Contest and 240 QSOs, 56 sections, 67,200 points in the Phone CD Party. K5SVC moved to Virginia and W5DYJ to Venezuela. K5NIKA is trying s.s.b. with a TR-3. W5IHP has a fine ham family with W5LPL the latest call. Columbus ARC did fine on Field Day says W5WZ. Traffic: K5-

VBA 300, W5JDF 178, W5WZ 48, W5BW 20, K4MDX 17, W5EMM 12.

TENNESSEE—SCM, William A. Scott, W4UVP—SEC: W4RRV, RM: W4MXF, PAMs: W4GQM and W4PFP.

Net	Freq.	Days	Time	Sess.	QNI	QTC
TN	3635 kc.	Daily	1900C	60	316	188
TSN	3635	M-W-F	2030C			
ETPN	3980	M-Fri.	1800C	13	45	38
TSSB	3980	M-Sat.	0640E	22	448	21
TPN	3980	M-Sat.	1830C	27	1116	102
		Sun.	0645C	31	1423	191
			0800C			

W4MXF is looking for more QNI for TN and liaison with phone nets. Congrats to K4MRIZ on becoming head of the Tennessee Council. Any ideas for using this valuable organization would be most welcome by Charlie. W4ZJY again will be director of TCC. K4LPW is in the process of transferring to Kentucky. The *Tennessee Ham* continues to increase membership and Tennessee news. Contact W4WHN for information. K4KYL reports many openings on 6 not reported by others, including Delaware! The Crossville Hamfest was the best yet. Oak Ridge deserves the thanks of the entire section for putting on what has become the Tennessee Section Hamfest. Traffic: W4FX 358, W4IBZ 253, W4GQM 169, K4SXD 155, W4ALXF 130, W4PQP 120, W4ZJY 116, W4OGG 99, W4WBK 60, W4PFP 35, K4RCT 28, W4TZB 27, W4UVP 27, W4ANUJ 20, W4PCW 19, W4YTS 19, W4TZJ 18, K4UMW 14, K4HRY 13, W4YAU 12, W4FLW 11, W4AMCC 7, W4EWW 6, W4AIZB 6, W4VJ 3, W4AKHD 2, K4BTY 1.

GREAT LAKES DIVISION

KENTUCKY—SCM, Lawrence F. Jeffrey, W4KFO—SEC: K4URX, PAMs: W4BEJ, W4ARDE, K4YZU, V.H.F. PAMs: K4KZH, W44UW, Acting RM: W4RHZ, Endorsements: K4OQN as OO.

Net	Freq.	Days	Time	Sess.	QNI	QTC
EMKPN	3960	M-Sat.	0630			
MKPN	3960	Daily	0830	31	556	138
KTN	3960	Daily	1900	31	918	197
KYN	3600	Daily	1900	30	252	237

The column this month is written by your new SCM, W4KFO. I have enjoyed meeting all the amateurs in Kentucky and hope that you give W4KFO the cooperation and consideration he deserves. I considered it an honor to be SCM, particularly so being a YL. I hope we will all continue to be friends and work for ARRL. Good luck—Pat. As SCM-elect I'm sure I can speak for all Kentucky amateurs and say thanks to Pat for a job well done. Owensboro amateurs assisted in a c.d. mass casualty plan exercise furnishing communications from the casualty site to the local hospitals and c.d. headquarters. KTN NCSs from Sun, through Sat, are W4GMA, W4AST, W4ARTI, W4AVJZ, K4ZCB, W4AELG, W44WVN. Two-meter f.m. activity is increasing in the western part of the state. The main channel is 146.94 Mc. with some activity on 147.3 in the Louisville area. 9RN check-ins include W4RHZ, K4DZM, W44TPB, W44AGH is active on the Interstate S.S.B. Net. Traffic: (July) W4RHZ 374, W4BAZ 258, W44AGH 174, W44UAZ 102, K4CSH 100, K4YZU 100, W44TFP 92, W4ARDE 77, W4AST 69, K4MAN 69, W4KFO 68, K4QIO 67, K4DZM 48, W4GMA 41, W4PFQ 21, W4KJP 19, W44QLK 17, W44DXA/4 16, W4OYI 12, W4VCN 8, W4YYI 8, W4SZB 5, W4CDA 4. (June) K4CSH 600, W4PFQ 172.

MICHIGAN—SCM, Ralph P. Thetreau, W8FX—SEC: K8GOU, RMs: W8ELW, K8KMQ, PAMs: W8CQU, K8LQA, K8JED, V.H.F. PAM: W8PT, Appointments: W8AXF, K8BZL, W8CHA, W8KOX as ECs; W8EGI, W8IBB, W8ILP, W8MGO as ORS; K8BZL, W8QPO as OPNS. Silent Key: W8QIX, commercial telegraph operator since 1917 and motion picture operator for many years. W8IDC had a complete checkup after heart attack. His Doc was W8MI/W8OZ. 8OZ was my 2nd contact on Spark! The Van Buren Co. ARC ran a profitable Fourth of July booth at Bangor to help pay for its new Swan 350. The S.W. Mich. V.H.F. group had a good picnic at Allegan County Park. K8JJC has a new Bandit linear. Ex-W8QBR is now W8BII at Vista, Calif. S.E. Mich. u.h.f. activity is building up on 432.0 Mc. K8EQC got married. Congrats. In the Huron Valley ARC, W8C'DR moved to Arizona so W8CXF was elected secy. The B/R/W8SB-Men "picnic" at Mackinaw City was well attended and some business was accomplished too. Mrs. Cy Jenks expresses appreciation for the sympathy extended in the death of W8JYJ. W8PIL from Berkley (Mich.) has a new TR-4 and a kw. linear and is the mother of K8CPW, of Kincheloe

AFB. WA8HHD built a kw. amplifier using a pair of 4-400A tubes. W8QOE left for a South American Church Mission. WA8HHB has his kw. (p.e.) on the air. K8TWW's brother, WA8NBF, made General. K8LNE now is on 2 meters. WASCZJ is a new HT-44 and an HA-6. W8LBB now is on 2 meters. W8AHD and WA8-AXF are using a Swan 350-A. W8AAM finally gave up on a.m. and has a new Collins 328S. W8DSW bought a mobile house trailer and is working mobile. Instead of worrying about the FCC Docket, K8YBK got his Extra Class No. 193. W8ZHB is going on phone—a.m.? W8PYP says the cast is off his broken arm and it's feeling fine. Looks like W8QJO is going high power. Gonna show up his pop. W8PEB. W8NOH/6 paid Grand Rapids a visit. W8SS. W8GA and W8RLT are back from a swell trip to Europe. U.P. had a fine convention. Traffic: (July) K8NJW 293, K8LNE 254, K8KMQ 153, K8WQV 126, WA8BQK 99, K8RHU/8 94, K8TIG 70, W8ELW 57, W8KXO 56, W8BEZ 55, W8EJR 46, K8-JED 40, W8YAN 40, K8LQA 38, K8BYX 26, K8KBN 24, W8FX 23, W8CZJ 20, W8LBB 19, W8MEE 13, W8PIM 18, W8HKT 17, W8MQT 15, W8AUD 14, W8GHE 14, W8AXF 12, W8GTE 11, W8MCD 11, W8UFS 11, W8DZP 10, W8TBP 8, K8VDA 8, W8UC 6, W8EU 4, W8WNX 4, K8QLL 3, W8AHV 2, W8SS 2, (June) K8GOU 268, K8LNE 124, K8WQV 41, W8HYR 27, K8ZJU 25, W8HGE 18, W8IUC 18, W8AXF 16, K8BYX 14, W8AHV 6, K8GJD 5, W8IWF 3.

OHIO—SCM, Wilson E. Weckel, W8AL—Asst. SCM; J. C. Erickson, W8DAE, SEC; W8HNP, RMs; W8BZX, W8DAE and K8LGB, PAMs; W8VZ, K8BAP and K8-UBK, Six Meter Nomads' *The Amateur Extra* states the Nomads provided communications for the Independence Day Parade with K8VJB/M, W8GFM/M and WA8NII/M and that WA8PIW/8 and W8VAJ vacationed in California. Canton ARC's *Feedline* tells us K8POL was discharged from the Navy and plans to attend Ohio State. K8YLK drove his son K8VLU back to Georgia Teck, and then vacationed in Florida. W8-DRT has a new boy harmonic, K8JZN vacationed in Florida using a new TR-4. W8HR vacationed in Nova Scotia and K8ITH entertained the FD throng by playing his bagpipe. W8OYL moved to Arizona. W8RQJ and K8NIB would like to see more activity on 1296 Mc. and are constructing 3300-Mc. gear. W8AL has an HT-37, K8DHJ and K8DVJ put up an 80-meter doublet for him, ex-8AAL joined the Silent Keys, Toledo's *Ham Shack Gossip* says W8NQOH, W8NQOL, W8NQVI, W8NQVJ, W8NQWP, W8NQWQ and W8NQYS are new Novices in the Toledo area, W8IP, and W8IWF, joined the Silent Keys, the Buckeye Bells held a picnic north of Mansfield, W8HXF and his XYL vacationed in Virginia, heavy wind bent W8BIQ's tower, W8FBI enlisted in the Navy, W8TKS spoke to the Toledo RC on neutralization problems and Wood County RC held a Ham-A-Rama (hamfest). W8QCU sends this news: The National Post Office Net held 22 sessions in June with 239 QNTs and 79 QTCs and 23 states took part. Appointments made in July were W8TV and W8HPI as ECs, WA8JXM as OPS, W8WBG, K8HKB and W8-GYX as ORSs. Your SCM attended the Buckeye Net Picnic at Mt. Vernon with W8BZX, W8DAE, W8DDG, W8LZE, W8PMJ, W8RO, W8RYP, K8DDG, K8HFL, K8LVC, K8OTJ, W8CFJ, W8AGYT and W8KKE attending. There may have been others, for there are so many new members I do not know. Many had their wives with them. According to Tusco RC's *The Beam*, the club held its annual banquet. K8YSO is forming a net, the Ohio Michigan Net (OMN), to cover Ohio and Michigan on 3685 kc. at 0100 GMT. K8SSY has a new 22SI transmitter. Ohio had two hamfests, Springfield and Cuyahoga County. The Lancaster & Fairfield County ARC's *The Rag Chever* informs us that WA8-LTO moved to Tennessee. Columbus ARA's *Carascope* tells us the club held its annual picnic. Springfield ARC's *The Q-ber* says that W8MMU received his General Class License and K8WQE vacationed in Florida. W8ORK is on 2 meters. The Ohio S.S.B. Net held 58 sessions with QNT 1910, QTC 648, average per session 11.2. K8ONQ has a new daughter. We gained one more county for EC (Wyandot), so how about clubs or groups of amateurs in counties in which we do not have an EC selecting a general to be your EC. Traffic: (July) W8ACCD 309, W8CFJ 253, W8DAE 242, W8RYP 224, W8WSM 171, W8AGYT 135, K8UBK 127, W8BZX 116, K8LGA 52, W8QCU 68, W8QES 63, W8AJZ 59, W8-GYX 56, W8AIZ 55, K8CKR 48, W8ENM 40, K8VMI 33, W8FTX/VE3 34, W8SDY 33, W8MGA 32, W8LAG 29, W8MOK 26, K8RYR 24, K8HKB 23, W8TV 23, W8RFD 18, W8CXM 16, K8LGB 13, W8POU 7, K8-DDG 2. (June) W8AHVR 167, W8AGYT 102, W8LZE 10, W8MGA 6. (May) W8AHVR 109. (Apr.) W8AHVR 180.

HUDSON DIVISION

EASTERN NEW YORK—SCM, George W. Tracy,

W2EFU—SEC; W2KGC, RM; WA2VYS, PAM; W2IJG. Section nets: NYS on 3670 kc, nightly at 2400 GMT; NYSPTEN on 3925 kc, nightly at 2300 GMT; ESS on 3590 kc, nightly at 2300 GMT. WAJWGS, who is the new Radio Officer for Ulster County, made WAS in July. WB2FVD handled traffic from Hristol, N.H., while attending summer camp. A new General Class licensee is WB2PUX in Mt. Vernon. WB2HZY reports 133 stations in 33 sections during the July, CD Party. The RACES group in New Rochelle provided communications for its annual fishing derby. K2LSX is now Class 1 Official Observer for frequency measuring prowess during FMT's. Two new Generals in New Rochelle are WB2MOH and WB2OCP. The Communications Club of New Rochelle reports 75 members equally divided between General and Technician Class' plus Novices. W2BXP, WB2IFN and WB2OCA are new members of the ESS Net. K2CBA worked KP4 via moonbounce on 430 Mc. Judson is using sixteen six-element yagis with transistor preamp at the antenna on 430. A new rotating 85-ft. tower under construction should allow the array to do even better. WB2HZY designed his own nuvistor preamp for 6 meters. K2DEM reported from Keeleer AFB, Biloxi, Miss., where he is a lieutenant in the Air Force on the legal staff. Traffic: (July) WA2VYS 196, WA2HGB 103, WB2HZY 80, W2-DXL 67, K2S2N 55, WA2JWL 53, W2URP 48, W2ANV 42, W2PKY 37, WB2YA 21, W2BXP 20, WB2FVD 19, WA2VYK 13, WA2WGS 11, WB2FXB 10, WB2FYP 7. (June) K2AVP 135, WA2VYK 26, WA2LJM 18.

NEW YORK CITY AND LONG ISLAND—SCM, Blaine S. Johnson, K2IDB—Asst. SCM; Fred J. Brunjes, K2DGI, SEC; K2OVN, Section nets:

NLI	3630 kc.	1915 Nightly	WA2EXP—RM
VHF Net	145.8 Mc.	2000 TWTh	W2EW—PAM
VHF Net	146.25 Mc.	1900 FSSm	W2EW—PAM
NYCLIPN	3932 kc.	1600 Daily	WB2HWB—PAM
NLS (Slc)	3630 kc.	1845 Nightly	WA2RUE—RM

NYC-LI AREC Nets: See Dec. 1964 column for schedules. Hey—happy Halloween to thee! Here are the BPL guys: WA2RUE, WB2DXM, K2AAS and WN2SLI. WB2DBW is going to Clarkson College of Technology. Best of luck to ORS WB2OTT, who has moved to Providence, R.I. WB2DZZ picked up a new HT-44 and worked VP8 and EP8 on the first play. WB2DBQ, W3-TUK's brother, is now signing his old call, W4IQG, down there in Florida. WB2NGZ has put up a new inverted "Y" for 20 meters and claims that the "W2AU Balun" works like the dickens with it. W2DBQ is running a new R-4 receiver nowadays. WB2EMJ has acquired his very own telephone-type pole and is threatening to install a cubical up there! K2SFG is doing work with TV/astronomical photos. Congratulations to WN2RBA, who just turned into WB2RBA while earning a CP-15 and handling traffic. W2PF, our roving reporter, dost report that the "Jumpsuit Net" is encouraging its members to go for the Extra Class license. So far, five members on both the East and West Coasts have made it, but that W2PF rasal got his rear's ago! While recuperating from an operation, WA2JZK gave the 40-meter band a good workout and built a TO keyer besides. WB2IQG received his commercial phone ticket and is now repairing those 11-meter-type rigs for the you-know-who! W2HAE and K2HTX visited the ARRL guys and girls in Newtoning just a couple of days before W2GKZ, K2IDB, K2SJO and W2TUK got there (I read the visitors log). K2SVY is making out like a bandit on 6 meters with a great big 1/2-watt! W2HAE reports that the Larkfield ARC has made all of its K2US commitments and proudly suggests that that is a fine feat for a small club. "Rightfully so," replied the beloved old station trustee. Did I tell you that K2GNC is experimenting with 160-meter antennas? WB2HJT seems to be working a lot of 9s and 0s lately, he says. It was toward the end of another record session of the AREC and there was a lull as the NCS gathered his fractured wits. Suddenly, a tiny carrier broke the stillness of the night. "Clunk!" It was WA2EXW with a message of import. "It's a boy!" WA2WAO has added a transistorized S-meter to the mobile rig and a noise limiter to the car receiver. OES W2SJOY has installed a nevisistorized i.f. strip in his Clegg 99er. K2PQY vacationed in Cape Cod this past summer. WA2ICE put the homebrew 6 and 2 rig on the air and has been getting excellent signal reports ever since. New appointment: W2BCB as OO. Traffic: WA2-RUE 1798, WB2DXM 541, K2AAS 237, WB2DBW 198, WN2SLI 155, WB2HWB 130, WB2OTT 123, WA2EXP 108, WA2QJU 106, WA2LJS 95, WB2DZZ 84, W2EW 68, WB2NGZ 54, WB2LUK 52, WB2AEK 48, WB2EGV 46, WA2VLK 41, W2DBQ 38, WB2EMJ 31, WB2FTT 30, K2SFP 23, W2EC 20, WB2RBA 15, WN2QHX 10, K2-UAT 8, W2PF 4, W2AWX 2, WA2JZX 1.

(Continued on page 188)

six pack

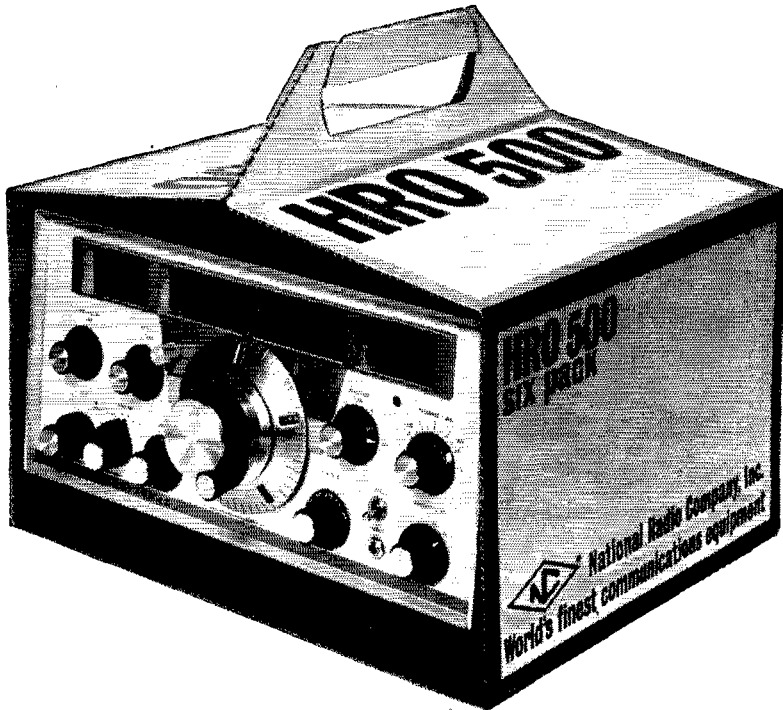

National offers six of the world's finest receivers to meet *your* particular requirement.

Receiver number one provides greater amateur band performance and features than any amateur receiver ever built. ■ Receiver number two has the widest frequency range (from 5 Kc to 30 Mc) of any general coverage communications receiver ever built for lab or commercial application. ■ Receiver number three is *completely* solid-state for high reliability, versatility and portability. It operates from 12/24 V.D.C. or 115/230 V.A.C. This receiver draws less current than a couple of dial lamps (when its dial lamps are switched off), and provides instant-on operation. ■ Receiver number four incorporates specific features for high selectivity and has a six-pole filter to provide built-in steep-skirted 500 cps, 2.5 Kc, 5.0 Kc, and 8 Kc bandwidths with *passband tuning* for CW and SSB. Also *AGC threshold control* to knock out background QRM. Also a 50 db notch filter. ■ Receiver number five has a phase-locked frequency synthesizer to replace conventional high frequency oscillator crystals for superior stability and over-all calibration. ■ Receiver number six offers frequency meter performance with 1 Kc dial calibration and accuracy over its entire tuning range, 24 feet of bandspread per megacycle, and 10 Kc per turn tuning rate.

Each of these receivers is called the HRO-500. National's new HRO-500, at \$1295, is the finest *total* receiver you can buy . . . at any price. Interested in trying out National's new sixpack? See your National dealer for an opener.

Behind This Honest Face

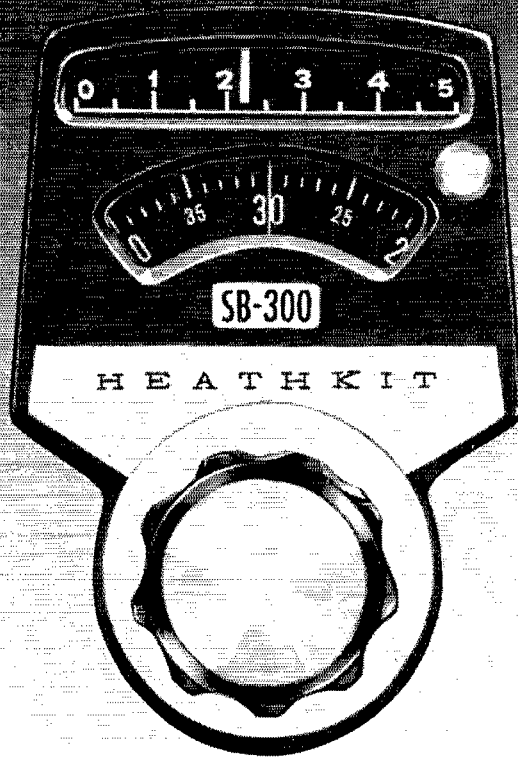

Heath Deluxe SB-Series Tuning Dial — with features proven by thousands of satisfied SB-Series owners . . . features you can prove for yourself!

- Calibration accurate to 400 cps on all bands
- Readable to 200 cps
- Bandspread equal to 10 feet per megacycle
- Uniform $\frac{1}{8}$ inch spacing between all 1 kc dial divisions
- Backlash less than 50 cps



HEATH COMPANY, Dept. 9-10, Benton Harbor, Michigan 49023
In Canada: Daystrom, Ltd., Cooksville, Ontario

Enclosed is \$ _____, plus shipping.

Please send model (s) _____

Please send me free 1966 Heathkit Catalog.

Name _____
(Please Print)

Address _____

City _____ State _____ Zip _____

Prices & specifications subject to change without notice. AM-156

FREE 1966 HEATHKIT CATALOG



See the wide array of Heathkit Amateur Radio Equipment available at tremendous do-it-yourself savings! Everything you need in "mobile" or "fixed" station gear with full descriptions and specifications. Send for Free copy!

*like
this...*

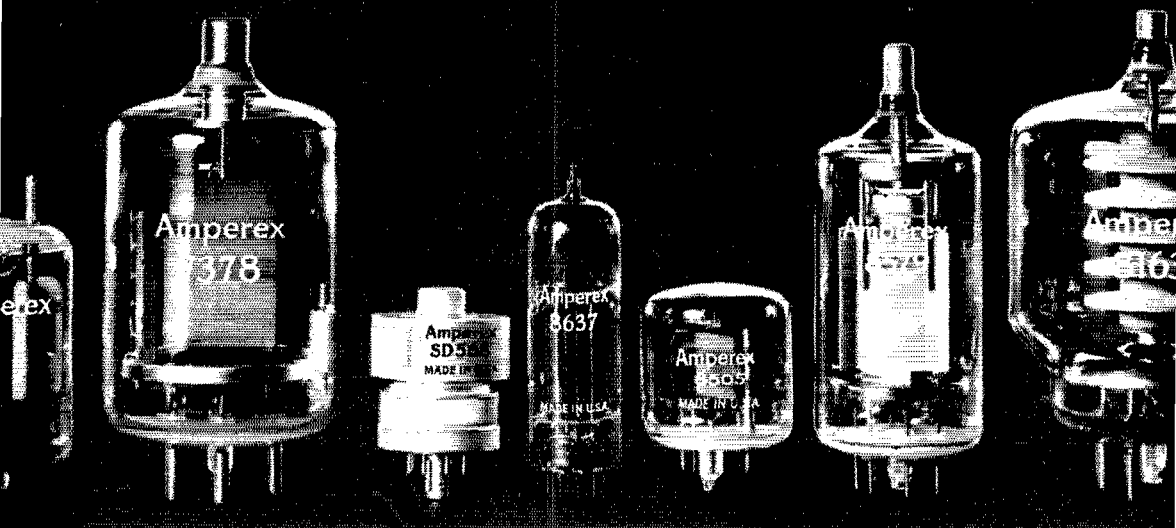

SSB TYPE NO.	7378	SD568*	8637	8505	8579	8163
Useful Peak Envelope Plate Power Output (watts)	167	180	78 (PTTS)	57	110	700
3rd Order Intermodulation Distortion (db) (without feedback)	35	30	25	30	30	35
5th Order Intermodulation Distortion (db) (without feedback)	40	35	35	43	40	40
Typical D.C. Plate Voltage (volts)	750	2000	600	750	600	2500

*Conduction cooled version of the 8321/4CX350 in development.

Illustrated are six new communication types of a line of more than 20 AMPEREX "Performance-Rated" SSB tubes with power ratings from 5 W. to 5 Kw. PEP. Watch for releases of new SSB tubes now in prototype stage. Write for technical data sheets. Applications engineering assistance available. AMPEREX Electronic Corp., Tube Division, Hicksville, L. I., N. Y. 11802.

Amperex[®]

IN CANADA: PHILIPS ELECTRON DEVICES, 116 VANDERHOOF, TORONTO 17.

Cush Craft

FOR THE HAM WHO WANTS TO GO PLACES

The standard of comparison in amateur VHF, UHF communications. Cush Craft beams combine all out performance with optimum size for ease of assembly and mounting at your site. These beams can be mounted vertically, horizontally, in pairs, quads, or virtually any combination — allowing you to design the antenna system that meets your exact requirements.

A144-11	11 element	\$13.95
A144-7	17 element	10.95
A220-11	11 element	11.95
A430-11	11 element	9.75
A144-20F	Multi polarized	29.50
A26-2P	Portable	10.95
A26-ZP	Portable	15.95
A50-3	3 element	14.95
A50-5	5 element	21.50
A50-6	6 element	32.50
A50-10	10 element	49.50
A26-9	10 element	27.50

Cush Craft coaxial stacking kits are available for all of our beams listed. They are complete — ready to use. Amateur net price \$4.95.

Cush Craft Quad arrays are complete package systems of four matched beams with stacking frames, hardware, and phasing lines for direct 52 ohm feed.

A144-11Q	2 meter	44 element	\$84.50
A144-7Q	2 meter	28 element	72.50
A220-11Q	1 1/4 meter	44 element	64.50
A430-11Q	3/4 meter	44 element	52.50

See your distributor or write for our free catalog of UHF beams, Colinear arrays, Squalos, Monobeams, Big Wheels, and the Blitz Bug Coaxial lightning arrester.

Cush Craft

MANCHESTER, N. H.

621 HAYWARD ST.

YL News

(Continued from page 119)

while her OM and K3HEC tried many different connections to the rig hoping for a successful contact. At just about the last minute before signals faded, Livy succeeded.

That great day, Livy could only guess that she was the first YL to bounce a signal off the moon. Sam Harris, W1FZJ, has since confirmed that to the best of his knowledge she certainly is. Congratulations, Livy!

Powder Puff Derby

On July 3 at 1600 GMT on 7.217 Mc., the Powder Puff Derby Amateur Net for 1965 went into full swing under the expert chairmanship of Carolyn Currens, W3GTC. This is the 14th year in which amateur radio has provided successful communications coverage for the Derby. The following Chairmen who assisted, and Carolyn, wish to thank all amateurs whose help made this possible: El Cajon, Calif., K6UTO; Tucson, Ariz., W7DRU; El Paso, Tex., K5GSA; Midland, Tex., K5ODH; Dallas, Tex., W5FCP; Monroe, La., K5BPK; Montgomery, Ala., W4AUP; Savannah, Ga., W4KGP; Chattanooga, Tenn., K4QNI and W4RMT. **QST**

The Challenge of Milliwatt Power

(Continued from page 67)

for power inputs from microwatt levels to 700 milliwatts.

Inputs in the range of 300 milliwatts can be handled easily by the equipment shown in the photographs although inputs at W2TKG have been restricted to 125 milliwatts or less, not only for the sport of it, but also to conserve battery power. Operating in the 100 milliwatt range, a pair of 9-volt batteries (NEDA 1600) will provide power for daily operation for at least six months.

Acknowledgement is made to the many fine operators who have given me the pleasure of contacts with them. Acknowledgement is also made to Jack Cleary, W2VSP, for circuit suggestions and editorial comment.

Operation at milliwatt input levels offers a new challenge to the amateur — a new sensation to experience. How else do you describe K5JVF and VE1ZZ responses to your CQ? But find out for yourself. Give real low power a try. **QST**

Important postal changes in handling second-class mail matter are now in effect. Please advise us direct of any change of address. Four weeks notice is required to effect change of address. When notifying, please give old as well as new address. Your promptness will help you, the postal service and us. Thanks.

SWITCH TO SAFETY!



... Beats A Stout Heart

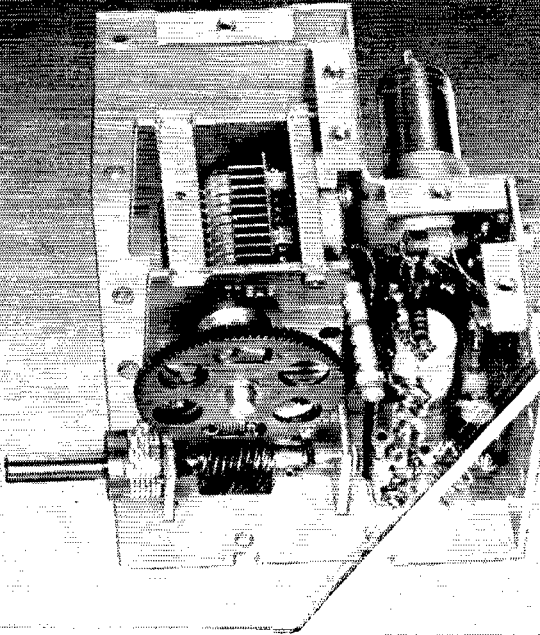

Heath Deluxe SB-Series LMO (Linear Master Oscillator) — with features factory built into the heart of every SB-300 and SB-400 ... features you can prove for yourself!

- True linear tuning . . . (within 400 cps)
- Stable—less than 100 cps per hour maximum drift after warmup
- Tuning repeatability better than 50 cps
- Rigid mechanical construction
- Highest quality components assure years of dependable performance

HEATH SB-SERIES PERFORMANCE IS A PROVEN FACT!

Operate 80 through 10 meters on either the SB-300 Receiver or the SB-400 Transmitter—operate 6 meters on the SB-110 transceiver—experience the same precision tuning and near-perfect stability on each. All of these features will be included in the SB-100, 80 through 10 meter transceiver, available soon.

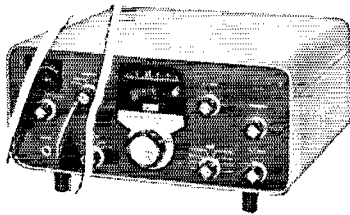

Kit SB-300, less speaker, 23 lbs.
 ... \$27 dn., \$22 mo. **\$265.00**
Export mo del available for 115/230 VAC, 50-60 cps: write for prices.

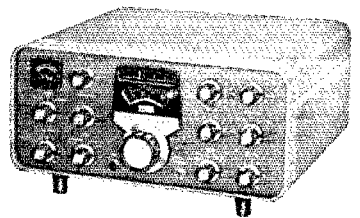

Kit SB-110, (less spkr. & pwr. supply), 23 lbs. . . . \$32 dn., \$28 mo. **\$320.00**

SSB *problems solved here*

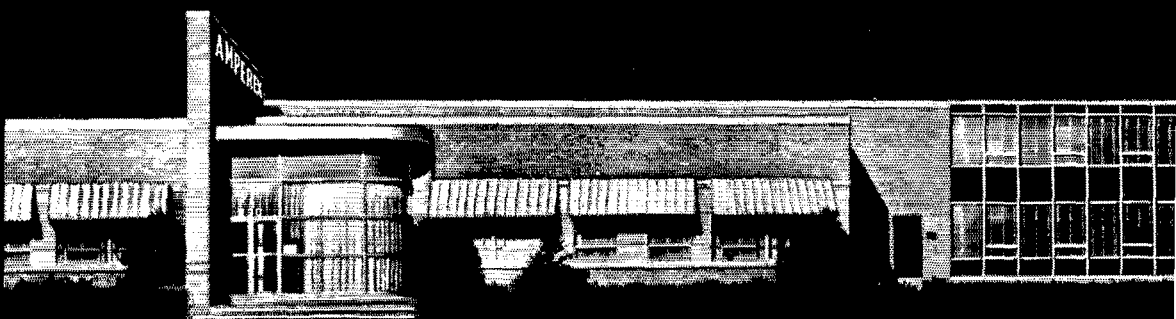

Amperex status as the source of more tube types for Single Sideband Suppressed Carrier Service than any other producer, didn't just happen. Leadership has been achieved as the result of a deliberate and continuing program of engineering research and intensive laboratory testing from which has emerged a distinctive and clearly superior comprehension of SSB

technology and SSB applications for any power level from 5 watts to 5 kilowatts PEP.

From internal tube geometry to overall envelope design, AMPEREX SSB Tubes are *Performance Tested, Performance Rated and Performance Guaranteed* for optimum linearity and minimum intermodulation distortion at *full Single Sideband* power ratings.

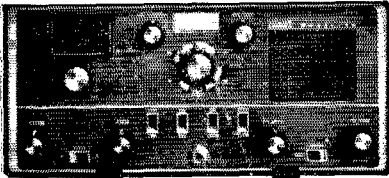
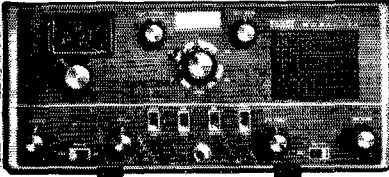
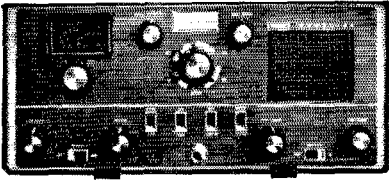

SB-34 ...your biggest dollar value!

The price of **395.00** includes built-in, solid-state, transformer type power supply that lets you operate on **12V DC** for mobile...on **117V AC** for fixed station service. The power change is simple too—just use AC or DC cable. (Both furnished). **SB-34**, the complete SSB station, is so small, lightweight and easily carried (has a handle for this purpose) that you can readily enjoy double use of this fine SSB four-band transceiver.

More power? Just add the big-value **SB2-LA KW Linear Amplifier**.

Mobile KW? Add the compact **SB2-LA Linear** and **SB3-DCP Inverter**.

CW? Merely plug in the new **CODAPTER** and key away.

HIGHLIGHTS:

- Expanded frequency coverage • Delta receiver tuning •
- Solid-state dial corrector • Panel switch selects **USB** or **LSB** •
- Solid-state switching—no relays • Collins mechanical filter •

Power input: 135 watts P.E.P. input (slightly lower on 15).
Freq. range: 3775-4025 kc, 7050-7300 kc, 14.1-14.35 mc, 21.2-21.45 mc
23 transistors, 18 diodes, 1-zener, 1-varactor, 2-6GB5's PA, 1-12DQ7 driver. **Speaker built in.** Pre-wired receptacles on rear accept **VOX** and **Calibrator**—both units optionally available.
Size: 5"H, 11¼"W, 10"D. 20 lbs. (approx.)

SB-34 Transceiver 395.00

SB2-LA Linear ... 249.50

SB3-DCP Inverter 249.50

Codapter 39.95



SIDEBAND ENGINEERS

213 East Grand Ave.
So. San Francisco, Calif. 94080

Export sales: Raytheon International Sales & Services, Lexington 73, Mass. U.S.A.



TOGETHERNESS

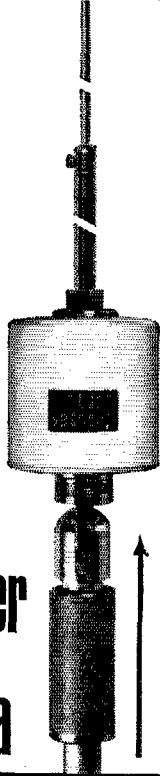

**top-sider
MOBILE
antenna**

**H-215
MOBILE
mount**

Matched pair—Top-Sider antenna and H-215 mount!

Top-sider column assembly features precision machined yoke normally locked in vertical position by knurled brass collar but capable of 90° hinging when released. Stainless steel top whip telescopes allowing 10" change in length for exact resonance... set-screw lock.

Two column lengths: H-218R, 93" max. and H-218S, 77" max. (less inductors). Low loss coils are sealed in protective white plastic... can be quickly changed for different bands.

Standard coils rated at 300 watts p.e.p. available 160 to 10 meters. 1KW p.e.p. coils, 80/15 meters.

Stainless steel strap needs only 1/16" clearance between bumper and car body, installs in 5 minutes using screw-driver!

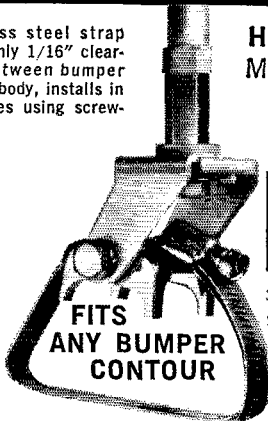

**H-215
MOUNT... \$8.50**

Webbcor band-spanner.

317 ROEBLING ROAD,
SO. SAN FRANCISCO,
CALIFORNIA

**FITS
ANY BUMPER
CONTOUR**

Continued from page 130

NORTHERN NEW JERSEY—SCM, Edward F. Erickson, W2CVW—Acting and Asst. SCM; Louis J. Amoroso, W2LQP. SEC: K2ZFI. NNJ ARPSC nets:

NJN	3695 kc.	7:00 P.M. Daily	WA2BLV-RM
NJ Phone	3900 kc.	6:00 P.M. Ex Sun.	W2PEV-PAM
NJ Phone	3900 kc.	9:00 A.M. Sun.	W2ZI-PAM
NJ 6 & 2	51,150 kc.	11:00 P.M. M-W-Sat.	K2VNL-PAM
NJ 6 & 2	146,700 kc.	10:00 P.M. Tu-Sat.	K2VNL-PAM
NJNN	3725 kc.	7:30 P.M. MTWTh	WB2KXG-RM

All times local. AREC skeds and information is available from K2ZFI. New appointment: WB2OYK as OBS Mon., Thurs. and Sat. at 9 P.M. local time on 145.08 Mc. WB2KXG is at Marquette University. Good luck to K2BEV in the new home. WN2TRP is a new ham in Sayreville. WB2LDE still is looking for 6-meter c.w. stations. W2TFM has returned from a business trip abroad. WB2LAM has a Gonet and four-element beam on 2 meters. W2NVA worked a T-150 during the 10-meter openings. W2HUG has his DXCC score up to 194 confirmed with his 150 watts. WB2JWB likes his new R4. WB2ALF now is using a multivibrator keyer. W2BIK did an FB job motorizing his 50-ft. crank-up tower. W2PBZ is waiting for four cards for his s.s.b. DXCC. WA2QPW is building a kw. rig for 20-meter c.w. Congratulations to K2MHP on his first harmonic, a 9-lb. 4-oz. boy. W2KIE gave up 10-meter a.m. for s.s.b. WB2GFY is using an HT-44. K2UKQ still is chasing DX. K2RDX is working on a tunable Balun for 432 Mc. W2NIY is clearing up his equipment problems. WB2BCS, EC for Monmouth County, has a 2-meter net that has met every night for over 18 months. Appointments renewed: WB2AEJ as ORS, WA2WHZ as ORS and WB2BCS as EC Monmouth County. Congratulations to WB2RIG on passing the General Class exam. A special note to all local club officers: Your SCM W2CVW, the SEC K2ZFI and Asst. SCM W2LQP are available to discuss the various appointments and section nets with your members. K2ZFI still is looking for ECs in certain areas. Contact him or your SCM if you are interested. WA2CCF joined CHC. K2BER still is chasing 2-meter DX. W2CVW received another 45-day assignment in W4-Land. We would like to hear from a few more members. Reports took a drop this summer. The NJN boys are looking for someone to organize their dinner. Good luck in the contest and let's hear more from you. Traffic: (July) WB2AEJ 289, K2VNL 274, WB2JWB 208, WB2FIT 130, WB2GFY 120, WB2HLH 104, WB2ALF 95, WB2KSG 73, WB2LUT 43, WB2ICH 24, K2KDG 19, K2ZFI 17, WB2BCS 12, WB2MAT 11, WB2QLF 11, W2DRV 10, W2LQP 10, WB2IYO 9, K2DEL 4, WB2KNN 4, WA2CCF 2, K2EQP 2, W2VMX 2, WA2ZFX 1, (June) WB2KXG 31, K2JTU 23, K2BEV 14, WA2KRC 7, WA2UDT 2, (May) WA2ZOW 3.

MIDWEST DIVISION

IOWA—SCM, Dennis Burke, W0NTB—Asst. SCM: Ronald M. Schweppe, K0EXN, PAM: W0NGS. The election of SCM for Iowa is over, with the OM being returned to office for another two years. Thanks to those who supported me. And to the nearly as many who supported my opponent. I hope you will give me the same support I know you would have given Owen and together we can keep Iowa an outstanding section. I hope to have a new SEC in a very short time to

First-Day Covers Still Available

When the Amateur Radio First-Day Covers were processed in Anchorage on December 15, we gambled and had a few extra unaddressed covers prepared, because orders for the first-day covers were still coming in and we didn't want anyone to be disappointed. We still have some of these left. They are all singles, unaddressed but carrying the amateur radio stamp and the official first-day cancellation, and they will be mailed to you in an envelope. Prices are 35c each, three for a dollar. Send your orders to ARRL Hq., 225 Main Street, Newington, Conn., 06111.

NOW! A TRI-BAND SSB TRANSCEIVER KIT FOR 179.95

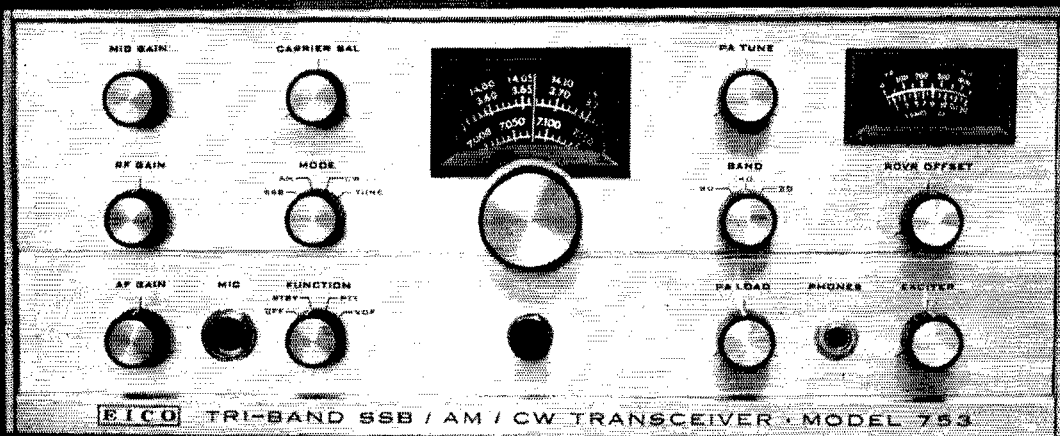

NEW EICO 753 SSB/AM/CW TRI-BAND TRANSCEIVER

Power Supplies Tailored for Optimum Performance of the 753.

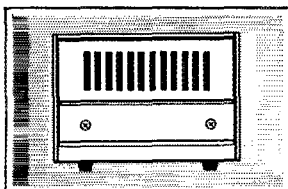

Model 751 Solid State AC Supply/Speaker Console. Matching table-top companion unit. Built-in PM speaker. Kit \$79.95 Wired \$109.95

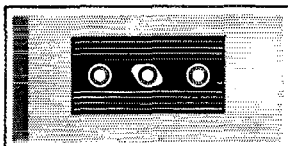

Model 752 Solid State Mobile Supply. For use with 12 volt positive or negative ground systems. Fully protected against polarity reversal or overload. Kit \$79.95 Wired \$109.95

Build the finest of SSB/AM/CW tri-band transceivers with 200 watts of SSB punch and every wanted operating facility, plus the extra reliability and maintenance ease inherent in kit design. Assembly is made faster and easier by VFO and IF circuit boards, plus preassembled crystal lattice filter. Rigid construction, compact size, and superb styling make this rig equally suited for mobile and fixed station use. The new EICO 753 is at your dealer now, in kit form and factory-wired. Compare, and you will find that **only the 753 has all these important features:**

- Full band coverage on 80, 40 and 20 meters. ■ Receiver offset tuning (up to ± 10 kc) without altering transmitter frequency. ■ Built-in VOX. ■ Panel selected VOX, PTT & STANDBY. ■ High level dynamic ALC to prevent flat-topping or splatter and permit the use of a linear amplifier. ■ Automatic carrier level adjustment on CW and AM. ■ Dual ratio ball drive permits single knob 6:1 rapid tuning and 30:1 vernier bandspread (over 10 degrees of scale). ■ Position of hairline adjustable on panel. ■ Illuminated S-meter/PA Cathode Current Meter and tuning dial. ■ Fast attack, slow decay AGC. ■ Grid-block break-in CW keying. ■ Product detector for SSB and CW, triode detector for AM. ■ TR relay with auxiliary contacts for use with high power linear amplifier. ■ Includes mobile mounting bracket.

ADDITIONAL SPECIFICATIONS

FREQUENCY COVERAGE: 3490-4010kc, 6990-7310kc, 13890-14410kc. SSB EMIS- SIONS: LSB 80 and 40 meters, USB 20 meters. RF POWER INPUT: 200 watts SSB PEP and CW, 100 watts AM. RF POWER OUTPUT: 120 watts SSB PEP and CW, 30 watts AM. OUTPUT PI NETWORK MATCHING RANGE: 40-80 ohms. SSB GEN- ERATION: 5.2 Mc crystal lattice filter; bandwidth 2.7kc at 6db. STABILITY: 400 cps after warm-up. SUPPRESSION: Carrier-50db; unwanted sideband-40db. RECEIVER: Sensitivity 1uv for 10db S/N ratio; selectivity 2.7kc at 6db; audio output over 2 watts (3.2 ohms). PANEL CONTROLS & CONNECTORS: Tuning, Band Selector, AF Gain, RF Gain, MIC Gain with calibrator switch at extreme CCW rotation, Hair- line Set (capped), Mode (SSB, AM, CW, Tune), Function (Off, Standby, PTT, VOX), Carrier Balance, Exciter Tune, PA Tune, PA Load, Receiver Offset Tune, MIC input, phone jack. REAR CONTROLS & CONNECTORS: VOX Threshold, VOX delay, VOX sensitivity, Anti-VOX sensitivity, PA Bias adjust, S-Meter zero adjust, power socket, external relay, antenna connector, key jack, accessory calibrator socket. METERING: PA cathode on transmit, S-Meter on receive. SIZE (HWD): 5 $\frac{3}{4}$ " x 14 $\frac{1}{4}$ " x 11 $\frac{1}{4}$ ". POWER REQUIREMENTS: 750 VDC at 300 ma, 250 VDC at 170 ma, -100 VDC at 5 ma, 12.6 VAC at 3.8 amps.

The Model 753 is an outstanding value factory-wired at \$299.95.



For FREE Catalog and 753 Spec. Sheet write to EICO Dept., QST-10, 131-01 39th Ave., Flushing, N. Y. 11532

ROHN sets the standard

for
**CRANK-UP
TOWERS**

Why settle
for less
than the best?



K7ASK

TWO CATEGORIES TO CHOOSE FROM

Standard Duty Guyed in Heights of 37 - 54 - 88 - 105 and 122 feet

Heavy Duty Self Supporting and Guyed in Heights of 37 - 54 feet (\$5) 71 - 88 feet (guyed)

ROHN has these 6 IMPORTANT POINTS:

- Ease of Operation**—roller guides between sections assure easy, safe, friction-free raising and lowering.
- Strength**—welded tubular steel sections overlap 3 feet at maximum height for extra sturdiness and strength.
- Unique ROHN raising procedure** raises all sections together—uniformly with an equal section overlap at all heights!
- Versatility**—designed to support the largest antennae with complete safety and assurance at any height desired!
- Simple Installation**—install it yourself—use either flat base or special tilting base (illustrated above) depending on your needs.
- Rated and Tested**—entire line engineered so you can get exactly the right size and properly rated tower for your antenna. The ROHN line of towers is complete.
- Zinc Galvanizing**—hot dipped galvanizing a standard—not an extra—with all ROHN towers! Prices start at less than \$100.

SEND FOR ROHN TOWER HANDBOOK

—\$1.25 Value

—ONLY \$100 postpaid (special to readers of this magazine). Nearest source of supply sent on request. Representatives world-wide to serve you. Write today to:



ROHN Manufacturing Co.

P. O. Box 2000

Peoria, Illinois

"World's Largest EXCLUSIVE Manufacturer of Towers; designers, engineers, and installers of complete communication tower systems."

be ready for the SET in October. The Iowa severe warning net is beginning to make history. Story County AREC reports completion of base stations in Nevada and Ames working 6 meters with Ray Calahan as EC. WOJVO is returning to activity after an absence of nearly thirty years. Welcome back, old friend. Net reports: Iowa 160 Meter Net, QNI 504, QTC 6, sessions 31; Iowa 75 Meter Net, QNI 1256, QTC 86, sessions 27. Hamilton County Net, QNI 127, QTC 2, sessions 27. TLCN, QNI 128, QTC 8, sessions 27. Traffic: WOLGG 1111, WONTB 95, KOMHX 64, KOKKD 30, WAODYV 17, WOJPI 10, KOTDO 10, KOJSK 9, WAOGUU 6, WOQVZ 6, WOGFL 5, WOBKR 3, WONGS 3, WONWX 3.

KANSAS—Acting SCM/SEC: Robert M. Summers. KOBXF—PAMs: KOEFL, WOBOR, V.H.F. PAMs: KOVHP, WOHAI.

Net	Freq.	Time	Days	Sess.	QNI	QTC	Arv.
QKS	3610	1830	Daily	68	21		
NCS	WA0JII	KOBXF	W0VBQ				
Kans.							
EC Net	3920	1300 CST	Sun.				
Mgr.	WA0CCW						
Kans.							
SB Net	3.920	1800 CST		14	141	65	
NCS	K0SKK	K0JPE	K0EMB	K0LHF			
HBN	3.880	1805		22	568	85	25.8
NCS	K0GZP	K0HGI	WA0HWJ	WA0FKD			
	WA0HJP	W0GQR					
KPN	392	0645 CST	Al-W-F				
	0800	Sun.		14	195	24	1.7
NCS	K0ORB	K0UER	K0GII	K0EFL			

Appointments endorsed: W0VBK as OO, W0AKA as OBS, K0GIC as OES, W0OHJ, W0RFF and W0QAQ as ORS. W0ZUX has moved to a new QTH in Scott City. Amateurs in Manhattan have set up 6-meter communications in 3 hospitals and 3 mobiles for emergency work, and an HW-12 s.s.b. to be used at City Hall. W0FRC also is mobile with an HW-12. K0JKA, Salina is Asst. Net Mgr. of HBN. New officers of the Wheat Belt Radio Club are WA0DAY, pres.; W0YDF, vice-pres.; K0IFL, secy.; K0MXU, treas.; K0RXX, act. mgr. W0BOR is moving to El Paso, Tex. The McPherson Radio Club was forced to cancel 1965 Field Day because of flood water conditions. W0OHJ made the RPL again. ECs reporting: W0FRC, W0BWM, K0LPE, K0EMB, WA0CCW. Traffic: W0OHJ 810, K0HGI 89, K0LHF 88, WA0JII 62, W0EMB 47, K0BFX 88, K0SKK 36, K0GZP 24, WA0EMQ 17, K0JDD 17, WA0CCW 14, K0EFL 9, K0LPE 8, W0ZUX 2.

MISSOURI—SCM, Alfred E. Schwaneke, W0TPK—SEC: W0BUL. K0TCB received PAM appointment replacing W0MM as manager of M0SSB. Other new appointments are W0RTO, WA0DKT and K0OYV as OPS; WA0BQU as OO; WA0DKT as OBS for MTTN. Appointments renewed: K0FPC as ORS and EC; K0WOP as OPS. WA0EMX has reorganized the teen net as the Missouri Teen Traffic Net (MTTN) meeting on 3940 kc. at 2330 GMT, Mon. through Fri. The Mo. Traffic Net (MON) now meets 7 days a week at 0100Z on 3580. The Show-Me Net (SMN) meets 7 days a week at 0400Z. K0ONK, mgr. of MSN, invites Novices, or Gen. Class licensees, also, who want to learn traffic-handling at slower code speeds to report into the Mo. Slow Speed Net (MSN) which meets on 3715 at 9 P.M. (0300Z) daily. M0SSB Net certificates were issued to W0CXF, W0ECA, W0HVJ, W0ITJ, K0LGZ, W0OBD, W0RTO, W0VZT and K0OYV. W0ECA is moving to K.C. About 100 hams and families attended the Zero Beaters ARC Hamfest at Washington. WA0FLL assembled an SB-300. W0TPK assembled one for W0EEE (UMR Radio Club). K0EYQ now is W0OYG in Oklahoma. WA0JLI is NCS for MSN Mon. K0JPS and W0AMO handled flood traffic in N.W. Mo. K0ONK has a new inverted "V" antenna. K0HNE has a new TR-4. K0AQO and WA0DSE have new towers. Net reports:

Net	Freq.	Time	Days	Sess.	QNI	QTC	Mgr.
MON	3580	0100Z	Daily	26	182	119	W0WYJ
MNN	3580	1900Z	Al-Sat.	27	74	24	W0OUD
SMN	3580	0400Z	Daily	4	—	6	K0AEM
MSN	3715	0300Z	Daily	22	43	18	K0ONK
M0SSB	3993	2400Z	Al-Sat.	23	498	110	K0TCB
PON	3810	2100Z	M-F	19	245	101	W0HVJ
MTTN	3940	2330Z	M-F	—	—	—	WA0EMX

Traffic: (July) K0ONK 2093, WA0PKD 384, K0AEM 139, WA0DKT 95, W0WYJ 79, W0OUD 67, K0HNE 57, W0HVJ 51, W0RTO 47, W0TPK 37, K0JPS 30, K0LGZ 29, WA0FLL 27, W0ZLN 25, K0VNB 21, W0JBK 15, K0BWE 13, WA0DGT 13, W0KIK 13,

Clegg



22'er TWO METER TRANSCEIVER

Signal reports on the 22'er are consistently excellent, thanks to the many fine Clegg design features that result from years of experience in pioneering VHF equipment. Hams, CD groups, MARS, CAP and other vital services are signing up enthusiastically for membership in the 22'er club because they know that they can depend on superior Clegg performance at the right price.

NOW AVAILABLE
AMATEUR NET \$239.50
 Clegg Mic \$10.50 additional

Features

RECEIVER

1. Unique new triple conversion design
2. Selectivity 10 KC at 6 db
3. Panel Meter doubles as calibrated S Meter on receiver and "relative output" meter for transmitter tune up
4. Full 143.8 MC to 148.2 MC coverage with tuning dial calibrated 144 to 148 MC
5. Adjustable Squelch
6. Excellent AGC performance
7. NUVISTOR RF stage and low noise first mixer provide .35 μ V sensitivity (6 db S + N to N)
8. 2 watts audio output available with self contained high efficiency speaker for operation in high ambient noise associated with mobile operation
9. Effective Automatic NOISE LIMITER

TRANSMITTER

1. Broadband exciter stages to simplify rapid QSY
2. High efficiency straight through final amplifier with crystal controlled 20WATT input
3. High level plate and screen modulation for typical Clegg "HIGH TALK POWER" performance
4. PUSH TO TALK with provisions to switch external LINEAR and VFO
5. TRANSMITTER frequency SPOTTING SWITCH
6. Self contained universal solid state power supply for 115 volts AC and 12 volts DC
7. Tube line-up

6CW4 RF Amplifier	12AX7 AF Amplifier
6KE8 Tripler/1st Mixer	6AQ5 Rec. Audio/Modulator
6EJ7 2nd Mixer	6AQ5 Modulator
6BA6 10.7 MC IF Amplifier	6KE8 VLO Buffer
6BE6 3rd Mixer	6KE8 OSC/Tripler
6BA6 456 KC Amplifier	12BY7 72 MC Amplifier
6AL5 Diode Detector/Noise Limiter	12BY7 Doubler
	2E26 Power Amplifier

Other S-S Products: SS-1R HF receiver, SS-1S Noise Silencer, SS-1V Bandscanner; Venus, Thor VI, and 99'er Transceivers; Interceptor B VHF Receiver; Allbander HF Converter; Apollo Linear Amplifier

Squires - Sanders, Inc.

MARTINSVILLE ROAD / LIBERTY CORNER • MILLINGTON, N.J. 07946

NOW!

TURNER SSB MICROPHONES FOR BASE STATIONS AND MOBILE RIGS

Now you can have single sideband microphones in both your base station and mobile rigs. Get both these fine Turner SSB microphones for just \$28.80, amateur net!

TURNER MODEL 454X

The base station SSB microphone you asked for. Choice of PTT or VOX. Wired for PTT, it features two separate switching arrangements — push-to-talk and lever-lock. Response: 300 to 3000 cps. Output: -48 db. Just \$15.90, net.

TURNER MODEL 333

A professional noise cancelling mobile microphone, engineered for amateur use. Coiled Cord, of course. Response: 300 to 3000 cps. Just \$12.90, net.



THE TURNER MICROPHONE COMPANY

917 17th Street N.E.
Cedar Rapids, Iowa

In Canada: Tri-Tel Associates, Ltd.,
55 Brisbane Road
Downsview, Ontario

Export: Ad Auriema, Inc., 85 Broad Street,
New York 4, N.Y.

Please send me the complete Turner catalog.

Name

Address

City

State

WAØKNW 10, KØYGR 10, KØJPL 8, KØWOP 6, WAØLJ 5, WAØFL 4, WØAMO 2, WAØDR/Ø 1. (June) WØZLN 17.

NEBRASKA—SCM, Frank Allen. WØGGP—SEC: KØJXN. Monthly net reports: Nebraska C.W. Net, WAØGHZ, 1st session, QNI 164, 2nd QNI 158, QTC 58. AREC Phone Net, WØRZ, QNI 123, QTC 4. Morning Phone Net, KØUWK, QNI 678, QTC 27. Nebr. Emergency Phone Net, WAØBID, QNI 1051, QTC 92. West Nebr. Phone Net, WØNIK, QNI 467, QTC 42. Nebr. Storm Net, KØJXN, 1st session QNI 639, QTC 6; 2nd session, QNI 434, QTC 3. All 3982.5 kc. Nebraska nets have now moved to 3982 to affect closer liaison with Nebraska RACES and c.w. headquarters. Appointments: KØVIZ as OO; WØRZ, KØFVB, WAØEEI, WØWKP, WAØJAV, WAØBEM and WAØCBJ as ECs. WAØEUM reports that a new 5-kw. generator has been purchased by the Red Cross for AREC use in Lancaster and adjoining counties. WØFQB is using a vertical "Joy-Stick" with "fantastic results" on all bands. Traffic: WAØGHZ 174, WØLOD 128, KØYDS 87, WAØBID 78, KØJFN 46, WØGGP 32, WAØBOK 22, WØFQB 20, WØHYD 17, WAØHWR 15, WAØEUM 14, WAØEL 10, WAØGVI 10, WØVEA 10, KØHNT 9, WAØHSX 8, KØDGW 7, WAØIXD 7, KØJXN 7, WØBFV 6, WØLJO 6, WØNIK 6, WAØBIE 5, WAØDPS 5, WAØERN 5, KØUWK 5, WØEGQ 4, KØFJT 1, WØPQP 3, WØCIW 2, WAØJZL 2, WØYFR 2, WØHOF 1, WAØIVW 1, WAØIXF 1.

NEW ENGLAND DIVISION

CONNECTICUT—SCM, Fred Tamm, K1GGG—SEC: W1EKJ, RM: W1ZFM, PAM: W1YBH, V.H.F. PAM: K1RTS. Net reports:

Net	Freq.	Days	Time	Sess.	QNI	QTC
CN	3640	Daily	1845	31	271	207
CPN	3880	M-S Sun	1800	31	12	(ave.) 112

High QNI: CN, W1ZFM, K1LMS, K1TKS, CPN, K1EIC, K1YGS, K1LFW. Your SCM is back on the air after changing QTH and can be reached via CN or CPN. K1RQO again is active after a short stay in the hospital. Your RM, W1ZFM, has his Extra Class license now, nothing like pushing traffic on c.w. to improve one's code speed! K1PRQ is back on the air. K1LMS and K1SRF assisted a motorist using mobiles on the AREC frequency. W1LUL, K1UGF and K1IIG are on 2-meter f.m. looking for other stations on 146.540 Mc. They will have a repeater in the New London area operating soon. New officers of the CWA are W1ZJJ, pres.; W1ECH, vice-pres.; W1RZG, secy.; W1TX, treas.; W1BGD, comm. mgr. W1NDSK, W1N2SLI and W1B2DXM are operating a Novice Net on 3743 kc. W1A1PY, NCS for the Transcon Relay Net is looking for new stations. TRN meets daily at 1500Z on 3520. CWA, W1TX/1 again tops in the nation in FD, operated the two transmitter class with 12,495 points. New appointments: W1CEP as EC, K1LFW as OPS, Endorsements: W1BGD as ORS, W1CHR as ORS, W1MBX as OO. Reports were received from OESs, K1QNF, W1A1CPU/3 and OOs W1EOL, K1QCC, W1BGD, W1EQV. DXCC was made by K1QCC and W1BGD. W1BGD also made the RPL again. It gets to be a habit with him. Traffic: (July) W1BGD 580, W1EWF 318, W1ZFM 211, K1LFW 174, K1EIC 145, W1WCW 123, K1EIR 118, K1LMS 107, K4EHY/1 92, W1GXF 92, W1A1PY 85, K1GGG 68, W1BDI 50, W1CTI 48, K1RQO 46, K1TKS 28, W1YBH 17, W1QV 14, K1NPR 10, K1SRF 10, W1BNB 8, W1OBR 8, K1YGS 8, W1A1CCR 5, W1CÜH 3. (June) W1BGD 548, K1LFW 137, K1OQG 125, K1RQO 50, W1OBR 26.

EASTERN MASSACHUSETTS—SCM, Frank L. Baker, Jr., W1ALP—W1AOG, our SEC, would like the other SECs in New England have someone check in each Sun, at 1300 GMT into the New England Emergency Net on 3870 kc. W1CWV is in the hospital. K1CCL painted his shack. W1VAH went to Wisconsin and put up a new antenna for 40/20/10. W1PRC is going s.s.b. W1KZD is building a transistor converter for 6. W1BVP moved to Brockton. W1N1DOD has a tower and a Big Wheel. The EM2MN had 23 sessions, 168 QNIs, 9 traffic. W1BGW says they have renamed the NFK Net in honor of Boyd Phelps, WØBP, W1NEAT is on 2. K1YUB has a quad for 15. A fox hunt was sponsored by W1AEC. Winners were W1ABZJ, W1ABBU and W1A1CNO, who received plaques. W1A1PX is s.s.b. with an HT-44. W1AQE is s.s.b. with an HT-37. W1CRX, Billerica, is on 80 c.w. and our net. K1HYF is on 2 and is attending a seminar in Brighton. New officers of the Middlesex ARC, W1HEB, are K1YVY, pres.; W1A1CDW, vice-pres.; K1QGA, secy.; K1TWV, treas. W1QA has a new QTH. K1NFH has his own plane. W1QGN is on 20-meter s.s.b. W1HXK is Extra Class. New Novices in Acton: W1N1s EUV, EUW, EUX,

The most tremendous transceiver value ever offered the radio amateur!

THE SWAN-350 SSB TRANSCEIVER

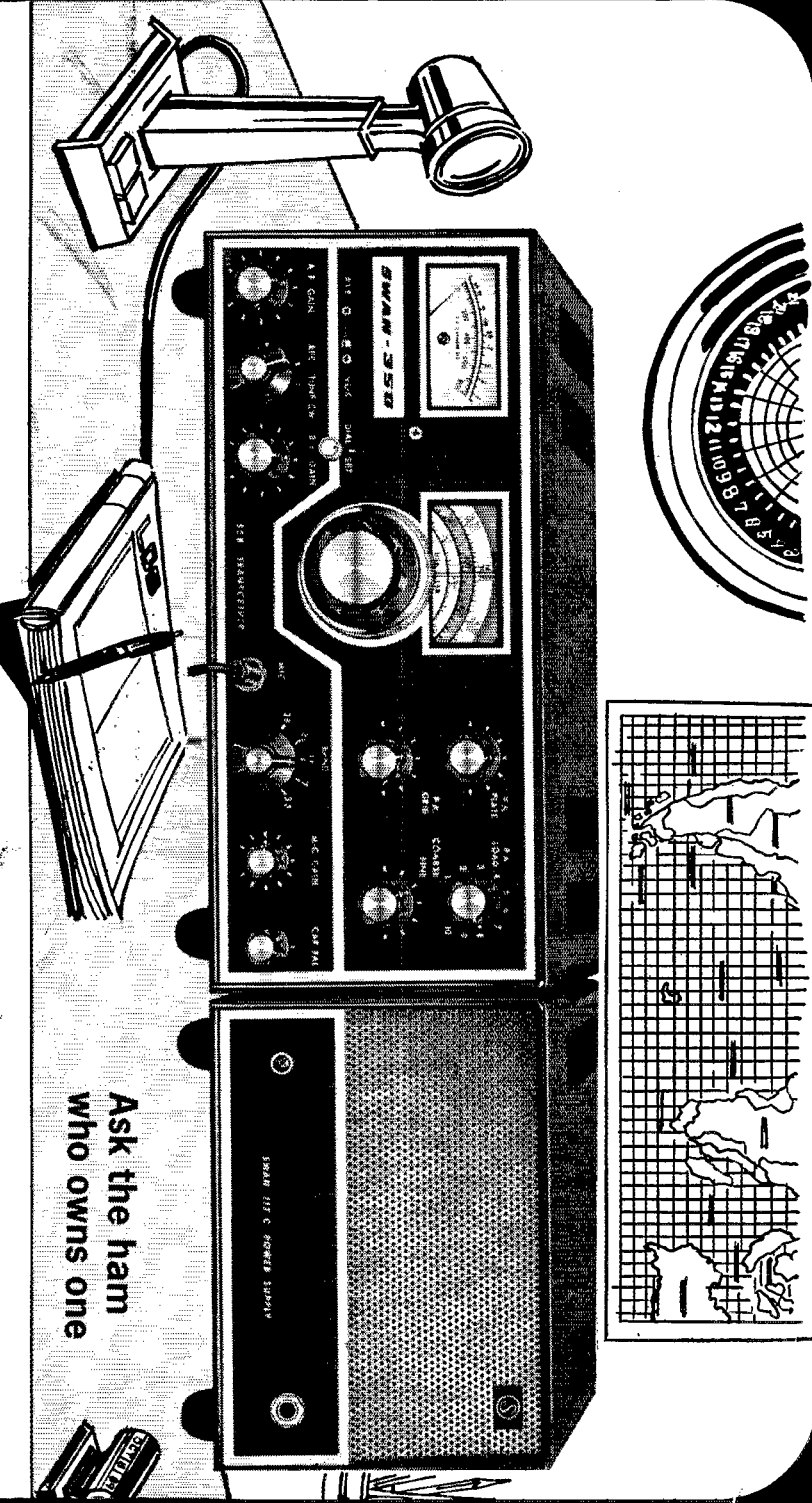

Ask the ham
who owns one

5 BANDS—400 WATTS \$395

HOME STATION—MOBILE—PORTABLE

Model 117C Power Supply... \$85



SWAN

ELECTRONICS

Oceanside, California

relax...
for the BEST
in HF and VHF
listening

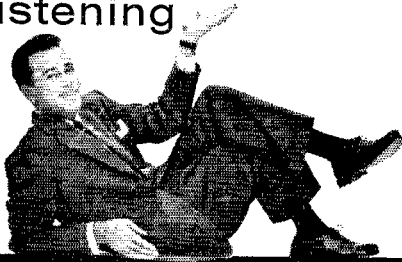

HAMMARLUND'S NEW HQ-170A-VHF

CAPTURES ALL POPULAR HAM BANDS

The exciting HQ-170A-VHF is the only Ham Band receiver that gives you everything you want. Separate NuVistor front ends (0.3 uV for 10 db S/N) for both 6 and 2 meters completely eliminates need for add-on converters or jury-rigged adaptations. Built-in 6 and 2 meter operation employs matched circuitry for outstanding performance.

Full coverage from 2 to 160 meters, superlative AM, CW and SSB reception make this Hammarlund receiver first choice for the amateur fraternity.

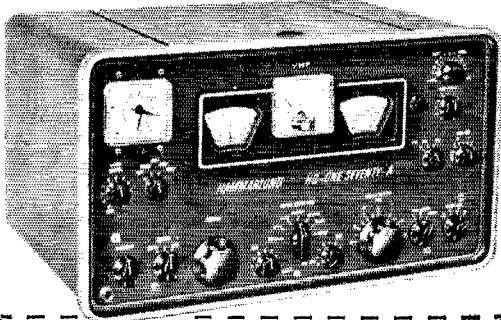

HAMMARLUND

MANUFACTURING COMPANY

A GIANNINI SCIENTIFIC COMPANY

73-88 HAMMARLUND DRIVE, MARS HILL, N. C.

Please send HQ-170A-VHF information to:

Name _____

Address _____

City _____

State _____ Zip _____

EUY, EUZ, EVA, EYB, EWV. W1s FZJ and HOY have moved to KP4-Land. On 432 Mc. Moonbounce KP4-BPZ worked W1s BU, HIV, IGT, UON1 and OOP. W1-UCN is KP4BPZ when he is there. This was manned by W1FZJ. Nice work. W1PEX made the RPL. K1ESG was in S.C. on a trip. K1s PNB and YSJ visited ARRL Hq. W1ATX is on 80 c.w. and 75 phone. K1CLM is acting as liaison for traffic between ARGC, Canada and the U.S.A. K1ZHS is moving to E.N.Y. K1YSJ has a dipole for 80. W1DJC is on 10 some. W1CTC is on 80 c.w. and in the Northeastern Ragehewing Net on 3830 kc. at 1800 GMT Mon.-Sat. Appointments endorsed: W1s STX, KWD, MME, YVI and K1BIF as ECs; W1s DFS, JNV, THT, BGW and AYG as OOs; W1ALP and W1MME as OBSS; W1MME as OPS; W1ZX as ORS. K1CLM is a new ORS. W1NF went to N.Y.C. W1AOG received reports from W1EHT, K1PNB and K1DZG. The Massasoit Club was in Plymouth for FD using the call W1M1/1 with 6 rigs and 25 operators. New officers of the Chelmsford ARA are K1OKE, pres.; W1LDZG, vice-pres.; K1TEE, secy.-treas. W1AKC says he has retired and now is in Pocasset active on the air and mobile. The 6-Meter Crossband Net had 21 sessions. 219 QNs, 4 traffic. W1EIH is on 6, 15, 40 and 80. The Needham AREC provided communications for "Road Race" with K1s VPJ, VFY, ZKK, EZX, NUD, FJW, VHZ, W1STX and W1ABU. K1PNB sent out another fine bulletin for our Novice Net. W20UO is secy. of the Brooks School Radio Club in North Andover. K1BIF writes that the nets are active on 2 and 6, and committees have been formed to assist local high schools on the Cape to set up stations. W1TJW and W1GJ have a 28-ft. Kennedy Dish antenna for 432 Mc., also the Association held a picnic in Falmouth. K1LZV has been on 160 some. By. ex-W1QOI, sent a nice note. Where do all the new Novices go? Let's hear from you. K1PNB and group have a net and code practice on 3733 kc. Mon., Wed., Fri. at 6:30 and 8:30 p.m. W1RSY, Area 1 Communications Officer, sends a new list of frequencies for RACES and says several towns need a Radio Officer. The Six Meter Mobiles did a nice job helping those looking for a little girl who disappeared in Middleboro. Traffic: (July) W1PEX 1236, K1ESG 228, W1DOM 154, K1VPJ 128, K1PNB 70, W1ATX 64, K1CLM 56, K1ZHS 43, W1DLT 30, W1-CRR 28, W1CTR 27, K1KOV 21, K1LCC 17, W1OFL 14, K1GKA 10, W1SVI 9, K1YSJ 8, W1AED 4, K1BKG 3, W1DJC 3, W1CTC 2, W1DEC 2. (June) K1CLM 26, K1BZ 4. (May) W1CTR 21, K1CLM 11. (Apr.) K1CLM 10. (Dec.) K1CLM 16.

MAINE—SCM, Herbert A. Davis, K1DYG—SEC: K1QIG. P.A.Ms: K1WQI, K1ZVN. RM: K1TMK. V.H.F. PAM: K1OYB. Traffic nets: Sea Gull Net, Mon. through Sat. Pine Tree Net, daily c.w. on 3596 kc. Two-Meter Phone and Traffic Net, Thurs. Our former RM, W12NPU, will be operating from KL6-Land. Good luck, Tom, and sure hope to hear from you. K1TMK is keeping the PTN going and needs the help of all. K1-WQI is keeping the SGN going and is looking for available stations. K1ZVN is holding out with the s.s.b. at night with the second session. Tribute to a Silent Key: K1NFM, who passed away recently, was active on 80-75-15 and 2 meters and is well known by many in all of the bands. Services were in Machiasport with many friends and amateurs attending. He will be sadly missed by all who had the pleasure of knowing him. K1TMK made a good score in the CD Party. W1GRG is on with an NCX-3 and a Hy-Gain antenna. W1ADK will be absent from our nets and sure will be missed. By this reading many of our southern exposure friends will be back or heading back and will be operating from 4-Land again. We still are looking for news from some parts of the state. Traffic: K1TMK 191, K1TMIJ 69, K1TVT 40, K1CLM 6.

NEW HAMPSHIRE—SCM, Robert C. Mitchell, W1-SWX/K1DSA—SEC: W1ALE/W1TNO. PAM: K1APQ. RM: W1DYE. The GSPN meets on 3842 kc. Mon. through Fri. at 2300Z and on Sun. at 1330Z. VTNH Net meets on 3685 kc. Mon. through Fri. at 2320Z. Endorsements: W1CTW/W1IQD as OES, KIAC and K1BGI as ORSs. W1ET as OPS. Congratulations to K1APQ/GSPN on 525 check-ins and 55 traffic for the month. K3YQJ/1 is operating from Bristol and is checking into the VTNH Net. W1EWW is a new member of the Dartmouth College Club. W1DYE has a new TA33 Jr. beam and kever and will try to win a few contests this fall. K1DWK's MVAREC Net had 26 check-ins and 6 traffic. W1APK was on the air from Weirs Beach this past summer. The VTNH Net reports 69 check-ins and 35 traffic. This net needs a lot more support from former members, appointees, and newcomers. Don't forget the New Hampshire QSO Party Oct. 30 and 31. We hope to see all you folks in the rare counties show up. This year should be the best one ever. W1CTW, W1PZA and W1OOP teamed up for the recent 432 moon-bounce and constantly heard KP4BPZ in Puerto Rico. W1CUE is active on the GSPN and CNEN. Traffic:

YOU COULD SPEND LOTS OF \$\$\$;

Cajole a dozen hams to put up a giant tower; guy it with a forest of wires; install a powerful rotator (and wire that!); top off the whole works with a monster antenna (your neighbors will love it); tune up with a dozen electronic instruments; and spend half your life dangling in space;

Guaranteed

OR

GET A GOTHAM V80 VERTICAL ANTENNA FOR \$1695

GOTHAM VERTICALS DELIVER THE CONTACTS

PROVEN! PROVEN! BY THESE EXCERPTS FROM UNSOLICITED TESTIMONIALS:

CASE HISTORY #71

"I am very delighted with the first V80 and want another for a different location." G. C., California.

CASE HISTORY #159

"I ordered a Gotham V40 Vertical Antenna and found it so successful that several others are wanting them, too. Will you please send me four more." W. A., Alaska.

CASE HISTORY #248

"I just wanted to let you know how pleased I am with my Gotham V80 antenna. I have worked a W.A.S. of 46/43, a WAC of 3/3, and DXCC of 14/12 in about 12 months." G. W., Maryland.

CASE HISTORY #111

"The V160 did a beautiful job on a VE1 for me. Also, I forgot to take it down during the hurricane of last week. It is just as straight as it was when I bought it." D. S., New Jersey.

CASE HISTORY #613

"I have never been happier with any antenna that I have been with the V80. I have worked all bands with it and have had tremendous success — i.e., DL4s, ZS3, etc., all solid copy." R. D. S., Penna.

CASE HISTORY #483

"My V80 is working wonders. I am able to maintain a 1:1 SWR all across the 40 meter band. After many years on 10, 15, and 20, the XYL and I are getting great kicks out of some of the lower bands." J. A., New Mexico.

CASE HISTORY #146

"I have had very good luck with mine (my V80) feeding it with a Johnson Adventurer, works fine on all bands." B. I., Nebraska.

CASE HISTORY #555

"Being an owner of your V80 vertical I would like to let you know of the excellent results I am getting with it, both working the DX and the local stations on the lower bands. It certainly is an excellent antenna system." F. H. Jr., New York.

CASE HISTORY #24

"A few months ago I purchased your V40 vertical and have achieved outstanding results on the air." K. G. B., North Carolina.

ALSO AVAILABLE AT

AIREX RADIO CORP. NEW YORK CITY
GRAHAM RADIO, READING, MASS.
EDWARDS RADIO, PROVIDENCE, R.I.
BROSCH ELECTRONICS, WEST GERMANY
VAREDEC-COMIMEX, PARIS, FRANCE
VICTORY ELECTRONICS, ODENSE, DENMARK
CAM GARD STORES, CANADA

NOW is the time to order

WHY

THE GOTHAM VERTICAL ANTENNA IS THE BEST ALL-BAND ANTENNA FOR YOU

- Absolutely no guying needed.
- Radials not required.
- Only a few square inches of space needed.
- Four metal mounting straps furnished.
- Special B & W loading coil furnished.
- Every vertical is complete, ready for use.
- Mount it at any convenient height.
- No relays, traps, or gadgets used.
- Accepted design—in use for many years.
- Many thousands in use the world over.
- Simple assembly, quick installation.
- Non-corrosive aluminum used exclusively.
- Multi-band, V80 works 80, 40, 20, 15, 10, 6.
- Ideal for novices, but will handle a Kw.
- Will work with any receiver and xmitter.
- Overall height 23 feet.
- Uses one 52 ohm coax line.
- An effective modern antenna, with amazing performance. Your best bet for a lifetime antenna at an economical price.

DO YOU KNOW

1. YOU WILL HAVE NO DIFFICULTY INSTALLING YOUR GOTHAM VERTICAL ANTENNA IN JUST A FEW MOMENTS, REGARDLESS OF YOUR PARTICULAR PROBLEM, SO ORDER WITH CONFIDENCE EVEN IF YOU HAVE RESTRICTED SPACE OR A DIFFICULT SITUATION.
2. LOADING COIL NOT REQUIRED ON 6, 10, 15 AND 20 METERS. FOR 40, 80, AND 160 METERS, LOADING COIL TAPS ARE CHANGED MANUALLY EXCEPT IF A WIDE-RANGE PI-NETWORK OUTPUT OR AN ANTENNA TUNER IS USED. IN THIS CASE BAND CHANGING CAN BE DONE FROM THE SHACK.
3. EVERY GOTHAM ANTENNA IS SOLD ON A TEN DAY TRIAL BASIS. IF YOU ARE NOT FULLY SATISFIED, YOU MAY RETURN THE ANTENNA PREPAID FOR FULL REFUND OF THE PURCHASE PRICE. THIS IS YOUR GUARANTEE OF FULL SATISFACTION.

FILL IN AND SEND TODAY!

Airmail Order Today — We Ship Tomorrow

GOTHAM Dept. OST
1805 PURDY AVE., MIAMI BEACH, FLA.

Enclosed find check or money-order for:

V40 VERTICAL ANTENNA FOR 40, 20, 15, 10 AND 6 METER BANDS.....\$14.95

THE V40 IS ALSO MADE FOR CITIZENS BAND OPERATION, WITH SPECIAL INSTRUCTIONS. DESIGNATE CB-11 ANTENNA. PRICE SAME AS THE V40

V80 VERTICAL ANTENNA FOR 80, 40, 20, 15, 10 AND 6 METER BANDS. MOST POPULAR OF THE VERTICALS. USED BY THOUSANDS OF NOVICES, TECHNICIANS, AND GENERAL LICENSE HAMS... \$16.95

V160 VERTICAL ANTENNA FOR 160, 80, 40, 20, 15, 10 AND 6 METER BANDS. SAME AS THE OTHER VERTICAL ANTENNAS, EXCEPT THAT A LARGER LOADING COIL PERMITS OPERATION ON THE 160 METER BAND ALSO..... \$18.95

HOW TO ORDER: Send check or money order directly to Gotham. Immediate shipment by Railway Express, charges collect. Foreign orders accepted.

Name.....

Address.....

City.....Zone.....State.....

73
GOTHAM

NOW...

40 METERS, TOO WITH YOUR MARK HW-3 TRI-BAND MOBILE HELIWHIP

The new HW-3/40 element permits instant in motion band switch between any 3 bands from 40 through 10 meters:
HW-3 (10-15-20 m.)

\$19.50

HW-3/40 (40 m.) \$ 7.95

Order today from your Mark Distributor or use coupon below.

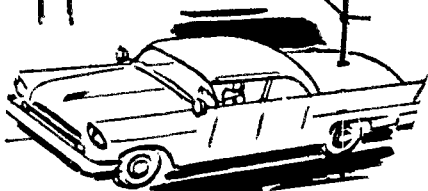
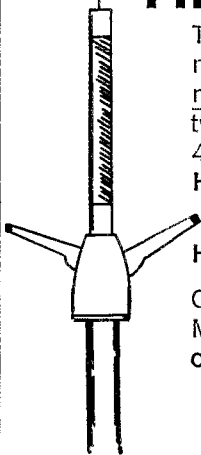

MARK PRODUCTS

DIVISION OF DYNASCAP CORPORATION
5439 W. FARGO AVE. • SKOKIE, ILL. 60076 • (312) OR 5-1500

My distributor, _____,
does not handle Mark antennas. Please enter my
order for _____ HW-3/40 and/or _____
HW-3. My check for \$ _____ is
enclosed.

Name _____ Call _____

Address _____

City _____

State _____ Zip _____

(July) WIDYE 59, K1BGI 38, K3YQJ/1 38, W1ALE 16,
W1JB/W1APK 7, W1SWX 2. (June) W1ALE 64.

SIXTEENTH NEW HAMPSHIRE QSO PARTY

October 30-31, 1965

The Concord Brasspounders, Inc., W1OC, announce their sponsorship of the Sixteenth New Hampshire QSO Party, and cordially invite all interested radio amateurs to participate. Here are the details:

(1) Contest period: 0000 GMT to 0400 GMT and 1200 GMT to 1600 GMT Sunday, Oct. 30 and 0000 GMT to 0400 GMT Monday, Oct. 31.

(2) No power restrictions.

(3) Scoring: N. H. stations count 1 point for each N. H. contact, plus 2 points per outside contact; stations outside the state count 2 points per N. H. contact; both multiply by the number of counties worked (10 maximum).

(4) Engraved certificates will be issued to all participants reporting, with special endorsements for the highest-scoring stations, both in N. H. and outside, in the phone and c.w. categories. Single operator stations only are eligible for the special endorsements.

(5) The same station may be worked for additional credit on more than one band, phone or c.w. Bands will be 160 to 10 and suggested frequencies are 1815 3530 3842 7030 7220 14,100 14,250 21,100 21,350 28,100 and 28,800 kc.

(6) General call: "CQ NH" on c.w.; "CQ NH QSO Party on phone, N. H. stations are requested to sign *de* W1-NH K.

(7) Contact information required: Report and QTH (including county of N. H. stations) and number of QSO. Those operators participating in both the c.w. and phone categories must submit separate logs for each mode of operation. Each log shall be scored separately based on the number of contacts and counties worked in each mode. Logs and scores must be postmarked not later than Nov. 25, 1965, and should be mailed to the Concord Brasspounders, Inc., Box 339, Concord, N. H. 03300.

(8) The WNH (Worked New Hampshire) certificates will be awarded to stations working all ten counties during this QSO Party, participating logs confirming. Detailed requirements for the WNH certificate, a standing award, may be obtained by writing the Concord Brasspounders, Box 339, Concord, N. H.

(9) The Granite State Award may likewise be obtained, details from the Nashua Mike and Key Club, Box 94, Nashua, N. H.

RHODE ISLAND—SCM, John E. Johnson, K1AAV—SEC: W1YNE, PAM; W1TXL, RM; W1BTV, V.H.F. PAM; K1TPK, Endorsements: W1TXL as PAM, OBS and OPS; K1TPK as V.H.F. PAM. RISPNS reports: 31 sessions, 494 QNI, 95 traffic, RIN report; 22 sessions, 67 QNI, 48 traffic. At a recent meeting of the NCRC of Newport the Rev. Archie Burdick, of the Seaman's Church Institute, installed the following newly-elected officers: W1TXL, pres.; W1A1UL, vice-pres.; W1N1-CSU, rec. secy.; W1JFF, corr. secy. Elected Honorary Members were James Edward, editor of the *Newport Daily News* and the father of W1IMJ and K1KOG, W1BVI, one of the organizers of the club and W1TXG for his past services to the club. Members taking part in communications for the folk festival were W1WLG W1s TXL, AWG, JFF, K1s VPK, MCT, W1A1s AUL, BLC, ACP, W1N1s CSU, DJJ, DCJ. Guests at the installation were SCM K1AAV and K1LII, secy. of W1AQ. The W1AW Club of Rumford Rag Chew Net meets every Thurs. at 2100 local time on 23.75 Mc. and invites anyone to join in, W1AEQF, ex-W1A4UPD, was elected to membership. K1GDD has a new harmonic, K1LDD is in charge of club AREC activity. K1ATI will be missed by the club as he joins the list of Silent Keys. K1USD made 63,555 points in the July CD Party. K1-EWL has a new TH-4, beam. Traffic: W1TXL 362, W1BTV 106, W1YNE 75, K1VYC 55, W1YKQ 33, K1-YEY 30, K1BRJ 29, K1TPK 22, W1ACSO 10, K1USD 10, K1EWL 9.

VERMONT—SCM, E. Reginald Murray, K1MPN—SEC: W1VSA, RM: W1WPFZ, July net reports:

Net	Freq	Time	Days	QNI	QTC	NCS
Gr.Mt.	3855	2130Z	Dy x S	no report	W1VMO	
Vt.Fone	3855	1300Z	Sun.	143	—	W1UCL

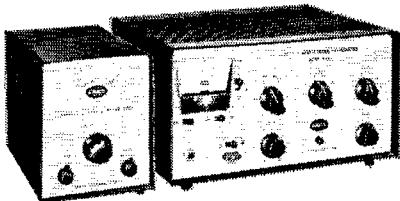
AMECO*Leader in Compact, Quality Ham Gear***NEW VFO FOR TX-62 or any other VHF TRANSMITTER****NEW AMECO VFO FOR 6, 2 & 1 1/4 METERS**

The new Ameco VFO-621 is a companion unit designed to operate with the Ameco TX-62. It can also be used with any other commercial 6, 2, or 1 1/4 meter transmitter.

Because it uses the heterodyne principle and transistorized oscillator circuits, it is extremely stable. An amplifier stage provides high output at 24-26 MC. The VFO includes a built-in solid state Zener diode regulated AC power supply.

This new VFO is truly an exceptional performer at a very low price
Model VFO-621 \$59.95 net.

The NEW AMECO TX-62

In response to the demand for an inexpensive compact VHF transmitter, Ameco has brought out its new 2 and 6 meter transmitter. It is easy to tune because all circuits up to the final are broadbanded. There is no other transmitter like it on the market!

SPECIFICATIONS AND FEATURES

Power input to final: 75W. CW, 75W. peak on phone.
 Tube lineup: 6GK6—osc., tripler, 6GK6 doubler, 7868 tripler (on 2 meters) 7984-Final, 12AX7 and 6GK6 modulator.
 Crystal-controlled or external VFO. Crystals used are inexpensive 8 Mc type.
 Meter reads final cathode current, final grid current and RF output.
 Solid state power supply.
 Mike/key jack and crystal socket on front panel. Push-to-talk mike jack.
 Potentiometer type drive control. Audio gain control.
 Additional connections in rear for key and relay.
Model TX-62 Wired and Tested only \$149.95

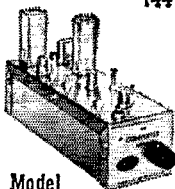
AMECO EQUIPMENT CORP. 178 HERRICKS RD., MINEOLA, L. I., N. Y.**Model CN****NUVISTOR CONVERTERS FOR 50, 144 AND 220 MC. HIGH GAIN, LOW NOISE**

Has 3 Nuvistors (2 RF stages & mixer) and 6J6 osc. Available in any IF output and do NOT become obsolete as their IF is easily changed to match any receiver. Average gain — 45 db. Noise figure — 2.5 db. at 50 Mc., 3.0 db. at 144 Mc., 4.0 db. at 220 Mc. Power required 100-150V. at 30 ma., 6.3V. at .84A. See PS-1 Power Supply. Model CN-50W, CN-144W or CN-220W wired, (specify IF.) \$49.95. Model CN-50K, CN-144K or CN-220K in kit form. (specify IF.) \$34.95

ALL BAND NUVISTOR. PREAMP 6 THRU 160 METERS

Model PCL, Wired, \$24.95
Model PCLP, with built-in power-supply, wired, \$32.95

2 Nuvistors in cascode give noise figures of 1.5 to 3.4 db. depending on band. Weak signal performance, image and spurious rejection on all receivers are greatly improved. PCL's overall gain in excess of 20 db. Panel contains bandswitch, tuning capacitor and 3 position switch which puts unit into "OFF," "Standby" or "ON," and transfers antenna directly to receiver or through Preamp. Power required — 120 V. at 7 ma. and 6.3 V. at .27 A. — can be taken from receiver or Ameco PS-1 supply. Size: 3"x5"x3".

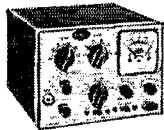
COMPACT 6 THRU 80 METER TRANSMITTER**Model TX-86**

Handles 90 watts phone and CW on 6 thru 80 meters. Final 6146 operates straight thru on all bands. Size — only 5" x 7" 7" — ideal mobile or fixed. Can take crystal or VFO. Model TX-86 Kit \$89.95 — Wired Model TX-86W. \$119.95. Model PS-3 Wired \$44.95. Model W612A Mobile Supply wired \$54.95.

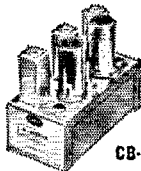
**CB-6**

CB-6K — 8 meter kit, 6ES8-rf Amp., 6U8-mix./osc. \$19.95
 CB-6W — wired & tested \$27.50
 CB-2K — 2 meter kit, 6ES8 1st rf amp., 6U8 — 2nd rf amp./mix. 6J6 osc. \$23.95
 CB-2W — wired and tested. \$33.95
 Model PS-1 — Matching Power Supply — plugs directly into CB-6, CE-2 and CN units. PS-1K — Kit ... \$10.50
 PS-1W — Wired \$11.50

EASY TO UNDERSTAND AMECO BOOKS

Amateur Radio Theory Course \$3.95
 Amateur License Guide50
 Radio Operators' Lic. Guide, EL 1-275
 EL 3 1.75 EL 4 1.25
 Amateur Log Book50
 Radio Electronics Made Simple 1.95

CODE PRACTICE MATERIAL

Ameco has the most complete line of code records, code practice oscillators and keys. Code courses range from start to 18 W.P.M. and are on 33, 45, or 78 r.p.m. records. Model CPS oscillator has a 4" speaker and can be converted to a CW monitor.

Write for details on code courses and other ham gear.

Dept. GST-10

Ameco equipment at all leading ham distributors.

AMECO EQUIPMENT CORP.

178 HERRICKS RD., MINEOLA, L. I., N. Y.

Affiliated with American Electronics Co. and Ameco Publishing Corp.

NEW 70-FT. FREESTANDING

TRI-EX

LM 470

*Another First
from TRI-EX!*

**ALL-WEATHER
MAINTENANCE
FREE...
PERMANENT!**

Absolutely freestanding. Capable of withstanding 60 mph winds at full 70 ft. height, with up to 16 sq. ft. of antenna. Rust free. All Tri-Ex towers are hot-dipped galvanized after fabrication. Unusual strength due to high strength steel tubing, solid steel bracing, all-electric welded by certified welders. Lowest possible wind drag.

**STARTS AT
\$995**

TILT-OVER AND OTHER
ACCESSORIES AVAILABLE.

WRITE FOR FREE BROCHURE

Tri-Ex TOWER CORPORATION

127 EAST INYO ST. • TULARE, CALIF.

VTNH	3685	2230Z	M-F	69	35	KIUZG
VTCD	3990.5	1400Z	Sun.	102	7	W1AD
VTSB	3909	2230Z	Dy			W1CBW
			exc. S.	380	6	W1CBW
		1230Z	Sun.			

Note the new Vermont Sideband Net on 3909 kc. at 6:30 P.M. daily and 8:30 A.M. Sun. All modes are welcome to check into this net. VTCD has moved to 3990.5 kc. K1QXD has moved to Essex Jct. K2QGA was in Vermont for eyeballs in July. K1FSY has his SB-300 operational. Traffic: (July) K1BQB 92, K1UZG 54, K1MPN 4, (June) K1BQB 161, K1UZG 42.

WESTERN MASSACHUSETTS—SCM, Percy C. Noble W1BVR—C.W. RM: K1JIV. The positions of Section Emergency Coordinator and Phone Activities Manager are vacant at this time. If you can handle either job please let me know. Or if you can't but you know someone who would do a good job, please let me know that, too. The West. Mass. C.W. Traffic Net has been quite active for summertime, and special credit goes to Route Manager K1JIV/1 and to W1ZPB for keeping the net controlled. W1ZPB also is doing a lot of work on his station getting everything in readiness for fall and winter. W1BVR had his troubles working portable from Lanesboro (nothing that a good soldering job on coax connector wouldn't have cured though). We learn in time! Once again I would like to call to your attention the fact that the League has many different types of appointments available such as Official Relay Station for c.w., Official Phone Station, Official Experimental Station, Official Bulletin Station, Official Observer Station and Emergency Coordinator (for specific towns or cities or parts of the section), as well as Amateur Radio Emergency Corps membership. We would like all of you to take an active part in your League-sponsored programs. Surely one or more of the above should be attractive to you. Let's hear from you, please. Traffic: W1ZPB 84, W1BVR 69, K1SSH 61, K1WZY 42, K1LBB 24, W1DVW 14.

NORTHWESTERN DIVISION

ALASKA—Acting SCM, Daniel S. Wright, KL7ENT—WL7FHN, WL7JW and WL7FB have a nice 2-meter link between Harding Lake and Fairbanks using twos and yagi. KL7ELR and KL7BLQ have a squalo and a new HE-45B 6-meter transceiver. KL7FHL and Eloise, KL7JHM, are on 20-meter s.s.b. KL7FAD and Ann, KL7BNY, have returned from their vacation in the lower 48. The Arctic Amateur Radio Club went to Moon Lake, July 4 week end for a successful campout. All reports and applications for appointments will be welcomed.

MONTANA—SCM, Joseph A. D'Arcy, W7TYN—SEC: W7RZY. PAM: W7YHS. V.H.F. PAM: W7TYN.

Montana S.S.B. Net	3910 kc.	M-F	1800 MST
Montana PON	3885 kc.	Sun.	0815 MST
Montana RACES	3996.5 kc.	Sun.	0900 MST
Montana State Net	3520 kc.	M-F	1800 MST
Missoula AREC Net	3805 kc.	Sun.	0900 MST

Our Northwest Division Director, Bob Thurston, W7PGY, asks that all radio clubs in Montana, whether affiliated or not, send him their addresses so that he might put them on his news letter mailing list. Bob's address is 7700 31st Ave., N.E., Seattle, Wash. 98115. The new American directors of the Glacier-Waterton International Hamfest are W7FLB, of Butte, and W7FGZ, of Great Falls. They will be asking your club group to help them out at the hamfest next year. If your club wants to put on an event or start a new type of contest for the hamfests contact Bob or Walt. The Directors also would like to have your ideas on where to hold the hamfest in the park, be it Aggar or some new spot on the American side. On July 3 W7RJG worked KP4BPZ the hard way on-off all-band 432 Mc. Ken was one of a very select group of amateurs who were able to work Puerto Rico via the moon to the 1000-ft. dish at Arecibo. W7YB is on the air with an S-Line. The Tri-Club Picnic was held Aug. 8 at Flat-head State Park. The technical chairman of the Anaconda Club informs us of the plans of that group to get on during the upcoming V.H.F. QSO Party. The club will have a rig on 2 meters, 144.450 Mc. from an 8200-ft. mountain west of Anaconda, Mont. Endorsements: W7CJN and W7TYN. If you hold a League appointment check to make sure that it has been updated. If you are interested in holding an appointment please write to me. Traffic: K7SYR 63, K7YPC 19, WA7DCF 12, W7NPV 7.

OREGON—SCM, Everett H. France, W7AJN—RM: W7ZFH, K7IFG, manager of O8N, reports for July, sessions 22, attendance 105, high 8, traffic 33, high 5, average 1.5.

Unretouched photo
of 6146B with
conventional plate.
Note pronounced
hot spot.

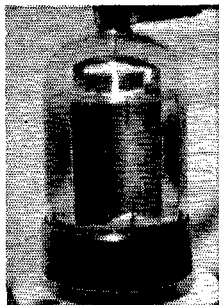

Unretouched photo
of Sylvania 6146B
with Hi-Con plate.
Note absence of
any color.

The 6146B with a difference

Let's face it---it's an old amateur custom to push final amplifier tubes to the limits of their endurance. Not because the practice shows up as a meaningful gain on some distant S meter, but because it gives the man behind the mike or the key a nice feeling of power.

Our reaction at Sylvania was to face the realities of the situation and come up with a popular type power amplifier tube that could be pushed beyond the limits of its predecessors. We've done just that with our own version of the 6146B.

To begin with, the Sylvania 6146B has a dark-coated heater that just about eliminates failure due to wire embrittlement. The heater in turn is electrically isolated from the cathode by a heavy oxide insulating coating. And increased heat transfer at a lower operating temperature is effected by the dark-colored outer coating. Together, these improvements aid in maintaining rated power output even at reduced heater voltage. Peeling and flaking of the emissive coating has been eliminated by using a new type of cathode cold-rolled from a blend of powdered metals. And that old devil "gm slump" is substantially reduced by progressive reactivation of the emissive materials.

We've also effectively reduced the possibility of secondary emission by gold-plating the No. 1 and No. 2 grids.

But the hot news is the cool-running plate. We call it the Hi-Con plate, and consider it a metallurgical breakthrough. The core material is iron. The iron is copper-plated, and the copper is then nickel-plated. This construction provides far greater uniformity in heat conduction and greater efficiency in heat radiation. Naturally, this affords a higher dissipation safety factor.

How does it work out in practice? We loaded up the two tubes shown in the photos identically. You can easily see what happened. The one on the left, a 6146B with a conventional plate, got a beautiful hot spot. The one on the right, Sylvania's 6146B with Hi-Con plate, ran cool as a cucumber.

So there you have it. Whether you want to push your luck a bit or you're just interested in longer tube life with an improved safety factor, Sylvania 6146B's will keep you happy and out of trouble.

73,
SYLVANIA
SUBSIDIARY OF
GENERAL TELEPHONE & ELECTRONICS **GTE**

Bob Lynch

K2RMN

You earn your FCC First Class License

OSN NTS 3585 kc. 0130 GMT MTWTF K7IFG mgr.
OEN 3840 kc. 0200-0300 GMT Daily
AREC 3875 kc. 0200 GMT Daily

Reports are slow because of vacation time and heat. W7GWT reports the 432-mc moonbounce project from KP4BPZ was a great success. W7UAB made contact on July 3. W7UDM made contact on July 24, also K7ZIR on the same date. Reports from stations just listening are that fancy antennas were not needed to get a good readable signal from KP4BPZ. Traffic: (July) K7JFG 369, K7TWD 300, W7ZFH 32. (June) K7ZMR 28, W7JHA 9.

WASHINGTON—SCM, Everett E. Young, W7HMQ—SEC: W7HMQ. RM: W7OEB. PAM: W7LFA. V.H.F. PAM: W7PGY. NTS nets:

WSN 0200Z Daily 3535 kc. QNI 311 QTC 152. Sess. 31.
WARTS 0230Z Daily exc. Sun. 3979 kc. No report

W7CXR is retiring soon and has the kw. all warmed up. The Swap and Shop Net meets at 0900 Sat. on 3970 kc. K7ZEK has a new inverted "V". Officers of the N.W.F. A.A. Amateur Radio Club are: W7MCU, pres.; W7JKO, vice-pres.; W7TRA, secy.-treas. K7ZRF now is 1/2 in N.J. W7IYC plans to return to Richland from Montana around November. ORS W7AIB reports the yard and house are looking better but radio activity is suffering. K7ZPM takes WSN traffic for Spokane. K7MGA now is mobile on 146.76 Mc. and reports the first Washington State Hamfest in Yakima was a complete success. ORS/OPS W7DZX reports the San Jose ARRL Convention the greatest. OO W7UVR hears lots of stuff on the low end of 20 and wonders if he should card 'em. ORS W7JEY now is showing friends his Extra Class paper, but still is active with WSN. ORS/OBS W7AMC is keeping Bremerton on the air. ORS W7GYF made a good score in the ARRL CD Party. RM/OO/ORS W7OEB attended the Yakima Hamfest then took off for Southern California for a visit with ex-W7SWA and my favorite shortstop, W7SMB. K7PVG, K7PVF and K7VSG were among the Richland hams at the Washington Hamfest. After 25 years the Michigan Emergency Net removed K7JHA from the roll call. Why? No QNI. K7RRQ reminds all amateurs that they are invited to drop in on 3700 kc. each night at 0400Z. K7VNB has been hospitalized. The Valley Amateur Radio Club now meets in its new home, courtesy of the local bank, North Meridian and River Road. K7UHO is a new arrival in Renton from Spokane. W7MCW was caught smoke-testing the new home-brew s.s.b. Volks-wagon-size transmitter, all systems a go go. W7BTB, with K7KAH and KL7BBL of Mountain Village, Alaska, arranged transportation for KL7MI, a stretcher case, to a Seattle hospital. W5CYG is now 17 in the Tri-Cities area. K7PVO is very active from Hunter AFB, Ga., also hangs out around 14,050 Mc. W7LEC has bang-up code sessions going about 9 a.m. LST, daily ex. Sun. around 3700 kc. The code of ethics contained in July *Parasite* belongs in all ham shacks. It pertains to all traffic nets. New WARTS directors are W7CYV, W7PWA, K7VAS, K7QNW and K7YFJ. W7CJW is the new EC for the Totem Net. W7JW sends in an PB run-down on BEARS EC work, what with new 3-kw. generator and 6-meter emergency type gear being built. W7DK had a real thrill in seeing its FD activities in pictures on KTNT TV. WN7AUS got an "A" to replace the "N." The Ashford mayor is doing OK. The N.W. WX Net meets on 3890 kc. at 1330Z. Other traffic nets:

N.W. Slow Speed 3700 kc. 0400Z QNI 196 QTC 71 Sess. 27
N.T.N. 3970 1730Z No report
N.W. S.B. 3945 0130Z No report

Traffic: (July) W7BA 1136, W7DZX 537, K7TCY 417, K7CTP 213, W7APS 200, K7ZPM 64, W7BTE 61, W7HMQ 52, W7OEB 32, K7MGA 31, W7GYF 23, K7URU 22, K7JHA 20, W7AMC 17, W7AIB 8, W7EVW 7, K7CHH 2. (June) W7OEB 116.

PACIFIC DIVISION

EAST BAY—SCM, Richard Wilson, K6LRN—SEC: WA6OLF. WA6WNG/WB6CRC is busy, has TCC sked as station J PAN NCS, liaison from NCN to RN6 and has a new antenna at WB6CRC. W6CBF has been keeping skeds with XE1FN. WA6QZA and WA6PTU are operating mobile from a new 1965 Bonneville. W6TYM has the new kw. power supply operating and says the duty cycle is much better. WA6DOO and K6JZR are active in the Diablo Valley 2-Meter f.m. group and assisted at the Contra Costa County Fair along with WA6FBS, K6POU, W6LNK, WA6ANE, W6LGW, WA6MIE and WA6NFF. W6HOF was chairman. The Silverado Six Shooters Net meets every Tue. but the first on 50.4 Mc. at 2100 and the two Timers Net meets Thurs. at 2105 on 145.35 Mc. This 2-meter frequency is on the NCFE and may be changed. W6ZF won an HX-50 at the National Convention. W6UB is active

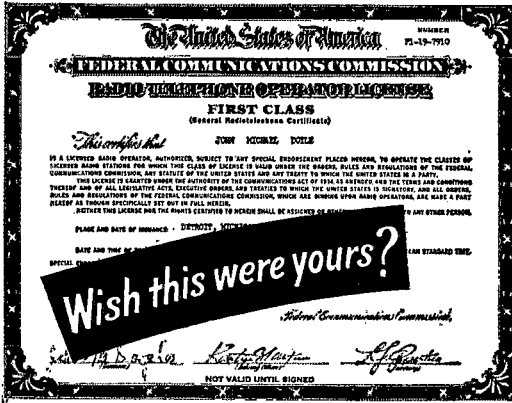

or your money back!

THERE'S A WORLD OF OPPORTUNITY FOR THE MAN WITH AN FCC LICENSE

All it takes is a few spare hours a week and NRI's FCC License Course to open the way to increased opportunities in Communications. With an FCC License, you're ready to operate, service and install transmitting equipment used in aviation, broadcasting, marine, mobile and Citizens-Band communications.

What does it take? Men with absolutely no training or experience in Electronics complete the course in 10 months. A Technician or man with some background can easily cut that time in half. And because NRI has a greater enrollment than any other school of its type, training costs you less than comparable courses offered by other schools. Further, **YOU MUST PASS your FCC exams or NRI refunds your tuition in full.**

Get full details today about NRI FCC License Course plus 9 other home-study instruction plans offered by NRI, oldest and largest school of its kind. Mail coupon for free catalog. There's no obligation. No salesman will call. NATIONAL RADIO INSTITUTE, Washington, D.C.

MAIL NOW for FREE CATALOG

NATIONAL RADIO INSTITUTE
Electronics Division
Washington, D. C. 20016 19-105

Please send me complete information on FCC License Training and other NRI courses, as checked below. (No salesman will call.)

<input type="checkbox"/> FCC License	<input type="checkbox"/> Radio-TV Servicing
<input type="checkbox"/> Complete Communications	<input type="checkbox"/> Industrial Electronics
<input type="checkbox"/> Aviation Communications	<input type="checkbox"/> Electronics for Automation
<input type="checkbox"/> Marine Communications	<input type="checkbox"/> Basic Electronics
<input type="checkbox"/> Mobile Communications	<input type="checkbox"/> Math for Electronics

Name _____ Age _____
PLEASE PRINT

Address _____

City _____ State _____ Zip _____

ACCREDITED MEMBER NATIONAL HOME STUDY COUNCIL

DIVERSITY PERFORMANCE

with Single Receiver and Antenna

Manufactured under
U.S. Pat. No. 2,999,925

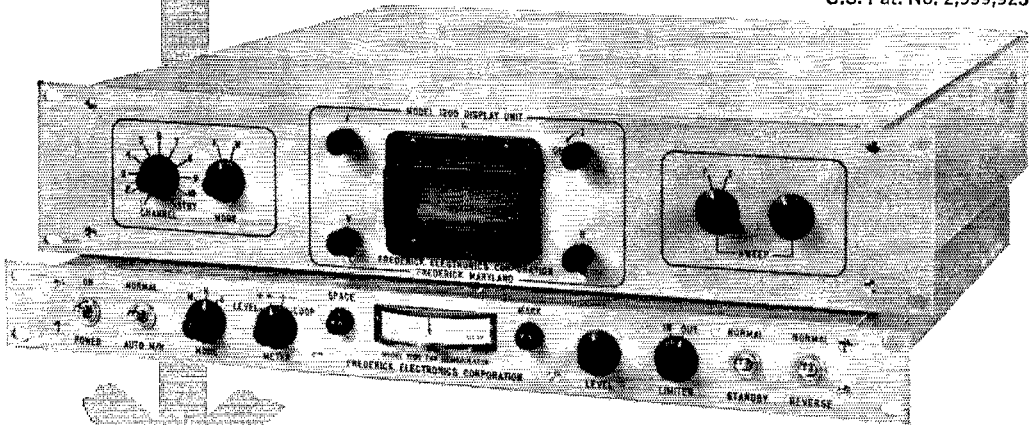

For the **FIRST** time . . .

MODEL 1200 FSK DEMODULATOR
WITH DISPLAY UNIT

a low cost all solid state FSK demodulator, Model 1200, having a patented Decision Threshold Computer providing optimum decision threshold with diversity performance.

Conventional FSK demodulators introduce errors due to their fixed decision threshold under conditions of selective fading on either the mark or space frequencies. With DTC in the Model 1200 FSK demodulator, the normally deleterious effects of frequency selective fading are used to advantage. The Model 1200, with its variable decision criterion, compensates for the selective fading by varying its decision threshold to provide optimum decision.

FEATURES

Rapid tuning indicator for "Mark-Only," "Space-Only," and normal FSK operating modes

Metering of audio signal input level and loop currents

Operator selection of limiter or linear "two-tone" mode

Optimum pre-limiter, pre-detection, and post-detection filters for best possible weak-signal performance

On-the-air tests show, typically, a 16 db improvement in signal-to-noise ratio over conventional demodulators

Unique "Mark-Hold" or "Auto-Start" circuit responding only to FSK signals

Entirely solid state construction

Shown with the demodulator is an accessory display unit (purchased separately) for providing an oscilloscope display of waveform and tuning information for up to ten demodulators

For further information write —



FREDERICK ELECTRONICS CORPORATION

HAYWARD ROAD, P.O. BOX 502, FREDERICK, MD. • PHONE: 301-662-5901

INTERNATIONAL DIVISION

750 THIRD AVENUE, N.Y. 17, N.Y. CABLE ADDRESS: ARTROCKE

NEED ANTENNA SPACE?

NOW . . . MINIATURIZED,
QUALITY ANTENNAS FOR . . .

- APARTMENTS
- SUBURBAN HOMES
- PORTABLE USE

featuring heavy wall
aluminum and stainless
steel construction
throughout

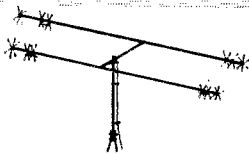

6 - 10 - 15 - 20
METERS

The time proved B-24 4-Band antenna combines maximum efficiency and compact design to provide an excellent antenna where space is a factor. New end loading for maximum radiation efficiency. No center loading.

Oper. Freq.	6-10-15-20 Meters
Power Rating	600 Watts AM
Turn Radius	7'
Total Weight	11 lbs.
Single Feed Line	52 ohm
SWR at Resonance	1.5 to 1.0 max.

**Model B-24
Net \$59.95**

MULTIBAND COAXIAL ANTENNA

For 6 - 10 - 15 - 20 METERS
Needs no ground plane radials. Full electrical 1/2 wave on each band. Excellent quality construction. Mount with inexpensive TV hardware.

Power Rating	600 Watts AM
Total Weight	6 lbs.
Height	12'
Single Feed Line	52 ohm
SWR at Resonance	1.5 to 1.0 max.

Model C4 Net \$34.95



40 plus 10
METERS

New end loading for maximum radiation efficiency. No center loading employed. Element length only 20'... boom 10'.

Oper. Freq.	40 and 10 Meters
Power Rating	1000 Watts AM
Single Feed Line	52 ohm coax.
SWR at Resonance	1.5 to 1.0 max.
Total Weight	22 lbs.

Model B 4010 Net \$79.50

RUGGED 6 METER BEAM

Rugged construction with no holes in elements or boom to weaken antenna. Heavy wall aluminum and stainless steel throughout.

Power Rating	1000 Watts AM
SWR at Resonance	1.4 to 1.0 max.
Impedance	52 ohms
Longest Element	9'8"
Boom	12'



**Model B6M5
Net \$24.95 each
Two for \$44.50**

Write for Mini-Product's Miniaturized Antenna Catalog.

If there is no stocking distributor near you... order direct from factory. Free shipping to your QTH and we will pre-pay the costs in continental U.S.A.

DISTRIBUTORS WANTED
IN KEY AREAS.
Write for details to...
Tom Venable, K3JZL, Sales
Manager

Mini-Products, Inc.

1001 West 18th Street, Erie, Pennsylvania

• LEADERS IN COMPACT ANTENNAS •

again after some heart trouble and reports activity on 6 is good with quite a few openings. W6OJW has a new converter for 2 meters and was able to hear Oscar III with a lower noise level. Bill also reports he went to Modoc County for a vacation. WB6LH has 54 countries. WA6ODP/6 made 1754 contacts for 15,848 points, an all-time high for the LARK operating in 13A. W6-QMO is the new manager of NCN. Any inquiries about this net may be directed to Jeri Bey, 1004 Walnut St., San Carlos. The NCN is the official net for the East Bay section. It meets on 3.635 Mc. at 0300Z every day of the year. We QRS for the less-experienced operator. Is there anyone in Hayward, Livermore, Lake County, North Solano County, East Contra Costa, Fremont or San Leandro who would like to volunteer for these vacant EC posts? WB6ETY has been off the air because of a move to a new QTH and a trip to L.A. and Disneyland. Section Net certificates have been issued to K6CKT for NCN and to WA6OLF and WA6TZO for 2-meter activity. Some appointees are not reporting and are not participating in the different programs as agreed. If you cannot for any reason meet the obligations as EC, ORS, etc., drop me a card or radiogram so I can take the necessary action to keep these appointments current. Please note the election notice on page 92 of Aug. QST. Also the notice for election of Director. If you are not satisfied with the incumbent now is the time to take action. If you fail to do this you will have no one but yourself to blame. Traffic: (July) WB6CRC 171, K6LRN 127, WA6PTU 19, K6JZR 18, W6OJW 6, WA6QZA 5, WB6LH 4, W6TYM 4. (June) K6TFT 284. (May) K6TFT 360.

HAWAII—SCM, Lee R. Wical, KH6BZF—Asst. SCM/SEC; Emie J. Kurlansky, KH6CCL, PAM; KH6ATS, RM; KH6EWD, V.H.F. PAM; Vacant. We had a very successful convention in Honolulu. KH6CUP and others did a bang-up job. We were pleased to have visitors/speakers from the mainland including W1LQV, from ARRL Hq.; W6HC, W6EL, Bernie Bissett, pres. of Linear Systems, Los Gatos, Calif.; W6ISQ, QST Contributing Editor, who was vacationing in KH6FHA's home, W6EL showed one of his pet linears he's worked up. W1LQV keynoted the banquet and led an informative "Open Forum." W6HC, ARRL Pacific Division Director, was quite pleased with the work done by the KH6ers. Perhaps some groups will undertake another convention for 1967. It's not too early to start planning. KH6EPW announced that the Honolulu ARC's official FD score was 10,578 working 1738 stations. KH6EXI reports that the Maui ARC, of which he's president, scored 3018. Maui members of the convention were KH6s EK, EL, EM, FF and EXL. Only the big island of Hawaii wasn't represented. The Keefers, KH6KS and KH6AFC, have been doing some traveling. KH6EM recently returned from the Far East. W4EXM/KH6 has returned from Washington, D.C. KH6FBJ and KH6EUU have been burning the 3 o'clock "oil" DXing lately. Keep those Form is coming in. If you need more contact your SCM (page 6 for his address) requesting additional forms. Traffic: KH6BZF 27, KH6WO 8, KH6AME 2, KH6IW 1.

NEVADA—SCM, Leonard M. Norman, W7PBK—SEC; W7JU/K7JU, Nevada was represented at the ARRL National Convention by W7AAF, WA7BNC, W7CTK, K7GCG, K7GQD, W7JU, W7PBV, K7UDC, K7UFD, K7ULP, K7RBM, W7RPG, K7SNS, K7TVN, K7ZAU and W7ZT. The Nevada C.W. Net, on 36.0 kc. at 2000 daily, needs Nevada check-ins. NAR's new officers are W7THH, pres.; W7AAZ, vice-pres.; W7YKN, secy.-treas.; W7CX, trustee. W7BIF is a new amateur in B.C. WB6LWV a new amateur in Las Vegas. K7ABT is active on 6 meters looking for Washington and Oregon. W7DSF has a new ham tied to a Swan 350. K7RWN is using a trap-doublet for FB reports. WA7CQT is a new amateur in Las Vegas. K7WVG is the new president of the LV.A.E.C. W7PRM and K7ZOK have new wheels for their mobile rigs. WA7BCU and K7DNE report RTTY activity on 80 meters. W7VVF is on 2 meters. K7OLG has been on the sick list but is back at work now. W7CQL is building an HB v.f.o. and an 811 GG final. W7DOS has a quad up 70 feet. K7XXX is making a TF-4 out of a TR-3. Armed Forces Day certificates were earned by W7CTK on RTTY and W7BJY on c.w. Traffic: (July) K7RBM/786, W7AAF 58, W7BKK 42, W7FBJ 8, W7PBV 3. (June) WA7BAV 57, W7PBL 12.

SACRAMENTO VALLEY—SCM, John F. Minke, III, WA6JDT—ECs: W6JDN, W6LW, W6SMU, WA6TQJ. RM: W6CMA. PAM: K6RHW.

NCN	3635 kc.	0300Z Daily
NCTN	3905 kc.	0100Z Daily
MTN	3854 kc.	0200Z Daily
SCEN	146,280 kc.	0400Z Wed.
SVN	3655 kc.	0200Z Daily

Penta Beam Pentodes for Amateur Radio



PL-175A



PL-177A

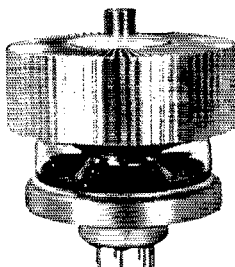

PL-8295/172

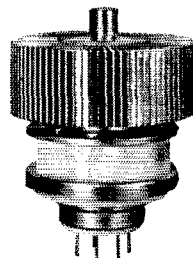

PL-8432

RATINGS

Type	Filament		Max. Plate Dissipation (Watts)	Useful Output* Class AB ₁ Linear Amplifier Plate voltage in volts				
	Voltage (Volts)	Current (Amps)		1000	1500	2000	2500	3000
PL-175A	5.0	14.5	400	—	—	445W	570W	680W
PL-177A	6.0	3.3	75	96W	140W	210W	—	—
PL-8295/172	6.0	7.8	1000	—	—	1020W	1280W	1540W
PL-8432	6.0	7.8	1000	—	—	1020W	1280W	1540W

*Actual power output delivered to load from typical amplifier.

These Penta beam pentodes are finding wide use for linear amplifier service. Reason: You get higher power output at lower plate voltages with minimum distortion. For 50-watt to 200-watt peak output service, choose the PL-177A. With the PL-175A, a 400-watt tube, you can replace the 4-400A, directly, provide substantially higher output without circuit or voltage changes. Both of these plus the PL-8295/172 and PL-8432 feature Penta's exclusive vane-type suppressor grid design for extra efficiency and linearity. Ceramic construction of the PL-8432 means greater shock and vibration resistance, plus high allowable operating temperature capability. For details, write The Penta Laboratories, Inc. 312 North Nopal St., Santa Barbara, California 93102. A Subsidiary of Raytheon Company.



Arrow Offerings

RTTY

Fox Machine TG2C/TG	Exc. Cond.,	\$99.50
I 193 Polar Relay Test Set	Exc. Cond.,	22.50
Olivetti Page Printer	Exc. Cond.,	95.00
255A Polar Relay	Exc. Cond.,	2.95
Lionel Transformer GH1203-2H	Exc. Cond.,	1.00

PANADAPTER IP69C/ALA2

400 cycle supply. Can be converted to make compact Panadapter. Complete with 14 tubes.

New **\$22.50**
Used **\$17.50**

COLLINS RECEIVER (R105/ARR15)

1500 to 18500 Kc. complete with 14 tubes, 100 kc. xtal, 2 Collins PTO's, etc. Exc. cond. **\$67.50**

DAVEN FREQUENCY METER

Direct indicating frequency meter covering 25 to 5000 cycles in four ranges (.1 — .5 — 1. — 5.kc) Exc. cond. **\$29.75**

R19/ARC12 RECEIVER

Tunable 118 to 148 Mc., complete with 9 tubes and schematic **\$34.50**

LM FREQUENCY METER

125 to 20,000 kc., complete with original calibration book. in exc. cond. **\$49.50**

Q-5'er BC453/R23ARC5

190 to 550 Kc. receiver with tubes. Used, **\$12.95**

Q-5'er

Lazy Man's Navy beam filter **\$1.95**

R4/ARR2

Versatile command type receiver covers 234 to 258 Mc. and is convertible to many other frequencies. Complete with 11 tubes and schematic. New, **\$6.95**
Less tubes & Side Cover **\$2.45**

TS126 2-meter watt or power meter, new, \$ 9.95

TS667 Convertible to Motorola test set. Has 100-0-100 microamp meter, etc. In handsome carrying case. New, **\$14.95**



2534 South Michigan Ave. • Chicago, Ill. 60616 • (312)-225-4750

The Sacramento Valley Net (SVN) has been in operation since Sept. 1. W6CMA is net manager. Now let's get the phone counterpart to this net going. The Yolo C.D. Net was closed down for the summer because of vacations. The Sacramento Co. Emergency Net (SCEN) now has 18 active members. An SET was successfully held July 25 with 6 mobiles and 3 fixed stations. On July 30 a meeting was held at the California Disaster Office with W6CIS, W6SMU, W6BWB, W6HGH, W6QHP, W6ZOH, W6RSZ, W6ZYYR and W6JDT attending. The purpose of the meeting was to get more ideas for a good Sacramento Co. Emergency Plan. Section Net certificates go to W6LNZ in Sacramento and W6LXX in Woodland. Both Ross and Hal have been very faithful QNI in the Northern California Net (NCN). W6WLI won the contest at Sacardex (W6SIG) with a transistorized bow tie! W6AHYU is recovering from an auto accident while at the National Convention in San Jose. New officers of the North Hills Radio Club are W6SMU, pres.; W6KZLN, vice-pres.; W6AUWY, treas.; W6APQN, secy. W6AQYD has completed a 160-meter mobile rig and checks into the CLEARs Net on 1920 kc. Traffic: (July) W6AHYU 48, W6LNZ 34, W6AJDT 28, W6CMA 20, W6BMAE 17, K7YBV 10, W6EAC 6. (June) W6AHYU 134, K6YBV 36, W6BMAE 31. (May) W6AHYU 45.

SAN FRANCISCO—SCM, Hugh Cassidy, WA6AUD—SEC: W6KZF advises that all should have a spare antenna rolled up and ready to string in case a storm blows down the regular one. The Marin and Tamalpais Radio Clubs held a successful joint picnic at Kenwood Aug. 15 with visitors from the San Francisco and Sonoma Radio Clubs. W6YES is back from the service and again is active on the Northern California Net. New appointments: W6GVI as PAM; W6YKS as RM; W6JOX, W6ZZK, W6RLY, W6FHH, W6DGI as OESs; WA6MGG, W6BDGJ as OPSs; WA6MGG as ORS. W6CRT has a 4CX250 and is aspiring to high power on 2 meters. The section net continues on 3900 kc. Mon. and Fri. with check-ins running from 10-15 each night. W6NDZ is working on code speed after two weeks of duty with the Marine Corps down in the desert. WA6RXM got as far as Florida during his vacation and is now home catching up on his OO duties. K6LIN is trying to corner an SB-33 for a renewal of activity. W6GGC has installed an s.s.b. transceiver in the Thunderbird. The San Francisco Radio Club held an outstanding meeting at Hamm's Brewery in July with many old-timers turning out. Two who got acquainted after 45 years were W6NL and W6CYO, who used to do a lot of experimenting together in the early 'twenties." W6KDF has a new Telrex spiral array for v.h.f. work. WA6STS has a new operating position at the top level of a water tower. W6HST forgot to turn off the beam rotor and two hours later found he was off the air with the beam still wind-milling. W6GQA found some section action on c.w. but none on phone in the last CD Party. New ARCC members in Marin are W6IZR and WA6PNT. W6AIVM got to NE-VPI-6Y5-Iand during his vacation. The Humboldt Amateur Radio Club had a fine turn-out at its Aug. meeting. The San Francisco Award is being publicized by the S.F. Club and details can be obtained from W6IVM or WA6VLX. K6QQL helps with the roll call on the southern portion of the San Francisco Section Net. W6AFQ retired from the Postal Service Aug. 1. W6UDL has been doing the art work for the club paper in San Francisco and W6IMO has been turning out QSA's for the Marin Club. The Tri-County Net Picnic in Crescent City in Aug. was a happy occasion with amateurs from W7-Land and Southern California in attendance. Traffic: (July) W6UDL 72, W6GLD 68, W6KQ 20, W6GVI 11, WA6AUD 7, WA6IVM 7, W6IP 4, W6CYO 3, W6ALX 2, W6GQA 2, WA6STS 2. (June) WA6STS 3.

SAN JOAQUIN VALLEY—SCM, Ralph Saroyan W6JPU—ORSs: WA6VPN, W6ADB, W6HVA, WA6DAU, K6MPM, W6MZU, WA6TZN and W6MIWY. W6HVA has a 75-A4 and likes it very much. K6CBR has an SB-34. W6JUK has an SB-33. WA6TZN is running 100 watts on 144 and 220 Mc. W6TJN has a Swan 350 mobile. W6PPO is looking for a mobile s.s.b. rig. W6MLZ and WN6OAI have moved to Fresno. WA6TZN has a 75-ft. tower to use on 2 meters. The San Joaquin Valley Net reports 769 check-ins, 89 contacts, 105 traffic count, 8 QSTs and 10 phone calls. New officers of the Tulare County Amateur Radio Club are W6UHN, pres.; W6PIX, vice-pres.; K6VVV, secy.; W6ARE, act. chairman. WA6IKW and W6EKT are preparing for 1296 skeds. W6SSL recuperated from a heart attack and is active on 75. W6PDD was a recent visitor in Fresno. WA6TZN is working part time at KWIP. The Fresno Amateur Radio Club meets the 2nd Fri. of each month in the PGE Building, 10th floor. Traffic: (July) W6ADB 137, WA6VPN 92, WA6TZN 69, W6JLX 21. (June) WA6TZN 38.

VALUABLE books from E. & E.

great "how-to-build" data in the famous

RADIO HANDBOOK (16th Ed.)

Tells how to design, build, and operate the latest types of amateur transmitters, receivers, transceivers, and amplifiers. Provides extensive, simplified theory on practically every phase of radio. Broadest coverage; all original data, up-to-date, complete. 316 pages. Order No. 166, only..... \$9.50

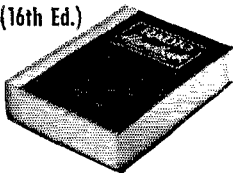

RADIOTELEPHONE LICENSE MANUAL

Helps you prepare for all commercial radio-telephone operator's license exams. Provides complete study-guide questions and answers in a single volume. Helps you understand fully every subject you need to know to obtain an operator's license. 200 pp. Order No. 030, only. \$5.75



LEADING BOOK ON TRANSISTORIZED COMMUNICATIONS EQUIPMENT

TRANSISTOR RADIO HANDBOOK, by Donald L. Stoner, W6TNS, Lester A. Earnshaw, ZL1AAX. Covers a wide range of communication uses for both amateur and commercial applications. Includes audio and speech amplifiers, VHF transmitting and receiving equipment, SSB exciters, and complete SSB transceivers. 180 pages. Order No. 044, only..... \$5.00



HOW TO CONVERT SURPLUS RADIO GEAR INTO AMATEUR AND CB EQUIPMENT

Here is a wealth of conversion data in 3 volumes; includes photos, diagrams, instructions.

Vol. 1. Covers: BC-221, BC-342, BC-312, BC-348, BC-412, BC-645, BC-946, SCR-274 (BC-453A & BC-457A series), SCR-522, TBY, PE-103A, BC-1068A/1161A, etc. Order No. 311, only..... \$3.00

Vol. 2. Covers: BC-454, AN/APS-13, BC-457, ARC-5, GO-9/TBW, BC-357, BC-946B, BC-375, LM, TA-12B, AN/ART-13, AVT-112A, AM-26/AIC, ARB, etc. Order No. 322, only..... \$3.00

Vol. 3. Covers: APN-1, APN-4, ARC-4, ARC-5, ART-13, BC-191, 312, 342, 348, 375, 442, 453, 455, 456-459, 603, 624, 696, 1066, 1253, CBY-5200, COL-43065, CRC-7, DM-34, DY-2, DY-8, FT-241A, MD-7/ ARC-5, R-9/APN-4, R-28/ARC-5, RM-52-53, RT-19/ARC-4, RT-159, SCR-274N, 508, 522, 528, 538, T-15 to T-23/ARC-5, URC-4, WE-701-A, etc. No. 333, only..... \$3.00

Order from your electronic parts distributor or send coupon below.



EDITORS and ENGINEERS, Ltd.

P.O. Box 68003, New Augusta, Indiana, Dept. QS-10
Ship me the following books:

No. 166 No. 044 No. 322
 No. 030 No. 311 No. 333 \$_____encl.

Name _____

Address _____

City _____ State _____ Zip _____

SANTA CLARA VALLEY—SCM, Jean A. Gmelin, W6ZRJ—Asst. SCM; Ed. Turner, W6NVO. SEC: WA6HYN, RM; W6QMO. V.H.F. PAM: WA6RRH. The Santa Clara Valley Section Net reports 19 sessions, QNS of J01 and QTC of 23. Mgr. WA6RRH is busy getting the net more active and looking for check-ins on 146.7 Mc. at 8 p.m. week nights. W6QMO, RM, is again the manager of NCN and is busy getting things going for the fall. Let's give this hard working gal our support, follows. W6RSY was busy planning for vacation but still made the BPL. W6ZRJ vacationed in Oregon and went salmon-fishing but got season. WB6FHH is a new ORS in the section and made his third BPL. W6YBV is active on NCN. W6ALT works NCN and RN6. W6PLS now has over 100 certificates. W6HC worked W6ZRJ and handled traffic while the latter was mobile in Northern California. W6DEF is now working two nets and is busy with AREC work. W6AGR now has 40-80 trap dipole and is working out better. K6YKG is NCS of NCN Sat. W6AUC active as an OO. Russ was M.C. at the QCWA Breakfast at the National Convention. WA6JSA visited the 0-3-car group in Dallas and K3NIO in Maryland on a recent trip. W6OII operated in the recent C.D. Party. W6PJW reports for the San Mateo group. W6CBX now sports an HX-10 and is working c.w., s.s.b., and phone. WB6IZF in King City, is active on the low bands on the Weather Net and on 2 meters in the C.D. Net. K6IQY is Red Cross Radio Officer for Palo Alto. K6SAW is active as an OO and sends in a report of 32 observations. WB6IZF is very active as OES and reports conditions and experiments from the King City area on v.h.f. The PARA is holding training sessions for licensing. The Santa Cruz Club is holding meetings at Cabrillo College Campus. Traffic: (July) W6RSY 437, WB6FHH 182, W6YBV 114, W6AJT 81, W6PLS 64, W6HC 63, W6QMO 63, WA6RRH 61, W6DEF 51, W6AGR 36, K6YKG 13, W6AUC 9, WA6JSA 6, W6OII 6, W6ZRJ 6. (June) WB6IZF 1.

ROANOKE DIVISION

NORTH CAROLINA—SCM, Barnett S. Dodd, W4BNU—Asst. SCM; Robert B. Corns, W4FDV. SEC: W4MFK, RM; K4CDZ and WA4ANH; PAMs: W4AJT and WA4WE. V.H.F. PAM: WA4EJZ. At the annual NCN/SSBN/V.H.F. Picnic the SCM issued certificates and trophy cups for the North Carolina Service Award to John C. Huffman, W4IRE, #1; Max Miller, W4LWZ, #2; James O. Pullman, WA4FJM, #3; Larry Glazier, WA4ICU, #4. WA4GMB, EC for Lenoir and Green Counties, sends in a nice report on the activity of the AREC net, with four drills per month and an average of ten participants per drill. WA4ANH says his homebrew 2-meter rig is on the air now, and he is planning a beam as his next project. K4TTN participated in an emergency search for a mobile operator in the Carolinas, who had illness in his family and was needed at home in Louisiana. K4ZKQ has repaired his 75-meter antenna and is checking into the SSBN.

Net	Freq.	Time	Days	QTC	Mgr.
NCN(E)	3573 kc.	2330Z	Daily	266	K4CDZ
NCN(L)	3573 kc.	0300Z	Daily	135	W4ANWH
SSRN	3938 kc.	0030Z	Daily	103	W4ALWE
THEN	3865 kc.	0030Z	Daily	53	K4WLW

Traffic: (July) W4LEV 2728, W4EVN 223, WA4PDS 157, WA4ICU 130, W4IRE 115, K4JEX 111, W4UWS 80, K4CWZ 70, K4HZP 56, W4LWZ 56, WA4UFQ 52, K4CDZ 49, WA4ANH 43, K4EO 23, K4TTN 27, WA4FJM 23, W4OTE 22, WA4VTV 16, W4YMI 15, W4RAW 12, WA4HMB 5, K4ZKQ 4, W4ACY 2, W4AJT 2. (June) K4CDZ 21.

SOUTH CAROLINA—SCM, Charles N. Wright, W4PRD—SEC: WA4ECJ. Asst. SEC: WA4QM, RM: K4LND. PAMs: K4WQA. (s.s.s.b.), K4OCU (a.m.).

SCN	3795 kc.	Daily 0000Z, 0300Z	60SSNS	QTC	115
SCEF N	3820 kc.	Daily 0030Z	35SSNS	QTC	32
SCEF N	3930 kc.	Sun. 1130Z/2030Z	31SSNS	QTC	159
SCSSB	3915 kc.	Daily 0100Z	SSNS	QTC	

W4AKC, W4CAL, W4CXO and W4FFH report new Extra Class tickets. Congratulations! W4PED, mobile once again on 75 meters, gave K4QEE rare Edgefield County for his 40th S.C. county. WA4OAZ and W4OWY earned SCN certificates, as did WA4UPR, WA4EFA and WA4VAL on SCEFN. K4VHH, recently moved from Charlotte, will put North Augusta on the v.h.f. DX scene. W4KYN reports completions of a 432-Mc. converter for moonbounce reception. K4VVT is scorching the airwaves with his new S-Line equipment. The Annual meeting of the State Radio Council will be held in Rock Hill Oct. 9. Traffic: (July) WA4PFQ 140, K4OCU 51, W4PED 51, K4LND 46, W4NTO 38, WA4SOL 22, K4ZHV 30, W4FFH 26, WA4ICF 21, WA4QKQ 16, WA4HFA 4, WA4LPV 1. (June) WA4QKQ 19, W4JA 9.

WRL

**HAS THE
BEST
RECON-
DITIONED
DEPT.
in the U.S.A.**

30 years of electronic
experience and two
generations of the
same ownership.



Leo I. Meyerson
President—WØGFQ



Larry B. Meyerson
Sales Manager
WØWOX

WRL

**HAS
37 HAM
and CB Spe-
cialists—to
give you
The Best
Service
Anywhere!**

WRL

**OFFERS YOU
THE BEST!**
National
SWAN GALAXY
Collins
DRAKE
HALLICRAFTERS
SBE
and many
more!

WORLD RADIO LABORATORIES

"THE HOUSE THE HAMS BUILT"

WRL'S ALL NEW 1966 CATALOG IS FILLED WITH FANTASTIC VALUES. HUNDREDS OF ITEMS AT THE LOWEST POSSIBLE PRICES — ORDER YOURS NOW! IT'S FREE!

FREE ALL NEW

1966 HAM/CB CATALOG

SEE WRL'S EX-
CLUSIVE HAM/CB
GEAR!

TUBES, PARTS
ETC., AT LOW-
LOW PRICES.

SELECTED GOOD
BUYS ON RADIOS,
RECORDERS, ETC.

SPECIAL PUR-
CHASES FOR
ELECTRONIC
BUILDERS

MOST COMPLETE
AMATEUR EQUIP-
MENT LISTINGS
EVER COMPILED

BUY ANYTHING
ON OUR EASY-
PURCHASE CRED-
IT PLAN



WORLD RADIO LABORATORIES

3415 WEST BROADWAY, COUNCIL BLUFFS, IOWA 51504

Rush me your Free 1966 Catalog

Name _____

Address _____

City _____ State _____ Zip _____

DON'T GAMBLE!

Trade with the World's
Most Recognized Dealer
in Amateur and CB
Equipment.

You can depend on WRL for

- THE VERY BEST SERVICE
- HIGHEST TRADE-IN ALLOWANCES
- LOW-BUDGET PAYMENTS WITH WRL'S CHARG-A-PLAN
- OUR CENTRAL LOCATION MAKES SHIPPING CHARGES MUCH LESS
- NO DOWN PAYMENT
- FREE TECHNICAL ADVICE

NOW THERE'S A BREAK-THROUGH FOR YOU

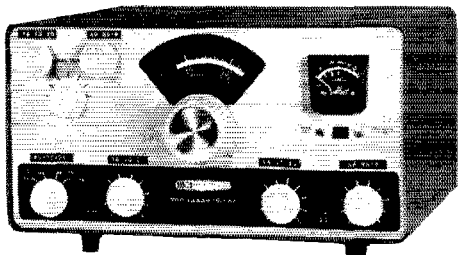

IN THE SSB PRICE BARRIER

—with DYNALAB'S Sensational New Three-Band Conversion Kit for the HW12, 22, or 32 Transceivers.

A few hours of construction and color coded wiring result in a three-band unit for the "HW" transceiver. A turn of the bandswitch actually produces the same circuitry of all three transceivers.

Here are the results:

- Coverage:
14.2-14.35, 7.2-7.35, 3.85-4.0 Mc. (Full 75 meter coverage with THW12)
- Operation:
LSB on 75 and 40
USB on 20
- Calibration:
2 Kc on original dial
- Receiver Sensitivity:
1 μ v for 15 db signal plus noise/noise ratio
- Stability:
200 cps after 20 min. warm-up under normal ambient conditions
- All other specifications:
UNCHANGED.

FEATURES AND HIGHLIGHTS

- ★ Well laid out assembly modeled after the famous Heath manual
- ★ 90-day parts guaranteed and replacement warranty
- ★ Free technical assistance and factory repair service at minimal charge.
- ★ Highest quality components throughout

PRICE **\$49.95** Ppd USA proper

ELSEWHERE, ADD \$1.50 FOR SHIPPING

HW12 owners order kit model THW12

HW22 owners order kit model THW22

HW32 owners order kit model THW32

DYNALAB COMPANY

215-28 Spencer Ave., Queens Village, N.Y. 11427

VIRGINIA—Acting SCM, H. J. Hopkins, W4SEJ—PAM: W5VZO/4. RMs: W4QDY, W4SHJ, W4ZM, WA4EUL. Nearly every appointee and member who reported claims that vacationing and summer activity cut into ham pursuits. New ECs include W4VCF for Area 12 and W4AKVR for Washington County. K4UVT, on summer work in Tennessee, hopes to use new equipment. W4MXU is off to Canal Zone and hopes to check in to 4RN from there. As you read this the annual SET should be days, perhaps hours, away; we hope your plans already are complete to originate and handle lots of record message traffic. If not, let this serve as a last minute reminder. Net members who can work more than one mode are not doing themselves and the organization a service by sticking to a single mode; all our nets need liaison with each other, only a few devoteds are now accomplishing this. For fun and traffic join the more-than-one mode group; witness the traffic total of K4LJK, who shuttles between c.w. and s.s.b. section nets several times weekly. W5VZO, W4MXU, K4SCL, K4LMB, WA4DAI and WA4UXXL do the same. Traffic (July) K4LJK 233, W4RHA 215, WA4FJL 157, WA4EDG 150, W4DVT 140, W4NLC 129, W4VZO/4 123, K4SCL 97, W4OKN 53, WA4DAI 51, W4SEJ 36, WA4FCS 33, K4FSS 27, K4LMB 28, K4VCY 27, K4YCH 21, K4WUM 14, W4MK 9, W4PTR 8, W4JUJ 7, WA4KVR 6, K4PIK 4, K4NOV 2, K4BAV 1, W4BZE 1. (June) K4LJK 86, WA4FSC 14, W4MK 10, W4BZE 8.

WEST VIRGINIA—SCM, Donald B. Morris, W8JM—SEC: W8SSA. RM: W8LMF. PAM: K8CHEW. S.S.B. Net Mgr.: K8SHP. Section Net reports:

Net	Freq.	Time	Days	Sess.	QTC	QNI	Mgr.
WVN- Phone	3890	2230	Mon.-Fri.	21	110	420	K8SCHW
WVN-SSB	3903	2300	Mon.-Fri.	22	18	447	K8SHP
WVN Sto- C.W.	3570	2300	Mon.-Fri.	18	28	98	W8LMF

K8BIT, K8MQB, K8QYG, WA8DOY, K8WWW and WA8GGI reported the W. Va. QSO Party, sponsored by the Kanawha Radio Club, was "real interesting." Congratulations to K8SHP on his fine leadership and excellent reporting of S.S.B. Net activities. W8JM scored over 10,000 points in the West Va. QSO Party. WA8PXF is a new General in Pine Grove. WA6AEA visited in W. Va. on vacation. FD, QSO Party, State Convention and OO work keeps W8HZA busy. WA8CPY built a 10-watt transceiver. WA8OVT worked VP and KP on 6-meter phone. WA8BUM has a new s.s.b. rig. Our sympathy to W8PZT on the passing of his daughter, W8TGS. W8NTV motored to the West Coast in July and attended the National Convention. W8LD has installed a new quad Tri-bander. Traffic: WA8IMY 265, WA8FIC 237, K8TPF 126, W8CKX 104, K8WWW 57, WA8KCO 46, W8HZA 38, W8JM 24, WA8OVT 14, WA8KUU 13, WA8CPY 9, K8BIT 7, WA8BUM 7, W8CZT 5, K8SCHW 4, W8PXF 4, WA8KXN 3, WA8CKN 2, WA8DAU 2, W8EEO 2, K8KDK 2, WA8KGU 2, K8SHP 2, W8SSA 2, W8VYI 2, W8WHQ 2, WA8ALI 1, K8BHG 1, WA8BYB 1, K8CFT 1, W8DYB 1, WA8EKC 1, K8EPI 1, WA8FIE 1, K8FZS 1, WA8GRE 1, WA8MRK 1, K8SDH 1, W8TGF 1, W8VOI 1, K8WMQ 1.

ROCKY MOUNTAIN DIVISION

COLORADO—SCM, Donald Ray Crumpton, KØTTR—SEC: WØSIN. Seems like everyone had a good time at the Rocky Mountain Division Convention. One of the main parts of our amateur activity is the AREC. This was proven in the floods we had in Colorado and the fact that the only communication for some time was the amateur radio groups. A new slow-speed net has been organized in the state, the Colorado C.W. Net. Its purpose is to expedite the operation of the other state nets, aid in getting traffic to and from them and to train operators in the handling of traffic on code. The net control will send at about 13 words per minute unless any operator requests a slower speed. Break-in facility is not necessary. Any operator with a code speed of even 5 words per minute will be welcomed. This net will meet daily at 0115 GMT (7:30 P.M. MDT) and will be closed in time to avoid interference with the Columbine Net. The frequency is 3780 kc. and the call-up CQ CCN. If you do not have an antenna tuner and are sure you cannot get out on this frequency (try once more), contact WAØJCA for a simple method that will not affect other frequencies. The first session was held Sun., Aug. 1. For information or to affirm interest, contact Jeff Grove, WAØJCAØ. 2231 Glenn Summer Rd., Colorado Springs, Colo. Net traffic: High Noon Net 149, Columbine Net 182. Traffic: WØTVI 171, KØDCW 50, WØSIN 25, KØZSQ 18, KØTTB 5.

NEW MEXICO—Acting SCM, Lowell E. Richardson, W5UBW—Asst. SCM: Kenneth D. Mills, W5WZK. SEC: K5QIN. A good time was had by all at the

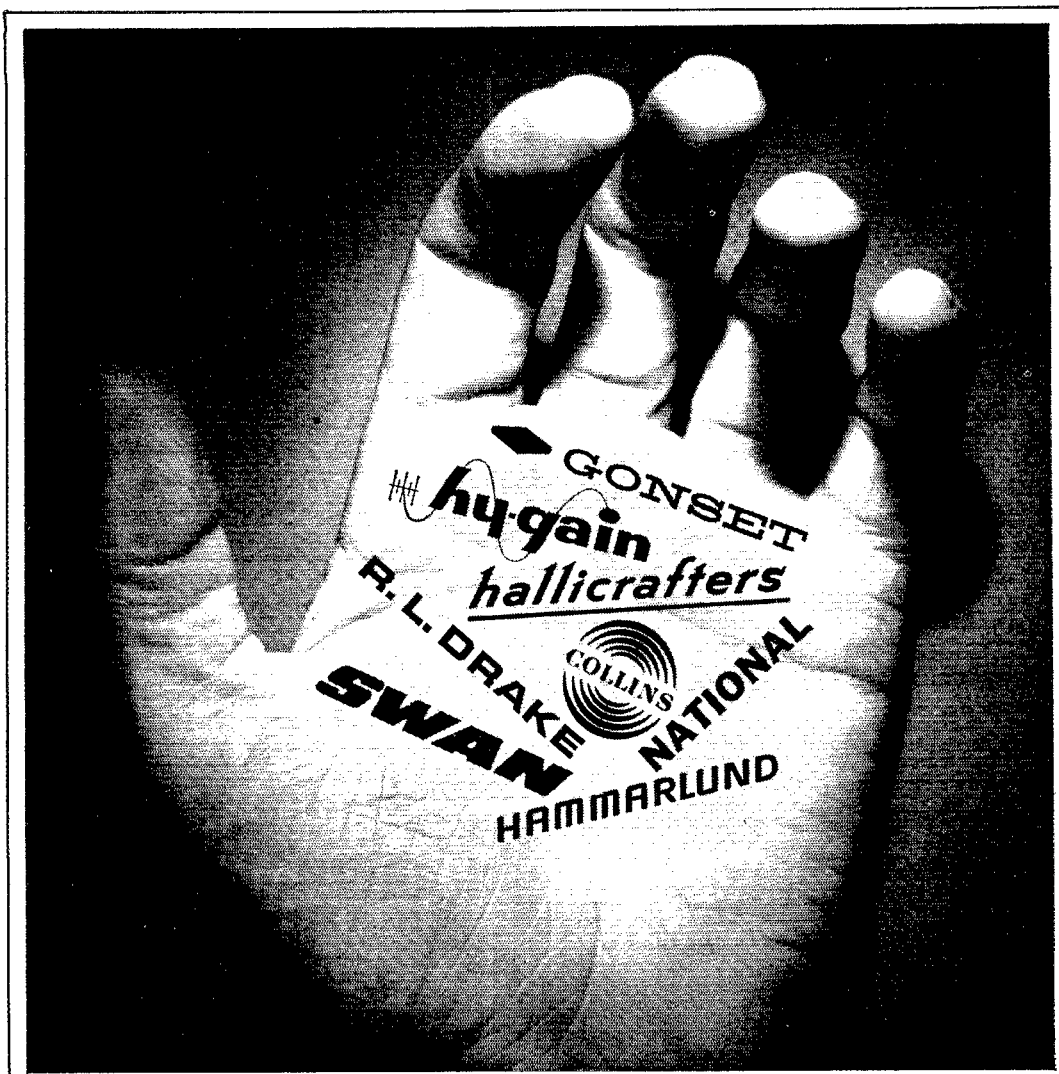

HARVEY OFFERS THE WIDEST VARIETY OF FAMOUS BRANDS AT THE BEST PRICES ANYWHERE!



103 WEST 43rd STREET
 NEW YORK, N.Y. 10036
 (212) JUdson 2-1500

For over 38 years Harvey's has kept pace with the popularity of ham radio throughout the world. And during this time the company's initial aim was and remains the same: Offer the widest variety of ham and electronic equipment at the lowest prices. Today more than ever we extend a hand to ham radio operators everywhere by efficient inventory of equipment and parts for quick delivery — and at the most competitive prices.

That's why you can rely on Harvey's for preferred service by the most experienced staff who are qualified hams themselves. We agree that it takes a ham to talk to a ham. At Harvey's you can feel confident that your specific needs and problems will be solved by experts who can aid you in making the right choice at the most economical prices. And remember everything you buy at Harvey's is always guaranteed:

To get the most for your ham dollar and the fastest mail order service, it pays to check Harvey's first. Serving the world from the nations crossroads in midtown New York.

— Elliot Berelson, WA2HDP

Watch for opening of new Harvey sales center in Woodbury, L. I., in September.

**THIS COULD BE THE BEST
DX ANTENNA YOU WILL EVER OWN!**



**COMPLETE KIT PRICE
CONTENTS**

- 8 FIBERGLASS Arms Special-ly reinforced at butt and element intercept points
- 2 Quad Arm "X" Mounts
- Boom to Mast "T" Mount
- 1 Instruction Manual

\$59.95

WRITE FOR BROCHURE TODAY

U. S. FIBERGLASS CO.

5101 N.W. 36 Ave. MIAMI, FLA. 33142

**WHAT ARE THEY ALL
TALKING ABOUT??**

Turn to page 166 and see. Something the hams have been not only talking about but waiting for . . . Here it is!

NEW TIE CLASP

FOR
A.R.R.L.



MEMBERS Your Ham Call custom-
engraved
With cuff-links \$1.75
\$3.25

APOLLO ENGRAVING P. O. Box 81 Brooklyn, N.Y. 11204

LEARN CODE!

SPEED UP Your
RECEIVING
with G-C
Automatic Sender
Type S
**\$32.00 Postpaid in
U. S. A.**

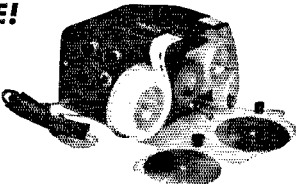

Housed in Aluminum Case. Black Instrument Finished. Small—Compact—Quiet induction type motor. 110 Volts—60 Cycles A.C.

Adjustable speed control, maintains constant speed at any setting. Complete with ten rolls of double perforated tape. A wide variety of other practice tapes available at 50c per roll.

GARDINER & COMPANY

STRATFORD

NEW JERSEY

Rocky Mountain Division Convention in Denver, Colo. The Denver ARC is to be congratulated on a fine convention. It looks like the Colorado Springs ARC may sponsor the convention for next year. Congratulations go to W5SA on receiving the PICON public service award for his participation with the Eye Bank Net. W5EOC has now moved to his new QTH near Tularosa to raise pecan trees and antennas for 160 meters. New amateurs in the Alamogordo area are WN5MOF and WA5LYM. W4NKQ/5 has traded for a 5th district call of W5OHU. WA5BMN is working lots of DX on 40-meter c.w. in the wee hours of the night. W8BZY/5 is enjoying S.S.B. with his new Galexy V. W5UBW is now QSL Mgr. for 7Q7GB in Malawi, Africa. His state-side call is W5VTH. W5FAG now has his high-power s.s.b. rig on 2 meters. Traffic: WA5DUH 288, WA5-FLG 175, WA5KSO 79, WA5PFL 50, W5UBW 27, K3-ONE 8, W5BZB 4, K5HTS 2, WA5LZX 1.

UTAH—SCM, Marvin C. Zitting, W7MWR/W7OAD—Asst. SCM: Richard E. Carman, W7APY, SEC, W7-WKF. Section nets: BUN meets daily on either 7272 kc. or 3980 kc. at 1930Z. UARN meets each Sat. and Sun. on 3525.5 kc. at 1430Z and on 3987.5 kc. at 1500Z. On July 15 the UARC held its annual steak try up Mill-creek Canyon. About 100 persons attended and heard WIICP, from ARRL Headquarters, who was featured speaker. The Salt Lake County AREC provided communications for the July 24 Days of '47 Parade. K7SDF, W7WKF, W7GKQ and W7OCX attended the division convention in Denver. K7RAJ, W7BAJ and K7SDF participated in the recent CD Party. K7SAI and K7RAJ continue to work many new countries each month. K7CLS has added an Apache and an HQ-180 to his collection of equipment. W7WKF has moved to a new QTH. WA7DVF has a new 2-meter ground plane in operation. Traffic: W7OCX 111, K7SDF 22, W7LQE 19, K7CLS 6, W7VTJ 4, K7SAI 3.

WYOMING—SCM, Wayne M. Moore, W7CQL—SEC: W7YWE, RM: K7TAY, PAMs and OBS: W7TZK and K7SLM. Nets: Pony Express, Sun. at 0800; YO, Mon., Wed., Fri. at 1830 on 3610; Jackalope, Mon. through Sat. at 1230 on 3920 kc. We are very sorry to lose W7TEL but Pueblo, Colo., is gaining a good ham. K7TAY is getting rigged up for RTTY. W7DIO is out of the hospital and making very good progress. The Casper Radio Club is planning classes again to start the first part of October. W7BAE vacationed in Yellowstone the first part of August. W7PVN also was vacationing in Colorado. K7ITH called an organization meeting in Casper for the AREC with law enforcement officials, etc., attending. This is a big step forward in getting his AREC organization set up for Natrona County. Traffic: K7SLM 20, W7BAH 10, W7NKR 10, K7OAF 8, K7POX 7, WA7BPO 2, K7ITH 2, W7TZK 2.

SOUTHEASTERN DIVISION

ALABAMA—SCM, William S. Craits, K4KJD—Asst. SCM/SEC: William C. Gann, W4NML, RM: WA4EXA, PAMs: K4NSU and K4WHW. Electronic Wholesalers of Huntsville is sponsoring a trophy for the Alabama club with the highest V.H.F. SS score. This gives us a trophy for all the winners of all the major ARRL contests. The next contest is the Sweepstakes in November. We have trophies for Alabama winners in club and individual phone and c.w. categories. Everyone should be prepared for the 1965 SET Oct. 9-10, July section net reports (times GMT):

Net	Freq.	Time	Days	Sess.	Ave. Tfc.	Ave. QNI
AENB	3575	0100	Daily	30	2.6	6.4
AENM	3965	0030	Daily	31	2.3	43.3
AENP	3955	1230	Mon.-Sat.	27	2.4	16.4
AENP	3955	2400	Daily	35	.97	12.8
AENT	3970	2230	Daily	34	1.1	5.1

According to WA4AVM, NM of AEND, our slow-speed c.w. net, the net is back in business again after being off several months. It meets daily on 3725 kc. at 2300 GMT. If you are not sending me a traffic report each month, please start doing so. Traffic: (July) WA4AVM 154, W4NML 72, W4YNG 70, W4USM 56, WA4EXA 47, K4NUW 41, K4BSK 37, K4WOP 37, WA4EXB 33, K4WWP 31, K4KJD 21, WA4TID 19, K4WHW 19, K4NSU 18, WA4FYO 15, K4GXS 12, K4ANB 11, K4TNS 11, K4GHX 9, W4ZVI 5, K4ZBX 4, K4AJF 2, K4FZQ 1, W4WJT 1. (June) WA4AVM 291, WA4TID 38, WA4-MGI 12, K4GHX 2. (May) WA4AMV 213.

EASTERN FLORIDA—SCM, Albert L. Hamel, K4SJH—SEC: W4LYT, RM C.W.: W4LUV, RM RTTY: W4RWM, PAM S.S.B.: W4GFX, PAM 40: W4SDR, PAM 80: W4TUB, PAM W.H.F.: WA4BMC. Since there were so many late reports for June, I will use material submitted on those Form I cards as well as July. It is still pretty slim pickings at that. I know

**CONVENIENT TIME PAYMENTS
PLUS SPECTACULAR SAVINGS
ON LIKE-NEW, EXTRA-CLEAN EQUIPMENT**



- TWO-WEEK TRIAL
- 90-DAY GUARANTEE
- TRADES ACCEPTED
- FREE PARKING

Tops in value, tops in performance, and tops in appearance—that's what you get with every piece of TRIGGER thoroughly reconditioned, clean-as-a-pin, like-new equipment.

Alignment, calibration, and performance are as good as new, and frequently better.

SEND FOR FREE PRICE LIST

Contact TRIGGER for a cash quote on your present gear or for a tremendous allowance on brand new equipment. For a real eye-opener visit TRIGGER—conveniently located in west suburban Chicago on Route 64, three blocks west of Route 42A, and only 20 minutes from the Chicago Loop via the Eisenhower Expressway.

Domestic and foreign inquiries or orders processed promptly.



Another important TRIGGER service:
WE BUY USED HAM GEAR FOR CASH!
PROMPT SERVICE/PROMPT CASH!

SPECIALS OF THE MONTH FOR OCTOBER

51J4.....\$795	S118.....\$ 67	HX50.....\$269	POLYCOMM PC62B..\$229	SHERWOOD S8000..
75A2..... 229	S119..... 27	NCX3..... 239	POLYCOMM PC6.... 199	FM STERO RCVR...\$229
75S1..... 299	CRX2A 152-174MC. 69	NCX3 DC SUPPLY.. 69	POLYCOMM PC2.... 239	JENSEN DUETTE...
75S3..... 469	FPM200..... 795	NC109..... 79	KNIGHT T150..... 79	2 WAY SPEAKER... 39
32S1..... 439	HT32..... 279	NC155..... 139	DX40..... 49	KNIGHT V1VM... 22
KWM1..... 249	HT33..... 199	NC183D..... 177	DX60..... 77	HICKOK V1VM TUBE
AC supply..... 69	HT37..... 279	NC188..... 77	HR10..... 77	6 TRANSISTOR CR. 69
KWM2..... 739	HT44..... 249	NC190..... 149	RX1..... 159	TRIPLET 3414.... 69
SWAN 120..... 129	PS150 AC..... 69	NC270..... 149	TK1..... 159	ETCO BATT ELIM.. 29
SWAN 240..... 249	HT45..... 249	GONSET 650..... 249	HW20..... 179	190-50KC RCVR.. 19
DRAKE 2B..... 207	P143AC..... 139	G6B8 6AC SUPPLY.. 77	HW10..... 169	AM-FM-SW 6 BAND
DRAKE 2BQ..... 32	VALIANT..... 199	GONSET 2B 2MTR.. 129	TWOER..... 47	transistor port 69
GPR90..... 249	JOHNSON 500.... 279	GONSET 3 6MTR.. 149	HP20..... 32	AM-FM transistr 27
SX71..... 99	INVADER 200.... 249	GONSET 4 6MTR.. 199	HP10..... 32	B & W LOW PASS 9
SX96..... 137	THUNDERBOLT... 279	UTICA 650..... 99	AM2 SWR BRIDGE.. 14	UOW TR SWITCH 7
SX100..... 149	RANGER..... 119	AMECO CMA CONV.. 49	HD11 Q MULT..... 14	JOHNSON TR SW.. 14
SX110..... 89	HO110..... 129	ETCO 722VFO..... 37	VF1 VFO..... 17	EV 664 MIKE&std 29
SX117..... 289	HO140X..... 109	THOR6 4AC..... 249	RE45B..... 79	MOSLEY TA53.... 49
S86..... 59	HO170C..... 217	INTERCEPTOR... 259	HICKOK S39A..... 79	TRANSISTOR TAPE
S108..... 77	SP600JX17..... 249		MILLEN SCOPE.... 37	RECORDER 6MIKE. 14

**NEW EQUIPMENT
ON LOW MONTHLY TERMS**

- | | | |
|--------------|-----------|-----------|
| SWAN | DRAKE | SBE |
| MALICRAFTERS | HY-GAIN | VIBROPLEX |
| AMECO | WATERS | SHURE |
| ASTATIC | NUMECHRON | LOW-KEY |

and other major brands

TRIGGER Attn: W9IVJ (ABC1234)

7361 North Avenue
River Forest, Illinois

Amount Enclosed

RUSH THE FOLLOWING:

NAME _____

ADDRESS _____

CITY _____ STATE _____ ZIP _____

ORDER BLANK TO: trade ur present gear, order equipment, sell ur gear for cash.

STORE HOURS

Weekdays 11:00 A.M.-8:00 P.M.
Saturdays 9:00 A.M.-3:00 P.M.

TELEPHONES (area code 312)

From Outside Chicago.. 771-8616
Chicago Area 889-6429

Or by Appointment
After Hours

Business phones
with QTH Extensions



TRIGGER Electronics

7361 NORTH AVE. • RIVER FOREST, ILLINOIS 60305
(WEST SUBURBAN CHICAGO)

#130
12-HOUR
#131
24-HOUR

SAMPLE &
QUOTATIONS
ON REQUEST

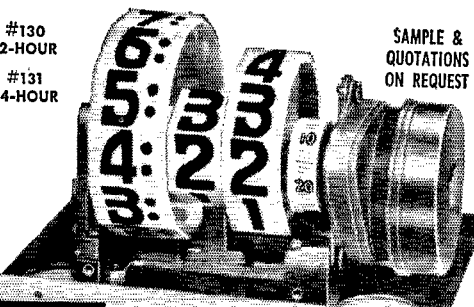

12
HOUR
5/8" Digits

TYMETER

DIGITAL READ OUT

24
HOUR
5/16" Digits

CLOCK MOVEMENTS

DIGITS RESETTABLE
INDIVIDUALLY

Available in 50 and 60 cy., all voltages, AC. UL approved motor and cord. One Year Guarantee.

TYMETER CLOCK MOVEMENT
as Used by

MOTOROLA

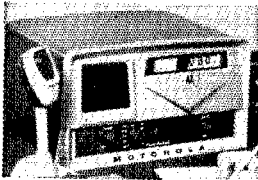

Complete Line: Delay, Interval, Cycle Timers, Digital Computers • Catalog on Request

TYMETER ELECTRONICS
PENNWOOD NUMECHRON CO.
7249 FRANKSTOWN AVE. PITTSBURGH 8, PA.



GO MODERN!

Turn Your Shack
Into a Studio
In Minutes

4 inches Scotch Tape Hangs 20 Cards. No nails, no clips, no glue, no staples no mess, no fuss, no misalignment, no damaged walls or unhappy XYL.

3 Packets \$1.00
10 Packets \$3.00

Postpaid & Guaranteed

ORDER NOW

TEPABCO

P.O. Box 198
Dept. T-10
Gallatin, Tenn. 37066



TENNA-BAL

← COAX ANTENNA →

BROAD BAND BALUN

BROAD BAND BALUN \$10 net p.p. in U.S.A.

• Flat in the amateur bands from 3 to 30 Mcs. • Full legal power • Fully weather sealed • Matches coax to antenna or balanced line. • Matches efficiency and radiation pattern.

Two models, 1 to 1 or 4 to 1 impedance ratio
Size 1 1/4" OD x 4" long. Wt. 4 oz.

FUGLE LABS 1835 Watchung Ave., Plainfield, N.J.

that there is news for this column because I hear it on the air sometimes. Why not put it on a Form 1 when you send in your report? I can't afford a spy network you know, 007 and that sort of stuff. W4BKC says that 8 active past-presidents of OARC were honored with presentation of "Golden Gavelts." W4FWZ, one of our past SCMs, had to get away from his "hot spot" for a couple of weeks in Philly. Betcha it was even hotter up there. W4E1E should now use Fla. Skip and tell us about that Sweden trip. W4LVV, our active Vice-Director, is always running off some place. This time it's Europe. If I know Chuck you will hear about it in Skip. Thanks to our busy RMs and PAMs for the gratifying response to our appointment effort. Many qualified and deserving tracklayers had their efforts acknowledged with a fine certificate. Many OESs also were appointed. It is too bad that others could not be appointed because they were not members of ARRL. W4GUJ is seeing that Duval County won't be hurting this hurricane season. Traffic: K4YSN 628, WA4LHK/4 627, WA4BMC 556, WA4SCC 294, W4TUB 243, WA4NEV 107, WA4QLZ 154, W4LUV 150, WA4JH 149, WA4-IDM 139, W4KIS 133, W4SDR 99, K4BY 95, W4TEI 74, W4AKB 70, K4KDN 68, WA4TZC 65, K4ILB 54, W4GUJ 44, WANBT 43, K4SJH 43, W4ELW 41, K4-DAX 38, W4OGX 38, WB4ABH/4 37, W4ACIQ 36, WA4-NBE 34, W4AYD 31, WA4KDL 28, WA4BGW 25, WA4-VSR 25, WA4AO 20, W4FP 19, W4TE 18, K4COO 16, W4NUH 16, W4BKC 15, W4TJM 15, W4OHO 13, W4-MVB 12, K4EBE 11, W4BAY 10, WA4DEV 9, WA4RXG 8, K4MTP 7, WA4WEW 7, K4MZR 6, W4DFZ 3.

GEORGIA—SCM, Howard L. Schonher, W4RZL—Asst. SCM: James W. Parker, Sr., W4KGP. SEC: W4SAZ. RM: W4DDY. PAMs: K4PKK, K4YZE, WA4-HSN, WA4JSU. The Fourth Mobile Amateur Radio Club has been formed at Hunter Air Force Base with W4WXB, pres. K4TXK reports QRP 2-meter activity with fractional watt QSOs in the hundred-mile range. The Savannah Radio Club operated a station in conjunction with the Powder Puff Derby. Among those participating were W4KGP, W4ESP, WA4EJA, WA4-LBJ, WA4CEB, K4YSA, W4TZN, K4YGD, WA4UFT, WA4HPK and WA4EHT. In spite of the extended nature of the operation traffic was handled to the satisfaction of all concerned. The new editor of *Savannah Key Kliz* is WA4EJA. WA4LLI is a new deputy coordinator for Georgia Navy MARS. Steve also is net manager for the Middle Atlantic Traffic Net. The Cobb County ARCC is fully organized with a regular program of activity. Present membership consists of K4YZE EC; WA4VMV, net mgr.; WA4TYW, WA4MF, K4KHH, net controls. K4KHH is director of net training. Other members include K4ZKS, W4SBN, WN4UQW, WA4-DKQ, WA4KVZ, W4PHN, WN4YED, WN4VX, W4-SAZ, W4UUD and WN4YCV. Limited members are WA4EKN, K4UOV, WA4AJU, K4OLF, K4YEN, W4-LRR, K4MSP and W4WNW. W4YE has a new 60-ft. tower and tri-bander. WN4AIU an all-band vertical. K4QNA and WA4GYO are mobiling on extended vacations. K4BYD and K4TKM are Nos. 1 and 2 in c.d. for Georgia. Traffic: K4TKM 118, W4TFL 114, W4DDY 113, W4UYT 109, W4NSO 74, W4LLI 61, WA4GAY 58, W4FOE 52, W4RZL 46, K4YZE 40, WA4CJN 19, WA4AJU 17, WA4JSU 15, W4FUN 14, WA4TYW 10, WN4AIU 9, WA4VMV 8, W4YE 4, WA4BVD 2.

WEST INDIES—SCM, Jose F. Saldafia, KP4JM—C.D. Radio Officer: KP4MC. QSL Mgr.: KP4YT. P.O. Box 1061. San Juan, P.R. EC: KP4BRM. OBS: KP4-BBN. 6-meter NTS San Juan: KP4BAN. OES: KP4-BPJ. OPS: KP4VT. Puerto Rico Emergency Nets on 6 meters (50,200) and 75 meters (3840) can be heard Fri. at 0300 and 2400 GMT. The first 6-meter emergency net convened July 17 with KP4BAN at the helm and KP4s BPJ, AXQ, BBI, BRS, CMI, JM and BBN answering the roll call. WICER, from ARRL Hq., was in KP4-Land as official observer visiting the Cornell University Ionospheric Observatory in Areibo, P.R., during the July 3 Moonbounce experiment on 432 Mc. A meeting of ARRL AREC members (Puerto Rico emergency nets) took place July 23 in San Juan with KP4s BJI, CLB, BNB, BRN, BBI, TL, BKP, BOX, BOW, BRN and JAI attending. KP4s were the object of an invitation on July 25 at 1300 GMT from WIPZJ/KP4. Director of the Ionospheric Laboratory at Areibo to visit the installation. W2NSD/1 was one of the many State-side guests present. The KP4 amateur fraternity was well represented. H8LGN, a charming XYL, headed the Foreign Delegation. The following were present: KP4s ABG, MV, RA, TL and XYL, CBD (ex-K2MRS), LK, JMN, GL, CF, LA, AYX, GH, BA, MQ, MC, OA, OL, BJJ, AES, EG, AWL, ABN, BRY operator at AXM, HQ, ACH, BJB, BMX, JM, K2LLC/KP4 and K8WNZ. KP4s LC, DN and BJD are back on the air after a long silence. KP4DJ is continuously heard on c.w., communicating with friends in the States and CH on 15 meters as usual in handling

From any angle...inside or out...

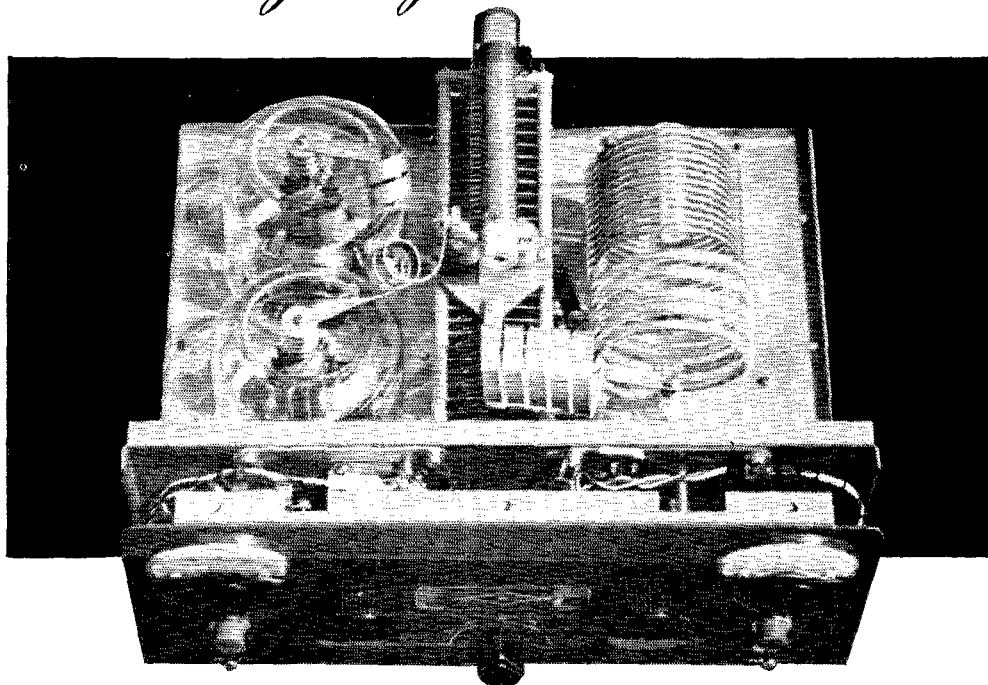

IT'S A CLASSIC!

With the **2-K LINEAR AMPLIFIER** beauty is obviously more than skin deep. The true functional beauty of the RF module is evident when removed from it's cabinet. Designed to be the Rolls-Royce of linear amplifiers, the enthusiastic response to the 2-K proves again that the amateur wants the finest. And make no mistake, it is the finest. You cannot buy a better linear.

The 2-K is loaded with engineering plus values which guarantee the highest quality possible at any price.

- Pi-L output circuit
- Cathode-Pi input
- Double rugged band change switch
- Step-start relay system
- Ultra heavy duty power supply with resonant input filler choke and 5000 volt oil-filter condenser
- Two superbly linear 3-400 Z zero bias triodes
- High efficiency silver plated tank coil
- All aluminum cabinet

The 2-K is rugged, reliable and "rarin' to go." Ten years from now you'll be saying what we tell you today . . . "The 2-K is a Classic!"

The 2-K console or desk model \$675.00 RF unit only \$425.00

Henry Radio Stores

CALL DIRECT . . . USE AREA CODE
Butler 1, Missouri 816 679-3127
11240 W. Olympic, Los Angeles, Calif. 213 477-6701
931 N. Euclid, Anaheim, Calif. 714 772-9200
431 E. Green St., Pasadena, Calif. 213 684-0861
6116 N. 27th Ave., Phoenix, Ariz. 602 AM 4-3895

"Worlds Largest Distributors of Short Wave Receivers"

ARROW ELECTRONICS INC

Presents a Fabulous Buy HAM MODULATION SCOPE

Model A-100

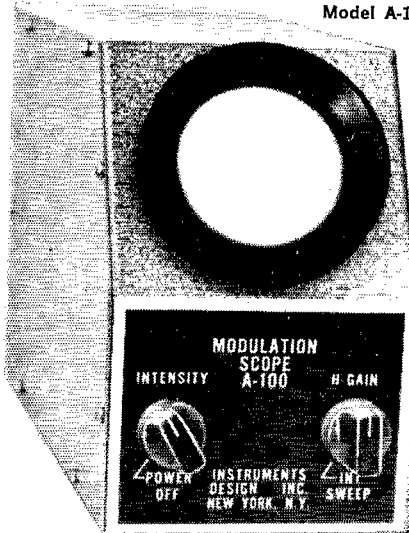

- AM, CW or SSB
- Wave envelope or trapezoid patterns
- No tuning required
- Up to 60 Mc
- Will handle 5W to 1 KW
- Uses standard connectors
- Internal sweep
- Size: 9½" deep, x 5½" high, x 3½" wide
- Weight: approx. 5 lbs.

ORDER NOW, LIMITED QUANTITIES AVAILABLE **\$2995**

ARROW ELECTRONICS INC

900 Rte. 110, Farmingdale, N.Y., 516 - MYrtle 4-6822
65 Cortlandt St., N.Y. 7, N.Y. 212 - DIgby 9-4730
525 Jericho Tpke., Mineola, N.Y. 516 - PIONEER 2-2290
225 Main St., Norwalk, Conn. 203 - VICTOR 7-5889

EASY TO LEARN CODE

It is easy and pleasant to learn or increase speed the modern way — with an **Instructograph Code Teacher**. Excellent for the beginner or advanced student. A quick, practical and dependable method. Available tapes from beginner's alphabet to typical messages on all subjects. Speed range 5 to 40 WPM. Always ready. No QRM. Beats having someone send to you.

ENDORSED BY THOUSANDS!

The **Instructograph Code Teacher** literally takes the place of an operator-instructor and enables anyone to learn and master code without further assistance. Thousands of successful operators have "acquired the code" with the **Instructograph System**. Write today for full particulars and convenient rental plans.



INSTRUCTOGRAPH COMPANY

4709 SHERIDAN ROAD, CHICAGO 40, ILLINOIS
4700 S. Crenshaw Blvd., Los Angeles 43, Calif.

his share of traffic for Puerto Rico. KP4VII, publisher of PRARC Bulletin *The Ground Wave*, visited the World's Fair in New York with XYL and family. He also paid a visit to ARRL Hq. in Newington, Conn. and had an eyeball QSO with W1BDI. KP4CB and XYL are back in Puerto Rico after a long stay in Brazil. KP4BOX has a loud voice on 6 and 2 meters with his new Viking linear. To KP4ACQ our sincere condolences on the passing of his brother after a tragic accident. KP4CK is back on the air after a short illness. H16NJH, from San Juan de la Maguana, in the Dominican Republic, was a visitor in KP4-Land recently. KP4TQ, a local newspaper man, is planning a series of articles on Amateur Activities and Operation in Puerto Rico, to appear soon in one of the island leading papers. Traffic (June) KP4BBN 154, KP4TL 128, KP4JM 98. (Apr.) KP4WT 326. (Mar.) KP4WT 383. (Feb.) KP4WT 280. (Jan.) KP4WT 361.

WESTERN FLORIDA—SCM, Frank M. Butler, Jr., W4RKH—SEC; W4MLE, PAM; K4NMZ, RM; W4BVE, Section net report:

Net	Freq.	Time	Days	Secs.	QNI	QTC
WFPN	3836 kc.	2300Z	Daily	31	534	193

Tallahassee: WFSU-TV carried a program on amateur radio showing WA4EOQ and other local hams handling traffic for the weather bureau via 75 and 2 meters. K4YPI is working full time as operator of the State C.D. RACES station. He will be responsible for aiding each county in West Florida in preparing its own RACES Plan. Port St. Joe: W4WEB added an RV-3 to his TR-3. Panama City: WA4IMC keyed K4VFY's station to 180K in the July CD Party. Port Walton: WA3-AP0/4 was appointed OBS, WB6KVA, WA4WKF and WA4WKG visited in the Santa Rosa Beach area. W4MMW has prepared an FB emergency communications plan for Okaloosa County. Have you joined the AREC? Milton: WFPN Net Mgr. K4NMZ vacationed in New York. Pensacola: W4ECY, K4BSS and K4LAN are regulars on QFN. K4SOI is experimenting with R/C boats. WA4WKL, is doing FB with traffic-handling. W4RUF is mobile with an SBE-33. WA4ILF made WAS on 6 meters. W4PAA is up to 301 countries confirmed. Traffic: (July) WA4EOQ 164, WA4WKL 158, K4BSS/4 157, K4VFY 145, K4VWE 137, WA4ECY 108, W4BVE 61, W4MLE 33, WA4JIM 24, K4NMZ 16, WB6KVA/4 12, WA4NRP 3. (June) WA4ECY 105, W4WEB 14.

SOUTHWESTERN DIVISION

ARIZONA—SCM, Floyd C. Colvar, W7FKK—Sec; K7NIY, PAM; W7CAF, RM; K7NHL, K7TNW. The annual Fort Tuthill Hamfest, sponsored by the Arizona Radio Council, was well attended, with K7VIS, of Black Canyon, getting the Swan 350 transceiver complete with accessories. The ARC should be commended on the fine way the hamfest was handled. The Arizona Amateur Radio Club is conducting code classes, with W7PCY as instructor. We regret to record the death of W7SNL of Jerome. A new Extra Class licensee is W7ZMD. K7NII reports keeping regular skeds with K7TQP and K5WXX on 144 Mc. WNTDAQ is active on 144 Mc. W7AYY is active on 50 and 144 Mc. The Arizona Amateur Radio Club was favored with a very fine slide and movie picture presentation of K7AWT's recent trip down the Colorado River on rafts. OES K7OFL is temporarily off the air while he is building a Schober Recital Organ, K7LDT, WA7BJF and K7YSE are active on 50 Mc. Congratulations to W7GX on getting the SR-34 transceiver at the ARRL National Convention. Traffic: K7NHL 160, W7FKK 34.

LOS ANGELES—SCM, H. G. Garman, W6BHG—Asst. SCM/SEC; John A. Vaidean, W6BNX, RAIs; W6BHG, W6BBO, W6QAE, PAMS; K6MDD, W6MLZ, W6ORS, K6EPT, K6LWV, K6WAH, K6YVN, W6WPF and W6BBO made the BPL for a grand total of 3939 messages, almost two-thirds of the total traffic 5726 reported this month. W6GYH probably would have made the BPL list also, but was on vacation. New appointments: K6KA as OO, K6NDD as OPS and PAM, W6BNX as Asst. SCM/SEC, OO and ORS, W6MLZ as PAM, WA6WKF as OPS. Endorsements: K5LDM and W6BHG. A new call is W6BNX, formerly WB6JGA/W4FOR. With a total of 979 K6EPT ssys traffic is slow! WB6BBO has 4 more rare old "bugs" for her collection, also added 3 spark keys. ASTRONET meets on 3885 kc. LSB Mon, through Fri, 8 to 11 P.M. PJT. All amateurs are invited to participate in ARIES (Amateur Radio in Experimental Satellite), which is sponsored by W6SD (San Fernando Valley Radio Club). WA6ZID now is attending USC on a scholarship. WB6AEL still QNIs even though the antenna mast rotted off, the antenna is only 10 feet off the ground and he has v.f.o. trouble. WA6WTX is back in operation again. There is lack of activity at W6PCP because of changing the



Accredited Member
National Home Study Council
good training doesn't cost
... It pays!

How To Get an

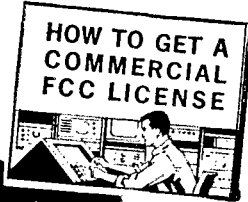

FCC License (Commercial)

An FCC License Or Your Money Back!

Completion of a CIE Licensing Course will prepare you for a First Class Commercial Radio Telephone License with a Radar Endorsement. Should you fail to pass the FCC examination for this license after successfully completing your course, you will receive a full refund of all tuition payments. This warranty is valid for the entire period of your enrollment agreement.

Increase Your Technical Knowledge

Get a government license plus an understanding of such electronic applications as computers... industrial electronics... radar... communications... and many more.

Get All 3 Booklets FREE!

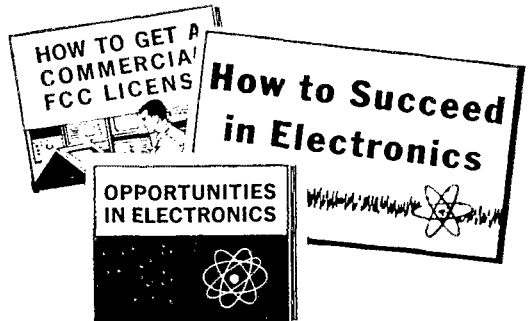

GET THIS HANDY POCKET ELECTRONICS DATA GUIDE

Free...

Puts all the commonly used conversion factors, formulas, tables, and color codes at your fingertips. Yours absolutely free if you mail the coupon in 30 days. No further obligation!

TO GET THIS
FREE GIFT

MAIL COUPON Within 30 Days!

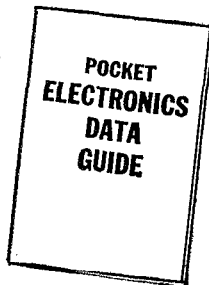

Cleveland Institute of Electronics

1776 E. 17th Street • Dept. QT-43 Cleveland, Ohio 44114

Please send Free Career Information Material prepared to help me get ahead in Electronics and a free copy of your "Pocket Electronics Data Guide".

CHECK AREA OF MOST INTEREST—

- | | |
|--|--|
| <input type="checkbox"/> Electronics Technology | <input type="checkbox"/> Electronic Communications |
| <input type="checkbox"/> Broadcast Engineering | <input type="checkbox"/> Industrial Electronics |
| <input type="checkbox"/> First Class FCC License | <input type="checkbox"/> Advanced Engineering |

Your Occupation _____ (Print Clearly)

Name _____ Age _____

Address _____ County _____

City _____ State _____ Zip _____

Cleveland Institute of Electronics

1776 E. 17th Street • Dept. QT-43 Cleveland, Ohio 44114

NEW!

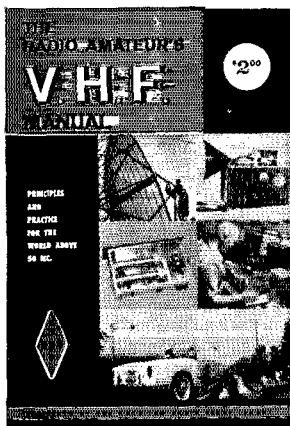

A new addition to the ARRL family of publications for the radio amateur, *THE RADIO AMATEUR'S V.H.F. MANUAL*, by Edward P. Tilton, is a book about things that work on v.h.f. It begins with the first history of v.h.f. ever written, and progresses through a discussion of the nature of the world above 50Mc., to receiving and transmitting principles, techniques and construction. The new *V.H.F. Manual* is profusely illustrated with numerous photos, charts and diagrams. Emphasis throughout is on tried and tested equipment and practice. *THE RADIO AMATEUR'S V.H.F. MANUAL* is an exciting new addition to the radio amateur's library.

\$2.00 Postpaid

U. S. A. Proper • \$2.25 Elsewhere

The American Radio Relay League

Newington, Conn. 06111

QTH. W6NKR is going up to the High Sierras. W6VUZ worked JA2HT from mobile in Lassen National Park. W6AM reports that his rhombic on the ten 140-ft. poles work better than when on 70- or 100-ft poles. K6EA is disgusted with the rig so is doing some rebuilding. W6NNA is planning a disaster drill. W6ORS is just about ready to go back to building again. W6PUZ heard KP4BPZ on 432 Mc., sigs were S6/7. WA6YKP finally finished homebrewing the 3-400Z linear. WA6- YMY is concentrating on 6-meter phone and 20-meter c.w. WB6BNP says that WA6KAW is in Rancho Los Amigos on sick leave from traffic nets. A little known fact is that Lou has been operating from a wheel chair. WA6SNK will be in the U.S. Army for 6 months, his Dad WA6SNJ and Mom WB6BNP will keep the gear busy. K6CYG is QSL Mr. for WA6LIM, who is now in the Canal Zone. WB6BDN has replaced his SR-150 with a Swan 350. The Eight-ball Net (EBN) meets Mon. through Fri. at 1515Z and Tue. through Sat. at 0130Z on 50.5 Mc. Southern California Net (SCN) meets daily at 0300 on 3600 kc. Traffic: K6EPT 979, K6YVN 881, WB6BBO 698, K6IWV 586, W6WPF 542, K6WAH 343, K6MDD 332, W6QAE 296, W6GYH 160, W6MLZ 121, WB6KKG 101, W6FD 85, W6BNX 83, WA6TWS 68, WA6WPX 67, WA6MXM 64, WA6WKF 55, K6LJ 54, WB6AKZ 46, K6LDM 39, WB6GGL 38, WB6FPQ 30, K6UMV 20, WB6RBH 18, WA6ZID 16, WB6AEL 15, WA6NUA 12, WB6GXI 11, K6HV 11, W6KMJ 10, WA6- WTX 10, W6HUJ 7, W6PCP 7, W6NKR 6, W6BHG 3, K2PHF/6 1, W6VUZ 1.

ORANGE—SCM, Roy R. Maxson, W6DEY—New AREC members are WB6MNN, Riverside, and WB6- WRG, Norco. A nice note was received from WB6OPA. CHOP at K6MCA. He is ex-K9UNC, WA4KPF. W6- JQB, Asst. SCM, has a new 14AVQ ant. vertical working FB. WA6CXB is the new treas. of C BAR C. He reports the 246 Net had 727 check-ins in 31 sessions with a traffic count of 112. W6VOZ headed east for a month and operated mobile. RM K6IME attended the SoCal Six meeting. With only a few hours notice the Orange County AREC furnished communications for the So. Calif Tennis Matches July 31, Aug. 1-2. Three locations were used with scores kept at a central office via ham radio. AREC members were W6VAA, K6LJA, WA6ALC, WA6DXJ, K6MJU, WA6YWN, W6NJJ, W6- DNA, K6OZW, W6WRJ, W6QAT and W6MRO. Thanks to WB6JAO and officers of the Tri-County ARA, Inc., for their nice bulletin and information on meetings. W6PJU and W6DEY visited WA6VUI and XYL Frances near Bishop while on vacation. Traffic: (July) K6MCA 1436, W6ZJB 671, WA6ROF 280, W6DNA 61, W6WRJ 46, WA6VUI 33, K6IME 24, W6CK 14, WA6CXB 10, W6- VOZ 9. (June) W6ZJB 393.

SAN DIEGO—SCM, Don Stansifer, W6LRU—The San Diego V.H.F. Club held its Fourth Anniversary meeting in Aug. with a program on Telstar. The Amateur Radio Public Service Corps held its second annual picnic Aug. 22 at El Monte Park near Lakeside. WA6- ZXJ caught a long-skip opening on 6 meters into the East Coast. The Palomar Club held a picnic for its August meeting. K6ROR has moved to a new QTH in Vista. W6NAT vacationed to Salt Lake City and the Grand Canyon. Orange SCM W6DEY and XYL W6PJU visited at the summer QTH of W6LRU/WA6VUI. The eldest son of W6LKC-W6YZV was married in August. WB6MXA, active on SCN, received a Section Net certificate. He is in Imperial County at Winterhaven. A visitor at the shack of W6YZV in Fallbrook was KL7- ESM. The San Diego area is in need of more active c.w. traffic men who can check in regularly on the Southern California Net on 3600 kc, at 0300 GMT daily. Traffic for San Diego on c.w. often must be cleared through Los Angeles area stations and then relayed down on v.h.f. because of a lack of regular c.w. traffic handlers. Traffic: (July) W6IAB 4576, K6BPI 4044, W6- YDK 3502, W6VWQ 969, WB6JUH 712, W6EOT 424, WB6GMM 316, W6BGF 105, K6LKD 20, WB6MXA 8. (June) W6EOT 324.

SANTA BARBARA—SCM, Cecil D. Hinson, WA6- OKN—RM: W7WST/6. W6YK sends a very nice report on his v.h.f. activities from Camarillo. Since Oscar is no longer the challenge, Bill has devoted his efforts to moonbounce on 144 and 432 Mc. After several frustrations, W6YK has a probable E-M-E contact with W6- DNG and is waiting for the tapes to provide the proof. Bill is interested in skeds with those who have similar activities, especially scatter and E-M-E contacts on c.w. or s.s.b. K6SHA has added an SR-150 and an HT- 33B linear to his plush ham shack. Casey now has 5 complete s.s.b. rigs. A TR-4 has been added to the ham shack at WA6OKN. WB6DPV reports he is now checking in on both SCN and RN6. WA6JBE has his Telerec "monarch" up and is trying to establish himself in DX circles. W6KZO has been working two jobs and has been on the air very little. Traffic: WB6DPV 84.

BARRY ELECTRONICS

Collins Mechanical Filter Sale: Collins #F455Q1-11V2, F455Q1-3W2, F455Q1-11-V2, 526-7466-009 (293-1127-00). Very limited quantities. **\$19.95 each.**

W2AU Quad. Bamboo — \$54.95. Fiberglass — \$99.95.

Audio Filter similar to FL-8. Mounts on desk or table. Allows simultaneous use of two headsets. No modifications. Simply plug into headset jack and plug headset in standard jack on unit. Complete ready to go. **\$2.50.**

Plate transformer: Pri: 115 VAC @ 60 CPS; Sec: tested @ 4,000 VCT @ approx. 500 Ma. In full-wave circuit (center-tapped), delivers 2,000 VDC @ approx. 500 Ma. In full-wave bridge circuit (not using center-tap); delivers 4,000 VDC @ approx. 250 Ma. Size: 5½" x 4½" x 6½". 23 lbs. **\$12.95.** Cat. #17-73. (Shipment via Railway Express or Truck collect for shipping charges).

Silicon Rectifiers: 800 to 900 PIV @ 1.5 Amps. @ **50¢** each; 600 PIV @ 1 Amp. @ **32¢** each; 400 PIV @ 750 Ma. @ **27¢** each; 400 PIV @ 400 Ma. @ **22¢** each. (Minimum order of 40 pcs . . . may be mixed). If you order fewer than 40 pcs, add 10% to price.

Sale: Silicon Diode: 1N3728. 400 PIV @ 400 Ma. **22¢.**

Eimac type HR-6 Heat Radiator Cap: 95¢.

WESTINGHOUSE MW XMTR

3 KW output. 2 to 20 Mcs. Xmtr. only **\$350.00** and up. Write or call for further details. (See picture)

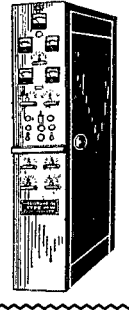

Vantron 300 Watt PEP GG Linear Amplifier: Brand new. Orig. ctn. W/blt-in 115 VAC @ 60 CPS. P.S. 10 thru 80 meters. Only **\$69.00.**

Johnson #115-2 Variable Capacitor. from 8 to 54 Mmf. 2 KV Peak. Only **90¢.**

Sale W.E. Model 255A Teletype Relays: \$2.95.

W.E. Model 215A Teletype Relay. \$3.95.

W.E. Model 314A (non-Adj.) Teletype Relay. \$5.95.

Sockets for any of the above relays: \$2.95.

B & W Deluxe Ceramic Rotary Coils. \$5.95.

General Radio #50A Variac (115 V.-40 A.). \$85.00. (X1'nt)

G.R. #50B Variac (220 V.-20 A.). \$115.00. (New)

Come visit us. Mon. to Fri. 9 to 5:30;
Sat. (Free Parking)
10 am to 2 pm. (Parking — 501 Broadway).

EXPANSION SALE

New third floor — now gives us 30,000 square feet to select and not so select Ham gear, transformers, relay racks, variable capacitors, meters, tubes, chokes, semiconductors, wire, power supplies, test equipment, lab supplies, scopes . . . Many in large quantity, some one of a kind. Some very unusual esoteric electronic items. We invite you to browse and make some fabulous buys for the coming dreary fall and winter months ahead.

Remember, we have the biggest diversified unused, first-quality TUBE stock in the United States. Best brands, highest quality at sensible prices. All mdse guaranteed (cost of mdse only). Ask for Barry, W2LN1. Mon. to Fri.: 9 to 5:30. Sat. 10 a.m. to 2 pm. Write for new #17 Green Sheet Catalog • Send 10¢.

BARRY ELECTRONICS DEPT. O-10
512 BROADWAY, NEW YORK, N. Y. 10012
WALKER 5-7000 (Area Code 212)

Enclosed is money order or check and my order. (Prices FOB, NYC. Shipments over 20 lbs. will be shipped collect for shipping charges. Less than 20 lbs. include sufficient postage. Any overage will be refunded. Fragile tubes shipped via Railway Express. 50¢ service charge for orders under \$5.00.)

Send 10¢ for Fall "Greensheet" catalog #17.

Send information.

Name Title

Company

Address

City State

New from Philco: an up-to-date handbook for **SSB** Communications

Comprehensive treatment of SSB Systems for the Radio Amateur. Sections of SSB Modulation, Transmitter Theory, Receiver Theory, and much more. Price, only \$4.50

Send orders with remittance to:
PHILCO TECHREP DIVISION DEPT LQ
P. O. BOX 10, FORT WASH., PA. 19034



CUBEX FIBERGLAS QUAD KIT

Based on the famous CUBEX MK III mechanical design. Kit includes 8 — 13 ft. Fiberglass Arms, 2 Cubex Quad End Spiders and 1 Cubex Boom-Mast Coupler. **\$59.95** COMPLETE KIT ONLY F.O.B.

WE INVITE CRITICAL COMPARISON! The CUBEX MK III and MK III-FG now available in multi-element models. Also single, dual and tri-band models. Write for FREE BROCHURE.

CUBEX COMPANY
P.O. Box 732, Altadena, California

"Your Friendly Supplier"

h THE
HALLICRAFTERS
SR-42 & SR-46
VHF
TRANSCEIVERS



The SR-42 provides full coverage of the 2 meter band and the companion SR-46 provides complete 6 meter band coverage. Both give you double the usual bandspread, through use of dual tuning ranges. Four transmitter crystal positions (1 crystal provided), plus external VFO socket. Power input 10-12 Watts. Also with Push-to-talk.

IN STOCK SR-42 \$189.95 Net
SR-46 \$189.95 Net

ALSO IN STOCK: MR-40 Mobile Mounting Kit for above units, including vibrator & DC Cord for 12 Volt Mobile operation. \$11.50 Net
HA-26 VFO for use with above. \$39.95 Net

"Used Equipment Special"
HALLICRAFTERS SX-101A \$194.95
HALLICRAFTERS HT-37 \$249.95
WRITE FOR LATEST COMPLETE LIST

Evans RADIO

P.O. BOX 312 FONE 603-225-3358 CONCORD, N. H.

VHF • UHF

CONVERTERS & PREAMPS

50 thru 432 Mc.

Write for Literature

PARKS ELECTRONICS RFD 2 Beaverton, Ore.

100 KC CRYSTAL BARGAIN!

U.S. Navy Surplus. Hermetically sealed standard octal base. Check or money order. No COD's or export orders please. Add 25c for postage and handling.

295

ELECTRONICRAFT, INC.

Box 13, Binghamton, N. Y. 13902

10-15-20M QUADS

*Pre-Cut *Pre-Tuned *Triband

2, 3 & 4 ELEMENT QUADS

FIBERGLASS OR BAMBOO

from **\$59.95**

- * ROTATE WITH TV ROTOR
- * HIGH F/B RATIO
- * VERY LOW SWR
- * LOW Q BROADLY TUNED
- * HIGH GAIN
- * EASY TO MATCH
- * LOW WIND RESISTANCE
- * ONE FEED LINE FROM XMTR FOR ALL 3 BANDS NO SWITCHING

WRITE DEPT. A

Skylane PRODUCTS

406 Ban Air Dr.
Temple Terrace, Florida
Phone 988-4213

WEST GULF DIVISION

NORTHERN TEXAS—SCM, L. L. Harbin, W5BNG—Asst. SCM; E. C. Pool, W5NFO, SEC; W5PYL, PAM; W5BOO, RM; W5LLR. The old saying "when it rains, it pours" has been brought to my attention more in the past two months than ever before. Field Day and three hamfests went by and I was unable to attend any of them. Most regrettable was the West Gulf Convention in Oklahoma City. This was the first convention I have failed to attend in more than nine years. The hardest part of not being able to attend these activities was listening to the amateurs returning home and talking about the wonderful time they had. A full report from Midland on the activities during the Sanderson Flood has been received and it is gratifying to know that many amateurs still are interested in rendering a public service in case of an emergency. Four amateurs from Midland traveled 160 miles with their emergency equipment to furnish communications from the flood stricken area of Sanderson. W5FDD, W5VOH, W5IKT, W5BSM and W5LFT went from Midland and W5LQV from Ft. Stockton and set up emergency stations at the Red Cross and Sheriff's Department centers. W5JSM has been appointed EC for Deaf Smith County. K5DEB is the new EC for Dallas County. K5VWJ has qualified as OPS. K5DNQ, formerly from Jandale, Tex., is now W8GRP and is in Akron, Ohio. Notice to Emergency Coordinators and other appointees: Please check your appointment date and send in your certificates for endorsement. Traffic: (July) W5CVB 113, W5VFM 94, W5EVS 49, K5DEB 36, W5LR 20. (June) W5CVB 97.

OKLAHOMA—SCM, Bill F. Lund, K5KTW—Asst. SCM; Cecil Andrews, W5MEX, SEC; K5DLP. The Electron Benders Amateur Radio Club of Tulsa is planning another school for future hams. W5UYQ and K5-VVQ each has a new TR-4. W5MJA added a new TX-62 to his station. Ex-WN5JOJ is going for his Tech. Class ticket. W1ALP, SCM of Eastern Massachusetts, writes to advise that his minister Rev. Phillip A. Muth, K1TXF, ex-W0ETN, is leaving his section and will be assistant professor of history at Oklahoma City University. We will be real pleased to have him here in Oklahoma. The West Gulf Convention held in Oklahoma City July 9-10-11 went off real well. With officials from ARRL Hq. and the FCC present I think that everyone was well informed of the new proposals. I missed my good friend Les Harbin, SCM of Northern Texas, who was not able to attend as he was recovering from a heart attack. At this time I would like to thank my assistants and those who helped me in carrying out my job as SCM for Oklahoma. I have enjoyed the last two years as your SCM and it has been a deep pleasure to work with all. I hope that you will give the new SCM, whoever he or she may be, the support that I have received. Again I want to say thanks and it has been a pleasure. Traffic: K5TEY 438, W5NBI 100, K0BWN/5 30, K5KTW 28, K5DLP 27, W5MFX 20, W5-PML 16, K5OCX 14, K5MTC 11, W5BXX 7, W5-KZA 4, W5EHC 2.

SOUTHERN TEXAS—SCM, G. D. Jerry Sears, W5-AIR—SEC; K5RDP, PAM; W5ZPD, RM; K5ANS. Newspaper, radio and TV are giving excellent publicity to the Honduras Project. Many amateurs are now taking part in the Honduras Project helping with communications between many students and trained medical people sent there to inoculate all persons possible against several contagious diseases. The first group was sent to Honduras by the Riverside Baptist Church of Houston and is now being joined by helpers from everywhere. Stations known to be keeping regular schedules with Steve from Houston, using the call HRIEZY in Honduras, are W5CGT, W5LQP and W5ZPD, who advises schedules are on 14,265 kc, at 1245Z and 0030Z. We hope to get a complete report from Steve (his Houston call sign unknown at this time) when he returns home. Aug. 23 marked the 10th Anniversary of the formal dedication of the new Houston Amateur Radio Club building. Congratulations to W5ABY, W5GK and W5GQC, who are among the many new Extra Class licensees. W5AQN is now operating from a new shack, K5EJL just completed remodeling and K5RDP is putting the finishing touches to a fancy new shack. W4-DAA is our new EC in Kingsville and Kleberg County. W5ABQ sent his report on ARRL Form 1 of 1926 or 1928 vintage. Good thing he added some postage to the 1¢ postal card. Come on, gang in Southern Texas, let's hear from you. Your activities should be included in this column. Traffic: W5ZPD 23, W5ABQ 18, W5AIR 6.

CANADIAN DIVISION

ALBERTA—SCM, Harry Harrold, VE6TG—SEC; VE6FK, PAM; VE6PV, Asst. PAM; VE6SS, ECs; VE6SA, VE6SS, VE6AFJ, VE6HB, VE6ALL, ORS;

YOU CAN'T BEAT THIS KIT FOR VALUE!

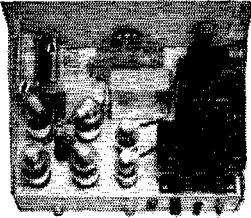

**P & H
LA-400C
LINEAR AMPLIFIER
800 WATTS PEP
ONLY \$179.95***

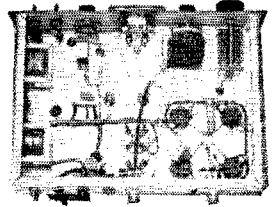

IT'S EASY TO ASSEMBLE AND WIRE — QUALITY THRU AND THRU

The P&H LA-400-C is not an ordinary kit, because a lot of the assembly has already been done for you. The plate transformer, filter choke, plate tuning capacitor etc. are mounted. Plate coil and band switch are assembled and mounted. Output loading capacitor network is assembled; in fact — about all you have to do is mount small parts, mount sockets and finish the wiring. As for performance — just ask anyone who uses an LA-400-C. Just compare his signal with the so-called "talking kilowatts" — it will be mighty hard to tell 3 DB difference. The difference in cost will pay for a good scope, plus a top notch receiver. One other point — Where else can you get a warranty such as P&H gives you on the LA-400-C ?

The 80 thru 10 meter band-switching pi network is designed for 800 watts PEP SSB, 400 watts CW, FM or FSK and 230 watts Linear AM (controlled carrier) or 185 watts (constant carrier) with 50-70 ohm output. Popular 100 watt SSB exciter require no swamping or matching networks to drive the low Z untuned input. Grounded grid circuit uses four 1625's or 837's on customers request. Meter reads RF drive, plate current, RF amps output. New modern compact 9" X 15" X 10 1/2" gray cabinet also contains power supply using 816's. TVI suppressed, Parasitic Free.

LA-400-C Wired & Tested \$219.95
Slightly higher West of Rockies.

**ONE YEAR WARRANTY
ON ALL PARTS AND TUBES !**

P & H ELECTRONICS INC.
424 Columbia • Lafayette, Ind.

QUICK QUIZ

- Q. On what frequencies and under what conditions may amateur maritime mobile stations operate?
- Q. Is a photocopy of an amateur station license valid during mobile operation?
- Q. How do U.S. amateurs obtain authorization to operate in Canada?
- Q. Under what conditions may applicants for amateur licenses take examinations by mail?

Score 100%? If not, better get the 54th Edition of the License Manual. Complete FCC and International Rules and Regs governing amateur radio . . . detailed explanations of amateur licensing . . . separate study guides for all amateur operator exams. The up-to-date license and regulations manual for all, newcomer and oldtimer alike.

The ANSWERS?

You'll find them all in . . .

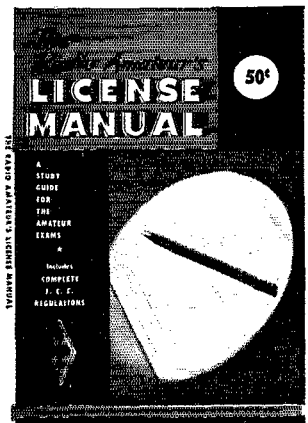

50 cents postpaid

THE AMERICAN RADIO RELAY LEAGUE

Newington, Connecticut 06111

TELETYPE

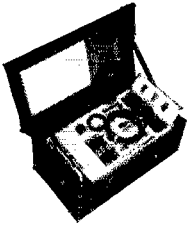

PULSE GENERATOR AND POLAR RELAY TEST SET BRAND NEW I-193C

U. S. Gov't. Surplus

- Generates perfect 22 millisecond (60 wpm) element pulses for adjusting radioteletypewriter transmitter keyers, receiving converters, repeaters, etc. for zero bias.
- Tests static and dynamic performance and permits precise adjustment of any 215 or 255-type polar relay having ten pin or eight pin two-row, or octal or noval bases.
- No internal power required. Operates from any loop supply, rectifier or "B" battery, capable of supplying 115 to 130 volts DC at 25 ma.
- Contains complete tool kit, including set of 12 thickness gauges, 265C burnishing tool set, two 340 type wrenches and a jeweler's file.
- Will mount in standard 19 inch rack panel, if desired.
- Supplied complete with tools, four 255-type polar relays (two spares), two technical manuals, three different power input cord sets, spare parts and fuses.
- Cost government over \$600.00.

BRAND NEW

F.O.B. Harrisburg, Pa.
Crated for export. Shipping weight: 100 lbs.
(Ohio residents add 3% sales tax)

TELEMETHODS INTERNATIONAL

3075 E. 123rd Street Cleveland, Ohio 44120

\$29.95

BE SMART—BUY AND SAVE ON THE PLAN THAT FITS YOUR POCKETBOOK

- Plan 1—Best terms—no finance charges—no trades!
- Plan 2—Best Cash Price—No Trades!

"Don't Delay—Write Today"

Drake-Hallicrafters-Hammarlund-Johnson
National-SBE-Swan, etc.

WILLARD S. WILSON, INC.

405 Delaware Ave., Wilmington, Delaware 19801
Est. 1920 Willard-W3DQ Tel. 302-654-5344

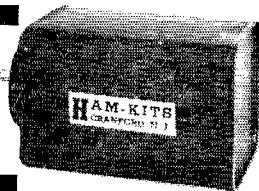

DUMMY LOAD

52 ohm, non-reactive
film oxide R.F. unit, All
band, all power to 1 KW.
SWR 1.2 to 1.

Kit \$7.95 postpaid.
Wired, add \$2

HAM KITS
Box 175 Cranford, N. J.

IN LOTS
OF 1000
2 COLOR
2¢ EACH

IN LOTS
OF 500
2 COLOR
2 1/2¢ EACH
MIN. ORDER 500 CARDS

WB2NVJ

WB2MTP

NOW YOU CAN

Design

YOUR OWN

QSL CARDS

A SIMPLE NEW
WAY TO DESIGN
QSL CARDS, YOU
DESIGN AND WE
PRINT IN TWO
COLORS YOUR OWN
DISTINCTIVE CARD
JUST SEND 50¢ IN
COIN FOR THE NEW
MODULE-QSL-DESIGN
KIT CONSISTING OF
LETTERS, NUMBERS,
REPORT BOXES, AND
ILLUSTRATIONS. SEND

TODAY FOR YOUR UNIQUE KIT, CUSTOM
PRICES AND PRINTED SAMPLES TO...

THE ROLAND COMPANY

1270 AVE. OF AMERICAS, NEW YORK, N.Y. 10020

VE6BR. OPSs: VE6CA, VE6PY, VE6HM, VE6SS, VE6BA, VE6ADS. OOs: VE6HM, VE6NX, VE6TW, VE6TY. OBSs: VE6HM, VE6AKV. OESs: VE6DB, VE6AKV. Fellows, don't forget to help out with the Boy Scout On-the-Air Jamboree Oct. 16 and 17. Our PAM reports that APN will go on its winter sked in October, bands permitting. Don't forget to do your part with the AREC Provincial Test in October. The Water-ton-Glacier International Hamfest was well attended this year, from as far away as New Zealand. Also the hamfest was honored with the presence of Seventh District Director Robert Thurston and Vice-Director Rex Roberts, Ed Titton, from Headquarters, gave a very timely talk on v.h.f. Well, after five years it has happened! We are going to have an EC in Edmonton. By the time this issue comes to you most holidays will be over, except for mine. I will be away for the month of October. Don't forget to support your ARLA, traffic: (July) VE6HM 97, VE6FK 16, VE6ALL 10, VE6SS 8, VE7ADK 7, VE6TG 7, VE6BL 3, VE6US 1. (June) VE6HM 126.

BRITISH COLUMBIA—SCM, H. E. Savage, VE7FB—OK Falls was the gathering place for the Okanagan International Hamfest. Fifty-one American, 85 Canadians and a good overall total of 208 came with tent, truck or trailer. Our furthest visitor was VE8AH and his XYL of N.W.T. Radio CKOK of Penitence gave the International Hamfest many spot announcements. Much thanks for this very successful hamfest goes to Pres. VE7BH and his crew. Many have asked me where VE7IR is. In the July '65 report he signed the following calls: YU7LAL, G8SFD, P8SFD, 3V81R, VE7IR/3V8, now VK2IQ. Little Eva, VE7BBB, has been collecting new awards; a bowling ball for 638 points, also LP records. VE7DH has a many-element beam for 2 meters and hopes VE7SH, Edna, can hear him. VE7SH hopes for a sewer pipe antenna to hear him. Whilst this goes on out in Burnaby VE7BMC's tower is being raised. VE7BOH went up 60 feet. VE7-BHH did only 40 feet. VE7KZ, an old member of BCEN, has a complete change of transmitting equipment with only an 80-meter antenna and will be Vancouver's outlet. VE7BQB, Nanaimo, is doing well on BCEN for the Nanaimo District. VE7OM, our SEC, is coming along very nicely. VE7JI sure is having a rough time in and out of the hospital. You have heard and read about the soft fruit crop being destroyed by last winter's storms. Edna and I visited VE7BJC who has a large spread of peaches and this fall the power saw will take them out. VE7AC and others also are badly hit. We are happy to report our section membership is over the three hundred mark and I hope heading for four hundred before the end of 1965. Traffic: VE7BQB 160, VE7BH 73, VE7AC 16, VE7BGW 11, VE7DH 10, VE7BOQ 9, VE7BHW 7, VE7BMN 6, VE7BJC 5.

MANITOBA—SCM, John Thomas Stacey, VE4JT—Highlight of the month was the MAARC-sponsored meeting to welcome W1HDQ. Thirty-nine attended, with the v.h.f. gang well represented. We regret to report the passing of VE4RO. Our SEC, VE4OL, reports 71 members but seeks other AREC members. VE4GN, at Thompson is invading 80 with an ART-13 and an R1155A. VE4AO is DXing on 20-meter s.s.b. with a KWM-1 and a TA-83 combo. VE4EP, at Rivers, is QRL as a pilot on RCAF DC3s but keeps up traffic work on MTN. VE4YW still is doing good work on 6. Moonbouncers VE4HA, VE4JX, VE4QX and VE4RE tried hard but no luck. VE4QX is the latest on RTTY. VE4JW sent his OO certificate in for endorsement for four straight years. VE4HI now is located in Boissevain and is a new OES for that section. The new PAM for 75 is VE4JQ, at Dauphin. Former PAM VE4QJ now is an OBS and transmits Official Bulletins Thurs. on 3760 kc. at 1845 local time. Support the traffic nets, phone on 3760 kc. at 1900 local daily and c.w. on 3635 kc. at 0100Z daily. This column lives on station reports. Please get them in by the fifth of the month. We need an OO for 6 meters for modulation and frequency checking. Traffic: VE4JT 133, VE4QX 86, VE4EI 13, VE4UX 10, VE4JA 9, VE4NE 9, VE4XN 9, VE4SC 8, VE4EF 7, VE4JY 6, VE4QD 6, VE4UM 4, VE4GB 2, VE4PE 2, VE4GE 1, VE4PA 1.

MARITIME—SCM, D. E. Weeks, VE1WB—Asst. SCMs: A. E. W. Street, VE1EK and R. P. Thorne, VO1EL. SEC: VE1HJ. Deepest sympathy is extended to the relatives of VO1BU (ex-VE1AHY), who has joined the ranks of Silent Keys. Congratulations and best wishes to VE1AI and his XYL on their recent wedding. Congratulations to VO1s AX, DA, GW, GS and HB on passing their A-3 exams. VE1AQB is a new call from Sussex. VE2UX (ex-VE1YG) is now located at Bathurst. VO1EC and VO1FX are new members of the HW-12 Club. Congratulations to VE1ANX, the XYL of VE1GC, on passing her A-3 exam. Sadie and her OM recently acquired a new NCX-3. New appointments include VO1AE and VO1ET as OOs, VO1FX as PAM, VO1BR as RM, VO1AO as OES. What? You don't know what the above initials represent? Well,

A MAJOR ADVANCE IN POWER TRIODES SINECO TUBE TYPE 572B

Using a revolutionary filament made from **thoriated tungsten-rhenium wire** developed by the **Rhenium Division of Chase Brass & Copper Company**, SINECO tube type 572B is guaranteed to withstand 300g shock loads and operate for more than 2000 hours. Old style thoriated tungsten filament type power triodes exhibit erratic operating lives from several thousand hours down to only several hundred and have been so fragile they could not be given a shock rating. As the curve below shows, in actual life tests the 572B has shown no deterioration in peak emission after 10,000 hours of operation, an amazing fact when related to the performance of old style power triodes that have no rhenium content.

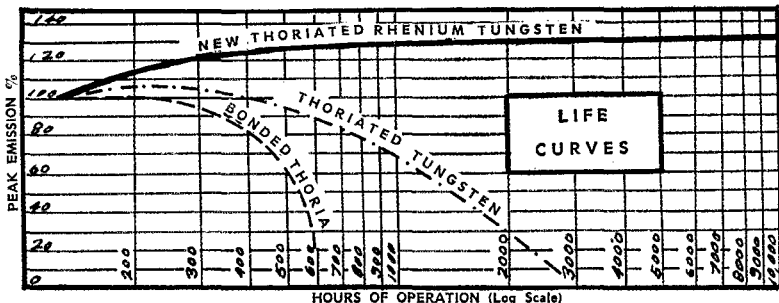

Scientific Instrument Research & Development Company

525 LEHIGH AVE., UNION, NEW JERSEY

Phone MUrdock 7-5550

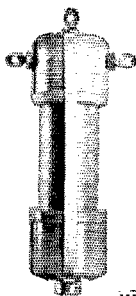

W2AU 4-PURPOSE BALUN

Only 6½ Oz.

2 KW P.E.P.—\$12.95

... with built-in lightning arrester—center hang-up hook for inverted vees, doublets, etc., eliminates center insulator—broadband 3 to 32 Mc. rated 2 Kw. P.E.P.—Two models: 1 to 1 Model goes from 50 or 75 ohm UNBALANCED coax, to 50 or 75 ohm BALANCED beam or antenna—1 to 4 model goes from 50 to 75 ohm UNBALANCED coax to 200 or 300 ohm BALANCED load.

Also Designed for Quads!

W2AU Super Fiberglass Quad \$99.95
W2AU Korean Bamboo Quad \$54.95

UNADILLA RADIATION PRODUCTS
Unadilla 1, N.Y.

FREE GIANT NEW CATALOG

100's OF BIG PAGES
NOT IN
ANY OTHER
CATALOG

100's OF BIG PAGES
CRAMMED WITH SAVINGS

TOP VALUES IN
POWER &
HAND
TOOLS

SAVE UP TO
50% ON
CHOICE
KITS

EVERYTHING
IN HI-FI
AND
STEREO

TUBES, PARTS
ETC. AT
LOWEST
PRICES

SAVE ON CAMERAS,
FILM &
PHOTO
EQUIPMENT

BURSTEIN-APPLEBEE CO.

Dept. QT, 1012 McGee, Kansas City, Mo. 64106

Rush me FREE 1966 B-A Catalog.

Name

Address

City..... State.....

Please be sure to show your Zip No.....

**SEND
FOR IT
TODAY**

FREE

*Faster
CW-*

**BETTER
READABILITY**

Preferred by better operators

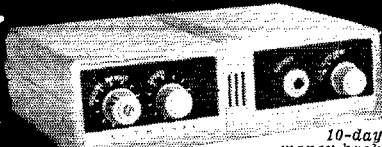

\$69.50

10-day money back guarantee. Budget payments

AUTRONIC—the finest, 10 matched transistors, 10 diodes. Rugged, no relays, tubes, heat. More energy & punch in CW signal. Minimizes keying clicks. Approved for FCC exams. Perfect self-completing dots, dashes, spaces. Smooths erratic fist. Speaker & phone-jack for monitor or practice. 8 to 60 wpm, semi- or fully-automatic. Use in any position, compact, lightweight. Unaffected by vibration or gravity. Also try the companion AUTRONIC KEY—\$19.95. Free brochure.

ELECTROPHYSICS CORP. Since 1929

898 W. 18th St., Costa Mesa, California



CONVERTER SALE

New series 300 with 3 VHF-UHF transistors, crystal-controlled oscillator, tuned I.F. stage and low noise mixer. One microvolt sensitivity. More than 30 high quality parts carefully assembled and tested. Measures only 3" x 2 1/4" x 2". Operates at 12 volts DC 4-5 ma. Available in the following models:

	Model	Input mc.	Output mc.	Price
2M	300-D	144-148	50-54	\$12.95 ppd.
	300-E	144-145	6-1.6	\$12.95 ppd.
	300-F	144-146	28-30	\$12.95 ppd.
	300-Q	144-148	14 18	\$12.95 ppd.
6M	300-B	50-51	6-1.6	\$12.95 ppd.
	300-C	50-54	14-18	\$12.95 ppd.
	300-J	50-52	28-30	\$12.95 ppd.
20M	300-G	14.0-14.35	1.0-1.35	\$11.95 ppd.
CB	300-A	26.965-27.255	1.0-1.29	\$11.95 ppd.
WWW	300-H	5.0	1.0	\$11.95 ppd.
Int'l.	300-I	9.0-10.0	6-1.6	\$11.95 ppd.
CHU	300-K	7.3	1.0	\$11.95 ppd.
CHU	300-L	3.35	1.0	\$11.95 ppd.
Marine	300-M	2-3	6-1.6	\$11.95 ppd.
Aircraft	300-N4	121-122	6-1.6	\$13.95 ppd.
	300-N5	122-123	6-1.6	\$13.95 ppd.
Fire, Police etc.	300-P	155-156	6-1.6	\$13.95 ppd.

All above converters are supplied with Motorola type connectors. For two SO-239 connectors instead, add 75¢

For prompt shipment of stock models include postal money order or cashier's check. Special models shipped within six weeks. Personal checks must clear before shipment. For C.O.D.'s include 20% deposit. New York City Residents add 5% sales tax. New York State residents add 2% sales tax.

VANGUARD ELECTRONIC LABS

Dept. S-10

190-48-99th Ave.

Hollis 23, N. Y.

brother, it is time you became more familiar with your ARRL field organization! The ARPC Net still meets Sun. at 1830 ADT on 3750 kc. All are welcome. VE1ARJ, the jr. operator of VE1OM and VE1WV is active on 3.5 Mc. Congrats to VO1BD and XYL: New jr. operator, VO1AQ and VO1HC are active on s.s.b. VO1DL has moved to Battle Harbour, and VO1GV to St. John's, Traffic:—(July) VE1OM 15, VE1ABS 13, VE1AEB 10, (June) VE1HE 13, VE1OM 11, VE1ABS 9, (May) VE1OM 20, VE1ABS 8.

ONTARIO—SCM, Richard W. Roberts, VE3NG— I am sorry to have to list VE3BZP, of Brantford, as a Silent Key. Art will be missed at the conventions with his little wooden cut-outs. Our sympathy to Eleanor and family. VE3BWM now resides in Goderich. VE3-EUM will speak at an AREC Forum in Sudbury at the Ontario Division Convention Oct. 2. The SET will be held the second week in October. ECs should get ready and have their members "on the ball" this year. Add to your list of club bulletins the *Solid State* of the Cooksville ARC. CJTH is Peter Denyer, 3511 Ivernia rd, Cooksville. The club will exchange papers with other clubs. VE3ABG is on 160 meters and looking for QSOs. As of Mar. 31 this year the Ontario Regional DOT Office showed 4149 station licenses issued in Ontario. The total for Canada was 11,280 station licenses (amateur), a small increase (8%) over last year. VE3GG, of Willowdale, is in the Branson Hospital in North York and will be there for some time. Cards would be very welcome. Mike admits to age 84. Appointment holders, check the date on your certificate and if endorsement is due, send it to me soon as possible. C.W. operators are urged to call into local nets. There is much traffic to pass and you are needed now. VE3 stations would do well to listen up in the American band for VEs vacationing in the U.S.A. While your SCM was in Maine I heard many VE3/W1, etc., calling any VE3 near 3800 kc. but without success. VE3OZ of North Bay also is a Silent Key. Traffic: VE3NG 133, VE3BI 106, VE3-CVR 96, VE3GI 82, VE3AWE 58, VE3DPO 58, VE3-BTV 37, VE3DU 37, VE3BUR 34, VE3EHL 32, VE3-DVE 31, VE3BI/2 29, VE3TT 27, VE3HFV 26, VE3ETM 23, VE3FGV 23, VE3AUU 19, VE3CFR 18, VE3EBH/ VE2 18, VE3AGQ 15, VE3EBC 15, VE3BWM 12, VE3-DWN 9, VE3DH 3.

QUEBEC—SCM, C. W. Skarstedt, VE2DR—Asst. SCM: Claude Dubergier, VE2ALH. We have a new SEC, VE2AAH. All ECs are reminded to send their monthly reports to him to allow him to report promptly to ARRL. The annual congress of RAQI at Louiseville was a great success. Meetings and social events were well attended by ARRL officials. Director Eaton, VE3CJ, VE2BK and VE2RE enjoyed meeting our French contreres. W2TUK, Director of the Hudson Division also was present. At elections, VE2AOS became president and VE2ANY was elected vice-president. VE2AUU presided at an AREC meeting which was well attended and of great interest. Surplus 2-meter transmitters which have become available were on display. VE2KQ got a Swan transceiver. VE2ANY and his charming XYL spent three weeks in Ireland. VE2ONB, on board the HMCS *Gatineau*, visited Montreal. VE2-WM now is active at a new QTH, Mont Joli, and retains his EC appointment. The two National Emergency Calling Frequencies for Canada are 3755 and 14,140 kc. VE2BPT is the new EC for Bromo and Sheffield. VE4IG is a good outlet for VE8 traffic. He is the new net manager of the Trans-Canada AREC Net. VE2-BTD wants skeds on 2 meters. VE2AGI again is mobile on 75 and 2 meters. A DX feud exists between father and son, VE2AUH and VE2ANK, with the latter probably having the edge. Traffic: VE2XT 624, VE2DR 127, VE2AGQ/3 89, VE2OJ 84, VE2AUU 80, VE2BOC 40, VE2EC 35, VE2BRT 25, VE2CP 11, VE2WMM 4.

SASKATCHEWAN—SCM, Mel W. Mills, VE5QC— How about it you amateurs. Who could volunteer some interesting station reports? Appointment applications welcomed too! We sometimes wonder if VE5s might not be restricted to c.w. if incapable of writing and filling out their logs! Traffic: VE5LA 146, VE5HP 38, VE5BO 9, VE5OB 9, VE5KZ 8, VE5YR 6, VE5CB 4, VE5FP 2, VE5TP 2.

A Tale of Tornadoes

(Continued from page 92)

WA9AJF tells us he did a lot of listening to Indiana nets during the emergency and was greatly impressed with the way they handled things. He says that one NCS, when told that President Johnson was visiting a devastated area, said "Fine, but tell him if he has traffic he must wait his turn."



NEW!
THE IMPROVED NIKEY
Now with ball bearing pivots. The only key especially designed for use with all types of Electronic Keyers. Independent Dot-and-Dash Levers make your fist sound "Truly Automatic." Standard Model \$17.95, Deluxe Model \$19.95. Check or Money Order.

THE PRODUCTIVE TOOL & MFG. CO., INC.
9 Market Street Stamford, Conn.



Model 525L

NEW DUMMY ANTENNAS

Gentec Dummy Antennas permit transmitter adjustments under electrical conditions duplicating actual antenna conditions, but converting and dissipating electrical power as heat, preventing radiation and eliminating TVI, QRM and associated problems. Transmitters readily peaked for top DX operation.

SPECIFICATIONS

Price	\$11.95	\$12.95	\$19.95	\$21.95	\$1.95	\$2.25
Model	525	725	525L	725L	507	707
Impedance (ohms)	50	70	50	70	50	70
VSWR (DC to over 250 Mcs)	Less than 1.1		Less than 1.05 to 1.00			
Power Ratings	125 Watts		Steady State		7 Watts	
	250 Watts		ICAS		Steady State	

Terms: C.O.D. plus postage or ppd in U.S.A. when check included with order.

Write for Free Literature

GENTEC INCORPORATED, P.O. Box 233, Raritan, New Jersey

Smooth out Communication Problems with —

THE NEW C-P BROADBAND **SUPER STATIONMASTER**[®] BASE STATION ANTENNA



Watch this publication for complete details in the very near future. Communication Products Company, Marlboro, New Jersey—Tel. (201) 462-1880

DIVISION OF PHELPS DODGE ELECTRONIC PRODUCTS CORPORATION

WANTED • WANTED • WANTED

AIRCRAFT RADIO SETS: Collins: 51R - 51X - 51Y - 51V - 51Z
Bendix: T-21; R-21; DFA-70; RA-18C; MK-7; GSA-1

TEST SETS: ARC, Boonton, Collins, Hewlett-Packard, Bird, Textronics

LIGHT WEIGHT RADIOS: Lear - Narco - Bendix - Motorola - ARC
(including parts & accessories) • Headsets, Microphones, Antennas
G. duBord, Box 105, New Haven, Conn. Phone: 865-0164

WANTED • WANTED • WANTED

TV CAMERA

We have the lowest prices and complete stock of all components for making your own Ham TV or closed circuit TV camera plus exclusive VANGUARD printed circuits and incredibly low prices on F1.9 lens with focusing mounts. Complete ready-to-operate cameras also available at the lowest prices you'll ever find. For more information, price list, and photos, send 19c coin or stamps.

VANGUARD ELECTRONIC LABS
190-48-99th Ave.

Dept. S-10
Hollis, N. Y. 11423

FREE! HOW TO IMPROVE YOUR TWO-WAY RADIO!

The right communications microphone may double the talk power of even the finest transmitters! Learn how unwanted noise can be eliminated—reliability improved—intelligibility increased by proper microphone selection.

Write for our helpful free booklet today!



ELECTRO-VOICE, INC., Dept. 1052Q
631 Cecil Street
Buchanan, Michigan 49107

Please send the free E-V booklet on choosing communications microphones. I am interested in the following areas of two-way radio: Amateur Aviation CB Business.

NAME _____

COMPANY _____

ADDRESS _____

CITY _____ STATE _____

A NEW MOBILE CONCEPT

MOBILTRANS 40

Complete 40W Transmitter and Receiving Converter in a Single Unit Including Power Supply!

40/75/160

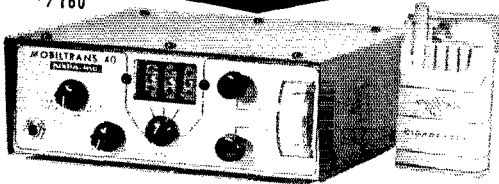

LOW COST • NEW DESIGN

MOBILTRANS provides the amateur with a low cost mobile installation utilizing the existing car radio for receiving. New design provides exceptionally low battery drain.

- Modulated carrier amplitude controlled by voice.
- Stand-by drain less than 300 ma at 12 volts.
- Contains 9 transistors, 6 diodes, one tube.
- Available for either 40, 75 or 160 meters.
- Accessory coils available for band change.
- Three position crystal selector (FT-243 type).
- Operating wt. 5 lbs. Size: 2 1/2" H, 8" W, 8 1/4" L.
- For 12 volts negative ground ONLY.

\$99.50

For Detailed Brochure, Write or Wire:

justin, inc.

BOX 135, SAN GABRIEL, CALIFORNIA



I can give you personal service on helping you select better gear per dollar for your operating pleasure. Over 30 years' experience. Big trades, easy terms. Used bargains.

VAN SICKLE RADIO SUPPLY CO.
Gene Van Sickle, W9KJF, Owner
4131 N. Keystone Ave.
On the northeast side of Indianapolis 5, Indiana

CQ de W2KUW

We require the following tubes:

833A • 304TL • 4-250 • 4-400
250TL • 450T • 4X500A • 4CX5000A
Others purchased at highest prices. Collins & Bendix Radios & Test Gear needed. 171-51X-390A-ARC-GRC-UFM-URM-USM et al.

TED DAMES CO. • 308 Hickory St., Arlington, N.J.

MARIN AMATEUR RADIO SUPPLY

COMPLETE STOCK ALL BRANDS
BUY & SELL USED

70 Woodland Avenue
San Rafael, California 94901

state with tornadoes in Jefferson County. Responding to W9AYK's call for assistance on the Badger Emergency Net, K9KAA and W9RXJ drove 60 miles to the scene, under police escort, and provided emergency communications into the net. W9DHF and K9MJM also aided places in the west central part of Jefferson County.

* * *

The above does not begin to tell the full story, nor list all the participants. Over 40 detailed reports had to be studied carefully, correlated, synopses made eliminating all but the salient facts, and published material and newspaper clippings studied. The end result of a full week's work leaves us with a feeling of inadequacy in expressing fully our admiration for the hundreds of amateurs who took part in these emergency activities. With all our condensation, the account is inordinately long, and we hope those who were active but whose calls do not appear above will bear with us if we put them on our public service list here at headquarters and see that their efforts are duly recognized. Public service is its own reward, for the most part. We congratulate and salute all of you who participated as we chalk up another "well done" for amateur radio public service.

EST

ARPS

(Continued from page 61)

communications from the starting and finish points as well as from various points along the 50 mile canoe course. Over 600 messages were handled, and the 2-meter equipment was given a good test. — W4APFQ, EC Owensboro, Ky.

ARPC members in Saginaw, Mich, were requested to provide communications for the Knights of Templar parade and three-day convention. Six-meter mobiles, walkie-talkies and base stations were used. The amateurs relayed requests for courtesy cars and kept the drill field and hotel in constant contact. During the parade, the walkie-talkies were used to keep doctors in touch with ambulances stationed along the parade route. — W4SGRI, EC Saginaw, Mich.

On June 6, members of the Mankato Area Radio Club provided communications for the annual parade in Janesville, Minn., using six-meter f.m. units extensively. Nine amateurs operated. The event provided routine operating experience and a little publicity for the amateurs. As in all planned operations, something happened. W0TCK, Minn. SCM, coasted into town with a broken fan belt and was assisted in obtaining a replacement by the other amateurs. — W0TCK, SCM Minn.

Forty-one SECs reported for June, representing 17,317 AREC members. This is an increase of 5 SECs and 371 AREC members over last June. Those Sections reporting were: N.N.J., N.C., Ind., Iowa, Nebr., NYC-LI, Los A., Miss., R.I., Alta., Sask., E. Pa., B.C., Man., La., W.N.Y., Del., Ga., S.F., Hawaii, E. Mass., W. Pa., Ariz., W. Fla., Kans., Wisc., Maine, Mich., Ala., E. Fla., Wash., Nev., Ohio, Utah, Minn., Mo., Ont., Ark., Va., Colo., S. Dak., Okla.

At the half way point for 1965, we have received a total of 247 SEC reports from 50 different sections. This is an increase of 2 sections and 17 reports. Those sections at the 100% mark so far are: E. Mass., Ariz., Maine, Mich., Ala., E. Fla., Wash., Nev., Ohio, Utah, Mo., Ark., Va. Colo., S. Dak., Okla., N.N.J., N.C., Ind., Iowa, NYC-LI, Los A., Alta., Sask., E. Pa., Man.

Your section isn't listed above and you think it should be? We'll gladly let any SEC know what reports he's missing, and upon receipt will credit him with that report. C'mon fellows, let's get those reports in!

EST



— to GREATER Efficiency!

NEW C-P BROADBAND **SUPER STATIONMASTER**[®] BASE STATION ANTENNA

Soon to be announced—the new, higher-performance broadband antenna by C-P. Communication Products Company, Marlboro, New Jersey—Tel. (201) 462-1880

DIVISION OF PHELPS DODGE ELECTRONIC PRODUCTS CORPORATION

GET ON 432 MC

1. Model 1432—VARACTOR TRANSMITTING FREQUENCY MULTIPLIER, 144 to 432 mc, up to 12 watts output, no power supply required, \$64.95 wired and tested.
2. Model 4314—NUVISTOR RECEIVING CONVERTER, 432 to 144 mc, low NF and high sensitivity, \$44.95 wired and tested, matching power supply available.
3. Model 431A—432 MC NUVISTOR RF PRE-AMP, two 6CW4's in cascade, built-in power supply, \$19.95 wired and tested.

See these and more at your local distributor or send for descriptive technical bulletins. All units shipped FOB Denver. VHF ASSOCIATES, P.O. Box 22185, Denver, Colorado 80222

FM EQUIPMENT SCHEMATIC DIGEST

A comprehensive collection of Motorola schematic diagrams covering low band, high band and 450 Mc. equipment, manufactured between 1949 and 1954. Crystal formulas, alignment instructions and a wealth of technical data included in 92 pages.

PRICE \$3.95 PPD

TWO-WAY ENGINEERS, INC., 1100 Tremont, Roxbury 20, Mass.

QST ADVERTISERS

“Advertising is accepted only from firms who, in the publisher’s opinion, are of established integrity and whose products secure the approval of the technical staff of the American Radio Relay League.”

Quoted from QST's advertising rate card

Amateurs and Electronic Engineers: Practically everything you need can be supplied by the advertisers in QST. And you will know the product has the approval of the League's technical staff.

REVISED

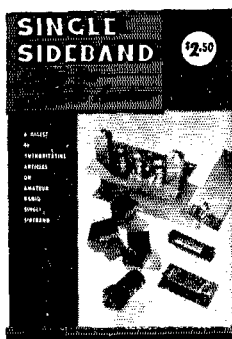

4TH EDITION

This recently enlarged Edition is a revised and up-to-date collection of the best SSB articles that have appeared in *QST*, grouped to present a handy and useful reference book. Active side-banders, as well as amateurs planning to adopt this very effective mode, will find the 4th Edition indispensable. Following an introduction to sideband, the text is carefully organized to cover modulators, product detectors, crystal lattice filters, exciters and transceivers, using transistors, linear amplifier theory and construction, V.H.F. techniques, receiving, adjustment and testing, and accessories it includes not only theory discussions but plenty of practical construction and operating information. The entire area of single sideband is covered, both transmission and reception. Keep up to date. Get a copy of the bigger than ever 4th Edition now.

\$2.50 Postpaid

U. S. A. Proper • \$3.00 Elsewhere

The American Radio Relay League

Newington, Connecticut 06111

Silent Keys

It is with deep regret that we record the passing of these amateurs:

- W1AI, Olin C. Brown, Milbridge, Me.
ex-W1IRD, Francis C. W. Kazenby, Reading, Mass.
W1IST, Raymond E. Longway, Rumford, Me.
W2AOE, Dana A. Griffin, Summit, N. J.
W2GKQ, August J. Schau, Roselle, N. J.
W2HII, William J. Dailey, Allendale, N. J.
K2MEM, Herbert B. Champlin, Jr., Blue Point, N. Y.
W2PYU, Philo H. Stevens, Eden, N. Y.
W2VCO, Milton Lopyan, Flushing, N. Y.
W3BN, James F. Marx, Reading, Pa.
W3CKL, Alex Wise, Indiana, Pa.
K3EH, Harry Densham, Levittown, Pa.
K3ROP, James D. Lamborn, Philadelphia, Pa.
W3UMI, Wilfred C. Jones, Philadelphia, Pa.
W4JDZ, Reginald L. Wood, Danville, Va.
WA4TKI, Jerry G. Haley, McMinnville, Tenn.
W4UPG, Ray B. Pledger, Marietta, Ga.
K5ARK, Morris W. Robertson, Dallas, Tex.
K5LAA, Everett H. Marshall, Houston, Tex.
W5MFC, Raymond Brumbaugh, Sand Springs, Okla.
W5NNG, Walter E. Stuermann, Tulsa, Okla.
K6ASU, Otto Draper, Grass Valley, Calif.
W6KS, Alfred King, Altadena, Calif.
K6OEW, Joseph McBride, Los Angeles, Calif.
W6SAH, William P. Baldwin, Stockton, Calif.
W7ESB, Ady Tandler, Sparks, Nev.
W7NPK, John W. McVeigh, Bremerton, Wash.
W7SNI, Harry J. Mader, Jerome, Ariz.
W8AYY, Aaron D. Brooks, Midland, Mich.
W8DUZ, Gerald H. Steele, Leroy, Ohio
W8GHI, Hal J. Shafer, Toledo, Ohio
W8NHT, Howard K. Cundiff, Clawson, Mich.
W8QIX, Frank MacDonald, Detroit, Mich.
W7TGS, Ann Greathouse Price, Martinsburg, W. Va.
K8ZFE, Thomas A. Kelly, Mayfield Heights, Ohio
W9DNB, Fredrick I. Hirt, Barron, Wis.
W9JLM, Hobart H. Wantland, Milwaukee, Wis.
W9UFX, Theodore W. Kennedy, Stoughton, Wis.
W9WMI, Olven W. Childress, Anderson, Ind.
W9HXV, Julian McCutchan, St. Cloud, Minn.
W9OVV, Lorenz K. Thomforde, Lindstrom, Minn.
W9YLZ, Joseph J. Sentyrz, Minneapolis, Minn.
EI8J, Canon N. F. Waring, Dublin, Ireland
EI8P, J. E. Mills, Dublin, Ireland
G8TS, Jack St. C. T. Ruddock, London, England
G15QX, Jack N. Smith, Belfast, Ireland
KL7BR, Virgil F. Hanson, Anchorage, Alaska
VE3BZP, Arthur F. Elliott, Brantford, Ontario
VE3OZ, Hal B. Grover, North Bay, Ontario
VE3SD, Stroyan Leith, Guelph, Ontario
VE5UK, Alf. Miller, Regina, Sask.
VE6PS, Frank D. Thompson, Barrhead, Alberta
VE7BGI, Jack T. Llewellyn, Terrace, B. C.
9M4GT, Tan Geok Gim, Singapore

Dana Griffin, W2AOE

We regret to report the death of a well-known amateur and *QST* author, Dana Griffin, W2AOE. Dana wrote many technical articles for *QST* on subjects covering s.s.b., teletype, v.h.f. and band-planning. He was one of the first 5-meter enthusiasts in the second call district back in the thirties. He will be missed by his many amateur radio friends.

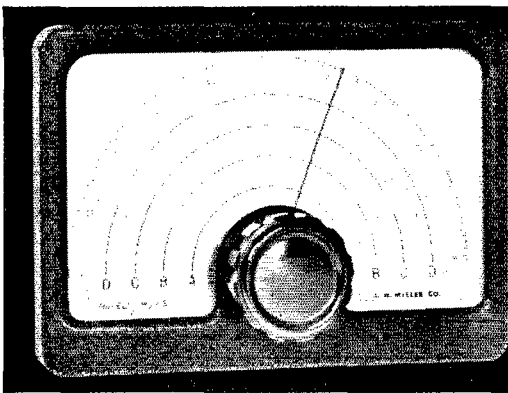

VERNIER DIALS—9 to 1 and Combination 36 to 1 & 6 to 1

MODEL NUMBER	TURNS RATIO	NO. OF SCALES	NET PRICE
MD-5	9 to 1	4	\$ 8.25
MD-6	9 to 1	6	\$ 9.00
MD-7*	36 to 1 & 6 to 1	6	\$15.00
MD-8*	36 to 1 & 6 to 1	6	\$15.00

*Dial allows fast tuning at a 6 to 1 ratio with fine tuning at the 36 to 1 ratio over any 6-division portion of the scale.

J. W. MILLER COMPANY
5917 So. Main Street • Los Angeles, California 90003

★ FORT ORANGE RADIO ★ DISTRIBUTING CO. INC.

ALL MAJOR BRANDS

Write for Literature and
Used Equipment List.

•
Foreign Trade Solicited.
•

904 Broadway, Albany 7, N.Y., U.S.A.

Cable Address: "UncleDave"

CALL Albany 518-436-8411; Nights 518-477-589

THE LATEST

New Xtra Class Addenda to Posi-Check \$2.00
General Class Posi-Check \$2.98
(A Good Review, Tool!)
BOTH FOR \$4.50 Postpaid

POSI-CHECK

P.O. Box 3564, Urbandale Station, Des Moines, Iowa 50322

ENJOY EASY, RESTFUL KEYING

With **VIBROPLEX**

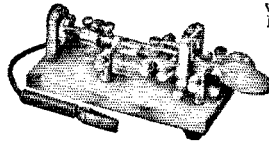

Sending becomes fun instead of work with the SEMI-AUTO-MATIC Vibroplex. It actually does all the arm-tiring nerve wrecking work for you. Adjustable to any desired speed. Standard models have polished Chromium top parts and gray base. DeLuxe models also include Chromium Base and red finger and

thumb pieces. Five models to choose from, priced at \$17.95 to the 24K Gold Plated Base "Presentation" at \$33.95.

VIBRO-KEYER

Works perfectly with any Electronic Transmitting Unit. Weighs 2½ lbs., with a base 3 ½" by 4 ½". Has Vibroplex's finely polished parts, red knob and finger, and thumb pieces. Standard model \$17.95; DeLuxe model includes Chromium Plated Base at only \$22.45.

Order today at your dealers or direct

THE VIBROPLEX CO., INC.

833 Broadway New York 3, N. Y.

FREE
Folder

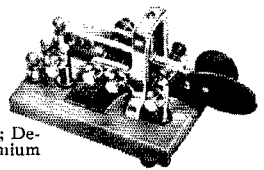

BIG PROFITS FOR HAMS IN BUSINESS RADIO



CITIZENS BAND... MARINE... AVIATION... AND PUBLIC SAFETY RADIO

There are almost five million mobile radios in use... they all must have periodic maintenance and checks on frequency and modulation to comply with FCC regulations. Frequency adjustments can be made only by properly licensed and equipped men—usually on a regular contract basis. Your ham experience is the ideal background for entering this profitable field—and the LAMPKIN frequency meter is the ideal instrument to build your business around. It has continuous coverage... can be checked in the field... and will measure unlimited numbers of channels at the lowest cost per channel! It's all you need for measuring CB and all other mobile services except the high-band split channels; later you can add the split-channel PPM METER and the LAMPKIN FM MODULATION METER as your business grows.



LAMPKIN 105-B FREQUENCY METER 100 KC to 175 MC and up, heterodyne type. Only 8 lbs. \$295.00. (0.0001% accuracy with inexpensive accessory PPM Meter.)



LAMPKIN 205-A FM MODULATION METER 25 to 500 MC, continuous coverage. Dual scales, 0-12.5 and 25.0 Peak KC \$290.00. With additional scales of 0-1.25 and 2.5 KC, \$340.00

To Learn More About
This Big Money Opportunity

MAIL
COUPON
TODAY!

LAMPKIN LABORATORIES, INC.
MFG Division, Bradenton, Fla.

At no obligation to me, please send me free booklet "HOW TO MAKE MONEY IN MOBILE-RADIO MAINTENANCE"—and data on Lampkin meters.

NAME _____
ADDRESS _____
CITY _____ STATE _____

LAMPKIN LABORATORIES, INC. BRADENTON FLORIDA

THE LEAGUE EMBLEM



With both gold border and lettering, and with black enamel background, is available in either pin (with safety clasp) or screw-back button type. In addition, there are special colors available in the pin style emblem only, for Communications Dept. appointees.

- ▶ Red enameled background for the SCM.
- ▶ Green enameled background for the RM, PAM, SEC or EC.
- ▶ Blue enameled background for the ORS, OES, OBS, OO or OPS.

THE EMBLEM CUT: A mounted printing electrotype, $\frac{5}{8}$ " high, for use by members on amateur printed matter, letterheads, cards, etc.

Pin, Button or Cut: \$1.00 Each, Postpaid

AMERICAN RADIO RELAY LEAGUE

Newington, Connecticut 06111

CODE

THE WAY YOU LIKE IT.

For many years TELEPLEX METH-OD has been used exclusively by schools training professional operators. It is now available to any one wishing to learn Code or advance his present ability. You will be amazed to see just how easy and simple it is to thoroughly master the Code. This professional type equipment has too many exclusive features to be explained here. Write today for full details and short history of telegraphy. It is free. It can save you months of frustration and dismal failure.

TELEPLEX CO. 739 Kazmir Court Modesto, Calif.

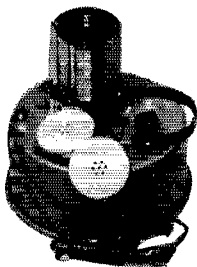

BIG CATALOG

World's "BEST BUYS" in GOV'T. SURPLUS Electronic Equipment

FULL OF TOP QUALITY ITEMS

Transmitters, Receivers, Power Supplies, Inverters, Microphones, Filters, Meters, Cable, Keyers, Phones, Antennas, Chokes, Dynamotors, Blowers, Switches, Test Equipment, Headsets, Amplifiers, Converters, Control Boxes, Indicators, Handsets, etc., etc. SEND 25¢ (stamps or coin) for CATALOG and receive 50¢ CREDIT on your order. Address Dept. Q.

FAIR RADIO SALES
P. O. Box 1105 • LIMA, OHIO • 45802

Happenings of the Month

(Continued from page 39)

Commission's office at Gettysburg, Pennsylvania. . . . [The amateur may] continue operations, pending receipt of the superseding authorization, under the present license without using a portable designator."

STAFF NOTES

In addition to the retirement of David H. Houghton, there are other changes at headquarters. Joseph A. Moskey, W1JMY, moves up from assistant circulation manager to fill the vacancy. Joe, an active traffic handler, came to work at headquarters in 1938 initially to check contest logs in the Communications Department. In 1940 he took over the administration of the National Trunk Lines System and other duties as assistant to the communications manager. During the war W1JMY worked on radar development at M.I.T. and overseas. Returning to ARRL, Joe became deputy communications manager and then in 1953 moved to his present post in the Circulation Department. He operates c.w. and s.s.b. on 80 through 10.

We have a new face at headquarters — Robert J. Rinaldi, K1AFC, of Waterbury, Connecticut, as Assistant Circulation Manager. Bob is a 1965 graduate of Fairfield (Conn.) University with a major in economics. He operates 20, 40 and 80 meters, c.w. and s.s.b.

In the Communications Department, we now have Stanley Israel, WA2BAH, of Schenectady, N.Y., as an assistant for contests and awards. A ham since 1958, Stan has operated on all bands from 1.8 to 432 Mc., though he concentrates on 6 and 2 meters.

We regret to report the resignation of Raymond T. Higgs, K1FLG. An assistant secretary since 1961, Ray has now returned to sunny California; we expect to hear him on the air from W6OGI once again.

LICENSE SUSPENDED

The FCC has suspended the Advanced Class amateur operator license of Dale A. Hoppe, W6VSS for the remainder of the license term (i.e., until October 16, 1968). On March 6, 1959, the amateur had operated with power in excess of a kilowatt, and had refused to permit an FCC representative to inspect his station. Accordingly, his operator license was suspended for one year because of the violations. FCC records show that again, on November 27, 1964, Mr. Hoppe was using power in excess of a kilowatt, and again refused to admit an inspector. An Official Notice of Violation was issued on January 15, 1965, and the license suspended on April 7, effective 15 days later. W6VSS asked for a hearing but later cancelled the request and surrendered the license.

ANOTHER AMATEUR RADIO WEEK

Governor Charles I. Terry, Jr., proclaimed the week of August 9-15 as Amateur Radio Week in Delaware. The dates were chosen by the requesting amateur groups to coincide with the

ECHOPLEX



Model EP-63-JR-1

Kahn Research Laboratories' patented ECHOPLEX, EP-63-JR-1, provides commercial operators and advanced amateurs with one of the major communications system improvements of recent years.

- Signal-to-noise gain of 5-to-1 makes a 1 kw SSB transmitter produce the same signal/noise as a 5 kw SSB transmitter.
- Reduces the effects of fading by transmitting same information three times (time diversity).
- Allows you to identify your signal from non-echoplex signals thus easier to read through QRM.
- Can be used with existing amateur or commercial SSB or AM transmitters and receivers.

\$399.60 TERMS THROUGH
GENERAL ELECTRIC CREDIT CORP.



For Further Information Write Dept. Q105

81 SO. BERGEN PL., FREEPORT, L.I.
(516) FR 9-8800

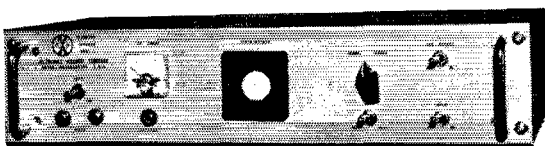

ALLTRONICS—HOWARD CO.
Box 19, Boston, Mass. 02101. Tel 617-742-0048

Telewriter Model "L" frequency shift converter designed for two-tone AM or FM with Limiter operation available by switch. Solid state ratio corrector compensates for fading signals. Permits copying on Mark or Space only. Selector magnet dc loop supply built-in with bias supply and octal socket for optional polar relay to key transmitter. 6W6 keyer tube. Plug-in discriminator for 850 cycle or other shifts. Cathode ray or dual eye indicator. Auto-start control system optional. Prices for 19" rack mounting: Model "L" with dual eye \$199. Model "L" with C. R. tube indicator \$279. Cabinet \$19.50

The GAIN MOONBOUNCER

Satellite Tracking
SKYBEAM

and
SKELETON
SLOT
BEAMS

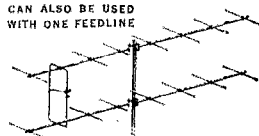
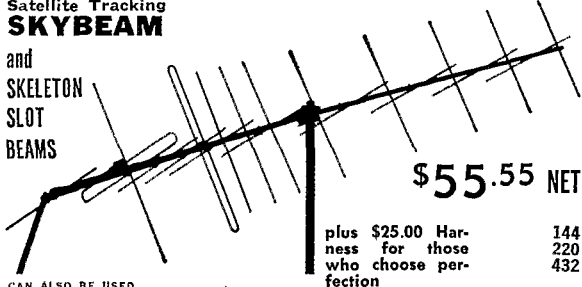

CAN ALSO BE USED WITH ONE FEEDLINE

SKELETON SLOT BEAMS

V H F HAMS ... ATTENTION!

The only VHF Beam with quadrature feed. Delivers helical or vertical or horizontal patterns . . . selected by flip of switch at operator's desk. No rooftop adjustments. Get full details on this satellite tracking antenna BREAKTHROUGH.

\$55.55 NET

plus \$25.00 Harness for those who choose perfection

52Ω OR 300Ω HORIZONTAL OR VERTICAL POLARIZATION

LOOK AT THESE LOW PRICES ON SKELTON SLOT SERIES

	2 over 2	4 over 4	6 over 6	8 over 8	10 over 10
144 mc	\$14.95	\$19.95	\$27.95	\$36.50	
220 mc	\$12.50	\$15.95	\$22.75	\$29.95	
432 mc		\$14.95	\$16.95	\$23.95	\$25.75

Stacked Yagis with infinite impedance type feed. High gain on short booms. All feed points sealed against moisture for peak operation in any weather. Water-proofed baluns and harness allow stacking any size array on any band. H Frames available.

FREE!

Complete technical data and GAIN CATALOG of UHF-VHF BEAMS and Equipment. WRITE TODAY.

DISTRIBUTORS PLEASE WRITE:

Coming: "Progressive" SIX METER LINE
Starting with a 4-element beam you can add on to ten elements any time for greater gain.

GAIN, inc. 27 East 112th Place — Chicago 28, Illinois
Dept. Q-10 PHONE ANY TIME: 312-568-1973

Emergency Drill, Deluxe Style

(Continued from page 29)

2) Sufficient personnel must be assigned to communications centers and NCS posts to log, assign precedences, record, route and relay information. Paper work multiplies at an astounding rate and proper logging becomes difficult — in fact impossible without sufficient personnel. Mobile units should carry at least two persons, only one of which need be licensed to operate. If possible, the second person in a mobile should be an official of some sort.

Our recommendation for your SET this fall: Use Schmutz's LAW to attain realism, and see how good you *really* are. QST

The Multimillimeter

(Continued from page 87)

for a dime each. Wire-wound shunts can be made as described in the ARRL Handbook, referring to the wire table for approximate copper-wire resistances. If the latter are used, and no means is available for accurate adjustment to the required resistance values, the shunts may be adjusted experimentally step by step, after the construction of the unit has been completed. After R_2 has been adjusted as described, place S_2 and S_3 in their 1-ma. positions. Connect the 1.5-volt battery and variable series resistor as before, and adjust the variable resistor for a meter reading of 1 ma. Switch S_2 to the 5-ma. position, and adjust R_4 for a reading of 0.2 ma.

With S_2 still in the 5-ma. position, readjust the variable series resistor for full-scale meter deflection. Then turn S_2 to the 25-ma. position, and adjust R_5 for a meter reading of 0.2 ma. With S_2 still in the 25-ma. position, adjust the series resistor again for full-scale meter deflection. Turn S_2 to the 100-ma. position, and adjust R_6 for a 0.25-ma. reading.

With S_2 still in the 100-ma. position, once more adjust the series resistor for full-scale meter deflection. Turn S_2 to the 250-ma. position, and adjust R_7 for a meter reading of 0.4 ma. These adjustments should be made with the resistors in the positions where they will finally be used.

Construction

I mounted the components in a $4 \times 7 \times 4\frac{1}{4}$ -inch sloping-panel cabinet (Bud AC-1613). The meter was a $3\frac{1}{2}$ -inch model which I had on hand. Similar meters are sometimes available in surplus. Try to get one that is not hermetically-sealed, so that it can be fitted with a multiple scale for direct reading. No. 20 or larger wire should be used for all connections to avoid introducing errors caused by lead resistance. Since the multiplying resistance becomes less than one ohm for the higher current ranges, lead resistance must be negligible in comparison. QST

DOW-KEY DK60 SERIES COAXIAL RELAYS

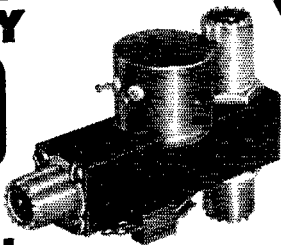

Size
 $2\frac{1}{4} \times 3\frac{1}{4} \times 1\frac{1}{2}$
Less than 9 oz.

DK60-G2C

4 Standard Models, AC or DC,
UHF, N, BNC, TNC or C Conn.

Outstanding favorite for amateurs... Versatile combinations for industrials! Low VSWR less than 1.15:1 from 0 to 500 mc. LOW LOSSES... High Contact Pressures. LOW CROSS-TALK through use of patented "isolated connector" arrangement. HIGH POWER RATING. All coils encapsulated in epoxy resin for quieter operation and resistance to moisture.

- ★ UNCONDITIONAL GUARANTEE for one year. (We will repair if faulty within 1 year.)
- ★ See one of our 700 dealers and distributors in U. S. and Canada for catalog sheets or write:
- ★ All Relays available in weather-proof boxes for exterior installation
- ★ Ganged, multiple position switch arrangement available for remote control selection of antennas.

STANDARD RELAYS: DK60, DK60-G, DK60-2C and DK60-G2C

PRICED FROM . . . \$12.45

DOW-KEY CO., Thief River Falls, Minn.

No Magic!

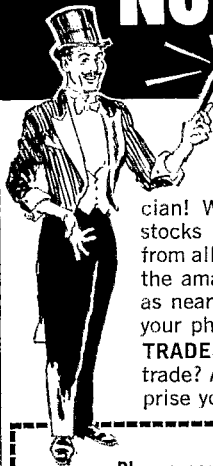

Locating parts for your home brew QST rig... or anything else you build... doesn't take a magician! Walter Ashe has complete stocks of parts and equipment from all top manufacturers serving the amateur radio operator. We're as near to you as your mailbox or your phone.

TRADES: Want new gear... got a trade? All we can say is let us surprise you! Write for our deal.

FREE Q-105

Please send catalog to:

NAME _____
ADDRESS _____
CITY _____ STATE _____ ZIP _____

WALTER ASHE RADIO CO.

A DIVISION OF RADIO SHACK CORP.
1125 Pine Street • St. Louis, Missouri 63101
Phone CH-1-1125 Dept. Q-105

TA-3640

for 10
15
20
and
40
meters

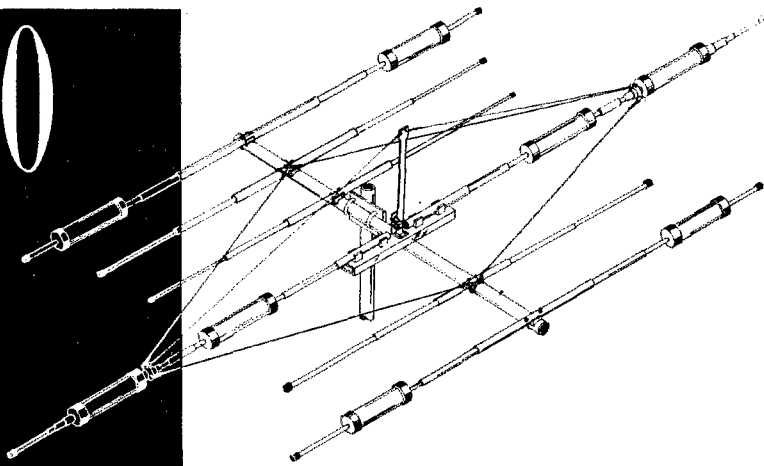

Put your signal where it counts. Use the ultimate in Ham beams - - - the Mosley TA-36 with Kit TA-40KR added to radiating element. Employs 4 operating elements on 10 meters, 3 operating elements on 15 meters, 3 operating elements on 20 meters. SWR is 1.5/1 or better at resonant frequencies over all 4 bands. Constructed of heavy-wall aluminum for maximum strength. Rated for full power.

Write for detailed specifications and performance data on the Mosley TA-3640.

Mosley Electronics, Inc.

4610 NORTH LINDBERGH BLVD.
BRIDGETON, MISSOURI 63044

HYE-QUE ANTENNA-FEEDLINE CONNECTOR

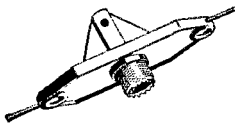

New 3-in-1 molded plastic-and-metal fitting provides: coax feeder connection, heavy copper leads to elements, antenna center support. Hye-Que 1 connector fits standard PL259. Reinforced, weather protected, ultra-efficient. At your ham store, or \$2.95 ppd. Companion insulators, 2 for 99¢ ppd. Includes complete instructions.

BUDWIG MFG. CO. P.O. Box 97, Ramona, Calif. 92065



Before you buy or trade, wire, write, call or drop in to see **WARD, W2FEU**
Be Sure to Write for Our Latest Used List

ADIRONDACK RADIO SUPPLY
185-191 W. Main St., Amsterdam, N. Y.
Phone: V1ctor 2-8350
Ward J. Hinkle, Owner

TRANSTENNA 102A

A PRESELECTOR SECOND TO NONE AND A T-R SWITCH BEYOND COMPARISON

Pat. Pndg. U.S.A. & Canada

MODEL 102A
\$69.45 (Add \$7 for Sidetone)
15 DAY TRIAL

Return For Full Refund If You Burn It Out Or Are Not **FULLY PLEASED**

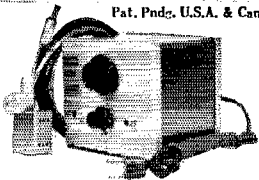

- Std. coax coupler (smtr to feedline)
- No TVI or Suck out
- 30 DB Min. Gain (10-80 mtrs)
- No Effect on Transmission
- Monitored switching
- Full Legal Input
- Burnout Proof
- CW Sidetone (optional)

IMPROVEMENTS
Muting circuit breaks between dots and dashes. Through operating positions for unity gain on all frequencies.

102B \$59.00 (excludes rcvr muting)

FICHTER ELECTRONICS

Write or Free Literature
33 Myrtle Avenue, Cedar Grove, N. J.
Tel: CEnter 9-6412

EDDYSTONE

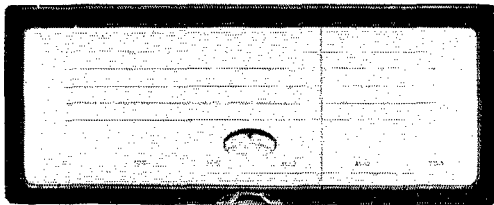

GEARED SLOW MOTION DRIVE
For Amateur Radio & Communications
RECEIVERS & TRANSMITTERS

A high grade assembly, flywheel loaded, manufactured to fine tolerances, provides a smooth positive drive with a reduction ratio of 110:1. The vernier with its 100 divisions rotates 5 times for one pointer traverse, giving 500 divisions with positive reset readings. A cam adjustment on the vernier assures correct zero setting. A spring loaded jockey arm maintains tension of the pointer drive. Overall dimensions 9 3/4" x 5 3/4"

Manufactured by
Stratton & Co., Ltd. (Eddystone) PRICE \$21.50 NET
Birmingham, England Postpaid

Distributed by
BRITISH RADIO ELECTRONICS, LTD.

1742 Wisconsin Ave., N.W.
WASHINGTON 7, D. C.

N. Y. MIDTOWN HEADQUARTERS

for world famous **hallicrafters**

SR • 150 Amateur Band Fixed/Mobile

Transceiver . . . provides, with unvarying dependability, a range of operating features never available at this price . . .

P-150 AC Power Supply
\$99.50

P-150 DC Power Supply
\$109.50

\$650.00

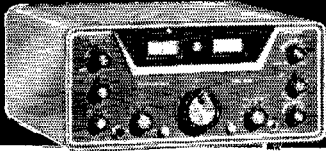

Enjoy the ultimate in proven engineering reliability. HALLICRAFTERS' (maximum flexibility) SR-150 is the most advanced, most outstanding example of HALLICRAFTERS' ability to build the world's best value in professional quality sound equipment.

ALL HALLICRAFTERS in stock for immediate delivery. Complete audio demo dept. Depend on us.

EVERYONE eventually goes to

1 Door East of Lexington Ave.

GRAND CENTRAL
Radio Inc.

Hrs.:
8:30 to 6
Sat. Incl

124 East 44th Street, N.Y.C. • MU 2-3869

HOW'S DX

(Continued from page 111)

Research ship *Meteor*, DJ2DR, is operated by DJ2KS in South Atlantic waters. After a peek at St. Peter and Paul Rocks, a Fernando de Noronha stopover was scheduled in September. DJ2DR keeps busy with homeland liaison on 14,100 and 21,100 kc.

HEREABOUTS — KV4CF seeks Idaho to sew up WAS, according to K3AHN, particularly on week ends at 1230 GMT near 14,290 kc. . . . FP8CV (W2GKZ) joined the summer St. Pierre invasion for 1600 QSOs on 80 through 10 meters . . . Long Island DX Association's contest committee is hard at work preparing unique trophies and certifications for amateur radio's 1965 DX champions. If you haven't done so already, check with LIDXA Contest, P.O. Box 599, Lynbrook, N. Y., 11563, for marathon entry particulars . . . Ex-W9APY, now labeled WA4RPK, was miffed when his XYL, ex-K5BRQ, came up with the call W4BFA. Hi! . . . VE6AJB and helpmeet VE6API want ticket reservations for next May's meeting of the DX Hoggery & Poetry Depreciation Society. Don't they know all of their insurance will be canceled at the door? . . . Ten WP4 QSOs may qualify you for a certification offered by Puerto Rico Amateur Radio Club, P.O. Box 476, Roosevelt Stn., San Juan, P. R. This from WA8MAT . . . "Let's not fool ourselves," warn WA7s BOA and BOB. "A lot of those guys we hear calling and calling CQ DX are a lot smarter than they sound. They just *have* to be." . . . Of Puerto Rico's first handful of pioneer radio amateurs, seventeen strong in 1921, KP4s JA and TL still ride the airwaves today . . . Remember VP2VB/mm, DXpeditionary highlighter of a few years back? We hear Danny is nearly a W/K himself, now, and has joined the *Yasme* Foundation gang to foster the imminent DX travels of W6KG and XYL. Prominent DXers WS 51GJ 6GNU 6LDD 6RGG 8EWS, K5JLQ G2DC and KV4AA are on the team. **SET**

SET Announcement

(Continued from page 30)

4) The EC solicits "test P" messages from Red Cross and c.d. officials to their superiors at state or national levels.

5) Each AREC member originates a message to his Section emergency coordinator, to be handled through regular Section channels.

6) Nets of the National Traffic System will be activated for extra sessions to clear the expected overload of "emergency" traffic.

7) Watch out! There may be some special test traffic floating around, originating at the behest of headquarters, to test our system facilities for accuracy, speed and efficiency.

8) Traffic for which there is no regular outlet, or for which you don't know the regular outlet, may be cleared on one of the National Calling and Emergency Frequencies (see box insert).

Although between three and four thousand amateurs annually participate in this test, the on-the-air activity stands a good chance of being swamped by casual amateur operation if we do not get cooperation. This is the time to observe those NCEFs, for one thing! Note that part-time NCEFs will be considered full time during the SET period. Amateurs not participating in the test (you all should be!) are requested to avoid the use of frequencies on which test activities are being conducted. This is an exercise aimed at public service in the name of amateur radio, something that will be of benefit to everybody.

If this cramps your style, why not get in on it yourself? See your EC. If you don't know who he is, or there is none, isn't it about time to do something about this?

See you in the Simulated Emergency Test, October 9-10! — WINJM. **SET**



CALL-LETTER SIGNS

Order your call in neat 2-inch die cut letters with base. Just right for the shack. You assemble — Letters: 3/32" silver showcard stock. Base: Satin finish black plastic. Price \$1.50 postpaid

GIFT SHOP — Box 73-Q, Northfield, Ohio 44067

URGENT, NEED IMMEDIATELY

Very high prices paid. Freight prepaid. AN/GRC; PRC; APR; APN; ARC; ALT; URM; UPM; TS- We also buy all military and commercial test, radar, and communication equipment. Call collect. It costs you nothing to hear our high offer. SPACE ELECTRONICS 4178 Park Ave., Bronx, N.Y. (212) CY 9-0300

Convenience
Engineered

From *Waters*

**PROTAX™ AUTOMATIC GROUNDING
COAXIAL ANTENNA SWITCH**

WATERS MFG. . . WAYLAND, MASS.

UHF DOW-KEY CONNECTORS

Coaxial Collectors and Adapters — machined brass with all surfaces silver plated.



95c
DKF-2
UHF Double Male



70c
DK60-P
UHF Panel Mount Female



\$1.25
DK201
UHF Panel Mount Male



85c
DK202
UHF Double Female



\$1.25
DK210
UHF Female to Male Phono



\$1.25
DK211
UHF Male to Male Phono

Available at your dealer or write:
DOW-KEY CO., Thief River Falls, Minn.

THESE OM'S
HAVE RECENTLY
SWITCHED TO A

SHURE 444 MIC

W0CKC
W1BHG
WB2HVA
W2YGJ/6
VE3BSJ
W3FUH
K3KEN
W3LOR
WA4MVCV
F5JA

K5GOT
K5KNE
W6ZJW
K7DGZ
K7KRV
WA8KQQ
K8LTT
WA9KCD
W9EDG
K9UTN



... notice their improvement
in intelligibility
and added punch?

Shure Brothers, Inc.,
222 Hartrey Avenue, Evanston, Ill.

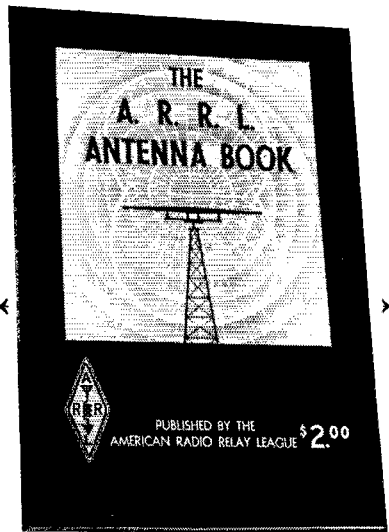

PLANNING new antennas for the Sweepstakes and other contests coming up soon? Looking for dope on transmission lines? From basic theory to how to build 'em, horizontals, verticals, rotaries, fixed beams, transmission lines, together with dimensions, photos, drawings, radiation patterns, you'll find the information in the Antenna Book. Better pick up your copy now.

\$2.00 U.S.A. PROPER
\$2.25 Elsewhere

THE AMERICAN
RADIO RELAY LEAGUE, INC.
NEWINGTON CONNECTICUT 06111

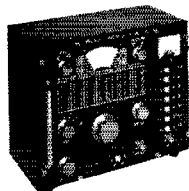

STANDARD
GENERATOR
MODEL SG-83A \$275.00

50 Kc—54 Mc., 1% dial accuracy.
1 Mc. xtal. Calibrated output 0.6 to
160,000 microvolts. Pure sine AM to
50%—no FM. All transistor. Battery
or AC powered. Write for specs

CLEMENS MANUFACTURING CO.
630 S. Berry Road St. Louis, Mo. 63122

LRL-66 ANTENNA 66' LONG. 80 THRU 10M

Power rating 2 Kw. P.E.P. or over on 80, 40, 15
On 20 and 10 1 Kw. P.E.P. Transmitter input

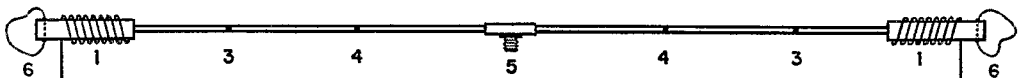

PRICE
\$30.00
in Cont.
USA, ppd.

OPERATES ON 5 BANDS AUTOMATICALLY
1. Loading coils for 80 & 40M doublet operation
2. Adjustable ends to set 80 meter resonance
3, 4. Decoupling stubs for 20 & 10 meters

5. Center insulator with female coax
connector to take PL-259 plug
6. Fittings on insulators to tie on rope

LATTIN RADIO LABORATORIES

Box 44

Owensboro, Kentucky

HAM-ADS

- (1) Advertising shall pertain to products and services which are related to amateur radio.
- (2) No display of any character will be accepted, nor can any special typographical arrangement, such as all or part capital letters be used which would tend to make one advertisement stand out from the others. No Box Reply Service can be maintained in these columns nor may commercial type copy be signed solely with amateur call letters. Ham-Ads signed only with a box number without identifying signature cannot be accepted.
- (3) The Ham-Ad rate is 35¢ per word, except as noted in paragraph (6) below.
- (4) Remittance in full must accompany copy, since Ham-Ads are not carried on our books. No cash or contract discount or agency commission will be allowed.
- (5) Closing date for Ham-Ads is the 20th of the second month preceding publication date.
- (6) A special rate of 10¢ per word will apply to advertising which, in our judgment, is obviously non-commercial in nature. Thus, advertising of bona fide surplus equipment owned, used and for sale by an individual or apparatus offered for exchange or advertising inquiring for special equipment, takes the 10¢ rate. Address and signatures are charged for. An attempt to deal in apparatus in quantity for profit, even if by an individual, is commercial and all advertising so classified takes the 35¢ rate. Provisions of paragraphs (1), (2) and (5), apply to all advertising in this column regardless of which rate may apply.
- (7) Because error is more easily avoided, it is requested copy, signature and address be printed plainly on one side of paper only. Typewritten copy preferred but handwritten signatures must accompany all authorized insertions. No checking-copies can be supplied.
- (8) No advertiser may use more than 100 words in any one issue nor more than one ad in one issue.

Having made no investigation of the advertisers in the classified columns except those obviously commercial in character, the publishers of QST are unable to vouch for their integrity or for the grade or character of the products or services advertised.

GREATER Bay Area Hamfest, Peacock Gap Country Club, San Rafael, Calif. October 16-17. Write to Box 113, Hayward, Calif.

FLATBUSH Radio Club, Auction, October 18th, 8 PM, at the Sgt. Meve Levin Hall, 1628 East 14th Street, Brooklyn, N.Y. For information call 282-4737.

TRI-STATE Sideband Dinner for the Pittsburgh Area will be held October 16th at the Warrendale Holiday Inn on Route 19, just off Pennsylvania Turnpike, Interchange No. 1, Dinner will be served 6:30 P.M. to 7:30 P.M. Thompson, WA3BY5, RR 1, Box 197M, Greensburg, Penna.

WANTED: Early wireless gear, books, magazines, catalogs before 1922. Send description and prices. W6GH, 1010 Monte Dr. Santa Barbara, Calif.

MOTOROLA used FM communications equipment bought and sold. W5BCO, Ralph Hicks, Box 6097, Tulsa, Okla.

WANT Callbooks, catalogs, magazines, pre-1920 for historical library. W4AA Wayne Nelson, Concord, N.C.

MICHIGAN Hams! Amateur supplies, standard brands. Store hours 0830 to 1730 Monday through Saturday. Roy J. Purchase, W8RP, Purchase Radio Supply, 327 E. Hoover St., Ann Arbor, Michigan, Tel. NOrmandy 8-8262.

WANTED: All types of aircraft on ground radios, 17L, 618F or S388, 390, GRC, PRC, 51 JRXX, Collins linear amplifier, Type 204; Especially any item made by Collins Radio, ham or commercial. Also large type tubes and test equipment in general. For fast cash action contact Ted Dames W2KUW, 308 Hickory, Arlington, N.J.

SELL swap or buy ancient radio set and parts magazines. Laverty, 118 N. Wymbolic, Landsdowne, Penna.

WANTED: Military and commercial laboratory test equipment. Electroncraft, Box 13, Binghamton, N.Y. 13902.

SAVE On all makes of new and used ham equipment. Write or call Bob Crimes, 89 Ascen Road, Swampscott, Massachusetts; 617-598-2530 for the gear u want at the price u want to pay.

WANTED: 2 to 12 304TL tubes, Callanan, W9AU, 118 S. Clinton, Chicago 6, Ill.

304TL tubes wanted. Also other xmts and special purpose tubes. We will buy military or commercial transmitters and receivers with designations ARC, GRC, URR, 51 and MN. Air Ground Electronics Co., 64 Grand Pl., Kearny, N.J.

WANTED: Collins Parts. BC-610, GRC-27, Antodyne, Bethpage, L.I., N.Y.

INTERESTING Offers galore in the new combined "Equipment Exchange-Ham Trader", Next 12 issues \$1.00. Sample free. Brand, Sycamore, Ill.

We Buy all types of tubes for cash, especially Eimac, subject to our test. Maritime International Co., Box 516, Hempstead, N.Y.

ACT Now! Barry pays cash for tubes (unused) and equipment. Barry Electronics, 512 Broadway, NYC 12. Call 212-Walker-5-7000.

TUBES Wanted. All types, highest prices paid. Write or phone Lou-Tronics, Inc., 74 Willoughby St., Brooklyn 1, N.Y. 11021. Tel. UL5-2615.

WANTED: For personal collection: QST, May 1916, WICUT, 18 Mohawk Dr., Unionville, Cogn.

QSLs? WPES. Personalized made-to-order! One-day service! Largest variety samples: 25¢. Deluxe, 35¢. Religious 25¢ (re-funded). Sakkers, W8DED, Holland, Mich.

QSLs, samples 20¢. QSL Press, Box 281, Oak Park, Illinois 60303.

QSL "Brownie" W3CJT, 3111 Lehigh, Allentown, Penna. Catalog with samples, 25¢.

C. FRITZ back on the job! Bringing hams greater QSL returns, over a quarter century! Samples 25¢ deductible. Box 1684, Scottsdale, Arizona (formerly Joliet, Illinois).

QSLs-SMS, Samples 10¢. Malgo Press, Box 375 M.O., Toledo 1, Ohio 43601.

DELUXE QSLs Petty, W2HAZ, P.O. Box 5237, Trenton, N.J. 08638. Samples, 10¢.

QSLs. See our new "Eye-Binder" cards, Extra high visibility. Samples 5¢. Dick, W8VXX, 1994 N. M.-18, Gladwin, Mich.

QSLs. Twenty exclusive designs in 3 colors. Rush \$3.00 for 100 or \$5.00 for 200 and get surprise of your life. 48-hour service. Satisfaction guaranteed. Constantine Press, Bladensburg, Md.

QSLs: Fairplay with service. Samples free. R. A. Larson Press, Box 45, Fairport, N.Y.

SRV, Felias! Your orders are coming in so thick we have to hold up our ad for a while. Volpress, Box 133, Farmingdale, N.Y.

QSLs, SWLs, XYL-OMs (sample assortment approximately 9¢) covering designing, planning, printing, arranging, mailing; eye-catching, comic, sedate, fabulous, DX-attracting, prototypal, snazzy, unparagoned cards (Wow!). Rogers K0AAB, 961 Arcade St., St. Paul 6, Minn.

DISCONTINUING QSL Printing. Prices reduced to use up remaining card stocks. Send for samples, prices, Garpey, 2624 Kroemer Road, Fort Wayne, Indiana.

CREATIVE QSL Cards—25¢ for catalog samples, 50¢ coupon. Personal attention given. Wilkins Printing, Box 787-1, Atascadero, Calif. 93422.

QSL, SWL, cards that are different. Quality card stock, Samples 10¢. Home Print, 2416 Elmo Ave., Hamilton, Ohio.

QSL, SWLs, WPE, Samples 10¢ in adv. Nicholas & Son Printery, P.O. Box 11184, Phoenix 17, Ariz.

ZIP Code Rubber Stamp, Call, name, address, with ink pad. \$1.00. K4ISA, Perry, Box 8080, Allandale, Fla.

SUPERIOR QSLs, samples 10¢. Ham Specialties, Box 73, Hobbs, New Mexico (formerly Bellaire, Texas).

QSLs, Samples 25¢. Rubber stamps; name, call and address \$1.55. Harry Sims, 3227 Missouri Ave., St. Louis, Mo. 63118.

QSLs \$2.00 per 100 postpaid. Free Sample. Hobby Print Shop, Umatilla, Fla. 32784.

QSLs 300 for \$4.35, Samples 10¢. W9SKR, "George" Vesely, Rte. #1, 100 Wilson Road, Ingleside, Ill. 60041.

QSLs 3-color glossy, 100, \$4.50. Rutgers Vari-Typing Service. Free samples Thomas St., Riegel Ridge, Milford, N.J.

QSLs Kromekote 2 & 3 colors, attractive, distinctive, different. Free ball point pen with order. Samples 15¢. Astart for Call-D-Cal decals K2VOB Press, 31 Arlyle Terrace, Irvington, N.J.

QSLs. Free samples, fast service, customized cards. W7IJZ Press, Box 183, Springfield, Ore.

QSLs \$2.50 per 100. Free samples and catalog. Garth, Box 510, Jutland, N.J.

3-D QSL Cards have that prestige look, with glittering colors and metallic in raised space-age designs fused to brilliant plastic finishes. Cost so little more than mere mediocrity! Samples 25¢ (refundable). 3-D QSL Co., Monson 2, Mass.

QSL Specialties. Distinctive Samples, 15¢. DRJ Studios, 2114 N. Lavergne Ave., Chicago, Illinois, 60639.

QSLs-100 3-color glossy \$3.00; silver globe on front, report form on back. Free samples. Rusprunt, Box 7575, Kansas City, Mo. 64116.

At Last! Something new in Qsl cards! All original designs. Send 25¢ for samples to Yarsco, Box 307, Yorktown Heights 1, N.Y.

CUSTOMIZED QSLs with your autographed photo. Dime brings sample. Pic-Ur-QSLs Rice Lane, Baltimore, Maryland, 21207.

QSLs New cartoons. Top quality, fast service. Samples 20¢. Ed's Press, 3232 Le Moyne, Chicago, Ill. 60651.

QSLs, Gorgeous rainbows, cartoons, etc. Top quality! Low prices! Samples 10¢ refundable. Joe Harms, WA4FJE, W2JME Edgewater, Fla. 32032.

QSLs, Stamp and call brings samples, Eddie Scott, W3CSX, Fairplay, Md.

QSL Cards; free samples, catalog 20¢. Knight Printing Co., 1550 Downey, Indianapolis; Ind.

PLASTIC Holder frames and displays 20 QSL cards, 3 for \$1.00 or 10 for \$3.00. Prepaid Iepabco, Box 198, Gallatin, Tenn.

QSLs, 18 samples, 10¢. Filmcrafters, Box 304, Martins Ferry, Ohio.

QSL, 3-color glossy, Samples, 10¢. Gates Print Shop, 317-11th Ave., Juniata, Altoona, Penna. 16601.

RUBBER STAMPS \$1.00. Call and address. Clint's Radio W2LUD, 32 Cumberland Ave., Verona, N.J.

QSLs. Free samples. WA6QAY Press, Box 17112, San Diego, Calif. 92117.

QSLs, 18 samples, 10¢. Filmcrafters, Box 304, Martins Ferry, Ohio.

1966 QSL Designs. Samples 10¢. Brigham, Colson St., No. Bilterica, Mass.

QUALITY QSLs. New designs monthly. Samples: 10¢, 25¢, 50¢. Savory, 172 Roosevelt, Weymouth, Mass.

"GOLDEN CALLS" QSLs (Only QSL) crafted by Samco for 1965. Samples 10¢. "Compare if you care". Samco, Box 203, Wynantskill, N.Y. 12198.

106 Brings free samples. Sims Advertising Service, 3227 Missouri Ave., St. Louis, Mo. 63118.

DX-QSL. The original plastic display for ur cards. Holds 20 cards, 3 for \$1; ten for \$3. Satisfaction guaranteed. Dealers' inquiries invited. DX-QSL, Box 19033, Houston, Texas 77024

ENGRAVED Badges, 1" x 3" call and first name, \$1.00 pre-paid. OSLs, YLRL specials, OMS, samples 10¢. W2DJH Press, 31 Warren, Warrensburg, N.Y. 12885.

DON'T Buy QSL cards until you see my free samples. Bolles, WSOWC, Box 9363, Austin, Texas.

CANADIANS: Mohawk receiver. Just checked out. Guaranteed performance, \$250.00. VEF3VO, Dr. Forbes Colgate, The Governor's Road, Woodstock, Ont., Canada.

TOOOBES. Transmitting, special purpose, new, boxed, guaranteed: 6CW4, \$1.40; 614B, \$4.75; 417A, \$3.95; 6146, \$2.55. Free catalog. Vanbar Dist., Box 444, Stirling, N.J. 07980.

DRAKE R-4 Receiver, in new condx. First \$320.00 takes it. W8HDB.

HT-37, \$250.00; Drake 2-B, \$200. P&H Linear, \$150.00; HW-32 with A.C./D.C. p/ss, \$150.00. Dr. M. L. Lee, 5219 Nichol Ave., Anderson, Ind.

FOR Sale: 8 KVA motor generator, 115 or 220 volts, 50 or 60 cycles, \$150.00. S. J. Arnold, 11119 North H St., LaPorte, Texas.

SELL: CE-20A xmt'r with QT-1, 458 VFO, homebrew linear (4 6CL6s) with p/s, all in exlnt condx and all for \$135.00. New BC-223 with 3TUs, \$20. Will deliver within 100 miles. Sry, no shipping! Fred Firestone, 3660 Helen St., Bethlehem, Penna. Phone: 866-7616.

SELL: PH565 Tam-TV camera 90-MM Raptor lens, converted, airtested, \$60.00, prepaid K7VOI, 5018 East Cooper St., Tucson, Arizona 85711

WANTED: Tubes, all types, write or phone W2ONV, Bill Salerno, 243 Harrison Avenue, Garfield, N.J., Tel. Garfield Area code 201-471-2020.

FOR Sale: Plate Transformers, 3600-0-3600 VAC @ 1000 ma. CCS, with 120/240 VAC primary. Commercial quality units carry one year unconditional guarantee. Price \$35.00, 4-1000A filament transformers 7.5 V.C.T., @ 21 amps, pri 110, 117, 125 V.C. @ 20 cps, fully enclosed unit fits under 4" chassis, net wt. 9#. \$12.00. Write us for free estimates on any of your special transformer needs. Dummy loads, 52 ohm 1000 watt capacity, SWR below 1.3 to 1 from D.C. to 54 Mc., \$8.95 plus pp, net wt. 7#. Peter W. Dahl Co., 401 4th St. S.E., Minneapolis, Minn. 55414.

FOR Sale: QSTs dated 1923-1960. Write or call 865-5-5303, Mrs. Walter Wakeman, 22 South St., Walton, N.Y.

RANGER II, in perf. condx. Virtually new, used under 20 hours: \$220.00. Dan Franklin, Rte. 7, Box 401, Tallahassee, Fla.

BOOST Reception: 3-4-30 megacycle SK-20 Preselector Kit, \$18.98. Boost modulation: AAA-1 clipper-filter kit, \$10.99. Postpaid - literature free. Holstrom Associates, Box 8640-1, Sacramento, Calif. 95822.

SELL: Eimac 4X250B tubes. Guaranteed good, \$6.50 each, \$10.00 pr. Prepaid in U.S.A. Send check or m.o. Everett Stidham, Jr. W5TLO, 722 South 30th, Muskogee, Okla.

FOR Sale: Hy-Gain HT-18 Htvower, \$50.00; Hy-Gain model 203, 3-el, 20-m, beam, \$25.00, Telrex 8-el, 2-m, beam, model 2-m, 814, \$8.00, W2UGM, 66 Columbus Ave., Closter, N.J.

SELL: DX-100, modified to CX-100B with built-in SWR meter, FSK, and antenna relay. In mint condx. W8NRE, 1598 Van Geisen Rd., Caro, Mich.

MUST sell: SBE-33 in perfect condx. First reasonable offer takes it. Dan Pierce, K8OCT, 1930 Avenue 8, Kearney, Nebraska.

WANTED: QSTs January 1917 and August 1919. Will pay top dollar. W2TAM, 140 Summit Avenue, Trenton, N.J.

WILL Sell entire 2 year old station now on air or will consider offers for units. HT-32B, SX-115, 30L-1, Ta-33 Jr, 2-band Cliffdeweller and misc. smaller units. Art, WA9TQF, 811 Franklin, River Forest.

TELETYPE Machines, converters, R-388, 5113 and 5114, R-390 HQ-180 spkr, \$249.00, R-390A receivers, mechanical filters for R-390A (455 IF), Alltronics-Howard Co., Box 19, Boston, Mass. 02101. Tel: 617-742-0048.

DXer Beware: A real bomb. York 5000 transmitter, 1 kw, using 4-1000A, bridge power supply, vacuum tuning condenser. Size 33" wide, 24" deep, 6 ft high. Further details, Bill Brown, W8SYK, 28 Marine Lane, Hazelwood, Mo. Tel.: H8mpstead 4-5440.

CASH For Callbooks, U.S. Government Amateur Callbooks wanted. W8EF, 801 Lakeshore, Grosse Pointe 36, Mich.

HAM Discount House, Latest amateur equipment, Factory-sealed cartons. Send self-addressed stamped envelope for lowest quotation on your needs. HDH Sales Co., 170 Lockwood Ave., Stamford, Conn.

CASH For Your Gear. We buy sell and trade. Send for free bargain list. H & H Electronic Supply, 506 Kishwaukee St., Rockford, Ill.

WANTED: FR-2409 bandpass filter, State price, Pete Chalmers, W1BGD, 111 Buena Vista Road, West Hartford, Conn. 06107.

CASH, Sony Transistor TVs, etc., swapper for G-R, H-P, L&N, etc. equipment, special tubes, manuals, military electronics. Engineering Associates, 434A Patterson Rd., Dayton, Ohio 45419.

75A-4 SN3956 v/vernier, \$375.00; 4-1000A linear w/3600 v, 1 aps, \$295; Milten GDO, \$35; EV664, \$33.00; Dumont 304A DC-AC laboratory oscilloscope, \$75; Tektronix 511, \$95; 513, \$175.00; 1 KW continuous linear w/power supp., \$115.00; Boren 1B-20 hi-f amplifier, \$32.00; 250V 500 Ma, regulated p/s, \$19.00. All perf. condx. Tom Perera, K2DCY, 410 Riverside Dr., NYC, N.Y. 10025.

DRAKE 2-B, used 2 hours, \$215.00; calibrator, \$10; HT-41 kilowatt with new 7094 tubes, \$269; HT-33 kilowatt, \$239.00. Elvin Miller, 3845 Kipling Ave. So., Minneapolis, Minn.

VIKING II and VFO, HQ-150, Astatic JT-30 mike, 3-el, Tri-bander, CDR rotator 100 ft. cord and control, Heath GG meter, Heath 5" scope, \$295. You pay to ship. K6CZK, 1501 Spencer, Santa Rosa, Calif.

WANTED To Buy: HRO-60 coil set, AC for 15-meter bandspread. Cash or trade. Don Hall, W5OBS, 813 Northlake Dr., Richardson, Texas 75080.

COLLEGE Expenses force sale of my beautiful HQ-170AC. Only two years old and in perfect shape, \$285.00. Richard Surratt, WA0TQ, #43 Thurston, Manhattan, Kans.

WANTED: Hy-Gain Roto-brake rotator, indicator. State condition. W9JIT, 343 W. Windsor, Lombard, Ill.

SELL: BC-312N, \$50; RME DB23, \$29; ASH5, \$9.00; SASE for list of parts, chassis, manuals, etc. M. Marshall, 46 Lincoln Pl., Waldwick, N.J.

POWER Trans. for Gonset 101 linear, 1900-0-1900, 500 ma, new, \$25.00 35 lbs. F.o.b. Fullerton, Calif. W6PLK, 1715 West Southgate Ave.

HT-32B, \$450. SX-115, \$375; Gonset Linear, \$250. Like new condx. K2HEA, 12 Elm, Lynbrook, N.Y.

CLEGG 99'er, \$99.00; CDR-Ar22 rotator/100 ft. cable, \$20.00; Shure 440 mic/stand, \$12.00; 6-el. Telrex 100 ft. RG-8-U, \$25.00. All in exlnt condx. Kellersman, Stoney Brook Road, Danien, Conn.

AMAZING "DX-ER" Swiss global wrist watches feature 24-hour time conversion dial/berzel for time in any world zone, plus 12-hour local dial, \$14.96 each. Free brochure. Nordlund, 7635 West Irving Park, Chicago, Illinois 60634.

MOHAWK Receiver RX-1 for sale: \$140.00. Bob Radkey, K9RFX, 220 Marquette, Park Forest, Ill.

HW12, 22, 32 w/units complete Triband transceiver conversion plans: \$10.00 ppd. Tribander, Box 18, Queens Village, N.Y. 11427.

HX-20, mint condx; going transceiver, \$130.00 or best offer. Ray, K8BOI, 2702 Oak, Hays, Kans.

HAMS' Caribbean Retreat: Go forein Antigua W.I. Hotel Beachcomber, VP2AZ/Ex-V3E3P, GZZB, 73. Bill Wyer. See travel agent.

COLLINS, one year old: 516F-2 ac/p-s, \$60.00; 312B-3 spkr, \$15.00. KWM-2 dc/p-s and mobile mount (MP-1 and 351D-2), \$175.00. In mint condx. WA4AEB.

SELLING Out: GPR-90; KWM-1; HW-22; Heath Warrior, etc. Send for list. W4VTZ, William Slater, P.O. Box 741, Greenville, No. Carolina 27834.

RUBY Laser Rods. Single crystal ruby rods are now available for the university student and amateur experimenter from one of the nation's leading fabricators of sophisticated optical elements. Rods are 1/4" diameter, 3" long; finely polished, and with flat and parallel ends silver coated for immediate installation. \$75.00 per unit, plus \$1.00 postage and handling. All rods guaranteed to last. Money back if returned unharmed in 10 days. Valpey Corporation, Department 610, Holliston, Mass.

SELL: Poly-Comm 6 in like-new condx. Make offer. K3JHH, 1328 Hillside Ave., Honesdale, Penna.

COLLINS 755-3B serial 15857 with 2100 and 500 cycle mechanical filters. Used only few hours and like-new in every respect. Only \$445.00 shipped in original carton. Also perfect Hallicrafters HT-32B, used but a few hours; late serial number for \$395.00. Both units true mint condx. K7BDG, H. Roddick, 5105 East Sunset, Yakima, Wash.

MODELERS: Modified 6M, 3 channel, B&D proportional (no relay); power converters for both receiver and xmt'r, Ni-Cad batteries. In plane, ready to fly. \$200.00. WA5CRY/Ø, 1054 Doris Drive, Columbia, Mo.

75A3 Collins receiver for sale, with 2100 and 800 cycle filters, best offer. L. S. Lewis, 1125 Cheyenne Dr., Indian Harbour Beach, Florida 32937. Tel: 305-262-6238.

COLLINS VFOs, new, unopened cartons: 70E-24 for 75A-4, \$49.00; 70E-23 for KWS-1, \$39.00; 70E12 for 75A-2 and 75A-3, \$39.00; 70K-1 for KWM-1, \$29.00; 70J-2 for R-390A, \$39.00; 399B DX adaptor for KWM-1, \$19.00; 399B-3 Novice adaptor, \$9.00. Richard E. Mann, 7205 Center Dr., Des Moines, Iowa.

WANTED: Cash for Collins 32S-3 and 312-B4. Within 100 miles of Boston. K1ODR, 16 Amy Road, Framingham, Mass.

HEATH Shawnee, wired by professional engineer, in superb condx; major components replaced with computer grade components for maximum reliability and long life: \$200.00. Guaranteed. Ansel, Greenriver Road, Williamstown, Mass. 01267.

FREQUENCY Meter LR-1 160 Kc.-60 Mc. Accurate within cycles, \$125.00 with manual. Finco 6N2, \$15.00; XCU 300 calibrator, \$10.00; QSTs, 1959-1964. Sry, no shipping! K1KRO, Tel: 203-529-9281.

FREE Sales Catalog. Laboratory and microwave test equipment, including military types. Wanted: Your surplus equipment, tubes, components. Electronic Research, 715Q Arch St., Phila., Penna 19106. Tel: 215-627-6771.

BRAND New Heath MT-1 90 w. VFO transmitter, fone/c.w. factory-tested, calibrated. \$85.00, or your best offer. W1KO, 377 Oldham, Pembroke, Mass.

SELL: Valiant II, two hours use, \$300. Drake 2B, \$250.00; Craig, 104 Kathleen Dr., Srosset, L.L., N.Y. Tel: WA 1-4315.

FOR Sale: Collins 75A receiver with matching speaker and side-band slicer; Central 20-A exciter with 458 VFO; Class B push-pull linear amplifier, using 272-B tubes with 2000 volts, 300 Ma. p/s. W1JND, Elmer A. Capwell, Coventry, R.I.

SELL: Hallicrafters S-53A and SX-99. Best offer accepted. WA2-NIM, 582 East 42nd St., Brooklyn, N.Y. Tel: BU-4-3516.

CLEGG 22'er, with halo. Immaculate condx. \$180.00. K2MHP, Pete Adely, 1576 John, Ft. Lee, N.J.

MOHAWK RX-1, \$125.00 F.o.b. Park Ridge, Ill. In exlnt condx. W9BGI, 521 Cumberland, Park Ridge, Ill. 60068.

KNIGHT T-60, \$40.00; V-44 VFO, \$25.00. Both in exlnt condx. WA6ZMR, Dave Fisher, 243 Cimmoner Trail, Glendora, Calif. 91740.

VALIANT Original carton and manual, \$160.00; 75A-1 matching sprk and manual, \$135.00. Both exclnt. You pay shipping. WA2KW.H. RD2, Lebanon, N.J. 08833.

SALE: HW12, SB-200, SB-300, SB-400, DX-60, HR-10, SX-101, GR64. Name the kit you want, wired or repaired. Lan Richter, 131 Florence Dr., Harrisburg, Penna. 17112.

FOR Sale: 1-AF68 transter 1, PMR-7 Rec 1, M-1070 p/s 1 ant. relay and P.T.T. mic, all for 12 volt operation less than 100 hours. Operation in original cartons. First \$150.00 takes all. W2PSH, 38 Ferris Pl., Ossining, N.Y.

HAVE QSTS. complete years 1947 through 1958 and year 1964. You make offer. Mrs. Everett Stout, 2157 East 33rd St., Brooklyn, N.Y. 11234.

HEATHKIT SB-300 SSB rcvr, assembled. New, with all filters. \$210.00. Otto, 118 Sapphire, Redondo Beach, Calif.

COLLINS 325-3, \$500.00; 516F-2 p/s, \$75.00; 75S-3, \$450.00. Lot price: \$975. RITTY model 28R0, \$150.00. Delivered within 150 miles. K9HUK, RR #1, Box 303V, Brownsburg, Indiana.

SELL: Apache, \$160.00; Clegg 22'er, 3 months old, plus 8-element Telrex beam, \$210.00; SR-46 6-meter transceiver, \$150.00; 6-meter 6-element Telrex beam, originally cost \$69.00; will sell for \$40.00. Hy-Gain full-sized 20-meter beam, 3 months old, \$50.00. All items guaranteed and in perf. working order. Duke Giannazo, WA4EY, Box 293, Aiken, S.C. Tel: MI-9-2730.

NC-303, clean; crystal calibrator, 6-meter converter, manual, \$260.00. Capt. R. H. Perez, 1861 Papago, Glendale, Arizona 85301.

COLLINS, guaranteed xclnt condx. in original boxes, 75S-1, \$300.00; 325-1 with 516F2 p/s, \$500.00. W5ZKJ, 2636 S.W. 51st, Oklahoma City, Okla.

HALLICRAFTERS SX-62, \$135.00; Knight "Ocean Hopper", \$10.00; Instructograph 10 Continental Tapes, \$25.00; Policalarm P.R.-9, \$30.00. Shipping c.o.d. H. L. Danner, 840 South 29th St., Omaha, Nebr.

FOR Sale: Collins 32V-2, perf., \$150.00; National HRO-5T, \$40.00; Ameco, Mod. 1200, 2 track stereo tape-recorder, new, \$280.00; 4/400 new, \$15.00; 3 KV Ct./250 Ma., \$12.00; SWR bridge, \$7.00; 5" Precision AC voltmeter, 0-150-600, \$10.00; MRT-9 2-meter transceiver, \$15.00; Turner 350C mike, \$5.00. Need: 312B-4-SMI, W2LEC.

KWM-2 with 516F-2 power supply, near mint condx, never mobile, \$750.00. Also HX-50 brand new, \$250.00. Jack Holt, K1VFO, Woodbury, Conn. 203-263-2341.

HALLICRAFTERS SX-122 with R-8A speaker, recently new, \$269.95. Melvin E. Kesner, WA3DWF, Box 68, Accident, Maryland 21520.

SELL: Dow-Key relay 110VAC, \$5.00; Advance Relay 12-28VDC, \$4.00; Asiatic 531 (new), \$5.00; xtals. P.R., 8379, 8404, 7168, \$1.40 each; Tubes 6X4 (687), 6SH7, 6SC7, 27, 84, 80, other odds, 20¢ each. Driggs, WA8OMP, 1807 Riverhill, Columbus, Ohio.

SELL: \$450. LPA1 KW linear and IPSI power supply, brand new, never used, L. J. Magrora, 375 Pierce St., San Francisco, Calif.

SELL: Gonset G-50, gud condx. Will include 6M Squalo, \$200. Owen Schellhase, 7th & Monroe Sts., Ellis, Kansas 67637.

SELL: HX-30 6M SSB-AM-CW xmttr, \$170; Twoer with mobile p/s, \$44.00; CN-50 (14-18) with p/s, \$45.00. All in like-new condx, less than 12 hours use. I. Gene Miller, 1580 Lori Lane, NE, Grand Rapids, Mich. 49505.

LAFAYETTE HE-45A, 6 mtr. transceiver w/xtals, mike, Hi-Par 6 halo, bumper mount and cables, \$100. National NC-85 rcvr, \$45. Both xclnt. Herbert Reed, W2EGQ, 169 Stonybrook Rd., Somerville, N.J.

NCX-3 with AC supply, \$225.00; HP-13, \$50; Hustler antennas and mast for 75, 40, 20, \$25.00. Will demonstrate all items. K9PQG.

WANTED: Johnson Valiant II F/W clean, reasonable. Jim Garcia, WA4WFV, 3616 West Cass, Tampa, Fla. 33609.

HT-41 amplifier, like new condx. Make reasonable offer. Will ship. K9DOO, W. Dres. Box 273, Palos Heights, Ill.

COLLINS KWM-2 and PM-2 power supply in CC-2 carrying-case. Equipment never on air, \$950.00; 30L-1 in unopened carton, \$400.00; Johnson 275 watt Matchbox with indicator, \$50.00. Larry, WB2CCQ, Tel: 609-494-1922.

PHASEMASTER Jr., SSB exciter with mike, HB-700 and 300V silicon power supply and VFO, needs some work, \$43.00; 4CX-250B tubes, new, \$22.00 pair, excellent, used \$15.00 pair, 4X-150A tubes, \$5.00 pair, excellent; used, all tubes guaranteed. 1/2 in. Trinicon telescope, tripod and accessories, inc. camera. Cost \$360.00. Consider trades. C. M. "Cy" Truett, Star Rte. C, Flamingo Bay, N. Ft. Meyers, Fla. 33903.

TWO TONS of equipment and components must go. Send for list. SB-300, all filters and speaker, in exlnt condx. Best offer over \$285.00. G. Petrilak, K2SWI, 132 Fifth Ave., Kings Park, N.Y. 11754.

WANTED: HRO-5 or 7. State price, condx and coil coverage. W8WTC/2, L. M. Stevenson, 6315 Shimer Dr., Lockport, N.Y. 14094.

SX-111, almost new, \$155; DX-60, 1/2 year old, \$50.00. Also want Galaxy V with AC supply. WN6QEG, 3171 Walker, Rossmore, Calif. 90720.

SELL: Heath HW-32 20-meter SSB transceiver kit, partially assembled, with kits for AC power supply, crystal calibrator, microphone, and doublet antenna with coax, \$140.00. Never used. Original cost \$180. Ray Dopmeyer, P.O. Box 22844, Baton Rouge, La. 70803.

HQ-170C, DX-60, HG-10 VFO; T-R switch, cables. All in superior condx. \$300. Mike Torellora, 2805 Pond Place, Bronx, N.Y. Tel: FO 4-6581.

KWM-2A with noise blanker: 3510-2, MP-1, PM-2, MM-2, 440E-1, 351E-4 extra MAR5 xtals; all like new, \$1350. W6ROH. N.Y. Tel: FO 4-6581.

APACHE, \$160.00; SB-10, \$70.00; Mohawk, \$160.00 or complete AC-CW-SSB station for \$350.00. All in exceptionally fine condx. W3LNU.

AF-67 Elmac, Dynamotor, PMR-7 receiver and 12V. Power supply, \$160.00. Thommas Holbrook, 4780 Bowen, Memphis 22, Tenn.

SELL: Collins DC p/s MP-1, like new, \$120.00. W4GVVW, Box 574, Delray Beach, Florida.

RCA FM30-44 MC, 60 watt model MI transceivers. Complete with heads, mike and cables. \$35.00. Sid Nelsen, Leeds, N. Dak.

GOING 6 Meter SSB. Will sell Filtering VHF 50 6-meter converter, Skysweep Model 345 6 meter receiver by Tapetone, Heathkit Seneca VHF-1. Make offer. W6ANN, Rte. 1, Box 730, Joshua Tree, Calif.

STILL Have Apache, SB-10 (together only) \$200.00, 75A-1 (cabinet perfect), \$175.00. Ron Samson, W0DCB, 3301 Mt. Vernon Rd., Cedar Rapids, Iowa.

W8NSJ lost all gear and records on July 24th. Lightning came in on house wiring, destroying shack and several other rooms. Everything was insured in The Hartford Group and will be rebuilt. Would appreciate other stations checking their logs and perhaps sending duplicate QSLs. Albert E. Aldrich, Box 73, Concord, Michigan 49237.

HALLICRAFTERS S-118; new condition: \$50.00. WA7AUW, 544 E. 4800 So. Murray, Utah.

COLLINS 75S-1, 325-1, 312B-4, 516F-2, all perfect. 800 bucks. W8LKD, 1484 Graham Road, Cuyahoga Falls, Ohio.

GALAXY V 110v supply, new. Make offer. K0HIF.

POWER Plant, Navy gray standby PE-197, 120VAC, 6Kw, Hobart Generator, 15 H.P. Hercules 4 cyl. 88 hp engine, completely instrumented, voltage regulated, with circuit breaker, completely shielded, local and remote self-starting, 20 hrs., monthly test runs, on time meter, water-proof canvas cover, warranted excellent, with manual, \$285.00; matching ball-bearing, rubberized, swivel wheeled dolly and 75 ft. heavy duty 4/C/8 cable with mating connector, \$25.00; Stancor Transformer for 220V operation, 1 Kw, \$25.00. Consider trade for high serial number 75A-4, 75 S-3, etc. W2GIC, LeRoy Judge, 96 Scudder Place, Northport, L.I., N.Y. Tel: ANI-7659.

NCX-3, \$245.00; NCX-D, \$80; Hammarlund HQ-150, \$140.00; Hammarlund HC-10, \$80; Elmac AF-67, \$70.00. Frank Mrozak, 59 Wellington Ave., Kenmore, N. Y. 14223.

FOR Sale: DX-20, \$25.00; V-44, \$20.00; Heath baluns, \$5.00. Offers acknowledged. WA2SDJ, Box 101, Ripley, N.Y.

IMAGINE: An E-Z Way HD-40 tilt-over tower, ground mount with AR-22 rotator, used less than one year, in gud condx, and all for only \$75.00. WA6FLO, Bob Seltzer, 14351 Galy St., Tustin, Calif.

RITTY Channel filters, octal mounted, 2125/2975 cps, \$5.95 a pair, 88 mh toroids 5 for \$2.50. WA6GI, 3232 Selby Ave., Los Angeles, Calif. 90034.

W0TUT, 27 years old, radio amateur 11 years, free to travel, due to sale of private business would like an opportunity with organization in USA or overseas, 1st phone, 2nd telegraph, ship radar and aircraft telegraph endorsements, am. extra, touch typist. Would consider apprentice position on 2-way communication equipment maintenance or operation or similar assignment. Write S. J. Prewitt, W0TUT, Hayden, Colorado.

DB-23 Preselector, like new, \$35.00; OST Dec. '55 to Dec. '63, mint, Highest bidder, CQ May '59 to Apr. '63, mint, highest bidder, 4-400A plus chimney, new, \$25.00. Will not ship. Val, K8DTU, 4505 Westlawn, Pontiac, Mich.

SR-150: AC-DC power supplies; mobile mount, Hustler base and resonators for 10-20-40-75; D-104 with G-stand B&W low-pass filter; two extra finals. All in like-new condx. Total package only \$500. Firm. John Norton, WA1BWV, 40 Sherman Bridge, Wayland, Mass.

COLLINS 75A-4 serial No. 4054 with 3.1 Kc. filter and vernier tuning dial. Perfect in every respect. Looks like new inside and outside. In factory shipping carton with manual, \$395.00. C. Crooner, P.O. Box 101, Morton, Ill.

COMPLETE Station: Central Electronics 20A and VFO, Halli-crafters SX-101, Q-1 keyer, PL-175A homebrew, KW amplifier, 1B-500 ant. and extras; \$625.00. Complete Receiver, transmitter alone, \$350.00. WA2VUM, 401 Nelson Ave., Cliffside Park, N.J.

RITTY Gear for sale. List issued monthly, 88 or 44 myh toroids, five for \$1.75 postpaid. Elliott Buchanan, W6VPC, 1067 Mandana Blvd. Oakland, Calif. 94610.

HEATH Sixer, w/mobile whip and spring base, \$35.00; Globe Squot 65B, w/mike, \$42.00. Heath VF-1, VFO, \$11.00; HQ-129-X w/HD-11 O-muit, and Preselector, \$101.00. You pay shipping. WA5EJN, 1575 Duchess Dr., Baton Rouge, La.

MOBILE Rig for sale. Gonset Twins, Webster Bandspanner, PIT mike, All cables, rack, Will ship. \$250.00. K5QJG, 4485 Shirley, Jacksonville, Fla. 32210.

COLLINS Owners: AM King \$5.00! State model KWM-2, independent receiver control, \$150.00. Kitcraft, 763, Kram, Ky.

HAM Paradise for sale on beautiful Maine lake. Fully equipped station with Telrex Xmas Tree, 300 ft. lake frontage, 10 acres, boating, fishing, swimming. W1AUR, H. G. Riley, Fayette, Maine.

FOR Sale: Gonset GSB-100 transmitter, \$225.00; Gonset GSB-101 linear, \$160.00; Hammarlund HQ-170C Receiver, \$215.00. All in top condx with manuals and factory cartons. Bob Wetherald, W2CZI, 128 Chestnut Hill Dr., Rochester, N.Y. 14617.

SWAN 240 with upper or lower sideband and AM detector. Wired for ICU unit. Lake model \$225; Collins 32V-1 in gud condx with low-pass filter, \$85.00. SX-71 receiver, \$70.00. Ameco TX-86, \$45.00. Philip Schwebler, W9CGG, 4536 N. 50 St., Milwaukee 3218, Wisc.

AMPEX 600 deck in gud condx; half-track stereo and four-track stereo heads, \$130.00 or your best offer. Dan Harzer, W8BC1, 537 Woodrow Ave., Lansing, Mich.

TWOER, one year old, professional wiring, less than 10 hours use, in mint condx, \$40.00. Will ship. WA1BYF, 5 Moulton St., Hamden 17, Conn.

APACHE: SB-10, Audio and suppression xclnt. Work me on 20 and see. Also, Heath SWR bridge. Best offer over \$250.00. K4-WMB, Lewis E. Smith, Rte. 2, Caneyville, Ky.

SELL: 75A-3, in xclnt condx, \$260.00. Want 75A-4 2.1 kc filter. Have 500 cycle and 6 kc. filter for sale or swap. W2AIH, Paul Bittner, 814 4th St. S., Virginia, Minn. 55792.

TR-4, \$480.00; AC-3, \$66.00; DC-3, \$108.00. All factory sealed, never opened. Warranty, naturally. Sell separate. K4LGR, Box 10021, Greensboro, N.C.

75A-4—HO-170—Viking Invader and high power components. Like new condx. John Seaman, W3FKB, 1440 Oakwood Dr., Bethlehem, Penna.

"HOSS-TRADER Ed Moory needs folding money to buy hay for his ponies on a cash and no trade deal, factory warranty demonstrator equipment. SR-500, \$319; SB-2, \$199; new Galaxy II, \$249; Ham-M rotor, \$329; KWM-2, \$349; TR-4, \$469; TR-3, \$409; SBE-34, \$319; 30L-1, \$399; HRO-50, \$1155; new TA-33 beam and demo Ham-M rotor, \$169; R-4, \$299; T4-X, \$319; NCX-5, \$549; NCL-2000, \$539. Reconditioned gear: SB-33, \$209; Swan 240, \$219; TR-3, \$399; HT-37, \$239; 2-B, \$179; Viking Valiant, \$149; Johnson Ranger II, \$159; HQ-140X, \$89; Galaxy 300, \$189; SR-160, \$199; 20-A, \$95; 20-V, \$399; CSB-100, \$169; 30L-1, \$349; Ham-M rotor, \$69; 328-V, \$399; 75S-1, \$289. Ed Moory Wholesale Radio, DeWitt, Arkansas, Box 506. Tel: WHitney 6-2820.

WANTED: Commercial or military, airborne or ground. Equipment and test-sets, Collins, Bendix, others. We pay freight. Ritco, P.O. Box 156, Annandale, Va.

SELL: 75A-1, speaker, \$135.00; 515B, \$85.00; FW Valiant, \$160.00; Gonset Super Six, Manuals for all, WA5ESW, 646 McClelland, Corpus Christi, Texas.

WANTED: Hints & Kinks. Volume I through V. Will pay double, or will swap numerous tubes, electronics, etc. Mironce, 122 E. Pierson Ave., Somers Point, N.J.

SELL-Trade: 15-watt 6-meter transmitter, \$30.00; Ameco 6 and 2 meter converters, \$30 each; 160 meter 12-watt mobile transmitter, converter, transistor supply, mike, \$45.00 complete; 40-watt modulator, \$15.00; 125 watt, \$20.00. Mobile transistor supply, \$50/400v, 100 ma, \$18.00. Transformer, 4,000 v, c.t./400 ma, \$25.00. Supply 750v/250 ma, \$13.00. Need: Receiver, dipper, tube-checker, BC-348, or?? Stan, W8OKU, 2748 Meade, Detroit, Mich. 48212.

SELL: HT-41 KW linear, \$190.00. Globe V-10 VFO, \$200.00. WA2ZJV, Tel: 5H3-2525.

BC-221-M/orig. calibr. book/p-s. Will trade for 50/75 watt xmtr or HA-1 keyer. Lynn, W8PSE, 205 N. Central, Coffeyville, Kansas.

FOR Sale: Back issues of Radio News, 1949 through 1956; CO 1948 to 1961; QST 1950 to 1962; 5" RCA 158 oscilloscope, 16-element 2-meter collinear, Alliance rotor, Meissner frequency standard, new Lightning Bug, Stancor ST-203 transmitter, 10 and 2 meter, and 80 through 10 transmitters, both suitable for mobile, SCR-57C unconverted, Handbook 2-meter converter, Dynamotors, BC-342, ART-13, 700 and 350V 1/4 amp, continuous supplies with PIT wiring, Johnson mobile 12V VFO, all F.o.b. Make offer. W2JCI, Tel: 201-342-5743.

WANTED: MBR-5 and MB-560, any condx. Ralph Anderson, W9CES, 6018 Henderson St., Chicago, Ill. 60634.

GUARANTEED A-1 reconditioned equipment on approval. Terms, Collins 75A-1, \$129.00; 75A-2, \$159.00; 32V-3, \$159.00; 75S-1, \$299.00; 30L-1, \$349.00; 75A-4, \$395.00; 75S-3, \$445.00; Drake 2-A, \$159.00; TR-3, \$395.00. Hallcrafters SX-101A, \$219.00; HT-37, \$249.00; Hammarlund HQ-170, \$169.00; Valiant \$150.00; NCX-3, \$39.00; NCX-5, \$449.00; Central 20-A, \$99.00. Other equipment. Write for lists. Henry Radio, Butler, Mo.

TRADE New GPR-90 revt for tape deck or recorder. Mono or stereo. NYC, Tel: ST9-4170. Bruno, 185 Hall St., Brooklyn 5, N.Y.

BLUE Book used list free! Check our low prices. Over 1,000 items; Communicator III, 6M, \$169.00; Galaxy 300, \$219.00; NCX-3, \$245.00; SB-33, \$249.00; HG-303, \$45.00; 32V-1, \$149.00; AF-68, \$99.00; HT-40, \$49.00; MTL, \$49.00; MB560A, \$39.00; HT-37, \$275.00; HX-50, \$259.00; Invader 200, \$285.00; NC-98, \$72.00; 75A-1, \$199.00; SX-101A, \$219.00; SX-117, \$269.00. Free catalog. We buy for cash. What do you have? Write Leo, W8GFO, WRL, Box 919, Council Bluffs, Iowa.

MINT SB400 transmitter, \$300; SB-300 receiver, all filters, \$275; homebrew 4400 linear, BW tank 850A, four meters, screen, filament, bias built-in, spare tube, \$140.00; KW ant. tuner SWR bridge included, \$40.00; BC221AH frequency meter, original book, A.C. supply built-in, \$50.00. Test equipment, meters, various parts. SAS for list. Kirchhuber W2KJT/4, 2804 Broadview Dr., Huntsville, Ala. 35810.

NOVICE Station, NC-300, Eico 720, Novice crystals. Go to highest bidder. Will ship collect. WA4UMN, 580 Garden Drive, Louisville, Ky. 40206.

DRAKE 2B like new, with crystal calibrator, \$200; BC-221, \$50.00; Collins 12V D.C. receiver, \$25.00; xmtr, \$25.00; Jemini, \$25.00; 117, \$100.00; 300 mfd variable vacuum, \$25.00. Money order, R. H. Sneed, W5RY, 4049 Berkley Dr., Jackson, Miss.

BC-221-T with calibration book and regulated AC power supply; \$65.00. W2EXX, 58 Birch Pl., Buffalo, N.Y. 14215.

FOR Sale: Mobile equipment, Cheyenne xmtr with mike, \$65; MP1 12V D.C. supply, \$15.00; Gonset G66B rec, w/3 p.s., \$75. PM-2 tuning meter, \$10.00. Complete station with all cables and manuals; \$150.00. Also have Johnson 250 W Matchbox w/o meter, \$20.00. K20CB, "Mei". Tel: 201-KI-19266.

ANTENNAS Mobile, Hustler, mast, 75, 40, 15, 10 resonators. New \$30.00; Hy-Gain Topper mast, 75, 40 resonators, new, \$20.00. Bandsman, new, \$15.00. Heli whips 75, 40 used, \$5.00. Al, W3KRQ, R. 3, Danville, Penna.

4000 Radlowords for hams, German-English. Send one dollar bill to Christian Zanserl, Oe9CZI, Dornbirn, Austria

S&H Green stamps. Can be used to purchase equipment for missionary ham station. Father Jude, WA2YNO, St. Paul's Abbey, Newton, N.J. 07860

MUST Sell: College expenses! Hallcrafters SX-100 and R-46B spkr, \$135.00; DX-100B with spare tubes, \$130.00; coax ant. relay with DPDT aux. contacts, \$15.00; all in gud condx. Colling F455N-20 2.1 kc. filter, new, \$30.00. Loren Lafferty, WA6OIP, 5624 Broadway, Sacramento, Calif. 95820.

TOWERS: 100-ft. tilt-over tower kits, 15 sq. ft., 86 mph. galvanized; you supply concrete and labor. \$695 F.o.b. Spang Enterprises, W3DVV, WB2APG, Barry, 25 Mercator, Willingboro, N.J.

CRYSTALS Airmailed: MARS, Marine CD, Nets, SSB, Novice, etc. Custom finished, heat stabilized FT-243, .01% any kilocycle \$500 to \$600 (1.90) (five or more same or mixed frequencies \$1.70) (ten or more same frequency \$1.35) (1700 to 3499 and 8601 to 20000 \$2.50) Overtones supplied above 10,000 Kilocycles, Add 50¢ each for .005%, HC-6/u metal miniatures above 2000 Kc, add 75¢ each. ARRL Kits: FT-243; "HCS-500", "IMP", Three Band Converter, \$345. Many other filters, amplifier crystals, and kits including 370 to 540 Kc. FT-241 and HC-6/u. Write—State exact needs. Add 10¢/crystal for airmail, 5¢ surface. Crystals since 1933. C-W Crystals, Box 2065-Q El Monte, California 91732.

QST's straight run 1932 to 1955, best offer. Also most 1928 thru 1931. Radio 1936 to 1944, CO 1945 to 1955. Going transistor; send SASE for list. DX-100, \$90; BC-779 and pwr., \$55.00. Roomful of misc. parts. Boone, W8EKS, 1108 Sioux Drive, N.W., Cedar Rapids, Iowa.

HIGHLY Effective home-study review for FCC commercial phone exam preparation. Free literature. Cook's School of Electronics, Box 747, Riverdale, N.Y. 11902.

SELL: Hallcrafters HT-37, \$250.00; Drake 2B with 2B0, \$190.00; Hallcrafters HA-5, V.F.O., \$50.00; Heath AM-2, \$10.00; Ampilidyne C-23 2 mtr. converter with PS4 p/s, \$30.00; Vibroplex Original, \$15.00; Shure 440, \$10.00. Equipment is in perf. condx, located Brooklyn, N.Y. Original manuals, cartons and sales receipts. All inquiries answered. Donald Cook, WB2DU1, P.O. Box 872, Lehigh University, Bethlehem, Penna.

HQ-129X, in excnt condx, contains sealed KRP relay for equipment switching. Highest bid over \$70 gets the receiver, delivered in Wisconsin. WA9ACC, Steve Jackson, Lincoln Ave., Hartford, Wc.

SELL: Hallcrafters SX-101A, \$215.00; HT-32, \$270.00; Johnson Ranger II, \$155.00; 6N2 with VFO, \$135.00. All in like new condx. Home-brew 80 thru 10, 1 kw. linear with 1500 volt Variac p/s, \$175.00. WIACK, Hobart, Robin Lane, Pocasset, Mass. 02559.

COLLINS Home and mobile station, complete; KWM-2, SM-2 mike, 516E-2, 30L-1, MP-1 p/s; 351D-2 mobile mount, MM-1 mike; Hy-Gain TH04 beam, RBX-1 rotor with map indicator, 40 ft. steel tower, Webster Band-spanner mobile antenna, all in exc. condx. original price cost \$2500. Spec Lefler, W8FPU, Room 255 Stadium Building, University of Colorado, Boulder, Colorado. Phone 442-6568.

KWM-2 ser. 1388 with noise blanker. All latest modifications and front panel AM model added; \$800.00; 312B-5 external VFO and watt-meter, \$250; PM-2 light-weight AC power supply, Ser. 11809, \$85.00; 516E-1 12 volt mobile power supply, \$80.00; mobile mount, \$50.00; 30S-1 kilowatt linear amplifier, \$1000; all in prime condx. Frank A. Hayes, K2VVL, Red Hill Road, Middletown, New Jersey. Cash, and carry deal only, sry.

SBE-33, SB2-DCP D.C. to A.C. inverter, carrying case and New-Tronics mobile antenna, like new in original cartons with instruction books. Make offer. D. Fulton, 4977 Palo Dr., Tazana, Calif. 343-7641.

TRADE: Drake TR-3/AC power supply for Johnson Valiant II and a top-notch receiver, TR-3 has never been mobile, can't tell from new. Charley Haynes, K3VQF, Rte. 1, Box 5, Beaumont, Texas. Tel: TW2-1534.

FOR Sale: Collins KW-1. In excnt shape with spare tubes and modulation transformer. Best offer over 1800 dollars. Diagrams for SSB conversion included. Henry Galbraith, 1214 South Alford Blvd., Evansville, Ind. 47714.

FOR Sale: Pawnee 2-BUETY transistor, \$180; Sixer, \$30. Both absolutely new. W1BUY, 38 Carey Ave., Apt. 6, Watertown, Mass. 02172.

SELL: HQ-170C and speaker, \$240.00. Eico 722 VFO, \$25.00. WA5HRD, 62 Crane, New Orleans, La.

SELL: Collins KWS-1, serial No. 644, 75A-4 serial 2036, \$1000; used very little. W2EQV, 17 Kenosha St., Albany, N.Y. 12209.

FOR Sale: Swan 350 Transmitter and 117 AC supply, in perf. condx, original cartons and manuals; \$360.00. Need the money for college. Webb, 140 Ocean Ave., Jersey City 5, N.J.

FOR Sale: Hammarlund HQ-170A, One year old, in excnt condx. Must sell for financial reasons; \$225.00. Ken Kinderman, WA2JDS, 43 Passaic Ave., West Paterson, N.J. Tel: 201-256-4170.

SELL: Heath Mohawk. Best offer over \$160.00, WA9KGX, 418 N. Main, Columbia, Ill.

CIRCUITS From Handbook, QST, CQ, etc., constructed. All work guaranteed. Reasonable. Free information. WA6IKR, Wilmington, 240 Machado Ave., Santa Clara, California 95051. Tel: 248-2637.

FOR Sale: Heath Marauder, excnt, \$285. Robert W. Curry, W9UYM, 5227 E. 21st St., Indianapolis, Ind. 46218.

SPECIALS! DX-100, \$79; Heath "Q" multipl, \$100; Heath tube checker TCP-1, \$30; Transmitter 100 W. AM, 1600 meters, \$50.00; Polaroid J-33 camera (trade) \$35.00; Cross 22 pistol (trade) \$20.00. W2OND, 176 Winding Way, Little Silver, N.J. 07739.

ALL Classes Amateur, Commercial, FCC-type tests corrected and returned with comments. Details. Write Schoening, 10040 Brookside, Bloomington, Minn. 55431.

SB300, like new, with all 3 filters. Perfect operating condx. Very nice wiring, \$285.00. Joe deCourcelle, K3OBU, 2803 Duncan Rd., Wilmington, Del. 19808.

75A2 with product-detector, speaker, etc. \$200.00. mating mechanical filter slicer, \$25.00; 20-A with VFO, \$15.00; Heath HX-20 with HP-20 AC supply, \$140.00; B&W Model 850 tank, \$10.00; two new Pyranols 8 mfd at 5 kv., \$15.00 each; one Sprague 100 mfd. at 4 kv., \$20.00. Morrison, 612 Beach, Moorestown, N.J. Tel: 609-235-0576.

CRYSTAL Filters: 3.0 mc. center frequency, 2.8 kc bw at 3 db, 7.8 kc bw at 30 db, loss 1 db, 3.9K termination, 1/9/16 by 1 3/8W x 1 3/4 H, \$175.00. CC Electronics, 12017 W. 92nd St., Lenexa, Kans.

NATIONAL NC-125 receiver with speaker, in exlnt condx, \$75.00; RCA Mark 7 c.b. brand new condx, instrux manual/ cables, 12V/115 AC \$40.00; 6V/115 AC. \$25.00; 27 Mc. groundplane antenna, \$15.00; RCA IBM card tube-tester, Model WV-98, brand new, \$50.00 (201) 256-0826 after 6 p.m. Herb Holzberg, 115 Sandra Drive, Totowa, N.J.

IN College, must sell: DX-40 xmtr, \$40.00; Heath VF-1 VFO \$12.00; National NC-125 revr plus Heath Q-multiplier, \$80.00. All in perf. condx. You pay freight. T. White, K8UUX, 729 Allerton St., Kent, Ohio.

WANTED: Diesel or gasoline powered a.c. generator, 120/240 volt, single phase, four wire, 12 to 15 kw. in gud condx. W1WL, 226 Chestnut St., Northampton, Mass.

HQ-170C, DX-100, R100; best offer(s) by October 31st. Inquire, K5ZOM, 1703 East 46th St., Lubbock, Texas 79404.

RA-20 power supply needed for BC-342, must be like new condx. W2LFR, Box 517, Montvale, N.J.

WANTED: B&W HDV1, 15, 20, 40 meter coils in gud condx. WA4GNW, 6709 Green Meadow Court, Louisville, Ky. 40207.

TELREX 4-36B, 4-cl. 36 ft. boom, 20-meter beam, cost: \$350.00. \$200.00. Like new HT-37, cost: \$395.00. \$239.00; SX-111, spkr, cost \$239.00, \$129.00. Near new 3-1000Z tube, \$65.00. Exclnt 4-1000A, \$60.00, WA6MSE, 6803 Amestoy Ave., Van Nuys, Calif. Tel: Dickens 4-1736.

FOR Sale: Viking II transmitter, \$50.00; Viking VFO, \$10.00; HQ-140X, \$100.00, W4CWO, Kenneth G. Ackermann, 3249 Kildeeje Dr. Birmingham, Ala.

HALLICRAFTERS HT-37 in exlnt condx, like new, in original owners' hands, for \$250.00; SX-111 in exlnt condx and original owner, for \$150.00. Take both for \$350.00. Must hold at these prices. Write: Robert Ansell, K1WGM, 12 Peacock Farm Rd., Lexington, Mass. 02173.

CLEANING OUT: HG-10 VFO and p/s, \$20; Dow-Key DK-60-62C relay, \$8.00; Ameco CN-144 2-meter converter and p/s, \$35.00; Gonset code oscillator and c.w. fone monitor, \$12.00; 5 position coax switch, \$5.00; 10-12 5-in. scope, \$45. all manuals, \$115.00 takes all. Prefer a local deal. WBGMQE, Jim Minkal, 5177 Avenida Emerson, Monterey Park, California Tel: 213-280-8202 nites.

COLLINS 2 K.W. amplifier 30S-1, in mint condx. New 4CX1000A, Twenty months' old, No. 10272. Still lack operating time and still need \$900. LeRoy Harris, WA4JSU, Box 143, Griff'n, Ga.

SELL: Collins 75A3 in top shape, just reconditioned, \$295.00; Johnson Ranger, \$150.00; Johnson Thunderbolt, \$350.00; 45 ft. tilt-over tubular tower and 4-element Hornet kilowatt beam, \$195.00; entire station for \$995.00. All equipment on the air. Write or call: schedule, W4GSO, J. H. Connor, 1 River Drive, Cary, Ill. Phone: 212-639-4521.

COLLINS 75S-3 receiver, \$435.00; 312B5 VFO control unit, \$165.00. Both in mint condx. Will ship. G. Costa, Box 4, Brnklow, Maryland.

COLLINS 51J3, \$350.00; TS-175 w/power, \$95.00; Bird 611 wattmeter, \$65.00; APR-4 receiver w/5 converters, 30 thru 4000 mc.; BC-1032 Panadaptor, \$45.00; VHF-UHF-SSB gear, parts, excess to need. List for stamp. W4API, Box 4095, Arlington, Va. 22204.

SPECIAL Gear made up to order. Also may I have some of the hard-to-find parts you need for your own projects? Morgan, W5KRU, Box 88, Keittville, La. 71047.

FOR Sale: Equipment of W3AEM, the late Russell E. Freed, Collins 32S-1 with \$169-2, now less than 20 hours, \$750.00; 301-1 linear, \$350.00; Central Electronics 200V, \$425.00; Clegg Interceptor, \$295.00; Clegg Zeus 331 transmitter with 332 p/s/mod., \$495.00; Hallcrafters SX-115 w/2ptr, \$400; two Johnson "500", \$375.00 and \$325.00; HC-221T with original call hook, \$60.00. Heathkit capacitor checker HT-11, \$10.00; Standard Electric variable transformer, type 3020-BU, \$35.00; Gonset Super 12 converter, \$20.00; Quantity of miscellaneous items. Send for list. Write Mrs. Russell E. Freed, Ridge Road, RI 01, Potstown, Penna.

FOR Sale: Parabolic Reflector spin aluminum 40-inch, long focus, for distant recordings. Also deep paraboloid mike mount with 2-3 in. focus, molded fiberglass in both 18 and 26 inch diameter for portable field recordings birds, animals, Pair 4-250A unused, \$18.00 each. Assorted receiving tubes of twentys and thirties. Variety of surplus gear, mostly excellent condx. 813 RF amplifier switching grid, coils in output, fully metered, sell for component cost, 500 watt AM modulator, Carl Frank, W6COS, RR #1, Rochester, Minnesota.

FOR Sale: 75S3 receiver, \$400.00; RME 4301 with 4301 Sideband adaptor, \$100.00; HQ129X with spkr, \$60.00; Utica 650 with matching VFO, \$100; HT-37, clean, \$240.00; HT-33 2 Kw. P.E.P. final, modified to HT-33B, \$235.00; Johnson 250-watt Matchbox with SWR bridge, \$35.00; DB-22 Presetector, \$20.00; BC-221M complete with AC power supply and calibration manual, \$45.00; KW modulator Pp 810's with 600 ohm input, \$35.00; 2 mfd. 10,000 volts oil-filled condenser, new, \$10.00; Millen 10-meter Presetector, \$10.00, W4ZRZ, P.O. Box 6742, B'rnmhsham, Ala. 35210.

C-E 600L linear, One owner, in mint condx, and in original shipping case: \$225.00, W4IEN, Box 257, Norcross, Ga. 30071.

SELL: Auto-Mate Electronic keyer with Poucel EI-Key, \$40.00; pair Eimac 4-400As with SK-400 sockets and SK-406 chimneys, new, \$60.00; Jennings U-250 vacuum variable, new, \$35.00; Johnson 226-3 variable inductor, new, \$25.00; Hammarlund SP-600 (military 274-C, JX-26) in exlnt condx, \$450.00; replacement PTO oscillator assembly for Collins 75A-2, new, \$35.00; Ballantine 300 VTM, \$65.00, H. Cervantes, 34 Johnson Rd., Binghamton, N.Y. 13905.

NEED ANY band coils fitting the HRO-7 and components or unit for ART-13 AC power supply, G. Evans, W4WVS, 803 Rosselle St., Jacksonville, Fla.

FOR Sale: Hornet TR1000-4 4-element Triband beam, 1 yr. old, \$40.00. W4BUN, 5772 Yorktown Ln., Youngstown, Ohio.

VHF Station, Gonset 2m, Comm III, mike xtal, unused Finco 2 and 6, A-62 beam and C.D. rotor, All for \$200.00, F.o.b. Chicago, Ill. C. Crum, W9LC, 751 N. Central Ave., Chicago, Ill. 60644.

HEATHKIT HX-30 six meter SSB transmitter and matching HA-20 linear, in exlnt condx, \$275.00, or your best offer; 3-element Fiberglass Triband quad, \$90.00; KW 4-400A in 6 ft. rack cab.net complete with p/s, Meissner Signal Shifter and Millen 50-watt exciter, \$100.00; pick-up deal only: 4-250A, \$15.00; 6 ctr. converter, \$12.00; 3 meter converter, \$23.00; p/s in both for SX-101A, W9TOA, 2521 Clara Ave., Fort Wayne, Ind.

NATIONAL NCX-5 transceiver, latest model xtal calibrator, NCX-AC power supply, factory checked out. Best offer over \$585.00. Price new \$827.00. Also, NCL-2000 linear amplifier, G. Golden, 920 Cambridge St., Cambridge, Mass. Tel: UN 8-6600. Nites: LA 7-2641.

FIRE Sale: We purchased entire Hunter inventory to offer at half price. All units are new, tested OK, cleaned with new cabinets. Smoke damage only, no heat damage, no warranty. Hunter Bandit 2000B, regular net, \$575.00. Now \$250.00 less tubes; UE-572 B tubes, \$13.00 each, station control console regular \$190, now \$89; watt meter regular \$79, now \$39.00. Send certified check, return option 10 days, Bob Evans Amateur Radio Supply, 2200 Ingersoll Ave., Des Moines, Iowa 50312.

HUNTER Bandit 2000B, like new, \$325, new 75A-4 in plexiglas case, \$525; new 75A-3, \$350.00; VFO 75A-4, new \$49.00; VFO 75A-3, new, \$39.00; VFO KWM-1, \$29; VFO KWS-1, new, \$39.00; R-81A Collins checked, new, \$190.00. Richard E. Mann, 7205 Center Dr., Des Moines, Iowa.

HALLICRAFTERS SX-140 receiver, gud condx, \$70.00. You pay express. Ron, K7UXC, Box 125, Flagstaff, Arizona.

CLEGG 99'er, \$90; Shure 440 microphone/stand, \$12.00. Kellersman, Strongbrook Rd., Darien, Conn.

TRANSMITTER, Gates, 250-watt, UC-250 GY, surplus all new, consisting of modulation monitor, limiting amplifier, switching panel, power termination cabinet, desk, code beacon, tower lights, co-ax cables, and lead covered wire, including many extras, 27 boxes. Send for complete list. Also surplus all new 10KW linear 2-18 Mc. Make offer on either or both. FOUFE, G. Markos, 1720 North Jackson, Litchfield, Illinois. Tel: 324-3178 after 6 PM.

SELL OR trade in part for transceiver: Collins 75A4, \$425; GPR-90 receiver, w/MSR SSB filter, and speaker, \$425; Jennings vacuum variable capacitor UC5L 750, \$30; Collins 2.1 kc. mech. filter F455FA21 4V2, \$20 (new), 6 417A/5842; Ericsson tubes (new), \$4 each, PR 4CX250B/7203 tubes (new) with sockets, \$60, W2GBS, 341 Stanley Ave., Mamaroneck, N.Y.

SELL: Gonset Communicator III, 6 meters, PTT mike, 110 VAC and 12 VDC, 3 xtals, immaculate, \$120.00. WA9BYR, 760 Dundee Ave., Barrington, Ill.

COMPLETE Stations: Four choice! New Galaxy V, remote VFO, VOM, galib, deluxe console, mike: \$750. Or, excellent KWM-2, 512F2 AC, 30L1 linear, mike, \$1095. Also, dozen years QSTs. Offer, Warren Geary, K9KMX, 34 E. Hickory St., Hinsdale, Ill. Fone: (312) 325-1950.

GENUINE Bargain, Rare \$100 SX-88 general coverage receiver, Selectivity variable to 250 cps, etc. Only \$225.00, Valiant with low-pass, etc., \$210.00. Guaranteed. D. King, 2992 Andross St., Costa Mesa, Calif.

FOR Sale: SR-160 SSB transceiver, with AC and DC p/s, mounting rack and cables. All for \$400.00, or you make best offer. Mary Grossman, K2CON, 1665 Monroe Ave., Bronx, N.Y. 10457. Tel: 212-FR8-1174.

CLOSE-OUT: Full size three element 20 meter beams, new, 1/2" and 3/4" aluminum tubing, all hardware, complete, \$22.00. Express collect. Gotham, 1805 Purdy Ave., Miami Beach, Fla.

GOING OUT of ham business, Valiant, \$210.00; HQ-140XA, w/xtal calibrator, spkr, \$140; Ham-M rotor w/20 meter 3-element trap beam, \$80. All immaculate. E. A. Frekko, K4KXN, 402 Queens Road, Sanford, N.C.

DRAKE 2B revr, \$165; Hammarlund HK1B keyer w/Skilman key, \$35.00; Taetone XC 50 6-mtr. convr. w/power supply, \$20.00, Heath HD-20 xtal calibrator, \$7.00, K8PYU, 2921 Page Ave., Jackson, Mich.

HQ-170AC, \$225.00; Galaxy Deluxe accessory console, \$60.00; Ameco 6M Preamp, \$7.00; Johnson bug, \$7.00; Dow-Key 10V AC coax relay, \$8.00; all in mint condx. F. S. Eggert, 11833 Wisconsin, Detroit, Mich. 48204.

NC-303, In tip-top condx. Xtal calibrator. Instruction manual. Original shipping cartons. One owner, only \$375.00. W. Raabe, 4523 W. Seminar Ave., Richmond, Va. 23227. Tel: 703-353-5895.

WANTED: Sideband Engineers DC to AC inverter SB3-DCP for SBLA linear. Quote lowest cash price, Col. F. L. Moore, 730 Osceola Circle, Eglin Air Force Base, Fla.

GOING SSB, Polycorn 62B, \$225.00; NC-300, \$190.00, both in exlnt condx. K3IBQ, 1239 Wheatshaf, Abington, Penna. 19001.

FOR Sale: Globe King, 500 watt xmtr, \$200.00, W4TKL, Rte. 4, Box 1811, Huntsville, Ala. 35803.

SB-200 Linear, Excellent condition, \$189.00. Harry Partin, 2209 Morehead, Durham, N.C. 27706

ANY Fair offer, mint condx. Johnson Viking Valiant I, neobob filters, Hallcrafters SX-101A, RME ant. booster, Hy-Gain Tri-beam, CDR Ham-M, trans. code osc., code monitor, Arco 2 & 6 meter converters, ant. multi-switch, elec. switch, mike Atlas DS-10, Webster Fkoptae #111 recorder, needs work. Jerry Barr, 3130 Brighton 6 St., Brooklyn, N.Y. 11235.

FOR Sale: Collins 7553 revr, \$425.00; 32S-1 trans., \$375.00; 516F power, \$75.00; 312B control unit, \$100.00; NCL-2000, \$475.00. All are in AI condx. Complete for \$1400, K2GDP, 2316 Rosendale Rd., Schenectady, N.Y.

75A-4 serial #4728, vernier dial, \$415.00; HRO-60 A thru F coils, \$275.00; Viking Valiant, \$185.00; homebrewed brute 1 kw xmtr-Pair 250THs final 810 modulators, less than year old, in 83 1/2" rack, \$400.00. Sry, cannot ship. KW transmitter. All equipment in exlnt shape. Milt Hall, P.O. Box 486, Wichita, Kans.

RME-6900 receiver and RME DB23 Preselector, both in exclnt condx, for first check for \$200.00. W2DNG, 89 Van Horn Ave., Demarest, N.J.

DX-60, perf. condx, Ideal for Novice, OK for 2nd rig. Estate of W1OF, \$35.00. W1KSB, Wendell Cushins, 5 Bickford Rd., Malden, Mass. 02148.

SELL Excellent Gonset G-76 12VDC transistor pwr supply m/c, \$200 80-10 meter Babcock mobile 50-watt transmitter, 12 volt V1B p/s; Gonset 12 conv., \$100. VFO c.w. 100 watt trans. Needs p/s. \$35.00. K2DVK, 81 Washington St., Perth Amboy, N.J.

FOR Sale: Prop-pitch motor for rotator, unused surplus, medium size, converted, ready to use, \$35.00. Model 15 teletype transmit-receiver page machine, with table, clean, in exclnt condx, \$125.00. All equipment guaranteed. Will prepare for shipment. S. E. Hernandez, W2BSA/1, River Road, RD #1, Essex, Conn. Tel: (203) South 7-1410.

SELL: Spaulding crank-over heavy-duty 56 ft. tower. In exclnt condx, \$200.00. K9RZY, Don Walther, 1419 Ravinia Rd., West Lafayette, Ind. 47906.

POLYCOMM 62B, \$199 plus shipping. R. Bintliff, K1YDG, RFD, West Acton, Mass.

WANTED: Antenna 20, 15 and 10 meters plus rotator. Romano, 105 Perrine Ave., New Brunswick, N.J.

WANTED: NCX-D or HP-13 power supply, grid dip meter. W3ZQJ.

FOR Sale: HT-32A, \$300; SX-101 MK III, \$170.00, both in exclnt condx for \$450.00. Used infrequently. Also new, unused equipment includes Hallicrafters HA-1 T.O. keyer, \$75.00; Vibro-keyer, \$15.00; Hallicrafters R48-A spkr, \$15.00; Johnson lo-pass filter, \$10.00; Turner SSB ceramic mike, \$10.00; Knight SWR bridge, \$15.00; Dow-Key ant. relay DK-60-G2C, \$13.00; Hy-Gain lightning arrester LA-1, \$15.00; Johnson Standard key, \$2.00; Mosley RV-4 vertical ant. \$25.00 with roof-mount kit RV4K, \$10.00; Heathkit antenna dummy load, \$5.00; 100 ft. RG/8U foam core cable, \$5.00. Will take \$650 for entire station. Cash and f.o.b. Neenan, Dr. (414) Larson, K9LWG, 449 Edgewood Ct., Neenan, Wis. Tel: (414) PA5-3227.

KILOWATT Eldico SSB-1000 amplifier. Will sell cheap. A. Lukach, W2DPP, 35 East 84th St., New York City 28.

FOR Sale: Collins 51-J3 receiver. In gud condx. \$250.00. Will ship. K5ZPJ, 1222 Gretchen Ln., Bossier City, La.

1FCRAFT 2-meter trans. Globe Scout model 68A; Heathkit Q multiplier, 2 meter converter. E. B. Odell, 9 Ridge Drive, Carmel, N.Y.

LINEAR. Coasts at 2 kw. P.E.P., 1 kw, AM or CW; 4000 w. power supply, 4-1000A tube, cabinet 5 ft. 9 in. x 22 in. You pick up. \$215.00. W8EW, 949 Maxwell Ave. S. E., Grand Rapids 6, Michigan.

JOB Location changed! Selling modern ranch home, double garage, blacktop drive, large lot, 10 minutes drive from Portland, nice residential area on bus line. Includes antennas 80-40 meters, TA-33, Ham-M mounted on permanently sanded 52 ft. Tri-Ex tower. Move in and you're on the air. Also sell Drake 25 w/Q-multipl.-spkr. \$199; Model 15 printer w/homebrew TU, \$125.00; NCL-2000, \$325.00; KWM-2, AC and DC p/s, \$850. Wendell Lewis, K1RPE, 72 Pleasant St., Yarmouth, Maine, 04096.

G-76 Owners! I have three new Gonset G-76 DC p/s, model 3350 in unopened, factory-sealed cartons with manufacturer's warranty priced at \$60 each. Wayne Hicks, W5FYX, 3708-24th St., Lubbock, Texas.

SELL: Central Electronics 200V, \$500; Hallicrafters SX-101A, \$200; Rohm Tower, 66 ft., \$70.00. Sry, will not ship the tower. K6RTC, 470 Commercial Ave., South San Francisco, Calif.

FOR Sale: HQ-110A, in exclnt condx, \$160.00 f.o.b. Now have HQ-170 SASE for list of extra gear, gud. some VHF. W8FZ, 4328 State Road, Saginaw, Mich. 48603.

SELL Or trade for new aircraft radio, 2 Gonset Sidewinders including AC and DC p/s. Don Eddy, Staples State Bank, Staples, Minn.

SR-150 and AC supply exclnt condx. Both for \$430.00. Robert Schwartz, Bucknell University, Lewisburg, Penna.

SELL Johnson Ranger, Hammarlund HQ-110 w/spkr, mint condx, \$150.00 each; new Johnson Matchbox, \$65. Sry, no shppg. Colman, 170 Sandy Hollow Rd., Northport, N.Y. 516-ANI-4129.

SR-300 Receiver w/SSB and c.w. filters, professionally wired and like new, \$250 or best offer. Want gud 75A4. W4PRO, 15 Willow Rd., Hampton, Va.

SOUTHERN Calif. Complete SSB station for sale. GSB-100, GSB-201, Drake 2-B, tower, TA-33 beam, tower, new Ham-M rotor. All like new condx and not a scratch! Many extras. First \$750 takes all. K6YQW at 544-6278 after 6:00 PM or see at 18232 Beneta Way, Tustin, Calif.

WANTED: Early or unusual Command type equipment (RAV, AN/ARC-5, etc.); any Aircraft Radio Corp. components. Private collection. Write, 5716 N. King's Highway, Alexandria, Va.

COMPLETE Station for sale; Heath Apache with instruction book, \$185, RME 6900 rcvr, less spkr, with instr. book, \$200. Both in A-1 condx. Low hours operation. W2IGH, RD 4, Newton, N.J. Tel: 383-2437.

SELLING Entire Novice station: National NC-300 with Lafayette HE-11 spkr and manuals. Exclnt condx, \$230; Heathkit DX-40 w/4 xtals and manuals. Exclnt condx, \$45. Take both and will thro in chrome swivel ball mount base and assorted other gear. Sanford Stevens, 274 First Ave., NYC. Tel: Canal 8-7273.



THE LEAGUE IS YOU!

Working together, the members of ARRL have for fifty years provided the base of support from which our great public-service hobby has grown and maintained the precious privileges that many amateurs now take for granted.

Through membership in the League and affiliated clubs, many people pool their knowledge, their skills, their energy, and a small part of their material resources to help one another. The result is top-notch training programs and publications, top-efficiency traffic nets, community communications programs—and an amateur radio service which is useful to our country and deserving of its privileges.

Newcomers gain from the experience of the old timers, and old timers gain from the enthusiasm of the beginners. The more we work together in the League, the greater will be our collective achievements—and our security.

Each and every radio amateur is vital to the League, and the League is vital to each and every radio amateur. Join now with over 100,000 League members so that we can all share more fully in these mutual benefits. League membership, including QST subscription, is only \$5 in the U.S., (additional licensed family members at the same address \$1), \$5.25 in Canada, and \$6.00 elsewhere.

If you are already a member, help strengthen your League by spreading this word to others!

THE AMERICAN RADIO
RELAY LEAGUE, INC.
Newington, Conn. 06111

Designed for

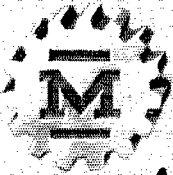

Application

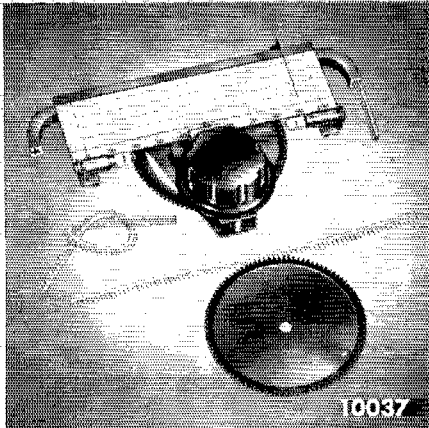

NO-STRING DIAL

No strings; no pulleys; no back lash; no flimsy assembly. The No. 10037 is a sturdy mechanically engineered "Designed for Application" dial assembly which completely eliminates the annoyances of string-driven pointers, eliminates all indicator stutter or wobble and provides positive pointer travel and resetability. The pointer is driven positively by a flexible but non-elastic molded gear driven rack which cannot slip, break or fall off a pulley. The geared flexible rack rides in a multi-slot extruded aluminum channel. This girder-like extruded piece provides mechanical rigidity to the assembly. Furnished complete with panel trim bezel and flexible coupling for output shaft.

**JAMES MILLEN
MFG. CO., INC.**

MAIN OFFICE AND FACTORY
**MALDEN
MASSACHUSETTS**



Index of Advertisers

Adirondack Radio Supply	181
Altronics-Howard Co.	179
Ameco Equipment Corp.	147
American Radio Relay League	189
<i>QST</i>	189
<i>Advertising Policy</i>	175
<i>Antenna Book</i>	183
<i>Emblems</i>	178
<i>License Manual</i>	169
<i>Single Sideband</i>	176
<i>VHF Manual</i>	166
Amperex Electronic Corp.	134, 135
Apollo Engraving	160
Arrow Electronics, Inc.	164
Arrow Sales	154
Ashe Radio Co., Walter	180
Barry Electronics	167
Belden Manufacturing Co.	191
British Radio Electronics, Ltd. (Eddystone)	181
Budwig Manufacturing Co.	181
Burstein-Applebee Co.	171
Clemens Manufacturing Co.	183
Cleveland Institute of Electronics	165
Collins Radio Co.	2
Communication Products Co.	173, 175
Cubex Co.	137
Cush Craft	136
Dames Co., Theodore E.	174
Dow-Key Co., Inc., The	180, 183
Dutson, G.	173
Dynalab Co.	158
Editors & Engineers, Ltd.	156
Eico Electronic Instrument Co.	139
Eitel-McCullough, Inc.	4
Electro-Voice, Inc.	173
Electroncraft, Inc.	168
Electrophysics Corp.	171
Evans Radio	165
Fair Radio Sales	178
Fichter Electronics	181
Fort Orange Radio Distributing Co., Inc.	167
Frederick Electronics Corp.	151
Fugle Labs.	162
Gain, Inc.	179
Gardner & Co.	160
Gentec, Inc.	172
Gift Shop	182
Gotham	145
Grand Central Radio, Inc.	182
Hallcrafters Co., The	1
Ham Kits	170
Hammarlund Manufacturing Co., Inc.	144
Harrison Radio	192
Harvey Radio Co., Inc.	159
Heath Co., The	132, 133
Henry Radio Stores	163
Hi-Gain Electronics Corp.	5
Instructograph Co., Inc.	164
International Crystal Manufacturing Co., Inc.	7
Justin, Inc.	174
Kahn Research Labs., Inc.	179
Lampkin Labs., Inc.	177
Latin Radio Labs.	183
Marlin Amateur Radio Supply	174
Mark Products Div.	146
Millen Manufacturing Co., Inc., James	190
Miller Co. J. W.	177
Mini-Products, Inc.	152
Mosley Electronics, Inc.	181
National Radio Co., Inc.	131, Cov. III
National Radio Institute	150
P & H Electronics, Inc.	169
Parks Electronics Lab	168
Pennwood Numechron Co.	162
Penta Labs, Inc.	153
Philco Techrep Div.	167
Post-Check	177
Productive Tool & Manufacturing Co., Inc., The	172
RCA Electronic Components & Devices	Cov. IV
Rohn Manufacturing Co.	130
Roland Co., The	170
Scientific Instrument Research & Development Co.	171
Shure Bros., Inc.	183
Slideband Engineers, Inc.	137
Siliconix, Inc.	155
Skylane Products	168
Space Electronics	182
Squires-Sanders, Inc.	141
Swan Electronics Corp.	143
Sylvania Electric Products, Inc.	149
Telemethods International	170
Teleplex Co.	178
Tepabco	162
Tri-Ex Tower Corp.	148
Trigger Electronics	161
Turner Co., The	142
Two-Way Engineers, Inc.	175
Unadilla Radiation Products	171
United States Fiberglass Co.	160
United Transformer Corp.	Cov. II
Van Sickle Radio Supply Co.	174
Vanguard Electronic Labs.	172, 173
VHF Associates	175
Vibroplex Co., Inc., The	177
Waters Manufacturing Co.	182
Webster Manufacturing Co.	158
Wilson, Inc., Willard S.	170
World Radio Labs.	157

improve radio transmission and reception with Belden wire and cable

Service rated—Quality controlled. Easy-to-use packaged lengths for ham or citizen band requirements.

Ham Transmission Lines— Parallel Type

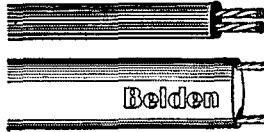

Made with brown virgin polyethylene for best weather resistance and lowest losses. Uniform quality control prevents standing waves and mismatches.

Antenna Rotor Cables

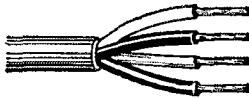

Sturdy, flexible, plastic insulated cable for all ham antenna rotor applications. Color coded for easier hook-up. Chrome, vinyl plastic jacket resists sun and aging.

Power Supply Cables

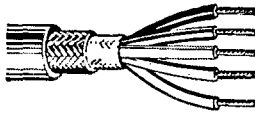

Provide dependable service as power supply cords, interconnecting cables on electronic equipment, remote control circuits, special press-to-talk microphone circuits, and other ham applications. Designed for long service life with excellent mechanical and electrical characteristics and uniform quality. Special jacket offers maximum resistance to abrasion and ozone.

Ham Transmission Lines— 75 Ohm Foam Core RG/U Type

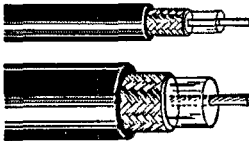

Designed for lowest losses, longer service life, and maximum dependability. Cables are essentially flat with no peaks in attenuation to reduce signal on either high or low frequencies.

Shielded Hook-Up and Grid Wire



Provide most effective TVI suppression. Vinyl insulated with tinned copper braid shield. Available in wide range of capacities from 24 AWG to 12 AWG.

Coiled Microphone Cable

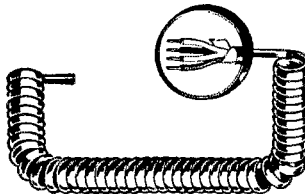

Provides low impedance for mobile microphone applications. Black neoprene jacket remains flexible at low temperatures. Available with or without shielded conductors.

Specify Belden the next time you need wire or cable. There isn't one requirement that Belden can't supply. It's available at your electronic parts distributor.

Better Built—Better Buy—



Magnet Wire • Lead Wire • Power Supply Cords • Cord Sets and Portable Cord • Aircraft Wires
Electrical Household Cords • Electronic Wires • Welding Cable • Automotive Wire and Cable

8-1-5

Rx

FOR MORE "SOCK" PER WATT

Come to the HARRISON BETTER PROPAGATION CLINIC

Talk to experts from the leading manufacturers of antennas, towers, and accessories.

Ask questions—discuss your problems — get their experienced advice. See how you can put out the biggest signal from your shack or mobile. Improve your reception, too.



Columbus Day
October 12,
9 to 5

Prescriptions filled promptly, at lowest cost
by:



"HAM HEADQUARTERS, USA"
225 GREENWICH STREET • NEW YORK, N. Y.

BA 7-7922

YOU, TOO,
CAN HAVE
A MORE
POWERFUL
SIGNAL,
BETTER
QSO'S,
MORE
FUN!

CASH
ALLOWANCE
FOR YOUR OLD
ANTENNA
Regardless of
make or condition

QUESTIONS

ANSWERS

QUESTIONS

ANSWERS

QUESTIONS

ANSWERS

QUESTIONS

ANSWERS

QUESTIONS

ANSWERS

MR. NEW-TRONICS
Jim Taylor, W8EEC

MR. CUSH CRAFT
Les Cushman, W1AWZ

MR. HY-GAIN
Bob L. Ruyle, WØFCH

MR. E-Z WAY
Len Zlowe, K2MII

HARRISON

proved

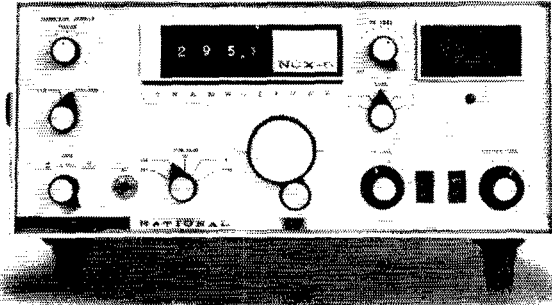

improved

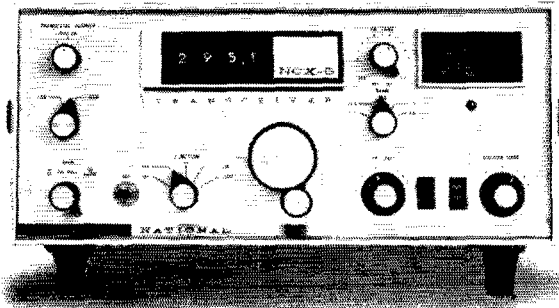

One thinks long and hard before making a change in a rig like the NCX-5 — after all, it has proven itself as the finest transceiver ever offered the amateur at any price. But we have designed a new balanced modulator circuit which offers such high performance that we felt it should be incorporated in new NCX-5 production. The new balanced modulator is a solid state ring-type device which is totally unaffected by external or magnetic influences, on-off cycling, aging, or warm-up time. Minimum carrier suppression is 50 db through all of these variables, and typically can be adjusted to provide even 65 or 70 db! In fact, the circuit cannot be unbalanced far enough, using the carrier balance control, to provide sufficient carrier for AM or CW operation of the NCX-5. We therefore replaced the carrier balance control with a new Carrier Insertion control to provide a gradual increase in carrier as the control is turned clockwise. Carrier is also now inserted automatically in the AM

or CW positions of the NCX-5 mode switch. "Carrier balance" has become an internal factory adjustment which need never be touched.

The new NCX-5 is designated Mark II, and is identical in appearance to previous units. The superb dial calibration, stability, selectivity, and all other maximum performance features of the NCX-5 are, of course, unchanged (including the remarkable price of only \$685).

When we make performance improvements during production we try to make certain that owners of earlier units can similarly improve their equipment, if they wish. So our Customer Service Department has a Mark II kit available for satisfied NCX-5 owners so that they can become satisfied NCX-5 Mark II owners. The NCX-5 is the finest transceiver on the amateur market, proven in operation by amateurs the world over. The Mark II NCX-5 is even better.

NATIONAL RADIO COMPANY, INC. 

37 Washington St., Melrose, Mass. 02176./World Wide Export
Sales: Auriema International Group, 85 Broad St., N.Y.C./
Canada: Tri-Tel Associates, 55 Brisbane Rd., Downsview, Ontario.

Save
battery power
with the
RCA "quick heat"

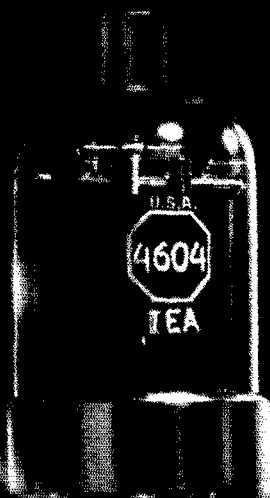

Beam Power Tube

Mobile rigs using the RCA-4604 "quick heat" tube *conserve* filament battery power while operating. It requires *no* filament power in standby, resulting in reduced battery drain . . . you'll be drawing filament battery power *only* when transmitting.

Similar in capabilities to the famous RCA-6146 Family, the sturdy RCA-4604 has a maximum plate dissipation of 25 watts under ICAS conditions in cw and fm telephony service. At this service, it can be operated with full input to 60 Mc and with reduced input to 175 Mc.

For additional information on the RCA-4604 and its use in mobile rigs, contact Commercial Engineering, Section J-37-M, Harrison, N.J.

RCA ELECTRONIC COMPONENTS AND DEVICES



The Most Trusted Name in Electronics