

October 1963

50 Cents

55c in Canada

# QST





# "S" SERIES

## AUDIO & POWER TRANSFORMERS & REACTORS For Complete Ham Systems

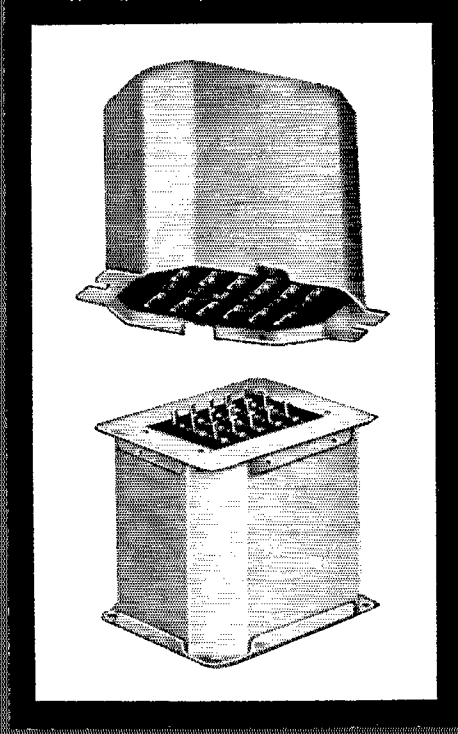

Popular Priced  
Matched Components  
for  
Power Supplies  
Modulation  
Pre-Amp &  
Power Amplifiers  
... for entire ham rigs

Many years of attention to ham requirements have resulted in a complete line of reliable, accurately constructed, tested, capacity to volume. The "S" series of audio and power transformers and reactors, designed specifically for ham and PA service, are completely engineered for dependability in conducting a rig. These are available in standard and special sizes and configurations. All units are built and tested to meet the highest standards of reliability.

Write for catalog of stock  
1-800-SWITCHTEERS

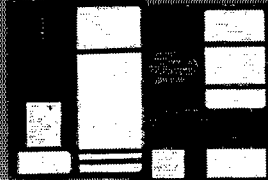

### UNITED TRANSFORMER CORP.

207 MADISON STREET - NEW YORK 13, N.Y.

WHISKEY DIVISION 8830 EASTERN BLVD. CUPERTINO CALIF.  
COURTESY DIVISION 13 EAST 40th STREET, NEW YORK 16, N.Y. CABLE "ARLAY"

# All this performance for only \$650<sup>00</sup>!

Full amateur band coverage, 80 through 10 meters • Hallicrafters exclusive new R.I.T. (Receiver Incremental Tuning) for  $\pm 2$  kc. adjustment of receiver frequency independent of transmitter, and AALC (Amplified Automatic Level Control) • Receiver AF gain and RF gain controls • SSB operation, VOX or PTT . . . CW operation, manual or break-in • 1650 kc. crystal filter . . .

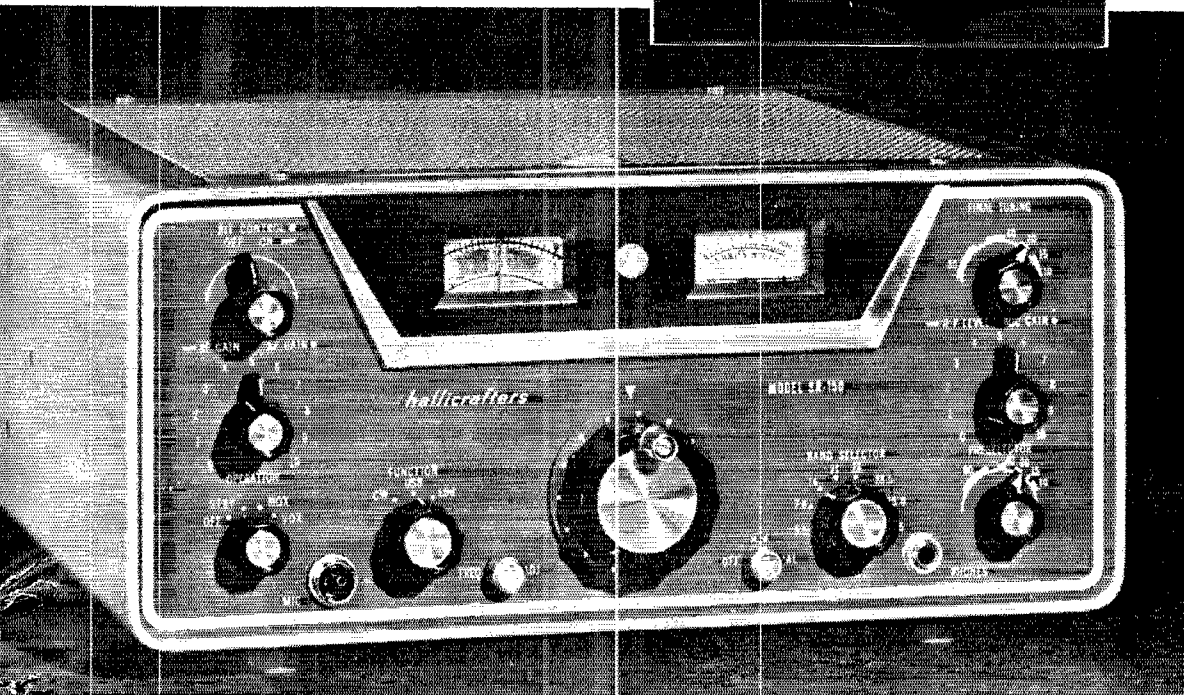

## SPECIFICATIONS

**Frequency coverage:** Eight-band capability — full coverage provided for 80, 40, 20, 15 meters; 10M crystals furnished for operation on 28.5 — 29.0 Mc. Other crystals may be added for full 10 meter coverage without adjustment. Available for operation on specified non-amateur frequencies by special order.

**Front panel controls:** Tuning; Band Selector; Final Tuning; RF Level; Mic. Gain; Pre-Selector; R.I.T.; Rec. RF Gain; AF Gain; Operation (Off/Standby/MOX/VOX.); Function (CW/USB/LSB); Cal.

**General:** Dial cal., 5 kc.; 100 kc. crystal cal.; VFO tunes 500 kc.; 18 tubes plus volt. reg., 10 diodes, one varicap. Rugged, lightweight aluminum con-

struction (only 17½ lb.); size—6½" x 15" x 13".

**Transmitter Section:** (2) 12DQ6B output tubes. Fixed, 50-ohm Pi network. Power input—150W P.E.P. SSB; 125W CW. Carrier and unwanted side-band suppression 50 db.; distortion prod., 30 db. Audio: 400-2800 c.p.s. @ 3 db.

**Receiver Section:** Sensitivity less than 1  $\mu$ v for 20 db. signal-to-noise ratio. Audio output 2W; overall gain, 1  $\mu$ v for ½ W output. 6.0 — 6.5 1st I.F. (tunes with VFO). 1650 kc. 2nd I.F.

**Accessories:** P-150AC, AC power supply, \$99.50. P-150DC, DC power supply, \$109.50. MR-150 mounting rack, \$39.95.



*New*

# SR-150

Fixed/Mobile  
Transceiver

# hallicrafters

talk about

# TALK POWER

No other comparable equipment gives you more talk power than the compact, portable Collins 30L-1 Linear with exclusive automatic load control. The 30L-1 provides a conservatively rated 1,000 watts PEP input on SSB (500 watts average dc) and 1,000 watts average on CW. It is designed to be driven by the KWM-1, KWM-2, 32S-3 or most other 70-100 watt CW/SSB excitors. When used with the KWM-2, you can have a kilowatt station in two suitcases. But more talk power is just one of the 30L-1 features. You'll also find solid state rectifiers which help reduce heat. There's a self-contained power supply with safety interlocks. An automatic antenna transfer, a high/low power capability, and an RF inverse feedback. Get the facts on more talk power and all the other features offered you in the Collins 30L-1 Linear. For free copy of Collins amateur catalog, see your distributor today.

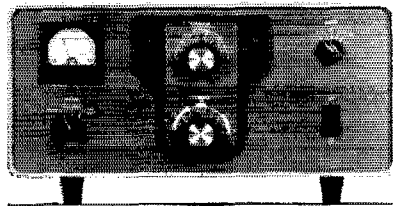



PUBLISHED, MONTHLY, AS ITS OFFICIAL ORGAN, BY THE AMERICAN RADIO RELAY LEAGUE, INC., NEWINGTON, CONN., U. S. A.; OFFICIAL ORGAN OF THE INTERNATIONAL AMATEUR RADIO UNION

STAFF

- JOHN HUNTOON, WILVQ Editor
RICHARD L. BALDWIN, WIKE Managing Editor
EDWARD MEHNERT, W3ZJ/1 Assistant Managing Editor
GEORGE GRAMMER, W1DF Technical Editor
DONALD H. MIX, W1TS BYRON GOODMAN, W1DX Assistant Technical Editors
EDWARD P. TILTON, W1HDC V.H.F. Editor
LEWIS G. McCOY, W1CPC E. LAIRD CAMPBELL, W1CUT Technical Assistants
ROD NEWKIRK, W9BRD Contributing Editor, DX
JEAN PEACOR, K1JIV Contributing Editor, YLs
SAM HARRIS, W1FZJ HELEN HARRIS, W1HOY Contributing Editors, V.H.F.
SYLVIA M. RIDER Editorial Assistant
LORENTZ A. MORROW, W1VIG Advertising Manager
EDGAR D. COLLINS Advertising Assistant

- DAVID H. HOUGHTON Circulation Manager
J. A. MOSKEY, W1JMY Assistant Circulation Manager

OFFICES

225 Main Street
Newington 11, Connecticut 06111
TEL.: 866-1541
Area Code 203

Subscription rate in United States and Possessions, \$5.00 per year, postpaid; \$5.25 in Canada, \$6.00 in all other countries. Single copies, 50 cents. Foreign remittances should be by international postal or express money order or bank draft negotiable in the U. S. and for an equivalent amount in U. S. funds.

Second-class postage paid at Hartford, Conn. and at additional mailing offices. Copyright 1963 by the American Radio Relay League, Inc. Title registered at U. S. Patent Office. International copyright secured. All rights reserved. Quedan reservados todos los derechos. Printed in U. S. A.

INDEXED BY
Applied Science and Technology Index
Library of Congress Catalog Card No.: 21-9421

--CONTENTS--

TECHNICAL --

- The Single Sideband Sixer Jay Gooch, W9YRV and Estil Carter, WA9DNF 11
The Hampmeter.....Horner Kuper, K2CU and Frank J. Rizzo, W2OCM 20
A Pre-I.F. Noise Silencer..William K. Squires, W2PUL 22
S.S.B. with an AN/ART-13 Theo. A. Brunner, W4MTM 27
Antennas and Feeders -- Part I George Grammer, W1DF 30
There is Still Life in That Old Receiver Wells Chapin, W2DUD 40
The TDCS Communications Receiver...T. L. Thomas 41
Some Notes on the Care and Feeding of Grounded Verticals.....Eugene E. Baldwin, W0RUG 45
A Simple Automatic CQ Sender Fred H. Calvert, W9JCV 53
Recent Equipment;
Heathkit Model HG-10 V.F.O..... 54
WRL Galaxy 300 S.S.B. Transceiver..... 55

BEGINNER AND NOVICE --

- Updating the "Novice Gallon" Lewis G. McCoy, W1ICP 35

OPERATING --

- 1963 Simulated Emergency Test Announcement..... 38
Official Results -- 1963 ARRL International DX Competition..... 64
Third World-Wide RTTY Sweepstakes Announcement.. 78

GENERAL --

- Project Oscar Finds a New Home William I. Orr, W6SAI 26
Building Fund Progress..... 34
Members Are Saying..... 34
QMT.....John G. Troster, W6ISQ 39
Two Plus Two Equals Four..A. Prose Walker, W0DCA 48
An Interview with Barry, KTUGA..... 60
On the Art of QSLing.....Ted Wilds, KZ5SW/W4GVD 61

- Coming Conventions..... 10 "It Seems to Us..."..... 9
Southwestern Division Convention..... 10 Operating News..... 92
Midwest Division Convention.. 10 Our Cover..... 33
Correspondence From Members.. 59 Silent Keys..... 176
Hamfest Calendar..... 10 Station Activities..... 104
Hints & Kinks..... 76 World Above 50 Mc..... 82
How's DX?..... 87 YL News and Views..... 79
Index to Advertisers..... 190 25 Years Ago in QST..... 19

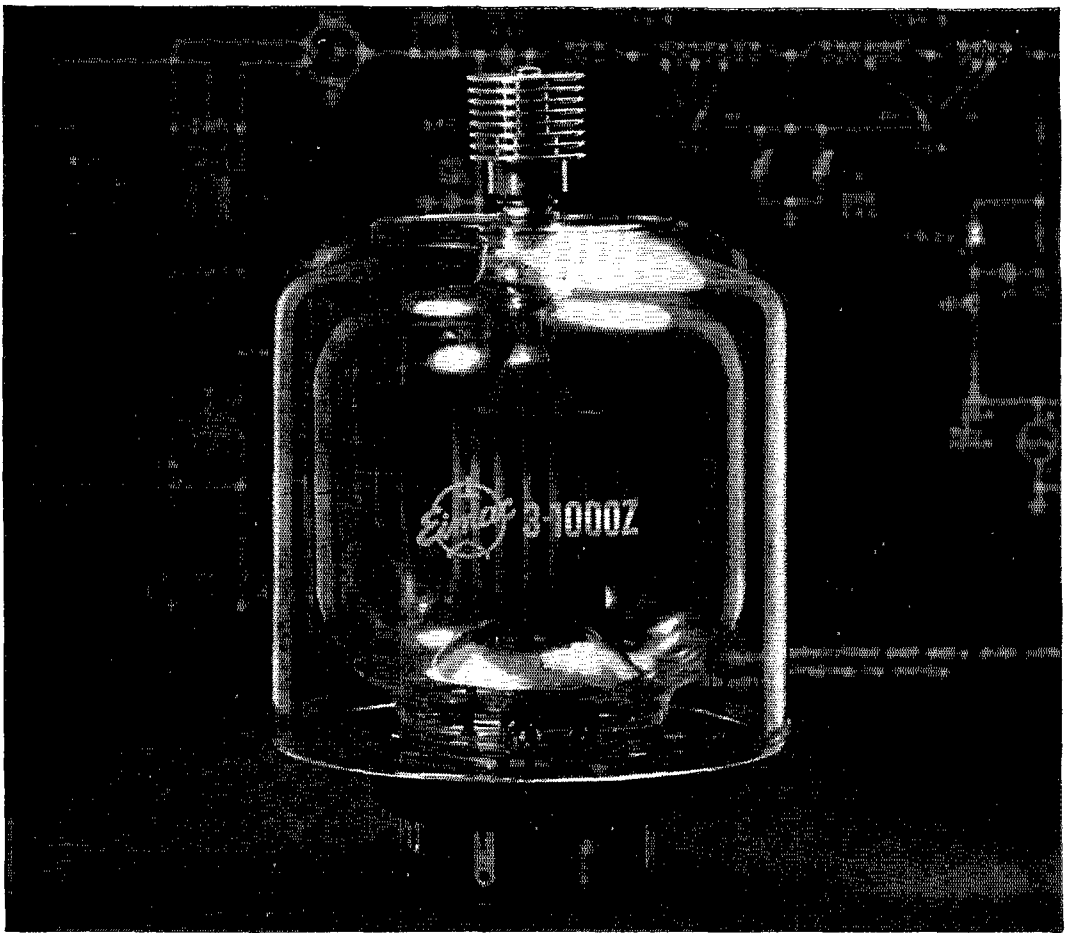

## Eimac cuts the price of the 3-1000Z power triode.

Today the 3-1000Z, high-Mu, 1 kw power triode is the most economical tube you can buy. With its new low price, the compact 3-1000Z gives you more work per dollar than any tube suitable for amateur operation. Since there's no screen grid, it requires only simple associated circuitry. It offers longer life. It gives you adequate power margins, provides reliable, trouble-free performance. **\$119.00** amateur net.

Here are typical operational characteristics (single-tone conditions):

D-C Plate Voltage	3000 volts	Resonant Load Impedance	2650 ohms
Zero-Sig D-C Plate Current*	240 ma	Max-Sig Driving Power	65 watts
Max-Sig D-C Plate Current	670 ma	Peak Envelope Plate Output Power	1360 watts
Max-Sig D-C Grid Current	300 ma	Max. Plate Dissipation	1000 watts
Driving Impedance	55 ohms		

\*approximate value

Recommended Heat-Dissipating Plate Connector  
Sole Recommended Socket (at new low price!)  
Recommended Chimney

Eimac HR-8  
Eimac SK-510  
Eimac SK-516

For additional material on the 3-1000Z and a reprint of the article, "A two-Kilowatt P.E.P. Amplifier Using the 3-1000Z," from QST magazine, write Bill Orr, W6SAI, Amateur Service Dept., Eitel-McCullough, Inc., San Carlos, Calif. Subsidiaries: Eitel-McCullough, S.A., Geneva, Switzerland; National Electronics, Geneva, Illinois.



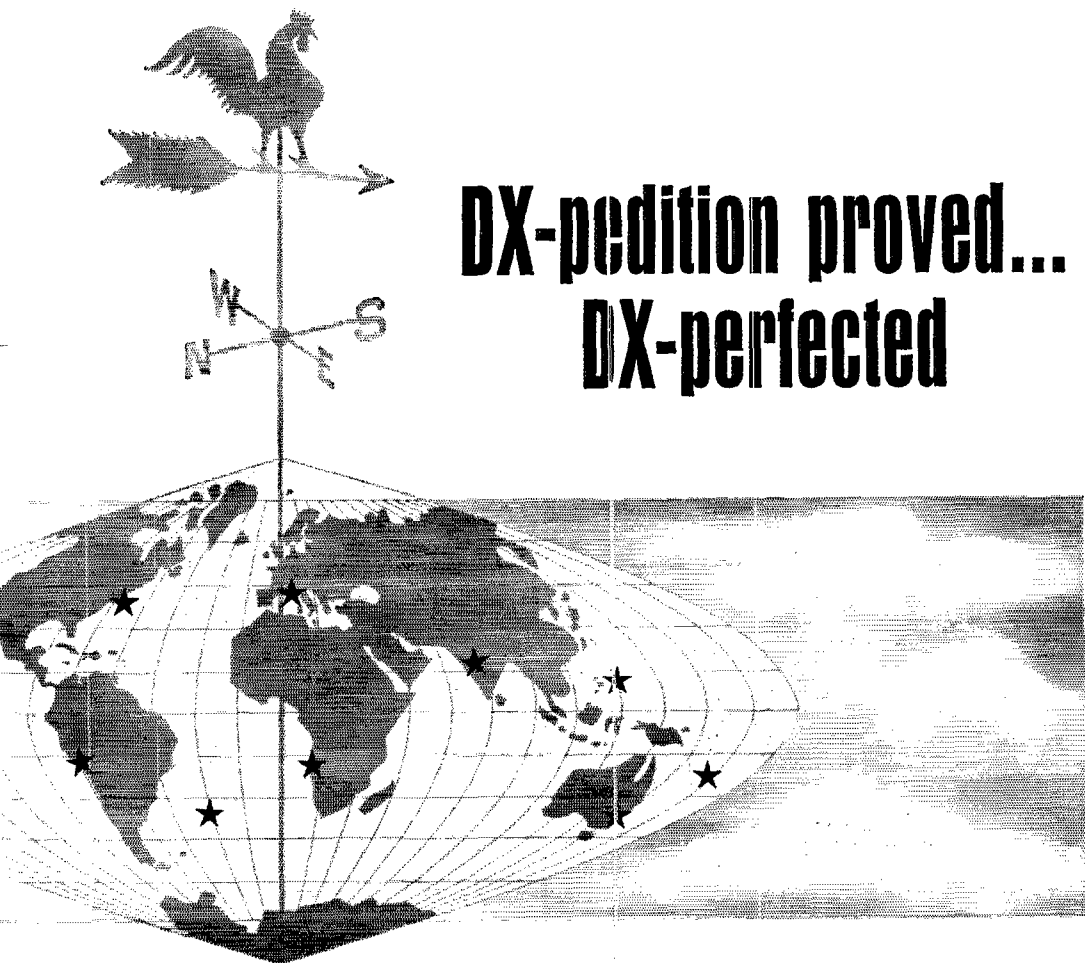

# DX-pedition proved... DX-perfected

## HAMMARLUND'S FAMOUS GLOBE-TROTTING PAIR—THE INCOMPARABLE HX-50 AND HQ-170A

Literally thousands of DX-hungry operators throughout the world can attest to the big signal of the HX-50 SSB/CW transmitter from remote, rarely contacted areas of the world.

- ★ *From Nauru in the Southwest Pacific...*
- ★ *From the Ocean Islands in the Southwest Pacific*
- ★ *From the island of Corsica*

... and from yet-to-be-announced DX-less areas in the Middle East and other parts of the world, Hammarlund's HX-50 and HQ-170A have made, and will continue to make, thousands of DX contacts.

Here is irrefutable proof of outstanding performance—the BIG performance amateurs have come to expect from Hammarlund-quality communications equipment.

See your nearest Hammarlund distributor for up-to-the-minute news of DX-PEDITION OF THE MONTH and a close-up look at Hammarlund's "full-control" equipment.

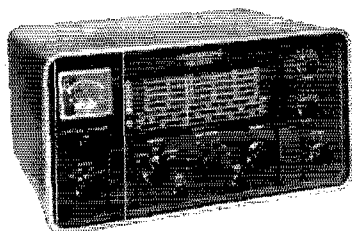

HX-50 ... \$449.50

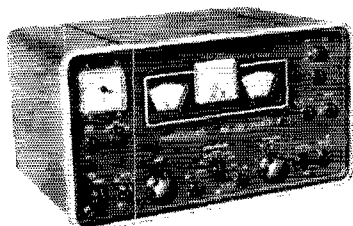

HQ-170A ... \$379.00



ESTABLISHED 1919



**HAMMARLUND**  
MANUFACTURING COMPANY  
A GIANNINI SCIENTIFIC COMPANY

53 West 23rd Street, New York 10, N. Y.

*Amateur Radio Equipment • Commercial Communications Equipment • Variable Air Capacitors ... and ... The Outcom 2-Way Radio*

## Section Communications Managers of the ARRL Communications Department

**Reports Invited.** All amateurs, especially League members, are invited to report station activities on the first of each month (for preceding month) direct to the SCM, the administrative ARRL official elected by members in each Section. Radio club reports are also desired by SCMs for inclusion in *QST*. **ARRL Field Organization station appointments** are available in areas shown to qualified League members holding Canadian or FCC amateur license, General or Conditional Class or above. These include ORS, OES, OPS, OO and OBS. SCMs desire applications for SEC, EC, RM and PAM where vacancies exist. OES, v.h.f. bands appointment, is available to Technicians and Novice, as well as to full-privilege amateur licensees.

ATLANTIC DIVISION			
Eastern Pennsylvania	W3ZRQ	Allen R. Breiner	212 Race St.
Maryland - D. C.	W3JZY	Andrew H. Abraham	RFD 1
Delaware	K3GKF	M. P. Nelson	305 Milltown Rd.
Southern New Jersey	K2BG	Herbert C. Brooks	800 Lincoln Ave.
Western New York	K2HUK	Charles T. Hansen	211 Rosemount Drive
Western Pennsylvania	W3UHN	Anthony J. Mroczka	475-5th St.
CENTRAL DIVISION			
Illinois	W9PRN	Edmond A. Metzger	1520 South 4th St.
Indiana	W9FWH	Donald L. Holt	1312 East 28th St.
Wisconsin	K9GSC	Kenneth A. Ebneter	822 Wauona Trail
DAKOTA DIVISION			
North Dakota	W0HVA	Harold A. Wengel	805-3rd St., S. W.
South Dakota	W0RRN	J. W. Sikorski	1900 S. Menlo Ave
Minnesota	W0OPX	Mrs. Helen Mejdrich	Route 3
DELTA DIVISION			
Arkansas	W5DTR	Curtis E. Williams	Route 3, Box 230
Louisiana	W5FMO	Thomas J. Morgavi	3409 Beaulieu St.
Mississippi	W5EMM	S. H. Halston	2321-27th Ave.
Tennessee	W4GGG	David C. Goggio	1419 Fawell Dr.
GREAT LAKES DIVISION			
Kentucky	K4QTO	Mrs. Patricia C. Schaefer	732 Greenbridge Lane
Michigan	W8FX	Ralph P. Thetreau	27209 W. Six Mile Road
Ohio	W8AL	Wilson E. Weckel	2118 Tuscarawas St., W.
HUDSON DIVISION			
Eastern New York	W2EFU	George W. Tracy	1138 North Country Club Drive
N. Y. C. & Long Island *	K2OVN	John Brandau	1659 East 46th St.
Northern New Jersey	W2CVW	Edward F. Erickson	13 Robert Circle
MIDWEST DIVISION			
Iowa	W0NTB	Dennis Burke	1418 Douglas Ave.
Kansas	W0ALA	C. Leland Cheney	814 Levitt Dr.
Missouri	W0TPK	Alfred E. Schwaneke	Edgar Star Rte.
Nebraska	W0GGP	Frank Allen	Box 272
NEW ENGLAND DIVISION			
Connecticut	W1FHP	Robert J. O'Neil	Hard Hill Road
Maine	W1AHM	Arthur J. Brymer	20 Berwick St.
Eastern Massachusetts	W1ALP	Frank L. Baker, Jr.	35 Clair Ave.
Western Massachusetts	W1BYR	Percy C. Noble	856 Dennis St.
New Hampshire	W1YHI	Albert F. Haworth	20 Plummer Rd. (Bedford)
Rhode Island	K1AAV	John E. Johnson	30 Fruit St.
Vermont *	K1MPN	R. Reginald Murray	3 Hillcrest Drive
NORTHWESTERN DIVISION			
Alaska	KL7BZO	Kenneth E. Koestler	2005 Sunrise Dr.
Idaho	K7HLR	Raymond V. Evans	Route 3.
Montana	W7KUH	Walter R. Marten	3021-6th Ave., So.
Oregon	W7ADN	Everett H. France	3535 S.E. 116th Ave.
Washington	W7PGY	Robert L. Thurston	7700-31st Ave., N.E.
PACIFIC DIVISION			
Hawaii *	KH6ARL	Mike Fern	P. O. Box 107
Nevada	W7PBV	Leonard M. Norman	652 Utah St.
Santa Clara Valley	W6ZRJ	Jean A. Gmellin	10835 Willowbrook Way
East Bay	W60JW	B. W. Southwell	200 South Seventh St.
San Francisco	W6BTP	Wilbur E. Bachman	*80 Dartmouth St.
Sacramento Valley	W6BTY	George R. Hudson	2309 Meer Way
San Joaquin Valley	W6JPU	Ralph Saroyan	6204 E. Townsend Ave.
ROANOKE DIVISION			
North Carolina	K4QFV/W4YZH	Barnett S. Dodd	420 West Franklin St.
South Carolina	K4HDX	Lee P. Worthington	118 Crestview Drive
Virginia	W4QDY	Robert L. Wolmar	1057 Duane St.
West Virginia	W8JM	Donald B. Morris	1136 Morningstar Lane
ROCKY MOUNTAIN DIVISION			
Colorado	K0TTB	Donald Ray Crumpton	1200 Alexander Circle
Utah	W7QWH	Thomas H. Miller	3148 South 3360 East
New Mexico	W5ZHN	Carl W. Franz	2323 Krogh Court, N.W.
Wyoming	W7AMU	L. D. Brauson	342 South Elk
SOUTHEASTERN DIVISION			
Alabama	K4KJD	William S. Crafts	Route 3, Box 233
Eastern Florida	W4QVJ	George E. Cushing	Box 8045
Western Florida	W4RKH	Frank M. Butler, Jr.	494 Elliott Rd.
Georgia	W4HG	James A. Giglio	1378 Metropolitan Ave., S.E.
West Indies (P. R.-V.I.)	KF4DJJ	William Werner	563 Ramon Lovet
Canal Zone	KZ5TD	Thomas B. DeMels	P. O. Box 1111
SOUTHWESTERN DIVISION			
Los Angeles	W6FNE	John A. McKowen	11845 S. Purche Ave.
Arizona	W7QZH	Kenneth P. Cole	221 East Camelback, Suite P-15
San Diego	W6LRU	Don Stansifer	4427 Pescadero
Santa Barbara	K6AAK	William C. Shelton	2036 Grandview Drive
WEST GULF DIVISION			
Northern Texas	W5BNG	L. L. Harbin	4515 Calmont
Oklahoma	K5KTW	Bill F. Lund	1220 S. Owasso
Southern Texas	W5QEM	Roy K. Eggleston	1109 Vernon Drive
CANADIAN DIVISION			
Maritime	VE1WB	D. E. Weeks	170 Norton Ave.
Ontario	VE3NG	Richard W. Roberts	62 St. Johns Rd.
Quebec	VE2DR	C. W. Skarstedt	
Alberta	VE6TG	Harry Harrold	1834-5th Ave.
British Columbia	VE7FB	H. E. Savage	1553 West 12th Ave
Manitoba	VE4JY	M. S. Watson	249 Lanark St.
Saskatchewan	VE5BL	Jack Robinson	4527 Elgin Rd
Tamaqua			
Smithsburg, Md.			
Marsballtown			
Palmyra			
Buffalo 26			
Donora			
Springfield			
Portage			
Minot			
Sioux Falls			
Aitkin			
Little Rock 72205			
Metairie 70001			
Meridian			
Memphis 16			
Louisville 7			
Detroit			
Canton 8			
Schenectady			
Brooklyn 34			
South Amboy			
Ames			
Wichita 7			
Rolla			
Gering			
Bethlehem			
Portland 3			
Brooklyn 02185			
Westfield			
Manchester 03102			
Pawtucket 02860			
Montpelier			
Anchorage			
Twin Falls			
Great Falls			
Portland			
Seattle 15			
Lihue, Kauai			
Boulder City			
Cupertino			
Dixon 95620			
San Francisco 24			
Sacramento			
Fresno			
Salisbury			
Spartanburg			
Norfolk 3			
Fairmont			
Pueblo			
Salt Lake City 9			
Albuquerque			
Casper			
Athens 35611			
Jacksonville 11			
Fort Walton Beach			
Atlanta 16			
Urb. Truman			
Rio Piedras, P. R.			
Balboa			
Inglewood			
Phoenix 12			
San Diego 7			
Camarillo			
Fort Worth 7			
Tulsa 20			
Corpus Christi			
Harvey Station, N. B.			
Willowdale, Toronto, Ont.			
Pointe Claire			
Montreal 33, P. Q.			
N. Lethbridge, Alta.			
Vancouver 8, B. C.			
Winnipeg			
Regina			



# Gateway

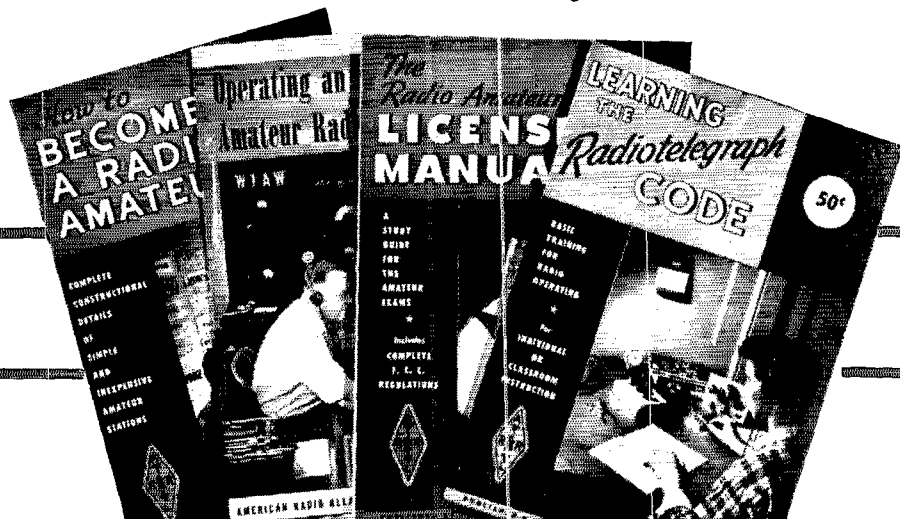

## *to Amateur Radio!*

- ★ HOW TO BECOME A RADIO AMATEUR
- ★ THE RADIO AMATEUR'S LICENSE MANUAL
- ★ LEARNING THE RADIO TELEGRAPH CODE
- ★ OPERATING AN AMATEUR RADIO STATION

Anyone starting out in amateur radio will find these publications a necessary part of his reading and studying for the coveted amateur radio operator's ticket. Written in clear, concise language, they help point the way for the beginner. Tried and proven by thousands upon thousands of amateurs, these ARRL publications are truly the "Gateway to Amateur Radio."

**\$1.50**

POSTPAID

The American Radio Relay League, Inc.—Newington 11, Connecticut

# THE AMERICAN RADIO RELAY LEAGUE, INC.,

is a noncommercial association of radio amateurs, bonded for the promotion of interest in amateur radio communication and the experimentation, for the relaying of messages by radio, for the advancement of the radio art and of the public welfare, for the representation of the radio amateur in legislative matters, and for the maintenance of fraternalism and a high standard of conduct.

It is an incorporated association without capital stock, chartered under the laws of Connecticut. Its affairs are governed by a Board of Directors, elected every two years by the general membership. The officers are elected or appointed by the Directors. The League is noncommercial and no one commercially engaged in the manufacture, sale or rental of radio apparatus is eligible to membership on its board.

"Of, by and for the amateur," it numbers within its ranks practically every worth-while amateur in the nation and has a history of glorious achievement as the standard-bearer in amateur affairs.

Inquiries regarding membership are solicited. A bona fide interest in amateur radio is the only essential qualification; ownership of a transmitting station and knowledge of the code are not prerequisite, although full voting membership is granted only to licensed amateurs.

All general correspondence should be addressed to the administrative headquarters at Newington, Connecticut.



## Past Presidents

HIRAM PERCY MAXIM, W1AW, 1914-1936  
EUGENE C. WOODRUFF, W8CMP, 1936-1940  
GEORGE W. BAILEY, W2KH, 1940-1952  
GOODWIN L. DOSLAND, W0TSN, 1952-1962  
(President Emeritus)

## Officers

President . . . . . HERBERT HOOVER, JR., W6ZH  
900 Wilshire Blvd., Los Angeles 17, California  
First Vice-President . . . . . WAYLAND M. GROVES, W5NW  
1406 West 12th Street, Odessa, Texas  
Vice-President . . . . . FRANCIS E. HANDY, W1BDI  
225 Main St., Newington 11, Connecticut  
Vice-President . . . . . ALEX REID, VE2BE  
240 Logan Ave., St. Lambert, P. Q., Canada  
Secretary . . . . . JOHN HUNTOON, W1LWQ  
Treasurer . . . . . DAVID H. HOUGHTON  
225 Main St., Newington 11, Connecticut  
\* \* \* \* \*  
Secretary & General Manager Emeritus . A. L. BUDLONG, W1BUD  
\* \* \* \* \*  
General Manager . . . . . JOHN HUNTOON, W1LWQ  
Communications Manager . . . . . FRANCIS E. HANDY, W1BDI  
Technical Director . . . . . GEORGE GRAMMER, W1DF  
Assistant General Manager . . . . . RICHARD L. BALDWIN, W1KIE  
Assistant Secretaries . . . . . PERRY F. WILLIAMS, W1UED  
RAYMOND HIGGS, K1FLG . . . . . GARY L. FOSKETT, W1ECH  
225 Main St., Newington 11, Connecticut  
\* \* \* \* \*  
General Counsel . . . . . ROBERT M. BOOTH, JR., W3PS  
1735 DeSales St., N. W., Washington 6, D. C.  
Associate Counsel . . . . . ARTHUR K. MEEN, VE3RX  
Suite 405, 19 Richmond St. West, Toronto 1, Ont.

## DIRECTORS

*Canada*  
NOEL B. EATON . . . . . VE3CJ  
R.R. 3, Burlington, Ontario  
Vice-Director: Colin C. Dumbrie . . . . . VE2BK  
116 Oak Ridge Drive, Baie d'Urfee, Quebec

*Atlantic Division*  
GILBERT L. CROSSLEY . . . . . W3YA  
Dept. of E.E., Penna State University  
State College, Pa.  
Vice-Director: Edwin S. Van Deusen . . . . . W3ECP  
3711 McKinley St., N.W., Washington 15, D.C.

*Central Division*  
PHILIP E. HALLER . . . . . W9HPG  
8000 S. Tripp Ave., Chicago 29, Ill.  
Vice-Director:

*Dakota Division*  
CHARLES G. COMPTON . . . . . W0BUO  
1011 Fairmount Ave., St. Paul 5, Minn.  
Vice-Director: Martha J. Shriley . . . . . W0ZWL  
Box 78, Black Hawk, S. D.

*Delta Division*  
FLOYD C. TEETSON . . . . . W5MUG  
2469 Paden, Jackson 4, Miss.  
Vice-Director: Graham H. Hicks . . . . . W5IHP  
100 Magnolia Place, Natchez, Miss.

*Great Lakes Division*  
DANA E. CARTWRIGHT . . . . . W8SUPB  
2979 Observatory Ave., Cincinnati 8, Ohio  
Vice-Director: Robert B. Cooper . . . . . W8AQA  
132 Guild St., N.E., Grand Rapids 5, Mich.

*Hudson Division*  
MORTON B. KAHN . . . . . W2KR  
22 Birch Hill Rd., Great Neck, N. Y.  
Vice-Director: Harry J. Dannels . . . . . W2TUK  
RFD 1, Arbor Lane, Dix Hills, Huntington, L. I.

*Midwest Division*  
ROBERT W. DENNISTON . . . . . W0NWX  
Box 631, Newton, Iowa  
Vice-Director: Sumner H. Foster . . . . . W0GQ  
2315 Linden Dr., S.E., Cedar Rapids, Iowa

*New England Division*  
MILTON E. CHAFFER . . . . . W1EFW  
28 Reusser Rd., Southington, Conn.  
Vice-Director: Bigelow Green . . . . . W1EAE  
236 Marlboro St., Boston 16, Mass.

*Northwestern Division*  
R. REX ROBERTS . . . . . W7CPY  
837 Park Hill Drive, Billings, Mont.  
Vice-Director: Robert B. Thurston . . . . . W7PGY  
7700 31st Ave., N.E., Seattle 15, Wash.

*Pacific Division*  
HARRY M. ENGWICHT . . . . . W6HC  
770 Chapman, San Jose 26, Calif.  
Vice-Director: Ronald G. Martin . . . . . W6ZF  
1573 Baywood Lane, Napa, Calif.

*Roanoke Division*  
P. LANIER ANDERSON, JR. . . . . W4MWH  
428 Maple Lane, Danville, Va.  
Vice-Director: Joseph F. Abernethy . . . . . W4AKC  
784 Colonial Drive, Rock Hill, S. C.

*Rocky Mountain Division*  
CARL L. SMITH . . . . . W0BWJ  
1070 Locust St., Denver 20, Colo.  
Vice-Director: John H. Sampson, Jr. . . . . W7OCX  
3618 Mount Ogden Drive, Ogden, Utah

*Southeastern Division*  
JAMES P. BORN, JR. . . . . W4ZD  
25 First Ave., N.E., Atlanta 17, Ga.  
Vice-Director: Thomas M. Moss . . . . . W4HYW  
P.O. Box 20644, Municipal Airport Branch,  
Atlanta 20, Ga.

*Southwestern Division*  
RAYMOND E. MEYERS . . . . . W6MLZ  
Box R, San Gabriel, Calif.  
Vice-Director: Virgil Talbott . . . . . W6GTE  
1175 Longhill Way, Monterey Park, Calif.

*West Gulf Division*  
ROEMER O. BEST . . . . . W5QKF  
P.O. Box 1656, Corpus Christi, Texas  
Vice-Director: Ray K. Bryan . . . . . W5UYQ  
2117 S.W. 61st Terrace, Oklahoma City 19, Okla.

# "It Seems to Us..."

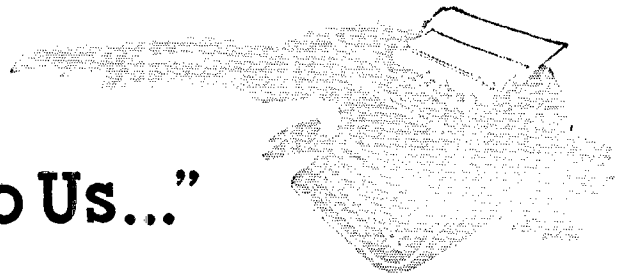

## Are You Ready?

No activity has attracted more favorable or consistent public attention than the instances where amateurs have kept communications open during and after floods, forest fires, hurricanes, ice storms and the like. And no activity gives the amateur himself a stronger sense of fulfillment, of pride in a job well done, than to aid his neighbors in time of distress.

Among various users of two-way radio, the amateur service is unique in its combination of substantial numbers and widespread geographical distribution, its long-distance capability, its variety of equipments and bands, and its freedom to serve all relief agencies voluntarily and on an equal footing. Surely, other services with two-way radio gear and a means of powering it can do a little something when the chips are down, but a trained group with pre-tested equipment and well-laid-out plans can do so much more.

A League objective for many years has been to improve our emergency-communications training and capabilities through the Amateur Radio Emergency Corps (AREC). To make our combination of local-area and long-distance services even more effective, the Amateur Radio Public Service Corps (ARPS) has now been established, marrying the AREC to the National Traffic System without destroying the individuality or internal organization of either. This action was taken as part of the Board of Directors' program to strengthen the amateur radio service.

The new ARPS gets its first workout in this year's Simulated Emergency Test (see announcement elsewhere in this issue). The SET is a grass-roots show. At the national level, ARRL provides a framework within which local groups can practice and prove the procedures they'll follow when a real test of their ability arises. Emergency Coordinators are in the driver's seat within their areas of jurisdiction. The form the SET takes is up to

the ECs and their co-workers. Indeed, some AREC units will hold their tests on days other than those suggested (October 5-6) to provide complete surprise and thus make the test more realistic.

Every amateur owes it to himself and to his community to live up to the expectations in our regulations concerning public service. This means being equipped with adequate gear and know-how to use his station and operator ability in any type of disaster or emergency in which standby radio provisions are called for. It means being a member of AREC (or RACES) or the National Traffic System (or both) and participating in their self-training activities.

If you are already a member of AREC, hold the weekend of the 5th open, and check with your EC about his plans. If you're a member of a regular traffic net, try to be on hand for every net session during the weekend and the following week.

If you're neither an AREC or RACES member, nor a net operator, isn't it time you were? Contact your local Emergency Coordinator, who voluntarily gives much time and effort in the over-all interests of public service, to ask about details of participation. If neither you, other hams, nor the ham club, know his name, drop us a line at HQ. There's a place for you, whatever your frequency band or mode. As to NTS, start with your section net as listed in the Station Activities columns of *QST* each month; or contact your SCM, address on page 6 of this and every issue. Listen a few evenings to catch on to net procedures, then wade in. Most control stations will be patient, courteous and genuinely glad to welcome a new recruit.

It's been said many times and in many ways: amateur radio exists basically because of the service it renders. Are you doing *your* part to strengthen the justification of amateur radio?

**QST**

## COMING A.R.R.L. CONVENTIONS

October 11-13 — Southwestern Division, San Diego, Calif.  
October 26-27 — Midwest Division, Wichita, Kansas  
November 29-30 and December 1 — Delta Division, Lafayette, Louisiana  
January 18-19, 1964 — Florida State, Miami  
April 3-5, 1964 — Great Lakes Division, Detroit, Michigan  
May 9-10, 1964 — New England Division, Swampscott, Massachusetts  
June 12-14, 1964 — West Gulf Division, Brownwood, Texas  
August 21-23, 1964 — ARRL National, New York City

### SOUTHWESTERN DIVISION CONVENTION

San Diego, California — October 11-13

The San Diego Council of Amateur Radio Organizations announces that this year's Southwestern Division Convention will be a split affair with activities at both famous Balboa Park and the El Cortez Hotel in San Diego. Shuttle bus service will be provided between the two areas. Registration is \$10 and includes a Sunday morning breakfast and the Sunday afternoon banquet. The ladies will receive a number of extras including Saturday luncheon, a fashion show and various tours.

Saturday activities include FCC examinations, a "home-brew" contest, a technical session for Novices directed by Don Stansifer, W6LRU, San Diego SCM, a c.w. speed contest, mobile transmitter hunts, a contest for the best mobile installation, a YL luncheon, a dinner for SWOOP, and a midnight Wouff Hong ceremony and displays of amateur gear.

Saturday afternoon ARRL Assistant Director Lew Cartwright, W6BKZ, will lead an ARRL forum which will include League President

Hoover, League Vice-President F. E. Handy, Southwestern Director Ray Meyers, and Southwestern Vice-Director Virgil Talbott.

Sunday morning breakfasts will include gatherings of QCWA, YLRL, s.s.b., DX, traffic, v.h.f. and possibly RTTY enthusiasts.

The convention banquet will be Sunday at 2 p.m. with principal addresses by League President Hoover and Krafft A. Ehrlicke, director of Advanced Studies of General Dynamics Astronautics, who will talk on "The Forward Look in Space Communications."

Further information may be obtained by writing to Larry Higgins, W6CAE, 1265 Trieste Drive, San Diego.

### MIDWEST DIVISION CONVENTION

Wichita, Kansas — October 26-27

The ARRL Midwest Division Convention will be held October 26 and 27 at the Broadview Hotel in Wichita, Kansas, with registration commencing at 9 A.M. on the 26th. Operating and technical group sessions will be held all day Saturday, covering such topics as RACES, e.d., transistors and solid-state conductors. Featured speakers will include Chuck Carney, W0GDJ, of Collins Radio who will talk on s.s.b., and Bob Ruyle, W0FCH, of Hy-Gain, who will discuss the latest developments in antennas. L. M. Divinia, W0VBK, Kansas Director for Air Force MARS, has planned a program which will include Major Henry C. Becker, Jr., Chief MARS Army, and Major Alva H. Cole, W4IYR, Chief MARS, Air Force. There will also be a c.w. speed contest, a mobile judging contest and mobile hunts on various popular bands, and amateur equipment displays.

The climax of the convention will be the ARRL Division meeting Sunday morning followed by the banquet at which Midwest Division Director Bob Denniston, W0NWX, will be master of ceremonies.

For more information contact Bernard Borst, W0LNZ, 519 Beacon Bldg., Wichita.



**California** — The eighth anniversary of the Radio Amateur Mobile Society will occasion a birthday party and hamfest October 12. For more info, contact Frances Tucker, K6SBL, 1309 Eastern Ave., Sacramento 25, Calif.

**Connecticut** — The annual Tri-City Radio Club hamfest will be held on Saturday, October 12, at the Crocker House on State Street, New London. Registration and dinner, \$5.50. Attendance by reservation only, limited to 250. Contact General Chairman Robert Chapman, W1QV, % Crocker House, New London, Conn.

**Indiana** — The Hoosier Hills Ham Club will present their annual hamfest at Spring Mill State Park near Mitchell, Indiana, on October 13. Fun, games, refreshments, plenty of parking, special activities for the XYLs and kids. Contact General Chairman J. F. Strom, K9BSL, % P.O. Box 484, Bedford, Indiana.

**Louisiana** — The annual New Orleans hamfest will be held October 13 at Jackson Barracks. Tickets are \$1.00. No other information available.

**New York** — The 9th annual Syracuse V.H.F. Roundup will be held October 12 at Three Rivers Inn, Route 57, 10 miles north of Syracuse. Registrations at noon. Tickets \$6.00 from Joe Zippi, K2BYU, 405 Edgerton, Minoa,

N.Y. (Telephone 315-656-9144). Sam Harris, W1FZJ, will speak on "V.H.F. Techniques;" W2BVU and W1QMN will discuss "Practical Pulse for Amateur Microwave."

**New York** — The Rip Van Winkle Radio Society will hold their annual banquet October 26 at Red's Restaurant, Coxsack, N.Y. Steak dinner beginning at 1930. Contact WA2IRK, Rte. 81, Earlton, New York.

**New York** — The sixteenth annual dinner-meeting of the Quarter Century Wireless Association will be held Friday, October 25, at the Hotel Shelbourne, East 38th St. and Lexington Ave., New York City. Informal pre-dinner cocktail party from 6 P.M. Ivan Loucks, W3GD, of the FCC and long-time QCWA member, will be the guest speaker. For dinner reservations write John DiBlasi, W2FX, QCWA President, 155 Bay View Rd., Plandome Manor, N.Y.

**Pennsylvania** — The annual roundup of the Western Pennsylvania Mobiles will be held October 25. Details from Paul Edelman, K3PIB, 112 Maple Lane, Trafford, Pa. 15085.

**Texas** — The Houston-Harris County hamfest will be held at Sinclair Park on October 19-20. Talk-in on 3855 kc. For details, write Cindy Dougharty, W5ZPD, 3518 Dalstrom Street, Houston, Texas 77047.

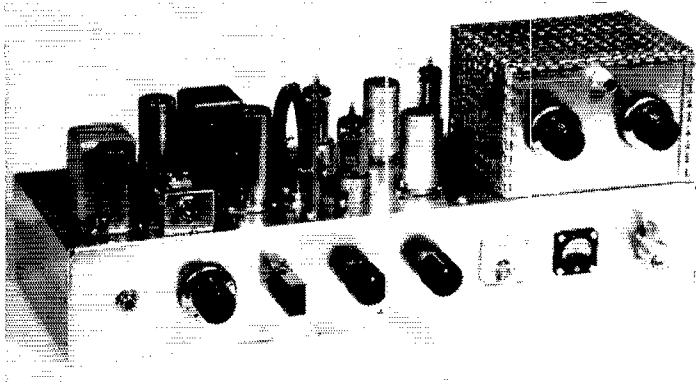

The complete 12-watt, 50-Mc. s.s.b. transmitter is shown on the 17 × 6 × 3-inch chassis. The 2E26 linear amplifier is enclosed in the shielding box on the right, with its tuning and loading controls on the upper right. The 6JH8 balanced-modulator tubes are to the right of the loop of coax, and are shown with tube shields removed. The small coil of coax provides 90-degree r.f. phase shift at 50 Mc. The left knob is the audio gain. The sideband-selection switch is directly above. Next to the audio gain control is the 8-Mc. crystal, and on its right are the two carrier-balance controls. On the extreme right is a meter switch that was little used and has been omitted from the schematic. Power requirements are 300 volts at 60 ma. and 600 volts at 90 ma. The -75-volt bias supply and the regulated 150-volt screen supply are included in this chassis.

## The Single-Sideband Sixer

### A 12-Watt Beam-Deflection-Tube Transmitter

BY JAY GOOCH,\* W9YRV AND ESTIL CARTER,\* WA9DNF

The applications of the unique balanced-modulator circuit used in this exciter aren't confined to 6-meters—the circuit is usable at any frequency. Combining beam-deflection mixing and cascode output coupling, it offers a high degree of stability in balance, along with enough output for driving small power tubes directly.

A SIMPLE, straight-through phasing type 6-meter s.s.b. exciter has been constructed and shows smooth, stable operation. New G.E. type 6JH8 beam deflection tubes,<sup>1</sup>  $V_4$  and  $V_5$ , Fig. 1, are used as balanced modulators in a novel cascode circuit. Sufficient power is obtained from the balanced modulators along with two 12AT7s,  $V_6$  and  $V_7$ , to drive directly a 2E26 linear amplifier which provides 12 watts p.e.p. output measured at the 50-ohm load.

The 50-Mc. suppressed carrier frequency, which provides the r.f. drive to the balanced modulators, is furnished from an 8-Mc. crystal, a triode third-overtone oscillator,  $V_{3A}$ , and a pentode frequency doubler,  $V_{3B}$ . The two sections of a 6AW8 are used. The 90-degree r.f. phase difference between the control grids of the two balanced modulators is obtained by a length of 75-ohm coax cable,  $W_1$ .

\* Coordinated Science Laboratory, University of Illinois, Urbana, Illinois.

<sup>1</sup> Description and Rating Sheet, 6JH8, ET-T3029, General Electric Company, Receiving Tube Department, Owensboro, Kentucky.

A speech amplifier,  $V_1$ , a 90-degree audio phase-difference network,  $Z_1$ , and two split-secondary audio transformers,  $T_2$  and  $T_3$ , provide the required push-pull audio drive for the balanced modulators.

D.c. feedback, obtained from the balanced-modulator cascode-tube outputs, coupled through neon bulbs and the audio transformer split secondaries to the deflector elements, gives unusually good carrier-null balance stability.

The buffer amplifiers in the plates of the balanced modulators are cascode-connected, direct-coupled, and grounded-grid. These have advantages which include:

1. Some r.f. power gain.
2. Increased d.c. feedback gain, resulting in improved carrier-null balance stability.
3. Isolation between plates of the quadrature-driven beam-deflection tubes, resulting in less distortion due to intercoupling.
4. High-impedance output from the cathode driven amplifiers following the balanced modulators, which makes possible more ideal current addition of the two balanced-modulator channels.
5. Elimination of the need for special quadrature balance of the carrier null because of a large increase in the plate resistances shunting the two halves of the output tank circuit.

These advantages result *without requiring* additional tuned circuits.

The unit is operated from a TV transformer and bridge-rectifier power supply which furnishes +300 and +600 volts. A -75-volt d.c. bias

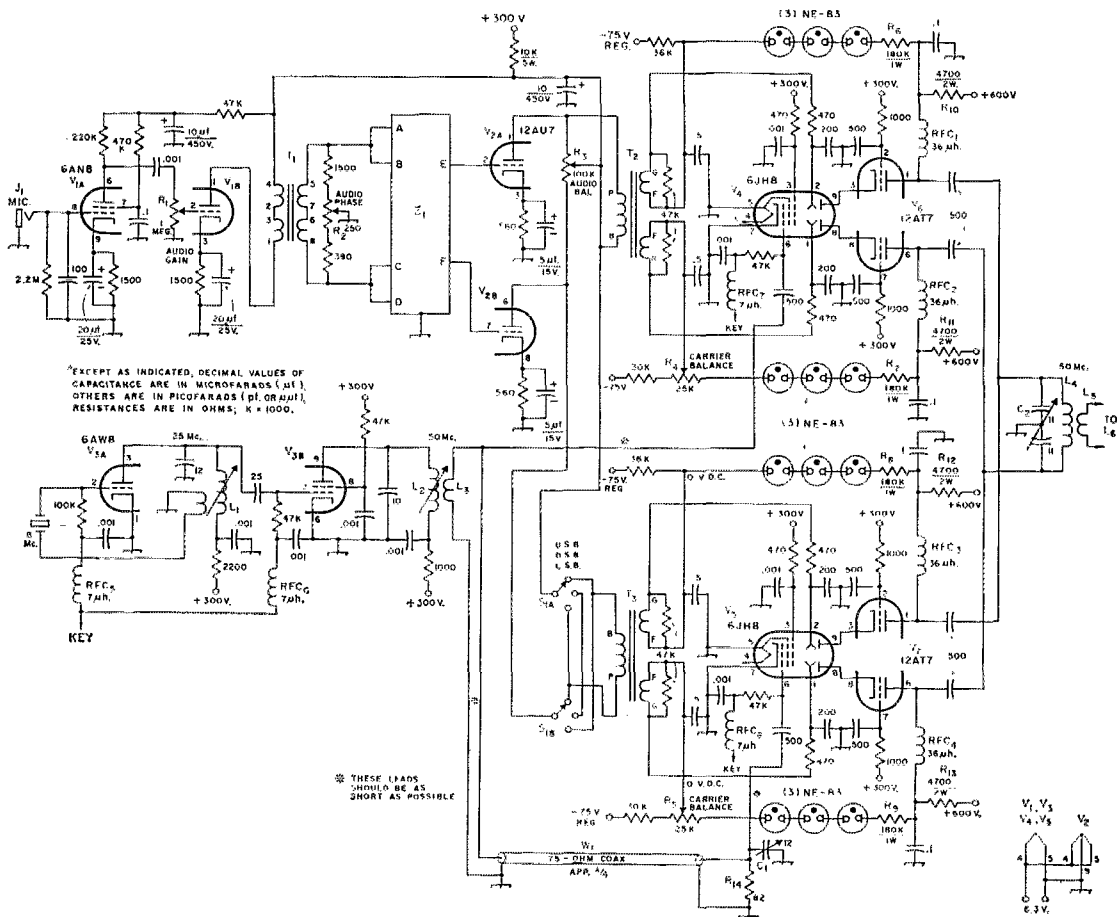

Fig. 1—Circuit diagram of the s.s.b. exciter for 6-meter operation. Except as indicated, resistors are 1/2-watt composition; fixed capacitors above 0.001- $\mu$ f. are paper, 0.001- $\mu$ f. capacitors are ceramic, those with polarity marked are electrolytic, others are mica. See text on heater supply for  $V_6$  and  $V_7$ .

- C<sub>1</sub>—Ceramic piston, 1.5-12 pf. (Cambion CST-50 or equivalent).
- C<sub>2</sub>—10.8 pf. per section, butterfly (Johnson 11MB11 or equivalent).
- J<sub>1</sub>—Open-circuit jack (or microphone connector).
- L<sub>1</sub>—3-5.5  $\mu$ h., slug-tuned (North Hills 110B, Miller 4504 or equivalent). Feedback coil 5 turns No. 24 close-wound at cold end.
- L<sub>2</sub>—7 turns No. 24 close-wound on 3/8-inch diam. slug-tuned form (CTC PLS5-2C4L/N or Miller 4400 form).
- L<sub>3</sub>—3 turns No. 24, diam. 3/4 inch, close-wound at cold end of L<sub>2</sub>.

- L<sub>4</sub>—8 turns No. 20, diam. 3/4 inch, 16 turns/inch (B & W Miniductor 3011); see L<sub>5</sub>.
- L<sub>5</sub>—Center turn of L<sub>4</sub>, cut to form link; inner ends of remaining two sections of L<sub>4</sub> connected together.
- R<sub>1</sub>—Audio-taper control.
- R<sub>2</sub>, R<sub>3</sub>, R<sub>1</sub>, R<sub>5</sub>—Linear-taper control.
- R<sub>6</sub>-R<sub>14</sub>, incl.—For text reference.
- RFC<sub>1</sub>-RFC<sub>4</sub>, incl.—Single-pie choke (Miller 6176-TV peaking coil or equivalent).
- RFC<sub>5</sub>-RFC<sub>5</sub>, incl.—V.h.f. choke (Ohmite Z-50 or equivalent).
- T<sub>1</sub>, T<sub>2</sub>, T<sub>3</sub>—See text and photo captions.
- W<sub>1</sub>—See text.
- Z<sub>1</sub>—Audio phase-shift network; see Table I and Footnote 9.

supply is built into the transmitter.

The beam-deflection tube is attractive as a balanced modulator since it (1) operates well at frequencies as high as 50 Mc., (2) gives moderate power output without excessive distortion, (3) has good inherent carrier-null balance stability due to its single cathode and control grid associated with two anodes, and (4) has separate high-impedance inputs for r.f. and for audio drive.

Several phasing-type beam-deflection-tube ex-

citers have been described.<sup>2,3,4</sup> These generally have been lower-frequency, lower-power units which require additional amplifier or heterodyne stages for v.h.f. use. This unit, although simple, is attractive as a complete transmitter for a

<sup>2</sup> Vance, "S.S.B. Exciter Circuits Using a New Beam-Deflection Tube," *QST*, March, 1960, p. 33.

<sup>3</sup> "A Phased Single-Sideband Exciter," *The Radio Amateur's Handbook*, ARRL, 38th edition (1961), pp. 307-312.

<sup>4</sup> Evans, "Another Phasing-Type S.S.B. Exciter Unit," *QST*, September, 1962, p. 28.

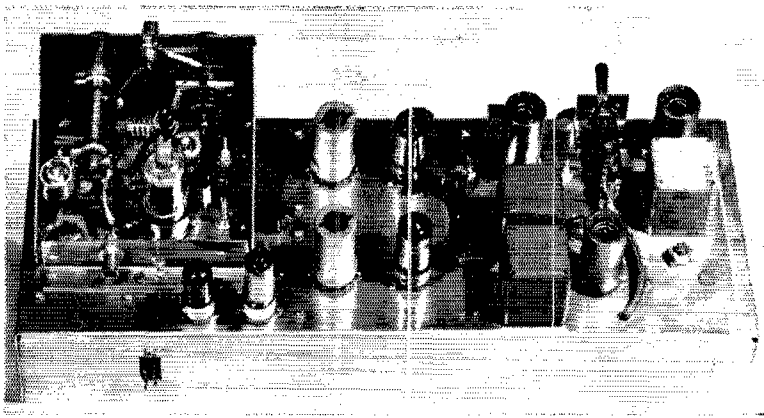

The 2E26 compartment can be seen on the left, with perforated metal cover removed. On the extreme left is the pi-network loading capacitor, and to its right is the 2E26 plate tuning capacitor. The piston-type 2E26 neutralizing capacitor is near the rear right corner of the tuning capacitor. It is mounted on top of a 500-pf. feed-through capacitor which is the partial bypass for the bottom end of  $L_7$ , the 2E26 grid coil.  $T_2$  and  $T_3$ , the audio transformers for driving the deflectors, are UTC type A-19 but can be replaced by less expensive Chicago-Stancor type A-4774.  $T_2$  and  $T_3$  furnish 12 volts of peak-to-peak audio (4.2 volts r.m.s.) to each deflector element of each 6JH8.

6-meter station.

### 50-Mc. Carrier Generation

An 8-Mc. crystal is used in a third-overtone oscillator with its output on 25 Mc. This is followed by a pentode frequency doubler. The two sections of a 6AW8 are used in a circuit similar to that in *Handbook* v.h.f. transmitters.<sup>5</sup> A link,  $L_3$ , on the output coil,  $L_2$ , of the doubler is connected to two paralleled loads. One is the control grid of the first balanced modulator. The other is a length of 75-ohm coax cable which provides 90-degree phase shift to the 50-Mc. signal and feeds the grid of the second balanced modulator.

### R.F. Phase Shift

This phase shift is accomplished by an approximate quarter wavelength of 75-ohm coax

cable. Both subminax, 21-579, and RG-59/U were tried with no noticeable difference.

The amount of phase shift furnished by the coax depends on its length, its characteristic impedance, and its terminating impedance. Here the 75-ohm characteristic impedance cable is terminated in approximately 8 pf., the capacitance of the 6JH8 control grid input. An 82-ohm resistor,  $R_{14}$ , is added to lower the v.s.w.r. on the coax. This avoids the large change in phase shift which accompanies a very small length change in a cable operated at a high v.s.w.r.

Simplest construction if operation near 50.2 Mc. is intended is to omit  $C_1$ , the 1.5- to 12-pf. trimmer capacitor, and to cut the total length of coax to  $31\frac{3}{4}$  inches. This is estimated to give phase shift of  $90 \pm 1$  degrees over about a  $\frac{1}{2}$ -Mc. frequency range. Lengths for other spot frequencies in the 6-meter band, where the cable is terminated in the 6JH8 control grid capacitance, can be calculated from

<sup>5</sup> "Simple Transmitters for 50 and 144 Mc.," *The Radio Amateur's Handbook*, 38th edition (1961), p. 437, and 39th edition (1962), p. 442.

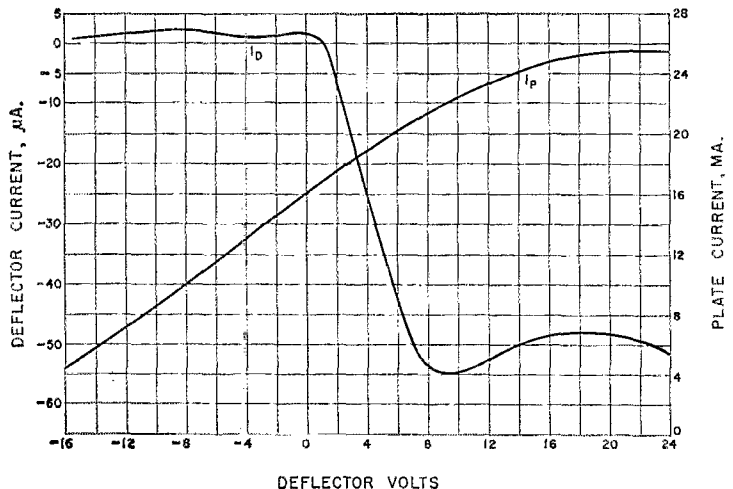
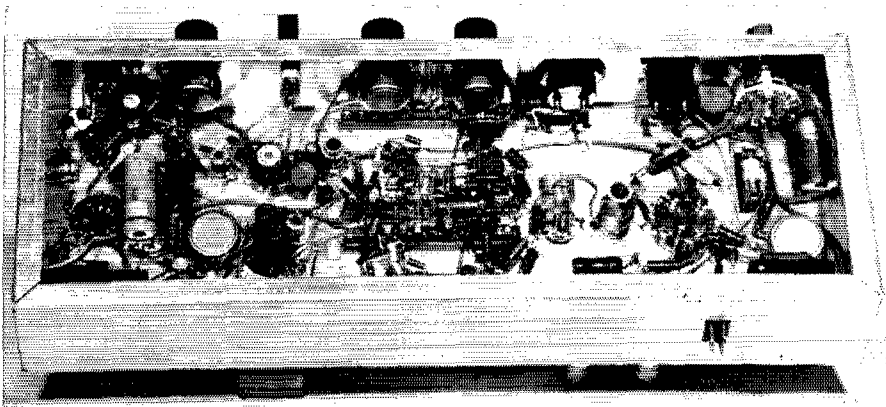

Fig. 2—Deflector current and plate current as a function of deflector voltage, 6JH8 beam-deflection tube.



The 6AN8 speech amplifier socket is in the upper left corner. The overtone crystal oscillator and doubler are adjacent to the crystal socket on the front panel. Two carrier-balance pots occupy the center position of the front panel. The left-hand miniature meter reads r.f. output voltage and the right-hand meter reads 2E26 plate current. The water switch at upper right permitted reading 2E26 plate, screen, or control grid current, but proved of little use and was omitted from the schematic. At center right is the 2E26 socket and, on its left, the 2E26 grid tank coil, with link coupling from the balanced modulator plate coil. The silicon bias rectifier is at the far right center, adjacent to the electrolytic bias-supply filter capacitor. The 6JH8 balanced modulator sockets with their short leads connecting to the coax cable are below the left carrier-balance pot. This photo shows that all coils and tuning capacitors except the 2E26 plate components are mounted below the chassis. The 2E26 plate circuit components are kept above the chassis for isolation. The output connection to the antenna is also above the chassis.

$$\text{length, inches} = \frac{1592}{\text{freq. in Mc.}}$$

This length was verified both for RG-59/U and Amphenol subminax 21-579, both of which have a velocity factor of 0.66. Alternate construction is to incorporate a 1.5-12 pf. piston capacitor ( $C_1$ ) as an r.f. phase adjustment and cut the coax to 29 inches. This allows adjustment that will give a 90-degree phase shift on any frequency in the 50 to 54-Mc. band

The r.f. voltages measured at the control grids of the two 6JH8 tubes are nearly equal. They read 5.1 volts r.m.s. on the link and 5.3 volts r.m.s. at the terminated end of the coax.

#### Cascoded Balanced Modulators

The control grids of the two 6JH8 balanced-modulator tubes,  $V_4$  and  $V_5$ , are fed 90-degree phase difference r.f. Likewise, each tube has its set of deflector elements fed 90-degree phased push-pull audio. Each tube has a push-pull double-sideband signal appear at its two anodes. When equal outputs from the two channels are added, single sideband results. Previous experiments, without the cascode amplifiers, indicated that a considerable amount of intercoupling was occurring between the two beam-deflection tubes when the anodes were tied directly together to add their outputs. Only small output was possible before distortion became large. With outputs in parallel, but inputs consisting of quadrature signals, it appeared that distortion was being caused by the first balanced modulator plate modulating the second, and vice versa.

A better understanding of the 6JH8, or any of the other beam deflection tubes, can be had by considering the following:

The 6JH8 deflector-anode characteristics, which are typical of most beam-deflection tubes, describe the portion of the tube beginning at the accelerator (screen grid) and including the deflectors and two anodes. If this part of the tube is considered to be analogous to a dual triode with common cathode, operating in class-A push-pull, the class-A characteristics of one triode section, which is analogous to half of the above portion of the 6JH8, would have an amplification factor ( $\mu$ ) of 6.3, a plate resistance of 9000 ohms, and a transconductance ( $g_m$ ) of 700 micromhos.<sup>6</sup> The output circuit of the 6JH8 should be designed considering the equivalent of two of these triodes in class-A push-pull.

Distortion caused by intercoupling between the two balanced modulators with plates paralleled was attributed to the low plate-to-plate resistance of the 6JH8s (18,000 ohms) and to the low amplification factor (6.3) between the deflectors and anodes. The plate-to-plate resistance of the tube, when viewed as the equivalent generator internal resistance, is low compared with the usual tank-circuit load impedance. Therefore, the output tank does not load down the voltage swing of the plates appreciably. The low amplification factor of 6.3 means that a differential, or push-pull, voltage between the plates of 6.3 volts is fully as effective in deflecting the beam as would be a one-volt push-pull signal applied between the deflectors. A rather unfortunate situation exists whereby one tube can very effectively plate modulate the other. To avoid this intercoupling without undue circuit com-

<sup>6</sup> Private Correspondence: W. P. Kimker, Advanced Applications, General Electric Company, Owensboro, Kentucky.





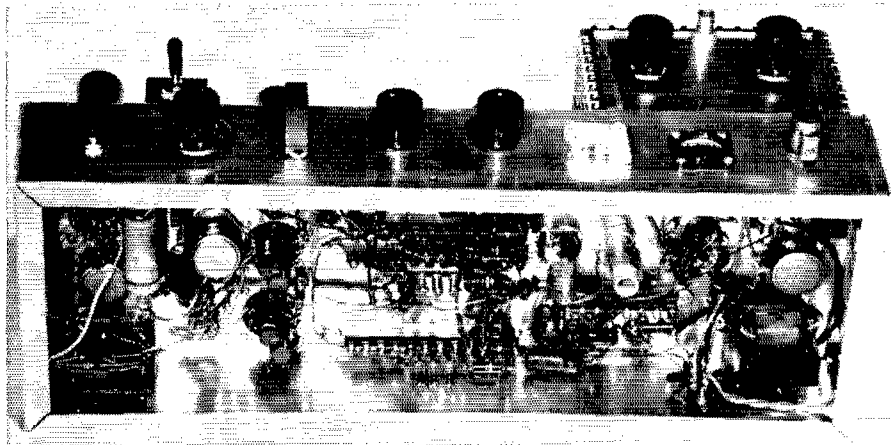

Another view inside the chassis. Mounted on the resistor board at left bottom is the homemade audio phase-shift network. A commercial audio phase network could plug into an octal socket mounted at this location. The NE-83 neon bulbs, identical in appearance to NE-2 types, are mounted on tie points near the center of the chassis. NE-2 bulbs can be substituted but have a shorter operating lifetime. The audio components, including the amplifier and deflector driving transformers, are located in the left one-fourth of the chassis. The balanced-modulator plate coil is mounted by its leads on the back of the vertical split-stator tuning capacitor,  $C_2$ , adjacent to the left wall of the 2E26 compartment. On the right rear is the backwards-operated filament transformer which is part of the  $-75$ -volt bias supply.

shunting audio balance control,  $R_3$ , than from the more usual cathode-bias control. To help realize maximum output with low distortion in the balanced modulators, push-pull audio from the secondaries of  $T_2$  and  $T_3$  was used to drive the deflectors. While single-ended audio drive to one deflector is simpler, lower distortion results from this push-pull drive.

Under conditions of high deflector d.c. return resistance, or high drive impedance, deflector secondary emission currents have been found to cause distortion.<sup>10</sup> D.c. return resistance through the transformers is low.

Deflector currents of the 6JH8 were measured under large drive conditions and were found to be lower than those of the 7360 or 6HW8. The measured 6JH8 deflector currents are shown in Fig. 2.

Deflector circuit d.c. return was made through the relatively low resistances of the secondaries of transformers  $T_2$  and  $T_3$ , and the beam-centering d.c. voltages are series-fed through the appropriate split secondaries of the transformers. The sum of a d.c. and an audio voltage appears at each deflector.

#### D.C. Carrier-Null Feedback

Drift in the balanced-modulator tubes could necessitate frequent readjustment of the carrier-null balance controls. However, use is made of the fact that r.f. output from each half of the beam deflection tube is closely related to the amount of d.c. plate current drawn by that half tube. A sample of the plate current is obtained in each case by taking the proportional voltage drop across a plate decoupling resistor ( $R_{10}$ ,  $R_{11}$ ,

$R_{12}$ ,  $R_{13}$ ) and feeding this voltage back through neon bulbs where it is applied as a d.c. beam center stabilizing voltage on the deflector element. The burden of maintaining carrier balance is thus transferred from the active tube structure to the more stable d.c. divider chain. The direct-coupled 12AT7 tubes, neon bulbs, and divider return to the  $-75$ -volt supply result in excellent stabilization of carrier-null adjustment.

TABLE I

Connections for Commercial Audio Phase-Shift Networks

Terminal (Fig. 1)	Central Electronics PS-1	B & W 350-2Q4	Millen 75012
A	2	1	A-IN
B	6	5	B-IN
C	3	3	A-COM
D	7	7	B-COM
E	4	2	A-OUT
F	8	6	B-OUT
GND	1		Case

The nominal drop (constant 65 volts) across the NE-83 neon bulbs may vary from bulb to bulb and require trimming of resistors  $R_6$ ,  $R_7$ ,  $R_8$  and  $R_9$ . This can be done by centering the carrier-balance pots and placing a d.c. voltmeter on the deflectors. The four resistors should be trimmed in value until each deflector is within a few volts of ground under no-signal conditions.

#### 6JH8 Cascoded with 6DJ8

The alternative balanced-modulator circuit shown in Fig. 3 has been used with a 300-volt supply. Here, the plates of the cascode tubes are operated from 300 volts, and their grids are

<sup>10</sup> Technical Correspondence "7360 Deflector Currents and Large-Signal Operation," QST, March, 1962, p. 41.

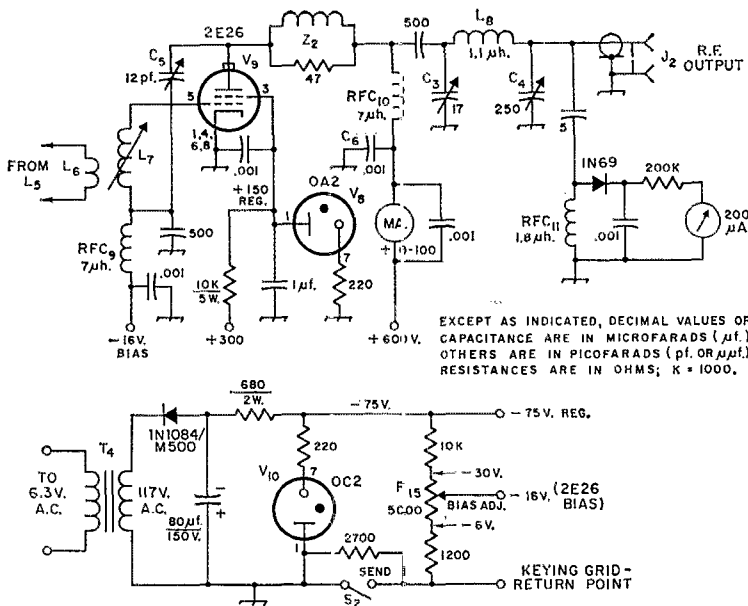

Fig. 4—Linear amplifier and bias supply. Except as indicated, resistors are 1/2-watt composition; 0.001- $\mu$ f. fixed capacitors are ceramic, those with polarity marked are electrolytic, others are mica.

- C<sub>3</sub>—Approx. 17-pf. variable (Hammarlund HF-15 or equivalent).
- C<sub>4</sub>—250-pf. variable (Hammarlund MC-250-M or equivalent).
- C<sub>5</sub>—Ceramic piston, 1.5-12 pf. (Cambion CST-50 or equivalent).
- J<sub>2</sub>—Coax receptacle, chassis-mounting.
- L<sub>6</sub>—2 turns No. 20 wound on form for L<sub>7</sub> (1/2 inch diam.) at cold end.

- L<sub>7</sub>—6 turns No. 20, diam. 3/4 inch, 16 turns/inch (B & W Miniductor 3011) cemented on 1/2-inch diam. slug-tuned form (CTC PLS7-2C4L/Q or Miller 43A000CB).
- F<sub>15</sub>—Linear-taper control.
- RFC<sub>9</sub>, RFC<sub>10</sub>—7  $\mu$ h. (Ohmite Z-50 or equivalent).
- RFC<sub>11</sub>—1.8  $\mu$ h. (Ohmite Z-144 or equivalent).
- T<sub>4</sub>—Filament transformer, 6.3 volts, 1 amp.
- Z<sub>2</sub>—3 turns No. 18 wound on 47-ohm, 2-watt composition resistor.

pegged at +150 volts. Resistor values in the neon bulb-resistor divider chain are changed, so that the deflectors remain within a few volts d.c. of ground, under no-signal conditions, with the +300-volt power-supply voltage.

The cascode-tube type is changed to a 6DJ8.<sup>11</sup> This tube performs well in this lower-voltage circuit because its characteristics are such that it will handle the required 30 ma. peak plate current with as little as 75 volts across plate to cathode—and without the grid going positive with respect to cathode.

The circuit will not provide sufficient drive for the 2E26 at 50 Mc., a fact made clear by the condition of no excess drive for the 2E26 from the balanced modulators operating from a 600-volt supply. However, at lower frequencies where drive is easier, or when driving a smaller tube such as a 6BQ5 or 6CL6, the 6JH8 and 6DJ8 balanced modulators work well.

### New Neon Bulbs

NE-83 neon bulbs were used.<sup>12</sup> These appear similar to NE-2 bulbs, but are an improved

design, rated at 500 hours of life at 10 ma. current, and at greatly extended life at lower currents, such as the 2 ma. used here.

The NE-83 should prove useful in furnishing regulated voltages in multiples of 65 volts where currents under 10 ma. are required.

### Survey of Beam Deflection Tubes

The 6JH8 beam deflection tube was picked for this unit after considering the 7360, 6ARS, 6JH8, 6HWS, and 7763. Its merits are a useful peak plate current which is approximately three times that of the 7360, and a higher plate dissipation. The large-signal deflector current is lower than that of the 7360 or 6HWS. Although the 6JH8 has a higher-current beam, it has a more elaborately-focused electron gun and the deflection linearity is better than that of the 7360 or 6HWS. The tube capacitances are about equal. More deflector drive voltage (audio in the present case) is required by the 6JH8. The 6ARS is an early tube<sup>13</sup> and had poor internal anchoring of cements, causing a shift of carrier null under mechanical shock.

None of these has a screen grid between de-

<sup>11</sup> Tube Data Sheet 6DJ8, Amperex Electronic Company, 230 Duffy Avenue, Hicksville, Long Island, New York.

<sup>12</sup> *Glow Lamps as Circuit Control Components*, Miniature Lamp Department, General Electric Company, Cleveland 12, Ohio, Bulletin 3-1177.

<sup>13</sup> Adler and Heuer, "Color Decoder Simplifications Based on a Beam Deflection Tube," Trans. I.R.E., PGEBTR (January, 1954), p. 64.

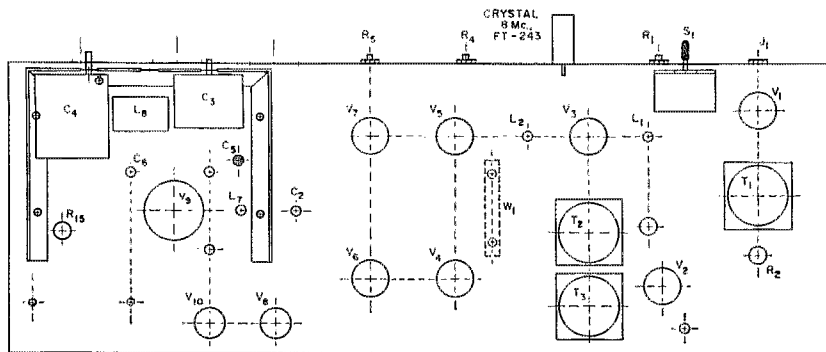

Fig. 5—Top-of-chassis layout of the 6-meter s.s.b. transmitter. This drawing is to scale and may be used for layout dimensioning;  $\frac{1}{4}$  inch in the drawing above equals one inch of actual chassis size.

flectors and anodes, and a cascode circuit can sometimes improve performance. The 7763 has a screen grid between deflectors and anodes, but it is an experimental high frequency limiter tube and has no control grid.

Balanced modulators operate at lower efficiency than do linear amplifiers. For this reason, balanced modulators usually are operated at low levels followed by large amplification. However, for simplicity in this unit, the balanced modulators are operated at a high enough power level to be able to drive the 2E26. Fortunately, the 6JH8 is available to do this at low distortion.

Single-sideband power generation at 50 Mc. is more difficult than at lower frequencies, and there is no reserve of drive for the 2E26. For this reason, low-loss coils and capacitors and high  $L$ -to- $C$  ratios should be used in the balanced modulator output and the linear-amplifier grid tuned circuits, consisting of  $L_4$ ,  $C_2$  and  $L_5$ .

### 2E26 Linear Amplifier

Straightforward design and construction were used for the linear amplifier, Fig. 4. The tube is operated with  $\pm 150$  volts regulated on the screen grid and 600 volts on the plate. This screen

voltage is slightly less than is usually specified, but it results in a negative bias closer to zero (about  $-16$  volts) than would be required with higher voltage; consequently, less r.f. drive voltage is required to overcome the bias and drive the grid up to the required peak of zero volts.

Bias is adjusted, under no signal conditions, by  $R_{15}$ , until plate current is about 20 ma. This adjustment places about  $-16$  volts on the grid. At a plate voltage of 600 volts, the tube is at rated plate dissipation. During voice peaks the dissipation rating is exceeded slightly, but no ill effects resulted from prolonged single tone testing; and operation at this screen and bias voltage minimizes linear amplifier crossover distortion.

A parasitic suppressor was incorporated only in the 2E26 plate lead. Precautions were taken in layout to keep the balanced-modulator output tank and the 2E26 grid coil under the chassis, while the 2E26 plate coil and capacitor were kept above the chassis.

The bias supply, regulated at  $-75$  volts, also is shown in Fig. 4. This supply also furnishes the  $-75$  volts for the deflector d.c.-voltage-divider return point.

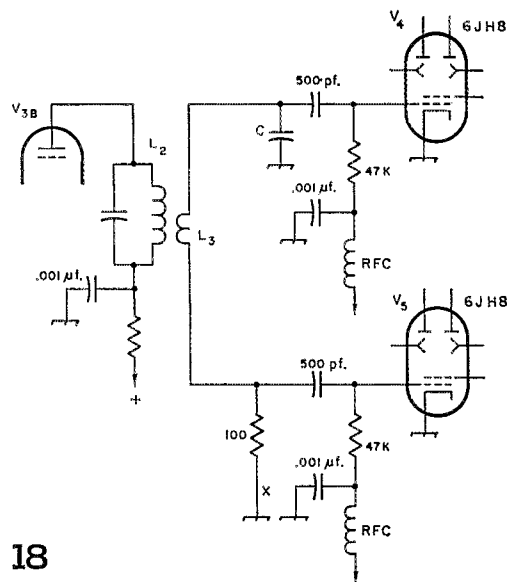

Fig. 6—Ninety-degree r.f.-phasing network for use on lower frequencies where transmission-line elements are impracticably large.  $L_2$  and  $L_4$ , Fig. 1, must be replaced by tuned circuits appropriate for the frequency used.  $L_3$  and its leads should have low capacitance to ground. Values for capacitor  $C$  are given below:

Freq. Mc.	Capacitance, pf.
3.9	400
7.2	210
14.3	100
21	65
29	46

A conventional pi network is used in the 2E26 plate circuit to match to a 50- or 75-ohm coax line to the antenna.

### Adjustment for SSB Output

With an audio oscillator and oscilloscope, adjustment for sideband and carrier suppression is fairly routine. The procedure for phasing-type exciters has been well covered.<sup>14,15</sup> Adjustment of the 2E26 linear amplifier includes neutralizing and loading.

Additional features and accessories can certainly be added, but the mission of this article is accomplished if it is an aid to you in generating an s.s.b. signal on v.h.f.

It has been suggested that this balanced-

<sup>14</sup> Eulich, "How to Adjust Phasing-Type S.S.B. Exciters," *QST*, November, 1956; or *Single Sideband for the Radio Amateur*, ARRL, 2nd edition, p. 107.

<sup>15</sup> *The Radio Amateur's Handbook*, ARRL, 38th edition (1961), p. 310.

modulator circuit might also be useful on lower frequencies. This has indeed been the case in this area, where Jack Washburn, W9IVB, and Lou Goodman, W9DCZ, are using this circuit on 4 Mc. with excellent results. Drive power on 4 Mc. is more plentiful than at 50 Mc., and the balanced modulators are used to drive a 6146 in one case and a pair of 6DQ6Bs in the other.

The quarter-wave coax is impractical for r.f. phase shift at lower frequencies, and the circuit shown in Fig. 6 is used. The value of  $C$  is selected for the frequency band used from the table in Fig. 6. The link,  $L_3$ , should have a minimum of capacitance to ground. Circuit calculations show that an inductance of about  $0.08 \mu\text{h}$ . should be used at point X in Fig. 6, but experimentally no improvement could be found, probably because the distributed inductance of the 100-ohm resistor is near this value. QST



October 1938

... The new Maxim Memorial station, W1AW, was visited for *QST* readers. Although much of the gear and furnishings are gone now, still with us are the 65-foot wooden masts and author F. E. Handy, W1BDL.

... George Grammer, W1DF, described a low-cost, double-regenerative receiver featuring improved image rejection and i.f. selectivity.

... W2LXY and VR6AY were awarded Public Service certificates for radio contact work in connection with the threatened isolation due to epidemic of Pitcairn Islanders; and W6CUH/W4DHz, W2GOQ and W2UK were commended for their radio work with Howard Hughes record-breaking round-the-world flight by aeroplane.

... W6EI described a compact kilowatt for all bands, 160 through 5 meters; RCA's J. B. Sherman wrote about construction of television receivers; and W1LJI discussed "Refinements in Combination Exciters." Other technical features were "sky-wave" propagation de W9BOE, W2DKJ and some thoughts on rotary beam antennas, a speech amplifier by W6AAR and W6ABF, and a follow-up on September's model-airplane article by ARRL's W1CBD.

... And George Hart, W1NJM, National Emergency Coordinator, who has just celebrated his 25th anniversary with the League, was introduced to *QST* readers. QST

### Strays

Who d'ya suppose broke in while K3RJX and K8RJX were in QSO recently? Sure — K1RJX!

Hams on the staff of the Los Angeles Herald-Examiner include W6MLZ, K6GEF, K6HTI, WA6IPA, WA6SKC, WB6BGF, and WN6FNZ.

October 1963

### Strays

The Society of Radio Operators, one of Chicago's oldest amateur radio clubs, will hold an open house October 12 at the Edgebrook Field House, Chicago. Space will be provided for swapping ham gear, refreshments will be served, and there'll be demonstrations of advanced and unusual amateur equipment. The Project Oscar satellite exhibit which has been displayed around the world, will be displayed.

The purpose of the open house is to provide personal transistor radios (and, later, replacement batteries) to needy persons in the Chicago area who have suffered a hearing loss. For further information, contact Al Rutherford, 729 N. Delphia Avenue, Park Ridge, Illinois, or phone HU 9-2172. Mention "Lend an Ear Day."

— — —

Lee Bergren, W0AIW, received the May 1963 *QST* Cover Plaque award from Midwest Director Denniston (left) at the August 8 meeting of the Kansas City DX Club. The award is presented each month to the author of the article adjudged best by the ARRL Board of Directors; OM Bergren's winning entry was "The Multielement Quad." The central feature of the Cover Plaque Awards is the actual engraver's plate used in printing the cover, suitably chromed and mounted on a walnut plaque.

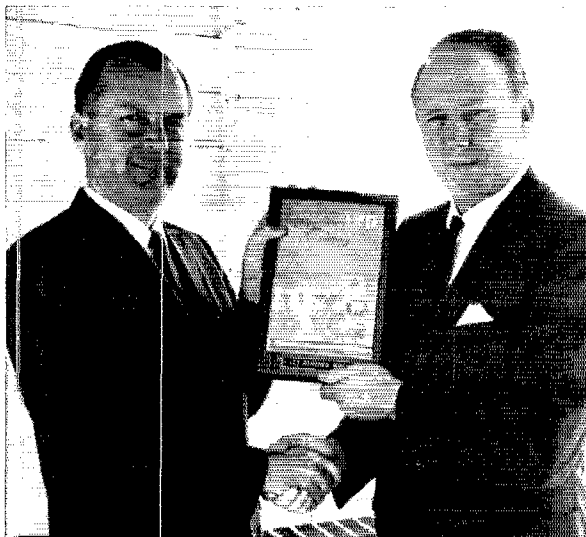

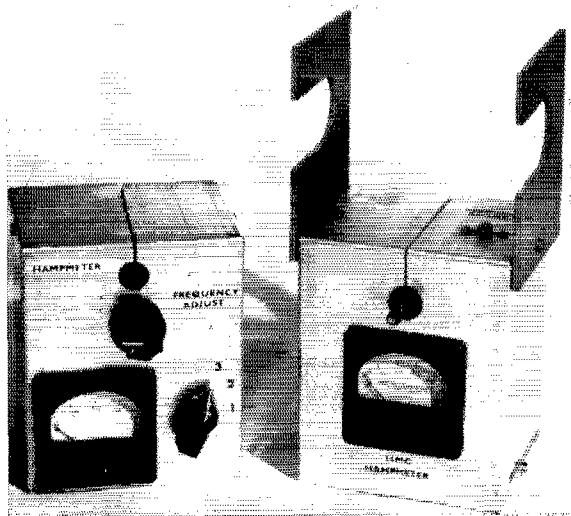

Two versions of the Hampmeter. On the left is the original model covering 3.4 to 40 Mc. in three bands; at the right is a single-band version with hooks for hanging on an antenna.

Conventional field-strength meters work on the electric field. This one works on the magnetic field with certain advantages. The Hampmeter will be found useful in checking current distribution and for antenna-adjustment purposes.

# The Hampmeter

## Magnetic Field-Strength Indicator

BY HORNER KUPER,\* K2CU AND FRANK J. RIZZO,\*\* W2OCM

**T**HE Hampmeter (for *A*MPLitude *M*ETER) is a simple, light-weight and compact r.f. field-strength meter which operates on the magnetic component of the electromagnetic field, rather than the electric. Since the two components are firmly tied together by Maxwell's equations, the relative field-strength measurements are completely equivalent, but use of the magnetic field offers certain advantages. For one thing, the instrument can be made much more compact for a given sensitivity but, more important, it may be used near an antenna element or other conductor to measure the current flowing in it, without cutting the conductor.

The gadget was first developed and used in 1960 at Brookhaven National Laboratory<sup>1</sup> in

\* Box 266, Setauket, L. I., N. Y.

\*\* 13 Shelley Place, Huntington, L. I., N. Y.

<sup>1</sup> Operated by Associated Universities, Inc., for the U. S. Atomic Energy Commission.

connection with some antenna problems, but soon found its way into the hands of some local hams who have been enthusiastic about its utility. So many requests for details have come in that it seems worthwhile to write it up briefly.

The coils are wound on a ferrite rod mounted in a 3 × 4 × 5-inch Minibox with an appropriate coil, tuning capacitor, diode and meter, to provide a magnetic pickup shielded from electric fields. We find a 4-inch length of 1/4-inch diameter ferrite is convenient. It is important to use a grade of ferrite that has reasonably high  $\mu$  and  $Q$  at the frequencies of interest. Ferramic "Q-2"<sup>2</sup> can be used on all ham bands up through 6 meters, giving a  $\mu$  of about 40. The next grade, "Q-1", gives a  $\mu$  around 125 but probably will not work well above about 10 Mc.

<sup>2</sup> Indiana General Corp., Keasbey, N. J.

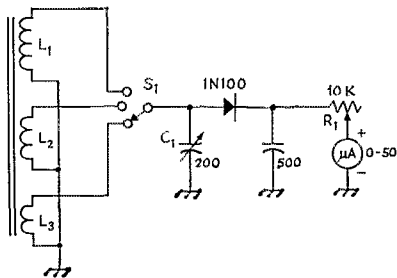

Fig. 1—Circuit diagram of the Hampmeter. Capacitances are in pf.; resistance is in ohms.

C<sub>1</sub>—Midget variable capacitor (Hammarlund MC-200).

L<sub>1</sub>—3.4 to 12 Mc.—17 turns.

L<sub>2</sub>—8 to 25 Mc.—5 turns.

L<sub>3</sub>—18 to 40 Mc.—3 turns.

Note: Above coils are close-wound with No. (22 enam.) wire on a single ferrite form 1/4-inch diameter, 4 inches long, with no spacing between windings. (Form is antenna rod Cat. No. CF-501, Indiana General Corp., Keasbey, N. J. In case of difficulty in securing this item, one may be obtained from W2OCM for \$1.00 handling expenses.)

R<sub>1</sub>—Linear control.

S<sub>1</sub>—Ceramic rotary switch: 1 section, 1 pole, 3 positions (Centralab PA-2000).

### Construction

The circuit diagram of the Hampmeter appears in Fig. 1, and construction is shown in the photo and the sketch of Fig. 2. The winding data given here apply only to a ferrite rod of the particular dimensions and material specified. Almost any microammeter can be used, but it is usually convenient to use a rather sensitive meter and provide a large series resistor to adjust sensitivity as required. The tuning capacitor may be almost anything that will cover the desired range. If it is provided with a calibrated dial, the gadget can also be used as an absorption wavemeter.

The ferrite rod is mounted through the Minibox from front to back in grommets set in holes about  $\frac{5}{8}$ -inch from the top of the box. After the matching holes are drilled in the two halves of the box, the box is assembled and a hacksaw cut is made across the top and running down the front and back to reach the holes. This is important to prevent the box from acting as a shorted turn.

Hooks made of Lucite, bakelite, or similar material are provided so that the meter can be hung from an antenna element and slid along it to measure the current distribution. In measuring current in a conductor, the ferrite rod should be kept at right angles to the conductor and at a constant distance from it.

### Using the Meter

When using the Hampmeter as a field-strength meter, as for antenna tune-up and pattern measurements, it is important to remember that the magnetic field is at right angles to the electric field and the direction of propagation. Therefore, in making measurements on a horizontal antenna, the meter should be located at least two wavelengths away, at approximately the same height as the antenna, with the ferrite rod vertical. For vertical polarization, the rod should be in a horizontal position perpendicular to the direction to the antenna.

In addition to its use as an ordinary field-strength meter and for measuring current distributions in antenna elements, we have found the gadget useful in some other ways. In the average ham location it will be found that quite substantial currents may be flowing in guy wires, masts and towers, coaxial-cable braids, gutters

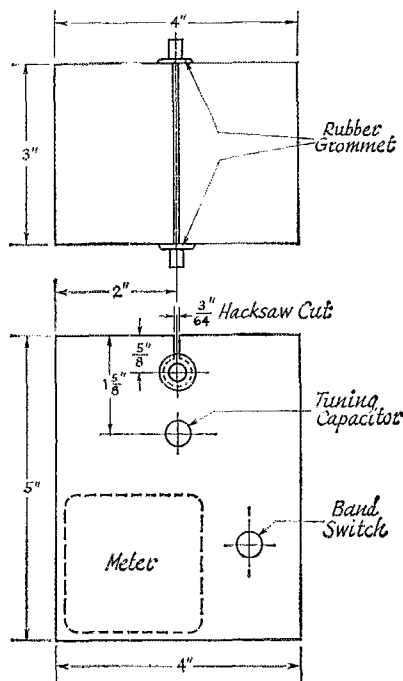



Fig. 2—Sketch showing mounting of ferrite through box and saw cut.

and leaders, piping, and telephone and power wiring. Knowledge of the existence of these currents will help in explaining anomalies in antenna directive patterns, and may shed considerable light on TVI problems; and often they may be reduced or eliminated by bonding or relocation of grounds. Presence of these parasitic currents will often give a tilt to the plane of polarization and make a marked difference in front-to-back ratios. When the ferrite is oriented parallel to the electric field lines, there will be a sharp null in the reading that may be used to locate the plane of polarization quite accurately.

With the aid of this meter it has been possible to completely tune up a home-brew 3-element beam in a couple of hours, with most gratifying signal reports. We wish to thank VK1JW for suggesting the Hampmeter's name. 

## Strays

K4YMO and WA4GPJ would like to hear from other hams who own tape recording equipment, with a view to arranging skeds, exchanging information, and compiling a directory. Send your name, call, address, and a description of your recording gear to WA4GPJ, 511 Gaskins Road, Richmond, Virginia 23229.

WA4BDW recently worked Aurora, South Dakota (K0DEL) and Aurora, Colorado (W0DKA) within a few minutes' time on six meters.

A cumulative index to *QST* is now available for 25¢ postpaid. This 64-page booklet covers the years 1950-1962, with provision for updating it easily for the next five years. Send your order and 25¢ (no stamps, please) to ARRL, 225 Main St., Newington, Connecticut 06111.

The Alabama Emergency Net D *Bulletin* reports that old postal directories are available from local Post Offices since they are renewed once each year. They can help you deliver your traffic.

# A Pre-I.F. Noise Silencer

Another Step Forward in the War on Man-Made QRN

BY WILLIAM K. SQUIRES,\* W2PUL

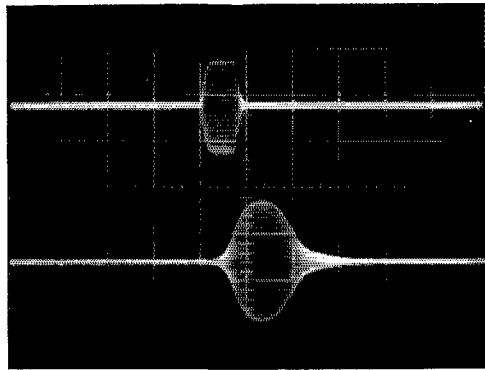

Fig. 1—Oscillograms of (above) 150- $\mu$ second pulse at input to a 1-Mc. i.f. amplifier, and (below) the same pulse at the output of the amplifier. Amplifier bandwidth is 5 kc.; note delay and lengthening.

(Displayed by Tektronix 531A oscilloscope with dual-trace pre-amplifier, sweep speed = 200  $\mu$ seconds/cm.)

THE battle against impulse noise has been long enjoined. In the period that saw the appearance of audio and i.f. noise limiters, i.f. noise silencers,<sup>1</sup> and even noise "blankers," came a proliferation of neon signs, arc welders, automatic controllers and the ubiquitous automobile. The development of a receiver "front-end" with good overload behavior<sup>2</sup> suggested the possibility of creating a more powerful weapon against impulse noise. While the technique can produce major improvement when properly applied to almost any receiver, truly phenomenal noise "elimination" can be attained when it is used with a receiver that is not seriously susceptible to cross-modulation and overload.

## Impulse Noise Characteristics

To review quickly, by "impulse noise" is meant man-made noise usually produced by the accompanying the making or breaking of an electrical circuit, as in an ignition system. The resulting noise pulse is very high in peak amplitude (often large fractions of a volt at the antenna terminals) but extremely short in duration (individual pulses infrequently exceed 25-50 micro-

\* *QST*, Squires-Sanders, Inc., 475 Watchung Ave., Watchung, N. J.

<sup>1</sup> Lamb, J. J., "A Noise Silencing I.F. Circuit for Superhet Receivers," *QST*, February 1936.

<sup>2</sup> Squires, "A New Approach to Receiver Front-End Design," *QST*, September 1963.

seconds). Repetition rates vary from almost random to 60-cycle synchronous.

Atmospherics, produced by ionospheric propagation of a large number of individual lightning strokes for each noise burst, can be of extremely long duration — hundreds of milliseconds. Consequently, attempts to silence<sup>3</sup> over such long intervals cause severe deterioration of speech (and high-speed c.w.). Therefore, for the purposes of this article, by impulse noise we mean only that high-intensity, short-duration noise that is susceptible to receiver silencing.

Although the incoming pulses are of very short duration, selectivity (as in the i.f. amplifier) lengthens them. Fig. 1 shows the delay and lengthening caused by a 5-kc. wide i.f. amplifier. The upper trace is that of a simulated noise pulse seen at the i.f. input; the lower trace shows the same pulse as it appears at the i.f. output. The more serious lengthening caused by a narrower i.f. amplifier can be seen in Fig. 2, which shows the same pulse applied to a 2-kc. wide i.f. amplifier with very steep skirt selectivity (4 kc. wide at -60 db.).

Any stage that overloads can cause extreme lengthening. Once the pulses become long in duration, silencing is much less effective because bigger "holes" are made in the signal. Limiting can reduce the abuse to the ears, but can do little to improve weak-signal performance because the (now) long noise bursts obscure the signal.

It should be clear that silencing should take

<sup>3</sup> By "silence" is meant to render the receiver inoperative for the duration of the pulse. A "limiter" simply prevents the pulse (or signal) from exceeding a given amplitude.

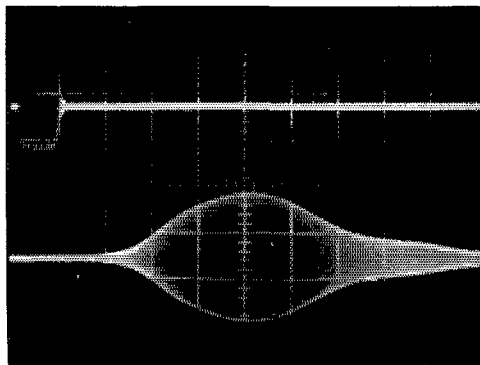

Fig. 2—The delay and lengthening of the pulse of Fig. 1 when passed through a 2-kc. wide amplifier with good skirt selectivity (4 kc. at -60 db.).



place in the receiver *before any appreciable selectivity*. When this is done, the noise pulse will be eliminated before the i.f. even begins to respond (see Fig. 2). This implies that the silencer *must be pre-i.f.* if it is to really perform. Three other requirements must also be met.

### Silencer Requirements

If the silencer is to render the receiver inoperative only during the pulse interval, the bandwidth of the silencer should be as *great as possible*, so that it will produce the shortest possible silencing pulses (and with negligible delay). An upper limit on this maximum bandwidth is not only that available at the receiver front end, but on the requirement that the silencer should "see" the same portion of the spectrum as that to which the receiver is tuned.<sup>4</sup>

Next, since the silencer "sees" *all* of the signals (and noise) over a wide range (say 500 kc. to 1 Mc.), it must have a way to separate the noise pulses from the signals. Fortunately, impulse noise tends to distribute its energy rather uniformly over large slices of the spectrum, so that peak-envelope detection over the full bandwidth will, in most cases, recover the noise pulses at greater amplitude than the instantaneous sum of all the signals present. The noise pulse must then be shaped and controlled in amplitude, to properly actuate a gate. The over-all silencer block diagram is shown in Fig. 3.

In the process of turning the gate off and on, the silencer *must introduce no disturbance of its own into the i.f. amplifier*. Typical i.f.-input signal levels may be only a few microvolts. The silencer itself must introduce no i.f. spectral components that even approach this level. If the silencer does, it may produce more noise in the output than if it were inoperative, particularly on weak signals. At the same time the gate should introduce little insertion loss when on, or open, but produce great loss (80 db. or more) when off, or closed. Even quite sophisticated vacuum tube gates are grossly inadequate in meeting the above requirements.

### Silencer Design

The particular "front end" with which this

<sup>4</sup> Noise "blankers" have been made to "look" at v.h.f. while silencing a receiver tuned to an h.f. band. While effective against certain types of impulse noise, particularly ignition, this is less effective against power leaks, switches, welders, etc., which may have little spectral energy at v.h.f.

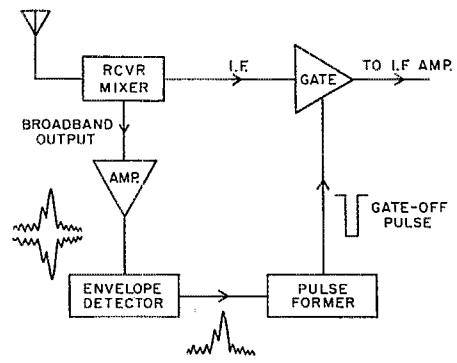

Fig. 3—Block diagram of the basic silencer circuit.

silencer was to be used provided a 5.0- to 5.5-Mc. output on all bands, and a 1.0-Mc. i.f. output. The experimental silencer employs three tubes, one crystal diode and one transistor. Its detailed block diagram is shown in Fig. 4.

Two stages of high-gain bandpass amplifier, using high-transconductance tubes (6GM6s), bring all noise and signals from the frequency-converted input to the level of several volts where they are (all) envelope-detected and filtered (retaining the 500-kc. bandwidth). This filter is a.c.-coupled to remove the d.c. component, which can be quite considerable when all the signals in the 500-kc. band are integrated. Up to this point we have a conventional bandpass amplifier and detector whose over-all gain can be set by the "threshold" control, which sets the bias on the tubes. The resulting noise pulses (and mish-mash) are fed to the 6AH6.

The 6AH6 operates with its bias beyond cutoff and with low screen voltage (about 25 volts); consequently it conducts only on the positive-going noise peaks, and when it does, it delivers a current pulse sharply limited by its depressed screen voltage. Over a very wide range of input amplitudes, it will produce the identical-amplitude current pulse. This pulse is coupled to a rather peculiar gate, whose circuit is shown in Fig. 5.

This gate exploits the characteristics of a bidirectional n-p-n switching transistor. When the base is biased positively with respect to the emitter, the impedance between collector and emitter is extremely low (a few ohms) and current flows between base and emitter (almost none to

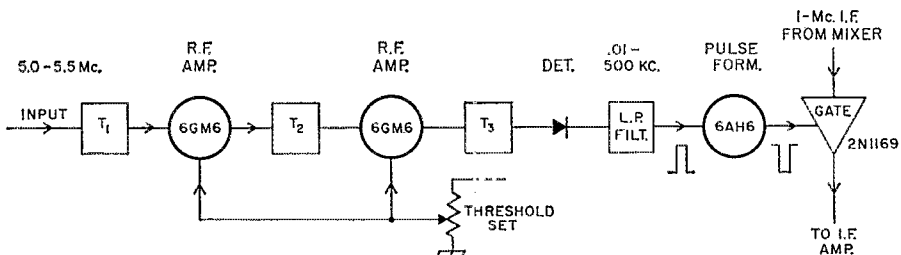

Fig. 4—Detailed block diagram of the pre-i.f. noise silencer.

T<sub>1</sub>, T<sub>2</sub>, T<sub>3</sub>—Broadband transformer, 5.0-5.5 Mc.

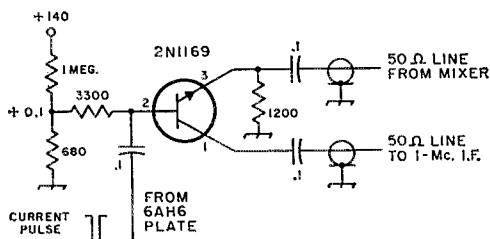

Fig. 5—Circuit diagram of the silencer gate. The 2N1169 is a bidirectional n-p-n switching transistor. D.c. return for pin 1 is through the back resistance.

the collector, pin 1). If now the base is pulsed negatively with respect to emitter, the base-emitter current ceases, and the impedance between emitter and collector increases to a very high value, over a megohm.

Consequently, until it is pulsed, the gate provides practically a short circuit between input and output. When pulsed, it opens the circuit, providing great insertion loss. Since the current into the collector does not change at any time, the gate itself generates no "noise" of its own. Moreover, this gate will handle relatively large signals (1 to 2 volts) without producing cross modulation or overload, and good front-end characteristics can be preserved.

### Performance

This is a case where one "listen" is worth a thousand pictures: however, some indication of performance can be gained from the accompanying oscilloscope pictures. To give an indication of the gating action, Fig. 6 shows the gate output with a 1.0-Mc. carrier 30 per cent modulated at 1000 c.p.s. at the input to the gate. The signal is at 100  $\mu$ v. and the gate pulse is 20  $\mu$ seconds wide. It can be seen that the gating action is complete and that no i.f. noise is introduced. The lower trace shows the pulse at the input to the 6AH6 pulse former.

The detailed action of the gate can be seen more clearly in Fig. 7, which shows a gated carrier (at 120 kc., so that individual cycles can be seen)

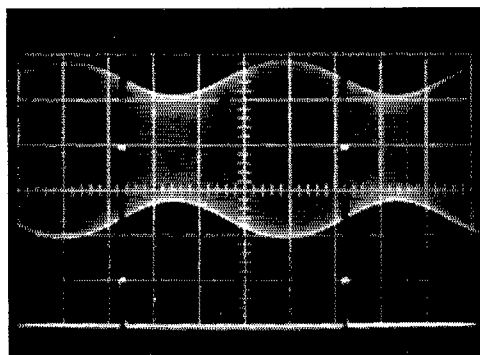

Fig. 6—(Above) A 1-Mc. carrier modulated 30 per cent, seen at the output of the silencer gate. (Below) Input to silencer pulse former. Pulse duration is 20  $\mu$ seconds. Sweep speed = 200  $\mu$ seconds/cm.

at the gate output, with the gating pulse at the pulse-former input in the lower trace. It is clear that the carrier is turned off quickly and completely.

Finally, the performance of the silencer on noise pulses can be seen by examination of Figs. 8 and 9. Both show the output of a 1.0-Mc. i.f. with a 5-ke., 6-db. bandwidth with the front end being fed a 3.75-Mc. signal modulated 30 per cent (400 cps. at a 30- $\mu$ v. level). At the same time a noise burst of a peak level of 30,000  $\mu$ v. was injected into the antenna input (the noise bursts were made synchronous with the 400-cps. modulation to make photography possible). In Fig. 8, the silencer is *off*, and the noise pulse not only "blasts" the signal but i.f. overloading can be seen following the pulse. The pulse was also actuating the a.g.c. and reducing the receiver gain. Admittedly, this represents a severe case of noise interference.

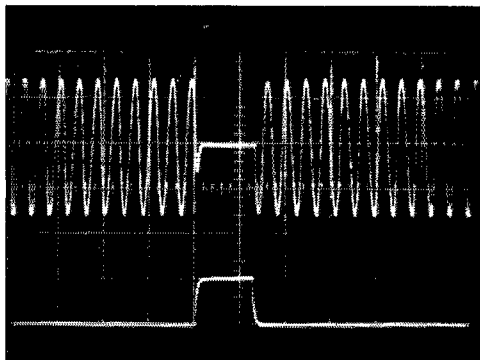

Fig. 7—(Above) A steady 120-ke. carrier, no modulation as observed at the silencer gate output. (Below) The 20- $\mu$ second gating pulse at input to pulse former. Sweep speed = 20  $\mu$ seconds/cm.

Fig. 9 shows the same situation: the only change is that the silencer has been turned on. It can be seen that the signal level has increased, since the noise pulses are no longer actuating the a.g.c. Between taking the pictures of Figs. 8 and 9, nothing was changed except the silencer threshold level. Signal levels, oscilloscope gain and noise level were not touched.

The noise pulses, as such, have been eliminated, and it is clear that the modulation envelope, if smoothed (as in the detector and audio filtering) shows little deviation from the 400 c.p.s. modulation.<sup>5</sup> The audible effect is to go from a situation where all that can be heard is the impulse noise with a weak 400-cycle tone in the background, to one in which all that is heard is a clean 400-cycle note with a faint "buzzing" in the background.

It should be remembered that these measure-

<sup>5</sup> The photograph shows more apparent variation than actually occurs; it is extremely difficult to photograph these traces without "seeing" a nonintegral number of sweeps, which leads to the overlapping and waveform changes between successive pulses.

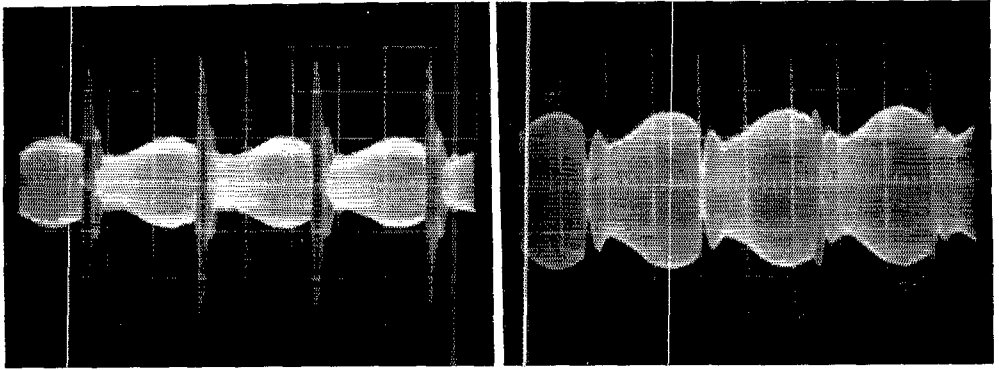

Fig. 8—(Above, left) a 3.75-Mc. carrier modulated 30 per cent, interfered with by noise pulses. The noise pulses were originally 1000 times the amplitude of the signal; they have been reduced (and lengthened) by overload in the i.f. The i.f. bandwidth is 5 kc. Sweep speed = 1 millisecond/cm.

Fig. 9—(Right) same as Fig. 8 but with silencer on.

ments were made with steady repetitive noise pulses (for the purposes of 'scope photography) and the more random nature of actual impulse noise makes any remaining "buzz" almost unnoticeable. Silencer "on" pictures using s.s.b. (2.5 kc.) or c.w. (0.35 kc.) filters show *no* perturbations — just pictures of a 400-cycle modulated carrier.

Extensive use under actual operating conditions in an extremely noisy location has produced a rather thorough evaluation of the silencer's capabilities and limitations. It will not eliminate (or much attenuate) atmospherics — they last too long. If there is a *big* c.w. signal in the band, it *will* silence the receiver during characters (only remedied by backing off on the

threshold control). To date these have been the only serious limitations.

Its main capability lies in literally eliminating the majority of impulse noise. Truly weak signals become perfectly readable under the most severe noise conditions — when without the silencer *no* signal weaker than S7 could be heard at all. It becomes increasingly effective as narrower and narrower i.f. bandwidths are used. While on a.m. it can be spectacular, on s.s.b. and c.w. it is often seemingly miraculous. At the same time, unlike limiters and i.f. silencers, it produces *no* deleterious effects on the signal (since it prevents i.f. overload and lengthening), *no* distortion, *no* audible holes, *no* volume reduction — it just quietly removes the noise. Q57

## Strays

K4CSI has mentioned the value of trichlorethane as a resin remover in Hints and Kinks (August 1963 *QST*, page 47). A2c Joseph Woodward, who works with Air Force teleprinters, points out the danger of confusing the relatively safe trichlorethane with another cleaner, trichloretholene. The latter chemical is deadly if inhaled for any length of time, and can cause skin irritations. Remember: trichloroethane, not trichloretholene.

— . . . —  
A cumulative index to *QST* is now available for 25¢ postpaid. This 64-page booklet covers the years 1950-1962, with provision for updating it easily for the next five years. Send your order and 25¢ (no stamps, please) to ARRL, 225 Main St., Newington, Connecticut 06111.

— . . . —  
WA6WDX would like to know whether there are any other midgets in amateur radio.

— . . . —  
VE3GG (who is 79 years young) suggests that hams add their age to their RST report. "Once this information is received on both ends of the QSO, right after the RST, both parties can adjust their conversation to suit each other," says Mike.

The Navy's exhibit at this year's Armed Forces Communications and Electronics Association convention was a four-position amateur radio station, K4NAA, in the lobby of the Sheraton-Park Hotel in Washington, D. C. Shown (l. to r.) at one of the rigs are ARRL Southwestern Division Director W6MLZ and Sen. Barry Goldwater, K7UGA-K3UIG. (Official U. S. Navy Photo)

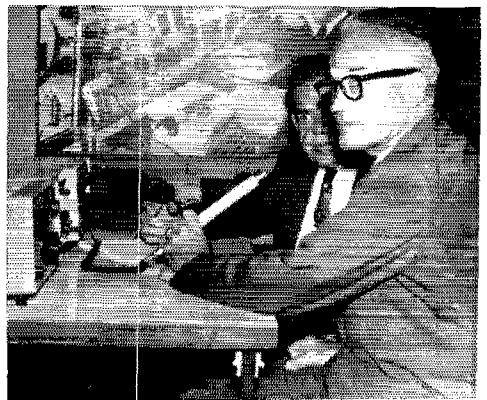



W6SAI contemplates the unfinished interior of the Project Oscar HQ. Weeks of work lie ahead to install electric wiring and antennas. Volunteers, anybody?

## Project Oscar Finds a New Home

BY WILLIAM I. ORR,\* W6SAI

FOOTHILL College in Los Altos, California, is erecting and equipping a complete Space Science Laboratory, including a 16-inch optical telescope, a 28-foot radio telescope and a planetarium (the latter already in operation). It is the hope of the College to have first-class tracking facilities in operation by the time Oscar III orbits, for Project Oscar's new home is on the Foothill Campus. Negotiations for the use of the building by Project Oscar were aided by the cooperation and support of Dr. Robert C. Smithwick, W6JZU, member of the Board of Trustees of Foothill College, and Professor John W. Sherman, Jr., W6KAS, Chairman of the Division of Engineering and Technology, who has recently been elected to the Board of Directors of Project Oscar. (Other new directors of Project Oscar are O. H. Brown, W6HB, and E. Finley Carter, K6GT).

\* Project Oscar, Inc., Box 183, Sunnyvale, California



The new Project Oscar Headquarters building! Now only a shell, the Oscar gang plans to install electrical wiring, an extensive ground system, and complete workshop during the summer months. Tracking and communications activities will be on the second floor, with lab and workshop on ground floor. Once a four-car garage, the building will be completely converted to communication and tracking facilities.

*After three years of working out of garages and home workshops, Project Oscar has at last found a home! Within the next few weeks, the Project will move into a large, two-story building at Foothill College in Los Altos, California. The college has made available a former garage and storage building on the edge of the campus, complete with utilities and the necessary land to erect antennas. The Project Oscar crew hope to move all tracking and communication facilities to the new QTH during the summer months. Mail address for Project Oscar will continue to be Box 183, Sunnyvale, California.*

Meanwhile, work continues on the prototype Oscar III translator (see February 1963 *QST* for details). Various vexing problems remain, chief among which is proper operation of the transistorized linear-amplifier package. Efforts are underway to raise the stage gain, drop the primary-power requirement, and to decrease the intermodulation distortion. Oscar III will be designed to function either with a "one-shot" battery supply (with approximate life of 3 to 4 weeks) or with a combination of battery and solar-charging cells, for extended life. A decision will shortly be made on choice of supply to be used on the first flight.

Bob Walton, W6CYL, is charged with the communication facilities for the forthcoming Oscar program. At this time, it is planned to transmit "Oscargrams" on 80, 40, and 20-meter RTTY and s.s.b., and on 160 and 2-meter a.m. European outlet for information from Oscar Control Station W6EE will be the International Telecommunications Radio Club station 4UIITU in Geneva, Switzerland. Direct transmissions will also be made from W6EE to Oscar coordinators and to IARU member societies for local re-broadcast.

It is hoped that Oscar newsletters will soon be distributed to all interested radio amateurs on a monthly basis. Manpower limitations and loss of several key radio amateurs from the program have handicapped the Project during the early months of 1963. W6EJU has moved to Alaska, W6OLO is now situated in New York, and W4IJC/6 is also back east. Recruitment of new members has been a pressing problem during the last months.

The flight prototype of Oscar III is now well underway, the receiver portion being built by Jim Ouimet, K6OPO, and Herb Vanderbeck, W6WAI. Al Diem, W3LSZ/6 and Bayman McWhan, W2GAX are at work on the transistorized linear amplifier. Hugh McLain, K6SPK, and Lance Ginner, K6GSJ, are working on the power supply problems. Don Norgaard, W6VMH, and Ed Hilton, W6VKP, are working with over-all design of the various articles of equipment and are concerned with system operation. Hank Brown, W6HIB, is coordinating the efforts of the Oscar III team. And so work continues apace. All members of the Oscar crew look hopefully forward to completion of the equipment design and anticipate the launch of the Oscar III translator satellite at the earliest possible date.

**QST**

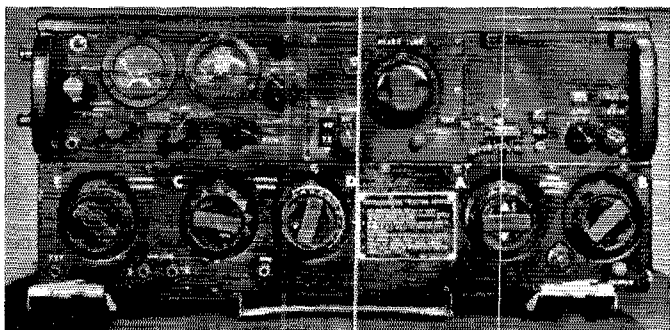

The converted ART-13. The s.s.b. exciter is behind the panel in the upper right-hand corner, and the high-level mixer is behind the top-center panel.

## S.S.B. with an AN/ART-13

BY THEO. A. BRUNNER,\* W4MTM

This modification of a readily-available surplus unit provides a complete medium-power s.s.b. transmitter covering 20, 40 and 75 meters at minimum cost.

**D**URING the almost three years the author has been on 20, 40 and 75 s.s.b. with an AN/ART-13, he has worked many other Collins-equipped stations, but only one other using an ART-13. This station had a nice-sounding signal using an outboard SB-10 as the means of conversion. This system, although effective, does not make full use of the ART-13 capabilities. Admittedly, the ART-13 will not do everything that some store-bought jobs will, but it does have two big advantages: cost and satisfaction of accomplishment. The ART-13 also has advantages over a completely home-built rig. Foremost is the lovely, lovely, solid-as-a-rock stability of the ART-13. In addition, the conversion can be made much more cheaply and in less time than a home-brew rig could be constructed. By judicious buying, a ham should have no great difficulty in doing the job for \$200 or less. The writer actually spent less than \$50 cash money. By writing a surplus house and explaining that an AN/ART-13 with the Class-B modulators missing or damaged and with a low-frequency oscillator consisting of chassis only would suffice, a price of \$30 plus express charges was secured. A

\* 2803 King Street, Augusta, Georgia 30906.

Collins mechanical filter was acquired by swap and a power supply used to operate an ART-13 on c.w. and a.m. was on hand. As for satisfaction, good reports and a good-looking signal on the scope furnished that in good measure. In fact, the NYL has accused the author of being a bit of a snob, looking down his nose at store-bought equipment. If this is so, it is quite unwarranted, because the Collins people did all the really hard work in building the ART-13.

### General Features

The best feature is that nothing is mounted outboard. The power supply is a separate unit, of course, but the entire transmitter is self-contained. Most of the original features of the ART-13 were retained. The built-in frequency calibrator works, with the s.s.b. exciter frequency being added to that in the calibration book. The m.c.w. tone generator can be switched to the audio input for single-tone tune-up. The auto-tune functions, so the only manual tuning is that of the high-level mixer which must be touched up when changing bands. Operation on c.w., s.s.b. and s.s.b. with carrier are possible.

The actual conversion consisted of three steps. The first was the construction of a 455-ke. s.s.b. exciter on the original speech-amplifier chassis. The second was the building of a high-level mixer on the low-frequency oscillator chassis. The final step consisted of some changes in the filament circuitry and in the p.a.-output pi network, and a few subchassis interconnections.

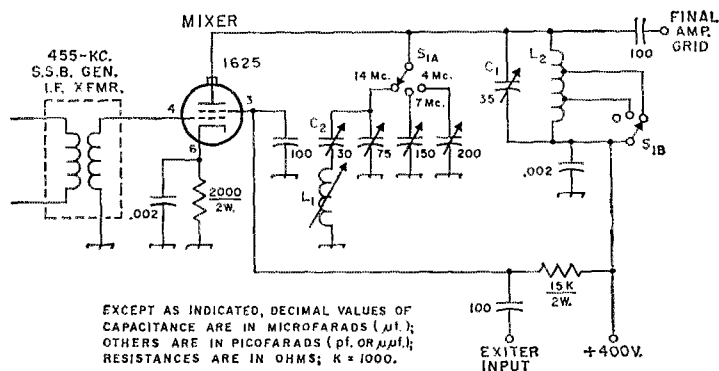

EXCEPT AS INDICATED, DECIMAL VALUES OF CAPACITANCE ARE IN MICROFARADS ( $\mu$ t.); OTHERS ARE IN PICOFARADS (p.f. OR  $\mu$ p.f.); RESISTANCES ARE IN OHMS; K = 1000.

- C<sub>1</sub>—Midget air variable.
- L<sub>1</sub>—Approx. 3- to 6- $\mu$ h. slug-tuned coil.
- L<sub>2</sub>—15 turns No. 16, 1½-inch diam., 2 inches long, tapped

at 4 turns and 8 turns from plate end.

- S<sub>1</sub>—Rotary switch: 1 section, 2 poles, 3 positions (may be possible to adapt original band switch in some ART-13 units).

Fig. 1—Circuit of the 3-band mixer. Fixed capacitors are 1000-volt mica. Except for C<sub>1</sub>, variable capacitors are ceramic trimmers, three of which were salvaged from the ART-13 low-frequency oscillator circuit. L<sub>1</sub> and C<sub>2</sub> form a series trap tuned to the 14-Mc. exciter frequency (see text).

### S. S. B. Exciter

The circuit used for the exciter is a slight modification of the one described by WGCHB in his article in an earlier issue<sup>1</sup> (also in the second edition of *Single Sideband for The Radio Amateur*). The speech-amplifier chassis was completely stripped, and the top cut out and replaced with a matching piece of ½-inch aluminum for a fresh start on the socket-hole cutting. About the only original parts used were the microphone transformer and the Jones plug with its mounting. Other than making room for all of the components, no special difficulty was experienced in getting the exciter working. To make as few changes in the ART-13 as possible, a carbon microphone was used, and a substantial improvement in audio quality was effected by loading the primary of the microphone transformer with a 47-ohm resistor in parallel.

### High-Level Mixer

The circuit of the high-level mixer is shown in Fig. 1. This mixer is of conventional design. The 455-ke. s.s.b. signal is fed to the grid of a

<sup>1</sup> Hoisington, "Three-Band S.S.B. Exciter Using A Mechanical Filter," *QST*, January, 1956.

1625, and the ART-13 v.f.o. multiplier output to the screen. Some trouble was experienced on 20 meters with the v.f.o. multiplier frequency feeding through the mixer. This problem was solved by a series trap (C<sub>2</sub>L<sub>1</sub>) connected across the mixer tank and tuned to the v.f.o. multiplier frequency. The trap is switched out of the circuit on the other bands and, other than for some slight detuning effects, works satisfactorily. However, if the writer were to convert another ART-13 he would use a balanced mixer with an 829B or a pair of 5763s, thus making the trap unnecessary. The mixer has ample undistorted output to drive the S13 to an input (meter-reading power) of about 265 watts. This section was built on (actually in) the low-frequency oscillator chassis. For best front-of-panel appearance, the original band switch was used to switch bands. This switch is not of the best low-loss construction, but there is mixer output to spare, and no difficulty has shown up.

### ART-13 Modification

The writer found Army technical manual TM-11-692B-1 to be indispensable in making this conversion. The ART-13 filaments were rewired

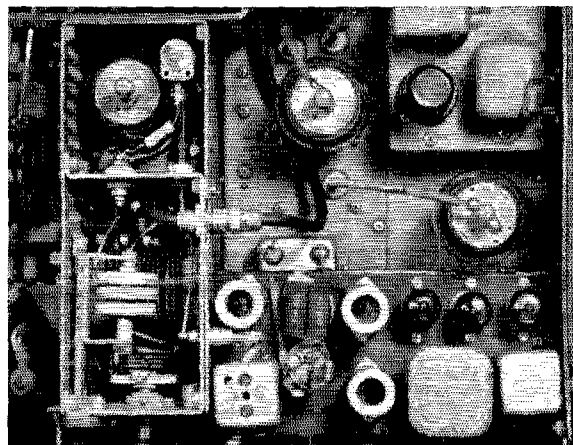

The 455-ke. s.s.b. exciter is the chassis at lower right, which formerly served for the ART-13 speech amplifier. Along the top of this chassis in his view, from right to left, are the speech amplifier, clipper, VOX, and carrier-oscillator tubes, the upper- and lower-sideband carrier crystals, and the 455-ke. amplifier tube. In similar order along the bottom are the VOX relay, the microphone transformer, the balanced-modulator tube, the mechanical filter and the 455-ke. output transformer.

The high-level mixer is in the partitioned section to the left. The 1625 mixer tube and 14-Mc. series trap are visible above the partition divider, with the output-circuit components below. The three ceramic trimmers mounted over the coil were rescued from the original ART-13 low-frequency oscillator.

(Photos by George Schaeffer, Augusta, Ga.)

and connected to the filaments of the newly-added tubes as shown in Fig. 2.<sup>2</sup> The combination is operated from a 23-volt d.c. supply, the circuit of which is also shown in Fig. 2. With this connection, the filament of the 813 is at an average positive potential of about 18 volts above ground which appears as additional bias when the grid is returned to ground (through the bias supply). Use of d.c. filament power is recommended, since it simplifies the conversion, and allows use of the original keying relay, mode relays and the autotune. The original keying relay includes provision for antenna change-over and receiver muting.

The 813 pi-network output switching had to be rearranged in order to add capacitance in the output for a low-impedance load. The variometer was retained for inductance tuning, and the large tuning capacitor was switched to the output of the pi network. Some other minor changes, such as elimination of the modulation transformer, had to be made, and these will become evident to the individual as the conversion progresses.

### Output Circuit Modification

This is not a conversion for the weekend kit builder so, for the most part, detailed instructions are not furnished. The experienced builder will most certainly have his own ideas as to details. However, a procedure covering modification of the output pi network will be outlined.

- 1) Refer to Fig. 4-13 and Table 4-2 on pages 4-14 and 4-15 of Manual TM 11-1692B-1.
- 2) Use position 6 of control C for 75 meters. Cut down the fiber cam controlling  $S_{113H}$  so the switch will close in position 6 of control C.
- 3) Use position 11 of control C for 40 meters.
- 4) Use position 12 of control C for 20 meters.
- 5) Disconnect  $C_{124}$  and  $C_{125}$  from  $S_{113B}$  and connect them to the output of the pi network between  $L_{113}$  and  $S_{116}$ . Disconnect contacts 1

<sup>2</sup> The calibrator/ tone-generator circuits in some ART-13s have three tubes. In this case the parallel resistor should have a value of 10 ohms.

and 2 of  $S_{113B}$ .

- 6) Remove  $L_{110}$ ,  $C_{137}$  and  $L_{116}$ .

When these changes have been made, with control C in position 6 for 75 meters,  $S_{113C}$  will connect to contact 6 and short out most of  $L_{113}$ .  $C_{124}$  and  $C_{125}$  will comprise the pi-network output capacitor.  $S_{113H}$  will connect  $C_{122}$  as the pi-network input capacitor. Other switches will be open and the pi-network inductance will consist of part of  $L_{113}$  and the variometer  $L_{112}$ .

With control C in position 11 for 40 meters,  $S_{113C}$  will connect to contact 7 and short out all of  $L_{113}$ .  $C_{124}$  and  $C_{125}$  will be the pi-network output capacitor and  $S_{113F}$  will connect  $C_{130}$  as the pi-network input capacitor. Other switches will be open and  $L_{112}$  (the variometer) will be the pi-network inductance. With control C in position 12 for 20 meters, conditions will be the same as on 40 except that  $S_{113C}$  will be open and the pi-network input capacitance will be the distributed capacitance only. If additional output capacitance is required on 75 meters,  $S_{113B}$  (which was previously disconnected) may be used to connect an additional capacitor in the circuit when  $S_{113B}$  is in position 1, as it will be with control C in position 6.

### Operation

The 813 is operated according to the maximum ratings shown in the ARRL Handbook and s.s.b. manual, with 2500 volts on the plate and 750 volts on the screen. A small mercury battery provides 75 volts of bias which, when added to the 18 volts of "cathode" bias previously mentioned, brings to total close to the recommended value of -95 volts.

Many sincere compliments have been received on the signal from this rig from discerning hams, and it is believed that any ham making a similar conversion will find his time well spent and end up with a top-flight s.s.b. rig. Correspondence is invited from anyone with specific questions.

QST

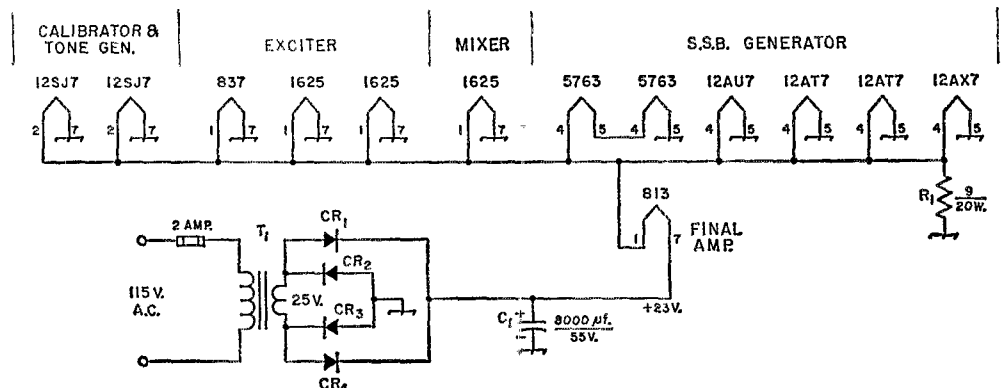

Fig. 2—Circuit showing filament connections and d.c. filament supply.

$C_1$ —Electrolytic capacitor (Sprague 113T or similar).  
 $CR_{1-4}$ —Selenium or silicon rectifiers; 70 p.i.v., 10 amp.

$R_1$ —See Footnote 2.

$T_1$ —Selenium-rectifier transformer: approx. 25 volts, 6 amps. (Knight 62 G 334, or similar).



# Basics for Beginners

## Antennas and Feeders

### Part I — Resonance in Linear Circuits

BY GEORGE GRAMMER,\* WIDF

SOME years ago a widely-used textbook on radio engineering began a chapter on antennas with this statement: "An understanding of the mechanism by which energy is radiated . . . involves conceptions which are unfamiliar to the ordinary engineer." Obviously radiation must be a stiff subject. So we simply ask you to accept the well-known fact that energy *is* radiated in the form of electromagnetic waves. We won't attempt to explain why.

Everyone who has studied for an amateur license has been introduced to wavelength and frequency. The formula is:

$$\text{Wavelength in meters} = \frac{300}{\text{Frequency in Mc.}}$$

In Fig. 1 the transmitter is generating a radio-frequency voltage, indicated by the sine wave in the upper drawing. When the voltage is applied to an antenna, energy is radiated into space and travels away with the speed of light. As shown by the lower drawing, it covers a certain distance — one **wavelength** — in the time the voltage takes to go through one cycle.

#### Current in a Wire

This relationship between wavelength and frequency has a very practical use. Suppose we connect an r.f. ammeter in the center of a wire having a length  $L$ , as in Fig. 2. Further, suppose that by some means we introduce r.f. energy of adjustable frequency into the wire. If the frequency is gradually raised, it will be found that the current indicated by the ammeter will also rise, at first. But after reaching a maximum at some frequency,  $f$ , the current will start to go down again if we continue to raise the frequency. This

\* Technical Director, ARRL.

is the sort of thing we found to happen in an  $LC$  circuit, as discussed in an earlier article.<sup>1</sup> The wire, in fact, acts like a resonant circuit. It is tuned to the frequency,  $f$ , for which its length is equal to one-half wavelength. If the wire is 40 meters long, for example, 40 meters would be one-half wavelength, and the full wavelength would be 80 meters. From the formula above, this would correspond to a resonant frequency of 300/80, or 3.75 Mc.

A wire such as this is called a **dipole**, when its length is of the order of a half wavelength, or less. One exactly a half-wavelength long is called a **half-wave dipole**. Very often, the simple term "dipole" is used when a half-wave dipole actually is meant.

#### Two Practical Points

Before going farther, it is well to translate this into a more familiar unit of length, the foot. Converting units and changing to a *half* wavelength gives us

$$\frac{1}{2} \text{ wavelength in feet} = \frac{492}{\text{Frequency in Mc.}}$$

or

$$\text{Resonant frequency in Mc.} = \frac{492}{\text{Length in feet}}$$

The second point is this: these formulas are not quite accurate for an actual wire. They apply only to a wave traveling in space. In a practical half-wave antenna the difference amounts to about 5 per cent, on the average. Thus an *average* formula for resonant length would be

$$\frac{1}{2} \text{ wavelength in feet} = \frac{468}{\text{Frequency in Mc.}}$$

<sup>1</sup> "A.C. in Radio Circuits," Part II, *QST*, April, 1963.

The earlier group of articles in this "Basics" series concerned itself with a class of circuits using concentrated values of inductance, capacitance and resistance, generally called "lumped constants." The present article opens a discussion of circuits having "distributed constants" — "linear" circuits. A linear circuit is simply a wire, or group of conductors, running in a more-or-less straight line.



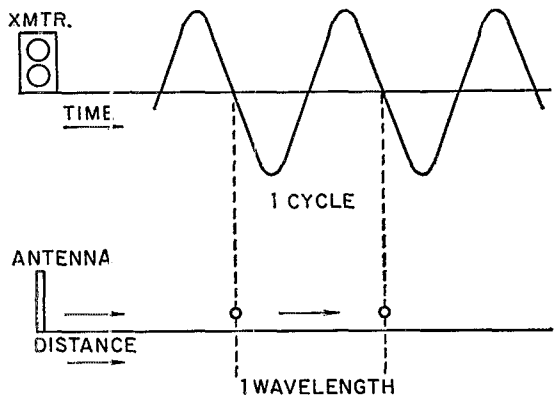

Fig. 1—One wavelength is the distance that radiated energy will cover, traveling at the speed of light, during one cycle of the radiated frequency.

Remember that this is only an average. In a particular case the actual resonant length might differ by a few per cent from the length given by this formula. The difference is usually small enough to have little practical effect.

### Electrical Length

Electrically, the length given by the last formula is a half wavelength because it is a *resonant* length, even though it is physically short of being a half wavelength in space. We can account for the difference in length by the fact that energy does not travel quite as fast along a wire as it does in **free space**.

In some cases, as you will see later when we get to transmission lines, there can be quite a marked difference between electrical wavelength and free-space wavelength. When you see the length of an antenna or line expressed in terms of wavelength you can safely assume that an electrical measure is being used, unless it is made plain that free-space measure is meant.

### Enter Time

In the preceding series of articles<sup>2</sup> we dealt with circuits that offered a complete path around which electrical energy could move. A wire such

<sup>2</sup> "A.C. in Radio Circuits," Parts I-V, incl., *QST*, March-July, 1963.

as is shown in Fig. 2 doesn't offer any such path. How is it that current can flow in it?

In the "closed" circuits considered earlier it was assumed, without our having said it in so many words, that electrical energy traveled around the circuit so rapidly that its action could be taken to be instantaneous. In the circuits we use in transmitters and receivers for frequencies up to 30 Mc., at least, this is a satisfactory assumption. As long as the circuit is small compared with the wavelength (the wavelength corresponding to the frequency we happen to be using) the action is instantaneous, for all practical purposes.

But an antenna such as the wire in Fig. 2 is *not* small compared with the wavelength. If the length  $L$  is one-half wavelength, a length of time equal to one-half cycle of the applied frequency is needed for energy to go from one end of the wire to the other. Imagine a voltage applied to the left-hand end of the wire at an instant when the voltage is at the positive peak of the cycle. A voltage impulse will go along the wire to the right, reaching the end one-half cycle later. But at this instant the *applied voltage* has moved on to its *negative* peak.

### Standing Waves

In other words, when the left-hand end of the wire is negative the right-hand end is positive,

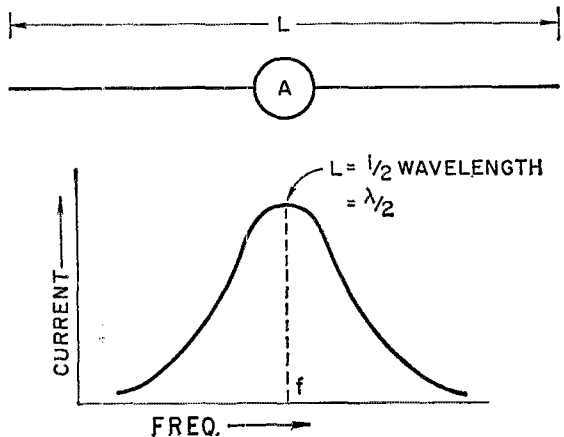

Fig. 2—The r.f. current at the center of a wire is highest when the wire length is equal to one-half wavelength.

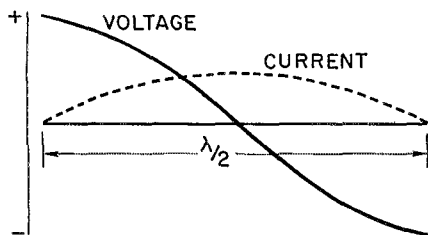

Fig. 3—The current and voltage along a half-wave wire have different values at all points along the wire. When plotted as shown above, the graphs are wave-like in shape, and since their positions are fixed with respect to the wire they are called standing waves.

and vice versa. Also, when the voltage reaches the end of the wire it comes to the end of the track. There is no place for it to go except back over the same path. The energy is **reflected** from the end. In going back, it combines with energy — from a later part of the cycle — that is going out.

Fig. 3 shows what happens in a wire one-half wavelength long. All the components of voltage, those traveling out and those reflected back, add up to make a **standing wave** of voltage. If we could go along the wire with a meter for measuring r.f. voltage we should find that the voltage is highest at the ends of the wire and is practically zero at the center. Between the ends and the center it gradually decreases. When plotted against length, as in Fig. 3, it is like part of a sine wave.

### Polarity

The plus and minus signs on the scale at the left can be somewhat misleading. One end of the antenna isn't always positive, and the other end isn't always negative. In fact, both ends alternate between positive and negative each r.f. cycle. What the picture tries to show is that *when* the left-hand half of the wire is positive the right-hand half is negative. The reverse is also true. The voltages in the two halves of the antenna always have opposite polarity.

On the other hand, if we went along the wire with a meter for measuring the r.f. current, we should find that the current is zero at the ends. This you might expect, since current can't flow off the wire into space. The current gets larger as we move toward the center, and is largest

right in the middle of the wire. In the drawing, the current is shown entirely on the plus side of the scale. Again this shouldn't be taken literally; it actually goes from positive to negative and back again each cycle. The picture means that the current is always flowing in the *same* direction, at any given instant, throughout the entire length of a half-wave wire.

### Loops and Nodes

The point where the amplitude of a standing wave passes through zero is called a **node**. Thus in Fig. 3 the standing wave of voltage has a node at the center of the antenna. The standing wave of current has two nodes in this figure, one at each end of the wire.

A point of maximum amplitude is called an **antinode** or, sometimes, a **loop**. (Properly, the term loop refers to the entire segment of the standing wave between two nodes.) The standing wave of voltage has antinodes at the ends of the wire in Fig. 3, while the current antinode is at the center.

Note that where there is a current antinode there is a voltage node, and where there is a current node there is a voltage antinode. Also, an antinode of current is one-quarter wavelength away from a current node; similarly with the voltage. These two statements are true, in general, of all standing waves along wires.

### Longer Wires

Tuned circuits using coils and capacitors are resonant at just one frequency, that for which the inductive and capacitive reactances are equal. An antenna isn't quite so simple. If the things shown in Fig. 3 happen when a wire is a half wavelength long because of the *time* it takes energy to surge back and forth, it seems reasonable to expect that another half wavelength of wire added to the first will see a repetition of these same events. And so it is. There will be a repetition each time a half wavelength is added.

Fig. 4 shows the **current** and **voltage distribution** when the wire is two half-waves (or one wavelength) long and three half-waves ( $1\frac{1}{2}$  wavelengths) long. At the ends of each half-wave section the voltage is high and the current is zero. In the middle of each such section the current is high and the voltage is zero. But there

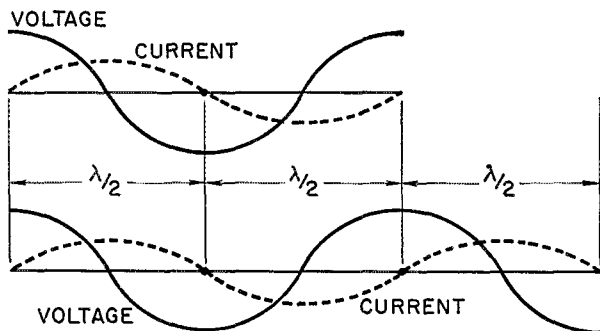

Fig. 4—Harmonic resonance. The upper drawing shows the standing waves on a wire one wavelength long; the lower shows them on a wire  $1\frac{1}{2}$  wavelengths long.

is a difference between two adjacent half-wave sections. You can see that if the voltage at the left end of the first section is positive, as shown, the voltage at the left end of the second section is negative. It has to be the same as the voltage at the right-hand end of the first section, of course, since the two sections are connected together. Also, if the current in the first section is positive, as shown, the current in the next section will be negative. That is, the currents in adjacent half-wave sections flow in opposite directions. This is called a **phase reversal**.

### Phase

In the third section, shown in the bottom drawing of Fig. 4, there is again a phase reversal. This brings the phase relationships in this section back to exactly what they are in the first section. In other words, *alternate* half-wave sections have identical standing waves of current and voltage on them. They are said to be **in phase**. *Adjacent* sections are **out of phase**. This goes on no matter how many half-wave sections are added to the wire.

### Harmonic Resonance

Each of these sections is just as much resonant to the applied frequency as another. In effect, we have two resonant antennas end-to-end in the upper drawing of Fig. 4, and three in the lower drawing. These are called **harmonic resonances**, since they occur at the same frequencies as the harmonics of a fundamental frequency. That is, they are integral (whole-number) multiples of the fundamental.

In the case of an antenna, the fundamental frequency is the one for which the entire wire length is equal to one-half wavelength. For example, an antenna that is a half wavelength long at 7150 kc. will be two half-waves long at 14,300 kc. (second harmonic), three half-waves long at 21,450 kc. (third harmonic), and so on up the

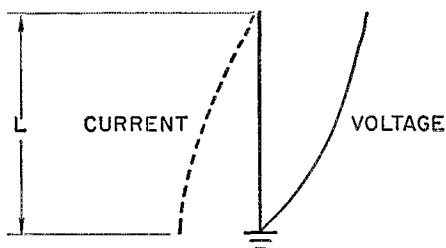

Fig. 5—Grounding one end of the antenna chops off one-half of the standing wave—that is, the length  $L$  need be only a quarter wavelength for the antenna to be resonant.

scale. The actual multiples are approximate, not exact, integers. The resonant frequencies will differ slightly from exact harmonics. The reasons are the same as given earlier, in the discussion of the length of a practical antenna.

### Grounded Antennas

A half wavelength is the shortest length of wire that will be resonant to a given frequency, if the wire is simply considered by itself. However, if we connect one end of the wire to earth the grounded end is no longer free. We can't raise the potential of the earth itself, so the voltage at the grounded end has to be zero. On the other hand, we *can* make current flow into the earth. Thus the earth can be made to act as a substitute for one half of the half-wave antenna.

Fig. 5 shows this. The current is large at the earth connection, and decreases to zero at the open end of the antenna. The voltage is zero at the bottom and has its greatest value at the top. But the length  $L$  for this antenna is only a *quarter* wavelength, at resonance. So a grounded antenna need be only half as long as a dipole antenna to be resonant at the same frequency. QST

(Part II of this series will appear in an early issue. — EDITOR.)

## Strays MOW

Outstanding achievement in any aspect of amateur radio will be recognized yearly by the St. Louis Amateur Radio Club, with an Amateur-of-the-Year Award. Nominations are solicited from all amateurs of the St. Louis area, and these should be sent to Lane Jackson, K0KJX, 645 Marshall Ave., Webster Groves, Mo., before Nov. 1. The award will be presented at a meeting to be held in the Moseley Auditorium Nov. 15, with ARRL Midwest Division Director Denniston as principal speaker.

— \* \* \* —

W9IOP's famous "Second OP" has been entirely revised. The dial-a-prefix DX-operating accessory now includes the new African republics and most of the recent prefix changes; a total of more than 300 countries, each cross-referenced with its great circle bearings, time differential, postage rates, continent, and zone. QSL bureaus of the world are listed on one side and operating instructions on the other. The W9IOP Second Op is available from Electro-Voice, Inc., Buchanan, Michigan, for a dollar.

The QSO Club of Pasadena (Calif.) City College has announced their bi-annual (school radio clubs only) Field Day. The next session will be October 25-26, *local standard* time; and all school and college clubs are invited to participate. Write the QSO Club, c/o Ken Johnson, W6VEB, Department of Engineering and Technology, Pasadena City College, Pasadena 4, California.

### OUR COVER

Our cover this month shows a transmitter and its schematic — products of W9YRV and WA9DNF. An exciting new balanced-modulator circuit is featured in this compact six-meter beauty. Read all about it in "The Single Sideband Sixer," beginning on page eleven.

# Building Fund Progress

Which ARRL division will be first to go over the top on its Building Fund quota? Three — Dakota, New England and Hudson — are within striking distance! Considering that matching funds double the amount contributed by individuals and clubs, one substantial gift or several modest ones could put either division past the 100% mark. Yet the distance to go is sufficient that a concerted effort in any one of several other divisions could scoop the prize for it. This is fair warning that the race is getting hot and close. How about it?

— . . . —

Will *your* name and call be inscribed in the Building Fund record of participants? It should be — and we can provide no better reasons than those in various comments from contributing

members, examples of which follow. A helpful reminder: contributions are U.S. tax-deductible. Each individual or club donor receives a handsome certificate of participation in the Building Fund drive. Get yours now, YL and OM!

The division standings as of the end of August are as follows:

Dakota	92.9%	Central	52.7%
New England	89.3	Canadian	51.9
Hudson	80.2	Atlantic	50.6
Northwestern	73.9	Rocky Mt.	46.8
Southwestern	70.5	West Gulf	42.4
Midwest	65.2	Delta	41.9
Roanoke	58.1	Great Lakes	41.0
Pacific	57.3	Southeastern	36.8

## Members Are Saying

In a research paper I made on the ARRL, I found the amateurs indebted to the League for their hobby. As one of these amateurs, I am sending this contribution for the Building Fund and hope others will do the same. Sorry it cannot be more. — *W6VMP*.

This contribution is in recognition of ARRL services I have received, including bulletins and the code proficiency program which is helping me get my General. — *W2HOK*.

Earlier in the drive we sent in a contribution with the promise of more if the building wasn't paid for by the time you moved in, so here it is. . . . — *W7PJJ, W7SEU*.

Enclosed is a small contribution to the Fund. Ham radio will not exist without ARRL. — *W3AUM*.

Enclosed is a check. Good luck in your new location! — *Tusco Radio Club, Inc., Ohio*.

The enclosed is in addition to what I have already given, since I am now able to send a little more. The new headquarters building will help the radio amateurs of the world advance into the unforeseeable future of electronics. — *W6RJC*.

Yesterday I bought an extra copy of August *QST*, and looking at the cover reminded me that my intended contribution to the new headquarters had not been sent, so here it is. — *G3MNJ*.

I am very happy to make this contribution. We should all be proud of the accomplishments the ARRL has made representing us. — *K9SBQ*.

In its small way, I hope this contribution will help to express my appreciation of the League's service to amateur radio over the years. — *W6LVK*.

I believe I have been a continuous member of ARRL for over forty years and read *QST* since its inception. I consider it a privilege to help an organization that has done so much for hams through the years. Without the ARRL I hate to think what might have happened to hams. — *VE3PZ*.

If I were a wage earner my contribution would be more. I am 13 years old and very much interested in the promotion of interest in amateur radio. — *W4FNM*.

Thanks, fellows, for sticking with us through the years. I believe that there are untold numbers of members, like myself, who are seldom heard from, but who form a huge group of rather silent supporters who are not unaware of what goes on in "handom" and are thankful we have and can participate in an organization such as ARRL to keep us on an even keel. Ah yes, the existence of ham radio in the world today, I feel, owes much to ARRL. — *W7JIZ*.

Although I am fairly new to the ham world, the ARRL has helped me out in many ways. I would therefore like to show my appreciation to the League with this contribution. I wish it could be more, but my college tuition seems to be getting higher every year. — *W4SDUK*.

Please accept this modest contribution. My sincere congratulations for your many years of excellent service to the amateur fraternity and the numerous contributions to the field of communications. — *W3TGF*.

Enclosed is my second donation. I need a new receiver, but the building fund needs it more. — *W3WFF*.

I like the looks of what I saw on the front of August *QST*. Keep up the good work. — *W6PZC*.

# • *Beginner and Novice*

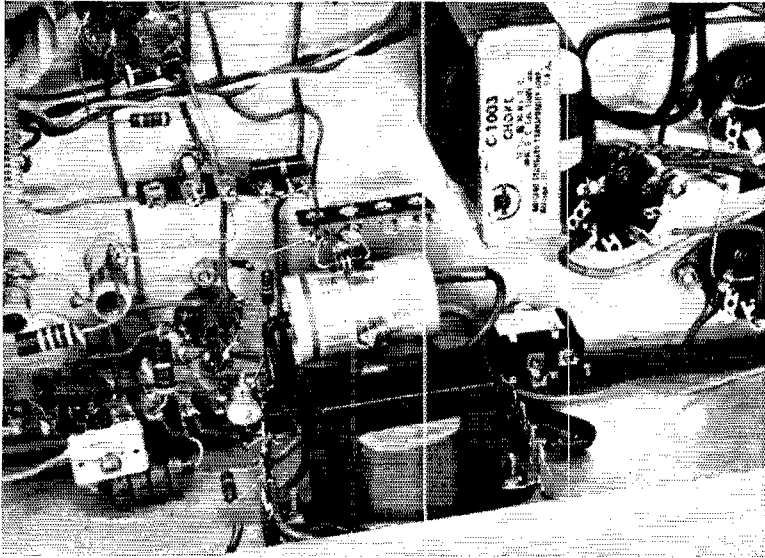

The bias-supply transformer and other components are mounted on the side of the chassis just to the rear of the crystal-oscillator stage.

## Updating the "Novice Gallon"

### *Some Modifications and Operating Hints*

BY LEWIS G. MCCOY,\* W1ICP

JUDGING by the mail received during the past year, the "Novice Gallon"<sup>1</sup> was built by a large number of amateurs, many of whom wrote asking for help with certain problems. We've kept track of the more common troubles, and this article was prepared in the hope that it will help others who had difficulties.

The "Novice Gallon," as originally described in *QST*, was operated on the air and, after thorough testing, appeared to be stable in every way. Many builders likewise had no problems in this respect. However, probably because of different wiring layouts or differences in the components used, some constructors ran into self-oscillation in the buffer stage on some bands, particularly on 80 and 40 meters. Also, difficulty in neutralizing the amplifier was a common problem.

The original unit was given a going-over with the object of getting better stability and providing other improvements in line with the questions asked. This article covers the installation of a fixed-bias supply, reworking the input circuit

of the buffer for better stability, details for adding a v.f.o., and changing the transmit-standby switching to disable the +B voltages while receiving.

#### *Adding a Fixed-Bias Supply*

A high-gain tube such as the 6GJ5 is sometimes difficult to "tame." Some builders have had difficulty in neutralizing the amplifier or getting it to stay in neutralization over several bands. In checking the rig we found that the cathode lead to the key jack appeared to be "hot" with r.f. One way to get the cathodes "cold" for r.f. is to ground the cathode pins directly to chassis at the tube socket. With cathode keying, bypass capacitors are necessary between the cathodes and ground, and even when these are right at the base of the tube the cathode keying lead can still be hot. However, direct grounding of the cathodes requires fixed bias on the amplifier grids. With the 6GJ5s a bias of -40 to -45 volts is required to reduce the plate current to zero. A supply that would furnish this voltage was made up and installed as shown in the bottom-view photograph, and the cathodes of the 6GJ5s were

\* Technical Assistant, *QST*.

<sup>1</sup> McCoy, "A 'Novice Gallon' or General 150-Wattter," *QST*, June and July, 1962.

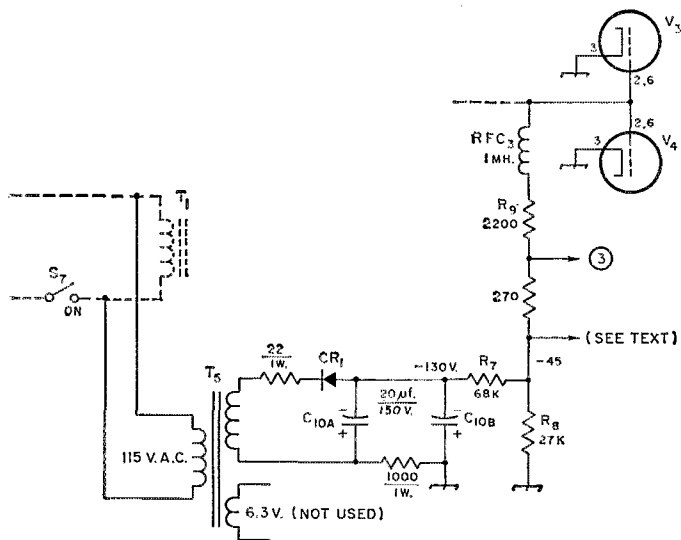

Fig. 1—Bias-supply circuit. Resistances are in ohms and, unless indicated otherwise, resistors are 1/2 watt.

- CR1—Miniature selenium or silicon rectifier, 400 volts p.i.v. 130 volts r.m.s. or more.
- C10—Dual 20- $\mu$ f. 150-volt electrolytic.
- R7—68,000 ohms, 1/2 watt.
- R8—27,000 ohms, 1/2 watt.
- R9—2200 ohms, 1/2 watt.
- T5—Power transformer, 125 volts, 15 ma. (Knight 61G410).

grounded directly at the tube sockets. The keying lead was removed.

With the 6GJ5 cathodes grounded, the two 10-ohm resistors in series with the grid leads could be removed without causing any instability. This in turn meant an increase in grid drive on 10 meters, low drive on this band being a point about which some builders had complained.

The bias-supply circuit is given in Fig. 1. The transformer is a half-wave type and gives an output of about -130 volts through the rectifier and filter. A voltage divider,  $R_7R_8$ , drops the voltage to -45 volts for the grids of the amplifier tubes. The original 22,000-ohm grid leak was removed and a 2200-ohm resistor was substituted. In the original circuit the bottom of the 270-ohm meter-shunt resistor was grounded, and when the meter was switched (by  $S_5$ ) to read amplifier

grid current, one side of the meter also was grounded. The ground lead should be removed from the switch terminal and the terminal connected to the bottom of the 270-ohm resistor. Don't overlook this change or you may burn out the meter.

The primary winding of  $T_5$  should be connected across the primary of  $T_1$ . When wiring the bias supply, make sure that  $CR_1$  and  $C_{10}$  are connected as shown in Fig. 1. It is easy for a beginner to make a mistake because he is inclined to think in terms of connecting the negative side of electrolytic capacitors to chassis ground.

#### Stabilizing the Buffer Stage

The changes necessary for stabilizing the buffer stage are shown in Fig. 2. Although the stage could be neutralized on bands where the input and output frequencies are the same, this is cumbersome in a buffer stage. An alternative method is to reduce the gain, and thus reduce the tendency toward self-oscillation, by loading the tuned circuits with resistance. This method is simple, but is practical only when the output without loading is more than is needed for driving the following stage. The 5763 buffer in the "Gallon" has much more output than is required on those bands where it works straight through, so resistance loading was used to stabilize it.

As indicated in Fig. 2,  $L_3$  in the original circuit was shorted out. In addition, a 47,000-ohm 1-watt resistor was connected across  $L_1$  and  $L_2$  to load these circuits. All other connections remain the same. These changes resulted in a completely stable buffer stage.

To adjust  $L_2$ , tune up on 14 Mc. and turn the slug for maximum grid drive to the 6GJ5s. For 28 Mc., adjust the slug in  $L_1$  for maximum grid drive to the final.

#### Neutralization

Some builders found that the adjustment of

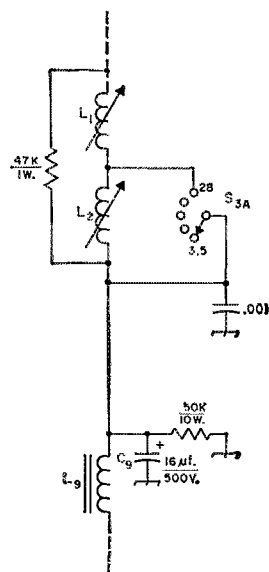

Fig. 2—Revised buffer grid circuit.

$C_3$ , the neutralizing capacitor made from the piece of aluminum, was critical. A better arrangement suggested by a few builders is to use a half turn of No. 14 wire around each tube. The new capacitor for  $C_3$  is made from an 11-inch length of No. 14 solid wire. Remove the old  $C_3$  and then mount the center of the wire under the screw on the one-inch standoff insulator, forming a small loop in the wire to hold it in place. Dress the two halves of the wire over to the tubes and wrap a half turn around each tube near the bottoms of the tube plates. Follow the neutralizing procedure described in the original article. We found that the tubes neutralized with the wires positioned just slightly below the tube plates.

### Turning Off the Plate Voltages on Standby

Some builders have asked for suggestions on turning off the plate voltages in the standby position. One method for doing this is shown in Fig. 3. This uses a relay to open the plate-to-ground connections on the 6DE4 rectifiers and also the center tap of  $T_1$ . Opening the plate connections on the 6DE4s turns off the high voltage, and opening the center tap shuts off the low-voltage supply. The 115-volt a.c. leads for  $K_1$ , the relay used for the switching, are connected through the standby switch,  $S_2$ , as shown.

### Adding a V.F.O.

With fixed bias on the final amplifier and cathode bias on the buffer, the only stage that depends on grid-leak bias is the crystal oscillator. This stage is keyed by opening and closing the cathode circuit. Thus, if a v.f.o. is added, both the crystal-oscillator stage and the v.f.o. must be keyed. It appeared to be much simpler to use cathode bias for the crystal-oscillator tube so it need not be keyed along with the v.f.o. Fig. 4 shows this simple change.  $S_1$  is the existing crystal-v.f.o. switch. In the v.f.o. position the cathode of  $V_1$  is grounded for r.f. by a 0.01- $\mu$ f. capacitor, Fig. 4, so that when  $S_1$  is thrown to the v.f.o. position the tube is cathode biased. Don't forget to open the keying line with a dummy plug at  $J_2$ . Unless this is done, the cathode bias resistor will be shorted out, since a closed-circuit jack is used in the keying circuit.

In our tests we used the latest *Handbook v.f.o.*,<sup>2</sup> which has a built-in differential keying

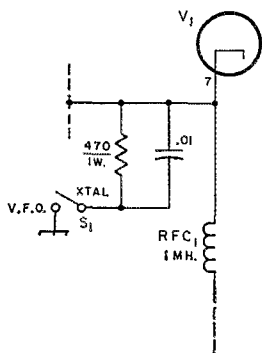

Fig. 4—Adding cathode bias to the crystal oscillator.

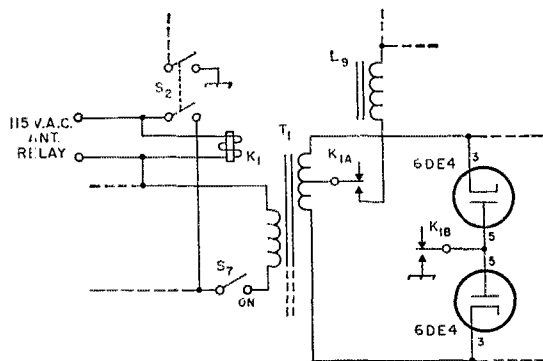

Fig. 3—Circuit modifications for switching  $-B$  voltages.  $K_1$ —D.p.d.t. relay, 115 volts a.c. (Potter & Brumfield KA11AY).

system and provides approximately 20 volts output on either 3.5 or 7 Mc. In the 80-meter position of the v.f.o. there was adequate output for operating the transmitter on 80, 40 and 20 meters. The 40-meter position gave sufficient drive on 40, 20, 15 and 10 meters. Any similar v.f.o. could be used.

With the differential keying system the complete setup provided an excellent c.w. signal with no discernible clicks or chirps. It shouldn't prove difficult to incorporate this system in practically any v.f.o.

### Final-Amplifier Loading

A few builders have had difficulty getting the amplifier to load, particularly on 80 meters. As pointed out in the original article, the transmitter is designed to work into loads of approximately 50 to 70 ohms impedance. If the load departs widely from these values, it may prove difficult to load the amplifier properly. Many amateurs these days use random-length end-fed antennas with the end of the antenna connected directly to the output terminal of the transmitter. In many such cases the amplifier will "see" a load that the tank circuit cannot match. The answer here is to use a transmatch. When connected between the transmitter and antenna, the transmatch can be adjusted so that the transmitter sees a 50- to 70-ohm load.<sup>3</sup>

Another common mistake made by beginners is to use 50- or 70-ohm coaxial cable between the transmitter and the end of a random-wire antenna. The user believes that because he has 50- or 70-ohm coax connected to the transmitter the actual load is 50 or 70 ohms. For coaxial cable to "look like" 50 or 70 ohms at the transmitter end, the load at the antenna end should be the same as the characteristic impedance of the feed line. The ARRL's new book, *Understanding Amateur Radio*, treats this subject in easy-to-understand terms.

<sup>2</sup> *The Radio Amateur's Handbook*, 40th edition, page 212. Note: At the output of the  $-300$ -volt bias supply change the 10,000-ohm resistor and the 0.5- $\mu$ f. 400-volt capacitor to 47,000 ohms, 2 watts and 0.1  $\mu$ f., 400 volts, respectively.

<sup>3</sup> Construction details of a suitable transmatch are given in *Understanding Amateur Radio*, published by ARRL.

## • For Public Service

# Announcing 1963 ARRL Simulated Emergency Test

October 5-6, 1963

The 1963 SET will make its first concerted use of a new concept in amateur radio public service, the Amateur Radio Public Service Corps. Under this concept, greater use will be made of the facilities of the ARRL National Traffic System, and perhaps less use of the National Calling and Emergency Frequencies for routine traffic. The SET becomes more and more an amateur radio communications exercise, with less operational, on-the-air assistance from official agency amateur stations. Supplying communications for the various to-be-served agencies is our job.

Therefore, traffic men operating in units of the ARRL National Traffic System and independent nets are as much concerned with this exercise as are AREC members. NTS net managers at all levels have been given their instructions on how to proceed, and these instructions will be coming down to you at whatever echelon of the system you frequent. There won't be much time. We are on an extremely tight schedule, and there are a number of new methods and procedures to absorb, so we urge all to dig in and make this the best SET yet.

Red Cross plans have not yet been solidified at the date of this writing; we hope to have something definite to include in the bulletin which will reach ARPSC officials before this copy is printed. We expect that most Red Cross traffic will be directed to its area offices at Arlington, Va., Atlanta, Ga., St. Louis, Mo., and San Francisco, Calif. It is not likely that there will be amateur stations in all those cities set up for the specific purpose of handling this traffic (with the probable exception of Arlington, where W4PAY should be active), so, as in the case of most long-haul traffic, the regular traffic nets and particularly NTS will bear the brunt of the load. With this in mind, we have asked NTS managers to conduct extra net sessions during the weekend to handle this traffic with greater dispatch than would normally be the case. We expect that some Red Cross and regional e.d. stations will be available on the National Calling and Emergency Frequencies for direct contact with some RC areas and e.d. regional headquarters, and in a real emergency these frequencies may be used to set up "hot-line" circuits between key cities; but most traffic will flow through regular, but stepped-up, NTS circuits.

Please read the details, in this month's "Traffic Topix," of the new traffic procedures to be used, in the SET, where applicable.

We divide our instructions into four parts: (1) general, applicable to all participants; (2) to the

### NATIONAL CALLING AND EMERGENCY FREQUENCIES (KC.)

3550	3875	7100	7250
14,050	14,225	21,050	21,400
28,100	29,640	50,550	145,350

casual amateur who is not currently a member of AREC, NTS, or other traffic-handling net or group; (3) to the traffic man who participates in regular amateur traffic-handling nets, and (4) to the AREC member.

(1) *General:* All amateurs are requested to give us a break in making this SET an effective amateur radio public service demonstration. If you find yourself tangling with an emergency or traffic net, please QSY and let them get on with their business. If you want to help, this is one way to do so.

(2) *To the casual amateur who wants to take part:* Find out who your EC is and contact him. He will probably welcome your services in the SET, and maybe sign you up in the AREC. If you are more interested in the long-haul aspect, your RM or PAM is the man to contact. For information on who these people are, contact your SCM (see page 6) or your SEC (see page 95). Once you are put to work, don't foul up the procedure by being independent.

(3) *To NTS members and traffic amateurs:* You will be in for some extra work during the week end. Keep in touch with your net manager during the week prior so you will be familiar with the plans and the net operating schedule for the week end. Tell the wife and kids you won't be available that week end and volunteer for whatever extra duty is required.

(4) *To the AREC member:* Set some time aside to get in on the most important AREC activity of the year, second only to an actual emergency. Jog your EC on plans, offer to help, take part in whatever planning is being undertaken, even if it's a little inconvenient. Emergencies don't always lend time for this, and your local SET may be no exception, but it's up to you to find out what your EC wants you to do, then to do it to the best of your ability.

We expect that there will be more network operation during this SET. One of the cardinal rules of network operation is to follow the instructions of the NCS, whoever he might be. Help him by volunteering assistance when or if he asks for it; at other times, remain off the air, even if you think the NCS needs help. This is not for you to decide, unless you are NCS.

Remember, the dates are Oct. 5-6. If these are inconvenient for a local group, they will schedule the SET at some other date, but at such times your exercise will not have the advantages of special nationwide circuits. See you in the SET!  
— W INJM.



# QMT

BY JOHN G. TROSTER,\* W6ISQ

THE Communications And Transmitting Society Net is now in session. All them with traffic break in and tell me whatcha got and where it goes. W6ISQ net control standing by."

"ISQ . . . wheece, gargle gargle . . . YH . . . LQ . . . C . . . ahhhh . . . ZZZZZZ . . . Yecooooowwww . . . J . . . & . . . X . . . Q"

"OK, you guys, one at a time. W6ISQ by."

"Yecoooouuuupp . . . woowwwwwwaa . . . GH . . . Huussss . . . 6 . . . DH . . . Wheece."

"OK OK, hold it. I can see you guys is pretty unorganized out there in old radio land tonight. Suppose I'll have to call ya one by one. Where's that roll? Nuts . . . was here a while ago . . . mangy mutt. Oh well, guess I remember most of the regulars. So for the regulars now, come in when I call ya. W6A — (not here) . . . W6C — (not here) . . . W6H — (not here) . . . W6P — (not here) . . . K6 — WA6 —"

"Hmmm . . . no regulars on check-in tonight! Well, then, are there any late or other check-ins? W6ISQ by"

"ISQ . . . pooooowwww. ZZZ . . . OL . . . Blaahhh . . . Yecooooowwww . . . youppp."

"OK, I got a couple of 'em. K6CQM, what ya got over there tonight?"

"QTC 3 LA"

"Rajah. Down 10 and give 'em to the guy."

"W6WX, guess you were next. Whatja got?"

"QTC 4 KL7."

"Rajah. Up 29. Give 'em to the guy."

"29 up is out of the band."

"OK then, down 29. Lessee, who's next?"

"ISQ de WX. Ya, but who I give 'em to?"

"Come on, come on, don't block my master control frequency. If he ain't up — errr, down 29, go down 39. You'll find somebody. W6FYM was next. Yours, OM?"

"QTC 1 Arizona."

"No Arizona check-ins yet . . . standby . . ."

"QTC 5 PAN . . . down 5, give it . . ."

"Up 6 . . . down 14 . . . up 19 . . . down 3 . . . keep my master control frequency clear, men . . ."

"Nobody down 29. Where shall I go?"

"You're wide open, mate. But try down 33."

"Nobody up 17."

"A W7 net is up 14. My stuff for Florida."

"Nobody down 3 . . ."

"QTC 17 KH6 . . . give it to the guy down

21 . . ."

"Nobody down 21."

"Up 21."

"Guy in Oregon took my San Diego traffic. Said he wanted the points for delivery."

"OK, take it back and give it to the guy up 14. Everybody doubles their points."

"He's in KH6."

"Take your choice. Double your points or down 14."



"Still QRX for Arizona."

"No Arizona check-ins. Try next week . . . say Thursday."

"Nobody down 3 . . . nobody up 17 . . . QTC 32 NYC . . ."

"Clear my master control frequency. Now down 32 . . . give it to the fella up 9 . . . nobody? . . . he's in Colorado . . . my traffic for KH6 . . . down 25 . . . up . . . clear my master control channel . . ."

"OK OK OK, QST QST QST . . . you guys have got this net so fouled up tonight ya can't even unload a few messages. Ya gotta keep my master control frequency clear of all spurious and extra-terrestrial communications at all times."

"I'm gonna teach you guys a lesson. I'm gonna shut this net down for the night. Maybe tomorrow you'll conduct net affairs in a business-like manner and we'll get somewhere."

"The Communications And Traffic Society Net is closed. Everybody QMT. W6ISQ."

"What ya say?"

"I say, the CATS Net is closed for the night. Everybody QMT."

"What's QMT mean — 'Meet Tomorrow'?"

"You must be new around here, fella. QMT is Mail your 'Traffic!'"

QST

\*45 Laurel Avenue, Atherton, Calif.

# There is Still Life in That Old Receiver

## Product-Detector Adapter for S.S.B. Reception

BY WELLS CHAPIN,\* W2DUD

MANY of the older high-quality receivers meet most of the requirements for today's s.s.b. reception. They have adequate selectivity and stability and usually are equipped with a good substantial dial, free from backlash. In these respects, they are often superior to some of the less expensive late-model receivers in current use. It is in the area of detection that most of the old klunkers fall short. Many of them have diode detection along with improper injection from a b.f.o. that is none too stable. A good product detector and a stable higher-output b.f.o. will update that old receiver, and make a fine instrument out of it.

In my case, the "klunker" is an old HRO-50. It has a wonderful mechanical dial that is ideal for s.s.b. tuning, regulated voltage for the h.f. oscillator, and plenty of selectivity. The new detector and b.f.o. were built in the form of an adapter that plugs into the n.b.f.m. adapter socket. It may take other forms, of course, to suit different receivers. Only one additional control is needed—a single-section rotary switch.

The circuit of the adapter is shown in Fig. 1. The 6BE6 product detector takes its i.f. signal directly from the plate pin of the original diode detector. A 12AT7 is used as a dual Pierce b.f.o. to provide for lower- and upper-sideband recep-

\* 118 Woodmancy Lane, Fayetteville, New York.

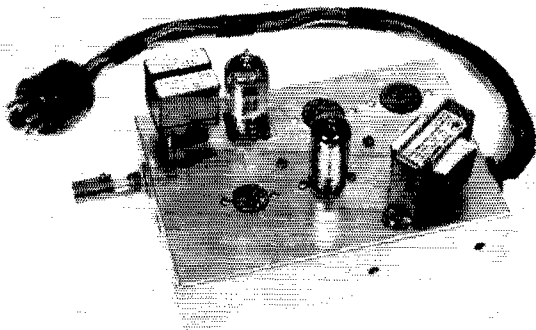

In this view of the product-detector adapter, the upper and lower side-band crystals and the b.f.o. tube are in the upper left-hand corner. The 6BE6 product detector is near the center of the chassis. Other components are for the future addition of an audio-derived a.g.c. system, as mentioned in the text.

tion. The selection is made by  $S_{1A}$  which grounds the cathode of the appropriate triode section.

The original diode-detector return circuit (through its load resistor) is broken, and a switch ( $S_{1B}$  inserted) that permits feeding the audio from the product detector to the audio amplifier for s.s.b. reception, or restoring the original connection to the diode detector for a.m. reception. In the HRO-50,  $S_{1B}$  is not needed. With the original

(Continued on page 160)

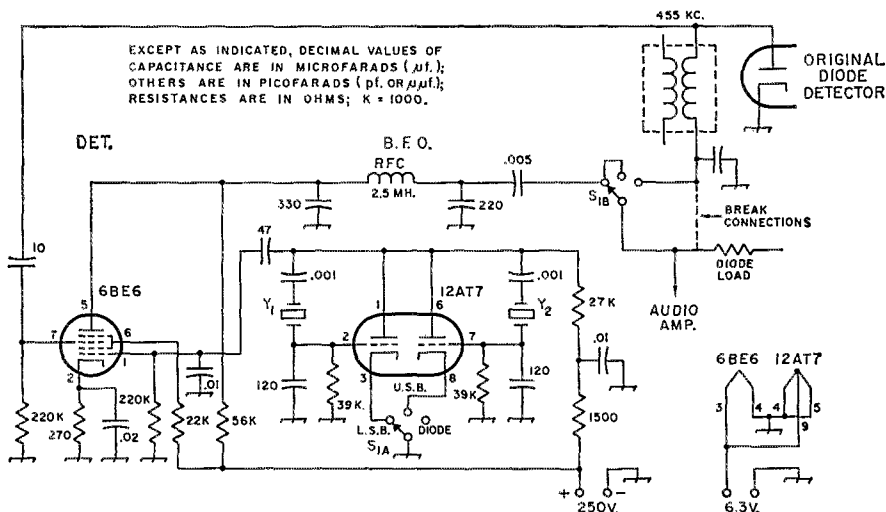
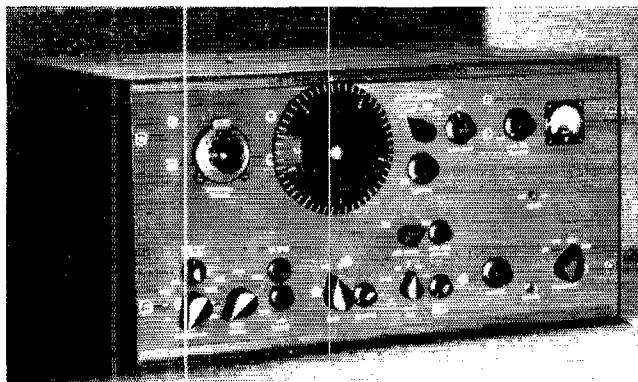

Fig. 1—Circuit of the product-detector adapter. Capacitors of decimal value are disk ceramic; others are mica or NPO ceramic. Resistors are  $\frac{1}{2}$  watt.

$S_1$ —Ceramic rotary switch: single section, 2 poles, 3 positions (Centralab 2002, 3 positions not used).

$Y_1$ —457.407-kc. crystal (surplus, Channel 47).  
 $Y_2$ —452.777-kc. crystal (surplus, Channel 326).

Panel view of the TDCS receiver. To the left of the National NPW-0 dial, which is the main tuning control, is a small vernier dial controlling the v.f.o. trimmer  $C_3$ . To the right, are the crystal-calibrator switch and squelch control, the b.f.o. tuning control, b.f.o. injection control, and the S meter. Along the bottom of the panel, from left to right, are controls for the 80-meter mixer trimmer and antenna attenuator, the band switch, r.f. gain and antenna trimmer, mechanical-filter switch, i.f. gain, audio attenuator and a.g.c. time-constant switch, main bias ( $R_7$ ) and noise-limiter, audio gain, and audio-filter switch.



## The TDCS Communications Receiver

*An All-Transistor Unit Covering the Amateur H.F. Bands*

### Part I

BY T. L. THOMAS\*

**This double-conversion receiver covers the amateur bands from 80 through 10 meters (plus 5 Mc. for WWV) in steps of 500 kc., thus providing plenty of bandspread. Only a single tuning circuit is used, and sectional construction is employed, simplifying both assembly and adjustment. Included in the features are a crystal-controlled front end and first i.f., a mechanical filter in the second i.f., a selective audio filter, squelch control and a crystal calibrator.**

A NUMBER of considerations prompted the construction of this receiver. However, the prime mover was just a desire to build a good transistor communications receiver for the enjoyment and sense of accomplishment. No attempt was made to build the unit in the smallest possible space, flexibility and ease of construction and maintenance being considered more important.

The complete receiver is divided into several subassemblies, each one of which is capable of being operated independently. This goes a long way to sustain interest in an admittedly lengthy project, as well as to provide obvious constructional advantages. These subassemblies are as follows:<sup>1</sup>

- 1) R.f., mixer, crystal oscillator, first i.f.

\* 17 Candlewood Dr., Pittsford, N.Y.

<sup>1</sup> To adapt the circuit diagrams to *QST*'s page size, the circuit grouping differs somewhat from the physical grouping used by the author. Any desired physical arrangement that observes the usual precautions as to lead length and circuit isolation in respect to frequency may be used, of course. — Editor.

- 2) V.f.o.
- 3) Second i.f., a.g.c., noise limiter, squelch.
- 4) B.f.o.
- 5) Power supply, audio section.
- 6) Crystal calibrator.

#### *R.F. and First Frequency Converter*

The diagram of this portion of the circuit is shown in Fig. 1. A fixed-tuned r.f. amplifier and a crystal-controlled oscillator feed the first mixer to produce an output in the 5-Mc. range. A 5-Mc. filter at the antenna input is required to prevent feedthrough of very strong signals in the 5-Mc. range. Attenuation is greater than 70 db. and no signals in the 5-Mc. range have been heard while using the receiver in the amateur bands.

The attenuator controlled by  $S_1$  was inserted to avoid anticipated overloading of the r.f. stage by strong signals. However, no difficulty in this respect has been observed thus far with the attenuator cut out.

$C_3$  is the customary antenna trimmer. Occasional retrimming of the mixer input was found necessary in covering the 80-meter band.  $C_4$  is provided for this purpose in the 80-meter position (only) of the band switch. It is not needed on the narrower higher-frequency bands. The resistor loading of the r.f. amplifier input and output circuits is for broad-banding and stabilizing purposes.

A base mixing circuit was used in the first mixer because conversion gain is much less dependent on oscillator injection voltage than is the base-emitter type of mixer circuit. The terminal marked "Test" will be found useful in aligning the r.f. and first i.f. sections.

When receiving WWV, or other signals in the 5-Mc. range, a separate antenna is connected to the terminal provided which bypasses the 5-Mc.

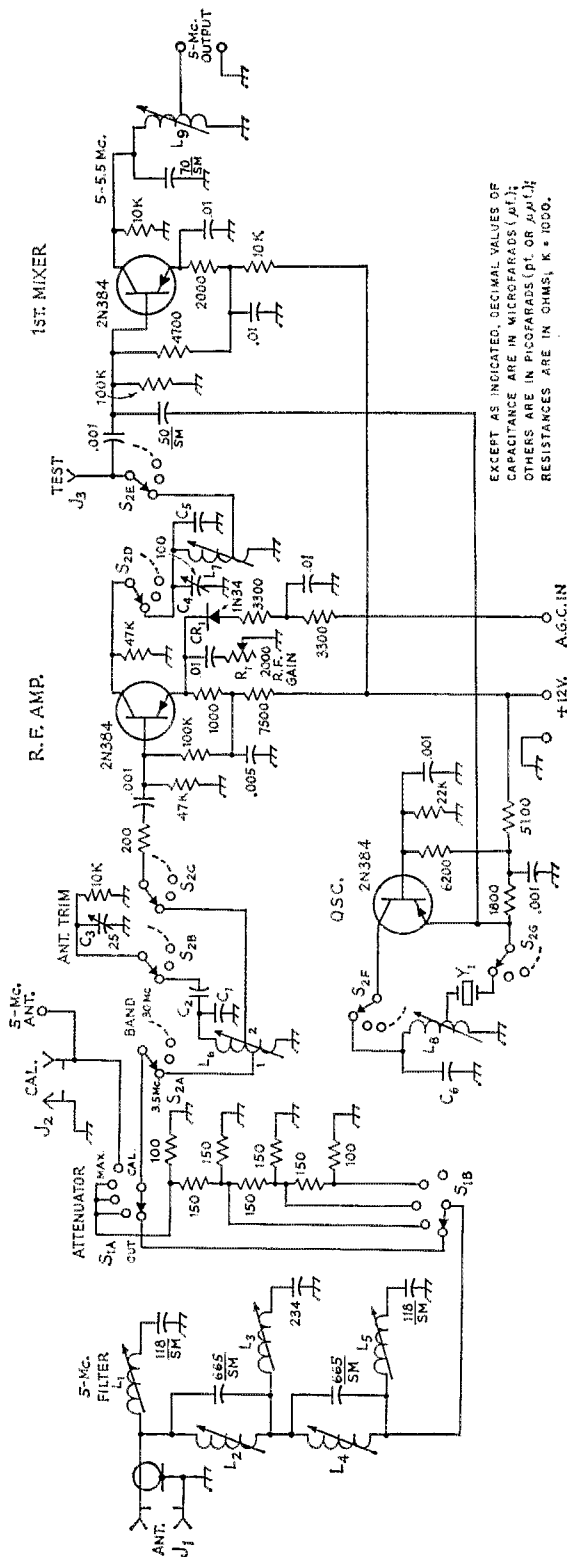
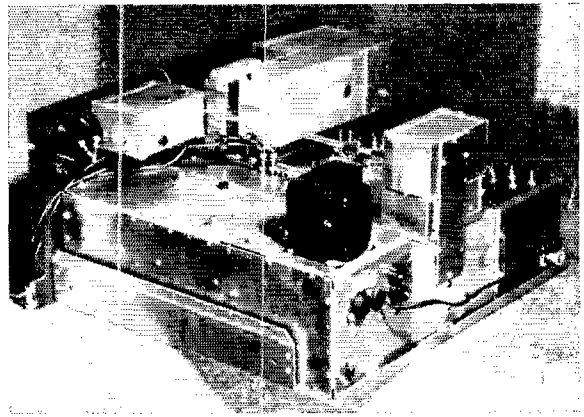

Fig. 1—R.f. amplifier and first frequency-conversion circuits. Resistors are 1/2 watt. Fixed capacitors of decimal value are disk ceramic; others are silver mica or NPO ceramic; nonstandard values are made up of series or parallel combinations. Components not listed below are identified for text-reference purposes.

- C<sub>1</sub>, C<sub>2</sub>, C<sub>3</sub>, C<sub>4</sub>—Silver mica, see table for value.
- C<sub>5</sub>—Air trimmer (Hammarlund APC25-B or MAPC25-B)
- C<sub>6</sub>—Air trimmer, connected to S<sub>2D</sub> at its 80-meter position only (Hammarlund APC100-B or MAPC100-B).
- J<sub>1</sub>—Chassis-mounting coaxial receptacle (SO-239).
- J<sub>2</sub>—Miniature shielded connector.
- J<sub>3</sub>—Pin jack.
- L<sub>1</sub>, L<sub>5</sub>—8.5 μh., slug-tuned; 25 turns No. 30 enam., close-wound on 1/4-inch form (CTC PLS-5 form).
- L<sub>2</sub>, L<sub>4</sub>—1.51 μh., slug-tuned; 15 turns No. 26 enam., close-wound on 1/4-inch form (CTC PLS-6 form).
- L<sub>3</sub>—4.28 μh., slug-tuned; 25 turns No. 30 enam., close-wound on 1/4-inch form (CTC PLS-6 form).
- L<sub>6</sub>, L<sub>7</sub>, L<sub>8</sub>—See table.
- L<sub>9</sub>—9—18 μh., slug-tuned; 51 turns No. 30 enam., close-wound on 1/4-inch form, tapped at 15 turns from ground end (CTC PLS-6 form).
- R<sub>1</sub>—Linear control.
- S<sub>1</sub>—Single-section double-pole five-position rotary switch
- S<sub>2</sub>—Seven-section seven-pole nine-position rotary switch (made in two shaft-coupled units of CRL PA-2000 series components).
- Y<sub>1</sub>—See table.

EXCEPT AS INDICATED, DECIMAL VALUES OF CAPACITANCE ARE IN MICROFARADS (μF.); OTHERS ARE IN PICOFARADS (pF. OR p.p.f.); RESISTANCES ARE IN OHMS, K = 1000.

Rear view of the completed receiver. The v.f.o. is in the enclosure at upper center, behind the dial-drive mechanism. The b.f.o. is in the smaller box to the left. The crystal calibrator is at the rear, to the right of the power transformer. This photo shows how the inverted  $14 \times 17 \times 3$ -inch chassis has been opened up to form a base for the three subassembly chassis.



filter, and the first mixer operates as an additional 5-Mc. amplifier. Since there are no circuit connections to the h.f.-oscillator band switch in the 5-Mc. position, the oscillator does not function.

Gain in the r.f. amplifier may be adjusted manually by means of  $R_1$ . A.g.c. to this stage is delayed by  $CR_1$  and the associated network.

### First I.F. and Second Converter

This portion of the circuit is shown in Fig. 2. The second mixer is fed by a 5-Mc. amplifier following the first mixer, and by a v.f.o. and emitter-follower buffer in the 4.5- to 5-Mc. range to produce mixer output at 455 kc. The 5-Mc. amplifier is broad-banded by stagger-tuning the input and output circuits,  $L_9$  (Fig. 1) and  $L_{10}$ ,

and resistance-loading in both circuits. A.g.c. is delayed by  $CR_2$  and the associated network.

The low-pass filter between the 5-Mc. amplifier and the second mixer was found necessary to suppress harmonics from the crystal oscillator which were producing spurious signals on some bands. This filter should be mounted in a Mini-box, with internal shielding between the coils.

The series-tuned Colpitts, or Clapp, circuit is used in the v.f.o. It should be noted that  $C_4$  is the only major tuning element in the entire receiver, all other circuits being broad-banded. It was necessary to provide temperature compensation in the form of a small N750 capacitor to overcome fairly serious variations in frequency with temperature. With compensation, there is a

Tuned-Circuit Data

		Band — Mc.								
		3.5-4	5-5.5	7-7.5	14-14.5	21-21.5	23-28.5	28.5-29	29-29.5	29.5-30
$L_6$	$L, \mu h.$	25-50	20-40	3.5-7	1.3-2.6	0.5-1.0	0.3-0.6			
	Turns	76	53	24	12	7	6			
	Tap 1	6	8	1.5	1	0.75	0.75			
	Tap 2	15	15	4.5	2	0.75	0.75			
	Wire	36	36	26	26	22	22			
$L_7$	$L, \mu h.$	4-8	20-40	3-6	1-2	0.5-1.0	0.3-0.6		0.3-0.6	
	Turns	22	53	21	10	7	6		6	
	Tap	8	20	4	1.75	0.75	0.75		0.75	
	Wire	30	36	26	26	22	22		22	
	$L_8$	$L, \mu h.$	0.7-1.4	None	2-4	0.6-1.2	0.3-0.6	0.25-0.5		0.25-0.5
Turns		8	—	16	8	6	6*		6*	
Tap		1	—	3	1	0.25	0.75		0.75	
Wire		22	—	26	26	22	22		22	
$C_1$		$\mu f.$	33	18	75	51	62	39		
	$\mu f.$	None	30	27	20	18	15		15	
	$\mu f.$	300	22	100	62	62	50		50	
$C_5$	$\mu f.$	300	—	51	68	62	62		62	
	Mc.	9.0	—	12.5	19.5	26.5	33.5	34.0	34.5	35.0

All coils are close-wound with enamel wire on  $\frac{3}{8}$ -inch iron-slug forms, except \* which use  $\frac{1}{4}$ -inch forms. Circuits should tune with slugs set for the approximate center of the inductance range shown. In the case of the 10-meter coils and capacitors, where a single set of figures is given, a single coil or capacitor serves for all four sections of the band, the corresponding band-switch positions being wired together. Where two sets of figures are given, two coils and capacitors are required (with different coil-slug settings); the two lowest-frequency switch positions are wired together as are the two highest-frequency positions. Taps are in respect to grounded end of coil.

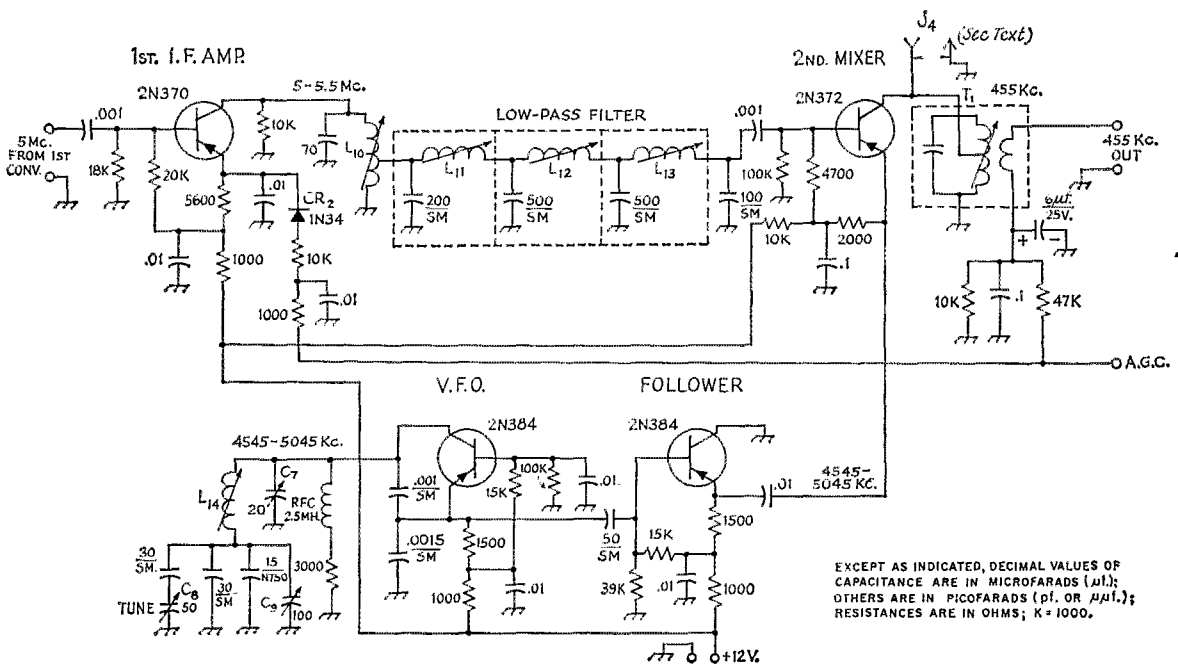

Fig. 2—First i.f. and second frequency-conversion circuits. Resistors are ½ watt. Fixed capacitors of decimal value are disk ceramic or mylar, except SM indicates silver mica; others are mica except SM again indicates silver mica; N indicates negative temperature coefficient, and polarized capacitors are electrolytic. Components not listed below are labelled for text-reference purposes.

- C<sub>7</sub>—Air trimmer (Hammarlund MAC-20).
- C<sub>x</sub>—Air trimmer (Hammarlund APC50-B).
- C<sub>11</sub>—Air trimmer (Hammarlund APC100-B or MAPC100-B).
- J<sub>4</sub>—Subminiature r.f. jack.
- L<sub>10</sub>—Same as L<sub>x</sub>, Fig. 1.

- L<sub>11</sub>, L<sub>12</sub>, L<sub>13</sub>—6 μh., slug-tuned; 28 turns No. 26 enam., close-wound on ¼-inch form (CTC PLS-5 form).
- L<sub>14</sub>—14–28 μh., slug-tuned; 56¼ turns No. 26 enam., close-wound on ½-inch form (Millen 69046 form)
- T<sub>1</sub>—Transformer 455-kc. i.f. transformer (Lafayette MS-268A).

variation in frequency of less than 600 cycles for the first hour of operation, less than 300 cycles for the next four hours, and less than 100 cycles variation in any 15-minute period after an initial 15-minute warm-up.

The output from the oscillator is about 0.5 volt, peak to peak, which is optimum for the mixer circuit which it feeds. The gain in a base-emitter type of mixer is quite sensitive to oscillator injection voltage, and a higher or lower

voltage will reduce the gain. However, this is not a serious matter in a receiver having generous gain in other stages, as this one has.

The resistor in series with the v.f.o. collector choke was necessary to suppress a low-frequency parasitic. J<sub>4</sub> was installed to provide a connection for a panadapter should this materialize. QST

(Part II of this two-part article will appear in an early issue.)

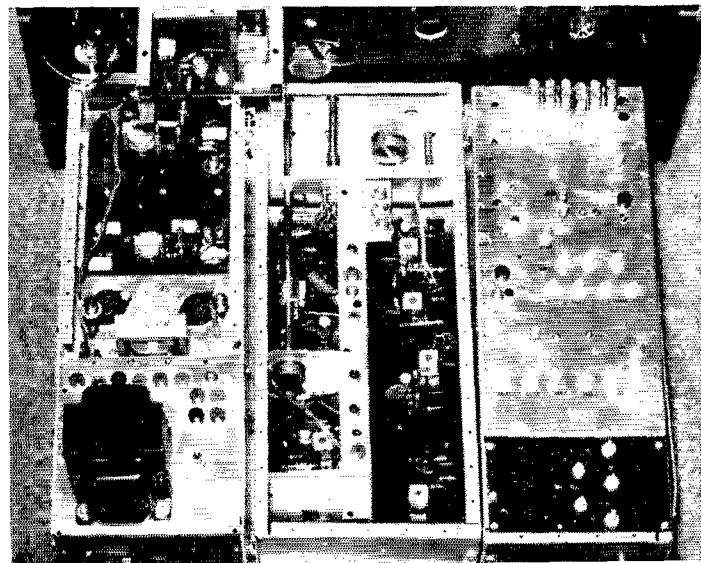

Rear-top view of the TDCS receiver with some of the shielding removed. The audio and power section is to the left. The center chassis is devoted principally to the i.f. circuitry, while the chassis to the right contains the h.f. stages. The v.f.o. compartment has been removed to expose the crystals and slug-tuned coils of the oscillator feeding the first mixer.

# Some Notes on the Care and Feeding of Grounded Verticals

## Shunt-Feed Matching Systems

BY EUGENE E. BALDWIN,\* WØRUG

This material refers in particular to the feeding of grounded metal towers as radiators. The methods, however, apply to any type of grounded vertical.

**I**N general, the input impedance of a random-height vertical is unsuitable for direct coupling to the transmission line or rig, in which case a coupling device is needed between the two impedances. The simplest matching device is the common-reactance transformer. This becomes a bit of a problem with a grounded tower.

### Simple Shunt Feed

An alternate method of feeding the grounded antenna is the shunt-feed method, shown in Fig. 1A. This can be viewed as half a delta-fed dipole, the ground system furnishing the missing or "image" half. Used for years in the commercial broadcasting industry, feeding is accomplished by a wire running at an angle of about 45 degrees from the rig, or the end of the transmission line, to a point about  $\frac{1}{8}$  to  $\frac{1}{4}$  the total tower height. This method is not too suitable for towers of less than about 0.2 wavelength; with shorter towers the feed point appears too far up on the tower. While any type of shunt feed has the merit of allowing the tower to be grounded, its bad features are that the base current is quite high and, when a series capacitor is used to cancel the inductive reactance, the voltage across this capacitor becomes rather high as tower heights approach a half wavelength. An additional disadvantage of the system shown in Fig. 1A is that significant radiation from the feed section is unavoidable.

Perhaps a simple explanation of the theory behind shunt feed will assist in a clearer under-

\* Route 3, Box 153A, Longmont, Colo.

standing of what we are attempting to do. Try to visualize, in Fig. 2A, the flow of current  $I_1$  at a given moment as from the rig, through the coax, up the feed line to the tower, down the tower to ground and via the ground system back to the transmitter. The current loop thus formed induces a current  $I_2$  in the main tower which may be thought of as the secondary of a transformer, thus matching the rig to the radiation resistance of the antenna. Fig. 2B is an approximate equivalent circuit for this type of installation.

Shunt feed is usually employed with towers of about a quarter wave or less in height. In a typical case where A and B are about  $\frac{1}{4}$ , the height of a quarter wave tower the input impedance is about  $70 + j300$  ohms. Since the capacitor can be adjusted to produce the  $-j300$  needed for a flat line, we have a 70-ohm feed point in this example. The changes in impedance with changes in lengths A and B may be roughly summarized as follows: when A is made larger, the resistance and the positive reactance both increase, and when B is made larger, both resistance and positive reactance decrease.

As you may have guessed by now, feeding a grounded tower is, from a ham's point of view, a matter of cut and try. However, despite the lack of elaborate test equipment, the average ham with an understanding of antenna fundamentals can make it work.

### Shunt-Feed Adjustment

With simple shunt feed two methods are available. In the first, get someone to climb the

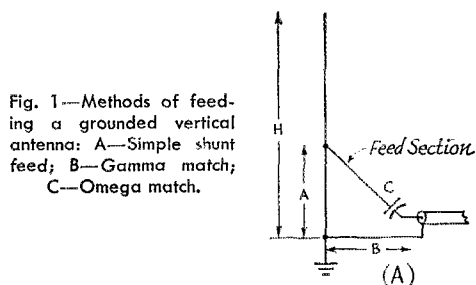

Fig. 1—Methods of feeding a grounded vertical antenna: A—Simple shunt feed; B—Gamma match; C—Omega match.

tower and, with a large battery clip attached to the feed section, locate the best point by experiment. Be sure to shut down the rig before the clip is moved. The man on the tower may stay there though since, with a grounded tower, there is no danger of r.f. burns at amateur power levels.

In the second method, before connecting the feed section to the line, an r.f. ammeter in series with a dummy load equal to the characteristic impedance of the line is connected across the line output terminals. With a known power input to the rig, the meter reading is recorded. Then, without readjusting the transmitter, the feed section is attached to the line with the meter in series. The antenna tap and the series capacitor are adjusted to obtain the same r.f. current. It should not be difficult to come quite close by this method.

### Gamma or Omega Match

Two other matching methods, the gamma match of Fig. 1B and the omega match of Fig. 1C are now worthy of our attention. These two operate in a similar manner, adjustment of  $C_1$  in Fig. 1C being equivalent to changing the length of the gamma section in Fig. 1B. Similar in theory to simple shunt feed, both the gamma and omega, as shown in many handbooks, and the actual hardware, are rather simple. The gamma rod used here on a 65-foot tower operating at approximately 2 Mc. consists of about 18 feet of one-inch tubing, supported at the top, as shown in Fig. 3, by a  $2\frac{1}{2} \times 12$ -inch aluminum plate,  $\frac{1}{4}$ -inch thick. The plate is clamped to both gamma rod and tower by  $\frac{1}{4} \times 2$ -inch bolts and the remains of some TV hardware. Conventional U bolts would serve equally well. The lower end of the gamma rod drops over a cone-shaped feed-through insulator mounted in the top end of a surplus metal box which is clamped to the tower with two U bolts as shown in Fig. 4. No attempt will be made here to describe the exact details but, with the over-all picture in mind, the reader may proceed to "load up" and get on the air.

In my own case, the box includes two tuning capacitors, two progressively-shortening switches and a handful of 400-pf. mica capacitors, all surplus. Admitting that all this is not needed, it is not difficult to mount a few extra parts and, when the urge to make a change strikes again,

the components are in place and ready to use.

For a start on tune-up of the gamma match, make C (Fig. 1B) a total of about 1000 pf. with a large variable capacitor making up as much of the total as possible. With the coax line connected to the antenna, couple a grid-dip meter to the transmitter end of the line with a 2- or 3-turn loop and adjust the gamma capacitance and, if needed, the length of the gamma section, by moving the top clamps until a clean dip is obtained at the lowest frequency to be used. Many dips will appear; however the dip that occurs at the lowest frequency is the correct one. Once this step is completed, a low-power signal from the transmitter may be applied and the remaining adjustments made for maximum r.f. line current and lowest v.s.w.r.

### Ground System

One point not stressed thus far is the physical ground system. Looking at Fig. 2A again, the current  $I_1$  must have a good, low-resistance return path from the tower base to the transmitter as well as to "earth." The grounding system here in northern Colorado, where the ground conductivity index is very poor, consists of a 4-inch strip of flashing copper buried 4 inches deep, and running from the tower base to the rig. This strip is a common item both simple to obtain and to solder to and, in our case, was laid through and under a block wall to a termination behind the baseboard in the ham shack. All equipment within the room is connected to this common ground point and, at the base of the tower, all radials solder directly to this same strip and fan out in several directions. Use as many radials as your pocketbook and aching back will allow. Once the soil has been watered rather heavily, it is a simple matter to use a square spade and open a narrow slit 4 to 6 inches deep. After placing the radial in this slit, allow the earth to resume its normal position. In my case, where the ground system was installed in the lawn, an unexpected side benefit was better grass along the radials because of unpacking the sod! Most handbooks suggest a good ground and the importance of this aspect of an antenna system should not be overlooked.

Remember that the total antenna resistance is composed of two parts—the radiation resistance  $R_R$  and the ground resistance  $R_G$ , and that total power input  $P_{IN}$  is dissipated in

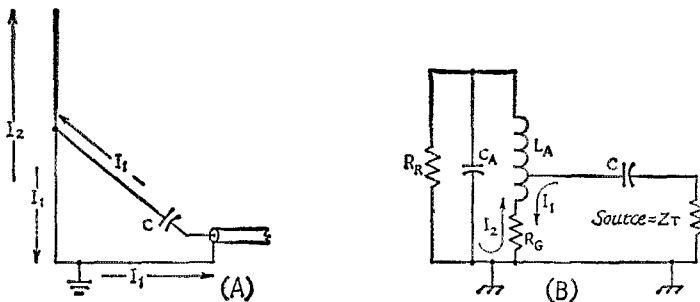

Fig. 2—A Current flow in a shunt-fed system. B—Equivalent lumped-constant circuit.



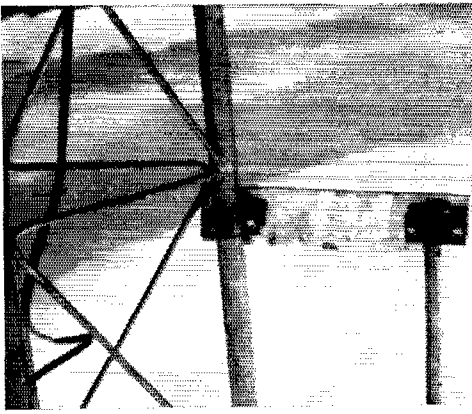



Fig. 3—Method of supporting top end of gamma rod when feeding a grounded tower as a radiator.



Fig. 4—Housing for matching capacitors at bottom end of the gamma rod.

these two resistances.  $P_{IN} = I_2 (R_R - R_G)$ . The power wasted in  $R_G$  is what we are concerned with and, naturally, the less  $I_2 R_G$  loss, the more we have available for use in the radiation resistance  $R_R$ . This reminds us that radiated power  $P_R = I_2 R_R$ . We lost  $I_2 R_G$  and it's gone! In amateur circles, the old timers use the phrase "get it into the antenna." As an example, the  $R_R$  of a typical quarter-wave tower is about 36 ohms and decreases with shorter towers. If we start feeding a shorter tower of perhaps  $R_R = 20$  ohms and  $R_G = 2$  ohms,<sup>1</sup> approximately 10 per cent of our r.f. has been wasted even without considering other losses at all.

For any skeptics, I've been on about 1995 kc. for many years and will be happy to work you there. Since information seems scarce on this subject I have included a list of references so you may find more detail than I can give in a short article. 

<sup>1</sup> An abnormally low value for a practical case. — Editor.

#### Bibliography

##### Books:

- Henney, *Radio Engineering Handbook*, Chapter 20, McGraw-Hill.  
 Kraus, *Antennas*, p. 261, McGraw-Hill.  
 Landee, Davis and Albrecht, *Electronic Designers' Handbook*, Chapters 21.1 and 21.2, McGraw-Hill.  
 Terman, *Radio Engineering Handbook*, pp. 792-795; 845-848, McGraw-Hill.  
 Terman, *Radio and Electronic Engineering*, pp. 886-888, McGraw-Hill.  
 Walker, N.A.B., *Engineering Handbook*, Section 2, McGraw-Hill.  
 Williams, *Antenna Theory and Design*, Vol. 2, Pitman & Sons, Ltd.  
**Periodicals:**  
 Bauer, "Simplified Shunt Feed," *Communications*, Sept., 1939.  
 Hubbell, "Feeding Grounded Towers as Radiators," *QST*, June, 1960.  
 Kasper, "Added Gain Using Vertical Antennas," *CQ*, Dec., 1960.  
 Morrison and Smith, "The Shunt-Excited Antenna," *Proc. I.R.E.*, June, 1937.  
 Nose, "Notes on Parasitic Beams," *QST*, March, 1960.  
 Nose, "Gamma-Matched 160-Meter Vertical," *CQ*, May, 1961.

## Strays



The JARL is offering several new certificates for hams and s.w.l.s. Write the Overseas Committee, the Japanese Amateur Radio League, P.O. Box 377, Tokyo, Japan, for details.

— . . . —

Maybe the new ZIP code will help. W6GTE received a post card from W6HC dated June 10, 1962, setting up a sked for June 13. It was delivered late in July 1963, marked "found in supposedly empty equipment." Needless to say, Director Harry and Vice-Director Virg could not keep their sked.

Shown at the left are VS1LP/EP2BK and QST's K1IJV, at Jean's Springfield, Mass., home. VS1LP writes "Congratulations to QST on the appointment of Jean Peacor, K1IJV, as your new YL Editor!" and goes on to say that his 80-meter QSO with Jean from EP2BK in Iran was his greatest thrill in more than twenty years of hamming. This photograph was taken while Bob was on his way home from Iran to Singapore last year.

# Two Plus Two Equals Four

BY A. PROSE WALKER,\* WØDCA, W4CXA

*In any language . . .*  
Deux et deux font quatre  
Dos y dos son cuatro  
Дважды два равняется четырем

ANYONE who dares to postulate on the future of amateur radio, or what should be done to preserve our status and frequencies, is usually considered slightly deranged. Amateurs generally are not concerned about what *might* happen at some future date under circumstances that are vague and possibly not even remotely under their control. But we all would feel a serious personal loss if some of our frequencies, both h.f. and v.h.f., were removed from our use. This loss would be not only emotional, but would represent a financial impact depending upon the investment we have in our stations.

The purpose for choosing this subject is not to alarm or berate anyone or any organization, but to emphasize the necessity for action and outline a reasonable program for amateur organizations throughout the world to follow . . . *the goal being the preservation of our frequency bands.* If some explanation is given on how frequency allocations are administered, and the operation of international conferences, perhaps you will not be too bored. Both h.f. and v.h.f. bands are included in this discussion, although undoubtedly the backbone of amateur radio is our 80-, 40- and 20-meter bands. You may have other opinions based on your own personal experiences and interests in ham radio.

No one wishes to be an alarmist, but there are many reasons why there is a measure of urgency



related to this subject. The creation of the correct impression about amateur radio and its record of performance is not accomplished overnight. The establishment of liaison with many of the new countries is a long, drawn-out process. Im-

The author can speak on international conference matters with even more authority than his potent signal from WØDCA. An amateur since 1924, and a former professor of physics and mathematics, he was with FCC from 1940 to 1953; director of engineering of the National Association of Broadcasters from 1953 to 1961; and currently is assistant to the vice president, Cedar Rapids Division of Collins Radio. He has participated, as a member of the U. S. delegation, in ten conferences of the International Telecommunications Union during the last 15 years, concerning allocations, h.f. broadcasting, and technical standards. He is national and international chairman of CCIR Study Group X; a member of the U. S. CCIR Executive Committee; a member of FCC's National Defense Executive Reserve; and former vice-chairman of the National Industry Advisory Committee.

provement in band utilization cannot be accomplished in a short time. It may be desirable to further cement relations with people in governments of the world in order to secure their support and backing at the crucial moment in the future when the "chips are down." You can form your own opinion in another few minutes.

### Frequency Allocation Procedures

As everyone probably knows, the United States does not decide the allocation of the spectrum. We participate with other countries in choosing which frequencies are to be used by what services. The international body devoted to this work is the International Telecommunications Union (ITU). The ITU functions under the aegis of the United Nations. It was formed nearly 100 years ago, under a different name, by countries who recognized the need for international agreements concerning communications, which, at that time, were conducted on wire lines and cables. As radio came into being as a link between nations of the world, the need for such an organization was even more imperative to prevent the chaos that would develop without coordinated use of the spectrum.

The technical advisors to the ITU are the

\*3211 Park View Court, S.E., Cedar Rapids, Iowa.

international consultative committees, one for radio, and one for telephone and telegraph. The one for radio is the International Radio Consultative Committee (CCIR), which you have undoubtedly heard about. With their advice on technical matters, the ITU administers the use of the radio spectrum. Prior to 1959, the useful spectrum was internationally allocated from 10 ke. to 10,000 Mc. At the Administrative Conference in Geneva in that year, the allocation was extended to 40,000 Mc.

Many of the same people take part in both the CCIR work and the subsequent administrative conferences, where the allocation of the spectrum is done. The CCIR does not deal in frequencies, only in the technical aspects of their planned use. Their conclusions are not mandatory, but are, in the strongest sense, recommendations, which are considered by the ITU for possible inclusion into the allocation table and the Radio Regulations. The CCIR is important in its international role in providing a forum for the exchange of new thinking, thus permitting a common outlook to be developed much sooner than would otherwise be possible. Two typical examples relate to marine communications; first the technical characteristics of ship-to-shore and inter-ship v.h.f. communications, and second, the essential characteristics of s.s.b. in the m.f. and h.f. portions of the spectrum, thus paving the way for a gradual move to sideband by the maritime service. These two items may prove of considerable importance to amateur radio, although it is doubtful if anyone had such a benefit in mind when the discussions were taking place.

At an ITU administrative conference, the work is divided among committees, one being responsible for the allocation of the spectrum. As you might imagine, groups and sub-groups are formed to deal with specific portions of the spectrum under consideration for the various services. The conclusions of these groups are submitted to the parent committee for further discussion and approval, and thence to the Plenary Assembly of the conference for more discussion, if necessary, and approval or rejection.

#### **Each Country Has One Vote**

About 100 countries participate, *each with one vote*, regardless of how big or small they are, regardless of population, regardless of the number of communication circuits they operate, how many broadcasting stations they have, or how many amateurs are in their respective countries. There is, of course, a difference in the influence that can be exerted by one country versus another, but when the votes are taken, they all have a single vote each. Arithmetic being what it is, *two plus two still equals four in all the working languages of the ITU* (English, French, Spanish, and Russian), and 50 votes against and 49 votes for a proposal, constitute a defeat. It is clear therefore, that *votes* at an administrative conference are most important to the resolution of whatever proposals are made.

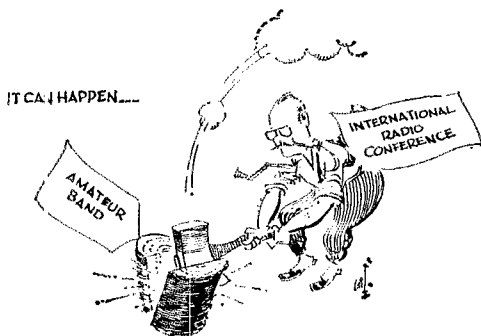

The day is forever gone when the United States of America, or any other country, can pound the table and threaten to raise the power limit on amateurs, if we don't get our way. This was done once about 30 years ago and it temporarily postponed the encroachment of broadcasting in our 7-Mc. amateur band. You know what the situation is today, both in conformity with international agreement and in contravention thereof. Like it or not, the status of amateur radio could be changed by those votes. Like it or not, our frequency bands could be altered or eliminated by those votes. We must get a sufficient number of favorable votes.

Perhaps of equal importance to votes is the content of the proposals submitted to ITU by member administrations (countries). Before the convening of such a conference, each country puts down the changes it wishes in the entire spectrum allocations, including the Radio Regulations applicable thereto. This is done in our country in a series of preparatory meetings guided by the FCC and the Department of State and participated in by interested parties. Undoubtedly, the same procedure is followed in most other countries. If these individual proposals are favorable to amateur radio, the biggest part of the battle is won. If they are unfavorable, the first task at the conference is to change them, if possible (which is difficult), and if not, defeat them. You can see that if the various countries all submitted the right kind of proposals relative to our bands, we would have no difficulty; and in reverse, we could be "out of business."

While our country might take a reservation on certain portions of the allocation, the importance of an international agreement to the other users of the spectrum probably would result in our becoming a signatory to the Convention. In any case, you well know what a state of chaotic con-

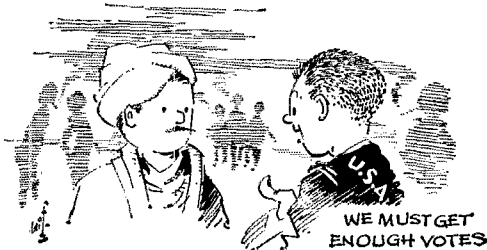

fusion and impossible communication would result, even if Uncle Sam decided to go his own way. Think what 20 meters would be like with 100-kw. RTTY transmitters with 15-db. antennas! Some of these transmissions are bad enough as it is, with only occasional occupancy throughout the bands. Think of additional broadcast stations in our bands with 250-kw. transmitters, 18-db. antennas, and the potential

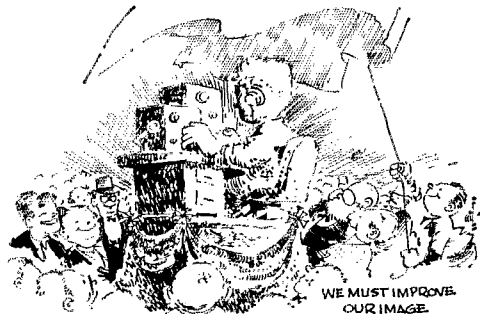

spurious types of emission heard today wherever high-frequency broadcasting operates. No, we couldn't exist long, regardless of the position of our own country or even several others, if the majority of the world went against us.

#### **An Appraisal — and a Program**

Well, what are our chances? . . . Good, poor, medium or just what? Unfortunately, that is not an easy question to answer. You can appreciate the factors involved by the general background just outlined. An ITU conference is a meeting of people having different ethnic backgrounds, cultural development, languages, interests and methods of doing things. It is a perplexing area where norms of procedure vary, words convey different ideas, and often quandaries are compounded into confusion. There is real danger for amateur radio. Everyone can hope that certain developments will enable us to return to the days of 1-Mc. (or more) exclusive bands (remember?), but don't hold your breath. There will be another administrative conference probably from 2 to 5 years in the future. The earliest date might be 1965, the 100th anniversary of the founding of the parent organization of the ITU. But surely by 1967 or 1968 it will occur. Regardless of the date, there is not too much time available for amateurs to do what must be done.

What should be done? There are four main avenues of approach to maximize the chances of preserving our status. This is not to say that if we do not follow this course, all is lost, but certainly our chance of survival is immeasurably enhanced if we do.

**Point 1:** Without getting into the controversial aspects of details, the first thing is to *clean up our utilization of the bands in this country.* (Other countries should follow suit.) Why? U.S. hams have the highest power allowed anywhere in the world. Undoubtedly we also have the greatest percentage of high-gain directional an-

tennas connected to our kilowatts. There are more U.S. hams than in all the rest of the world put together. For these reasons, we are heard more frequently in foreign countries than any other nationality of amateur. The electronic equipment and components available to us, as well as technical information, suggest strongly that we should set an example of high technical quality in our emissions.

This could be of great significance in forming impressions of amateur radio in many of the new countries of the world as well as many other countries not well disposed toward us. The spectrum proposals of these nations before the next conference could easily be influenced by the attitudes of people who have listened in on our ham bands. If they are pleased with what they hear, the impression is good. The opposite is equally true. Whether your favorite operating mode is phone (a.m. or s.s.b.), c.w., RTTY, etc., or your chief interest is experimenting in your basement, rag-chewing, traffic handling, DXing, emergency communication or whatever — certainly you will agree that there is much to be desired in both the technical characteristics of our signals and also in operating techniques, including the choice of the band for the particular purpose. The ARRL program set forth in June *QST* has as its objective raising the technical competence level of amateurs.

On c.w. the conglomeration of just plain "lousy" signals on the bands is not in keeping with the state of the art in 1963. The key clicks, yoops and chirps on the bands today are a disgrace. One wonders just how many hams recognize good keying. If they knew good from poor, why would there be so many poorly-keyed signals on the air? But that is only part of the trouble. Lots of fellows just don't care. Not all of the culprits are newcomers to our bands, although a great many have been on the air for only a relatively short time. Perhaps we might pardon their enthusiasm to make contacts rather than to have the cleanest signal on the air, but we must help them to clean up their signals. There is no excuse for the more experienced amateur having this type of signal, and certainly no justification exists for the "go to hell" attitude often encountered. Not all the poor signals are c.w., as you well know if you operate on a.m. or sideband. Instability, carrier shift, hum, sideband splatter, distortion products and other undesirable characteristics are usually in evidence. We are using a valuable portion of the spectrum. How we use it could be crucial in our retaining the privilege. We have no God-given *right* to our bands.

In addition to the signals themselves, our operating techniques often are not the most gentlemanly, nor very efficient in terms of results. You still hear an occasional long CQ, or a long call from the other fellow even if he is on your frequency or only a few kc. away. The DX gang often will "climb all over" the station they want to contact, with the result that no one can identify who is being worked when he does come

back. This may be improving, if the most recent experience with Gus over in the far reaches of Asia is any criterion. This happened only through cooperation of hams all over the world.

These are details which describe a condition all of us would like to see improved. The ARRL Board of Directors has indicated its concern in this matter and has made certain recommendations directed toward this first point of the program. Serious reflection will surely bring most amateurs to agree with the things ARRL has suggested. It is important to understand the basis for the proposals, and discuss them in a rational manner with the long-range purpose in mind — the preservation of our frequencies. If anyone is against that, he shouldn't have an amateur license.

**Point II:** *Point II of the program is directed toward making sure that amateur representatives are well informed and thoroughly appraised of the important aspects of all services, so that they may be "armed" with necessary information to intelligently and vigorously take part in the preparatory conferences which establish the position of each country before the ITU. The timing of this course of action is important. It should not be started too soon or some of the information developed would become obsolete before it could be useful. Neither can it be postponed too long or there will be insufficient time to complete the groundwork. A significant part of this aspect of the problem is in maintaining personal as well as official relations with appropriate persons in both Government and industry; making certain that the proper perspective of Amateur Radio is held by those in a position to influence the position of the country in both domestic and international aspects of allocations.*

Some of the information that could be developed relates to frequency utilization, trends in communication practices, possible future requirements of all services in the h.f. spectrum, the potential for transferring existing h.f. traffic to v.h.f., u.h.f., cables or satellite communication, and undoubtedly a host of other aspects which would come to light as these studies progressed. There was previous mention of the work of the CCIR in relation to increased use by the Maritime Service of v.h.f. rather than h.f. This same trend also now seems to be apparent for the Fixed and Aeronautical Services. The Fixed Service (long distance point-to-point) places a high premium on circuit reliability. The h.f. bands are not as reliable as they require. Perhaps a significant portion of the operations of these services could be improved by operation on other than h.f., thereby relinquishing those frequencies to others who must use them.

Just because we are amateurs is no reason why we should not engage in studies related to frequency allocations. Every other service continually engages in studies of this nature, not only to better utilize the spectrum available, but to prepare for participation in allocation proceedings. *Frequencies constitute the life-blood of every service.* Somehow, there should be pro-

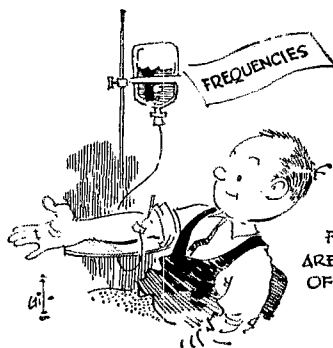

**FREQUENCIES ARE THE LIFE BLOOD OF THE AMATEUR SERVICE.**

vision made in the structure of amateur organizations (ARRL, IARU, etc.) for such studies. Effort would not have to be continual, but could be initiated at such time as desirable. This information would constitute the necessary background for those who represent us at the preparatory conferences. They must be knowledgeable on a wide base, thoroughly grounded in communications techniques and practices, have available as much pertinent information as possible prior to the time when it must be used, and be personally acquainted and on an easy conversational basis with appropriate people. This point of the program is extremely important and would require full time of one or more persons to do it satisfactorily during the period involved. As the next administrative conference approaches, there should be greatly increased effort by the ARRL, IARU and affiliated amateur societies throughout the world in an aggressive, coordinated program. The ARRL has the capable people on its staff, provided they can spend the necessary time on this urgent matter and get the job done.

**Point III:** *Points III and IV are extensions of Point II into the international area. At the 1959 Administrative Conference, one country previously friendly to amateur radio submitted a proposal to withdraw frequencies from their amateurs. She either would not or could not change her position. Well-founded information revealed that had there been satisfactory relations between amateurs and government in that country during the preparatory phase, the proposal probably never would have been made. By the time they got to the conference, the government position was firm and it was too late*

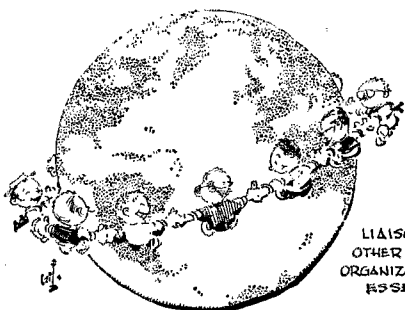

**LIAISON WITH OTHER AMATEUR ORGANIZATIONS IS ESSENTIAL.**

to change it. Amateurs in that country lost those frequencies. Another proposal would have reduced our 80-meter band by 50% in the American region. Fortunately, that proposal was withdrawn. Point III therefore, is to *initiate liaison with other countries of the world* so that these unfortunate situations do not develop, and so that amateurs in as many countries as possible can present a united front both to their Governments, and through them, before the ITU. Such action throughout the world would have a tremendous impact on improving our status and chances of survival in the h.f. spectrum. This cannot be done in a short time. It cannot be done by correspondence. It must be done in person by appropriate individuals, who could be convincing as to the wisdom of this course of action. ARRL has already done some of this, but not world-wide and perhaps not entirely concentrated on this issue. More will undoubtedly be done in the days ahead. No one should underestimate the difficulties involved, but it can be done with the will to do it. It would cost money, but the funds are available. *If the result is the preservation of our allocations, it's worth whatever it costs!*

**Point IV: Point IV concerns proper representation at the ITU Administrative Conference.** There is where the fine points of negotiation and bargaining take place. Although the allocation table is based on sound engineering, many things are settled in other ways than by calculation of interference, efficiency of channel utilization, bandwidth of emissions, frequency stability, etc. Make no mistake about it, effective representa-

30 NEW COUNTRIES  
WANT TO TELL THE WORLD  
ABOUT THEMSELVES

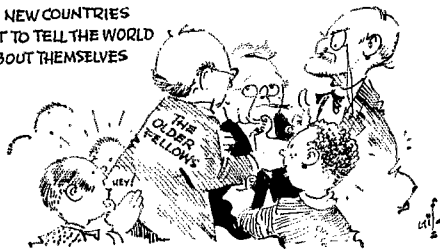

tion at an international conference is not a hobby. It requires experience to develop expertise in this field. It is important to have established previously the same kind of personal relations internationally, as discussed in Point II on the domestic level. The effort at the conference must be coordinated with the individual country's delegation . . . you can't "take off" on your own, but must work to further the official position of your government. This further emphasizes why it is so important that the proposals of the country satisfactorily reflect the amateur cause. This is the only hope for the future of amateur radio as we know it today.

Where are the greatest danger spots in the future? Undoubtedly high-frequency broadcasting is the most critical, particularly at this period of the sunspot cycle, but dangerous regardless of sunspot activity. Since the 1947 Atlantic City Conference, numerous attempts have been made to formulate an acceptable h.f. broadcast assign-

ment plan, without success. Many of the reasons for failure are purely political and should have no bearing on the plan. Unfortunately, common sense and reason do not prevail in this field. What seems reasonable to one country, does not meet with approval by another. Broadcasting requirements are highly inflated. In the meantime, approximately 30 new countries have come into existence, each with its own sovereignty and desire to tell the world about its way of life and culture. This only increases the difficulty of reaching acceptable agreement on the utilization of the existing broadcasting bands.

The big users of the broadcasting bands are the U. S. S. R., United Kingdom, France, United States of America and India, with several others not far behind. With such pressure on the effectively narrowed bands (more stations), the degree of acceptability of assignments is much less than satisfactory. The International Frequency Registration Board (IFRB) in Geneva examines the broadcasting schedule submitted by most countries on a quarterly basis (certain countries refuse to submit their schedules) and assigns frequencies and hours to enable the most satisfactory broadcasting possible. This procedure was adopted on a trial basis as a result of a proposal of the United States at the 1959 Conference. Probably this was the major reason why the broadcasting bands were not widened at that time.

Broadcasting has become an instrument of foreign policy. Regardless of your opinion of its effectiveness or utility, the number of such transmitters is steadily increasing. At the next conference, there is every likelihood that users of those bands will attempt to secure more space for broadcasting. If so, the problem of where to obtain the frequencies will be of paramount importance to Amateurs all over the world.

### Summary

- 1) We must upgrade the Amateur Service to keep pace with the state of the art and through this acquired status gain increased prestige and respect from people and governments who exert vast influence on communications.
- 2) We must prepare for conference participation on both the national and international levels.
- 3) We must establish liaison throughout the world to the end that we all work *together* in presenting a united front to our respective governments, and through them, to the ITU.

We *must* not bicker and fight among ourselves in this country or any other. Without detracting from all the fine contributions of the many amateur organizations throughout the world, what has been done before will not be enough in the period ahead of us. No one country nor organization can "carry the ball." Amateurs throughout the world must recognize this situation and unite in a program to save our frequency bands.

*Now is the time!*

**QST**

# A Simple Automatic CQ Sender

## Making Use of a Tape Recorder

BY FRED H. CALVERT,\* W9JCV

**T**his little device, when used in conjunction with any tape recorder, will relieve you of the monotony of calling CQ in code, and free your hands and mind for other matters, such as bringing the log up to date or lighting the pipe.

The circuit of the keyer, which is driven by the audio output from the tape recorder, is shown in Fig. 1B. Audio voltage from the low-impedance output of the recorder is stepped up in  $T_2$  (a filament transformer connected in reverse) and fed to a bridge rectifier with capacitor filter. The d.c. output operates the keying relay  $K_1$ . For keying speeds up to 20 w.p.m., a capacitance of 1  $\mu$ f. should be used at  $C_1$ . For higher speeds, this capacitance should be reduced to 0.5  $\mu$ f.

I built this unit into a 3  $\times$  4  $\times$  5-inch aluminum Minibox.

Fig. 1A shows  $S_1$  and  $J_1$  installed in the output circuit of the recorder to transfer the audio signal from the recorder speaker to the keyer. This modification may not be needed if the recorder has a jack for an external speaker that cuts out the internal speaker when the external speaker is plugged in.

### Making the Tape

The tape is made by picking up the signal from the keyed oscillator, or low-level stages, of the transmitter on a receiver, and feeding the audio output from the receiver speaker into the recorder microphone. Tune the receiver to produce a

beat note of 300 to 400 cycles, and place the recorder microphone close enough to the receiver speaker to override ambient noise. Adjust the receiver volume, or the recorder input control, to the proper recording level, and set the tape speed to 3 $\frac{3}{4}$  inches per second.

Now call CQ with the key that you normally use, and sign your call. This can be done several times on one side of a 300-ft., 3-inch reel of tape. Leave about a half minute of silence between calls. This will give you plenty of time to listen for replies. If the recording is made at 10 w.p.m., it will be a simple matter to increase speed to 20 w.p.m. by using a play-back speed of 7 $\frac{1}{2}$  inches per second.

### Using the Keyer

Shielded wire should be used between the recorder and keyer to avoid r.f. pickup. When the recording has been made, rewind the tape, connect the recorder to the keyer, and set the recorder for play-back. With the recorder playing into the keyer, adjust the recorder play-back level and the tension of the relay spring for positive keying action. Greater spring tension and a higher input signal level will usually be required when the 0.5- $\mu$ f. capacitor is used at  $C_1$  for higher speeds.

Now connect the output terminals of the keyer across your transmitter key terminals, turn on the rig and let the simple CQ sender do the work for you. When a reply is received, just turn the recorder off and start the conversation rolling.

□♦♦□

\* 7855 15th Avenue, Kenosha, Wisc.

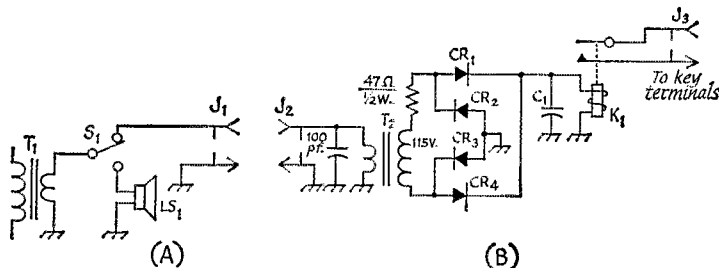

Fig. 1—A shows modification of the tape-recorder output circuit, while B shows the circuit of the keyer.

$C_1$ —200-volt paper (see text for capacitance value).  
 $CR_1$ ,  $CR_2$ ,  $CR_3$ ,  $CR_4$ —Silicon diode: 400 p.i.v., 10 ma. min. (T.I. 1N2070 or similar).

$J_1$ ,  $J_2$ ,  $J_3$ —Phono jack.

$K_1$ —Sensitive relay: 2500-ohm coil, 1.4-ma. pull-in (Sigma 5F-2500-S-SIL).

$LS_1$ —Recorder speaker.

$S_1$ —S.p.d.f. toggle switch.

$T_1$ —Recorder output transformer.

$T_2$ —Filament transformer: 6.3 volts, 0.6 amp. (Knight 61 G 416 or similar).

### Important Notice—Changes of Address

Important changes in handling second-class mail matter are now in effect. Please advise us direct of any changes in address. When notifying, please give old as well as new address. Thanks.

## • Recent Equipment —

### Heathkit Model HG-10

#### V.F.O.

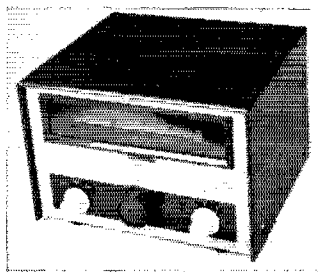

Though the manufacturer says in his instruction book that this v.f.o. "was designed primarily to match the Heathkit DX-60 transmitter, both electrically and in styling" he must have had other uses in mind. The DX-60 is an 80-through-10 transmitter, while the HG-10 v.f.o. has calibrated ranges for these bands and for 50 and 144 Mc. as well. Electrically, only the keying method and the power cable are designed for the DX-60, and adaptation to other uses is not impaired thereby. V.h.f. operators with transmitters using 8-Mc. crystals will find it well suited to their needs.

The oscillator is the pentode section of a 6CH5 in a series-tuned Clapp circuit. The triode portion of the tube is a cathode follower, for coupling the output to the crystal socket of the transmitter with which the v.f.o. is to be used. A voltage regulator tube (0B2) is included, and instructions are given for determining the value of dropping resistor required for various supply voltages. Specific values are recommended for the DX-60 and DX-40 transmitters, whose power supplies will provide the heater and plate

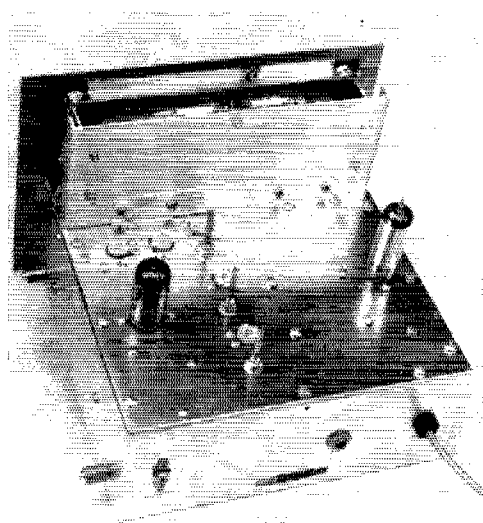

Rear view of the Heath HG-10 v.f.o. The oscillator tube is at the left. Trimmers for setting the various bands are just above the oscillator and in a line at its right.

power for the HG-10. Since only 6.3 volts a.c. at 0.75 amp. and either 108 volts d.c. regulated at a few milliamperes (or 150 to 350 volts unregulated d.c. at about 30 ma.) are required, power usually can be taken from the transmitter. Information on a simple power supply is given in the instruction book, in case the user wishes to provide one especially for the v.f.o.

In using the v.f.o. with the DX-60 the transmitter supplies the necessary negative voltage for grid-block keying. This may be adaptable to other transmitters but in any case the instructions are explicit in regard to adaptation to other keying methods. V.h.f. men need not be concerned here, as it is customary in work at 50 Mc. and above to key in stages farther along in the transmitter.

Three coils are used in the v.f.o. tuned circuits, one for 40, 20, 15 and 10, another for 80, and a third for 6 and 2. Various fixed and variable capacitors are switched in to make the oscillator cover the calibrated ranges for the 7 bands. Though they are not provided for in calibrated dial scales, the 220-Mc. band and the most-used middle portion of the 420-Mc. band can be covered on the 2-meter range. Temperature compensation is provided on all ranges. Except for the 80-meter position the output frequency is always between 7 and 9 Mc.

Operating controls of the HG-10 are a function switch on the left side of the panel (standby, operate and spot), a 7-position bandswitch on the right, and the frequency-control knob at the center. The dial scales are about  $4\frac{3}{4}$  inches long, printed in black on a translucent white drum which is rotated by the bandswitch. Only one scale at a time shows on the illuminated window. The dial mechanism has the usual array of nylon and spring-loaded gears, and the indicating pointer is string-driven.

The model shown in the photographs was shipped wired, so we cannot report on the assembly and wiring process. It is relatively simple, mechanically and electrically, so there should be little trouble in putting it together and on the air. It was given the acid test at W1HDQ — operated on the v.h.f. bands, where instability problems are many times more severe than on lower frequencies. Our observations were that the temperature compensation was extremely



### Heathkit VFO. Model HG-10

Height: 6½ inches.

Width: 9⅜ inches.

Depth: 9⅛ inches.

Weight: 9½ pounds.

Power Requirements: 108 volts d.c. or more, at 25 ma.; 6.3 volts a.c. or d.c., at 0.75 amp.

Price Class: \$35 in kit form.

Manufacturer: Heath Company, Benton Harbor 9, Michigan.

good, and the quality of the note was acceptable. The critical listener would not need to be told that a v.f.o. was in use, but there was no buzz-saw effect, so commonly heard on the v.h.f. bands these days. Even with 54 times frequency multiplication, on 432 Mc., there was little drift, and the note was only slightly fuzzy. It was considerably less than T9 at this frequency, but if there's a v.f.o. that wouldn't be, we've yet to see it. — E.P.T.

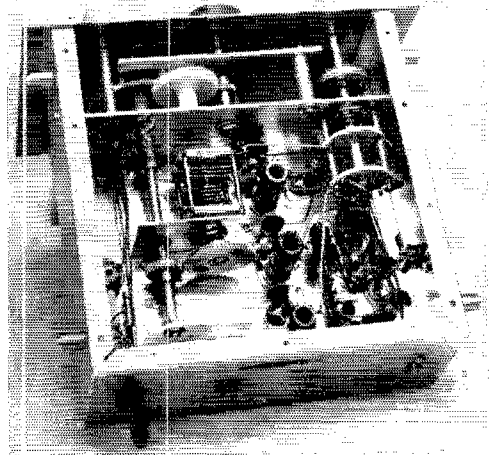

Bottom of the v.f.o., with its cover plate removed. The dial-driven main tuning capacitor is at the left center, with the three coils at its right. At the upper right is the band switch

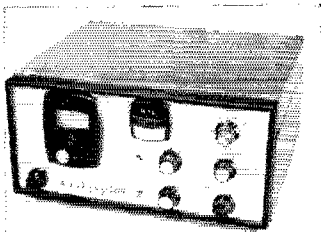

## WRL Galaxy 300

### S.S.B. Transceiver

WRL's contribution to the current s.s.b. transceiver craze is the Galaxy 300. Rated at 300 watts p.e.p. input, it covers the phone portions (3.8-4.0 Mc., 7.05-7.35 Mc., 14.2-14.4 Mc.) of the 80-, 40-, and 20-meter bands. The transmitter and receiver sections use a common 9-Mc. crystal filter and share some of the same tubes, including a few of the new compactron types. The transceiver is supplied for push-to-talk operation with an optional plug-in voice-operated break-in (VOX) unit. A matching power-supply console and a linear amplifier are available from the manufacturer.

For simplicity of explanation, the block diagrams of the transceiver shown in Figs. 1 and 2 have been broken down to show the transmitter and receiver sections as separate units. A star alongside a tube in the diagrams indicates that the tube is used for both transmitting and receiving.

#### Transmitter

Fig. 1 shows the line-up of major components when transmitting. Audio from any high-impedance microphone (with a push-to-talk switch and a PI-68 3-circuit small-barrel plug) is amplified in two triode stages of a 6D10 compactron, V<sub>14</sub>, and fed to a 7360 balanced modulator. Also arriving at the balanced modulator is

9.1-Mc. energy from a crystal-controlled oscillator, V<sub>5A1</sub>, a 6M11 compactron. The oscillator frequency is controlled by either of two crystals, Y<sub>1</sub>, Y<sub>2</sub>, which are selected by a panel sideband switch, S<sub>2A</sub> in Fig. 1.

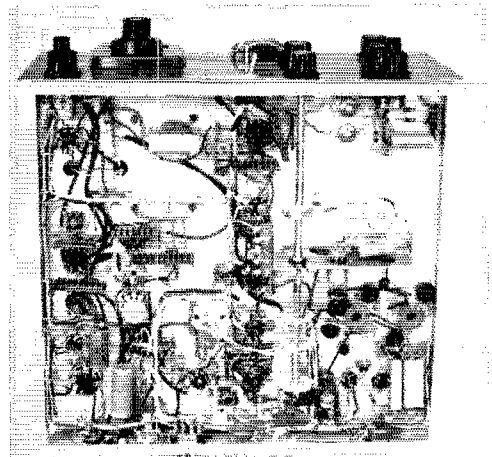

Bottom view of the Galaxy 300 transceiver. The figure-eight belt drive coming off the shaft that runs down the chassis from the front panel is for the final amplifier band switch.

# TRANSMITTER

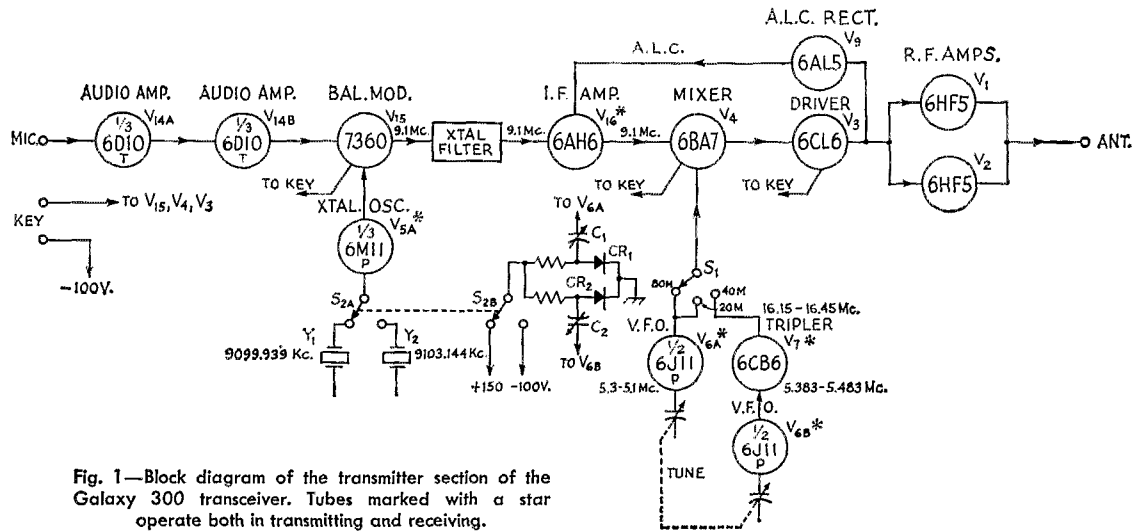

Fig. 1—Block diagram of the transmitter section of the Galaxy 300 transceiver. Tubes marked with a star operate both in transmitting and receiving.

Output from the balanced modulator is double sideband, and when it passes through the crystal filter, one sideband or the other is suppressed, depending upon the frequency of the suppressed carrier with respect to the bandpass of the filter. Rated carrier and unwanted sideband suppression for the transmitter is "better than 45 db."

The 9.1-Mc., single-sideband signal is amplified by  $V_{16}$  and fed to the 6BA7 mixer,  $V_4$ , along with the v.f.o. signal, which is in the 5-Mc. range. Actually, there are two v.f.o.s in the Galaxy 300. One is used for 80- and 20-meter operation, with output in the 5.1- to 5.3-Mc. range; the other is used for 40-meter operation

and has output in the 5.3- to 5.5-Mc. range. The 40-meter v.f.o. is followed by a tripler stage,  $V_7$ , so that injection to the mixer,  $V_4$ , is between 16.15 and 16.45 Mc.

Although there are two separate v.f.o. circuits, the tuning control is common to both oscillators. Tuning is done through a single drive mechanism which is a dual-planetary drive. Fast tuning gives a 12 to 1 ratio; vernier tuning is 72 to 1. Dial accuracy is rated at 5 kc. and drift is noted at less than 100 cycles in any 15-minute period after warm-up. Because of the frequency combinations used in the Galaxy, the dial scale reads down in frequency on 80 meters with clockwise knob rotation, and up in frequency on 40 and 20 meters. On 80 and 20 meters, one turn of the vernier knob moves the dial about 5 kc., and on 40 meters about 10 kc.

Also associated with the v.f.o. is the sideband switching circuit. Ganged to the sideband switch  $S_{2A}$  is another switch,  $S_{2B}$ , that applies a d.c. bias to a pair of crystal diodes,  $CR_1$  and  $CR_2$ . The diodes act as gates to switch capacitors  $C_1$  and  $C_2$  in or out of the v.f.o. tuned circuits. When changing sidebands, the v.f.o. frequency is shifted an amount equal to the frequency difference between the crystals  $Y_1$  and  $Y_2$  in the oscillator,  $V_{5A}$ . This scheme keeps the v.f.o. dial calibration the same even when switching sidebands. Because of the frequency combinations, the switch position that gives u.s.b. on 40 meters gives l.s.b. on 80 and 20 meters.

Output from the mixer,  $V_4$ , is in the selected amateur band (on 20 meters the injection signals are added; on 80 and 40 meters they are subtracted) and is fed to the 6CL6 driver,  $V_3$ . The signal is then amplified by the two 6HF5 final r.f. tubes, which are TV horizontal-sweep tubes operated in class AB<sub>1</sub>. The plate tank is a pi network designed for non-reactive loads between 25 and 100 ohms.

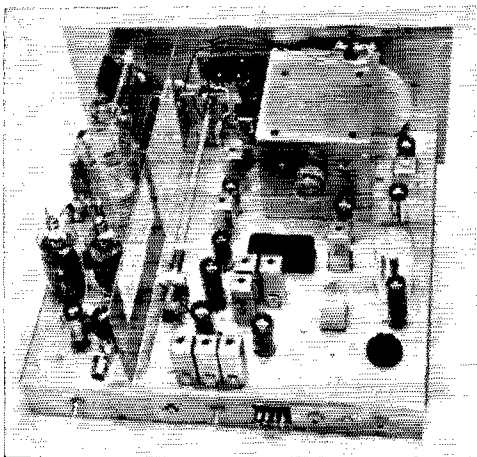

This top view of the Galaxy 300 shows the final amplifier components grouped at the left of the shield plate. Attached to the shield plate are drawings showing rear apron connections and tube and component placement. The optional VOX unit plugs into the socket on top of the chassis at the lower right in this photograph. A jumper plug is in the socket in this shot.

Automatic load control (a.l.c.) protection for the amplifiers is used in the Galaxy 300. Bias for controlling the gain of an earlier amplifier,  $V_{16}$ , is obtained by rectifying audio generated by rectification in the grids of the r.f. amplifiers when they go into grid current.

C.w. operation is possible with the Galaxy 300, although the equipment as supplied won't operate outside the phone bands except on 40 meters, where it's possible to go down to 7050 kc.  $V_{15}$ ,  $V_4$ , and  $V_3$  are grid-block keyed on c.w.

A panel meter with two calibration and color scales reads either transmitter final-amplifier cathode current or relative signal strength when receiving.

As supplied, push-to-talk switching changes the Galaxy from transmit to receive. Either a panel send-receive switch or remote switch on the microphone can be used to operate the circuit. The send-receive relay is a plug-in type that can be removed for easy adjustment and cleaning.

### Receiver

The receiver section of the Galaxy 300 is shown in the block diagram in Fig. 2. The front-end tuned circuit is the same pi-network used in the transmitter's final r.f. amplifier. Signals are amplified in the 6BZ6 and then mixed in  $V_{11A}$  with the v.f.o. output. The v.f.o. arrangement here is similar to that used when transmitting, except that the cathode-follower stage,  $V_{11B}$ , helps to isolate the v.f.o. circuit from the mixer.

Selectivity is furnished by the same 9.1-Mc. crystal filter (2.7 kc. at 6-db. points), followed by two stages of i.f. amplification. Signals are detected in the product detector,  $V_{5C}$ , where injection is provided by the crystal oscillator,  $V_{5A}$ .

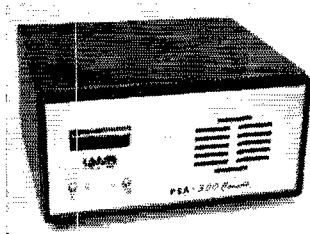

The PSA-300 power supply console furnishes the necessary operating voltages for the Galaxy 300 transceiver. The box also contains a speaker and an optional 24-hour clock.

Sideband switching, including v.f.o. shift by diode switching, is accomplished here in the same manner as described for transmitting. Three stages of audio follow the detector to give a maximum of about 2 watts output.

Gain of the r.f. amplifier,  $V_{10}$ , and the i.f. amplifier,  $V_{17}$ , is controlled by an a.g.c. bias derived from rectified audio obtained at the plate of the audio amplifier,  $V_{14C}$ . The audio signal is rectified by a semiconductor diode,  $CR_3$ , and applied to the grids of  $V_{10}$  and  $V_{17}$ .

### Accessories

A companion power-supply unit, shown in the accompanying photograph, is styled to match the Galaxy 300 in size and appearance. Also included in the power-supply package is a 5 × 7-inch speaker and an optional 24-hour digital readout clock. A panel "knock-out" fills the hole to be occupied by the clock. The power supply unit furnishes all the necessary operating voltages for the Galaxy and utilizes silicon diodes in a bridge circuit to give 315 and 800 volts

### RECEIVER

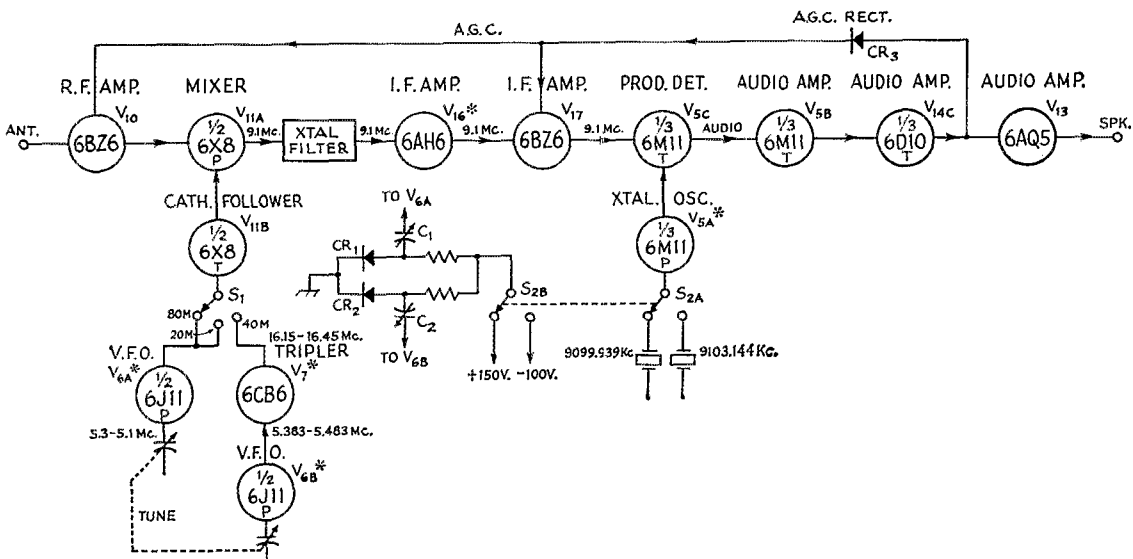

Fig. 2—Block diagram of the receiving section of the Galaxy 300 transceiver.

**Height: 7 inches**  
**Width: 15 inches**  
**Depth: 13½ inches**  
**Weight: 27 pounds**

**Power requirements: 800 v.d.c. at 400 ma., 315 v.d.c. at 200 ma., —120 v.d.c. at 15 ma., and 12.6 v.a.c./d.c. at 4 amps.**

**Price class: \$300**

**Manufacturer: World Radio Laboratories Inc., Council Bluffs, Iowa**

output. The 800-volt supply uses a choke-capacitor combination that the manual says is "tuned to approximately 120 cycles." However, using

the constants given in the circuit diagram, it calculates out to be about 240 cycles.

Other accessories for the Galaxy 300 are a linear amplifier, mobile power supply and mobile mount. The mobile power supply is designed to operate from 12 volts d.c. and is transistorized. An optional plug-in VOX (voice operated break-in) is available; it simply plugs into a socket provided at the rear of the chassis. Controls are provided for VOX sensitivity, anti-VOX sensitivity, and VOX hold-in time. A kit of plugs for the microphone, key, speaker and external control circuits is also available.

The Galaxy 300 cabinet is perforated steel; the front panel is gold-anodized aluminum.

—E. L. C.

## Strays



Pictured at a recent Explorer Scout Conference are eight of the ten hams attending. Left to right, they are K3VBC, K3OPL, K3TEZ, K3UGR, K3TXP, K3NXO, K3OMI, and KN3UYR. Missing when the picture was snapped were KN3YEP and K3KTF.

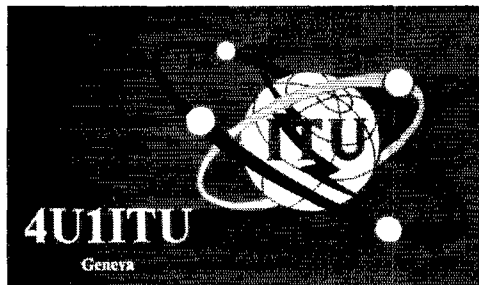

A grand international hamfest will be held in Geneva Switzerland October 19 and 20, under the auspices of the International Amateur Radio Club and 4U1ITU. It will coincide with the first Extraordinary Administrative Radio Conference on Space Communications of the ITU. Among the guests will be some of the world's most eminent authorities on space communications. This is a sample of the special 4U1ITU QSLs.

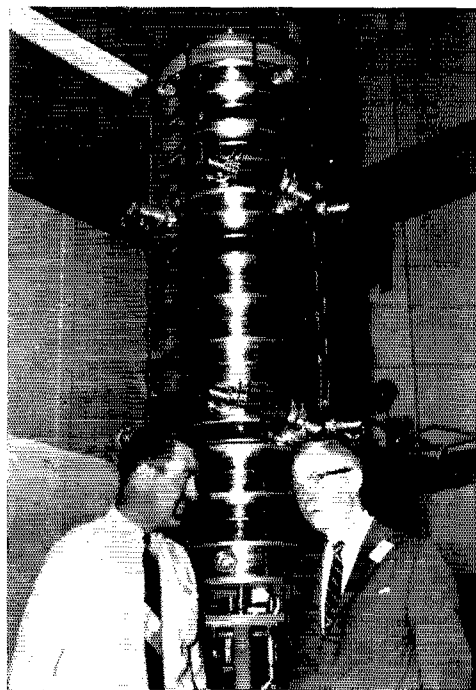

Here are ARRL Technical Director George Grammer, W1DF, and George Badger, W6RXW, of Eitel-McCullough, Inc. They are shown next to the huge new Eimac experimental tube, the X-3030, which is being designed to produce a megawatt of c.w. at 8 Gigacycles (8000 Mc.), with 40% efficiency and a gain of 30 db. Other operating data for the X-3030 are:

Beam voltage	150 kv.
beam current	16.7 a.
beam power density	12.4 megawatts/cm <sup>2</sup>
coolant water flow	400 gal. per min.

The tube acts as an extended-interaction klystron. It stands eleven feet high and weighs 2000 pounds, and the lead x-ray shield which covers the tube weighs two and a half tons.



# Correspondence From Members-

The publishers of *QST* assume no responsibility for statements made herein by correspondents.

[EDITOR'S NOTE: The following are excerpts mostly from letters to the League from persons utilizing the League's technical information service.]

☞ Thank you for the technical assistance your department has rendered us in the past. We consider our membership in the League a very valuable thing. — *James H. Summers, W8KCO/5, Albuquerque, N. M.*

☞ I think this is an opportune time to express my deepest gratitude for all the services and helps the League has provided me, to make it possible to get the licenses. My receiver is the  $2 \times 4$  plus 1 which I built from the 1960 and 1961 *Handbook*. My rig is the Novice gallon from the June and July 1962 issues of *QST* (modified for a power supply which another ARRL member sold me at a very nominal cost).

Although I never send in my copy, I use the W1AW code practice transmission very regularly. — *Anthony Lameika, W4SQY, Jackson, Michigan.*

☞ A word about *QST*, which I find very valuable and helpful. From my view point there is only one improvement that could be made, and that is to make the printing a little larger so I can lay aside my magnifying glass. I call it my *Q* multiplier for reading, hi! Seriously, tho, your print is really too small for comfort. I am 63 yrs. old and just got my Novice ticket. — *Chas. G. Hyde, W2FKZ, Ballston Spa, New York.*

☞ I might say that even though I have been a General class ham since 1956 I still turn to your "Novice and Beginner" department first. I am always anxious to learn something new about our hobby and as far as ham radio is concerned, I shall probably always be a General-licensed "Novice" and a "Beginner." I enjoy your articles immensely and have followed your advice many times successfully and constructed many of your smaller items. I also read the other "build" and technical articles in *QST* and to all the staff I can only say a million thanks and "keep up the good work." — *Dick Routebush, K9DMT, Fort Wayne, Indiana.*

☞ This is the first occasion I have had to write you, and let me say that the *Handbook* is a very fine book and it is like a bible to me around my ham shack. I have obtained a great deal of my "electronic" education from it. — *Norman E. Newman, W1QBSS, St. Charles, Mo.*

☞ I recently received from your office a copy of *Understanding Amateur Radio*. My, what I wouldn't have given for the info in this little book about 40 years ago! About that time, my first ticket was in effect. And the book isn't so blamed little, either. Thanks, loads! — *Garth Oler, K9EDG, Pennville, Indiana*

☞ I am looking forward to more and more of your issues and articles on radio theory and eventually to advance theory so when the time comes I'll have enough confidence in taking and passing the General written test. — *Seymour Paul, Brooklyn, N. Y.*

☞ I am greatly encouraged by the response you are getting to the "homebrew" articles. I wish you would publish one more book entitled, "How to become an Advanced Amateur" giving explicit details on how to build the HBR-16 and a good sound design s.s.b./a.m./c.w. rig with VOX and all. Make it complete with templates, source of parts, and the works. — *Glenn A. Mack.*

☞ I would like you to know how much I do enjoy *QST*. My copies are read and re-read from start to finish. It goes without saying that I am proud of my ARRL membership and find that this association gives me something in common with my brother hams that makes it easier to form lasting friendships. — *W. A. Henson, W5DWD, Monroe, La.*

☞ I gave my 1960 copy of the *Handbook* to the NAS Glyneo ham club, of which I am secretary. We teach code classes and theory to beginning hams and make extensive use of League publications. We have found these to be an invaluable aid in our training program. — *Dom Tomaro, W4YZB, Brunswick, Ga.*

☞ I think you have an excellent magazine and organization. I know that you hear this often, but the League does incomparable service to the amateur. And, we really appreciate it. — *Dan Cole, W19ANV, Blue Island, Ill.*

☞ I have been reading and hearing a lot of undeserved criticism of *QST* and the League. I would like to say that you have my support, 100%, and the support of many other hams who may not take the time to write but appreciate the League's efforts on their behalf anyway. — *James S. Rice, K1HDP, Needham, Mass.*

☞ *QST* is still the *only* magazine for hams and I enjoy it very much. — *Charles Michel, K0QVL, Omaha, Nebraska.*

☞ I would like to take this chance to thank you for your excellent advice and entertainment in *QST* during the three years I have been a member of the ARRL. Although a lot of the theory behind the technical articles is hard for me to understand I have retained every copy in anticipation of the times when I can refer back and improve myself. — *Robert Charles Mrra, K9BGR, Chicago, Ill.*

☞ I would like to express my feelings about *QST* magazine. I have been a member since 1957 and look forward each month to reading about new and improved methods of communications. — *R. G. Clinton, K4QEK, Portsmouth, Va.*

☞ I would like to thank all the staff of the League for giving amateur radio as much help as you have, both in the past and now. Without your help I am sure that I never would have become a ham. — *James D. Edwards, K8VLZ, Westerville, Ohio.*

☞ I think that you do a wonderful job. Your handbooks, *QST*, other publications, and operating awards are invaluable. — *Ronald Turner, W5ERY, Merryville, Louisiana.*

# An Interview with Barry, K7UGA

... who works for the government

**THE TRANSCRIPT OF AN INTERVIEW WITH SENATOR BARRY GOLDWATER  
RECORDED BY BILL LEONARD, W2SKE IN WASHINGTON, D. C., JUNE 4,  
1963, FOR THE VOICE OF AMERICA'S "RADIO AMATEUR'S NOTEBOOK"  
PROGRAM, BROADCAST SUNDAY, JUNE 16, 1963.**

Leonard: We have noted the fact before that amateur radio embraces people in all walks of life . . . and that it is a strangely persistent hobby — you may give it up for a while, but the likelihood is you will come back to it someday.

Our guest today, Senator Barry Goldwater of the State of Arizona, was interested in radio as a youngster, and that interest was revived recently despite his very pressing duties in the United States Senate. I met the Senator in Washington last week and he readily agreed to take time out from his busy schedule to "talk ham radio." Like a number of U.S. amateurs who must live in different parts of the country each year, Barry holds two sets of call letters. I asked him first what they were . . .

Goldwater: Well, here in Washington, it's K3UIG and out in Arizona, it's K7UGA. I did that because at the outset I had only K7UGA, slant 3, but that gets kind of cumbersome on c.w. I found out you could get two calls and I did it.

L: Well . . . let's go back a long way to the time when you first became interested in electronics and radio, and then we'll talk about the revival movement?

G: All right. Well, I was — I think I was 12 years old — and I used to help a fellow who made the first wireless sets in Phoenix. He was a Chevrolet mechanic by day, and at night we worked in his garage — made what they called wireless sets and I, of course, picked up a crystal and a Ford spark coil and learned the code, and then graduated to a rotary-gap spark, and about that time the c.w. circuit started to come in and I picked up a five-watt tube. In those days, they were a dollar a watt and dollars were hard to come by.

L: And watts were almost as hard to come by?

G: Well, they didn't do much for you. I used to burn out a five-watt tube about once a week and I'd sweep the floor out a little harder and pick some more cotton, and finally I built up to 20 watts and had an old Grebe Receiver. I remember I had a 600-volt d.c. generator that — on a cold morning — wouldn't start, and I'd have to go out and heat it up with a torch. It was a lot of fun though. I think the greatest DX I ever worked was Sioux City, Iowa, with 20 watts and I was heard in Hawaii once. That was the crowning achievement of my young life.

L: And they don't make thrills much bigger than that?

G: No, even though today, every once in a while, you get a shaker. You can't believe these little sets get out like they do. Lord, that 20-watt rig of mine covered what a 50,000-watt broadcasting station would cover today.

**FLASH!** — Just at press time, a hearing was called by the Senate Subcommittee on Communications on S.920, Senator Goldwater's bill to provide for reciprocal operating privileges. After the Senator's introduction and statement in strong support, President Hoover, Southwestern Division Director Meyers, General Counsel Booth and General Manager Hunton presented prepared testimony urging adoption of the bill. More next month.

L: What was your first call?

G: Oh, 6BPI. That's before we had any Ws, or anything else.

L: Well, now I know about a great many of your hobbies, including flying and golf and photography and I wonder whether it was some other hobby that took you away from ham radio as the years went by, or was it politics, or what?

G: No, I came to Virginia to go to school, and rigs weren't portable in those days. After four years of school, I just didn't go back to it. Then my interest began to be revived. Of course, during the war when I was with first, the Army Air Corps, and then the Air Force — you never forget the code — it's like swimming — and I taught it during the early war years. First to the Chinese cadets and later to our own cadets. I was always wishing that somebody would come along in my family and give me an excuse to get back in it. My youngest son paid part of his way through college by buying kits — stereo kits, making them up and selling them and I thought, "this is going to be my pigeon," but he never went so far as to get all the way into ham radio.

L: And what and when did your interest begin to get revived and stimulated?

G: Well, as I say, it was always there, and last year — oh, it was about this time when I was out of town, General Jack Bestic conniving with General LeMay —

L: Who are, of course, hams?

G: Yes, and they put a Collins transceiver up in my apartment and put a vertical on the roof and had it all hooked up when I came back, and even had a call that Major MacElroy — you must have met him, he's the wild Irishman, sort of General LeMay's electronics aide. We used his call. I sent out a CQ and, by golly, I got a guy in Miami, Florida and I was gone. (LAUGHTER) I was back then! I borrowed a code machine and started practicing with it, and MacElroy coached me on the electronics. That wasn't too hard to get back to, but I had to take that code three times. Finally, I got mad and I said, 'By golly, this time I'm going to do it,' and I think I knocked off about 16 or 17 words. So we're back at it.

(Continued on page 172)

# On The Art of QSLing

BY TED WILDS,\* KZ5SW/W4GVD

*An article that may prove helpful in getting a card in return for one sent out, for the newcomer and the occasional DXer for whom the returns are few and far between.*

ONE of the phases of ham radio that causes much concern to the newcomer to the DX bands is the fact that the ratio of QSLs sent to those received can be very poor. Unfortunately, the high hopes that accompany that air-mailed, outgoing QSL are doomed to weeks of waiting for a return confirmation that never shows up in the mail box. Just as you decide that the station never QSLs, you hear that another local has received his card from your DX station and you worked him before your friend across town did. Why is life so full of trials and tribulations? Does your friend know something that you don't? Probably he knows the art of QSLing that it seems to take years to learn. Gather round for some tips that maybe you haven't heard, not-so-secret info that never seems to be passed on the air, but is common knowledge among the successful wallpaper hangers.

There are two basic groups of "rare" stations that we would like to pry pasteboards out of:

1. The Wandering DXpedition, and the "Rare State."

2. The Genuine DX (who lives there).

We will take up the DXpedition problem first because it is easy. Simply *do* as the man says! Listen to the operation for a while, because the operator usually gives out the information regularly. If he has a QSL manager, find out who this manager is. If QSLs are to be sent to the DXpeditioner's home QTH, check that QTH in a recent *Callbook*. Do not simply send your card with an air mail stamp on the back. This probably won't get you a return in your post box. *Always* send your card in an envelope *together* with an envelope addressed to yourself, with a stamp on it. (Remember we are discussing now W-K DXpeditions who indicate a stateside QSL address *only*. U.S. stamps are not good elsewhere.) This will assure a reply to your post office, instead of by the bureaus, of which we will have more to say later. Before sending your card make *sure* that the card is complete, and that it is accurate! If you still keep your log in local time, be *sure* that the QSL shows CORRECT Greenwich Mean Time, and the GMT date (it can be *different!*). Avoid like the black plague such times as EDST, A.M. or P.M. This

enables the log checker to find your QSO easily and quickly. Anything that you can do to aid him verify your contact will add wings to the card you are waiting for! Remember that he may have thousands of cards to answer. The card for the QSO that is hard to find in the log is bound to be delayed. The ones that arrive without a self-addressed, stamped envelope will usually be answered last and "via the bureau." Follow these suggestions and you are reasonably sure to get that W4XXX/ABØ QSL in a reasonable time. Goof up and you may never get it!

The "Rare State" should be handled the same way as the DXpedition. If he truly is a rare state, he gets thousands of cards also. He has no real recourse to the bureau system since the stateside bureaus don't handle domestic QSLs. Therefore, his postage and printers bills can be costly. Figure it out. Say a minimum of a thousand cards per year at 2 cents for the card (or more) and a minimum of 4 cents postage adds up to \$60.00 a year for W cards that *he* needs like a hole in the head! \$60.00 a year would keep him in tubes. So the self-addressed *stamped* envelope is really welcome. The notes to follow on the "Complete QSL" apply here also.

Now let's discuss the "problem" of the genuine DX station, rare or otherwise, and (the one that really lives there), all stations outside of the continental U.S. and Canada. The facts of QSL are much the same for all of them, varying only in degree. These are the facts, like it or not:

1. They do *not* hold their breath waiting for a W-K QSL. They get thousands and thousands of them.
2. Overseas postage and printing bills can be astronomical, in proportion to income.
3. The secretarial chores of answering, checking, and mailing thousands of cards can take as long as the QSOs did, especially if they work

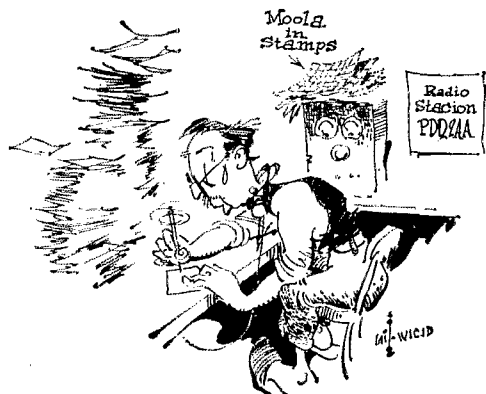

\* P. O. Box 323, Aiken, S. C.

in the contests, in which case QSLing takes much more time than the contact!

4. They QSL via the Bureaus, unless you send them postage! (Remember that Uncle Sam's stamps are *not* good outside of the 50 states, with few exceptions.)
5. Most hard-pressed DX operators cannot be bothered chasing down an incomplete QSL.
6. A courteous QSO does not harm your chances of getting a QSL for it! Don't interrupt his rag-chew with an old buddy, or his DX QSO simply because YOU need a card.

The first 5 we will go into. Number 6 should be self-explanatory to all but the complete boob.

### ***Make your card one that he will be pleased to receive***

Some chambers of commerce, two major parts supply houses, an air line, a power company, and a few other commercial enterprises have done the building ham a favor of sorts by making available low-cost QSL cards. These are fine for Novice days and domestic confirmations. However, the run-of-the-mill DX station can probably count WAS many times over in either the Red-White-and-Blue cards from St. Louis, the Map-of-the-U.S. Cards from Council Bluffs, or the Big Mechanical Bird. Your addition to his collection of these is not guaranteed to make a big hit. My suggestion would be to use the run-of-the-mill cards for the run-of-the-mill contacts. Incidentally, most of the "stock" cards from the printeries fall into basically the same category. The most welcome cards are those that show something of interest. Your local souvenir shop, drug store, or five-and-dime usually have some color post cards of local interest. (Something other than the post office, hotel, or bank building, please.) These are usually priced at 5 or 10 cents each, but usually can be bought a hundred at a time for much less.

Buy a hundred and take them to the print shop and have your call *printed* on them along with all necessary fill-in blanks. These will look and will be different from any in his collection. Of course, photo-cards featuring yourself and your shack (or the whole house and car, antenna, etc.) are good also, but may cost more. Keep it post-card size; the giant size and the minute are both hard to file in most filing systems, get lost easily, or get mutilated.<sup>1</sup> Use some imagination!

### ***Help out his wallet if you want a direct reply***

With QSL volume in the thousands per year for an active DX station, it is impractical to pay for both the printing of cards and individual postage too. Inasmuch as U.S. stamps are not good at his end of the line, how can you take the stamp load off his shoulders? One way, if his country is a member of the International Postal Union (consult your post office) is to send him an IRC (International Reply Coupon). This may be purchased from any U.S. or Canadian Post Office for 15¢. Your DX guy trades it in at his

end of the line for a regular mail stamp. If you want him to send you your card air mail send him several IRCs. (The number necessary varies with the country concerned. There's a list in the *Callbook*.) I know, it adds up, but it does get results! If you want to be really fancy, check with a stamp collectors' supply shop and send him the correct stamp from his own country; he will be surprised and pleased at your thoughtfulness. If still in doubt, send him a U.S. dime or two. There is still a demand for any U.S. coinage or currency in many parts of the world. A few dimes here and there enable a foreign ham to subscribe to U.S. ham publications, where he otherwise could not obtain the U.S. funds most of the publishers seem to like. If you send two dimes, he will send your card back air mail and probably make a small profit.

### ***Be his secretary—at least for your card***

Keeping up with the deluge of cards that flood a DX operator is a real task. Besides making sure of the GMT time *and* date on your card to help him locate your QSO in his log, you can aid him by sending along a self-addressed envelope. I have found that I can answer 30 cards an hour if I don't have to fill out those \* \* \* addresses. Addressing will slow the reply rate to a slow crawl. Most DX stations have a card designed for a minimum of actual hand printing to fill them out. If you think I'm kidding about this, sit down and write your own address out 200 times and see how long it takes! 200 cards a week is *not* unusual for a rare station, who is contesting or is just active daily.

### ***The Bureaus***

It is amazing how many stateside hams don't know what the Bureaus are! These are cooperative organizations dedicated to cutting QSL costs for DX stations. Overseas, they work like this: Say a DX station has 500 cards ready to go out. None of these recipients have sent postage, envelopes or other aids. The DX station will send them all in a low-cost package to his bureau. Here they will be sorted according to country. At regular intervals a package is made up and sent from his local bureau to the central bureau in the country of destination. Upon arrival, these will be forwarded to the local bureaus in that country, where they are picked up by the individual station to whom they are addressed. All this takes time and may take anywhere from a few weeks to a year or more, but they usually get there. The missing link is usually the U.S. ham who fails to pick up his cards from his local bureau. In the United States, the bureaus are an ARRL function. Thousands of choice DX cards arrive every month. They are sorted by call area and mailed to the local call area bureau and here they stay if *you* don't take action. Mail a self-addressed envelope with a couple of stamps and *your own call* in the upper left-hand corner to the bureau in your call area, as listed in *QST*. When DX cards arrive for you they will be placed in your envelope. At regular intervals,

<sup>1</sup> And recent postal regulations forbid their use. — *Ed.*



or when your envelope gets full, the bureau manager mails it to you with those long-lost pasteboards. That's all there is to it. It works fine but *you* must make sure you have the envelope at your local bureau.

If you are portable send envelopes to both your old call area and to your present one. If you modify your call, send new envelopes. Please remember that the bureaus' managers are volunteers and have too much to do to look up and see if you have a particular card waiting. The list of call area bureaus is published regularly in *QST*. Even if you are a non-DXer, get an envelope to your bureau — you may have some rare foreign s.w.l. cards waiting for you. (I remember the time when I was struggling to work 40 c.w. from the Canal Zone to the states with lousy luck and gave up the band. A month or so later, via the local bureau, I got s.w.l.s from Japan, U.S.S.R., and Tibet reporting my 589 sigs!)

For a small fee you can join an international bureau such as the International Short Wave League's bureau. This has two advantages. One is that all QSLs and SWLs that arrive there for you are sent to you via direct mail (prepaid) and also you can send *all* of your going-out cards thru them. It is a help when you do not know the addresses of your DX or W/K stations. They will send them on to the bureaus in the countries you worked at no cost to you. Write them for details. (Note: this is the best and cheapest way to get cards to the registered s.w.l.s throughout the world. Stateside s.w.l.s (SWL-W1 etc.) should not expect a DX station to send him a direct reply when the DXer replies to hams via the bureau!)

### Ye Complete QSLe

Added reply insurance may be bought cheaply by making sure that you have every scrap of valuable information on your card before you mail it. By this I do *not* mean your rig, brand of mike plug, antenna connectors, line cord, lightning arresters etc. I *do* mean the information that helps him to qualify for the various awards, certificates, diplomas and the like. For the card to be of any value certain items should be included.

These are:

1. The fact that you are confirming a two-way contact.
2. Time and date. These *should* be accurate and in GMT.
3. Frequency band.
4. His report.
5. Mode. A.m., c.w., TV, f.m., s.s.b. If cross-mode, it should be stated on the card. ("fone" is no longer enough! What kind? s.s.b.-to-a.m., d.s.b.-s.s.b., a.m.-a.m., 2 × s.s.b.?)
6. Your location, including county or province.
7. Your signature.

These would seem to be obvious. However they are not generally understood, particularly numbers 5 and 6. Two fairly recent developments have given more value to W-K cards in the minds of some DX operators. These are the certificates

or awards given for 2-way s.s.b. QSOs and for working various combinations of counties of the U.S. All cards confirming QSOs with all s.s.b. stations should indicate 2-way s.s.b. if you are also on that mode. The phrase "Ur s.s.b. sigs 5 8" is *not* enough. If you were on a.m. and he was on s.s.b., make sure your card says so. He probably does not log the fact you were on a.m. For counties awards, make your card welcome by putting the name of your county in a prominent position on your QSL. It wouldn't hurt to include your ARRL Section, too. Make sure that the *state* is on the front of the card also. You would be amazed at how many cards there are on which you have search for the state of origin.

The urge to file a card in the circular file is never so strong as when you finally get a QSL from a hard-to-work state for phone WAS or 2-way s.s.b. WAS, and the cotton-picker has forgotten to fill in the mode section of the card. Incidentally, in this discussion, I remember trying to work WAS 2-way s.s.b. and believe it or not I sweated out 27 New York, 6 Colorado, 4 Maine, 16 Tennessee, 7 Arkansas, and 8 North Carolina QSLs before obtaining one completely



accurate 2-way s.s.b. confirmation from each of those states. Very frustrating!

Here is what should be on the card in graphic form:

"Other info" such as your equipment, weather, QRM-QRN-QSB, awards won, and the like is up to you. Highly unnecessary, but if you want to clutter up a card, it is up to you. Make sure you have all of the stuff shown and also don't forget to sign it. This matter of the date is confusing to many. Please put the name of the month down, or use Roman numerals for it. A date such as 1-3-62 means 3rd of January to some people and the 1st of March to many others. If you mean 1 March, write it 1 March 62 or I-III-62. It will then be understood by the DX station. He won't have to scramble through two log books instead of one. If your card has your call sign on the front and the QSO info on the back, be sure that your call sign is on the back as well. This facilitates the mechanics of filling out a reply and is a welcome aid to the secretarial chores of a DX operator or his manager.

In conclusion here is a check list to keep in

(Continued on page 162)

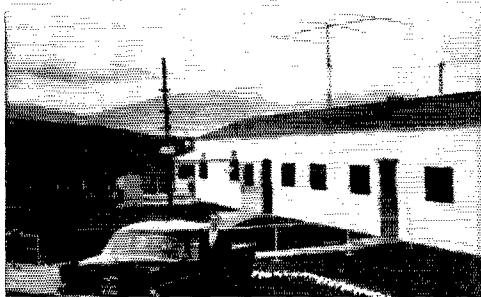

A master at work! HC1DC, tops c.w. with well over a million and 3rd high phone DX at almost half a million points, must find that 11,700' altitude agreeable. The station includes a 51-J receiver, Viking 500 and Collins 32S-2 transmitters plus a Ranger and a 300-watt 160-meter amplifier (not visible) all used to advantage in a fabulous performance. Behind the tribander can be seen the snow line of 20,000' Mt. Cotopaxi, top in the clouds. That's Don in the foreground with the long-wire just barely visible over the rooftop.

# ARRL DX COMPETITION

## 1963 Results

COMPILED BY ELLEN WHITE,\* W1YYM

"... the ease with which the big guns took charge in the pileups... the great operating skill of W1YH... the terrific VK signals at sunrise Sunday a.m. on 80, 3:24... the monumental pileups on the late newcomers just before 2400Z 3:24... the nerve wracking wait to find out who HK0AI was going to call while he sent a string of V's and his call first... the great signals of 9M2UF and VS1LP on 14 Mc. at noon... the great DX potential of 21 Me... the fine signals and competitors from Europe..." — W2CBK

**T**HE stage was set last February and March, the 2nd and 4th weekends scheduled for the competition separating the men from the boys. The ARRL International DX Competition, 29th running, was on the way! What transpired was an interesting example of what can happen when a high degree of W/VE/DX activity challenges a steadily declining m.u.f. Charts and graphs elsewhere in this report indicate what happened to the higher-frequency bands, and additionally, the upsurge of transcontinental DX that was found on 40-80 and 160 meters.

Statistically, this latest continuation of the First Transatlantic Test found 1383 amateurs reporting results, an increase of about 60 over the previous year. A total of 314 section, country and club awards are scheduled for mid-October mailing.

Space won't permit listing all of the single-operator c.w. scores, but here's the top ten: W3GRF 679K, W8FGX 622K, W4YHD 605K, W3ECR 600K, K4RDE 507K, W9EWC 496K, W4DHz 488K, W8VSK 478K, W4DQS 466K,

\* Assistant Communications Mgr., ARRL

W3ALB 445K. Multi-operator scores draw a lot of interest too; here's the breakdown on the top ten W/VEs: W6RW 683K, W3TMZ 658K, W3WJD 658K, W4KXV 619K, K6EVR 609K, W0NFA 527K, W3KFQ 418K, W3MWC 394K, W3ADO 387K, W3GRS 380K.

On the phone side of the DX picture, the top ten single-operator W/VEs show up as follows: K5MDX 332K, W2FXN 198K, K2GXI 196K, W1ONK 168K, K2IEG 166K, W4BVV 166K, W3ALB 141K, W3TLN 131K, W3OCU 122K, K1RTB 108K. In the more-than-one operator category the top ten W/VE phones are: W3MSK 576K, W6HJT 427K, W8NWO 206K, W3WJD 180K, W3ADO 174K, W2SKE 165K, W3KFQ 141K, W8NGO 107K, K6EXO 90K, W3HHK 70K.

### The Clubs

Back again in the box-topping spot is the Frankford Radio Club with 68 entries for an 8-million-plus aggregate and still another cocobolo gavel to add to their collection. In the 2nd slot, averaging almost 190K points per member is the Potomac Valley Radio Club. Third and fourth show a reverse of last year's position too, with the Northern California DX Club outpointing the SCDXC, a million points more this year for NCDXC, *f.b.!* A newcomer to the upper echelons of the tabulation with a big jump from '62 is the Virginia Century Club with 13 entries. No stranger to the stratified region of the million-pointers is the Order of Boiled Owls of New York, placing 6th in the club competition. A total of 33 clubs made the box, having the minimum number of entries (3)... lots more were ineligible with less than that number.

## Highlights

**1** WIBIH made all his points the first weekend, spending the second one at Dutch St. Maarten. WIOPB found the last two contest hours on 40 an absolute bedlam. WIECH had almost "given up" at his city QTH but, nevertheless, got 4 new ones on 20. K1DIR managed to find 56 mult. on 15 and 6 too on 160. W1NJL tried c.w. à la multiop. and found it a saving on nerves and family relations too. Maestro KIRTB finds this by far the contest of contests, bar none.

W1ONK with 168-K phone points in E. Mass. found plenty of goodies with a mult. of 70 on 20 and a total of 92 different countries worked. W1NJL puts in a plug to really use 40 next year. After working South Americans off the ends of his fixed 20-meter east-west array W1ZFV of R. I. concludes he could have used a rotary.

**2** W3SQX, opr. W2FXN, bemoans the loss of the only 15-meter c. w. opening to Europe due to broken coax 80' up. W2GGL earns kudos from ARRL's weak-eyed K1MYQ & W1YYM for a neat orderly and readable log. In turn W2GGL credits a cooperative xyl. FRC faithful K2CPR feels that a ZC4 on 40 and HL9 on 20 are still good catches in such a fracas with 175 watts, sans beam. In WNY K2INP asks "doesn't W3MSK or W8FGX miss anything?" 15-yr. young WA2WGI figures if he improves as much by age 50 as he did over last year he'll have about 1069 points! OT W2WZ puts in a plea for some of our DX friends to sign their calls at least once every 5 QSOs. 13-yr. old WA2RUB worked 5 bands for a 110 multiplier and wonders if he's the youngest entry at age 13. (Nope, there's W2BOW at 121). W2GGE, top c.w. in NNJ, lists some of the bad-type operating observed: key-down v.f.o. tuning, holding key on DX freq., calling too long overlapping the DX reply, disregarding KN, calling during the WVE transmission, slow drift during call. WB2APG claims some DX stations are still in the dark about the WB prefix, prone to give 599 reports.

W2FXN led the phone boys in SNJ with almost 200-K for the Frankford RC - - and a most readable log. K2GXI found it a tough battle for every QSO this year. K2PZF worked 3 new ones while WA2LZS went up to #296 with Gus at FR7ZC/J. WA2HOK plans to be on 40 and 75 in '63 instead of sleeping. K2LEG at his fine QTH tallied 101 on 20 and with others on 75-40-15-10 tallied 165-K. WA2RUB suffered torment tuning across the sideband areas thinking what might have been had he been on s.s.b.

**3** W3MFW keyed W3ECR to the 3rd high single op. W. VE-snagging 4 QSOs in 3 continents on 160 along the way. After a fine 7-Mc. performance K3NBU says he'll leave that ground plane up forever. Lennie Chertok the grand master of W3GRF shows his system for keeping track of countries and quotas elsewhere in this report. In addition to the totals by W3GRF on 80-10, Lennie snagged 10 multipliers down on 160. W3QQL demonstrated cool, clear-headed positive thinking, i.e., after smoke poured forth from his rotator control box and couldn't be fixed, he climbed the tower, pointed the beam at Europe and finished out the 2nd weekend. W3RNY credits a score improvement to the ability to change bands rapidly. In a 20-meter solo "go", PYRC's W3AFM summed up 282 two-ways in an even 100 countries. W3BKE's log was among the neater, many thanks, Tom. The boys at the U. S. Naval Academy, W3ADO, did a grand job on 80 through 10 to the tune of "BEAT ARMY." The crew at W3GRS made a "must" list for '64: 1) two receivers, one to check the band and locate the stations the DX is working for zero purposes 2) another to keep those really weak ones tuned in on at all times 3) separate finals for quick band changing. Operating during the 2nd weekend only was K3KMA, his first DX test since '64. Bob used a handful of crystals, 100 watts, a folded dipole, pre-WW II receiver and a lot of patience. After realizing how much fun he missed K3KMA plans a return in '64, modern style, perhaps even a v.f.o.!

The boys at W3WJD had fun and found 23 multipliers on 75 phone calling it no less than fantastic. K3CBW throws in a note of appreciation for the DX operator's request for one district at a time, giving the QRP boys a chance. K3SMN got a laugh at the guy answering in a falsetto to a "now let's hear from the YL." The crew at W3MSK racked up points galore for a larger score in spite of worsened conditions, due to a better set up. The boys at the U. S. Naval Academy, W3ADO, did a fine job at their first year of contesting with Midshipman 4/C K0DQI commenting "the midwest was never like this."

## 1964 ARRL DX COMPETITION

Phone: February 8-9, March 14-15

C. W.: February 22-23, March 28-29

## NUMBER OF COUNTRIES WORKED BY BANDS

LISTED ARE COUNTRY TOTALS  
MORE THAN

30 ON	3.5 Mc.
50 ON	7 Mc.
80 ON	14 Mc.
60 ON	21 Mc.

(Lower Totals Not Listed)

CALL	3.5 Mc.	7 Mc.	14 Mc.	21 Mc.	CALL	3.5 Mc.	7 Mc.	14 Mc.	21 Mc.
K1DIR	34	51			W3TMZ *	45	70	100	69
W1JYH		54	83		W3WJD *	49	72	107	76
W1NJL *	33	55			W4BCV			81	
KIRTB		54	80	60	W4BVV *	36	64		
W1SWX/I	37				W4CKD		80		
W1WY				61	W4DHE	35	66	89	67
WB2APG *	30	52			W4DQS	39	62	84	60
W2AYJ		67			W4DXI		50		
W2CWK			99		W4KXV *	43	58	96	67
W2FXN		62	89	60	W4MCM			90	
W2GGE	30		83		K4RDE	38	69	94	80
W2HAQ			84		W4RQR		61	83	61
W2HMJ		54	86		W4SHJ	36			
W2HO			82		K4VWH		51		
K2INP		50			W4YHD	44	75	89	64
W2SKE *	34				K5AHV		63		
W2VJN		51			W6BYB		67		
W2WZ			84		W6EPZ		63		
W3ADO *	38		82		K6EVR		78	108	
W3AFM			100		W6GRX		53		
W3ALB	38	52	95		W6HQC		56	78	
W3BES		55			W6KG		56		
W3DAO			85		W6RW *		84	108	
W3ECR	35	74	94	71	W8ETU			89	
W3EIV	31	56			W8FGX	37	80	99	74
W3GHM *	33	52	91		W8SJU			101	
W3GRF	43	77	94	76	W8VSK		97	101	75
W3GRS *		55	92		W8ZCQ			80	
W3IYE			89		W9ERU		55	82	
W3KFO *	31	63	89		W9EWC	37	66	95	60
W3KT			92		W9GIL			85	
W3MVB		54			W9WFS			85	
W3MWC *			92	67	W0NFA *	63	105	61	
W3OCU			81		VE2NV	30			

\* Multi-operator

For what transpired on 160 meters, please turn to Operating News, page 92 this issue.

## DX Multioperator Scores

Over 50-K	
PI5ME.....475K	UA6KFG.....101K
VP9L.....338K	1ICWN*.....88K
ON4DY.....255K	OK3KAG.....73K
HA1KSA.....202K	UA6KOD.....73K
HA3KGC.....145K	G3KFX*.....58K
* Phone	

**4** K4LPW, the man in Tenn., in general found things tougher but maintains he's surprised at how well the h. f. c.w. bands held up. First-time contesteer and N. C. winner was K4WVP who feels this contest makes you a veteran in a hurry. An enjoyable highlight for 600-K single op. W4YHD was a QSY to 80 with VQ4IV in broad daylight, 569 both ways on an otherwise empty band. Youthful WA4EDY (14) hopes he topped Ala., he did — Bert has since qualified for DXCC, congratulations! W4DQS was amazed at the excellent 21 Mc opening the northern gang got the first weekend while conditions were very poor down Florida way. W4WEK wants to know if you've ever set the receiver on one band and called on another. (Ed. — You mean there are some that haven't!). K4PKM worked VP8HD and ZL1ABZ in 5 minutes are waiting and chasing them for 2 months.

W0FPA/4 in N. C. enjoyed pulling out choice ones in KW alley on 20 phone with his peanut whistle and dipole. K4HIF's most interesting experience was working ZL2WS on 75, the first call through the pack with the dipole only 15' off the ground, pointed NE-SW. WA4LZM, ex-W5SAY, hadn't planned to enter but caught a 15-meter opening and couldn't resist working 'em, then couldn't stop.

**5** WA5CBL (W0KON) managed to snap up the Arkansas c.w. award with a limited operation while recovering from recent lung surgery. Down in Louisiana, old pro W5BUK finally got caught by Murphy. John says everything went wrong, from funerals to antennas. Hey, W5FJE has his own CRPL predictions! Cedric looks over old logs and turns his beam to probable openings and very often there they are. This system paid off with the New Mexico section award.

K5MDX has reason to be pleased with his A3 332-K. He says friend VK3BM summed up his 75/40 phone operation saying he didn't have the signal of the really big boys (Dave ran 200-500 watts, dipoles and a tri-bander) but seemed to be readable in a pile-up; the proof of the pudding. W5LEF found his Spanish, French and German helping out in those sideband pile-ups. W5AJY reports just 10 of his 165 phone two-ways were on a.m. Over in No. Tex. K5FKD found that his 150 watts s.s.b. really got out. Among the neater phone logs (appearance-wise) was the entry by K5JZY. *Gracias!*

Striking similar poses are, left to right VE4XO and VE2NV. Chas., VE4XO, led Manitoba on both phone and c.w. during the competition while Jack, VE2NV, using an Apache and SB1Q, topped all VEs on c.w. for a resounding 145-K.

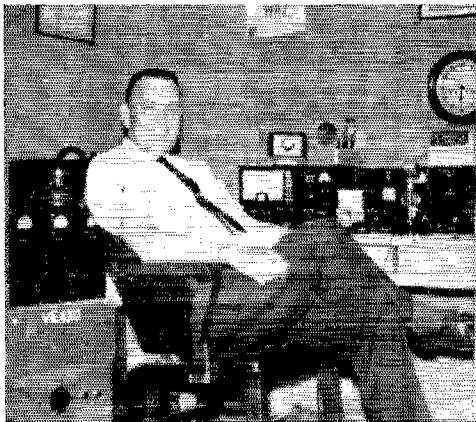

**6** Up in the Santa Clara Valley the staunch supporters of the NCDXC really turn out. W6HOC found it a rough go but reports that the beam really paid off on 40. W6PHE elatedly reported working HZ1AB on 20 after an unsuccessful 4-year chase. You think you had troubles? On January 29 W6MISM lost his beam in a storm and later the same day was hit by a truck, nevertheless replacing that antenna in time. With just 75 watts, WA6SLU got 599 reports from VK VSI DU7 and even worked Europe on 7 Mc. WA6KNE found things confusing what with W6KNE participating on A1. K6TZX found 15 a surprier with considerable activity compared to non-contest times. In L. A. W6TZD found 10 good, with 14 different countries! Hey watch out for W6YY, just casual this year but wait till next! San Diego SCM nominates the following as the best DX c.w. oprs.: W9WNV/KG6 VK2EO VK2GW and W6ZDF/KM16.

A look at the countries/band phone chart will show what the boys at W6HJT accomplished, for a look-see at antennas note the July '63 QST cover. W6PYM found his interest perking up when 10 opened, 17 multipliers too! WA6NJY concludes sideband is inevitable.

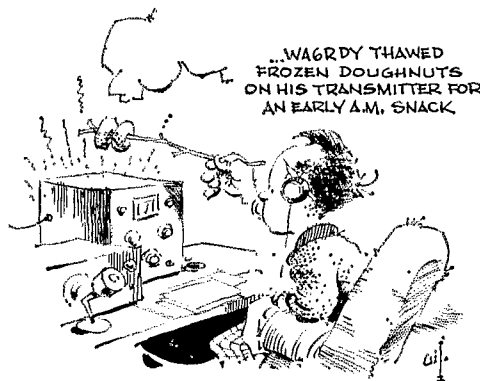

**7** W7DIS from Ore. got 5 new ones on c.w. towards his DXCC finding it ever worthwhile to pitch into the ARRL DX Competition. W7s generally bemoaned the dearth of African activity. After 31 years of hamming, W7POU finally got countries 98 through 101. K7ADL reported that VS4RS said the water was so high it was beginning to come in on the floor of his shack. After a 27-year absence, W7MX returned finding things "slightly" more crowded than in the 20s!

Rare Idaho K7TMJ applauded XE1CV for a fine phone operating job. Over in Utah, W7UOM honestly found it no less than tough what with poor band conditions and a high local noise level. W7DIS finds the club competition a good shot in the arms for clubs and operators both, leading to a nice showing by the Willamette Valley DX Club boys.

**8** W8ZJM bettered 220-K but felt conditions were poor all around at his Centerville Ohio QTH. W8EGR says he didn't tailend even once and feels he should get an award for listening. W8VSK's log represents the culmination of an all-out effort after a year of planning with many thanks to Detroiters W8GB and W8NGO for pointers on working DX . . . his first real contest action since the '32 '39 era at W9KELL. W8SJU says he doesn't know why he keeps doing this at his age but adds, "When's the next one?" K8MTI will be working on education at Duke U. in '64 instead of DX.

After a one-year leave due to a change of QTH, Michigan phone winner W8WT noted more stations using higher power. W8NWO has comment enough in the following ". . . Lost 120' tower 2 days before the 2nd weekend." W8NGO reports he checked his contest logs back to '51 and found this year the only one when WWV transmitted W3. From his Michigan QTH he says that means "take up photography."

**9** In the windy city W9WFS found c.w. conditions fabulous for Europe on 20 during daylight hours. On the other hand W9JGV claims conditions were worst ever. In spite of weekend work, W9AZP found 26 good ones on 40. WA9AUM is disgusted with Ws calling CQ DX while WA9CVI poses the problem "where do all the DX stations go during the rest of the year?" W9SZR, manning W9EWC, reported Wise, conditions better than expected with first weekend conditions superb on 80. W9KXK found 7 Mc. an interesting first-time contest experience. W9RH, holder of the same call for 40 years, met many old friends. W9AOW missed the 2nd c.w. go the hard way, by breaking a leg.

W9GAI sums things up neatly in this lucid quote. "The areas of the world heard on phone and worked during this so-called off-year proves to me that while the sunspots may effect circuit strength and reliability, the possibility of amateur communication is dependent on activity in the DX countries. Although weak they were, they were there and being worked." Congratulations to WA9ENF for one of the neatest voice log reports received this year.

**Ø** WØCQC found it great even with a peanut whistle but the best was when he beat a buddy and his k.w. three times in a row on 21-Mc. c.w. KØAYO suffered from a terrific line noise on 20 and 15 and wandered up and down alleys at 2200 looking for noisy poles, etc, with a transistor set but managed only to find numerous neighborhood dogs. The WØNFA group found the c.w. test a real shake-down for the equipment, wound up having a grand time and achieved 525-K. KØLSG at KØMIC, the U.S.A.F Academy, worked 42 on 7 Mc., a real treat hearing Europeans on 40 for the first time. Antenna changing was a real chore for Kurt, requiring a climb to the top of the dorms to change fittings — best time was 25 minutes. That plus the losses involved in 700' of coax made it tough indeed to rack up that 178-K and the Colorado award. YL KØIKL of Minn., a star of the Twin City DX Club, found 20 a revelation the 2nd weekend, helping "up" her countries worked total to 216. Still problems at home with meals to fix and kid-style QRM to contend with.

WØUCK says it would sure be nice if the W/VE phone boys would listen to the DX and figure where he's listening. At KØAXU the boys found sideband fine but did discover that the a.m. rig helped out very well, especially on 40.

**VE** VE2NV's outstanding c.w. Canadian score comes by way of good multipliers on 80-40-20-15, a nice log too! Ontario activity was fine with VE3BOG finding it a good contest, ditto conditions, but a tough go the 2nd half thanks to Murphy and the flu. VE3ES found 20 good, 15 spotty. VE7BHN reported B. C. conditions on 20 while VE7AHG/7 was disappointed by not being able to break through to Europe on 80.

WA4EDY, top c.w. from Alabama, has held his General Class license for 14 months but acts like an old pro in chasing DX. Besides the section award, Bert holds DXCC.

## NUMBER OF COUNTRIES WORKED BY BANDS

LISTED ARE COUNTRY TOTALS  
MORE THAN

5 ON	3.8 Mc.
20 ON	7.2 Mc.
50 ON	14.2 Mc.
50 ON	21.25 Mc.

(Lower Totals Not Listed)

CALL	75	40	20	15	CALL	75	40	20	15
W1AW	7				K41IF	6			
K1DIR	20				W4MCM			67	
K1RTB	8		58		W4OM			63	
W1FZ			50		W4OPM			57	
WINJL *	16				K4QBP			52	
W1ONK	18		70		K4SXT	8		58	
W1ZFV	20		59		K4TEA	12			
W2FXN	10	27	80		W5AJY	6			
K2GXI	17	40	61		K5JZY	8			
WA2HOK			57		W5KC	6			
K2IEG	21		101		K5MDX	18	49	81	
K2PZF			63		K6ERV	8			
W2QKJ	10				W6FYM	5			
W2SKE *	28	24	57		W6HJT *	11	30	79	53
W3ADO *	15		64		W6RCD	7			
W3ALB	15		69		W8NGO *	13		63	
W3EQA	5				W8NWO *	20	29	74	
W3HHK *			59		K9ECE			54	
W3IYE	12		50		WA9ENF	11			
W3JTC			76		W9GIL			55	
W3KFQ *	11		73		K9VRU	10			
W3MCG			50		KØAXU *	5			
W3MSK *	24	36	87	67	KØIKL			52	
W3OCU			65		VE2WM	20			
W3TLN	8		68		VE3FLO	13			
W3WJD *	23		66		VE3PV	5			
W4BCV			57		VE4XO	7			
W4BVV	23	30	59		* Multi-operator				

On phone, VE2WM reported 75-meter conditions quite good the first weekend leading to pileups 6 deep at times. He reports appreciation for the excellent cooperation from the boys overseas. Although openings seemed shorter, VE3ES reported surprisingly good phone conditions on 20 during the February weekend. VE3PV after hunting VR3O for ages finally made, of all bands on 75.



DX COMPETITION C.W.

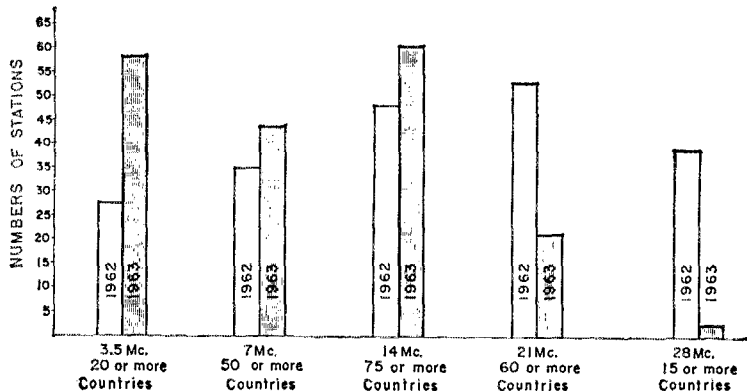

This visual comparison of the past two c.w. competitions makes it pretty clear just what happened to the m. u. f.!

AFRICA

Perennial EA9AP reported poor c.w. conditions in Sp. Morocco on 40-20-15. In a single hour-long appearance on Feb. 23, EL2PN caused a brief flurry by working 37 in 8 areas. F88XX was a fine multiplier for some and an honest reporter to boot — only one 599 given and that to W7PHO. ST2AR, 2nd high code score on the continent, reported that 21 Mc. showed once again that band conditions are generally good, just a plain lack of activity outside of contest times. Multiopr. ZD6OL trekked to the summit of Zomla Mt., 8000' high, and found Murphy in the form of an invasion of African red ants, reducing 2nd weekend operating hours to 9 after exterminating was accomplished. 5N2RSB got a new state and found the c.w. portion a fine test for W/K but what I happened to VE/VO? Continent code leader 5AITW did best on 21 Mc. for 535 two-ways though best multiplier on 20. The ubiquitous Bob Roberts adds 5X5IU to the calls-I-have-held list, currently including VU2DB G2HIL D2CH DL2CH SU1REC ZC4CH VQ5IU.

Continental leader ET3USN spent 9.1 hours on 20 phone alone snagging 226. One of the higher-up QTHs in this competition found ET3USN (K4JRW) operating A3 from an altitude of 7600' in Asmara, Eritrea. An interesting note on F7RZC/J's log, "If I've won for Juan de Nova, please mail the phone award to my home address at W4BPD." (Ah, come on, Gus.) 601WF reported awesome pile-ups on 20 when the phone bands opened with just one chap losing his temper.

ASIA

It's quite an event if 3 fellows show up from E. Pakistan! It was so in '63 when the Tiger ARC turned in c.w. reports from 3 members, AP5s CP AH JA. In a 32-hour sprint at HL9KH, the enthusiastic W9WNV totalled 1124 code exchanges. Another familiar stateside call, W1TYQ, manned the works at HZ1AB. The big score in exotic Asia was from JA1VX, close to 226-K with a big showing on 20. KR6BQ (KØPIV, CN8IF) reported that c.w. conditions were considerably worse the 2nd weekend with 20 fading frequently. VS11P reported having a great deal of fun in the test and an especial thrill working W4KFC and W3MSK on 40, for his very first two east-coast exchanges.

Vocal reports from Asia were dominated by the consistent reports from Japan. Big or small, scores were turned in to make this report as complete as possible. The Asian phone leader HL9KH put in 24 hours for 652 QSOs from Korea. JA1ANA led A3/JA entries averaging about 20 QSOs/hour.

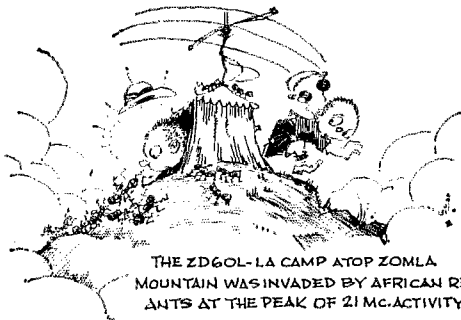

Top Asian phone was HL9KH with 80-K. During the c.w. portion Don led Korea at HL9KH with 195-K and livened things up considerably with a sojourn to Rota in the Marianas as W9WNV/KG6 to the tune of 193-K.

Single-Operator DX, over 200-K

HC1DC . . . . . 1,028,568	W6ZDF/KM6 . . . . . 277,068
YV5AGD . . . . . 652,092	G4CPC . . . . . 266,580
NE1CCB* . . . . . 588,720	HK7ZT . . . . . 262,224
NE1CY* . . . . . 585,298	LUI1AB* . . . . . 259,302
HC1DC* . . . . . 487,272	GW3JJ . . . . . 251,883
KV4CF . . . . . 461,196	ZP9AY . . . . . 249,015
HP1IE . . . . . 456,459	VP5BP* . . . . . 241,215
CE1AD . . . . . 370,992	CP3AG . . . . . 241,152
OX3DL . . . . . 360,900	KZ5AF* . . . . . 237,750
NE2OK . . . . . 329,706	JA1VX . . . . . 225,992
YV5AGD* . . . . . 318,087	HB9JG . . . . . 222,805
YV4AV . . . . . 303,844	OK1ZL . . . . . 215,028
KP4CC . . . . . 294,624	PA6LOU . . . . . 206,754
HK7BE . . . . . 284,580	YV1IK* . . . . . 204,724
	TG9SC* . . . . . 202,725

\* Phone

XE1CCB created quite a splash down Mexico way with the top single-operator phone DX score and third high score in both competitions. With few exceptions Earle feels that the W/VEs are top ops, patient and cooperative. Look for him from KP4BOQ in '64!

### EUROPE

DL7AA's log, an interesting report using different colored inks to differentiate band changes, summed up a fine A1 performance: 734 contacts on 20, 392 on 10. DJ2SR joined in the fracas for the first time and discovered how easy it was to work a relatively high number of stations. EI9J did a bang-up job for his country award and included a sojourn on 160 for 16 QSOs and 5 areas. F8IH led his country with 1151 exchanges, putting 6146s to the task on 80-10-20-15. F8VJ, League member since '35, also broke 1000 QSOs for 160-K. A rare and most welcome addition to our current competition was the brief appearance of F3AT. G1CP, continental champ with 267-K, bettered his sterling performance of '62 by about 2000 points. G6BQ put in a little over 4 hours in on the top-band, and came up with 15 contacts — mighty fine, Jack! G2RO was happy to report a higher standard of operating. In Northern Ireland, G13OQR found 40 poor, but many fine signals coming through on 80. G13OTV reported a dearth of VE/VO. GW3JI's big band was 20, 850 exchanges keyed thereon, an excellent reporting job and the Wales award. In a rare change of pace, HB9JG, Swiss leader, hopes for poorer conditions in '64 with possibly less QRM. I1GO found his first competition an exciting and interesting experience. Giuseppe plans more than 45 hours at the key next year. In Finland, 17-year young G1E2BZ, certificate winner, hopes some of the Ws will please QSL. A tremendous turnout and subsequent reporting job by the OKs brought in seeds of c.w. logs, topped by a grand performance from OK1ZL. PA6LOU reported in a most interesting fashion, preparing a table of call areas per band, QSOs and percentages thereon. Louis says it doesn't prove anything but it makes it clear that the eastern states are heavily populated with hams and conditions weren't too bad. However, the western states came through very well on 20, at times W6s and W2s pounding in at the same strength.

EI4AK, tops in phone for Europe, found propagation poor both Sundays but had thought he had broken 700 QSOs until he started scratching dupes. One of the interesting sidelights of this annual affair was the log presentation submitted by the boys at ICWV (11s AUP CWN NU ZEN). The beautifully bound and embossed report illustrates the enthusiasm these "old-timers" brought to their first sideband endeavor. They all voice a "thank you" to the W/VEs and their ability to "get through." LA5HE reported that it was very nice to see so many sidebanders on 40 and that he would appreciate confirmations for all new contacts. Phone fanciers in G-land reported well while over



in Estonia OT UR2BU reported conditions poorer for phone than for the c.w. portion of the competition.

### NORTH AMERICA

Tops in N. A. for telegraphy for '63 with 161-K is KV1CF with a walloping 2238 QSOs and 69 multipliers from 80-10. OX3DL reported fair conditions while bemoaning difficulties with the mail situation. Ole plans to double his 36-K next year. Old reliable KP4CC, continent champ last year, hopes his health will permit a return in '64. So do we, Juan! In a one-weekend-only sojourn, two of the top N. E. ops, W1E HHH and EOJ, teamed up with W2ADE and W9GVZ to put on a dazzling display of c. w. know-how on an expedition sponsored by the Conn. Wireless Assn. The 42-hour score of 475-K demonstrated the effectiveness of top-notch ops, albeit modest power (100 watts). Over in the Barbados, 3 of the ops, at VP6LJ found forty so much fun that they were reluctant to venture into the realm of 14 Mc. Another big Caribbean performance was presented by WINBA and W2YTH joining JC, VP9L, in a 2000-QSO endeavor, doing fantastically well on 80 and 40, let alone 20. HP1EE got the most multipliers when on 15 and we gratefully report did a fine reporting job, removing his own duplicates, etc. It looks as if some W/VEs have neglected using Operating Aid #6! South of the border down Mexico way, when the boys get on they really do it big . . . witness the c.w. performances of XE2OK at 330-K and XE1VT at 161-K.

### CLUB SCORES

	Score	Valid Entries	C. W. Winner	Phone Winner
Frankford Radio Club	8,323,294	68	W3ECR <sup>1</sup>	W2FXN
Potomac Valley Radio Club	6,356,116	33	W3GRF	W4BVV
Northern California DX Club	3,194,763	45	W6KC	K6BBV
Southern California DX Club	2,126,418	15	W6ZD	W4OM
Virginia Century Club	1,693,262	13	K4RDE <sup>2</sup>	W4OM
Order of Hotted Owls of New York	1,449,969	11	W2AYJ	W4MCM
Southeastern DX Club (Ga.)	917,328	12	W4MCM	W4MCM
Ohio Valley Amateur Radio Assn.	859,269	3	W8FGX	W8IBX
Order of Hotted Owls of Ohio	620,161	7	W1JYH	W6EPZ
Connecticut Wireless Assn.	551,042	6	W1JYH	K1RTR
San Diego DX Club	528,623	8	W6EPZ	W0MPW
Nashua Mike and Key Club (N. H.)	492,377	4	K1RTR	W9GIL
Twin City DX Club (Minn.)	474,762	5	W0MPW	W9GIL
Milwaukee Radio Amateurs' Club	462,109	7	W9GIL	W5FJE
Germanatown Radio Club (Pa.)	326,157	4	W5FJE	W5FJE
Order of Hotted Owls of New Mexico	324,857	8	W5FJE	W2DAJ
Waltham Amateur Radio Assn. (Mass.)	307,851	4	W2DAJ	W42TJA
South Jersey Radio Assn.	295,018	18	W2DAJ	W7GBW
Lake Success Radio Club (N. Y.)	188,602	8	W42TJA	W2TUK
Willamette Valley DX Club (Ore.)	173,139	12	W7GBW	W7DIX
Springfield Radio Club (Ohio)	149,802	4	K8DEO	W2TUC
Niagara Frontier DX Assn. (N. Y.)	146,156	6	K2PQC	W2GKZ
Suffolk County Radio Club (N. Y.)	140,181	4	W2GKZ	K8ZPK
West Park Radlops (Ohio)	134,829	9	K8ZPK	W2BJH
Rochester DX Assn. (N. Y.)	131,217	5	W2BJH	W8CQN
Central Michigan Amateur Radio Club	114,807	5	W8CQN	W4DVT
5 Towns Radio Club (N. Y. Club)	83,812	3	W4DVT	W3LIV
Lynchburg Amateur Radio Club (Va.)	71,013	3	W4DVT	W3LIV
Horseshoe Radio Club (Pa.)	70,476	7	W3LIV	W3LIV
Northwest St. Louis Amateur Radio Club	44,943	3	W3LIV	W3LIV
20/9 Amateur Radio Club (Ohio)	39,466	4	W3LIV	W3LIV
Chicago Suburban Radio Assn.	38,338	3	W3LIV	W3LIV
Motor City Radio Club (Mich.)	15,516	4	W3LIV	W3LIV

<sup>1</sup> W3MFW, opr. <sup>2</sup> K4SXT, opr.

FY7						
G-@	2PL	2DC	6BQ	5CP	8FF	4DP
GC						
GD						
GI						
GM						
GW						
HA						

OT W3GRF, top W/VE c.w. single-op., utilizes sheets similar to this extract for each band. A glance at this check list avoids duplicate QSOs and over-quota calls. Additionally, the numeral following the country's prefix indicates to Len on what page of his ARRL logs he enters England contacts, for example.

#### SOUTH AMERICA

KZ5GRS at KZ5AF enjoyed his first phone contest from a DX location. KZ5LC reported an improved standard of operating in general, with tail-enders still remaining a big problem to DX stations. Canadian Director VE3CJ down at his Caymans location VP5BP commented on the outstanding performance of 15 and the excellent habits and manners of most operators. Noel managed 17 multipliers on 75. An interesting sidelight is the 6 meter venture by VP7CX. Hal found 51 contacts in 4 areas on 50 Mc! No less than great was the phone competition south of the Rio Grande where final totals of less than 3 thousand points separated XE1CCB and XE1CV. XE1CCB, top phone single-op., with a sum of 2455 contacts after removing his own duplicates, found multipliers galore on 75-20, totalling 588,720. Earle's new QTH is c/o PRIMAICO Box 595, Caguas, Puerto Rico. XE1CV with over 2000 QSOs and all areas on 15/20, 19 areas on 40 and 18 areas on 75 and 10 plans an even better than 585,296-pointer come '64. In general Carlos found lots of activity in spite of poorer band conditions.

#### OCEANIA

Continental high-scorer for Oceania was the Midway entry of W6ZDF/KM6, 277-K on a 5-band operation. With 160 watts input and a 270' longwire, Jack had a ball — but reports spending the first weekend just getting rid of the W6s! Many a W/VE bemoaned the dearth of VK signals, alleviated somewhat by VK5NO: Tubby did right well in his 50-hour "go," finishing up with 189-K. Making it easy to confirm Marianas contact was the W9WNV operation from Rota. Running a k.w. on 10-80, Don scored 193-K in just 28 hours. Murphy played a dirty trick on F08AA shutting off the a.c. from 0951 GMT March 21 through the end. Regardless, 1224 QSOs in 48½ hours is fine indeed. ZK1AR was a welcome addition on 5 bands for 990 W/VEs. ZL1AMO upheld the honor of New Zealand reporting 701 with a 61 multiplier, about 128-K in 27 hours. More VK/ZL signals and reports in the '64 Competition, we trust.

Where oh where were the phone logs from Oceania? Outstanding things did occur, witness the Oceania-topping score by YR30, with 174-K — on a one weekend stint! Martin noted that he worked more call areas on 75 than any other band. ZK1AR regretted equipment troubles during the February weekend (oh that Murphy!).



With a KWM-1 and a TA-33, KC6BK in the Eastern Carolines proved most popular to both phone and c.w. followers. Stan plans big things for '64.

Two walloping scores were submitted from Chile, CE1AD with 371-K and long-time contesteer CE3AG with 241-K. Along with CE2OF these chaps dispensed 3577 CE two-ways. A thrilling highlight of the 1963 ARRL DX Competition was the million-plus code compilation by HC1DC. This mathematically-minded maestro started out with the definite goal of breaking a million points and with conditions holding up well, Don hit the mark with an hour and 15 minutes to spare. Final code results for a 76¼ hour stint were 3609/95 for 1,028,565 — the fourth highest ever recorded single op. A truly amazing performance in a year of low sunspot activity. Over in Colombia, HK7BE found our affair well organized and gleefully reported he has finally cornered Utah and Idaho to complete his WAS. After a 30-hour stint, PJ2AE can only say "now I know I'm nuts." Down in Venezuela, YV5AGD operated 6 bands for an impressive 652-K, which included 36 QSOs with a multiplier of 12 on the "top band."

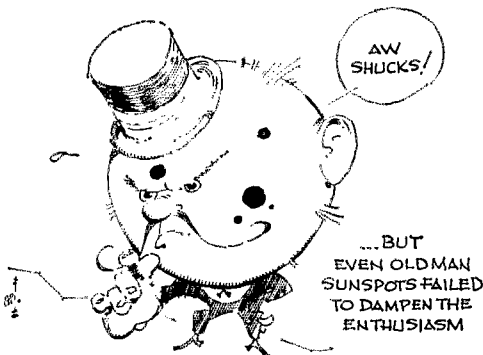

Phone-wise there was a fine degree of activity in S. A. highlighted by the 59-hour vocal stint by HC1DC. Don reports starting the event with one of the worst sore throats of his life, which improved as he talked! Most QSOs were on 20 (934). Interesting to note were 2 contacts on 160 (8th and 2nd call areas). Indignation was voiced by many DXers for the carelessness by W/VEs in repeat contacts, keeping the DX from working valid additional QSOs. LU1DAB affirms the situation. Hey, who said 10 was dead? LU1DAB made 552 exchanges thereon! PJ2AF tallied 181-K prior to returning to W4-land and retirement. Competition in YV-land was keen with YV5AGD leading the group with 318-K, a notable improvement over his last year's score. Eva, YV1IK with 205-K, afforded interesting competition and was said to report a miss again on Vermont. A beautifully typed log, dupes clearly marked, f.b.! YV5BPG reports being favorably impressed by the fine operational practices of the W/VE contingent.

#### Disqualifications

The following are deemed ineligible for score listing or awards. In each case disqualification under contest rule 14 was in view of non-observance of FCC rules as reported by at least two accredited Official Observers, or by a single FCC citation. Such violations as out-of-band operation, phone splatter outside band edges, key clicks and spurious signals, etc. were the criteria for these disqualifications: C.w. — W1MX K3ELL W3MSK W3WPG WA4DCP W4KFC W4PTR W6PBI W6GYM X K7RQX W8CLD W9LRH K9WRX; Phone — W2WZ W3GEM WA4DCP K5SEK W6QNM W9NZM.



## Twenty-Ninth ARRL International DX Competition

Operator of the station first listed in each section and country is winner for that area. . . . The multiplier used by each station in determining score is given with the score — in the case of U.S.-Canada this is the total of the countries worked on each frequency-band used; in the case of non-W/K/KH6/KL7/VE/YO entries it is the total of the U.S.-Canada districts worked on each band. . . . The total number of contacts is listed next. . . . The letters A, B, and C approximate the input to the final stage at each station; A indicates power up to and including 150 watts; B indicates over 150 watts, up to and including 500 watts; C indicates over 500 watts. . . . The total operating time to the nearest hour is given for each station and is the last figure following the score. . . . Examples of listings; W3ECR 600,480-288-695-BC-80, or final score 600,480; multiplier 288; 695 contacts; power over 500 watts; total operating time 80 hours. . . . Stations manned by more than one operator are grouped in order of score following single-operator listings in each section or country tabulation; calls of participants at multi-operator stations are listed in parentheses. . . . In sections or countries where three or more multiple-operator entries appear, the top-scoring station is being awarded a certificate.

### C.W. SCORES

#### ATLANTIC DIVISION

<i>Eastern Pennsylvania</i>		<i>W3ETA (5 ops.)</i>	
W3ECR1	600,480-288-695-BC-80	97,398-126-259- C-10	
W3ALB	445,050-258-575- C-70	K3NTD (K3s NTD OMP)	
W3BES	327,240-216-505- C-50	324- 9- 12- B- -	
W3OCU	308,258-207-502- C- -	<i>Maryland-D. C.</i>	
W3DAO	235,152-184-428- C-80	W3GRF	678,930-305-742-BC-90
W3HHK	229,710-190-403- C-45	W3BIV	330,750-225-490-BC-75
W3IHS	219,096-179-408- B-52	W3MYB	241,878-182-443-AC-55
W3KTT	201,872-183-379- C- -	W3MFE	162,162-154-351- C-60
W3EQA	173,250-168-350- C-55	W3KA	140,346-138-339- B-38
W3DBX	148,950-150-331- B- -	W3MCG	119,136-136-292-BC-30
K3JNP	99,685-129-255-AC-50	W3FRZ	117,180-126-310- C-46
W3HNI	94,656-116-272- C- -	W3MSR	111,375-135-275- C-38
W3EYW	66,402-102-217- C- -	W3QQL	109,242-126-289- B-43
W3FDH	60,900-100-204- C- -	W3RNY	98,040-129-254- C-52
W3BIP	46,992- 88-178- C-22	W3AFM	84,600-100-282- C-46
W3MLV	43,296- 82-177- B-62	W3QZ	80,712-114-236- C-41
W3GED	37,548- 84-149- B- -	W3ABL	32,501- 93-153- C-20
K3MNI	33,534- 69-192- C-12	W3BLS	33,152- 74-150- B-31
K3HTZ	32,508- 84-129- A-35	W3BKE	14,040- 45-104- B-20
W3CAA	31,484- 60-152- A-25	K3QXP	10,062- 39- 86- A-33
W3CTJ	29,400- 70-140- C-12	W3EPR	8316- 44- 63- C-20
W3QLW	29,388- 62-158- B-32	W3WU	7752- 34- 76- C- -
K3NBH	29,770- 70-137- C-20	K3KMA	2139- 23- 31- A-18
W3NHU	29,575- 75-127- C-15	W3YKQ	462- 11- 14- B- 4
W3KDF	21,717- 57-127- C-10	W3BVO	300- 10- 10- B- 5
K3BUR	16,125- 43-125- B- 4	W3TMZ (5 ops.)	
W3HFA	15,960- 56- 95- C-13	657,972-294-746- C-93	
W3AEM	8775- 45- 65- C-13	W3ADO (6 ops.)	
K3RFB	5040- 30- 56- B-26	386,552-229-564- C-96	
K3MNT	3948- 28- 47- A-15	<i>Delaware</i>	
W3DYL	3666- 26- 47- C- 8	W3IYE	268,983-209-429-AC-50
K3NDG	3591- 21- 57- A-15	W3DRD	95,976-129-248- C-41
K3MBQ	2871- 29- 34- B-10	K3SMN	48,060- 90-178- C-40
W3QIR	1296- 18- 34- B-10	<i>South New Jersey</i>	
K3JGJ	855- 15- 19- A- 4	W2FXN <sup>2</sup>	417,425-235-585- C- -
K3QMP	741- 13- 19- A- 4	W2DAJ	442,408-148-332- C-48
K3LJZ	624- 13- 16- A- 2	W2GGL	124,845-145-287-BC-61
W3PN	297- 9- 11- B- -	W2HDW	115,062-127-302- A-30
K3KLE	196- 8- 8- B- 5	W2SDB	74,229-109-227- C-36
W3URE	192- 8- 8- B- 5	W2QDY	67,266-111-202- A-60
K3TEB	147- 7- 7- A- -	K2OEA	35,757- 87-137- A-25
W3LEZ	90- 5- 6- B- 2	W2IEK	27,306- 74-123- C-41
K3LWY	12- 2- 2- A- 3	K2CPR	25,842- 73-118- B- -
W3WJD (K3JJG, W3WJD)		W2IZS	20,703- 67-103- B- -
658,035-315-697- C-93		W2NSJ	13,515- 53- 85- B-20
W3KPF (K3UGJ, W3KPF)		W2FYS	9462- 38- 83-AB-18
47,972-244-571- C-85		K2SQM	6208- 32- 66- A- -
W3MWC (K3s JLL, LJZ, W3MWC)		W2ZVW	4032- 32- 42- A-10
394,092-246-534-AC-96		W2QKJ	3450- 25- 46- B-20
W3GRS (K3JCT, W3GRS)		W2REB	3078- 27- 38- B-10
380,457-231-549- C-94		K2BGB	2622- 23- 38- B- 6
W3GHM (W3s GHM KDF NOH)		W2BFF	1311- 19- 23- B-21
367,740-227-540- C-70		W2BEL	648- 12- 18- A- -
K3NUM (K3s DFK KPV)		W2BRW	561- 11- 17- A- 6
177,840-156-380- C-75		K2BYK	378- 9- 14- A- 5
W3YUW (W3s BGN YUW)		W2BKS	182- 6- 9- B- 6
145,530-147-830- B-90		W2UOF	21- 3- 3- A- 2
W3QMZ (K3JXX, W3QMC)		W2BAPG (W2BBLV, W2BAPG)	
112,068-132-283- C-92		230,400-192-100-AC-96	



"Roger DL3LL, K5MDX 59 Mississippi-over." As usual, K5MDX is in there with a big score on phone, leading all the W/VE single ops in '63 with 332-K. Dave runs under 500 watts a. m. or sideband, but manages to get through consistently. A 50' high tri-bander and dipoles for the lower band takes care of the radiating end from a location Dave claims is just not suitable for DXing.

<i>Western New York</i>		K9YRA	231- 7- 11- A- 2
K2TQC	139,104-144-322- B-50	W9ACS	48- 4- 4- A- 2
W2BJH	101,760-128-265- C-55	K9KILK	12- 2- 2- A- 2
K2INP	77,550-110-235- C-35	<i>Indiana</i>	
W2LX	57,600-100-192- C-55	K9VRU	22,563- 69-109- C-50
W2QQ	18,585- 59-105- B-20	K9LVK	10,512- 48- 73- A-45
W2WGL	16,068- 52-103- B-26	W9MUR	9786- 42- 79- B-30
W2TVT	12,420- 46- 90- B-10	W9EGQ	6912- 36- 65- C- 9
W2HUV	5508- 34- 54- A- 7	W9LKI	3528- 28- 42- B-21
W2AFN	3537- 27- 45- A-15	W9AUM	2808- 26- 36- A- 9
W2SSC	2652- 26- 34- A- -	K9100	3700- 25- 36- A-24
W2AUKA	495- 11- 15- B-11	W9KPN	2075- 25- 29- B- -
<i>Western Pennsylvania</i>		W9ACVI	714- 14- 17- A- 9
W2LIV	37,584- 72-174- C-52	<i>Wisconsin</i>	
W2BVP	29,547- 67-147- A-31	W9EWC	496,472-271-612-BC-80
W2KQD	7560- 36- 70- B-21	W9RQM	209,208-184-379- C-55
W2QPF	2376- 24- 33- A-18	W9GIL	195,693-173-377- C- -
K2OLG	565- 11- 17- A- -	W9VZP	145,440-160-303- C-68
<b>CENTRAL DIVISION</b>		W9KXK	126,072-136-309- C-58
<i>Illinois</i>		W9QYW	108,936-136-267- B-43
W9PERU	294,168-260-479- C-66	W9IHN	64,155- 91-235- B-30
W9WFS	128,904-164-262- C-45	W9RKP	39,444- 76-173- C-24
W9JGV	95,700-100-199- C-52	W9VSO	28,480- 55-112- - -
W9BUD	11,085- 83-165- C-27	W9RH	21,490- 60-136- C-28
W9WYB	35,280- 84-140- C-16	K9OPE	10,320- 43- 80- A-18
K9YOE	25,477- 71-129-AB-30	W9DTE	6912- 36- 64- B-23
W9GMS	25,179- 77-109- B-40	W9AOW	126- 6- 7- B-10
W9WIO	24,495- 71-115- B-16	<b>DAKOTA DIVISION</b>	
W9FTD	24,453- 57-143- C-30	<i>North Dakota</i>	
W9IIV	19,110- 65- 98- C-27	K9QWY	918- 17- 18- A- 3
W9DGG	14,681- 53- 93- A-45	<i>South Dakota</i>	
W9WHY	11,352- 43- 88- C-21	W9BLZ	62,073- 99-209- C-35
W9AZP	10,128- 48- 71- C-20	W9WUU	5184- 36- 48- B-13
K9DWG	8532- 36- 79- B-16	W9BMMW	1455- 33- 45- A-20
W9QQG	4416- 32- 46- B- 6	W9CUC	1620- 20- 27- B-15
K9GSD	4278- 31- 46- A- 4	<i>Minnesota</i>	
W9QM	4116- 28- 49- C-21	W9MPV	172,890-170-339- C- -
W9YDQ	3388- 28- 41- B- -	K9KLL	118,428-139-284- C-67
W3ZYD	2652- 26- 34- - -	W9YCR	107,442-127-282-BC-65
W9TCU	855- 15- 19- A-19	W9PNQ	63,228- 78-142- B-12
W9AQN	714- 14- 17- A-10	<b>W/VE High Scorers — Under 150 Watts Only</b>	
W9EVX	396- 11- 12- A- 5	<i>C.W. — Over 50-K</i>	
W9GML	297- 9- 11- B- 7	<i>Phone — Over 10-K</i>	
K4TEA	172,935	K9ECE	59,691
W9BTD	161,564	K5FKD	41,580
W2ARZ	76,010	W9BTD	32,760
W4FZW	69,042	K4TEA	18,156
K1LPL	69,015	VE3PV	16,836
W2QDY	67,266	K5YUV	14,784
VE7EH	61,812	VE2AMW	12,474
W2NUM	61,760	W9FPA/4	12,054
W2HUG	55,872	VF7EH	11,550
W8CQN	52,398	WA4ARV	10,011

## DX Continental Champions

Single Operator

C.W.	Phone	
5A1TW . . . 154,224	Africa	ETBUSN . . . 11,577
J41VX . . . 225,992	Asia	HL9KH . . . 80,262
G4CPX . . . 266,580	Europe	EL1AK . . . 70,074
KV4CF . . . 161,196	No. America	XE1CCB 588,720
W6ZDF/KM6		
277,068	Oceania	VR3O . . . 173,880
HC1DC . 1,028,565	No. America	HC1DC . . 487,272

### DELTA DIVISION

Arkansas	
WA5CBL . . . 41,010-95-146	C-30
K5TYW . . . 18,848-63-100	C-16
W5DRW . . . 17,326-55-76-BC-35	
W5GFT . . . 2754-27-34	B--
Louisiana	
W5KC . . . 135,900-150-302	C-64
W5BUC . . . 47,595-95-167	C-50
W5FRU . . . 5616-39-48	C-30
W5AJL . . . 2079-21-33	--
W5KWY . . . 1914-22-29	B-14
W5JPB . . . 324-9-12	B-3
Mississippi	
W5CKY . . . 225,792-196-384	C-13
Tennessee	
K4LPW . . . 172,815-167-345	B-50
WA1CGA . . . 23,596-68-117	B-27

### GREAT LAKES DIVISION

Kentucky	
W4BCV . . . 319,039-177-160	C--
W4EPA . . . 124,278-154-289-A-C-40	
W4JFW . . . 77,499-109-237	C-26
Michigan	
W8VSK . . . 477,717-280-555	C-68
W8UCU . . . 133,608-152-293	B-60
W8SCL . . . 62,730-102-205	C-30
W8CQN . . . 52,398-82-213	A-65
W8S1R . . . 45,675-87-175	C-30
W8EWA . . . 42,314-79-179-A-C-29	
W8VPC . . . 32,625-75-145	C-40
W8MCC . . . 16,995-55-103	C-29
W8EGR . . . 15,423-93-97	B-10
W8EFO . . . 9417-43-73	B-6
W8BNE . . . 7956-39-68	B-16
W8SS . . . 7206-38-64	C-12
W8ROO . . . 7035-35-67	A-9
W8WTT . . . 6105-37-55	C-16
W8RXY . . . 5394-29-62	C-10
K8AEB . . . 810-15-18	B-6
Ohio	
W8FGX . . . 621,621-299-693	C-89
W8ZJM . . . 223,410-196-380-BC-E2	
W81BX . . . 159,970-70-319	B-47
W8S1J . . . 125,532-132-317	C-55
W8FTU . . . 121,716-138-204	C-50
K8LEE . . . 113,400-110-270	C-60
W8ZCQ . . . 105,726-134-263	C-75
K8DEQ . . . 76,690-120-213	C-50
W81RG . . . 72,357-89-271	C-35
K8MTI . . . 66,297-111-199	B--
K8SWE . . . 61,272-92-222	B-51
W8KMD . . . 38,250-85-150	C-31
K8ZPK . . . 31,968-72-148	C-3
K8NMG . . . 31,920-80-133	B-36
W8GMK . . . 30,414-74-137	A-27
W8CJN . . . 28,080-65-144	C-32
W8YPT . . . 25,200-75-112	B-12
W8OQV . . . 14,550-50-97	A-0
W8KC . . . 11,040-46-80	C-20
W8CHZ . . . 8484-42-68	B--8
W8AJW . . . 5040-35-48	B--8
W8YGR . . . 4794-34-47	A-12
ESANX . . . 2730-26-35	B-4
W8KFM . . . 2148-24-34	A-5
F8NEK . . . 1122-17-22	A-6
W8VZE . . . 765-15-17	B-2
K8OZL . . . 510-10-17	C-8
W8CAG (W8 BWQ CAG)	
70,632-108-218	C-19

### HUDSON DIVISION

Eastern New York	
WA2OJD . . . 307,632-208-193-BC-75	
W2HO . . . 262,200-190-160	C-71
WA2IGC . . . 104,532-124-281	B-65
W2AWF . . . 38,880-72-180	C-31
WA2HLH . . . 30,396-68-150	A-26
W2BFMK . . . 15,228-54-94	B-4
W2VIR . . . 12,943-43-103	C-2
W2PPDU . . . 12,450-50-83	A-0
W2AJM . . . 4704-28-56	A-15
WA2RUD . . . 4705-9-15	A-10
K2ZEM . . . 189-7-9	C--
WA2SLQ (WA2s QM V QM X SLQ)	
3307-39-71	A-25
N. Y. C.-L. I.	
W2AYJ . . . 328,536-216-507	C-54
W2WZ . . . 270,972-193-488	C-38
W2HAG . . . 184,320-160-384	C-43
W21RV . . . 184,194-162-370	B-57
W2HJM . . . 164,934-147-374	C--
WA2TJA . . . 160,768-157-542	C-37
W2PCU . . . 133,545-145-307	C-38
W2BCKS . . . 125,706-146-289	C-57
W2ZKQ . . . 102,912-134-250	C-35
K2CHL . . . 87,792-121-236-BC-54	
W2JDL . . . 80,845-115-297	B-45
WA2RUB . . . 76,010-110-238	A-78
W2MUM . . . 71,760-104-230	A--
W2GKZ . . . 70,725-115-205	C-7
K2ZVR . . . 44,132-84-191	A--
W2YCW . . . 41,232-83-178	C-53
WA2KSD . . . 38,889-87-149	ABC-20
W2GKW . . . 211,417-519-121	B-35
WA2YLL . . . 16,377-53-103	A-25
WA2V1K . . . 12,000-40-100	C-12
W2BHO . . . 9,925-53-75	C-8
W2CWD . . . 11,475-45-85	C-8
WA2DNQ . . . 8904-43-78	A-25
WA2IZV . . . 9348-41-78	AB-10
K2CF . . . 7620-45-58	C-7
WA2QMC . . . 7020-39-60	B-11
W2WAS . . . 6438-29-74	B-20
W2RDD . . . 6336-32-68	C-5
K2YOR . . . 6264-38-58	C-7
W2EQG . . . 4929-31-53	B-9
W2BOT . . . 4278-23-62	A-4
W2ICO . . . 3672-24-51	B-4
W82BDK . . . 3820-20-47	A-31
W2NCG . . . 2400-24-34	A-20
W24WD . . . 2079-21-33	B-8
WA2TKL . . . 1914-22-29	A-16
WA2EFN . . . 1349-19-25	AB--
WA21UQ . . . 684-12-19	A-20
W2JB . . . 528-11-16	A-8
WA2QJU . . . 480-10-16	A-5
K2CMV . . . 324-9-12	A-2
W2TUK . . . 297-9-11	C-1
W2SKE (W2s IWC SKE)	
251,526-206-407	C-70
WA2ZXL (WA2s RJJ ZXL)	
41,280-80-172	B-92

### Northern New Jersey

W2GGE . . . 331,785-219-505	C-61
K2GJN . . . 306,720-210-471	C--
W2CWL . . . 187,410-165-290	C-50
W2HUC . . . 65,872-96-194	A-39
K2EAC . . . 47,855-73-215	B-30
WA2MNG . . . 38,387-63-204	A-48
W2LQP . . . 34,632-74-148	A-24
K2KFP . . . 24,528-73-112	B-16
W2VJN . . . 21,304-79-92	A-5
WA2GLX . . . 14,880-40-79	C-16
W2JKH . . . 9222-53-58	A-11
WA2DLJ . . . 4187-29-51	A-22
W2CVW . . . 1530-17-30	--

### MIDWEST DIVISION

Iowa	
W0FDL . . . 152,028-164-309	C-63
W0EQN . . . 18,054-51-118	C-8
W0CQC . . . 9024-47-64	A--
W0LBS . . . 5916-34-58	B--
W0BSY . . . 4284-34-42	A-18
K0VEJ . . . 504-12-14	B-8
Kansas	
W0DAE . . . 123,015-139-255	C-50
W0VLO . . . 50,100-95-170	C-24
W0VFE . . . 6048-36-56	A-22
K0QJG . . . 4557-31-49	B-7
K0AYO . . . 1944-24-27	A-24
K0JJR . . . 243-9-9	A-5
Missouri	
W0BTD . . . 161,564-169-319	A-57
W0LBB . . . 38,544-88-140	C-50
W0GUW . . . 34,974-87-134	C-40
K0ZBO . . . 7098-38-62	B-14
K0GVS . . . 2784-27-34	A-19
K0VSH . . . 1080-18-20	A-12
W0NFA (9 oprs.)	
526,524-267-662	C-96
K0AXU (7 oprs.)	
85,088-86-130	C-31
Nebraska	
W0ASO . . . 5022-31-54	C-15
W0BHL . . . 4590-34-45	AC-18
W0NXP . . . 1380-20-23	A-12

### NEW ENGLAND DIVISION

Connecticut	
W1B1H . . . 220,970-190-100	C-33
W1HKE . . . 111,444-132-289	C-55
W1JTX . . . 81,795-115-237-BC-30	
W1GVE . . . 71,955-117-205-BC-25	
W1HKB . . . 51,939-87-198	B-25
W1AW5 . . . 37,074-74-167	C--
W1DIT . . . 34,880-80-146	B-37
K1NHR . . . 29,829-61-163	B-20
K1PNS . . . 18,564-51-124	C-35
W1AH . . . 17,384-53-110	B-32
W1WHQ . . . 13,818-47-98	A-16
K1SDX . . . 13,416-52-86	C--
W1WY . . . 11,529-61-63	C-12
W1OPB . . . 10,190-42-83	A-30
K1PCE . . . 8550-38-75	A-30
W1ECH . . . 3571-29-32	A-10
W1BDI . . . 585-13-15	B--
K1YIG . . . 510-10-17	A-6
K1VII . . . 216-8-9	A-12
K1WKK . . . 216-8-9	A-3
Maine	
W1YIS . . . 106,932-134-266	B-66
W1GKG . . . 89,148-114-262	AC-36
K1SWG . . . 72-4-6	A-2
K1NIA (5 oprs.)	
1083-19-21	B-48
Eastern Massachusetts	
K1DIR . . . 335,478-221-506-BC-73	
W1RPF . . . 152,760-152-335	B-70
K1NOL . . . 144,744-143-326	B-50
W1EHT . . . 53,040-85-208	B-40
K1YJX . . . 52,164-84-207	C-18
W1BQL . . . 25,344-61-132-BC-21	

W1MO . . . 25,200-80-105	B-23
W1NS . . . 14,085-45-105-BC-10	
K1ZBQ . . . 9120-40-76	A-21
K1EJT . . . 8920-40-75	B--
W1IPL . . . 5316-42-60	B-30
K1UDU . . . 3741-29-43	--
W1IPI . . . 2340-20-39	B-7
W0PAN/1 . . . 812-14-20	A-14
W1RWU . . . 747-13-21	B-6
K1RHZ . . . 396-11-12	A-5
W1NJL (K1SNO, W1NJL)	
189,243-163-387	B-85

### Western Massachusetts

W1JYH . . . 241,773-203-397	C-35
W1AEW . . . 58,968-91-216	B-46
W1OUK . . . 40,182-74-181	B-45
K1ODV . . . 3910-45-66	C-22
K1JLU . . . 8290-40-69	A-7
K1DFC . . . 75-3-5	A--

### New Hampshire

K1RTB . . . 361,020-220-547	C-77
W1PZ . . . 203,661-171-398	C--
K1PFY . . . 18,618-58-107	B-36
W1PEG . . . 6502-38-61	B-27
W1SWX/1 . . . 4995-37-45	B--
K1IIE . . . 684-12-19	C-4
W1ETV . . . 3150-25-42	C-3

### Rhode Island

K1LPL . . . 69,015-107-215	A-30
W1GOC . . . 39,606-82-161	B-32
W1AVE . . . 23,166-54-143	C-11
K1LDK . . . 8820-12-70	B-8

### NORTHWESTERN DIVISION

Alaska	
KL7CYS/KL7	
11,360-40-100	C-13
KL7MF . . . 3519-23-51	C-8
Idaho	
W7BSP . . . 91,410-127-240	B-80
K7KTQ . . . 3024-24-42	B-20
Montana	
K7A BV . . . 19,488-58-113	C-17
W7QB . . . 5698-37-52	A-20
K7NHV . . . 1035-15-23	AC-11
Oregon	
W7GBW . . . 60,990-107-180	AB--
W7DIS . . . 51,796-86-162	A-30
W7BTT . . . 25,296-68-124	C-20
W7GAD . . . 20,601-63-109	C-8
W7G1B . . . 13,770-51-60	B-30
K7PBB . . . 8244-35-77	C-27
W7PL . . . 4128-32-43	A-12
W71Y . . . 1560-20-28	C-6
W7QY . . . 588-12-17	B-16
W7DLR . . . 12-2-2	C-1
Washington	
W7VQG . . . 125,268-142-292	C-63
W7PQE . . . 102,705-123-280	C-45
W7MT . . . 25,368-73-132	C-70
W7UEU . . . 5967-30-51	A-40
W7RPF . . . 1824-19-32	A-4
W7MH . . . 1620-18-30	B-9
K7QWC . . . 294-7-14	A-7
K7GGN (K7s IGN KCS)	
6048-32-63	A-32

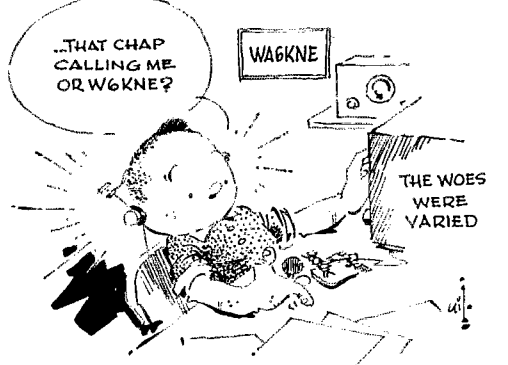

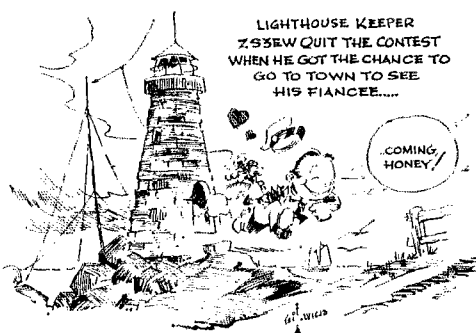

**PACIFIC DIVISION**

*Hawaii*

KH6IJ... 40,824-84-162- C-10  
 KH6EYP... 21,192-63-128- A-75  
 KH6EJM... 17,472-56-104- A-34

*Nevada*

W7TVF... 1767-19-31- C-11

*Santa Clara Valley*

W6HOC... 216,948-202-358- C-61  
 W6PYM... 166,080-173-320- C-65  
 W6WXX... 134,991-159-282- C-60  
 W6HVN... 118,368-144-27-4- C-42  
 K6OHL... 117,306-147-266- C-80  
 W6ATO... 113,847-137-277- C-80  
 W6KEY... 100,380-149-239-AC-46  
 W6CBE... 91,059-127-238- C-53  
 W6ZFW... 84,240-120-224- C-54  
 W6LSQ... 71,509-118-202- C-27  
 K6BWX... 70,725-115-202- C-65  
 W6OQU... 62,034-99-211- C-64  
 K6BOR... 58,428-95-205-AC-42  
 W6PBE... 52,530-102-170- C-52  
 W6JWD... 45,824-88-166- C-43  
 W6IKJ... 43,524-92-156- C-33  
 W6LJZ... 40,449-97-139- C-44  
 K6LEC... 35,040-80-146- C-34  
 K6JC... 29,565-73-135- B-24  
 W6TGY... 19,206-66-97-AC-13  
 K6PZX... 16,390-55-100- B-47  
 W6NRYK... 14,151-53-89- B-32  
 W6QGW... 6840-40-57- A-25  
 W6KHS... 3915-29-45- A-11  
 W6CIZ... 3585-26-46- B-7  
 W6NRYJ... 1638-21-26- B-13  
 W6JSA... 168-7-8- A-5  
 W6CTO... 3-1-1- C-3  
 W6HLRS (W6HLRS, W7WJ4B)  
 132,399-141-313-BC-70

*East Bay*

W6KGI... 254,412-191-444- C-84  
 W6LDD... 225,895-185-389- C-88  
 W6POW... 84,336-112-251- C-1  
 K6AHV... 62,916-107-196- C-34  
 W6FLT... 18,480-56-110- C-26  
 W6BBJ... 15,660-58-90- A-17  
 W6VAT... 5394-31-58- A-15  
 W6RHD... 1326-17-26- B-8  
 W6FPZ... 630-14-15- A-5  
 K7QKB/6... 90-5-6- A-9  
 W6PPS... 45-3-5- A-2

*San Francisco*

W6WB... 151,800-150-338- C-70  
 W6BYB... 133,152-152-292- C-79  
 W6MSM... 91,113-121-251- C-70  
 W6ERS... 76,228-118-216-BC-75  
 K6LXS... 22,491-63-119- C-27  
 K6ANP... 22,230-65-114- C-58  
 W6ZZM... 8487-41-69- A-24  
 W6PZX... 3276-28-39- A-32  
 W6WLV... 2691-23-39- A-17

*Sacramento Valley*

W6GRX... 216,876-186-389- C-72  
 W6GNZ... 165,584-158-350- C-64  
 W6BIL... 32,472-82-132- C-46  
 W6EOU... 27,081-59-153- -  
 W6SLU... 14,742-54-91- A-38  
 W6AF... 1860-30-54- C-36

*San Joaquin Valley*

K6RTK... 85,008-112-253- C-48  
 W6BYM... 66,096-108-204- C-43

W6KTW... 50,904-101-198- C-53  
 W6KJS... 58,782-101-194- C-1  
 K6AYA... 31,995-79-135- C-1  
 W6UDR... 19,203-59-109- C-22  
 W6VFC... 1674-18-31- A-18  
 W6AIKA... 1292-17-28- A-15  
 W6ARDY (W6AGS IRL RDY)  
 5100-34-50- B-67

**ROANOKE DIVISION**

*North Carolina*

K4WVP... 48,576-92-176- B-90  
 K4ADT... 3813-31-41- B-9  
 W4OMW... 1725-23-25- B-1  
 W4KXW... 1224-18-24- A-5

*South Carolina*

W4ATKU... 49,599-99-167- B-62  
 K4WJT... 11,205-45-83- B-21

*Virginia*

W4YHD... 604,920-284-710-BC-85  
 K4RDE... 507,486-281-604-BC-83  
 W4DHz... 488,391-265-619- C-80  
 W4RQR... 390,988-244-543- C-65  
 W4CKD... 204,660-180-379-AC-46  
 W4OPM... 157,248-156-336- C-30  
 W4JAT... 153,768-149-344- C-41  
 K4LIQ... 148,584-151-328-BC-47  
 K4QRQ... 124,581-131-317- C-60  
 W4WBC... 77,280-115-224- C-32  
 W4RWV... 67,512-97-232- C-46  
 W4GPF... 64,419-109-197- C-1  
 W4DVT... 60,717-111-183- C-25  
 W4AMP... 44,928-96-156- A-48  
 W4ZM... 41,082-82-167- C-16  
 W4LRN... 38,367-87-147- C-18  
 W4QOM... 30,336-64-158- C-1  
 K4VWH... 28,272-76-124- C-59  
 K4WUY... 24,282-71-114- B-20  
 K4GWO... 10,560-44-80- A-36  
 W4SHJ... 7884-36-73- B-24  
 K4QKY... 5220-29-60- C-1  
 W4DLA... 5076-36-47- B-18  
 W4KMS... 2886-26-37- B-19  
 W4KXV (7 ops.)  
 618,520-280-736-BC-96  
 W4BVV (W4BVV, W44IVL)  
 318,304-224-474- C-96

*West Virginia*

W8UMR... 8643-43-67- A-9  
 W8BKK... 144-6-8- A-2

**ROCKY MOUNTAIN DIVISION**

*Colorado*

K8MIC... 178,002-174-341- C-70  
 W8EKS... 2277-23-33- A-30  
 K8SLD... 798-14-19- C-5  
 K8QVA... 351-9-13- B-4  
 W8DZH (4 ops.)  
 131,823-151-291-AC-85

*Utah*

W7POU... 9585-45-71- A-37  
 W7BAJ... 3360-28-40- C-10  
 K7RAJ... 1122-17-22- A-5

*New Mexico*

W5FJE... 118,863-141-281- C-67  
 W5CK... 100,203-127-263- C-51  
 K5UYF... 33,462-78-143- B-20  
 K5TTL... 14,355-55-87-AB-19  
 K5WMB... 4830-35-46- A-15

*Wyoming*

W4PGS... 184,748-174-354- C-47  
 W4GGE... 114-2-3- - -

**SOUTHEASTERN DIVISION**

*Alabama*

W4EEDY... 21,168-63-112- A-30  
 W4PRP... 5994-37-54- C-24  
 K4HPR... 702-13-18- - -

*Eastern Florida*

W4DQS... 465,870-265-586-AC-75  
 W4LAV... 178,524-171-357-AC-70  
 W4QVJ... 137,700-153-300- C-42  
 W4CHA... 101,772-132-257- C-53  
 W4WHK... 68,562-126-229- B-1  
 W4PZW... 69,042-111-208- A-41  
 K4YFO... 25,488-72-118- A-43  
 W4ZQK... 22,916-68-113- B-50  
 K4LDR... 19,998-66-101- A-30  
 W4WYJ... 12,614-53-80- B-18  
 W4EEO... 7500-50-50- C-15  
 K4SXX/L... 5376-32-56- B-8  
 W4DXL... 3936-32-41- A-24  
 K4EJ... 2592-27-32- A-20  
 W4NTE... 1224-17-24- A-11  
 K4RQE (K4RQE, W5ZVT)  
 46,851-97-165-BC-38

*Western Florida*

W4NIX... 10,750-50-73- B-20  
 K4VFY... 5217-37-47- A-21

*Georgia*

W4MCM... 284,745-205-463- C-68  
 W4DXL... 234,585-195-411-BC-80  
 K4TEA... 172,935-183-315- A-35  
 W4BFR... 65,934-111-198- C-35  
 W4HOS... 30,954-77-134- B-28  
 K4TKM... 14,742-63-78- A-15  
 W4BHG... 2508-22-38- B-6  
 W4IYJ (K4ITBN, W4I4QU)  
 9504-44-73- B-1

**SOUTHWESTERN DIVISION**

*Los Angeles*

W6TZD... 180,393-157-383- C-64  
 W6EPQ... 153,036-156-327- C-80  
 W6AJJ... 149,145-163-305- C-84  
 W6NKR... 135,366-154-293- C-70  
 W6JFJ... 72,594-111-218- C-1  
 W6AUM... 68,848-104-223-BC-46  
 W6NEX... 52,896-96-185-BC-45  
 W6YV... 44,631-87-171- C-1  
 W6AKNE... 31,824-78-136- C-36  
 W6AKMF... 25,500-68-125- A-50  
 W6AYU... 21,546-63-114- B-40  
 K6YYQ... 20,832-62-112-AB-76  
 W6TLL... 17,748-58-102- A-50  
 W6VNJ... 17,442-51-114- C-19  
 W6QHQ... 13,377-49-91- C-14  
 W6CYV... 6018-34-59- C-8  
 W6PET... 2040-20-34- C-21  
 W6VAW... 1530-17-30- B-18  
 W6WNR... 1512-18-23- C-8  
 W6AYAT... 231-7-11- A-5  
 W6ATMY... 184-8-9- A-3  
 W6RW (5 ops.)  
 682,872-296-769- C-94  
 K6EVR (6 ops.)  
 608,760-285-712- C-96  
 K6EGF (K6EGF, W6WGO)  
 38,880-81-160- B-90

*Arizona*

W7ENA... 20,979-63-111- A-34

*San Diego*

W6EPZ... 279,642-209-446- C-60  
 W6SBO... 178,492-124-211-AC-39  
 K6EC... 48,222-94-171- B-20  
 W6QNM... 26,724-68-131- C-25  
 W6LRU... 17,472-56-104- A-16  
 W6HJT... 14,787-53-93- -11  
 W6PLK... 5742-33-58- C-30  
 W6AOZL... 5643-33-57-AB-23  
 W6ARUS... 2772-21-44- A-15  
 W6UUS (multiop.)  
 4680-30-52- C-17

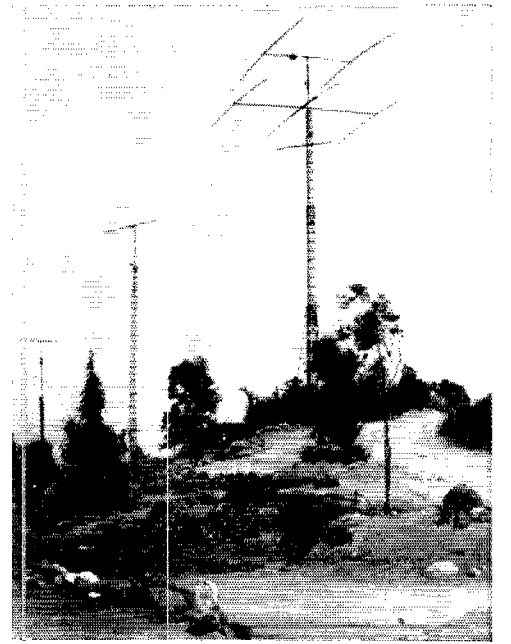

W6EPZ, top single-op c.w. score in California at 280-K, creates a stir locally with his fabulous QTH. "Epsie" is situated just outside of San Diego on a mountain in the middle of El Cajon, a clear shot with those 3-L rotaries on 15 and 20, 2-L on 40, dipole for ten and a long wire on 80.

**WPEZ AND SOME OTHERS  
ASK...WHERE WAS AFRICA?**

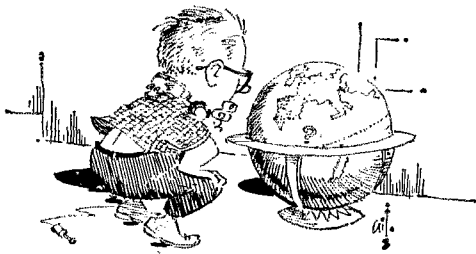

*Santa Barbara*  
WA6OJM...23,364- 66-118- C-60  
WA6OJL...2622- 23- 38- A- 7

**WEST GULF  
DIVISION**

*Northern Texas*  
K5TFL... 37,433- 83-151- C-45  
W5QF... 7749- 41- 63- A- 2  
W5MBO... 360- 10- 12- C- 4  
K5UKQ (K5E SEK UKQ UKR)  
9870- 47- 70- C-48

*Oklahoma*  
W5KIT... 25,661- 67-128- C-30  
W5USA... 14,193- 57- 83- C-22  
W5EHY... 3645- 27- 45- B-10

*Southern Texas*  
W5BR... 228,288-192-397- C-55  
W5MCO... 45,123- 89-169- C-16  
K5JZY... 22,680- 72-105-BC-25  
K5BDS... 16,992- 59- 96- A-40  
W5LJT... 9936- 48- 69- A-11  
W5KTW... 9828- 52- 63- C-15  
W5VA... 5724- 36- 53- C-21  
W5KPT... 1638- 21- 26-AC- 5

**CANADIAN DIVISION**

*Maritime*  
VE1EK... 24,759- 63-131- A-28  
K7GVM/VO1  
18,113- 59-107- A-45  
VO1AW... 6630- 26- 85- A-15  
VE1DB... 4368- 28- 52- B-10  
VE1YB... 1944- 24- 27- B-30  
VO2NA... 864- 12- 24- A- 8  
  
*Quebec*  
VE2NV... 144,615-155-311-AB-65  
VE2BV... 99,408-109-304- B-35  
VE2AYU... 14,406- 49- 98- B-61

*Ontario*  
VE3AU... 78,255-111-235-AB-46  
VE3BOG... 74,568-104-238- C-50  
VE3ES... 61,944- 89-232-AB-36  
VE3FLO... 59,486- 98-203- B-38  
VE3DBB... 25,110- 62-135- C-45  
VE3AWE... 10,428- 44- 79- B- 9  
VE3BTQ... 690- 12- 20- A-20

*Manitoba*  
VE4XO... 70,992-102-232- C- 2  
VE4ZX... 3510- 26- 45- A-26

*Saskatchewan*  
VE5PM... 10,998- 39- 94- B-25

*British Columbia*  
VE7EH... 61,812-101-204- A-46  
VE7BHN... 270- 6- 15- A- 8  
VE7AHG/7 (VE7s AHG VC)  
95,377-127-251- C-70

*Yukon-N. W. T.*  
VESRH... 8602- 34- 85- C-20  
VESDX... 2640- 20- 44- B- 2

**AFRICA**

*Mozambique*  
CR7LZ... 25,950- 25-346- A-20  
CR7LU... 2088- 12- 58- A- 2

*Spanish Morocco*  
EA9AP... 5436- 18-101- A- 8

*Liberia*  
EL2PN... 872- 8- 37- C- 1

*Kerguelen Is.*  
FB8XX... 2601- 17- 51- B-16

*Juan de Nova*  
FR7ZC/J... 35,360- 32-369- A- 2

*Sudan*  
ST2AR... 139,284- 53-876- A-50

*Nyasaland*  
ZD6OL (ZD6s LA OL)  
12,159- 21-193- A-10

*South Africa*  
ZS6FN... 33,894- 42-269- A-12  
ZS10... 6180- 20-103- A-30

*Southwest Africa*  
ZS3EW... 11,660- 20-197- A-10

*Swaziland*  
ZS7R... 7200- 20-120- A- 7

*Libya*  
5A1TW... 154,224-48-1071- A- 2

*Nigeria*  
5N2RSB... 47,421- 33-479- A-22

*Malaysia Rep.*  
5R8AF... 2046- 11- 62- A- 2

*Uganda*  
5X5U... 20,769- 23-301- A- 2

*Republic of the Congo*  
9Q5AB... 59,706- 31-642- A- 2

**ASIA**

*East Pakistan*  
AP5CP... 625- 7- 25- A-41  
AP5AH... 204- 4- 17- A-35  
AP5JA... 180- 6- 10- A-17

*Iran*  
EP2AM... 1107- 9- 41- B-16

*Korea*  
HL9KH... 194,616-53-1224- A-32  
HL9TF... 15,884- 19-269- A-10  
HL9TG... 3395- 7-163- A-32

*Saudi Arabia*  
HZ1AB... 31,725- 25-123- C-15

*Japan*  
JA1VX... 225,992-52-1454- C-60  
JA1CO... 94,940- 47-675- B- 2  
JA1BW... 23,700- 26-305- A-12  
JA2DN... 17,028- 33-172- B-33  
JA2HO... 13,932- 18-260- A-31  
JA1LZ... 13,185- 15-293- B- 2  
JA6AKW... 11,084- 17-218- A- 2  
JA1HSB... 11,004- 14-282- A- 2  
JA1RN... 9616- 16-202- A-10  
JA2AIR... 7633- 17-151-AB-30  
JA2WB... 6912- 18-444- A- 2  
JA8GR... 5994- 18-112- A-30  
JA1BDI... 3720- 12-104- C-20  
JA3ART... 3648- 12-103- A- 2  
JA1DFQ... 3610- 10-124- A- 2

JA1HBX... 2184- 7-104- A- 2  
JA6BCV... 391- 9- 33- A- 2  
JA1YL... 745- 5- 50- B- 2  
JA6OP... 728- 7- 35- A- 1  
JA7ADV... 378- 6- 21- A- 8  
JA1CUM... 156- 4- 13- A-15  
JA4DZ... 150- 5- 10- A- 4  
JA1BUL... 15- 3- 5- A- 2  
JA1CJU... 30- 2- 5- A- 5  
JA6PL... 18- 1- 6- A- 2  
JA3CED... 18- 2- 3- A- 2  
KA2KS (7 ops.)  
45,900- 25-612- C- 2  
JA1YDU (5 ops.)  
5423- 17-108- A- 2

*Ryukyu*  
KR6ED... 76,428- 36-708- C-41  
KR6BQ... 56,770- 35-544-AC-28

*Asiatic Russian S. F. S. R.*  
UA9DA... 23,766- 34-233- B- 2  
UA6CF... 6324- 17-124- B- 2  
UA9XG... 1437- 17- 87- B- 2  
UA6SH... 4185- 15- 93- A- 2  
UA6KQB... 2016- 14- 48- B- 2  
UA6BP... 744- 8- 31- B- 2  
UA9WS... 540- 10- 18- A- 2  
UA6LH... 480- 4- 10- A- 2  
UA9FV... 315- 7- 45- A- 2  
UA9FO... 120- 5- 8- A- 2  
UA6KFG (3 ops.)  
100,716-33-1017- B-96

*Uzbek*  
UA6KDA (3 ops.)  
46,284- 28-551- B- 2  
UA6KCO (3 ops.)  
34,542- 19-608- B- 2  
UA6KZB (2 ops.)  
16,200- 18-300- B- 2  
UA6KCA (3 ops.)  
6840- 15-152- B-56  
UA9KTF (UA9s TE TN TS)  
5871- 19-103- B- 2  
UW9CD (3 ops.)  
963- 9- 37- A- 2

*Kazakh*  
UL7KBE (4 ops.)  
1410- 10- 48- A- 2

*Kirghiz*  
UM8KAA... 1656- 12- 46- B- 2

*Singapore*  
VS1LP... 66,742- 34-662- A-36

*India*  
VU2AJ... 4368- 14-104- A- 2

*Israel*  
4X4OZ... 25,810- 29-301-AB-30

*Uzbek*  
UT8LB... 1650- 10- 55- A- 2

*Uzbek*  
UT8LB... 1650- 10- 55- A- 2

*Uzbek*  
UT8LB... 1650- 10- 55- A- 2

*Uzbek*  
UT8LB... 1650- 10- 55- A- 2

*Uzbek*  
UT8LB... 1650- 10- 55- A- 2

*Uzbek*  
UT8LB... 1650- 10- 55- A- 2

*Uzbek*  
UT8LB... 1650- 10- 55- A- 2

*Uzbek*  
UT8LB... 1650- 10- 55- A- 2

*Uzbek*  
UT8LB... 1650- 10- 55- A- 2

*Uzbek*  
UT8LB... 1650- 10- 55- A- 2

*Uzbek*  
UT8LB... 1650- 10- 55- A- 2

*Uzbek*  
UT8LB... 1650- 10- 55- A- 2

*Uzbek*  
UT8LB... 1650- 10- 55- A- 2

*Uzbek*  
UT8LB... 1650- 10- 55- A- 2

*Uzbek*  
UT8LB... 1650- 10- 55- A- 2

*Uzbek*  
UT8LB... 1650- 10- 55- A- 2

*Uzbek*  
UT8LB... 1650- 10- 55- A- 2

*Uzbek*  
UT8LB... 1650- 10- 55- A- 2

*Uzbek*  
UT8LB... 1650- 10- 55- A- 2

*Uzbek*  
UT8LB... 1650- 10- 55- A- 2

*Uzbek*  
UT8LB... 1650- 10- 55- A- 2

*Uzbek*  
UT8LB... 1650- 10- 55- A- 2

F8TM... 54,234- 46-393- A- 2  
F7CP... 23,577- 29-268- A-18  
F8ZF... 20,184- 29-232- A-20  
F8TQ... 12,383- 29-145- A- 2  
F3AT... 6650- 19-117- A- 2  
F3IL... 2448- 16- 51- A- 2  
F9BB... 1752- 12- 49- A- 7

*England*  
G4CP... 266,580-60-1481- A- 2  
G2QT... 155,268- 57-908- A-51  
G2DC... 151,632- 54-936- A- 2  
G6BQ... 97,146- 54-600- A-42  
G2RO... 80,136- 42-652- A-44  
G3EYN... 51,944- 43-406- A- 2  
G3APN... 28,256- 32-295- A-61  
G3HRY... 27,951- 33-286- A-50  
G3DYY... 9100- 26-117- A- 2  
G3MWZ... 651- 7- 31- A- 7

*Northern Ireland*  
G13OQR... 143,100- 50-954- A-58  
G13OTV... 47,810- 32-502- A-26

*Wales*  
GW3JJ... 251,883-57-1473- A- 2

*Hungary*  
HA6NI... 29,550- 25-395- A- 2  
HA1SD... 1875- 13-125- A- 2  
HA8KCF... 1518- 11- 46- A- 2  
HA5BI... 810- 10- 28- A- 2  
HA1KSA (3 ops.)  
201,824-53-1272- A-96  
HA3KGC (3 ops.)  
144,900-42-1150- A- 2

*Switzerland*  
HB6JG... 222,905-55-1352- B- 2  
HB9KC... 26,406- 22-408-AB-18  
HB9AAG... 12,974- 26-168- A- 2  
HB9DX... 11,361- 21-181- A- 2  
HB9ZY... 7050- 15-159- B- 2  
HB9NL... 5117- 17-101- B- 2  
HB9UD... 1215- 15- 27- B- 3  
4U1ITU (DL1YJ, HB9UD)  
HS1UN... 39,292- 19-696-AC-27

*Italy*  
II6GO... 82,917- 47-762- A-45  
II6ER... 10,800- 25-144- A- 2

*Norway*  
LA6U... 33,480- 31-360- A-20  
LA5HE... 8959- 17-176- A- 2  
LA4LG... 4848- 16-101- A- 9  
LA6LH... 4716- 12-131- A-20  
LA9AF... 2250- 15- 50- A-23  
LA2H... 2266- 11- 69- A- 2  
LA7H... 609- 7- 29- A- 2  
LA4K... 45- 3- 5- A- 2  
LA1H (5 ops.)  
14,743- 23-217- A-48

*Bulgaria*  
LZ1KSA... 4743- 17- 94- A- 2  
LZ1KRF (3 ops.)  
30,990- 32-323- A- 2

*Finland*  
OH2BZ... 77,328- 36-716- B- 2  
OH2FB... 37,800- 20-630- B-47  
OH1SM... 26,390- 26-339- B- 2  
OH1TY... 14,472- 24-391- A- 2  
OH5PT... 12,382- 26-236- A- 2  
OH2B... 9823- 26-136- A-16  
OH2PM/1... 3823- 17-173- B- 2  
OH5TM... 1008- 12- 28- A- 2  
OH1YR... 828- 7- 13- A- 2  
OH5BAC... 273- 7- 13- A- 2  
OH5UQ... 188- 7- 8- A- 2  
OH1QT... 150- 5- 10- A- 2  
OH5OJ... 54- 3- 6- A- 2  
OH5UX... 9- 3- 1- A- 2

*Czechoslovakia*  
OK1ZL... 215,028-54-1334- B-86  
OK2KJ... 157,456-52-1014- A- 2  
OK1PC... 131,820- 52-845- A- 2  
OK1GT... 107,505- 45-808- B- 2  
OK1BY... 82,755- 43-624- A- 2  
OK1KFI... 43,928- 39-387- A- 2  
OK1KRF... 19,920- 16-415- A- 2  
OK3CAG... 19,348- 28-235- A- 2  
OK1JX... 18,144- 32-191- B-40

*Ireland*  
EI9J... 107,848- 52-693- A-28  
EI9F... 7880- 20-132- A-30  
EI6D... 1512- 12- 44- A- 4

*France*  
F8IH... 183,062-53-1151- A- 2  
F8VI... 159,838-49-1089- A-41  
F9MS... 84,348- 44-638- A-28  
F2PO... 59,014- 38-523- A-40

*France*  
F8IH... 183,062-53-1151- A- 2  
F8VI... 159,838-49-1089- A-41  
F9MS... 84,348- 44-638- A-28  
F2PO... 59,014- 38-523- A-40

*France*  
F8IH... 183,062-53-1151- A- 2  
F8VI... 159,838-49-1089- A-41  
F9MS... 84,348- 44-638- A-28  
F2PO... 59,014- 38-523- A-40

*France*  
F8IH... 183,062-53-1151- A- 2  
F8VI... 159,838-49-1089- A-41  
F9MS... 84,348- 44-638- A-28  
F2PO... 59,014- 38-523- A-40

*France*  
F8IH... 183,062-53-1151- A- 2  
F8VI... 159,838-49-1089- A-41  
F9MS... 84,348- 44-638- A-28  
F2PO... 59,014- 38-523- A-40

*France*  
F8IH... 183,062-53-1151- A- 2  
F8VI... 159,838-49-1089- A-41  
F9MS... 84,348- 44-638- A-28  
F2PO... 59,014- 38-523- A-40

*France*  
F8IH... 183,062-53-1151- A- 2  
F8VI... 159,838-49-1089- A-41  
F9MS... 84,348- 44-638- A-28  
F2PO... 59,014- 38-523- A-40

*France*  
F8IH... 183,062-53-1151- A- 2  
F8VI... 159,838-49-1089- A-41  
F9MS... 84,348- 44-638- A-28  
F2PO... 59,014- 38-523- A-40

*France*  
F8IH... 183,062-53-1151- A- 2  
F8VI... 159,838-49-1089- A-41  
F9MS... 84,348- 44-638- A-28  
F2PO... 59,014- 38-523- A-40

*France*  
F8IH... 183,062-53-1151- A- 2  
F8VI... 159,838-49-1089- A-41  
F9MS... 84,348- 44-638- A-28  
F2PO... 59,014- 38-523- A-40

*France*  
F8IH... 183,062-53-1151- A- 2  
F8VI... 159,838-49-1089- A-41  
F9MS... 84,348- 44-638- A-28  
F2PO... 59,014- 38-523- A-40

*France*  
F8IH... 183,062-53-1151- A- 2  
F8VI... 159,838-49-1089- A-41  
F9MS... 84,348- 44-638- A-28  
F2PO... 59,014- 38-523- A-40

*France*  
F8IH... 183,062-53-1151- A- 2  
F8VI... 159,838-49-1089- A-41  
F9MS... 84,348- 44-638- A-28  
F2PO... 59,014- 38-523- A-40

*France*  
F8IH... 183,062-53-1151- A- 2  
F8VI... 159,838-49-1089- A-41  
F9MS... 84,348- 44-638- A-28  
F2PO... 59,014- 38-523- A-40

*France*  
F8IH... 183,062-53-1151- A- 2  
F8VI... 159,838-49-1089- A-41  
F9MS... 84,348- 44-638- A-28  
F2PO... 59,014- 38-523- A-40

*France*  
F8IH... 183,062-53-1151- A- 2  
F8VI... 159,838-49-1089- A-41  
F9MS... 84,348- 44-638- A-28  
F2PO... 59,014- 38-523- A-40

*France*  
F8IH... 183,062-53-1151- A- 2  
F8VI... 159,838-49-1089- A-41  
F9MS... 84,348- 44-638- A-28  
F2PO... 59,014- 38-523- A-40

*France*  
F8IH... 183,062-53-1151- A- 2  
F8VI... 159,838-49-1089- A-41  
F9MS... 84,348- 44-638- A-28  
F2PO... 59,014- 38-523- A-40

*France*  
F8IH... 183,062-53-1151- A- 2  
F8VI... 159,838-49-1089- A-41  
F9MS... 84,348- 44-638- A-28  
F2PO... 59,014- 38-523- A-40

*France*  
F8IH... 183,062-53-1151- A- 2  
F8VI... 159,838-49-1089- A-41  
F9MS... 84,348- 44-638- A-28  
F2PO... 59,014- 38-523- A-40

*France*  
F8IH... 183,062-53-1151- A- 2  
F8VI... 159,838-49-1089- A-41  
F9MS... 84,348- 44-638- A-28  
F2PO... 59,014- 38-523- A-40

*France*  
F8IH... 183,062-53-1151- A- 2  
F8VI... 159,838-49-1089- A-41  
F9MS... 84,348- 44-638- A-28  
F2PO... 59,014- 38-523- A-40

OK2PO... 14,480-16-305-A-  
 OK2KJU... 33,824-32-134-A-  
 OK3KGI... 13,041-23-189-A-  
 OK1ADM... 7279-29-145-A-  
 OK2KMB... 6318-13-162-A-  
 OK2SN/1... 5904-16-123-A-  
 OK1DK... 3948-14-94-A-  
 OK100... 3381-23-49-A-19  
 OK3QQ... 990-11-31-A-  
 OK2QX... 819-13-21-A-  
 OK3KW... 581-7-28-A-  
 OK2KFK... 288-6-16-A-  
 OK2BCI... 217-7-11-A-  
 OK1NK... 96-4-8-A-  
 OK2BCN... 3-1-1-A-  
 OK3KAG (2 ops.)  
 72,680-40-610-A-2

**Belgium**  
 ON4XG... 32,832-32-342-A-34  
 ON4GU... 16,335-15-363-A-37  
 ON4CF... 6394-14-157-A-19  
 ON4DY (ON4m DY UN)  
 254,676-57-1501-A-59  
 ON4GL (ON4s GL NU)  
 5729-17-113-A-4  
 ON4HX (ON4HX, ON5BQ)  
 1110-10-37-A-3

**Denmark**  
 OZ1W... 102,672-48-725-A-60  
 OZ2LX... 44,310-35-422-B-2  
 OZ7G... 35,397-27-437-A-45  
 OZ4RT... 33,300-25-444-A-4  
 OZ3FL... 33,150-25-442-A-2  
 OZ4H... 10,269-21-163-A-2  
 OZ2NU... 1806-14-43-A-10  
 OZ4DX... 1150-10-40-A-4  
 OZ7KV... 106-10-29-B-2  
 OZ9Q... 198-6-11-A-2  
 OZ2CE... 150-5-10-A-2

**Netherlands**  
 PA0LOU... 206,754-51-1380-A-63  
 PA0WAC... 20,288-23-294-A-14  
 PA0FLX... 12,474-22-189-A-4  
 PA0UZ... 10,395-15-231-A-22  
 PA0VDV... 2184-14-56-A-3

**Sweden**  
 SM5CCE... 54,672-34-547-B-29  
 SM6BHI... 35,721-21-567-A-28  
 SM3TW... 35,244-22-534-B-2  
 SM5BEU... 27,216-21-432-B-2  
 SM5U... 3564-18-66-B-11  
 SM5XX... 3603-13-77-A-4  
 SM7TV... 1368-12-38-A-2  
 SM5AIO... 1089-11-34-A-26  
 SM5BDY... 108-6-6-A-2  
 SM6ALA... 54-3-6-A-2  
 SM6JY... 24-3-3-B-2

**Poland**  
 SP6PZ... 85,455-6-633-BC-52  
 SP5ADZ... 53,703-39-486-A-49  
 SP1HU... 41,696-32-444-A-4  
 SP9ADU... 9360-26-121-A-16  
 SP5VC... 9270-15-206-A-20  
 SP8YA... 5616-12-156-A-12  
 SP2AJO... 3825-15-85-A-4  
 SP9ZU... 3255-15-73-A-3  
 SP8MJ... 3168-16-6-A-3  
 SP5AFL... 2925-13-75-B-7  
 SP3KHJ... 1776-8-74-B-1  
 SP5ALN... 966-7-46-A-4  
 SP6ALD... 864-8-36-A-2  
 SP5ARN... 660-5-44-A-4  
 SP9AOX... 616-11-19-A-1  
 SP3AT... 410-10-14-A-1  
 SP8HR... 288-9-11-A-5  
 SP9AGS... 6-16-A-4  
 SP5AHW... 162-6-9-A-2  
 SP2AOZ... 54-3-6-A-2  
 SP2KDS (SP2s CJ WB)  
 3094-17-61-A-2

**Crete**  
 SV0WZ... 3437-17-68-A-2

**Iceland**  
 TF3AB... 31,257-23-453-A-2

**European Russian S. F. S. R.**  
 UA1DH... 61,425-35-595-B-2  
 UA4IF... 18,312-21-292-B-15  
 UA1TL... 2772-14-66-B-2  
 UA3BK... 1962-18-37-A-2  
 UA3NG... 792-12-22-A-2  
 UW3AX... 777-7-37-A-2

UA3TA... 424-8-18-A-2  
 UA3KWB... 312-8-13-B-2  
 UA3GO... 132-4-11-A-2  
 UA6KOD (3 ops.)  
 73,167-29-841-B-96  
 UA3KWA (3 ops.)  
 26,292-28-313-B-2  
 UA4KHW (3 ops.)  
 7155-15-159-B-13  
 UA3KET (3 ops.)  
 648-8-27-A-2

**Kalinigradsk**  
 UA2AC... 39,240-17-574-B-2

**Ukraine**  
 UB5WF... 178,050-50-1189-B-58  
 UT5RB... 8526-14-203-A-2  
 UB5MZ... 1998-9-74-A-2  
 UB5KED (3 ops.)  
 39,888-24-554-A-2

**White Russian S. S. R.**  
 UC2AR... 3640-15-80-A-2  
 UC2BI... 150-5-10-A-2  
 UC2AW (2 ops.)  
 17,153-17-339-A-2

**Georgia**  
 UF6AU... 324-6-18-A-2  
 UF6KPA (3 ops.)  
 3289-13-85-A-2

**Moldavia**  
 UO6BM... 21,063-17-413-A-27

**Lithuania**  
 UP2NK... 7824-16-163-A-2

**Latvia**  
 UQ2CC... 819-9-31-B-2  
 UQ2KAR (3 ops.)  
 19,808-16-413-A-20

**Estonia**  
 UR2BU... 17,670-19-313-B-2  
 UR2BV... 798-7-38-A-2

**Rumania**  
 YO2BU... 72,713-43-587-B-75  
 YO8RI... 55,062-38-487-B-2  
 YO6KAF... 8106-21-131-B-12  
 YO3IF... 3798-18-71-A-12  
 YO6EY... 408-7-20-A-4  
 YO4KAK (2 ops.)  
 13,386-23-197-A-2  
 YO5KAU (2 ops.)  
 11,134-19-196-A-34

**Yugoslavia**  
 YU1SF... 266-7-13-A-25

**NORTH AMERICA**

**Cuba**  
 CO2HB... 27,510-35-264-A-10

**Guadeloupe**  
 FG7XJ... 11,883-17-233-A-2

**Panama**  
 HP1IE... 456,459-71-2143-A-65

**Guantanamo Bay**  
 KG4CY... 32,760-39-282-B-13

**Puerto Rico**  
 KP4CC... 294,624-62-1584-A-45  
 KP4BJU... 192,717-49-1311-B-2  
 KP4CH... 97,356-38-854-B-4  
 KP4RK... 38,590-34-379-A-8  
 KP4DV... 2160-9-80-B-2

**Virgin Islands**  
 KV4CF... 461,196-69-2238-A-72

**Canal Zone**  
 KZ5LC... 116,754-61-638-AB-2

**Greenland**  
 OX3DL... 360,900-60-2005-B-2  
 OX3WQ... 1920-12-138-A-2

**Sint Maarten**  
 PJ5ME (4 ops.)  
 475,230-62-2555-A-42

**Grenada**  
 VP2GD... 825-11-25-A-2

**St. Kitts**  
 VF2KR... 81,765-45-607-A-31

**Barbados**  
 VP6LJ (3 ops.)  
 23,055-15-523-A-18

**Bermuda**  
 W4WQQ/VP9  
 115,830-55-702-A-2  
 VP9L (W1NBA, W2YTH, VP9L)  
 337,657-53-2123-A-38

**Mexico**  
 XF2OK... 329,706-78-1502-A-46  
 XF1VT... 161,244-54-1016-A-57

**OCEANIA**

**French Oceania**  
 FC8AA... 172,161-47-1224-A-49

**Eastern Carolines**  
 KC6BK... 54,513-27-673-A-2

**Marianas**  
 W6WNV/KG6  
 192,510-62-1035-C-26

**Midway Islands**  
 W6ZDF/KM6  
 277,068-66-1400-B-53

**Marshalls**  
 KX6AJ... 27,081-27-335-A-10

**Australia**  
 VK5NO... 188,680-53-1191-A-51  
 VK2GW... 166,430-55-1009-A-51  
 VK2AFK... 106,128-48-737-A-2  
 VK3AXK... 76,824-44-582-A-37  
 VK2RA... 25,779-39-221-A-12  
 VK3ZR... 22,515-45-169-A-2  
 VK5JT... 3907-19-61-A-2

**Fiji Islands**  
 VR2EM... 10,608-26-137-A-13

**Cook Islands**  
 ZK1AR... 171,912-58-990-A-2

**PHONE SCORES**

**ATLANTIC DIVISION**

**Eastern Pennsylvania**  
 W3ALB... 141,384-187-344-C-70  
 W6OCU... 122,220-126-331-C-2  
 W3EQA... 60,098-96-210-C-45  
 W3KTT... 27,714-62-149-C-15  
 W3ZSS... 26,943-67-134-C-15  
 W3CGS... 22,935-55-139-C-32  
 W3GHD... 18,648-56-111-B-2  
 W3FDH... 16,830-55-102-B-2  
 W3QIR... 13,617-51-89-B-42  
 W3NM... 12,220-47-87-BC-27  
 W3HHA... 9324-42-74-B-2  
 W3QMZ... 8892-39-76-C-6  
 W3CTJ... 8400-35-80-C-6  
 K3RPU... 3864-28-46-B-1  
 W3GHS... 3900-10-13-B-1  
 W3CAA... 363-11-11-A-3  
 W3QLW... 324-9-12-B-2  
 W3BIP... 189-7-9-C-1  
 K3/NP... 105-5-7-A-10  
 W3WJD (K3JJG, W3WJD)  
 180,272-152-306-C-85  
 W3KFG (K3JGJ, W3KFG)  
 140,535-135-347-C-80  
 W3HHK (W3s HPM MWC)  
 69,615-91-285-C-35  
 W3GRS (K3JCT, W3GRS)  
 33,507-73-153-AC-11  
 K3MBS (6 ops.)  
 9920-40-83-C-2  
 K3LJZ (K3s JLI LJZ)  
 8073-39-69-A-20

**New Zealand**  
 ZL1AMO... 128,283-61-701-A-27  
 ZL3OX... 156-6-9-A-3

**SOUTH AMERICA**

**Chile**  
 CE1AD... 370,992-59-2096-B-2  
 CE3AG... 241,152-64-1256-AC-34  
 CE2OP... 16,875-25-225-A-2

**Bolivia**  
 CP3CN... 17,135-23-251-A-2  
 CP3OD... 10,164-14-242-A-2

**Ecuador**  
 HC1DC... 1,028,565-95-3609-B-76

**Colombia**  
 HK7BE... 284,580-62-1545-AB-61  
 HK7ZT... 262,224-72-1214-A-67  
 HK1QQ... 184,236-52-1181-B-20  
 HK3TH... 135,654-46-999-B-45  
 HK3AH... 118,320-58-680-B-10  
 HK7UL... 27,993-31-301-A-21

**Argentina**  
 LU6PK... 83,173-31-900-A-36  
 LU8FBH... 57,618-33-582-A-2  
 LU5ABL... 4774-14-114-A-12

**Netherlands Antilles**  
 PJ2AE... 147,340-53-928-A-30

**Brazil**  
 PY4BH... 113,064-42-908-A-40  
 PY1ADA... 51,891-49-353-B-10  
 PY1NEW... 25,443-33-287-A-28  
 PY7AQ... 13,182-13-338-A-2  
 PY7TY... 13,068-12-363-B-2  
 PY7BX... 6783-19-119-A-4  
 PY2BBO... 2736-12-76-A-2

**Venezuela**  
 YV5AGD... 652,092-98-2218-B-2  
 YV4VA... 303,844-74-1416-B-70  
 YV5BZ... 12,880-26-160-B-2  
 YV1DP... 2610-10-87-B-2

**Paraguay**  
 ZP9AY... 249,015-65-1277-A-70

**Maryland-D. C.**

W3TLN... 130,875-125-349-C-56  
 W3JTC... 64,296-76-282-C-57  
 W3MCG... 30,885-71-145-C-2  
 W3ZQ... 17,985-55-109-C-20  
 W3AYD... 9120-40-76-C-2  
 K3CBW... 2040-24-29-A-12  
 W3MSK (6 ops.)  
 575,592-232-827-C-96  
 W3ADO (7 ops.)  
 173,584-152-382-B-96

**Delaware**  
 W3IYE... 55,449-101-183-C-30  
 K3SMN (K3s JCT SMN)  
 22,491-63-119-C-31

**Southern New Jersey**

W2FXN... 198,432-156-424-C-2  
 K2PZR... 42,924-73-197-C-50  
 WA2IZS... 37,653-67-163-B-20  
 W2DAJ... 31,416-68-154-C-38  
 W2QKJ... 22,600-61-123-B-56  
 W2SDQ... 11,664-54-72-C-50  
 WA2EY... 4836-31-52-A-20  
 W2QDY... 4650-31-50-A-35  
 W2HVW... 1128-32-43-C-7  
 W2DMR... 2016-21-32-C-9  
 WA2PWI... 129-15-16-A-2  
 K2OEA... 789-7-9-A-3  
 K2HBY... 108-6-6-A-4  
 W2BAPG (WA2BLV, W2BAPG)  
 8748-54-54-AC-48

1 W3MFW, opr. 2 W3SQX, opr. 3 K9RHN, opr. 4 W9SZR, opr. 5 Hq. staff - not eligible for award. 6 W1WPR, opr. 7 K7APJ, opr. 8 W6VAT, opr. 9 K4SXT, opr. 10 K6LSG, opr. 11 K5ETA, opr. 12 K6PJT, opr. 13 K5ABA, opr. 14 W1TYQ, opr. 15 OK2BDX, opr. 16 SM6CKU, opr. 17 Y06EH, opr.

(Continued on page 164)



# Hints and Kinks

For the Experimenter



## ANTENNA BUMPER MOUNT

RECENTLY I needed a bumper mount for my mobile antenna. In a Sears, Roebuck catalogue I came across an illustration of a universal trailer hitch that looked almost like an antenna bumper mount. The swivel ball normally used for trailer hitches is not included with the hitch and isn't necessary anyway for mounting antennas. The hole which normally mounts the swivel ball is used for the antenna base support. The Sears number is type 6530 trailer hitch, and it costs less than three dollars.

— Charles Curran, K2DQD

## MOBILE BURGLAR ALARM

TO protect my mobile equipment from theft, I mounted a normally closed push-button switch behind the equipment. When the equipment is installed the switch is open and is connected in parallel with the car horn button, so that if the equipment is removed the spring return push-button will complete the horn circuit and discourage the thief from any further tampering!

— Lynn Kuluwa, K6IMI

## BETTER HEAT RADIATING TUBE SHIELDS

KDAPF suggests that HX-30 owners boil the tube shields of all the tubes, except the one for the 6360, in salt water. This blackens the shields and increases their ability to radiate heat, thus extending tube life. I tried the scheme and found that I now can touch the driver tube of my HX-30, which I could not do before the salt water treatment. — From K9TYH's OES report

## STABLE V.H.F. OSCILLATOR

V.H.F. men looking for high-stability crystal oscillators for s.s.b. or other applications would do well to try the Transitron, described by W3PYW in January, 1960 *QST*, page 18. In using this circuit we had some trouble with 6AS6 tubes, until the resistor across  $L_1$  was

changed from 3900 to 39,000 ohms. After that every 6AS6 tube we had worked equally well. With either value the oscillator stability is excellent. — Paul M. Wilson, W4HHK

## S.L.F. DIAL READOUT WITH AN S.L.C. TUNING CAPACITOR

IN developing a receiver where the local oscillator must tune 5.0 to 5.5 Mc. on all bands, and must also serve as a heterodyne v.f.o. for a multi-band transmitter, I desired to have the 0 to 500 logging scale on the Eddystone dial read directly in kilocycles. Since the tuning capacitor in the receiver was a straight-line-capacitance unit, I evolved the method shown in Fig. 1 for achieving straight-line-frequency dial calibration.

An aluminum disc is attached to the main tuning shaft. A second variable capacitor is mounted nearby and connected in parallel with the main tuning capacitor. A lever is fixed to the second capacitor shaft and arranged to ride on the edge of the disc under tension provided by a light spring.

If material is removed from the disc, the plates of the second capacitor will open and the v.f.o. frequency will increase. When the disc is filed to form a cam, the second capacitor acts as a continuously variable trimmer controlled by the main tuning shaft.

The compensating system is adjusted by setting circuit padding capacitors to produce a frequency slightly low at all dial positions, and then filing the disc to bring the frequency up to the dial readings. This process is not as laborious as might be assumed from a glance at the photograph. The main tuning shaft turns through 180 degrees, not 360 degrees, and only half of the disc must be formed into a cam. Also, when the second capacitor is of relatively large value, such as the broadcast unit used here, the motion of its shaft for a given frequency correction is small and the amount of material which must be removed from the disc is correspondingly minimized. — William L. Hale, K8JIX

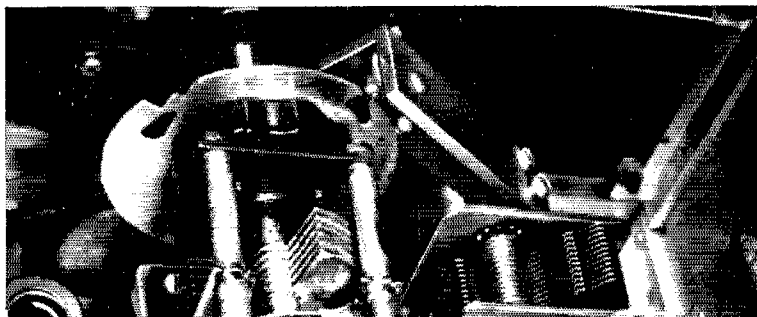
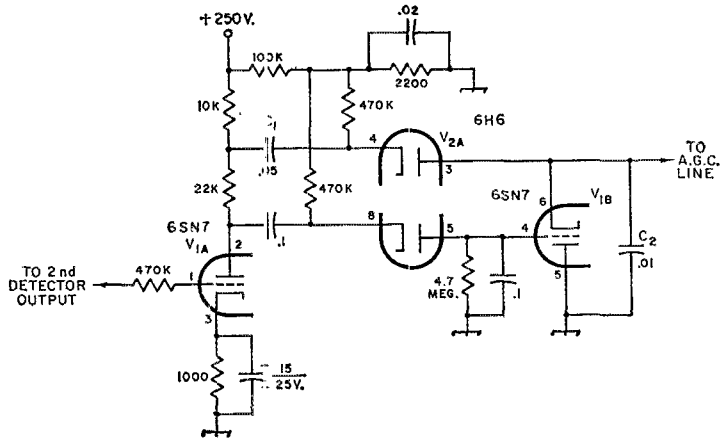

Fig. 1—The cam on the capacitor shaft at the left works against the spring loaded lever arm which is attached to the variable capacitor at the right.

Fig. 2—K7UUC's hang a.g.c. system. Capacitances are in microfarads, resistances are in ohms, resistors are 1/2-watt.



### HANG A.G.C. CIRCUIT

THE circuit shown in Fig. 2 is a modification of the audio-hang system described by W0BFL, *QST*, October 1957, and has helped to give a new lease on life to my 17-year-old HQ-129-X receiver.

A comparison of the circuit in Fig. 2 with W0BFL's will show that this one is somewhat simpler. That is, only two diodes are required and no audio transformer is needed. Capacitors C<sub>1</sub> and C<sub>2</sub> were determined by experiment, so as to give a suitably fast attack. The resistor in the grid lead of V<sub>1A</sub> reduces audio distortion that would otherwise occur because of grid-circuit clipping on strong signals.

Although my application required the use of a 6SN7GTB and a 6H6, more modern types such as the 12AU7 and the 6AL5 can be substituted with no other changes.—*Frank E. Stuart, K7UUC*

### CHASSIS HOLE PUNCH

HOLES for meters, or sockets, CRT bezels, etc. can be made in panels and chassis with a Greenlee Model 740 Electricians Knockout Punch. The tool looks like a cross between the familiar chassis punch and a can opener, and comes with four anvil disks for making holes 2, 2½, 3, and 3½-inches in diameter. The tool has no trouble cutting aluminum up to 1/8 inch in thickness.—*Thomas E. Coates, W8FQJ*

### SHIELD CAN SOURCE

FLUORESCENT light starters have aluminum cases which make excellent miniature shield cans. The shields measure 13/16 inch in diameter and about 1¼ inch in length. Four tabs at the open end of the shield can be run through the chassis and bent for mounting.—*Laverne A. Bamberg, W9KCR*

### TRIMMER CAPACITOR SHAFT

TRIMMER capacitors are often used in place of regular variable capacitors by soldering a shaft to the metal slot on the trimmer's rotor. A su-

perior mechanical job, with the extra advantage of electrical insulation when it is desired, can be obtained by joining the rotary part of the trimmer to a phenolic or metal 1/4-inch shaft with a glob of epoxy cement, such as that now commonly available at hardware stores.—*Thomas E. Shopal, W3WJN*

### CRYSTAL SOCKET

THERE is nothing new about using a tube socket for a crystal socket. However, the old style octal wafer socket is sometimes overlooked as a

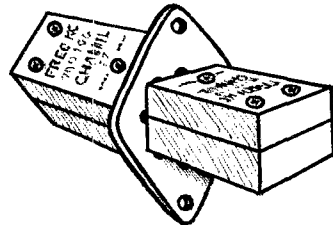

Fig. 3—A four-way crystal socket using an octal wafer socket.

satisfactory crystal socket for four FT-243 crystals. The sketch in Fig. 3 shows how two crystals are mounted on top of the socket and two are plugged into alternate pins on the bottom of the socket.—*Lew North, W4GEB*

### KNOBS FOR MINIATURE SHAFTS

IN THIS age of miniaturization many variable capacitors and controls are coming through with smaller than 1/4-inch diameter shafts. These sizes run either 1/8 or 3/16 inch. It is sometimes difficult to obtain knobs that will fit the shafts. One answer to the problem is the use of rubber grommets to act as knobs. The smaller grommets, the type with 1/8-inch diameter inner hole, can be slid over the end of the shaft making an inexpensive knob. Some of the smaller size rubber "feet" for equipment can also be used as knobs.

—*Lewis G. McCoy, W1ICP*

# Third World-Wide RTTY Sweepstakes

October 18-20

**R**TTY, INC. announces the Third World-Wide RTTY Sweepstakes to be held from 0200 GMT October 18, to 0200 GMT, October 20, 1963. The contest looks to be bigger and better than ever this year because of greatly increased amounts of overseas activity on f.s.k. Suitable awards will be given to the ten top scorers.

Stations will exchange messages consisting of message number, check (RST), time in GMT, and name of state or foreign country.

Be sure to check carefully the log form, scoring sample, and complete SS rules which follow. Logs and score sheet must be received by RTTY, Inc., 372 West Warren Way, Arcadia, California, by November 30, 1963 to qualify.

## Rules

1) This is a competition between all stations throughout the world to determine their ability to exchange messages via two-way radio teleprinter.

2) *Contest period:* 0200 GMT, Oct. 18, to 0200 GMT, Oct. 20, 1963.

3) *Bands:* This test will be conducted in the 3.5, 7.0, 14.0, 21.0, and 28.0 Mc. amateur bands.

4) Stations may not be contacted more than once on any one band. Additional contacts may be made with the same station if a different band is used. To encourage multi-band DX operation, the same country may be claimed more than once if contacted on different bands. The same state worked on more than one band may only be claimed once.

5) *Country status:* For the purpose of this contest, KH6, KL7, and VO will be considered separate countries, in addition to the ARRL Countries list.

6) Stations will exchange messages consisting of message number, check (RST), time in GMT, and state or foreign country.

7) *Points:* (a) All two-way RTTY contacts by North and South American countries (including KH6) will earn two (2) points. (b) All two-way RTTY contacts by countries other than in (a) above will receive ten (10) points. Partial contacts do not count. (c) All stations receive 200 points per country worked, not including their own.

8) *Scoring for all stations:* (a) Two-way exchange points times total states worked. (b) Total country points per band times number of continents worked. (c) Add item (a) and (b) above, for your *FINAL SCORE*.

9) Follow the sample score sheet and log form shown. Log the state only once, the first time contacted. Log the country the first time contacted on each band. To qualify, logs and score sheet should be received by RTTY, Inc., 372 West Warren Way, Arcadia, California, by November 30, 1963.

**QST**

## LOG, THIRD WORLD-WIDE RTTY SWEEPSTAKES

Station log of W6TPJ (call) My state or country Calif. Date 18, Oct. 1963

NR Sent	RST Sent	Time Sent	Band	Station	NR Rcvd.	RST Rcvd.	Time Rcvd.	State or Country	Exchange Points
1	599	0205	14	W6CG	2	589	0204	CALIF.	2
2	569	0230	14	VK3KF	6	579	0231	AUSTRALIA	2
3	559	0217	14	W6NRM	?	?	?	---	0
4	599	0300	14	W2JAV	7	599	0259	NEW JERSEY	2
5	579	0514	7	VK3KF	22	569	0514	AUSTRALIA	2

CLAIMED SCORE: (a) Exchange points 8 × 2 States = 16  
 (b) Country points 400 × 2 Continents = 800  
 (2 × 200)  
 Add (a) and (b) \_\_\_\_\_ = 816  
**FINAL SCORE**

This log is correct and true to the best of my knowledge.

Signature \_\_\_\_\_



The FCC has granted permission for a special propagation research program to be conducted by K6HME and W6MGI from August through November 16. The experiment will investigate the actual propagation characteristics of ten meters as the sunspot cycle approaches its minimum. A beacon will be operated 24 hours daily on 28.6 Mc., modulated by a 600-cycle tone interspersed with the message "BEACON QSL K6HME POST OFFICE BOX 20121 SAN DIEGO CALIFORNIA." All reports will be

welcomed. (First reported as ARRL Official Bulletin 909.)

-----  
 This is the month for the 6th Boy Scout World Jamboree-on-the-Air. For details, see page 54, August 1963 QST.

-----  
 W0FDM sez that K0SLU is well connected in ham radio — his residence phone number is 73, his business phone is 173, and his initials are C.W.



# YL news and views

CONDUCTED BY JEAN PEACOR,\* KIIJV

## Cartographers Beware!

**Q**TH? Or, what is your position (location)? This exchange between stations is nearly as essential to amateur radio as the transmitter enabling you to ask or answer it. Merely logging the answer is entirely satisfactory for all intended purposes. On the other hand, pinpointing it on the map adds something a little extra. Whereas names are often forgotten, calls of stations worked linger on; QTHs that are identified in some special way are implanted more firmly in one's memory.

Most operators delight in expounding on the exact whereabouts of their QTHs. One simple question can bring forth a wealth of information. Many are fortunate enough to operate from rare sites (as only hams can find). Perhaps it's the highest elevation in a community, or the lowest, and the feat is being heard from such a spot at all. Maybe it's a community having a name like no other.

We've all heard maritime mobiles give exact reports as to their longitude and latitude. Other mobile stations, of course, must keep you posted on the exactness of their whereabouts. However, most times the amateur isn't required to be so specific and could easily not even know his precise geographic location without extensive work or research.

An interesting example has been furnished by a challenger for the title of "continental U.S.A.'s most western YL" (see June, 1963 *QST*). Bette Peterson, K7TTV, of Forks, Washington, was very justifiably given this recognition since Forks certainly gives all appearances of being the very westernmost. However, Frank and Mary Lou Knottingham, K7QCM and K7QCN, of Port Orford, Oregon, take exception to this claim.

To quote Frank: "Port Orford, Oregon's local power company antenna location is recorded as being at longitude 124° 30' 30" and we live about one quarter of a mile northeast of this antenna in 'sunny old Port Orford', the most westernly incorporated city in W and K land, continental U.S.A."

Several public libraries and maps later, research has produced a  $\frac{3}{16}$ " difference between the two communities, Port Orford being  $\frac{3}{16}$ " farther west than Forks. Since the reference map used a 39.46 miles to an inch scale, it would appear that Port Orford is 7.38 miles farther west than Forks,

which would change the title claim to K7QCN. However, if Bette is in the north or southwest section of Forks, and since Mary Lou's QTH is in the northeast section of Port Orford, could we have a tie? Just to be sure, let's try and work both stations!

## All-Woman Transcontinental Air Race

July 13 saw 83 women pilots airborne from Bakersfield, California and the 17th annual Powder Puff Derby (AWTAR) underway. Their destination — Atlantic City, New Jersey, by July 17.

Twelve years ago radio amateurs joined in assisting with the race. Radio stations are active at the take-off point, all stop-over fields, and at the finish line. Arrival-departure forms are completed for each contestant at every stop-over point. This information is then relayed via amateur radio and provides continuous information to points in all directions.

Carolyn Currens, W3GTC, has been chairman of the amateur radio net for six years and is already looking forward to next year. Carolyn reports: "I am constantly amazed at the helpfulness of my fellow amateurs who give unstintingly of their time for this project."

Eleven official stop-over fields were manned by radio amateurs who ably assisted in the race. Much well deserved credit goes to the following: Bakersfield, Calif., Harryette Barker, W6QGX; Irma Weber, K6KCI, Las Vegas, Nev., Eldon Carlisle, W7WWT; Tom Burford, K7TDQ; Jerry Porter, K7RQU; Mel North, W7FJN; Bob Bordine, K7QPK; Dale Pozray, K7RBM; Al Parker, W7OYQ; Jerry Mann, W7VYC. Page, Ariz., Carl Hutton, W7MSC. Farmington, N. Mex., Paul Blackman,



Westernmost YL in continental U.S.A.? K7QCN, Mary Lou Knottingham, of Port Orford, Oregon.

\* YL Editor, *QST*: Please send all news notes to KIIJV's home address: 139 Cooley St., Springfield, Mass.

K5WSH. LaJunta, Colo., "Judge" Gorton, W0PGX. Great Bend, Kans., William Jones, K0CIY. Kansas City, Kans., Cecil Gesch, K0ONK; Donna Hosey, W00MM. Springfield, Ill., Charles Barber, W9YJF. Dayton, Ohio, James Dakin, K8BPC. Cumberland, Md., Thomas Herndon, K3RWT; Paul Eirich, K3CUZ; Dr. Leland Ransom, W3FXL; Joe Brandenburg, K3HYC; Wilbur Flake, K3HYE; William McCoy, K3KNA; Gary Wagner, K3OMI; Joe Faller, K8MDI; Dick Billmyre, W8AZH; Ronald Barb, K3OMN; William Fatkin, K3LEG. Atlantic City, N. J., Jack Muller, WA2MVS; Gene Madison, WA2WCC; George Ell, WA2WVY; Robert McFadden, WB2IFP; Jake Kaferle, W3LMG; Charles Clements, WB2EGM; Robert Mayer, WA2VGC; Ken Greywall, K8GPF; Tom Paprocki, K2DTB; Richard Redding, W4WSS; Cliff Poindexter, W4FHS; Al Roland, W3JIL; Wes Sammis, W2YRW; George Boltenbach, WA2PFN; Ken Harrigan, WA2TQY; Link Hartz, W3IVS; Barbara Anders, W3WML; Carolyn Currens, W3GTC.

### CONTEST FOR ALL YLS

24th YLRL Anniversary Party

Contest Period — C.W.

Starts: October 23, 1963, 1700 GMT (1200 EST)

Ends: October 24, 1963, 2300 GMT (1800 EST)

PHONE

Starts: November 6, 1963, 1700 GMT (1200 EST)

Ends: November 7, 1963, 2300 GMT (1800 EST)

**Eligibility:** All licensed YL and XYL operators throughout the world are invited to participate. YLRL members only are eligible for the cup awards. Non-members will receive certificates. Only YLRL members are eligible for the Corcoran Award. Contacts with OM's will not count.

**Operation:** All bands may be used. Cross-band opera-



At the recent State Radio Convention, Jackson's Mill, W. Va., Alice M. Nelson, K8MQB, from South Charleston, W. Va., was presented with a framed copy of Gov. W. W. Barron's proclamation designating her as 1963's Most Outstanding Amateur in W. Va. Alice is the first W. Va. YL to ever receive this award and it was presented for her unfiring efforts on behalf of amateur radio operators in the state. In addition to her duties as 8th District Chairman of YLRL, Alice well represents the distaff side of amateur radio by serving as secretary of the Kanawha Radio Club in South Charleston, W. Va., chairman of its Awards Committee, and as a member of the National Nominating Committee for YLRL.



Barbara Anders, W3WML, from Norristown, Pa. is one of many who assisted during the AWTA race. Barbara operated the 2-meter rig at the hotel near the finish line.

A teacher in California during the winter months, she hopes to be on the air from there soon.

tion is not permitted. Only one contact with each station will be counted in each contest.

**Procedure:** Call "CQ YL".

**Exchange:** Station worked, QSO number, R/S or RST, ARRL section or country. Entries in log should also show the Time, Band, Date, Transmitter and Power. Please know your own ARRL section or country. (ARRL section list available for s.a.s.e. to V.P.)

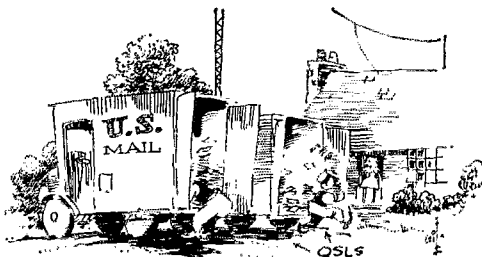

--MUST BE CONTEST TIME AGAIN!

**Scoring:** (a) C.w. and phone sections will be scored as separate contests. (b) Multiply number of contacts by total number of ARRL sections and countries worked. (c) A.m. or c.w. contestants running 150 watts input or less at all times may multiply the results of (b) by 1.25 (low-power multiplier). (d) S.s.b. contestants running 300 watts p.e.p. or less at all times may multiply the results of (b) by 1.25 (low-power multiplier).

**Awards:** Highest c.w. score — Gold Cup (YLRL member).

Highest phone score — Gold Cup (YLRL member).

Highest phone log and c.w. log in each district and country will receive a certificate.

Highest combined phone and c.w. score, YLRL member only, will receive Corcoran Award.

**Logs:** Copies of all logs must show claimed score, be signed by the operator and postmarked no later than Nov. 23, 1963 and received no later than Dec. 6, 1963 or they will be disqualified. Send copies of log to Blanche Randles, K11ZT, 62 Linda Ave., Framingham, Mass. Be sure the log you send is a copy. No logs will be returned.

### YL NETS

With the arrival of fall, the YL Nets will be humming with activity. All YLs are welcome — newcomers and old timers. You will find the nets a fine way to get to know the gals.

The following listing may be subject to changes, but was compiled from the latest available information for your convenience.

(GMT)

Time	Freq.	Name	NCS or Mgr.
<b>Monday</b>			
1330	3900 kc.	Buckeye Belles	K8MZZ
1400	7225 kc.	Floridoras (a.m.)	
1400	3920 kc.	Mich. Upper Peninsula YL Net	Rotates
1600	7225 kc.	Floridoras (mixed transmissions)	
1700	7235 kc.	Loaded Clothes Line Net	KØRZI/7
1800	50.4 Mc.	Indiana Mich. Petticoat Sisters (IMPS)	K9YIC
1930	3737 kc.	Buckeye Belles (c.w.)	K8TFG
2300	3890 kc.	Oregon YL	W7IHII
0230 (every 3rd Mon.)	146.502 Mc.	Jersey Tomatoes Radio Club Net	Rotates
<b>Tuesday</b>			
1330	3940 kc.	Jayhawker	KØHEU
1330	3900 kc.	Blue Ridge	K4CZP
1400	3933 kc.	Floridora (s.s.b.)	
1400	51.3 Mc.	Buckeye Belles	Rotates
1400	145.260 Mc.	Buckeye Belles	K8WDZ
1500	50.33 Mc.	Floridora YL Southern Net	W4VSG
1800	14.240 Mc.	YL Chapter 4 Net	
1800	7179 kc.	Buckeye Belles (c.w.)	W8DZL
1800	14.333 kc.	Fla. Internat. Sidebanders (FINS)	K4ICA
1800	50.4 Mc.	IMPS	K9YIC
0230	50.5 Mc.	Colorado YLs	KØWZN
0230	3825 kc.	Gaylars	Rotates
<b>Wednesday</b>			
1330	3900 kc.	WRONE Yankee Lassie Net	K1LCI
1400	3933 kc.	Floridora (a.m.)	
1400	3900 kc.	Mich. YL Welcome Net	W8ATB Alt. K8LHF
1430	50.2 Mc.	Hoosier Amateur Women's Klub (HAWK)	K9MZY
1600	7100 kc.	Loaded Clothes Line Net (c.w.)	Rotates
1800	50.4 Mc.	IMPS	K9YIC
1900	50.65 Mc.	WRONE	K1LCI
1900	14.288 Mc.	YL SSB	W4FJF Alt. K6KCI
0200	50.7 Mc.	Chix on Six (Cleveland)	Rotates
0200	50.3 Mc.	Fla. Suncoast YL Net	K4EAC
0300	146.1 Mc.	Los Angeles Young Ladies Radio Club (Laylars)	K6BUS
<b>Thursday</b>			
1400	3860 kc.	Georgia Peaches	K4ZNK



Newly elected Colorado YL officers are: front row, Tillie Curington, KØRGU, Pres.; back row (l. to r.), Kay Barclay, KØBTV, Treas.; Marte Wessel, KØEPE, Secy.; Lola Hensley, KØRXK, V. Pres.

1400	7270 kc.	Friendly Forty	W3UUG
1630	7235 kc.	Tex. YL Roundup Net (Tyrun)	K5IOJ/Pres.
1800	14.333 Mc.	FINS	K4ICA
1800	50.4 Mc.	IMPS	K9YIC
1800	14.240 kc.	Tangle Net	
0400	28.8 Mc.	Teu Meter Chirps (6 call area)	Rotates
<b>Friday</b>			
1330	3600 kc.	WRONE (c.w.)	W1YPH
1700	3830 kc.	Minow Net	K7RAM
1730	7250 kc.	40 Mtr. Roundtable (6 call area)	Rotates
1800	50.4 Mc.	IMPS	K9YIC
<b>Saturday</b>			
1430	3910 kc.	HAWK Roost	K9ILK
1800	3845 kc.	Bay Area YL Ladies Amateur Radio Club (Baylars) Mermaid Net	W6LIZ
<b>Sunday</b>			
2200	3940 kc.	Jayhawker	W9JUV
<b>YL Clubs</b>			
<p><i>Kilo-ettes</i> — newly formed Fort Meyers, Fla. Radio Club, announces their new officers are Donna Sousa, W4JYH, Pres.; Pat Sammons, WN4IUU, V. Pres.; Alice Justham, Rec. Secy.; June Jones, K4NXZ, Corr. Secy.; Mary Lou Propp, Treas.; Fay Williams, Parliamentarian; Betty Stout, Chaplain.</p> <p><i>San Diego Young Ladies Radio Club</i> — announces a revision of officers: Pres., W6CQS; V. Pres., K6YGJ; Corr. Secy., W6EAI; Treas. and Cert. Custodian, W6GGX; Pub., K6UTO.</p> <p><i>Colorado YLs</i> — announce new officers as of July, 1963: Pres., KØRGU; V. Pres., KØRXK; Secy., KØEPE; Treas., KØBTV.</p>			

## Strays

All Catholic minor seminary radio clubs interested in joining a net for minor seminaries, write to K5QBN, St. Joseph Seminary, St. Benedict, La.

The popular reprints of W1HDQ's "Complete Two-Band Station for the V.H.F. Beginner" are still available for 50¢, including drilling templates.

CONDUCTED BY SAM HARRIS,\* W1FZJ

**Antennas and the VHF**

I HAVE always subscribed to the notion that a v.h.f. antenna should be both large and high. The fact of the matter is I have never had an antenna which I felt was quite large enough or anyway near high enough. The *ARRL Antenna Book* states that "an antenna is an electrical circuit of a special kind." Now if you are as familiar with the *Antenna Book* as you should be, you should also identify:

"It is fair to say that the ultimate success of the station is in most cases determined more by the antenna than by any other single category of equipment."

"The importance of high-gain antennas in v.h.f. work cannot be over emphasized."

"A good antenna system is often the difference between routine operation and outstanding success in the v.h.f. field."

Before we get involved in the never-ending argument over the relative merits of types of antennas, let me point out that an antenna is a device intentionally designed so that the major portion of the energy impressed thereon is radiated. If you like yours round instead of square,

\*P.O. Box 334, Medfield, Mass.

that's your problem. The important thing to worry about is the size and the height.

In general it is safe to say that the results obtained by doubling the size of an antenna are about the same as those obtained by doubling the height. Changing from "Brand X" to "Brand Y" will probably accomplish nothing. No one in the antenna business has come up with any substitute for size or height. In v.h.f. work a narrow vertical angle is more to be desired than a narrow horizontal beam width. The improvement obtained by going from a 4-element beam to an 8-element beam are about the same regardless of how you arrange the extra elements. However, if you stack one 4-element beam above another the extra gain is obtained by narrowing the vertical lobe with little effect on the horizontal beamwidth. If the same 8-elements are made into a single "in-line" yagi type beam the additional gain will be taken in part from the horizontal beamwidths, thereby lessening the coverage for a given beam heading.

If you are really troubled with loud local overloading, the sharper horizontal beam will be your best choice. If you are interested in the best over-all coverage the stacked beams are for you. In either case the improved results obtained by doubling your beam size will quite likely start you planning on doing it again. Don't forget however, you have to double the *whole* thing next time. (16 elements, that is!)

**144 Mc. and Up**

In Benton Harbor, Michigan W8PT is running daily meteor-scatter skeds with W1MEH in Connecticut. Jack sez they are getting lots of pings and bursts and expect to have a contact almost any time. He also reports an aurora opening of about fifty minutes' duration on July 5 when a number of stations in Ohio and West Virginia were heard on 144 Mc. Contact was made with K8AXU and W8KAY. Tests run with K4LXC on July 4, 6 and 7 resulted in contacts each day, and a July 14 contact with W5UKQ gave the Louisiana end of the contact state #10. K6JC is back on the v.h.f. bands with a bang, running 450 watts s.s.b. and c.w., and the first part of August got on 432 Mc. with sixteen elements about 40 feet high. Jim worked nine stations out to fifty miles with 6 watts and reports from W6NNS and W6OHQ on his s.s.b. and c.w. were very good.

In La Mesa, California, Dick, W6IEY sez there were four days in July when inversion was "good," one day when it was "fair" and one day (the 21st) when it was "excellent" on 432 Mc. Another California station, WB6DMB, is experimenting to determine normal or extraordinary conditions on the 1215-Mc. band. One of many conclusions drawn to date is that shorting-type coaxial-stub tuners have been found to be a definite advantage in matching transmission line to the APX-6.

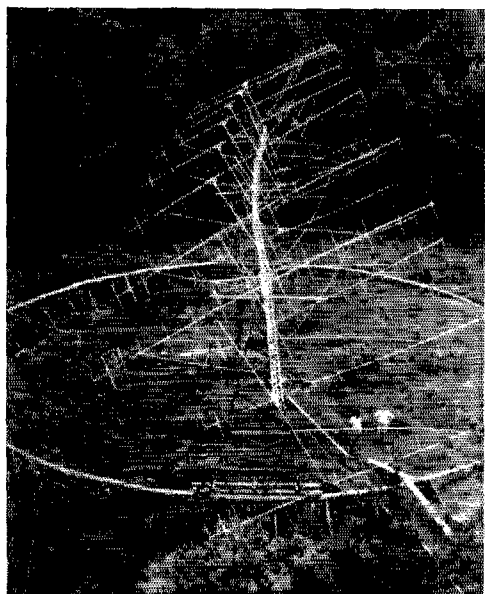

You may not be able to see them all, but there are 480 elements in this 144-Mc. moonbounce array at K1HMU, Farmington, Conn. Supporting towers fitted with automobile wheels ride on the circular tracks. Movement requires at least two manpower, though more is welcome. Elevation is controlled with ropes. System has crossed dipoles, switchable for left or right hand polarization.

K4QIF in North Carolina has finished his 432-Mc. Nuvistor converter and is presently working on antenna and tripler for same band.

Another newcomer to the 432-Mc. band is WA4GHK at Palm Bay, Florida. Jim sez he has recently completed his 432-Mc. gear and is on the air, but to the best of his knowledge there is no one on the Florida peninsula on the band. He would like skeds with anyone interested and of course with Alabama, Louisiana, Arkansas, Mississippi or Texas when conditions are good. Rig runs 30 watts to a 2C39A and antenna is a 13-element yagi. At Sunbury, Pennsylvania K3ARR and W3NDB are laying out plans for a 432-Mc. amateur TV rig but as Bill sez: "process is involved and costly."

WA2IFP is looking for skeds on 220 Mc. between 0400 and 0630 any day of the week, either a.m. or e.w. Rig runs 20 watts to two eleven-element beams. August 19 was a good date for W3RUE who worked W4HJQ in Glendale, Kentucky for the first Pennsylvania/Kentucky two-way contact on 432 Mc.

The Perseids meteor showers (August 10 through 14) brought a number of reports of stations worked or heard on 144-Mc. skeds. W1AZK in New Hampshire sez that although he worked no new states himself, he did give New Hampshire to K4IXC, W4WNN and K9UIF via the Perseids. "Had a close miss with W5JWL, just could not get that final 'R' through." Plenty of good bursts and pings were received from W0QDH but none long enough for a contact. W0EMS put a complete set of calls into Don's QTH with S7 report but no contact was made.

From Waltham, Mass., W1JSM reports that he upped his states-worked total during the Perseids when he worked W4WNN in Kentucky and W5JWL in Arkansas on 144 Mc., bringing his total to twenty-two states worked in seven sections. Don still keeps nightly skeds with W9AAG in Illinois. WA2UDT reports good conditions on 144 Mc. on July 7 and 8 when he worked W4FJ and K4EUS with good phone signals; and excellent conditions on July 25 from Virginia to Maine when Bill worked K1CRN and W1AZK for states 9 and 10.

K3OBU in Wilmington, Delaware managed to keep his rig warmed up during July by working W1MEH, W4FJ, W3TFA, WA2UDT, W1JSM, K1WHT and K1YMQ. Joe also heard W1AZK but didn't manage to nab him. K3ADS and K1NFS have begun a Friday night sked (146.8) at 2300 E.D.T. Each station is running about 845 watts.

Perseids report from W4MNT sez that he worked K9UIF, W8PT, W3SDZ and W8LCA on schedule. George runs a kilowatt to a pair of 8-element beams up 65 feet. Converter is a W2AZL 417A mounted on the antenna, feeding an NC-300 at 14 Mc. An audio filter is the most recent addition. Now that the Perseids are over, George is looking for skeds for the Geminids with anyone interested in getting Florida on 144 Mc., and is also looking for early morning tropo skeds.

K4GPL says that two-meter activity has been very good lately in the Greensboro, North Carolina area. Ron hoped to have s.s.b. on two meters by the middle of September. "Big opening" reported by Sam, K4EUS on July 7 when he worked six 3s, 14 2s and two 1s. Last contact was at 0142 on the morning of July 8 with W2MVR in New York City who was running 4 watts on phone. Jim had a solid 5/9 signal into Chester, Virginia.

New entrant in the two-meter box is K5TQP with 11 states, 4 call areas and greatest distance 1170 miles. Fred sez he will finally be operational at his 7300-foot elevation on the east side of Man-

### **Ionospheric Beacon Satellite, S-66**

Scheduled for launch in late September is a new type of satellite. Primary objective of NASA satellite S-66 will be to transmit information on conditions in the ionosphere, thus permitting scientists to plot its form and structure more accurately than has been possible from information obtained by the long-standing program of ionospheric sounding by ground-based equipment.

NASA will attempt to place S-66 into a nearly circular polar orbit, inclined 80 degrees to the equator, at about 600 miles altitude. In this orbit the satellite will examine each area of the ionosphere every 24 hours. The satellite will transmit on seven frequencies: 20.005, 40.01 and 41.01 Mc., continuous e.w. for ionospheric measurements; 136.17 for tracking; 162.0 and 324 Mc. for Doppler measurements; and 360.09 Mc. for ionospheric measurements.

Nearly all amateurs should be able to receive the 20-Mc. signal, and they may find it of interest for propagation observations, since at 600 miles it will be coming through the ionosphere. Those having experience with Doppler measurement may find other frequencies of interest as well. Discussions between Project Oscar and NASA officials are taking place as this is written, and if a coordinated program of amateur observations appears desirable information will be circulated through Oscar channels and via W1AW.

zano's Mountain this fall, and hopes to make that states-worked number climb fast.

W5UKQ sez that the Perseids were unproductive for him although he heard much more this year than any other year, with bursts up to 30 seconds or more being common. John worked K7HKD and heard K4EUS, W3BYF, W3SDZ and K8AXU.

At Costa Mesa, California K6HMS brought his states-worked total up to 5 when he worked W7WVE in Seattle during the Aquarids meteor shower. He is looking for skeds each shower at distances of 600 to 1500 miles. West Virginia took care of the v.h.f. bands through Al, K8AXU during the month of July. After two years of trying, Al contacted W0ENC in South Dakota for state number 31 on July 12, and on the 13th he contacted K7HKD in Wyoming for number 32 on 144 Mc. His grand total stands at 32 states, 9 call areas and 1275 miles.

W9KLD/9 in Champaign, Illinois tells us that there is a lot of local activity on fixed-frequency f.m. on 147 Mc. and quite a lot of activity other than that in the Champaign-Urbana area. Don sez he is using a five-element yagi but due to space considerations it is only about 12 feet off the ground. As he sez: "not much DX but maybe if I could get the antenna up a little higher I'd do better." (No doubt about it, Don.)

Out in Harrisonville, Missouri K0JWN worked WA0ENM and K0JVW in Kansas on July 1. On the 10th he worked a station in Omaha, Nebraska on phone and on the 22nd he heard but did not work W0DQY in St. Louis and heard a K9 on s.s.b. calling CQ on 145.2. All of the above on two meters.

Word received from VP7CX sez that he intends to QSL all contacts made from his HI8 location during July, and also mentions that there is the possibility of a VP2 expedition during the month of October. Hal sez that he will be working with several v.h.f. clubs throughout the winter making plans for next summer, as the group feels that at least ten new countries can easily be put on six meters. Let's hope their plans go along with no hitches and that conditions next summer will be as good as they were this year. The week-end of July 13 and 14 was a good one for Hal. He worked FP8CB and FP8CG, VE4s, and North Dakota for state number 28 for 1963.

Of the hundreds of six-meter hams in New England we have received two reports of recent activity. WIQXX, after being off the air for more than a year, came back on six meters June 5 and in the following month worked 33 states and 5 countries and heard two others which he missed. K1VPJ reports openings on 14 days during July with 4s, 5s, 6s, 9s and 0s coming through, but sez he was disappointed as the skip was not nearly as good as he had expected it to be. Bruce is wondering why the ARRL appointees don't get on 50 Mc. during the c.d. parties and also why he doesn't hear any c.w. operators. (Have you listened during openings and contests?) Only report received from New Jersey was from K2LNS who worked and/or heard thirty-two states plus VP7CX, FP8CB and CO5CN during 21 days of openings in July.

Among the lucky New Yorkers working FP8 land during July were WA2OLB and WA2ZZR. Louis, WA2PSL sez that it's become quite a common thing to work VP7CX as he always comes through during openings; that on July 14 a number of stations in Puerto Rico came through and other than regular skip into 4, 5, 7, 9, and 0 lands he made his first Wyoming contact with W7VDZ. Barry (WA2ZZR) sez the most notable band opening was on July 20 when the band was open for five solid hours, and all call areas except 7 were copied. Louis (WA2RAQ) reports his first new state worked on six meters since spring of 1962 is West Virginia. W2SEU reports working HISXHL on July 2 and sez that other than regular single-hop sporadic E, he heard Wyoming and Colorado on July 29. "Six-meter openings almost daily" sez Fred.

At New York City, WA2TQT sez that several KP4s, VP7s, XE1s, VEs and VOs were heard and worked in that area plus frequent contacts with other skip stations. Jim, WA2DRP sez that whenever the band opens he moves up to 51 Mc. and wishes that more stations were active at that frequency. He mentions that during the opening of July 14 west coast stations were coming through into New York. High spots in the log of WA2VOK for July are on the 2nd, when KP4s AXC, CK, BEO and AMY plus HISXHL were all heard with S9 signals, and July 14 when W7VDZ was heard. While operating mobile in Anniston, Alabama during June and July, WA2UTO worked 26 states plus two VE4s, one VE3, Cuba and the Bahamas. Karl was using a Gonset IV and hill-topper beam.

According to K3KEO and K3WUJ in Delaware, that state also has had its share of skip. Sam (K3KEO) reports that 48 states were heard on 50-Mc. s.s.b. during July with 39 of them worked 2-way s.s.b. Sam sez that VP7CX is now a "regular." XE1OE is "in" often and VE3, VE4, VE5, FG7, FP8, VP9, YV5, CO2, CO5 and KP4s were all heard during the month of July. Henry (K3WUJ) observes that the best openings of the month were

on July 7, 17, 20 and 27, and adds VE1 land to the list of K3KEO.

At Oxon Hill, Maryland K3LLR sez it "drove a man crazy, swinging the beam so much! Just about every time I turned on the six-meter rig there would be lots of DX to the north, south and west." K3QOY and W3GCO, also in Maryland, concur with the above statement and K3QOY adds that on July 4 CO5CN was heard, and on the 14th VP9WB and KP4AXC were heard.

In Pennsylvania W3JYL sez that 50 Mc. has been terrific; K3KPA sez it's been just great with KP4s, VP7s, FP8 and California coming thru; W3RUE worked K7MAC in Utah for state number 49 on 50 Mc.; K3HNP reports hearing Oregon, Washington, Wyoming and Montana very strong and very consistently. K3ARR observed openings on 18 days during July, with 7s coming through on the 27th and 28th; and K3ADS reports this the best sporadic-E season since he arrived on 50 Mc. in 1957.

Down Alabama way K4NGD reports the band open nearly every day and all call areas were heard. She also tells us that K4UTH is on 50-Mc. RTTY and would like skeds with anyone within ground-

**220- and 420-Mc. STANDINGS**

<b>220 Mc.</b>		K0ITF.....6	3	515
W1AJR.....11	4	480		
W1AZK.....9	3	412		
W1HDQ.....11	5	450		
K1JIX.....10	3	450		
W1OOP.....12	4	400		
W1RFU.....15	5	480		
W2AOC.....13	5	450		
K2AXC.....9	3	240		
WA2BAH.....1	2	187		
K2CBA.....13	6	650		
K2DGG.....4	3	140		
W2DWJ.....15	5	740		
W2DZA.....12	5	410		
K2DZM.....12	5	400		
K2TTP.....10	5	265		
K2TTO.....11	5	265		
E2JWT.....6	3	244		
K2KIB.....12	4	300		
W2LRJ.....10	4	250		
W2LWI.....12	4	400		
W2NTE.....12	5	300		
K2PPZ.....11	4	400		
K2QJQ.....13	5	340		
W2SEU.....9	3	225		
K2UUR.....6	3	210		
W3AHQ.....4	3	180		
W3EYF.....11	5	350		
K3IVU.....3	3	310		
W3JYL.....8	4	295		
W3JZ1.....4	3	250		
W3KEN.....10	4	255		
W3LOC.....10	5	300		
W3LZD.....15	5	425		
W3RUE.....10	6	480		
W3UJG.....13	5	400		
W3ZRF.....5	4	112		
K4TFU.....8	4	400		
W4TLC.....5	1	315		
W4UYB.....7	5	320		
W5AJG.....5	2	1050		
W5RCL.....8	5	700		
K6GTG.....2	1	240		
W6MAU.....2	2	225		
W6NLZ.....3	2	2540		
K7ICW.....1	1	250		
K8AXU.....10	5	1050		
W8LJC.....9	5	475		
W8LPD.....6	4	480		
W8NRM.....8	4	300		
W8PT.....10	5	660		
W8SVL.....6	4	520		
W9AAG.....9	4	660		
W9JCS.....6	2	340		
W9JEP.....9	4	540		
W9OVL.....6	3	475		
W9UED.....4	1	605		
W9ZIH.....10	5	500		
K9DGU.....5	3	425		
K0ITF.....6	3	515		
KH6UK.....1	1	2540		
VE3AIB.....7	4	450		
VE3BPR.....3	3	300		
<b>420 Mc.</b>				
W1AJR.....11	4	410		
W1HDQ.....8	3	210		
W1RUE.....8	3	170		
W1OOP.....11	3	390		
W1QVJ.....10	3	300		
W1UHE.....7	4	430		
W2AOD.....6	4	290		
W2BLV.....12	5	360		
K2CBA.....7	4	225		
WA2DTZ.....6	3	200		
W2DWJ.....10	4	196		
W2DZA.....5	3	130		
K2DZM.....10	4	390		
W2HFQ.....8	4	280		
K2KIB.....4	2	100		
W2NTE.....3	2	100		
W2OTA.....10	4	300		
K2UTR.....9	3	280		
W2VCG.....9	4	280		
K3GLK.....9	4	250		
K3EOP.....6	3	250		
W3FFY.....8	4	296		
K3IUV.....7	3	310		
W3LCC.....3	2	380		
W3RUE.....4	3	380		
W3UJG.....2	4	350		
W4HHK.....8	4	550		
W4VVE.....7	4	430		
W4TFL.....4	2	500		
W5AJG.....5	1	425		
W5HTZ.....5	3	440		
W5RCL.....12	3	660		
W5SWV.....7	3	525		
K6GTG.....1	1	180		
W7LHL.....2	1	180		
K8AXU.....5	3	660		
W8HCC.....3	2	355		
W8HRC.....3	2	250		
W8LQ.....4	3	275		
W8NRM.....3	2	390		
W8PT.....6	3	310		
W8RQL.....6	3	270		
W8TYY.....9	5	580		
W8UTS.....3	2	25		
W9AAG.....8	4	525		
K9AAJ.....7	3	425		
W9GAB.....9	4	608		
W9OJL.....6	3	330		
K9UIE.....6	3	240		
K0ITF.....3	3	158		

The figures after each call refer to states, call areas and mileage of best DX.

wave range; W4MI needs only Hawaii and Alaska for 50-Mc. WAS; K4ZCY and K4HQ8 are conducting nightly QSOs after midnight on 51 Mc. and would welcome all who'd like to join 'em; W4OGT and K4NGD are "mountain topping." Nan says that local activity on six is the best she's ever heard and would like to remind any visitors in the area who might be mobile through Alabama to be sure and use the national calling frequency of 50.550 Mc. as one or more of the Alabama Emergency Net members is constantly monitoring that frequency.

At Fort Walton Beach, Florida W4ZGS noted openings on 15 days during the month of July with the 16th and 19th being the exceptional days when 7s were coming through.

Dale, WA4CQG in Kentucky, sez that several local stations (Louisville) worked KL7s during July and that on July 26, 4s, 9s, 1s, 2s, 7s, 8s, VE7s and KL7s were coming into Louisville. "Openings seem more numerous to the West Indies, Bermuda, Carribean, and Cuba, than in the past couple of years," sez W4OAB. (Could be because of the increased activity in those areas.) Within three days' time during the last week in July, Brian worked all call areas plus Cuba, Puerto Rico, VE4 and VP7. Seems that Jim, K4KYL at Knoxville, Tennessee missed out on some sporadic E when he was out of town for four days during the month of July. Because of this he can report only 29 openings on 25 days during the month with 43 states heard plus VE1, VE4, CO, VP7 and FG7. (Wonder what he did miss from the 22nd to the 26th!) WA4LRX in Memphis managed to grab off West Virginia when he heard W8BYX on July 13.

In Virginia, W4GVQ sez that on four different occasions during the month he swung down to 50.04 Mc. and resorted to c.w. to escape the QRM in the phone band. Paid off for him, too, as he had good c.w. contacts with Florida, Louisiana, Texas and Puerto Rico. (Attention, all youse guys who want to know where the c.w. operators are hiding out!) Although the band was frequently open into Annaudale, Dave sez the outstanding days were July 8 with 6s, 7s, Kansas 8s and VE1; July 14 with CO2s, VP5, VP7, VP9, K7 and K9s; July 20 with the band opened from 1500 to 2200 first to the south, then southwest, next west and finally northwest.

From John Lee, W6YKS we received the following: "Just a note to fill you in on the six-meter activity (?) in the north coast area. As far as I know at this writing there just isn't any. I am still the only six-meter ham in the Fortuna-Eureka area but am trying to promote something. Had three good openings here since I arrived and managed to work Montana and Wyoming which brings my states-worked total up to 2. Still haven't worked California from this location so can't even add that to my states. (Who sez things aren't tough on 50 Mc.?) In Redwood City, K6JIC is back on the v.h.f. bands and has worked 8 call areas and 21 states on s.s.b. this summer. 99 per cent of Jim's 50-Mc. work is done in the late evenings so he has missed a number of the really good openings. WA6YIT worked 15 new states during July plus VE3 and VE7. All this during 13 days of openings. At La Mesa W6IEY observed openings on 12 days and heard or worked 20 states.

A detailed report received from K7ICW lets us know that Las Vegas, Nevada was a good place to operate 50 Mc. during July. Al heard 46 states plus VE3, VE4, VE6 and VE7 during that period, and needs Maine, Vermont, Alaska and Hawaii for 50-Mc. WAS. On July 2, WA6AJM/MI in Las Vegas

## 2-Meter Standings

W1REZ	32	8	1300	W5YYO	7	4	1330
W1AZK	38	8	1205	W5UNH	6	3	1200
W1C8H	24	7	1150				
W1AJR	23	7	1130	W6QSQ	15	5	1390
W1MINN	22	8	1200	W6NLZ	12	5	2540
W1JSM	22	7	1330	W6DNG	9	5	1040
W1HQQ	22	6	1020	W6AJF	6	3	800
W1EZY	20	7	1080	W6ZL	5	3	1400
W1CRQ	19	6	800	W6HJ	5	2	1010
W1MFH	18	6	1000	K6GTG	2	2	800
W1AFO	18	6	920	W6MMU	3	2	950
K1AFR	17	6	675				
				W7JRG	17	6	1230
W2CNY	37	8	1360	K7KHD	15	5	1150
W2ORL	37	8	1320	W7LH	7	3	1050
W2NLY	36	8	1300	W7CMI	2	2	670
W2BLY	36	8	1020	W7JJP	4	2	900
K2LMG	30	8	1290	W7JU	4	2	235
K2GQI	35	8	1365				
W2AZL	29	8	1050	W8PT	39	9	1260
K2IEJ	27	8	1060	W8KAD	38	8	1245
W2RLL	27	8	1200	W8SBJ	37	8	1220
W2AMJ	25	6	960	W8LFX	35	8	980
W2ALR	24	8	1100	W8SPG	34	8	1040
W2RXG	28	8	1200	K8AXU	32	9	1275
W28TX	23	7	1090	W8LOP	32	8	1060
K2HJD	23	7	950	W8LJL	32	8	1180
W2WJY	22	8	860	W8HAY	28	8	960
W2PAU	23	6	753	W8RMB	32	6	910
W2LWI	22	6	1050	W8NOH	31	8	1090
W28SX	21	6	750	W8EHW	31	8	860
K2KIB	21	5	700	W8SVL	30	8	1080
W2CTH	20	7	880	W8PHW	30	8	860
W2WJR	19	7	1040	W8LFD	29	8	850
W2RGV	19	8	720	W8WBN	28	8	680
W2E6MA	19	6	1010	W8DX	26	8	720
W2RLG	17	6	980	W8LLC	25	8	800
K2JWT	16	6	550	W8JWV	25	8	940
				W8VNA	25	8	900
W3RIF	33	8	1100	K1CQ8	25	8	900
W38GA	31	8	1070	W8GPN	23	8	540
W3TDF	30	8	1125	W8LCY	22	7	680
W3GKP	30	7	1180	W8BLN	21	7	610
W3KCA	28	8	1110	W8CFR	17	7	550
W38YF	28	8	1070	W8N8N	17	7	550
W38PH	22	8	1100				
W38LA	22	8	720	W9KLR	41	9	1160
W3LST	21	6	800	W9WOK	40	9	1170
W3NKM	20	7	730	W9AAG	35	9	1050
W3LZD	20	7	650	W9GAB	34	9	1075
K3HDW	12	6	1015	K9AAJ	33	8	1070
				W9RML	29	8	850
W4HJQ	39	8	1150	K9LTF	29	9	970
W4HLK	37	9	1280	W9ZIH	30	8	830
W4LTU	34	8	1160	W9PBP	28	8	820
W4ZNI	34	8	954	W9LVC	27	8	950
W4VNH	33	9	1050	W9QJL	27	9	910
W4MLJ	33	8	1140	K98KJ	26	8	840
W4AO	30	8	1120	W9ZEL	25	8	700
W4LYA	26	8	1000	W9BPV	25	7	1030
K4EUS	26	7	1130	W9CUX	24	7	1000
W4EQM	25	8	1040	K9AQF	24	7	900
W4AB	25	8	900	W9LH	22	7	825
W4TLV	23	7	1000	W9KPS	22	7	690
W4JC	23	6	725	W9ALU	15	7	600
W4VVE	23	6	724	W9WDD	16	5	600
W4RMU	21	7	1080				
W4IKZ	20	6	720	W0BFB	39	9	1350
W4OLK	20	6	720	W0LHD	31	8	1030
W4XGJ	19	7	1080	W0RCP	30	7	970
W4RFB	18	9	820	W0SAL	29	9	1075
K4VFX	18	8	830	W0QDH	27	9	1300
W4CPZ	18	6	650	W0RUF	23	7	900
K4VWL	18	6	590	W0MOX	23	6	1150
W4MDA	17	6	757	W0IC	22	7	1360
				W0RHO	22	6	1100
W5RCL	38	9	1280	K0TTF	21	6	840
W5FYZ	33	9	1275	W0LNI	21	6	830
W5AJG	32	9	1360	W0TGC	21	7	870
W5JWL	29	7	1150	W0RYC	20	8	925
W5DFU	29	9	1300	W0DQY	20	7	760
W5PZ	27	8	1300	W0JAS	19	7	1350
W5LPC	25	7	1000	W0AZT	18	7	1100
W5KTD	23	8	1200	K9AQJ	16	6	1120
W58WV	20	5	960	W0IFS	16	6	1100
W5ML	16	6	700				
W5KFU	13	1	1300	VE1CL	8	4	800
W5UGO	13	4	635	VE3DR	36	9	1350
W5F8K	12	5	1390	VE39	29	8	1300
W5HEZ	12	5	1250	VE3BP	24	7	950
W5UKQ	12	5	1100	VE3BQ	21	7	790
W5CVW	11	5	1180	VE3AG	18	8	1300
W5NDE	11	5	620	VE3DR	17	8	1340
K5TQP	11	1	1170	VE3HW	17	7	1350
W5WAX	10	5	735	VE8D	11	1	905
W5YV	10	3	1200	VE7EJ	2	1	365
W5BEP	9	3	1000				
W5EDZ	8	5		KH6UK	2	2	2540

The figures after each call refer to states, call areas and mileage of best DX.

worked stations up and down the California coast as far south as Bakersfield (220 miles), the shortest "s" noted in that area on 50 Mc. Al (K7ICW) reports that the opening of July 13 when he worked all call areas in exactly 10 hours, was the best widespread opening since 1958. He also provided the first s.s.b. contact from Nevada for a number of sidebands

who wanted a two-way s.s.b. contact with that state.

From Oregon and K7GWE we hear that 50 Mc. was open on 15 days during the month when Randy worked 24 states in 7 call areas. Big news from Bothell, Washington and W7DYD is: "on July 30 and 31 KL7AUG at Ketchikan, Alaska worked around 40 stations in the Seattle-Portland area. Opening lasted only 5½ hours. Distance about 750 miles. KL7AUG (Bob) has c.w., s.s.b. and a.m., so you can take your choice. Aurora was heard on local stations but KL7AUG was solid with no sign of aurora on his signal."

W8HFA and W8MBH, both of Michigan, report numerous openings with VP7CX coming through several times. The only report received from Ohio was from W8EWT who heard 6 states plus the Bahamas and Cuba during two openings on July 13 and 31. Seven openings and 8 states is the score for July at K9FNB. Dick sez that one of the more interesting contacts was the one with K7SVC/7 on Francis Peak in Utah who was using a regenerative receiver and running 750 milliwatts to a single-element beam. His signal was S8, one of the louder ones on the band. Steve, K9PVS in Indiana, says that a Sixer and a dipole is not the best rig for working skip on 50 Mc. That is the rig that he was using up to the first of this year and at that time he had one state and one call area to his credit. Now, however, he is using a three-element beam, people are beginning to hear his signal, and he has 12 states and 8 call areas.

From Wisconsin and K9FPM we hear that on July 28 there was c.w. activity on 50 Mc. Ron worked five c.w. stations from New Jersey and Pennsylvania and then the band shifted to the Pacific northwest and he worked stations in Oregon and Washington. The log of K9HBT in Beloit, Wisconsin shows openings on 24 days of the month and contacts to all call areas and six countries. Heard or

worked were FG7XT, VP7CX, H8XHL, KP4BCT, VE1DE, numerous VE3s, VE4 and VE8BY. On July 3 Jerry worked K7HKU in Washington for state 48, and during the period between June 6 and July 14 he worked 47 states with only North Dakota missing.

During 11 days of openings for W0DRE the most interesting contacts were with K7MKW, Sandpoint, Idaho (attention, those needing Idaho), and K7MAC in Salt Lake City, Utah. Both these contacts provided new states for John, bringing his six-meter total to 44 states worked. Still needs Minnesota, North and South Dakota, Oregon, KL7 and KH6.

Out in Wichita, Kansas K0GIC observed 12 days of openings with 31 states heard plus VE3, VE4 and VE6. Dot worked Maine on July 26 for a new state on 50 Mc. at her QTH. Score at Kansas City, Missouri and QTH of WA0PFL now stands at 32 states contacted with 29 confirmed. For July (the first 9 days that is) Bob heard 16 states. Balance of the month Bob operated portable in Kansas, Oklahoma, New Mexico and Colorado. All contacts made were while in Colorado. "When calling CQ from Tin Cup, Colorado (11,000 feet and COLD), QRM from so many 6-land signals prevented us from making one single contact. When we kept quiet copy was excellent." (And the moral of that story is—???)

At Harrisonville, Missouri, K0FPC had just one skip contact and that with WA0BMB in South Dakota, a new one for Bob. Band openings were observed 16 days by K0FLE in Nebraska with all call areas heard and 20 states worked. And from South Dakota and K0FKJ we hear that "K0LIJ in Missouri was worked on July 1 for a new state and K7MKW in Idaho worked on July 3 for another new one. The band was open at some time most days in July, but on the 28th I was working both coasts and getting QRM from whichever one I was not working." (Ain't it fun?) QST

## Strays NEWS

The Automobile Manufacturers' Association has been strongly commended by the FCC for their voluntary efforts to suppress ignition interference from cars and trucks. A. C. Doty, Jr., K3CFU and AMA spokesman, tells us that virtually all cars and trucks have now been suppressed to within SAE standards in the range from 30 to 400 Mc. (And the SAE are on our side, too. Among the engineers who set the interference standards are W8RXI, W9DPI, K9GFQ and K3CFU.)

W6MLZ tells us that at least three hams are serving as destroyer squadron commanders with the U.S. Navy. W6LCU is COMDESRON 7, W6RVU is COMDESRON 13, and KH6EFL commands Destroyer Squadron 25.

WN4NPW says that his Pensacola, Florida, Explorer Scout Post specializes in ham radio—and every member is a licensed amateur.

The Post Office Department promises faster mail service with the new Zip codes. Use yours when you write League Headquarters. Use ours, too. It's 06111.

Eight young men in Buffalo, New York have claimed a new world's record for the longest QSO. Using the calls WA2SMO and WA2TLA, they talked and played table games in shifts for a total of 200½ hours. Frequency used was 21.3 Mc.

Here's Mary Kaye Schoettlin, K9TJT, and her Science Fair Award-winning seismograph. Mary Kaye, who will enter college in the fall, comes from a radio family: Dad is W9UMS and sister Ruthanne is K9JUS. Mary Kaye recently won fourth place in the National Science Fair at Albuquerque, New Mexico.

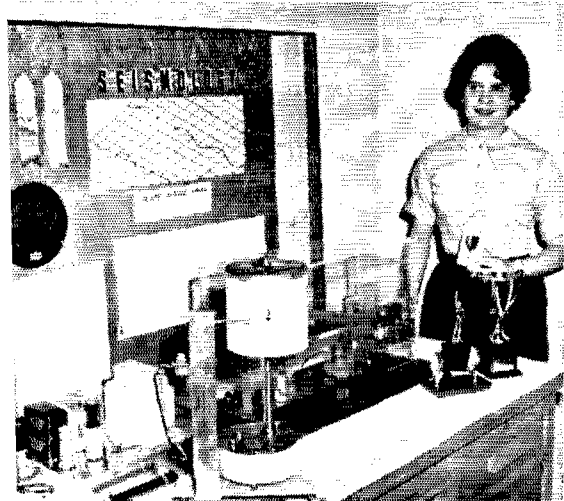

**QST** for





# How's DX?

CONDUCTED BY ROD NEWKIRK, \* W9BRD

## How:

A recent lively discussion down at the club dealt with the tenacity and general *joie de vivre* of amateur radio's old-timers. Like OM River, those two-letter-call guys just keep rollin' along. Ham spirit? Man, you don't know the meaning of the term till you find it still shining forth from birds who broke in with spark and bloopers. A special breed!

There are plenty of old OTs with three-letter calls, to be sure, but for statistical purposes the two-letter nucleus is solid enough to use as an entity. We can trace it like a radioactive isotope through the ham body, and it's interesting to note how well the old-timers are holding their own in this great game.

Comparing QSTs of ten years ago with those of today reveals two-letter calls scarcer by only about 3 per cent in the Two-Meter Standings and the Brass Pounders League, an almost negligible figure. Apparently they're holding their own very well in v.h.f. and traffic work against the challenge of young fry.

The job of ARRL Section Communications Manager isn't operating *per se*, but it's an elective office of hard-working responsibility. In this category two-letter calls have diminished by about 6 per cent in the past ten years, a diminution less than one out of ten. Not exactly a take-over by the junior operators.

DX and contests? ARRL's DX Century Club well combines these two facets of hamming, for DXCC is essentially an open-ended continuous supercontest. Ah, surely the poor grizzled OTs must be fading faster in these rugged ranks, for DX is considered by many authorities to be the most competitively blood-curdling pursuit in ham radio. Oh yeah? Ten years ago there were 4 two-letter men included in the DXCC Honor Roll of 18, or 22 per cent. This year the figure is 12 out of 59, still a whopping 20-plus per cent! Junior still has a long, long way to push grandpa out of the pile-ups and into his rocking chair.

Jeeves & Co. are forced to draw these conclusions from this brief analysis: (1) Those dog-goned old-timers are rougher and tougher than nails, and (2) amateur radio, ARRL's DX program in particular, maintains a magnificently steadfast appeal to maturity.

## What:

The autumnal equinox is famed for pepping up propagation on h.f. bands, but at this stage of the solar cycle we're not sure which way the DX ball will bounce. The surprising summer of 1963 will go down as one of the liveliest in DX history, from 10 through 160 meters. Yet here we are near the bottom of the sunspot cycle, a period fraught with dire predictions of scant and spotty DX! Was this merely a lull before the storm, a flash DX hood before the drought? Your guess is almost as good as anyone's, for short-wave propagation prognostication must still be classified among the more

inexact sciences. What will 20 be like next week? Next month? Next year? In the next 10 minutes? *Nobody* knows — for sure. And that's one of the main reasons why DXing is such great sport, of course, filled with uncertainty and surprises.

**15** Novice denizens know just what we mean. Even though the pickin's grow slim, WNs 41IF 4KXC 8EWT and 9ICQ hang in there for successful shots at EA7LL, F9UC/FC (21,135 kc.) 2100-2200 GMT, KZ5s EBN (150) 21, HK, LUs 1BAA 0, 4DGY, OA6W, ON4ZY, PYs 1MCC 21, 4GA, WP4s GNL 23, BNR 1, BNT BOR (185) 22-23 and YV5ANT.

**15** c.w., non-Novice style, still enables Ks 1VWL 2YFE 40GV 68XN 4, WAs 2KSD 2ZVJ 5CVK 6MIN 6VAT 9ATA, WB2CAV and IERD to click with CE1GJ, GM2PP (70), CR6DX, CT1HX, many DJ-DLs, DM2AND (40) 23, Fz 2LV (50) 18, 2LA 3KR 8NB, plenty of Gs, GC3HFE, GM1TF (85) 21, GW8FSP, HG1DC (30) 15, HK7UL, Hs ALX LCC, JA1MHL/mm (60), K7GVM/VQI, KG4AM (70) 21, KH6s DKG DSW (44) 4, KP4s CB CC RK, KZ5s FZ (82) 0, HK (40), JW (30), MJC (51) 0, LA2MA/mm (43) 2, LU4DGY, LZ1s FO (40) 21, KSA (40) 15-16, OA4s AD NFP (60), OB1s EV (60) 22, SQ, ONs 40V 5Z0, OK3KM, OX3DL, OZ2LV, PJ3AF (102) 1, PYs 1AJX 1MCC (81) 1, 2CQM 2GR 3AF 4BC 5ASN (50) 23, 5AST 7KI 7NQ, PZ1BH, VKs 2APK (50), 3AEX (35), 3AZV (40), 3RJ (50), 7SM (58), VP4TR, WP4BJI, YN8KM (90) 1, YVs 1DP 4HV (135) 2, 5BRA 5FT (28) 0, ZL31S, 4X40N (65) 19, 5X5JE (30) 20, 6W8DD (75) 21 and 9Q5CA (15) 19.

**15** phone keeps Ks 1VWL 2YFE 3CNN 7RBM 7UGE, WAs 2KSD 2ZVJ 4AYX 6GKH 6MIN, WBs 2AHR and 6BZA well supplied with CE 2AW 2GF 3GL, CN8FX\*, COs 2PP 2VE 8CO, CX1BI, DL4AC, EI9S, EL3C (273), F7GX, F7LX (188) 21, GIBKYP\*, GM3OCU, HCs 1GG IRS\* 1RY 5CN 5EJ\*, HIBNSL, HKs 3AKB 3UF 3YF 9LX, HP3EL, HRs 2JJC (239) 20, 3DW, Hs DFD\* DG, IT1ZDA, K5DYR/VO2, KG4BQ\*, KH6EJR, KP4s AOW\* ATQ\* BAH\* BLC\* BLR\* BMA\* MT, KZ5s AE\* (410) 23, AX\* BL\* EJ NG TG, LUs 2CM 2JV 4DEG, OA8B\*, ON4s BH TK, PJ3AF\*, PYs 1BVU 1NAX 1NBA 2CMA 3BBD 5BTL 7AEG, PZ1s AX\* BA BW, TGs 6PB 9DC 9RI 9SL\*, TIs 2M 2MO\* 2PT 2RO\* 5KW, VPs 2SM 2SY (280) 23, 2SYL 6LX 7CC\* 7NB 7NX 9AK, Ws 4WQQ/VP9 5YMLX/mm\* near the Azores, WA4GBH/KG4, XE1s CCK (220) 2, NY\*, YNs 1MCC\* (240), 9RJM, YQZBN (217) 23, YVs 1EM\* 1HN 2BM 4BB, ZP5s CN\* (422) 23, IT\* ML, 5A1TK (225) 21, 6YAAH (230) 19 and 9Q5CP, the asterisks representing single-sidebanders.

**10** phone, a real mystery band for the moment, slid off an early summer peak, but W5ERY, Ks 1SLB 1YKF and 2YFE hung around to grab CE3TV (588) 22,



\* 7802-B West Lawrence Ave., Chicago 31, Ill., 60656.

GX2DT (510) 20, KZ5SN, LU5 3AEQ 3DCU 4DM (400) 22, OA1s D Z, VP9FD (720) 19, YV5 1LP 5AGM 13 and BO1. . . . WB2CGY keeps us solvent on 10 c.w. by reporting contact with HP1AIN. We've come to the time of year when 28 Mc. used to live it up. Game to give ten a good try?

40 c.w., now under heavy nighttime fire with 14 Mc. swooning after dark, sees W5 6YKS 7DJU 8YGR 9GML 9NN, Ks 1PCIE 1VWL 2UJK 2UYG 3C3NN 68XX/4 6TZK 7RBM 7RXC 7SEN 7TRG 7UGE 9GVA, WAs 2KSD 2VCG 3CVK 6JDT 6KHK 6USU 9ATA, WBS 2CAV 2CGY 6BZA 6CIN, WNs 41IF 9FWB and HER swapping salutations with GE1s AD (2) 2-3, BD (1) 1, CM2s FA VQ, CO2FM, GK1AAC (10) 6-7, DM3s MISE SSL ZMB, DUINL, FUBAG, HA5KQD, HI3PC (13) 9, HKs 1GQ (20) 23-0, 3AMA 41DP (2) 3, 4JC 7AHM (3) 3, 7AJJ 7UL (2) 3, HM4AQ, HPIIE 6, ITIAGA 3, JA5 1BZQ 1CSE 1CWM 1EDI 1ELX 1EMT 1EZX 1FBW 1FNA 1GTZ 1HXX 1IHL 1IWC 1JCE 1JQC 1JRZ 1LYZ 1MIN 2AGP 2CKS/mm 2IX 2WB 3BAC 3BDO 3CAF 3DDG 3D8A 3EGZ 3FFD 3F1P 4BE 6AKW 6BVJ 6CAV 6VV 6WI 7ACP 7ADD 7AKQ 7BRX 7BVA 7AGB 8AJS 8ARO 8QO 9BE 6ADY 6AEH, K64USN (11) 7, K6s 1BA (10) 6 6NAA (11) 10, KH6s BYG EDW EYP EZB, KL7s EMA ZF, KP4s ALU (10) 6, TIN, KX6AJ (8) 7, KZ5s CU (10) 8, FC (5) 5, MQ (4) 4-5, LU5 1CB (12) 4, 1DQB (7) 10, 2XL (8) 6, 9AH, OAs 2C (18) 5, 4PZ, PJs 2AE 2AQ 3AO (13) 10, Pys 1MCC (10) 11, 2DAG (6) 3, 2GDB 5, 4AP 6, 4KZ (1) 1, 7AKQ (14) 2, 7NJ 7, 7VLYN 7VLS (22) 9, 7TY (70) 23, SL5AB, SMs 3TW 3YF 6CNX, SPs 5ATZ 5ARN 5ADF, TIZWR, UAs 1KAE (20) 6 of Mirny base in Antarctica, 0FG, UP2PZ, VEs 8RG (7) 5, 0NV 6, two dozen YKs plus VK9BI, VO1Fs, VP5 2MV (16) 2, 6LJ (7) 1, 6RB (9) 9, 8FU (5) 5, 8GQ (23), 9DH (5) 5, VS9AAA (2) 3, WL7EMP, WH6FBU, a dozen XE1s and XE2s, YNs 1GO 1PT 3KM, YU1BCD, YVs 2AH (7) 4, 3CD 3FZ (8) 10, 5BGG 5BMX 5BOA 5BTK (3) 5, ZK1BV, ZLs 1AIX 1GQ 1MQ 2APZ 2GH 3IS 3OR, ZSs 1A (1) 6, 2HI (8) 6, 5KI, 5B4TC (18) 2 and 5N2ACB (3) 0. . . . W9GML and K1VWL sampled 40 phone for HIRICM (298), KZ5MA and OA4NKY (200-235) 2-7, all via s.s.b.

80 c.w.'s DX surface has only been scratched so far during this spurt minimum. Ws 6YKS 7DJU 9GML, K6SXX/4 and DL1IN punched through the static for two-ways with DJ5AZ, F9UC FC 2, some Gs, JA3CIV, KL7ECA, VKs 2APE 7SM, W8UPV/VO2, ZK1BV, ZLs 1AIR 1AXB and 20Y. . . . Late summer put a sag in 75 phone long-haul work but British s.w.l. J. Gentry remarks on consistent transatlantic signals from K4s MGL MOJ and WA4EZU despite unfavorable conditions.

No space to include a look at 20 this month, but we thank c.w. reporters W5 5KZK 7DJU 7QB 7VRO 9GML 9LNG, Ks 1LNC 1VWL 2UJK 2UYG 3C3NN 68XX/4 6TZK 7RBE 7RAJ 7RBM 7TRG 7UGE 9CZY 9FKD, WAs 2BRI 4CZM 4KEY 6JDT 6MIN 0BMM, WBS 2AHR 2CDX 2CGY and 2BZA, plus 14-Mc. phone auditors Ws 7VRO 9LNG, Ks 2UYG 3C3NN 7RBM 7UGE, WA6JDT, WB6BZA and KL7PAG, for contributions of 20-meter data we intend to incorporate in these minutes next month. And watch out for 160!

## Where:

ASIA — VS9OC's Jeff Rackstraw writes, "I've been receiving complaints about the lack of QSLs from our club station VS9OC for operation that took place before



K1KSH/KG6 worked W6ML from Guam in midsummer on 160 meters, then topped this feat with a July 1.8-Mc. W1BB two-way from Marcus Island. Gary expects to log more DXceptional operation in the Pacific area this fall, 160 meters preferred. (Photo via W1ECH)

I arrived on Masirah (Muscat & Oman). I'd like it made known that those to whom we still owe cards are invited to write me at [the address in the roster to follow]. I will check the logbooks and then reply to the operator direct. This applies only to contacts prior to this year whereafter QSOs have been confirmed in the normal manner via R8GB. . . . "I leave HL9TF and Korea as of August 8th," notifies K2GMF. "Others will still be operating under that call. Cards for my own QSOs can be obtained through my home address. QSLs for HL9TF contacts made with other operators should be sent via KARL, Box 62, Central P.O., Seoul, Korea, or to the EUSA Signal Officer, APO 301, San Francisco, Calif. Self-addressed stamped envelopes are always appreciated." . . . W4SAMZ, scheduled to leave Formosa next month with WA4HWO, recommends, "Anyone who contacted us at BV1US and did not yet receive a QSL should let me know before the end of October for prompt action. After that some delay might occur." Write CWO M. Winkler, Jr., Box 8, USARSCAT, APO 63, San Francisco, Calif. . . . HS1P (W4LCY) is frustratingly on the ITU-CCF Banned Countries List but W4CKB stands ready as Frank's QSL manager when and if the W/K/VE/VO lid is lifted.

AFRICA — "You might tell the boys not to bother with A International Reply Coupons, for all our mail goes free," advises VE3BGV/SU, Camp Rafah. W1s BPY and WPO point out that W/K/VE/VOs can route their QSLs to Bill through Amateur Radio VE3BGV/SU, UNEF Middle East, 5th Cdn. Sig. Bldg., CAPO 5049, Montreal, P. Q., Canada. Others will do better c/o UNEF Base P.O., Beirut, Lebanon. . . . Ex-3V8CA reports faulty liaison with QSL aide W4YWX. All W/Ks who sent me cards direct should have received my QSLs by now. Statesiders who still haven't their due 3V8CA cards can write me at my new TL8 address enclosing s.a.e. and two IRCs." Syd soon will add a TL8 suffix to his growing collection. You may have worked him formerly as W8UTQ, W4CGK, KL7YT and XW8AH. . . . "All who sent QSLs to me via the 5A bureau in Tripoli must be patient," pleads 5A3CJ. "Due to administrative difficulties there I've received no cards for over three months. All QSLs sent direct to my Callbook address have been answered through R8GB, or direct when IRCs were included." . . . 9X5 is said to be Burundi's new label but we've had no reports of such critters as yet. . . . ARRL Assistant Secretary W1EC1I states, "60IMT, in a note enclosed with a batch of cards for W/Ks, pleads for more of the fellows to send their QSLs in reply. 'I have much difficulty to qualify for awards if I haven't the cards. Even as a rare country I QSL 100 per cent.'" . . . WGDXC's DX Bulletin mentions s.a.e. and IRCs for direct TU2AU (W8HAM) replies. . . . "All my Liberia QSOs have now been confirmed through bureaus," affirms ex-EL2PN. "All were land-based. If anyone fails to receive a confirmation, or if replacement of a 'rubber stamp' card is desired, a printed QSL will be sent upon request." Perry's current address appeared here last month. . . . LDXA's ocean relays G3PFU's assurance that QSLs for his ZD7BW doings will be getting around this month. . . . WGDXC has it that W4NEI brought back a batch of W4BP1/DX logs for delivery to QSL chief W4ECI after visiting Gus down East, also that K8RTW has supplied the orbiting Orangeburger with more convenient logs that produce automatic transcript for shipment back home.

OCEANIA — KG6AIG gives us a revised address for the Marianas QSL bureau: Marianas Amateur Radio Club, USPO 96910, Box 445, Agaña, Guam. Luis is the MARC bureau proprietor and business is booming. . . . KG6ALD went back to Oahu in May after a 151/136-worked/confirmed Oceania DX career. "I'm very anxious to be sure everyone who wants one gets a deserved card from me." Bob's address is in the list to follow. . . . From K5JVP: "KX6AJ says he is 'way behind in QSL chores but will have adequate time for this detail later.'"

EUROPE — Renewed activity by UPOL-type stations are triggering inquiries once more, such as UPOL-12 on 20 c.w. These calls have been used in the past by Russians located on north polar ice islands and are QSL'd via the U.S.S.R. bureau. By the way, K3CUI reports brisk correspondence arising out of his August "How's" Russian prefix-suffix breakdown. . . . "Coaxed a QSL out of F9QU/FM8 for a 1949 QSO," gloats W5KZK. "He's been back in France since 1950." Nener give up. . . . W1TS modifies a previous comment on the commendable dependability of Yugoslavia QSLers. Don has received QSLs from all but three of the 61 YU3s he has worked. . . . K9RNO, doing QSL chores for TF2s WHT and WIG, states s.a.s.e. will bring direct reply to W/K applicants. Others will have contacts confirmed subsequently via bureaus. . . . DL4BV (K1KRY) reminds W1ECH of a fresh QSL route to Yanks in Germany: DL4/DL5 QSL Bureau, Support Co. Signal, APO 403, New York, N. Y. . . . Missing F9UC/FC's QSL? DL9PF finds extenuating circumstances to account for this. Jean's installation was demolished by the elements a few years back. DL9PF is salvaging logs and QSLs for past F9UC/FC contacts and will continue as Jean's QSL manager after the reclamation job. HB9TL takes on similar QSL responsibilities in behalf of F9RY/FC.

**SOUTH AMERICA** — The proper International Amateur Radio Union QSL bureau listing for Aruba is VERONA, P.O. Box 392, San Nicolas, according to WIECH's records. W3ZQ wants it known that QSLs for his PJ5AC Sint Martin (March 26 to November 2, 1962) and W3ZQ/KS4 Swan Island (April 10-14, 1963) DXcursions are still available through his home address. S.a.s.c., of course down his way has been reorganized, PZ1AR becoming QSL manager. The bureau address now is Surinam Amateur Radio League, P.O. Box 240, Paramaribo. This from WIECH who adds that PZ-land likes to be called Surinam (or Suriname), not Netherlands Guiana or Dutch Guiana.

**HEREABOUTS** — Time for our customary bow to "QSLers of the Month," namely CR9AH, DUOR, ET3USA, FK8AU, FP8CB, G2FUX, GC8KS, HG3 11C, IWU 8CA, H18XAA, HK8 3RQ 3VV 0AL, HL9TG, HZ1AB, KA2YA, KB6EPN, KG8 1BA 1PR 4BQ, KH6EU, KL7s AZN WA1, KP4AWH, KV4AA, OH3NY, PJ2ME, PZ1BD, SM5BBI, T12USA, VE3FFW/SU, VKs 7ZZ 9LA, VP2GAC, VR2EAL, VS8 6AZ 9MB, YN1MAL, YV5BTK, ZE2JV, ZL1HY, ZSR7, 4871W, 1X1s JU RH, 5T5AD, 601ND, 9G1EO and 9M2UF, plus QSL managers Ws 2CTN 40PM 7ZAS 9W1M, K6GMA and WA51AJ. For examples, W8DCH clutched VE3FFW/SU's QSL only one week after contact, W8DDG had ZL1HY's card in ten days, K9RNQ gripped KA2YA's pasteborder after a brief 8-day wait, and VE3ATZ got quick ten-day 9G1EO service from VE4OX. FB OMI! Other nominators are "How's" correspondents Ks 3CNN 6P0C 7RAJ 7RBM 7U1GE 8BC K 8RXD 9CZV, Ws 2BRI 8AZJ 81XU 8BMW and WB6BZA. Help! W2PTM needs a push toward the tardy QSL of VP3RS; W8DDG is anxious for word on strange E1HKDM/nm; K7KTE desires tracers on the whereabouts of HL9KAI and CE8AB; K7RAJ seeks some scoop on K0DNI/KJ6, VP1FTR, VR3E and VS1LJ; and K9CZV will settle for the current address of 6W8DE/P2VM. K9CZV and WA6PSK offer their services as QSL managers for DX operators in bona-fide need of such assistance. K1SCJ tells K, Mass ARRL SCM W1ALP that H18XHL's QSLs were due for dissemination last month and should now be getting around. "I'll handle VP7NC's QSLs for the U. S. A. and Canada," notices WA4EDY. S.a.s.c. are required, and contacts should date after June 26, 1963. VP2MV tells K6SXX/4 that some weirdo with an electronic key and full break-in appropriated his call this summer. He uses neither facility. Various factors conspired to delay VP2KP/a's QSLs for October, 1962, Anguilla activity, but Mac and VP2KJ now declare the situation well in hand, according to an L1DXA dispatch. VP2KP hopes to get the home station back in harness shortly but expects no early return to Anguilla. From time to time it's necessary to caution amateur radio's DXpeditionary venturers concerning the necessity of keeping expense fund solicitations and financial bookkeeping entirely divorced from resultant QSOs and QSLs and the promptness thereof. Discrimination in this area moves the whole fun-filled DXpeditionary angle (and reciprocal international licensing possibilities) toward tin ice. The following individual postal recommendations are placed at your disposal with the reminder that the listings are necessarily neither "official," complete nor accurate.

GN8FN, Navy 217, Box 55, FPO, New York, N. Y.  
 GN8FR, P.O. Box 632, APO 117, New York, N. Y.  
 DU1AA, 108 Tenth St., New Manila, Quezon, P. I.  
 DU4PAR (via DU1CE)  
 EP2DM (via W21PB)  
 EP2RV (to G5RV)  
 ET3USA, APO 843, New York, N. Y.  
 F9RY/FC (via H89TL)  
 F9UC/FC (via DL9PF)  
 HI4XAB, S. Criphtan, c/o Grenada Co., Manzanillo, D. R.  
 HL9TF (see preceding text)  
 HS1P (via W4CKB)  
 HS1X (via WA2WCB)  
 ex-KG6ALD, R. Dessert, 531 Stinecomb, Apt. 3, Columbus 2, Ohio, 43202  
 KP6AZ (to W6FAY)  
 LJ2A (via LA4NI)  
 MP4TAX, Hammarlund DXpedition, G.P.O. Box 7388 New York 1, N. Y.  
 OA4PF (via RCP)  
 OH1EW/OH0 (via W2CTN)  
 PX1s AI CX VW (to F8 3A1 9CX 9VW)  
 PY2DAG (via LABRE)  
 PY7VLS (via LABRE)  
 SM5TU/9Q5 (via S8A)  
 TA2BK (via DJ2PJ)  
 TF2s WHT WIG (via K9RNQ)  
 TZ2AU, c/o U. S. Embassy, Abidjan, Ivory Coast  
 VE3BGV/SU (see preceding text)  
 V89RO, Box 204, Port Moresby, P. T.  
 VP2KP, L. Pennyfeather, P.O. Box 161, St. Kitts, W. I.  
 VP7NC (W/K/VE/VOs via WA4EDY)  
 VP9FC, U. S. Navy 138, FPO, New York, N. Y.  
 VR1H (to VR2EH)  
 VR2DK (via W2CTN)

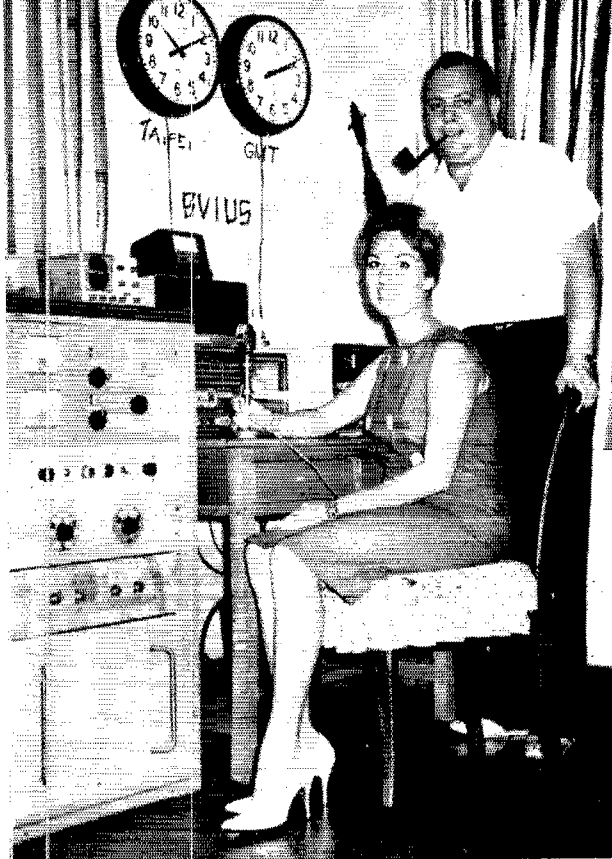

W45MZ and XYL WA4HWO have dispatched QSLs confirming some 3500 BV1US QSOs over the past two years. Mike and Helga are due to leave Formosa next month for Germany where they'll be signing a DL call from Heidelberg.

- VS9AAA (via RSGB)
- VS99C, J. Rackstraw, Twynham Eleven, RAF, Masirah, BFPO 69
- W2PCJ/KJ6 (to W2PCJ)
- WA3YU/TA (via WA3WUV)
- WA1MZN/KL7, E. Jackson, Det. 1, 71th AP&W Sgdn., Nikolai, Alaska, 99638
- WA5GOU/KJ6 (to WA5GOU)
- YN9BJM, P.O. Box 7, Jinotega, Nicaragua
- YS1A, R. Trigueros, P.O. Box 517, San Salvador, El Salvador
- YV2AH, Box 187, Merida, Venezuela
- YV5BTA (via RCV)
- ZD&WF (via RSGB)
- ZE4JS (W/Ks via W3HMK)
- 3A2GP (to G3HPH)
- ex-4V8GA, S. Wagoner, jr. (W8UTQ), B.P. 302, U. S. Embassy, Bangui, C.A.R.
- 6W8AA, G. Danancher, Box 3006, Dakar, Senegal
- 9G1EW, P.O. Box 194, c/o U. S. Embassy, Accra, Ghana
- 9K3AG, Box 187, Kuwait, Persian Gulf
- 9M2FT (W/K/VE/VOs via W7VRO)

The preceding catalog is contributed by Ws 1BPY 1ECH 1WPO 1WPR 1VPD 5ACL 5KZK 6YKS 7DJU 8GU 9LNQ, Ks 2GMF 2UYG 3CNN 5JVF 6SXX/4 6TZX 7RAJ 7RBM 7UGE 9FKD, WA2s BR1 OJD, WBS 2AHR 6BZA, HB9DX, VE3ATZ, J. Gentry, DARC's DV-MB (DLs 3RK 9PF), DX Club of Puerto Rico DXer (KP4RK), Far East Auxiliary Radio League News (KA2EB), Florida DX Club DX Report (K4HF), International Short Wave League Monitor (12 Gladwell Rd., London N8, England), Long Island DX Association DX Bulletin (W2MES), Newark News Radio Club Bulletin (L. Waite, 39 Hannum St., Ballston Spa, N. Y.), Northeastern DX Association DX Bulletin (W2DTGW, R2U VU), Northern California DX Club DXer (W6GTG), Western Washington DX Association Northwest (W7JPC) and West Gulf DX Club DX Bulletin (W5IGJ). Got any recent "Where" data in your log to help the gang along?



PX1IK, manned by HB9s IK KU DX and s.w.l. HE9EZB, left to right, scored 5700 c.w. and s.s.b. QSOs from Port d'Envalira in June and July. Andorra is rapidly becoming Europe's favorite summertime DXpeditionary target, and HB9DX writes, "During the first week of our stay DL2OX operated PX1OX from a tent about 100 feet away. Then Fs 3AI 9CX and 9VW showed up to sign PX1s AI CX and VW in a trailer with mobile rigs." PX-land is not without certain DXpeditionary hazards. Etienne recounts, "On the final night, in the middle of an 80-meter session with U. S. stations, a herd of wild horses overthrew a mast of our Vee antenna, causing many W/Ks to miss rare QSOs with PX1IK."

## Whence:

**EUROPE** — Redcoats are coming! Radio Society of Great Britain invites 40-meter DX hounds through the world to participate in the second RSGB 7-Mc. DX Contest, an event to occur (phone) between 0001 GMT October 19 and 2359 the 20th, and (c.w.) same times November 2-3. Our objective is to capture as many British Isles brethren as possible, and the serial exchange is the customary RST001, RST002, etc., the "T" omitted on phone. It's a single operator affair. Scoring for non-U.K. types: 5 points for each station worked, plus a 50-point bonus for the first contact with each British Isles prefix-numeral (G2 G3 G4 G5 G6 G8 G9 G2, etc.), plus another 50-point bonus for every ten stations worked in each prefix-numeral category (ten G3s, for example). The entrant shall submit a log covering the whole of his operation on the 7-Mc. band during each contest period and shall designate any continuous 24-hour period therein for scoring purposes. List on one side of each scoresheet GMT and date, call of station worked, serial sent, serial received, bonus points claimed, and contact points claimed in that order. To be eligible for certificates of merit offered to high scorers in each overseas country and W/K/VE call area, entries must be post-marked on or before November 25, 1963, for shipment to Contests Committee, Radio Society of Great Britain, New Ruskin House, Little Russell St., London WC1, England, and should include the signed statement: "I declare that this station was operated strictly in accordance with the rules and spirit of the contest and I agree that the decision of the council of the RSGB shall be final in all cases of dispute. I certify that the maximum input to the final stage of the transmitter was \_\_\_ watts." K9RNQ has it that TP2s WHT (K9HXT) and WIG (K3KLC) will keep a KWN-1 hot around 14,270 kc. till the end of this month, operating as much as twelve hours daily when conditions and duties permit. OY7ML has applied for special authorization to join the 160-meter gang for the promising 1963-'64 season. Some "Whences" for you via the clubs route: G3HPH tried his 3A2CP DX luck on 20 phone last month. HB9s AAV and AAW supplied Liechtenstein briefly on 20 c.w. in August as HB1s AAV/H and AAW/H. Hammarlund's F9RY/FC enterprise afforded eight kiloQSOs from Corsica this summer. SV8WQ offers Rhodos on 14,330-ke. sideband around 2030 GMT.

**OCEANIA** — K1KSH/KG6 used a makeshift antenna 30 feet high when he worked WBBB from Marcus on 160 on July 27th. "I QSO'd Stew only an hour before I had to return to Guam." Gary has a KWS-1 available for Sunday skeds with W1s ECH ETF, K1ANV and other 14-Mc. 1X buddies but he finds his 50-watt rig adequate most of the time. On Guam he uses dipoles for 20 through 160, the latter end fed, and c.w. is preferred. K1KSH expects to visit other Pacific and Asia regions though probably without provision for hamming. Px-KG6ALD hunts data on restricted-space antennas for his new Ohio quarters. If you have a pet approach to indoor or out-the-window radiators you might drop Bob a line (see "Where"). K5JVF finds W4VBB holding forth at the 7-Mc. key of KG6NAA. Nick likes to work the southern states on 40. "VK4IQ gives the East Coast fits with erratic operation from Willis Isle," declares K2UYG. Perhaps John subscribes to the ancient DX truism, "The best DX is the rarest DX." More patter from Pacific points courtesy club journalists: VK6VK goes back to Australia this month with hopes of a brief operational stop at Heard Isle. LU4PAR was a group DX effort atop 3500-ft. Mayon mountain in August. VK9BH produced three kiloQSOs from Nauru before its gear was shipped toward Christmas Island's VK9s DR and XI. W6JOU & Co. included FK8-land on their summer tour of Oceania. VK2ADK scheduled VS4/V5S DXertions in late summer after a ZC5 disappointment. VK3ARX of past Lord Howe Isle fame lost his quad in a 70-m.p.h.

windpuff. . . . VR6AC returns to Pitcairn much improved after Canal Zone hospitalization.

**ASIA** — "VS9OC is on the air every night, 1500 to 1800 GMT," asserts operator Jeff Rackstraw from Muscat-Oman's Masirah Island. "We operate 15-land 20-meter phone or c.w. and expect to be trying single-sideband in the near future." "Activity is picking up a bit here," observes W4SMZ of BV1US. "New equipment has arrived for BV1USA, the Taiwan American Radio Club, and this could become the most active station on the island." EP2DM operates 14,100-ke. c.w. daily at 2100 GMT looking for Stateside contacts," advises QSL aide W2IPB. "Javad uses a 1X-35, HQ-150R and dipole." "Flying was fairly rough, with the Bay of Bengal and the Arabian Sea just about one big dead spot so far as amateur radio is concerned," reports W4KKA/um, back from aerial weather research in the Far East. "Most contacts and QRM came from Russian call areas. JT1CA and 9N1MM were the rarest DX worked." WB6AXW, s.w.l.ing with the military in Viet Nam, seeks to compile a list of Yaok amateurs stationed in 3W8-land with a view toward eventual easing of ITU-FCC and local amateur radio restrictions. Scant optimism at present. In another off-limits area for W/K/VE/VO QSOs, HISIX (WIFAX) resumes activity on a fresh two-year assignment

## VK/ZL Oceania DX Contest

NZART and WIA invite all amateurs to participate in this year's VK/ZL Oceania DX Contest. The usual contest rules apply with some major changes to allow QSOs with any Oceania countries as well as ZK/ZL stations. Contest rules follow.

**DATES:** Phone: 24 hours from 1000 GMT October 5 to 1000 GMT October 6, 1963. C.W.: 24 hours from 1000 GMT October 12 to 1000 GMT October 13. **SCORING:** For Oceania stations other than K/ZL: 2 points for each QSO per band with VK/ZL stations; 1 point for each QSO per band with stations in rest of world. For rest of world other than VK/ZL: 2 points for each QSO per band with VK/ZL stations; 1 point for each QSO per band with Oceania stations other than VK/ZL. **FINAL SCORE:** Multiply total QSO points by the sum of VK/ZL call areas worked on all bands. The same VK/ZL call area worked on different bands counts as a separate multiplier. **EXCHANGE:** Six figures (five for phone) made up of RS(T) plus QSO number, starting with 001. Example 579001, 589002, etc. **LOGS:** Logs must show date, GMT time, stations worked, band, number sent, number received, and points. Underline each new VK/ZL call area contacted. Use a separate sheet for each band. Include a summary sheet to show call, name, address, rig, and score computations; include a statement that all rules and regulations were observed. **AWARDS:** Especially attractive certificates will be awarded to each country (call area in W/K, JA, SM, UA) on the following basis (1) Top scorer using all bands. (2) Top scorers on individual bands. (3) Those with minimum contact requirements to be determined by conditions and activity. LOGS should be posted to reach WIA Box 688J, GPO, Brisbane, Australia, on or before January 19, 1964.

in Bangkok. WA2WCB says Carl will have 200 watts of sideband and c.w. available on 14 Mc. Signals from HS1P (W4LCY) also tantalize the W/K 20-meter gang. Perhaps these two can yet get something going toward easing Thailand's QSO restrictions. . . . W21PPP, visiting old-timer XZ2KN, finds Tara's son Henry just about set to sign his own call on DX bands. . . . K53VF wonders how JA1JQC and other JAs manage to get into Oklahoma so consistently on 40 c.w. with inputs of 20 watts or less. . . . Asia addenda via the clubs press: JA1BRK put Torishima, a speak not far from Okinawa, on 20 c.w. and sideband in August. . . . AC5A (W4BPD) worked the States handily from a mobile shack while gadding about in the Himalayas near the Tibetan border. . . . Ex-5N2AMS is newly licensed for DX developments as MP4s BEF MAP QBD and TAX. Angus and the NYL scheduled s.s.b. operations with the latter call in late August. . . . UA6IH and UW0IH represented rare Wrangle Isle on 14-Mc. c.w. and sideband in midsummer. . . . UA1CC/UJ8 gave Tadzhiik to luck 20-meter sidebanders in August. . . . A jumpy v.f.o. hampered 9N1MM's summer DX doings but he hopes to be back in full production this month. . . . YL2s AP and WS still lurk on 20 c.w. around 1800 GMT.

**AFRICA** — "I currently operate the amateur station provided by the Canadian contingent of the United Nations Emergency Force in Gaza Strip," writes VE3BGV/SU. "We usually devote at least half an hour per evening, 2030-2100 GMT, to c.w. DX on 14,040 or 14,050 kc. and have made a good number of W/K contacts. I'm struck, however, by the lack of VE signals. We have schedules with stations in Ottawa, Kingston and a few other eastern Canada locations but we desire similar arrangements with central and western Canada. VE3BGV/SU has a KW5-1 and 75S-3 operative every night except Saturday between 14,100 and 14,200 kc., 2000-0200 GMT, to help keep our Canadian servicemen in touch with home. A rhombic and 3-element beam are directed towards Canada, so let's hear some more VEs in there!" . . . ZS1OU, impresario for Marion Island's ZS2MI, tells W4ECI he finds it impossible to oblige all DXers who have requested schedules with that rare one. "I have persuaded Ray to come on 14 Mc. more regularly during the week, 7 Mc. as well." Watch for ZS2MI week days on 20 meters at 1030-1145 GMT, on 40 meters at 0500-0600. Jack adds, "ZS2MI is troubled by terrific rain static and strong winds most of the time, all of which makes copy of weak DX signals really tough." . . . "My first application for a TL8 call was lost, so I had to submit another to Brazzaville," explains ex-3V8CA (W8UTQ). "I'm all set to go with a KWML-2 and TA-33. I expect to be here for about three years with home leave in Michigan about a year from now." Syd did his darndest to urge Tunisian authorities to liberalize their prohibitive amateur radio policy but results were far from encouraging. . . . Africa oddments from DX club organs: TU2AU (W8HMI) expects a two-year I.C. DX sojourn using code and s.s.b. . . . EA5 2CA and 7ID may activate rare Spanish Africa regions by February. . . . W8M1Y is mentioned in conjunction with imminent Indian Ocean DXpeditioning.

**SOUTH AMERICA** — ZP5s ML and OG of RCP invite amateurs of the 21 American republics to participate in *Primera Semana Turistica del Paraguay*, a 15-, 20- and 40-meter phone DX contest scheduled to come off between 1600 GMT, October 11, and 0400 the 13th. Scores are calculated at one point per QSO, this total multiplied by the number of band-countries collected, and your prompt log entry to RCP, Casilla de Correo No. 512, Asuncion, Paraguay, may qualify your results for certificate recognition. Spanish- and/or Portuguese-speaking W/K/Ves should make a killing in this one. . . . WA2BRI was OA1PF's first 20-meter DX contact. . . . WGDXC calls attention to VP4TY's popular 14,265-ke. sideband station, 1000-1100 GMT. . . . W8BBJ and HC7FD were recently featured in a Detroit *News* spread labeled "Ham Helps Missionaries Set Up Jungle Station." After extensive preparation W8BBJ flew to Quito, armed with tools, blueprints and components, where an HC7B ("Voice of the Andes") technician joined him for a nearly impossible 200-mile journey into Jivaro Indian country. There HCGM, a kilowatt BC outfit, was fired up on 4870 kc. Groups of natives monitor the daily

service broadcasts with battery-powered receivers within a radius of several hundred miles. Schedules with K8HHK kept W8BBJ in touch with home during construction and installation. Another ham job well done, DX style.

**HEREABOUTS** — WA6BMW tells us that the QRP Amateur Radio Club, a world-wide group of under-100-watts chaps, now has about 900 members in thirty countries. Various operating activities and special services are in the planning stage. Write K4WYX for membership specifications. . . . K4EF finds XE2KH specializing in the collection of QSOs with U.S.A. two-letter-call stations on 14,050-ke. and 7-Mc. c.w. Bill's a competent amateur astronomer, too, and grinds his own lenses. . . . VP2VB-7/m of Yagme DXpeditionary fame was featured guest at Florida DX Club's gala 3rd Annual Lake Placid (Fla.) DX Conference in mid-July. . . . W6PNE, leading mid-west 160-meter DX specialist, was licensed in 1931 at the age of 12, promptly worked all continents with a home-built 20A receiver and 45 transmitter, and now has 35 countries and five continents on 1.8 Mc. This thumb-tiler court-ney W1BB. . . . W7QB and others are perturbed by complaints of "Gus-watchers" who would keep W4RPD's DXpeditionary frequencies unused even when Gus is sacked in. . . . Room 202, Thunderbird Hotel, Las Vegas, is jammed with fancy radio gear feeding a rooftop antenna farm that is radioactive as K7UGE about ten hours daily. Some 25 members of Las Vegas Radio Amateur Club hold forth there, including "How's" correspondent K7RBM/WB0BZA. . . . K5JVF says T2ZWK will take a crack at 3.5-Mc. c.w. DX this season after he solves an antenna problem. . . . W1BB received his first whale-tooth QSL, an engraved tusk from 1.8-Mc. DX enthusiast K7HDB. Doubtless with an eye toward 160-meter DX application, Dick recently rigged up a floodlight system on 50-foot poles for nighttime whale-stripping operations. K7HDB and VE7AKI pool efforts in the design and perfection of noise-eliminators to deal with that bane of top-band DX diggers, Loran splatter. . . . Thomas of 14-Mc. sidebander K2TDF toured Europe this summer to shake hands with some of the DX he's logged over the years. . . . K3CNN is irked by c.w. hounds who trample rare s.s.b. DX above 14,100 kc. . . . W/Ks are queuing up for those new DX Club of Puerto Rico certifications, and KP4s BEA and EBJ signed on as new DXCPR members. . . . FDXC's W4RWM lists current 14-Mc. radioteletype actives DL3LR, EL5B, ET8USA, G2UK, GM3GNR, 11BNO, LA68 J NC, LU5 IAA 3BAC 5AZ, DH2YV, PA4XW, VK3KF and ZL1WB. QST

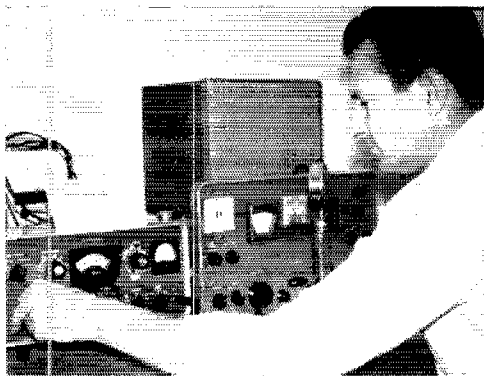

3V8CA, Tunisia's last licensed amateur station, closed down this summer when operator W8UTQ moved to the Central African Republic. Syd should be active from Bangui with a TL8 call by the time you read this. Meanwhile, how do we work Tunisia?

## Strays

The Chicago Area Radio Club Council will sponsor a demonstration of amateur radio s.s.b. and RTTY at the 1963 National Electronics Conference in Chicago, October 28-30. The station will be set up and operated by members of the Ladies Amateur Radio Klub (LARK) of Chicago, and the Indiana Teleprinter Society. An added feature of the show will be a demonstration of a device for translating punched printer tape into embossed braille ma-

terial for the blind. The latter is an invention of W9GRW.

Anybody ever do this before? K3UIG (K7UGA) during the course of a jet flight from Washington, D.C., to Marietta, Ga., when 33,000 feet in the air had a three-way with K5GHF land mobile near Winchester, Va., and W5FQQ mobile on board ship near Houston.



# Operating News



F. E. HANDY, WIBDI, Communications Mgr.  
GEORGE HART, WINJM, Natl. Emerg. Coordinator  
ELLEN WHITE, WIYYM, Ass't. Comm. Mgr.

ROBERT L. WHITE, WIWFO, DXCC Awards  
LILLIAN M. SALTER, WIZJE, Administrative Aide

<i>ARRL Activities Calendar</i> .....	99	<i>RACES News</i> .....	99
<i>Brass Pounders League</i> .....	95	<i>RTTY Frequencies</i> .....	102
<i>Code Proficiency Program</i> .....	102	<i>Section Emergency Coordinators</i> .....	97
<i>DX Century Club Awards</i> .....	101	<i>Sweepstakes Announcement</i> .....	94
<i>Election Notice and Results</i> .....	100	<i>Traffic Topics</i> .....	94
<i>Emergency Frequencies</i> .....	102	<i>With the AREC</i> .....	96
<i>WIAW Operating Schedule</i> .....		102	

**Results on 160 (!) in ARRL's '63 DX Competition.** Elsewhere in this issue are reported, at length, the higher-frequency results of the ARRL International DX Competition. With a dropping-off of the m. u. f. there has been a resultant increase in interest in the "top band." Among the W/VE reporting their results note the following c.w. DX performance where a little time was spent on 160. The 160-band seems sure to be real good in '64 . . . and traffic net operators will be missing a bet not to recruit a group and put it into duty use this fall season. Here's the score: *8 Countries; W4DQS: 6 Countries; K1DIR: 5 Countries; W1TX, W3GRF: 4 Countries; W3s ALB ECR, W4KXV, W6RW, W9EWC, W0DZH: 3 Countries; K2GUN, W2GGL, W3s EIV IYE, VE7EH: 2 Countries; WA2OJD, W3IWS, W4YHD: 1 Country; K2CHQ, W3s BKE MCG, K4LPW, W4LVV, W6s KEV PLK, W0NXF.*

The '63 Simulated Emergency Test. Public Service and Amateur Radio are being increasingly tied together, and justifiably so. Every amateur owes it to himself and his community to live up to the expectations written into our Amateur Service Regulations to get into emergency tests and be equipped with enough know-how to use his station and operator-ability in any

type of disaster or emergency in which standby radio provisions are called for.

There's no better way to be ready than to be registered in the Amateur Radio Emergency Corps and, or signed up in a RACES plan. Each October the League sponsors an SET. Local ARRL Emergency Coordinators are requested to set a date for a "simulated emergency," preferably the first week end. This can be an exercise employing mobiles and with test activation of emergency power at fixed stations, also an occasion to re-register and expand the Amateur Radio Emergency Corps membership. We thus test given plans and performance for a specific simulated condition!

Contact your local EC to ask about details or registration in AREC. There's a place for you, whatever your favorite amateur frequency band or mode. Emergency Unit Plaards and AREC decals are available to AREC members from ECs for those who register and will be active in tests or on stand-by. Emergency Coordinators may get statements of support from city, state or agency officials that might be served in emergency. Their concurrence in the kind of test held is important and may set the stage for future emergency working together. We hope that the October test will be but the first of a number of

## MEET THE SCMs

Two popular Canadian SCMs with calls familiar to us all are shown below. On the left, R. W. Roberts VE3NG, SCM of the Ontario section, surrounded by his admiring family. "Capt. Morgan" has an interest in amateur radio dating back to '25, though first licensed in '49. Sharing his hobby interest is his XYL Marge, VE3DZA. On the right, no stranger to his many friends on the air, is British Columbia SCM VE7FB. Ernie has been licensed since '36 and has held VE5FB prior to his current call. Ernie too has an understanding wife, VE7SH.



local radio exercises held during the year (with critiques) so constantly improved and tested plans for radio coverage in disasters can be made.

Emergency Coordinators will receive latest information on the new plans for the Amateur Radio Public Service Corps (ARPS), as well as suggestions on running a local SET exercise . . . also a manner of counting "points credit". by groups holding tests in this SET. Our report on the last SET appears in June '63 QST. Support the Emergency Corps by your personal registration in it on Form 7. If possible, be active in this October SET so your EC will have your report and points for the next QST account! Belong to AREC and get in the SET.

**Section Emergency Coordinators Listed; About SET Traffic.** The annual listing of all SECs addresses appears in the next pages. If you don't know your local EC (to register) you can find the address from him. In towns having no EC yet appointed amateurs should recommend suitable candidates so SECs can arrange for such leader-appointments.

Besides message traffic appropriate to the "simulated" emergency pertinent to handling assumed difficulties in the area, there will be radiograms (we hope) from local Red Cross chapters to area and national officers, EC and SEC reports to ARRL, individual dispatches to SEC and SCM set down on paper in proper message form and a challenge to any hams who have never, as yet, delighted in the joys felt from practical accomplishment of making accurate and speedy radio handlings with correct notations for the record on such messages.

Some tips may be in order for the uninitiated . . . especially about how to route a message

systematically if you have one on the hook. Where the Station Activities Reports do not list your section net frequencies we suggest that you consult the annual ARRL Directory of Nets (sent on radiogram request); or you may use the National Calling and Emergency Frequencies with a proper directional CQ as a secondary means of getting a successful traffic-taker if you operate at hours when a net is not in session. Your state net can customarily relay your message through the National Traffic System (regional net) to other states; under emergency conditions your message often can be passed right into a state's net at point of destination. This net's frequency is also in the Net Directory. All Section nets in the National Traffic System try to operate on a daily basis so this is a dependable plan for systematic handling of out-of-state traffic. In conclusion, best luck in the SET and in your traffic handling.

**Code Proficiency Certificate Issuances (through June '63.)** There were 4049 copies sent us for checking in '62, with issuances up 16% from the previous year. The practice transmitted by WIAW tapes start at 5 words per minute. Most certifications of those made to persons submitting text on WIAW W6WGP monthly qualifying runs, in fact 40.7% are to those who qualify. The runs go up to 35 w.p.m. in 5 word increments and endorsement stickers continue to be available for each speed increase from an initial certified speed. There's practice at 5 and 7½ w.p.m. but no certifications below 10 w.p.m.

This month we want to especially commend those who have won certificates and endorsements at the 30- and 35-w.p.m. level.

— F. E. H

**CP AWARDS, 30-35 W.P.M THROUGH JUNE '63**

ARRL certified at 35 w.p.m.:

K1QVX	WA2SZK*	K4VAY*	WA6UHM*	WA8AAD*
K1RTV/K1TLR*	WA2VBW*	K5INC*	W6UL	WA8BGF*
K1TFV	K2ZQW	K6ELD*	K7LPZ	W6CRW
WB2AGT	W8MIGU	W6MNN	K7PVE	K9GVB
WB2EVA	K4CDZ*	W6NFX*	W8CHT*	VE3FBQ*
K2JWD*	WA4CTD*	W6PLS*	WA8DDI	VE5JV
WA2OPI*	K4GMR*	WA6PWV*	K8HLR*	VE7BJO*
W2POL*	WA4JWV*	WA6ROU	W8WNX	Luis R. Mateo
WA2HMP*	WA4KHG	WA6RXXM*	K8YJV*	C. A. Veckarelli*
K2SBS*	W4UHA	K6SWL	W9KPN	

ARRL certified at 30 w.p.m.:

K1MZB*	WA2RUE	K4CSY*	WA6PMK*	W8SQO*
K1NVM*	WA2TJA	K4BJQ*	WA6RG	WA9APT*
W1OTZ*	WA2UFT*	W4GYP*	WA6SLU	WA9BCJ*
K1PNB*	WA2VYS*	WA4JFY*	WA6UHM*	W9BLM*
W1SIK*	WA2WSB*	WA4JJA*	W6YHT*	W9QFV*
K1SSH*	WA2ZQU*	W4JKP	WA6ZGG	K9UUT*
K1YQZ*	K3CFR	WA4JWV*	WA6ZID*	K9ZNY*
K1ZBQ*	K3NUM	WNVLUD	W7ADY	W9ZYD*
W2ALF*	W3OAL	W4LWZ	K7GCX*	K9BAT*
WB2CRP*	K3PWN*	K4MPE*	W7LYN*	WA9DJG*
W2ECZ	W3RFX*	W4UVE*	WA8AJE*	K9WGC*
WB2FBC	K3RGT*	K4VAY*	WA8BHP	VE2ARA*
WB2GMN	K3SLP*	K4VOX	WA8BLO	VE3PHV
WN2HAIH	K3SPZ	WA6BBJ*	W8FCB*	VE6AGW*
K2IQH*	K3TLX*	WA6JMS	W8MOG	G3MNI
WA2PCL*	K3VHK	W6PLS	W8RQ*	KHOCYT

James Bowman\*  
Kenneth Gibbs\*  
Ronald L. Deets\*  
C. J. Haynes  
L. Moss\*  
L. E. Northway

\* Endorsement sticker

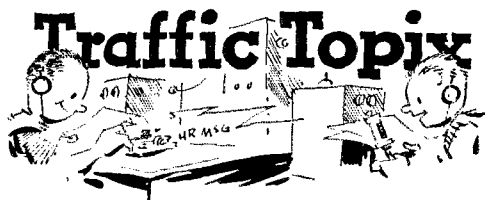

Effective October first, some new traffic-handling procedures will become standard ARRL practice. These have been discussed and analyzed in various bulletins, and most of them have previously been mentioned in this column. We hope that you will use them when required, not use them when not required, use them properly, and not over-use them. Not enough use or too much improper use may kill them, and we would hate to see this, because properly used they can be very valuable traffic-handling tools.

1) *Precedences*. Most amateurs call this subject "priorities." Precedences is generally considered to be the more proper word — and besides, "priority" is one of the precedence designations which are to be adopted. While there are some questions in the minds of a lot of traffic handlers whether or not such designators are actually needed, we have, after long consideration, decided to adopt three very simple designators, to be used as a standard and mandatory part of each message preamble, as follows:

*Emergency*. Any message having life and death urgency to any person or group of persons, which is transmitted by amateur radio in the absence of commercial facilities. This includes official messages of welfare agencies during emergencies requesting supplies, materials or instructions vital to relief of stricken populace in emergency areas. It does not include "worry," "agony" or "notification" traffic between individuals trying to get information as to the status of friends or relatives or notifying friends or relatives of their well being. This category will be *very rare* in normal times. When in doubt, *do not use it*.

*Priority (P)*. Important (but not life-and-death) messages having a specific delivery time limit. Official messages other than those covered in the "Emergency" category. Personal inquiry and notification welfare traffic. Press dispatches and other emergency-related traffic requiring prompt handling but not of the utmost urgency. This does not include birthdays or anniversaries or "dates" unless there is an aspect or urgency about them. This precedence will be fairly common in an emergency situation, relatively rare in normal times.

*Routine (R)*. Most traffic in normal times will bear this designation. In an emergency situation, traffic labeled "Routine" (R on c.w.) should be handled *last*, or not at all if the circuits are busy.

A "precedence" (accent on the second syllable to distinguish from the plural of "precedent") is an order of handling. The messages with the highest precedence rating are handled *first*, those with the lowest *last*. There is no intention, however, to neglect *any* traffic. The rule is, keep the traffic flowing, high precedence first.

On c.w., the precedence designator will follow the message number, using a single letter (P or R) if the message is priority or routine, but spelling out the word "emergency" if it carries this designation. On phone, the precedence will be spoken, of course.

2) *New Count for "Book" Messages*. Messages having common preambles (except for number) and texts, with different addresses, which are sent in "book" form, may now be given one count for each three addresses in the book. That is, if such a message contains two or three addresses, it counts as one; if four, five or six addresses, it counts as two, etc. *But*, if the name and address is one of the common parts of the message, then there must be at least *three* variable parts in order to qualify for this counting method; otherwise, the count remains as now, one count for each book, regardless of length.

3) *Originator Handling Instructions*. Many times the originator of a message wishes to convey delivery or handling instructions to the operator or operators relaying or delivering his message. The following HX prosigns are now authorized (to follow the message number and precedence) for use as an optional part of the preamble:

HXA (followed by number): Collect headline delivery authorized within \_\_\_\_\_ miles.

HXB (followed by number): Cancel message if not delivered within \_\_\_\_\_ hours of filing time, and advise originating station.

HXC: Report date and time of delivery.

HXD: Advise originating station date, time and station from whom received, and date time and station to whom sent. If delivered, date, time and method of delivery.

HXE: Get reply, originate by amateur radio.

HXF: Hold delivery until \_\_\_\_\_ (date).

The "HX" stands for "Handling Extra." These prosigns will be printed in the ARRL log book as part of an insert page (available without charge as Form 31). A sample preamble containing an HX prosign: NR 207 R HXA50 W4MLE CK 12 TALLAHASSEE FLA 2236Z MAY 17. If more than one HX prosign is required, they can be combined without repetition of the HX unless insert numbers are required, in which case the HX should be repeated.

4) *Filing Time*. This has always been an optional part of the preamble and still remains so. However, the ARRL-recommended practice of using NFT (no filing time) is now dropped. If the message contains no filing time, then the date immediately follows the place of origin. If the message *does* contain a filing time, it must be carried through to its destination.

We hope to be able to present these changes in more detail at some later time, but here they are for the immediate needs of those wishing to use them.

#### July Net Reports.

	Net	Sessions	Check-ins	Traffic
All Service		5	16	23
7290		46	1543	1064
North East Area Barnyard		—	914	6
75 Meter Interstate S.S.B.		31	1148	2045
Eastern Area Slow		25	113	35
20 Meter S.S.B.		22	441	1783
Q5 Traffic		31	204	254

## 30th ARRL Sweepstakes — Nov. 9-11 and 16-18

Next month *QST* will have the complete announcement of the Sweepstakes Contest. This early announcement is for the benefit of amateurs in remote ARRL sections who will not have received the next issue before Sweepstakes. Refer to November 1962 *QST* for general contest details. A contest rules change this year incorporates the following: the *ck* sent will be the last two digits of the year first licensed, and the *date* sent will be the month and day of birth (not year). More next month.

If you are anywhere in the League's field-organizational territory (see page 6, this *QST*) you are urged to take part in this popular contest activity. Although not an ARRL section, Yukon-N. W. T. (VE8) counts as a separate multiplier in the contest. There are two separate contests, phone and c.w. The total operating time allowed each contestant in either contest is 40 hours. There are section awards, and special Novice awards as well. The week-end periods start Saturday afternoon (2300 GMT) on the 9th and 16th of November.

Contest reporting forms will be sent free to anyone requesting them by mail or radiogram. *Get your requests in early*. Check the full details in next month's issue of *QST*. Good luck.



**National Traffic System.** An emergency plan for NTS has existed for several years (take a close look at your copy of CD-24, if you don't believe it), but now that the system is to become officially the traffic division of the ARPSC this plan is in for some vigorous implementation. We are confident that NTSers will take this in their stride, as though it has been something they have been doing right along.

And indeed it has. The regular handling of third party traffic according to a time schedule and flow plan is "old hat" to the NTS, and its handling on an emergency basis is accomplished by nothing more spectacular than a speed-up of the system, along with some provisions for special handling of traffic bearing the "emergency" tag. All it means is that NTSers will have to work a little harder and a little longer during an emergency — which is what we all expect to do anyway.

By the time you read this, NTS net managers at all levels will have received (we hope) the first ARPSC Bulletin, which outlines in detail how the NTS will operate during an emergency. Elsewhere in this issue is the announcement of the first Simulated Emergency Test in which NTS will play a major part in functioning as the long-haul traffic arm of ARPSC, in conjunction with the AREC for generating and delivering much of the traffic that will flow. In the near future, we hope to revise and re-write CD-24 with particular emphasis on its emergency-time function. Some time later, it would seem appropriate to include NTS and AREC data, instructions and philosophy in a manual of the ARPSC, to replace our present Emergency Communications Manual; this is a longer-range project.

For the nonce, suffice it to say that we expect a gradual increase in the liaison function of local emergency nets into NTS section nets, and we hope you will welcome their representation with open arms. Otherwise, during normal times, there will be no great change in NTS operations. Carry on as you have been, which has been pretty good — W1NJM.

Net	Ses- sions	Traffic	Rate	Aver- age	Represen- tation (%)
EAN	31	2201	1.267	71.0	98.9
CAN	31	1338	.800	43.1	97.8
PAN	31	1145	.686	36.9	95.6
1RN	60	588	.329	9.8	61.4
2RN	62	1063	.765	17.1	99.3
3RN	62	955	.469	15.4	96.2
4RN	62	767	.378	12.4	83.9
HN5	62	985	.522	15.9	84.7
NR7	62	556	.301	9.1	—
SRN	62	697	.384	11.3	95.1
9RN	62	584	.509	9.4	53.9
TEN	51	527	.416	10.3	56.3
ECN	29	106	.210	3.7	69.1 <sup>1</sup>
TWN	27	220	.429	8.1	41.5 <sup>1</sup>
Sections <sup>2</sup>	90	7027	—	5.9	—
TCC Eastern	97 <sup>3</sup>	730	—	—	—
TCC Central	93 <sup>3</sup>	371	—	—	—
TCC Pacific	96 <sup>3</sup>	798	—	—	—

Summary Record	1884	20658	EAN	10.0	2RN	100.0
Record	1918	20350	1,050	15.2	100.0	

<sup>1</sup>Region net representation based on one session per day or less; others are based on two sessions per day or more.

<sup>2</sup>Section nets reporting: BEN & WIN (Wis.); NCN, NCSN & THEN (N.C.); MDDS & MDD (Md.-Del.D.C.); BUN (Utah); TEX & NTPN (Texas); SCVSN, SCN (Calif.); Ont. Fone; QKS (Kans.); GBN (Ont.); GEM (Idaho); Tenn. SSB, Tenn. CW, East Tenn.; CN (Conn.); W. Fla. Phone; VFN, VN & VSN (Va.); OZK (Ark.); 50th State (Hawaii); QMN (Mich.); AENMI, AENO, AENP Morn, AENP Eve, AENR, AENS, AENT, AENY, AENH, AENB, AEND (Ala.); EPA (Pa.); MSN (Minn.); Central Pa. 6AI WSN (Wash.); OQN (Ont.-Que.).

<sup>3</sup>TCC functions reported, not counted as net sessions.

Some of you NTSers are putting out some terrific bulletins, and you certainly deserve some recognition. At one time or another nearly every NTS region and area net and many section nets have produced bulletins at regular or irregular intervals. So many of these cross our desk that it is well nigh impossible to make mention of them, but they go in the proper file and are frequently used when we are digging for material. But most of all, a good bulletin enhances the morale and fraternalism of a traffic net in which the members have the strongest possible bond — pride in efficiency. Currently, we have bulletins in the file published by the managers of CAN (W9DYG's "CAN-KAN"), PAN

## BRASS POUNDERS LEAGUE

Winners of BPL Certificate for July Traffic:

Call	Orig.	Recd.	Rel.	Del.	Total
W9HDA	11	2761	2886	26	5484
K6BPL	76	2474	2856	239	5543
W3CUL	364	2101	1698	392	4555
K9ONK	104	2062	2000	98	4264
K9KZH	8	1361	1318	43	2730
K9DHN	1387	456	468	15	2326
W9DHM	16	752	1397	0	1165
W7BAJ	5	1051	983	66	2105
WA9CCP	5	885	915	265	1859
W8UPH	14	632	567	64	1277
W3EML	29	537	612	37	1115
W2MTA	28	558	402	119	1107
W6SCA	17	533	532	0	1082
W0HTO	18	327	351	176	1072
W0LGG	119	477	434	35	1065
K3QFG	15	504	464	54	1037
W1PEX	30	500	456	37	1023
K1WKK	65	495	454	5	1019
W6RSY	47	468	339	114	968
W2RUF	18	444	444	62	935
K4RQR	0	457	450	7	914
W7DZX	5	458	426	25	914
W6JXK	31	436	345	91	903
W42EXP	17	423	392	25	857
W3R	37	394	386	9	826
K9ZLA	109	353	353	0	815
WA9AJF	16	403	330	165	814
WA4JH	14	392	347	45	798
K7CTP	55	385	202	142	784
K1RYT	34	368	363	2	767
K1LOM	8	404	312	10	734
WA2YK	21	358	341	14	734
W9SCT	0	363	363	2	728
WA4PDS/WA2WBA	53	353	299	16	711
W6BBO	60	315	303	3	681
K9IMR	30	319	172	143	664
W4RMJ	2	339	320	2	663
W4BQ/4	23	321	210	20	653
W401Q	17	287	303	18	655
W6WTF	10	304	283	21	618
WA2KQL	25	289	252	49	615
W1TXL	94	275	228	14	611
W2EIV	103	248	88	166	605
W6JQZ	6	333	260	2	601
WA2YYS	51	276	242	22	592
WA2UOO	2	292	262	27	583
K4POA	19	267	223	63	572
W4DLA	19	250	295	0	564
W8DAE	52	287	194	60	563
W6BOT	6	306	234	3	549
W4SXXV	11	274	260	4	544
K5TEY	10	165	363	9	547
WA2RMP	141	202	160	29	532
K8DIU	21	269	218	20	528
W4ZJY	8	286	231	1	526
K8HLD	21	241	247	26	523
K3MNT/3	28	249	241	5	523
W4BYG	3	254	256	8	521
W9TT	27	247	185	62	521
K2UCY	27	244	212	32	515
W5VNJ	23	249	242	1	515
W9DYG	31	257	215	12	515
WA6KWV	3	254	235	19	511
WA8ENO	33	236	222	13	504
WA2UWA	20	240	230	10	500

Late Reports:

K5VNI (June)	15	352	346	6	719
WA4BMC (June)	46	293	263	64	666
K1RYT (June)	6	306	287	8	607
K5TEY (June)	5	309	270	15	599
W5PPE (June)	73	264	253	7	597

### More-Than-One-Operator Stations

Call	Orig.	Recd.	Rel.	Del.	Total
W6IAB	552	1967	1910	53	4482
W8YDK	2419	876	840	36	4171
KR6CP	777	141	58	81	1057
W4PFC	22	376	333	20	751

### BPL for 100 or more originations-plus-deliveries

K6GZ 422	K1DQC 120	W8KEG/8 108
W7APS 319	WA2WGN 117	K9IME 108
W9NZZ 239	WA4KX 116	WA2CCF 107
K84CG 202	W3NEM 114	K3APM 107
WA2BNF 196	K9VJG 113	W2R 106
E7BHH 154	WA2TQT 111	WA9AKE 103
K48JH 145	K4CDZ 111	W3KUN 101
K6GJM 132	WA2QJU 109	Late Reports:
	W4DVR 109	W5LR (Apr.) 195
K1WKJ 126	W4RHA 109	W6JXK (June) 138
W2OE 124	K8GOU 109	WA4JYB (June) 111

### More-Than-One-Operator Stations

KR6DI 213	KR6CP 111	KR6MD 107
K30RS 164	WA8BYO 109	

BPL medallions (see Aug. 1954 QST, p. 64) have been awarded to the following amateurs since last month's listing: WA2UOO, K3MVO, W4KIS, K5QWR, K6GMU, K9DHN.

The BPL is open to all amateurs in the United States, Canada, and U. S. Possessions who report to their SCAM a message total of 500 or more or 100 or more originations plus deliveries for any calendar month. All messages must be handled on amateur frequencies within 48 hours of receipt in standard ARRL form.

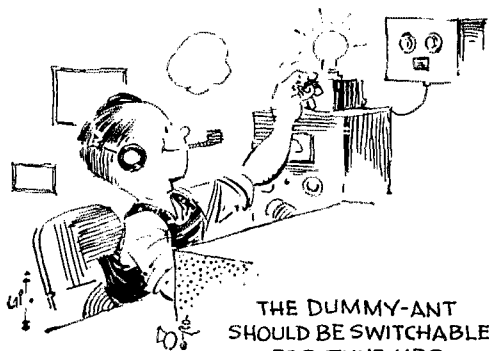

**THE DUMMY-ANT  
SHOULD BE SWITCHABLE  
FOR TUNE-UPS**

(WA6ROF), 2RN (W2GQZ's "Traffic Lines"), 4RN (W4SHJ), RN5 (W4ZJY), RN7 (K7JHA), 8RN (W8CHT) and TEN (W0BYV). The best net is not always the one with the fanciest bulletin, but there can be no doubt that an informational bulletin to regular net participants once in a while improves attendance and performance.

EAN continues to run away with all records; in their one-hour-limit operation, this net is truly a model of traffic-handling efficiency. W9IYG says no changes on CAN, except that everybody seems to be on vacation. WA6ROF is resigning from PAN managership, having acquired an increased burden of fatherhood. A 2RN certificate has been awarded to WA2WSB, who has now moved to New England. W3IUF denies any deterioration of 3RN; the net is going fine. Additional RN5 certificates have been awarded to K4VVF, W4ZWD and W5QMJ; Mississippi representation is dropping off rapidly again. K7JHA reports by radio — which is perfectly acceptable, but watch out for garbles! Things continue to look promising on 8RN, says W8CHT, the current bulletin having reversed a negative trend for an over-all gain. W9ZYK says that 9RN is not proud of its representation from sections. W0BYV is looking forward to cooler weather to relieve bad QRN conditions that have been plaguing TEN. K0ZSQ was awarded a very well deserved TWN certificate; Manager W4UGI  $\emptyset$  says that although the July report is "grim," things are beginning to pick up.

*Transcontinental Corps.* Considerable difficulty is being encountered replacing W9JOZ in the FCC-Central directorship; we hope that by the time you read this the matter will have been settled. Stations are needed for the west coast to east coast transcontinental function (station J); oddly enough, stations are available on the east coast, but the west coast is delinquent. Any California kilowatts with good traffic operators want a job?

July reports:

Area	Functions	% Successful	Traffic	Out-of-Net Traffic
Eastern	94	70.7	2165	730
Central	93	87.1	1108	371
Pacific	96	77.4	1596	798
Summary	283	73.9	4869	1899

The FCC roster: Eastern Area (W3EML, Dir.) — W1s EMG NJM, W7s K1LOM NEF, W2MTA, K2s SIL, UAT, W4s BLV VLK, W3s EML IVC, K3MVO, W4DLA, K4PQL, W8s BZX CHT ELW QFO. Pacific Area (W7DZX, Dir.) — K6GID, W6s EOT HC, WA6ROF W7s 10ZX ZB, K0s EDH EDK, W9KQI.

At left is K1PIL, net control station of the Maine Blueberry Net. At right is W1QQY of Portland, who relays data collected by K1PIL from net stations in Maine's blueberry country to the weather bureau where a "dusting" forecast is originated for the benefit of Maine blueberry farmers.



We hope that by the time you read this, the first bulletin of the Amateur Radio Public Service Corps will be in the hands of your ARPS leaders — EC's, SEC's, RA's, PAM's and elected officials. Many of the principles announced therein will be in effect in the fall Simulated Emergency Test, which many AREC groups will already have conducted.

Actually, the schedule is a little too tight for a really effective test in the October SET, but we hope some of you are able to give the new plans a good try. As soon as possible, we hope to have a feature QST article on the subject. Then comes the arduous task of revising our emergency manual and operating booklet and all the forms, certificates and awards connected with emergency and traffic activities.

Yes, the amount of work inherent in a change so long expected and planned is still great, despite all efforts that have been made to eliminate the ill effects of the change. We hope you will continue to be patient with us as we slug away at it.

The consolidation of the Amateur Radio Emergency Corps and the National Traffic System has been a long time coming. For many years, it has been the custom in the AREC to set up long-haul point-to-point facilities in emergencies when and as they were needed. Usually, this was done on 75-meter phone, the most crowded band of all, accompanied by a large ruckus to get and keep a clear frequency or segment, appeals to FCC, and more often than not an extension of the cleared area far in excess of its actual need, both in frequency limits and time.

The AREC still remains the primary amateur radio vehicle for emergency communication, especially at local level, which is often the only level required. When or if a need for longer-distance communication is required, instead of forming a spur-of-the-moment net, appropriate units of NTS will be activated and will operate in much the same manner as they operate every day. If special arrangements are necessary for the handling of emergency traffic over medium and long distances, they will be made by amateurs who are familiar with such problems and daily do these things in accordance with a regular procedure.

While NTS must make some changes in its routine to serve the AREC, the latter must also take some steps toward linking itself with NTS. One of these is more practice in handling record traffic in standard ARRL form. Another is arranging for proper liaison with the appropriate NTS net at section level and the consolidation of section emergency facilities now existing with NTS units so that all are part of the over-all ARPS concept. EC's will be responsible for activating local ARPS groups, and SEC's will be responsible for keeping in touch with the situation so that a wider area can be activated if necessary. The NTS net manager or managers (RM and/or PAM) are responsible for the conduct of their nets, which are activated at the request of the SEC when he perceives a need for section-wide communication. When or if he perceives a need for inter-section communication, he may request the NTS region net manager to activate the NTS region net.

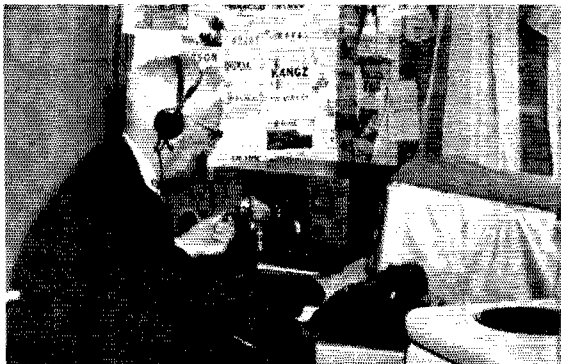

## Section Emergency Coordinators of the Amateur Radio Emergency Corps

The Section Emergency Coordinator is appointed by the SCLC to take charge of the promotion of the Amateur Radio Emergency Corps organization throughout the Section. He acts as the SCLC's executive in the furthering of provisions for emergency amateur radio communications in every community likely to suffer in case of a communications emergency. One of the duties of the SEC is to recommend the appointment of Emergency Coordinators for the various communities in his Section. Does your town have an ECG? If not, recommend the name of a likely prospect to the SEC. The SEC invites your questions concerning the status of the AREC in your Section.

<b>ATLANTIC DIVISION</b>				
Eastern Pennsylvania Maryland-Delaware-D. C. Delaware Southern New Jersey Western New York Western Pennsylvania	W3DUI W3CVE K2ABY W2ICZ W3LIV	Emmet W. Kuehner Cowan W. B. Barger Norris J. Mundell Sydney F. Chiswell William T. Tobin	242 E. Broad St. 7512 Foster Ave., S.E. So. Johnson St. 76 Chardon Dr. 4916 Fifth Ave.	Hazleton District Heights, Md. Carneys Point Buffalo 25 Altoona
<b>CENTRAL DIVISION</b>				
Illinois Indiana Wisconsin	W9RYU W9SNQ W9BCC	Harry Studer, Jr. Leonard M. Chalk Frank L. Guth	RFD 1 815 West Arch St. 428 Ellis St.	Milan Portland Stevens Point
<b>DAKOTA DIVISION</b>				
North Dakota South Dakota Minnesota	W0CAQ W0SCT K0KKQ	Douglas Chasson Lester R. Lauritzen Lloyd Pearthree	449 — 16th Ave., So. Rt. 3, Box 32 800 — 5th Ave., West	Fargo Centerville Pine City
<b>DELTA DIVISION</b>				
Arkansas Louisiana Mississippi Tennessee	W5KRO W5MXQ W4WBK	Rev. Kenneth M. Goode A. L. Powell Franklin Cassen	124 Harrell St. 221 Hollywood Drive 925 North Trezevant	Hot Springs Metairie Memphis
<b>GREAT LAKES DIVISION</b>				
Kentucky Michigan Ohio	W4TFK W8LOX W8HNP	Johnny Gerard Wilbur S. Stoltz Arlington A. Garn	116 Tanglewood Road 3418 State Road 5034 Oak Ridge Drive	Frankfort Royal Oak Toledo 13
<b>HUDSON DIVISION</b>				
Eastern New York N. Y. C. & Long Island Northern New Jersey	W2KGC K2OVN K2ZFI	William L. Stahl John S. Brandau John Banke	Shirley Ave. 1659 E. 46th St. P.O. Box 177, Main Rd.	Fishkill Brooklyn 34 Towaco
<b>MIDWEST DIVISION</b>				
Iowa Kansas Missouri Nebraska	K0EXN K0BXF W0BUL K0TSU	Ronald M. Schweppe Robert M. Summers C. O. Gosch John Spahr	605 West 9th 1125 North 50th Place 711 South Oakland 705 W. 28	Spencer Kansas City 2 Webb City Kearney
<b>NEW ENGLAND DIVISION</b>				
Connecticut Maine Eastern Massachusetts Western Massachusetts New Hampshire Rhode Island Vermont	W1EKJ K1DYG W1AOG W1BYH/ K1APR W1TNO W1YNE K1DQB	Vernal G. Charles Herbert A. Davis Donald F. Guphill Norman Rivers Edward F. Everett Gordon F. Fox Gerald E. Wood	216 Clement Road Lakes Lane 17 Park St., Court Box 147R, Rindge Rd. 77 North Main St. 151 Whipple Road RFD	East Hartford 8 Ellsworth Falls Mofford 55 Ashburnham Concord Esmond 17 Ferrisburgh
<b>NORTHWESTERN DIVISION</b>				
Alaska Idaho Montana Oregon Washington	K7AEZ W7WKP W7HMJ	Verlon E. Cox Jesse E. Parrish Everett E. Young	1124 Parkhill Drive P.O. Box 11 2217-5th St., S.E.	Billings Sweet Home Tuyaltup
<b>PACIFIC DIVISION</b>				
Hawaii Nevada Santa Clara Valley East Bay San Francisco Sacramento Valley San Joaquin Valley	W7JU W4A6IC W4A6LLE W6KZF K8IKV K6ODA	Ray T. Warner Edward M. Petersen John A. Howell Bill Ray Antone P. Buzdas Heinz King	539 Birch St. 67 Michael Way P.O. Box 1122 52 Matilda Ave. 4308 — 38th Ave. 1926 Chelsea Ave.	Boulder City Santa Clara Concord Mill Valley Sacramento Modesto
<b>ROANOKE DIVISION</b>				
North Carolina South Carolina Virginia West Virginia	W4MFK W4BCZ W4SHJ W8SSA	James W. Botsford Phillip A. McMasters Harry J. Hopkins, Jr. E. Keith Chambers	P.O. Box 452 5809 Moore St. 8609 Hammett Ave. P.O. Box 62	Hillsboro North Charleston Norfolk 23503 Bluefield
<b>ROCKY MOUNTAIN DIVISION</b>				
Colorado Utah New Mexico Wyoming	W0SIN K7BLR K5QJN	Charles Cotterell Ronald B. Twelves Robert E. Cowan	430 South Swatley 1450 Harvard Ave. 1466B-45th St.	Denver 28 Salt Lake City 5 Los Alamos
<b>SOUTHEASTERN DIVISION</b>				
Alabama Eastern Florida Western Florida Georgia West Indies (Cuba-P.R.-V.I.) Canal Zone	W4NML W4IYT W4MLE W4YE KZ5RM	William C. Gann Andrew C. Clark George Thurston Leland W. Smith Roger M. Howe	2115 Brookline Dr. 41 Lenape Drive 2116 Gibbs Ave. 1274 Citadell Drive, N.E. Box 462	Huntsville Miami Springs Tallahassee Atlanta 5 Balboa Heights
<b>SOUTHWESTERN DIVISION</b>				
Los Angeles Arizona San Diego Santa Barbara	K6YCX K7NIY WA6OKN	Frank P. Merritt, Jr. George Mezey Ceil D. Hinson	3131 Riverside Dr. P.O. Box 73 1933 Coventry Court	Pomona Sun City Thousand Oaks
<b>WEST GULF DIVISION</b>				
Northern Texas Oklahoma Southern Texas	K5AFN K5DLP W5AIR	Robert G. Bender William Pierce G. D. Sears	c/o OGDIM Civil Defense 901 Bell Ave. 5634 Eskridge	Denton Lawton Houston 23
<b>CANADIAN DIVISION</b>				
Maritime Ontario Quebec Alberta British Columbia Manitoba Saskatchewan	VE3AML VE2QN VE6FS VE7OM	Rowland Beardow Felix Edge Walter Jordan W. C. Orchard	1899 Lakeshore Rd. 2624 de la Falaise Ave. 142 — 19th St. N. 13733 — 62 Ave., RR 15	Sarnia Sillery 10 Lehrbridge North Surrey

Actually, of course, a procedure for accomplishing all this should have been worked out beforehand, so that the necessity for hasty conferring and impulsive decisions will, for the most part, be eliminated. In some sections, the section-wide emergency plan will provide for all alerting procedures and methods in which, led by the SEC, all ECs will be a part. Section nets will be bound together by an agreed-upon liaison plan, so that they will comprise a single organization of the ARPS. Naturally, some will be better organized than others, depending entirely upon the quality of leadership and personnel.

The above is presented so that all and sundry will understand what is going on. Your AREC leaders will have further details and will be able to elaborate in greater particulars on your section plans. It is axiomatic that organization is more effective if each participant has a good idea not only of his own particular part, but also of overall objectives and procedures. Therefore, it is our intention to keep such information available in this column and "Traffic Topix" in as great detail as possible, and we hope you will read both. — *WINJM*.

At 1430 local time, April 20, a small brush fire broke out behind a plastics factory in Bayonne, N. J. Within an hour, high winds had driven the flames completely out of control and the AREC was requested. Shortly thereafter, WA2UZI/mobile, with WA2MGA, arrived at police headquarters and acted as liaison with the other mobiles. Ten minutes later, WA2SYD/mobile arrived at the scene of the fire, and then WA2RZG/mobile with WA2UPT arrived. WA2UZI/mobile and WA2MGA were dispatched with two police officers to the scene of a head-on collision. WA2VLR assumed control of the mobiles and established a landline circuit with the police, replacing a radio circuit manned by WA2UOX and WA2SZY. Other mobiles assisted in evacuation procedures. At 1730 local, WA2NQE/mobile, with WA2QYX, reported in and were headed toward the disaster area; they arrived at police headquarters shortly after 1800 and were assigned evacuation duty, where they arrived at 1830. Meanwhile, WA2UZI/mobile provided transportation to the scene of the fire for several police officers and remained there for some time. At 1915, four mobiles were strategically located at various points to watch for small fires breaking out because of flying sparks. By 1930 the wind started to die down and by 2015 the fire was under control. At 2045 WA2UZI/mobile and WA2MGA arrived at police headquarters and ascertained that further services were not needed, so at 2100 all mobiles rendezvoused at WA2VLR for a critique and operation was terminated. Other amateurs not mentioned who participated included WA2Ss KRI YZY TAY and WZF. — *WA2GBW, EC Bayonne, N. J.*

Amateurs of the Fort Lewis (Wash.) Amateur Radio Operators were all set up for Field Day (June 22) when they were notified of a highway accident nearby. A call for assistance from K7MAI at the FD site was answered by K7VQN at Fort Lewis, who dispatched immediate assistance from the post dispensary for the three people seriously injured in the accident. — *K7MAI*.

A Boy Scout encampment in the mountains above Horse Tail Falls, just south of Monterrey, Mexico, was flooded on July 7 as continuous rain deluged the approximately 1,000 scouts and brought an emergency demand for supplies and equipment to cope with this unforeseen development. XE2RJ, in charge of the amateur station at the camp, and his team of young amateurs, kept the power plant going and the station in operation for 16 hours a day, passing traffic, providing the encampment with the only source of contact with the outside world. Several Monterrey stations stood almost constant vigilance for relaying messages and handling traffic to all parts of Mexico and the U. S., as many scouts from Texas, California, New Mexico, Oklahoma and Arizona were participating. The activity was not only an outstanding example of emergency communications, but it also went a long way to breaking down barriers of culture and language that might have existed between the two countries. — *W5AIR, SEC Southern Texas*.

On July 13, W9ZPV was called upon to give assistance on communications as about 14 different groups were out in

the rain searching for a 75-year-old nun who had strayed away from a convent at Elm Grove, Wisc. W9ZPV set up at the Elm Grove Fire Department and a mobile was dispatched with each search group. Net control dispatched all search groups and their mobile units to pre-planned locations, and search parties worked out afoot from each radio car. At about noon on July 13 the party with K9ZPP/mobile located the sister and an ambulance was dispatched. The sister suffered no apparent ill effects, although she had been out all night in the rain. The net operated on the local net frequency of 146.67 and used f.m. Other amateurs known to have taken part were mobile K9s CMX COX GNJ RCP, W9s DSY DIM JKT KQD SUF; also fixed W9s ATK DBP EBF and K9KJT. — *K9KJT, EC Milwaukee County, Wis.*

A patient escaped from a mental school in Baldwinville, Mass., on July 27, and amateurs swung into action to provide communications for the searching party. The "Hill-toppers" and the Mass. Emergency Corps took part in the activity and were solely responsible for all communications. Seven amateurs took part during the four-day search period: K1s LNC JQT NUR MEB PCK WVK and JPP. — *K1LNC, EC Gardner, Mass.*

On July 22 the AREC of Jasper Co., Ind., was alerted when Chicago TV broadcast a series of tornado warnings for this area. Four amateurs manned the emergency net and were ready, but no tornadoes developed so the net was secured. — *WA9BNW, EC Jasper County, Ind.*

Amateurs in British Columbia AREC reported two activities in public service during the month of May. One was at Vancouver, where VE7BJV and VE7AKE supplied communications during Sports Day at the stadium of the University of British Columbia. Operation was on the local two-meter frequency using portable and hand-carried gear, from the umpire's table to the public address announcer high in the stadium. Officials praised the amateurs for a most effective job of relaying reports and announcements.

At Nanaimo, on May 30, four amateurs supplied six-meter communications for the Nanaimo Parade and Celebrations. Most of the equipment was homemade. The parade moved smoothly as a result of the amateurs' efficient and timely communications, and officials were very much pleased. — *VE7FB, SCM British Columbia*.

On May 24, ten amateurs set up communications between the Boy Scout camporee at Dundee, Milwaukee and the state police district office at Fond du Lac, in case of emergency. Operation was conducted on 2 and 75 meters, using a 2500-watt generator provided by the West Allis Radio Amateur Club. The stations at the camporee were used mostly for informal contact between campers and their homes. Although none of these was solid on 75-meter s.s.b., scout officials were pleased with the result. — *K9KJT, EC Milwaukee County, Wis.*

On May 26, the Story County (Iowa) Amateur Radio Club and the AREC were asked to provide communications at the Ames Jaycee airplane contest. Contact was maintained between various points of flight at the airport and a link to town was also maintained. One emergency developed when a small boy cut his head and was rushed to the hospital by W0LSF/mobile who radioed ahead via the town link to notify the hospital. The group was instrumental in locating a number of planes in free flight as several mobile units patrolled about the vicinity. — *W0LSF, EC Story County, Iowa*.

Thirty-six SECs reported June activities, representing 17,049 AREC members. This is low for the year, but still a record June by quite a wide margin. It also compares very favorably with the 28 reports and 14,331 AREC members reported last June. Sections reported: Ont., Del., Md.-D.C., S. Texas, Mich., E. Mass., S. Dak., Alberta, Ariz., E. Fla., Utah, N.Y.C.-L.I., E. Bay, No. Car., Ind., N. Dak., Wash., Nev., Minn., Ala., Ore., Ohio, W. Pa., Tenn., N.N.J., Mont., Ga., Iowa, E. Pa., R.I., Sac. Valley, Okla., Maine, W. Mass., Los A., B.C.

This brings us to the halfway mark for 1963 (already!)

and shows that this year we have received 245 reports from 49 different sections, while at this time last year we had shown 187 reports from 45 sections. So you see, there aren't many more different sections reporting, but those who are get more reliable each year. Look, for example, at this list of 100-percenters for the first six months of 1953: Mich., E. Mass., N.Y.C.-L.I., S. Texas, Alberta, Ohio, E. Pa., W. Pa., Ind., S. Dak., Tenn., Maine, Mont., Ore., Wash., Nevada, E. Bay, N.C., Utah, Ala., E. Fla., Ga., Ariz., Minn., N.N.J., Iowa, R.I., Okla., B.C.

We have always been very liberal about accepting incomplete reports, but in a couple of cases we have drawn the line. One was when an SEC each month sent in a report form with nothing on it except the name of his section and "same as last month" scrawled across the front. Another was a report form supposed to cover activities for two or three months (it can be counted only as a report for the current month). We have been more liberal about accepting reports for two or three months at a time if they are separate reports for each month, but when we think about it, this isn't much different from writing the names of two or three months on a single report form, and it doesn't even have the advantage of economy. So, we may have to get tough if these shenanigans don't cease.

### RACES News

There is little enough to report at federal OCD level, because OCD is now decentralized almost 100% to the regions. There are eight such regions throughout the United States: at Harvard, Mass.; Olney, Md.; Battle Creek, Mich.; Thomasville, Ga.; Denton, Texas; Santa Rosa, Calif.; Everett, Wash.; and Denver, Colo. Bob Arrowsmith, K8BFI, still holds down a desk at OCD in Washington and coordinates whatever there is to coordinate at this level, but he tells us there actually is very little, with nearly everything now being handled in the regions, and most of his duties are in other areas. So, if you have questions regarding RACES, direct them to your nearest regional OCD office, or to us. If we can't tell you the answer, we'll be sure to tell you *something*.

On July 21, the Jackson County, Mo., RACES organization held a drill simulating a nuclear attack on Kansas City. Base stations were on the air at Swope Park for Kansas City C.D. W0EZM served as the state link to Jefferson City. The RACES radio van was used at Lake Jacomo, W0GSM operated in Ruskin Heights, and there were many mobiles in operation. K0TGU/mobile maintained contact from Richards Gehaur Air Force Base. K0OIM/mobile was dispatched to Independence to investigate a reported fire at Sugar Creek, and K0JXI/mobile was dispatched to Lee's Summit to report on conditions there. Altogether, four base stations and four mobiles with a total of 11 operators took part in a very successful test operation. — K0TCB, Civil Defense Comms. Officer, Jackson County, Mo.

### JULY CD PARTIES

K5ABV has recently done some digging in back QSTs and among Marv's statements is the following: "Note that the central portion of the U.S.A., W8 9 and 0 has not had a single 1st place finish in recent years." K9ELT must have got wind of Marv's research and forthwith turned in the whopper of a claimed score below. Let's join with ORS K4TEA in congratulating Phil for this new CD July record at W9EWC. Although far from records, three scores below top 200-K with the top four c.w. QSO totals above 600 QSOs; a July c.w. showing to be proud of! Phone reports showed just about the same numbers topping 5-K, led by the fine performance of W1NJL, portable in New Hampshire. K2QDT and WA2NCE joined Fred in topping 100 QSOs. W1ECH and W1AW wishes some more of the c.w. ops. would learn first hand about the fun participating in a phone party. Helpfully, Gary lists some good CD phone operating frequencies in the October bulletin. A reminder again fellas, the following are the high-claimed scores number of QSOs and sections. Final results will appear in the *October CD Bulletin*. — W1YYM

### A.R.R.L. ACTIVITIES CALENDAR

(Dates shown are per GMT)

- Oct. 3: CP Qualifying Run — W6OWP
- Oct. 5-6: Simulated Emergency Test
- Oct. 12-14: CD Party (c.w.)
- Oct. 22: CP Qualifying Run — W1AW
- Oct. 19-21: CD Party (phone)
- Nov. 1: CP Qualifying Run — W6OWP
- Nov. 20: CP Qualifying Run — W1AW
- Nov. 9-11, 16-18: Sweepstakes Contest

### OTHER ACTIVITIES

The following lists date, name, sponsor, and page reference of QST issue in which more details appear.

- Oct. 5-6, 12-13: VK/ZL Oceania DX Contest, W1A-NZART (p. 90, this issue).
- Oct. 11-13: *Primera Semana Turistica del Paraguay*, RCP (p. 91, this issue).
- Oct. 12-14: Delaware QSO Party, Delaware ARC (p. 104, this issue).
- Oct. 18-20: Third World-Wide RTTY Sweepstakes, RTTY, Inc. (p. 78, this issue).
- Oct. 19-20, Nov. 2-3: R.S.G.B. 7 Mc. DX Contest (p. 90, this issue).
- Oct. 26-27: New Hampshire QSO Party, Concord Brasspounders (p. 138, this issue).



C.W.		
W9EWC 1.....	229,680-690-66	K3MNT/3.....
K4TEA.....	225,790-670-67	K7NHV.....
W9AQW.....	204,180-635-64	K8RDE.....
WA1JFY.....	199,550-908-65	W9LNQ.....
K5HRR 2.....	193,800-565-68	K3QFG.....
K0R JF.....	189,120-591-64	W4BZE.....
K1WJD.....	187,440-561-66	
W561AE 3.....	177,885-524-67	PHONE
K4ZRA.....	170,240-526-64	W1NJL/1.....
W8VPC.....	163,200-503-64	K4ZRA.....
K2KTK.....	162,855-510-63	WA2NCE.....
W2ZRC.....	161,955-525-61	K2QDT.....
W0W YJ.....	152,460-477-63	W1AW 4.....
VE2NI.....	150,480-453-66	K5MDX.....
W2MTA.....	132,300-415-63	WA4ELB.....
WA8NO.....	127,890-436-58	K3MNT/3.....
WA2NCE.....	125,670-422-59	VE2NI.....
K7CBH.....	122,555-384-63	W2ZVW.....
K2EJU/5.....	121,040-350-68	K4TEA.....
K5OXX.....	113,155-365-61	K1NBN.....
WA4JFM.....	109,800-359-60	W9AQW.....
K8HLR.....	108,190-342-62	K5HRR 2.....

<sup>1</sup> K9ELT, opr. <sup>2</sup> K5ABV, opr. <sup>3</sup> K4DRO, opr. <sup>4</sup> W1ECH, opr.

### CONTEST CORRECTION

In the June QST report of the January VHF SS, the W. Mass. listing of 1386-33-11-B should be accredited to KN1VSC/1, not KN1USC/1.

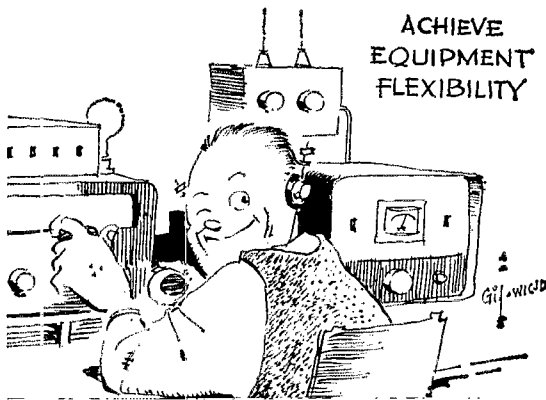

## ELECTION NOTICE

(To all ARRL members residing in the Sections listed below.)

You are hereby notified that an election for Section Communications Manager is about to be held in your respective Section. This notice supersedes previous notices.

Nominating petitions are solicited. The signatures of five or more ARRL full members of the Section concerned, in good standing, are *required* on each petition. No member shall sign more than one petition.

Each candidate for Section Communications Manager must have been a licensed amateur for at least two years and similarly a full member of the League for at least one continuous year immediately prior to his nomination.

Petitions must be received at ARRL on or before 4:30 P.M. on the closing dates specified. In cases where no valid nominating petitions were received in response to previous notices, the closing dates are set ahead to the dates given herewith. The complete name, address, and station call of the candidate should be included with the petition. It is advisable that eight or ten full-member signatures be obtained, since on checking names against Headquarters files, with no time to return invalid petitions for additions, a petition may be found invalid by reasons of expiring memberships, individual signers uncertain or ignorant of their membership status, etc.

The following nominating form is suggested. (Signers will please add city and street addresses to facilitate checking membership.)

Communications Manager, ARRL [place and date]  
225 Main St., Newington, Conn. 06111

We, the undersigned full members of the .....  
..... ARRL Section of the .....  
Division, hereby nominate .....  
as candidate for Section Communications Manager for this  
Section for the next two-year term of office.

Elections will take place immediately after the closing dates specified for receipt of nominating petitions. The ballots mailed from Headquarters to full members will list in alphabetical sequence the names of all eligible candidates.

You are urged to take the initiative and file nominating petitions immediately. This is your opportunity to put the man of your choice in office.

— F. E. Handy, Communications Manager

Section	Closing Date	SCM	Present Term Ends
West Indies	Oct. 10, 1963	William Werner	Aug. 10, 1963
Wisconsin	Oct. 10, 1963	Kenneth Ebnetter	Oct. 10, 1963
Rhode Island	Oct. 10, 1963	John E. Johnson	Oct. 12, 1963
Utah	Oct. 10, 1963	Thomas H. Miller	Oct. 28, 1963
Western Florida	Oct. 10, 1963	Frank M. Butler, Jr.	Dec. 15, 1963
Saskatchewan	Oct. 10, 1963	Jack Robinson	Dec. 10, 1963
Illinois	Oct. 10, 1963	Edmond A. Metzger	Dec. 15, 1963
Hawaii	Nov. 11, 1963	John A. Montague	July 14, 1963
East Bay	Nov. 11, 1963	B. W. Southwell	Jan. 10, 1964
New York City & Long Island	Nov. 11, 1963	George V. Cooke, Jr.	Resigned
Eastern Florida	Nov. 11, 1963	George E. Cushing	Resigned
New Mexico	Dec. 10, 1963	Carl W. Franz	Feb. 10, 1964
Eastern New York	Dec. 10, 1963	George W. Tracy	Feb. 10, 1964
Virginia	Dec. 10, 1963	Robert L. Follmar	Feb. 11, 1964
Georgia	Jan. 10, 1964	James A. Giello	Mar. 26, 1964
Ohio	Jan. 10, 1964	Wilson E. Weckel	Mar. 28, 1964

## ELECTION RESULTS

Valid petitions nominating a single candidate as Section Manager were filed by members in the following Sections completing their election in accordance with regular League policy, each term of office starting on the date given.

West Virginia	Donald B. Morris, W8JM	Sept. 18, 1963
Arkansas	Curtis R. Williams, W5DTR	Oct. 13, 1963
Indiana	Ernest L. Nichols, W9YXX	Oct. 14, 1963
San Diego	Don Stansifer, W6LRU	Oct. 15, 1963

In the Iowa Section of the Midwest Division, Mr. Dennis Burke, W0NTB, and Mr. Owen G. Hill, W0BDZ, were nominated. Mr. Burke received 276 votes and Mr. Hill received 175 votes. Mr. Burke's term of office began July 2, 1963.

In the Kentucky Section of the Great Lakes Division, Mrs. Patricia C. Schafer, K4QIO, and Mr. J. B. Wathien,

## ARRL Phonetic Alphabet

<b>A</b>	ADAM	<b>N</b>	NANCY
<b>B</b>	BAKER	<b>O</b>	OTTO
<b>C</b>	CHARLIE	<b>P</b>	PETER
<b>D</b>	DAVID	<b>Q</b>	QUEEN
<b>E</b>	EDWARD	<b>R</b>	ROBERT
<b>F</b>	FRANK	<b>S</b>	SUSAN
<b>G</b>	GEORGE	<b>T</b>	THOMAS
<b>H</b>	HENRY	<b>U</b>	UNION
<b>I</b>	IDA	<b>V</b>	VICTOR
<b>J</b>	JOHN	<b>W</b>	WILLIAM
<b>K</b>	KING	<b>X</b>	X-RAY
<b>L</b>	LEWIS	<b>Y</b>	YOUNG
<b>M</b>	MARY	<b>Z</b>	ZEBRA

ARRL Communications Department  
Operating Aid No. 1

III, W4BAZ, were nominated. Mrs. Schafer received 221 votes and Mr. Wathien received 159 votes. Mrs. Schafer's term of office began Aug. 20, 1963.

In the Northern New Jersey Section of the Hudson Division, Mr. Edward F. Erickson, W2CVW, and Mr. Louis J. Amoroso, W2LQP, were nominated. Mr. Erickson received 585 votes and Mr. Amoroso received 277 votes. Mr. Erickson's term of office began Aug. 21, 1963.

### New Training Aids Available

Our Training Aids Library has again enlarged its film selection with four more additional titles to choose from. The TA library of visual aids and tapes are available *only* to ARRL Affiliated Clubs, since there are over 1300 active affiliates and a limited TA library.

F-45: "RADIO WAVES," color, 28 min., both man made and radio waves are discussed. The influence of the ionosphere on radio waves is explained.

F-46: "THE CATHODE RAY OSCILLOSCOPE," b & w, 24 min. Explains the purpose of the cathode ray oscilloscope and examines the general principles of operation and demonstrates various operating checks.

F-47: "SINGLE SIDEBAND RADIO INTRODUCTION," b & w, 19 min. Explains the theory of single sideband radio techniques and discusses s.s.b. as compared with a.m. techniques.

F-48: "PRINTED CIRCUITS AND THEIR REPAIR," color, 28 min. Shows how to manufacture, clean, coat and dry printed circuits and describes methods and tools used in their repair.

T-6: "HOW TO RUN YOUR LINEAR," magnetic tape accompanied with eight 35 mm slides, 16 min. long. This tape explains what your linear can do and what it shouldn't do. The subject is developed to show how voice signals can be examined using one's own receiver and looking at phone signals. We urge all clubs to take advantage of tapes like this as they become available.

A new Training Aids list (TA-21) will be available shortly. Plans are underway to produce another tape such as T-6 also to be accompanied by slides on the subject of using one's receiver as an analyzer or to check signal quality. We are also receiving films pertaining to first aid to give the safest and most up to date methods for dealing with accidental emergencies. Affiliated clubs must use Booking Form TA-24 for requesting the new availabilities (above) or listings from TA-21.



# DX CENTURY CLUB AWARDS



## Honor Roll

The DXCC Honor Roll consists of the top ten numerical totals in the DXCC. Position in the Honor Roll is determined by the first number shown. The first number represents the participant's total countries less any credits given for deleted countries. The second number shown represents the total DXCC credits given, including deleted countries. Positions in cases of ties are determined by date of receipt. All totals shown represent submissions received from July 1, through July 31, 1963.

W1FH . . . 309/330	W8BF . . . 306/322	W9LNM . . . 305/323	W8KML . . . 304/320	W1BIH . . . 303/322
W1ZCK . . . 309/327	W2HML . . . 306/321	W8ASG . . . 304/323	W2TQC . . . 304/318	W0AIV . . . 302/320
W2AGW . . . 308/327	W9RBI . . . 306/326	CE3AG . . . 304/323	W4GD . . . 304/321	W8DAW . . . 302/320
W1GKK . . . 308/328	W8DMD . . . 306/323	G2PL . . . 304/322	W7GBW . . . 304/323	W4TM . . . 302/320
W8BRA . . . 308/326	K2GFO . . . 306/323	CX2CO . . . 304/321	W9NDA . . . 303/322	W2LV . . . 302/316
W4DOH . . . 308/326	W7GUV . . . 306/325	W6EBG . . . 304/324	G3AAM . . . 303/322	W2HJO . . . 301/320
W6CUG . . . 308/328	W9YFV . . . 305/324	W5ADZ . . . 304/322	W8BKP . . . 303/320	W3JNN . . . 301/320
W6GHD . . . 308/327	H116DJX . . . 305/324	W4QCW . . . 304/317	W3LMA . . . 303/320	W3JTC . . . 301/319
4V4DK . . . 308/322	G4CP . . . 305/324	W1CLX . . . 304/322	W6AM . . . 303/323	W8FWS . . . 301/320
KV4AA . . . 308/328	W9HUZ . . . 305/320	W1JYH . . . 304/322	W6GPB . . . 303/320	W0ELA . . . 301/319
W8JIN . . . 307/327	W6YY . . . 305/321	W2JT . . . 304/318	W81KH . . . 303/319	K2DCA . . . 300/313
W8KIA . . . 307/326	W3KT . . . 305/324	W0OVZ . . . 304/321	W2BXA . . . 303/322	W4AIT . . . 300/317
W8UIAS . . . 307/323	H89J . . . 305/324	W8DUU . . . 304/321	V67ZM . . . 303/322	W5ABY . . . 300/313
W7PHO . . . 307/321	W2LPE . . . 305/321	W5MMK . . . 304/320	W8JBI . . . 303/318	W2ZCX . . . 300/315
W1ME . . . 307/325				OE1ER . . . 300/318

## Radiotelephone

PY2CK . . . 309/327	W8GZ . . . 306/324	CX2CO . . . 304/321	W4DOH . . . 302/318	PY4TK . . . 298/311
4X4DK . . . 307/321	W9RBI . . . 306/324	VQ4ERR . . . 304/322	W8KML . . . 302/318	W6AM . . . 296/315
W8RIS . . . 306/326	W8BF . . . 305/321	W6YY . . . 304/320	W2ZCX . . . 299/314	W2JT . . . 295/306
W1FH . . . 306/322	W7PHO . . . 305/319	W8PQQ . . . 302/315	W3JNN . . . 298/314	W0AIV . . . 295/312

From July 1, through July 31, 1963 DXCC Certificates and Endorsements based on contacts with 100 or more countries have been issued by the ARRL Communications Department to the Amateurs listed below.

## New Members

W1YDO . . . 287	K8QTF . . . 112	K8CZY . . . 104	K8JOZ . . . 102	W6YJL . . . 101	W3TYW . . . 100
W8AAIZ . . . 185	W3MYT . . . 110	G8RPE . . . 104	K8ADU . . . 102	K8BK . . . 101	W3TRR . . . 100
G8JAM . . . 188	W4ZBR1 . . . 110	W8IDN . . . 104	K4NTS . . . 102	K8OBQ . . . 101	W6CZP . . . 100
Z86YQ . . . 154	Z87R . . . 109	W1HQO . . . 103	OE3HY . . . 102	OKLADP . . . 101	W6TYM . . . 100
L1ZLN . . . 126	W5ISF . . . 105	W4LSG . . . 103	ZC4S . . . 102	UQ2CC . . . 101	W9AOW . . . 100
J11BN . . . 124	ON4UN . . . 106	W5AKH . . . 103	W42BQ . . . 101	K1PVG . . . 100	W9KPC . . . 100
NA12UF . . . 123	K4JTO . . . 105	K87DWB/6 . 103	W42KAZ . . . 101	W48SNY . . . 100	W9NFC . . . 100
OH4NS . . . 122	W4PAM . . . 105	K8PMD . . . 103	W7TE . . . 100	K8JZH . . . 100	R0ZZD . . . 100
OK1KDC . . . 120	G8OZU . . . 105	S15CX . . . 103	W46JJP . . . 101	W44EDY . . . 100	K0QYD . . . 100
W9ADV . . . 113		K1SDX . . . 102		W4G8X . . . 100	

## Radiotelephone

V44XO . . . 204	W1M0V . . . 121	V866K . . . 108	Z86QW . . . 105	W5IPH . . . 102	W45AKH . . . 101
K4ISHN . . . 189	W42F0K . . . 120	W9ADV . . . 106	W891V . . . 103	W6OHU . . . 102	W1LTY . . . 100
Z86YQ . . . 146	PY7JL . . . 115	OK1MP . . . 106	W4UAF/KH6 . 103	W6RER . . . 102	K4LPR . . . 100
K6GALD . . . 130	K5DFZ . . . 114	W4AQT . . . 105	103	W46SBO . . . 102	K0WEM . . . 100
W8AAIZ . . . 127	OZ8EA . . . 110	K7CHT . . . 105	W9TKW . . . 103	W3MYE . . . 101	PA0WR . . . 100

## Endorsements

W6CYL . . . 310	W1RAN . . . 260	W4FNQ . . . 230	W6ISQ . . . 200	OK1MP . . . 187	W2LJF . . . 141
W3CGS . . . 307	W2RGV . . . 260	W7ABO . . . 230	VE3IR . . . 200	W2GHEK . . . 165	K1LW . . . 140
W49CZ . . . 305	K2ZKU . . . 260	W8KMD . . . 230	VPTNS . . . 200	K6ASL . . . 164	W4ZJBV . . . 140
W40FP . . . 304	W4JFL . . . 260	K6JFY . . . 224	K7CHT . . . 196	KV4CL . . . 164	K8MNJ . . . 140
W38AM . . . 299	W6WQ . . . 260	W7RQ . . . 224	W4QVA . . . 195	W1Q0V . . . 163	W5AF . . . 140
W9FXO . . . 301	W0DRL . . . 259	W4BSB . . . 222	W6JKJ . . . 190	K4OEL . . . 162	KNZRY . . . 140
W6CAE . . . 300	W1M0V . . . 255	W8KSR . . . 222	W8CUT . . . 190	K6EXO . . . 162	W0CAW . . . 140
W6NJU . . . 300	W2VMG . . . 254	VK5RX . . . 222	W8ETU . . . 190	HB9ZT . . . 162	W9GM8 . . . 136
W1HA . . . 294	W3AYS . . . 252	K4TKM . . . 221	W0Y7B . . . 190	W9KXZ . . . 161	W44DCP . . . 134
DL1BN . . . 293	W69XA . . . 251	W5LGS . . . 221	G8HIV . . . 190	W2RWQ . . . 155	DJ5LA . . . 133
W2HBS . . . 290	W10HA . . . 250	W4JJB . . . 220	H1BAF . . . 187	K6ASL . . . 154	K6PWU . . . 131
W2EJS . . . 290	W21ES . . . 250	W6PHF . . . 220	W6CHE . . . 183	Z86WS . . . 153	L1CWN . . . 131
W4BJ . . . 284	W2PZL . . . 250	W8QNW . . . 220	W7DIS . . . 183	K1ANV . . . 152	W42HGW . . . 130
W7A . . . 281	W2ZVS . . . 250	SP9RF . . . 220	W1NTH . . . 182	H1BV . . . 152	K2SZK . . . 130
W3AYD . . . 280	W4AVY . . . 250	W2CDP . . . 218	W48NU . . . 182	W4FOS . . . 151	W0TW . . . 130
W6ANN . . . 278	W4HTB . . . 250	W9ZB . . . 218	W6HYN . . . 181	W4GGLD . . . 151	W2CZF . . . 125
W8KHT . . . 280	K4RJJN . . . 250	W4DLG . . . 212	VE3AGC . . . 181	W1TP . . . 150	W5HTP . . . 125
KP4CC . . . 280	K4TFA . . . 250	K4HYL . . . 211	U43AN . . . 181	K1HNS . . . 150	5A3CJ . . . 21
W4CXB . . . 279	W81BX . . . 250	Z86A . . . 211	W5VA . . . 180	W3LSG . . . 150	W45CBL . . . 120
L18AQ . . . 279	G8KZL . . . 250	W11JO . . . 210	K8WOT . . . 180	K8MWH . . . 150	K6M8K . . . 120
W3GJY . . . 276	W4RCJ . . . 247	W21NB . . . 210	K3DNU . . . 179	H1ITE . . . 150	K8EHD . . . 120
P21AX . . . 276	K7CCM . . . 246	W2QDY . . . 210	W6HYN . . . 175	L45LG . . . 150	W9RDL . . . 120
Z81RM . . . 276	W4PEZ . . . 243	W4QVJ . . . 210	W9LJR . . . 173	PY4AYO . . . 150	W6RE . . . 117
W48SU . . . 274	SP9JK . . . 241	W9CMQ . . . 206	W0VPL . . . 173	5U7AC . . . 150	W1G0G . . . 115
W1CKA . . . 271	W2PDB . . . 240	W1QV . . . 203	K9JLR . . . 172	Z86JZ . . . 147	K8ONW . . . 113
W7W8N . . . 271	W2ZVS . . . 240	W4BDU . . . 203	DJ5GG . . . 172	K8ZPK . . . 145	G81P . . . 112
G3A1Z . . . 270	K8OHG . . . 240	DL7BK . . . 202	W1BPW . . . 171	W0YYS . . . 144	W1COL . . . 110
K48AU . . . 270	W7JAT . . . 238	DJ6QW . . . 201	W5NGW . . . 171	W5AJY . . . 143	W8KXL . . . 110
W8WT . . . 270	K1SHN . . . 231	K2DBN . . . 200	W8LJU . . . 171	K6JFJ . . . 143	K21BM . . . 110
W9WIO . . . 265	W4ZAE1 . . . 231	K4BVD . . . 200	K9PNV . . . 171	W6HRS . . . 142	K4UTE . . . 110
K4TFW . . . 264	W9KMLN . . . 231	K6JIC . . . 200	K8VSL . . . 170	VE4XJ . . . 142	K8AJK . . . 110
K8ONV . . . 261					

## Radiotelephone

DL1IN . . . 283	W3CGS . . . 244	K4ASU . . . 217	W3ORD . . . 180	K4TWF . . . 152	W10HA . . . 140
P21AX . . . 276	V55AJK . . . 242	W9JYJ . . . 217	W5WC . . . 180	F2MO . . . 152	K2P0C . . . 140
W2LV . . . 272	W6NJU . . . 241	W28UC . . . 214	K3DNU . . . 172	VP6WD . . . 151	W5AJY . . . 140
W1JFG . . . 270	W1JYH . . . 232	K8ONV . . . 212	K8OHG . . . 172	W8QNW . . . 150	DJ5JA . . . 132
Z86QW . . . 270	PY1NC . . . 231	K4HYL . . . 210	I2ZTF . . . 165	L45LG . . . 150	W2MM . . . 130
W48AU . . . 270	W48IS . . . 230	W8NXP . . . 208	W3PFF . . . 163	W1KID . . . 148	W3CBY . . . 130
W4AZD . . . 260	W3AYD . . . 229	VY5AQ . . . 203	K4OFL . . . 162	SP9RF . . . 147	K1DF . . . 127
W1YDO . . . 256	W5KFT . . . 227	W8CUG . . . 200	K1BDP . . . 160	Z86WS . . . 147	5183AN . . . 127
W2RIV . . . 252	W6MYV . . . 225	W4DLG . . . 199	K5YY . . . 160	W2GHEK . . . 146	K1ANV . . . 125
W911W . . . 251	W48SU . . . 224	W8ALJ . . . 190	K8EXO . . . 160	W1BPM . . . 144	K1UDP . . . 122
G3A1Z . . . 251	K2JFV . . . 221	H1BAF . . . 187	SP9KJ . . . 153	H1BV . . . 144	W2CZF . . . 112
W4TDF . . . 250	W48VQ . . . 220	W8NVP . . . 185	W1RO . . . 152	K8DYX . . . 141	VE3AGC . . . 110

## NATIONAL CALLING AND EMERGENCY FREQUENCIES (KC.)

3550	3875	7100	7250
14,050	14,225	21,050	21,400
28,100	29,640	50,550	145,350

During periods of communications emergency these channels will be monitored for emergency traffic. At other times, these frequencies can be used as general calling frequencies to expedite general traffic movement between amateur stations. Emergency traffic has precedence. After contact has been made the frequency should be vacated immediately to accommodate other callers.

The following are the National Calling and Emergency Frequencies for Canada: *c.w.* — 3535, 7050, 14,000; *phone* — 3765, 14,160, 28,250 kc.

## SUGGESTED OPERATING FREQUENCIES RTTY 3620, 7040, 14,090, 21,090 kc.

**WIDE BAND FM 52.525 146.94**

### GMT CONVERSION

To convert to local times subtract the following hours  
 ADST — 3, AST — 4, EDST — 4, EST — 5, CDST — 5,  
 CST — 6, MDST — 6, MST — 7, PDST — 7,  
 PST — 8, Hawaii — 10, Central Alaska — 10.

## CODE PROFICIENCY PROGRAM

Twice each month special transmissions are made to enable you to qualify for the ARRL Code Proficiency Certificate. The next qualifying run from W1AW will be made Oct. 22 at 0130 GMT. Identical tests will be sent simultaneously by automatic transmitters on 1820, 3555, 7080, 14,100, 21,075, 28,080, 50,700, and 145,800 kc. The next qualifying run from W6OWP only will be transmitted Oct. 8 at 0400 Greenwich Mean Time on 3590 and 7129kc. **CAUTION:** Note that since the dates are given per Greenwich Mean Time, Code Proficiency Qualifying Runs in the United States and Canada actually fall on the evening previous to the date given. *Example:* In converting, 0130 GMT Oct. 22 becomes 2130 EDST Oct. 21.

Any person can apply. Neither ARRL membership nor an amateur license is required. Send copies of all qualifying runs to ARRL for grading, stating the call of the station you copied. If you qualify at one of the six speeds transmitted, 10 through 35 w.p.m., you will receive a certificate. If your initial qualification is for a speed below 35 w.p.m. you may try later for endorsement stickers.

W1AW conducts code practice daily at 0130 GMT on all frequencies listed above with speeds of 15, 20, 30, and 35 w.p.m. on Tuesday, Thursday, and Saturday, and at 5, 7½, 10, and 13 w.p.m. on other days. Approximately 10 minutes' practice is given at each speed. To check your copy the texts used on several transmissions are listed below. The order of words in each line of QST text is sometimes reversed. To improve your list, try to send in step with W1AW. (Please note that there will be no code-practice runs on the nights of the quarterly Frequency Measuring Tests).

- Date Subject of Practice Text from August QST.  
 Oct. 2: "It Seems to Us . . .", p. 9  
 Oct. 8: A 7-Mc. Mobile S.S.B. Transceiver, p. 11  
 Oct. 17: How To Read Circuit Diagrams — Part 1, p. 39  
 Oct. 23: Beam Hoist for a Wood Pole, p. 48  
 Oct. 29: A Day at the FCC Laurel Monitoring Station, p. 55  
 Date Subject of Practice Text from *Understanding Amateur Radio*, First Edition  
 Oct. 11: C.W. Break-in, p. 10  
 Oct. 21: C.W. Monitoring, p. 11

## W1AW SCHEDULES

(Oct. 1963)

### Operating-Visiting Hours

Monday through Friday: 1 P.M.—1 A.M. EDST.  
 Saturday: 7 P.M.—2:30 A.M. EDST.  
 Sunday: 3 P.M.—10:30 P.M. EDST.

The ARRL Maxm Memorial Station welcomes visitors. The station address is 225 Main St., Newington, Conn., about 10 miles south of Hartford. A map showing local street detail will be sent on request. On Oct. 27, W1AW will switch to its winter schedule. The winter schedule will appear in November QST.

### Operating Frequencies

**C.w.:** 1820, 3555, 7080, 14,100, 21,075, 28,080, 50,700, 145,800 kc.  
**Voice:** 1820, 3945, 7255, 14,280 (s.s.b.), 21,330, 29,000, 50,700, 145,800 kc.

Frequencies may vary slightly from round figures given; they are to assist in finding the W1AW signal, not for exact calibrating purposes.

### Official Bulletins

Bulletins containing latest information on matters of general amateur interest are transmitted on the above frequencies according to the following schedule in Greenwich Mean Time.

**C.w.:** Monday through Saturday, 0000; Tuesday through Sunday, 0400.

**Voice:** Monday through Saturday, 0100; Tuesday through Sunday, 0330.

**Caution.** Note that in the U. S. and Canada, because times are GMT, bulletin hours actually fall on the evening of the previous day.

## W1AW CONTACT SCHEDULE

Would you like to work W1AW? W1AW welcomes calls from any amateur station in accordance with the following schedule:

Time (GMT)	Sunday	Monday	Tuesday	Wednesday	Thursday	Friday	Saturday
0000-0030 <sup>1</sup>	.....	14,280	3555 <sup>3</sup>	14,100	14,100	7080 <sup>3</sup>	14,100
0030-0100	.....	14,280	3555	14,100	14,100	7080	.....
0100-0130 <sup>1</sup>	.....	145.8 Mc.	21,330	145.8 Mc.	50.7 Mc.	21,330	.....
0230-0300	.....	.....	.....	1820	.....	1820	.....
0300-0330	.....	.....	.....	3555	.....	3945	.....
0330-0400 <sup>1</sup>	.....	.....	3945	7255*	3945	7255*	3945
0400-0500 <sup>1</sup>	.....	.....	3555 <sup>3</sup>	.....	3945	7080 <sup>3</sup>	.....
1700-1800 <sup>2</sup>	.....	21/28 Mc.	21/28 Mc.	21/28 Mc.	21/28 Mc.	21/28 Mc.	.....
1900-2000	.....	7080	14,100	7255	14,100	7080	.....
2000-2100	.....	14,280	7080	14,100	14, 80	14,100	.....
2200-2300	.....	14,280	14,280	14,280	14,100	7255	.....
2300-2330	.....	7255*	.....	21,075 <sup>3</sup>	.....	14,280	.....
2330-2400	.....	14,100	.....	3555	.....	14,280	.....

<sup>1</sup> Starting time is approximate. General-contact period on stated frequency begins immediately following transmission of Official Bulletin, on c.w. at 0000 and 0400, on phone at 0100 and 0330.

<sup>2</sup> Operation will be on 21,075, 21,330, 28,080 or 29,000, depending on band and other conditions.

<sup>3</sup> W1AW will listen for Novice Class licensees on the Novice portion of this band before looking for other contacts.

\* Operation may be on s.s.b. as announced at the beginning of the period.

Station Staff: W1QIS, WIWPR, K1MET.



## REPORT FROM PROJECT HOPE

**A**FTER one full voyage during which Project Hope has been operating an amateur radio station both aboard the SS HOPE and in the Headquarters in Washington, I wanted to convey our impressions of what amateur radio has meant to HOPE

**T**HESSE two stations were outfitted as donations by the manufacturers. Many others cooperated in a magnificent effort to assist HOPE. The call sign of Bill Halligan, (W9AC), was used by the hospital ship throughout her historic voyage to South America. Many amateurs pitched in to install and maintain these stations, many handled messages from the ship and countless others just stood by in case they could render assistance.

**A**MATEUR radio has made a significant contribution to the directing of far-flung operations thousands of miles away, operations which must be closely coordinated or they fail. Amateur radio can take credit for saving lives in several instances. Equally important, amateur radio has made it possible for the dedicated volunteers aboard the ship to talk to their families and loved ones in the States; these people who have left homes and jobs to help others also express their gratitude to the many faceless but friendly voices who have given their time to help. Hence, amateur radio can also take credit for bringing happiness into homes and into the lives of others.

**T**O ALL these people go our deepest gratitude for a real contribution; their role is one in which the entire amateur radio fraternity should feel a deep sense of pride. HOPE, after all, is people, and what better example can we show the people of countries HOPE visits — that people keep it running — than a sophisticated communications network which depends for its success on many, many individuals who have never met?

**O**NE should see the expressions on Peruvians' faces when the ship station would call the States, 2,000 miles away, and be greeted by half a dozen friendly and cooperative voices. They would ask: "Americans do this for free? For no charge? Just to help others?" And another step was taken in showing the true face of America to foreigners.

**I**N FACT, I have been so impressed with the caliber and interest of the amateur radio fraternity (and I must admit, it is fascinating!!!) I am shortly going to begin work on a license myself. So, if you hear a very hesitant CW novice on the air, please have patience!!

NICHOLAS W. CRAW  
Director of Operations and Logistics  
Project HOPE

*W. J. Halligan W9AC*

*David Marshall K9EBE*

  
**hallicrafters**

• All operating amateurs are invited to report to the SCM on the first of each month, covering station activities for the preceding month. Radio Club news is also desired by SCMs for inclusion in these columns. The addresses of all SCMs will be found on page 6.

## ATLANTIC DIVISION

**EASTERN PENNSYLVANIA**—SCM, Allen R. Breinert, W3ZRQ—SEC: W3DUI, RM: W3EML, PAM: K3CAH, V.H.F. PAMs: W3SAO, W3SGL. The EPA C.W. Net on 3610 kc. had 319 QNI with QTC on 378. The Copen 6 on 50.4 Mc. had 154 QTC. W3CUL had a rough time making skeds because of band conditions. The Bucks County ARC made an interesting tour of WRCV-TV, New Antenna Dept.: W3LXN erected 9 elements on a 30-ft. boom for 6 meters. K3SHY topped him with twenty elements on a 50-footer. K3RYR elevated his 6-meter three-element beam to 50 feet. W3ZRQ adorned his new 70-ft. tower with a six-element 6-meter beam. K3RFH, K3SLP and K3AVX have a new 80-meter antenna installation. A windstorm demolished the 144.220 and 432-Mc. antenna installation of W3FEY. New General Class ops are K3RLO, K3ADS, K3QCQ and K3SWZ. New Gear Dept.: To K3KNL a Heath "Sixer"; K3DSM an NCX-3 and K3KPA a Heathkit Monitor Scope. K3YQJ is a new addition to the EPA C.W. Net. K3ZDK, an ex-British Navy operator, is now living in the Lancaster area. W3PDJ operated mobile-marine while cruising the Bahamas. K3OMP made the WAS award. The Artics High Speed C.W. Net is looking for recruits on 20,360 and 7,125 Mc. K3HTZ spent his vacation with V3EYEC in Canada. Tioga Co. EC, W3BKF suffered first degree burns while on duty with his local volunteer fire dept. K3PPR and K3PSS, both of Troy, Pa., received the Tech Class license. K3KTH operated portable in Eastern Mass. with very little traffic to handle. Radio communications were supplied the Tamaqua Soap Box Derby by W3DGN, K3SLG, K3NYX and W3ZRQ. Anyone interested in chess playing, look for K3MLP on 6 meters. W3WDZ is NCS for the Post Office Net on 3610 kc. The Del-Lehi ARC held its annual picnic in Easton Aug. 18. K3ALLI has deserted v.h.f. operating for 20-meter DX. The Juniata Co. 6-meter mobiles assisted with the Firemen's Parade at McCallisterville. W3GIU and W3ORJ both entered the hospital for operations of the same type. K3CAH, new PAM, suffered a bad accident while at work. Traffic: W3CUL 4555, W3EML 1115, W3VR 826, K3MNT/3 523, W3IVS 377, K3MVO 298, K3JXS 244, K3MQE 237, K3HNP 167, K3CAH 112, K3QWE 108, K3JHF 83, W3ZQR 67, K3RJX 65, W3AXA 32, K3BHU 31, K3KNL 21, W3FEY 15, W3FLP 14, W3ELI 11, W3PDJ 11, K3SLP 11, W3BFF 10, W3BUR 10, K3ARR 9, K3YQJ 9, K3AUT 8, W3FAF 8, K3OMP 8, W3DUI 7, W3VAP 7, W3GJA 6, K3HTZ 6, K3GEQ 5, K3LTI 5, W3BKF 4, W3EEN 4, W3OY 3, W3HNK 2, K3HYM 2, W3LXN 2, K3RFH 2, K3KTH 1.

**MARYLAND-DISTRICT OF COLUMBIA**—SCM, Andrew H. Abraham, W3JZY—SEC: W3CVE, RMs: K3JYZ and W3TN for the MDD Traffic Net which meets on 3849 kc. daily at 0600Z, RM: W3ZNW for the MDDS (slow) traffic net on 28.1 Mc. and 3649 kc. at 0130Z, PAM: W3EQK. The MEPN meets on 3920 kc. M.W.F. at 2300Z and on Sat. and Sun. at 1800Z. K3APM made the BPL. W3BKE is taking a rest from traffic-handling. W3CJT has a 1200-watt emergency generator for use in any emergency. W3EQK had a vacation in Nova Scotia and stopped at W1AW on his way home. W4EXM/3 is now in the U.S. and is employed by the Page Communications Engineers. W3HQE has a new Telrex tower up 86 feet for the tribander and has a two-element 40-meter beam up to 71 feet. K3GVE has built two transmitters, one for 80-meter c.w. and the other for 40-meter c.w. K3LLR hopes to have his antenna problems cleared up soon. K1MDI/3 is attending Gaudaud College in Washington, D.C. K3NCM keeps busy on the MFPN. K3OAE and K3QDD had a good time in the CD Party. W3OHI has a cubical quad on 15 meters, also an HT-37 S.S.B. and a Drake receiver. W3IVC has been awarded the BPL medallion. W4OSG/3 is operating mobile on 6 meters with a sixer and 1/4-wave whip. W3PQ has been

enjoying the traffic work on the Morning Watch and HB Nets. K3QFG handled over a thousand messages this month, making the BPL. K3RGB maintains skeds on 28,680 kc. K3RAU and K3SGD are active on 10 meters, also K3USE and K3TQN. K3RQH keeps his OBS skedules. K3RUQ will be operating portable 8 for awhile. K3WTE is moving back to Monroe, Wash., and hopes to get his old call back. K3SMT is a new OBS. Ralph applied for his CP-25 certificate. W3TNZ is back in the area after visiting amateurs in the S.C.V. section in California and he had a wonderful time out there. W3TN reports that the volume and participation on the MDD is further ahead this year than it was for the same period last year (month of July), the MDD handled 211 more messages this month than last July and the total time in minutes is only 25 minutes more. Dave had a well-earned vacation in N.C. for two weeks. K3JYZ spent two weeks in California. K3QOO has been a theological student at Holy Cross College, now he is Reverend Mr. J. M. Conley. Mike will be back in the fall handling traffic. K3VOP is a new station reporting. W3ZNV is waiting for cooler weather to work on his antennas. The Antietam Radio Club will hold its first transmitter hunt this month. There will be more to follow. Traffic: K3QFG 1037, K3ORS 327, K3APM 275, W3TN 220, K3SMT 111, W3PQ 81, K3RUQ 59, W3ATQ 39, K3OAE 39, W4OSG/3 35, K3CSX 30, K3WBJ 26, W3HQE 21, K3NCM 21, K3GZK 14, K3LLR 7, K3RQH 4, K3SGD 2, K3VOP 2.

## EIGHTH DELAWARE QSO PARTY

*October 12-14*

The Delaware Amateur Radio Club of Wilmington announces its 8th Delaware QSO Party and invites all amateurs to participate. Delaware hams are urged to work as many out-of-state stations as possible, so that those interested can earn credit toward WAS and the W-DEL certificate. Here are the details:

- (1) Time: 30-hour period from 2200 GMT Oct. 12 to 0400 GMT Oct. 14.
- (2) No time limit and no power restrictions.
- (3) Scoring: *Delaware stations*: 1 point per contact and multiply total by the number of states, Canadian provinces and foreign countries worked during the contest period. *Outside stations*: 5 points for each Delaware station worked and multiply total by the number of counties in Delaware worked during the contest period.
- (4) Credit for contacts with the same station on other band will be given.
- (5) A certificate will be awarded to the highest-scoring station in each state, Canadian Province and foreign country (with 3 or more contacts) and to the highest-scoring station in each Delaware county. In addition, a W-DEL certificate will be sent to any station working all 3 Delaware counties. Party logs showing required data will be accepted in lieu of QSLs.
- (6) *Suggested freqs.*: A.m. 3825, 7225, 14,225, 21,325, 29,000 kc. C.w.: 2525, 7025, 14,025, 21,025, 28,025 kc. S.s.b.: 3975, 7275, 14,325, 21,425, 28,650 kc. V.h.f. 50, 50.4 and 144 Mc.
- (7) General Call: "CQ DEL." Delaware c.w. stations should identify themselves by signing *de (call) DEL K*. Phones say, "Delaware calling."
- (8) Contact information required: Delaware stations send number of QSO, RS(T) and county (New Castle, Kent or Sussex). All others send number of QSO, RS(T) report, and state, province, or country.
- (9) Logs and scores must be postmarked not later than Nov. 4, 1963, and should be sent to the Delaware Amateur Radio Club, c/o J. E. McCarley, K3NMY, P.O. Box 201, Newark, Delaware. Applications for the W-DEL certificate should also be addressed there.

(Continued on page 110)

The Heath Company takes pleasure in introducing on the following pages, the first of a complete series of fully integrated SSB amateur radio equipment that will set new standards for value, quality, style, and performance. To be designated the Heathkit SB Series, these products represent a major step forward in amateur radio SSB equipment. Now, the best in SSB design features are combined with Heathkit's leadership in electronic kit techniques to bring maximum performance and operating convenience to amateurs at modest prices.

What design features are essential or desirable for the best SSB performance? Some of the more important ones are high mechanical and electrical frequency stability achieved only by employing crystal-controlled heterodyne circuitry with low frequency variable frequency oscillators, optimum receiver selectivity and minimum transmitted signal bandwidth obtainable by means of the excellent shape factors exhibited only by crystal or mechanical filters, linear tuning with 1 kc dial calibration, smooth anti-backlash dial, automatic level control, small size, and light weight. The SB Series has all these plus the several improved and unique features listed below.

To provide even better performance plus maximum ease of assembly, these new Heathkit SSB products also feature linear dials providing 500 kc frequency coverage per bandswitch position while maintaining 1 kc calibration marks spaced approximately  $\frac{1}{8}$ " apart, a high frequency bandpass IF (8.4—8.9 mc) for improved image rejection and suppression of spurious responses, preassembled and prealigned LMO (linear master oscillator), circuit boards and wiring harnesses, plus specially tooled cabinet, knobs, dial mechanism, and LMO components. When the transmitter and receiver are operated in the transceive mode, in addition to the usual practice of employing a common VFO and high frequency oscillator, the receiver BFO is used as the transmitter carrier oscillator to prevent even minute frequency changes between transmit and receive due to crystal tolerances. This attention to detail is typical of the careful, thorough engineering behind the Heath SB Series.

Only Heathkit experience and know-how can provide the engineering and manual skills necessary to bring such quality and performance to kit-form SSB equipment. Despite this background, Heath engineers spent over two years in the design of the equipment, and the developing and specifying of the critical components (such as the LMO, crystal filters, and dial mechanism). Only the most capable manufacturers have been selected to supply the special components and, as always, only the highest quality parts are employed throughout.

Carefully read the features and specifications of the SB-300 SSB Receiver described on the next two pages. The entire SB Series will exhibit all these fine performance characteristics using the same basic critical components in equipment covering all amateur interests.

## HEATH COMPANY

Benton Harbor, Michigan



# *an announcement of significance to all amateur radio operators*

# *the deluxe* **HEATHKIT<sup>®</sup>** **SB-300** **SSB RECEIVER**

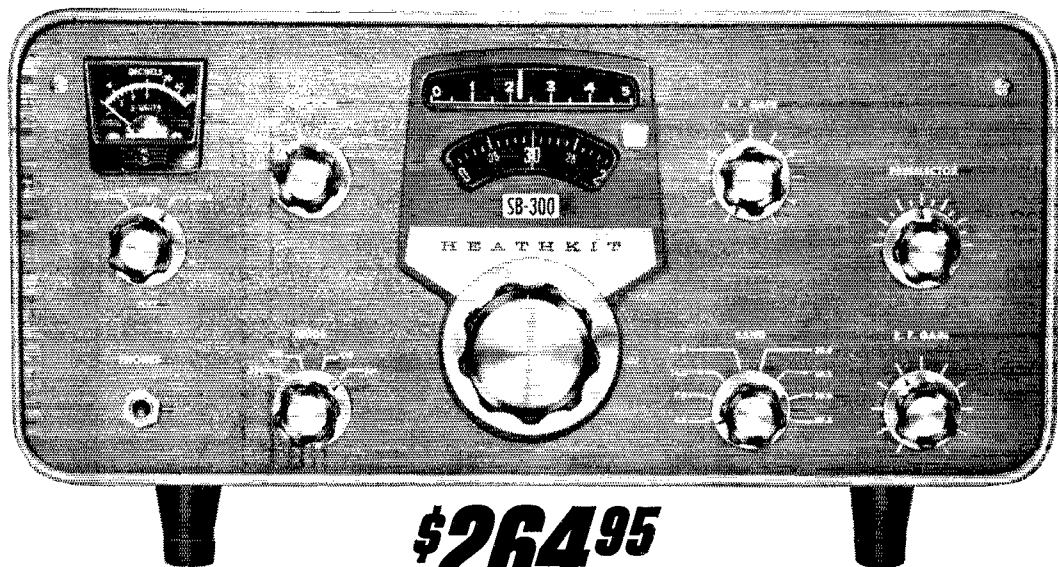

**\$264<sup>95</sup>**

*deluxe*  
*features for*  
*finest*  
*performance*

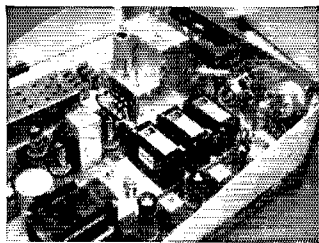

Precision-built Linear Master Oscillator (LMO) is completely assembled and calibrated, ready to install; specially designed dial assures accurate readout and smooth frequency control.

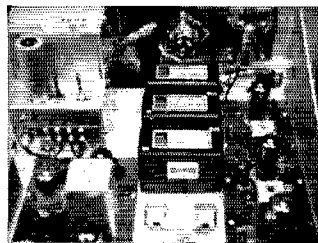

Prebuilt, hermetically-sealed 2.1 kc crystal band-pass filter for SSB provides the excellent nominal shape-factor of 2:1 (60/db). Optional AM and CW filters shown installed.

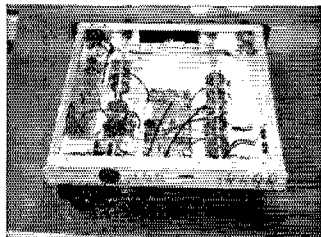

Two heavy-duty 3/32" circuit boards and pre-cabled wiring harness maintain a clean, uncluttered layout for fast, easy assembly, years of faithful performance.

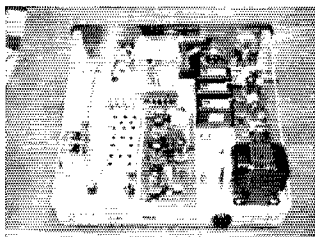

All adjustments are conveniently made from the top of the chassis; chassis screening clearly identifies coil and tube locations, etc. Entire top of ventilated cabinet opens for easy access.

# SB-300 features

- Complete coverage of 80 through 10 meter amateur bands with all crystals furnished, plus provision for VHF converters
- Crystal-controlled front-end for same tuning rate on all bands
- 1 kc dial calibrations — 100 kc per dial revolution provides band spread equal to 10 feet per megacycle — tuning knob to dial ratio approx. 4:1
- Provision for transceive operation with matching SB-400 Transmitter (available soon)
- Prebuilt linear master oscillator (LMO), wiring harness and two heavy-duty circuit boards for fast, easy assembly
- Professional styling and features throughout for finest HF and VHF amateur band communications

Experienced amateurs will especially appreciate the careful attention to detail behind the design of the SB-300. Its many features include a crystal controlled front-end that provides the same tuning rate on all bands, a pre-built Linear Master Oscillator (LMO) for linear tuning with 1 kc dial calibrations, built-in crystal calibrator and 2.1 kc crystal-lattice bandpass filter, a smooth, non-backlash vernier dial drive mechanism, and a beautifully styled cabinet and panel. Cabinet top opens completely for easy access to top chassis components. Optional AM and CW filters are low-cost and easily installed, their steep-sided bandpass eliminates, not merely attenuates, adjacent interfering signals for exceptional reception.

Circuit features include a high frequency I.F. for maximum I.F. and image rejection, audio inverse feedback, fast-slow-off AGC control, stability of 100 cps after warmup, and a host of other deluxe features that assure finest communications results. Order your SB-300 now for 60% savings over comparable factory-built receivers! A matching Transmitter, 1 KW Linear Amplifier, and an All-Band SSB Transceiver will be available soon!

Kit SB-300....17 lbs.....no money dn., \$25 mo..... \$264.95  
 SBA-300-1 CW Crystal Filter (400 cps)....1 lb..... \$ 19.95  
 SBA-300-2 AM Crystal Filter (3.75 kc)....1 lb..... \$ 19.95

## Check the superb specifications below and see what a tremendous dollar value the SB-300 represents!

**Frequency Range (megacycles):** 3.5 to 4.0, 7.0 to 7.5, 14.0 to 14.5, 21.0 to 21.5, 28.0 to 3.25, 28.5 to 29.0, 29.0 to 29.5, 29.5 to 30. **Intermediate frequency:** 3.395 megacycles. **Frequency stability:** 100 cps after warmup. **Visual dial accuracy:** Within 200 cps on all bands. **Electrical dial accuracy:** Within 400 cps on all bands. **Backlash:** No more than 50 cps. **Sensitivity:** Less than 1 microvolt for 15 db signal plus noise-to-noise ratio for SSB operation. **Modes of operation:** Switch selected: LSB, USB, CW, AM. **Selectivity:** SSB: 2.1 kc at 6 db down, 5.0 kc at 60 db down (crystal filter supplied). AM: 3.75 kc at 6 db down, 10 kc at 60 db down (crystal filter available as accessory). **Spurious response:** Image and IF rejection better than 60 db. Internal spurious signals below equivalent antenna input of 1 microvolt. **Audio response:** SSB: 350 to 2450 cps nominal at 6 db. AM: 200 to 3500 cps nominal at 6 db. CW: 600 to 1200 cps nominal at 6 db. **Antenna input impedance:** 50 ohms nominal. **Muting:** Open external ground at Mute socket. **Crystal calibrator:** 100 kc crystal. **Front panel controls:** Main tuning dial; function switch; mode switch; AGC switch; band switch; AF gain control; RF gain control; preselector; phone jack. **Rear panel controls:** Accessory power plug; IF antenna; VHF #1 antenna; VHF #2 antenna; mute; spare; anti-trip; 600 ohm; 8 ohm speaker; line cord socket; heterodyne oscillator output; LMO output; BFO output; VHF converter switch. **Tube complement:** (1) 6BZ6 RF amplifier; (1) 6AU6 First mixer; (1) 6AB4 Heterodyne oscillator; (1) 6AU6 LM osc.; (1) 6AU6 second mixer; (2) 6BA6 IF amplifier; (1) 6AU6 Crystal calibrator; (1) 6AT5 1st audio, audio output; (1) 6AS11 Product detector, BFO, BFO amplifier. **Power supply:** Transformer operated with silicon diode rectifiers. **Power requirements:** 120 volts AC, 50/60 cps 50 watts. **Dimensions:** 14-7/8" W x 6-5/8" H x 13-3/8" D.

## WATCH FOR THESE NEW HEATHKIT RELEASES!

SB-100 ALL-BAND SSB TRANSCEIVER

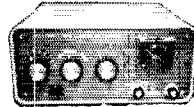
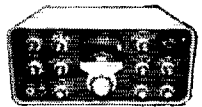

SB-200 1 KW LINEAR AMPLIFIER

SB-400 SSB TRANSMITTER

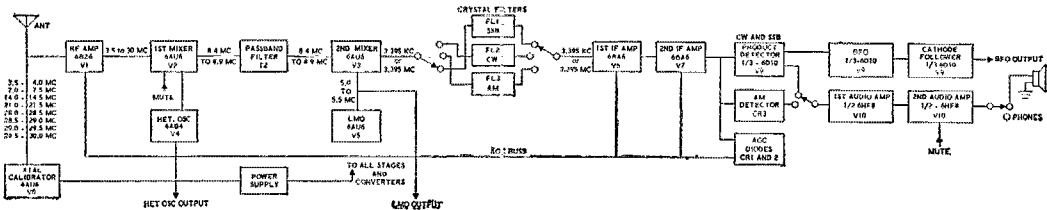

### NEW! FREE 1964 HEATHKIT CATALOG

HEATHKIT-1964



See the latest new products in Heathkit's wide, wonderful line. Over 250 do-it-yourself kits for stereo hi-fi, marine TV, electronic organ, amateur radio, test instruments, educational, home and hobby that will save you up to 50%. Send for your free copy today!

HEATH COMPANY, Benton Harbor 9, Michigan 49023

- Please send FREE copy of New 1964 Catalog
- Please send SB-300 Specification Sheet
- Enclosed is \$ \_\_\_\_\_, please send Model \_\_\_\_\_

Name \_\_\_\_\_

Address \_\_\_\_\_

City \_\_\_\_\_ State \_\_\_\_\_ Zip Code \_\_\_\_\_

# THAT YOU CAN BE YOUR OWN BOSS... ENTER... GIANT "I WISH..."

Just complete this statement in 25 words or less:

*Over \$35,000 in prizes—*

Easy to enter, easy to win!

**1** Nothing to buy! Just visit your Hallicrafters distributor listed below and secure an entry blank. (We won't mind if you look over his featured Hallicrafters display while you're there!)

Fill in entry blank, and complete sentence, "I WISH ... everyone would use VHF for short range contacts because ..."

**2** **DO NOT MAIL ENTRY TO HALLICRAFTERS.** Turn in or mail to distributor. He will select local winner on basis of originality and sincerity of statement, and award HA-2 or HA-6 local prize.

**3** Local winners become eligible for GRAND NATIONAL PRIZE. Hallicrafters will select winner. All decisions final. Entries become Hallicrafters property; winners' names and statements may be published.

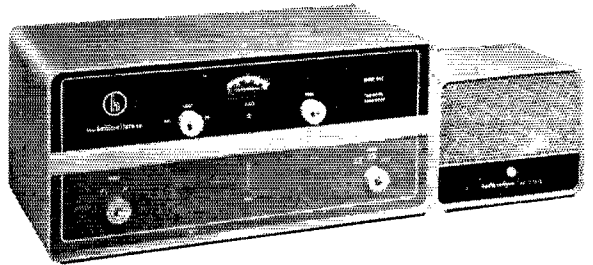

one of OVER 60 HA-2 or HA-6  
TRANSVERTERS WITH POWER SUPPLY  
... OR THIS FABULOUS, DELUXE  
HALLICRAFTERS SSB/AM/CW STATION!



**hallicrafters**

**CALIFORNIA**  
Anaheim: Henry Radio, Inc.  
Los Angeles: Henry Radio, Inc.  
North Hollywood: Arrow  
Electronics Distributors  
San Jose: Quement Industrial  
Electronics  
San Francisco:  
Amrad Supply, Inc.  
Zack Electronics

**COLORADO**  
Denver:  
Burstain Applebee Co.  
Radio Products Sales Co.

**CONNECTICUT**  
Hartford: Hatry of Hartford  
New Haven: Radio Shack Corp.  
West Hartford: Radio Shack Corp.

**FLORIDA**  
Jacksonville:  
Kinkade Radio Supply, Inc.  
Miami: Amateur Radio Center, Inc.  
Orlando: Amateur Electronic  
Supply  
Tampa: Kinkade Radio Supply, Inc.

**GEORGIA**  
Atlanta: Specialty Distributing Co.

**ILLINOIS**  
Chicago:  
Allied Radio Corp.  
Amateur Electronic Supply  
Genoa: Crawford Electronics  
Lincoln: Hursh Radio & TV

**INDIANA**  
Indianapolis: Van Sickle Radio

**IOWA**  
Council Bluffs: World Radio  
Laboratories, Inc.  
Des Moines: Radio Trade Supply  
Co.

**MARYLAND**  
Wheaton: Electronic Distributors,  
Inc.

# HALLICRAFTERS VHF SWEEPSTAKES!

"I WISH...everyone would use VHF for short range contacts because..."

*your opinion may win-*



## GRAND PRIZE

HT-44 transmitter (slaves with SX-117 for transceive operation) . . . HT-45 "Loudenboomer" amplifier . . . SX-117 triple conversion receiver . . . R-47

speaker . . . HA-10 low freq. converter . . . HA-1 "T.O." keyer . . . HA-8 Splatter Guard . . . P-150 AC and P-45 AC power supplies.

### MASSACHUSETTS

**Boston:**  
DeMambo Radio Supply Co.  
Lafayette Radio  
Radio Shack Corp.  
**Braintree:** Radio Shack Corp.  
**Hyannis:** DeMambo Radio Supply Co.  
**Natick:** Lafayette Radio  
**Reading:** Graham Radio, Inc.  
**Saugus:** Radio Shack Corp.

### MICHIGAN

**Detroit:** Reno Radio  
**Grand Rapids:** Radio Parts, Inc.

### MISSOURI

**Butler:** Henry Radio  
**St. Louis:** Walter Ashe Radio Company

### NEW HAMPSHIRE

**Concord:** Evans Radio Co.  
**Manchester:** DeMambo Radio Supply Co.

### NEW JERSEY

**Bloomfield:** Variety Electronics Corp.  
**Paramus:** Lafayette Electronics of Paramus

### NEW YORK

**Farmingdale L.I.:** Arrow Electronics, Inc.  
**Jamaica, L.I.:** Harrison Radio Corp.  
**New York:**  
Arrow Electronics, Inc.  
Harrison Radio Corp.  
Harvey Radio Co.  
Terminal-Hudson Electronics, Inc.

### OHIO

**Cleveland:** Bernie's Ham Shack  
**Toledo:** Selectronic Supplies, Inc.  
**Youngstown:** Armie's Electronics

### PENNSYLVANIA

**Blairsville:** Holiday Electronics  
**Pittsburgh:** Tydings Co.  
**Wyncote:** H. M. Buergler

### RHODE ISLAND

**Cranston:** Radio Shark Corp.  
**Providence:** DeMambo Radio Supply Co.

### SOUTH DAKOTA

**Aberdeen:** Burghardt Radio Supply, Inc.  
**Rapid City:** Burghardt Radio Supply, Inc.  
**Sioux Falls:** Burghardt Radio Supply, Inc.  
**Watertown:** Burghardt Radio Supply, Inc.

### TEXAS

**Abilene:** Howard Radio  
**Amarillo:** Capitol Electronics  
**Dallas:** Amateur Electronics  
**Houston:**  
Busacker Electronics  
Lafayette Radio Electronics  
**Pasadena:** Lafayette Radio Electronics  
**San Antonio:** Modern Electronics Co.

### VIRGINIA

**Norfolk:** Priest Electronics

### WISCONSIN

**Milwaukee:**  
Allied Radio Corp.  
Amateur Electronic Supply

### WASHINGTON, D.C.

Electronic Wholesalers, Inc.

## Station Activities

(Continued from page 104)

**DELAWARE**—SCM, M. F. Nelson, K3GKF—PAM: K3LEC, RM: W3FEB, DEPN meets Sat. on 3905 kc. at 1830 local time. DSNM meets Tue. on 50.4 Mc. at 2100 local time. Appointment: W3RDZ as OO, Renewals: W3EBB as RM, K3AZH as EC New Castle County; K3GKF as OBS. Six-month MDD Net certificates were issued to W3EBB, W3EKO and K3PZL. The Delaware ARC-sponsored QSO Party will take place Oct. 12-13. All logs and entries go to K3NMY at Box 201 in Newark, Del. It is hoped that all three counties will be represented, especially on 3.5-, 7- and 14-Mc. phone and c.w. A little c.w. action from Dover, especially on 80 and 40 meters, certainly will be welcomed by those seeking the State Capitol's award. See rules and suggested frequencies appearing elsewhere QST. Traffic: W3EBB 170, K3SXA 21, K3PZL 14, K3KAJ 13, K3GKF 6, K3AXW 2.

**SOUTHERN NEW JERSEY**—SCM, Herbert C. Brooks, K2BG—SEC: K2ARY, PAM: W2ZI, RM: WA2VAT. With regret we report the passing of W2ZNF, Delanco, K2CBF, Erlton, has graduated from the U.S. Naval Academy, Annapolis, Md. K2RXB, Margate, has a sked with HL9KH, W2RG, Merchantville, made BPL with 106 deliveries. WA2VAT has received membership in TCC. W2ZI, Trenton, has returned from a trip to N.E. Canada visiting friends and the site of Marconi's first transatlantic station "GB". W2ZVW, Beverly, is making plans for 160 meters this winter. W2BAY, Hadfield, is vacationing at Cape Cod. K2JJC, Pitman, is going s.s.b. WA2TQY is vacationing in Trinidad. The Atlantic County AREC held its first simulated emergency test in July. Those taking part were K2HBA, K2SOX, WA2OZQ, WA2WKF, WA2TQY and W2TUR. WA2OZQ is Atlantic County EC. W2PAU, Westmont, has returned from France. W2DF, QST Tech. Editor, was the speaker at SJRA's July meeting. W2FYS, Hadfield, replaces WA2EJY as SJRA's rec. secy. SJRA's teletype activity is on the increase with W2JAV, W2BLV, W2LXB and WA2GSO being the most active. W2JAV is NCS Mon. 7 to 8 p.m. on 146.3 and 50.3 Mc. WA2JCF is reported to be in a Chicago hospital after an auto accident. K2HOD, of Delanco is vacationing. The Levittown (N.J.) Radio Club plans a picnic. WA2OZQ, who recently visited Ireland, is the club's pres. Your SCM is beginning his sixth two-year term. Your cooperation in the past has been very much appreciated. I hope to have your support during my present term of office. Those holding appointments are urged to check the expiration date on their certificate and present them for renewal if necessary. Traffic: W2RG 303, WA2BLV 259, WA2VAT 154, W2ZI 29, W2ZVW 26, W2MMD 17, K2RXB 16, K2SHE 16, W2BEI 4.

**WESTERN NEW YORK**—SCM, Charles T. Hansen, K2HUK—SEC: W2LXZ, RMs: W2RUF, W2EZZ and W2FEB, PAM: W2PYI. NYS C.W. meets on 3670 kc. at 1900, ESS on 3590 kc. at 1800, NYSPTEN on 3925 kc. at 1800, NYS C.D. on 3610.5 and 3993 kc. (s.s.b.) at 0900 Sun. and 7102.5 kc. at 1930 Wed., TCPN 2nd call area on 3970 kc. at 1900, IPN on 3980 kc. at 1600, 2RN on 3690 kc. at 0045 and 2345 GMT. BPL this month goes to W2RUF, W2OPE and WA2KQG. Congratulations! The city of Buffalo and County of Erie was declared a disaster area on Aug. 7 because of 4 inches of rain in four hours with extensive flooding and property damage. C.D. was alerted and RACES operators provided vital communications for police, fire and government agencies. K2HUE, W2LXE, WA2CEB, W2YMY, WA2LDM and many others congregated on the 2-meter calling frequency and in turn activated others. With telephones knocked out government officials, including police and fire, soon realized the vital importance of an organized emergency radio network capable of mobile and portable operation. Amateur base stations were set up in hospitals, police headquarters and fire dispatch headquarters. Keep Oct. 12 open to attend the greatest V.H.F. round-up in the nation sponsored by the Syracuse V.H.F. Club. W2RHQ is general chairman. I am sorry to report that W2QS, of Savannah, active since 1908, became a Silent Key in June. W2QHQ passed the Extra Class exam. K2IQH reports that his XYL is now WN2JH. He just made YLCC and WRONE. K2RUM and WN2EPP have tied the knot and moved to N.Y.C. Congratulations! The GRAMS devoted a club meeting to giving Novices a helping hand—a fine idea. K2HUK is installing emergency equipment in the travel trailer—it makes a fine mobile base station. Traffic: W2RUF 935, WA2KQG 615, K2SIL 463, W2OE 311, W2FEB 262, W2JVH 216, K2OFV 73, W2FCG 51, WA2WEE 31, K2IMI 29, WRQF 21, K2JBX 16, WA2GLA 12, W2QHQ 11, WB2CET 9, WA2ILE 7, WA2FRR 2.

**WESTERN PENNSYLVANIA**—SCM, Anthony J. Mroczka, W3UHN—SEC: W3LIV, RMs: W3KUN, K3OOU and W3NUG. The WPA Traffic Net meets Mon.

through Fri. at 2400 GMT on 3585 kc. K3PJO and K3UTR now have their General Class licenses. New officers of the Breeze Shooters are K3SMB, pres.; K3QHY, secy.-treas.; K3EBX, checker; W3SIR, K3GWX and K3RKKW, wind gaucers. The Etina RC reports via Oscillator: W3UHM has a new SR-150; W3LAC is moving permanently back to the West Coast; W3ATB is in the local Veterans' Hospital. The Horseshore RC Hamateur News: K3BMMG has a new HE-45; the K3BDIs have their first harmonic; W3CHN received public recognition in the local paper. The South Hills Brass Pounders & Modulators RC, via *Vidi-Oh*: W3WFR moved to a new QTH; K3CNZ is on s.s.b. with an SM-10. W3ZDW has worked his 203rd country. The Cumberland Valley ARC had W3ZRO as guest speaker at its annual picnic in July. The Coke Center RC reports: K3HEIN is a Silent Key; K3PLP is the proud mother of a baby girl; W3NCE, K3BTF and K3HSP attended the W. Va. State ARRL Convention. New officers of the RAE are K3EJU, pres.; K3IVG, vice-pres.; J. McCray, secy.; W3VNC, treas. W3NXXK has a new beam. The Uniontown ARC, via *Maple*: A new Novice is KN3YIG; K3SAA now has an NC-300; the club operated a rig at the local county fair. This past summer the gang on WPA certainly did a fine job keeping seven-day coverage on the traffic net. Traffic: (July) W3NEM 450, W3KUN 256, K3DKH 104, K3PEZ 96, K3PYS 92, W3IYI 78, K3NZB 67, W3OEO 36, W3UHN 29, K3SMB 9, W3LOD 6, K3COT 4, W3SMV 1. (June) W3KWO 10.

## CENTRAL DIVISION

**ILLINOIS**—SCM, Edmond A. Metzger, W9PRN—Asst. SCM: Grace V. Ryden, W9GME, SEC: W9RYU, RM: W9USR, PAM: W9VWJ, EC of Cook County: W9HPG. Section net, ILLN, 3515 kc. Mon. through Sat. at 1900 CDT. In the August issue of QST it was erroneously reported that W8MRZ was a Silent Key. It should have read W9MRZ, Ed Barczuk, of Chicago. K9EIV is now portable nine with QTH at Scott Arb. Ill. WA9EHT has a new NCX-3. WA9CWZ is QSOing on 220 Mc. Father William Roell, W9CSW, was honored by the Green Bay newspaper as a favorite son. For the last 25 years he has been a complete invalid and makes his home in St. John's Sanatorium, Springfield, Ill. The Chicago Area Emergency Net (CAEN) is back on the 1805 frequency. Silent Keys are W9BIX, of Normal, and W9VBY, of Streator. W9QKE and W9REC participated in the May Frequency Measuring Test. Their reports were received from Headquarters too late to be inserted in Sept. QST. WA9AFD has joined the Air Force. The Hamfesters (Chicago) Hamfest was very well attended and many eyeball QSOs were experienced. K9ILU has gone mobile up 2 and 6 meters and W9VWJ has a new home-brew 6146 on the same bands. The League's Executive Committee has approved the application of the PiCoRams (Monticello) for club affiliation and declared them a duly affiliated society. New appointments this month include K9ZNU as OBS, W9EFT as OO, WA9DKM as OBS and K9ZGX and K9MMS as OBSs. The North Central Phone Net had a traffic count of 1156 and the Interstate Single Sideband Net handled 2045 messages during July. K9AUB is now portable JA with his QTH as Fuchikawa AFB, Japan. K9CNE is now back from the Navy and is working for Motorola. K9MIZ has a new HyGain beam for his 6-meter rig. A new call in the Rockford area is WA9FFF. With final reports in on Field Day, many past records seem to have been broken. The band conditions must have contributed much to the great scores received. K9GQM has moved to W5-Land. WA9PBC is interested in the inauguration of a ham-astronomy net and wants all astronomy-minded amateurs to contact him. W9HLX is recuperating in a Decatur hospital after receiving a very serious burn. W9IDA, K9KZB, WA9CCP and WA9AJF are recipients of the BPL award this month. Traffic: (July) W9IDA 548, K9KZB 2730, WA9CCP 1859, WA9AJF 814, W9AKV 233, W9USR 105, K9CYZ 92, W9GMZ 80, K9LRN 74, K9BTE 36, WA9DKM 28, K9RAS 14, K9DRS 13, W9PRN 12, K9UCG 11, K9ZVT 7, W9LNQ 2, WA9AWP 2, K9GSD 2, W9DRO 1, WA9DOC 1. (June) K9GMZ 44, W9VWJ 23. (May) W9GMZ 67.

## Harry M. Matthews, W9UQT

This column's sympathy is sent to the wife and family of W9UQT, Harry M. Matthews, who recently passed away. "Doc," as he was known to the various members of the amateur fraternity, was Director of the Central Division from 1955-1956. He also was a charter member of the Illinois Emergency Net, and the PAM appointment that he held was the oldest in the League.

**INDIANA**—SCM, Donald L. Holt, W9FVH—Asst. SCM: Clifford A. Singer, W9SWD, SEC: W9SNO, PAMs: K9KTL, K9CRS, K9GLL, RMs: W9TT, K9DHN, W9JOZ. Net skeds (all times in GMT): IPN, 1300 daily except Sun. at 1830 and 2300 M-F on 3910 kc. ISN

(Continued on page 120)



# 1st Choice Among Nation's Amateurs!

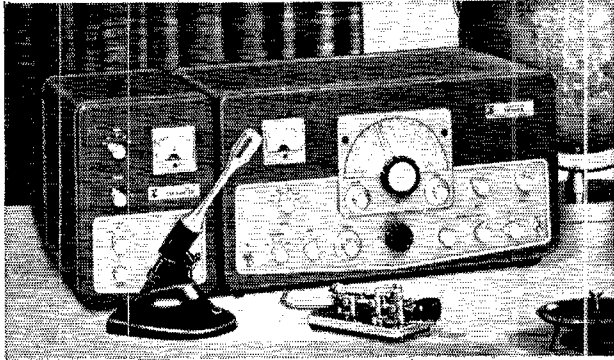

## Matched Pair

Outstanding performance on SSB, AM and CW with absolutely no compromise on any mode!

**"SSB ADAPTER"**—The new filter-type SSB generator—with bandswitching 80 through 10 meters . . . more than 50 db sideband suppression . . . more than 45 db carrier suppression! When used with the Viking "Valiant" or "Valiant II" it places 275 watts P.E.P. at your command. Two compact units and interconnecting cables . . . RF unit is only 8" wide—may be placed on your operating desk. Power supply unit may be placed in any convenient location. Features built-in multiplier requiring VFO input only—band-pass interstage couplers require no tuning—design and front panel make operating practically fool-proof. Superb audio fidelity and balanced audio response; excellent sideband, spurious and carrier suppression. Other features: positive VOX and anti-trip circuits with built-in anti-trip matching transformer and adjustable VOX time delay. With remote power supply, tubes and crystal filter, less microphone.

Cat. No. 240-305-2—Wired, tested . . . . . Net \$369.50

**"VALIANT II"**—Outstanding flexibility and performance—bandswitching 160 through 10 meters—delivers 275 watts input CW or SSB (with auxiliary SSB exciter or Viking SSB adapter) and 200 watts AM! Low level audio clipping—differentially temperature compensated VFO provides stability necessary for SSB operation! High efficiency pi-network tank circuit—final tank coil silver-plated. Other features: TVI suppression; time sequence (grid block) keying; high gain push-to-talk audio built-in low pass audio filter; self-contained power supply; and single control mode switching. As an exciter drives any popular kilowatt level tubes and provides quality speech driver system for high power modulators. Provision for plug-in SSB operation with no internal modification. With tubes, less crystals.

Cat. No. 240-105-1—Kit . . . . . Net \$375.00  
Cat. No. 240-105-2—Wired, tested . . . . . Net \$495.00

**INVADER**—More exclusive features than any other Transmitter/Exciter on the market today! Specially developed high frequency, symmetrical, multi-section band-pass crystal filter for more than 60 db sideband suppression—more than 55 db carrier suppression! Instant bandswitching 80 through 10 meters—no extra crystals to buy—no realigning necessary. Delivers a solid 200 watts CW input: 200 watts P.E.P. SSB input; 90 watts input on AMI (25-30 watts output—upper sideband and carrier). Built-in VFO—exclusive RF controlled audio AGC and ALC (limiter type) provide greater average speech VOX and anti-trip circuits. Fully TVI suppressed. Self-contained heavy-duty power supply. With tubes and crystals.

Cat. No. 240-302-2 Wired, tested . . . . . Net \$619.50

**INVADER 2000**—Here are all of the fine features of the "Invader", plus the added power and flexibility of an integral linear amplifier and remote controlled power supply. Rated at a solid 2000 watts P.E.P. (twice average DC) SSB, 1000 watts CW, and 800 watts AM! (250 to 300 watts output—upper sideband and carrier.) Wide range output circuit (40 to 600 ohms adjustable). Final amplifier provides exceptionally uniform "Q". Exclusive "push-pull" cooling system. Heavy-duty multi-section power supply. With power supply, tubes and crystals.

Cat. No. 240-304-2 Wired, tested . . . . . Net \$1229.00

**HIGH POWER CONVERSION**—Take the features and performance of your "Invader" . . . add the power and flexibility of this unique Viking "Hi-Power Conversion" system . . . and you're "on the air" with the "Invader 2000". Wired, tested, includes everything you need—no soldering necessary—complete conversion in one evening.

Cat. No. 240-303-2 . . . . . Net \$619.50

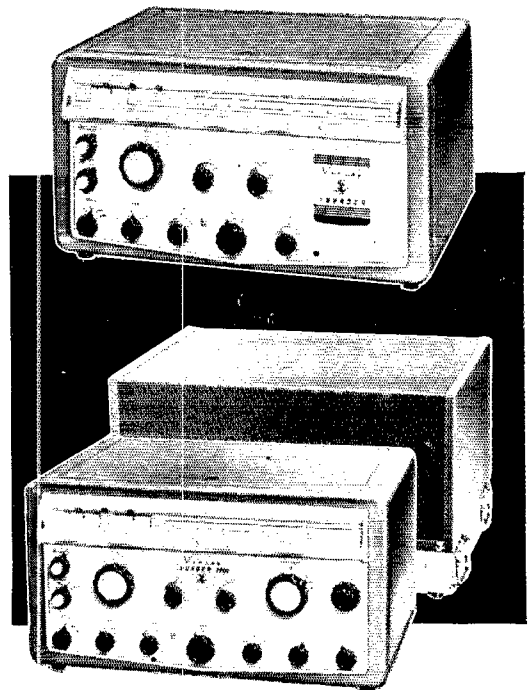

**E. F. JOHNSON COMPANY**  
WASECA, MINNESOTA, U.S.A.

# ANTENNA ACCEPTANCE

IS DECIDED IN THE MARKET PLACE, BY PUBLIC CHOICE. AN ANTENNA THAT SURVIVES THE COMPETITIVE STRUGGLE CONTINUES TO BE ADVERTISED. THE FREAKS, EXPERIMENTS, AND REJECTS DISAPPEAR FROM VIEW.

OVER 20,000 GOTHAM ANTENNAS HAVE BEEN SOLD. ONLY GOTHAM HAS BEEN CONSISTENTLY ADVERTISING FOR OVER 10 YEARS AND NEVER MISSED A QST IN ALL THAT TIME.

WHAT DOES THIS PROVE? THAT GOTHAM DESIGN, GOTHAM PERFORMANCE, GOTHAM MATERIALS, GOTHAM PRICE AND GOTHAM SERVICE ARE WHAT HAMS WANT.

# GOTHAM VERTICALS DELIVER THE CONTACTS

THE ULTIMATE PROOF OF THE FINE PERFORMANCE OF THE GOTHAM VERTICAL ANTENNAS IS IN THE ACTUAL FIELD RESULTS, BY HAMS ALL OVER THE WORLD.

## PROVEN! PROVEN! BY THESE EXCERPTS FROM UNSOLICITED TESTIMONIALS:

### CASE HISTORY #71

"I am very delighted with the first V80 and want another for a different location." A. C., California.

### CASE HISTORY #159

"I ordered a Gotham V40 Vertical Antenna and found it so successful that several others are wanting them, too. Will you please send me four more." W. A., Alaska.

### CASE HISTORY #248

"I just wanted to let you know how pleased I am with my Gotham V80 antenna. I have worked a W.A.S. of 46/43, a WAC of 3/3, and DXCC of 14/12 in about 12 months." G. W., Maryland.

### CASE HISTORY #111

"The V160 did a beautiful job on a VE1 for me. Also, I forgot to take it down during the hurricane of last week. It is just as straight as it was when I bought it." D. S., New Jersey.

### CASE HISTORY #613

"I have never been happier with any antenna than I have been with the V80. I have worked all bands with it and have had tremendous success — i.e., DL4s, ZS3, etc., all solid copy." R. D. S., Penna.

### CASE HISTORY #483

"My V80 is working wonders. I am able to maintain a 1:1 SWR all across the 40 meter band. After many years on 10, 15, and 20, the XYL and I are getting great kicks out of some of the lower bands." J. A., New Mexico.

### CASE HISTORY #146

"I have had very good luck with mine (my V80) feeding it with a Johnson Adventurer; works fine on all bands." B. I., Nebraska.

### CASE HISTORY #555

"Being an owner of your V80 vertical I would like to let you know of the excellent results I am getting with it, both working the DX and the local stations on the lower bands. It certainly is an excellent antenna system." F. H. Jr., New York.

### CASE HISTORY #84

"A few months ago I purchased your V40 vertical and have achieved outstanding results on the air." K. G. B., North Carolina.

## BEAMS

Rugged Yagi design, full half-wave, Gamma-matched

2 Meter, 12 Element . . . . .	\$24.95
6 Meter, 4 Element . . . . .	25.95
10 Meter, 4 El., #R10 . . . . .	40.95
15 Meter, 3 El., #R15 . . . . .	49.95
20 Meter, 3 El., Deluxe . . . . .	59.95
15-20 Two-Bander . . . . .	49.95
10-15-20 Tribander . . . . .	59.95

## FREE CATALOG

# WHY

## THE GOTHAM VERTICAL ANTENNA IS THE BEST ALL-BAND ANTENNA

- Absolutely no guying needed.
- Radials not required.
- Only a few square inches of space needed.
- Four metal mounting straps furnished.
- Special B & W loading coil furnished.
- Every vertical is complete, ready for use.
- Mount it at any convenient height.
- No relays, traps, or gadgets used.
- Accepted design—in use for many years.
- Many thousands in use the world over.
- Simple assembly, quick installation.
- Non-corrosive aluminum used exclusively.
- Multi-band, V80 works 80, 40, 20, 15, 10, 6.
- Ideal for novices, but will handle a Kw.
- Will work with any receiver and xmitter.
- Overall height 23 feet.
- Uses one 52 ohm coax line.
- An effective modern antenna, with amazing performance. Your best bet for a lifetime antenna at an economical price.

73  
GOTHAM

# DO YOU KNOW

1. YOU WILL HAVE NO DIFFICULTY INSTALLING YOUR GOTHAM VERTICAL ANTENNA IN JUST A FEW MOMENTS, REGARDLESS OF YOUR PARTICULAR PROBLEM, SO ORDER WITH CONFIDENCE EVEN IF YOU HAVE RESTRICTED SPACE OR A DIFFICULT SITUATION.
2. LOADING COIL NOT REQUIRED ON 6, 10, 15 AND 20 METERS. FOR 40, 80, AND 160 METERS, LOADING COIL TAPS ARE CHANGED MANUALLY EXCEPT IF A WIDE-RANGE PI-NETWORK OUTPUT OR AN ANTENNA TUNER IS USED; IN THIS CASE BAND CHANGING CAN BE DONE FROM THE SHACK.
3. EVERY GOTHAM ANTENNA IS SOLD ON A TEN DAY TRIAL BASIS. IF YOU ARE NOT FULLY SATISFIED, YOU MAY RETURN THE ANTENNA PREPAID FOR FULL REFUND OF THE PURCHASE PRICE. THIS IS YOUR GUARANTEE OF FULL SATISFACTION.



**FILL IN AND SEND TODAY!**

*Airmail Order Today — We Ship Tomorrow*

**GOTHAM** Dept. QST

**1805 PURDY AVE., MIAMI BEACH, FLA.**

Enclosed find check or money-order for:

V40 VERTICAL ANTENNA FOR 40, 20, 15, 10 AND 6 METER BANDS..... \$14.95

THE V40 IS ALSO MADE FOR CITIZENS BAND OPERATION, WITH SPECIAL INSTRUCTIONS. DESIGNATE CB-11 ANTENNA. PRICE SAME AS THE V40

V80 VERTICAL ANTENNA FOR 80, 40, 20, 15, 10 AND 6 METER BANDS. MOST POPULAR OF THE VERTICALS. USED BY THOUSANDS OF NOVICES, TECHNICIANS, AND GENERAL LICENSE HAMS... \$16.95

V160 VERTICAL ANTENNA FOR 160, 80, 40, 20, 15, 10 AND 6 METER BANDS. SAME AS THE OTHER VERTICAL ANTENNAS, EXCEPT THAT A LARGER LOADING COIL PERMITS OPERATION ON THE 160 METER BAND ALSO..... \$18.95

**HOW TO ORDER.** Send check or money order directly to Gotham. Immediate shipment by Railway Express, charges collect. Foreign orders accepted.

Name.....

Address.....

City..... Zone..... State.....

with **VLFC-1**  
FREQUENCY  
STANDARD  
COMPARISON  
SYSTEM

OPERATING  
OVER THE

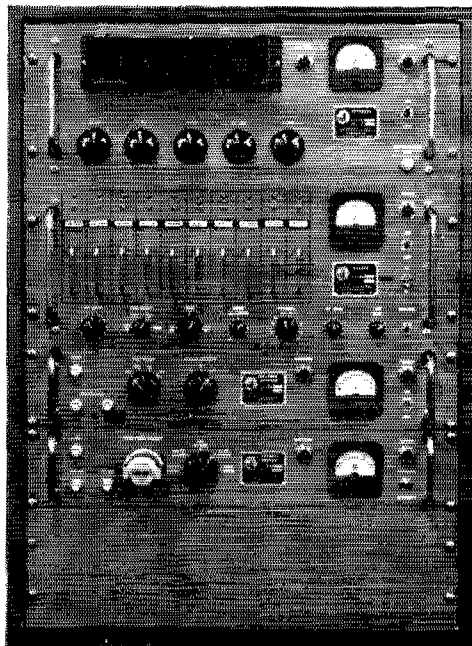

# 10KC TO 30KC VLF RANGE

- 10 channels for world wide coverage
- Instantaneous direct frequency comparison in parts in  $10^9$
- Corrected standard output frequencies in parts in  $10^9$
- Instantaneous "No-Break" battery supply
- Doppler correction for mobile use
- Complete coverage frequency synthesized in 1 cps steps

REQUEST TB 6003

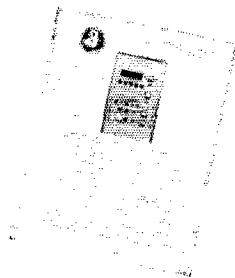

## THE TECHNICAL

*and Subsidiaries*

OTTAWA, CANADA • GARLAND, TEXAS • SAN LUIS OBISPO, CALIF. •



...and **THE SOLID STATE**  
**VLR**  
**SERIES OF COMMUNICATION RECEIVERS**

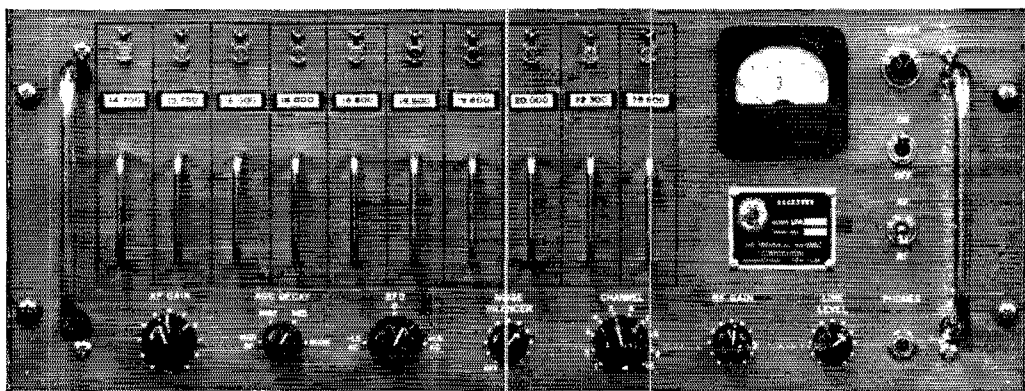

*providing* **INSTANT SELECTION**

OF **10** PRE-TUNED  
 FREQUENCIES

FROM **10** KC TO **540** KC

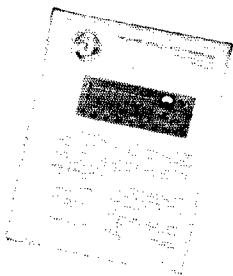

REQUEST  
 TB 3008

**MATERIEL CORPORATION**  
 MAMARONECK, NEW YORK

OXNARD, CALIF. • ALEXANDRIA, VA. • POMPANO BEACH, FLA. • LUZERN, SWITZERLAND

**NOW ARRIVING ON TRACK SIX!**



# *Clegg's* **VENUS 6** **TRANSCEIVER**

**A COMPLETE SSB STATION FOR 6 METERS**



Yes, the long awaited VENUS 6 SSB TRANSCEIVER is now being delivered to your distributors. We take this opportunity to thank the hundreds of hams who have waited so long and patiently for their orders to be filled.

As the result of the acquisition of Clegg Laboratories by Squires-Sanders, Inc. (opposite) the design and production of more and better new Clegg products will move forward rapidly. Excellent financing and a completely ham oriented program have resulted in vastly improved test, quality control and manufacturing facilities and, as the VENUS 6, the first in this new line of products makes its bow, its superior design and construction features will be readily apparent.

The VENUS 6, a high quality compact attractively styled SSB RECEIVER and TRANSMITTER, puts you on 50 Mc single sideband without all the fuss, bother and expense associated with adapting low frequency SSB exciters, relays and linear amplifiers. Its 20 tubes and 4 semi-conductors provide performance equivalent to 35 tubes.

The VENUS employs all the latest circuit techniques including crystal lattice filter, balanced beam tube modulator, low noise NUVISTOR front end and the newly conceived RECEIVER OFFSET tuning.

Packaging is sturdy, attractive and, most important . . . designed for maximum operating convenience. The same dial assembly that has drawn thousands of raves from ZEUS and INTERCEPTOR owners has been further refined for use in the VENUS. Accurate 1 KC per division performance, so desirable for SSB, is further supplemented with a precision electrical vernier. An effective IF noise limiter with adjustable threshold provides excellent rejection of impulse noise on SSB, AM or CW.



See your Distributor or write for information.

**LABORATORIES**  
Division of Squires-Sanders, Inc.

RT. 53, MT. TABOR, N. J.  
TELEPHONE 627-6800



Clegg Laboratories, well known for high-performance VHF equipment — the Zeus transmitter, Interceptor receiver, Thor 6 and 99'er 6 meter transceivers — has recently become a division of Squires-Sanders, Inc. Amateurs interested in VHF will find that this means a vastly better Clegg — as the result of excellent technical support and financial backing, plus association with a company whose entire interests center upon superior amateur communications equipment.

Squires-Sanders recent technical innovations, which have resulted in a truly remarkable line of HF amateur equipment, give this announcement even greater significance to the amateur fraternity. The combined product lines will thus include equipment of the highest quality for *both VHF and HF* — produced by a company whose principals have both a strong professional and technical background and a deep interest in amateur radio.



**D. F. SANDERS, President**

A founder and president of Stavid Engineering, Inc. and subsequently president of Lockheed Electronics Company. Squires-Sanders Directors include ALDEN R. LOOSLI, General Manager, Fibres Division, American Cyanamid; RANDOLPH B. MARSTON, Associate of Laurance S. Rockefeller; and JAMES W. WALKER, Vice President of Brady Security and Realty Corp.



**WILLIAM K. SQUIRES, W2PUL, Vice President**

Former Chief Scientist for Lockheed Electronics Company and previously with the Rand Corporation, president of Telemeter Magnetics (now a division of Ampex), and supervisor of advanced development for the Radio and Television Division of Sylvania Electric Products.



**EDWARD T. CLEGG, W2LOY, Clegg Laboratories Division**

A founder and president of Clegg Laboratories since 1951. Formerly vice president of Transistor Devices, Inc., of which Clegg Laboratories was a division. Responsible for many original developments in VHF communications equipment, including all Clegg amateur products. Extensive prior background in military communications and countermeasures.

SS-1-R is the designation for the first *Squires-Sanders* product — a 3.5 to 30 MC, amateur band, AM/SSB/CW receiver having performance characteristics superior to previously available equipment. The SS-1-R will feature unparalleled freedom from overload and cross modulation\* plus excellent sensitivity, selectivity and image rejection. Digital read-out of frequency, automatic all-band calibration with WWV and a motor driven tuning mechanism are just some of the unusual refinements. A pre-IF noise silencer accessory that literally eliminates the majority of impulse noise will complement the receiver.

The SS-1-R and the Silencer are already "on the air" in field testing. They will be available at your favorite dealer soon.

\*See "A New Approach to Receiver Front End Design", W. K. Squires, QST, September 1963

# Squires - Sanders, Inc.

475 WATCHUNG AVENUE, WATCHUNG, N. J.



Westinghouse applies its heavy duty industrial experience to your ham transmitter

## SOMETHING NEW! SILICON RECTIFIER ASSEMBLY CAN

Its name is **Oz-Pak**. The first solid state rectifier unit designed by a major manufacturer with the amateur radio operator in mind. Oz-Pak is a highly engineered unit for operation under all known environmental conditions (heat, cold, humidity, etc.).

In addition to replacing tubes, Oz-Pak eliminates two to four sockets, one to three filament transformers plus connectors, insulators and high voltage wiring problems. All rectifier maintenance disappears as well as "stand-by" rectifier hash present with gaseous tubes.

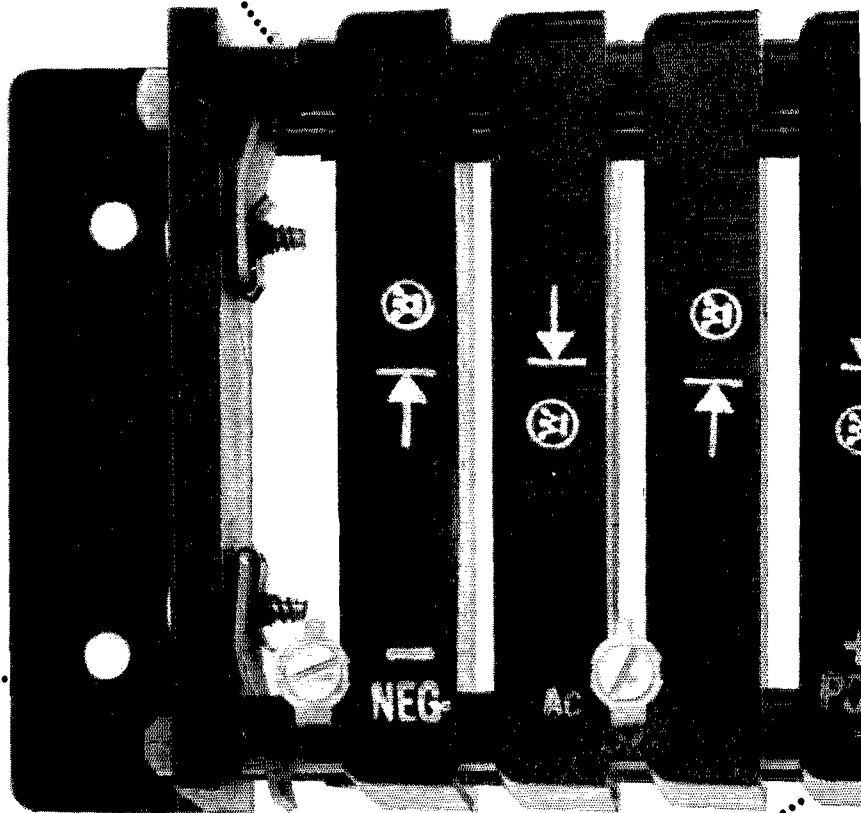

Oz-Pak is lightweight and compact. Only 3 pounds. Measures 2" x 4" x 9½". If you want an additional choke and/or filter capacitors, there's plenty of room.

To get your **Oz-Pak**, order from your favorite distributor or any distributor listed (right). Send check or money order. But act now. You can be sure... if it's Westinghouse.

SC-1104

Henry Radio Co., 211 N. Main Street, Butler, Missouri  
Walter Ashe Radio Co., 1125 Pine Street, St. Louis 1, Missouri  
Harrison Electronics Corp., 227 Greenwich St., New York 13, N.Y.  
Elmar Electronics Corp., 140 Eleventh St., Oakland, California  
Ack Radio Supply Co., 3101 Fourth Ave., S., Birmingham 5, Ala.



# REPLACE ALL OF YOUR RECTIFIER TUBES IN 15 MINUTES!

Use Oz-Pak two ways. To build your own equipment. Or to replace the tubes in your present transmitter. 15 minutes... and it's installed. Mounts on any surface. No special brackets or insulators needed.

Think of it! No tubes to burn out. Forget all those familiar rectifier tube problems. Goodby to aging-in... to pre-heating... to hot weather arc backs... to cold weather starts. Hello to a rectifier life so long we can't even predict it.

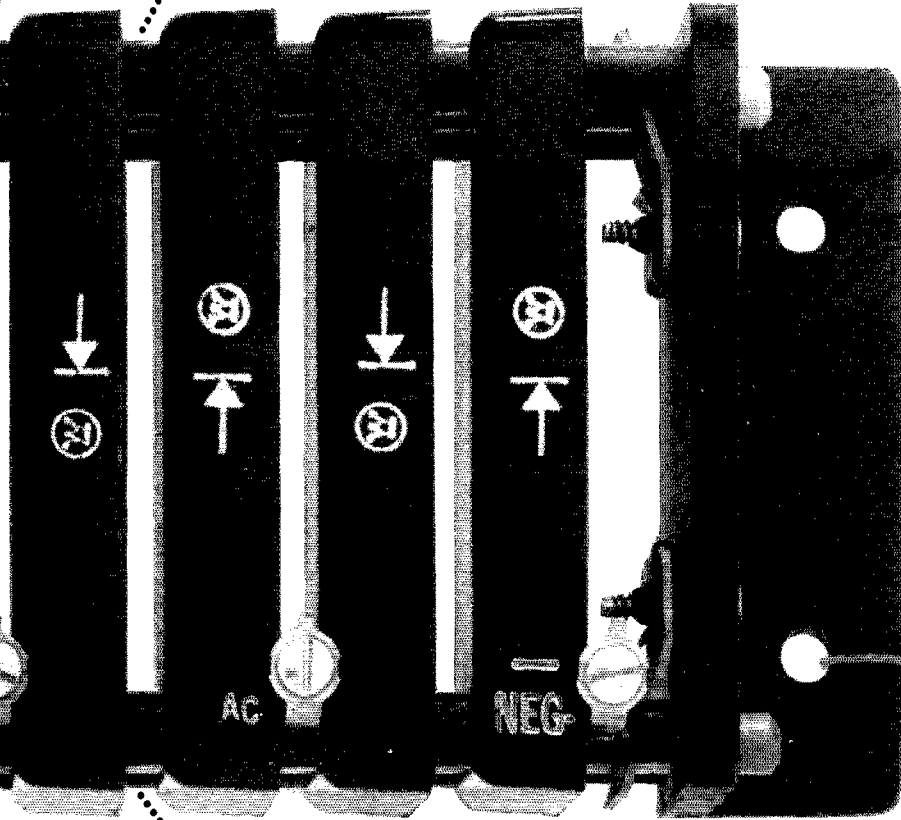

Rated output is 1 KW. Here are the DC load conditions. (Operation in ambients to 100 degrees F using natural convection cooling.)

1500 V @ 666 ma	2500 V @ 400 ma
2000 V @ 500 ma	3000 V @ 333 ma
3300 V @ 300 ma	

Another bonus. You can tune up to 2 KW p e p for sideband operation (even when using up to 120 mfd of output filter capacity).

Westinghouse experience with industrial and commercial rectifier assemblies helped us produce Oz-Pak as economically as possible. The heavy-duty assemblies have gone 40,000,000 stack hours without failure!

**\$69.95**

Manufacturer's  
suggested  
selling price

Mytronic Co., 2145 Florence Avenue, Cincinnati 6, Ohio  
Newark Electronics Corp., 223 W. Madison St., Chicago 6, Illinois  
Allied Radio, 100 North Western Avenue, Chicago 80, Illinois  
Cramer Electronics, Inc., 320 Needham Street, Newton, Mass.  
World Radio Labs, 3415 W. Broadway, Council Bluffs, Iowa

We never forget how much you rely on  
**Westinghouse**

# DOW-KEY DK-60 SERIES

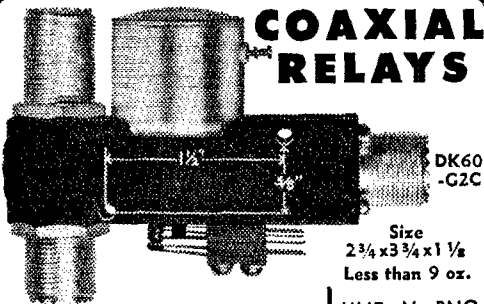

## COAXIAL RELAYS

Size  
2 3/4 x 3 3/4 x 1 1/2  
Less than 9 oz.

**4 VERSATILE MODELS, AC or DC OPERATION** UHF, N, BNC, TNC and C CONNECTORS

**COIL RATINGS:** 6, 12, 24, 28, 32, 48, 110 and 220 V DC @ 2 watts. 6, 12, 24, 110 and 220 V AC @ 6 VA, 50-60 cps. Special coil voltages available on request. Coil terminals are solder connections feed-through insulators.

**r.f. RATINGS:** 1 kw power rating to 500mc. 20 watt power rating to 500 mc in DK60-G and DK60-G2C in de-energized position. The DK60-G and DK60-G2C have a special isolation connector in the de-energized position to reduce crosstalk to a minimum.

**AUXILIARY CONTACTS:** Form 2C (DPDT) on DK60-2C and DK60-G2C. Bifurcated contacts rated at 5 amperes at 110 V AC non-inductive.

**VSWR:** Less than 1.15:1 from 0 to 500 mc (50 ohm load). 72 ohm relays available.

**ISOLATION:** Greater than 60 db @ 10 mc in DK60 and DK60-2C Greater than 100 db from 0 to 500 mc in DK60-G and DK60-G2C when in the energized position.

**OPERATING TIME:** Less than 30 milliseconds from application of coil voltage; less than 15 milliseconds between contacts.

Standard Relays with	DK60	.....\$12.45
	DK60-G	.....\$13.70
UHF Connectors include:	DK60-2C	.....\$14.35
	DK60-G2C	.....\$15.65

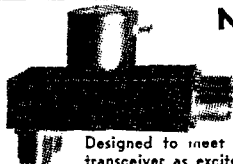

## NEW DK2-60B TRANSFER SWITCH

Designed to meet switching needs when using transceiver as exciter to drive any linear amplifier.

Performs necessary switching to either transmit directly with transceiver or to transmit with transceiver amplifier combination.

Distributors in U.S. and Canada.

**SPECIFICATIONS:** Freq. range 0 to 500 mc. to 1 kw; VSWR 1.15:1; Isolation 30 db at 500 mc, 50 db at 30 mc; Insertion loss 0.03 db at 30 mc; Available in all std. AC and DC voltages. Connectors: UHF std., type N, BNC, TNC and C available.

DK2-60B with UHF Connectors....\$19.00

**DOW-KEY COMPANY**  
Thief River Falls, Minnesota

(s.s.b.) 0030 daily on 3920 kc. Q1N (training) 0000 M-W-F on 3745 kc. Q1N daily at 0000 and RFN at 1200 Sun. on 3656 kc. New appointments: W9BZI as EC of Blackford Co., W49BG1 as EC of Crawford Co., W90G1 as EC of Vanderburgh Co., K9GFL as 100 Class I-II-III-TV. W49AQW as 00 Class IV. W9JQZ is the new RM for the Q1N training net. With deep regret the following Silent Keys are reported: John E. Hall, W49-ASJ, and Larry McGinnis, W49FUV. W49IAJ is the first YL technician in Jay County and W49HFF is a new Tech. in the same county. K9IVG received a Public Service Award for operation during 1981 Hurricane Carla. Q1N honor roll: K9HYV, W9TT, K9DHN, K9-KTL, K9WVJ, K9VHY, K9LXX and K9ARW. Those making RPL: K9DHN, W9M1, K9ZLA, W9JOZ, W9TT, W9NZZ and K9IVG. *Amateur radio exists as a hobby because of the service it renders.* June net reports: IFN 266, 1SB 2902, Q1N 835, Q1N (training) 0, RFN 43, Hoosier V.H.F. 92, 9RN 584. Indiana was represented 100 per cent. Traffic: (July) K9DHN 2328, W9M1 2165, K9ZLA 821, W9JOZ 601, W9TT 521, W9ZYK 425, W9NZZ 376, K9IVG 217, W9QLW 171, K9KTL 169, K9RWQ 116, K9HYV 102, K9ARW 87, K9CRS 73, W9FVH 56, K9-ZLB 46, W9CC 41, W9OG 38, W9SNQ 37, K9MSJ 33, K9-WVJ 31, K9RSL 29, W9BTZ 29, W9AEL 27, K9ILK 27, W9RTH 24, K9QXI 21, K9VHY 21, K9UXX 18, W9RFQ 16, W9QWI 15, W9FJH 14, W9QYQ 12, W9YYX 11, W9-DOK 10, K9FPA 10, W9KJW 9, K9FYM 7, K9THQ 7, W49RFF 6, W49QW 4, W9WDP 4, W9ZZR 4, W49DVJ 3, W49AEL 2, K9DHI 2, K9GEL 2, K9LIA 2. (June) K9OXA 31, W9QWI 28, W9BTZ 28, W9GUX 2.

**WISCONSIN**—SCM, Kenneth A. Ebner, K0GSC—SEC: W9BCC, RM: W9KQB, PAMs: W9NRP, W9SAA and W9NGT. Nets: WIN on 3535 kc. daily at 0045Z, BEN on 3950 kc. daily at 2400Z, W5BN on 3985 kc. daily at 2315Z. SWRN on 50.400 Mc. Mon.-Sat. at 0300Z. New appointment: K9PKQ as EC for Sauk County. Renewed appointments: W9FUY, W9LQC, W9VHA, W9-KWJ and W9QLX as ECs; W9FBC as OPS; W9NRP as OPS; W9APB, W9IQW and W9SIZ as ORSs. The WIN Nets again is being sent to all WINers by The Ole Geezer. The Milwaukee AREC assisted in finding a lost person in July. W9VSO led the OOs in July with 223 notices sent. W49AOT has a new Heath HW-12. W49-FMQ has received his General Class license. W49ERI has a new Apache. W9PFK had an FMT result of 218 p.p.m. error. The WNA Picnic was a success, with the mobile contest being won by W9LTC. The Falls Radio Club has been affiliated with the League. Net reports for July: W5BN, 153 offered, 710 cleared by 1069 stations in 31 sessions; WIN, 865 offered, 127 cleared by 259 stations in 31 sessions; BEN, 821 offered, 144 cleared by 1285 stations in 31 sessions. Net certificates issued: WTX, W49AKE; BEN, W9HBK, K9AIR and K9LGI. RPL certificates for July traffic went to W9IMR, W9DYQ, K9IME and W49AKE. Traffic: (July) K9IMR 664, W9-DYG 515, K9IME 340, W9CXY 216, W49AKE 161, K9-GSC 102, W9SAA 83, W9KQB 71, W9OTT 50, K9DOL 42, W9AOW 41, W9NRP 41, K9BLN 39, K9LGI 36, W9CRF 28, W49ESP 27, K9FWJ 22, W9VJ 16, W49PB 15, W9UEB 14, W9BIB 10, W9HPC 8, K9ZMU 8, W49-AOI 7, W9ONI 3, K9FPM 2. (June) K9YPT 140, W49ERI

## DAKOTA DIVISION

**NORTH DAKOTA**—SCM, Harold Wenzel, W9-HVA—SEC: W9CAQ, PAM: KOTYY, W9VQC has a new GSB-201 linear and is working on a three-element beam for 20 meters. W49AYS has built a transmitter for 2 and 8 meters. New calls in Minot are W9OCTV, Vernon Helsinki, and W9OCTU, Kermit Mostade. The North Dakota 75-Meter Phone Net reports for July 25 sessions with a total of 440 check-ins, a maximum of 29 and a minimum of 10, 47 formal messages handled and 55 informal with 10 relays. Traffic: KOTPT 123, W49AYS 21, W9VCL 13, W49CRH 6, W49CZS 6, KOTYY 5, W49AAD 4, W9CAQ 4, K9RFP 4.

**SOUTH DAKOTA**—SCM, J. W. Silorski, W9ORN—SEC: W9SCT. New calls: W49CUL, Buffalo, and W9OGNS, Mitchell. W9ZWL announces that the Weather Net will resume operations Oct. 1. W9RSP is operating a 400-watt rig for portable use. A new call in Brookings is W9OQSD. W49ARC and W49BGD have been transferred from Sioux Falls to Pierre. K9FKJ and K9ESC are experimenting on 432 Mc. It's a daughter for K9ESC, born in July. Traffic: (July) W9SCT 728, W9DYB 267, K9BIMQ 182, W9ZWL 82, W49AOY 45, K9VYV 41, K9TIVQ 23, K9GSI 22, K9JHJ 16, W49-CWX 13, K9KOY 12, K9BSW 11, K9J 8, W49CKH 4, K9CCL 4, K9RFP 4, W9BRW 4, K9ZBJ 4, K9-HQD 3, K9JEN 3, W9OFP 3, K9ZTY 3, W9FZJ 2. (June) W49CIVZ 28, K9ZTV 13.

**MINNESOTA**—SCM, Mrs. Helen Meidrich, W9OPX—Asst. SCM: Emerson Meidrich, W9RIQ, SEC: K9-KKQ, RMs: K9ZRD, K9IJU, PAMs: W9YHR, K9-VPI, M5SB PAM: W9HEN. Appointments issued are K9IJU as ORS; W9YHR as OPS. A warm welcome is

(Continued on page 122)

Everything's

# GO! on VHF!

with *hy-gain's* all new complete line of  
**BASE STATION AND MOBILE ANTENNAS**

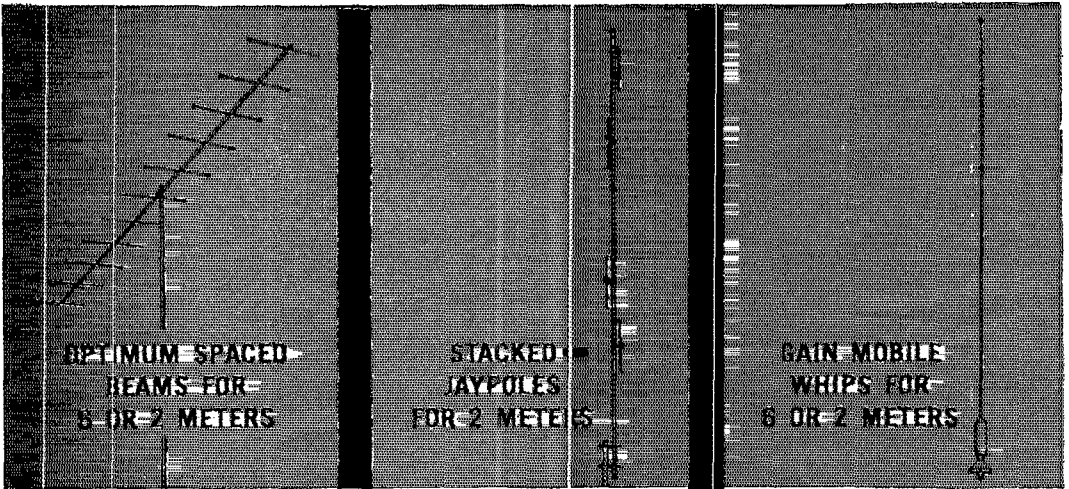

AND THAT AIN'T ALL...there are OVER 40 MODELS including LOG PERIODICS for 6 and 2 meters... 3-ELEMENT OPTIMUM SPACED BEAMS that will deliver more gain than 5-element medium or short spaced beams...GAIN STACKED HALOS for 6 or 2 meters featuring a new peak in mechanical superiority with new center mount which delivers unparalleled impedance control and true omni-directional performance...Extremely compact omni-directional GAIN GROUND PLANES...Duoband 6 and 2 meter UNITY GAIN GROUND PLANES...Single band and Duoband MOBILE WHIPS AND HALOS...EVERY SIGNIFICANT ANTENNA CONFIGURATION KNOWN TO THE ART...All of superior mechanical and electrical quality. They're all illustrated and fully described in Hy-Gain's new VHF catalog. A top performance antenna for every possible application...a price to fit every pocketbook. Prices range from as low as **\$3.95**.

Send for your FREE copy of Hy-Gain's full line catalog on VHF antennas TODAY...you absolutely can't afford to buy an antenna until you've looked at Hy-Gain!

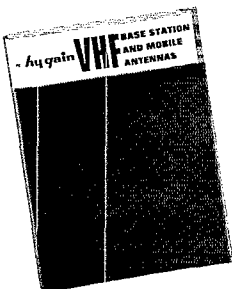

I want a FREE complete line catalog on Hy-Gain's all new VHF antenna line

NAME \_\_\_\_\_

STREET \_\_\_\_\_

CITY \_\_\_\_\_ STATE \_\_\_\_\_

**hy-gain** ANTENNA PRODUCTS CORPORATION  
8400 NE Highway 6 Lincoln, Nebraska

# OK

## ...Go Ahead and Throw Away Your Money

... that is, if you're so darned rich you don't care what your old gear is worth! \* But if you want the best trade-in offer in the business for your present receiver or transmitter, you and Walter Ashe are going to make real nice music together. You just "ain't heard nothing yet" until you get the Walter Ashe deal. Put the coupon below in today's mail and find out what we mean.

**Anxious? call us at Area 314—  
Chestnut 1-1125**

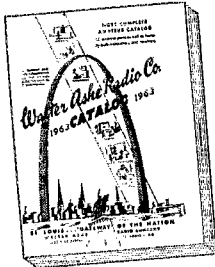

# FREE!

Here's the new Walter Ashe catalog, everything for the ham whether you home brew it yourself or buy it ready to go. Just check the coupon for your free copy.

(\*Quotes confined to gear made since 1945)

## WALTER ASHE RADIO CO.

1123 Pine Street, Dept. Q-10-63, St. Louis 1, Missouri

WALTER ASHE RADIO CO.

Dept. Q-10-63

1123 Pine St., St. Louis 1, Mo.

OK—Surprise me! I am interested in.....

What is your Ashe "Surprise" allowance on.....

NAME .....

ADDRESS .....

CITY..... ZONE..... STATE.....

Send New Catalog (Catalogs sent only in Cont'l U.S.)

Send Reconditioned Equipment Bulletin.

extended to the Itasca Amateur Radio Club, which is newly affiliated with the ARRL. OO WOTV reports more operating time and cites 18 violators. V.H.F. OBS WAOCQG, of Minneapolis, installed a new eight-element 6-meter beam and has worked 25 states on 10 meters. Carl requests correspondence from those hearing his transmissions on 50.62 Mc. at 0245Z and 145.008 Mc. at 0300Z Tue., Thurs. and Sat. OBS WAODIE is making improvements on his mobile transmitter. EC KOJOA conducts a bi-monthly AREC net in his area. Former RM KQAKM is now stationed in Hawaii. Father and son, WAOCAL and WAOCAH, work 20-meter phone and c.w. and are building a 6-meter 50-wattter. WAOEGT is aligning his Pacemaker and has erected an 80-meter dipole. OBS KOXUC hopes his gamma-matched tower will solve his antenna problems. WAOPCJ received his General Class license. He is building a Vo-Cou v.f.o. and has RCC and CPS-15 certificates. WAOFIK received his Conditional Class license. WAOPYO and 16 other operators demonstrated amateur radio at the Little Falls Chamber of Commerce "Crazy Days." NCS WOKYG and his XYL vacationed through the state and visited KOVPO. WAOPYO, WOTUS, KOOUZ and KOMNY. WQALW completed a 4300-mile tour of the East Coast. KOZOH and XYL KOGGY have moved to Newhall, Calif., where Al has accepted a teaching position. WOOJG and XYL KOERQ have moved to their farm near Atkin. WOTRD is a Silent Key. Cartoonist WAQAWZ has issued a special certificate featuring a golden shovel to WAOBZG and WAQEDN for a 19½-hour QSO. They were joined by newly-licensed WAQGOS, who queried about RCC and was informed he qualified 5½ hours later. Traffic: (July) WAOPYO 328, WAQARA 225, KOXUC 104, WOHEN 90, WOOPX 79, WOTMAM 75, KOIHD 72, KOZRD 63, WQCR 61, KOLJU 61, WAODCJ 60, WAODGW 59, WQRIQ 43, KOZKK 42, KOJYJ 38, WAOCPW 33, KOWWY 31, WQYHR 29, WAQABU 25, WOBUO 25, KOJFY 22, WOTHY 21, KOIKU 20, WQALW 18, WQATO 18, KOSXQ 16, KOGPI 15, WOHRRM 14, KOVPI 14, KOFLT 12, KOJFJ 11, KOJOA 11, WQEQO 10, KOIKU/O 8, KOKNL 7, KOZRC 7, WAODW 6, WAODIE 6, WQOPCJ 4, KOICG 4, WORA 4, KOIFS 3, KOZWG 2. (June) KOGPI 29, KOKNL 4.

### DELTA DIVISION

ARKANSAS—Acting SCM, Curtis R. Williams, W5-DTR—SEC: W5KRO, PAM: K5SGG, RM: K5TYW. The AEFN had 1234 check-ins and handled 125 pieces of traffic during 27 sessions in July. The OZK had 29 sessions and handled 91 pieces of traffic. More stations are needed on the Arkansas CW Net (OZK). New appointments: W5HPL as Sebastian County EC, W5WFE as Boone County EC, K5YEP as Lonoke County EC, WA5CAG as OPS; W9PHR/5 and WA5EKA as ORS. Please contact me as soon as possible if interested in Official Observer and other appointments. New tickets in the Harrison area are WA5GVG and WA5BQE. New hams in the Pine Bluff area are WA5HHG and WA5HDF. Officers of the Southeast Arkansas ARC are WA5EOP, pres.; WA5DRV, vice-pres.; W5CAML, serv.-treas. Bill Gilliland, K5FNV, Route 1, Box 78, Brooksville, Miss. would like to hear from all hams in the Delta Division who run under 100 watts input as he wants to organize a division QRP ARC. K5YEP has the S/Line back in operation. Mississippi County has a c.d. net Sun. at 0840 local time on 50.450 Mc. WA5CAG has a new ARC-2 transceiver. Arkansas made RN5 100 per cent during June largely because of the efforts of WA5AVO. Bill made all sessions of RN5 except one—a total of 59! Everyone had a good time at the CAREN picnic July 28. K5FNJ won a Heathkit Chevyenne. The NLRARC has a new TVI committee that is getting plenty of experience under W5EBE. Don't forget the Delta Division Convention at Lafayette, La., Nov. 29 and 30. K5YTR is the state RACES club station and Wayne Jeffries, communications officer, monitors 3990 kc. Mon. through Fri. and during periods of severe weather warnings. Traffic: WA5AVO/5 257, W9PHR/5 230, W5-DTR/5 169, WA5EKA 152, K5YEP 65, W5HPL 51, K5SGG 48, K5GTN 38, K5TYW 22, WA5AMM 11, K5GKQ 9, K5TCK 8, WA5BQL 7, W5FML 7, WA5CAG 4, K5EDH 4.

LOUISIANA—SCM, Thomas J. Morgavi, W5FMO—SEC: W5MXQ, PAM: W5CEW, RM: W5CEZ, W5CEW has graciously accepted the PAM job. Delta Division Convention sponsor ribbons, now available from any club member for \$15.00, entitle the holder to all convention activities plus a special "sponsor breakfast" to be held Sun. morning. The Lafayette ARC surpassed its own previous record by about 150 contacts operating Class 1A (one transmitter under 30 watts). The club made 884 contacts. Sorry to hear that W5CEZ lost a sister in Los Angeles in July. K5KQG, newly-appointed GO, is now permanently located in Houma. K5MIKE has been appointed OPS. W5SUM built a new Pelican that

(Continued on page 124)

# How to choose a microphone for SSB



Model 664  
\$51.00 Amateur Net

Hand us a blank check. Tell us you want the best microphone you can buy for SSB — with price no object. We'll hand you the Model 664 dynamic cardioid microphone. We'd like to tell you why the 664 is so uniquely suited to SSB operation.

Let's start with the transmitter. Almost every quality SSB transmitter, commercial or home-brew, incorporates an automatic level control circuit. And the general practice in transmitter design is to assume that the microphone response will be flat. On this assumption, the audio input circuits are designed to shape your speech characteristics, in conjunction with the ALC control, so that proper transmitter setup gives you maximum PEP.

Anything less than flat microphone response limits your ability to obtain maximum PEP, and your effective radiated power will be reduced. To satisfy this basic requirement, the 664 is unusually free from peaks or dips in response. It allows maximum PEP while retaining your natural voice characteristics.

Another important SSB feature, found in almost every modern transmitter, is voice operation. The 664 flat response, plus the effective Variable-D® cardioid pattern, reduces the possibility of accidentally opening the VOX circuit when speaker level is high. That's because the 664 rejects sound from the back and sides of the microphone. You can operate with higher receiver volume with complete safety. And noise, reverberation and echoes in the ham shack are reduced by the cardioid pattern to give you better intelligibility on the air.

Despite the performance advantages of the 664, this is not a fragile microphone, far from it. It's rugged, almost indestructible. The dynamic design meets the most rigorous tests for quality and service. And at the heart of 664 dependability is the diaphragm, made of Acoustalloy®; a unique plastic material available only from Electro-Voice. Acoustalloy is virtually impervious to shock, temperature extremes, humidity and the countless other environmental conditions that gradually destroy less rugged instruments.

But there's more to the list of 664 advantages: High output level, handsome appearance, and the guaranteed backing of a manufacturer of unquestioned integrity and wide experience in electro-acoustics.

While we manufacture microphones ranging from the communications units in the Gemini space program to professional models that have won an Academy Award for their contribution to motion picture sound, no field is closer to our hearts than amateur communications. And the engineers and hams in our organization are particularly responsive to the needs of the amateur fraternity. They insist on good value for every product, in every price range.

But when price is no object, their choice is the 664 for SSB. Outstanding in performance and value for even the most critical amateur radio operator. We urge you to try the 664 in your own shack soon. We guarantee your satisfaction, or your money back.

**ELECTRO-VOICE, INC.**  
Dept. 1032Q, Buchanan, Michigan

**Electro-Voice®**  
SETTING NEW STANDARDS IN SOUND

Get Your Commercial  
Ticket Easier and Faster With  
The Completely Up-To-Date . . .

(May 15, 1961)

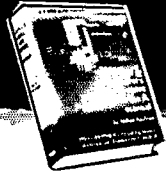

6th Edition  
**RADIO OPERATOR'S  
LICENSE Q & A  
MANUAL**

—by Milton Kaufman—

Completely up-to-date to May 15, 1961 with new supplement. All FCC question revisions and question re-numbering.

More people have earned their commercial radio licenses with this famous book than with any other available today. —It is the best book for FCC license preparation! It is just as indispensable to anyone who desires a commercial "ticket" as it is to the licensed operator, as a reference volume. Truly, it is a book anyone interested in the radio operation can't afford to be without. The Q&A Manual covers elements 1 through 8. It is the only book giving the question—the answer and a detailed follow-through discussion on every vital technical question in the FCC Study Guide. This makes it very easy to answer correctly multiple choice questions!

It is so effective as a teaching aid that it is the standard text in schools teaching commercial radio operating as well as by industrial organizations. All fundamentals required for all kinds of commercial licenses are included. Numerical examples in the follow-through discussion show how problems are solved and answers arrived at.

There are many illustrations to make the technical questions and answers picture-clear. The manual is based on government study guide and supplementary FCC releases. In every regard, there is no equal to this book.

Here is what leading publications in the communications field say about the Q&A Manual.  
"Thorough treatment"—QST.

"up-to-the-minute . . . presentation. Method is clear, logical and easy to read . . ."  
**WIRE AND RADIO COMMUNICATIONS.**

**CONTENTS:** Element I, Basic Laws (New) . . . Element II, Basic Operating Practice (New) . . . Element III, Basic Radiotelephone . . . Element IV, Advanced Radiotelephone . . . Element V, Radiotelegraph Operating Practice . . . Element VI, Advanced Radiotelegraph . . . Element VII, Aircraft Radiotelegraph . . . Element VIII, Ship Radar Techniques . . . Appendix I, Part 13: Rules Governing Commercial Radio Operators . . . Appendix II, Extracts from Radio Laws . . . Appendix III, Conventional Abbreviations: International Morse Code . . . Appendix IV, Small Vessel Direction Finders . . . Appendix V, Automatic Alarm, Index.

#130, Cloth Bound, 736 pp. . . . . Only \$7.10

Get it at your electronic parts distributor or bookstore, or order direct from:



**JOHN F. RIDER PUBLISHER INC.**  
A division of Hayden Publishing Co., Inc.  
850 Third Avenue, New York 22, N. Y.

looks and operates out of this world, W5EA finally made it to 20 meters for the first time since he got a license and that must have been about 35 years ago. K5BIB landed in the hospital with a heart attack. The N.O. Hamfest will be held Oct. 13 at Jackson Barracks, tickets \$1.00. W5NDV reports that the Louisiana Post Office Net continues to maintain its scheduled nets during the summer without reduction in participants and with several out-of-state stations checking in each Sun. W5CDX is regular NCS, Sun, 7 a.m. CST, 3870 kc. W55HAN is having a time wiring that Marauder with his fingers crossed. W5BQA worked WAS and WAC and is busy building a TO keyer. W5JGV procured a Videcon camera tube. He also is working on an old SB-10 and plans to make it bandwidthing, 160-6 meters. Traffic: (July) W5CEZ 318, K5QXV 144, W5MXQ 80, K5CZV 76, K5-KAIG 69, W5BQA 36, K5OKR 23, K5FYY 10, W5NDV 10, K5VJT 9, W5EA 6, K5MOJ 2, W5JGV 2, (June) K5-VJT 8.

**MISSISSIPPI**—SCM, S. H. Hairston, W5EMM—We certainly enjoyed the Biloxi Hamfest. Congratulations to W5'OO, W5FVM, et al, for the big success. K5CIT/5 won two top prizes. W5A1Y has really been working hard to pass traffic. K5DZE is now mobile with a Swan 175. W5HEC and K5ZNX are now on the air from Columbus. Navy AARS needs more coverage in Mississippi. Congratulations to W5ACAC on the new license, the HT-37 and the SX-117, and for winning the Novice Roundup for Mississippi. W5BMC will operate for a short period from W5YD at Miss. State. W5ACRY is the new secy.-treas. of the Tombigbee ARC. The Keeler Club elected W5FRO/5, pres.; W9DUM/5, vice-pres.; W5A9EPG, secy.; K5VYV, treas. The Jackson kick-off dinner and hamfest were a huge success, with amateurs coming from many states. K5PPI didn't win the triband beam this year! My hat is off to K5GVV and W5MUG and their committees for a fine job. Among ARRL officials present were W5MUG, W5RIM, W5BN, W5TR, W5GGZ, K5PYS, W5HP, K5MDX. Traffic: W5JDF 173, W5WZ 48, W5A1Y 36, W5BMC 29, W5EMM 26, W5-CKY 10, K5DZE 10, K5GAD 1.

**TENNESSEE**—SCM, David C. Goggio, W4OGG—SEC: W4WBK, RMs: W4OQG and W4ZJY. PAMs: K4-WWQ and W4A1S. New appointments: K4FZJ as Shelby County EC; K4LPW as C.W. OO. K4ENA and W44RX as OHSs. Field Day results: Oak Ridge—4 transmitters, 144 contacts; ARA—1 and 44; Kingsport—3 and 800; Delta—1 and 221. Net reports for July:

Net	Freq	Time	Days	Sessions	QTC	QNI	Average
TN	3635	1900C	M-Sat	26	67	138	5
ETPN	3980	0640E	M-Fri	23	40	518	23
TSSN	3950	1900C	M-Sat	27	69	639	24

K4GMQ's and W4KXI's Obion County radio school produced 9 Novices. At Crossville's hamfest 198 registered, Kingsport 200, Delta 152, Loudon Field Day activities made the paper; K4EAJ is new president-elect. All ECs: Plan now for your SET, Oct. 5-6; use CD-85 to register your net! Tennessee was 4th in the nation, let's shoot for 1st. W4OQG will be on 3980 kc, Oct. 6 3-5 p.m. CST for SEC messages. Congrats to W4RMJ and W4ZJY on making the BPL, The Mid-South V.H.F. Club suggests phone operation without Q signals and ARRL concurs. Use under 100 watts? To join the QRP club write K4FNV, Bill Gilliland, RI, Brooksville, Miss. An idea: Since each General has to certify to FCC on renewal he can copy 13 w.p.m., why not join our c.w. net and get the speed up. Your Tennessee SCM recommends a state council of clubs. Each club would have 2 delegates; clubs would receive news and be part of section activities. Suggested assessment, 10¢ a club member a year. See you at the Delta Division Convention, Lafayette, Nov. 29. Traffic: W4RMJ 663, W4ZJY 526, W4PQP 244, W4OQG 121, W4MXF 99, W4MCC 76, K4WVQ 73, K4AQ 34, W4GLS 32, W44VX 30, K4FZJ 30, W4OQG 29, W4VTS 26, W4ADBP 23, W4A1S 22, W4LLJ 22, W4EFP 21, W4WBK 20, W4CVG 18, W4AHRJ 17, W4ZAC 16, K4CPC 14, W4HPN 14, W4CAT 12, K4MIF 12, W4TYV 12, K4JG 11, W44RX 10, K4RIN 10, W4ODR 9, W4JVM 8, W4AKOG 8, K4LPW 8, K4AAE 7, W44CRH 7, K4OUK 6, W4RRS 6, W4BVP 5, W44HG 5, W4SGI 5, K4JNG 4, W44LX 3, K4BWB 2, K4GBN 2, K4KYL 2, K4RQP 2, K4STR 1, K4WUH 1.

**GREAT LAKES DIVISION**

**KENTUCKY**—SCM, Elmer Leachman, W4BEW—SEC: W4TFK, PAMs: W4SZB, K4ECJ, W4BEJ, V.H.F. PAM: K4LOA, RAI: W4CDA, Asst. RM: K4NYO, RM (KNN): W44APU. The East Kentucky Amateur Radio Society (EARS) held its quarterly meeting in Ashland July 21 with ARRL Director Cartwright in attendance. W4FPV has been appointed Asst. Director in Kentucky. Early morning KPN reports 23 sessions, 320 check-ins, 55 stations participating, 62 QTCs. Regular MKPN reports 28 sessions, 120 check-ins, 40 QTCs. W4SZB is back  
(Continued on page 126)

# C·P COMMUNICATION ANTENNA SYSTEMS

—mean  
CERTIFIED PERFORMANCE!

BASE STATION COAXIAL ADVANCED DESIGN ANTENNA (2X-Omnidirectional Gain)

CAT. No. 79-509, FREQUENCY RANGE 108-174 MC\*

Cat. No. 79-509 2X-Gain Antenna combines the simplicity of a coaxial antenna with the gain of a more complex structure. Though external appearance is that of a standard coaxial antenna, the union of special element lengths and internal matching devices produces 3 db omnidirectional gain.

## SPECIFICATIONS

### Electrical:

Nominal input impedance .....	.50 ohms
Maximum power input .....	500 watts
Omnidirectional gain .....	3 db
Internal feedline .....	RG-8A/U
Flexible terminal extension .....	18" of RG-8A/U
Termination .....	Type N male with Neoprene housing
VSWR .....	1.5:1
Bandwidth .....	±1%
Lightning protection .....	Star gap

### Mechanical:

Skirt .....	2" dia. red brass
Whip rod .....	6061-T6 aluminum
Support pipe .....	1-5/16" dia. hot-galvanized steel, 24" minimum length exposed available for mounting
Rated wind velocity .....	100 MPH at 150 Mc
Lateral thrust at rated wind .....	19 lbs. at 150 Mc
Bending moment 6" below skirt .....	55 lbs. at 150 Mc
Weight .....	30 lbs. at 150 Mc

\*Exact frequency must be specified



COMMUNICATION  
ANTENNA SYSTEMS  
FOR AMERICAN  
BUSINESS

*Communication Products Company*

DIVISION OF

**PHELPS DODGE ELECTRONIC PRODUCTS**

CORPORATION

MARLBORO, NEW JERSEY — Telephone HOpkins 2-1880 (Area Code 201)  
LOS ANGELES 65, CALIF. — Telephone CHapman 5-1143 (Area Code 213)

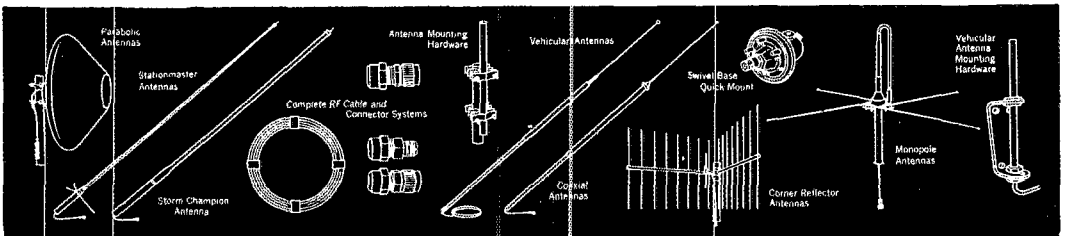

**Webster band-spanner.**

# top-sider

## STREAMLINED MOBILE ANTENNA

Better! More versatile! Communicate on 160-75-40-20-15-11-10 meters... merely by changing inductors. These are high "Q"—excellent form factors—ample geometry—protectively sealed in high strength white tenite tubing—efficient. Top-sider just loafs at 300 watts P.E.P.

Polished aluminum 9/16" OD column hinges below coil—has fast release/positive lock-up action allowing quick coil change or coil/whip tie down. Stainless steel top whip adjustable over 10" range. Column butt threaded standard 3/8-24.

2-models: 218-R, 79" overall. 218-S, 68" overall.

Complete antenna assembly consists of mast w/whip and A-70 series coil.

Mast/whip only, less coil...13.50

Coils only, less mast:

- A-70, 75M ... 5.10
- A-71, 40M ... 5.10
- A-72, 20M ... 4.70
- A-73, 15M ... 4.60
- A-74, 11M ... 4.30
- A-76, 10M ... 4.45
- A-77, 160M ... 5.80

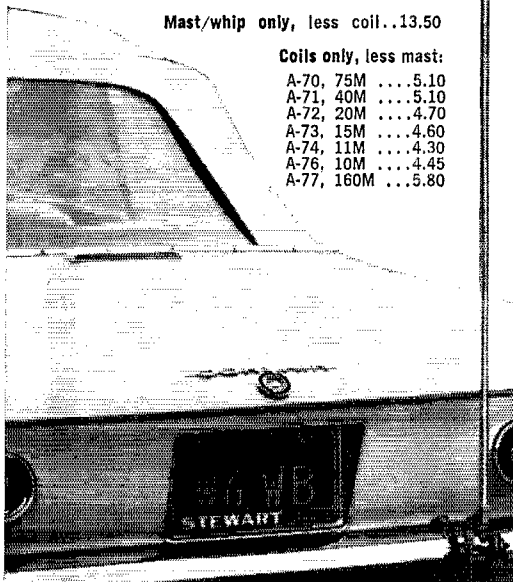

BAND-SPANNER, 317 Roebling Rd. So. San Francisco, Calif.

Please send information on Top-sider and other Band-spanner antennas and mounts.

Name \_\_\_\_\_

Number \_\_\_\_\_ Street \_\_\_\_\_

City \_\_\_\_\_ Zone \_\_\_\_\_ State \_\_\_\_\_

on the job after a serious illness. The s.a.b. session of KPN reports 608 check-ins and 76 QTCs. WA4AGH reports receiving his General and is active in local c.d. nets as well as EMKPN. K4KWQ is operating from his new QTH in Illinois. Louisville RACES, c.d., Red Cross and Louisville Area Emergency Nets participated in the search for two missing boys, proving the effectiveness and usefulness of amateur radio in the public interest. K4ZQR, W4GSTI, W4TWW and W4ADFQ completed courses in radiation monitoring. K4WJI, K4HSB and WA4ELR, Maysville, are all active in traffic-handling, CD Parties and award programs. FINAL—It has been a pleasure to serve as your SCM for the past two years. One of the satisfactions comes from the many compliments and expressions of appreciation from hams throughout the state. There have been barbs, too—admittedly well-deserved, but thanks to all. My best wishes to you and to the new SCM who will have my support and cooperation in a job I know will be well done. 73. Traffic: (July) W4BYG 521, W4USE 136, K4YDN 98, W4RHZ 94, WA4AGH 82, K4KWQ 61, W4CDA 32, K4ZQQ 32, K4VDO 27, W44FLK 17, K4HBB 16, W4KJP 16, K4TQZ 16, K4ZQR 15, WA4KEY 14, K4LOA 12, WA4JQR 9, W4REW 5, K4YCB 3, WA4ELB 1. (June) K4WJI 47.

**MICHIGAN**—SCM, Ralph P. Thetreau, W8FG—SEC: W8LOX. RMs: W8EGI, W8XJ, W8FWQ, K8KMQ. PAMs: W8CQU, K8LQA, V.H.F. PAM: W8PT. Appointments: W8DSE, as EC: W8DSE, W8EGI, W8IBB, W8ILP, W8MGO, W8OCC, W8WVL as ORSs: W8OCC as OPS; W8GGZ and W8PT as OESs: WA8DZP as OBS. We wish to record the passing of W8JK, active for about 40 years, who died from a heart attack, as did W8WE. Also W8QBC has left us, cause unknown here. Vale! W8JX was my guitar-playing buddy of the "thirties." Most Michigan clubs are using transmitter hunts for meetings during the summer. W8GA and W8LU were both in the hospital, but seem OK now. W8SS/MI worked ILEN on 20 meter. Just back from U.P. Hamfest where I met many OTs I know. It was a good shindig, too. WA8ENO made the BPL the hard way, and K8GOU BPLed on originals/deliveries. W8QFO has a model 15 on RTTY. The RR/MEN net mgr. now is W8QPR, K8JED is asst. mgr. and W8FJU is secy.-treas. W8IWF now has a boat: this means marine mobile? W8FGB is back in Michigan with his old call, and his XYL is W8EMS. Glad to welcome these Michiganders back! New officers: Lapeer County Amateur Radio Assn.—W8NCJ, pres.; WA8BLS and K8RZA, vice-pres.; WA8ASU, secy.-treas. Cooley Electronic Club:—K8ELLR, pres.; W8IBNI, vice-pres.; W8BVU, secy.-sponsor. W8TSG lost his big tower and all beams in a big wind. K8TOI/M puts nice herringbone on a drive-in theater screen! W8DHD lost part of a thumb on an electric saw—try a jointer-planer like I did! When you send me lists of new club officers, please include their call letters. W8BBJ is back home after helping put HC7FD, Ecuador, on s.w. broadcast. To all OO applicants: Don't ask for OO appointment unless you've held General Class for four years and have made two FMTs. QMN is back with Slow and Fast nets. 2300-2330 and 2330-0015 daily. Traffic: (July) WA8ENO 504, K8GOU 283, W8QFO 191, K8KMQ 184, K8NJW 167, WA8DZP 156, W8ELW 152, K8YAY 134, K8BYX 110, W8BEZ 108, WA8CQM 96, K8VCB 80, WA8ASV 70, W8FWQ 69, K8LNE 63, W8DSW 56, W8NWW 55, K8LQA 51, WA8EFC 50, W8FX 46, K8HLR 41, K8VDA 41, K8CIP 37, WA8FHH 30, K8ZYJ 30, K8JFD 29, W8ZHB 23, W8ZLK 20, W8SSK 18, W8EU 13, W8HKT 13, W8UPS 11, W8NJM 10, W8RTN 9, K8TFE 8, W8IBM 6, W8LQA 4, W8IWF 4, W8AUD 3, K8GJD 3, K2PYB/8 1. (June) K8WQV 72, K8LQA 24, W8SSK 17, K8YZP 8, WA8LEQ 4, W8IBM 3.

**OHIO**—SCM, Wilson E. Weckel, W8AL—Asst. SCM: J. C. Erickson, W8DAE, SEC: W8HNP. RMs: W8BZX, W8DAE, W8IEP and K8ONQ. PAMs: W8VZ, K8BAP and K8UBK. K8HYT left for the Air Force. Notice: All appointments are good for one year and to keep it valid the certificate must be sent to me for my endorsement. Look at your certificate, check the date and if it has expired send it to me. You must also be active at your appointment or it will be cancelled, for we want no deadwood. I know of two ORSs who have not handled a piece of traffic in more than ten years, all they do is get into CD Parties. This is going to stop, so don't be surprised not to find yourself listed. This goes for all appointments. Your SCM attended the Hueyvee Net Picnic at Mt. Vernon along with W8ALS, W8AZF, W8BZX, W8CHT, W8CKY, W8DAE, W8ECB, W8FFK, W8OPT, W8OUU, W8PMJ, W8RO, K8DDG, K8HFL, K8HKT, K8LDS, K8LGA, K8LGB, K8MTI, K8MYG, K8RXT, and WA8AZS. Appointments made in July were K8LGB and WA8AJZ as ORSs. K8TCO and K8VGL as OESs. We heard that about 1400 attended the Lancaster Hamfest, about 150 took the General Class license examinations with about 45 passing the code and Mrs. Arline Homan won the main prize. Parma RC's P.R.C. Bulletin says the club held its picnic and heard a technical

(Continued on page 128)



# EXPERIMENTER, SWL or RADIO AMATEUR

Select your receiver, transmitter, or VFO from easy-to-build International AOC kits.

Simple step-by-step instructions show you how to assemble factory prewired units. Designed for top performance at a low cost!

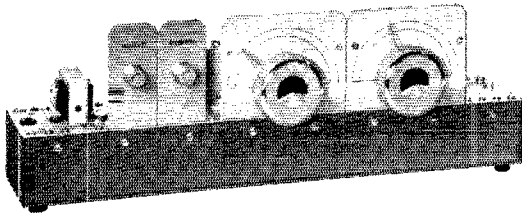

## RECEIVER KITS

This new line of International receiver kits cover a wide range of amateur, citizens band and special frequencies. Designed for AM, CW, or SSB reception, this basic receiver using a superheterodyne circuit\* with regenerative second detector may be expanded to a more elaborate receiver by the addition of other Add-On-Circuits. Sensitivity usable to below 10 microvolts for voice and 1 microvolt for code. Nuvistor rf amplifier, mixer, oscillator, I.F. transformer, detector/1st audio, and power audio amplifier. Tube lineup: 6DS4 nuvistor, 6BE6, 6U8, 6AQ5. Shipping weight: 15 lbs.

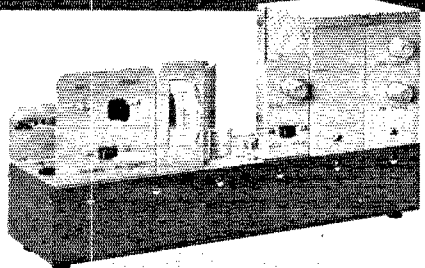

## TRANSMITTER KIT

A compact package delivering a plate input of 50 watts for CW operation on 80 or 40 meters. 12BY7 crystal oscillator—6DQ6 power amplifier. Pi-network final. When used with AOR-44 receiver, transmitter operates from receiver power supply. Meter and TR switch.

AOT-50 transmitter kit less power supply and key, but with one 40 meter novice band crystal. Shipping weight: 5 lbs. **\$35.00**

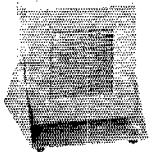

Receiver kit includes 4" speaker and power supply.

Kit	Frequency	Price
AOR-40	Special	\$59.00
AOR-41	150 kc — 450 kc	\$2.50
AOR-42	2 mc — 6 mc	\$2.50
AOR-43	6 mc — 18 mc	\$2.50
AOR-44	80 meter/40 meter	\$2.50
AOR-45	15 meter/10 meter	\$2.50
AOR-46	5 meter	\$6.50
AOR-47	2 meter	\$6.50
AOR-48	Citizens 27 mc	\$2.50

\*AOR-41 uses a tuned rf circuit with 6BAG

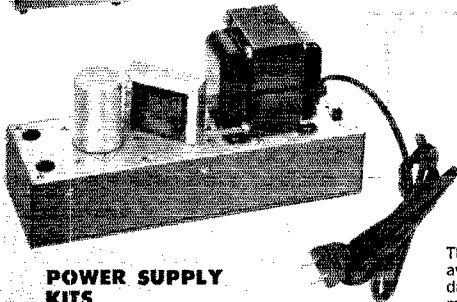

## POWER SUPPLY KITS

AOP-100 350 volts, 150 ma intermittent or 100 ma continuous service, 6.3 volts @ 5 amps. Shipping weight: 8 lbs. **\$18.50**

AOP-200 650 volts, 250 ma intermittent or 200 ma continuous service, 6.3 volts @ 10 amps. Shipping weight: 10 lbs. **\$32.50**

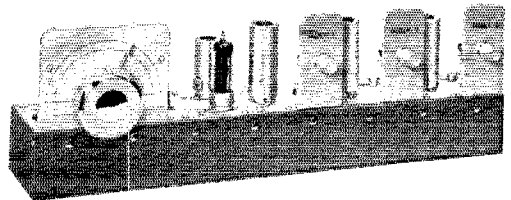

## VFO KITS

The International AOF series of variable frequency oscillator kits is available in three versions. For example, the AOF-91 kit is a complete driver unit to be used with 6 meter and 2 meter transmitters. Approximately .5 watt of power is available on both bands. Tube lineup: 6BH6 oscillator, OB-2 voltage regulator, 12BY7 buffer-amplifier/multiplier. Shipping weight: 5 lbs.

Kit	Frequency	Price
AOF-89	VFO 8 mc — 9 mc and buffer	\$22.00
AOF-90	VFO 8 mc — 9 mc plus buffer multiplier and 6 meter output	29.00
AOF-91	VFO 8 mc — 9 mc plus buffer multiplier, 6 meter/2 meter output	36.00

INTERNATIONAL CRYSTAL MFG. CO., INC.  
18 NORTH LEE, OKLAHOMA CITY, OKLAHOMA

Please ship \_\_\_\_\_

I enclose \$ \_\_\_\_\_ Send free catalog \_\_\_\_\_

Name \_\_\_\_\_ (print)

Address \_\_\_\_\_

City \_\_\_\_\_ Zone \_\_\_\_\_ State \_\_\_\_\_

Include sufficient remittance to cover postage. See shipping weight.



18 NORTH LEE · OKLA. CITY, OKLAHOMA

Communications, mobile radio...

# A First Class FCC License

...or Your Money Back!



Your key to future success in electronics is a First-Class FCC License. It will permit you to operate and maintain transmitting equipment used in aviation, broadcasting, marine, microwave, mobile communications, or Citizens-Band. Cleveland Institute home study is the ideal way to get your FCC License. Here's why:

Our training programs will quickly prepare you for a First-Class Commercial Radio Telephone License with a Radar Endorsement. Should you fail to pass the FCC examination after completing your course, you will get a full refund of all tuition payments. You get an FCC License . . . or your money back!

You owe it to yourself, your family, your future to get the complete details on our "proven effective" Cleveland Institute home study. Just send the coupon below TODAY. There's no obligation.

**MAIL COUPON TODAY FOR FREE CATALOG**

**Cleveland Institute of Electronics**

1776 E. 17th St., Dept. QT-23  
Cleveland 14, Ohio

Please send FREE Career Information prepared to help me get ahead in Electronics, without further obligation.

**CHECK AREA OF MOST INTEREST -**

- |   |  |
|---|--|
| <input type="checkbox"/> Electronics Technology | <input type="checkbox"/> First-Class FCC License   |
| <input type="checkbox"/> Industrial Electronics | <input type="checkbox"/> Electronic Communications |
| <input type="checkbox"/> Broadcast Engineering  | <input type="checkbox"/>                           |

Your present occupation \_\_\_\_\_

Name \_\_\_\_\_ Age \_\_\_\_\_

Address \_\_\_\_\_ (please print)

City \_\_\_\_\_ Zone \_\_\_\_\_ State \_\_\_\_\_

Accredited Member National Home Study Council

**How to Succeed in Electronics**

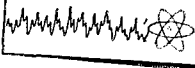

talk on TVI and K8IPS moved to Arizona. The Six Meter Nomad, *The Amateur Extra* informs us that W8JBS, W8URV, K8MLJ, K8VGF, K8VIL, K8VJB, WA8ADD, WA8GVF and WN8BSD furnished communications for a parade in Independence and K8SEV received his General Class license. A long-time member of the Buckeye Net, a member of AREA, the editor of Findlay RC's *W8FT News*, a more than a thirty-year friend of your SCM, namely W8WE, joined the Silent Keys. Lake-Geauga ARC's officers are W8LAG, pres.; K8CQY, vice-pres.; and W8OED, secy.-treas. Western Reserve Emergency Communication Services' officers are K8HZL, pres.; W8RBL, vice-pres.; W8FFA, secy.; K8-UMA, treas. Greater Cincinnati ARA's *The Mike and Key* tells us the members toured through the Voice of America transmitter and Jack Grays' Old Time Radio Museum and the club's former treasurer, W8NDN, is in the hospital. Springfield ARC's *The Q-5* informs us that Donald Matulka, an electronics engineer at Wright-Patterson AFB, spoke and showed a film on Lashers covering their application and use. They had 51 check-ins on the 2-meter net, KN8IBP is a new ham and the Springfield *News-Sun* gave the club FD publicity by a write-up in the Friday night paper with pictures of FD activities in the Sunday paper. Clermont County ARC held its annual picnic. The South East ARC gave a demonstration of amateur stations set up at a number of Sears stores parking lots and one of them had a TV receiver in operation and W8TGC showed color pictures of this demonstration at a club meeting. W8DAE, W8-UPI, K8AAG, K8NDO and WA8CXY made the BPL in July. Toledo's *Ham Shop's Gossip* names K8HWB an accomplished pianist, as its Ham of the Month and W8-BCQ, W8DN, W8HSW, W8TIT, W8QO, W8RZM, W8-RZQ, W8TSD, K8LFL, K8LUE, K8MBP, K8NBQ, K8-OMG, K8YJG, K8VOO, K8YON, K8ZMI and WA8AOO furnished communications for the 43rd Annual Mills Trophy Regatta. Queen City Emergency Net's *The Listening Post* contained a nice letter from ex-W8WYS. Warren ARA's *Q-Match* tells us the club toured the W8HH transmitter facilities, W8FIF is on vacation and W8NJJ and W8EEH are back from their vacations. The Eastshore V.H.F. Radio Club held its Annual Family Picnic Aug. 11. The club will go 2-meter f.m. as soon as the gear is ready. Traffic: (July) W8TPB 1277, W8-DAE 593, WA8CXY 549, K8DIY 528, K8RDO 525, K8-AAG 473, W8GHT 418, W8MCA 266, K8LGA 181, W8-CKY 116, W8BZG 98, W8RG 91, K8XND 80, K8UBK 68, WA8BOV 57, W8LT 56, K8ON 49, K8BND 48, K8-LGB 41, W8OCU 43, W8RO 29, WA8ARZ 28, K8VFN 24, WA8AVV 22, WA8ZF 21, W8CXM 18, W8AL 17, K8DDG 17, K8YAL 12, K8ZFS 9, WA8AJD 8, W8ALS 8, K8HVT 5, W8EEQ 4, W8YGR 3, W8ZYU 2. (June) K8HVT 148, K8NYM 5, W8AEB 4.

**HUDSON DIVISION**

**EASTERN NEW YORK—SCM,** George W. Tracy, W2EFU—SEC; W2KGC, RMs; W2PHX and K2QJL, PAM; W2JGJ, Section nets; NYS on 3670 kc. nightly at 000 GMT; NYSPTEN on 3925 kc. nightly at 2300 GMT; ESS on 3590 kc. nightly at 2300 GMT; MHY (Novice) on 3716 kc. Sat. at 1800 GMT; Interclub on 28,600 kc. Mon. at 0130 GMT; Emergency Coordinators on 146,550 kc. Fri. at 0015 GMT. Endorsements: W2PKY as SEC, WA2AKK as GEN, WA2QAO as EC and W2KGC as ORS. Westchester AREC reports 16 active members on the net. It's nice to hear from our newer traffic handlers such as WA2KUL, WB2PZC, WN2JPP and WN2HYB. We could use more; just send a net of your choice listed above and become a regular member. WA2AKK is back on v.h.f. after recovering from an accident. Director W2KR and Vice Director W2TUK spoke on "incentive licensing" at the Westchester Club. K2SJO is one of the chairmen for the National Convention to be held in N.Y.C. Aug. 21-24, 1964. The Hudson Amateur Radio Council will supervise and operate a station at the New York World's Fair. See it in the Coea Cola exhibit. WA2OBZ and WA2-OCA have added a 30L1 linear to their Collins rigs. WA2-FCR has a new triband beam for the h.f. equipment in the shack. Welcome to new Generals WB2FER and WB2-GMN. WA2NRB has a new Swan mobile on 75-meter s.s.b. The Westchester Club paper *Bandspread* is rimming feature stories on the history of the club. Other editors take note when news is thin during the summer months. Long-time RACES members and others have received 10-year certificates from the State Civil Defense all signed by the governor. Congratulations, Traffic: WA2VYS 592, WA2ZK 377, WA2LJM 278, WA2HGB 160, WB2PZC 113, WA2PUM 108, W2PKY 55, K2SUN 52, K2MPK 44, WN2-HYB 29, W2THE 29, WN2JPP 15, WA2KUL 8, W2EFU 3.

**NEW YORK CITY AND LONG ISLAND—SCM,** George V. Cooke, Jr., W2OBU—SEC; K2OVN, RM; W2-WFL, V.H.F. PAM; W2FW, Section nets; NLI 3630 kc. at 0015Z nightly; NYCLLPN, 3908 kc. at 2230Z nightly; V.H.F. Net, Tue., Wed., Thurs. 145.8 Mc. at 0100Z and Fri. through Mon. on 146.25 Mc. at 0000Z; Mike Farrad on 7238 kc. at 1700Z; All Service Net at 1900Z on 3925

(Continued on page 130)

# NEW Mosley EL TORO antennas



TW-3X  
\$19.95

TW-3X Jr.  
\$14.95  
NS-3

- **THREE MODELS** - Mosley El Toro antennas are available in three models, TW-3X - NS-3 and TW-3X Jr., designed to give outstanding performance. These versatile antennas were developed for the ham with a limited budget, limited space and the traveler working portable.

- **THREE BAND OPERATION** - Mosley TW-3X and TW-3X Jr. antennas operate on 20, 40 & 75/80 meters. Mosley NS-3 (Novice Special) operates on 15, 40 & 80 meters. All Mosley antennas feature pretuned, compact design & excellent broad band characteristics.

- **TWO POWER RATINGS** - Mosley TW-3X has an AM rating of 1000 watts input to the final amplifier and a CW/SSB rating of 2000 watts P.E.P. Mosley TW-3X Jr. and NS-3 (Novice Special) have ratings of 300 watts on AM & 1000 watts input to the final amplifier on CW and SSB.

Mosley El Toro antennas are trap type grounded quarter wave antennas using a unique method of tuning and a single 52 ohm coax line. Antenna is 58 ft. long and can be mounted to fit most any location. No radials are needed when mounted at ground level. Antennas come pretuned, in kit form and can be easily adjusted to resonate at any portion of the rated bands.

**Mosley Electronics, Inc.**

4610 N. LINDBERGH BLVD., BRIDGETON, MISSOURI

63044

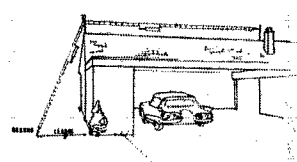
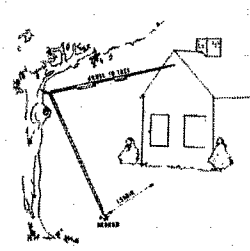
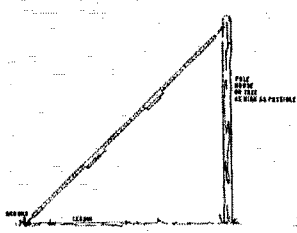
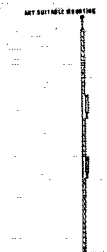

A T R I B A N D B E A M A T 6 0 F T — N O C U Y S

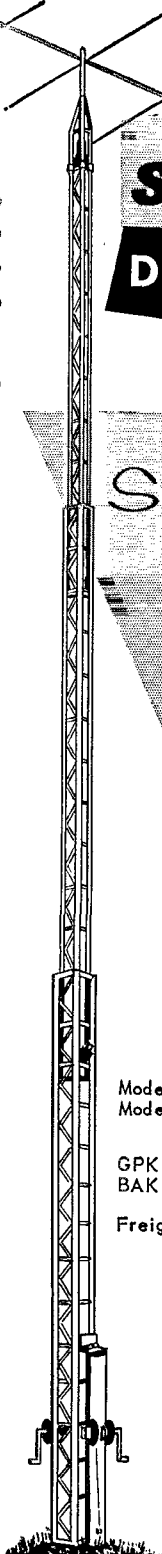

**DESIGN**

**STRENGTH**

**DEPENDABILITY**

THREE REASONS WHY  
YOUR BEST BUY IS...

**E-Z WAY**  
Satellite "60"

E-Z WAY AERO-DYNAMIC design decreases wind load and provides telescoping action that permits raising and lowering of tower sections. CRANK UP TO 60 FEET, DOWN TO 25 FEET and TILTS OVER FOR ACCESS TO ROTOR OR BEAM.

STRENGTH is built-in to every E-Z Way Tower...Heavy wall steel tubing legs, continuous diagonal bracing of solid steel rod and electrically welded throughout...no loose-bolts or nuts here. E-Z Way design and strength are your assurance of DEPENDABILITY that you can count on year after year. See your nearest distributor today or write for free literature.

**The SATELLITE**

Model RBX-60-3P (Painted) \$335.00  
Model RBX-60-3G (Galvanized) \$410.00

**MOUNTING KITS:**

GPX X60-3 (Ground Post) \$125.00  
BAK X (Wall Bracket) \$17.00

Freight Prepaid anywhere in (48) U.S.A.

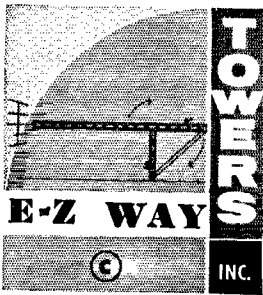

P.O. BOX 5767 TAMPA 5, FLORIDA

ke.; Q5 Net on 3935 ke, at 2100Z daily. July traffic totals gained over previous figures and W2MTA, WA2EXP, WA2VLLK, W2EWW, WA2RMP, WA2UWA, WA2QJU, WA2WGN and WA2TQT were recipients of BPL certificates from their excellent part in our section traffic activity. WA2GPT is now feeling fine after a bit of surgery. WA2SDQ is now in the Navy Submarine Service. W2ELK states there is a new 6-meter AREC net for Nassau County on 50.250 Mc. Mon. at 2030 and requests are sought. WN2DTH is a brother of WA2VLLK. Plans for the annual QCWA Dinner at the Hotel Shelburne Oct. 25 are completed, according to W2PP. WA2VKK has gone from 2 to 15 meters and is racking up many good QSOs. WA2ICV wants to hear from anyone who has contacted a TRW-5. WB2CSS, a new OBS appointee, is the son of W2ZJM. The newly-formed Nassau Radio Association in the Valley Stream area. WB2EWK, elected WB2DDL, pres.; WA2TMS, vice-pres.; WB2FZA, treas.; WA2TRK, secy. Club meetings are held the 1st Tue. of each month. W2QPP is the proud father of a new male jr. operator. The NLI 80 C.W. Traffic Net cookout and beach party was a huge success with over 30 net members in attendance and included the SCMs from NNCLI and NNJ, the 2RN Manager and the NYCLI SEC. WA2NWA has a new Marauder. WA2TAQ, EC for the Queens 2-Meter AREC Net, announces the net's reorganization and operates Thurs. at 0100Z on 146.25 Mc. There's something in the wind about a new mystery receiver at the QTH of W2MTA. Watch a future column for exciting details. WA2ZFD now is attending R.P.I. W4ZCS, ex-K2AZT, holds s-keds on 50.310 Mc. week ends from 2200 to 0000Z for friends here on the island. WB2DUD is acting as NCS of the Brooklyn 6-Meter AREC Net, replacing WA2FUL. K2QVN has a new 14AVS vertical and a Drake TR3. W2HSB is using a new homebrew 10 through 40 vertical with a dozen radials on the roof; no traps but vertical radiating elements for each band. Contact Kurt for hot information. WA2SAR, the son of WA2KSP, has signed up in the Air Force. WB2CYL is doing a fine job on 6 and 2 meters with a five-element Telrex and an NC-3038 converter. WB2CEW has been called into Army service. WB2CVT has gone mobile with a new NCX-3. WB2ECR has stacked halos on 2 and is working out FB. WB2DLL has a new Seneca. A field exercise was held in Van Cortlandt Park, Bronx, by the Bronx AREC/RACES groups for public demonstration and recruiting in all phases of c.d. with a fair degree of success. WA2FRW is looking for more c.w. on 6 meters during band openings. WB2BKS received a 25-w.p.m. CP sticker. With the filing of this report I conclude almost 17 years of full activity in many posts in our organization, having resigned as the current SCM for our section upon the advice of my doctor. My heartfelt thanks go to everyone who had any part in making these past years happy ones both for me and our hobby. I will be around to assist wherever possible. Traffic: W2MTA 1107, WA2EXP 857, WA2VLLK 734, WA2EW 605, WA2RMP 532, WA2UWA 500, WA2QJU 391, WA2WGN 320, WA2GPT 212, WA2TQT 116, K2KYS 104, K2THY 78, W2GKZ 75, WB2GKX 36, WA2PZD 30, WN2FB 24, W2ELK 18, WN2DTH 17, WA2LJS 16, WA2UYQ 16, W2DBQ 14, WA2PAW 10, WA2ZXR 10, WA2PSL 8, WA2EPN 4, WA2IK 4, WA2KSD 4, W2PT 4, K2YQK 3, WA2RAQ 2, WA2VKK 1.

**NORTHERN NEW JERSEY**—SCM, Edward F. Erickson, W2CVW—NNJ Amateur Radio Public Service Corps Nets—July:

Name	Freq.	Time Days	Sess.-	QNI-QTC
				Mgrs.
NJN	3695 ke.	2300Z Dy	31-404-503	W2QNL-RAI
N.J.	3900 ke.	2200Z Al-Sat.	31-436-118	K2SLG-PAM
Phone		1300Z Su		
NJ	51.15 Mc.	0300Z T, Th, Su 22-	84-161	K2VNL-PAM
	6&2	146.70 Mc.		

AREC Net schedules (local nets) are available from SEC K2ZFL. The NJN had a good picnic despite bad weather at the QTH of WA2GQZ. The Union County Amateur Radio Assn. has 80 members and meets at the Roselle C.D. the 2nd and 4th Fri. at 8 P.M. Contact WA2ZWY for information. W2COT visited K7BSQ (ex-W2YGY) on a western vacation. WA2BNF was awarded CHC No. 1006. WB2HBC has worked W5 on 6 meters and has 2 new awards. EC WA2ZKT spent 2 weeks at the shore operating portable. W2NIV has been rag-chewing with the OTs on 80. K2UKQ continues DXing from Colt's Neck. The YLs are favorites among foreign stations. WB2DDA is building 6-meter equipment. WA2EDG continues his very interesting experiments with light communications as well as gadgets for the d.c. bands. WA2UDT is constructing gear for 144, 220 and 432 Mc. WA2KIY continues his duties as OBS. W2-ZI made a trip through Canada and visited Marconi's wireless station "GB." The GSARA has appointed W2NTR publicity manager and WA2INU chairman of the TVI committee. The RBRA held its summer picnics

(Continued on page 132)

A NUMBER of these pages have been devoted to unusual circuit techniques used in the NCX-3 SSB transceiver, but it seems desirable also to review some of the operating features built into the NCX-3 as "standard equipment" — important features for the ham contemplating purchase of a transceiver for mobile operation, and vitally important for permanent fixed station work.

CW CAPABILITY seems to be ignored in the medium-priced transceivers, but the NCX-3 covers the *entire* 80, 40, and 20 meter bands with overlap at each band edge — 3480 to 4020 KC, 6980 to 7310 KC, and 13880 to 14420 KC — and shaped grid-block keying is provided for T9 clickless CW — with automatic break-in for maximum convenience. Just tap the key to transmit; stop sending and the receiver automatically recovers. Delay may be adjusted to the operator's preference.

VOX operation goes hand in glove with SSB, and so the NCX-3 incorporates voice control as well as push-to-talk circuits, with full anti-VOX and adjustable sensitivity and delay controls. Although VOX is most frequently used for fixed-station operation, mobile VOX is a handy feature to have — particularly in conjunction with a lavalier type mike for hands-on-the-wheel driving in turnpike and freeway traffic.

THE AGC SYSTEM used in the NCX-3 was discussed on this page two months ago, and provides a remarkably smooth AGC characteristic in all modes. On SSB at full RF gain, for example, signals are held to a few db of one another with absolutely no trace of objectionable pops or thumps — or undesired muting of the receiver from noise impulses. The mobile operator particularly benefits, since the necessity of riding the gain control during round-table QSO's is eliminated. Along with AGC, the NCX-3 also has an S-meter operable in all modes — automatically switched to read final cathode current during transmit.

AM DETECTION, as well as SSB-CW product detection, is available in the NCX-3 — and inserted-carrier AM may be transmitted. This feature is particularly important to the AM ham making the transition to SSB, since it allows him to enjoy SSB without having to unnecessarily resort to "exalted carrier" reception to keep in touch with his AM-only buddies.

JUDGING from returned warranty cards and the sales of the accessory NCX-A and NCX-D power supplies, around 90% of the thousands of NCX-3's on the air are being used as the main fixed station as well as for mobile — a compliment to the ease of operation and performance of the rig. If your interest is in an all-around transceiver in the same price class as competitive units which lack VOX, S-meter, AGC, AM, and CW coverage, then the NCX-3 is your logical choice — with the additional assurance of proven performance and a One-Year Guarantee.

MIKE FERBER, W1GKX



Amateur/CB/ or industrial —  
 You can't go wrong with HORNET.

**Model TB 1000-4**  
 Cash Price \$112.50  
 Only \$10.50 per month

**Model TB 1000**  
 Cash Price \$89.75  
 Only \$8.35 per month

**Model TB 750**  
 Cash Price \$67.50  
 Only \$6.30 per month

**Model TB 500**  
 Cash Price \$55.95  
 Only \$5.20 per month

Co-Axial Antenna for CB.  
 Model CO-CBI Price \$34.50

Stacked Co-Axial Antennas.  
 108 to 470 MC  
 Write for Price.

**MAIL YOUR ORDER TODAY**

**HORNET ANTENNA PRODUCTS CO., INC.**  
 BOX 808, DUNCAN, OKLAHOMA

Please rush the Hornet Antenna indicated below for a 10-day trial. If not satisfied, I agree to return the antenna prepaid within 10 days without obligation.

- I prefer shipment to be c.o.d. 25% is inclosed.
- Payment in full is inclosed.
- I wish to use your Time Payment Plan.

Model	Description	Price

Name \_\_\_\_\_ Call Letters \_\_\_\_\_  
 Address \_\_\_\_\_  
 City \_\_\_\_\_ State \_\_\_\_\_

**SATISFACTION GUARANTEED**

at South Amboy Beach. WA2UOO has been busy with a new Windom and home-brew equipment. K2UCY has qualified as an A-1 Operator. The EC V.H.F. Pierre was a success with a large attendance and traffic was originated. SEC K2ZFI has a new HQ-170. WB2CZZ has received his General Class license. K2AGJ has two new awards. W2CVW wishes to thank all for their support in the recent SCM election. New appointments: WB2CVN as OBS; WA2VYN and WB2HBC as OESs. WA2SRV is moving to Washington. WA2DEW (also KV4CQ) travels between New Hampshire, New Jersey, and the Virgin Islands with ham operation at each QTH. Don't forget the ARRL National Convention to be held in New York City during the World's Fair year, 1964. The convention itself will be in the city, while a complete ham station will be in operation at the Fair. The affair is sponsored by the Hudson Amateur Radio Council which will welcome your help in running the convention and/or station. Contact man for Northern New Jersey is Guy Brennert, K2EFB. All appointees without recent endorsements, please send in your certificates. Traffic: (July) WA2UOO 583, K2UCY 515, K2VNL 320, WA2SRK 243, WA2BNF 207, WA2ZKO 145, WA2SRV 142, WA2QPX 124, WA2CCT 115, W2CVW 81, WA2LUD 68, WA2WAJ 48, WB2HBC 39, K2ZFI 38, WA2ZKT 35, WA2SWP 27, W2ANG 26, WA2GQI 25, K2SBS 18, K2SLG 18, W2DRV 14, W2PEV 14, W2FNX 13, WA2MYB 10, K2EQP 8, W2OPB 8, WB2COZ 6, WA2GOZ/2 6, W2TFM 6, K2MFX 5, W2OXL 5, W2ABL 4, WB2CZZ 3, W2VMX 3, W2EWZ 2, WA2ZQH 2, K2AGJ 1, W2NIY 1, W2RXL 1. (June) W2TFM 28, WB2DDA 8.

**MIDWEST DIVISION**

**IOWA**—SCM, Dennis Burke, W0NTB—SEC: K0EXN, RM: W0LGG. PAMs: W0LSF, K0BBL. New appointees: K0DFH as Blackhawk Co. EC; K0GID and K0JQI as OBSs; K0JQI as ORS; W0USL as O Class I. My thanks to those whose votes returned me to office for another term. To those who voted for my opponent, you voted for one of the outstanding amateurs in this section and I hope he runs next time. W0ZYB has a new 90-ft. high skyhook. W0JERT is now General Class. W0BRM is having rig trouble. Ex-WV6YC, now W0KAN, and his XYL W0GTT are in our section now. Welcome to Iowa. The Ames ARC was entertained by its president, W0III. The SET will be upon us when you read this. Let us support the AREC and the best SEC in the business. If you do so, this section can be No. 1 again this fall. Nets for July: 160 Meter 31 sessions, QNI 595, QTC 10, 75 Meter sessions 27, QNI 838, QTC 195, Webster County AREC-RACES, sessions 25, QNI 53. Traffic: (July) W0SCA 1082, W0LGG 1065, W0BDR 435, K0QKD 188, W0NTB 130, W0USL 36, K0BBL 23, W0JO 21, K0IHC 16, W0TTT 10, W0PTL 9, K0TDO 9, K0GXP 7, W0YDY 7, W0QVZ 6, W0MMZ 5, W0EGE 4. (June) W0QVZ 4.

**KANSAS**—SCM, C. Leland Cheney, W0ALA—Asst. SCM; Richard G. Caspari, W0VZB. SEC: K0BXF. PAMs: K0EFL, W0BOR. RMs: W0QGC, W0PFG. V.H.F. PAMs: W0HAJ, K0VEP. New appointments: K0JDD as EC, K0ODA as EC, K0YGR as ORS, K0GQO as OPS. July net reports:

Net	Freq.	Time	Days	Sessions	QTC	QNI	Ave.
KPN	3920	1245Z	M-W-F	18	91	318	17.6
KPN	3920	1400Z	Sun.				
QKS	3610	0030Z	T-T-S-Su	17	111	71	4.17

Net Controls: KPN—W0ORB, K0OKS, K0YTA, K0EFL, QKS—W0BYV, W0QGG, K0YTA. The Midwest Division Convention will take place at the Broadway Hotel, Wichita, Oct. 26 and 27. The committee has gone all out to make this an outstanding event and your visit an interesting one. Join in the activities, have fun, meet your friends, get up to date on what's going on in amateur radio. Make it a point to visit with your ARRL officials in the ARRL Hospitality Room. Discuss your ideas and problems with them. Remember, you'll get out of amateur radio in proportion to what you put in. More traffic operators are urgently needed on both phone and c.w. Write or radio your SCM for an appointment as OPS or ORS. Traffic: W0BYV 215, K0YTA 90, WA0DFZ 55, W0QGG 37, K0GII 32, W0ALA 26, K0EFL 26, W0ERQ 20, K0OKS 16, K0GIG 14, K0BXF 6, K0VQC 5, K0YGR 5, W0BMW 2.

**MISSOURI**—SCM, Alfred E. Schwaneke, W0TPK—SEC: W0BUL. RMs: W0GUD, K0ONK. PAMs: W0BUL, W0BVL, W0LFE (v.h.f.). W0ONM, K0ONK. New appointments: K0TGU as OPS, W0AFBO as OBS. Endorsements: K0FPC and K0QCC as ORSs; K0OLW and W0KCG as OBSs. A new O call, W0HTO, ex-9NW, made the hPL along with regular, K0ONK. Old-timer K0IHA is back in business, dropping his W5KVZ call. I am sorry to report that K0AEB and W0AEP are Silent Keys. The St. Louis ARC wants

(Continued on page 134)

**AMECO***Leader in Compact, Quality Ham Gear*

Improve your receiver's sensitivity and noise figure with an

**ALL BAND NUVISTOR PREAMP**

- All Bands— 6 thru 160 meters
  - Two Nuvistors in cascode
- only \$24.95 wired & tested

**The NEW AMECO Model PCL**

Adding the new Ameco All Band Preamp ahead of your receiver will allow you to really pull the weak signals out of the mud. Model PCL is a tuned RF amplifier covering 6 meters thru 160 meters. It uses two Nuvistors in cascode and gives noise figures of 1.5 to 3.4 db., depending upon the band used. The weak signal performance of all receivers (regardless of price) will be improved. Image and spurious rejection will also be improved. Overall gain of preamp is in excess of 20 db.

Panel contains bandswitch, tuning capacitor and a three-position switch which puts the unit into "Off" position, "Standby" or "On," and transfers the antenna directly to the receiver or through the Preamp. 3" high, 5" wide, 3" deep. wired and tested \$24.95

**AMECO EQUIPMENT CORP.**

178 HERRICKS RD., MINEOLA, L. I., N. Y.

Affiliated with American Electronics Co. and Ameco Publishing Corp.

**NUVISTOR CONVERTERS FOR 50, 144 AND 220 MC. HIGH GAIN, LOW NOISE**

Has 3 Nuvistors (2 RF stages & mixer) and 616 osc. Available in any IF output and do NOT become obsolete as their IF is easily changed to match any receiver. Average gain — 45 db. Noise figure — 2.5 db. at 50 Mc., 3.0 db. at 144 Mc., 4.0 db. at 220 Mc. Power required 100-150V. at 30 ma., 6.3V. at .84A. See PS-1 Power Supply.

Model CN

**TRANSISTORIZED MOBILE CONVERTERS. CRYSTAL CONTROLLED**

Model CHT will convert any single frequency or band between 108 and 174 Mc. down to the broadcast band or any other IF output. Has a 1/2 microvolt sensitivity. Complete with one crystal ... \$35.95 Model CLT same as above except that it receives any frequency or band between 2 and 54 Mc. Complete with one crystal ... \$35.95

Model CHT

**COMPACT 6 THRU 80 METER TRANSMITTER**

Handles 90 watts phone and CW on 6 thru 80 meters. Final 6146 operates straight thru on all bands. Size — only 5" x 7" x 7" — ideal mobile or fixed. Can take crystal or VFO. Model TX-86 Kit \$89.95 — Wired Model ... \$119.95. Model PS-3 Wired \$44.95. Model W612A Mobile Supply wired \$54.95.

Model TX-86

CB-6K — 6 meter kit, 6ES8-rf Amp., 6U8-mix./osc. .... \$19.95  
 CB 6W — wired & tested .... \$27.50  
 CB-2K — 2 meter kit, 6ES8 1st rf amp., 6U8 — 2nd rf amp./mix. 616 osc. .... \$23.95  
 CB-2W — wired and tested, ... \$33.95  
 Model PS-1 — Matching Power Supply — plugs directly into CB-6, CE-2 and CN units. PS-1K — Kit ... \$10.50  
 PS-1W — Wired ..... \$11.50

CB-6

**EASY TO UNDERSTAND AMECO BOOKS**

Amateur Radio Theory Course \$3.95  
 Amateur License Guide ..... .50  
 Radio Operators' Lic. Guide, EL 1-2 ..... .75  
 EL 3 ..... 1.75 EL 4 ..... 1.25  
 Amateur Log Book ..... .50  
 Radio Electronics Made Simple 1.95

**CODE PRACTICE MATERIAL**

Ameco has the most complete line of code records, code practice oscillators and keys. Code courses range from start to 18 W.P.M. and are on 33, 45, or 78 r.p.m. records. Model CPS oscillator has a 4" speaker and can be converted to a CW monitor.

Write for details on code courses and other ham gear.

Dept. Q10 Ameco equipment at all leading ham distributors.

**AMECO EQUIPMENT CORP.**

178 HERRICKS RD., MINEOLA, L. I., N. Y.

Affiliated with American Electronics Co. and Ameco Publishing Corp.



# HERE IS THE TOWER WE PROMISED YOU— YOUR BEST BUY IN A FREE STANDING TOWER

Here at last is a low cost free standing tower with all the quality of design and construction that the biggest most expensive TRI-EX TOWERS are famous for. This crank-up tower is free standing — no guying is required — even in hurricane winds with extremely large antenna loads topside! Write today for complete data on these and other TRI-EX towers. There is a TRI-EX tower to fit YOUR antenna requirements.

MODEL HM-354 3 SECTIONS (ILLUSTRATED)	PRICE (STANDARD FINISH)
Tower complete with steel base assembly for concrete (nothing else to buy) Tower equipped for tilt-over feature complete with steel base assembly for concrete (nothing else to buy)	\$475.75
Extended height 54'; Collapsed height 20'-1"	\$509.00

Hot dip galvanized after fabrication also available at slightly increased price.

**NOTE THESE WIND LOAD CAPABILITIES:**  
(Based on a six foot mast above the tower, with the center of the antenna at the top of the mast: i.e. 60 feet above ground.)

UNIFORM BUILDING CODE WIND PRESSURE	ANTENNA projected area
20 lbs./sq. feet	10 sq. feet
30 lbs./sq. feet	5 sq. feet
L.A. City Code (Strong Winds and Earthquakes)	10 sq. feet

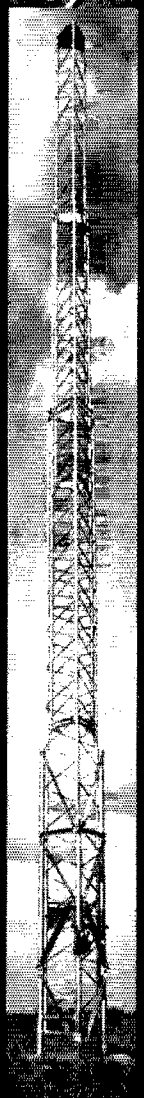
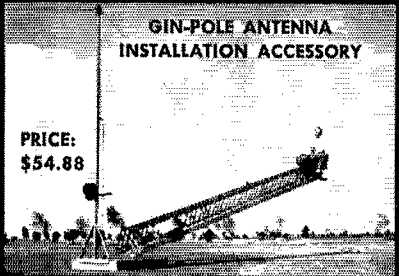
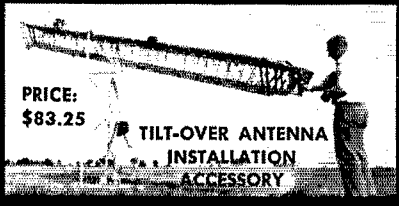

new members in the city and county. Contact KOAEM, sec'y, if interested. Add WNOGAM and KOVHM to the Boot-Heel AREC Nets. W0AH, W0KY, KOVBT, KOVPH, KOZAN, and WOUD received citations for RACES work. W0AIM is now a mobile EC. W0DQY, St. Louis, worked Florida on 2 meters. KOJWN reports hearing QDQ at Harrisonville, across the state. KOFCP, WA0FLL and KOJWN report good hunting on 8 meters. WA0FLL has 29 stations confirmed on 8 meters. W0GBJ and WOUD are sporting new antennas. GBJ with a loud signal. OUD's pattern still questionable. WAOCWV is portable around the state using fences, etc., for antennas. KOONK blames s.s.b. for the traffic total. New on s.s.b.: WA0BVG and WA0BOI. Net reports for July: MEN-QNI 314, QTC 211; NCSs WO-TPK 4, W0BUL 3, KOONK 3, KOVPH 3, MON-QNI 188, QTC 268; NCSs WOUD 15, W0KIK 5, KO-FPC 4, KOVPH 3, K0GFA 1, MSN-QNI 109, QTC 72; WAOCWV 10, KOFCP 5, KOONK 5, SMN-QNI 18, QTC 9; WOUID 4, MO SSB-QNI 142, QTC 68; W0-OMM 5, KOIHA 3, PON-QNI 230, QTC 135; K0BWE 7, KOONK 7, KOVIO 6, KOMMR 2, Traffic: (July) KOONK 4264, W0HTO 1072, KOFCP 355, KOTGU 252, K0GFA 223, WOUID 171, KOVPH 114, KOMMR 77, WOUMM 62, K0BWE 46, WA0CHD 44, W0KIK 37, WAOCWV 27, W0PTW 26, W0GBJ 20, K0RKW 17, W0RVA 16, WA0CHE 13, KOVIO 12, W0BUL 10, W0-BVL 10, KOOGM 10, W0AIM 8, WA0FLL 2, K0QCQ 2. (June) W0AYB 338.

**NEBRASKA**—SCM, Frank Allen, W0GGP—Nehr. 75-Meter Morning Phone Net. K0DGW NC, reports QNI 517, QTC 164. Western Nehr. Net, W0NIK NC, reports QNI 452, QTC 73. 100 per cent check-ins: WA0-AES, W4LEE/O, Nebraska Emergency Phone Net, W0-EGG NC, WA0BES supporting, reports QNI 806, QTC 114, 31 sessions. New members: W0BKW, WA0BYK, DXS/O, K0RJG, Nebraska Storm Net, W0GIF NC, reports QNI 432, QTC 15, 31 sessions. The Old Goat V.H.F. 6-Meter Net meets at 0200Z Mon. (local time); W0CCD is NC. Appointment: W4LEE/O as OO. Endorsements: W0MTI and K0WPF as KCS. Net activity during the summer has dropped, but is expected to pick up with the winter months. All nets will welcome new members so check in whenever you can. Traffic: WA0BYK 349, W0LOD 108, W0EGG 72, W0NIK 45, K0DGW 42, W4LEE/O 38, W1CJP/O 22, W0FIG 30, K0ZEQ 28, W0CCD 18, W0VJZ 16, W0RJA 15, W0-NOW/O 14, K0MSS 10, K0MZV 10, K0JZN/O 8, K0-OVY 8, W0VEA 8, W0A0ES 6, K0CGM 6, K0JFN 6, W0AKG 4, W0BKW 4, WA0CQ 4, W0YFR 4, W0-ZJF 4, K0ZYP 4, K0KEM 3, W0CIW 1, WA0DFS 1.

## NEW ENGLAND DIVISION

**CONNECTICUT**—SCM, Robert J. O'Neil, W1FHP —SEC: W1EKJ, H.F. PAM, W1YBH, RM, K1GGG, V.H.F. PAM, W1FHP, Traffic Nets: CPN, Mon. through Sat. 1800 hrs., Sun. at 1000 hrs. on 3880 kc. CN, daily 1945 hrs. on 3640 kc. CFCN (Conn. Emerg. C'd-or'd Net) Sun. 0900 hrs. on 3880 kc. CVN, Mon., Wed. and Fri. 2030 hrs. on 145.980 Mc. Net Control tunes 148 Mc. down to 144 Mc. Section Net certificates were awarded to K1DQC, W1X, W1KK, PUG, for CN traffic work. W1RFJ and K1GGG are working on a net bulletin for CN members. Anyone who wishes one, send a card to RM, K1GGG, Milford, Conn. Appointments: K1DQC as ORS and K1WKJ as OPS. K1LOM made the BPL again in July; also still is looking for a QSO on 3522 Kc. at 60 w.p.m. or better on C.W. Not many takers, reports Seth. The W-Conn. award goes to W1ETF from the Willimantic J.C.s. Endorsements: W1AW, Headquarters station as OBS/ORS/OPS. W1QV as OPS/OBS, W1NQO as EC; K1PLR as OES. New AREC cards went to KN1FYQ, W1BNB and KN1FVY. OES reports are slow in coming in this time of year. Hope you fellows will get them in for next month. OO W1ZGO had fun looking over 6 meters for July, and the same thing is happening yet (loads of discrepancies) mostly phone in the c.w. portion 50 to 50,100 Mc. K1QPN reports no 2-meter activities near Lake Champlain, and he's taking up flying and having fun. W2-CCP, New York office of the PCC, visited the QRC while staying at camp in the area. High QNI for CPN in July: K1OJZ, W1DAV, K1NTR, K1PUG, K1VIJ. New stations and those active again are K1LLJ, K1-TVD, K1YTG and K1WKJ. CN High QNI: K1WKK, W1CTI and W1RFJ. Both nets held 31 sessions in July. CN totaled 363 and CPN 289 messages. Traffic: K1WKK 1019, K1LOM 734, K1WKJ 332, K1DQC 285, W1EFW 185, W1FHP 66, K1QPS 66, K1GGG 87, W1AW 53, W1-BDI 51, W1YBH 48, W1OBR 42, K1PUG 42, W1CTI 38, K1EIR 36, W1RZG 30, K1VIJ 26, K1DGG 24, K1NTR 24, K1TGX 22, K1OJZ 20, W1MPW 14, K1QPN 14, W1-QV 14, K1WKJ 8, K1MBA 4, K1QVX 4.

**MAINE**—SCM, Arthur J. Brymer, W2AHM—SEC: K1DYG, PAM: K1ADY, RM: K1MIZB, Traffic nets: Phone, Seagull Net, 3940 kc. 1700-1800 EDT daily except Sun. Pinetree Net, 3596 kc. 1900 EDT Mon.-Fri.

(Continued on page 138)



# GUARANTEED!



THE BARKER & WILLIAMSON MODEL 6100 TRANSMITTER IS SO FAR AHEAD OF OUR TIME IN DESIGN, PRINCIPLES AND ENGINEERING, THAT WE CAN OFFER A GUARANTEED LIST OF FEATURES . . .

*Barker & Williamson Guarantees that NO other Amateur Transmitter on the Market today offers ALL these features:*

- Crystal controlled synthesizer, frequency continuously variable
- No free-running oscillators
- Direct frequency read-out (no interpolation)
- Frequency resetability approaches a frequency meter
- Crystal stability on all frequencies of every band
- Sideband selection by crystal filter
- MARS frequency coverage
- Sideband and carrier suppression down 50 DB
- Distortion products down 40 DB
- 180 watts PEP input
- SSB, CW, AM
- Pi-network loading control
- Dual ALC, and many others

**YOU CAN OWN AND OPERATE  
TOMORROW'S TRANSMITTER TODAY!  
for only \$875.00**

## **Barker & Williamson, Inc.**

BRISTOL PENNSYLVANIA • Telephone 215-788-5581

OCTOBER 1963

See your local B&W Distributor or write for colorful brochure.

# BULLS-EYE EVERY TIME!

VERSATILE

EFFICIENT

DEPENDABLE



## TECRAFT

### VHF TRANSMITTERS

#### For Mobile and Fixed Stations . . .

All models employ 12AX7 as speech amplifier/driver, and 2 6AQ5 tubes as CI. A Modulators. 6360 Power amplifier.

Requires 6.3 V AC or DC @ 3.89 amps for filaments. 250V DC at 250 ma. for full input. May be operated at lower plate current levels, to permit use of inexpensive power supplies, in mobile service. Filament circuitry is arranged so that either 6 or 12 volts may be used.

#### FEATURES

- Audio gain for either Dynamic or Crystal microphone
- Antenna tuning system to match either 52 or 72 ohm feed line, terminating in standard co-axial output connector.

Model TR 20/21 (10-15 meter band)  
20-25 Watts input

Model TR 20/50 (6 meter band)  
20-25 Watts input

Model TR 20/144 (2 meter band,  
or CAP) 20 Watts input

Model TR 20/220 (1 1/4 meter  
band) 20 Watts input

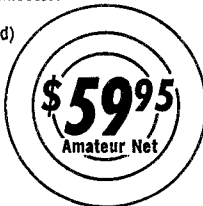

Complete with  
Crystal & Tubes

# Tecraft

## EQUIPMENT CRAFTERS

BOX 116 RIVER EDGE, N. J. COlfax 2-0159

First Regional Net, 3605 kc. 1815-1930 daily. The Main State C.D. net meets Sun. at 1100 EDT on 3993 kc. and Wed. at 1900 on 3530 kc. W1YBK is net control. The AREC Net meets Sun. at 0900 EDT on 3940 kc. K1-DYG is net control. K1MZB and K1TEV are two new OOs. Endorsements: K4BSS/1 as ORS. K1TAMI, a new General from Yarmouth, also made it at Swampscott. Congrats. W1HZE is eligible for 1XCC as he has 130 confirmations. K1RQE is working on it; he has 92 worked and 71 confirmations. K1GZL, of E. Windham, Me., has skeds with K4USB and K4USK and works K4UCV four nights a week. His rig is a DX-100 and a 75A-3 with a three-element wire beam on 40 meters. K1VEQ is having troubles with v.f.o.s. We had better start listening for the southern exposure of the Barnyard Net. The first bit of QRM from the south will start to show up on the weather net and from then on look out. W4BU will have a lot to say about the continent in the spring. The hams in the northern part of the state are asked to send the SCM some notes of interest so that all the reports are not from one section of the state. Let's keep the northern part happy too. Traffic: K4BSS/1 219, K1MZB 73, K1MDM 20, W1FV 10, K1VEQ 8.

**EASTERN MASSACHUSETTS**—SCM, Frank L. Baker Jr., W1ALP—W1AOG is our SEC. New appointments: K1MOD and W0PAN/1, Brockton, as OBSS. K1YUN, Newton is on 6 meters. K1TFV, ex-WA6KHA, moved to San Diego. W1HPV moved to Norton. W1JKZ, Wakefield, has his old call back and is active on the air. Heard on 75 meters: W1s NVV, KWD, LYL, FEC, SKP, MINK, K1s KVZ, WYE. The Mass. V.H.F. Society held a meeting at W1BU's. K1s VKW and HBM put up K1VKW's beam. Mr. Langston, K1GPR, of C.D. at Natick, is in the hospital. K1YBD and TVY are on 75 meters. K1JU rebuilt the entire radio shack and now is working at WGBH-TV. W1BGW has a new grounded grid linear using a 4-1000A. K1SCJ worked V7PCX again on 6 meters. W1LDC uow is on No. Quincy and has a rig for 8 meters. K1RHZ says he received signals from WESH-TV, Daytona Beach and WTSB-TV, Miami, on channel 2 June 28-29. K1YAE is Tech. Class KN1EPN is on the air from camp. W1-NJL is working at 73. K1MOD has DXCC on A3 with 250 countries on c.w. and worked FT8XG and W4PDP/4W1 on 7 Mc. KN1EVR is in Littleton. K1MDI/1, from Gallaudet College, is in Washington. D.C. W1STX, K1s VPJ, VHZ, LKL, WTK and ZKK took part in the road races for NEAAAU on 6 meters. WN2GKP/1 is on the air from Orleans. W1EPA writes from N.H. and says he will be going to Washington, D.C., and then to Haiti and will be on the air with an HH call. The Catholic Mission Radio Assn. has been formed. W1JS is on the advisory committee. W1HWK is corr. secy. K1KMB is pres. W1ELP worked his 25th country on 6 meters. St. Pierre, over 2800 contacts. KH6EOG/1, ex-K1KTK was on 2 meters while on vacation here. K1GTX is very ill in the hospital. W1WTF is now in Somerville and has his old call back. W1NJL is going to Colby this fall and has DXCC 200. W1BB reports some DX on 160 meters. K1SGZ is Asst. EC to K1PNB, who has been in N.H. K1MTT had the mobile on vacation. K1VLB joined the Navy. W1HGT says he heard 46 states on 6 meters. W1AOG received reports from W1AAU, W1FON and K1-PNB. KN1ESG and KN1FUP, son and father, are active on 80-meters c.w. K1OUM is the new Radio Officer for Somerville. This part of my report is directed to all Radio Officers and ECs: I am very much disturbed by the attitude of some civil defense directors toward the amateur. Our record in the past years in all kinds of disasters should be called to their attention and I suggest that everyone stand up in his boots and let this be known. We have the second case where an amateur group has turned in the radio equipment and quit in disgust. This was down my way. EM2AIN had 23 sessions. 172 QNIs, traffic 157. W1DOM is on 6 meters, also K1SWX. W1JKB had an operation and is recuperating up in Kennebunkport, Me. W1AAU, our Dedham EC, says that his group is very active, helped the police on July 4, and has a new home in the fancy colonial mansion police station. W1s JLI and LYL have worked into N.H. on 2 meters. Ex-W0PBM now is in Framingham. K1SMT has WAC. W1NF went to N.Y.C. Appointments endorsed: W1AOG, W1PEX, W1NJL, W1-AR and K1MEM as OPSs; W1NJL as ORS; K1SRZ as OBS; W1s BGW and SVU as OOs; W1AR Belmont. W1PSG Gloucester. W1MOJ Millis as ECs. Traffic: (July) W1PEX 1023, K1PNB 229, W1EMG 222, W1OFP 163, W1LES 160, W1FON 57, W1DOM 55, K1GKA 37, W1AOG 31, W1VYS 30, W1FJJ 28, K1LCO 23, W1STV 25, KN1ESG 23, K1SMT 23, W1GEX 10, W1DII 9, W1-NJL 6, K1OCD 6, W1HGT 4, W0PAN 2. (June) W1STV 27, W1FJJ 22, W1BB 3, K1VLB 1.

**WESTERN MASSACHUSETTS**—SCM, Percy C. Noble, W1BVR—SEC: W1BYH/K1APR, C.W. RM: K1-LJV, PAM: K1RYT. The West. Mass. C.W. Traffic Net meets nightly on 3560 kc. at 7 P.M. The net is extremely active with good attendance and the welcome mat is out

(Continued on page 138)

# GOOD MOBILES GO...



## 10-15-20-40-75 METERS NEW-TRONICS MOBILE ANTENNA

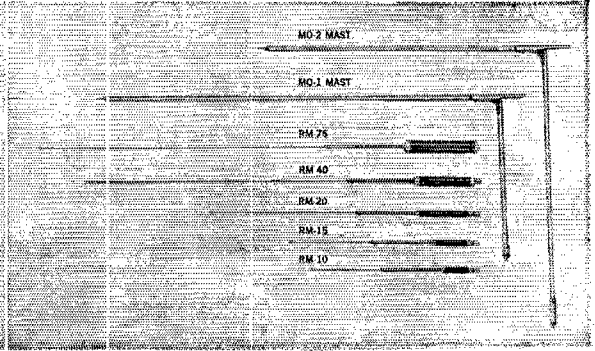

### ● Now, Get Fixed Station Reports with the "HUSTLER"

Buy only the mast and resonators for the bands you operate. No need for matching devices, no feed line length problems. Use any length of 52 ohm cable. This is a new, efficient concept of center loading. Each of the five resonators has a coil specially designed for maximum radiation for a particular band. Center frequency tuning is by means of an adjustable stainless steel rod in the resonator.

The 54-inch fold-over, heat treated, 1/2-inch aluminum mast permits instantaneous interchange of resonators. Mast folds over for garage storage. When opened to full height, the two sections of the permanently hinged mast are held rigidly in position by a shake proof sleeve arrangement. Mast has 3/8-24 base stud to fit all standard mobile mounts. Power rating is 75 watts dc input A.M. — 300 watts PEP input for SSB.

#### ANTENNA ASSEMBLY CONSISTS OF 1 MAST and 1 RESONATOR

Part No.	Description	Total Height of Antenna	Amateur Net
MO-1	54" Mast folds at 15" from base	(For Rear Deck or Fender Mount)	\$ 7.95
MO-2	54" Mast folds at 27" from base	(For Bumper Mount)	7.95
RM-10	10 Meter Resonator	Maximum 80" — Minimum 75"	5.95
RM-15	15 Meter Resonator	Maximum 81" — Minimum 76"	6.95
RM-20	20 Meter Resonator	Maximum 83" — Minimum 78"	7.95
RM-40	40 Meter Resonator	Maximum 92" — Minimum 87"	9.95
RM-75	75 Meter Resonator	Maximum 97" — Minimum 91"	11.95

ANY MAST OR RESONATOR MAY BE PURCHASED SEPARATELY

### FITS MORE CARS THAN ANY OTHER BUMPER MOUNT!

**MODEL BM-1** Flat alloy steel strap fits tightly against any shape bumper yet is inconspicuous. Length of strap permits its attachment to both large and small bumpers.

Assembly is held in place by two "J" bolts at the top of the bumper and strap clamp at the bottom. "J" bolts may be inserted between top of bumper and car body where clearance is as low as 1/4".

Whip receptacle assembly consists of a heavily chrome plated 1 1/2" die cast Zamak ball with 3/8-24 thread. Adjustable so as to maintain whip in true vertical position. Black phenolic base. All metal parts of the bumper mount are heavy cadmium plated. ....\$6.95

See these outstanding NEW-TRONICS products at your electronics distributor. If he cannot supply you send check or money order to Dept. Q for immediate delivery. Write for literature on the complete NEW-TRONICS line.

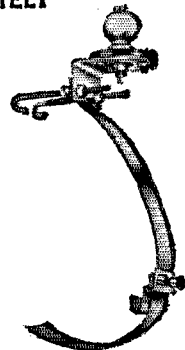

**NEW-TRONICS CORP.** 3455 VEGA AVENUE  
CLEVELAND 13, OHIO

## A Word From Ward . . .



### THE CORPORATE IMAGE

*A*merican corporations have one thing in common: they want to enjoy the highest esteem of the American public. Every year they spend millions of dollars on TV, radio, magazine advertising and public relation programs to build up a favorable "corporate image" about their particular companies.

*I*f it spends enough money, for a long enough time, practically any corporation can convince the public that it is a good, sweet, kind, public-spirited corporation, devoted to progress, interested in humanity—and the proud possessor of a genuine, bona fide soul.

*D*oes this mean that only a multi-million dollar company can afford to have a "good" corporate image? Not on your life! Here, at Adirondack Radio Supply, we've got an "image" every bit as favorable as the big boys'—but we didn't spend millions to get it.

*D*on't look for our "image" on a coast-to-coast TV program—but in the honest-to-goodness policies we follow in our store. Don't expect to find our message spread across the pages of TIME and LIFE magazines—but in the quality of the merchandise spread upon our counters. Don't depend on any high-flown public relations program to learn about our reputation—but go to any of the thousands of people who have been doing business with us, year in and year out, since 1936.

*A*nybody can buy a manufactured corporate image—but an image like ours has to be earned.

WRITE FOR OUR LATEST "USED" LIST

*Ward J. Hinkle W2FEU*

Before you buy or trade, wire, write,  
call or drop in to see WARD, W2FEU

### ADIRONDACK RADIO SUPPLY

185-191 W. Main St., Amsterdam, N. Y.  
Phone: Victor 2-8350 Ward J. Hinkle, Owner

at all times! The Massachusetts Phone Net meets Mon. through Fri. on 3842 kc. at 5:30 P.M. Maybe you would prefer that, or even better both! RM KIJJY and husband KIJJU spent two weeks on the Cape. SEC W1-BYH/K1APR and his XYL moved to Lunenburg during August. As soon as they are settled, we can expect a big increase in AREC activity. W1JYH is QSL Manager for PJ5ME and has filled out some 3000 cards for their DX contest operation. Also, W1JYH now has 320 confirmed DXCC. Congrats, Rog! PAM K1RYT says that a great deal of 6-meter DX is being worked from northern Berkshire. K1CAU was a recent visitor at W1-BVR and says he will be looking for West. Mass. stations on 20 meters come fall and winter from his California location. W1DWA has been bitten by the certificate bug. FC K1LNC reports that Gardner High School will have a station on the air in September. W1ZPB and Betty are the proud parents of Joy Anne Congdon, born July 29. K1EUL, after 5 years with the USN, is on with an SR-150. PAM K1RYT has 200 watts of 6-meter sideband with a Tapetone SB-100. May I suggest that you look at the League ad on page 144 of Aug. QST to see what you are entitled to? A goodly supply of Official Relay and Official Phone Station certificates are on hand here ready to be made out to qualified operators. Interested? Traffic: (July) K1-RYT 787, W1BVR 166, K1SSH 164, K1JJV 88, W1DWA 84, K1ZBN/1 71, W1ZPB 46, K1LBB 45, K1LNC 20, K1VFN 10, K1TTT 5, K1ZVJ 5. (June) K1RYT 602, W1DVV 19.

**NEW HAMPSHIRE**—SCM, Albert F. Haworth, W1YHI—This month's report will not be true to the form of past reports because of vacation and a change of QTH of your SCM. The new location and address is 20 Plummer Road (Bedford), Manchester, New Hampshire 03102. As a follow-through from last month our public service traffic men are listed for your information. OPSs: W1ET, K1BCS, K1BGL, W1AJJ, W1YHI, W1-BYS, K1MID, K1IHK, W1YHF, W1ARR. ORSs: K1-UHE, K1TMD, K1BCS, W1QGU, W1AJJ, K1IHK, W1-EVN, W1ARR. Congratulations to those who serve and may the ranks enlarge. Any errors will be noted in next month's report when the file is put back in order. Sorry to report the death from an auto accident of W1GWY. Traffic reports and news items will be listed forthwith.

### FOURTEENTH NEW HAMPSHIRE QSO PARTY

October 26-27, 1963

The Concord (N. H.) Brasspounders, W1OC, announce their sponsorship of the Fourteenth New Hampshire QSO Party, and cordially invite all interested radio amateurs to participate. Here are the details:

(1) Contest period: Saturday, October 26, 2300 GMT to Sunday, October 27, 2300 GMT.

(2) No time limit and no power restrictions.

(3) Scoring: N. H. stations count 1 point for each N. H. contact, plus 2 points per outside contact; stations outside the state count 2 points per N. H. contact; both multiply by the number of counties worked (10 maximum).

(4) Engraved certificates will be issued to all participants reporting, with special endorsements for the highest-scoring stations, both in N. H. and outside, in the phone and c.w. categories. Single operator stations only are eligible for the special endorsements.

(5) The same station may be worked for additional credit on more than one band, phone or c.w. Suggested frequencies are 3550 3842 7050 7220 14,100 14,250 21,075 21,350 28,100 and 28,800 kc., 50.4 and 145 Mc.

(6) General call: "CQ NH" on c.w.; "CQ NH QSO Party" on phone. N. H. stations are requested to sign *de* W1-NH K.

(7) Contact information required: Report and QTH (including county of N. H. stations) and number of QSO. Those operators participating in both the c.w. and phone categories must submit separate logs for each mode of operation. Each log shall be scored separately based on the number of contacts and counties worked in each mode. Logs and scores must be postmarked not later than Nov. 15, 1963, and should be mailed to the Concord Brasspounders, P.O. Box 339, Concord, N. H.

(8) The WNH (Worked New Hampshire) certificates will be awarded to stations working all ten counties during this QSO Party, participating logs confirming. Detailed requirements for the WNH certificate, a standing award, may be obtained by writing the club.

(Continued on page 140)

# STILL LEADING THE FIELD...THE SWAN SW-240



**NOW...**  
**WITH NEW STYLING**

**AND EXTENDED  
 CW COVERAGE**

**14,000-14,350 KC**

**7,000-7,300 KC**

**3,650-4,000 KC\***

240 watts PEP input. High frequency crystal lattice filter. Precision tuning mechanism. Exceptional frequency stability. Receiver sensitivity better than one microvolt.

Automatic gain control. ———— **\$320**

Break-in CW operation.

**MOBILE MOUNTING KIT**

Locking type, including speaker switch, with front-mounted mike jack... **\$19.50**

**SIDEBAND SELECTOR KIT**

Provides both opposite sideband and AM receive position... **\$18**

\* Kit for full 80 meter coverage available.

**SWAN POWER SUPPLIES**

SW-117AC (illustrated) for home station. With 5 x 7 speaker and phone jack... **\$95**

SW-12DC for mobile operation. With pre-wired cables and installation hardware... **\$115**

**ASK THE HAM WHO OWNS ONE**



# MAXIMUM SELECTIVITY

for the  
**Drake  
2A and 2B  
Receiver**

**Now**

AN EXCITING NEW 2KC.

## Mechanical Filter Modification Kit

IS AVAILABLE FOR THE **DRAKE 2A • 2B**  
RECEIVER

... EXCLUSIVELY AT **HENRY RADIO**

LIKE MAGIC THE **DRAKE** BECOMES A  
TRULY SUPERLATIVE **SSB** RECEIVER.

Imported

**MODEL DMF-2**

**\$29.**

UNIT COMPLETELY  
WIRED, READY FOR  
EASY INSTALLATION!

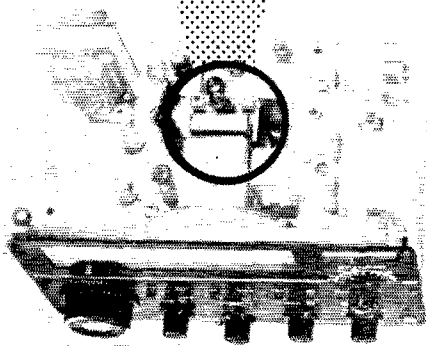

**Henry Radio Stores**

Butler 1, Missouri Ph. ORchard 9-3127  
11240 West Olympic Blvd.  
Los Angeles 64 Ph. GRanite 7-6701  
931 No. Euclid Ave., Anaheim, Calif.

**RHODE ISLAND**—SCM, John F. Johnson, K1AAV—  
SEC: W1YNA, RM: W1BTY, PAM W1TXL, Appointment:  
K1PAM as EC for East Providence, R1SPN report:  
31 sessions, 542 QNL, 99 traffic, The W1AQ Club of  
Rumford reports issuing WRI certificates to the follow-  
ing stations: No. 30 to K1WGU, No. 31 to K3GKF, No.  
32 to W9OKN, No. 33 to K1TPK and No. 34 to W2-  
KTV/2, W2KTV/2 received the first certificate issued to  
a 2-meter station, K1RLE will replace K1LDK as award  
chairman for the club because LDK will leave for college  
this fall. Twenty-two members of the club participated  
in Field Day activities with five stations on the air,  
K1JYN was made a member, The NCR of Newport had  
a lecture on the cathode ray oscilloscope given by  
Jack Zoran of Raytheon Company, Jack is the brother  
of former member K4BSS, The club president, K1PTY,  
read a letter of thanks from the police dept. for the  
club's participation in providing communication for the  
recent Jazz Festival, The club elected W1ACP and  
W1ACO to membership, W1YNE is mobile on 10 meters  
with an HE-45, K1PAM is mobile on 6 meters, K1KAZ  
has a new HQ-170, K1NEF is operating a new T-150  
transmitter, K1LNI has completed his new HW-30, K1-  
THE operates a Clogg 99er on 6 meters, Traffic: W1TXL  
611, K1NEF 358, K1TPK 81.

**VERMONT**—Acting SCM, E. Reginald Murray, K1-  
MPN—The Green Mt. Net meets on 3855 kc. at 2130Z  
daily; the Vt. Fone Net on 3855 kc. at 1300Z Sun.; the  
Vt. C.W. Net on 3520 kc. Mon., Wed. and Fri. at 2300Z,  
Congrats to K1WZD, who passed the Technician, and  
K1ZRD, who passed the Conditional Class exams, More  
Vermonters have moved to Connecticut: W1VSA (former  
SCM) and W1UCL recently joined the exodus, Vt.  
S.S.B.ers: Please note that 3855 kc. has been selected as  
a Vermont s.s.b. frequency (like 3855 is for a.m.ers)—no  
net has been set up yet until we see how much activity  
results, The antenna system of our top-notch v.h.f.er,  
W1MIN, was accidentally put out of commission, Green  
Mt. Net traffic: 61, Traffic: K1BQB 32, K1SLU 19, K1-  
MPN 13, W1LJF 5, K1RMG 5, K1YID 5, W1WZS 3, W1-  
HRG 3, K1VKN 3, W1PMH 1.

### NORTHWESTERN DIVISION

**IDAHO**—SCM, Raymond V. Evans, K7HLR—We  
regret to report the passing of the XYL of W7EMT,  
Carl, manager of the GEM Net, soon will be moving to  
Star, Congratulations to the Aberdeen ARC on its af-  
filiation with ARRL, Keep us informed as to the activ-  
ity, fellows, K7NHA is sporting a new HX-20, A new  
call in Twin Falls in KN7YSI, New officers of the Eagle  
Rock RC are W7DQU, pres.; K7PGG, vice-pres.; Tom  
Moss, secy.; W7GRU, treas, W7DMP, W7DQU and K7-  
UAE provided communications for the Equestrian Club,  
Doug Pearsall, VK2ASA, visited in the section and made  
a hit with everyone at the W1MU Hamfest, Next year's  
hamfest will be held under the leadership of W7RZY  
and K7CHO, The GEM Net and RN7 representation is  
being carried by about three stations How about some  
help? GEM Net Traffic 56, FARM Net Traffic 50, Traffic:  
W7EMT 66, K7OAB 29, W7GGV 20, K7HLR 16,  
K7NEY 9.

**MONTANA**—SCM, Walter R. Marten, W7KUH—  
Asst. SCM/LF PAM: Dr. Marvin F. Hash, W7YHS,  
SEC: K7AEZ, LF PAM: W7TYN, RM: W7FIS, En-  
dorsements: K7OGP as OO and OBS, OO reports were  
received from K7VMJ and W7FIS, The Montana S.S.B.  
Net was organized Aug. 5 and meets Mon., Wed. and  
Fri. on 3910 kc. at 1800M, K7EWZ is doing a fine job of  
handling traffic on RN7 on 3560 kc. at 6:30 and 8:30  
p.m. The 29th Annual Glacier-Waterton International  
Hamfest was held at Waterton Park, Alberta, Programs  
were in charge of VE6ZI, hamfest president, W7IBG,  
auctioneer for 25 years, was presented with a memento,  
The pre-registration prize went to VE6UH; the grand  
prize to VE6CA, K7KME is the new general chairman  
with K7BYB, 1st vice-pres.; W7BKM, 2nd vice-pres.;  
W7SNY, 3rd vice-pres.; K7LMZ, 4th vice-pres.; K7-  
PGO, secy.; W7YHS (new 3 year term), director, At-  
tendance was 581, of which 220 were registered hams,  
The W1MU Hamfest was held at Big Springs with 153  
registered hams, VK6ASA was auctioneer, The new  
chairman for 1964 is W7RZY with K7SVR, vice-pres.;  
The Helgate Radio Club held a Western Montana  
Combined Ham Picnic at Big Arm State Park, Only 191  
amateurs have their 1963 Montana amateur license plates,  
W7WRK is back on the air with a new s.s.b. transceiver,  
W7GCS was chief cook and bottle washer while his wife  
was in California, The following stations are on the air  
with mobile s.s.b. transceivers: W7CDG, K7PKV, K7-  
PKW, W7PGZ, W7KUH, K7DTK, W7FTO, W7DXK,  
W7SWW, W7AYG, W7OIQ, W7AU, K7MUM, K7ISW,  
W7ELY now is on with new s.s.b. equipment, W7VLZ  
is active again after repairing his antenna, W7JGG re-  
turned from a vacation trip to Minnesota, W7CGG, Sid-  
ney EC, moved to Helena, W7DSS was awarded a  
plaque at the hamfest for managing the hamfest money

(Continued on page 142)

# Build the best ham shack in town with



2 great transmitters plus a series of instruments that provide top flight performance, at lowest cost

**Eico 720 90-Watt CW Transmitter** 'clean' 90W, CW, 65W, AM/Phone with EXT plate modulation. 80 through 10 meters. Kit \$89.95; wired \$129.95.

**Eico 723 60-Watt CW Transmitter** 'clean' 60W, CW, 50W, AM/phone with EXT plate modulation. 80 through 10 meters. Kit \$59.95; wired \$89.95.

**Eico 722 Variable Frequency Oscillator** (self powered). Approaches crystal stability. 80 through 10 meters. Kit \$44.95; wired \$59.95.

**Eico 706 Transistor Code Practice Oscillator** Select variable tones, flashing light or both together. Phone jack for private use. Clean, loud signals. Kit \$8.95; wired \$12.95.

**Eico 730 High-Level Universal Modulator-Driver** Delivers 50W undistorted audio for phone operation. Can plate-modulate Xmitters with RF inputs up to 100 W. Unique over-modulation indicator. Kit \$59.95; wired \$89.95. E-5 Cover; \$4.50.

**Eico 710 Grid-Dip Meter** Continuous coverage 400 kc to 250 mc. 500  $\mu$ a meter. Includes complete set of coils for full band coverage. Kit \$29.95; wired \$49.95.

**Eico 430 General Purpose 3" Scope** Compact, portable, lightweight. Flat-face CRT; sharp, bright trace. Flat from 2 cps to 500 kc, 25 mv/cm sens. (vert.); 2 cps to 300 kc, .25 v RMS/cm sens. (horiz.). Easy, direct connections to CRT vertical plates. Kit \$65.95; wired \$99.95.

USE  
THIS  
COUPON

Q5-10

**EICO ELECTRONIC INSTRUMENT CO., INC.** 3300 Northern Blvd., L.I.C. 1, N. Y.

<input type="checkbox"/> Send free Catalog & name of neighborhood distributor.	Name _____
<input type="checkbox"/> Send free "Short Course for Novice License."	Address _____
<input type="checkbox"/> Send 36-page STEREO HI FI GUIDE: 25c enclosed for postage and handling	City _____ Zone _____ State _____

Add 5% in the West

# BARRY ELECTRONICS

**NATIONAL NCX-3 Tri-Band SSB Transceiver. \$369.00.**  
**NCX-A POWER SUPPLY FOR NCX-3 (115 VAC @ 60 CPS) \$110.00.**  
*In stock:* Collins 75S1A \$650.00; Collins KWM-1 with Collins A.C.S. \$425.00.  
**HAMMARLUND SP-600JX-17 \$475.00.** Other SP-600's... write)  
**GONSET G-43 All Band Receiver.** (Reg. \$159.50). Special \$89.50 (like new).  
**DRAKE 2B Receiver \$279.95;** Drake 2-BS Speaker \$16.95; Model 2-BQ Q-Multiplier & Speaker \$39.95.  
**HAMMARLUND HX-50 with ZBZ \$483.90;** HO-110AC \$259.00; HO-170-AG \$379.00.  
**HAMMARLUND HK-1B Electronic Keyer \$39.95;** HO-180AC \$449.00; HXL-1 Linear Amp. \$395.00.  
**COLLINS AM-1526/URC... ARC 58 I.F. Strip. \$49.00;** Central Electronics GC-1 Gated.  
**COMPRESSION AMPLIFIER \$39.00;** NATIONAL RDZ-1 (220 to 400 Mcs Receiver). 115 VAC @ 60 CPS \$50.00.  
**JOHNSON TYPE "L" BUTTERFLY CAPACITOR.** 4.3 to 26 Mmfd per section 95¢.  
**JOHNSON TYPE "L" MINIATURE CAPACITOR** 3.5 to 27 Mmfd. 75¢.  
**GENERAL RADIO 50-B VARIAC.** Input: 230 VAC (7 KVA) @ 60 CPS; Output: Variable from 0-270. r/e \$80.00.  
**PLATE TRANSFORMER:** Pri: 220 @ 50/60 CPS with 4 taps. Sec: 2550-0-2550 @ 550 Ma. Test: 11.5 KV. \$75.00.  
**JOHNSON 25 WATT BAYONET SOCKET** for 866, 3B28, etc. 65¢.  
**HAMMARLUND 320-320 Mmf. Dual Xmtg Capacitor.** Fully-meshed spacing: .087". \$4.25.  
**SPRAGUE OIL CAPACITOR. 1 Mfd @ 2,000 VDC. \$1.00.**  
**LARGEST DIVERSIFIED TUBE STOCK IN THE USA!**... Here are some types. Write or call on other needs. 465A @ \$10.00; 4-1000A @ \$95.00; 4CX300A @ \$42.00; 4CX1000 @ \$120.00; 4E27 @ \$8.75; 3B28 @ \$2.50; 811A @ \$3.75; 812A @ \$3.75; 816 @ \$2.50; 830B @ \$1.00; 866A @ \$1.65; 872A @ \$4.75; 1616 @ \$1.00; 5514 @ \$6.95; 5842/417A @ \$5.90; 5847/404A @ \$3.90; 5894 @ \$18.90; 6146 @ \$3.25; 6360 @ \$3.90; 6383 (RCA) @ \$25.00.  
**SALE - Porcelain Insulator:** 4 1/4" L. 1 1/2" Diam. Center-to-center dimensions of holes: 3". Ten for \$1.00, 100 for \$8.00.  
**GUSH CRAFT BLITZ BUGS:** Type LAC-1 @ \$3.95; Type LAC-2 @ \$4.45; type LAC-2N @ \$5.95.  
**SALE Clegg 99'er: \$135.00;** Clegg Zens \$595.00.  
**GLEGG INTERCEPTOR: @ \$389.00.**  
**JOHNSON VIKING II RANGER - Factory Wired.** 6 thru 160 Meters. 75 Watts CW/65 Watts AM. \$359.50.  
**4 VOLT 500 MA. POWER-TAPPED @ 50 A. Transformer:** Pri: 115 VAC @ 60 CPS. 28 lbs. \$27.00.  
**83 Tube Aircraft Electronic Gun Control.**... Excellent for spare parts... Contains many precision parts for the experimenter. Tubes include (1) 0A2, (1) 21D21, (1) 6AQ5, (2) 6AH6, (1) 6AS6, (2) 616, (5) 6X4W, (2) 12AT7, (5) 12AX7; (2) 6654, (4) 5670, (1) 5725, (3) 5726; (8) 6005/6A35W. Parts include (1) tube 3D Mc I.F. Strip, 28 V.A. sealed relays, (11) Potentiometers, (5) BNC chassis connectors 5 & 10/2, Allen Bradley resistors. Metalized paper capacitors, silver mica capacitors, 1% precision resistors and many other parts too numerous to mention. Good used condition. Wt: 35 lbs. Cat. 11-APG3, F.O.B. warehouse, Ga. \$11.95... Or \$14.95 postpaid in 48 states.  
**RME 900 RECEIVER (CW/SSB, AM).** Coverage: 80, 40, 20, 15 and 10 to 5 bands plus 10 to 11 Mc for WWV or WWVH. \$369.00. RME6901 Matching Speaker: \$19.50.  
**CLOSED CIRCUIT T.V. CAMERAS:** Grundig, type Fernauge FA 40, high definition. W/115 VAC 60 cycle power supply, Excel. cond. lab checked. Comes with one lens, photostat of book. \$595.00.  
 Tripod for above @ \$35.00. RCA 6198 VIDICON - \$100.00.  
**SYLVANIA CLOSED CIRCUIT TV CAMERA.** W/8 1/2-in 115 VAC 60 Cv. Power Supply. Excel. cond. lab checked. No book. \$495.00.  
**WRITE FOR #11 Midsummer/Fall "Green Sheet" Cat. alog.** COME IN AND BROWSE. MON. TO FRI. 9 to 6. Saturdays 10 to 2 P.M. (free parking Saturdays on Street). Mon. to Fri. Parking at Garage 501 Broadway. (We buy and sell and swap as well... let's hear from you!)

**BARRY ELECTRONICS DEPT. Q-10**  
**512 BROADWAY, NEW YORK 12, N. Y.**  
**WALKER 5-7000 (AREA CODE 212)**

Enclosed is money order or check and my order. Prices FOB NYC. Shipments over 20 lbs. will be shipped collect for shipping charges. Less than 20 lbs., include sufficient postage. Any overage will be refunded. Fragile tubes shipped via Railway Express.

Send copy of new 1964 "Green Sheet" Catalog.  
 Send information.  
 I have available for trade-in the following.....

Name..... Title.....  
 Company.....  
 Address.....  
 City..... State.....

for approximately 25 years. K7EGJ is retiring from the Montana Power Co. W7DEO is back in Great Falls. W7FGZ has installed mobile in his new car. ARRL membership increased 15 per cent in Montana during the past year. K7PKV is on a vacation trip to California. K7NRR is awaiting a new s.s.b. rig. K7JXL repaired his transmission line to his inverted "V" antenna. W7CK and K7CCZ are installing new mobile rigs. Traffic: K7EWZ 147.

**OREGON**—SCM, Everett H. France, W7AJN—Do not expect to be back from vacation in time to meet report deadline. CU next month's issue of QST, Ev.  
**WASHINGTON**—SCM, Robert A. Thurston, W7P9Y—Asst. SCM/SEC: Everett E. Young, W7HMQ, RAI; W7ATB, PAM; W7LFA, Washington Section nets are W7ARTS, 3970 kc.; WSN, 3535 kc.; ESN, 3920 kc.; CBN, 3960 kc.; NSN, 3700 kc. Approximately 160 attended the Washington Amateur Radio Traffic System (WARTS) picnic held at Cougar Inn on the upper end of Lake Wenatchee July 13-14. First prize went to the family of K7OOM and the second prize was won by K7COD. The Amateur Operators in Tacoma received a lot of very fine publicity for their activity during the two and a half million dollar waterfront fire July 14. At one time there were 17 mobiles standing by besides the ones working at the fire. K7GUN has moved to Albuquerque, New Mex. Aug. 24-25 the gang at W7DK made a week-end trip to the beach place of W7LIR at Westport. W7CMO has his beam up to the 80 ft. level now. W7RGL spent a week on Ediz Hook where the big salmon are running. Paul also is working and rebuilding his center fed zepp. He has two 50-ft. masts to erect. The Skagit Bar-B-Q was held Aug. 24 at Bomans Bay. W7REC was chief op on the BBQ pit. K7PIG has his Ranger back and says he will be a regular check-in on WSN again. W7CZY sends Official Bulletins on RTTY on 3637 kc. Mon., Tue. and Wed. at 0500Z. W7JEY spent his vacation in B.C. K7CTP turned in a good traffic count and made his first RPL card. A new ORS is K7CFH and a new ORS is K7SRI. K7OFX is trying to swap his TX-1 and HQ-160 for an s.s.b. transceiver. W7MIDA finally got his r.f. generating in the Richland area. K7CDD blew his DX-100 sky high. K7ICQ has his complete station for sale. Bob is going to the U. of W. in the fall. W7OEB worked 199 stations in seven hours of operation during the recent CD Party. Ev and family headed south to W6-Land for a vacation. K7NIH and XYL K7VSD attended the Waterton Hamfest in VE6-Land. K7PWW and K7NVGI returned from a short stay in K7-Land. W7AMC is about ready to give his 160-meter rig the smoke test. The ARAB of Bremerton will in all probability change its meeting place to the Red Cross Bldg. when the e.d. moves to the court house. W7AIB spent the entire month operating portable from a cottage on the shores of Puget Sound near Sequim. Hap also has the bugs out of the TCM-2 and has a nice big spare rig good for 300 watts. K7JRE received CFC No. 985 and has worked ten states on 40 meters with the 6V6 running 5 watts. K7EY has the receiver back and active again. Al also modified his transmitter so break-in could be used. W7HMA is preparing for a cruise in Canadian waters and has obtained his radio permit. Two new General Class licensees located in the Bremerton area are K7VVC and K7VUZ. W7BTB is trying out the new 40-meter quad. K7NHG handled traffic for a scout group camping on Orcas Island. Traffic: W7BA 2105, W7DZX 914, K7CPT 784, W7APS 845, K7JHA 326, K7-RSD 183, W7OEB 169, W7AMC 38, W7CBO 38, K7JRE 32, K7EY 29, W7IEU 14, W7BTB 13, K7WB 4, W7-EVW 4, K7NHG 4.

## PACIFIC DIVISION

**NEVADA**—SCM, Leonard M. Norman, W7PBV—SEC: W7JU, K7SLU is on the air in Sparks. K7JVZ and K7CJZ are running low power on 80-meter c.w. with great success. The Powder Puff Derby communications were handled by the LVRAC. K7ADD has an SBE-33 in his auto now. W7OYC is doing fine after a few days in the hospital. K7PPE and family moved to a new QTH complete with tower and antennas. K7NVC is in KH6-Land. K7QHJ is in Montana for the summer. K7-TNY is the new team. of the LVARC, and the membership now totals 95. The new e.d. RACES officers for the Southern Nevada area plan are W7TGK, Boulder City; K7PPE, Las Vegas; K7RKH, North Las Vegas; W7-YDX, Henderson, K7ICW reports better v.h.f. and u.h.f. conditions than last month and has more rebuilding projects underway. W7YYC is off to KG6-Land for a few months. W7MWF has moved back to Las Vegas. W7HQS enjoyed a lot of 2-meter contacts in the LA area while on vacation; 2-meter contacts here are few and far between except with the old stand-bys. Traffic: W7-PBV 2.

**SANTA CLARA VALLEY**—SCM, Jean A. Gmelin, W6ZRJ—Asst. SCM: Ed T. Turner, W6NVO. SEC: WA6EIC, RM; K6KCB, PAM; WA6HVN, V.H.F. PAM: WA6RHH. Members of the San Jose C.D. Net participated in a special drill with Santa Clara County  
 (Continued on page 144)



# Fun with photoconductors

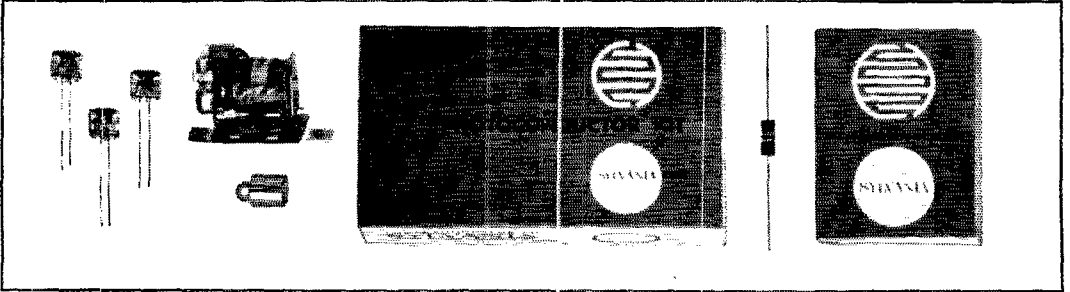

No self-respecting Ham ever uses manual control when he can do the same job with banks of tubes and relays. It's a way of impressing visitors. And it's fun.

To add to the fascination of doing simple things the clever way—and in many cases, the best way—we've brought out a Photoconductor Kit containing all the basic components required for a wide variety of measurement and control circuits activated by light.

As you more than likely know, a photoconductor is a resistor whose ohmic value changes with light intensity. In total darkness, the resistance can be as high as 2 megs, and as low as 10 ohms under optimum light intensity. It's 1,000

times more sensitive than the photovoltaic cell and up to 1,000,000 times more sensitive than ordinary photoemissive types. And, because the photoconductor will dissipate as much as 300 milliwatts, it can be used to operate a relay directly.

The basic relay control cir-

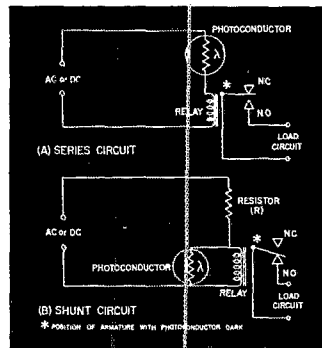

Fig. 1

uits are shown in Fig. 1. In circuit A, the relay opens when the photoconductor face is stimulated by a proper light source. In circuit B, the relay remains energized in the absence of light on the photoconductor.

You could take it from there. But we've included a 52-page circuits booklet in the kit that casts a lot of light on the number and variety of control and measurement schemes you can cook up...such as a transmitter tuning indicator, a noiseless volume control, and an AF automatic gain control.

The Sylvania PCK-10 Photoconductor Kit is now available from your Electronics Distributor\*...so why not start inventing something?

73,

*Bob Lynch*

K2RMN

# SYLVANIA

SUBSIDIARY OF  
GENERAL TELEPHONE & ELECTRONICS



\*Or send \$9.95 (plus 50 cents handling charge) to Dept. PCK-10, Sylvania Electric Products Inc., 1025 Westminster Drive, Williamsport, Pa., and we'll send the kit postpaid.

# New

## POSTPAID!

### ALL BAND VERTICAL

#### WRL

### WVG MARK II

New low cost vertical antenna which can be tuned to any amateur band 10-80 meters by simple adjustment of feed point on matching base inductor. Efficient radiator on 10, 15, 20, 40, 75 and 80 meters. Designed to be fed with 52 ohm coaxial cable.

Conveniently used when installed on a short 1-5/8" mast driven into the ground. Simple additional grounding wire completes the installation. Roof top or tower installation. Single band operation ideal for installations of this type. Amazing efficiency for DX or local contacts. Installed in minutes and can be used as a portable antenna.

#### Mechanical Specifications:

Overall height - 18' Assembled (5' Knocked down)  
Tubing diameter - 1 1/2" to 2 1/8". Maximum Wind - Un-guyed Survival - 50 MPH.  
Matching Inductor - Air Wound Coil 3 1/2" dia. Mounting bracket designed for 1-5/8" mast. Steel parts irridite treated to MILS Specs. Base insulator material - Fiberglass impregnated styrene.

#### Electrical Specifications:

Multi-band operation - 10-80 meters. Manual tap on matching inductor. Feed with 52-75 ohm line (unbalanced). Maximum power - 1000 watts AM or CW-2KW PEP. Omni-directional. Vertically Polarized.

### WRL WORLD RADIO LABORATORIES

3415 West Broadway  
Council Bluffs, Iowa

Check enclosed.  Ship one WVG MK. II @ \$15.95 Postpaid.

Name \_\_\_\_\_

Call \_\_\_\_\_

Address \_\_\_\_\_

City \_\_\_\_\_

State \_\_\_\_\_

### WVG MARK II

### \$15.95

RACES, W6CER, with much success. The Santa Clara Valley Section Net reports 19 sessions, with 103 check-ins and 23 traffic. The Northern California Net increased traffic by over 50 per cent for the month of July, which is outstanding for this time of year. BPL members this month include W6RSY, K6GZ, W6JNK and WA6OLQ. W6RSY reports he is now member No. 408 in the "Old-Timers Club." W6JNK is active on NCN and NTS as well as Navy MARS traffic. WA6OLQ is looking for someone with whom to play on-the-air chess. W6AIT is active on NCN, RN6 and PAN. W6YBV works the swing shift so only has week ends for traffic work. OPS K6VQK reports that the Monterey Bay Radio Club had a booth at the County Fair in August. K6DYX is busy with the RATTs Net and is now OBS with ARRL Official Bulletins on RTTY. W6DEF fills many spots as NCN NCS during the summer. W6HC spent vacation time in the Mother Lode country and visited several clubs as Division Director. W6AUC maintains regular skeds with Hawaii, Alaska and Virginia. W6AH installed a new tower for beams on 40, 20, 15 and 10 meters. W6PLS was hospitalized during July but is back on his feet now and enjoyed the July CD Party. K6EQE is active on MTN. K6TEH reports that the Salinas Valley Red Cross Radio Club has been organized with K6JHK, pres.; WA6TKE, vice-pres.; the RC director as Secy., treas. and himself as RO and trustee. K6MTX finished a new RATTs terminal unit. W6PLG is busy with Navy MARS. WA6HVN reports that the San Jose Red Cross now has a communications van for the amateur group complete with RTTY and flip-top gear. Hal seriously injured his hand in June but is recovering nicely. W6CBX is busy with the SARO but finds time for OO activity. W6YCL has acquired the basic RTTY equipment for Project Osear work. Bob is communications director. WA6HYM, Bob, Jr., spent time in Marine Corps training and says it was lots harder than hamming. W6ZRJ now has a Boehme keyer and a perforator. Regular OBS section skeds are now held on 80-meter c.w. Check with your local club or W6ZRJ for times and frequencies. Traffic: (July) W6RSY 908, W6JNK 903, WA6OLQ 625, K6GZ 470, W6AIT 98, W6YBV 82, W6DEF 57, W6HC 54, W6AUC 49, K6VQK 31, K6DYX 18, W6ASH 15, W6PLS 8, W6RFB 8, (June) W6JNK 285, W6AIT 93, WA6OLQ 67, WA6HVN 20, W6ASH 11. (May) W6JNK 187, W6ASH 16, K6VQK 6.

**SAN FRANCISCO**-SCM, Wilbur E. Bachman, W6BIP-EC: W6KZF. EC copy. "RACES renewals no longer require a notary witness. Use FCC Form 481-1 of July, 1962. Others are obsolete. Keep your RACES Net active in the Public Interest or Necessity Program." Silent Key: K6TPX, Bob Kodak of Scotia, died suddenly of a heart attack. The BAYLARC girls and other friends extend deepest sympathy to WA6ISB, Pat, his XYL, W6YKS has moved to Fortuna, Ellen, the XYL of W6SLX, is improving and getting about with limited speed and range. W6ZSE still is in the hospital in a serious condition. K6NCG had 15 operators and 3 transmitters on emergency power at Harbor Point on Field Day. The station custodian reports there are no AREC members in its ranks. The CCRC meeting was held at the QTH of W6LGW, in Alamo. The HAMIS (Red Cross club) had a work party recently, put up a new long-wire antenna, checked the condition of 6- and 2-meter antennas, installed antenna and mike lines to the MARS rig, and painted and cleaned up the club room. W6KGC will be pres. of the Mission Trail Net for the next year; WA6CKR, vice-pres.; WA6JFB, secy.; W6WOU, treas.; and W6KVQ EC. The CCRC Net meets on the air the 3rd Wed. of each month at 8 p.m. on AREC net frequency 3900 kc. Congratulations to WA6PKX and W6NROZ on their recent wedding. WA6QCR and WA6QFV now are in a new QTH. K6ANP was speaker at the Tamalpais Club meeting and spoke on his and W6HVN's trip to Ensenada. WA2JMX, of Treasure Island Naval Station, promises to send BIP reports each month and requested that the club station have OES forms. BAYLARC News: Congrats to Jan and Alan Childs on the birth of jr. operator James Alan; to Fred Leif, jr. operator of WA6OGK and W6WTL, on being awarded the Eagle Scout Badge, the highest rank in scouting; to WR6BSA, a new member; to W6OTV and his XYL on the birth of son. The girls also report that the recent club picnic was a huge success. The S.F. Club had the movie "Capacitors." The club reports that it will no longer print letters in the club paper unless the writer signs his name with editorial. Traffic: K6TWJ 30, W6PZE 24, WA6UHN 5, W6GGC 2, WA6QXV 2.

**SAN JOAQUIN VALLEY**-SCM, Ralph Saroyan, W6JPU-On July 4, 1963, WA6LIU, W6QOE and WA6ESH assisted Z62NR in reporting a plane crash to WA6UUD, who in turn reported to the Coast Guard in National City. K6FIM was a recent visitor in Fresno, visiting his brother, W6JUK, WA6ZGQ has a Swan Tri-band. New officers of the Tulare County Radio Club are WA6EDQ, pres.; W6OHT vice-pres.; WA6OJJ, secy.; WA6OQE, act. W6SVM is a lookout in the High Sierras and is on 6 meters working into Fresno. W6BAN

(Continued on page 148)

# start right stay right with **HEATHKIT**

Here's the low cost,  
high quality set-up  
you need to begin  
your new hobby  
of Amateur Radio . . .

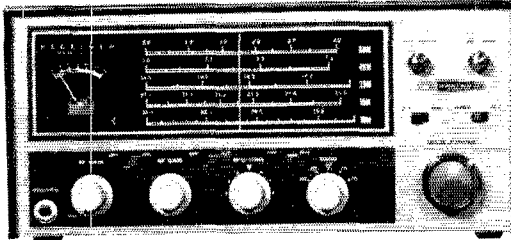

## HR-10 RECEIVER

• Covers 80 through 10 meters • Tunes SSB, AM & CW signals • Prebuilt, prealigned tuning assembly • RF stage for extra sensitivity • Lattice-type crystal filter for high selectivity

An ideal novice receiver! Easy to build with preassembled, aligned tuning unit, and precut, cabled wiring harness! Versatile controls, large slide-rule dial, built-in "S" meter for easy tuning, built-in BFO for SSB & CW reception and a host of other high performance features to delight any amateur radio fan! Features amateur band coverage only for maximum accuracy and stability. Provision for plug-in 100 kc crystal calibrator. 7-tube superheterodyne circuit. A perfect style & performance mate to the DX-60 Phone & CW Transmitter!

Kit HR-10...20 lbs...\$8 mo... **\$79.95**

Kit HRA-10-1, Plug-in 100 kc crystal calibrator. 1 lb..... **\$8.95**

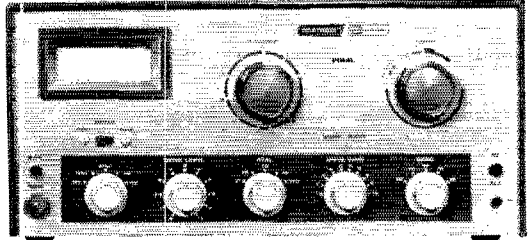

## DX-60 TRANSMITTER

• 90-watts phone or CW on 80 through 10 meters • Neutralized 6146 final amplifier • Built-in low pass filter • Operates at reduced power for novice operation

An exceptionally fine transmitter for the novice! Provides CW operation at the novice power limit and AM operation later as a general class license holder. Clean, rugged construction, high quality components, and easy to follow instructions make assembly an easy, fun-filled task. Controlled-carrier modulator and power supply are built-in. Single-knob bandswitching and Pi-network (coaxial) output provide for complete operating convenience. Panel meter monitors final grid or plate current for easy tuning. Less crystals.

Kit DX-60...24 lbs.... **\$79.95**  
\$8 mo.....

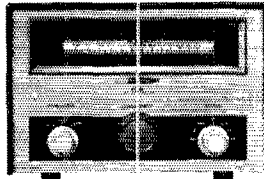

## HG-10 VFO

• 80 through 2 meters coverage • Plugs into DX-60 for general class operation • A tremendous savings over crystals for similar coverage

This high quality Heathkit VFO requires only plug-in connection to the DX-60 Transmitter to tune any frequency, any band for complete amateur coverage. Beautifully designed throughout for years of top-notch performance & high stability. 12 lbs. Kit HG-10 \$5 m.o.... **\$34.95**

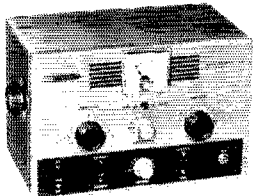

## WANT CW ONLY? ... USE THE HX-11

Specially designed for CW work! Efficient circuitry provides 50-watt plate power input for outstanding amateur communications. Covers 80 through 10 meters. Features built-in low pass filter, neutralized final amplifier, switched antenna relay power, pi-network output coupling and panel meter. Husky built-in power supply. Single knob bandswitching. Kit HX-11...18 lbs...\$5 mo..... **\$43.50**



HEATH COMPANY, Benton Harbor 9, Mich. 49023.

Please send free 1964 Heathkit catalog.  
 Enclosed is \$ \_\_\_\_\_, plus postage send \_\_\_\_\_

NAME \_\_\_\_\_  
(please print)

ADDRESS \_\_\_\_\_

CITY \_\_\_\_\_ ZONE \_\_\_\_\_ STATE \_\_\_\_\_

**HEATHKIT-1964**

**FREE 1964 CATALOG**

Fully illustrates over 250 different Heathkits at money-saving do-it-yourself prices. Choose from a complete line of "mobile" or "fixed" station amateur gear and accessories at savings of 50% or more!

# P & H "Spitfire"

**KILOWATT MOBILE  
(or fixed)**



## LA-500M LINEAR AMPLIFIER

- \* 1000 WATTS PEP POWER
- \* SINGLE KNOB TUNING
- \* BUILT IN ANTENNA SWITCHING
- \* 6 TUBES IN GROUNDED GRID
- \* LOW TUBE REPLACEMENT COST
- \* CHROME PLATED CABINET 3"X12"X15"
- \* REQUIRES 900 to 1200 VDC AT 500 MA AVERAGE - 1 AMP PEAK
- \* AIRCRAFT TYPE METER ILLUMINATION

**PRICE \$189.95**

Amateur Net

**Available NOW**

Thru Your Distributor

Power Supplies For LA-500M

Model PS-1000 115 V.A.C. For Fixed Station \$119.95

Model PS-1000B 12 V.D.C. For Mobile Station \$179.95

**P & H ELECTRONICS, INC.**

424 COLUMBIA STREET • LAFAYETTE, INDIANA

## 10-15-20M QUADS

\*PRE-CUT      \*PRE-TUNED      \*TRIBAND

**\$59.95**  
Bamboo

**\$99.95**  
Fiberglass

- Rotate with TV Rotor
- High F/B Ratio
- Very Low SWR
- High Gain
- Low Q Broadly Tuned
- Easy to Match
- Low Wind Resistance
- Rugged Construction

Write for Free Literature  
Write Dept. A

**Skylane PRODUCTS** 406 BON AIR DR  
TEMPLE TERRACE FLA

is mobiling again on 75 meters. W6PPO has a Galaxie. W6PSQ is the area coordinator for Navy MARS. The 6-meter gang in Fresno is conducting transmitter hunts again every Mon. night on 50.2 Mc. WB6GJG is a new call in Kingsburg. K6ZCD is mobiling on 40-meter s.s.b. with an NCX-3. W6NKK is on 40-meter s.s.b. mobile. K6OER is heard on 6 meters. W6JUK is on 2-meter s.s.b. W6QON is thinking of a pair of 4-400s. W6CUA has a new car and is thinking of installing some s.s.b. gear in it. WN6GMW is a new call in Kernman. The new officers of the San Joaquin Valley net are K6GDS, pres.; K6OJJ, net mgr.; W6KHH, asst.; WA6VAX, secy. K6AXV has an HBR-10 receiver. The Delta Radio Club Annual Picnic will be held Sept. 8 at Lodi Lake Park for members and their families. K6UBJ has a Swan Triband. Keep those reports coming in. Traffic: WA6-ESH 43, WA6VPN 30, W6ARE 12, K6AXV 3, K6OLN 3.

## ROANOKE DIVISION

**NORTH CAROLINA**—SCM, Barnett S. Dodd, K4-OFV—Asst. SCM: Robert B. Corns, W4FDV, SEC: W4MFK, RM: WA4FJM, PAM: K4ODX, V.H.F. PAM: W4BUZ, Nets: NCN, 3547 kc. 2330Z, CCEN, 3907 kc. 0000Z, THEN, 3865 kc. 0300Z, NCSN, 3612 kc. 0300Z. In July the CCEN held its annual picnic and business meeting at Manteo, where we met all the gang and had the pleasure of meeting and enjoying an eye-ball with Roanoke Division Director Andy Anderson, W4MWH. The NCN(NCSN) teamed up with the Carolina V.H.F. Society and held its annual picnic and business meetings at Salisbury. Some of the NCN/NCSN gang are getting on v.h.f. maybe a v.h.f. c.w. traffic net, huh? The 6-meter F.M. gang held its annual picnic at Tanglewood, near Winston-Salem, and were sorry that we had to miss that one. Received a very comprehensive report on v.h.f. net organization potential from W4BUZ. Hearty congratulations to WA4PDS/WA2WBA/4, W4EJQ/4 and K4CDZ on making the BPL. K4EX reports the N.C. Chapter of CHC granted charter No. 22. Anyone interested, contact W4EJQ. W4COJ reports increased activity in v.h.f. AREC/c.d. nets. W4OAB worked all call areas, Cuba, Puerto Rico, VE4 and VP7 on 6 meters in a three-day period. NCN traffic was 314. Traffic: (July) WA4PDS/WA2WBA/4 711, W4EJQ/4 653, K4CDZ 230, K4LWZ 147, WA4FJM 98, WA4ANH 65, K4EX 64, WA4DAA 58, K4YJY 47, K4QDO 45, W4EJP/4 24, K4-MPE 19, K4WLV 17, W4COJ 13, K4QFV 13, W4BAW 12, W4AETS 12, W4MUP 9, K4EO 6, K4SWN 2, (June) W4-EVN 126, WA4DAA 23.

**SOUTH CAROLINA**—SCM, Lee E. Worthington, K4HDX—SEC: W4BCZ, RM: W4PED, S.S.B. PAM: K4JOQ, A.M. PAM: K4KCO, Nets: C.W., 2400Z and 0300Z, 3795 kc.; A.M., 0100Z, 3930 kc.; S.S.B., 0100Z, 3914 kc.; AREC, 2400Z, 3914 kc. Wed. Our congratulations to three newcomers to the C.W. Net—WA4GPU, WA4ICO and WA4LPV. These men are doing an excellent job of traffic-handling and assuming net control duties. One of these, WA4LPV, held the highest QNT for July with 81 per cent representation. W4YIW reports July 6-meter openings were frequent and he worked VP7, VP9 and CO2. Leroy now has 42 states toward WAS 6 meters. A newcomer on 6 and 2 is K4VCA, in Greenville. W4JA is the latest Official Observer to be appointed in the state. Gil has served as OO in both W1- and W3-Land and should be a fine addition to the S.C. group. S.S.B. Section Net certificates have been awarded to WA4ECJ, WA4BSO, K4JVV, W4WQM, W4-FFH, W4KOH, K4LNJ, W4MTK, K4VVT, W4UJB, WA4AMI, K4ZLW, K4BAM, K4WJU, K4NUG, and WA4EFP. Net traffic: C.W. 113, AREC 5, A.M. 20, Traffic: K4LND 120, K4WJR 69, K4OGU 41, W4PED 39, W4AKC 33, WA4LPV 33, WA4GPU 29, K4VVL 23, W4-NTO 13.

**VIRGINIA**—SCM, Robert L. Follmar, W4QDY—Asst. SCM/SEC: W4SHI, RMs: W4LK, K4ITV, W4SHJ, W4QDY, Nets: C.W. VSN and VN on 3680 kc. at 2330 and 0000 GMT, respectively, VFN, 3885 kc. 0000 GMT and VSN, 3935 kc. 0200 GMT. K4ORQ is leaving for PK-Land for a 3-4 year tour of duty. W4JUJ picked up VQ8 and PX1 for 2 new countries. W4MXU has installed 12 different antennas since moving into the new QTH 4 months ago and still is trying to find a good one! WA4-EUL has rig troubles but hopes to get them ironed out. W4NVX is building a new 3-kw. antenna tuner similar to the "Matchbox." W4PTR was so busy with net assignments that he missed out on the CD Party. W4TE and W4ZM are working hard for the Atlantic Division Convention. (4s in 3-Land). W4FXD enjoyed the CD party in small "whiffs" instead of a great big "drag." K4SDS reports the VSN a good source of traffic for relay. Up Owens, Va., way, K4SGQ is using poor man's rig (small stuff) while his main gear is being overhauled. K4TZF is DJ at his local radio station. The XYL of W4TE was in Japan for three weeks. W4MK visited W7-Land for a couple of weeks. The new Universal antenna is working like a charm, says W4RHA. K4VVT managed to double his traffic total even though he missed

(Continued on page 148)

# KEC's Mechanical Filter

for all purposes... especially in SSB

Needle-sharp selectivity  
 Compact, lightweight  
 Extreme stability  
 Inexpensive

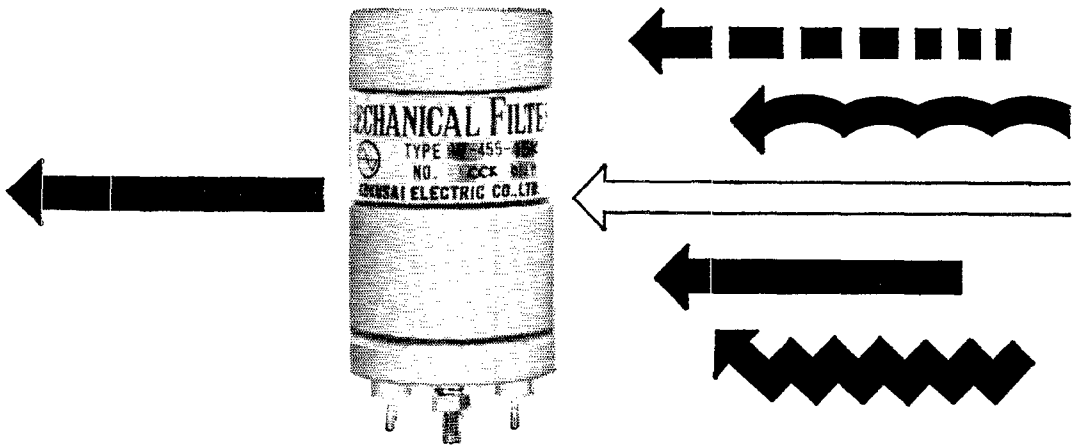

**\$19.95**

Type	6 dB deviation bandwidth	60 dB deviation bandwidth
MF 455-10K	More than 2 KC	Less than 7 KC
MF 455-15K	More than 3 KC	Less than 9 KC

## HENRY RADIO STORES

11240 West Olympic Blvd., Los Angeles 64, Calif. Ph: GRanite 7-6701  
 931 North Euclid Ave., Anaheim, Calif. Ph: PRospect 2-9200  
 Butler 1, Missouri. Ph: ORchard 9-3127



**KOKUSAI ELECTRIC CO., LTD.**

Tokyo, Japan

# ROHN Superior Design

## CRANK-UP TOWERS

*Versatile • All-Purpose*

**ROHN Crank-Up Towers** are especially engineered for amateur and experimental use. They represent the finest, most practical towers of their kind available. ROHN Crank-Ups feature:

- (1) construction of welded steel;
- (2) hot-dipped galvanizing after fabrication throughout;
- (3) special roller guides between sections on SD & HD Series to eliminate friction for smooth raising and lowering.

Also, ROHN towers assure uniform structural strength **regardless** of tower extension from highest to lowest height! Available in 37', 54', 71', 88', 105' and 122' heights. Prices start at less than \$100.

Also available are ROHN communication and microwave, TV reception, amateur radio and general purpose towers for all heights to 800'; telescoping masts and roof towers; and complete accessories including microwave passive reflectors and lighting equipment.

WRITE FOR FREE LITERATURE AND FULL FACTS AS TO WHY ROHN CRANK-UPS ARE BEST! See for yourself before you buy.

### ROHN

*Manufacturing Company*  
P. O. Box 2000 • Peoria, Illinois

"World's largest exclusive manufacturer of TV-Communication towers - Representatives world-wide"

**BUY RIGHT — BUY CWO\***  
NO DOWN PAYMENT  
FINANCE CHARGES  
MONTHLY PAYMENTS  
TRADE-IN DEALS  
Just Plain CWO (Cash With Order)

Specials for OCTOBER

	Reg.	CWO Price
New GE 11" TV	\$ 620.00	\$ 99.95
Collins KWM-1, used	820.00	299.00
Collins KWM-1, new demo.	695.00	450.00
Hallcrafters HT-33	129.50	249.00
Cent. Elec. MM2, new	99.95	79.50
GE-Mod B Spl-Q Mult. new	195.00	75.00
Collins 312B4, new demo.	85.00	149.50
Collins CC-2, new		69.50

PROMPT DELIVERY ON TR-3, NCX-3, SR-150, SR-160, SBE-33, etc., etc., etc.

**WILLARD S. WILSON Inc.** (Est. 1920)  
403-405 Delaware Avenue Wilmington, Delaware  
Willard, W3DQ OCWA VWOA

2 weeks of the month. WA4GWD is losing his base station so is going mobile (tough on traffic work). K4NYO has 50 countries confirmed, 21 awards, and is more active in traffic than before. Everything is sold but the receiver, reports WA4HHP, but he will be back soon with 130 watts on 80-meter c.w. W4ZAU plans a boost in power. WA4FCS is the new VFN mgr. and W4TXB is mgr. of VFSB with W4JMA Asst. mgr. W4DLA worked HK4DP during the CD Party on 3.5 mc. Ye SCM and his XYL attended the Winchester Hamfest Aug. 3-4 and enjoyed it very much. Traffic: (July) W4-PFC 751, K4POA 572, W4PLA 564, W4RIA 234, K4PXY 219, W4JMA 141, W4LK 126, WA4FCS 122, K4WVT 121, K4ITY 117, W4LNU 98, W4ZM 94, WA4GWD 88, K4SDS 88, W4PTR 71, WA4EUL 58, W4SHL 42, W4QDY 35, W4JUL 22, K4GRZ 17, K4SGQ 16, W4NLC 15, W4-DVT 14, W4DUW 13, W4NVX 12, W4ZAU 12, K4DCU 11, K4NYO 10, W4TE 10, K4TFZ 10, WA4HHP 6, W4-MK 6, K4BAV 5, W4JXD 4, W4KX 2. (June) K4POA 270, W4JUG 5

**WEST VIRGINIA**—SCM, Donald B. Morris, W8JM—SEC: W8SSA, PAAL: K8EPI, RMs: W8CKX and W8JUE. West Va. nets: C.W. 3570 kc. at 0000; phone, 3890 kc. at 2330; PON. at 2215 on 3905 kc.; S.S.B. 3903 kc. at 0100. Thanks to PAM K8CFT and RM K8HID for their excellent work in the past. Let's give new PAM K8EPI and RMs W8CKX and W8JUE a lot of support. Centennial Showboat QSL cards and excellent amateur publicity speaks well for a job well done by many operators as the Showboat steamed through the state this past summer. A new Novice in Oak Hill is WN8JPC. W8DUW is a new EC and W8HZZ a new OO. WA8AZY, WA8GGI, WA8AYP have received General Class licenses. W8DUV, Kay, and K8MQB, Alice, received excellent publicity in newspapers for their contributions to ham radio. New members of the WACWV Club are K8RLC, K8YOD, K8CFT and W8HWX from Oregon, Ohio. Congratulations, The S.S.B. Net, with WA8CRW as net mgr., reports 9 sessions, 89 stations, 73 messages; Phone Net, 15 sessions, 389 stations and 93 messages. Traffic: (July) K8YFK 181, W8KEG/8 113, W8DUV 92, WA8FIC 88, WA8CKN 67, W8CKX 35, K8TPP 34. (June) K8YFK 171.

### ROCKY MOUNTAIN DIVISION

**COLORADO**—SCM, Donald Ray Crumpton, K0-TTB—SEC: W0SIN, PAAL: W0CXW, W0GNK, RMs: W4UGL/O, KOFDH. On July 14 the Denver AREC group journeyed to Idaho Springs to provide communications for the Annual Burro Race. For the information of the eastern hams, these little animals, better known as "Rocky Mountain Canaries," go over some of the most rugged terrain in our hills to carry out the old gold dust. In fact, they are the only thing that can get into some of the mines. We hate to have to report that W0IA is in the Army Hospital in Denver and will not be heard on the WX Net for awhile. K0ZSQ (XYL) received a well-deserved TWN certificate for her work. Congratulations, Val. Ham activities were down a little in July with the hot wx. K0RUR is a new Class I OO and reports he is ready to help you anytime. K0PKG is now NCS on the Columbine Net. A word for Ripley: Doc, K0BCX, is now heard on s.s.b. Traffic: W4UGL/O 407, K0ZSQ 190, K0DCW 128, K0QGO 117, W2VQSO 114, W0SIN 82.

**UTAH**—SCM, Thomas H. Miller, W7QWH—Asst. SCM, John H. Sumpson, W7OCX, SEC: K7BLR. The Beehive Utah Net (BUN) meets daily at 1930 hours GMT on 272 kc. for the purpose of handling traffic. Traffic in this net holds up and is cleared in spite of unfavorable band conditions. BRAT awards for July went to W7OCX, K7DJM, K7MIPQ, K7QGW and K7RGY. K7JVF reports that DX is especially good on 20 meters now that he has a new 73-ft. tower, beam and rotator. W7OCX is writing this column for W7QWH, who finished his special computer course at the Missouri School of Mines and plans to continue with this work this fall at the University of Utah and also head up the Mathematics Department at Westminster College. Before too long we may be referring to our SCM as Dr. Miller. When Tom gets back I hope all amateurs will submit to him a monthly activity report. Let us support our SCM 100 per cent. Traffic: W7OCX 174, W7VTJ 66, K7LIFV 12, K7MIPQ 10, K7QGB 10, K7SDF 4.

**NEW MEXICO**—SCM, Carl W. Franz, W5ZHN—SEC: K5QLN, V.H.F. PAM: W5FPB, 10-Meter PAM: W5WZK. The Albuquerque surprise AREC drill was a thing after the SCM's heart. That was a sneaky trick, Ike, but I'm sure they all got a kick out of it. My sincere congrats to the whole gang. The Yale ARC boys are getting set for AREC portable emergency operation. W5FQQ just got a new rig to cover complete field operations, two are about ready for their General Class licenses. About 70 hams attended the Annual July 4th Picnic at Los Alamos and all had the usual fine time. W5WZK soon will be on RTTY. Some talk of an Ama-

(Continued on page 150)

# Belden Wire and Cable for every ham application

service rated—quality controlled  
easy-to-use packaged lengths

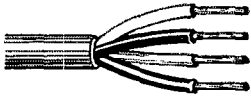

**Antenna Rotor Cables.** Sturdy, flexible, plastic insulated cable for all Ham antenna rotor applications. Color coded for easier hook-up. Chrome, vinyl plastic jacket resists sun and aging.



**Power Supply Cables.** Provide dependable service as power supply cords, interconnecting cables on electronic equipment, remote control circuits, special press-to-talk microphone circuits, and other ham applications. Designed for long service life with excellent mechanical and electrical characteristics, and uniform quality. Special jacket offers maximum resistance to abrasion and ozone.

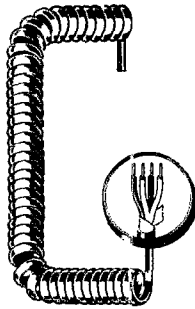

**Coiled Microphone Cable.** Provides low impedance for mobile microphone applications. Black neoprene jacket remains flexible at low temperatures. Available with or without shielded conductors.



**Shielded Hook-up and Grid Wire.** Provide most effective TVI suppression. Vinyl insulated with tinned copper braid shield. Available in wide range of capacities from 24 AWG to 12 AWG.



**Ham Transmission Lines—75 Ohm RG/U Type.** Designed for lowest losses, longer service life, and maximum dependability. Cables are essentially flat with no peaks in attenuation to reduce signal on either high or low frequencies.



**Ham Transmission Lines—Parallel Type.** Made with brown virgin polyethylene for best weather resistance and lowest losses. Uniform quality control prevents standing waves and mismatches.



Magnet Wire • Lead Wire • Power Supply Cords • Cord Sets and Portable Cord • Aircraft Wires • Electrical Household Cords • Electronic Wires • Welding Cable • Automotive Wire and Cable

# BIG SAVINGS ON NEW & DEMO HAM GEAR

**TRADE-INS ACCEPTED**  
On Ham Gear, CB Marine  
Electronics & Hi-Fi equip.

**TIME PAYMENTS**  
Up to 24 months  
to pay

**PARTIAL LIST OF DEMOS WITH 90  
DAY PROTECTION POLICY ON PARTS**

National NC-270... \$165.00	Johnson 6N2..... \$89.95
Globe Sidebender... 69.50	EICO 730 Wired.... 49.95
Globe Chief..... 39.95	Heathkit AT-1..... 19.95
National NC-98.... 74.95	Heathkit UFO..... 29.95

We are one of the largest retailers of Ham Gear, C.B., Marine Electronic and Hi-Fi equipment. Complete lines of new equipment of almost all manufacturers are carried in stock.

**WE WILL BUY FOR CASH**  
Your used Ham, C.B., Marine  
Electronics, and Hi-Fi equip.  
High prices paid!

Mail orders filled promptly. 20% deposit required. Balance C.O.D. Many other specials available. Send us your requirements and get our quotation.

## AIREX RADIO CORP.

85 QS Cortlandt St., New York 7, N. Y.  
WOrth 4-1820

### CQ de W2KUW

We will pay for every good  
**304TL \$10.00**

Send to us before December 31, 1963

Other large transmitting tubes & equipment also needed.  
ARC-GRC-PRC-MN-TS-UR. 51J-V-X-Y-388-390, 17L.

**TED DAMES CO. • 308 Hickory St., Arlington, N.J.**

## 6 METER BARGAIN

6 meter, 150 mw., 4 channel, transistorized transmitter with AM modulator. Complete with transistors and 50.5 mc. crystal. Requires only 12 volts at approximately 35 Ma. Ideal for walkie-talkie or get 10 to 15 mile range with a beam. Only \$14.95 ppd. while they last.

**VANGUARD** Dept. 5-10  
**ELECTRONIC LABS • 190-48 99th Ave. • Hollis 23, N.Y.**

### LEARN CODE!

**SPEED UP Your  
RECEIVING  
with G-C  
Automatic Sender  
Type S  
\$32.00 Postpaid in  
U. S. A.**

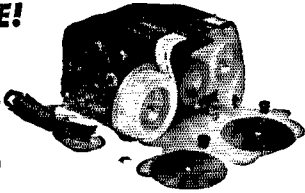

Housed in Aluminum Case. Black Instrument Finished. Small—Compact—Quiet induction type motor. 110 Volts—60 Cycles A.C.

Adjustable speed control, maintains constant speed at any Setting. Complete with ten rolls of double perforated tape. A wide variety of other practice tapes available at 50c per roll.

**GARDINER & COMPANY**

STRATFORD

NEW JERSEY

teur Radio Rifle Club is being bandied around Albuquerque. How many are interested? The Los Alamos boys had a civil defense communications display at the county fair. W5ZHN has been named chief of communications of the Albuquerque c.d. organization. The Veterans Hospital at Albuquerque is setting up an amateur radio club. ACF amateurs got a nice write-up in the plant paper. Traffic: W5AHO 42, W5WZK 38. K6ONE 32. K5HTT 12.

**WYOMING**—SCM, Lial D. Branson, W7AMU—The Pony Express Net meets Sun. at 0800 MST on 3920 kc.; the YO Net is a c.w. net on Mon., Wed. and Fri. at 1830 MST on 3610 kc.; the TWN Net is a daily net at 2000 MST on 3570 kc.; K7MAT is moving to Casper, later to Cody. The weather has been hot here but soon will cool off. The W1AMU Hamfest was well attended—Wyoming, Idaho, Montana and Utah is around thirty years old. W7AMU still is on the sick list. K7OWT has a new Marander transmitter. Fishing is good—hamming is on stand-by. Cold weather soon will be here then hamming will get started. We need a new EC for Natrona County and a new SEC for Wyoming. W7YVW and his XYL visited W7AMU and others in Casper. W7AEC, W7AMU and W7BKI have a c.w. sked on 3680 kc. each morning. Traffic: W7AMU 18, K7AHO 12, W7DWD 12, K7LPH 4, W7AEC 2, W7CQL 2, W7ABO 1.

### SOUTHEASTERN DIVISION

**ALABAMA**—SCM, William S. Crafts, K4KJD—SEC: W4NML, RAI: W5USM, PAMs: K4BTO, K4DJR (v.h.f.), K4TNS and K4WHW. July reports of all section nets (all times GMT):

Net	Freq.	Time	Days	Sec- sions	At- tend- Tfc.	At- tend- Quoc
AENB	3575	0100	Daily	30	8.0	10.3
AEND	3725	2300	Mon.-Sat.	27	1.9	10
AENM	3965	0030	Daily	31	4.7	39.7
AENO	50.55	0115	M.-W.-F.	14	3.44	29.6
AENP	3955	1230	Mon.-Sat.	23	8	19.
AENP	3955	0000	Daily	35	4.95	31.5
AENR	50.55	0115	Tue.-Thurs.	8	3.75	26
AENT	3970	2230	Daily	35	5.34	16.32

This is one of the best months on record for traffic averages. The SET called by W4NML proved the need for and some possible improvements in the new emergency plan soon to be published. K4IWI, our only Class I OO was listed in the top 10 in QST. The new AREC net in Birmingham is AENJ on 28.8 Mc. Congrats to K4WOP, a new A-1 Operator. Welcome WN4LBF to AEND. WN4PFI is a new Novice and WA4IUV a new General. W4RIS is back on 6 meters. K4NKT has a new five-element 6-meter beam. WA4KUP is the new net mgr. of AENS. New appointments: K4TFC as EC, K4EJM as OPS and WA4EXA as ORS. Teenagers, remember the AENT Contest. Check in for full details. K4ROR made the RPL again. Traffic: (July) K4ROR 914, WA4EXA 310, WA4AVM 250, WA4BDW 210, K4BSK 202, K4WVP 187, K4WOP 182, W4USM 155, K4KJD 98, W4ZNI 74, K4WHW 73, K4FZQ 70, K4A0Z 51, K4NGD/W4OGT 51, K4NKT 26, K4HJM 25, K4DSO 18, WA4ENJ 16, K4GXS 16, K4RSB 16, K4NUW 15, K4BTO 14, W4NML 13, WA4IHL 10, K4TJD 9, WA4HGN 7, K4GRA 6, K4PBY 6, K4PHH 5, W4ACWI 4, W4TSY 4, K4WSS 3, K4TFC 2, W4CIU 1, WA4EDF 1, WA4EFC 1. (June) K4PBY 18, WA4LSB 15, W4DS 9, K4WVP 1.

**EASTERN FLORIDA**—SCM, George E. Cushing, W4QVJ—SEC: W4IYT. The upcoming Tropical Ham-boree promises innovations not previously incorporated at any other regional gathering. Dade Radio Club members have tickets at bargain prices *now*. Art Melvin, WA4UHY, State CD Communications Officer and a Jacksonville mainstay, has QSWed to the West Coast of the U.S.A. Art Monzees, W4EXM, now is in Washington, D.C., arriving from E-P-Land. I strongly recommend using ARRL Form 1 for your monthly activity reports. My report must be in the mail on the 7th of the month therefore if your report is mailed no later than the 2nd of the month your totals are guaranteed to be included. Use the remarks area for items of interest that can be included in this column. The contest season is upon us and there is much enjoyment for you whether or not you are out for the top spot. ARRL ballots for the election of both Director and Vice-Director should receive your prompt attention, as well as your careful consideration. Several live wire clubs are starting code and theory classes for both Novice and General Class examinations. More volunteers are needed for on-the-air practice transmissions. The ORS setup in the state now includes all modes, including c.w. and RTTY. Traffic: (July) WA4UJH 798, W4DVR 453, K4BY 303, W4MIN 295, K4KDN 288, W4SGH 279, W4KIS 223, WA4JYB 201, K4SHH 171, W4TRS 158, W4EHW 151, WA4IXI 141, WA4BCW 131, W4GUJ 124, WA4FGE 109, K4FQP 81, (Continued on page 152)



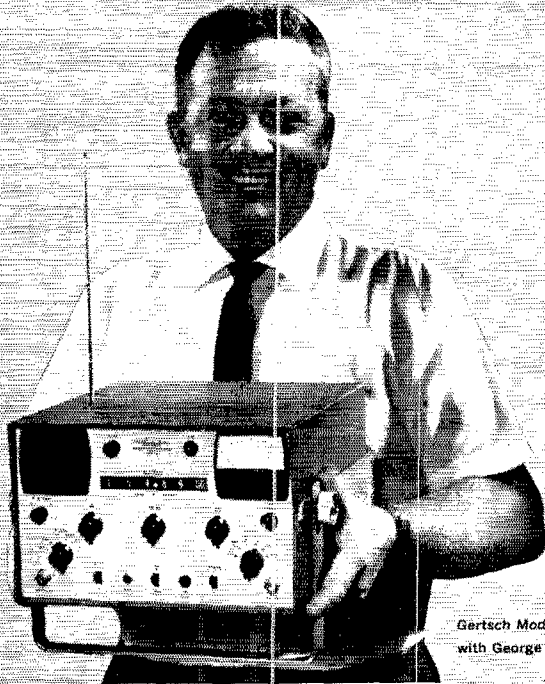

Gertsch Model FM-9 photographed  
with George (Skipper) Maynard—K6RTD

**NOW... GERTSCH COMBINES  
FREQUENCY METER  
SIGNAL GENERATOR  
DEVIATION METER  
IN A SINGLE, PORTABLE PACKAGE — \$1,495**

—direct digital reading of *every* FCC assigned channel in the 150-162 mc band.

With this Gertsch meter, you can measure and generate *all* allocated channels in both 150-162 mc and 450-486 mc bands... with .0002% (2 ppm) accuracy. Generated outputs can be attenuated to less than  $0.5 \mu v$  for receiver sensitivity checks. 400-500 kc output also available for I.F. alignment.

**As a deviation meter**, instrument measures peak FM deviations... two full scale ranges of 5 and 15 kc.

**Simple operation.** Just set dials to read desired frequency. No charts, curves or calibration books needed.

**Easily calibrated.** Accuracy solely dependent on a single 1-mc oven-controlled crystal... easily checked against WWV.

**All solid-state circuitry** results in a compact package only 8" H x 12" W x 12" Long. Weighs less than 25 pounds.

**Operates anywhere**... on 115/230 AC line, 12 volt DC, or optional rechargeable battery pack.

*Send for literature on FM-9 Series*

**Gertsch**

GERTSCH PRODUCTS, INC., 3211 SOUTH LA CIENEGA BLVD., LOS ANGELES 16, CALIF. ■ Upton 0-2761—Vermont 9-2201

# FREE GIANT NEW CATALOG

1964  
**BA**  
RADIO TV ELECTRONICS  
100'S OF BIG PAGES CRAMMED WITH SAVINGS

TUBE PARTS ETC. AT LOWEST PRICES  
SAVE UP TO 50% ON CHOICE KITS  
100'S OF BARGAINS NOT IN ANY OTHER CATALOGS  
EVERYTHING IN HI-FI AND STEREO  
TOP VALUES IN POWER & HAND TOOLS

**BURSTEIN-APPLEBEE CO.**  
Dept. QST, 1012 McGee St., Kansas City 6, Mo.  
 Rush me FREE 1964 B-A Catalog.

Name .....

Address .....

City..... State .....

**SEND FOR IT TODAY**  
**FREE**

## THE LEAGUE EMBLEM



With both gold border and lettering, and with black enamel background, is available in either pin (with safety clasp) or screw-back button type. In addition, there are special colors, available in the pin style emblem only, for Communications Dept. appointees.

- ▶ Red enameled background for the SCM.
- ▶ Green enameled background for the RM, PAM or EC.
- ▶ Blue enameled background for the ORS or OPS.

**THE EMBLEM CUT:** A mounted printing electrotype, 5/8" high, for use by members on amateur printed matter, letterheads, cards, etc.

Pin, Button or Cut: \$1.00 Each, Postpaid

## AMERICAN RADIO RELAY LEAGUE

Newington 11, Connecticut

W4CWD 65, K4DBT 62, W4BKC 55, W8L DU/4 53, K4-DAX 40, W4OGX 40, WA4JQQ 36, K4JLD 30, WA4PVD 29, WA4CJC 27, W4ADU 23, K6SNX/4 19, WA4ESS 18, K4MTP 18, K4MVD 13, W4ZJZ 12, K4MZR 7, K4PVP 1, (June) WA4BMC 666, K4KDN 319, WA4JYB 203, WA4-GBM 163, W4EHW 123, WA4LHK 48, W4CWD 41, WA4-CTQ 33, WA4XN 32, W4ADMV 29, W8L DU/4 29, K4-YSN 14, W4ZJZ 11, (Apr.) WA4GDS 40.

**WESTERN FLORIDA**—SCM, Frank M. Butler, Jr., W4RKH—SEC, W4MLE, PAM: W4WEB, V.H.F. PAM: W4ZGS, RM: W4BVE, Panama City: K4CNY and K4-VFY received 4RN certificates. WN4IMC is building a v.h.f. receiver using compactrons, K4CEF is on 2 meters. WN4OLP and WN4PJB are new hams. WA4FJ won the PCARC 2-meter transmitter hunt, Tallahassee; The Fla. Division of Corrections may use amateur nets for routine traffic, if plans by W4MLE work out. A Statewide 6-meter AREC net is being set up by W4-KOB. The Tallahassee 2-Meter Intercom Net now uses 145.50 Mc. Monticello: W51BD/4 has moved here and has been appointed EC. He runs an HT-37. Fort Walton: Elgin AFB: The EARS hosted a picnic for WFPN members and other local hams. WA4BOZ, W4RKH and K4YVQ provided communications for an Air Force rocket launching at Elgin AFB when telephone lines were knocked out by lightning. WN4OPN has joined the 2-meter gang. Pensacola: W4QK has a Ranger II and will be on 6 meters soon. W4VR, another old-timer, should be back on 40 and 20 meters soon. W4VBU/m keeps in touch on 75 meters when on trips to New Orleans. W4SRM remains the transmitter-hunting champ. Parasitics, edited by K4BZJ, is always good for laughs, and full of good information too. WA4EFC is now NCS for Western Fla. Navy MARS Net. Traffic: (July) K4-VFY 313, W4ZWD 174, W44ECY 80, WA4FLJ 70, WN4-INC 4, W4BVE 3, W4ZGS 2. (June) W4BVE 69.

**GEORGIA**—SCM, James A. Giglio, W4LG—SEC: W4VE, PAMs: W4FYH, K4PKK and W4RZL, RM: W4-DDY. New officers of the Georgia Cracker Radio Club are W4FYH, pres.; W4WKP, Sun, morning NCS; WA4-CEL, Tue, eve NCS; K4FRM, Thurs, eve NCS; W4-MZO, secy.-treas. It's good to hear W4ATX on again with the KM2 after repairs. WA4CZM writes that he has been appointed Ga. correspondent for WAMRAC. Congrats to K4FRM on his A-1 Operator award. WA4-ARE is going great guns with a new Apache. K4WVY is moving from a "Voyager" to a "Valiant." W4YEK and W4TJS are nervous as novices, expecting a grandson. Congratulations to K4VDF on the swell job of organizing the "Cracker" picnic. Also to K4LNL for the best job of leading mobiles to a meeting that we have ever heard. W4KXMI has a signal that seems to get better each week. W4DDQ maintains an active station using a.m., s.s.b., RTTY and v.h.f. and is an active MARS member. W4HEG and K4KPU are happy with new TR3s. K4BAI is active again after a spell of ROTC. The old wagon master, W4TT, has a new hamfest ja-lopy. K4VQG is hard at work on a 50-Mc. converter. K4MDR finally has given in to the urge and gone s.s.b. with Collins equipment. New appointments: W4FYH as PAM, Traffic: W4DDY 315, K4FRM 200, K4QPL 111, K4WVY 80, WA4CPA 38, W4MLA 26, W4OHA 22, W4-HYW 19, K4BAI 18, W4BG 4, W44ARE 2.

**CANAL ZONE**—SCM, Thomas B. DeMeis, KZ5TD.—The annual Field Day was worked by the Crossroads Amateur Radio club. KZ5RW, first time in a contest, took to it like a duck to water and made the most contacts for the group. KZ5MQ, KZ5TD, KZ5CC and many others participated and, aside from the attacks of sand fleas, all went well. The July meeting of the CZARC featured a transmitter hunt in a downpour. KZ5KR, the fox, picked a good location that, although we went around and around for an hour, could not locate, mainly because of the heavy rains. The fox was found but not after one of the cars got stuck in the mud trying to locate him. A terrific time was had by all despite the rain. General activity has been fair to good; some 8-meter activity has started up on a small scale. KZ5BX displayed a few of his many certificates as the No. 1 CHC from the Canal Zone. KZ5TD was in the States on vacation in August.

## SOUTHWESTERN DIVISION

**LOS ANGELES**—SCM, John A. McKowen, W6FNE—Asst. SCM, Richard H. Ingham, WA6DJB, SEC: K6-YCX, Asst. SEC: W1KUX/6, RMs: W6BHG, W6QAE, PAMs: W6ORS, K6PZM, WA6TWS. With only 35 stations reporting the traffic count held to over 4000 and is a good comparison to 8000 plus with 41 stations reporting. The ranks of the Brass Pounders League again were honored by the scores of W6RBO, W6WPF and WA6-KWV. We welcome to the ranks of League Officials in the section W1KUX/6, EC of West Covina, newly appointed Asst. SEC. W6WPF has the rig all moved and by the traffic totals the new location must be pretty good. New OES WA6YMB reports on radio control  
(Continued on page 154)

**NOW!** for discriminating amateurs  
 who are satisfied  
 with nothing less than **THE VERY BEST**

# McCoy SINGLE-SIDE-BAND-FILTERS

## The GOLDEN GUARDIAN (48B1)

### TECHNICAL DATA

Impedance: 640 Ohms in and out (unbalanced to ground)  
 Unwanted Side Band Rejection: Greater than 55db  
 Passband Ripple:  $\pm .5$ db  
 Shape factor: 6 to 20db  
 1.15 to 1  
 Shape factor: 6 to 50db  
 1.44 to 1  
 Package Size:  $2\frac{7}{16}'' \times 1\frac{19}{32}'' \times 1''$   
 Price: \$42.95 Each

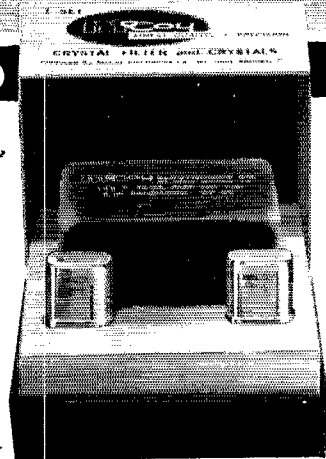
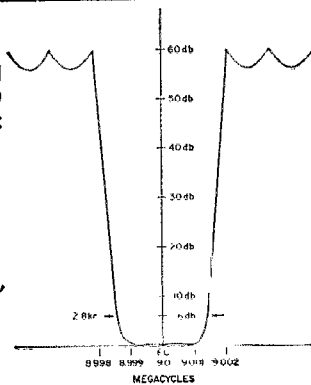

## The SILVER SENTINEL (32B1)

### TECHNICAL DATA

Impedance: 560 Ohms in and out  
 Unwanted Side Band Rejection: Greater than 40db  
 Passband Ripple:  $\pm .5$ db  
 Shape factor: 6 to 20db  
 1.21 to 1  
 Shape factor: 6 to 50db  
 1.56 to 1  
 Package Size:  $1\frac{1}{2}'' \times 1\frac{1}{4}'' \times 1''$   
 Price: \$32.95 Each

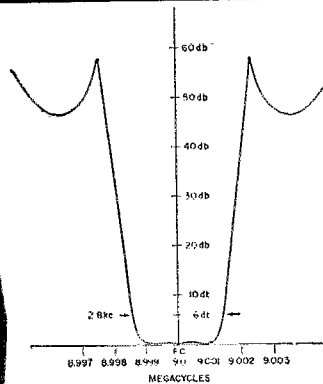

Both the Golden Guardian and the Silver Sentinel contain a precision McCoy filter and two of the famous M-1 McCoy Oscillator crystals. By switching crys-

tals either upper or lower side band operation may be selected. Balanced modulator circuit will be supplied upon request.

Both sets are available through leading distributors. To obtain the name of the distributor nearest you or for additional specific information, write:

# McCoy

**ELECTRONICS CO.**

Dept. Q-10

MT. HOLLY SPRINGS, PA.

Phone: HUnter 6-3411

SUBSIDIARY OF OAK MANUFACTURING CO

Want High Efficiency and Small Size?

**6 10 15 20 METERS**  
**MINIATURIZED 4 BANDS**

\* 300 WATT AM.  
 \* Turning Radius 7'  
 \* Total Weight 11 lbs.  
 \* Size 25" x 11"

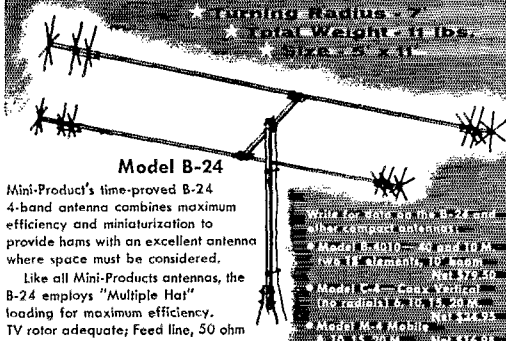

Model B-24

Mini-Product's time-proved B-24 4-band antenna combines maximum efficiency and miniaturization to provide hams with an excellent antenna where space must be considered.

Like all Mini-Products antennas, the B-24 employs "Multiple Ha!" loading for maximum efficiency. TV rotor adequate; Feed line, 50 ohm coax; SWR 1.5:1.

Amateur Net  
**\$59.95**

**Mini-Products, Inc.**

1111 WEST 15TH STREET, Erie, PENNSYLVANIA  
 (Special Application for Direct from Factory)

Write for sales on the B-24 and other compact antennas:  
 \* Model B-24 10, 15 and 20 M. Net \$79.50  
 \* Model B-24 6, 10 and 15 M. Net \$69.95  
 \* Model B-24 4, 6, 10 and 15 M. Net \$59.95  
 \* Model M-4 Mobile 6, 10, 15, 20 M. Net \$16.95  
 Patents pending.

for **BIG**  
**SAVINGS**  
 on A-1  
**Reconditioned Equipment...**  
**call Henry**

Our time payments save you money because we finance ourselves. Write, phone or visit either Henry store to get better equipment at less cost on better terms.

**Henry Radio Stores**

Butler 1, Missouri Ph. ORchard 9-3127  
 11240 West Olympic Blvd.  
 Los Angeles 64 Ph. GRanite 7-6701  
 931 No. Euclid Ave., Anaheim, Calif.

work. New OES WB6DMB is very active on 1200 mc. WA6YIT was flooded by the 6-meter DX openings. The YTRL's new officers are W6VDP, pres.; W6QYL, vice-pres.; WA6BJB, rec. secy.; WA6QPI, corr. secy.; K8-ELO, treas. WA6DII is conducting tree theory classes for new and old alike. I am pleased to see the response to my request to support the AREC. Applications have picked up nicely and we still could use more. Contact K8YCX. The section has been asked to provide mobile and fixed stations for the Rose Parade Jan. 1. Contact this office for details. WIBDI, ARRL Communications Manager, will be at the San Diego Convention Oct. 11 to 13. Thanks to all of you for your reports. Support the sections nets: Southern California Net (SCN) 3600 kc. 0300Z daily and So. Cal Six on 50.4 Mc. 0200Z daily. Traffic: (July) WB6BBO 681, W6WPF 618, WA6KWW 511, WA6TWS 442, K6IWW 403, K6PZM 262, WA6AAH 163, W6BHG 141, W6BAJT 115, WA6KAW 114, WA6USU 109, K6HIT 102, W6QAE 97, W6PNE 76, W6BBH 64, WA6ZID/6 54, W6EEU 45, W6B6YJ 43, K6SIX 40, WA6CXB 32, K6OZJ 30, W6BZX 26, WA6CKR 22, K6-JCT 22, WA6DJB 13, WA6KVS 13, W6USY 8, W6EBK 7, W6NKR 5, WA6SNK 4, W6VUZ 4, WA6FXJ 3, WA6-UHM 3, W6SRE 2. (June) WA6GAG 90.

**ARIZONA**—SCM, Kenneth P. Cole, W7QZH—Asst. SCM/SEC; George Mezey, K7NYI, PAM: W7OIF, RM: W7LND. The Copper State Net meets at 1930 MST Mon. through Fri, on 3880 kc.; the Grand Canyon Net Sun. at 0800 MST on 3880; the Tucson AREC Net Wed. at 1900 MST on 3880; the Cochise County AREC Net each Sun. at 1400 MST on 7260; the Tucson 2-meter Net at 1000 MST on 145.35 Mc. Thanks to W7PQ, Tucson, for his report on 6 meters. Over a period of 30 days openings occurred 23 evenings. The log shows several W2s, W6s, W4s and W0s. The rig being used is a crystal-controlled 7-watt transmitter. The antenna is a two-element beam 18 feet high. And for those Arizona hams who still believe that the high frequency bands are dead, your SCM recently worked South America, Central America, Honolulu and Alaska on 10 and 15 meters. Tune up there once in awhile; you will be surprised! The Huachuca Amateur Radio Club now boasts a membership of 35, including 3 honorary members, one of whom is W7AJO. The Scottsdale Amateur Radio Club elected K7QWR, pres.; K7UYG, vice-pres.; K7RJD, treas.; K7KAV, secy. W7AMM, one of our active net members from Ft. Huachuca, recently was transferred to Rio de Janeiro, Brazil. Look for him on 20-meter s.s.b. Congratulations to W2QHH, the first "2" call to be awarded Worked All Arizona. New calls: K7VXF, K7YED, K7YPU. Traffic: (July) W7FKK 114, K7VQI 10, K7RUR 7. (June) K7WBC 236. (May) K7WRC 497.

**SAN DIEGO**—SCM, Don Stansier, W6LRU—K6BPI spent 9 days in the hospital in July, and took top traffic honors with a count of 5034. Other BPL awards for the month include W6IAB, W6YDK, W6EOT and K6GJM. Welcome to K4AKP/6, in Imperial Beach. He is a traffic man only and was TCC director of the Central Division and manager of the Fifth Regional Net while in Memphis. K8TFT, 2-meter EC, reports a gain of 7 full members this month. A new operator at W6IAB is WB6PNM. WA4KFP has terminated at W6IAB and is awaiting school or overseas duty. W6FWU now has a Swan on the air. W6CAE vacationed to the High Sierra area during August and dropped in on the SCM, who was away fishing! WA6ENZ was elected secretary of the Anaheim Amateur Radio Association to fill the vacancy of WA6NFI. W6IEY, OES in La Mesa, reports many openings during July into western states on 6 meters. WA6ROF, ORS in Yorba Linda, reports the addition of a son on July 28. In case you haven't gotten your ticket for the Southwestern Division Convention in San Diego Oct. 11, 12 and 13 they will be available at the registration desk those dates. With school now started and vacations over let's all point for a full fall and winter of operating with Sweepstakes coming up next month, a CD party this month, and other ARRL-sponsored activities throughout the year. Traffic: K6BPI 5034, W6IAB 4482, W6YDK 4171, W6EOT 549, K4AKD/6 268, K6GJM 238, WA6ROF 237, WA6BRG 187, WA6CDD 50, K6LKD 44, K6IME 42, W6WRJ 23.

**SANTA BARBARA**—SCM, William C. Shelton, K6-AKK—SEC: WA6OKN, RM: W7WST/6. The CB base at Port Hueme has a new club with the following as charter members: W6UHF, K6YRB, WA6STO, K6-LYB, WA6IY, W9YXX/6, WA6NYC, WA6SHA, and K6PEC. It meets the 2nd Mon. at the Ham Shack; the club station is K6NCT. W6HUT reports for the new hams in Santa Barbara, W6GJIT and W6GEE. W6-MLZ QSLed from KH8 with Marge enjoying the islands. The heavy QRN from the power co. still plagues the Ventura County area. The PUC, FCC and local clubs all are trying to get the problem resolved as DX and local contacts are QRT until solved. W7WST/6 is doing a fine job on the SCN on 3600 kc. Very few reports were received this month. The Ventura County Radio Club is selling all its gear. Very little use is being made of it. Traffic: K6AAK 18.

(Continued on page 156)

New from Gonset

# A HIGH QUALITY TRANSISTORIZED SSB TRANSCEIVER



that is

**ULTRA-COMPACT • LIGHT WEIGHT • low in cost**

Gonset has scored a breakthrough with the new "Sidewinder"—a 2 meter SSB, AM and CW transceiver that combines technical excellence with contemporary design and compact, sturdy construction.

The Gonset "Sidewinder" provides coverage of the entire 2 meter band in four segments 1 Mc wide. It has built-in VFO and the receiver is *completely* transistorized. There are a total of 21 transistors, 6 diodes and three tubes in the "Sidewinder," which operates on either SSB, AM or CW.

The power supply is designed for snap-on back or remote installation and is available either as a kit or a wired and tested unit.

## CHECK THESE DELUXE FEATURES AT YOUR LOCAL DISTRIBUTOR!

- Receiver and transmitter utilize dual conversion.
- Designed for mobile and fixed station operation.
- Illuminated dial and "S" meter.
- High voltage power supply is used only in transmit mode.
- Highly Stabilized VFO.
- Crystal lattice filter for both receiver and transmitter.
- 20 watts PEP input SSB, 6 watts input AM, 20 watts input CW.

Transceiver: 8¾" wide, 4¾" high, 7" deep.  
Weight: 7 lbs.-10 oz. Amateur net price \$349.95

Power supply: 8¾" wide, 4¾" high, 5½" deep.  
Weight: 11 lbs.-2 oz. Amateur net price—kit \$39.95  
Wired and tested unit \$49.95

*The new Gonset "Sidewinder" SSB Transceiver will be on display at your local distributor's in August.*

**GONSET** INC.  
A SUBSIDIARY OF ALTEC LANSING  
801 SOUTH MAIN STREET, BURBANK, CALIFORNIA

**EVERY HAM SHACK NEEDS THIS!**



Now! . . . Really impress your friends, with this smart official looking personalized wall plaque in your station.

**YOUR CALL LETTERS AND HANDLE IN GOLD** — on a colorful vinyl overlay, mounted on an attractive wood grained hardboard background, with border and contemporary Coat-of-Arms in golden yellow. 7/4x5/4 in.

● Make wonderful gifts. ● \$2.95 PPD in USA  
California residents add 1% sales tax — Save no COD.

**BE SURE TO PRINT CALL AND HANDLE PLAINLY**

**VANCO**

*Vanco Radio Equipment Co. Inc.*  
 3815 1st St. S.E. Seattle, Wash. 98148

**BRELONIX, Inc.**

**TRANSISTORIZED MODULATOR KIT**

STEP-UP performance of Mobile or Field-Day transmitters with a BRELONIX 40-watt TRANSISTORIZED MODULATOR. Modulates xmtrs up to 100 watts input.

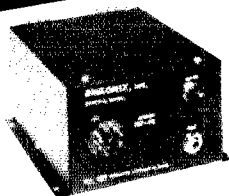

MODULATOR MP-40 — Power output, 40 watts. Output impedance, 3000 to 7000 ohms. Input, 50-ohm carbon mic. Frequency range, 200-4000 cps. Auxiliary Speaker Output, 4-ohm 10-watt. Auxiliary Input, 15,000 ohm Hi-Z. Gain control adjusts for transmitter powers of 20 to 100 watts. Modulation Limiter/Filter prevents over-modulation with 4000 cps cut-off for clean AM signal, even at close range. For 12-14 Volts DC operation.

KIT PRICE, MP-40 ..... \$53.50

MODULATION LIMITER/FILTER KIT — 4000 cps cut-off. Incl. choke, diode, capacitors, and mounting bracket. For transmitters using up to 100 watts input power.

KIT PRICE, MLF ..... \$9.95

TERMS — 10% deposit with orders, balance COD. Prices FOB Seattle, Wash.

**BRELONIX, Inc.**  
 5415 - 26th Ave. N.W.  
 Seattle, Wash. 98107

**MAIL order to**

**WEST GULF DIVISION**

**NORTHERN TEXAS**—SCM, L. L. Harbin, W5BNG —Asst. SCM: E. C. Prod. W5NFO. SEC: K5AEX. PAM: W5BOO. CM: W5LR. Congratulations to the Big Spring ARC on becoming an ARRL affiliated club. The 2nd Annual Big Spring Swap-Jest held Aug. 4th was attended by 225 hams and their families and was enjoyed by all. The many tables of swapping gear kept the hams busy bargaining for needed pieces of equipment while the NYLs were exchanging ideas about how to get the yard cared for. The noon meal was furnished by a caterer and consisted of fried chicken or ham and all the trimmings and had the home-cooked flavor. W5NFO has just returned from an extended vacation trip back East and has promised to start sending more news from West Texas. E.C. says that he was disappointed that he did not get to visit the new Headquarters building but the traffic was a bit more than he could take. The Garland ARC reports good results on Field Day activity with an estimated score of 2316 points. The club wants to express its appreciation to the Air Force for its help in making this operation possible with the loan of power equipment. The club has voted to open a station on a full-time basis as soon as they can get full-time power installed. W5CMC is captain of the Marcat Motor Patrol and has been very busy with that activity but he still found time to take part in the Wichita Falls ARC Field Day program. Traffic: (July) K5ETA 98, K5VWJ 45, K5PXV 18, W5LR 9. (Apr.) W5LR 263.

**OKLAHOMA**—SCM, Adrian V. Rea, W5DRZ— Those reporting on Field Day to the SCM were W5PAA, K5RLAI, W5SXA, K5VOZ, W5HTK, K5IRO, K5IBZ, K5LRU, W5OK. The Enid Club kept transmitters going most of the time through a 7-inch ruin. Two prominent Oklahoma Amateurs have joined the ranks of Silent Keys: W5NS, after a long illness and W5DTU in a plane crash in Arizona. Congratulations to K5TEY and K5VNJ on making the BPL K5VNJ also got a special write-up in *Regional Net Fire Bulletin*. New officers of the Lawton-El. Hill Club are K5LEZ, pres.; W5HIM, vice-pres.; K5FSU, secy.; K5NDO, treas. New officers of the Bartlesville Club are W5JMF, pres.; K5JIG, vice-pres.; K5JZT, treas. K5OCX is the latest we have heard of to get an Extra Class license. K5ELK is the state director for Air Force MARS. W5UZX has gone sideband. W5MFX and K5CAY lost their antennas recently in a storm that produced an 80-mile-an-hour wind. W5CBY and W5CCK were temporarily off the air as the result of lightning in the same storm. K7RPA/5 has a new "3" call. W5MNE; also a new baby boy. K5ZCJ has a new baby daughter born July 30. W5JXM moved to Oklahoma City. K5VFR is the new 6-meter PAM. Since this is my last report I would like to take advantage of this opportunity to express my appreciation to all the amateurs of Oklahoma for their help during my four years as SCM. To those who have served as SEC, PAM, RM, EC, OO, ORS, OPS, OES, OBS and the NCS on the various nets and the many others who have cooperated so wonderfully in all the affairs of the section, we would like to say a great big THANKS. We would not forget the several clubs who have cooperated in a wonderful way. I am grateful for my experience with you and thankful for the many friends I have made. Let us all get behind the new SCM, K5KTW, and really make things hum. Traffic: (July) K5TEY 547, K5VNJ 515, W5PPE 427, K5IBZ 109, W5DRZ 33, K5ZEP 28, K5BBA 21, W5PML 20, K5LZF 16, K5MTC 13, W5MFX 12, K5YAO 12, K5JOA 11, W5CCK 9, K5RWL 8, K5OCX 6, W5PNG 3, W5WDD 2. (June) K5VNJ 719, W5PPE 607, K5TEY 599, K5IBZ 84, K5RWL 40, K5AUX 37, K5JOA 34, W5PML 27, W5QMJ 20, K5ZEP 18, K5YAO 13, W5PNG 11, K5OCX 10, K5CBG 6, W5DRZ 4. (May) K5OCX 11.

**SOUTHERN TEXAS**—SCM, Roy K. Eggleston, W5QEM—SEC: W5AIR, PAM: W5ZPD. The Tex. C.W. Net had 55 sessions, QNI 287, traffic 322. The following stations now have net certificates: W5AIR, W5EZY, W5LVC, W5UMY, K5HDU, K5LYT and K5ZJK. The Amateur Radio Club of Texas A&M University plans to hold Novice theory and code classes this fall. Anyone going to A&M and interested in amateur radio should get in touch with Frank Stewart, Physics Dept., and he will get you started. The Tex. C.W. Net could use some more participation. It meets on 3770 kc. daily at 0100 and 0400 GMT. You RTTY boys, listen for K5ANS on RTTY real soon. K5ABV has a new Ranger. BRZ has been vacationing around Houston. Thanks, Frank, for the plug in the net bulletin. Maybe we can get some news sent in for a change. K5LQJ has been vacationing in Missouri. K5OFR is operating portable from the Emergency Center in Eagle Pass. Danny Weil, of *Yams* fame, was guest at the DX Dinner in Houston. I understand that W5JNE is laid up with a broken leg. Sure

(Continued on page 158)

short on  
**SPACE?**  
**CASH?**



# New-Tronics Cliff-Dweller<sup>™</sup> and Harrison is the Answer!

- Want to join the fun on 75 and 40—but don't have space for the antenna?
- Want an antenna you can rotate—to give you less QRM, better signals?
- Want to be able to remotely tune the elements—to give peak signal strength at any spot in the band?
- Yes? Then you need the New-Tronics Cliff-Dweller!

Here's a rugged, rotatable dipole with a turning radius of less than 16'. From your operating desk, you can make the elements

telescope to tune them to peak resonance. (You can even shift your coax cable feed point off-center for possibly better match.) VSWR 1.1 to 1 or less across the entire band!

- Short on cash? At Harrison, you can say "Charge it!" and take months to pay.

CD 40	6.8-7.4 mc	\$92.50
CD 75	3.47-4.1 mc	99.50
CD 40-75 Two-Bander:		
	3.47-4.1, 6.35-7.7 mc	129.50

Use a HAM-M or TR-4 rotator, or mount it 7' above your VHF beam. Weight under 20-lbs.

**NEW!** To help any antenna system take more soup from the transmitter, and squirt out stronger signals!

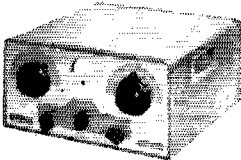

### MILLEN TRANSMATCH

Adjustable RF transformer to match 50-70 ohm transmitter to coax-fed antenna presenting true load impedance of 15 to 1000 ohms. Band switching 75 thru 10. Handles 2 KW. Built-in Reflectometer Indicator.

Millen Model 92200 \$129

**NEW!**

FROM WATERS

### Model 334

### DUMMY LOAD-WATTMETER

Tune up, and measure output —without causing QRM! Less than 1.3 to 1 VSWR up to 230 mc. 52 ohms. 250 Watts cont., 1 KW int.

\$79.95

**NEW!**

FROM WATERS

### Model 331 Transistorized "LITTLE DIPPER" T.M.

RF Dip Oscillator. 2-230 mc ± 3%. 1 kc modulation. Uses pen-lite batteries.

\$129.75

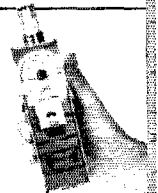

# HARRISON

Mail orders carefully and promptly filled.

225 Greenwich Street • New York 7, N. Y. • BA 7-7922  
[Jamaica Store: 144-24 Hillside Avenue • RE 9-4102]

# "The Third Hand"

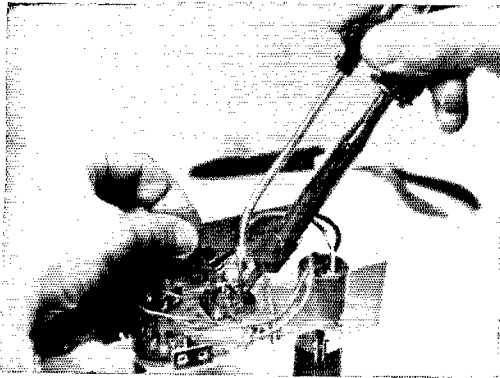

## SOLDER DISPENSER

The "Third Hand" solder dispenser is a unique device designed for soldering where an extra hand can save many hours of frustrating labor. Eliminates pre-tinning and pre-wrapping. Applies solder with such accuracy that solder will consistently hit a 1/16" diameter target. Solder feeds directly from a roll which automatically eliminates kinks and bends. Tips for #18 and #22 solder provided. Sold individually only to amateur radio operators. Need more information? Send for it.

Order must state that you are a radio amateur. Ten-day money-back guarantee. You must be satisfied!.....

**\$7.95**  
PPD

(Price does not include Soldering Iron)

**IDEA** P.O. BOX 2215 • SANTA FE NEW MEXICO

\*\*\*\*\*

# BLITZ BUG

## Coaxial Cable Lightning Arrester

MAIL ORDERS PROMPTLY PROCESSED. SAME-DAY SHIPMENT FROM STOCK.

\*\*\*\*\*

### "BLITZ BUG" LIGHTNING ARRESTER

Designed to eliminate heavy static charge build-up to protect valuable radio equipment; in many cases eliminates noise problems; fits any standard coaxial cable. Power handling capacity 1 kw fully modulated. Will not affect SWR or performance to 500 mc. It will not create insertion loss. U.S. PATENT NO. 2,922,913.

Model No. LAC-1—With type 83 connectors. Net Each... **\$3.95**

## MAIL COUPON — TODAY!

**COMMUNICATIONS EQUIPMENT CO.**

518 State St., LaCrosse, Wis.

Name.....

Address.....

City..... Zone..... State.....

Check  Money Order Q10 (Ppd, USA) **\$3.95**

hope. Glen, that you will be up and around soon. K5-ZSC is s.s.b. with an SB-10 and an Apache. K5EIJ is the new EC at Bay City, and W5ZPJ at Pt. Lavaca. Traffic: (July) K5ZJK 387, K5ANS 327, K5ABV 200, W5AC 104, W5ZPD 21, K5LWL 15. (June) K5ANS 242.

## CANADIAN DIVISION

**MARITIME**—SCM, D. E. Weeks, VE1WB—Asst. SCMs: A. E. W. Street, VE1EK, and H. C. Hillyard, VOICZ. The Fundy V.H.F. Society recently held its annual dinner in Moncton. Officers for the coming year are VEICL, pres.; VEILT, secy. The annual NBARA picnic and meeting was held at Grand Lake. Newly-elected officers are VEIRN, pres.; VEIMZ and VE1-AJT, vice-pres.; VE1AHV, secy.-treas. Members of the SONRA recently toured the Argentina Naval Base and were entertained by the Argentina Club, VE0MU, owned by VOIFL, became disabled at sea and requested assistance on 20 meters. Newfoundland amateurs (no calls available at time of writing) monitored the frequency and relayed messages until help arrived. VE1KG has transferred to Torbay. VOIFC has a new NCX-3. Award hunters should make note of the new WAH/VO1 Award (Worked all Harmon). Details from any Harmon amateur. All amateurs are reminded that the Nfld. Net meets daily (Fri. excepted) at 2130 GMT on 3785 kc. Please note correction on the transmitting frequency of VEISR. This should read 145.96 Mc, and not 146.96 as previously mentioned. WA4NNS/VO1 is operating from Freshwater with a KWS-1 and a 75A-4. VOIBL is working on RTTY. Traffic: VE1OM 15.

**ONTARIO**—SCM, Richard W. Roberts, VE3NG—VE3BCJ is in Europe on vacation. VE3CBK was in the hospital. The Ottawa Valley Mobile Club held its summer meetings out of doors with the XYLs and YLs in attendance. We regret to advise you of a Silent Key, Bert Campbell, VE3XL, of Owen Sound, who passed away early in July. New hams in the Sarnia Club who have just received their calls are VE3FOU, VE3AJT, VE3ARI, VE3AVK, VE3BHG, VE3AYA, VE3EXI in W-land. Once again I remind you of the Boy Scout Jam-boree to be held Oct. 19 and 20. Help your local Scouts by inviting them to your station, Jamaica, B.W.L., has a new prefix viz 6YAAA to 6YZZZ; Turks and Cayman Islands remain VP5. Ex-VE3DEX (now 6YAVI) was a visitor to the shack of your SCM and VE3YD in Toronto. I received a very fine club paper from the Lakehead Amateur Radio Club. VE3AVS is the editor. This club was very active on Field Day. VE3ECR visited Ft. Williams on his vacation, from him, it was learned that VE3EDU of Nipigon, is now a Silent Key. Once again, fellows, if you hear of a Silent Key, please advise the SCM as soon as possible by radiogram or by mail. Manitoba now has License call plates. Even though we have the majority of VE hams right here in Ontario, are we to be the last to get this type of recognition for our public services? Perhaps our R.S.O., who is affiliated with ARRL, may take the problem to Queens Park. VE3DPO, editor of the Grey Bruce Amateur Radio Assn. Bulletin, has retired from the paper after six years of hard work. We will miss hearing from you, Reg. Good luck. Traffic: VE3CFR 160, VE3AML 96, VE3AGG 90, VE3NG 83, VE3GHL 78, VE3DPO 65, VE3CYR 61, VE3ETM 40, VE3AG 37, VE3ELQ 34, VE3AKO 24, VE3DRF 22, VE3DU 21, VE3BUR 20, VE3GI 17, VE3FGV 14, VE3RN 14, VE3CO 9, VE3YD 2.

**QUEBEC**—SCM, C. W. Skarstedt, VE2DR—Asst. SCM: Jean P. Achim, VE2ATL. The RAQI CONGRES ANNUEL was held at Mont Sutton with some 500 members and friends attending. VE2PS was reelected president. The St. Maurice Valley Balloon Project was carried out without a hitch. Many outside stations reported reception of the tiny balloon transmitter but full details are not yet available. VE2BDV won the main prize, a transmitter. VE2DK now operates on 20 meters from Gagnon. Sorry to report the loss of two good c.w. men. VE2LO has moved to Hamilton, Ont., and VE2-AQV to Los Angeles, Calif. VE2CLO is the call of the Lovola College Club station, using a Drake 2B receiver, a DX 20-transmitter with expected addition of a 600-watt linear and a Mosley vertical antenna. VE2BFT, VE2AME, VE2BDH, VE2BHM and one SWL constitute the operating squad. VE2AGM is very QRL with his new job and gets little time for hamming. VE2AGI also is busy but hopes to return to the air shortly. WJMI and his XYL, in a private plane, visited many VE2 and VE3 friends. VE2BLT is active on all bands with a fine 500-watt station. From VE2BEU: Lors de la conflagration à l'Hôtel-Dieu St-Vallier de Chicoutimi, soit le 27 mai, les amateurs, encore une fois, ont prêté leur concours, soit dirigeants, sauveteurs, fournissant de nombreuses informations au sujet des personnes déplacées. Les participants étaient VE2HDT, VE2TV, VE2AXV, VE2RD, VE2BEF, VE2AAW, VE2BEI, VE2AJE, VE2-

(Continued on page 160)



# SSB COMMUNICATIONS

## The *NEW* COMPACT *Series*

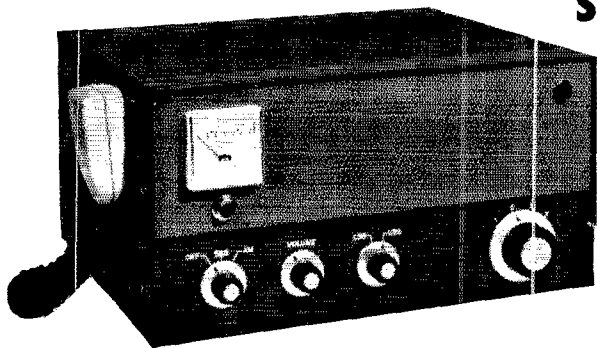

### SSB TRANSCEIVER

SUGGESTED LIST PRICE  
Upper Sideband

1 Channel . . . . .	\$695
2 Channel . . . . .	\$795
3 Channel . . . . .	\$870
4 Channel . . . . .	\$925

COMPLETE with coils, ovens, channel crystals and mike. Fully aligned and ready to operate.

The new COMPACT Series of single sideband transceivers are priced for use in applications formerly reserved for AM radiotelephone equipment. The COMPACT can be equipped for 1, 2, 3 or 4 channel operation, upper or lower sideband only—or selectable sideband. Channels can be set anywhere between 1.6 and 16 Mc. Power output is 100 watts, p.e.p. Compatible AM is standard, as is the front panel meter.

The COMPACT weighs only 34 pounds and measures 15½ x 13 x 8¼ inches, including power supply. Automatic level control (ALC) and receiver AGC are standard. A Collins mechanical filter is used for sideband selection. Remember, under poor signal conditions, the COMPACT has approximately the same communications range as a 700 Watt AM transmitter. Can be used to drive the RF-101 Linear Amplifier.

## SB-6F *Series* BASE STATION SSB SYSTEMS

COMMERCIAL/SEMI-MILITARY QUALITY

Since its introduction in 1961 the Model SB-6F has been the quality leader in SSB Communications. Equipped for six channel operation, the unit provides full communications capability for all commercial, government and semi-military applications. The 125 Watt p.e.p. SB-6F is being used by 12 U. S. Government Agencies. Our customers use the SB-6F in over 50 countries of the world. The photo shows the SB-6F mounted on the RF-101 Linear 1KW Amplifier. This complete 1KW station measures only 35 inches high.

SB-6F  
TRANSCEIVER

RF-101  
LINEAR  
AMPLIFIER



WRITE FOR DETAILS ON THESE AND OTHER PRODUCTS IN THE  
WORLD'S MOST COMPLETE LINE OF FIXED CHANNEL SSB EQUIPMENT

Overseas Distributor Inquiries Invited



# RF COMMUNICATIONS INC.

1680 UNIVERSITY AVENUE • ROCHESTER 10, NEW YORK • CH 4-5830

# 2 ANTENNAS IN 1

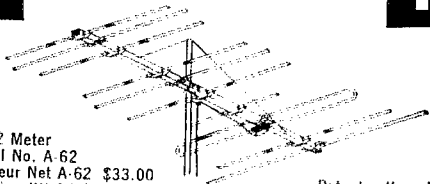

6 & 2 Meter  
Model No. A-62  
Amateur Net A-62 \$33.00  
Stacking Kit AS-62 \$2.19

Patents allowed  
and pending

The Only Single Feed Line  
6 and 2 METER  
COMBINATION YAGI ANTENNA

another first from **FINCO®**

### ON 2 METERS

- 18 Elements
- 1 — Folded Dipole Plus
- Special Phasing Stub
- 1 — 3 Element Colinear Reflector
- 4 — 3 Element Colinear Directors

### ON 6 METERS

- Full 4 Elements
- 1 — Folded Dipole
- 1 — Reflector
- 2 — Directors

See your FINCO Distributor  
or write for Catalog 20-226

**THE FINNEY COMPANY**

Dept. 21

Bedford, Ohio

**SOUTHWEST'S  
MOST COMPLETE  
HAM STOCK**

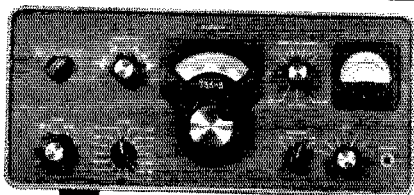

**COLLINS**

75S-3 RECEIVER

TIME PAYMENTS • TRADE-INS  
IMMEDIATE DELIVERY

CALL OR WRITE { RONNIE W5ATB  
BERT W5FU

**Radio, Inc.**

1000 S. MAIN • LUTHER 7-9124  
TULSA 19, OKLAHOMA

AUF, VE2AJS, 400 Traffic, Temps 30 hrs. Fréq.: 3750 ke. Traffic: VE2AGQ 115, VE2ALH 36, VE2EC 35, VE2-CYM 2 33, VE2DR 33, VE2AIR/2 18, VE2QC/2 4, VE2-AJD 3.

**ALBERTA**—SCM, Harry Harrold, VE6TG—SEC: VE6FS, PAM: VE6PV, RM: VE6AEN, ECs: VE6FK, VE6SS, VE6ABS, VE6AJY, VE6AFJ, VE6PZ; OPS: VE6CA, VE6PV, VE6HM, VE6SS, VE6BA, OOs: VE6-HM, VE6NX, VE6PL, OESs: VE6HM, VE6AKV, ORS: VE6BR, OESs: VE6DB, VE6HO, VE6AKV, Edmonton reports some activity on 6 meters with WOs and W9s, VE6ZX took the prize for the July 9th bunny hunt; also got some work done with the AREC, Red Deer reports a very good turnout for its picnic; also lots of work with the Boy Scouts camp, Calgary reports that there still are some Golden Jubilee certificates left for those who want to try for them. The Vulcan Club did a very good job with communications at the International Hamfest, I have not heard from the hamfest committee, but I understand that more than 1000 attended. Thanks to VE6PV for filling in for me at the hamfest, VE6UH walked off with the preregistration prize, a scope. The auditor and auctioneer were presented with gold inscribed plates for their 25-year's service to the International Hamfest. Next year's hamfest will be Glacier Park, Montana, Traffic: VE6HM 267, VE6TG 9, VE6ES 6, VE6SS 6, VE6BA 4, VE6FK 2.

**BRITISH COLUMBIA**—SCM, H. E. Savage, VE7PB—The Okanagan Valley International Hamfest was held at O.K. Falls and 101 licensed amateurs and their XYLs, YLs and jr. OMs had one good two-day party. The Canadian show was the hard work of VE7APP, VE7WU, K7RZH and many others. Of course VE7XW and his team again found the hidden transmitter, VE7DB was the MC and auctioneer. The Quarter Century Wireless Association is building up its membership in British Columbia with the hard work of VE7BHH. Anyone who can prove that he is an old, old operator had better join us old folks now. VE7FC is a silent key, VE7AOY will be helping for a while working in new mechanical choppers. VE7BHH and VE7AQT have been awarded the SNG, VE7ALU is back on with a Heathkit rig, VE7AOI is back after the holidays to manage the BCAREC Net. VE7DH seems to be the only one we hear from Nanaimo. The Nanaimo Club is planning an active winter training program. VE7AC reports that fruit farming is taking all his time from DX. While looking for fresh fruit near Oliver we found another busy fruit farmer, VE7BJC, VE7BAM is very pleased with his home-brew Simplex receiver and 6V6 oscillator. VE3EEP is now VE7BMS, VE7AKE is our OES and is exploring v.h.f. and u.h.f. VE7BBB has printed a very nice paper for the Canadian Certificate Hunter's Club. How is your Form 7? Traffic: VE7BHH 242, VE7BDJ 92, VE7BHW 16, VE7AC 12, VE7AMW 10, VE7AKE 2, VE7DH 1.

**MANITOBA**—SCM, M. S. Watson, VE4JY—Your SCM returned from an extended visit in England July 23 and while there enjoyed a visit to the Radio Society of Great Britain at 28 Little Russell St., London, W.C.1 and met among others Vice-Pres. G. M. C. Stone, G2-EC, who handed me the society's July bulletin featuring the occasion of its Golden Jubilee. Also I met ARRL Canadian Director Noel B. Eaton, VE3CJ, who was present to extend greetings from Canada. Manitoba amateurs will cooperate with the Boy Scouts to make their Jamboree on the air a success Oct. 19 and 20. After continuous pressure by many ardent supporters of amateur radio for some years Hon. Sterling Lyon Minister of Public Utilities, on behalf of the Manitoba Government, has authorized the Registrar of Motor Vehicles to reserve a block of license plates for amateurs in 1964 for an extra fee of \$5 to cover a six-year period. The Registrar will deal with the amateur license plate committee which is charged with collecting the fee. So far over 200 amateurs have sent in their fee to the committee, the plates being available to amateurs owning automobiles whether their station is fixed or mobile. VE4HW was the spark plug for this successful effort.

**There is Still Life . . .**

(Continued from page 40)

mode switch in the n.b.f.m. position, both the i.f. signal and the audio input (disconnected from the diode detector) are available at the n.b.f.m. adapter socket. Both plate and filament supply are also available at this socket.

(Continued on page 162)

# LAFAYETTE RADIO ELECTRONICS

# FREE!



1964 Catalog  
No. 640

422 Giant-  
Size Pages

LAFAYETTE—"WORLD'S AMATEUR & ELECTRONICS SHOPPING CENTER"

## GIVES YOU '64 MORE IN

**MORE HAM GEAR** . . . for receivers, transmitter, as well as the smallest accessory, more amateurs everywhere make Lafayette their headquarters for all their gear.

**MORE CITIZENS BAND** •  
**MORE TEST EQUIPMENT** •  
**MORE TOOLS** •  
**MORE TUBES** •

**MORE STEREO HI-FI** •  
**MORE TAPE RECORDERS** •  
**MORE P. A. EQUIPMENT** •

**MORE SERVICE** . . . more and more orders fully processed in 24 hours.

**MORE BUYING POWER** . . . choose from LAFAYETTE'S three Easy-Pay Credit Plans. **NO MONEY, DOWN** — up to 24 months to pay — as little as \$5 monthly.

*Mail the Coupon  
for your FREE  
1964 Lafayette Catalog*

### LAFAYETTE DELUXE 6-METER TRANSCEIVER HE-45-B

- High Efficiency—Up to 100% Modulation
- Superheterodyne Receiver Section for 50-54 MC
- 3-Stage, 14-Watt Transmitter
- Built-in 117V AC and 12VDC Power Supplies
- Complete with Push-to-Talk Ceramic Mike, Crystal for 50.12 MC, Detachable Mounting Bracket, All Power Cables

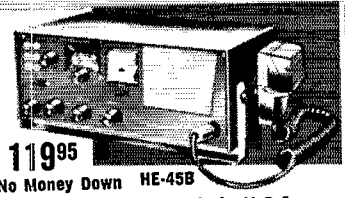

**1195**  
No Money Down HE-45B  
\$6 Monthly Made in U.S.A.

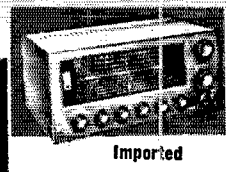

### LAFAYETTE AMATEUR COMMUNICATIONS RECEIVER

KT-320 HE-30  
Semi-Kit Wired  
**6495 7995**  
No Money Down  
\$5 Monthly

- Tunes 550 KCS to 30 MCS in 4 Bands
- Built-in Q Multiplier
- 8 Tubes plus Rectifier Tube
- 1 RF + 2 IF Stages for High Gain Reception



### LAFAYETTE STARFLITE 90-WATT PHONE AND CW TRANSMITTER KIT

**7950**  
No Money Down  
\$5 Monthly

- 90 Watts Phone or CW in 80 Thru 10 Meters
- Built-in 3-Section Low-Pass Filter
- Clear, Chirpless, Grid Block Keying
- Easy to Build and Operate

## LAFAYETTE Radio ELECTRONICS

## CUT OUT AND PASTE ON POSTCARD

Mail Order & L.I. Sales Center  
111 Jericho Turnpike, Syosset, L.I., N.Y.



- OTHER LOCATIONS**
- New York, N. Y. 100 6th Ave.
  - Jamaica, N. Y. 165-08 Liberty Ave.
  - Scarsdale, N. Y. 691 Central (Park) Ave.
  - Bronx, N. Y. 542 E. Fordham Rd.

- Newark, N. J. 24 Central Ave.
- Paramus, N. J. 182 Route 17
- Plainfield, N. J. 139 W. 2 St.
- Boston, Mass. 110 Federal St.
- Natick, Mass. 1400 Worcester St.

LAFAYETTE Radio ELECTRONICS  
Dept. VJ-3, P.O. Box 10  
Syosset, L.I., N.Y. 11791

Send me the FREE 1964 Lafayette Catalog No. 640.

Name \_\_\_\_\_  
Address \_\_\_\_\_  
City \_\_\_\_\_ Zone \_\_\_\_\_ State \_\_\_\_\_

## Goliath of WONDERSHAFTS

Free standing . . . rugged . . . heavy duty . . . 2-section . . . fiberglass whip with bronze mounting flange — these are the characteristics of STYLE 202. Constructed by the exclusive Columbia Products process, this WonderShaft antenna is excellent for base station and shipboard use.

STYLE 202 shown fully erected to its overall height of 35 ft.



**COLUMBIA PRODUCTS COMPANY**  
SHAKESPEARE CO. SUBSIDIARY, COLUMBIA, S. C.

### N. Y. MIDTOWN HEADQUARTERS for world famous *hallicrafters*

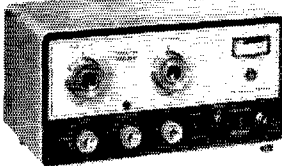

**HALLI-KIT HT-40  
TRANSMITTER**  
Have Fun & SAVE  
Thrilling coverage  
of all amateur  
bands 80 thru 6  
meters. 75-watts  
input.

KIT only \$89.95 — Wired & tested . . . \$109.95

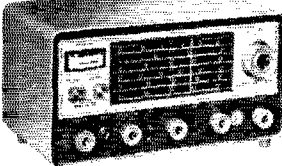

**HALLI-KIT  
SX-140 RECEIVER**  
(Complete coverage)  
Highly sensitive  
to all amateur  
bands 80 thru 6  
meters. Change-  
over control.

KIT only \$114.95 — Wired & tested . . . \$139.95

ALL HALLICRAFTERS in stock for immediate delivery. Complete audio demo dept.

EVERYONE  
eventually goes to



1 Door  
East of  
Lexington  
Ave.

124 East 44th Street, N.Y.C. • MU 2-3869

## Construction

I assembled the components of the adapter on a 4 × 5 × 1½-inch aluminum chassis. This fits into the HRO cabinet on the left-hand side. It is larger than necessary for the adapter alone, but provides space for an audio-derived a.g.c. system<sup>1</sup> which I plan to try out. A start on this project had been made when the photograph was taken.

I used surplus crystals in the b.f.o. These were obtained from Texas Crystals, who can also supply a set of matched 455-kc. s.s.b. crystals. **QST**

<sup>1</sup> Luick, "Improved A.V.C. for S.S.B. Reception." *QST*, October, 1957.

## The Art of QSLing

(Continued from page 63)

mind when you send out that card that you really want answered:

1. Follow the DX station's instructions to the letter.
2. Ask him if the *Callbook* address is still correct. Not all countries forward misdirected postal cards or even first-class mail.
3. Be sure to send a self-addressed envelope with IRC, his country's stamps, or a U.S. dime or two glued to a piece of cardboard.
4. Make *sure* your card is complete, including GMT time and date.
5. Be sure you have an envelope at your bureau in case the IRCs, stamps, or coins are of no use to him, or if his regulations require the use of his country's central radio association as a clearing house for all outgoing mail.
6. If he has a manager, do not QSL direct to the DX station.

In closing, I might detail the system used at KZ5SW. Once a month I gathered up all the cards that arrived during the month via the bureau or direct mail without s.a.e. and postage, arranged them according to GMT time and date, checked them in the log and filled out replies. W/K cards were sent in a package to the ARRL Headquarters. DX cards were all sent via the ISWL Bureau. All cards arriving with s.a.e. and IRC were answered the day of receipt via surface mail (U.S. cards will arrive in 2-4 weeks). Cards arriving with s.a.e. and either 3 IRC from DX stations, 2 IRC from W/K (cost to them at their P.O., 30¢), or a U.S. dime from W/K stations were answered on the day of receipt via air mail which takes 1 to 3 days to arrive in the states. QSLs from W/K in Local Time were answered when in the benevolent mood. Incomplete cards that usually lack mode, report, or frequency used, or unregistered SWL cards without s.a.e. and return postage were held for answering when the Panama Canal froze over. The methods of QSLing outlined in this article have worked well for me both as a W4 and as a "DX" station. (Believe it or not, KZ5 is considered rare by many overseas operators, particularly on s.s.b. and c.w.) I hope that they will work as well for

(Continued on page 164)

# TRANSCIVER HANDICAP



**WRL'S Winning Thoroughbred**

**GALAXY 300 WINS IN THE STRETCH.** A tough race all the way — it was neck and neck from the start. But Galaxy, through superior breeding (research and development), workouts (field-home-mobile testing), and the best owner/trainer (World Radio Laboratories), came through in the stretch and is paying off big for hundreds of cheering hams. When you buy the Galaxy 300 (300 watt SSB/AM/CW transceiver, covering 80-40-20-meters) you've got a winner — \$299.95 wired, or make it a daily double with deluxe matching power \$99.95. Like a full run-down? Mail the coupon . . . then you'll know why hamdicappers everywhere are choosing the Galaxy 300.

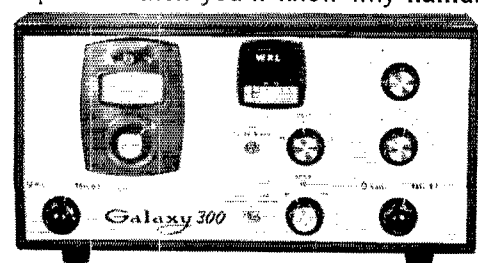

**WORLD RADIO LABORATORIES**  
3415 West Broadway, Council Bluffs, Iowa

SEND ME FREE:  RUNDOWN SHEET ON  
"GALAXY 300"  ALL NEW WRL HAM CATALOG  
 QUOTE ME "TRADE-IN" ON ATTACHED LETTER.

NAME \_\_\_\_\_

ADDRESS \_\_\_\_\_

CITY \_\_\_\_\_ ZONE \_\_\_\_\_ STATE \_\_\_\_\_

## **WORLD RADIO LABORATORIES**

3415 West Broadway • Council Bluffs, Iowa • Phone: 328-1851

# KTV

## THE HEIGHT OF QUALITY!

Knowing hams look for and require the following features in a good tower and find them in a KTV:

- Free-standing up to 50 ft. high
- Engineered safe in winds up to 80 MPH without ugly, hazardous guy wires
- Exclusive welded load bearers take all strain off joints
- No bolt holes in structural frame to rust, rip or cause weakness
- Free drainage joints prevent trapped moisture and corrosion
- Electro-plated with durable zinc for permanent high-lustre finish
- Easy installation and dismantling
- Constructed to climb for service requirements

Send for illustrated catalog of our entire KTV line

# KTV

TOWER & COMMUNICATION EQUIPMENT COMPANY P. O. Box 137, Sullivan, Ill.



## QSL PACKET FRAMES 20 CARDS



**3 PACKETS \$1.00**  
**10 PACKETS \$3.00**

PREPAID AND GUARANTEED  
 FRAMES AND DISPLAYS 20 CARDS IN PLASTIC  
**ORDER NOW!**

DEALERS' INQUIRIES INVITED

E  
Z  
I  
N  
C  
L  
E  
A  
R  
P  
L  
A  
S  
T  
I  
C

TEPABCO, DEPT. T-10, Box 198, Gallatin, Tennessee  
 Please rush—postpaid    I enclose \$.....  
 — 3 Packets for \$1.00    or    — 10 Packets for \$3.00

NAME.....  
 ADDRESS.....  
 CITY & STATE.....

you. Have patience — two-way bureau routing may take a year or more, surface mail can take many months, even two-way air mail can be delayed. And there is always the type of lid who never sends out a card in reply to one received! You won't get 100% return on your cards sent out, but if you can increase your replies from 25% (are you that lucky?) to around 75-85% you will be doing far better than before. *Good luck.*



## DX Competition Results

(Continued from page 75)

<i>Western New York</i>		W5QKZ.....5967- 39- 51- - -	
K2GXI.....195,816-164-400- C-85	W5DRW.....4050- 30- 45- - -	W5GFT.....429- 11- 13- A-14	
W2HOK.....61,596- 87-236- C-49	W2QWS.....30,459- 71-143- C-35	K5TYW.....360- 10- 12- C- 5	
W2CCO.....24,804- 53-156- C-46	W2SNL.....4437- 29- 53-BC-27	<i>Louisiana</i>	
W2CZT.....3444- 28- 41- C-20	W2QFK.....300- 10- 10- B- 4	W5AJY.....52,965-107-185-A-43	W5KCC.....37,410- 86-145- C-25
W2FUE.....168- 7- 8- B- 7	W42FUE.....168- 7- 8- B- 7	W5LDH.....22,230- 65-114- C-10	

<i>Western Pennsylvania</i>		<i>Mississippi</i>	
W3LIV.....18,315- 55-111- C-56	W3ZVA.....2940- 28- 35- C-14	K5MDX.....332,232-218-508- B-75	
K3ELL.....1404- 18- 26- B-16	K3SIQ.....297- 9- 11- A- 3	<i>Tennessee</i>	

### CENTRAL DIVISION

<i>Illinois</i>		<i>Kentucky</i>	
W4ENF.....80,028-117-228- C- -	K9CSW.....31,920- 80-133- C-40	W4BCV.....81,750-109-250- C- -	W4JRW.....16,908- 56-101- C-15
W9ZTL.....17,344- 54-107- C-41	W9GAI.....13,132- 49- 90- C-44	W4JRW.....6042- 38- 53- C-10	W4ACDL.....330- 10- 11- A-12
K9VFF.....12,300- 50- 82- C-58	W9LJV.....11,520- 48- 80- C-37	<i>Michigan</i>	
W1VIG.....4557- 31- 49- C-12	K9ZBI.....4557- 31- 49- A-25	W8WT.....27,864- 72-129-A-C-40	W8RXY.....24,000- 64-125- C-30
K9JLR.....4416- 32- 46- B-18	K9YWY.....2498- 26- 32- A- -	W8EW.....3907- 27- 47-A-C- 9	K80VK.....2112- 22- 32- B-11
K9BJM.....1716- 22- 26- C- 4	W9TRH.....1500- 20- 25- A- 4	W8QC.....1932- 23- 28- C- 5	W8OQL.....200- 10- 13- - 5
W9RHH.....1056- 16- 22- B-18	W9WIO.....810- 15- 18- B- 4	W8BNF.....216- 8- 9- B- 3	W8SS.....48- 4- 4- C- 1
W9CRN.....585- 13- 15- A- -	K9YRA.....189- 7- 9- A- 2	W8NWO (W8s NWO TWA ZTJ) 208,190-174-395- C-06	W8NGO (W8s CLR NGO ONA) 107,442-127-282- B-67
W9OKM (K9HUY, W9s OKM YYG).....19,647- 59-111- C-46		<i>Ohio</i>	

### INDIANA

K6ECE.....59,691-101-197- A-57	W9VHM.....56,316- 76-247- C-43	W9EGQ.....2507- 23- 37- C- 5	
<i>Wisconsin</i>		<i>HUDSON DIVISION</i>	
W9GIL.....54,900-100-183-BC- -	W9KXK.....11,070- 41- 90- C-22	<i>Eastern New York</i>	
W9VSO.....10,206- 42- 81- - -	W9AOW.....810- 15- 18- A- 9	W42JBG.....28,512- 72-132- C- -	W42RNM.....13,920- 48- 97- C- 9
W9SZR.....105- 5- 7- A- 3		W2VIR.....0179- 37- 57- C-10	W420JD.....3534- 31- 38- C-11

### DAKOTA DIVISION

<i>North Dakota</i>		<i>Minnesota</i>	
W9JWL.....7320- 30- 61- B-24	W9RRW.....6090- 35- 58- C-33	K9IKL.....42,804- 87-164- C-65	
<i>DELTA DIVISION</i>		<i>Arkansas</i>	
W5CGR.....18,522- 63- 98- C-21			

### DELTA DIVISION

<i>North Dakota</i>		<i>Minnesota</i>	
W9JWL.....7320- 30- 61- B-24	W9RRW.....6090- 35- 58- C-33	K9IKL.....42,804- 87-164- C-65	
<i>DELTA DIVISION</i>		<i>Arkansas</i>	
W5CGR.....18,522- 63- 98- C-21			

(Continued on page 166)

## TURN COUNT DIAL

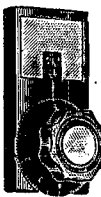

Registers Fractions to 99.9 Turns  
**FOR** roller inductances, INDUC-TUNERS, fine tuning gear reducers, vacuum and other multiturn variable condensers. One hole mounting. Handy logging space. Case: 2 1/2" x 4". Shaft: 1/4" x 3/8". TC 2 has 2 1/2" dial — 1 1/2" knob. TC 3 has 3" dial — 2 1/2" knob. Black bakelite.  
 TC 2 \$5.50 — TC 3 \$5.75 — Spinner Handle 75c extra  
 Add 12c for Parcel Post

R. W. GROTH MFG. CO.  
 10009 Franklin Ave.    Franklin Pk., Illinois

**AMECO CB-6 CONVERTERS**  
Tube-type low-noise, high-gain converters. IF easily changed. Specify IF.

- CB-6K — 6 meter kit, 6ES8-rf Amp., 6U8-mix./osc. \$19.95
- CB-6W — 6 meter wired and tested. \$27.50
- CB-2K — 2 meter kit, 6ES8 1st rf amp., 6U8-2nd rf amp./mix. 6J6 osc. \$23.95
- CB-2W — 2 meters wired and tested. \$33.95



Model PS-1—Matching Power Supply — plugs directly into CB-6, CB-2 and all CN units.  
PS-1K — Kit — \$10.50  
PS-1W — Wired — \$11.50

**DIRECT/5:1 REVERSE  
VERNIER DRIVE**

The newest in the line of fine tuning aids from Jackson Bros. Direct/Slow Reverse (5:1 ratio) Vernier Drive. Easy fixing — requires only one 3/8" hole. High torque, low back lash, smooth and permanent movement, coaxial spindles, 1/4" shaft dia.

Model 4111/RV  
Amateur Net \$1.95



**SUPEREX HAM HEADPHONES**

Full comfort even after many enjoyable hours of continuous use. Superb comfort even for eyeglass wearers. Crisp, distortionless reproduction and high sensitivity allows you to single out that weak signal and hard to reach station. 600 ohms impedance, completely adjustable head harness. \$24.95

**MURA MODEL NH-200  
COMPACT SUPER ANALYZER**

RANGES — DC Volts: 0-25, 1, 10, 50, 250, 500, 1000 V. (20,000 ohms/volt). AC Volts: 0-10, 50, 250, 500 (8,000 ohms/volt). DC Current: 0-50 ua, 10 ma, 250 ma. Resistance: 0-5K, 500K, 5 Meg. Db: -10 to plus 22 direct reading. Complete with test leads and batteries. Shipping wt.: 2 lbs., 4 1/2 x 3 3/4 x 1 1/2".

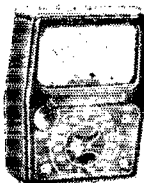

Amateur Net \$11.95

imported

**BULLSEYE**



handpicked  
for hams  
by hams...

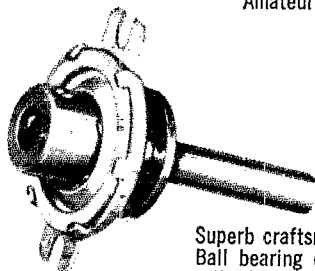

Shown approx. actual size.

**PRECISION PLANETARY-VERNIER  
for exceptionally fine tuning**

Superb craftsmanship by Jackson Bros. of England. Ball bearing drive, 1/4" dia. Shaft 1 1/8" long: 6:1 ratio. Vy FB for fine tuning. Easily adaptable to any shaft. Comparable value \$5.95 Model 4511/DAF Amateur net \$1.50 ea. 10 for \$13.50

**PRECISION BALL DRIVE DIAL**

Another superb product of Jackson Bros. of England. 4" dia. dial with 6:1 ball drive ratio. Fits standard 1/4" shaft. For that velvet touch... Amateur net \$3.95

Does not include panel.

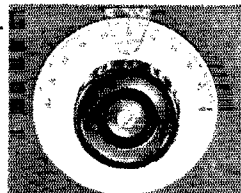

**VERSATILE MINIATURE TRANSFORMER**

Same as used in W2EWL SSB Rig—March, 1956 QST. Three sets of CT windings for a combination of impedances: 600 ohms, 5200 ohms, 22000 ohms. (By using center-taps the impedances are quartered). The ideal transformer for a SSB transmitter. Other uses: inter-stage, transistor, high impedance choke, line to grid or plate, etc. Size only 2" h. x 3/4" w. x 3/4" d. New and fully shielded.



Amateur net \$1.39.  
3 for \$3.49.  
10 for \$10.75

**MAIL ORDERS  
PROMPTLY PROCESSED.  
SAME-DAY  
SHIPMENT FROM STOCK.**

**TO SAVE C.O.D. CHARGES, PLEASE INCLUDE  
SUFFICIENT POSTAGE WITH YOUR ORDER.  
ANY EXTRA MONEY WILL BE RETURNED.**

ALL PRICES F.O.B. N.Y.C.  
Arrow's Export Dept. Ships To All Parts Of The World!  
Prices Subject To Change Without Notice.

**ARROW ELECTRONICS, INC.** 900 Broad Hollow Rd., Farmingdale, N. Y. 516 — MYrtle 4-6822

65 Cortlandt St., N.Y. 7, N.Y. • 525 Jericho Tpke., Mineola, N.Y. • 225 Main St., Norwalk, Conn.  
212 — DIgby 9-4730 516 — Pioneer 2-2290 203 — Victor 7-5889

SEND FOR  
FREE CATALOG

Trade-ins  
welcomed.

# NOW! IN STOCK

## DRAKE 2-B

"The most  
talked about  
HAM RECEIVER"



**ORDER NOW!**

Send check or money  
order. We prepay  
express charges.

**2-B Receiver  
\$279.95**  
**Q-Multiplier/Speaker  
2-BQ \$39.95**

WRITE OR CALL: BILL BRURING

# W9ZSO

COMMUNICATIONS EQPT. CO.  
518 STATE ST., LA CROSSE, WISCONSIN

## COMING SOON—ANOTHER FIRST! TRANSTENNA 102A

COUPLES TO FEED LINE  
(SIMPLIFIED DIAGRAM)

PAT. PNDG.  
U.S.A.  
& CANADA

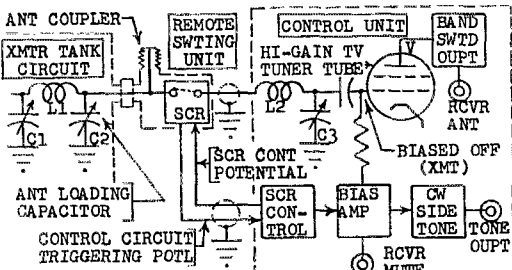

FULL LEGAL INPUT • 20 to 30 DB GAIN

### HOW IT WORKS

When C2 is adjusted for optimum transmitter antenna coupling, it also provides optimum antenna coupling for the 102A tuned input. The ultra high Q tuned input (C2-L2-C3) actually absorbs signal voltage from the transmitter tank circuit, rather than vice versa, which increases receiver gain and provides an astounding improvement in signal to noise ratio.

The semiconductor switching unit SCR opens the circuit at the antenna feed line, eliminating any effect on transmitter performance. There is no signal rectification by SCR or V to cause TVI.

**NO TVI • NO SUCK OUT • OUTPERFORMS  
REQUEST LITERATURE POPULAR 101**  
(See QST Jan. 1963)

DEALER INQUIRIES INVITED

**FICHTER ELECTRONICS**

33 Myrtle Ave.  
Cedar Grove, N.J.

WA2TJA ..... 27- 3- 3- A- 1  
W2SKE (W2s IWC SKL) .....  
165,168-148-372- C-75  
WA2RJZ (WA2RJZ, W2BJG) .....  
108- 6- 6- A- 5  
*Northern New Jersey*  
W2FFQ ..... 17,982- 54-111- B-55  
W2JSX ..... 7476- 42- 62- B-30  
W2JXH ..... 1554- 21- 25- A- 4  
W2MNV ..... 144- 1- 12- A- 1

### MIDWEST DIVISION

*Iowa*  
K6FAE ..... 11,520- 48- 80- C-20  
W0LBJ ..... 10,626- 46- 77- C-27  
W0LBS ..... 2700- 25- 36- A-25  
W0PDL ..... 1404- 18- 26- C- -

*Kansas*  
W0ALA ..... 10,296- 44- 78- C-27

*Missouri*  
W0LBB ..... 41,310- 90-153- C-59  
W0BTD ..... 32,760- 78-140- A-31  
W0UCK ..... 3240- 27- 40- A-54  
K0AXU (8 oprs.) .....  
8775- 45- 65- C-22

### NEW ENGLAND DIVISION

*Connecticut*  
W1BIH ..... 5841- 33- 59- C- -  
K1OSY ..... 5181- 33- 53- C- 7  
W1AW\* ..... 5040- 28- 60- C- -

*Maine*  
K1VXU ..... 17,442- 51-114- B-54  
W1GKJ ..... 14,400- 50- 96- C-24  
W1FDL ..... 1064- 14- 26- B-15

*Eastern Massachusetts*  
W1ONK ..... 168,099-137-109- -47  
K1DIR ..... 67,803- 97-233- C-45  
K1PJT ..... 11,907- 49- 82- B-36  
K1KRC ..... 2460- 20- 41- C-36  
W1PLJ ..... 576- 12- 16- B-15  
W1NJL (4 oprs.) .....  
16,245- 57- 95- B-37  
W1MX (K4s BVD RNE) .....  
252- 7- 12- A- 3

*Western Massachusetts*  
W1RF ..... 6264- 27- 78- C- 9  
W1JYH ..... 108- 6- 6- - -

*New Hampshire*  
K1RTB ..... 107,744-112-323- B-65  
W1FZ ..... 92,769-107-289- C- -  
K1HK ..... 60- 4- 5- C- 1

*Rhode Island*  
W1ZFY ..... 86,724- 99-292- C-50  
W1AWE ..... 495- 11- 15- A- -

### NORTHWESTERN DIVISION

*Alaska*  
KL7WAI (KL7DML, W408(f)) .....  
24,675- 47-179-AC-96

*Idaho*  
K7TMJ ..... 5772- 37- 52- A-44

*Oregon*  
W7DIS ..... 6090- 35- 58- A-30  
W7HIA ..... 1575- 21- 26- C- -  
W7BTH ..... 595- 13- 15- C- -  
W7DLR ..... 243- 9- 9- C- 4  
W7IYW ..... 45- 3- 3- C- 2  
K7RQX ..... 12- 2- 2- A- 2

### PACIFIC DIVISION

*Santa Clara Valley*  
K6ERV ..... 90,504-108-280- C-82  
K6OHJ ..... 94,870-115-246- C-60  
W6PYM ..... 40,770- 90-151- C-37  
W6WX ..... 22,815- 65-117- C-20  
W6UML ..... 10,512- 48- 72- C-25  
W6JKJ ..... 10,200- 50- 68- C- -  
W6HOC ..... 6201- 39- 53- C-20  
K6UXV ..... 5508- 34- 54- B-23  
W6JWD ..... 2520- 24- 35- C-17  
W6GMY ..... 1914- 22- 29- C-10  
W6ATGY ..... 1518- 22- 23- A- 3  
K6BWX ..... 1071- 17- 21- C- 8  
K6HOR ..... 960- 16- 20- B- 8  
W6BNYJ ..... 27- 3- 3- B- 6  
W6BNYK ..... 27- 3- 3- A- 5  
K6TZX ..... 27- 3- 3- B- 2

*East Bay*  
K17DTB/6 ..... 58,140- 95-204- C- -  
W6KG ..... 35,076- 74-158- C- -  
W6PQW ..... 26,820- 60-149- B-32  
K6AHV ..... 16,461- 59- 93- C-20  
W6LDD ..... 3483- 27- 43- C-10  
W6PLT ..... 468- 12- 13- C- 5

*San Francisco*  
W6YEJ ..... 4794- 34- 49- A-24  
W6RRS ..... 73- 5- 5- B- -

*Sacramento Valley*  
W6GRX ..... 35,604- 86-138- C-56  
W6SIA ..... 22,338- 73-102- B-34  
W6SLU ..... 324- 9- 12- A- 8

*San Joaquin Valley*  
W6BVM ..... 1680- 20- 28- B- -

### ROANOKE DIVISION

*North Carolina*  
W0PFA/4 ..... 12,054- 49-82- A-42

*South Carolina*  
K4WJT ..... 4872- 29- 59- B-13

*Virginia*  
W4BVV ..... 165,516-156-355- C-85  
W4OM ..... 39,880-107-280- C- -  
K4SXT ..... 69,230-115-201- C-35  
W4OPM ..... 60,720- 92-92- C-24  
W4LRN ..... 10,074- 48- 78- C-15  
W4NJF ..... 9585- 45- 71- C-17  
K4ORQ ..... 810- 15- 18- C- 3  
W4GF ..... 36- 3- 4- C- -

*West Virginia*  
W8UMR ..... 4995- 37- 45- A- 6

### ROCKY MOUNTAIN DIVISION

*Colorado*  
W0GAA ..... 20,085- 65-103-AC-55  
K0MTC ..... 10,350- 50- 69- C-20

*Utah*  
W7UOM ..... 6156- 36- 57- B-48

*New Mexico*  
W5FJE ..... 28,835- 79-125- C-38  
W5LEF ..... 26,199- 71-123- C-33  
K5STL ..... 1560- 20- 26- A-10  
K5UYF ..... 1380- 20- 23- B- 4

### SOUTHEASTERN DIVISION

*Alabama*  
W4PRP ..... 33,744- 74-152-BC-60  
W4DS ..... 10,578- 41- 86- -21

*Eastern Florida*  
W4QVJ ..... 66,768-107-208- C-39

(Continued on page 168)

### AMATEUR RADIO LICENSE COURSE

New York City Board of Education

Adult Community Center No. 59  
Springfield Blvd. & Merrick Rd.  
Springfield Gardens, L. I., N. Y.

**NOVICE • TECHNICIAN • AND GENERAL CLASS LICENCE  
THEORY AS REQUIRED BY FCC WILL BE COVERED.**

**Evening Sessions • Registration: October 7-14**

Course under supervision of W2HNG



# 16th EDITION RADIO HANDBOOK

—clear, concise theory  
...extensive new  
data for designing,  
building, and operating  
radio equipment

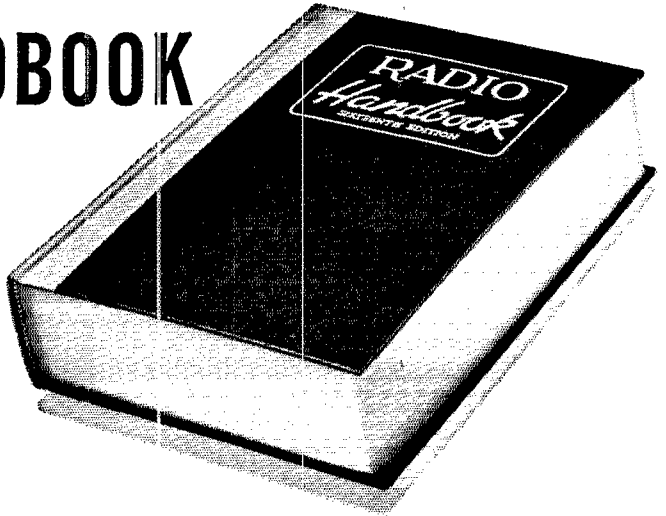

In the latest "Radio Handbook," you get comprehensive data on every subject listed below, plus original new design and construction articles. The 16th Edition is thoroughly revised, and brought abreast of the latest in technical progress.

**Broadest coverage in the field . . .** complete information on building and operating a tremendous variety of high-performance equipment items. All data clearly indexed. 805 pages, all text, with hard covers.

**\$9.50\*** Book #166  
(foreign \$10.50)

*at your distributor*

**CONTENTS INCLUDE:** AC & DC Circuits • VT Principles • Transistors & Semiconductors • VT Amps • High Fidelity • RFVT Amps • Oscilloscopes • Special VT Circuits • Radio Receiver Fundamentals • Energy Generation • R-F Feedback • Amplitude Modulation • FM & Radio Teletype Transmission • Sideband Transmission • Transmitter Design • TV & BC Interference • Transmitter Keying • Radiation, Propagation & Transmission Lines • Antennas • HF Antenna Arrays • VHF & UHF Antennas • Rotary Beams • Mobile Eqpt. Design & Install. • Receivers & Transceivers • Low Power Transmitters & Exciters • HF Power Amps • Speech & AM Eqpt. • Power Supplies • Workshop Practice • Electronic Test Equipment • Radio Mathematics & Calculations

## NEW AMPLIFIER DESIGNS

- Complete Grounded Grid Amplifier
- 3-100Z Linear Amplifier
- 4CX1000A Amplifier
- 813 Grounded Grid Amplifier
- 7094 Amplifier
- Tri-Band Linear Amplifier
- KW-2 Amplifier (economy g-g circuit)
- 4-400A General Purpose Amplifier
- Kilowatt All-Purpose Amplifier
- Transformerless 25-Watt Music Amplifier (Hi-Fi)

## NEW TRANSMITTER DESIGNS

- 50 Mc. Transistorized Xmitter
- 200-watt Deluxe Tabletop Xmitter
- VHF Strip Line Amplifiers
- "9T0" Electronic Keyer

## LATEST IN RECEIVERS AND TRANSCEIVERS

- Bandpass Filter Receiver
- 10-15 Meter Transceiver
- 2-6 Meter "Siamese" Converters
- Deluxe Mobile Transceiver
- DX Communications Receiver

All above units are modern in design, and free of TVI producing problems.

\*Order from your favorite electronic parts distributor.

If he cannot supply, send us his name and your remittance, and we will supply.

## EDITORS and ENGINEERS, Ltd.



Summerland 7, California 93067

Dealers: Electronic distributors, order from us. Bookstores, libraries, newsdealers order from Baker & Taylor, Hillside, N. J. Export (exc. Canada), order from H. M. Snyder Co., 440 Park Ave. So., N.Y. 16.

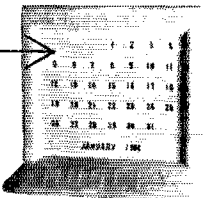
Free  
  
**Mosley**  
**1964 PERPETUAL CALENDAR**

Molded of sturdy ivory plastic with 12 printed month/date insert fillers. This attractive desk accessory measures just 3 1/4" X 3 3/8".

Here is all you do . . .

- Hurry to your Mosley Distributor!
- Fill out handy registration card!
- Receive your beautiful desk calendar!

. . . What could be easier?

You Must Hurry. Offer Expires Dec. 31, 1963.

BE THE FIRST IN YOUR DISTRICT TO BE

• UP TO DATE •



**FACTORY AUTHORIZED SERVICE**  
**ON RECEIVERS AND TRANSMITTERS**

REPAIRS, modernization, calibration and alignment by competent engineers using factory standard instruments. Collins, Globe, Hallcrafters, Hammarlund, Harvey-Wells, National Co. Service representative for Hickok and RCA Test Equipment. Factory parts. All work guaranteed. Our twenty-seventh year

**DOUGLAS INSTRUMENT LABORATORY**

176 Norfolk Avenue Boston 19, Mass

EVERY HAM NEEDS THIS FAMOUS KEY

**VIBROPLEX**



This famous key is the EXPERT'S choice. Semi-Automatic, with precision cut highly polished parts, and adjustable to any speed. Sending effort cut in half. Standard models have Polished Chromium top parts and gray base. DeLuxe models also include Chromium Base, and red finger and thumb pieces. Five models to choose from priced \$17.95 to the 24K gold plated Base "Presentation" at \$33.95.

**VIBRO-KEYER**

The key that works perfectly with Electronic Transmitting Units. Base 3 1/2" by 4 1/2" and weighing 2 3/4 lbs. Has Vibroplex's finely polished parts. Standard model \$17.95; DeLuxe model includes Chromium Plated Base at only \$22.45.

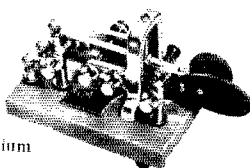

Order today at your dealers or direct

**THE VIBROPLEX CO., INC.**  
 833 Broadway New York 3, N. Y.

FREE Folder

K4QBP . . . 37,908- 81-156- C-21	Manitoba
K4HIF . . . 36,288- 84-148- B-43	VE4XO . . . 16,632- 56- 99- C-38
W4LWV . . . 10,320- 43- 80-B-14	VE4ZX . . . 3995- 11- 12- A- 8
W4ALZM . . . 4530- 30- 51-B-15	Saskatchewan
W4EEO . . . 3267- 53- 33- C-12	VE5GF . . . 1870- 22- 29- B-12
K4EJ . . . 2185- 23- 32- B-20	Alberta
K4RQE . . . 1320- 20- 22- B- 2	VE6PL . . . 1242- 18- 23- A- 9
K4LDR . . . 270- 9- 10- - -	British Columbia
W4KFB . . . 264- 8- 11- C- 3	VE7EH . . . 11,550- 50 -77- A-26
K4BUA (K4s BU A BWF)	VE7BBB . . . 75- 5- 5- A- 4
27,385- 65-143- B-69	
K4VGL (K4VGL, W44GVM)	
428- 11- 14- -12	

**Western Florida**

W44FL . . . 2520- 24- 35-AC-18

**Georgia**

W4MCM . . . 73,548-108-227- C-50
K4RPK . . . 25,740- 66-132- C-30
K4TEA . . . 18,156- 68- 89- A- 6
W4BFR . . . 13,608- 56- 81- B-17
W44ARV . . . 10,011- 47- 71- A-85
K4GSX . . . 9198- 42- 74- B- -
W4SSU . . . 9009- 39- 77- - -
K4TKM . . . 4782- 22- 27- A- -
W51NL/4 . . . 1680- 20- 28- C. 5

**SOUTHWESTERN DIVISION**

**Los Angeles**

W46IPY . . . 100,080-102-300- - -
W46QGM . . . 13,860- 60- 77- B- 24
W6VNI . . . 10,530- 45- 78- C-13
W46KNE . . . 6519- 41- 53- B-13
W6FET . . . 2997- 27- 37- C-24
W46HGC . . . 2691- 23- 39- C. 6
W6MBV . . . 310- 15- 18- C. 4
W6BBLU . . . 232- 9- 9- A- 6
W6BCGA . . . 90- 5- 6- B- 4
K6EXO (K6s EXO YRA)
39,925-109-275- C-75

**San Diego**

W6RCD . . . 18,308- 97-166- C-41
W46SBO . . . 23,532- 74-106-AC-19
K6AVF . . . 6724- 36- 53- A-32
W6HJT (6 oprs.)
426,624-202-704- C-96

**Santa Barbara**

W46KCM . . . 495- 11- 15- A-46

**WEST GULF DIVISION**

**Northern Texas**

K5FKD . . . 11,580- 90-154- A-60
K5YUV . . . 14,784- 56- 88- A-50
W51PH . . . 7560- 45- 56- C-14
W5AKH . . . 1980- 22- 30- C-31
K5MUX . . . 12- 2- 2-AC-19

**Oklahoma**

W5KIY . . . 7520- 40- 64- A-12
K5FSU . . . 565- 13- 15- A- 9

**Southern Texas**

K5JZY . . . 60,049-103-192-BC-75
W5FDX . . . 1584- 22- 24- A-14
W5OP . . . 342- 9- 13- - 4

**CANADIAN DIVISION**

**Quebec**

VE2AMW . . . 12,474- 42- 99- A-12
VE2BV . . . 7326- 37- 66- B-12
VE2WM . . . 4170- 30- 47- B-14
VE2ANK . . . 3530- 30- 37- A-15
VE2AFC . . . 195- 5- 13- B- 3

**Ontario**

VE3FLO . . . 25,024- 68-123- C-35
VE3ES . . . 24,130- 65-124-AB-33
VE3PV . . . 16,836- 61- 92- A- -
VE3BJZ . . . 363- 11- 11-C- 2

(Continued on page 170)



**DUMMY LOAD**

52 ohm, non-reactive film oxide R.F. unit. All band, all power to .5 KW SWR 1.2 to 1.

Kit \$7.95 postpaid. Wired, add \$2

HAM KITS  
 Box 175, Cranford, N. J.

by hams...  
for hams...  
*Harvey is reliability*

# Harvey

## VALUES OF THE MONTH

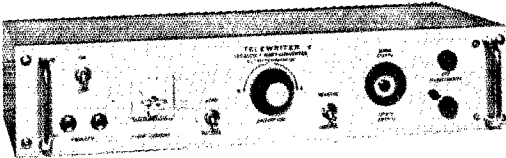

### MODEL K CONVERTER BY ALLTRONICS-HOWARD —

Audio input. Output jacks on front for Magnet and Keyboard. Keyer Tube keys magnet directly (no relay). Loop and bias supplies built-in. Wired sockets provided in converter for polar relay for keying transmitter, or external relay may be used. Distortion control on panel. Automatic Mark hold in absence of signal. Copies any shift 100 to 1,000 cycles.

Model K for Rack Mounting .....\$189.00  
Cabinet .....\$ 14.50

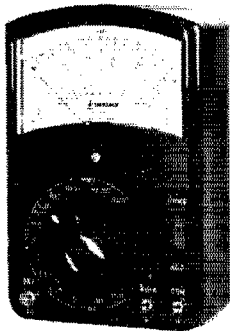

Imported

### MONARCH MODEL MT-220 VOLT OHM METER —

Ranges — DC Voltages: 0-2.5 - 10 - 50 - 250 - 500 - 5,000 Volts (20,000 ohms per volt) ... AC Voltages: 0 - 10 - 50 - 250 - 500 - 1,000 Volts (10,000 ohms per volt) ... DC Current: 0-0.05 - 5 - 50 - 500 ma ... Resistance: 0 - 12K - 120K - 1.2M - 12M ohms (60 - 600 - 6K - 60K midscale) ... Decibels: -20 to +62 db.  
Amateur Net.....\$14.95

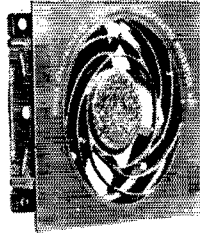

### ROTRON WHISPER FAN

The fan that moves 60 cu. ft. of air per minute... while running so silently you have to look to see if it's running! Removes heat to save your rig, yet uses only 7 watts. Measures 4 1/2" square by 1 1/2" deep. Has run for years in computers and other commercial equipment without attention — lifetime lubricated. Operates on 110-120V. A.C.  
Amateur Net.....\$14.85



### EXTRA-SENSITIVE HEAD PHONES BY SUPEREX

600 ohm impedance; extra-high sensitivity for weak signals and hard-to-read stations. reproduction is crisp, free of distortion... unequalled wearing comfort over long use. Amateur Headphone Model AP-S.  
Amateur Net .....\$24.95

### TELETYPE PAGE PRINTERS REBUILT BY ALLTRONICS-HOWARD —

most popular teletype machine among amateurs. Equipped with synch. motor for 110-120 VAC 60 cycles. Cover refinished... all units thoroughly tested mechanically and electrically.

Model 15 with holding magnet, keyboard.....\$250  
Model 15 with holding magnet, keyboard, automatic carriage return-line feed.....\$370  
Model 28 specially equipped Teleprinter.....\$750

**WE SPEAK YOUR LANGUAGE** — and have for 37 years. It means orders from every corner of the world are handled personally and your instructions, in any language, are followed. It means we speak the universal language of all radio amateurs. And that gives you such ham-to-ham extras as consultation on your problems, meeting specific requirements, and — at your request, with no charge — opening sealed cartons for complete equipment check-out.

Send check or money order including shipping charges. We return any excess.

# Harvey

## RADIO CO., INC.



103 West 43 St., New York 36, N. Y. (212) JUdson 2-1500

# Cush Craft "BLITZ BUG" COAXIAL LIGHTNING ARRESTER

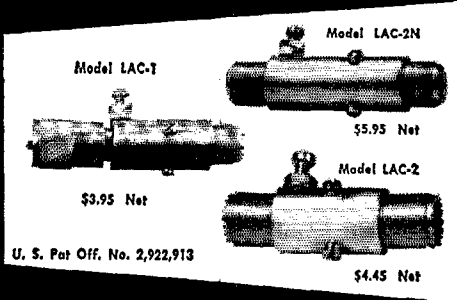

U. S. Pat. Off. No. 2,922,913

**LIGHTNING PROTECTION for AMATEUR • CITIZENS BAND COMMERCIAL RADIO EQUIPMENT**  
Models for All Applications

LAC-1 Type 83 connectors, 1 male, 1 female for direct to equipment installation. \$3.95 Net

LAC-2 Type 83 connectors—2 female for insertion in cable. \$4.45 Net

LAC-2N Type N connectors—2 female for commercial installations, inserts in cable \$5.95 Net

THERE'S NO BETTER INSURANCE THAN "BLITZ BUG"

See your distributor or write for Free Catalog



621 HAYWARD ST. MANCHESTER N. H.

## Faster CW—Better readability

10-day money back guarantee, Budget payments



\$16.95



\$69.50

**AUTRONIC**

**KEYER** is fully transistorized, automatically eliminates erratic sending. Built-in speaker for practice or monitoring. Separate weight, speed controls. Phone jack. Any position, fixed or mobile. 7x5x2". Finest buy for reliability, performance. AUTRONIC KEYER will not walk. Fully adjustable. No contact bounce. Usable with any keyer.

**ELECTROPHYSICS CORP.** SINCE 1929  
307 West Coast Highway, Newport Beach, Calif.

Send card or QSL for info

<i>Italy</i>	11BBZ.....1806-12-53-A-7	<i>Caymans</i>	VP5BP....211,215-65-1238-A-7
	IT1ZDA.....1012-11-31-A-7	<i>Bahamas</i>	VP7CX....112,926-59-638-A-60
	11LCF.....525-7-25-A-7		VP7CC....17,862-26-232-A-17
	11GO.....180-5-12-A-2		VP7NS....3220-10-109-A-7
	11CWN (4 oprs.)	<i>Bermuda</i>	
	87,500-35-834-A-70		W5JDX/VP9
<i>Norway</i>	LA5HE....14,094-29-162-A-7		67,725-45-502-A-25
<i>Austria</i>		<i>Mexico</i>	
OE1RZ....21,312-24-296-B-20		XE1CCB...588,720-80-2455-AB-52	
<i>Finland</i>		XE1CV...585,298-97-2012-C-7	
OH5NQ....2834-13-73-B-7		XE1FFU....165-5-11-B-1	
OH2PM/1...1340-11-30-B-7			
OH5TM....108-4-14-A-7			
OH2BR....72-4-6-A-1			
<i>Czechoslovakia</i>		<b>OCEANIA</b>	
OK1JX....564-12-16-B-4		<i>Eastern Carolines</i>	
<i>Belgium</i>		KC6BK....8772-17-172-A-7	
ON4UN....44,448-32-464-A-26		<i>Australia</i>	
<i>Denmark</i>		VK3HL....286-5-19-A-1	
OZ5JT....34,344-27-424-A-20		<i>Fanning &amp; Christmas Is.</i>	
OZ4RT....3375-15-75-A-6		VR3O....173,880-69-842-A-7	
OZ5KQ....784-8-33-A-7		<i>Cook Islands</i>	
OZ3KE....324-6-18-A-4		ZK1AR....10,080-28-120-A-15	
<i>Sweden</i>		<i>New Zealand</i>	
SL6BH <sup>s</sup> ....2160-8-90-A-7		ZL3RT....140-4-12-A-4	
SM5BFR....810-10-27-B-5			
SM6AOE (SM6s AOE BJ1)			
3520-16-115-B-7		<b>SOUTH AMERICA</b>	
<i>European Russian S. F. S. R.</i>		<i>Chile</i>	
UA1KBW (2 oprs.)		CE3XA....56,979-30-487-C-7	
17,920-14-418-B-44		CE8CG....270-6-15-C-3	
<i>Estonia</i>		<i>Ecuador</i>	
UR2BU....1352-13-36-B-7		HC1DC....487,272-79-2050-B-59	
		HC5EJ....73,556-37-672-B-26	
<b>NORTH AMERICA</b>		<i>Colombia</i>	
<i>Cuba</i>		HK4EB....20,916-18-391-B-14	
CO8RA....119,970-62-666-A-67		HK3LX....5740-23-127-A-7	
<i>Haiti</i>		<i>Argentina</i>	
HH2ML....17,134-26-222-A-26		LU1DAB...259,302-46-1879-B-66	
<i>Dominican Republic</i>		LU3EQ....58,170-35-554-B-37	
HI8MMN...22,002-38-193-B-11		<i>Peru</i>	
<i>Panama</i>		OA1W....13,788-36-129-A-16	
HP1AC....1644-12-46-A-7		OA4PX....12,033-21-191-B-8	
<i>Guantanamo Bay</i>		<i>Netherlands Antilles</i>	
KG4BH....36,855-35-356-B-27		PJ2AF....181,610-55-1105-A-31	
<i>Puerto Rico</i>		PJ2CR....5724-18-106-A-6	
KP4BTQ....91,665-45-678-C-7		<i>Brazil</i>	
KP4BMG....10,362-11-317-A-9		PY2BGO....4224-11-128-C-9	
KP4AYL....2640-11-80-C-2		PY1CK....108-6-6-A-1	
<i>Canal Zone</i>		<i>British Guiana</i>	
KZ5AF <sup>s</sup> ....237,750-50-1585-B-52		VP3HAG...164,142-66-828-C-26	
KZ5LC....103,776-47-736-B-24		<i>Venezuela</i>	
<i>Greenland</i>		YV5AGD...318,087-81-1309-BC-55	
OX3KM...29,856-32-311-A-7		YV1UK....204,724-62-1101-B-39	
<i>Guatemala</i>		YV5BFG...19,482-34-191-A-17	
TG9SC....202,725-53-1275-A-30		YV1DP....3207-10-109-B-7	

<sup>1</sup> K5VUV, opr. <sup>2</sup> W1WPR, opr. <sup>3</sup> Hq. staff — not eligible for award. <sup>4</sup> K6LSG, opr. <sup>5</sup> SM6CKU, opr. <sup>6</sup> KZ5GRS, opr.

ARRL thanks the following amateurs for submitting check logs C. W. — W2PZF W2RBB W2PFT W4EFS W6DAX W7HBO K9EJN W8HA W8JN D12RE G3WP HA5KBP KL7PI KP4XU OK1RX SM3AKW SM3CID SM5BDS SP5AKG SP5ZA VE2SI; Phone — W2PFT W4QD W6DAX W6POL W0DXB D12RE (38C SM5RC SM5CZQ YV5AKP.



## CALL-LETTER SIGNS

ORDER your call in neat 2-inch die cut letters with base. Just right for the shack. You assemble — letters:  $\frac{3}{8}$ " silver show-card stock. Base: satin finish black plastic.

Price \$1.50 postpaid

NEW PRODUCTS • Box 481 Dept. A • Grand Haven, Mich.

# TRIGGER FOR SENSATIONAL VALUES



FOREIGN INQUIRIES INVITED

WRITE FOR COMPLETE LIST  
(send stamped self-addressed envelope)

## ON LIKE-NEW HAM EQUIPMENT

- Two Week Trial
- 90 Day Guarantee
- Trades Accepted

Trigger specializes in ham gear that's *attractive* in appearance and *dependable* in performance. All components that can contribute to malfunction are replaced — insuring trouble-free performance.

Listed below are but a few of the hundreds of items and accessories currently available. Come in for a "look-see" and eyeball, or phone or write today.

### EXTRA CLEAN, SELECTED EQUIPMENT

51J4 w/cab	\$895.00	BICO 720	44.75
75A4 (late)	495.00	HA10	199.50
75A3	319.50	TN-1	180.50
KWM-1	367.50	DX100B	159.75
KWM-2	799.75	DX60	57.75
75R1	299.95	DX40	37.50
32R1	449.50	DX20	27.75
30R1	879.50	HRO-60	267.50
8X150	499.50	NC183D	177.75
8X117	297.50	NC109	174.75
8X115	344.75	NC125	99.75
8X101A	279.50	NC250	79.50
8X69A	229.50	T60	164.50
8X45	87.50	T60	34.75
8X111	177.75	T150	82.75
8X100	189.75	Q76	219.75
8X96	127.50	GR101	187.95
8X71	107.75	HL 6 mtr	144.75
8X110	99.75	ELEGG ZEUS	479.50
8X10	67.95	99er	97.75
8X99	87.50	AP68	99.95
8108	87.50	TA300C	129.50
894	19.95	HQ110C	189.75
CRX-2	69.50	HQ10AC	99.75
8118	69.50	HQ100	169.75
8107	39.75	HQ105	217.95
813A	239.50	HQ170C	279.75
SI34 (3 way)	57.50	HQ170A&NS	187.75
HT40	339.50	HQ145X	297.50
HT37	347.50	HQ180	129.50
HT32	477.75	HQ140X	149.95
HT32B	229.50	HQ150	124.95
HT33	799.50	MOSLEY CMI	47.50
INVADER 2000	147.50	RAA	237.50
RANGER	69.95	9000	184.50
VIKING 1	129.50	2A	208.95
COURIER	647.50	2B	

AMATEUR TRANSMITTING XTALS \$1.50  
6146 TUBES \$3.29 EACH

(above prices F.O.B.)

(A small deposit will hold the unit of your  
choice on Lay-Away)



### STORE HOURS

Weekdays . . . . . 1-8 P.M.  
Saturday . . . . . 9-3 P.M.

Or By Appointment After Hours  
Phones PR 1-8616

Chicago . . . . . TU 9-6429

Business phones with  
QTH Extensions

TRIGGER Attn: W91VJ

7361 North Avenue Amount  
River Forest, Illinois Enclosed \_\_\_\_\_  
(suburban Chicago)

RUSH THE FOLLOWING: \_\_\_\_\_

\* \_\_\_\_\_

NAME \_\_\_\_\_

ADDRESS \_\_\_\_\_

CITY \_\_\_\_\_ ZONE \_\_\_\_\_ STATE \_\_\_\_\_

\*ORDER BLANK TO: (1) trade ur present  
gear, (2) order above units, (3) sell ur  
gear for cash.

(ABC1234)



# TRIGGER

Electronics

7361 NORTH AVENUE • RIVER FOREST, ILLINOIS

# CANADIANS

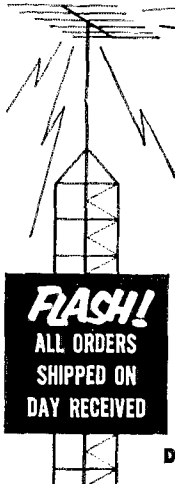

**RASH!**  
ALL ORDERS  
SHIPPED ON  
DAY RECEIVED

Complete stocks of nationally advertised products always available at **SMALLEY'S**—ham headquarters for Western Canada. Ten licensed hams on our staff to serve you.

- TRADE-INS ACCEPTED
- USED HAM EQUIPMENT
- SEND FOR SPECIAL FREE HAM BULLETIN

Pioneer ham suppliers since 1920. Specialists in **HI-FI, TELEVISION** and **INDUSTRIAL ELECTRONIC EQUIPMENT.**

**Smalley's RADIO LTD.**  
1105 - 7th Ave., S.W., Calgary, Alta.

## CONVERT YOUR AUTO RADIO

to a Shortwave Receiver the **MINIVERTER** Way!

- \* SMALL
- \* SELF-CONTAINED
- \* HIGHLY SENSITIVE
- \* CRYSTAL CONTROLLED
- \* GUARANTEED FOR 12 MONTHS



\* SHIPPED POSTPAID TO YOU

Any Model  
**\$12.95**

\* (H = High impedance antenna)

\* (L = Low impedance antenna)

\* ORDER DIRECT FROM

SCIENTIFIC ASSOCIATES CORP.

Box 1027

Manchester, Conn.

## Kreco GROUND PLANE ANTENNAS

*All Aluminum*

**LIGHT • STRONG • EFFICIENT**

2 METERS	MODEL GP-2A	15.00 net
5 METERS	MODEL GP-6A	36.00 net
10 METERS	MODEL GP-10A	42.00 net

These models are ordered out to exact frequency

25 to 30 MC	MODEL GP-30A	60.00 net
30 to 50 MC	MODEL GP-30A	42.00 net
50 to 100 MC	MODEL GP-30A	36.00 net
100 to 470 MC	MODEL GP-150A	15.00 net
3/4" ALUMINUM PIPE	PER FT.	1.00 net

ALL BRASS MODELS AVAILABLE

ASK YOUR DISTRIBUTOR OR WRITE

**HERB KRECKMAN CO. • CRESCO, PA.**

## An Interview with KTUGA

(Continued from page 67)

- L: Do you actually get enough time to operate, or do you just, like any ham, find the time?
- G: You ask my wife! I was up—well, just last night, I finally got a chance to hook up this Tribander with a rotator on it that we put up on the roof of the apartment house about a month ago. This was the first night I had really put all the wires together. Of course, I had built an oscilloscope from a Heath kit, and it's always a surprise to me when those things work the first time you turn them on. So I got it all hooked up, but the first time I went on 20, which came in like somebody was next door—then I moved something and found out that I hadn't fixed a plug right. Collins makes the most complicated plugs in the world! I'm going to have to talk to them about that. (LAUGHTER)
- L: Well, what bands have you been operating, Barry?
- G: Well, up until this Tribander, mostly 40, because 20 doesn't do too good on a vertical, although I've worked England on it, I've worked Peru, Venezuela and the West Coast, but conditions have to be just right for the vertical to get out.
- L: You'll do better now that you have a beam on the roof.
- G: Yes, well, I have a four-bander at home on a—about a 60-foot tower—that's KTUGA. It's about, I'd say, almost 900 feet above the valley floor, and that rascal really gets out.
- L: Well, now, will the gang on 40 or 20 let you be just Barry, or do you have problems being as well-known as you are, particularly when you're talking to the fellows in the U. S.?
- G: It's a funny thing. Very few of them look it up, and I never push it. Once in a while, someone will say, "Barry, what do you do in Washington?" I say, "Well, I work for the government," and then they keep pressing and finally I say, "Well, I'm a Senator from Arizona." The other night—oh, it's been a couple of months ago—I sent out a CQ and I got a call from a W0 up in North Dakota. It was a girl, and it turned out that this was her first contact. She had her license for years but this was her very first ham contact. And in the course of the conversation, of course, I gave her my handle, and then she sort of guessed it—and we spent about half an hour talking about Advise and Consent. She was reading it and she wanted to know what I thought about it. (LAUGHTER) Very few, and even when they do, there's no—I mean, they're just hams. There's no impressionist in ham. They're just out to do a job, and it's a thing I like about them.
- L: Well, the international aspects of ham radio are of particular interest to us and I know this must be fairly close to your heart, be-

(Continued on page 174)

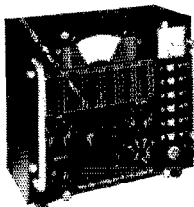

**STANDARD SIGNAL GENERATOR**  
MODEL SG-83 **\$140.00**

Calibrated output 0.6 to 16,000 microvolts. 360 Kc to 30 Mc in 6 bands. Pure 30% sine wave AM—No FM. All transistor. Write for complete specifications!

**CLEMENS MFG.**  
630 S. Berry Road • St. Louis 22, Mo.

Either your ham equipment

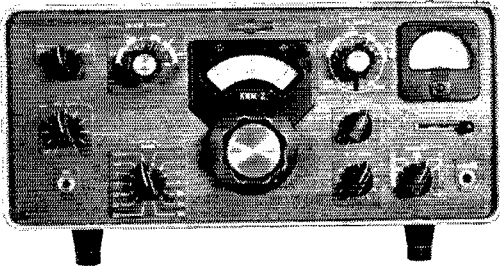

1 is designed around the latest systems concept

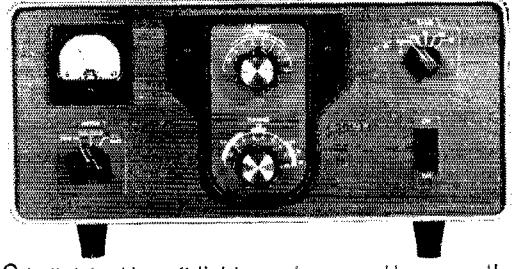

2 is finished in soft light-gray tones and has smooth, stylish lines

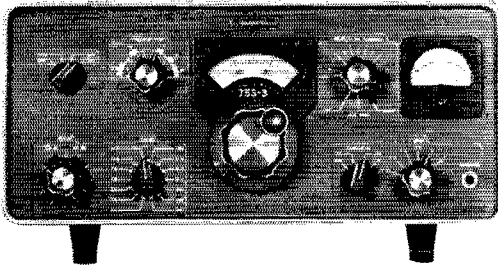

3 gives you swift, sure precise tuning on each unit



4 has station flexibility to let you operate as a transceiver or on separate frequency control, on HF or VHF

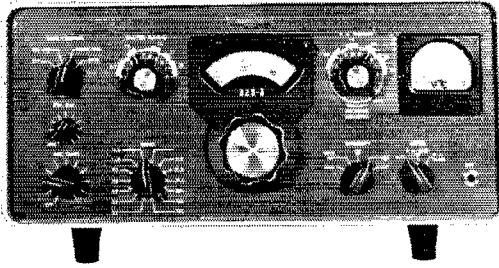

5 puts you on the air with the cleanest, clearest signal on the amateur bands

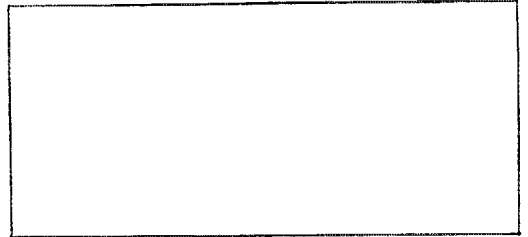

either that — or you're not using the Collins S/Line

See for yourself how much more pleasure the Collins S/Line can add to your ham operations, how much more beauty and style it adds to your ham shack. Come in for a demonstration soon.

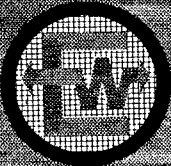

**ELECTRONIC  
WHOLESALERS  
INC.**

**9390 N.W. 27th AVE., MIAMI 47, FLA. Phone OXford 6-1620**

**2345 SHERMAN AVE., N.W., WASHINGTON 1, D.C. Phone HUdson 3-5200**

**1301 HIBISCUS BLVD., MELBOURNE, FLA. Phone PArkway 3-1441**

**938 BURKE ST., WINSTON-SALEM, N. C. Phone PArk 5-8711**

**2310 BOB WALLACE AVE., S.W., HUNTSVILLE, ALA. Phone 534-2461**

# FM MOBILE EQUIPMENT

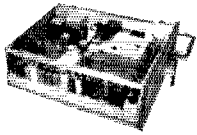

Motorola 80D 30 Watts out  
 Motorola 140D 60 Watts out  
 Motorola T44A 18 Watts out

SALES TO  
 AMATEURS ONLY

**FMTRU-80D 150Mc. FMTR-80D 30-50Mc.**  
 Cat. #16 150 Mc. 12 V. DC.....\$52.50  
 Cat. #17 30-50 Mc. 6V. DC.....\$39.50  
 Cat. #18 30-50 Mc. 12V. DC.....\$44.50

**FMTRU-140D 150Mc. FMTR-140D 30-50 Mc.**  
 Cat. #21 30-50 Mc. 6V. DC.....\$44.50  
 Cat. #22 30-50 Mc. 12V. DC.....\$54.50

Cat. #10 T44A 450 Mc. Mobile 6V. DC..\$40.00

Cat. #19 15 inch case for any of the above...\$2.50

### BOOKS

Motorola Schematic Digest.....Postpaid \$3.50  
 Wide-band FM for the Amateur.....Postpaid \$1.75

Equipment offered "as is". Any purchase may be returned prepaid for a full refund if you are not satisfied.

WRITE FOR FREE CATALOG

**F M SALES CO.**

1100 Tremont Street Boston 20, Mass.

## NOW-15% OFF ON PRECISION CRYSTALS! EXTRA SPECIAL • OCTOBER ONLY!

# \$1.95

ANY FREQUENCY—7000-10,000 K.C.  
 HC-6/U Fundamental Plated Crystals  
 Finished to .005%

.093 Pins For This Special Only—15¢ extra

**BOMAR CRYSTAL CO.: P.O. Box 481, Somerville, N.J.**  
**HC-6/U Plated Crystals**

FREQUENCY RANGE	TYPE	REG. PRICE	SPECIAL
2500-6999 KC	Fund.	\$5.80	\$3.65
7000-9999 KC	Fund.	3.75	3.10
10000-15000 KC	Fund.	4.25	3.50
15.0-21.9 MC	3rd Mode	3.85	3.25
22.0-29.9 MC	3rd Mode	3.85	3.30
30.0-45.0 MC	3rd Mode	4.25	3.50

UPON REQUEST, FT-243 PINS (.093" dia.) CAN BE HAD ON ANY HC-6/U CRYSTAL AT NO EXTRA CHARGE.

All crystals finished to .005% tolerance. Fundamental crystals are supplied for oscillator circuits having 32 µµf capacity, unless otherwise specified. 3rd overtone crystals are supplied for series circuits unless otherwise specified.

Freq. and Quantity .....

Enclose: \$..... Check  Money Order

Name .....

Address .....

City..... Zone..... State.....

cause of the bill that you've been sponsoring in the United States Senate which might amount to a form of reciprocity—if and when you're able to get it across. Would you tell us a little about that?

G: Well, first of all, it's not exactly my bill. Ray Meyers had me out to speak at an ARRL Conference about three years ago and he begged me on it. Senator Schoepfel had been trying to get it through unsuccessfully, so I introduced it and if we hadn't had the Telstar jibbustler last year, I'm sure it would have gone through. But this year, we've rewritten it to overcome all the objections. What we actually do now in this bill is to give a reciprocal privilege. This does away with the onus, if there is one, of a license. You might give a man a license and he'd hang around forever and use it. But I don't worry about that. I've seen too many hams from Mexico come up to the border, and they're told they can't come in the country with their radios. Here they are with a car full of kids and rig and they can't dismantle it. They can't come in, so they go home, and they get mad. I think that the United States at the very least could be reciprocal in this and — with the countries that allow us to operate (in their countries) — certainly we should give them the same privileges here. I have no worry about — oh, these people talk about spies and all that. Every embassy in Washington has its own radio outfit. If they want to call home, they can. So let the hams come over here and operate. I think it would be a great step in international relations. We talk to them — why not let them come in here and have fun with their own rig?

L: Now that you are on 20 meters with a beam in the east, where it isn't so hard to talk overseas, do you expect to be having some fun making some international contacts?

G: Oh yes, I want to work phone patch as much as I can. I'm a MARS operator and I've got a phone patch. I've worked a few for the boys. In fact, I got up this morning at 4 o'clock. I thought band conditions would be good. They were about as good as the back end of my head and I didn't have any luck, but usually — oh, 5, 6 o'clock in the morning, you can pick up Austrian and German stations without any trouble.

L: Well, then, I gather that you're back in ham radio with both feet, intending to stay, Senator Goldwater?

G: Well, just ask my wife. She gets so mad at me she could hit me on the head. This is the first thing that's ever kept me home. (LAUGHTER)

L: Well, we'll look forward to talking to you on the air.

G: Well, I'm looking forward to working foreign hams any time that they hear me on. Just scream back and we can get at it.

L: Thank you very much, Senator Barry Goldwater. QST

## TELETYPE WRITER EQUIPMENT • COLLINS

51J-3 RECEIVERS .50-30.5 MC. R-390A .50-32 Mc. SP-600 Receivers. 510 Kc.-51 Mc. Teletype: #11, 15, 19, 26, 28; Kleinschmidt; Mod. K Telewriter Receiving Converter, Boehme CW Keyers. Write to TOM WIAFN, ALLTRONICS-HOWARD CO., Box 19, Boston, Mass. 02101 Richmond 2-0018.





# FORT ORANGE

## Radio Distributing Co., Inc.

904 BROADWAY ALBANY 7 N. Y. U. S. A.  
AMATEUR HEADQUARTERS

Cable Address "Uncledave" CALL ALBANY 518-436-8411 NITES 518-477-5891

OCTOBER: THE GOLDEN HARVEST MONTH OF VALUES—REAP YOUR BENEFITS NOW FROM UNCLEDAVE'S SUPERB CROP OF RIPE, LUSCIOUS HALLICRAFTERS—THE CHOICEST FRUIT OF ALL.

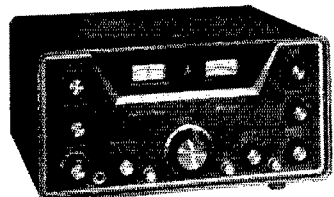

**HALLICRAFTERS SX-117** Triple conversion receiver. Sensitivity less than 1  $\mu$ v on AM, less than 1/2  $\mu$ v on SSB/CW. Selectivity .5, 2.5 or 5 kc. T-Notch filter, I.F. type noise limiter audio inverse feedback, 100 kc xtal calibrator. VFO can be used as crystal locked oscillator.  
Price..... **\$379.95**  
HA-10 adapter 85 kc-3 mc.....**\$24.95**

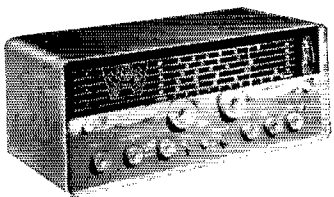

**HALLICRAFTERS SX-110....\$169.95**  
Covers 80 through 10 Meters.  
• Crystal filter  
• Slide-rule band-spread dial  
• Edge reading S meter  
• 7 tubes plus rectifier

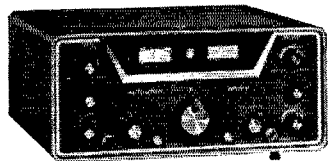

**HALLICRAFTERS SR-150** Fixed/Mobile Transceiver. 80 thru 1 segment of 10 meters. 150 watts SSB PEP, 125 watts CW. SSB—VOX or PTT; CW—manual or break-in. Receiver sensitivity less than 1  $\mu$ v for 20db S/N.  
Price..... **\$650**  
P-150 AC power supply.....**\$99.50**  
P-150 DC power supply.....**109.50**



**HALLICRAFTERS HT-32B...\$725.00**  
A transmitter designed for the amateur who must have the best  
• Complete amateur coverage capability, 80 through 10 meters without changing crystals  
• 144 watts plate input (P.E.P. two-tone)  
• Superior frequency stability, due to Hallcrafters' differential temperature compensation (U.S. Pat. #2718617)  
• Full 500 kc. coverage on VFO dial, with resolution to less than 1 kc.  
• Upper/lower/double sideband; full AM  
• Automatic break-in c.w.

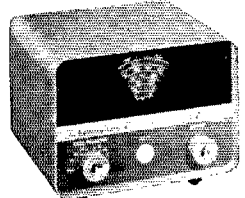

**HALLICRAFTERS MODEL HA-5 DELUXE**  
VFO High stability heterodyne-type for all bands. Three tubes plus voltage regulator and silicon rectifiers. Extreme stability. Illuminated dial calibrated for all amateur bands, 80 through 2 meters. Output frequency range: 3.5 Mc. to 4.0 Mc., 7.0 Mc. to 7.5 Mc., 7.8 Mc. to 8.3 Mc., and 8.333 Mc. to 8.833 Mc. Excellent keying; 30 to 1 tuning ratio permits precise tuning.  
**\$79.95**

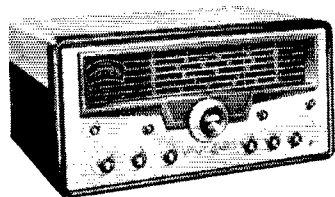

**HALLICRAFTERS SX-101A..\$445.00**  
The receiver with complete 80-10 meter coverage plus calibrated band for 2 and 6 meter converters.  
• Five steps of selectivity  
• Sensitivity of 1  $\mu$ v or less, all bands  
• Full gear drive  
• 10 Mc. position for WWV  
• Fast/slow AVC  
• Dual conversion

Write Uncledave  
W2APF  
with your needs  
and problems.

**TRADE-INS ACCEPTED AND FOREIGN  
TRADE SOLICITED • BANK FINANCING**  
All prices subject to change without notice

**UNCLE DAVE'S  
RADIO SHACK**  
A SUBSIDIARY OF  
FORT ORANGE RADIO  
DISTRIBUTING CO.

**TIME PAYMENTS** 18 Months to pay. Life Insurance at no extra cost

**MORE SIGNALS PER DOLLAR**  
From Money Invested in an Antenna

Self Supporting  
**STEEL TOWERS**  
For Rotary Beams, FM, TV

You can erect this tower yourself. Just dig four holes, set anchor posts in place, bolt the pieces together. 5 1/2 ft. ladder sections make it easy to work higher as tower goes up. It's a lot of fun to build your own tower — and saves you money, too!

**HURRICANE PROOF! VESTO TOWERS HAVE NEVER FAILED!**

- 4-Post Construction for Greater Strength!
- Galvanized Steel — Will Last a Lifetime
- SAFE — Ladder to Top Platform
- COMPLETE — Ready to Assemble
- ATTRACTIVE — NO GUY WIRES!

**SMALL DOWN PMT.—EASY TERMS**

Width of Base Equal to 1/5 Height

Vesto Towers are available in a wide range of sizes to meet requirements of amateurs and commercial users alike. Note the low prices for these quality lifetime towers

22'	\$ 174
28'	\$219
33'	\$262
39'	\$ 312
44'	\$350
50'	\$416
55'	\$ 472
61'	\$539
77'	\$850
100'	\$1312

Towers are shipped to your home knocked down. FOB Kansas City, Mo. 4th class freight. Prices subject to change... so order now!

Send check or money order... or write for free information.

WRITE TODAY FOR COMPLETE FREE INFORMATION AND PHOTOGRAPHS

**VESTO CO., Inc.**  
20th and Clay  
North Kansas City, Mo.

**DOW-KEY PANEL MOUNT**



Durable, silver plated, precision made. Only 5/8" hole is needed, no screws. **DK60-P .70 ea.**

**CONNECTORS**



**DOW-KEY DOUBLE-MALE CONNECTOR DKF-2**  
Favorite everywhere. Precision made, rugged locking type. Silver plated. **.95 ea.**

At your electronics dealer or write:

**DOW-KEY CO., Thief River Falls, Minn.**

**EASY TO LEARN CODE**

It is easy and pleasant to learn or increase speed the modern way — with an **Instructograph Code Teacher**. Excellent for the beginner or advanced student. A quick, practical and dependable method. Available tapes from beginner's alphabet to typical messages on all subjects. Speed range 5 to 40 WPM. Always ready, no QRM, beats having someone send to you.

**ENDORSED BY THOUSANDS!**

The **Instructograph Code Teacher** literally takes the place of an operator-instructor and enables anyone to learn and master code without further assistance. Thousands of successful operators have "acquired the code" with the **Instructograph System**. Write today for full particulars and convenient rental plans



**INSTRUCTOGRAPH COMPANY**

4709 SHERIDAN ROAD, CHICAGO 40, ILLINOIS  
4700 S. Crenshaw Blvd., Los Angeles 43, Calif.

**Silent Keys**

It is with deep regret that we report the passing of these amateurs:

- W1KYQ, Elmer P. Balcom, Bristol, Conn.
- W1UXN, Ambrose H. Seate, Dedham, Mass.
- W1ZLW, Carl S. Page, Kennebunk, Me.
- K2CXF, John Britt, Kenilworth, N. J.
- W2IAN, Arthur E. Gomersall, Brooklyn, N. Y.
- W2LCA, James K. Kewey, Madrid, N. Y.
- K2MXS, Howard A. Thomas, Binghamton, N. Y.
- W2OBW, Willets Roed, Nesconset, N. Y.
- W2OOF, William G. McKinty, Schoharie, N. Y.
- W2QS, Kenneth S. Forshoe, Savannah, N. Y.
- W2RGP, Gustave J. Marquardt, New York, N. Y.
- W3PEJ, J. Llewellyn Jones, Pittsburgh, Pa.
- W3QL, Gedney M. Rigor, Clinton, Md.
- WN4KOL, Patrick Ratley, Pensacola, Fla.
- W4NL, Herbert T. Cox, Intercession City, Fla.
- K4QMN, Robert L. Hall, Sheffield, Ala.
- W4VZW, Howard R. Speight, Roanoke Rapids, N. C.
- W5BBK, Preston T. Sellers, Houston, Tex.
- W5NS, Eli W. Whitney, Bartlesville, Okla.
- W6HFP, William T. McCluskey, San Diego, Calif.
- K6LDZ, Robert J. Casey, Corona, Calif.
- W6RUO, Matt J. Kovich, San Jose, Calif.
- K6TPX, Robert K. Kodak, Scotia, Calif.
- W6VWF, Howard M. Huckabay, San Francisco Calif.
- W6WR, Clarence H. Warne, Sherman Oaks, Calif.
- W7BLK, William Haferkorn, Clinton, Wash.
- K7JVY, ex-W6YAE, Truett C. Lusik, Bremerton, Wash.
- W7OBW, Howard L. Mayes, Las Vegas, Nev.
- WN8GHL, Clyde E. Loop, Lansing, Mich.
- W8PDZ, Edward E. Ballentine, East Detroit, Mich.
- W8WE, Bart J. Geib, Van Buren, Ohio
- K8ZAS, Albert R. Maki, Gladstone, Mich.
- K9AFP, Robert W. Hale, Fort Wayne, Ind.
- WA9ASJ, John E. Hall, Indianapolis, Ind.
- W9BAG, Frank E. Smolek, Oak Park, Ill.
- W9FRQ, Kenneth L. Broga, Champaign, Ill.
- W9GHP, Joseph H. Blair, Jr., Milwaukee, Wis.
- K9HQX, John H. Schneider, Sr., Winnetka, Ill.
- K9AEB, Joseph W. Parker, Rock Hill, Mo.
- K0DKX, John W. Reed, Mansfield, Mo.
- W0IRD, Lillian E. Feller, Duluth, Minn.
- KH6CUK, Joseph Okamoto, Wailuku, Maui, Hawaii
- KH6DKA, William S. Haddon, Hilo, Hawaii
- VE3XL, R. A. Campbell, Owen Sound, Ont., Canada
- VE7FC, Bruce B. Knowlton, Winfield, B. C. Canada

It is with extreme regret that we report the passing in April of one of amateur radio's early leaders, Robert S. Kruse, ex-9IQ, 3ABI. Kruse served as a director of ARRL in 1921 and 1922; and was the first Technical Editor of *QST* (1923-1928).

**CANADIANS!** We have large stocks of nationally advertised Ham parts. Write for Free Bulletin.

**THE CRAWFORD RADIO**

P. O. BOX 617

VE3YR 119-121 JOHN ST., N. VE3JU  
"Geo" HAMILTON, ONT. "Bill"

# HERE IT IS!

## THE NEW EDITION OF THE W6SAI

**NEW!**

# BEAM ANTENNA HANDBOOK

by William I. Orr, W6SAI

Before you build or buy  
your beam antenna —  
**READ This HANDBOOK!**

### FEATURING —

- ★ The new Inducto-match system
- ★ The W6SAI compact three element beam
- ★ Multi-band beams
- ★ Design of 40 meter beams
- ★ Inexpensive wire beam antennas
- ★ Design charts and SWR curves for 40, 20, 15, 10 and 6 meter beams

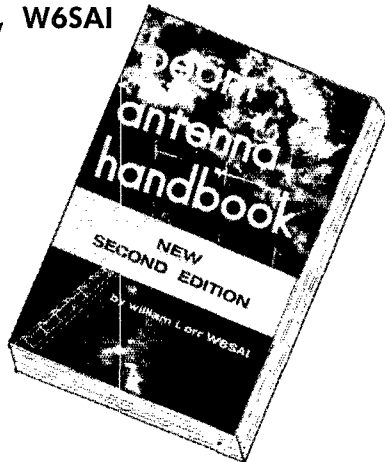

200 pages  
Price: \$3.75

Completely revised and brought up to date, the new Second Edition of the W6SAI "Beam Antenna Handbook" covers all details of antenna, theory, construction, installation and adjustment. New, simplified designs. Complete drawings and photographs of rotary beams you can build. How to evaluate your antenna!

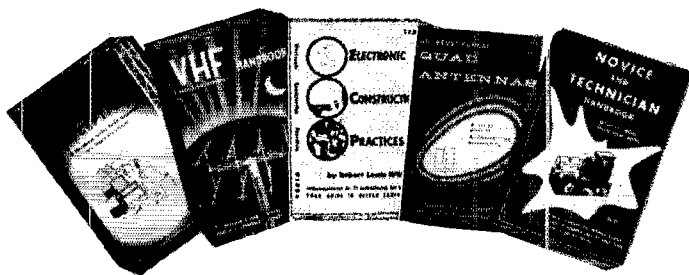

### FIVE ACES!

### READ THESE AMATEUR RADIO HANDBOOKS!

• **VHF HANDBOOK** by Orr, W6SAI and Johnson, W6GKI. First complete Handbook covering the VHF spectrum! Many VHF construction projects! Design and construction of VHF transmitters, receivers and antennas! Make your VHF station work! \$2.95

• **ELECTRONIC CONSTRUCTION HANDBOOK** by Robert Lewis, W8MQU. All about design—construction—layout and testing of electronic equipment. Non-technical guide for kit-builders and your best key to better performance of your equipment! \$2.95

• **ALL ABOUT CUBICAL QUAD ANTENNAS** by W6SAI. Construction and tuning data. Multi-band Quads. Charts, drawings and photos for your Quad. Full, complete data on home-made Quad antennas. The new X-Q Quad. \$2.85

• **NOVICE & TECHNICIAN HANDBOOK** by W6SAI and W6TNS. All about amateur radio in nontechnical language! How to learn the code. How to assemble your ham station. Transmitters! Receivers! DX! How to Get QSL cards. \$2.85

• **BETTER SHORTWAVE RECEPTION**, by Wm. Orr, W6SAI. Your introduction to shortwave radio. How to hear DX. How to buy a receiver. Amateur radio. How to align your receiver. Antennas! QSLs. Getting your ham license. \$2.85

At your radio dealer now!

Add 15¢ per order to the publisher:

DEPT. Q

RADIO PUBLICATIONS, Inc., Wilton, Conn.

# UP TO DATE . . .

THE 50th edition of the Radio Amateur's LICENSE MANUAL is complete, up to date and revised to include latest information on amateur licensing. Contains information on questions included in FCC amateur exams, all the dope on frequency privileges for the various classes of amateur licenses, the full text of RACES regs, details of the U.S.-Canada Reciprocal Operating Agreement, code-practice schedules, and the current FCC examination schedule. A useful manual for all, newcomer and oldtimer alike. Always up to date.

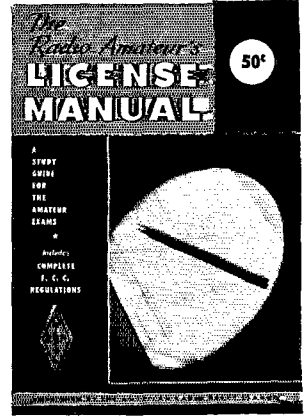

Order YOUR copy today

PRICE **50¢** POSTPAID

ALL the dope between two covers . . . complete and easy to understand.

- NOVICE • CONDITIONAL
- TECHNICIAN • GENERAL
- EXTRA-CLASS

## The AMERICAN RADIO RELAY LEAGUE, Inc.

NEWINGTON II, CONN.

**Custom Call-Letter Flag**

Your own amateur call imprinted in black on both sides. 11" x 8 1/4" quality color-fast lightweight fabric with sewn edges. Slip over antenna for xmr hunts, rallies, fly from mast, or hang in shack. Ideal for clubs. Order now for Xmas gifts. Red, yellow, or blue background, specify. \$2.95.

**WAGDUW • 808 S. Los Robles Avenue • Pasadena, Calif.**



I can give you personal service on helping you select better gear per dollar for your operating pleasure. Over 30 years' experience. Big trades, easy terms. Used bargains

**VAN SICKLE RADIO SUPPLY CO.**  
 Gene Van Sickle, W9KJF, Owner  
 4131 N. Keystone Ave.  
 On the northeast side of Indianapolis 5, Indiana

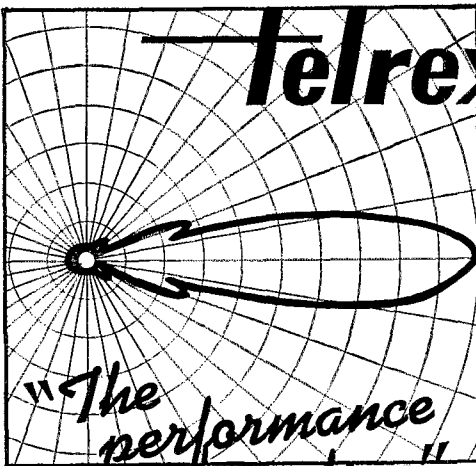

## "BEAMED-POWER" ANTENNAS and ANTENNA SYSTEMS

The Choice of the Discriminating Communication Engineer . . . the Man who Never Settles for Anything Less than THE-VERY-BEST!

You too -- can enjoy World renowned TELREX performance and value! Send for PL77 condensed data and pricing catalog, describing the World's most Popular antennas from \$6.95 to \$999.00. Expanded data sheets -- your favorite band, also available.

ANTENNAS SINCE 1921

Communication and TV Antennas

**telrex LABORATORIES**

ASBURY PARK 40, NEW JERSEY, U.S.A.

"The performance line" with a MATERIAL DIFFERENCE!"

# LEARN CODE THE MODERN ATKO WAY! NEW! FROM ATKO THE ATKO MINI-KEYER MODEL 10A

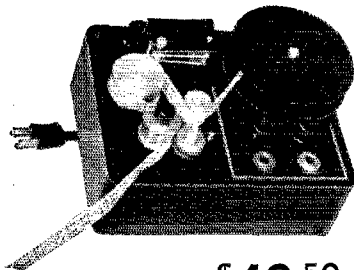

Price Complete **\$49.50**

A new compact dimension from ATKO, makers of the standard code training keyers now used by the Navy, Coast Guard, Air Force and other governmental agencies in their code training programs.

The ATKO MINI-KEYER is actually a complete radio school, with the added advantages that it can be used to automatically key your transmitter, or monitor your sending.

## FEATURES:

- Uses Wheatstone perforated tape. Standard the world over.
- Furnished with three reels of triple spaced tape. Additional tapes, normal, double or triple spaced, available at nominal cost.
- Code speeds controlled by easily interchanged capstans. Capstan giving sending rate of 16 wpm, which is 5.3 wpm with triple spaced tape, comes with Keyer. This provides excellent means of practicing sending. With telegraph key connected, the 10A sends a perfectly formed character, pauses while you imitate what you have just heard.
- Has Volume and Broad Band frequency controls.
- Will key outside tone source or your transmitter.
- Equipped with built-in oscillator, speaker and Key jack for sending practice.
- Equipped with Phone jack. Will drive up to 25 pairs of headphones.
- At 10 words per minute, tapes run for 45 minutes.
- All solid state design. Needs no warm-up. Operates from 115 Volt 60 cycle AC power line. No batteries.
- Includes 11 page instruction Manual.
- Other capstans available for 12, 14, 18, 20, 22 and 25 wpm at \$2 each.

**ATKO** The most trusted name  
in automatic code trainers.

**AUTOMATIC TELEGRAPH KEYS CORPORATION**

33 West 42nd Street

New York 36, N. Y.

**THE NIKEY**



The key especially designed for use with all types of electronic keyers. Through the use of independent dot-and-dash levers the final block in automatic sending is removed, making your first sound "TRULY AUTOMATIC." \$16.95 Check or M.O.

**THE PRODUCTIVE TOOL & MFG. CO., INC.**  
9 Market Street Stamford, Conn.

**CQ de W2KUW**

We will pay  
\$500.00 for 51X receivers      \$500.00 for 17L transmitters

Equally good prices for: ARC34 ARC38 ARC34 ARCS2 ARN14 SG1 SG13 SG66 ID249 ID250 ID251 ID351 ID387 R390 H14 Tektronix 333 545 HP608 624 and 618S transceivers. Any Collins Radio unit. Also FRR, GRC, PRC, URR units and all test sets for aircraft or ground service Ship Air Freight subject to your approval to

**TED DAMES CO., 308 HICKORY ST., ARLINGTON, N. J.**

in Canada it's  
**Alpha Aracon**  
RADIO ELECTRONICS LIMITED

**FOR EVERYTHING IN ELECTRONICS**



- SKY HIGH TRADE-INS
- EASY PAYMENT PLAN

write for **FREE CATALOGUE** -

555 Wilson Ave., Downsview, P.O. Toronto, Ontario

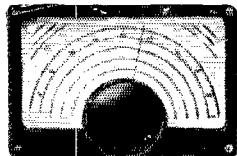

**CAT. #598**

Full Vision Dial—Epicyclic ball bearing drive, smooth in operation, free from backlash or binding. Reduction ratio 10 to 1. Measures 4" by 4 1/2" with 3/64" lip. A separate scale with 5 blank lines is provided for logging principal amateur wave-bands. Easy to mount with small cut-out.  
Price \$8.00 Postpaid.

## EDDYSTONE

By

**Stratton & Co., Ltd. (Eddystone) Birmingham, Eng.  
MANUFACTURER OF THE FAMOUS #893  
GEARED SLOW MOTION DRIVE**

### OTHER COMPONENTS:

- \*Communications Type Loudspeaker in steel case. **\$15.00**
  - \*Diecast Boxes for effective radio frequency screening. **\$ 4.00**
  - \*Receiver Mounting Blocks. **\$ 3.00 pr.**
- All Prices Postpaid

Detailed Catalogue available from:  
**BRITISH RADIO ELECTRONICS, LTD.**

1742 Wisconsin Avenue, N.W.  
WASHINGTON 7, D. C.

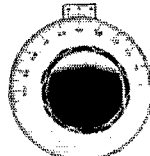

**CAT. #843**

Vernier Slow Motion Dial—Anodised satin finished hard aluminium dial, 4" diameter. The driving head, of an improved ball-bearing epicyclic type totally enclosed, gives a reduction ratio of 10 to 1.  
Price \$8.00 Postpaid.

## Direct-On-Line Morse Operation with existing 5-level Teleprinter Equipment

■ Obtain direct-on-line Morse operation from your existing 5-level teleprinter equipment with the new 660A Converter. It does not require special Morse keyboards, tape readers, or tape converters.

■ Through the use of internal storage and step control with a teletypewriter tape reader, perfect Morse spacing is accomplished.

■ The unit is 5¼ inches x 18 inches and mounts in a standard 19 inch rack.

■ The 660A effectively reduces costs and handling time in your communications center.

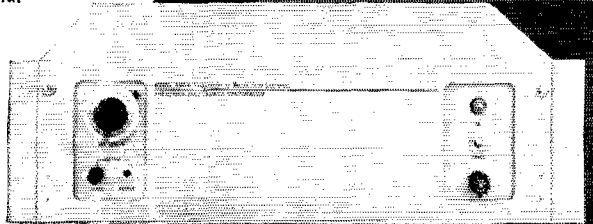

Teleprinter-To-Morse  
Code Converter  
Model 660A

Interested? Write



**FREDERICK ELECTRONICS CORPORATION**

414 Pine Avenue, Frederick, Maryland PHONE: 301-662-4156 TWX: 301-553-0466

## CONVERTER SALE

New model series 300 with 3 VHF transistors, crystal, and more than 30 high quality parts. Carefully assembled and tested. Measures only 3" x 2½" x 2". Low noise and better than 1 microvolt sensitivity. Made in USA and guaranteed. Available in the following models for 12 volts DC:

Model	Input mc.	Output mc.	Price
300-A	25,965-27,255	1.0-1,255	\$8.50 ppd.
300-B	20-31	6-16	\$8.50 ppd.
300-C	50-34	14-18	\$8.50 ppd.
300-D	144-148	50-54	\$10.50 ppd.

Supply limited at these low prices—order now.

All above converters are supplied with Motorola type connectors. For two SO-239 connectors instead, add 75c. N.Y.C. residents add 4% sales tax.

VANGUARD ELECTRONIC LABS  
190-48-99th Ave.

Dept. S-10  
Hollis 23, N. Y.

TOWERS... ANTENNAS... TOWERS... BEAMS  
Get them up now before Cold Weather!

## SSB-AM-CW

- ANTENNAS  
TELREX  
HY-GAIN
- TOWERS  
E-Z WAY  
TRI-EX  
AERMOTOR  
SPAULDING
- CDR ROTATORS

Major Brands XMTRS, RCVRs, AMPLFRS, etc.

Overseas Amateurs and Newcomers—our recommendations can save you costly mistakes... For personal attention write to W9ADN—or phone 815-838-1580 at ORGANS & ELECTRONICS, Box 117, Lockport, Ill.

**NOW**

EXCLUSIVE 66 FOOT **MOR-GAIN** 75 AND 40 METER DIPOLE  
NO TRAPS — NO COILS — NO STUBS — NO CAPACITORS  
Fully Air Tested — Hundreds Already In Use

**LOW PRICE**  
NEW



**SPECIAL NOVICE BAND 75 40, 15N (500 watts) \$25.00 or 75 40N \$23.00**

40% Copper Clad wire—Under 2 lbs. Air Weight—Rated for full legal power—AM/CW or SB—Coaxial or Balanced 50-75 ohm feed—VSWR under 1.5 to 1 at most heights—Rust resistant hardware—Drop-proof insulators, Completely assembled, ready to put up. Model 75 40 Amateur Net \$23.80. Terrific Performance—No coils or traps to break down or change under weather conditions—Fully Guaranteed.

Other MOR-GAIN Antennas—Model 40/20—34 feet—Net \$15.00, Model 75/40 15 Net \$27.00, TRI-BAND 33' VERTICAL—75/40/15 SV—\$67.50, 40/20 Rotable Dipole \$69.50—Plus many more.

ORDER DIRECT OR WRITE FOR FULL INFORMATION

**MOR-GAIN**

P.O. Box 6006  
Alexandria, Virginia

Phone 703-780-2171

OR THRU YOUR FAVORITE DISTRIBUTOR

**360° GAIN**

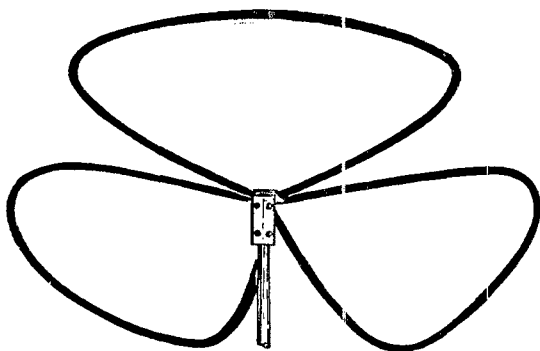

The **AMAZING BIG WHEEL** offers substantial gain over a halo in both single and stacked models. Plus 360 degrees horizontally polarized coverage.

**NEW** — Low prices: 2 Meter — ABW-144 \$10.95,

1 $\frac{1}{2}$  Meter — ABW-220 \$9.95,  $\frac{3}{4}$  Meter ABW-430 \$8.95

**NEW** — Improved materials and construction,

**NEW** — Add on stacking kits

See your distributor or write for free facts on a fantastic antenna system.

Cush  
craft

421 HAYWARD ST. • MANCHESTER, N. H.

**HUNTER**

AMATEUR

NET:

**\$575.00**

**BANDIT  
2000A**

**COMPACT!  
POWER SUPPLY  
SELF-CONTAINED!**

**BUILT ESPECIALLY  
FOR  
SSB AND CW OPERATION**

!

Grounded grid operation, 2000 watts PEP (twice average DC), 160 watt driver PEP required... 80, 40, 20, 15, 10 meter operation... 115 or 230 volt operation available... Relay operated with exciter controls... Solid state rectifiers... Many other features... Size, 14 $\frac{1}{4}$ " x 6 $\frac{3}{4}$ " x 14" deep... Weight, 45 lbs.

WRITE FOR MORE INFORMATION

*Hunter Manufacturing Company, Inc.*

IOWACITY, IOWA

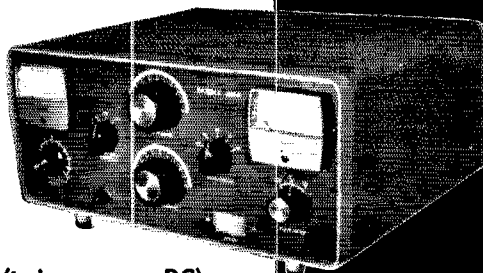

**LINEAR  
AMPLIFIER**

# Convenient... ... Complete

**Mobile?** Your log-keeping needs can be met by the ARRL MINILOG. Convenient, pocket-size, it contains proper headings for all necessary entries. MINILOG will help you comply with FCC regs, provide a lasting record of the many pleasant QSOs you'll enjoy the year round. *Spiral bound, 1" x 6".....30¢*  
*USA proper, 35¢ elsewhere*



**At Home?** If so, you may prefer more detailed station records, and the ARRL Log Book with ruled-8 1/2 x 11 sheets (also spiral bound to lie flat when open), will make record-keeping a pleasure. Useful also for portable or mobile as well as fixed station operation!... 50¢  
*USA Proper, 60¢ elsewhere*

These are available in loose-leaf form (punched for 3-ring binders), 100 sheets.....\$1.00

**The AMERICAN RADIO RELAY LEAGUE, INC.**  
NEWINGTON 11, CONNECTICUT

## LRL-66 ANTENNA

66' LONG. 80 THRU 10M

Power rating 2 Kw. P.E.P. or over on 80, 40, 15  
On 20 and 10 1 Kw. P.E.P. Transmitter input

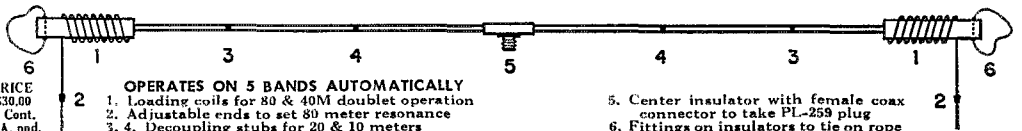

PRICE  
\$30.00  
in Cont.  
USA, ppd.

- OPERATES ON 5 BANDS AUTOMATICALLY**
1. Loading coils for 80 & 40M doublet operation
  2. Adjustable ends to set 80 meter resonance
  - 3, 4. Decoupling stubs for 20 & 10 meters

5. Center insulator with female coax connector to take PL-259 plug
6. Fittings on insulators to tie on rope

LATTIN RADIO LABORATORIES

Box 44

Owensboro, Kentucky

## TELEPLEX CODE INSTRUCTION

Now Available...

Our contracts with schools now permit us to furnish TELEPLEX to individuals. If your grandpap is a ham he can tell you about TELEPLEX. TELEPLEX teaches Code according to SOUND. That means you do not read dot-dash as A, but you hear A just as it is spoken. Set TELEPLEX at your speed; it will not change speed. An even speed is very important in learning Code. You learn a few letters at a time. Practically unlimited lessons. The HAM SPECIAL has everything required with no expensive cabinet. If you have tone source, oscillator, buzzer or other tone source, TELEPLEX will operate it. We can furnish tone source. HAM SPECIAL without tone source: three months for \$10. With tone source: \$12.50. May be kept beyond three months at \$2.50 per month. Order now and get started with the easy and quick way to learn Code. Send amount for equipment you want. Of course you can get your money back if not entirely satisfied after ten days. Our specialty—successfully teaching Code where other methods have failed. Just try it and see if you do not agree.

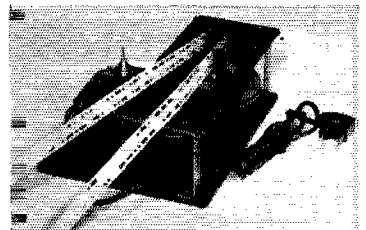

TELEPLEX COMPANY

739 KAZMIR COURT, MODESTO, CALIF.



# THE VERSATILE

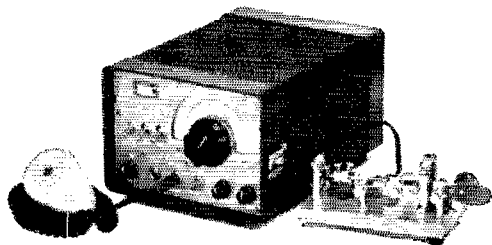

# *Li'l Lulu*

## COMPLETE 50 MC. TRANSMITTER

### "INSTANTUNE"

DESIGNED  
BY

F. E. LADD, W2IDZ

The only single-knob VFO  
ganged-tuned 50 Mc. transmitter  
commercially available.

Be able to QSY instantly!

Price **\$225** through your dealer.

WHIPPANY LABORATORIES, Inc. • 1275 Bloomfield Ave., West Caldwell, N.J.

## LRL-70 ANTENNA

70' LONG, 80 & 40 M

Power rating 2 Kw. P.E.P. or over

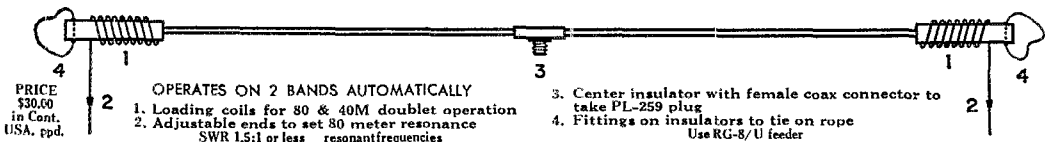

LATTIN RADIO LABORATORIES

Box 44

Owensboro, Kentucky

## THE QSO THAT

## STARTED ME UPWARD FINANCIALLY!

As the skip shortened up on 20 one morning and the VK5 I was QSO QSB'd out, a W8 called me. My contact with him was so long that it could have qualified me for the RCC! But it brought me something much more tangible: from this W8 I learned of the big money many hams are earning in commercial and public-safety 2-way radio maintenance. He told me how several years ago he had sent in a coupon from a Lampkin ad in QST—and received a free copy of "HOW TO MAKE MONEY IN MOBILE-RADIO MAINTENANCE". It started him on the road to a high extra income.

So after signing him out in the log, I found and mailed the coupon from a Lampkin ad. Now I, also, am in high-paying mobile-radio maintenance.

Why don't you send in the coupon? It's at the lower right of this ad!



LAMPKIN 205-A FM MODULATION METER. RANGE 25 TO 500 MC. DUAL SCALES, 0-12.5 AND 25 KC, \$270.00 NET. QUAD SCALES, 0-1.25 AND 2.5 KC ADDED, \$310.00 NET FOR SPLIT-CHANNEL MEASUREMENTS: The Lampkin PPM Meter accessory for the 105-B. Accuracy 0.0001%. Price \$147.00 net.

LAMPKIN 105-B FREQUENCY METER RANGE 0.1 TO 175 MC AND UP PRICE \$260.00 NET

THE PREFERRED MOBILE-MAINTENANCE METERS



MAIL  
COUPON  
TODAY

LAMPKIN LABORATORIES, INC.  
MFG. DIVISION, BRADENTON, FLORIDA  
AT NO OBLIGATION TO ME, PLEASE SEND ME "HOW TO MAKE MONEY IN MOBILE-RADIO MAINTENANCE"—and data on Lampkin Meters.

NAME \_\_\_\_\_  
ADDRESS \_\_\_\_\_  
CITY \_\_\_\_\_ STATE \_\_\_\_\_

LAMPKIN LABORATORIES, INC.,  
BRADENTON FLA.

# HAM-ADS

(1) Advertising shall pertain to products and services which are related to amateur radio.

(2) No display of any character will be accepted, nor can any special typographical arrangement, such as all or part capital letters be used which would tend to make one advertisement stand out from the others. No Box Reply Service can be maintained in these columns nor may commercial type copy be signed solely with amateur call letters. Ham-ads signed only with a box number without identifying signature cannot be accepted.

(3) The Ham-Ad rate is 35¢ per word, except as noted in paragraph (6) below.

(4) Remittance in full must accompany copy, since Ham-Ads are not carried on our books. No cash or contract discount or agency commission will be allowed.

(5) Closing date for Ham Ads is the 20th of the second month preceding publication date.

(6) A special rate of 10¢ per word will apply to advertising which, in our judgment, is obviously non-commercial in nature. Thus, advertising of bona fide surplus equipment owned, used and for sale by an individual or apparatus offered for exchange or advertising inquiring for special equipment, takes the 10¢ rate. Address and signatures are charged for. An attempt to deal in apparatus in quantity for profit, even if by an individual, is commercial and all advertising so classified takes the 35¢ rate. Provisions of paragraphs (1), (2) and (5) apply to all advertising in this column regardless of which rate may apply.

(7) Because error is more easily avoided, it is requested copy, signature and address be printed plainly on one side of paper only. Typewritten copy preferred but handwritten signature must accompany all authorized insertions.

(8) No advertiser may use more than 100 words in any one issue nor more than one ad in one issue.

*Having made no investigation of the advertisers in the classified columns except those obviously commercial in character, the publishers of QST are unable to vouch for their integrity or for the grade or character of the products or services advertised.*

S.R.R.C. Hamfest: June 7, 1964. Write for details after April 1, 1964. Starved Rock Radio Club, W9MKS/W9QLZ, RFD #1, Box 171, Oglethorpe, Illinois.

14 WEATHER Instrument Plans \$1.00. Saco Industries, Box 2513, South Bend, Ind.

WANTED: Early wireless gear, books, magazines, catalogs before 1922. Send description and prices. W6GH, 1010 Monte Dr., Santa Barbara, Calif.

MOTOROLA used FM communications equipment bought and sold. W5BCQ, Ralph Hicks, Box 6097, Tulsa, Okla.

We buy all types of tubes for cash, especially Eimas, subject to our test. Maritime International Co., 199 Front St., Hempstead, N.Y.

TOROIDS: Uncased 88 Mhy. like new. Dollar each. Five/\$4.00. P. P. DaPaul, 309 South Ashton, Millbrae, Calif.

SOUTHERN California: Transmitters and receivers repaired, aligned. Bandwidth, frequency, harmonics measured. Used ham gear bought, sold traded. Robinson Electronics, 922 W. Chapman, Orange, Calif. Tel. KEllogg 8-0500.

CASH For your gear! We buy, trade and sell. We stock Hammarlund, Hallcrafters, National, Johnson, KME, Hy-Gain, Mosley and many other lines of ham gear. Ask for used equipment list. H & H Electronic Supply Inc. 506-510 Kishwaukee St., Rockford, Ill.

WANTED: Military or Industrial laboratory test equipment. Electracraft, Box 399, Mt. Kisco, N.Y.

WANT 1925 and earlier ham and broadcast gear for personal collection. W4AA, Wayne Nelson, Concord, N.C.

MICHIGAN Hams! Amateur supplies, standard brands. Store hours 0830 to 1730 Monday through Saturday. Roy J. Purchase, W8RP, Purchase Radio Supply, 327 E. Hoover St., Ann Arbor, Michigan, Tel. NOrmandy 8-8262.

HAM TV Equipment bought, sold, traded. Al Denson, W1BYX, Rockville, Conn.

TOROID RTTY Kit: Mark-Space discriminator and bandpass filters. Includes 4-88 Mhy and 1-44 Mhy uncased like new condx. toroids; information sheet; mounting hardware and six mylar capacitors \$5.00 ppd. Toroids: specify 88 or 44, less capacitors. \$1.00 each. 5/\$4.00. ppd. KCM Products, Box 88, Milwaukee 13, Wis.

ACT Now! Barry pays cash for tubes (unused) and equipment. Barry Electronics, 312 Broadway, NYC 12. Call 212-WALKER-5-7000.

COMPLETE Ham Station with Collins S/Line transmitter and receiver; 516F-C power supply and 312B-4 station control, brand new. Present market price over \$2100 plus provincial taxes. Will consider all reasonable offers. Write J. Long, 920 Chentier Ave., Ottawa 13, Ont., Canada.

SELL, Swap or buy ancient radio sets and parts, magazines. Lavery, 118 N. Wycombe, Landsdowne, Penna.

INTERESTED In two-meter linear amplifiers, transmitters, receivers, etc. If the price is reasonable, for members of St. Mary's Radio Club, or as tax exempt donation to Missions. E8WLW, St. Joseph's Mercy Hospital, Centerville, Iowa.

304TL tubes wanted. Also other xmtrs and special purpose tubes. We will buy military or commercial transmitters and receivers with designations ARC, CRC, URR, S1 and MN. Air Ground Electronics Co., 64 Grand Pl., Kearny, N.J.

QSLs?? WPE?? SWLS?? Personalized fast service. Rainbow-maps? State-maps? Modernistics? Cartoon? Religious? Samples 70¢. DeLuxe, 35¢ (refunded), Sakers, W8ED, Holland, Mich. C. FRITZ QSLs. Highest quality consistently for a quarter century. Samples 25¢ deductible. Box 1684, Scottsdale, Ariz. (formerly Joliet, Ill.)

QSL Cards, Largest selection. Lowest prices. Samples and catalog. 25¢. Refund or 25 extra cards with your first order. Debbeler Printing, 1309-T North 38th St., Milwaukee, Wis. 53208.

QSL SWL cards that are different. Quality card stock. Samples 10¢. Home Print, 2416 Elmo, Hamilton, Ohio.

QSLs. Twenty exclusive designs in 3 colors. Rush \$3.85 for 100 or \$6.90 for 200 and get surprise of your life. 5 days' service. Satisfaction guaranteed. Constantine Press, Bladensburg, Md.

QSL Specialists. Distinctive Samples 15¢. DRJ Studios, 2114 N. Laverne Ave., Chicago 39, Ill.

QSLs "Brownie." W3CJI, 3110 Lehigh, Allentown, Penna. Catalog with samples, 25¢.

QSLs-SMS. Samples 10¢ Maigo Press, Box 375 M.O. Toledo 1, Ohio 44107.

DELUXE QSLs, Petty, W2HAZ, Box 27, Trenton, N.J. Samples, 10¢.

QSLs. Special, 100 50 Star U.S. Flags on glossy cards, \$3.70. Ppd. Other samples 10¢ or 25¢ refunded. Dick, W8VXK, Rt. 4, Gladwin, Mich.

QSLs-SWLS, 100 2-color glossy, \$3.00; QSO file cards, \$1.00 per 100. Samples, 10¢. Rusprint, Box 757, Kansas City 16, Mo.

PICTURE OF yourself, home, equipment, etc. on QSL cards made from your photograph. 25¢—\$7.50 or 50¢—\$10.00 postpaid. Samples free. Write to Picture Cards, 129 Copeland Ave., La Crosse, Wis.

QSLs: samples 25¢ (refundable). Schuch, W6CMN, Wildcat Press, 6707 Beck Ave., North Hollywood, Calif.

QSLs. Distinctive samples free. Volpress, Box 133, Farmingdale, N.Y.

CREATIVE QSL Cards. Free, new catalog and samples. Personal attention given. Wilkens Creative Printing, P.O. Box 1054-1, Atascadero, Calif.

QSLs, SWLS, WPE. Samples 5¢. Nicholas & Son Printery, P.O. Box 11184, Phoenix 17, Ariz.

QSLs, SWLS, XYL-OMs (sample assortment approximately 944) covering designing, planning, printing, arranging, mailing: eye-catching, comic, sedate, fabulous, DX-attracting, prototypical, snazzy, unparaded cards (Wow!), Rogers, K9AAB, 961 Arcade St., St. Paul 6, Minn.

SUPERIOR QSLs, samples 10¢. Ham. Specialties, Box 73, Hobbs, New Mexico (formerly Bellaire, Texas).

DON'T Buy QSLs until you see my free samples. Bolles, W5OWC, 7701 Tisdale, Austin, Texas.

QSLs 300 for \$4.35. Samples 10¢. W9SKR, "George" Vesely, Rte. #1, 100 Wilson Road, Ingerside, Ill.

QSLs, Samples 25¢. Rubber stamps: name, call and address \$1.55. Harry Sims, 3227 Missouri Ave., St. Louis 18, Mo.

QSLs 3-color glossy, 100, \$4.50. Rutgers Vari-Typing Service. Free samples Thomas St. Riegel Ridge, Milford, N.J.

QSLs, Kromekote 2 & 3 colors, attractive, distinctive, different. Free ball point pen with order. Sample 15¢. Adams for Call-D-Cal decals. K2VOB Press, 62 Midland Blvd., Maplewood, N.J.

RUBBER STAMPS, \$1.00. Call and Address. Clint's Radio. W2UDO, 32 Cumberland Ave., Verona, N.J.

QSLs, \$2.50 per 100. Free samples and catalog. Garth, Jutland, N.J.

QSLs 100, \$2.50. Samples free. Amee's Printery, W9FXQ Box 13A, Oak Lawn, Ill.

FREE Catalog of QSLs, WPE, and CB cards. New designs. Longbrook Press, Box 393-A, Quakertown, N.J.

QSLs. All kinds, free samples. W7IIZ Press, Box 183, Springfield, Ore.

QSLs! Send 10¢ for current specials. Harrison, Box 1171, Hyattsville, Md.

"1/4" call QSLs (2 sides printed) 100, \$3.15. Sample free. Garpey, 2624 Kroemer, Ft. Wayne, Ind.

PICTURE QSL Cards from your photographer, 1000 \$13.00. Also new and different designs of conventional QSL cards. Samples 20¢. Raun S, 4154 Fifth St., Philly 40.

AT Last! Something new in QSL cards! All original designs. Send 10¢ for samples to Yarsco, Box 307, Yorktown Heights 1, N.Y.

DELUXE Rubber stamp, King-size call. Name, address, \$2.00. Frey, Box 296, Schwenksville, Penna.

FINE QSLs, Dime, Filmmakers, Box 304, Martins Ferry, Ohio.

ATTRACTIVE QSLs: Large variety of styles; cartoons, colors, samples 25¢ (deductible). Paul Levin, K2MTT, 1460 Carroll St., Brooklyn, N.Y. 11213.

PHOTOSTAMPS of your station with gummed back for your QSLs, 100 \$1.50. Samples 10¢. Morgan, W8NLW, 443 Euclid, Akron, Ohio.

QSLs-SWLS, 3-colors, 100 \$2.00. Samples dime. Bob Garra, Leighton, Penna.

QSLs from the "Hobby Horse" printer. Glossy, red and green. \$2.00 per 100 postpaid. Free sample. Hobby Print Shop, Umatilla, Fla.

DON'T Buy QSLs until you see my free samples. Bolles, W5OWC, Box 9363, Austin, Texas.

RUBBER STAMPS for hams, sample impressions, Hamm, W9-UNY, 542 N. 93, Milwaukee, Wis.

QSLs. Send 10¢ for samples. Deductible. Blantons, Box 7064, Akron 6, Ohio.

QSLs. Stamp and call brings samples. Eddie Scott, W3CSX, Fairplay, Md.

OSLS, 3-color glossy, 100—\$3.79. Nice colors and designs. Samples 10¢. Gates Print Shop, 317-11th Ave., Juniata, Altoona, Penna.

DESIGN a QSL card. Sampler instruction kit 25¢. Helps you design, create. We print from your instructions. Samco, B 203, Wynantskill, N.Y. 12198.

OSLS. Samples, dime. Printer, Corwith, Iowa.

QUALITY OSLS. New low prices. Samples 10¢, 25¢, 50¢. Savory, 172 Roosevelt, Weymouth, Mass.

OSLS by the Ink Well, Spencer, Mass. Samples free. Menard, WIDQU.

OSLS, 100 2-color, \$3.00. Samples 10¢. Brigham, 32 Colson St., North Billerica, Mass.

OSLS, SWLS. Beautiful 5 color rainbows, only \$3.70 per 100. Immediate service. Samples 10¢ refundable. J. Harms, 903 Fernat, Edgewater, Pa.

RUBBER Stamps to make your own QSL cards. Complete QSL kit. Includes 3 stamps, ink and pad, also 5 year certificate for QTH and call changes. Complete, \$6.50. Write for free information and sample impressions. E & R Rubber Stamp, 50 Gerald Rd., Rantoul, Ill.

CANADIANS: Johnson Kilowatt Matchbox, Model 250-30, like new, \$100. Write: Lafontaine, 570 105th Ave., Drummondville, Quebec P., Canada.

CANADIANS: Selling DX-20, in gud condx. Make offer. Ernest Kleinman, 2310 Ekers, Montreal, Que. P., Canada.

COLLINS Owners: Increase S/Line and KWM-2 versatility. Receive Mars, RTTY, Short-wave, citizens and space transmissions with same precision as ham signals. Just plug adaptor in. Receive twice additional 200 Kc segments, \$29.75. Less crystals. Tele-Labs, P.O. Box 6, Brookline N., N.Y.

CASH promptly paid for your ham gear. Trigger, 7361 North, River Forest, Ill. PR 1-8616.

TUBES Wanted. All types, highest prices paid. Write or phone Lou-Tronics, Inc., 131 Lawrence St., Brooklyn 1, N.Y. Tel. UL 5-2615.

ATTENTION Mobileers! Heavy-duty Leeco-Neville 6 volt 100 amp. system, \$50; 12 volt amp. system, \$50; 12 volt 60 amp. system, \$60; 12 volt 100 amp. system, \$100. Built-in silicon rectifier alternators 12 volt 60 amps, \$100; 12 volt 100 amps, \$125.00. Guaranteed, no ex-police car units. Herbert A. Zimmerman, Jr., K2PAT, 1907 Coney Island Ave., Brooklyn 30, N.Y. Tel. DEWEY 6-7388.

MUST Dispose: 82 copies Proceedings of the IRE, 3 volumes complete, 1926 to 1952. Real bargain for lot. Write for list Mrs. Miriam Y. Knapp, WIZIM, 191 Beechwood Rd., West Hartford 7, Conn. Tel: 521-2055.

WANTED: For personal collection; OSTs March, April, May and August 1916; ARRL Handbook Edition 1. WICUT, 18 Mohawk Dr., Unionville, Conn.

MUST Sell antique wireless collection. Send large SASE for list. W6LIM, Box 308, Wrightwood, Calif.

SELL: SX-101A, \$260; HC-10 SSB converter, \$75; KW linear SSB-1000F Eldico, \$350; Transnetra T-R switch, outboard model, \$50. All like new condx. Lamb, 1219 Yardley Rd., Morrisville, Penna.

SELL: G-76 with Gonset DC supply. Brackets, cables, Band Spanner antenna, Mast, Mobile Mount. In exlent condx: \$375. William Schubeck, W2GSL, 52 First Ave., Franklinville, N.Y.

FOR Sale: HC-170 receiver, in mint condx. Must sell: \$275. Thomas C. White, RFD 3, Chariton, Iowa.

SELL: HT-30, \$200. John Gillen, 912 So. 37th St., Philly 43, Penna.

QST run for sale: 1934 through 1960, complete with 1934 through 1947 in binders. Make offer. Send for equipment and parts list. W4IUW, Box 4061, Roanoke, Va.

ANY Amateur in the U.S.A. wishing to be listed in the Ham Phone Directory, please send your call, name, address, phone number and \$1.00 to Ham Phone Directory, 1136 S.W. 74th Court, Miami, Florida, 33144, and you will receive a postpaid copy with your listing therein. All profits go to Variety Children's Hospital.

OSCILLOSCOPE, 5 Elco model 425, factory wired. New condition. \$50 delivered. W1MZB.

HALLICRAFTERS SX-99, in exlent condx, \$95. Will ship. John Boyd, WA9AYP, Egan, South Dakota.

JOHNSON Valiant factory-wired, in exlent condx with Johnson Matchbox, \$250; Hi-Gain Tri-band antenna, \$50, 106 feet KG-3/U coax, \$8. Dr. Patrick, Box 103, Caldwell, Idaho.

MOBILEERS: New alternators with transistor regulators and mounting brackets, 40 amp, \$55, 50 amp, \$60. Transistor regulators for Chrysler Corp. alternator equipped cars, \$19.95. Ciro (Cy) Cangialosi, K2KME, 19 Saddle River Ave., Garfield, N.J. Tel. GRGregory 3-9422.

WANTED: All types of aircraft or ground radios. 17L, 618F or S 388, 390, GRC, PRC, 511, RVX. Especially any item made by Collins Radio, ham or commercial. Also large tube types and test equipment in general. For fast cash action contact Ted Dames, K2KUH, 308 Hickory, Arlington, N.J.

KWM-1, AC pwr. supply, transistor mobile supply, mobile mount and connecting cables, complete \$600. Perfect condx. Kare, RFD 1, Millville, N.J.

WANT For cash—a good complete station. Must be perfect, like-new condx. Offers and complete information: Al Claf, Box 7565, Mexico City.

WANT Copies, in gud condx, Modern Radio published by Kruse in 1932; the Oscillator, published by P. E. Witzin and Radio Engineering Society of Pittsburgh, 1921-22 and Pacific Radio News published West Coast in 1921. State issues available and price. Marcy, W4ID, 461-3rd Ave., Sea Park, Eau Gallie, Fla.

I need an old Paragon or Zenith radio. Can anybody supply one? Will also buy other pre-1925 radios. Worcester, R.D. 1, Frankfort, N.Y.

CALL Cards, badges, decals. "All the Goodies". Illustrated literature with samples 25¢. (Clubs) Write on your letterhead for special prices). Decker, K1VRO, c/o Errol Engraving, 36 Hampden St., Westfield, Mass. 01085.

QST Magazine file from 1930 through 1956 for \$75.00. Eugene Butt, P.O. Box 569, Kerrville, Texas.

HAM Discount House. Write us for lowest prices on Ham Equipment. Factory sealed cartons. Specify equipment wanted. H E H Sales Co., 170 Lockwood Ave., Stamford, Conn.

WILL Trade new or used ham parts and equipment for U.S. or Canada philatelic stamps. W9AU, P.O. Box 155, Barrington, Ill.

FOR Sale: Complete instructions including 28 page booklet and 26 x 36 schematic for converting the ART13 transmitter to A.M. and SSB, \$2.50. Satisfaction guaranteed. Sam Appleton, K5MKI, 501 N. Maxwell St., Tulsa, Texas.

WANTED: Collins 51J-2, 3, 4, R-388, R-390, R-390A, R-391, 51S-1 Teletype, test equipment. Cash or trade for new amateur equipment. SELL: 200V \$649, Ranger \$159, 75A2A \$269, URA8A converter scope indicator, wide-narrow shift \$25, URA8A Comparator \$95, FRR-23 low freq. receiver \$245, Hoime automatic CW keyer \$125, CW tape perforator \$175, Allronics-Howard Co. Box 19, Boston 1, Mass (Richmond 2-0948).

FOR Sale: Two complete SCR-298 F.M. xmtr-recvrs w/all controls, cables, power supplies, etc. Both for \$60.00. Shipped collect. Earl Smith, K1NEV, AMEMB (DSRS) Navy 539, N.Y., N.Y.

LEECO-Neville-Alternator 150 amp., \$40.00, 10 amp, 25 volt Bridge Rectifier, \$5.00, 110 volt selvsns, \$2.00. Motorized Variac, \$20.00, B. J. Kucera, 10615 So. Highland Ave., Cleveland 25, Ohio.

KWS-1, \$725 cash. Late serial number. Fone collect for details, (203) 259-9727, Miller, 88 Stonewall, Fairfield, Conn.

COLLINS KWM-2A, 516F-2 supply, Mint condx, never mobile. Shp anywhere. \$1050.00. WA6VSC, 16 LaSalle Dr., Moraga, Calif.

FOR Sale: DX-40, SX-110 VFO, mic, relay. Jim Hampton, 1010 Booth, Dubuque, Iowa.

FOR Sale: Gonset III, 2 mtrs., with matching VFO: \$190; Gonset IV, 6 mtrs., \$225. Will ship. Don McCalley, WA6ICM, 9126 W. Ave. E., Lancaster, Calif.

HT-33A, new condx, 60 hours logged, \$500. H. L. Van Ness, 3715 47th Place, N.E. Seattle 5, Wn.

WANTED: Collins noise blander for 75A3, K1ABE, 130 Bishop Ave., East Providence, R.I.

FOR Sale: RTTY Converter ANFGC-1 with TTY power supply, \$30.00; Johnson T-R switch, \$15.00; Johnson low-pass filter 250-20, \$8.00. Harris W. Zuelke, 4157 N. Clarendon, Art. 601, Chicago 13, Ill.

SWAN: SW-140, unmodified, like new condx with 800 volt A.C. supply, \$200. Will ship. WA6TLB, 2132 East Montemar, Escondido, Calif.

MOBILE Station: PMR8, \$104; AF67, \$67; M1070, AC/DC p.s.; Webster all-band antenna, \$12.00; Dow-Key Relay \$7.00; Turner mike, \$4.00. Complete package deal: \$200. Also Hallcrafters HT-40, \$60.00; Hy-Gain 10-15-20 vertical \$10.00; Monarch Jap bug, \$5.00. W7OCY, 1304 W. Gold, Butte, Montana. SELL: SX101A, in mint condx, used 25 hours: \$275.00. W3MB, 1110 Register Ave., Baltimore 12, Md.

TRADE: Gonset G-76 transceiver, 1 yr. old, with new D/C, P/S; Turner mike, cables, manual. For movie sound camera and projector or Hy-Gard tape recorder. Fone 516-CH, 9-0923. Write Albert J. Bertolisi, 382 Fulton St., Farmingdale, L.I., N.Y.

WANTED: Morrow FTR fixed tuned receiver. State price and condx. Henry Hedden, K4TJK, 333 Cullow Street, Clinton, Tenn.

SELL: 75A-4, serial no. 4633, including 3.1 and 6 Kc. filters, vernier knob, \$500; Central 100-V, \$550; both in exlent condx. W2WRI, John A. Kammerer, 23 New St., Katonah, N.Y. 10536. Tel: 914-CE 2-4321.

FOR Sale: Heath "04" oscilloscope, \$20; 600v, 300v, ptt, 110Vac pwr. supply with antenna relay, \$15; 75v, 100v, 125v, experimenters power supply, \$7; all in fine condx, 60w. modulator, VOX, clipper, with 150 w. pwr. supp. for transmitter, custom-made, VOX needs relay; \$35. Custom 10M transmitter, mike, 6vdc pwr. supp., needs a little work, \$10. Johnson Whiplead 6 with whip and ball mount, \$13. Lecher wires for VHF, Experimenters, \$5.00; Brand new D-104 and G-stand, \$25. Write for full info or you may freight from K9YVV, 908 Johnson Lane, Mount Prospect, Illinois 60057.

WANTED: Commercial, Military, all types: ARC, ARN, ARM, BC, GRC, PRC, TRC, URR, URM, TS, 618S, 17L, 51R, others. Ritco, P.O. Box 156, Annandale, Va.

NOVICES: Heathkit DX-20, 50 watt c.w. transmitter, manual, crystals, key. Trimm phones: \$30.00. Excellent condx. K9SLD, 3031 West Belden, Chicago, Ill. 60647.

NCX-3, AC supply, factory-sealed cartons: \$400. Going home-ew. W0PRM, 316 ED 1-1173.

FOR Sale: 200-V xmtr. In perf. condx: \$675. Jack Mahoney, W3DJW.

COLLEGE Student must sell Drake 2-B with 2-AO spkr/Q-multiplier, \$225; Viking Adventurer, \$30.00; Viking Matchbox with Heath SVR Bridge, \$50. Heath "Sixer" with mobile Vib-rack supply, \$60. All excellent. Will consider any offer. K3RXX, 1333 Logan Blvd., Altoona, Penna.

CLEANING House: Heath mobile complete, also AC pwr., \$199; Iyasco xmtr, pwr, mike, two 3L beams, rotator, pick-up only, \$40; two 100 watt power phones, \$2.50. Bud freq. calibr, \$8. H. Cushing, WB6CQG/W1EUS, 2348 Menzel Pl., Santa Clara, Calif.

WANT: OST magazines before 1960 for personal library. Please write Joe Lester, WA6OLQ, Story House, Claremont Men's College, Claremont, Calif.

SELL: Viking Challenger 80 thru 6, in immaculate condx: 120 c.w. 70 tone. \$85.00, K1SNA, 2 Charles St., No. Reading, Mass.

FOR Sale: Late Central Electronics 200-V. In mint condx. No scratches. In orig. crate, manual: \$600.00, W4MZV, 616 Lakeview Drive, Raleigh, N.C.

HT-32A and SX-100, like new, both for \$545.00, Boyce Sims, 2849 So. 20th, Abilene, Texas.

SELL: HT-40, \$60.00 and SX-140, \$70.00 both in gud condx. I-B Novice rig. First certified check or m.o. and will ship pnd. Bob Thwaites, K3BYE, 1604C, Doolittle Rd., Baltimore 21, Md.

SELL: Compact linear amplifier, 750 watt, 3-811A in GG, band-switched. Only 15" wide, 6" high, 11" deep with power supply built in, \$150.00. Perfect Hallicrafters S108 receiver, \$90. Dr. Charles Thompson, 103 West Main, Napoleon, Ohio.

BOOST Reception: 3.5-30 Mc. SK-20 Preselector Kit, \$18.98. Boost modulation, AAA-1 Clipper-Filter kit, \$10.99. Reduce noise—NJ-7 Noisejoker. IF wired, \$4.49. Postpaid! Literature free. Holstrom Associates, Box 8640-T, Sacramento 22, Calif.

CRYSTALS: Precision. Mars, MARS, CAP, Amateur, FT-243 (our N-3) 3000 to 10,000 kilocycles within .005%, \$3.15. Nebel Laboratory, 31 Whitehall Blvd., Garden City, N.Y.

CENTRAL Electronics 100V transmitter, 6 bands: 10-11.15-20-40 and 75 meters; built-in VOX and scope, SSB-AM-PM-DSB, etc. Like new condx: \$595.00. National NC-303 receiver, with built-in Ameco distributor 6, 3, and 1 1/2 meter converters, best condx: \$325.00; Lettine Model 262, plate modulated six and two meter transmitter, built-in antenna switch and relay, A-1, \$160.00; Heath impedance bridge, wired, perfect, \$70.00; Heath Q-meter, wired, perfect, \$55.00, Sal Francione, W21DC, 146-07 Jamaica Ave., Jamaica 35, L.I., N.Y.

SELL Collins 75A4, 32S-1 with power supply 30L1, 312B-4, gud price; 516-MA-1-8211, Roslyn, N.Y.

NC-125, QF-1, speaker, in gud condx. Best offer takes. K7PID/7, 7710 Forest Drive, N.E., Seattle, Wash.

BUY Surplus direct from U.S. government. Transmitters, receivers, teletype, microwave, test equipment, misc. Where and how to buy. Depot Directory and Procedures, \$1.00, Ramco, Box 356, North Hollywood, Calif.

??You haven't seen The Ham Trader yet? Send us a post-card so you can. Box 1530S, Franklin Square, N.Y. 11010.

HOWARD Radio: In stock: (Collins) KWS-1, 75A-4, 75S-1, 32S-1, 312B-4, 516F-2, 75A-1 and 2; (B&W) 5100, 5100SB, and 515B; 3700; (National) NC-88, NC-98, NC-125, NC-155, NC-188, NC-183D, HRO-50R; (Hallicrafters) HT-37, HT-40, S-3RE, SX-96, SX-99, SX-100, SX-101, Mk III, SX-110, SX-111, S-108; (Globe) 90, 680, 350; (C-E) 20A and 458VFO; (RME) 4530A, 6900; (Gonset) G-66B, Super Six, Super 12, GR-212, GSB-100; (Johnson) Ranger, Invader 200, Viking 50, Viking 1 and II, Adventurer, Challenger; (Drake) 2A, AEG7, Multipl., (Heath) DX-35, DX-40, DX-100; (Eimac) A-5, A-6; (PMR) PMR-8; (Hammarlund) HQ-100, HQ-110; HRO-129X, HQ-140, XA, HQ-150, HQ-170C, HX-500. Write for new or used price list. P.O. Box 1269, Abilene, Texas 79604.

QCWA. Annual meeting of Quarter Century Wireless Association will be held Friday evening October 25th, Hotel Shelburne, New York City. Amateurs licensed 25 or more years are eligible for membership. Write Executive Secretary, Ralph Barber, W2ZM for information.

A-1 Reconditioned equipment. On approval. Terms. Hallicrafters S-85, \$79.00; SX-99, \$80.00; SX-110, \$119.00; SX-101 III, \$159.00; SX-101A, \$229.00; Hammarlund HQ-100, \$119.00; HQ-110, \$149.00; HQ-170, \$229.00; Ranger I, \$149.00; Valiant I, \$249.00; NC-300, \$199.00; Collins 75S-1, \$359.00; 32S-1, \$495.00; 20A, \$129.00; National, Gonset, Eimac, Heath, Johnson, RME, and many others. Write us for lists, Henry Radio Co., Butler, Mo.

JOHNSON Valiant, factory-wired, \$270.00; NC-300 receiver, \$195.00, both for \$420.00. In mint condx. WA6HTV, 4258 Kling, Burbank, Calif. Phone 849-4517.

SELL: Viking II, \$130.00; Heath VFO, \$15.00; low-pass, \$10. Need money to finish senior year at college. K0PAU, Larry Krusomark, Blue Earth, Minn.

COLLINS gear for sale. Firm, cash and pick up deal only. No haggling; all perfect, 20 hours, in orig. cartons with warranty cards: (1) KWM-2 transmitter, \$700; (1) PM-2 pwr. supply, \$75.00; (1) 312-B4 console, \$75.00; (1) 301 linear, \$325.00; (1) e-cel, 30 M beam and coax 100 ft., \$25.00. Contact K2REC at Michris Corp., tel. (516) MO 90573, Babylon, L.I. (Suffolk Co.), during business hours. Herb Baumgartner, 381 N. Little East Neck Rd., Staten Island 5, N.Y.

COMPLETE Station, only \$139.00; DX-60, HR-10, HQ-10, HRA-10-1; V4-6 ant. K3JFV, 652 N. Monroe St., Media, Penna. Tel. LO 6-0934.

SALE: Measurements Corp., Model 80 Standard Sig. Generator, Range: 2-40 Mc, with manual, \$30. RCA model WM-9A electronic meter with manual, \$85. W2ZCA, L. Jablonka, 18 W. 34th St., Bayonne, N.J.

SELL: Hallicrafters six-meter transverter model HA-6, 120 watts, with power supply. In original carton. Used only five hours. Cost: \$449.00. A bargain at \$280. WA2JCF, 160 Upland Way, Haddonfield, N.J.

APACHE, NC-300, gud condition, \$195.00 each. Will consider trading for car. Dick Loftin, K4RJM, TR 5-0300.

COLLINS 75S-2 receiver, with Collins recommended RTTY modification in the CW position; six crystals in extra coverage position; complete with Heathkit HD-11 Q-Multiplier, six and two meter converters with power supply; plus manual; like-new condx but priced to sell at \$350. Enclose SASE with inquiry. K8LL, Box 77, Rte. 2, Stevensville, Mich.

G-76 Gonset w/AC supply, \$240. W2NLQ, 20 Ferndale Pl., Keyport, N.J.

SALE: HT-40 wired de kit, \$50.00. In excnt condx. F.o.b. WA4DUR, 339 East 11th, Washington, N.C.

HALICRAFTERS SR-150, used for cross-country trip only, like new, \$550. Matching mount, \$20. Julius Galin, W1LOP, 71 Hilldale Rd., West Hartford 233-7206.

COLLINS Grab boxes (a treasure of goodies), \$2.50; Collins xtms for transceiver supplies, \$5.00; flexible hi-voltage wire 30K V, 16-18 ft. coils, \$1.00; Hunter Bandits, \$5.00; Johnson Thunderbolt, \$280.00; 20-A, \$115.00. We have most everything. Write Emrad, P.O. Box 3564, Urbandale Station, Des Moines 50322 Iowa.

ANTENNAS! Returning to Utah. Selling entire portable station, AF-68/PMR-8/M-1070, like new, \$250; thirteen experimental tubular antennas (verticals, directional dipoles, SFA antlers, etc.), \$10 each postpaid. Subject to prior sale. Send no money! Postcard will do for order. Use for 30-days and return express collect if not completely satisfied. Otherwise, send \$10. If you have worked K7SPA, your log will show what my antennas will do with 50-watts. Won't have time to acknowledge unfilled requests when these few are gone. Big collection of base and center loads for abbreviated tubular antennas free to each ham who will return cost of postage. K7SPA.

Complete stations for sale: HQ170C and GSB100; VHF-1 and H.B. 2-6-10 receiver; all operating and very clean. No reasonable offer refused. Bob, 626, 26, Cairo, Ill.

HALICRAFTERS SX-115 receiver, like new, \$475; large enclosed commercial transmitter cabinet, \$15; Superior Powerstat, 2KVA 115v pri., 0-135v, 15 amp. sec., \$20; National MBQSL, \$5; Heath TV alignment generator, model TS-3, \$20; three Sprague 475 pf 50-volt-pair capacitors, .002 mid., 5000 wv., \$2.00 each; two Hitrols, 5 mid., 115 vac., \$1.00 ea.; filament transformer, 115v. pri., 5v. 60 amp. sec., \$5; SCR522, \$15. W4NI, 3600 Old Vineyard, Winston-Salem, N.C.

GONSET Super 12" converter, mobile 12 volt, covers ham bands. Exclnt condx. \$40.00 or will trade for 20 year run of QST's. Gene Sanders, W4EDW, 3596 Canadian Way, Tucker, Ga.

HAMMARLUND HO-170 exclnt condx, \$240. S. F. Campion, WB2EBD, 10 Brampton Lane, Great Neck, N.Y. Tel 516-HU-7-6869.

VALIANT III \$225. Needs little work. K3VTZ, 5805 Conway Rd., Bethesda, Md.

COMPLETE Station: Viking I, VFO-122, Hallicrafters S-85, HRC-100, HA-6, VTR-1, 50 ft. 1 1/2" 8-U, mike, key, and relay, \$300. John, K0KVL, Casey, Iowa.

RME 6900 receiver, \$250.00; Eico 723 transmitter, factory-wired, \$50; trade Dewald 6-meter transceiver for Heath Twoer or sell \$35.00. Tom Desmond, K4EWU, 1251 N.E. 207th St., No. Miami Beach, Fla.

FOR Sale: Model 19 PTR complete with table and 14 TD, \$150.00; also one Model 15 150 watt xtal, like new, \$75.00. Both F.o.b. Omaha. K0JFE, 4020 14a, Omaha.

SELL: NC-300 with spkr, xtal cal., in mint condx, \$180.00; Globe 6w2 meter 50 watt xtal, \$40 in excnt condx; Viking Ranger, perfect, \$140.00; D-104 PTT mike, \$13.00. Peter Miller, W1AMJ, Prospect, Conn. Tel. 75-84992.

KWS-1 in excnt condx. All factory modifications, extra set of tubes, vernier knob, coax relay, will deliver within 250 miles: \$750.00. Rod Dewald, R.D. 3, Danville, Penna.

DRAKE TR-3 transceiver with AC power supply and speaker. Absolutely brand new. Circumstances force me to sell. I guarantee it has never been plugged in. Cost \$615.00. Will sell for \$300. Also Heath VTR linear, like new, works perfect, for \$150.00. Hy-Gain TR beam for \$45.00. W5LLV, W. A. Barker, 1414 Mistrywood, Denton, Texas.

SELL: Globe Champion 350 and DX-100 with spare tubes. Come and get them cheap on the air now. No shipping, sry. W8MJJ, Harry J. Cunningham, 148 Church St., Weirton, W. Va. 26062.

GALAXY Sales have brought about several hundred additional trade-ins: KWM-1, \$359.00; Champ 300A, \$229.00; King 500C, \$439.00; GSB-100, \$259.00; HX-50, \$299.00; Apache, \$189.00; Valiant, \$259.00; Pacemaker, \$169.00; 75A-3, \$279.00; 75A-4, \$389.00; SX-111, \$169.00; SX-101A, \$249.00; HRO-50T, \$159.00; HRO-50T, \$259.00 and many more. Write for free lists. Leo, W0GFO, WRL, Box 919, Council Bluffs, Iowa.

HQ-170 w/spkr, in mint condx, \$225.00. W2AVY, Jim Seltzer, Two Tudor City, New York 17, N.Y. Tel. OX 7-2895.

FOR SALE: NC-300, B&W 5100 and B&W 515B. Make an offer. David Sheats, 4755 Arapahoe, Boulder, Colo. 80302.

SELL: SX-101-A, like new, \$250.00; Eidico SSB-1000, \$300.00; Collins 32S1and AC pwr. supply, like new, \$575; Sony CS300 stereo tape recorder with 2 mikes, like new, \$250.00; Concertone-Stereo recorder, five heads, 10 1/2 in. reels, perfect, \$500; Transtenna T-R switch, outboard, \$50.00. Lamb, 1219 Yardley Rd., Morrisville, Penna.

G-76 transceiver, in excnt condx, with calibrator, \$250.00. AC power, \$35.00. Honeywell 12VDC power, relays, \$45.00. K1-GCV.

ESTATE of K6LIDZ, Viking Ranger, \$130.00; FME 6900, \$240.00; BC-348-0, ext. supply, \$40.00; RCA Voltomyst, Jr., \$20.00. Mrs. M. A. Casey, 615 West 11th St., Corona, Calif.

HQ-170C, used less than 40 hours. In orig. packing. Ship F.o.b. from Pennsylvania or New Jersey. QTH, \$260.00. K3-QYV/W2UPC, 563 N. Church St., Bound Brook, N.J.

NCX-3, AC and DC supplies plus Slim Jim mobile antenna. Used 3 hours. Original cartons, \$550. Apache, like new, \$190. Will deliver 250 miles. W1LWV, Box 32, Lisbon Falls, Maine.

FOR Sale: Hallicrafters SR-150 transceiver and PS150 AC supply. Used 8 hrs. High-rise Apt. forbids antenna; \$560. J. DiLiberti, K2IQZ, 10 Huron Ave., Apt. 2L, Jersey City 6, N.J.

SELL: Gonset GSB-101 linear, in excnt condx, complete with manual; \$160. F.o.b. Norfolk, Va. Can ship in original carton. W4DRV, 932 Defoe, Norfolk 13, Va.

SELL: SX-110, in exc. condx, HD-11, spkr, phones. Best bid over \$100. Call Mark Levine, 38-15 149 St., Flushing, L.I., N.Y. IN 1-9582.

SELL: NC-188, \$220. J. Lewis, 33-62 W. N.Y., N.J.

SELL: Marudner, professionally wired with manual—\$300. Going VHF. F. Gaenger, 2472 Hilltop Road, Schenectady 9, N.Y. WANTED: 10-15-20 meter beam. Advise prepaid price. WA0-EF, 1101 Longview, Marion, Iowa.

SELL: D-104 mike, \$12.00; Adventurer, VFO, Modulator, \$35.00; NR1 tube tester, \$12.00, \$38E, \$28.00. K2KGU, MO 6-8513.

SELL: Knight T-150, \$90. WA2JRE. Ray Robertson, Ogden Pl., Morristown, N.J.

GONE Sideband. Sell Ranger, \$135.00; 183D, \$175.00. Both in exclnt condx. W9WMR, Don Twining, 113 So. Elmwood, Aurora, Ill.

COLLEGE! Must have money! SX-110, \$110.00; GSB-100, \$240.00. Both in exclnt condx. KØYPV, RR #1, Anamosa, Ia.

FOR Sale: Complete years QST 1921 to 1962 inclusive; CQ 1947 to 1962 inclusive. Make offer for all. Buyer pays shipping. W9VZ.

FOR Sale: HQ-180-C receiver (used 100 hrs.). New condx. \$375. Two new Himac 450TL, \$25 each. Two new Amperex 4X250B, \$20.00 ea. Transformer, Sec. 7000 V. CT at 3.5 KVA pri.-115/230 V. oil-filled, \$65.00. Have other power supp. components. You pay shipping. Certified check or money-order. A. C. Emerald, K6E1V, 6057 Hereford Dr., Los Angeles 22, Calif.

BC610-F, new condx. All tuning units and some spare parts. Speech amplf., Ant. coupler. Asking \$450.00. Wm. K. Kern, K9BEH, 1807 12th St., Bedford, Ind.

MOBILE Station: Palco Bantam 65A transmitter, Gonset Super 12 converter, Master Slim Jim, all band antenna dynamotor pwr. supply with cables. First \$165.00 takes all KØAPZ, Pukwana, S.Dak.

COLLINS KWS-1, No. 959. Looks new, guaranteed perfect. Includes antenna relay, instrux manual, spare tubes. Will ship. Best offer above \$725.00 or will trade for KWM-2. Will accept NCX-3, SR-150 as part payment. Al Weiss, W6UGA, 2370 Knob Hill, Riverside, Calif. OV 3-3149.

CUSTOM Building VHF gear, converter, transmitter, etc. 432 Mc equipment. Free quotes. Frontier Electronics, Orr 1, Minn. Everett, WØHPS and Frankie Hoard, WØPYC.

SELL: SX-101 Mk III, in top condx. \$215.00. Not being used. Sry, no shipping. J. Eklund, 1586 Andrea, Ypsilanti, Mich. HU 2-1309.

SELL: G-66B, 3-way supply, all band Master whip, \$140.00; Ranger, mint condx. no modifications, \$140.00. All manuals. K1IGF, 83 Lovers Lane, Natick, Conn.

WIRE selling HT32A plus SX-111, \$500 takes both. Each in original cartons. Have swapped very little use and in like-new condx. Prefer local deal.

EVERYBODY Buy! Sell! Swap! Transmitters, receivers, components offered, wanted, in "Equipment Exchange". Interesting sample free! Write: Brand, Publisher, Sycamore, Ill.

SELL: HQ-145C, in mint condx. WA2ZVJ, 2115 East 27th St., Brooklyn, N.Y. 11229.

SELL: One 55 ft. Rohn tower, \$55.00; one AR-22 CDRR rotor, \$15.00 four 10 mfd. filter condensers, 2500V paragoni filled, \$10.00 each; two 2 mfd. filter, 3000V \$2.00 each; one transformer 1800V at 500 ma., \$18.00; one filter choke 3000V, insulated 500 Ma., \$6.00; one used 4-400A tube, \$10.00; one fla. transformer 30 amp, at 5.3V, \$8.00. Will ship collect as requested. Write G. G. Schuller, K6VIZ, 2601 Wiltshire Blvd., Los Angeles 54, Calif. Tel: DU-13381.

SELL: NC-98 revr. in exclnt condx, with spkr, \$65.00 or best \$5.00 plus \$7.63 final 40-80 meter xmttr. with key and xtal. \$10.00; "Precision" VOM, exclnt 20,000 ohms/volt, \$10; cath. ode modulator, \$5.00; 2 meter Cush Craft halo ant., new, \$4.00; 10 meter whip, bumper mount, and spring, new, \$8.00. Alan Rose, K2RHK, 50 West 90th St., New York City 24, N.Y. Tel TR 3-0434.

75A-1, in exclnt condx, w/Central Electronics Mod. B sideband slicer, and Q-multip., 3.5 mechanical filter and 100 Kc. xtal calibrator, \$275.00 or your best offer. Going back to college! Bob Fitzgerald, 6 Sharon St., Geneva, N.Y.

SX-71 with additional Pre-selector, in A-1 condx: \$125.00. W3BOP. Tel: 215-GL-9-3631.

POLY-COMM 62 complete, as new. No trades! First \$300.00 takes or your best offer. WA6TCS, Ronald F. Corrado, 5 Hillcrest Blvd., Millbrae, Calif.

MUST Sell! Johnson Valiant; RME 4350A, Johnson Matchbox; SWR Bridge, TA33, Jr. beam and rotor. First \$600.00 gets it! (Will consider individual offers). K2HQ5, Trenton, N.J.

ELMAC AF-67, \$75.00; PMR-7, \$85.00; both units with matching James G/12 volt power supply, \$160.00; B&W model 600 grid dip meter, \$19.00; SNC SP354 200 watt Multimatch modulation xmttr, \$18.00; Northern Radio VFO, Type 115, \$110.00. WA6VZG, Traver, 59A Burroughs Ave., China Lake, Calif.

COMPLETE Station: Drake 2A, \$220.00; Central 20A, \$169.00; VFO, \$20.00; 150 watt linear with p.s., \$45.00 Health Q Multiplier, \$9.00; crystal calibrator, \$7.00; crystal mike, \$5.00; console with many built-ins. Make offer for whole works. N. Dugatch, WA6NSF, 3954 Ursula, Los Angeles 8, Calif. Tel: AXminster 2-5187.

FOR Sale: 3ØL-1 No. 11196, \$395; 75A-4 No. 4871 and spkr, \$95.00; KWM-1 No. 731, noise blanker, 316E-1, 516F-1, 312B-1, 315D-1. Hy-Grain mobile Tri-Bander, Electro-Voice 600-D mike, \$55.00; KWS-1 No. 449, \$700.00, B&W L-1001-A, \$200.00; 4-1000-A, used \$25.00; 351D-2 mobile mount for KWM-2, new, \$75.00. J. Craig, 1646-B Sycamore Dr., Blytheville AFB, Arkansas.

LOOKING? Shopping? Trading? Trying to save money? Write Bob Graham for special deals on new and reconditioned used gear. Cash or budget. Graham Radio, Dept. A, Reading, Mass. Tel: 344-4000.

STEAM Engine driven generators, 500 watts AC/DC, kits, \$34.50 up. Catalog, \$1.00 refundable. Richardson Const. Corp., Sterling, Va.

WINDMILL Generators: 300 to 2000 watts; kits, \$19.00 up. Catalog, \$1.00 refundable. Richcraft Engineering, Sterling, Va.

SALE: SR-150 Hallicrafters transceiver including P-150 AC supply, P-150 DC supply, MR-150 Mobile Mount, in perf. condx. 3 months old. \$635.00, complete: Johnson Viking Thunderbolt 2000 watts P.E.P. amplifier, in exclnt condx, \$315.00. W3NEC, 707 Barclay Lane, Broomall, Penna. Phone 215-353-0226.

FOR Sale: 3600-0-3600 at 1000 Ma. plate transformers, with dual 110V and 220V primaries, \$35.00. General Electric 120 mfd., 3500V. filter capacitors. \$45.00. Pete W. Dahl, 5331 Oaklawn Ave., Minneapolis 55424, Minn.

FOR Sale: Viking Valiant, in gud condx: \$200.00; two new 4-400A tubes, \$25.00 ea., 825 watt modulation transformer and many other hi-pwr. xmttr components; also two "Recto Bulb" rectifiers in gud condx. QSTs from 1926 on. All years not complete. Write for list. All replies ans'd. W8ZQZ, Bob Ritz, Allegan, Mich.

JOHNSON Kilowatt desk model, Ranger, 6N2 all above and below factory wired and tested HQ-180; HT-32A; wide spaced 20-meter direct beam; Hallicrafters I.O. keyer; Lametone power supply and converters for receiver 6 and 2 meters; many other items All in original, like-new condx. Working perfect; bona fide buyers may operate any hand until satisfied. Harry Weinberg, 122 South St., Freehold, N.J.

SELL: SX-101 Mk III, \$225.00; 20A and QT1, \$150.00. Thunderbolt, \$250.00. All in gud condx. Bob Gutman, 345 8th Ave., N.Y.C., N.Y.

FOR Sale: Viking Valiant II, factory-wired. Nine months old. In perf. condx. \$350.00. For quick sale, Frank Thompson K1-TTT, Box 66-G, RFD 3, Great Barrington, Mass.

WANTED: 3ØL1 for about \$325.00. State condition, serial number and price. K21W, C. D. Whaley, 114 Pershing Ave., Valley Stream, L.I., N.Y.

GO'ING Homebrew: very clean HT-37, w/manual, \$345.00. F.o.b. Poughkeepsie, N.Y. Lacey, WØCEJ/2, Entry Rd., RFD 3, Hopewell Jct., N.Y. 12533.

75A4 KWS-1, in exclnt condx, complete station: \$1200. WA6-UUZ. Phone 415-697-5838.

COLLINS Owners! Work AMI Wired kit, \$5.00. No soldering, holes, chassis removal! Switch In-Out! (State model) Kit Kraft, 8763 Harlan, Ky.

SELL: DX-100B, \$160.00; HQ-110, \$165.00; A-54, \$50. Bob Cool, 407 New Meadow Rd., Barrington, R.I.

VIKING and VFO, \$135.00; HQ-100, \$95.00; DX-35, VFO, UMI plate mod., ant. coupler, \$70.00. Gonset Commander and James pwr. supply 12V, \$45.00. K2HER, Tel: AD 2-4513, Westfield, N.J.

SELLING Valiant II, F.W., with warranty, \$395.00. Send stamp for 3-page list, other gear, VHF beams, components, tubes, etc. B. G. Day, W1IRU, Suffield, Conn.

FOE Sale: In exclnt condx, Johnson Viking II, with Viking VFO, \$175; National HR60 5ØT with A., B., C. D., AC coils, \$180.00; Central Electronics Model A slicer, \$25.00; Johnson Courier, \$150.00; Elmac PMR6A, ACPS, 6-volt PS, Bancok M15A, \$75.00. Jimmy Davis, K5SOH, 702 Eleonor, Houston 9, Texas.

SELL: KWM-2, late model, Spinner knob No. 11900 power supply, 316F-2, No. 13349. Certified check or m.o.: \$950.00. WINPG, A. M. Wilson, 37 Round Hill Rd., Wethersfield 9, Conn.

SELL: Polycomm 62B, Six and Two Meter transceiver, extra mike, Drake TVI OLP, twometer big wheel, \$275.00. RCA CR8 General coverage receiver/spkr, \$125.00. Srv, cannot ship. WA2VBR, 1607 Ave. V., Brooklyn 29, N.Y.

MOVING October 25th. Sacrificing large quantity ham parts. Var surplus tubes, all in original cartons: 14-1625, 2-807, 5-6C4, 2-7ZT, 2-805, 2-810, 3Ø4TL, 1-866, 2-866R, x 6-872A; also not in cartons, slightly used, tested and guaranteed: 24-C16, 9-1625. Best offer gets all or part. Many transmitter and power supply parts. Send for list quickly, before I have to pack them. W2GWS, Charles Hieronymus, 100-35 201 Street, Hollis 23, N.Y. now, 65 Stanley Place, Edison Township, Metuchen, N.J. after October 25th. Prices higher then.

SX-101A, \$275 and HT-32A, \$400.00, both \$650.00. In perfect condition. Now inactive. Pick-up deal only. K5MVN, 304 Edgewater, New Iberia, La.

WILL Sell as one or two packages: Package No. 1: Brand new Collins 62S1, 6 & 2 mtr. converter, \$750.00. Package No. 2, A-1 condx: 32S-1 and 75S-1 converted for send and receive RTTY with added 455 K mech. fil. and crystal, and 516 F-2 power supp. \$900.00, or Packages 1 and 2 for \$1600.00 cash. Have cartons, Can ship. C. A. Traverse, K5UHP, 515 Colgate Ave., Alva, Okla. 73717.

NC-303, \$28 in original carton, exclnt condx, like brand new, used only a few hours, with extras. KWM-1, \$349.00, exclnt, used very little, with Collins DC supply mobile mount, cables and AC supply and new Mark Mobilewinds and mount for 10 and 20 meters. All for \$485. Jerry Hacker, 53 Overlook Rd., New Rochelle, N.Y. NE 2-0239.

SIDE-BAND Equipment: Heath HX-20, never mobile, used year, no buss. Built and used by TV broadcast engineer, \$195.00; Drake 2A, late, clean, \$189. Both for \$389.00. Will guarantee either for 90 days. Jack Tate, W6IIA, 425 Tufts Ave., Burbank, Calif. 91504.

HOUSE-CLEANING. Magazines, 1939 to 1956, best offer. Radio Craft, RCA Review, Proceedings of the IRE, American Scientist, QST, Astounding Science Fiction, others. In exclnt condx. Some books, 1947 or earlier. Send SASE for list. John Kinzer, 107 Evergreen Ave., Springfield, N.J.

ELCOR 230 tape recorder, \$35.00; Zenith "Royal 500" transistor radio, \$20.00; Astatic mike, \$4.00; Precise 116 tube tester, with CRT adapter, \$45.00. V. R. Hein, 418 Greory, Rockford, Ill.

GONSET G-76 with AC or DC pwr supply, \$365; Communicator IV, 2 mtr. also 6 mtr., \$275 each. With warranty. Never been used. K6RQT, Ron Terry, 9125 Fourth Ave., Inglewood, Calif.

STATION for sale: NC-183 w/spkr and Heath Q-mult. \$205.00; Viking II, \$150.00; Viking VFO mod. 122. \$15.00; RCA Volt-ohmmist WV97A, \$25.00; BC-221T, \$60.00. W. H. Ramstein, W311J, Box 372, Wallingford, Penna. Call 215-LO-6-0528—6:00 PM, 11:00 PM.

COLLINS 75A2, xtal calibr., \$225.00. K2EGL 15 Stratford Pl. N. Babylon, L.I. N.Y.

SELL: Kilowatt linear with power supply, \$100.00. W4ZYS, 320 Miami Ave., Melbourne, Fla.

AF67, PMR7, James pwr. supply, coax relay, mike, cable, \$225.00; Matchbox, \$35.00; Silver Vomag 900 VTMV w/RP probe, \$40.00. Instruction books, one owner. W3PWS, Long Green, Maryland.

SELL: SR-150 Hallcrafters transceiver with P150 AC supply; one month old and hardly used and in like-new condx: \$525.00. Roy Kelley, 7516 Wilson Park, Biggs AFB, Texas.

SELL: SB-10, \$75.00; QF-1 Q-multiplier, \$5.00; RME152A converter, \$40.00. Fred Grangers, Trenton, Ill.

SELL: NC-300, matching speaker, \$200.00; Viking II, Johnson VFO, \$135.00, or will trade for Orbit, F & M 10 channel R.C. equipment, John Lewis, WA6ETZ, 509 Sanford Dr., Bakersfield, Calif.

SACRIFICE: Johnson Thunderbolt, F/W tested, used four months, original cartons/manual, in mint condx. Offer over \$250. K8KCO/KIUAW, 82 Glenville Ave., Apt. 8, Allston, Mass. 02134.

SELL: NC-109, \$95; DX-40, \$40.00; Heath HG-10 VFO, \$35.00; Heath 6er, \$44.00; new BC-946, \$25.00; BC-696, \$6.00. WA4-DKQ, 116 Old Farm Road, Marietta, Ga.

NATIONAL NC-240D, perfect, \$125.00; RME VHF152, two, six and ten meter converter, \$35.00. Robert LaCava, W1FRF, 236 American Legion Highway, Revere, Mass. A1 4-0629.

IMMACULATE HQ-170, \$225.00; bug, \$7.00; B&W low-pass, \$9.00; Perry, 65 Hemenway, Boston, Mass. 02115.

WANTED: Morrow Falcon Schematic, operating manual. Buy, Rent, Trade, Borrow, J. D. Grigas, 258 Coe, Clarendon Hills, Ill. INVADER 2000, Drake 2A, MM2 with 50 Kc RM Adaptor. Sacrifice together or separately. W4GIMN, Box 371, Lebanon, Va.

C.E. 10B, new condx, \$80; late P & H 6-150 6 meter transmitting converter, \$165.00; HQ-145C receiver, \$165.00; four 4CX-250B, 10C mike, CN50W 6 meter converter, K0BCW, 7120 Clay, Westminster, Colorado.

100V in mint condx, \$475.00. K9BUB, 1414 S. 2nd St., St. Charles, Ill.

75A-4, perfect, \$450.00; 32S-1, \$425.00 KWM-1, \$375.00. W8-WGA, Phone 513-2770409

SALE: Apache, \$179.00; SB10, \$79. W6TZN, 5775 E. Siverly, Fresno, Calif.

DX-100, in exlnt condx, \$130.00; Lysco 600 TVI suppr., 35 w. xmtg, gnd, \$35.00. Will ship. WA2HPK, 58 Campus Dr., No. Buffalo 26, N.Y.

COLLINS 75A3, in excellent condx, \$300.00. Heavy duty motor, pitch motor converted, \$20.00. R. P. Kauphusman, 1275 West 6th St., Winona, Minn.

COLLINS R388 Receiver—5 to 30.5 Mc., 3:1 mechanical filter, new P.T.O., excellent condition, \$395.00. Prefer local sale and inspection. L. M. Divinia, 115 South Battin, Wichita 18, Kansas.

SELL: Lafayette HE-45A, HE-61VFO, Hi-Pair halo, all in exlnt condx: \$110.00. W3KXX, 1866 Watson Rd., Abington, Penna.

SELL: Gonset Communicator III, 2 meters, in excellent condx, \$145.00. K4FHG, 2001 Thomas Ave., Anniston, Ala.

WANTED: FM wide-band signal generator to at least cover 147 megacycles. W2ANB, John Lonagay, Slingerlands, N.Y. SELL: Station, GSB-100, Thunderbolt, Drake 1A, E. B. Snow, W2BZN, 139 Edgeview Lane, Rochester, N.Y., 14618.

SELL: Beautiful compact table top 811-A KW, Class B, 80-10 Silicon power supply, Variac controlled, fully metered. No junk, \$175.00. K81KB, 1414 Tiffin, Findlay, Ohio.

WANTED: Crystal calibrator for NC-303, Ameco 6 meter converter; Heath S.W.R., 6 meter halo, Peter Boudreau, 10 Forbes Ave., Burlington, Mass.

DRAKE 2B with matching speaker, Q-multiplier combination and xtal calibr, plus extra xtals. Like new! \$245.00. John Montague, WA4PDT, 218 Clay St., Blacksburg, Va.

SELL: HG-10 VFO in exlnt condx, \$30; DX-40 xmt in v. y. gud condx, \$45.00 and Apache xmt in v. y. gud condx, \$190. Harold Kusner, WA9END, 334 Grant St., Downers Grove, Ill. Tel WO 9-3429.

(GOING TO School: Must sell fast: Valiant, RME 4350, AM-2, E-1, mike 911 w/ PT. stand; Hy-Gain vert. and extras, all for \$350.00 or you can make individual offers. K2DPC, Dave, 303 North Park, Buffalo, N.Y.

COLLINS KWM-1 with 516-E power supply. Custom-mounted in 1957 Thunderbird, W9PJX.

HARVEY-Wells: T-90, 6146 VFO transmitter, clean, in exlnt condx: \$55.00; Elmac PS2V with cable, \$19.00. Both: \$70. Elmac A54H 12 volt all-bands, with relay, \$40. W5LLU, 4607 Huisache, Bellaire, Texas.

FOR SALE: HT-37, one year old, like new condx: \$350.00; Collins 75A-2 receiver with Drake SSB filter installed: \$250.00. Sry, no shipping but will deliver within 200 mi. radius, W8AES, Phone 293-7-0857. Win Patterson, 2660 Galewood St., Dayton 30, Ohio.

SELL: DX-60, used for 10 hours. SX-62A, VF-1 in gud condx. WA2VWQ, Westernville, N.Y.

COLLINS KWM-2 with 136B-2 noise blander and uninstalled Waters Q-multiplier: \$795.00; 351D-2 mobile mount, \$95.00; 136B-1 12 volt DC pwr. supply, \$150.00. Or steal the whole works for \$995.00. All equipment less than eight months old and in perfect condition. Robert Novak, 60 Valley Rd., Brookline 67, Mass. Telephone BE 2-4600.

SELL: SX-110, DX-20. Radio control set. Best offer or trade both for EICO 720-730, WN2HGB, 344 S. Wood Ave., Linden, N.J.

FOR SALE: Immaculate HT-37 with Shure controlled reluctance desk microphone w/rip-to-talk switch, \$300.00; HQ-170-C 24-hr. clock, \$205.00. Both in factory cartons. Scarcely used, look and work like brand new. K5YJR, 9627 Shadydale Lane, Dallas 75218, Texas.

SALE: 6146, 6883, new guaranteed: \$3.00 for \$5.00, H.S. 32, new, \$1.25. Many bargains. Free list. A & B Engineering, 1040 E. 43th St., Brooklyn, N.Y.

SELL: Two Comco 680 base stations, one mobile unit, one 35.90 mc FM, brand new condx, half-price, one G-E progress line, mobile unit, \$175.00, two Procton base station antennas, \$20.00 each. W4NF5, 640 Capri, Treasure Isle, Fla.

USED: S-38, \$19.95; S-20R, \$39.95; S-40, \$49.50; S-77, \$59.50; S-52, \$75.00; SX-99, \$85.00; SX-100, \$175.00; SX-110, \$110.00; SX-101A, \$295.00; SX-115, \$395.00; HT-32, \$395.00; HT-33A, \$399.99; HT-33B, \$495.00; GSB-101, \$225.00; G76, \$250.00; AC supply, \$99.00; DC supply, \$89.00; G77A, \$99.50; G63, revr, \$195.00 Adventurer, \$35.00; Challenger, \$69.50; G63, revr, \$175.00; Valiant, \$295.00; SW-140, \$195.00; (30) 99'er, \$129.00; SR-10, \$75.00; MR-1, \$75.00; TX-1, \$195.00; DX-40, \$49.50; VF-1, \$9.50; AF-68, \$95.00; RMR-7, \$129.50, new; HT-32B, \$695.00; GC-105, \$225.50; SW-240, \$320.00; Thor, \$349.00; SSB33, \$389.50. We trade, try us. Tenny Freck, W4WL, Gene Wheelton, K4EEV, Freck Radio Supply, Est. 1928. Tel. PH AL 33631. Asheville, N.C.

SALE: Drake 2B, new Feb., xtal calibrator, built-in spkr, \$210; HX-20 90 P.E. SSB rig, all bands, \$170.00; Globe King 500A with 300 B and C meters, \$275.00; 2-125V VDC 300 mls CCA pwr. supplies, \$25.00 each, 125 watt mod., \$25.00, parts for final \$20.00. W2KII, 111-33, 179 St., St. Albans, N.Y. Tel OL 7-8937.

HY-GAIN 6 thru 80 meter doublet, \$10.00 40 ft. galvanized steel mast, \$10.00. Unused Elmac 4-250A tube, \$5.00. WA2-SEU, 3823 Macklem Ave., Niagara Falls, N.Y.

CLEANING Shack: SX-28A, \$40.00; you pay ship. New BC-696, 457, 459, \$10.00, 12 w/50 A. Leece alternator complete, \$40.00; Original 51-14 manual, \$10.00; 4D32, 4X150A, \$10.00; 4X250B, \$20.00; 5R4WGY, \$1.25. John Conley, W7ZFB/4, 301 Burwyn Rd., Montgomery, Ala.

SELL: SX-111 receiver, \$165.00; DX-60 transmitter, \$60.00; HG-10 VFO, \$25.00. All in excellent condx. K4NQS, 911 Ann St., St. Marys, Ga.

SELL: Pancemaker, \$175.00; BC779A, \$74.00; Components for line-out, antenna, modulator, two power supplies. Other items. Stamped envelope for list. W7VUJ, Box 1025, Eiko, Nevada.

HT-32, SX-101; TR-switch, D-104 mike, 12" spkr, Mosley 10-80 antenna, RG-8/U cables, key, VT-M; BC-40, 400 2 amp; arid dip meter, completely assembled linear with three 4-100As, Elmac socket, tube and cover, Simpson meter, Pole-paw power supply, \$985.00 takes all. K7MAR/6, 6007 Greenwood, Bell Gardens, Calif.

ELECTRONIC Bargains, Discounts from net, free brochure. Franklin Electronics, Box 51b, Brentwood, N.Y. 11717.

FOR SALE: BC-221P with charts, never used, \$50; Eico HFC tuner and case, perfect, \$29; Knight K-B-85 amplifier, \$45 and K-P-50 preamplifier, professionally wired, \$40. Both \$80. Davis K5UNJ, 316 Terrace S.E., Albuquerque, N.M.

LINEAR, brand new, 3-1000Z tube, 3 ft. cabinet, 3600 volt P/S, \$350. HQ-100C, spkr., like new, cost, \$259.00, \$135.00, never used: UTC 7000-6000 5000 volt CT transformer 110-220 2 amps, \$60; UTC 3000-0-3000 110-220V 1 amp, \$45.00; 20 amp, 2.5 volt filament transformer, \$10; brand new, never used 4-1000A, \$75; used 250THs, \$10 each; Navy receivers 2-20 mgs. converted 10 volt, \$25.00; Telrex 3 6M. Monobander 20 meters, 26 ft. boom, cost \$250, \$165.00. Section 80 ft. Tri-Ex tower semi-permanent, \$175.00. GMEF, John Cordray, 6803 Amestoy Ave., Van Nuys, Cal. Dickens 4-1736.

SELL: Heath Twoer, in gud condx: antenna, xtal, All for \$40. WN2GBR, Carl Helmers, Jr., 29 Elmwood Rd., Florham Park, N.J.

WANTED: Antenna tuner for BC-610. Will trade new Eico signal generator M-322, also Eico Multimeter M-565, needs repair. J. Turner, 108 Lovejoy St., Durand, Mich.

BC-221, with AC supply, canvas carrying bag, metal cabinet, technical manual, \$80; National XCJ-300-calibrator, \$15; Heath GP-11 Vibrator supply, \$16.00. Lt. K. S. McTaggart, 22 Croin St., Ft. Rucker, Ala. 36362.

COLLINS 32S-1 with pwr. supply, 75S-1, 312B-4 station control and SM-2 mike for sale, \$850 takes all. No shipping. Ron Levine K2JXB, 773-5073, Passaic, N.J.

WANT Lampkin 205-A modulation meter, Harry Hammond, 219 E. Cedar, Fergus Falls, Minn.

USED Dial telephones, \$4.00; Magneto, \$8.00 plus postage. Guaranteed in working condx. Write for information and quantity discount. John Vokeli, Owendale, Mich.

100V in mint condition. All factory modifications, matching cabinet with black panel, set of new final tubes, and instruction manual, \$500.00. H. L. Rippe, W8BQH, 6532 Elwynne Dr., Cincinnati, Ohio 54236.

DX-100, T-R switch, extras, \$135.00; Lafayette KT-320 receiver, like new condx, \$65.00; Gotham 4-80 vertical, \$6.00; 7-12V dynamometers, 400V, 225 Ma, \$5.00; 235V, 75 Ma., \$3.00. WA2 WYH, Brooklyn, N.Y. Tel. NI 8-2078.

COMPLETE Collins S/Line: \$1,300 or separately as follows: 32S-1, \$450.00; 316F-2, \$85.00; 75S-1, \$350.00; 30L-1, \$375.00; 312B4, \$140. John Hinzay, K2RST, RD2, Vestal, N.Y.

GONSET G-76, #18400, Gonset AC and DC supplies, all brand new with guaranty, sacrifice for \$450.00 F.o.b. WA4JLF, 65B Camellia Ave., Satellite Beach, Fla.

JOHNSON Viking II, with matching VFO, priced for quick sale at \$140.00. On the air daily. K4NGO, 214 Hawkeean Dr., Frankfort, Ky.

SELL: 90W DX-20; VF-1, 50W plate modulator, with PS/mike, \$75.00, Trade R100 for Comanche, K7KAA, 4912 N.E. 19th Ave., Vancouver, Wash.

JONATHAN Dayton regional High school Radio Club lacks equipment and would appreciate contributions. Please contact secretary, WA2ZFF, 105 Henshaw, Springfield, N.J.

INDIAN Summer Specials from W5KFT, the "Kid from Texas": SR-150, \$499; Ar-67, \$49; NCX-3, \$269; HT-32A, \$349; Hallicraeters HT-44 and SR-160s for immediate delivery. New 4-1000s, \$60.00, used \$35.00; Variant, \$149.00; Ranger, \$119.00; 20-A, \$129.00; SX-99, \$75.00. Send for complete list of bargains. Regency A1C-1 converter, \$29.00; Heath Marauder, HX-10, \$249.00; Swan SW-140, \$159.00; Hallicraeters HT-33A, \$199.00; Super Six converter, \$14.00; Super 12, \$19.00. Terms: Cash, trade, or 24 months to pay. Bryan, W5KFT, the "Kid from Texas", Edwards Electronics, 4124-34th St., Lubbock, Texas. SW 5-2595.

SELL: NC-303, xtal cal., 2M conv., \$330.00; Apache, SB-10, \$225.00; Hy-Gain TH-3, \$50.00; Hallicraeters I.O. keyer, key, \$60.00.

HT-40, \$60.00; 15-watt 2-meter transceiver, \$100, 50 watt transmitter, \$25.00. WA2R17, Avon Drive, Essex Fells, N.J.

TR Switch, Johnson, like new, \$15.00; Hycon filters, 3 kc at 10.7 mc., Collins F250Z4 filter; DCDC converter transformer and power transformers, stamp for list; prop pitch transformer, \$4.50; parts: 4-1000A linear, tube, socket, transformer, vacuum caps, rotary inductor, dials, meters, power, blower. Stamp for list. Make offers or trade. W0LWZ, 1030 So. Dudley, Denver, Colorado 80226.

SELL: Nr. new Polycym II, complete. Make offer. 7730 Bonner, Sun Valley, Calif. K6RQJ.

SeLL: Drake 2B and 2BQ receiver combination, \$225. Johnson Ranger, \$150.00; receiver in new cond. Rig gud condx; new tubes. Will ship. Dick K9ZQF, 623 W. Prairie, Marengo, Ill. 615-568-8187.

SWAP: Electric train equipment for ham gear, Rodney Robbins, WN2JQS, 4 Washburn Ave., Franklinville, N.Y.

SELL: Apache, \$200; SX-99, \$100. Both: \$175.00. KIMPM, 34 Meadow Way, Bath, Me.

GONSET Comm. IV, 6 M., Mic., xtals. \$250.00. WA8GJN, Larry Hill, 200076 Valley Rd., Northville, Mich.

FOR Sale: Elmac A54, \$45.00, M1070, \$40; PMR7, \$80. John Guthrie, W3JIL, 317 Sixth St., Reynoldsville, Penna.

BARGAINS: Super Pro receiver, SP-400X with speaker, make offer. Write for list of tubes and parts. W3CNS.

SAVE Over \$150. SX-111 wid spkr, \$185.00 Adventurer. \$40; VF-1, \$15.00; Heath Twoer, in mint condx, \$45.00; Vibronex Deluxe Blue Racer bug, \$20.00; Package price, \$300.00. You pay shipping. WA6TIG, 1020 Palermo Dr., Santa Barbara, Calif.

HICKOK 288X sig. gen., \$100; Simpson 479 sweep and marker gen., \$125; Heath color bar gen., \$40; G-R, 7.5A varia, \$12; G.R. 1A Variac, \$2.00; Rack, \$3.00; Solar motor, \$3.00; 1/2A R.F. meter, \$2.00; phone ial, \$1.00; wavemeter, \$3.00; scope phse shifter, \$1.00; signal inductor, \$2.00, 40 meter transistor receiver, \$4.00. W6EHZ, 14945 Dickens St., Sherman Oaks, Calif.

WANTED: HT-20, all replies will be answered. Longstreth, WASCBL, #7 Michael Dr., Little Rock 4, Ark.

APACHE, NC-125, in exclnt condx, \$225.00, \$110 respectively, or best offers. Bob, 2819 Court, Saginaw, Mich.

FOR Sale: Complete QST collection from Volume One Number One to the highest bidder. Also have duplicates for later years. Ery Rassmussen, W6YPM, Box 612 Redwood City, Calif.

DRAKE 2B for sale, DX-100, \$129.00. K9FLU, A524 Cross St., Downers Grove, Ill. WO 8-2003.

"HOSS-TRADER" Ed Moory also has new display items: factory warranty, new Tri-Band Swan, \$269.00; new SBE-33, \$329.00; new NCX-3, \$339.00; new 75S-1, \$399.00; new Johnson 2000 Invader kit, \$439.00; 75S-3, \$509.00; new TH-4 beam and Ham-M rotor, \$179.00; Drake TR-3's, old price \$495.00; 75 meter Swans, \$149.00; new 20 meter Swans, \$159.00; repossessed HAM-2, \$695.00; Hoss-Trf Specials": HT-17, \$289.00; 10-B, \$69.00; Johnson Invader, \$359.00; HQ-129X, \$89.00; 2-A, \$159.00; HT-32, \$299; SR-150, \$399.00; 30L-1, \$349.00; new Hunter Bandit, \$469.00; 32V-3, \$189.00; 32V-2, \$179.00; 100-Vs, \$449.00; 200-Vs, \$549.00; 32S-3, \$495.00. Terms: cash. Ed Moory Wholesale Radio, P.O. Box 506 DeWitt, Arkansas. Phone: Whitney 6-2820.

SELL: Back issues QST, CQ, IRE, write for list. Aden, 2120 Martha N.E., Albuquerque, N, Mex.

JOHNSON 500 transmitter, in mint condx, \$600.00. L. G. Barnes, K4SDM, 1513 David Lane, Hopewell, Va.

INVADER 2000 high power conversion kit, \$350.00. W8KML, 19199 Blake, Detroit 3, Mich.

SWAN 175 transceiver, HP20 with built-in speaker; SW12A Topaz Exclnt condx, \$225.00. Shipping extra, prefer pick-up deal. W2PZS, Phone Trenton JU 7-3509.

HAM BUERGERS. Used equipment, money back guarantee. Collins KWS-1, \$95.00; Collins YV3, \$319.95; Collins 75A4-2 filter, \$59.00; Eico 720 \$54.95; Eico 730 \$44.95; Hallicraeters HT-32, \$295.00; Heath VFO VF1, \$19.95; Johnson Pacemaker, \$269.00; Lakeshore 2B, \$199.95; National HRO-50, 4 coils, spkr, \$199.95; National HRO60 7 coils, \$395.00; Polycymm 6 and 2, \$295.00. Trades. Write for free list. Ham Bueggers, Wyncote, Penna. CA 4-1740.

COLLINS KWS-1 transmitter, \$650.00; 73A3 receiver and speaker, \$300.00. Both: \$925.00. Good condition. Kootsey, 501 South Bascom, San Jose, Calif.

SELL: KWM-2 serial No. 10416 and 516F-2 AC pwr. supply. Like new condx. \$825. W4CHC, P.O. Box 2343, Macon, Ga.

SELL: 50 ft. Spaulding Tower, C.D.R., Ham-M rotor, T.A., 33 Jr., 60 ft. RG-7-U and rotor cable, Heath Mohawk tvrr; Eico 720 xmtr 730 mod., all in gud condx. W5JQK, John Popple, 11637 Coral Hills Drive, Dallas, Texas.

SELL: KWM-2 Sr., 11858, 312B-5 Sr., 10390. 516F-2 AC power-supply, in new condx, used but few hours. \$1200. Rev. A. J. Tamulis, W9POS, Macon, Ill. Tel. R. Ockwell 4-3795.

SELL: Knight T-150, \$75. W8GDC, 561 Elizabeth, Columbus, Ohio, 43213.

BC-610 complete with speech amp. and tech. manual. Like new. \$150.00. F.o.b. Denison, Texas. W. R. Hempkins, 1001 S. Armstrong, Denison, Texas.

Can you picture what hamming would be like without the many built-in conveniences to which we have all become accustomed: without the QSL system, without QST, without DXCC or WAS, without the National Traffic System, without the Sweepstakes, Field Day and other operating activities, without the RCC or the AREC, or without WIAW bulletins and code practice?

Did you ever stop to think about who provides all of these services? The answer, in all cases, is YOU—through your membership in the American Radio Relay League. The League is a democratic, cooperative effort of almost 100,000 radio amateurs in the United States and Canada to protect the hobby of amateur radio and to make it the most enjoyable of all possible hobbies.

To be 100% effective, the League needs the support of every man, woman and child who is interested in our wonderful hobby. If you don't belong—join now. If you do belong, sign up all the non-members you can.

Memberships, which include 12 issues of QST delivered to your door, can be had for only \$5 in the United States, \$5.25 in Canada, and \$6 elsewhere.

## THE AMERICAN RADIO RELAY LEAGUE, INC

225 MAIN STREET, NEWINGTON 11, CONNECTICUT

Designed for



Application

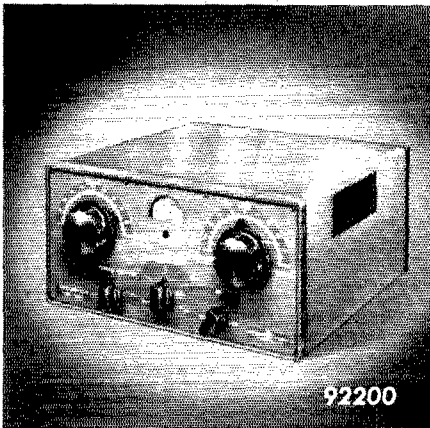

92200

**No. 92200  
TRANSMATCH**

Allows a transmitter to work into the 50 ohm unbalanced load for which it was designed. Converts a multi-band antenna to 50 ohms at all amateur frequencies between 3.5 and 29.7 MC. Matches 10 to 500 ohm unbalanced loads. Handles a KW.

**JAMES MILLEN  
MFG. CO., INC.**

MAIN OFFICE AND FACTORY  
**MALDEN  
MASSACHUSETTS**



**Index of Advertisers**

Aldronack Radio Supply	128
Alex Radio Corp.	150
Allied Radio Corp.	192
Alltronics-Howard Co.	174
Alpha Aracon Radio Electronics, Ltd.	179
Ameco Equipment Corp.	133
American Radio Relay League	
<i>QST</i>	189
<i>Emblems</i>	152
<i>Gateway</i>	7
<i>License Manual</i>	178
<i>Logbooks</i>	
Artow Electronics, Inc.	182
Ashe Radio Co., Walter	165
Automatic Telegraph Keyer Corp.	122
Barker & Williamson, Inc.	179
Barry Electronics	135
Belden Mfg. Co.	142
Bomar Crystal Co.	149
Bomar Crystal Co.	174
Breloux, Inc.	156
British Radio Electronics, Ltd. (Edystone)	179
Burstein-Applebee Co.	152
Clogg Labs., Div.	116
Clemens Mfg. Co.	172
Cleveland Institute of Electronics	125
Collins Radio Co.	2
Columbia Products Co.	162
Communication Products Co.	125
Communications Equipment Co.	158, 166
Crawford Radio, The	176
Cush Craft	170, 181
Dames Co., Theodore E.	150, 179
Douglas Instrument Co.	168
Dow-Key Co., Inc., The	120, 176
Editors & Engineers, Ltd.	167
EICO Electronic Instrument Co., Inc.	141
Etzel-McCullough, Inc.	14
Electro-Voice, Inc.	123
Electronic Wholesalers, Inc.	173
Electrophysics Corp.	170
E-Z Way Towers	130
Flinter Electronics	186
Floney Co., The	160
FM Sales Co.	174
Fort Orange Radio Distributing Co., Inc.	175
Frederick Electronics Corp.	180
Gardiner & Co.	150
Gertsch Products, Inc.	181
Gonsel, Inc.	155
Gotham	112, 113
Grand Central Radio, Inc.	162
Groth Mfg. Co., R. W.	164
Hallieraffers Co., The	1, 103, 108, 109
Ham Kits	168
Hammarlund Mfg. Co., Inc.	5
Harrison Radio	157
Harvey Radio Co., Inc.	169
Heath Co., The	105-107, 145
Henry Radio Stores	140, 154
Hornet Antenna Products Co.	132
Hunter Mfg. Co., Inc.	181
Hy-Gain Antenna Products Corp.	121
IDEA	158
Instructograph Co., Inc.	176
International Crystal Mfg. Co., Inc.	127
Johnson Co., E. F.	111
Kokusai Electric Co., Ltd.	147
Kreckman Co., Herb	172
KTV Tower & Communication Equipment Co.	164
Lafayette Radio	161
Lampkin Laboratories, Inc.	183
Lattin Radio Laboratories	182, 183
McCoy Electronics Co.	153
Millen Mfg. Co., Inc., James	190
Mini-Products, Inc.	154
Mor-Gain	180
Mosley Electronics, Inc.	129, 168
National Radio Co., Inc.	131, Cover 11
New Products	170
New-Tronics Div.	137
NYC Board of Education	166
Organs & Electronics	180
P & H Electronics, Inc.	146
Productive Tool & Mfg. Co., Inc., The	179
Radio, Inc.	163
Radio Publications, Inc.	177
Raytheon Co.	191
RCA Electronic Components & Devices	Cover IV
RF Communications Associates, Inc.	159
Rider Publisher, Inc., John F.	134
Rohn Mfg. Co.	148
Scientific Associates Corp.	172
Skylane Products	146
Squalley's Radio, Ltd.	172
Squires-Sanders, Inc.	117
Swan Engineering Co.	139
Sylvania Electric Products, Inc.	143
Technical Materiel Corp.	114, 115
Teeratt (The Equipment Crafters, Inc.)	136
Teleplex Co.	182
Telrex, Inc.	178
Tombago	164
Tri-Ex Tower Corp.	134
Trigger Electronics	171
United Transformer Corp.	Cover 11
Van Stickle Radio Supply Co.	178
Vanco	156
Vanguard Electronic Labs.	150, 180
Vesto Co., Inc.	176
Vibroplex Co., Inc., The	168
WA6DUW	178
Webster Mfg. Co.	126
Westinghouse Electric Corp.	118, 129
Whippany Laboratories, Inc.	183
Wilson, Inc. Willard S.	148
World Radio Laboratories	144, 163



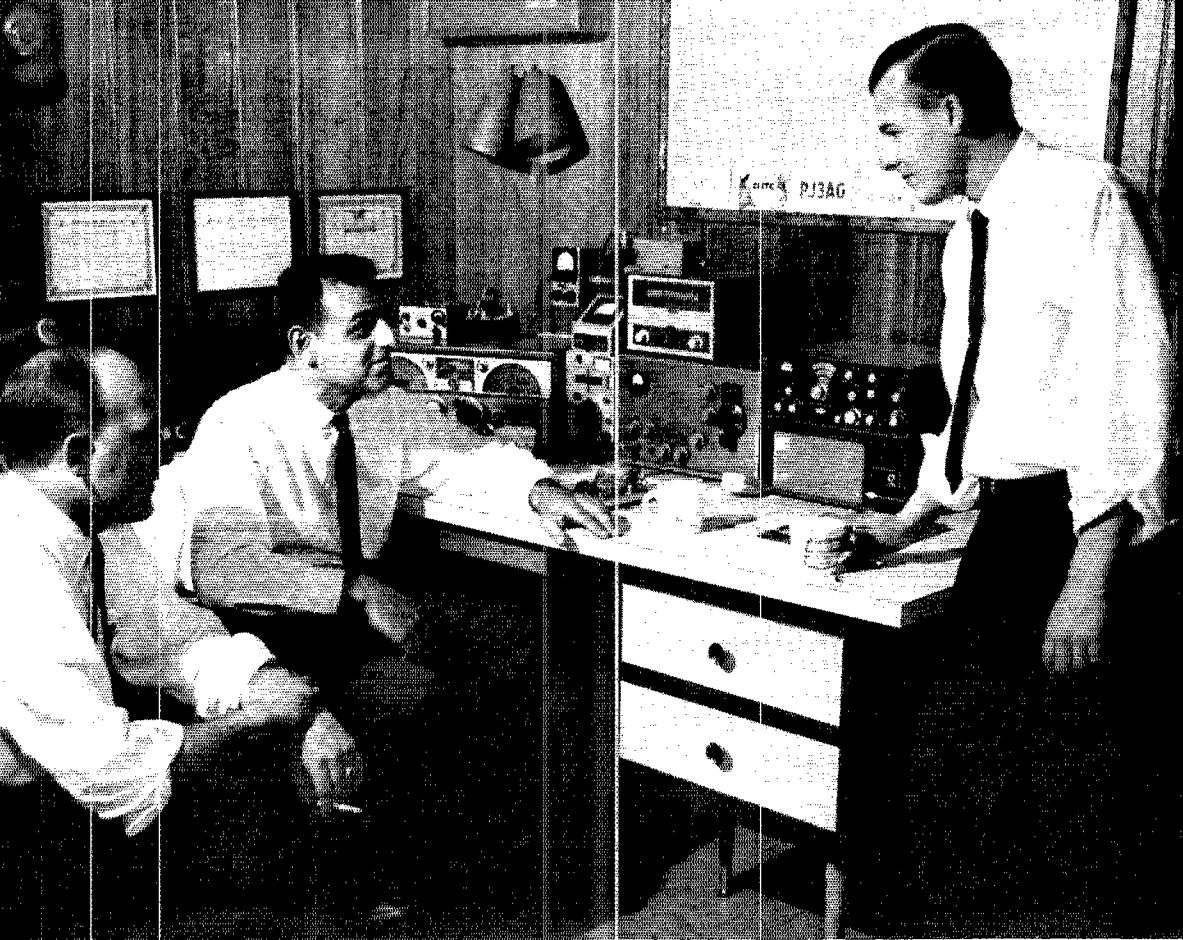

George Lucas, W1ZYS, "Pops" Karentz, W1YLB, and Ray Churchill, W1VBI, enjoy an infrequent eyeball QSO at "Pops'" Millis, Mass., QTH.

## FIELD ENGINEERING WITH A FUTURE

*Assignment: Advanced Radar, Worldwide*

It is unusual for the three people pictured above to get together in the same ham shack — more often all three are on far-ranging domestic or foreign assignments supervising Advanced Capability Radar installations for our armed forces.

George Lucas, W1ZYS, is currently Raytheon's resident field engineer at Boeing, Wichita, Kansas. He has advised and instructed on new ACR alignment techniques at many major Air Force bases in the U. S.

Ray Churchill, W1VBI, specializes in high speed bombing radar aboard B-52's. He may be at Loring AFB, Maine one day, Edwards AFB, California the next.

Pops is the Field Project Supervisor of Air Force Programs for Raytheon's Electronic Services Operation. Pops served in a wide range of field engineering assignments prior to his promotion to Project Supervisor and is currently responsible for field programs requiring the services of a large group of field engineers. George Lucas and Ray

Churchill are members of Pops' highly capable and fast moving field team.

It is possible you too can qualify for a Raytheon field engineering future.

Requirements include an E.E. or its equivalent in practical experience in guided missiles, fire control, radar, sonar or communications equipment.

Among Raytheon benefits: attractive starting salary with regular merit reviews; life and hospitalization insurance; retirement plan; educational and relocation assistance.

Sound interesting? For complete details, write Mr. R. E. Guittarr, Electronic Services Operation, Raytheon Company, Equipment Division, Northwest Industrial Park, Burlington, Mass. An equal opportunity employer.

**RAYTHEON**

from  
**ALLIED**

# punch out a clean **BIG SIGNAL** with this *knight-kit*® 150-Watt AM-CW Transmitter!

## GET TOP WATTS-PER-DOLLAR

- 150 Watts Peak AM/CW Input on 80 Thru 10-Meter Ham Bands
- Controlled-Carrier Modulation for Maximum Audio
- Stable VFO with Planetary Drive, "Spot" Switch
- Clean, Chirpless Keying—No HV Across Key
- Thorough TVI Shielding, Filtering, Bypassing
- Adjustable Pi-Network for 40 to 600-Ohm Antennas

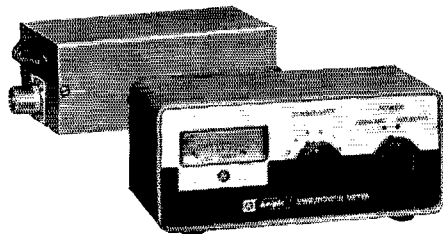

## Popular P-2 SWR/Power Meter Kit

ONLY  
**\$15<sup>95</sup>**

Now! Get the most from your transmitter and antenna! This easy-to-build "in-line" SWR/power meter measures relative power fed to antenna and standing waves reflected back from it. Lets you make your own matching adjustment between line and driven elements for

maximum RF. Features flexible two unit design (coupler and indicator units) with 4-foot shielded connecting cable; has coax connectors; full KW capacity; can be left in line as constant monitor; reads SWR from 1:1 to 20:1; accuracy better than 10%; negligible insertion loss; for unbalanced 50-72 ohm lines, Amateur and CB; range from 1.8 to 432 mc; has sensitivity adjustment; no AC power or batteries required. Coupler, 2 x 5 x 2 1/2"; indicator, 2 1/4 x 6 1/4 x 3". Complete with all parts and instructions. Shpg. wt. 3 lbs.

**\$15<sup>95</sup>**

83 Y 627FR. P-2 Kit, only.....  
83 Y 546FR. As above, but factory-assembled \$22.95

## T-150A 150-Watt Transmitter Kit

ONLY  
**\$119<sup>95</sup>**  
\$6 monthly  
on Allied's  
Credit Fund Plan

Latest version of the rig acclaimed by satisfied owners everywhere. Loaded with features to put out a solid signal that really punches thru the QRM. Controlled-carrier screen modulation for fine audio quality with negligible distortion, plenty of mike gain and top "talking power." Rock-stable VFO,

fully calibrated for 6 bands, has illuminated scales, backlash-free planetary drive, and spot switch to let you "zero-in" without putting a signal on the air. 4-stage simultaneous-cathode keying circuit offers clean CW for break-in work—ideal for contests, traffic and DX chasing. Peak AM/CW inputs, 150 watts on 80 thru 10 meters. 20 watts output on 6 meters. Other highlights: Single-knob band-switching, adjustable pi-network for 40 to 600-ohm antennas; VR tube in B+ of VFO oscillator; buffer stage for isolation; standby, remote standby and power takeoff plugs; power supply using 2 silicon diodes in full-wave voltage doubler (saves filament power and eliminates heat); heater/plate voltage takeoff to power auxiliary gear, plus 117 v. for antenna relay; PCIM mike connector; key jack. With all parts, wire, solder instructions and handsome gray satin metal case, 8 1/2 x 17 x 10 1/2". Less mike, key, crystals. For 110-125 v. 60 cycle AC. 35 lbs.

**83 YU 409FR. T-150A Transmitter Kit, only.... \$119<sup>95</sup>**

**PRaised BY THE LEADING HAM JOURNALS!**

**satisfaction guaranteed  
or your money back**

**NO MONEY DOWN: Take  
advantage of your Allied  
Credit Fund Plan!**

**ORDER TODAY FROM**

**ALLIED RADIO**

**ORDER  
TODAY**

**ALLIED RADIO**  
100 N. Western Ave., Chicago 80, Ill.

Ship me the following:

- T-150A Transmitter Kit 83 YU 409FR
  - P-2 SWR/Power Meter Kit 83 Y 627FR
  - P-2 SWR/Power Meter Assembled 83 Y 546FR
- \$.....enclosed (check) (money order)
- Ship No Money Down on Allied's Credit Fund Plan

Name.....  
PLEASE PRINT

Address.....

City..... Zone..... State.....

# fussbudget

Stan Taylor is Manager of National's Quality Control Division . . . and a fussbudget by profession. He and his staff make certain that when you buy a National product you can be confident that every component part, every stage of assembly, every aspect of performance, was checked, re-checked, and approved before the equipment was allowed to leave the factory. Stan has only one quota — 100% test and inspection — and only one criterion in "borderline" cases — "Will the customer be satisfied that his new rig meets National's advertised specifications for performance and workmanship in every respect?"

Our NCX-3 SSB Transceiver is a good case in point . . . Your National Dealer will tell you that the NCX-3 outsells all other transceivers by four or five to one. Why? It's a handsome feature-packed high performance rig — and it's well made. Conservatively rated parts, meticulous assembly, and the neatest wiring you've seen in ham gear since the last sun spot cycle.

When you try the NCX-3, you'll know at once that it is a transceiver built not to a price . . . but to a standard. The same high standard that allows National to offer a One-Year Guarantee on the NCX-3 and on all other National Equipment. In

addition, the NCX-3 at \$369 is the only transceiver in its price range to include, as standard equipment, features that would be expensive "options" (if available) in other sets . . . features required for fixed station as well as mobile applications: complete coverage with overlap of the 80, 40, and 20 meter phone and CW bands. Built-in grid-block break-in keying with adjustable delay. Built-in VOX as well as push-to-talk. Built-in RF-derived SSB/CW AGC without pops or thumps at full RF gain. Built-in S-meter and PA current meter. Built-in AM detector for fully-compatible AM operation. Mobile mount included with each unit. Conservatively rated Pi-network final amplifier that runs black at 200 watts PEP.

Only a demonstration can give you a true picture of the performance of a National rig . . . but for your preliminary reference, we'd like you to accept a free copy of our complete catalog (and NCX-3 Instruction Manuals are also available at \$1 ea.). Just send your name and address to: National Radio Company, Inc., 37 Washington Street, Melrose, Massachusetts 02176.



**NATIONAL RADIO  
COMPANY, INC.**   
37 Washington St., Melrose 76, Mass.

A Wholly Owned Subsidiary of National Company, Inc. World Wide Export Sales: Ad Auriema Inc., 85 Broad St., N.Y.C. Canada: Tri-Tel Assoc., 81 Sheppard Ave. W., Willowdale, Ontario.

