

February, 1947

35 Cents

# QST

devoted entirely to

# amateur radio



Gil. 20010

A. R. L. DX COMPETITIONS START FEB. 14, 1947



# 1-KILOWATT CW INPUT WITH THIS MODERN TRIODE

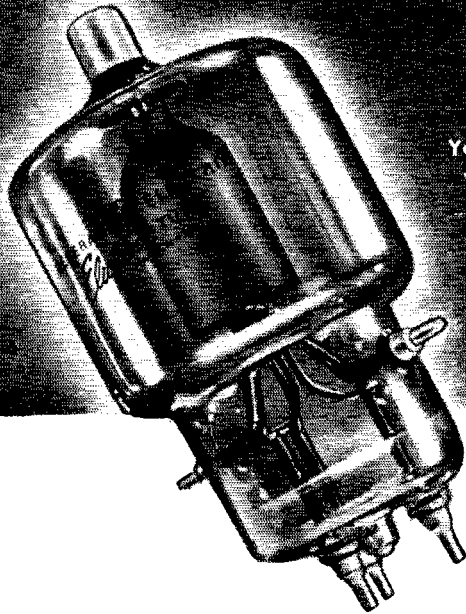

Your investment gives you 1 kilowatt of input (ICAS) with a single tube. That's real value, even without the GL-592 plusses such as 300 watts of plate dissipation, and operation at full ratings up to 110 megacycles!

**H**ERE'S lots of power for your final—and lots of tube, too, in the best, most modern sense! Check the *special* features below. They help to make the GL-592 the superior product that hams are hurrying to buy.

**COMPACT**—only 6" in height, including pins.

**ZIRCONIUM-TREATED ANODE.** Surprised that the GL-592's carbon anode will dissipate 300 watts? That's because zirconium treatment permits bright-orange temperatures without gassing.

**NO BASE**—therefore minimum r-f losses.

**NO SOLDERED TERMINALS.** Fernico metal-to-glass seals are used throughout.

Study ratings at the right. Then, to learn how you can *S-T-R-E-T-C-H* your dollars to buy *more watts plus better performance*, see General Electric's great GL-592 at your nearby G-E tube distributor's! Or write *Electronics Department, General Electric Company, Schenectady 5, N. Y.*



## GL-592 POWER TRIODE

Rating (ICAS)	Class C	Class C telephony telegraphy (plate-modulated)
Filament voltage	10 v	10 v
Filament current	5 amp	5 amp
Max plate voltage	3,500 v	3,000 v
current	350 ma	250 ma
input	1,000 w	750 w
dissip.	300 w	225 w
Frequency at max ratings	110 mc	110 mc

As is true with other new, modern-design G-E transmitting tubes—such as GL-4D21/4-125A and GL-5D24—the GL-592 triode attains its high watts-per-dollar value by utilizing the advantages of a small amount of forced-air cooling. An ordinary 8" household fan or a small furnace-type or other blower is all you need to cool a pair of GL-592's. See G.E.'s "Ham News" for January-February to learn how convenient and inexpensive forced-air cooling is for the amateur, and what that method will mean to you in high power output and long tube life, should you plan to develop your rig along the most modern lines.

ELECTRONIC TUBES OF ALL TYPES FOR THE RADIO AMATEUR

# GENERAL ELECTRIC

161-F4-8850

# Where every penny counts



## USE SOLAR CAPACITORS

For maximum reliability at minimum cost, radio amateurs everywhere specify Solar Capacitors. The extra dependability of capacitors bearing the Solar trade mark is attested to by old timers in ham radio, who learned the hard way.

Why take chances with your hard-earned gear? "Play It Smart" and make sure you specify Solar and get Solar Capacitors.

Get a complete catalog for your Ham Shack today. Write Solar Capacitor Sales Corp., 285 Madison Ave., New York 17, N. Y.



XDMR6-5  
5. MFD  
600. WVDC

1210

# SOLAR CAPACITORS

"Quality Above All"



FEBRUARY 1947

VOLUME XXXI

NUMBER 2



STAFF

Editorial

KENNETH B. WARNER, W1EH  
(Managing Secretary, ARRL)  
Editor

HAROLD M. MCKEAN, W1CEG  
Assistant to the Editor

GEORGE GRAMMER, W1DF  
(Technical Director, ARRL)  
Technical Editor

DONALD H. MIX, W1TS  
BYRON GOODMAN, W1DX  
Assistant Technical Editors

EDWARD P. TILTON, W1HDQ  
V.H.F. Editor

RICHARD M. SMITH, W1FTX  
C. VERNON CHAMBERS, W1JEG  
Technical Assistants

WALTER E. BRADLEY, W1FWH  
Technical Information Service

Production

RALPH T. BEAUDIN, W1BAW  
Superintendent

NANCY P. PORTEUS  
Assistant

Advertising

F. CHEYNEY BEEKLEY, W1GS  
Advertising Manager

Circulation

DAVID H. HOUGHTON  
Circulation Manager

RALPH T. BEAUDIN, W1BAW  
Assistant Circulation Manager



OFFICES

38 La Salle Road  
West Hartford 7, Connecticut

Subscription rate in United States and Possessions, \$2.50 per year, post-paid; \$3.00 in the Dominion of Canada, \$4.00 in all other countries. Single copies, 35 cents. Foreign remittances should be by international postal or express money order or bank draft negotiable in the U. S. and for an equivalent amount in U. S. funds.

Entered as second-class matter May 29, 1919, at the post office at Hartford, Connecticut, under the Act of March 3, 1879. Acceptance for mailing at special rate of postage provided for in section 1103, Act of October 3, 1917, authorized September 9, 1922. Additional entry at Concord, N. H., authorized February 21, 1929, under the Act of February 28, 1925.

Copyright 1947 by the American Radio Relay League, Inc. Title registered at U. S. Patent Office.

# QST

devoted entirely to

# AMATEUR RADIO

PUBLISHED, MONTHLY, AS ITS OFFICIAL ORGAN, BY THE AMERICAN RADIO RELAY LEAGUE, INC., AT WEST HARTFORD, CONN., U. S. A. OFFICIAL ORGAN OF THE INTERNATIONAL AMATEUR RADIO UNION.



## CONTENTS

"It Seems to Us . . ."	13
Operating the BC-645 on 420 Mc. <i>John T. Ralph, and H. M. Wood, W3JYA</i>	15
Silent Keys . . . . .	21
Transmitting Ratings on Receiving Tubes . . . . .	22
A Stabilized 813 Amplifier . <i>Richard M. Smith, W1FTX</i>	23
Technical Topics	
L.F.-N.F.M. . . . .	28
S-Meters — So What? . . . . .	29
"Maybe It's Just Conditions — " . . . . .	30
A Quiet Break-In System <i>Claude L. Robinson, W6KJV</i>	33
Happenings of the Month . . . . .	36
A Stacked Array for 6 and 10 <i>Edward P. Tilton, W1HDQ</i>	38
The Old Stand-By . . . . . <i>George D. Knipe, W7IGE</i>	42
Tenth ARRL Field-Day Results . . . . .	45
Postwar Countries List . . . . .	49
DX Operating . . . . . <i>Byron Goodman, W1DX</i>	51
In QST 25 Years Ago This Month . . . . .	54
Direct-Reading Modulation Meter <i>Dana W. Atchley, jr., W1HKK, and Richard E. Fricks, W6QUG</i>	55
Dishing Out the Milliwatts on 10 KMc. <i>James A. McGregor, W2RJM, Ex-W1LZV/2</i>	58
How's DX? . . . . .	62
"I Just Put Up Another Antenna" <i>Bill Lippman, W6SN</i>	66
The World Above 50 Mc. . . . .	69
Correspondence From Members . . . . .	73
Hints and Kinks . . . . .	74
Operating News . . . . .	76
Station Activities . . . . .	84
WWV . . . . .	142
Book Review . . . . .	152

A "third hand" to help you

reach for new horizons . . .

## THE *New* hallicrafters SKYRIDER PANORAMIC

Hallicrafters Skyrider Panoramic, Model SP-44 is actually a "third hand" to help you reach for new horizons in ham radio. The Panoramic shows not only the received signal but every signal 100 kc on either side of the received signal... provided visual sweepwidth is set at maximum. By making a wide range of radio signals visible a new dimension is added to the field of radio operating. Listed at right are a few of the things Panoramic enables you to do:

1. Spot frequency modulation or parasitics on an amplitude modulated signal.
2. Measure percentage of modulation and the quality of the signal being transmitted under all conditions.
3. Read signal strength instantaneously, aiding in quickly adjusting the output stages of the transmitter or the field strength of directional antennas.
4. Check other frequencies against known standards or the receiver calibrations. Any frequency drift can be spotted immediately.
5. Show where and how much to shift frequency to avoid interference once a QSO is under way.

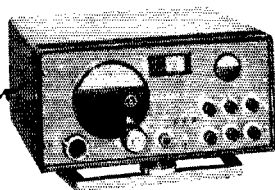

**MODEL SX-42.** Described by hams who have operated it as "the first real post war receiver." One of the finest CW receivers yet developed. Greatest continuous frequency coverage of any communications receiver—from 540 kc to 110 Mc, in six bands. FM-AM-CW. 15 tubes. Matching speakers available.

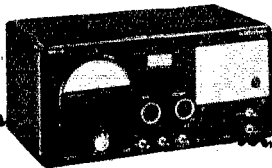

**MODEL S-40.** Function, beauty, unusual radio performance and reasonable price are all combined in this fine receiver. Overall frequency range from 540 kc to 43 Mc in four bands. Nine tubes. Built-in dynamic speaker. Many circuit refinements never before available in medium price class.

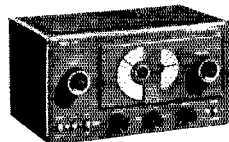

**MODEL S-38.** Overall frequency range from 540 kc to 32 Mc in four bands. Self contained speaker. Compact and rugged, high performance at a low price. Makes an ideal standby receiver for hams. CW pitch control is adjustable from front panel. Automatic noise limiter.

SEE THESE THREE GREAT NEW HALLICRAFTERS RECEIVERS



*Photo above shows Hallicrafters SP-44 Panoramic in use with Hallicrafters receiver, the Model S-40.*



**TEN TUBES INCLUDING CATHODE RAY TUBE \$99<sup>50</sup>**

No modifications are necessary in your receiver in order to connect the Model SP-44. It does not interfere in any way with normal receiver operation. The Sky rider Panoramic may be used with new and old Hallicrafters models or any receiver having an IF frequency range between 450 and 470 kc. The Panoramic picture which is presented on the scope screen

through a specially processed green filter appears bright and sharp. Easy to read in a normally lighted room. Just four simple operating controls make it easy to handle. Get the help of this valuable "third hand" in opening new ham horizons. Order from your local distributor today. Specify: Hallicrafters Model SP-44 Panoramic.

COPYRIGHT 1946  
THE HALLICTRAFTERS CO

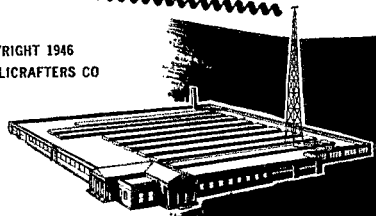

BUILDERS OF *Skyfone* AVIATION RADIOTELEPHONE

**hallicrafters RADIO**

THE HALLICTRAFTERS CO., MANUFACTURERS OF RADIO AND ELECTRONIC EQUIPMENT, CHICAGO 16, U. S. A.

Sole Hallicrafters Representatives in Canada:  
Rogers Majestic Limited, Toronto-Montreal

## Section Communications Managers of the ARRL Communications Department

**Reports Invited.** All amateurs, especially League members, are invited to report station activities on the first of each month (for preceding month) direct to the SCM, the administrative ARRL official elected by members in each Section. Radio Club reports are also desired by SCMs for inclusion in QST. All ARRL Field Organization appointments are now available to League members. These include ORS, OES, OPS, OO, and OBS. Also, where vacancies exist SCMs desire applications for SEC, EC, RM, and PAM. In addition to station and leadership appointments for Members, *all amateurs* are invited to join the ARRL Emergency Corps (ask for Form 7).

ATLANTIC DIVISION				
Eastern Pennsylvania	W3BES	Jerry Mathis	623 Crescent Ave.	Glenside Gardens
Maryland-Delaware-D. C.*	W3BWT	Eppa W. Darne	132 Tennessee Ave., N.E.	Washington 2, D. C.
Southern New Jersey	W2GCU	Ray Tomlinson	624 E. Brown St.	Trenton 10
Western New York	W2UPH	Charles I. Otero	4158 Ridge Road, West	Spencerport
Western Pennsylvania	W3NCJ	R. R. Rosenberg	927 East 23rd St.	Erie
CENTRAL DIVISION				
Illinois	W9AND	Wesley E. Marriner	624 College Ave.	Dixon
Indiana	W9SWH	Ted K. Clifton	550 Eben St.	New Haven
Wisconsin*	W9DKH	Ralph Kleia	1106 Manitou St., R.F.D. 3	Manitowoc
DAKOTA DIVISION				
North Dakota	W0EVP	Raymond V. Barnett	406 17th St.	Bismarck
South Dakota	W0QVY	P. H. Schultz	118 N. Yankton Ave.	Pierre
Minnesota*	W0EPJ	Norman Beck		Mound
DELTA DIVISION				
Arkansas	W5JIC	Marshall Riggs	4405 Howell Ave.	Fort Smith
Louisiana	W5VT	W. J. Wilkinson, jr.	Room 313, Jefferson Hotel	Shreveport
Mississippi	W5IGW	Harold Day	Route 1, Box 111	Greenville
Tennessee	W4FLS	James W. Watkins	220 North Howell St.	Chattanooga 4
GREAT LAKES DIVISION				
Kentucky	W5IEZ/4	Joseph P. Colvin	1653 Beechwood Ave.	Louisville 4
Michigan	W8DPE	Harold C. Bird	R.F.D. 2, Box 228	Pentac 2
Ohio	W8PNQ	William D. Montgomery	1290 Coolidge Ave.	Cincinnati 30
HUDSON DIVISION				
Eastern New York	W2HZL	Ernest E. George	2044 Lexington Parkway	Schenectady 8
N. Y. C. & Long Island	W2KDC	Charles Ham, jr.	151-06 84th Drive	Jamaica, L. I., 2
Northern New Jersey*	W2IIN	John J. Vitale	57 Sayre St.	Elizabeth 3
MIDWEST DIVISION				
Iowa	W0PIR	Leslie B. Venzard	2712 Washington St.	Burlington
Kansas	W0AWP	Alvin B. Unruh	842 N. Terrace Drive	Wichita 0
Missouri	W0UUD	Mrs. Letha A. Dangerfield	411 Moffett Ave.	Joplin
Nebraska	W0POB	Roy E. Olmsted	101 Arikari Ave.	Wauneta
NEW ENGLAND DIVISION				
Connecticut	W1KOY	Edmund R. Fraser	90 Atwater St.	West Haven
Maine	W1AOL	G. C. Brown	379 No. Main St.	Brewer
Eastern Massachusetts	W1ALP	Frank L. Baker, jr.	91 Atlantic St.	North Quincy 71
Western Massachusetts	W1AZW	Francis M. Bailey	62 Dexter St.	Pittsfield
New Hampshire	W1AXL	John H. Stoughton	RFD 2	Claremont
Rhode Island	W1HRH	Clayton C. Gordon	70 Columbia Ave., Gaspee	Plateau, Providence 5
Vermont	W1INDL	Gerald Benedict	23 Foster St.	Montpelier
NORTHWESTERN DIVISION				
Alaska	K7CBF	August G. Hiebert	c/o K FAR	Fairbanks
Idaho	W7IWU	Alan K. Ross	1017 East Jefferson St.	Boise
Montana	W7EQM	Albert Beck	2326 Amherst Ave.	Butte
Oregon	W7HAZ	Kateigh A. Munkres	Box 744	Baker
Washington*	W7EHQ	Lloyd Norberg	P. O. Box 281	Steilacoom
PACIFIC DIVISION				
Hawaii*	KH6EL	John Souza		Wailuku, Maui
Nevada	W7CX	N. Arthur Sowle	Box 2025	Reno
Santa Clara Valley	W6BPT	Roy E. Pinkham	1061 Fremont St.	Santa Clara
East Bay	W6TTI	Horace R. Greer	414 Fairmount Ave.	Oakland 11
San Francisco	W6NLL	Samuel C. Van Liew	215 Knowles Ave.	Daly City
Sacramento Valley	W6MGC	John R. Kinney	520 J St.	Sacramento 16
Philippines*	KA1CB	Craig B. Kennedy	25 Roosevelt Road	San Francisco Del Monte, Quezon
San Joaquin Valley	W6PSQ	James F. Wakefield	2940 Adoline Ave.	Fresno
ROANOKE DIVISION				
North Carolina	W4CYB	W. J. Wortman	c/o Duke Power Co.	Charlotte 1
South Carolina	W4BOE/ANG	Ted Ferguson	3422 Rosewood Drive	Columbia 25
Virginia	W4JHK	Walter R. Bullington	1203 E. Brookland Pk. Blvd.	Richmond 22
West Virginia	W8JM	Donald B. Morris	303 Home St.	Fairmont
ROCKY MOUNTAIN DIVISION				
Colorado	W0QYT	Glen Bond	2550 Kendall	Denver 14
Utah-Wyoming	W7LLH	Victor Urabble	1024 Oak St.	Ogden, Utah
SOUTHEASTERN DIVISION				
Alabama	W4GBV	Lawrence J. Smyth	808 Winona Ave.	Montgomery
Eastern Florida	W4IP	Robert B. Murphy	3302 S.W. Grapeland Blvd.	Miami 33
Western Florida	W4MS	LE Comdr. Edward J. Collins	1003 East Blount St.	Pensacola
Georgia	W4HYW	Thomas M. Moss	570 Oak Drive	Hapeville
West Indies* (Cuba-P.R.-V.L.)	KP4KD	Everett Mayer	P. O. Box 1061	San Juan 5, P. R.
SOUTHWESTERN DIVISION				
Los Angeles	W6QWZ	Ben W. Onstank	9631 3rd Ave.	Inglewood
Arizona	W7MLL	Gladden C. Elliott	1408 West Fresno St.	Tucson
San Diego	W6CHV	Ralph H. Culbertson	7172 Eads St.	La Jolla
WEST GULF DIVISION				
Northern Texas	W5DAS	N. C. Settle	2911 Elm St.	Dallas
Oklahoma	W5HXI	Bert Weidner	Box 14	Crescent
Southern Texas	W5JC	James B. Rives	1721 Kentucky Ave.	San Antonio 1
New Mexico	W5HJF	J. G. Hancock	110 S. E. Nevada St.	Portales
MARITIME DIVISION				
Maritime (Nfld. & Labr. att.)	VE1DQ	A. M. Crowell	69 Dublin St.	Halifax, N. S.
ONTARIO DIVISION				
Ontario	VE3DU	David S. Hutchinson	327 Lovett St.	London, Ont.
QUEBEC DIVISION				
Quebec	VE2SU	Gordon F. J. Phelan	4829 Isabella Ave.	Montreal, Que.
VANALTA DIVISION				
Alberta	VE6LQ	W. W. Butchart	10740-107 St.	Edmonton, Alta.
British Columbia	VE7WS	W. W. Storey	3915 W. 32nd Ave.	Vancouver
Yukon*	VE8AK	W. R. Williamson	P. O. Box 137	Whitehorse, Y. T.
PRAIRIE DIVISION				
Manitoba	VE4AM	A. W. Morley	26 Lennox St.	St. Vital
Saskatchewan	VE5CO	Notman Thompson	1120 7th Ave., N. W.	Moose Jaw

\*Officials appointed to act temporarily in the absence of a regular official.



# TRANS-WORLD DX

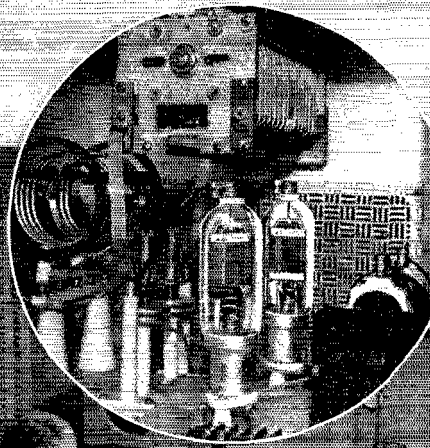

*John A. Callanan*  
AMATEUR RADIO W9HOB

December 11, 1946

Gentlemen:

Soon after the amateur bands reopened, I substituted a pair of UNITED V-70-D tubes for the type previously used and found that the final stage power output was increased about 50%. Moreover, this increased output was obtained with approximately 25% less driver power than required by the original tubes.

With the pair of tubes operating somewhat less than 1 KW input, I have contacted some 40 odd countries since the war on 14 mcs. and have been active in handling traffic for G.I.'s overseas.

Some of the unusual activities have been to transfer an army officer's wife and family from the States to North Africa; the radio and telephone contact to bring a G.I. stationed in Germany to his wife's bedside in a hospital in Indiana; to announce the arrival of a bouncing baby boy to a G.I. stationed in far-off Japan (needless to say it is understandable that many bottles were opened in that celebration). There have also been many dramatic incidents such as the time that a G.I.'s mother fainted when she heard her son say "Hello Mom" from Okinawa or the time that a G.I. spoke from his hospital bed in the Philippines to his wife and mother.

Considering that the brunt of this work is carried by the pair of V-70-D's in the final stage and they are often subjected to considerable abuse, such as no warm-up period, etc., I could not help but write you and offer my commendation. Needless to say, I am completely sold on these tubes and look forward to many more enjoyable hours of amateur operation with them.

Best of 73's  
*John A. Callanan*  
John A. Callanan, W9HOB

## UNITED V-70-D graphite anode

triodes fire powerful sigs from the final of W9HOB. Following are a few of the rare DX QSO's that have elated the O.M. pictured above.

- |           |       |       |       |       |       |       |
|-----------|-------|-------|-------|-------|-------|-------|
| V59AR     | PK5AR | YR2JI | F7AE  | CO7CX | TI4AC | VP3LF |
| OXTAS     | VO6G  | E13J  | XU144 | HH2ME | XE1JS | J9LG  |
| W1LTQ/TF  | EA1D  | GM2UU | J2AAP | XZ2AA | YV4AM | PZ1G  |
| VQ2PL     | LA7R  | G6BY  | KATCB | J9AAB | HK3BI | LU4EC |
| YQ4EE     | OZ5AA | F7AA  | ZS1CN | KG6AA | UE8NA | YP5AC |
| W9BND/KL7 | ZB1L  | XACP  | XADW  | CE3AB | FG3FP | OA4R  |
| W8S1R/VP9 | VU2WS | EL5B  | D4AOT | KH6FT | VK4JP | HC2CC |

Type V-70-D and similar type 812-H are briefly described below. See your electronic parts distributor or write us for further data.

Type	Filament		Max. Plate Dissipation	Max. Input per tube	Max. Plate	
	Volts	Amps			Volts	Mills
V-70-D	7.5	3.25	85 Watts	300 Watts	1750	200
812-H	6.3	4.0	85 Watts	300 Watts	1750	200

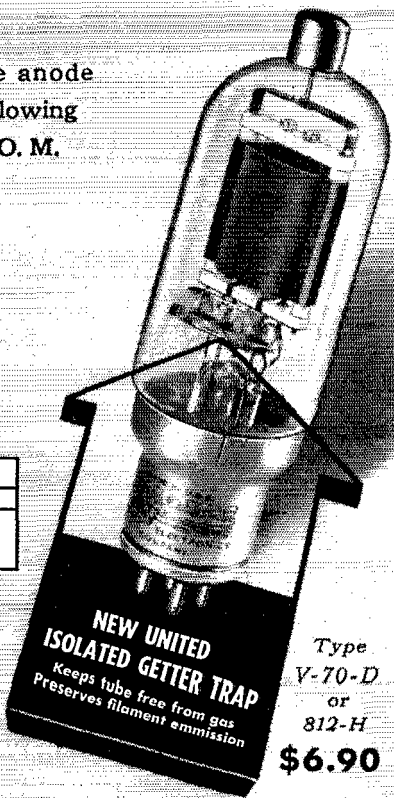

# UNITED

ELECTRONICS COMPANY

NEWARK, 2 NEW JERSEY

Transmitting Tubes EXCLUSIVELY Since 1934

**PUTTING ELECTRONICS TO WORK  
with**

*Government Owned Surplus*

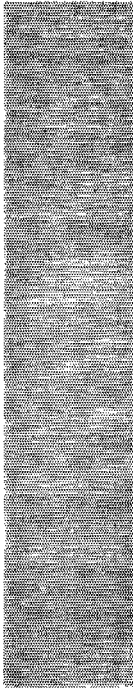

To help you incorporate the many advantages of electronics in your business, the War Assets Administration is making available its enormous inventory of tubes and equipment now.

Qualified distributors all over the country have been appointed by WAA to represent it. In every field where electronic application has proved its worth, these distributors maintain inventories and have the technical "know-how" to service your needs.

Get in touch with your nearest distributor and see how government-owned war surplus can help you—electronically. Or—if it is more convenient—write to

**ELECTRONICS DIVISION  
OFFICE OF AIRCRAFT DISPOSAL**

**WAR ASSETS ADMINISTRATION**

425 Second St., N.W.

Washington 25, D. C.

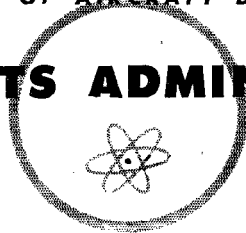

Millions and millions of electronic tubes are at your disposal. Pictured are some of the types which are available to you.

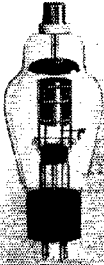

**RECTIFYING**  
(NO. 856A)



**TRANSMITTING**  
(NO. 415)



**CATHODE RAY**  
(NO. 3BP1)

**VOLTAGE REGULATOR**  
(NO. VR150)



**RECEIVING**  
(NO. 65K7)



**RECEIVING**  
(NO. 6L6)

**tubes! tubes! tubes!**

**"NO ELECTRONIC DEVICE IS BETTER THAN ITS TUBE"**

880

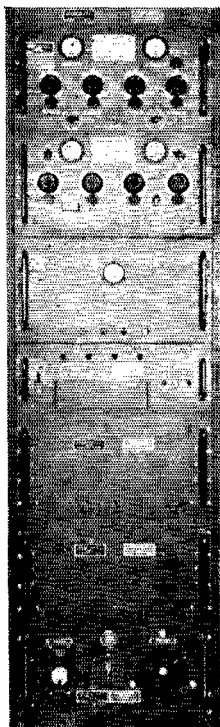

Transmitter

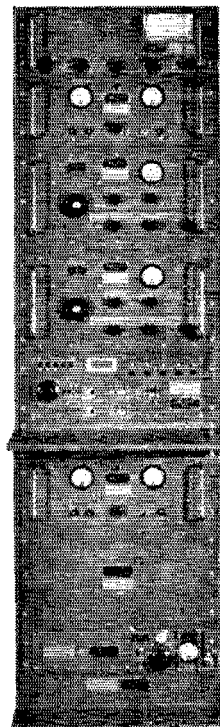

Receiver

# MODERN COMMUNICATION and PRODUCTION

depend on

*Electronics*

Today—virtually all methods of high-speed communication use electronic tubes. In the industrial field, heating, welding and various methods of control are being done better and faster because of electronics. From big broadcasting stations to tiny hearing aids—from induction heating to voltage regulation—the science of electronics is playing a major role in industry.



Microphone

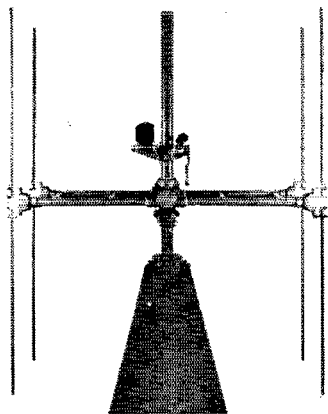

Matching Stub and Antennae

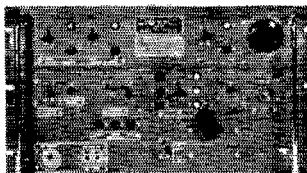

Control Unit

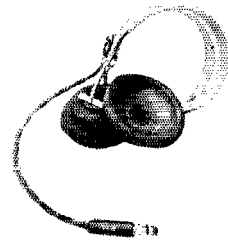
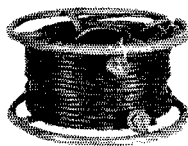

Headset

*these Authorized Distributors will serve you:*

Listed here are the names and locations of WAA appointed distributors. Not all of them will have complete stocks but it will pay you to consult them on your electronic problems.

Automatic Radio Mfg. Co., Inc.  
120 Brookline Avenue  
Boston 15, Massachusetts

Communication Measurements Laboratory  
120 Greenwich Street  
New York 6, New York

Toke Deutschmann Corporation  
Canton, Massachusetts

Electronic Corporation of America  
353 West 48th Street  
New York 19, New York

Electra-Voice, Inc.  
Buchanan, Michigan

Emerson Radio & Phonograph Corporation  
123 Duane Street  
New York 7, New York

Essex Wire Corporation  
1601 Wall Street  
Ft. Wayne 6, Indiana

General Electric Company  
Building 267-1 River Road  
Schenectady 5, New York

Hammarlund Mfg. Company, Inc.  
460 West 34th Street  
New York 1, New York

Hoffman Radio Corporation  
3741 South Hill Street  
Los Angeles 7, California

Hytren Radio & Electronics Corporation  
76 Lafayette Street  
Salem, Massachusetts

E. F. Johnson Company  
206 Second Avenue S. W.  
Waseca, Minnesota

Newark Electric Co., Inc.  
242 West 55th Street  
New York 19, N. Y.

Majestic Radio & Television Corporation  
125 West Ohio Street  
Chicago 10, Illinois

Raytheon Manufacturing Company  
60 East 42nd Street  
New York 17, New York

Smith-Meeker Engineering Company  
125 Barclay Street  
New York 7, New York

Sylvania Electric Products, Inc.  
Emporium, Pennsylvania

Technical Apparatus Company  
165 Washington Street  
Boston 8, Massachusetts

Tung-Sol Lamp Works, Inc.  
95 Eighth Avenue  
Newark 4, New Jersey

American Condenser Co.  
4410 Ravenswood Avenue  
Chicago 11, Illinois

# WAR ASSETS ADMINISTRATION

A UNITED STATES GOVERNMENT AGENCY  
FOR THE DISPOSAL OF SURPLUS PROPERTY

880

# THE AMERICAN RADIO RELAY LEAGUE, INC.,

is a noncommercial association of radio amateurs, bonded for the promotion of interest in amateur radio communication and experimentation, for the relaying of messages by radio, for the advancement of the radio art and of the public welfare, for the representation of the radio amateur in legislative matters, and for the maintenance of fraternalism and a high standard of conduct.

It is an incorporated association without capital stock, chartered under the laws of Connecticut. Its affairs are governed by a Board of Directors, elected every two years by the general membership. The officers are elected or appointed by the Directors. The League is noncommercial and no one commercially engaged in the manufacture, sale or rental of radio apparatus is eligible to membership on its board.

"Of, by and for the amateur," it numbers within its ranks practically every worth-while amateur in the nation and has a history of glorious achievement as the standard-bearer in amateur affairs.

Inquiries regarding membership are solicited. A bona fide interest in amateur radio is the only essential qualification; ownership of a transmitting station and knowledge of the code are not prerequisite, although full voting membership is granted only to licensed amateurs.

All general correspondence should be addressed to the Secretary at the administrative headquarters at West Hartford, Connecticut.



## Past Presidents

HIRAM PERCY MAXIM, W1AW, 1914-1936  
EUGENE C. WOODRUFF, W8CMP, 1936-1940

## Officers

**President** . . . . . GEORGE W. BAILEY, W2KH  
Washington, D. C.

**Vice-President** . . . . . J. LINCOLN McCARGAR, W6EY  
Oakland, California

**Secretary** . . . . . KENNETH B. WARNER, W1EH  
West Hartford, Connecticut

**Communications Manager** . . . . . F. E. HANDY, WIBDI  
West Hartford, Connecticut

**Treasurer** . . . . . DAVID H. HOUGHTON  
West Hartford, Connecticut

**General Counsel** . . . . . PAUL M. SEGAL  
1026 Woodward Building, Washington 5, D. C.

## Directors

### President

GEORGE W. BAILEY . . . . . W2KH  
921 19th St., N.W., Washington, D. C.

### Vice-President

J. LINCOLN McCARGAR . . . . . W6EY  
66 Hamilton Place, Oakland 12, Calif.

### Canadian General Manager

ALEX REID . . . . . VE2BE  
240 Logan Ave., St. Lambert, P. Q.  
Alternate: Leonard W. Mitchell . . . . . VE3AZ  
78 Raglan Ave., Toronto, Ont.

### Atlantic Division

EDWARD G. RASER . . . . . W2ZI  
315 Beechwood Ave., Trenton 8, N. J.  
Alternate: J. Victor Brotherson . . . . . W8BHN  
1743 Ottawa Drive, Erie, Pa.

### Central Division

CLYDE C. RICHELIEU . . . . . W9ARE  
4901 So. 30th St., Milwaukee 14, Wisc.  
Alternate: Harold H. Jansen . . . . . W9DJG  
3519 California Ave., Alton, Ill.

### Dakota Division

TOM E. DAVIS . . . . . W0SW, ex-W9VVA  
915 W. Becker Ave., Willmar, Minn.  
Alternate: Harold B. Lovv . . . . . W9ZRT  
Box 426, Mandan, N. D.

### Delta Division

GEORGE S. ACTON . . . . . W5BMM  
Plain Dealing, La.  
Alternate: Eugene H. Treadway . . . . . W5DKR  
P. O. Box 44, La Place, La.

### Great Lakes Division

HAROLD C. BIRD . . . . . W8DPE  
114 Hickory Dr., R. F. D. 2, Pontiac 2, Mich.  
Alternate: John H. Brabb . . . . . W8SPF  
1321 Berkshire Rd., Grosse Point Park 30, Mich.

### Hudson Division

JOSEPH M. JOHNSTON . . . . . W3ABI  
427 Lincoln Ave., Avon-by-the-Sea, N. J.  
Alternate: Robert A. Kirkman . . . . . W2DSY  
1910 Oak Drive, West Belmar, N. J.

### Midwest Division

C. A. COLVIN . . . . . W9VHR  
Acting Director:  
c/o Omaha & Council Bluffs St. Railway Co.,  
Omaha 2, Nebr.

### New England Division

PERCY C. NOBLE . . . . . W1BVR  
37 Broad St., Westfield, Mass.

### Northwestern Division

HAROLD W. JOHNSTON . . . . . W7DXF  
2727 Belvidere Ave., Seattle 6, Wash.  
Alternate: Rex Roberts . . . . . W7CPY  
110 W. Brennan St., Glendive, Mont.

### Pacific Division

WILLIAM A. LADLEY . . . . . W6RBQ  
200 Naylor St., San Francisco 12, Calif.  
Alternate: Elbert J. Amarantes . . . . . W6FBW  
1675 Dale Ave., San Jose, Calif.

### Roanoke Division

H. L. CAVENESS . . . . . W4DW  
2607 Vanderbilt Ave., Raleigh, N. C.  
Alternate: J. Frank Key . . . . . W3ZA  
Box 707, Buena Vista, Va.

### Rocky Mountain Division

FRANKLIN K. MATEJKA . . . . . W0DD  
P. O. Box 212, Estes Park, Colo.  
Alternate: P. Arthur Smoll . . . . . W0KVD  
529 No. Nevada Ave., Colorado Springs, Colo.

### Southeastern Division

WILLIAM C. SHELTON . . . . . W4ASR  
527 Revillo Blvd., Daytona Beach, Fla.  
Alternate: William P. Sides . . . . . W4AUP  
Fleming Road, Montgomery, Ala.

### Southwestern Division

HANS R. JEPSEN . . . . . W6KEI  
6837 Ethel Ave., No. Hollywood, Calif.  
Alternate: Arthur E. Schifferman, sr. . . . . W6RBH  
1445 Raymond Ave., Glendale 1, Calif.

### West Gulf Division

WAYLAND M. GROVES . . . . . W5NW  
c/o Humble Pipe Line Co., Odessa, Texas  
Alternate: Jack T. Moore . . . . . W5ALA  
4529 Fairway, Dallas 4, Texas

# "It Seems to Us..."

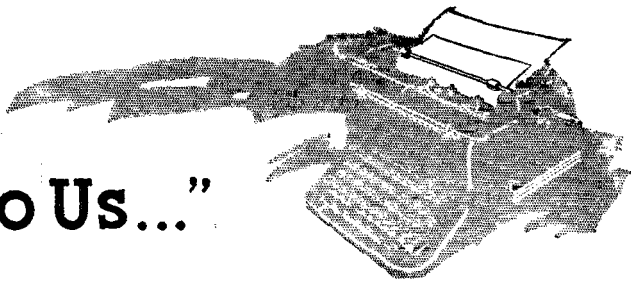

## BREATHER

The League announces to its members that, exclusively because of the imminence of a world telecommunications conference, the Board of Directors in December vacated the requests that have been on file with FCC since last May for the establishment of a 7-Mc. 'phone assignment and the widening of the 14-Mc. 'phone subband. It will now await the results of the world conference before making further requests in this matter.

When the question of widening the 'phone bands was under study a year ago, a world conference was only vaguely talked about and was in the dim future. When the Board's requests were transmitted to FCC in May it was expected that they could be put on the books some time during the past summer — to become operative when the rest of our frequencies were restored, as did occur in early November. But meanwhile a new federal law called the Administrative Procedure Act went into effect, requiring a much more formal procedure in general changes in rules by any of the Government regulatory agencies. So great are the necessary delays under the new procedure when unanimity doesn't exist that it became evident that it would be next spring before new rules could be put into effect. And similarly in the meanwhile the plans for a world conference — for three of them, in fact — progressed rapidly and it was announced that the conference will begin its work on May 15th, probably at a location in the United States not yet selected. Two of these conferences will respectively revise the Cairo regulations (including a general review of the frequency allocations of all radio services for the next several years) and the Madrid convention, and will be followed by a world h.f. broadcasting conference. It was obvious to our Board, as it must be to every amateur, that it would be exceedingly unwise to seek major changes in our interior assignments on the eve of a world conference dealing with the over-all allocations of every service, including amateurs. Despite the confidence that we may feel about the successful outcome of the affair for amateurs, a conference is never over until it

ends and it would not be the part of wisdom to make such changes while possible rearrangements of the spectrum were under study. Considering the lateness of the hour and the inescapable delays that had occurred, the over-all interests of amateur radio made it necessary, in the Board's opinion, to withdraw the requests and put the subject on ice until the conference results are known.

Naturally this decision will be a disappointment to some amateurs. The Board appreciates that. It trusts that all amateurs will see that the action was a wise one, and it calls upon all hands to QRX now on the question of what the 'phone frequencies should be and let it go over until the service allocations for the next several years are announced. At an appropriate time thereafter we can again take it up and see whether the League has any recommendations to lay before FCC. (We're thinking in terms of frequencies below 25 Mc. As there was Moscow agreement on our 10-meter band, and no pressure on it anywhere that we know of, we think we may continue our present study of plans for making a more effective use of that band, as recently laid before you in *QST*.)

In the meanwhile we shall need all our energies to preserve our frequencies. We are confronted by a critical period in our lives and we shall very much need to preserve a united front. The coming world conference will be a most severe test. It will be a full-panoplied meeting, of the sort held in various foreign countries at intervals of about five years before the war. There will be hundreds of delegates, representing somewhere around eighty countries and colonies, and the sessions will last many months. A general revision of the telecommunications convention and its regulations is in prospect, this of course including the allocation table.

It is now apparent that at that conference there is going to be great pressure to increase the allocations for h.f. broadcasting. A few months ago we expressed the hope that, with the war ended, the world could settle down to a saner point of view on international broadcasting but, as you can see from last month's report on the preliminary conference at Moscow, quite the contrary seems to be the case.

In America we are accustomed to a very extensive use of radio by innumerable civilian and Government activities. For this long list of services the allocation table is complexly subdivided, and it is always difficult to find room for anything new. It is not this way in many foreign countries. There are only two larger countries have extensive organizations in the fixed service. To many countries radio chiefly means broadcasting and they don't see why they can't have more of it, so they are all out for it. And to get it they would gladly throw amateur radio to the wolves.

This isn't anything new. It was visible at Madrid and much more so at Cairo. We were preserved through those conferences, as an American institution worth preserving, by the unflinching protection of the United States delegations. The increase in radio problems will make that task much more difficult at the coming conference, even without an ugly new complication that has recently raised its head: As a result of the war, the h.f. propaganda broadcasting stations of the United States are now operated by a branch of our Government, and that agency has suddenly come to the point of view of so many foreign countries, that the allocations for h.f. broadcasting should be materially widened. It even thinks that parts of our amateur bands would make very nice broadcasting assignments. For a nation whose interests occupy the spectrum as thoroughly as our country's do, this poses an exceedingly difficult national problem, since spectrum limitations make it impossible to provide both for great broadcasting expansion and for the undamaged preservation of the country's other interests. At high policy-making levels in our Government the question of this country's attitude on this question is now being decided. We hope for a sensible answer, since only the maintenance of a sensible attitude by the United States will prevent the world from going overboard for broadcasting at the next conference, to the considerable injury of the other services that mean so much in the life of a modern state.

We mention these things to show that we do have a difficult and uncertain time ahead — one in which we must be sure we are all pulling in the same direction. As far as the problems themselves are concerned, ARRL is on the job daily. We report them so that you will see how essential it is to our welfare that we now all agree to put such things as the question of 'phone subbands on the shelf until we know for sure what our allocations are for the next several years.

## YOU & WHO ELSE?

The other evening a friend telephoned from another state to invite himself for a short stay during the holidays. This particular guy is always welcome, being a savvy gent with a couple of years of M.I.T. engineering and several more years of practical stuff under his hat, and his visits always result in the generation of some new ideas and a few empty jugs of Highland Dew. The conversation was going along smoothly until he started talking about how "We'll come by train" and "We'll be there" at such-and-such a time, and "Yes, we had a nice Christmas," and so on. Since his marriage had not been announced, and the guest room can handle only one person in its present condition, these statements came as a bit of a poser, until it was established that he had just finished several weeks on 10 and 20 'phone and meant "I" all the time! Holy saints! why didn't he say what he meant? Prior to this experience, brief encounters with other 'phone men had established their tendency to eliminate the first-person-singular pronoun in favor of the first-person-plural but this was always attributed to Lindbergh-worship and plain lack of education. But here definitely was a man who should know better, coming up with an utterly incorrect speech style under the delusion that he was using "ham language" or "QST English," a habit that seems to be so prevalent that it's about time to consider its justification.

Let's take a look at the language, for those people who came in late. When you read the pages of QST or any other magazine or paper and the author, speaking in the first person, says we-this or we-that, he is using what is known as the "editorial we," in preference to the more personal pronoun "I." The writer uses it to reflect the editorial thoughts or policies of his organization, as expressed and sometimes formulated by him. But when he knocks off at the end of the day and walks into a barbershop alone, he doesn't say to Joe, "We would like a haircut and shave," because Joe would look around for the others. And the same writer doesn't say, "We are going to the store to buy us some new pants" — he would say "trousers," anyway — unless he is dragging along one of the small fry who is also in need of new leg covering. In other words, when one completely eliminates the use of "I" for the editorial-we first-person-plural ambiguity one is asking for nothing but misunderstanding, since to any outsider it sounds like something coming from a spokesman for a group.

(Continued on page 126)



# Operating the BC-645 on 420 Mc.

## A War Orphan Comes into Its Own

BY JOHN T. RALPH,\* AND H. M. WOOD,\* W3JYA

ONE of the most interesting pieces of equipment recently declared surplus by the Armed Services is the BC-645, a specialized piece of i.f.f. equipment which, in its original form, served as an airborne transponder when interrogated by the ground radar station, and also acted as an interrogator-transponder for plane-to-plane identification. The equipment was operated in the frequency band 450-500 Mc., and consists of a complete transmitter and modulator system and a receiver which actuates a series of relays to control the transmitter, its frequency and type of emission being in accordance with the type of signal received. Power supply for both receiver and transmitter was obtained from a dynamotor, PE-101, operating from either 12 or 24 volts of airplane battery.

The schematic diagram of this equipment in its original form is shown in Fig. 1. We were unable to obtain instruction manuals or other technical information on the BC-645 equipment and, therefore, a considerable amount of time was spent in tracing the schematic diagram through a maze of cabling and terminal boards used in mounting resistors and capacitors. No information was available regarding the control and indicator accessories and connections to them from

\* Tower Lakes, Barrington, Illinois.

• Not so long ago, the BC-645, described in this article, was in the supersecret class. Now thousands of them are available, at moderate cost, on the surplus market. Originally intended for airborne i.f.f. service, they are readily converted for use in the 420-Mc. amateur band. The conversion process, essentially painless, should provide the means for getting some real activity going in this most interesting u.h.f. band.

the various plugs and connectors on the BC-645, but, since conversion was our main interest, this lack presented no difficulty. Values of by-pass condensers are not shown in some instances because they are not critical and, in most cases, changes are not necessary in converting the equipment for ham use.

### How It Worked

Up to the second detector the receiver is a conventional superheterodyne utilizing tuned lines for the antenna and oscillator circuits. Variable capacitors across the open ends of the lines provide adjustment about the operating frequency. The intermediate frequency is 40 Mc.

Top view of the BC-645 before conversion. Components mentioned in the text are indicated with designations which correspond to those used on the schematic diagram. Note that the 955 mixer tube, VT-1, is mounted bottom up.

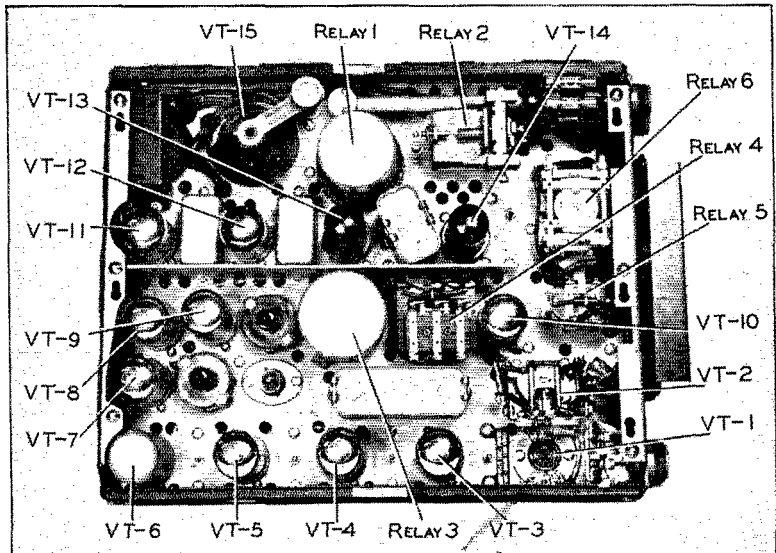
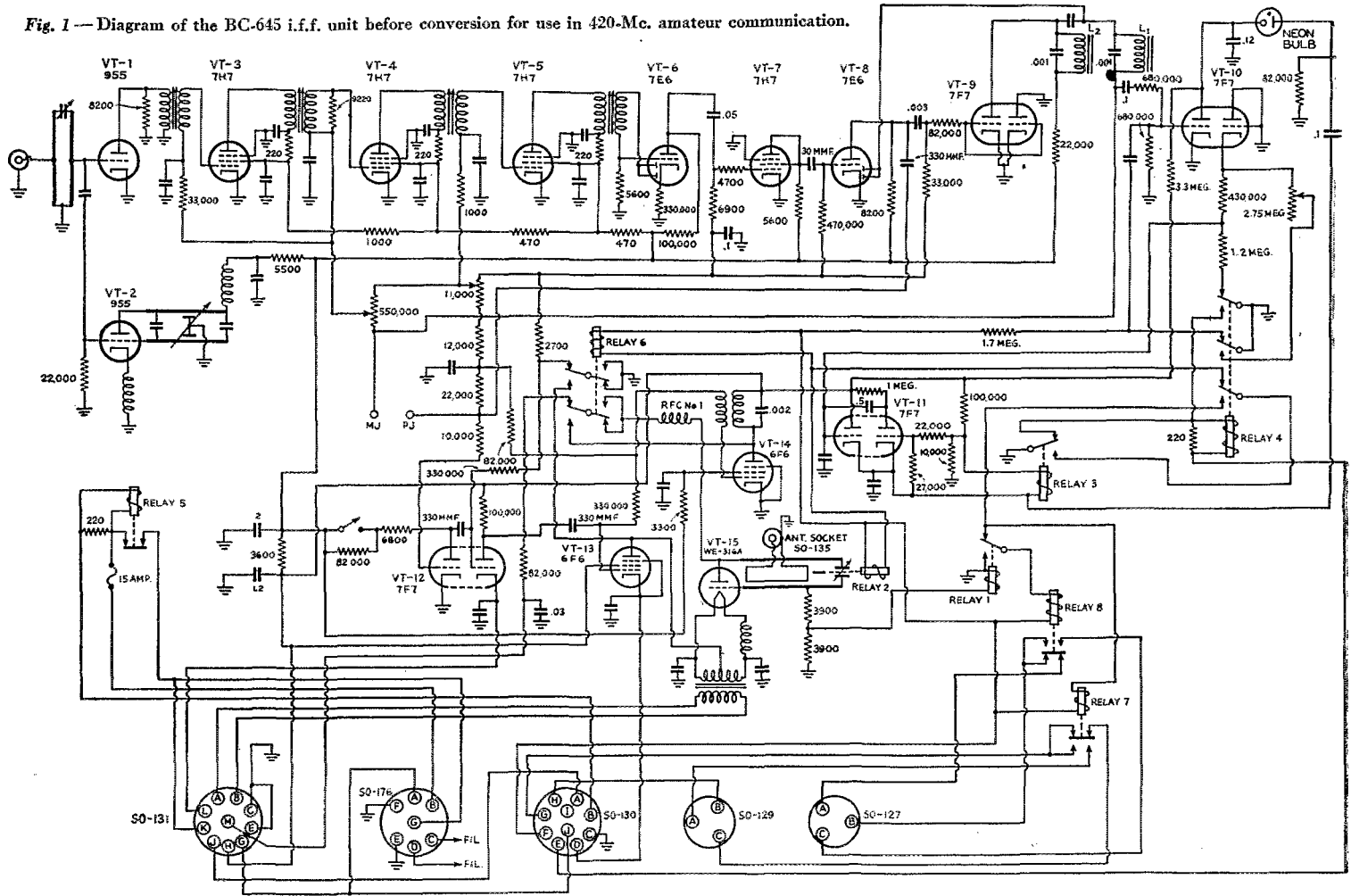

Fig. 1 — Diagram of the BC-645 i.f.f. unit before conversion for use in 420-Mc. amateur communication.



and the three stages of i.f. amplification are coupled by slug-tuned transformers with bifilar windings. The rectified signal from the diode detector is amplified by three video stages, *VT-6*, *VT-7* and *VT-8*. The signal is divided in the plate circuit of this last stage, one branch going to pulse-amplifier circuits ahead of the 6F6 pulse-keying tube, *VT-13*. The other branch feeds the grid of *VT-9* whose plate load consists of a tuned circuit resonant to 30 kc. If the received signal is modulated at 30 kc. this modulation is then fed to the diode portion of *VT-8*, the rectified d.c. filtered by  $L_1$  and its associated capacitor and the negative d.c. envelope pulses coupled to the grid of *VT-10*. The plate voltage of *VT-10* rises, firing the neon tube momentarily and producing a pulse in the cathode circuit of the "one-shot" multivibrator, *VT-11*, which builds up sufficient plate current to close Relay 3. The time constants of the circuit are so chosen as to keep Relay 3 closed for approximately one second. The action caused by operation of Relay 3 depends upon the position of Relay 4 which is energized from an outside control. In the de-energized position of Relay 4, Relay 3 energizes Relays 2 and 6. Relay 2 changes the frequency of the transmitter to the lower of two chosen frequencies (receiver frequency), and Relay 6 connects the 30-kc. oscillator-modulator in the 316A plate circuit so as to modulate the r.f. oscillator and grounds the filament center-tap of the 316A oscillator tube. In the energized position of Relay 4, Relay 3 controls the coil circuits of Relays 7 and 8 thus actuating external indicators through sockets *SO-127* and *SO-129*.

If the received signal consists of standard i.f.f. pulses transmitted by a ground station operating in conjunction with a radar set, the pulse which has been amplified by three video stages is coupled to the grid of the first section of the 7F7, *VT-12*. This pulse is further amplified by the second section of *VT-12* and applied to the grid of the keying tube, *VT-13*, a 6F6 in the cathode circuit of the 316A oscillator tube, thus repeating the received pulses in accordance with a prearranged code determined by coding cams on the dynamotor shaft. These coded pulses are received at the ground i.f.f. station and interpreted to identify the plane carrying the equipment as friendly, and incidentally to indicate the range of the plane for comparison against radar readings.

The transmitter consists of four tubes and associated circuits. The 316A (*VT-15*), is a self-excited power oscillator using tuned lines as the frequency-determining elements. Relay 2 moves a square of Micalex dielectric between two plates on the end of the line rods giving a choice of two operating frequencies. Two adjustable mechanical stops on the relay provide frequency adjustment. Two types of modulation are provided, the type depending upon the position of Relay 6. One type

is pulse modulation as described in the preceding paragraph, while the other is provided by *VT-14* operating as a 30-kc. oscillator and modulator. The antenna is coupled to the tuned lines by a pick-up loop whose coupling to the lines is adjustable. It connects to the antenna socket on the front panel through a short length of coaxial line.

#### Conversion for 420 Mc.

In converting the BC-645 for operation as communications equipment the basic thought in mind was to make the conversion with a minimum of changes in components and wiring from the original set. Improvements and refinements can be made in layout and circuit components for maximum performance in this new application at the expense of complicating the conversion.

Before proceeding with circuit rewiring, particularly in the receiver audio section and the transmitter-modulator section, it was felt advisable to remove excess components and relays. All relays except Relay 3, all potentiometers, the small two-position switch accessible from the front of the case and shown just to the left of *VT-12* in the schematic, the 30-kc. oscillator coil and the fuse strip in front of the frequency-change relay were removed. This provided less congestion in which to work and left a neater chassis when the job was completed.

Conversion of the receiver required that the gain-control system be revamped and an audio system added which would be suitable for operation of a speaker or headset. In addition, it was necessary to make changes to enable one to tune to the 420-450-Mc. amateur band. The diode detector circuit was altered to provide a source of a.v.c. voltage and to decrease loading on the last i.f. transformer. Grid-return leads of the i.f.

Top view of the BC-645 after conversion for use in 420-Mc. communication. Five relays and other miscellaneous parts have been removed. Note lengthened line in the receiver oscillator circuit, lower right.

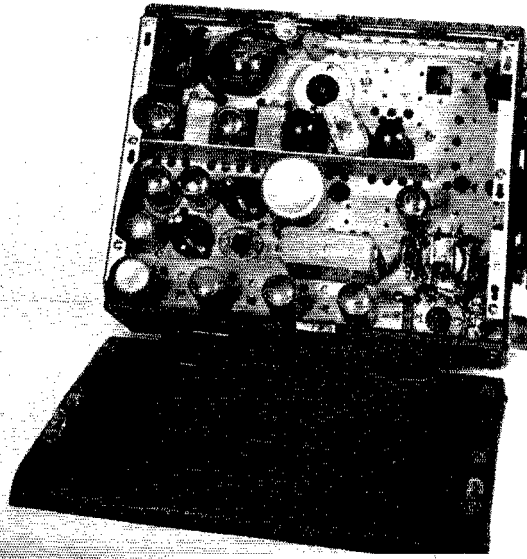

amplifiers were lifted from ground and returned to the a.v.c. line. Since it appeared that this equipment would find its greatest usefulness in 'phone work, no provision was made for an r.f. gain control or operation without a.v.c. The schematic diagram of the converted receiver, Fig. 2, shows the addition of cathode biasing resistors to provide initial bias for the i.f. amplifier tubes; however, operation was satisfactory without this initial bias. Although some improvement

in residual noise is gained by biasing these tubes, the omission simplifies the conversion.

The range of the tuning condenser across the end of the antenna tuning stub was sufficient to cover the lower range to 420 Mc. and no changes were necessary here, but an increase in the length of the local oscillator lines was required. The 955 oscillator socket and tuning assembly were removed as a unit by taking out the four screws holding the assembly to the chassis and unsoldering the six leads going into the set proper. The line-shortening condenser, grid leak and plate choke were removed from the end of the line, the ends of the rods were drilled and  $\frac{1}{2}$ -inch extensions were soldered in place, after which the components were replaced in the same relative position as in the original set.

The audio section following the detector may be as extensive as desired, with a selection of tubes for the purpose from which to choose (VT-7, VT-8, VT-9, VT-10, VT-12 and VT-13). In the sets converted by the authors, one-half of VT-9 and VT-13 were used and gave ample gain and power output. An output transformer was added for 'speaker operation, and is recommended for headset operation although satisfactory headset volume may be obtained by resistance-capacity coupling to the first a.f. or output plate circuits.

Shifting the transmitter frequency down to the 420-450-Mc. amateur band involved removing frequency-shifting Relay 2 and adding a capacitor of the circular neutralizing type across the ends of the oscillator line. The condenser was made by soldering No. 8 flat-head screws to two  $\frac{1}{8}$ -inch diameter copper disks. The extensions of the oscillator line consist of two metal strips approximately one inch long and  $\frac{3}{8}$  inch wide soldered to the capacitor ends of the original line so that the strips extend  $\frac{1}{8}$  inch beyond the ends of the line rods. At  $\frac{3}{16}$  inch from the end of these strips a tapped hole was provided for the screws of the capacitor plates. The ends of the screws

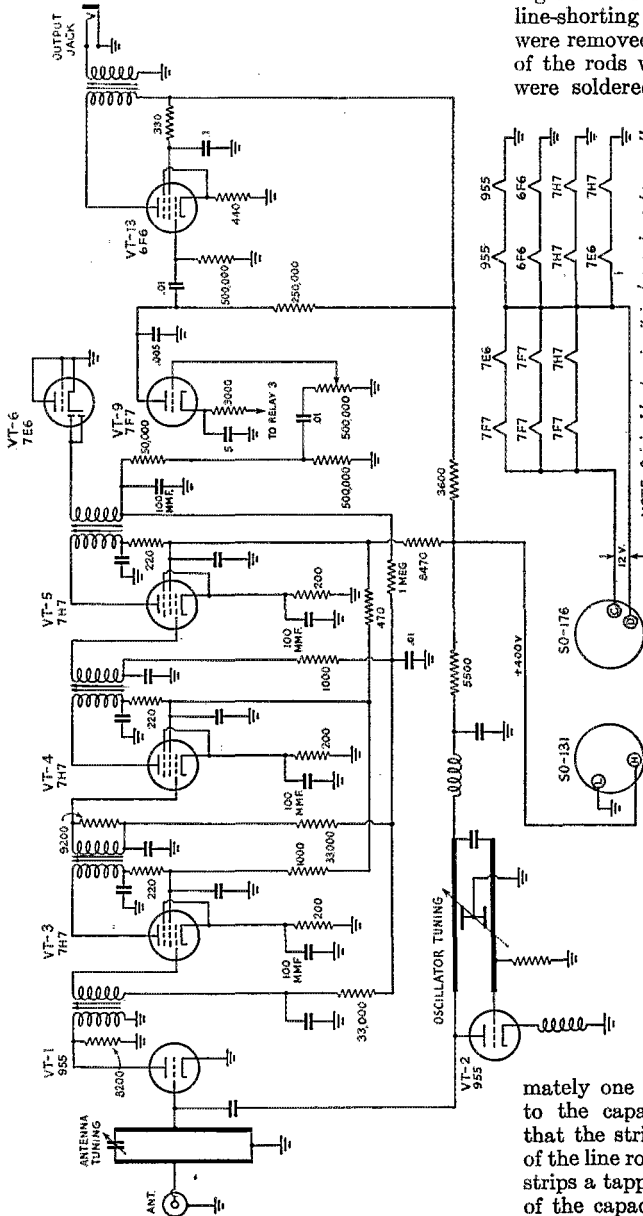
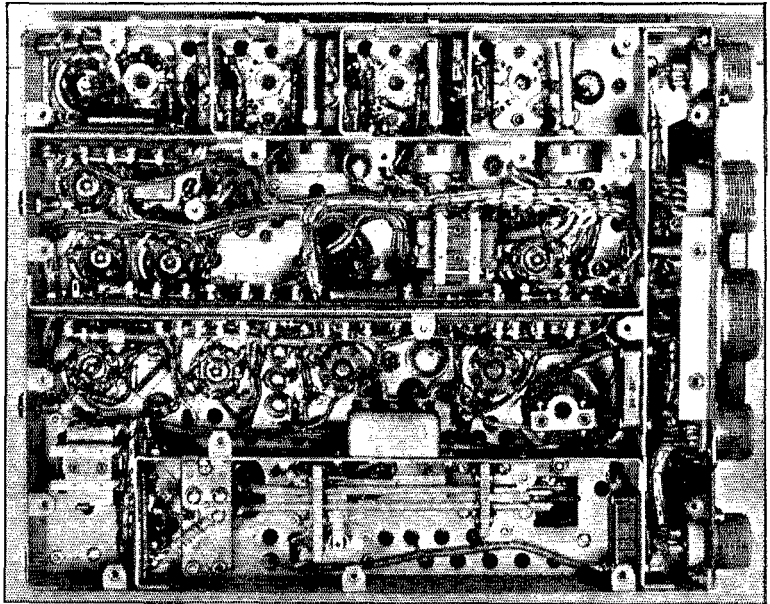

Fig. 2—Schematic of the receiver as converted for 420 Mc. Two stages of audio, employing tubes already in the unit, have been added. The oscillator lines are lengthened (see photo) and a.v.c. is incorporated.

approximately one inch long and  $\frac{3}{8}$  inch wide soldered to the capacitor ends of the original line so that the strips extend  $\frac{1}{8}$  inch beyond the ends of the line rods. At  $\frac{3}{16}$  inch from the end of these strips a tapped hole was provided for the screws of the capacitor plates. The ends of the screws

Bottom view of the BC-645 in its original condition. Many of the parts are not used and may be removed to simplify the conversion operation.



were slotted and screwdriver clearance holes drilled in the side of the case for access to the slotted ends of the screws. Circuit details of the transmitter section are shown in Fig. 3.

The modulator system is of the Heising constant-current type using a single 6F6 as the modulator tube. Since power obtained from the 6F6 is not sufficient to completely modulate the carrier oscillator, this is one of the most inviting sections for the aforementioned improvements and refinements. However, results obtained in tests were quite satisfactory using this set-up. The speech amplifier ahead of the modulator was arranged to handle a crystal or dynamic microphone, but a carbon microphone may be used by adding a microphone transformer and a source of d.c. for microphone current. The Army T-17 microphone has been used by the authors and proved entirely satisfactory. A push-to-talk switch on the microphone is used to place the transmitter in operation and render the receiver inoperative when transmitting by opening the cathode circuit of the first a.f. stage.

For mobile operation, a dynamotor supply capable of delivering 400 volts d.c. at 150 ma. and 9 volts a.c. at 1.2 amp. is required. In the conversion made and tested by the authors the dynamotor used with the original equipment was employed. Since this dynamotor required 12 volts d.c. input, no changes were made in the filament

wiring, and in the design of an a.c. power supply 12 volts a.c. was provided for the filament string in the set. The schematic of the a.c. power supply is shown in Fig. 4. Rearrangement of the filament wiring for 6-volt operation will present no problem.

The aircraft antennas intended for use with the BC-645 consisted of vertical quarter-wave faired rods working against the frame of the aircraft; however, any antenna which can be matched to the set at or near 50 ohms should prove satisfactory. Both dipoles and ground-plane antennas

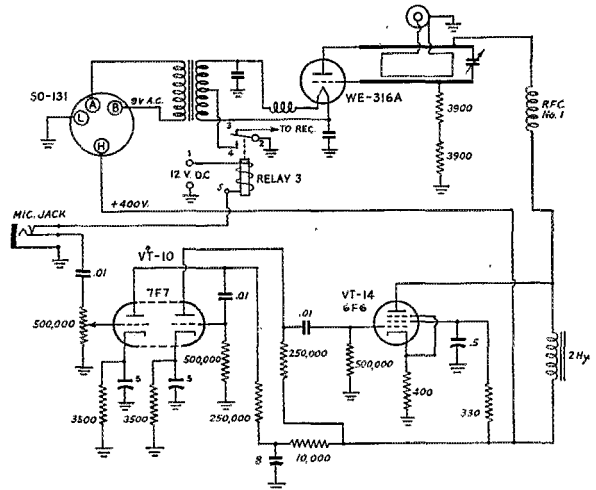

Fig. 3 — Wiring diagram of the oscillator, modulator and speech amplifier used in the converted BC-645. Like other portions of the conversion job these changes involve the use of tubes already in the unit.

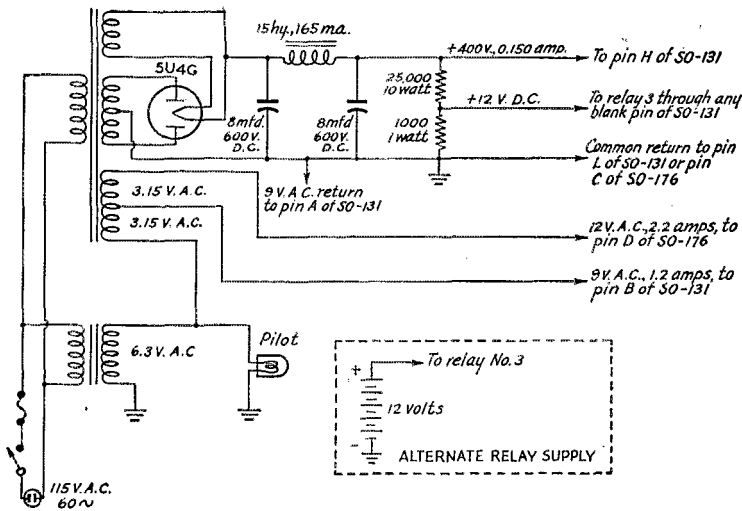

Fig. 4 — Diagram of the power supply used for a.c. operation of the BC-645. Two 6.3-volt windings are used in series to obtain the 12 volts required for the filament circuits. The transmitter oscillator filament transformer is supplied from one 6.3-volt winding and half of another, connected in series. Voltage for operation of Relay 3 is taken from a bleeder tap.

were tried in field tests with good results. More consistent results in mobile use were obtained with the ground-plane antenna, because of less-directional characteristics. For fixed stations any of several directional arrays may be chosen for higher gain in the desired direction. The reader is referred to either *The Radio Amateur's Handbook* or the *ARRL Antenna Book* for constructional details of directional arrays designed for low-angle radiation. At this frequency the propagation effects of directional antennas become an inter-

esting study, with rhombics, in particular, taking on a very practical and easily-rotated size.

#### On-the-Air Tests

Two models of the BC-645 were converted as outlined and in accordance with the circuit diagrams shown. Also, an a.c. power pack for 115-volt operation was built and the dynamotor, *PE-101*, modified for operation with the converted equipment. The dynamotor modification consisted only of rearranging connections and re-

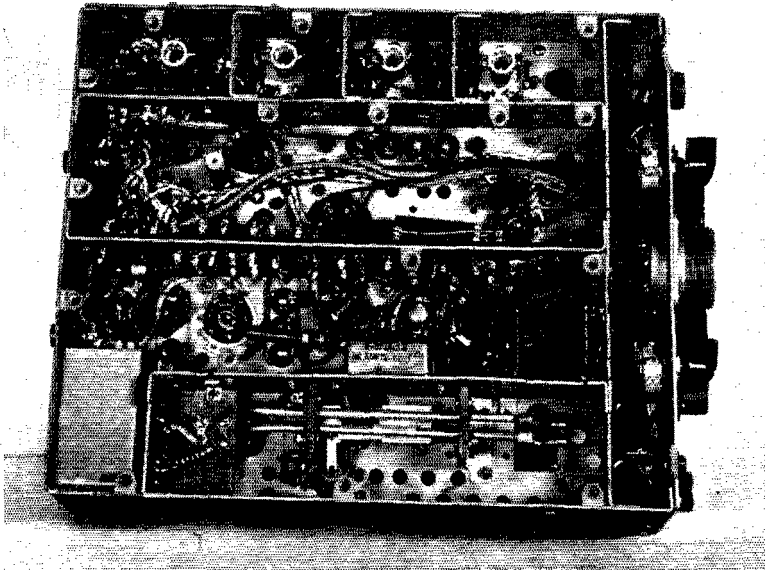

Bottom view of the converted unit. Relays, potentiometers, and other unused parts are removed. The transmitter oscillator line (bottom of photo) has been lengthened and a means of frequency adjustment added. The shielded compartments across the top of the unit are the slug-tuned i.f. stages in the receiver.

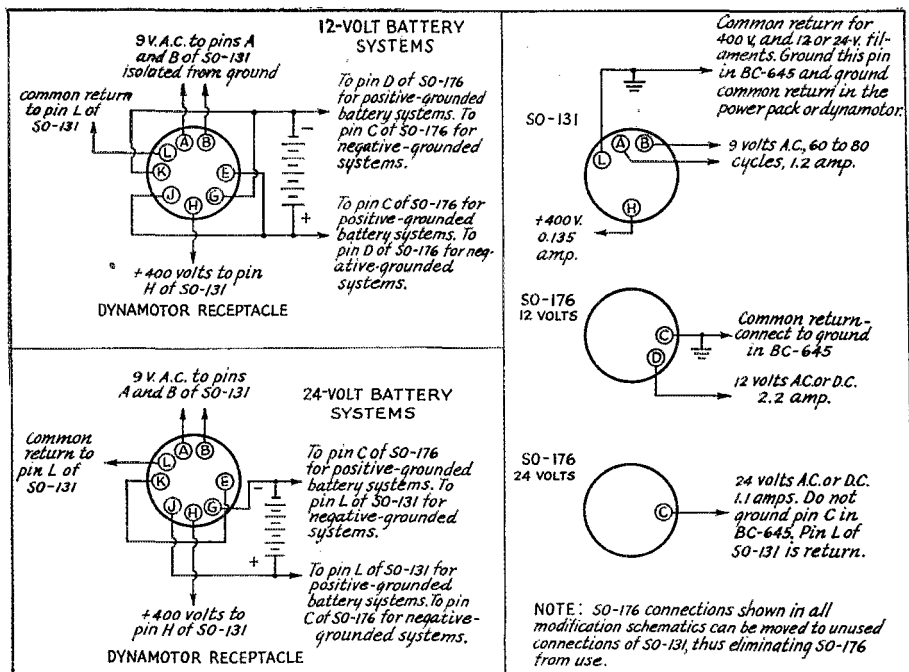

Fig. 5 — Power connections for the converted BC-645. At the left are the connections used for 12- and 24-volt battery operation. At the right are the connections used in a.c. operation.

moving the coding keyer on the end. In order to make field tests, the aid of W9WJM of Cicero, Ill. and W9BZK of Chicago was enlisted. Tests were conducted of point-to-point fixed-station operation and fixed-to-mobile operation. With one antenna mounted on the chimney of a two-story home at a height of approximately 39 feet and the mobile antenna mounted on the roof of an automobile, good reliable contact was maintained for a radius of two miles in residential and gently-rolling or lightly-wooded areas. In clear or essentially line-of-sight areas communication was good at slightly over 5 miles. Tests were not made to determine the maximum line-of-sight range, but with one antenna at a height of 30 feet and the other at 50 feet, signal strengths and quality were exceptionally good at 8 miles. At these elevations a line-of-sight range of 15 miles is possible and the signal strength at 8 miles indicated that contact at 15 miles or farther could be maintained very successfully.

In city industrial districts and among tall buildings difficulty with reflections and shadows, at times sufficiently serious to render speech unintelligible, was experienced in mobile operation. The phenomena are much like that of fast fading and in some cases it was necessary to stop the car in order to understand and be understood. In case signals were lost on stopping, a slight movement of the car would bring in the signal again to full strength.

Ideas for refinements are in mind and will be the subject of further experimentation. Among contemplated refinements are the use of push-pull 6F6s as modulators, the addition of an audio oscillator to be switched to the modulator circuit for m.c.w. or to the last i.f. tube of the receiver for modulating c.w. signals, and single-dial receiver tuning.

### Silent Keys

IT IS with deep regret that we record the passing of these amateurs:

- W4DIB, Robert M. Slack, Black Mountain, N. C.
- W6BIQ, T/4 Howard J. Meredith, USA, Sacramento, Calif.
- W6UVV, ex-W9WZB, William W. Lanham, sr., Long Beach, Calif.
- W8YGB, Ernest W. Moreau, Detroit, Mich.
- W9HRM, Erwin W. Kreis, Milwaukee, Wis.
- W0YOQ, C. E. Black, Perry, Iowa
- G5QF, Seymour A. Buckingham, London, England
- HH2MC, Emile Cadet, Port-au-Prince, Haiti
- VE7ER, Earl R. Streeter, Vancouver, B. C.

# Transmitting Ratings on Receiving Tubes

## Newly-Released Data on the More Popular Types

THESE is hardly an amateur transmitter in existence that does not have one or more receiving-type tubes somewhere in the r.f. line-up, tubes that were built and carry ratings only for audio service. Fortunately, they're cheap, so we haven't paid too much for the knowledge of what they'll stand in individual cases. But a manufacturer always has lots more tubes and facilities for finding out their limitations than we amateurs have, so it's nice to have the accompanying set of ratings on some of the more popular types. Furnished by RCA, it should be understood to apply primarily to tubes of RCA manufacture, but despite the manufacturing differences between tubes of different brands it is probable that these ratings will apply pretty closely to others as well.

In using the data, please note that these are *maximum ratings*, not operating conditions. You can use any operating conditions you please so long as no one of the maximum ratings is exceeded. Also note that the ratings appear conservative in the light of what some hams do to tubes, but the point is that the tubes will stand up under these ratings -- and it won't be neces-

sary to go through a half-dozen of them before finding one that will. Also (commercial please note), these are ratings specified *for amateur use only*.

The tubes listed in the table are ones frequently used as multipliers in exciters. It must be remembered that in frequency-multiplier service the plate efficiency is considerably lower than in straight-through amplification, and appropriate allowance for this reduction in efficiency must be made in determining permissible operating conditions. As a first approximation, assume an efficiency of 70 per cent for straight-through amplification, 50 per cent for doubling, and 33 per cent for tripling.

The maximum frequency limit should be observed in each case. RCA says that the octal-based types are usable in the six-meter band and the miniatures will work at 144 Mc., but for frequencies higher than those listed in the table all ratings should be reduced by 20 per cent. The ratings are based on nonmodulated service, and if the tubes are to be 100-per-cent amplitude-modulated a 20-per-cent reduction of all ratings is likewise in order.

Amateur Transmitting Ratings for Receiving Tubes

Type	6AG7	6AK6	6AQ5	6C4	6F6	6L6	6N7	6V6GT	12AU7
Max. plate-supply volts . . . . .	375	375	350	350	400	400	350	350	350
Max. screen-grid volts . . . . .	250	250	250	—	275	300	—	250	—
Max. control-grid volts . . . . .	-75	-100	-100	-100	-100	-125	-100	-100	-100
Max. plate milliamperes . . . . .	30	15	47	25	50	100	30	47	12
Max. screen-grid milliamperes . . . . .	9	4	7	—	11	12	(per plate)	7	(per plate)
Max. control-grid milliamperes <sup>1</sup> . . . . .	5.0	3.0	5.0	8.0	5.0	5.0	5.0	5.0	3.5
Max. plate dissipation, watts . . . . .	9.0	3.5	8.0	5.0	12.5	21	5.5	8.0	2.75
Max. screen-grid dissipation, watts . . . . .	1.5	1.0	2.0	—	3.0	3.5	(per grid)	2.0	(per grid)
Power output, watts <sup>2</sup> . . . . .	7.5	4.0	11.0	5.5	14	28	14.5	11.0	6.0
Maximum frequency, Mc. <sup>3</sup> . . . . .	10	54	54	54	10	10	10	10	54
Approx. amp. factor for grid-bias calculations <sup>4</sup> . . . . .	22	9.5	10	18	7	8	35	9	18
Capacitances ( $\mu$ fd.):									
Grid-plate (max.) . . . . .	0.06	0.12	0.35	1.6	0.2	0.4	—	0.7	1.5
Input . . . . .	13	3.6	7.6	1.8	6.5	10	—	9.5	1.6
Output . . . . .	7.5	4.2	6.0	1.3	13	12	—	7.5	0.5

<sup>1</sup> Maximum value of grid resistor, 0.1 megohm.

<sup>2</sup> Power output based on plate-circuit efficiency of 70%.

<sup>3</sup> Maximum frequency for full power input and output.

<sup>4</sup> For pentodes this is the screen-grid amplification factor.



# A Stabilized 813 Amplifier

*Single-Adjustment Neutralization Applied to a Beam-Power Tube*

BY RICHARD M. SMITH,\* W1FTX

How many times have you built an amplifier using a beam tetrode only to find that in spite of everything "the book" said about its stability, and in spite of all the pains you took to do a careful job, the thing just couldn't be tamed? Quite a few times, we'll bet, and if you have finally achieved the desired stability, you are a very fortunate guy. There are plenty of beam tetrodes in use today, and many of them put out very respectable signals, but there are altogether too many of them around which put out those clean signals only under certain rather precarious conditions of adjustment. If the grid circuit isn't tuned "just so," or if the drive falls below a certain point, the tube takes off by itself. In other words, most amplifiers of this sort are stable under one set of conditions, but are as unstable as an 1898 dime standing on edge under a lot of other conditions. This was brought home quite forcibly during the recent Sweepstakes contest, when a lot of sloppy signals showed up from stations that normally put clean signals on the air. Hasty adjustments made necessary by the "quick-QSY" method of operation used in contests undoubtedly caused much of the spurious racket which was heard.

While it is true that not all of the sloppy signals heard were caused by beam tetrodes, they undoubtedly contributed more than a fair share. The reasons for this are obvious if you've read "No Neutralization Required," which appeared in *QST* for June, 1946. It is a problem that has been with us ever since the first tetrode appeared on the scene, and one that will always be with us, from the look of things.

The solution to the problem seems to lie in either of two directions. One school of thought advocates the complete abolition of all beam tetrodes! The other solution is to *neutralize the beam tube*. Maybe a few eyebrows will be raised

• The real test of the stability of an amplifier is to remove both excitation and load while the amplifier is running at full plate voltage. If your beam-tube final can't pass this test without oscillating, here's the way to tame it.

at this suggestion, because after all, you just don't do that sort of thing in polite ham society. Why not? In our estimation it all boils down to the fact that we like to take pride in saying "Yep, the rig here uses a - - - beam tetrode in the final, and it *doesn't* need neutralization." Maybe it doesn't, but dollars to doughnuts you can make it oscillate merrily if you take the load off, or if you just happen to get things tuned up a certain way. If your amplifier will oscillate under such conditions, brother, beware! It needs neutralization, and you are looking for a QSL from Grand Island if you don't fix it pronto!

The amplifier described here uses an 813. It oscillated. We neutralized it . . . and now it works like a charm. It just can't be made to oscillate under any conditions of misadjustment. In addition, readjustment of the neutralizing condenser is not required when changing bands. Thus, the principal objection to having the thing neutralized is overcome. If you'd feel bashful about "confessing" that it was neutralized, forget about it. More pride should be taken in the fact that you recognize the dangers involved in *not* having it neutralized, and in the assurance that you will *always* have a clean signal, instead of just "usually." All of the usual precautions were taken in the design and construction of this amplifier, yet when we tested it in the lab, we found that it could be made to oscillate without any difficulty at all. Yes, it would have been possible to use the thing under some conditions of adjustment without neutralizing the 813, but

\* Technical Assistant, *QST*.

Front-panel view of the stabilized 813 amplifier. In addition to the meter and the plate and grid tuning controls, the panel contains the r.f. input jack, the key jack, a three-position meter switch, and a four-position bandswitch for the grid circuit.

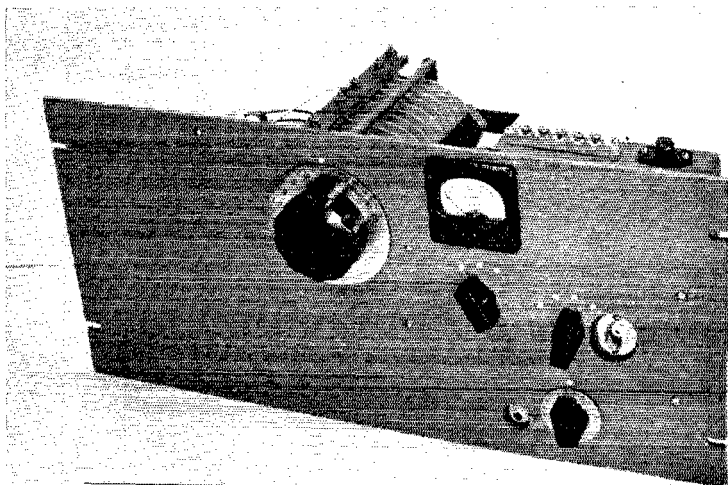

February 1947

the risks involved were too great, and when we discovered how easily the tube can be stabilized, and how beautifully it then handles in operation, we decided that the few minutes involved in making a homemade neutralizing condenser were definitely worth while. The original layout was such that it was simple to add a neutralizing circuit. A balanced tank circuit was used, because it is impossible to buy plug-in coils with anything but center-mounted swinging links. It was therefore only necessary to take a little r.f. from the "out-of-phase" end of the plate tank coil and feed it to the grid. The details are explained in a later paragraph.

As shown in the photographs, the unit is very

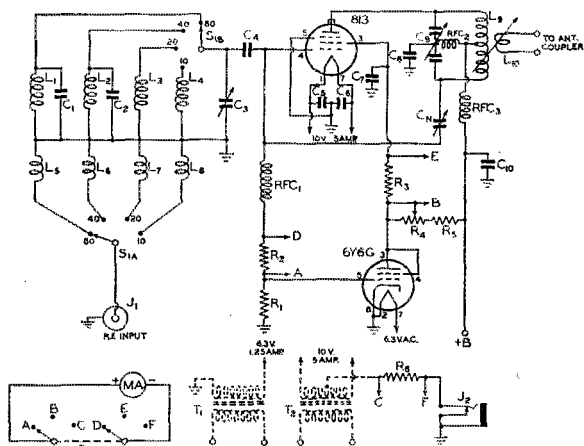

Fig. 1 — Schematic diagram of the 813 amplifier.

- C<sub>1</sub> — 100- $\mu$ fd. mica.
- C<sub>2</sub> — 68- $\mu$ fd. mica.
- C<sub>3</sub> — 50- $\mu$ fd. receiving-type variable (Millen Type 19050).
- C<sub>4</sub> — 0.0022- $\mu$ fd. mica.
- C<sub>5</sub>, C<sub>6</sub> — 0.01- $\mu$ fd. paper.
- C<sub>7</sub> — 0.001- $\mu$ fd. 2500-volt mica.
- C<sub>8</sub> — 0.001- $\mu$ fd. 5000-volt mica.
- C<sub>9</sub> — 50- $\mu$ fd. per-section dual transmitting type, 0.171-inch spacing (Cardwell XG-50-XD).
- C<sub>10</sub> — 0.001- $\mu$ fd. 5000-volt mica.
- C<sub>N</sub> — See text.
- R<sub>1</sub> — 10,000 ohms, 5 watts. (See text.)
- R<sub>2</sub>, R<sub>3</sub> — 100 ohms,  $\frac{1}{2}$  watt.
- R<sub>4</sub> — 35,000 ohms, 50 watts, with slider.
- R<sub>5</sub> — 15,000 ohms, 50 watts.
- R<sub>6</sub> — Meter shunt. Wound with No. 30 d.s.c. wire, length as required to multiply meter scale by ten.
- L<sub>1</sub> — 27 turns No. 22 d.s.c. spaced to occupy  $1\frac{1}{4}$  inches on a 1-inch diam. form.
- L<sub>2</sub> — 15 turns No. 18 d.c.c. spaced to occupy  $1\frac{1}{4}$  inches on a 1-inch diam. form.
- L<sub>3</sub> — 10 turns No. 18 d.c.c. spaced to occupy  $1\frac{1}{4}$  inches on a 1-inch diam. form.
- L<sub>4</sub> — 5 turns No. 18 d.c.c. spaced to occupy  $1\frac{1}{4}$  inches on a 1-inch diam. form.
- L<sub>5</sub>, L<sub>6</sub>, L<sub>7</sub>, L<sub>8</sub> — Two-turn links, No. 18 insulated stranded wire, wound over ground ends of L<sub>1</sub> through L<sub>4</sub> inclusive.

compact, requiring only a 19  $\times$  9-inch panel, and 9 inches behind the panel. On the front panel are the main tuning dial, a meter for measuring grid, screen, and cathode currents, a four-position bandswitch for selection of the proper grid coil, a coaxial input jack, the grid tuning dial, and a key jack. The neutralizing condenser is mounted behind the panel, as it needs to be adjusted only once. Mechanically, the unit is comprised of three separate assemblies requiring few interconnections, thus making construction much simpler than would be apparent at first glance. The panel assembly includes the meter, the plate tuning condenser, and a Barker & Williamson swinging-link assembly for the TVH series of plug-in coils used in the plate tank. The grid coils and their bandswitch, the grid tuning condenser, the meter switch, and the key jack make up the second assembly, constructed on the cover of a standard 6  $\times$  6  $\times$  6-inch steel utility box. The framework of the box itself supports the socket for the 813 tube, the screen dropping resistors, a socket for a 6Y6G screen-protecting tube, and terminals through which filament and d.c. voltages are supplied.

The circuit is shown in Fig. 1. A band-switched grid circuit is used to permit easy band change from 80 to 10 meters inclusive without requiring the removal of the rear shield plate. Meter switching is accomplished by the usual means of switching the meter across low-resistance shunts. Resistors of 100 ohms are used as the shunts in the grid and screen leads,

- L<sub>9</sub> — NOTE: These coils are B&W TVH series, for use with the B&W TVH swinging-link assembly. The coils are modified as described below.
  - 80 meters: B&W 160-TVH with 4 turns removed from each end. (54 turns No. 18 enameled,  $2\frac{1}{2}$  inches diameter, winding length  $4\frac{7}{8}$  inches.)
  - 40 meters: B&W 80-TVH with 8 turns removed from each end. (22 turns No. 14 enameled,  $2\frac{1}{2}$  inches diameter, winding length  $3\frac{3}{8}$  inches.)
  - 20 meters: B&W 20-TVH with 1 turn removed from each end. (12 turns No. 12 enameled,  $2\frac{1}{2}$  inches diameter, winding length  $4\frac{1}{2}$  inches.)
  - 10 meters: B&W 10-TVH with 1 turn removed from each end. (6 turns  $\frac{1}{8}$ -inch copper tubing,  $2\frac{1}{2}$  inches diameter, winding length  $5\frac{1}{4}$  inches.) (Winding lengths specified above include  $\frac{3}{8}$ -inch separation between halves of the coil for entrance of swinging link coil.)
- L<sub>10</sub> — 3-turn link assembly, part of B&W TVH swinging-link assembly.
- J<sub>1</sub> — Coaxial connector.
- J<sub>2</sub> — Closed-circuit jack.
- MA — 0-50 d.c. milliammeter.
- RFC<sub>1</sub> — 2.5 mh. (Millen Type 34104).
- RFC<sub>2</sub> — 2.5 mh. (National R-100).
- RFC<sub>3</sub> — 2.5 mh. (National R-300).
- S<sub>1</sub> — Single-gang 2-pole 5-position ceramic wafer switch. (Centralab S-2505.)
- S<sub>2</sub> — Two-gang 2-pole 5-position ceramic wafer switch. (Centralab S-2511).

and a shunt wound from No. 30 d.s.c. wire is used to multiply the range of the 0-50-ma. meter by ten for measurement of total cathode current. The plate tank circuit is arranged so that the plate-supply voltage is applied to both the rotor and stator of the tuning condenser, thus permitting the use of smaller plate spacing than would otherwise be possible. If only c.w. operation is desired, the blocking condenser,  $C_3$ , and  $RFC_2$  may be omitted. In this case, the rotor of the condenser should be grounded to the steel box.

The neutralizing condenser  $C_N$  is home-built, made of two copper disks, each 1 inch in diameter. Its construction is discussed in a later paragraph. The 6Y6G tube serves a dual purpose, protecting the tube by cutting off plate current in the event of excitation failure, and also permitting the exciter to be keyed without requiring any fixed bias. Operating bias for the 813 is developed across  $R_1$ , which at the same time applies a cut-off bias to the 6Y6G when excitation is present. When excitation is removed, however, the 6Y6G is without bias. It therefore conducts heavily, causing the voltage drop across screen resistors  $R_4$  and  $R_5$  to be large. This reduces the screen voltage to a negligible figure, which in turn cuts off plate current. If the break-in method of keying is not desired, the amplifier may be keyed in the center-tap of the filament transformer at  $J_2$ .

The value of bias resistor  $R_1$  may have to be changed if the tube is to be operated at other than maximum ratings. The value shown in Fig. 1 will be satisfactory in most cases, but if optimum performance is desired at lower input, the grid-leak value should be adjusted to provide rated bias under the particular operating conditions used, as set forth in the tube manufacturer's data sheets. The filament transformers,  $T_1$  and  $T_2$ , are shown in the diagram merely to indicate how they are to be connected. They are not included in the amplifier unit itself.

A word should be said about the ratings and values of the screen dropping resistors,  $R_4$  and  $R_5$ . The total resistance required to reduce the screen voltage to 400 volts from the plate supply is in the neighborhood of 35,000 to 45,000 ohms, depending upon how much screen current is flowing. Screen current normally runs somewhere between 30 and 40 ma., thus requiring a resistor capable of dissipating about 65 watts. Since the resistors are mounted within an enclosure, a wide

margin of safety is needed. Therefore two fifty-watt resistors in series were used, producing a combination rated for 100 watts dissipation. The resistance values were proportioned so that the slider on  $R_4$  would normally be set near the screen end of the resistor, thus utilizing almost all of this resistor, and all of  $R_5$ , to make maximum use of the heat-dissipating ability of each.

### Construction

The r.f. input jack, the grid coils, grid tuning condenser, bandswitch, key jack, and the meter switch are built as one assembly constructed on one of the cover plates of the utility box. All ground connections in this assembly are made to soldering lugs slipped under the screws which mount the coil forms. The coils themselves are held away from the chassis by National GS-10 stand-off insulators. Care should be taken in locating the mounting holes for the coils and the bandswitch to be sure that they will clear the lip of the utility box when the time comes for final assembly. If required, additional clearance may be obtained by filing semicircular notches in the lips of the box. The coils should be connected to the bandswitch before the coupling links are wound. This keeps the assembly clear of obstructions and makes wiring easier. Padding condensers  $C_1$  and  $C_2$ , used with the 40- and 80-meter coils respectively, are connected from the grid end of the coil to the same soldering lugs used for grounding the cold ends of the coils. When the links are wound on later, their ground connections are also made to these same lugs.

The meter switch provides mounting terminals for meter shunts  $R_2$ ,  $R_3$  and  $R_6$ , and for the grid resistor,  $R_1$ . The leads to the meter itself are passed through the top of the box through a grommet-lined hole after assembly. The other leads to the metered circuits are cabled and are run along the top of the box.

The socket for the 813 is submounted to the depth of the shield plate inside the tube and is held inside the box on an aluminum bracket. All of the by-pass condensers associated with the screen and filament circuits are mounted right on the socket and should, if possible, be grounded at a common point. All of this wiring, together with the filament and screen leads, should be soldered in place before the bracket is mounted within the box. The grid blocking condenser,  $C_4$ , may also

Rear view of the 813 amplifier. The steel utility box used to shield the input circuits is bolted to the rear of the panel. The home-built neutralizing condenser is visible just below the mica by-pass condenser which forms a part of the rear support for the plate condenser. The plate condenser and the swinging link assembly are mounted directly on the panel with stand-off insulators.

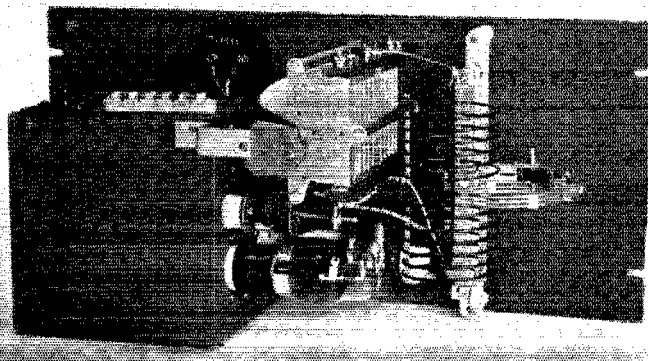

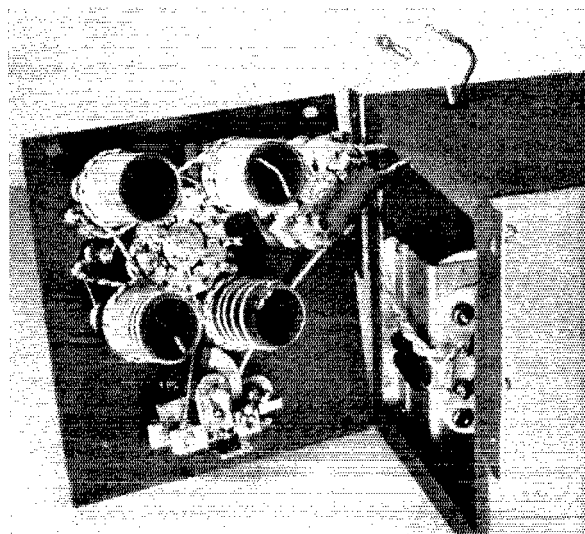

The grid coils are grouped around their bandswitch on one of the covers of the utility box. The coaxial input jack is mounted between the two coils at the left. The meter switch is in the upper right-hand corner, and the grid tuning condenser is at the bottom. The bracket which holds the 813 socket is visible inside the box. The two leads coming through the top of the box run from the meter switch to the meter.



the box by a small aluminum bracket, bent to provide adequate clearance between itself and the rotor. Blocking condenser  $C_8$  is made a part of this bracket. If  $C_8$  is not used (as discussed in a previous paragraph) the bracket may be extended to the rotor of the condenser itself.

be soldered in position, leaving one end free to be connected to the stator plates of the grid tuning condenser after assembly. The mounting of the screen dropping resistors is shown in the photograph of the interior of the box. Both are supported by small ceramic stand-off insulators. High voltage for the plate and screen supply enters the top of the box through a Millen safety connector, and is passed through the side of the box to the plate coil through a ceramic bushing. A bushing requiring a  $\frac{3}{4}$ -inch hole was used to provide maximum insulation. The fixed plate of the neutralizing condenser is mounted on a similar bushing just above the socket for the 6Y6G. The exact location of this hole should be determined after temporarily assembling the panel, the plate tuning condenser, and the box, because the fixed plate must be aligned with the variable plate, which is supported by the plate tuning condenser.

The plate tuning condenser is mounted on the front panel by three ceramic stand-off insulators. This is necessary because the condenser rotor is at full plate potential above ground. The rotor shaft is cut off about  $\frac{1}{4}$  inch from the rotor bushing, to permit the insertion of a high-voltage type shaft coupling. An insulated shaft made of  $\frac{1}{4}$ -inch bakelite rod couples the rotor of the condenser to the dial. Both r.f. chokes used in the plate tank circuits are mounted on the jack bar into which the coils plug. The high-voltage lead runs from the center-tap of the coil to the ceramic bushing on the side of the box, at which point the plate by-pass condenser,  $C_{10}$ , is mounted. The ground end of this condenser is mounted on a spacer which is held in place by one of the screws which passes through the side of the box to hold the socket mounting bracket in place. The rear of the plate tuning condenser is held to the rear of

of the tuning condenser. The copper disks used are each 1 inch in diameter. A hole is drilled in the center of each disk to pass a mounting screw. The "stator" disk is bolted to the ceramic feed-through bushing, and is held away from it by a  $\frac{1}{4}$ -inch spacer. The other end of the screw which goes through the bushing is fitted with a soldering lug to which the grid connection is soldered. The "rotor" disk is fastened to a 2-inch machine screw with a nut. The threaded end of the screw is then passed through the mounting bracket and is held in position firmly by two nuts, one on each surface of the bracket. This plate should be put in position first, after which the location of the hole for the bushing can be determined to provide proper alignment of the two plates. The plates of the neutralizing condenser do not of necessity have to be circular, but they should be of about the same surface area as those specified here to permit the required neutralizing capacitance to be obtained without having to reduce the plate spacing to less than  $\frac{3}{4}$  inch, necessary to prevent flash-over on modulation peaks.

After the three separate assemblies have been built and wired, the few remaining interconnections should be made. These include the connection of the metering leads to the proper points of the circuit, the connection of the grid coupling condenser to the stator plates of the grid tuning condenser, and the connection of the leads between the common terminals of the meter switch and the meter itself. The entire box assembly is then bolted to the front panel using homemade angle brackets as shown in the photographs.

#### Adjustments

Before applying plate voltage to the unit, a few preliminary adjustments are required. The circuit should be neutralized first, after which

the slider on the screen resistor should be set. The neutralization adjustments are best made with the aid of a sensitive absorption-type wavemeter. The crystal-detector unit described in recent editions of *The Radio Amateur's Handbook* is very useful in this respect. It should be coupled closely to the plate tank coil. Excitation should be applied to the grid of the tube, with the filaments lighted, but with the high-voltage lead disconnected at the safety terminal. It will probably be easiest to neutralize with the amplifier set up for operation in the 3.5-Mc. band. With the grid circuit tuned to resonance, rotate the plate tuning condenser and the tuning condenser of the wavemeter until a reading is obtained on the indicator of the wavemeter. Then adjust the spacing between the plates of the neutralizing condenser, a little bit at a time, until minimum reading is obtained. If it is not possible to actually tune the neutralizing condenser through a minimum the size of the plates of the condenser will have to be changed, but with the plates specified here, no difficulty should be experienced. The adjustment that produced the desired minimum was with the condenser plates spaced about  $1\frac{1}{4}$  inches apart.

After the neutralizing adjustment has been made, the slider on the screen resistor should be set. The preliminary setting can be made with the aid of an ohmmeter, referring to the tube operating data supplied by the manufacturer. For example, the tube data sheet sets forth the following operating conditions for Class C telegraphy: plate voltage 2250 max., screen voltage 400 max., screen current 40 ma. Using these figures in an Ohm's Law formula, we find that to drop the plate voltage from 2250 to 400 volts with 40 ma. current, it is necessary to use a series screen resistor of 46,000 ohms. Similar relationships can be worked out for other operating voltages. For maximum output, it is desirable to keep the screen voltage as close to the maximum as permissible. As a preliminary adjustment, therefore, the slider should be set so that there is 46,000 ohms between it and the high-voltage end of  $R_s$ . This should produce the desired operating conditions for the screen, but it should be checked under the following conditions: Excitation to produce rated grid current should be applied,

the plate tank tuned to resonance, and a dummy load capable of dissipating 300 to 350 watts should be connected to the swinging link. Then with full plate voltage applied, the link should be pushed in until full plate current (225 ma. for the conditions set forth above) is indicated. If it is impossible to load the final to this input, assuming that about 14 ma. grid current is flowing, it may be necessary to tap the dummy load across a few turns of the tank coil itself until the desired loading is accomplished. If it is still impossible to load the plate circuit to 225 ma. plate current, it is probable that excessive screen current is pulling screen voltage down so low that the plate will not behave properly. This can be caused by excessive drive or insufficient loading. In circuits which use a screen dropping resistor from the plate supply, excessive drive is highly undesirable, for the greater the grid drive, the greater the screen current, which merely pulls screen voltage down and reduces output. In other words, it becomes one of those carefully-balanced situations where excitation, load, and the value of the screen dropping resistor must be adjusted a little bit at a time until the rated operating conditions are obtained. However, once the desired screen-voltage and screen-current conditions are obtained, *with rated excitation at the same time*, maximum output will be obtained, and if 'phone operation is used, modulation will be linear. Most cases of fluctuating plate current under modulation can be attributed to an undernourished screen.

If the screen operating conditions are not "according to the book," the performance of the tube just can't be satisfactory, especially where plate-and-screen modulation is planned. Therefore, make sure that all of the above conditions are met before considering the adjustment complete.

After both screen and neutralizing adjustments are made, test the amplifier for stability by oper-

(Continued on page 128)

◆  
The interior of the shield box. The socket for the 813 is mounted on a bracket visible to the right of the four grid coils. The two large resistors are the screen-dropping units. This view also shows the construction of the neutralizing condenser, one plate of which mounts on a ceramic bushing on the wall of the box, the other being supported by a bracket from the plate tuning condenser.

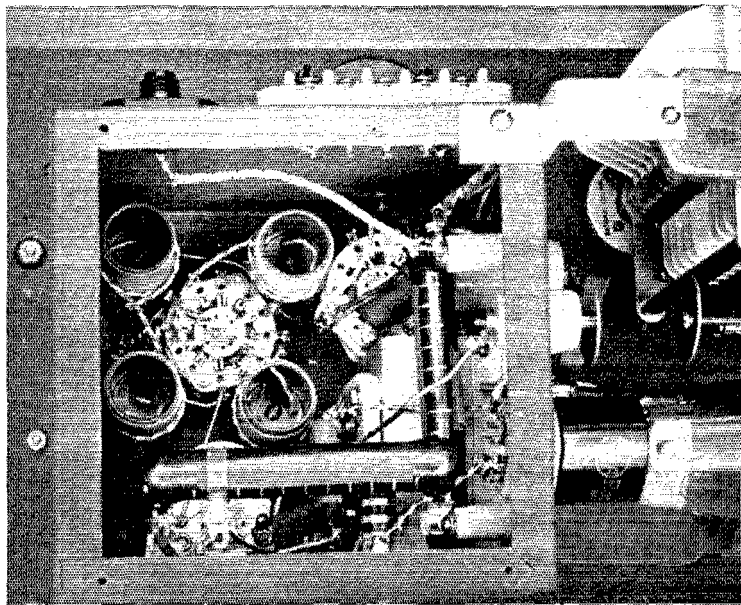

# • Technical Topics —

## L.F.-N.F.M.

No, it isn't an advertising slogan. It's simply a shorthand way of saying "narrow-band frequency-modulated 'phone on amateur frequencies below 14.4 Mc." — which is quite a mouthful if you have to say it often.

In early October a series of on-the-air tests of n.f.m. was begun on the 75-meter 'phone band by W1AW and W2GDG, under special temporary authority from FCC. The primary object of the tests was to determine whether any untoward effects would show up when n.f.m. was used under ordinary operating conditions in a crowded amateur 'phone band — effects which either theory or laboratory tests might not anticipate. The two stations have been maintaining communication schedules and promoting round-tables in which other stations could join and observe. The frequencies were chosen to be 2 kc. apart so that interference possibilities could be checked, W2GDG being on 3920 kc. and W1AW on 3922. W1AW, with a kilowatt input available on either n.f.m. or a.m., has many times switched from one method to the other while W2GDG was transmitting simultaneously on n.f.m. only, using 100 watts. At both stations the deviation ratio has been kept below 0.75 so that all sidebands of any appreciable amplitude would be confined to the normal a.m. channel.

To date, opinions of those who have heard the tests have been practically unanimous:

1) The n.f.m. transmissions are certainly no broader, and often appear to occupy less channel space than the a.m. signal.

2) When W1AW and W2GDG are transmitting simultaneously, the interference to W2GDG is much greater when W1AW is on a.m. than when using n.f.m.

In other words, there have been no unanticipated effects.<sup>1</sup>

We believe it is necessary, now, to consider seriously from the technical standpoint whether narrow-band f.m. as previously defined<sup>1</sup> should not be permitted on all amateur frequencies that are now exclusively a.m. The arguments for such permission can be summed up as follows:

1) The system as defined does not occupy a wider channel than a.m. and has no inherent peculiarities that result in more interference than a.m. In fact, the interference is less because the sideband power in an n.f.m. signal is less than in 100-per-cent amplitude modulation, when the n.f.m. channel is kept within the defined limits.

2) There is no reason for discriminating against

any particular system so long as its use does not increase congestion in the amateur bands.

3) Interference to nearby broadcast reception is reduced by a large factor and, depending upon the transmitting frequency, may be completely eliminated.

4) With f.m. there is no such thing as "over-modulation" in the same sense that it exists in a.m. Increasing the frequency swing does cause the channel occupied to widen out, but the limit on modulation extent is primarily set by the width of the channel for which the receiver is designed. "Overmodulation" in f.m. is therefore a receiver phenomenon. If the swing is too wide for the receiver there is a great deal of distortion of the resultant audio but not the increase in volume that goes with overmodulation in a.m. The volume may actually decrease, in fact. If the same thing were true of overmodulation in a.m. it's a certainty that we'd have much less of it.

5) With properly-designed receivers, effective noise suppression is possible and an improvement of the order of 6 db. in signal-to-noise ratio can be expected with signals at the threshold level.<sup>2</sup> However, no special receiver is required for n.f.m.

6) The modulating equipment is inexpensive and not complicated in principle, although differing from the better-known a.m. system. The requirements for linear operation of the r.f. section of the transmitter are much less rigorous than for a.m.

In our opinion, these arguments are pretty strong — particularly those that tend to result in better technical practices in the 'phone bands. However, there is also a "con" side as well as a "pro":

1) It can be argued that the use of n.f.m. will increase heterodyne interference because the power in the first pair of sidebands is not as great as in a 100-per-cent amplitude-modulated signal of the same carrier power, at deviation ratios that come within the definition of n.f.m.<sup>1</sup> In other words, in a.m. terms the modulation is less than 100 per cent, which means that a stronger carrier is radiated than is actually needed to carry the same voice power.

2) N.f.m. is so easily and inexpensively applied to a c.w. transmitter that its use, if permitted, will encourage 'phone operation to such an extent that congestion in the 'phone bands will increase tremendously.

3) The only solution to the question of enough space for 'phone eventually must be the adoption

<sup>1</sup> "Technical Topics — Amateur F.M.," *QST*, October, 1946.

<sup>2</sup> Crosby, "Band-Width and Readability in Frequency Modulation," *QST*, March, 1941. Grammer, "Some Thought on Amateur F.M. Reception," *QST*, March, 1941.

of single-sideband suppressed-carrier technique. F.m. is inherently unusable in such a case.

The last of these arguments probably has more real validity than the first two, but at that is rather nebulous. Single-sideband transmission without a carrier is not out of the question for amateur work, but would require such a complete overhauling of our transmitting and receiving methods that it is not likely to come about overnight. There may be easier methods, both operating and technical, to achieve the same end or to approximate it. Anyhow, amateur radio is a flexible art, and the privilege of using one or another method of communication is not the sort of thing that can be frozen forever; conditions change and methods must also change with them.

As for the No. 1 *contra* argument, it seems to us that this is simply one of the penalties of the system that has to be accepted along with the benefits. Numerically, it is not as great as the possible signal/noise-ratio improvement in weak-signal reception, so may not really constitute a penalty. Audio gain is easy to get in a receiver. The real disadvantage is in the presence of a.m. interference. No. 2 is not a technical argument at all.

The W1AW-W2GDG tests will continue until March 31st under the present authorization. By the time this appears in print it is hoped that the W1AW schedules can be expanded to permit alternate n.f.m. and a.m. on the regular 'phone broadcast periods on both 75 and 20 meters so that all those interested can have an opportunity to listen and judge for themselves. There seems small doubt but that the question of authorizing n.f.m. on our low-frequency 'phone bands will

be brought up at the ARRL Board meeting in May and, if a favorable decision results, be followed by a recommendation to the FCC to open all bands where a.m. is now exclusive. It is important, therefore, that those who have any technical reasons to advance against it should make themselves heard now. Such correspondence is invited.

There are many questions of technical interest which can better be answered on a laboratory basis than in air tests, and we are now engaged in a lab project which aims to uncover some quantitative data on relative interference and so on. However, it seems quite certain by now that n.f.m. as such does not increase interference. That, we think, is the critical point. It does not matter a great deal at this juncture whether there would be less over-all interference if all 'phone were n.f.m. and a.m. were washed out, nor whether the man on a.m. has an advantage over the n.f.m. operator. Those things can be determined on a leisurely basis, with accuracy the object.

Should n.f.m. eventually be permitted below 14.4 Mc., it will not only be necessary to set up standards<sup>1</sup> but, in line with present a.m. regulations, amateurs undoubtedly will be required to have means available for ensuring that the frequency deviation does not exceed the permissible values. Such things as whether or not the system should be phase modulation rather than frequency modulation also deserve full consideration, because there is considerable background in the field to help in arriving at the best answer for amateur communication. We expect to discuss these questions at some length in succeeding issues. — G. G.

## S-Meters — So What?

A CASUAL listener to any of the 'phone bands must be considerably impressed by the high technical development of amateurs when he hears their sage reports of "20 db. over S9" and the like that are so common. But he must become a little confused when, after learning that S9 means "extremely strong signals," he hears a report of "You're 10 db. over S9 but so-and-so is giving you trouble," and wonders how a signal 10 db. above "extremely strong" can be troubled by anything. He has a right to be puzzled — the paradox is one of long standing — but the trouble lies not with the S-meter, as some would have it, but with the manner in which it is used. S-meter readings are neither as sacred as some say nor as black as others would paint them, but they do have to be used intelligently to mean anything.

It is probably a safe assumption that 90 per cent of any group of hams asked, "What does the S-meter indicate?" would reply that it tells how

loud the signal is. Forget it! A properly-calibrated S-meter can give you a comparison of the relative strengths of signals, but only if certain conditions prevail. These conditions are that the antenna gain be similar for the two signals, that there be no other signals within the receiver pass-band at the time of measurement (remembering that noise and splatter rate as signals), and that the readings be made on the same amateur band because of the variation in receiver gain with changes in frequency. The antenna gain will be similar if a rotary beam is used, except in cases where the signals arrive at considerably-different vertical angles or where the horizontal bearings are different and the gain changes because of the loading effects of surrounding objects, but at lower frequencies and with simple wire antennas there is a good chance that the antenna gain will not be similar for the two signals if they come from different directions. That there be no other signals

within the receiver pass-band is a condition rarely obtained, except perhaps on 50 Mc. and during slack hours on 28 Mc. If all of the above conditions are satisfied, the S-meter can be used for the comparison of one signal with another. With the exceptions mentioned, a snowball in the well-known place has about the same chances.

Even if a minor miracle took place and all of the conditions were met, the report would probably come back as "so many db. above S9" and once again the usefulness of the S-meter would be thrown out the window, unless the operator went on to define S9 in his particular receiver — and assuming that the db. scale on his S-meter were accurate. Manufacturers have made an attempt to standardize on their S9s, and it seems to be the reading obtained for either a 50- or 100-microvolt signal in most cases. But unless the receiver has some compensation for change in gain at different frequencies, the S9 definition is correct at only one frequency. But forgetting these minor points, the "db.-above-S9" reports indicate to the receiving operator that his carrier strength is so many db. above one that would put 50 or 100 microvolts at the input of the receiver, and no mention is made of the gain of the antenna. A preselector, of course, throws everything off, because its gain boosts the noise and the signal, and in an extreme case it is possible to get an S9 reading from the amplified noise alone. In this case, a "20-db.-over-S9" report indicates a weaker carrier than an S6 reading on the same receiver without a preselector (assuming 6 db. per S point and a noise level of S1).

But that S-meter came with the receiver, and you can't sit down to the operating table without staring at it while calling CQ or waiting for someone to sign, so let's look for some sensible way to use it. Even if you have a receiver in which the manufacturer has made an effort to give you an accurate calibration on the S-meter, production variations and other variables make it unlikely that even the best receivers can be depended upon for their S scales. However, if a signal generator can be borrowed for an evening, the S-meter can be calibrated in decibels above S1 or whatever your minimum noise reading is, and it then becomes a useful measuring device in several ways. If it isn't calibrated by comparison with a signal generator it is an "indicating" device, but now

we're talking about *measurements* and there is a big difference. During those rare occasions when the station you are working is "in the clear," you can give the operator at the other end an excellent idea of *how well you are receiving him* — not how loud he is! — by giving him the db. reading that his carrier indicates above noise. (How loud he is depends on where you set your audio gain control.) All this requires is a reading on his channel when his signal isn't on and one when it is, and subtracting the no-signal db. reading from the carrier db. reading measures how well he comes in over the noise. Obviously, this requires a clear channel, so it can't be done during crowded hours. But the same principle can be used at any time, if the no-signal reading includes outside noise and other signals on the channel. Here is a way to use the S-meter intelligently, because it tells the other fellow how well you are receiving him! If you have a lot of outside noise or if the channel is crowded, your report to him will go down, even though your S-meter reading is up above what it would be with his carrier alone. A report like this would mean something, instead of the conventional "10-db.-above-S9-but-so-and-so-is-giving-you-trouble" business. It may be a new concept of S-meter use to many, but it will be just as impressive to the eavesdropper, and a whale of a lot more useful to the operator at the other end. Throw your S readings out the window, unless you are ready to define S9 or whatever you use for a reference, and simply give your reports in "db. above background." Or give your readings per the S scale, *with no reference to the meter* but with plenty of looks at the S scale printed in your logbook. After all, S7 or S8 is still a respectable report!

Your calibrated S-meter will also measure the extent of the fading of his signal, provided the background conditions aren't changing, and this is particularly useful in propagation studies and the identification of ionosphere peculiarities on the 28- and 50-Mc. bands. And, properly calibrated, your S-meter is a very useful device for checking a rotary-beam pattern and tuning — with a *local* observer or signal source. Occasionally you can overhear someone adjusting his 28-Mc. beam-element lengths with an observer several thousand miles away but, with 10 to 20 db. of fading, there isn't much hope for the instigator of the tests! — B. G.

---

## "Maybe It's Just Conditions —"

ONE need listen only a short time on any of our higher-frequency bands to realize that many amateurs have little or no conception of the means by which their signals are propagated to distant points, yet even a little knowledge of propagation phenomena and the application of

common sense in our daily observations can save us a lot of time and wasted effort, if we are interested in making the most of the time we spend in operating on 28, 50 or 144 Mc. If amateur communication is worth the time and money required to assemble and operate a modern station,



certainly it is worth a bit of study to determine the best ways of capitalizing on the opportunities afforded us by natural phenomena.

Contrary to the general impression, it is not necessary that one be a combination of astronomer, meteorologist, and mathematician to know his way around in this department. One will find most of what he needs to know in the propagation section of the ARRL *Handbook*, and intelligent and systematic observation will supply the rest. For a quick summary, the principal ways in which signals are propagated on the frequencies near the v.h.f. range are listed below.

#### **Atmospheric Bending**

The principles involved in this type of propagation, which ties in with easily-recognized weather phenomena, have been explained countless times in the pages of *QST*, yet the possibilities seem to be little understood, especially by operators now using the 10-meter band. By this medium contacts may be made on 10, 6 or 2 meters at distances up to 300 miles or more, and opportunities for unusual work can be foretold in advance if we take a little time to observe local weather signs, or, better still, by studying the daily weather maps now being published in many newspapers.

One's working range will vary from night to night, but distances up to 50 miles or so should be workable from the average location under normal conditions. The variation in working range is least on 28 Mc., as the amount of refraction increases with frequency. The 50-Mc. band is more responsive to changes in atmospheric conditions, and signals at a given distance are generally somewhat stronger, all other things being equal, on 50 than on 28 Mc. The 2-meter band is more variable than either 6 or 10, and under summer conditions it produces the most amazing signals at quite frequent intervals, often at times when 6 and 10 are exhibiting only slightly improved propagation. At this frequency, and on up through the microwave region, atmospheric duct effect begins to appear, and on occasion it may be possible for signals to get out to hitherto unbelievable distances. Little is known along this line in amateur work, but the fact that strong signals have been exchanged over distances up to nearly 400 miles on 144 Mc. gives some indication of the possibilities.

#### **Sporadic-E Skip**

Patchy concentrations of ionization in the *E*-layer region are often responsible for reflection of signals on 28 and 50 Mc. This is the popular "short skip" which provides fine contacts on both bands in the range between 400 and 1200 miles. It is most common in May, June and July, but may occur at any time, as is evidenced by its having shown up at some time during every month of the postwar period. It is most common during the evening hours, but it has been ob-

served around the clock. It is largely unpredictable, at our present state of knowledge, and consequently it is of high "surprise value."

Multiple-hop effects may show up, when sporadic-*E* ionization develops over large areas simultaneously, and contacts beyond 2000 miles are made on 28 and 50 Mc. by this medium. As far as is known, no 144-Mc. reflections have been observed, the known limit of sporadic-*E* work being somewhere in the vicinity of 90 Mc.

#### **$F_2$ -Layer Reflection**

The "normal" contacts on 28 Mc. are made by means of reflection from the  $F_2$  layer, the ionization density (and consequently its ability to reflect high-frequency waves) of which varies with solar activity. The highest frequencies are reflected at the peak of the 11-year solar cycle. The maximum usable frequency (m.u.f.) varies with other fairly well-defined cycles, including daily, monthly, and seasonal variations, all related to the movement of Old Sol. Generally speaking, the  $F_2$  m.u.f. will be highest for a given day at shortly after noon at the midpoint of the path under consideration. Turning of the sun on its axis each 27 days accounts for the m.u.f. peaks which roll around slightly less than a month apart. In northern latitudes, there are peaks each fall and spring, with a low period during summer and a slight drop-off during midwinter. At or near the Equator conditions are more or less constant at all seasons.

At the low point of the 11-year cycle (we were approaching the bottom at the outbreak of war) the m.u.f. may go as high as 28 Mc. only during a short period each spring and fall, and even then we may have many dead days, and others when the low end of the band is open and the high end dead. For the years near the peak (the present period) the 10-meter band will be open practically the year around, and the part of the band used has little bearing on the strength of signal. The high end may actually have stronger signals than the low end, most times, as the optimum working frequency is only slightly lower than the maximum usable. The m.u.f. is rising above 50 Mc. currently in some areas, and DX contacts on 6 will be made more often as the top of the cycle approaches.

Unlike sporadic-*E* skip, which may break at any time,  $F_2$  opportunities arrive on a well-defined schedule, and the v.h.f. DX aspirant need not make many shots in the dark if he has some coöperation lined up in the right places. Knowing, for instance, that the October peak came about the 26th, it took no clairvoyance to guess that the weekend of November 23rd and 24th was a good time to be trying for a European contact on 6. The first  $F_2$  communication in v.h.f. history, on November 24th, set off a furor of interest in 50-Mc. DX and for the next few days plenty of people were monitoring the 50-Mc. band for DX

signals, but they were too late. The peak had passed, and such a chance was not likely to return before the spring peak in March.

Increased ionization density, in addition to raising the m.u.f., results in a shortening of 28-Mc. skip and a general weakening of DX signals. When 10 is just opening up, the skip is about 2000 miles or more, signals from beyond this distance are very strong, and contacts between the two Coasts are common. In recent months, however, the skip has been as short as 1000 miles, and stations in the Middle West have been able to work both ways on most days. A condition simulating that of the low point of the cycle is noted each evening, when only transcontinental contacts are possible from the East in the last hour or so that the band is open.

### *Aurora Effect*

At times of ionospheric disturbances associated with variations in the earth's magnetic field, low-frequency communication may be wiped out by absorption of these frequencies in the ionosphere. Conversely, the 10- and 6-meter bands act up in a most interesting fashion, and contacts are made over distances not normally workable on either band. Magnetic storms may be accompanied by an aurora borealis display, if the disturbance occurs at night and visibility is good. If the display is confined to the northern sky, aiming a directional array at the auroral curtain will bring in signals strongest, regardless of the true direction to the transmitting station. When the visible display is widespread there may be only a slight improvement noted with the array aimed north. Such a condition is most common at the high point of a sunspot cycle, when solar activity is spread well over the sun's surface, instead of being concentrated in the region near the solar equator.

Aurora-reflected signals are characterized by a rapid flutter, which lends a dribbling sound to 28-Mc. carriers, and may render modulation completely unreadable on 50-Mc. signals. The only satisfactory means of communication is then straight c.w., a fact which is still not appreciated by enough of our v.h.f. fraternity. Many opportunities for interesting 50-Mc. work are lost by ignoring warning signs which precede the appearance of aurora-reflected signals. A general fade-out on the lower frequencies, a wavy quality on 28-Mc. signals, the tendency of north-south paths to be better than east-west ones, the appearance of an aurora — any or all of these signs should be enough to cause the experienced v.h.f. enthusiast to turn his beam north and start in making c.w. transmissions. No authentic instance of aurora reflection has been seen on 144 Mc., but with the advent of more crystal-controlled transmitters and improved receivers it is possible that it may be observed. Advanced 144-Mc. workers should be on the lookout for it.

### *Ionization by Cosmic Dust*

Probably the least-observed means of propagation of v.h.f. waves is that resulting from streaks of ionization caused by the passage of meteors across the signal path. This may be noted as a Doppler-effect whistle on the carrier of a station already heard, or it may cause the signal to be reflected to a point where it was not previously audible. It may also cause sudden large increases in signal level of a station which is normally only barely audible. Meteor showers of some magnitude and duration, such as that which occurred when the earth passed through the tail of the Giacobini-Zinner comet in October, may make communication possible for considerable periods. Signals so reflected may have a combination of the characteristics heard during sporadic-*E* and aurora sessions.

### *Miscellaneous "Scatter Signals"*

There are many signals to be heard on 14 and 28 Mc., and occasionally on 50 Mc., which cannot be accounted for by any of the explanations given above. In this category are the wavy signals heard in the early morning hours on 28 Mc., when the band is just opening up. A listener in New England can hear W1s, W2s, W3s, and even W4s and W8s, almost any morning, when the early birds are busy working the Europeans and Africans on 10. These signals are heard best when everyone's antenna is turned in one direction — east, and the wavy quality of the signals indicates the presence of multipath reflections. Usually such signals will disappear when two stations a couple hundred miles apart turn their antennas toward one another, giving rise to the belief that they are being reflected back at a sharp angle from one or more distant points. This effect is explained by the Bureau of Standards<sup>1</sup> with the example of a beam of light which is reflected by a mirror, with a thin layer of smoke in between the light source and the reflecting mirror. In the ionosphere the mirror is the  $F_2$  layer, smoke is the *E* layer. The light beam (the signal from a directive antenna) passes through the smoke (*E* layer) but is diffused somewhat thereby, accounting for the reception of the signal at points within the normal skip zone.

Such signals, and others one encounters when he begins to try to catalog them according to the type of propagation involved, point up the fact that there still are many things to be learned about wave propagation. The above is merely a partial inventory of the known means by which a signal may get through from a distant point. There may be various combinations of any of these media, which make identification of the cause difficult.

— E. P. T.

<sup>1</sup> *Radio Propagation Handbook*, Central Radio Propagation Laboratory, Part 1, issued November, 1943.

# A Quiet Break-In System

Effective Receiver Silencing for Efficient C.W. Operation

BY CLAUDE L. ROBINSON, \* W6KJV

• Those c.w. operators who have never tried a good break-in system do not realize what they are missing in the way of operating convenience. Not only is there a considerable saving in time and power, but a QSO takes on the nature of a conversation rather than a one-way broadcast. In this article, the author describes a smooth receiver-silencing system — a prime requirement for an effective break-in system.

IT HAS long been the writer's conviction that break-in operation is the most perfect form of ham communication. It eliminates excessively long calls and fruitless calling when your signal is blanketed by another. Since you know when your signals are being interfered with, pleasanter QSOs and more efficient operation when handling messages results. Long repeats are made unnecessary. Switching the rig on and off becomes unnecessary and a host of other desirable things that make operation a distinct pleasure are provided.

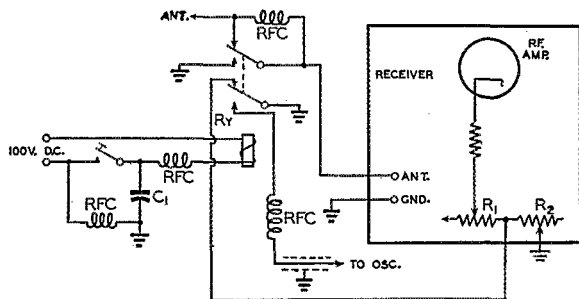

Break-in on a spot frequency requires some special considerations that are not usually necessary when working off your own frequency. It is believed that many more operators would make fuller use of break-in if they could be convinced of the advantages and if complete information were at hand. Periodically, mention of one break-in system or another has been made in *QST*. But they have all been tried and found wanting in one or more details.

My requirement was that the system should be absolutely noiseless except for the signal used for monitoring purposes — no clicks or thumps to paralyze the ear making it difficult to hear the

breaking signal. The system shown here in Fig. 1 does this and more. When the key is closed, the transmitter is keyed, the receiver input is short-circuited and the gain of the receiver is reduced.  $R_2$  is an auxiliary r.f. gain control which sets the level of the transmitter signal in the receiver. When the key is opened, this auxiliary gain control is short-circuited, restoring normal receiver gain.

By proper use of the potentiometer,  $R_2$ , the signal can be reduced from more than headphone volume to inaudibility, leaving the keying absolutely quiet. This suggests the use of an auxiliary audio oscillator for monitoring when working off one's own frequency, or for mixing with the transmitter signal when on frequency. The receiver is protected from r.f. and the attendant danger of burn-outs. The antenna used in experimenting with the system was 66 feet long and when the transmitter is on 80 meters the antenna picks up enough r.f. to give your fingers a good burn. It can be seen that the system must be really effective. In some of the other systems tried at W6KJV unless the monitoring signal was brought up to a certain volume, it

Fig. 1 — Circuit diagram of the break-in system used at W6KJV.

$C_1$  — 0.02- $\mu$ fd. paper (see text).  
 $R_1$  — R.f. gain control in receiver.  
 $R_2$  — 0.5-megohm potentiometer (see text).  
RFC — 2.5-mh. r.f. choke.  
 $R_y$  — Leach Type 1037 sensitive relay, d.p.d.t., 10,000-ohm coil, J-301 return spring.

would be accompanied by thumps or clicks, and even then when the receiver was tuned slightly off frequency the clicks again were noticeable.

## Relay Characteristics

A few inquiries from operators working spot frequencies and a perusal of back issues of *QST* started me off on my quest. I had been using negative bias on the a.v.c. line of the receiver, obtained from the voltage drop across the biasing resistor in one of the stages of my VFO exciter unit, keying the oscillator directly with a "bug," as shown in *QST* for May, 1945.<sup>1</sup> This system

<sup>1</sup> Robinson, "A Search for VFO Stability," *QST*, May, 1945, p. 18.

operated fairly well for off-frequency work but for spot-frequency use it was noisier than I liked. Searching the junk box I came up with two keying relays which I modified into the contact combination I wished. Each one then had one set of normally-closed and one set of normally-open contacts, the moving contacts or armature of each relay being grounded. The normally-open contact of one relay keyed the oscillator and the normally-closed set opened, placing a potentiometer in the receiver r.f. gain-control lead to ground. The normally-open contact on the second relay grounded the antenna post of the receiver and the normally-closed set opened, disconnecting the antenna from the receiver.

These particular relays proved a dismal failure because of their construction. The spring leaves were too flexible and "bouncing" contributed to the noise in the headphones, although from all reports this noise was not audible on the signal heard at other stations. It was sort of a raspy click on the "make" of the signal. I cured this by bracing up the bottom leaf of each relay, but at best this was only a makeshift arrangement. One other thing I noticed was a surge in the 'phones every time the key was released. This was traced to excess capacitance across the keying contacts. I found that this condenser really was

battery. I then placed it in the circuit. A click became evident on the make. This was traced to the receiver not being grounded slightly before the transmitter went on the air. This was cured by shimming up the lower-contact holding post so that it was higher than the keying contact. This assured proper action. A very slight scratchy click was noticed on the "break" and this was traced to the shock of connecting the antenna to the receiver. The remedy for this did not occur to me until later on when experimenting with the relay I am now using.

A few other things might be mentioned in connection with the above discussion. I have found several other operators who prefer to key with a relay rather than directly with the bug. The reason for this seems to be that the bug contacts tend to bounce at times, causing keying noises. Select a good place to key whatever stage you are keying. Usually cathode keying of an oscillator does not give a good keying characteristic because it is tied up in some way or other with part of the tuned circuit. Plate- or screen-lead keying can give good results. At W6KJV the negative lead to "ground" of the battery which supplies plate power for the oscillator is keyed, and the keying sounds perfect without any sort of lag circuit, both on "make" and "break." The

Fig. 2 — Alternative circuit for use with transmitters which are not keyed to ground. Values are the same as those given under Fig. 1.

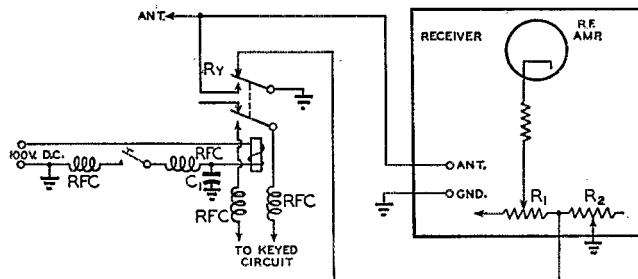

not needed because the signal was clean without it. Only the capacitance of the shielded keying leads and the by-pass condenser in the oscillator are across the key contacts now. R.f. chokes are used in series with the keying leads merely as a precaution rather than because they are actually needed.

### Relay Adjustment

Searching further I ran across a d.p.d.t. 110-volt a.c. relay that had served as an antenna change-over relay at one time. I decided to try it to see if it would key fast enough. I hooked it up and whether because of residual magnetism in the pole piece, age, wear or some other reason, it was sluggish on dots. A piece of Scotch Tape across the pole piece livened the action up but created an a.c. hum because of the spacing. I hooked 67½ volts of battery to it and it then worked to perfection except for the heavy load it placed on the

stages following the keyed stage should be free from parasitics if you are to get good keying.

### Alternative Circuit

An alternative hook-up is given in Fig. 2 for those who do not key to ground. Of course, with a d.p.d.t. relay, it is impossible to gain all of the advantages which keying to ground will give, but it is well worth while anyway. In this particular arrangement the key goes from relay coil to ground. If you wish to key an audio oscillator, the key can be changed to the other side of the coil; or I suppose you could hook the cathode of the audio oscillator to the bottom of the relay coil in the circuit shown, grounding it and placing it in operation when the key is closed. A separate keying relay could also be used for the audio oscillator, using the same power supply. The voltage for my relay comes from a divider in the power supply for the VFO exciter unit.

### Auxiliary Gain Control

$R_2$  functions as an auxiliary gain control, merely for the purpose of setting the level of the transmitter signal in the receiver at the proper point. With the value I am using, the receiver may be completely silenced by advancing the control. With the key held down, the potentiometer should be set to the point which satisfies the ear. With the key up  $R_2$  is shorted out and the receiver gain control again operates normally. No adjustment of this gain control is necessary beyond that of normal use. Look at the circuit diagram of your receiver and trace the lead from the receiver gain control to the point where it is grounded. Open this line between ground and the gain control and bring a lead outside the receiver for the auxiliary potentiometer which may be mounted in some handy spot. It is all very simple and works nicely. It is my prediction that once you have tried break-in under the correct circumstances, you will not be satisfied with the old method of operation.

The results obtained were so gratifying that I knew I was on the right track so I decided to contact the Leach Relay Co. of Los Angeles to see if they could provide me with a relay that would draw a much lighter load and still do the work I wanted. In reply they outlined to me some of the characteristics of a good relay for keying — light contacts and moving assembly so that the percentage keying, that is, the time the contacts are actually closed as compared to the time the coil is energized would be as high as possible. They suggested the use of their Type 1037 sensitive relay which is d.p.d.t. The stock relay has a very light contact pressure and return spring and a small contact opening. Equipped with a 10,000-ohm coil it will operate on as low as 2 ma. and consumes 0.04 watt. With this standard adjustment it would not be satisfactory for keying service. By using a 10,000-ohm coil and 100 volts d.c. on the coil, causing it to draw 10 ma. or 1 watt, the contact spacing can be increased by adjustment of the screws for that purpose. Then it is equipped with a heavier return spring, Type J-301. This makes an excellent keying relay; it will follow the bug as fast as you can send. In addition to being small in size, it is comparatively noiseless and the spacing of the contacts is adjustable. No doubt other relays of a similar type can be used just as successfully. The audio oscillator can be keyed by the 100 volts applied to the relay or by the voltage drop from a biasing resistor in the transmitter.

The adjustment of the relay is simple. On the keying side, adjust the spacing of the contacts exactly as you do your bug for the proper making of the dots. You will find that it is not nearly as critical in adjustment as your bug. On the receiver side, bend up the bottom contact a bit so that the receiver will ground before the transmit-

ter goes on; then screw down the top contact until the slight rasp caused by the antenna making connection is at a minimum. I dispensed with this noise entirely here by simply placing an r.f. choke as shown in Fig. 1. This leaves the antenna electrically connected to the receiver but dead so far as the ham bands are concerned when the key is pressed. When the key is up the choke is shorted out and everything is normal again. Merely connecting the antenna to the receiver and grounding it will not give as good results. Operation is much quieter the other way. The relay should be placed as close to the receiver antenna and ground posts as possible to reduce the size of the pick-up loop formed by the leads from the relay to the receiver. The larger this loop the more pick-up the receiver will have which the relay cannot affect. I tried two separate midget single-pole relays, one wired right into the receiver and the other outside. Results weren't as good as with the other relay because, no doubt, of the lack of proper coordination which is assured in the d.p.d.t. type when properly adjusted.

I mounted the relay on a sheet of polystyrene spaced 1 inch from the bottom cover of a 3×4×5-inch shield box. After the wiring was completed the rest of the box was screwed to the base, making a nice-looking job. The box also provides shielding as well as forming a dust cover for the relay. The lead-ins for the antenna proper and to the antenna post of the receiver were made through small-sized feed-through insulators. The value of  $C_1$  is not critical, although if it is made too large, it will affect the operation of the relay. The size of the auxiliary gain control,  $R_2$ , also is not limited closely. Any maximum value from about 20,000 ohms upward will serve.

### About the Author

• Claude L. Robinson, W6KJV, returns to our pages this month with another splendid article on making hamming a still more pleasant pursuit. In May of '45 he helped us stabilize our VFOs; this time it's tranquil break-in. W6KJV has been in radio since 1919 when he enlisted in the Marines at the age of 15. Pearl Harbor duty and long-wave sparks filled his service life. He waited until '34 to become KJV, but since then he has earned WAS and WAC and built a reputation as an inveterate rag-chewer and experimenter.

**SWITCH  
TO SAFETY!**



# Happenings of the Month



## OVERSEAS OPPORTUNITIES

The appeal for "Hams for Overseas" in August *QST* received an excellent response and the Government department concerned reports its satisfaction with the excellent quality of the men who applied and its regret that it could not employ more of them. All routine positions have now been filled.

Another Government department, however, is in need of a limited number of radio men, and old and new letters addressed to "Overseas Operations" are being delivered to it. Therefore it is unnecessary to write again if you have already applied through "Overseas Operations." But new applications are welcomed from single men who are interested in a base pay of between \$3000 and \$3400 (plus a quarters-and-subsistence allowance while outside the U.S.A.), who like to travel, and who are proficient both as operators and technicians. There is usually opportunity for a bit of ham operation "on the side," signing truly-DX calls. No jobs are available in the United States except for top-notch engineers.

Inquiries can be sent to "Overseas Operations," c/o ARRL Headquarters. Please state fully radio operating and technical experience, licenses held, code speed, etc. Full statements will decrease the delay in processing applications. The minimum time between application and employment is estimated by this Government department as three months.

## TRAFFIC WITH JAPAN

Apparently there has been a little embarrassment over some message traffic with GI stations in Japan. The War Department invites the attention of amateurs to their regulations governing GI stations in the Japanese area, which confine such message traffic strictly to persons in the United States military service. Even then, pecuniary interest may not be involved. Traffic to or from Japanese civilians is strictly prohibited. You will save both yourself and the GI operators embarrassment if you govern yourself accordingly.

## PROOF OF USE AGAIN WAIVED

FCC has again waived, until June 30th next, the requirement of proof of use of operator licenses as a condition to their renewal. This was done by Order No. 77-G on December 17th, effective January 1st. This action postpones for another six months the effective date of the requirement to show three c.w. contacts on renewal

applications. Meanwhile the applying portion of the application form may be ignored.

## HANDY AWARDED LEGION OF MERIT

Amateurs the country over will be proud to learn that ARRL Communications Manager Handy has been decorated for his wartime services in the organization of military communications. We are all aware of the manner in which amateur apparatus and circuit technique contributed to the success of military apparatus. In much the same way Colonel Handy was able to draw upon his long experience in organizing amateur communications to assist in the problems confronting a prodigiously-expanding AAF. Cited for the Legion of Merit, the official presentation was made to him at Westover Army Air Base by the commanding officer of that station on November 16th. His citation reads as follows:

Colonel Francis E. Handy, O-904943, Air Corps, Army of the United States. While serving with the Air Communications Office, Headquarters, Army Air Forces, from May 1942 to September 1945, Colonel Handy introduced new and improved procedures, techniques and military organizations into the worldwide use and contributed substantially to the successful employment of air power in the war. Colonel Handy's outstanding achievements and exceptional ability reflect great credit upon himself and the Army Air Forces.

## K CALLS

The first amateur K calls in continental United States have now made their appearance. In the ninth call area, where the bottom of the barrel was being scraped on W calls, a new series has been started beginning with K9AAA. The amateur stations of the electronic warfare companies of the Naval Reserve are also receiving K calls, with the suffix USN for the head station of the Naval District and the suffixes NRA, etc., for the unit stations.

Hawaiian and Alaskan amateur calls are being changed to KH6 and KL7 calls, respectively, with two-letter suffixes, as rapidly as they are renewed. If you have a prewar K6 or K7 call you should apply immediately for renewal, so as to get your call changed to the new series to prevent confusion with the new use of K calls on the mainland.

## WHAT BANDS AVAILABLE?

Below is a summary of the U. S. amateur bands on which operation is permitted as of January 10th. Future changes will be announced by W1AW broadcasts. Figures are megacycles. AØ means an unmodulated carrier, A1 means c.w. telegraphy, A2 is m.c.w., A3 is a.m. 'phone, A4 is

facsimile, A5 is television; FM means frequency modulation, both 'phone and telegraphy.

3.500-	4.0	— A1; except band is only
3.625-	4.0	in Territory of Hawaii
3.850-	4.0	— A3, Class A only
7.000-	7.3	— A1
14.000-	14.4	— A1
14.200-	14.3	— A3, Class A only
27.185-	27.455	— A0, A1, A2, A3, A4, FM
28.0	29.7	— A1
28.5	29.7	— A3
29.0	29.7	— FM
50.0	54.0	— A1, A2, A3, A4
52.5	54.0	— FM
144.0	148.0	— A0, A1, A2, A3, A4, FM; except
144.0	146.5	within 50 mi. of Washington, Seattle and
235	240	— A0, A1, A2, A3, A4, FM [Honolulu.
420*	430*	— A0, A1, A2, A3, A4, A5, FM
1,215	1,295	} A0, A1, A2, A3, A4, A5, FM, Pulse
2,300	2,450	
3,300	3,500	
5,650	5,850	
10,000	10,500	
21,000	22,000	
All above 30,000		

\* Peak antenna power must not exceed 50 watts.

The Canadian amateur assignments are the same with the following exceptions: A3 may be used in 3800-4000 and 14,150-14,300 kc. by licensees who have held a station license at least two years, with station in active operation during that period. The entire 10-meter band is open to 'phone by all licensees. Between 2450 and 10,000 Mc. there is only one assignment, namely, 5250-5650 Mc. No types of emission other than A1 and A3 are authorized on any frequency.

### F.C.C. DISTRICT CHANGES

As part of the recent reorganization of its field establishment, FCC has made quite a few changes in its inspection districts. Where states are split by counties, the detail is too long for us to publish here but we can give you a general idea and, in case of doubt, particulars can be learned from Hq. or the nearest FCC district office.

The State of West Virginia has been split, the eastern part now being administered by the Baltimore office, the western part remaining under the Detroit office.

While FCC still maintains a suboffice in Galveston, the district office has been moved to 216 U. S. Appraisers Building, Houston, Texas, and its territory has been expanded to take in the southern third of Texas.

The Denver office now administers the western overhang of Nebraska and a comparable area in South Dakota, which have been removed from St. Paul's jurisdiction.

Winnebago County, Wisconsin, has been transferred from St. Paul to the jurisdiction of the Chicago office. Kentucky has been split. The eastern part remains under the Detroit office but western Kentucky is now under Chicago.

The area of the Honolulu office is now specified as consisting not only of the Territory of Hawaii

but also of the "outlying Pacific possessions except Alaska and adjacent islands."

### S-BAND DIATHERMY

In December FCC held a hearing on proposed rules for diathermy and industrial heating equipment. One of the matters considered was the need for an additional frequency assignment in the vicinity of the wartime radar S Band. The penetration of such frequencies apparently offers some interesting possibilities in both fields.

FCC solved the matter, by an order on December 26th, by the unusual procedure of superimposing a new allocation on existing ones, without altering the latter. The band 2300-2450 Mc. is amateur. The band beginning at 2450 is non-Government fixed and mobile. FCC assigned the border frequency of 2450 Mc. nonexclusively for industrial, medical and scientific purposes, without license, on the conditions that the emitted bandwidth be reduced as much as possible, be in any event confined to 2400-2500 Mc., and cause no interference through spurious or harmonic radiation.

While we dislike this allocation philosophy and believe it dangerous, there is one silver lining for amateurs. The diathermy and heating market is many times greater than the communications market. The establishment of this service will result in the availability of much equipment, including continuous-wave magnetrons, useful in our adjacent amateur band. While it is believed that the commercial equipment will be used extensively, its nature and method of employment seem to assure limited interference range and quite brief operating cycles. Considering that we shall certainly use highly directive antenna systems, we do not believe we should experience interference of serious proportions and in a practical way we may benefit considerably from the availability of gear.

Among the devices that will now operate on 2450 is Raytheon's "Radarange," the r.f. cooker that does a hot-dog in a few seconds, a frozen steak in a few minutes. Anybody know the natural period of a hamburger?

### ARE YOU LICENSED?

• When joining the League or renewing your membership, it is important that you show whether you have an amateur license, either station or operator. Please state your call and/or the class of operator license held, that we may verify your classification.



WIOAB recommends a cribbage board as a handy container for octal-base crystal holders. Don's holds 24.

# A Stacked Array for 6 and 10

## Beams for Two Bands Working in Close Harmony

BY EDWARD P. TILTON,\* WIHDQ

**T**HE possibility of v.h.f. DX on an international scale, as a result of the approaching sunspot peak, has generated interest in the 50-Mc. band on the part of many of the ham fraternity who normally have no concern with the frequencies above 30 Mc. The current activity on 10 indicates that  $F_2$  DX work on 6 is not far off, and the two bands, 28 and 50 Mc., make an ideal combination for the man who is interested in new amateur horizons. In many ways the two bands are alike, the condition of the lower band often giving a clue as to what may be expected on the higher. Thus it becomes obvious that an antenna set-up which will provide good performance on the two bands is a highly desirable feature for anyone who wants to make the most of the interesting opportunities now coming up.

The mounting of two arrays in such a position that the line of directivity is common has many obvious advantages, such as the use of a single tower, rotating mechanism, and direction indicator. In tests with distant 50-Mc. stations it is nice to know that the array is aimed correctly, and such aiming can be accomplished readily if the two workers are in contact on 28 Mc. How closely together two such arrays may be mounted without harmful interaction is a point about which there has been much conjecture in amateur circles. The dual array shown in these pages is the result of a series of experiments aimed at finding some of the answers.

One commonly-used means of avoiding interaction is to mount the arrays at right angles, but this makes for bulky structures and eliminates the desirable features associated with a common line of fire. Another is the separation of the two arrays by at least a quarter wavelength at the higher frequency, but any safe reduction of this figure makes for greater ease of construction. The spacing of about three feet finally employed was the minimum at which completely satisfactory operation could be obtained, particularly in the case of the 50-Mc. system.

The dual array started out as a 3-element 10-meter beam, with provision for mounting the 6-meter elements after the 10-meter portion had been worked out satisfactorily. It was guessed, correctly, that the 50-Mc. elements would have little effect on the performance of the 28-Mc. section, so the lower-frequency part was built first. The original model allowed only two inches clearance between the two arrays, and even at

• It is probably not news to many readers that international work on 50 Mc., predicted in the first paragraph of this article, is now an accomplished fact. News of the first 50-Mc. work across the Atlantic, reported in these pages last month, went around the world in jig time, and interest in v.h.f. DX work is growing rapidly. For those who wish to work both 6 and 10 with one antenna, here are the details of the two-band array used in the 28- and 50-Mc. work with G6DH and G5BY.

this point there was almost no effect on the 10-meter performance when the smaller elements were mounted in place. Getting the 50-Mc. part to work was something quite different, however, and several models were constructed, erected and tested before the performance on 6 approached that of a similar 4-element array alone.

### The 10-Meter Array

The merits of various element spacings have come in for considerable debate in recent times, with close and wide spacing both having their strong adherents. The problems involved have been discussed at length previously,<sup>1</sup> and our earlier findings on 50 Mc. influenced the design of this dual array. The principal point in favor of wider spacing than the conventional 0.1 wavelength is the freedom from critical adjustment which results from the higher center impedance of wide-spaced systems. On both 10 and 6 we want broad frequency coverage, and in this dual array (where it was anyone's guess as to what the center impedance might turn out to be) we wanted as much latitude as possible in the matter of feeding and adjustment. The spacing selected for the 10-meter section was 0.2 wavelength for the director and 0.175 wavelength for the reflector, as these dimensions fitted nicely into the picture we had in mind for the 6-meter section, and the work with 50-Mc. arrays, referred to above, had shown that these spacings would do a good job.

The method of matching the line to the center of the array is the familiar "T-match," described by W7OWX in *Hints & Kinks in QST* for April, 1946. The "T" has the decided advantage that its use eliminates guessing as to the probable

\* V.H.F. Editor, *QST*:

<sup>1</sup> "The World Above 50 Mc.," *QST*, June, 1946, page 61.



center impedance of the array, a figure which must be known before such devices as the folded dipole and the "Q" section can be used. With the "T," it is simply a matter of making the point of connection between the "T" and the driven element adjustable for minimum standing-wave ratio. The setting is not particularly critical, and a satisfactory adjustment can be made without the use of fancy measuring instruments or mathematics. The feeder used is the popular 300-ohm flexible line. This has the disadvantage of being somewhat weather-sensitive, but if a good matching job is done it will be found that the loading will not vary beyond usable limits except in extremely heavy rain, when any antenna system is apt to give some trouble.

Provision was made for varying the element lengths for maximum forward gain, but careful adjustment, using a remote-indicating field-strength meter,<sup>2</sup> showed that there was no magic figure at which superperformance was obtainable, and we ended up close to conventional *Handbook* information. The serious worker may wish to tune his array for maximum forward gain, or for best front-to-back ratio, and some improvement in performance may result when the job is done carefully; but the fellow who has neither time nor patience for such work need not worry greatly. The driven element can be cut according to the following formula:

$$\text{length (in inches)} = \frac{5540}{f_{\text{Mc.}}}$$

The director and reflector are made 5 per cent

<sup>2</sup> "A Remote-Indicating Field-Strength Meter," *QST*, May, 1946, page 21.

shorter and longer respectively. Frequency response is sufficiently broad that fine adjustment is not required for good results.

### The 6-Meter Array

The 4-element array, using a folded dipole having a 4-to-1 conductor ratio as the driven element, with 0.2-wavelength spacing on the reflector and first director and 0.25 wavelength on the forward director (the array in use at WIHDQ since last March), had given a very good account of itself. It had a useful frequency range of at least 2 Mc., the gain was all that could be expected, and the standing-wave ratio on the line was low. We had spent enough time on it to feel that we could do little better, and we wanted to use a similar arrangement in the new dual array if at all possible. In the first dual model, where the two sets of elements were separated by about two inches, this type of array could not be made to perform satisfactorily. Standing-wave ratio was high, and the gain was about 5 db. below that of the old array, regardless of any tuning adjustments we could make. Thinking that perhaps only matching trouble was at the bottom of this discrepancy in performance, a "T-match" was installed. This made it possible to get the standing-wave ratio and loading within reason, but the forward gain and off-the-side attenuation left quite a bit to be desired. The new array worked, but not good enough.

The next step was a separation of approximately 6 inches, and this resulted in some slight improvement, but left the new array at least 3 db. below the old one in forward gain, and there was more pick-up off the sides than we liked.

The dual 28- and 50-Mc. array at WIHDQ. The 3-element array for 10 (lower section) is matched by means of a "T" section, while the 4-element 6-meter beam uses a folded dipole. Both are fed with 300-ohm line. The system is rotated from the operating position by means of ropes.

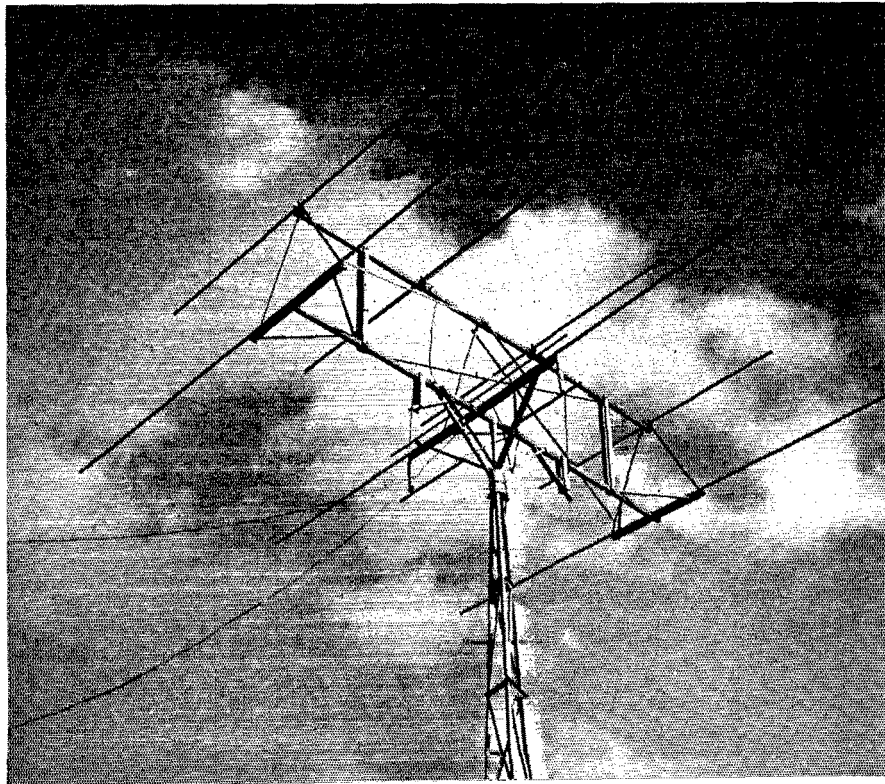

However, the results obtained with this arrangement indicate that the fellow who is really cramped for space can do a fairly good job with a dual array wherein the spacing is 6 inches or more. The performance of several outstanding 50-Mc. stations using such arrays bears this out. A 4-element array so mounted is probably at least the equivalent of a good 3-element job mounted alone, and that's not bad!

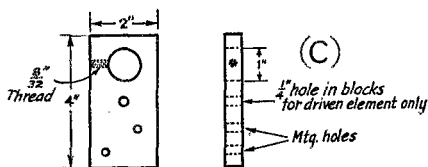
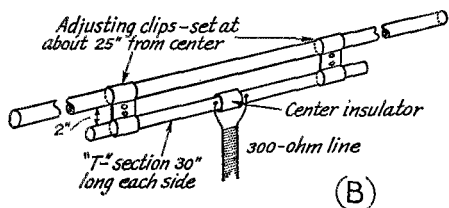
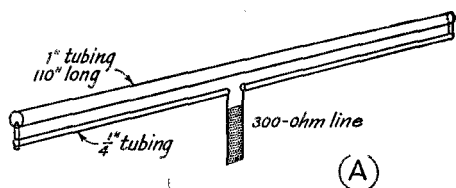

Detail drawing of the driven elements used in the dual array for 6 and 10 meters. A is the folded dipole used in the 50-Mc. array. It has a 4-to-1 conductor ratio, to provide a match to the 300-ohm line. B shows the "T-match" employed in the 28-Mc. array. The matching section is composed of two pieces of tubing which are held in alignment at the center by a polystyrene rod which is turned down to fit tightly inside the tubing. The adjusting clips are set at the point which provides the lowest standing-wave ratio. C shows the details of the bakelite blocks used for mounting the 6-meter elements.

We were prepared to go to a quarter-wave-length spacing between the two sections, if necessary, in order to get optimum performance from the 6-meter portion, but it was decided to try one spacing in between, and the array shown in the accompanying photograph is the result. Here the spacing is approximately three feet, a separation which lends itself to fairly lightweight construction with a minimum of cross-bracing. The folded dipole was tried in this array again, and the match was good enough so that it was included in the final model.

### Structural Details

The two arrays are mounted on 150-inch booms of good-quality seasoned  $2 \times 2$ . The selection of these two pieces is important; they should be free of knots and well seasoned, otherwise some distortion of the frame is likely to develop. Aluminum or dural tubing or channel stock might be substituted, if such material happens to be available. The two booms are separated at the proper distance and held in place by four vertical members, two pairs mounted about 30 inches from each end. These were  $1 \times 2$  stock, as is the "Z" brace between the booms, and the crossarms on which the 10-meter elements are mounted. Alignment of the 10-meter elements is maintained by means of triangular bracing of  $1 \times 1$ -inch stock. These braces were fastened in place in such position that the element crossarms were exactly horizontal when the booms were in a vertical plane. A large porch floor, a level, and a helper are handy here. Two small antisway braces were added, one on each side, when it was found that the whole assembly had a weaving tendency. The complication which appears near the center of the array in the accompanying photograph is largely the result of the rotating device, a temporary measure pending the acquisition of suitable motor-drive mechanisms.

The vertical support is a section of  $1\frac{1}{2}$ -inch pipe, which fits inside a bearing which is part of the Trylon tower used. The pipe is fastened to the lower boom by means of a strap of sheet aluminum which is bent to fit the boom and is pinned to the pipe by means of two bolts. The boom is braced fore and aft by two sets of braces made of 1-inch aluminum angle stock. The cross-arm on which the driven element is mounted is also braced to the vertical support.

The elements of the 10-meter array are mounted on cone insulators in the conventional manner, but the 6-meter elements are handled in a somewhat unusual fashion, the suggestion of W1PFJ, Waltham, Mass. Two blocks of good-quality bakelite, approximately  $\frac{1}{2} \times 2 \times 4$  inches in size, are used for each element. These blocks are drilled to fit the elements used, in this case 1-inch diameter, and are screwed to each side of the boom. A setscrew is inserted in a tapped hole in the edge of each block, to keep the element in place. The blocks which carry the driven element have a  $\frac{1}{4}$ -inch hole below the 1-inch one, to hold the driven section of the folded dipole in place.

Both arrays are fed with 300-ohm Amphenol line, which is light in weight and easy to use in such installations. One precaution must be taken to avoid breakage, however. If the line is left dangling for any appreciable length from the point at which it is fastened to the elements it is sure to break off in a few days. A handy device for preventing this trouble is the new stand-off in-

sulator produced by Workshop Associates, Needham, Mass. This neat little gadget which grips the line tightly, clothes-pin fashion, may be fastened to any support by means of a wood screw or bolt. The line will stand any reasonable load or strain when mounted in this way.

The elements are all of the same material: 1-inch aluminum tubing, the size being determined by what happened to be available at a local junk yard. As anyone knows who has shopped around for such things, aluminum or dural tubing is seldom easy to find these days. As a tip: try the second-hand yards and the smelting outfits, particularly those in or near cities where there are aircraft plants. There is a vast quantity of reject or surplus tubing being disposed of through such channels, and it's quite OK for antennas. Electrical and mechanical details of the 50-Mc. array, other than the points mentioned above, are contained in *QST* for June, 1946. The element lengths are derived by the formula mentioned above, except that the forward director is 6 per cent shorter than the driven element. Spacing is 46 inches for the reflector and first director, and 57 inches for the forward director. Element lengths for the low half of the band are 116 inches for the reflector, 110 inches for the driven element, 105 inches for the first director and 103 inches for the second. The driven element is a folded dipole having the fed section made of  $\frac{1}{4}$ -inch tubing or rod, spaced approximately one inch from the parallel section which is 1-inch tubing.

Typical examples of the "T-match" used on the 10-meter array are contained in *QST* for April, 1946, page 148, and the August issue, page 67. Almost everyone will have his own ideas on how this may be worked out, the main idea being to provide a pair of strap connectors which may be slid along the "T" section and the driven element, to provide a good electrical connection between the two, at the point which will give the best match. The two portions of the "T" are insulated at the center, and held in alignment by a piece of polystyrene rod which may be turned down to fit the inside of the tubing used. The 300-ohm line may be attached to the two portions of the "T" by means of soldering lugs and bolts. The "T" section should be made at least 30 inches long each side of center, to provide a range of adjustment.

### Tuning Up

Tuning adjustments turned out to be relatively unimportant on the final model. With everything adjusted for best performance it was found that we had no unusual dimensions. In fact, the first experimental model of the 10-meter portion was cut according to the information given above and erected without any tuning whatsoever. The "T"-section clips were set at two feet out from the center, and the beam provided very satisfac-

tory performance in that form, even though mounted on a temporary mast only 12 feet above ground. Though several days were spent in adjusting element lengths and resetting the "T-match," only a slight improvement was effected. We learned this the hard way, however, and a few pitfalls we encountered may be of interest.

In setting the position of the "T" clips, for instance, we found it impossible to get a low standing-wave ratio at first. There seemed to be two resonance points in the system when we checked the working range with our VFO, and one of these turned out to be caused by feeder resonance. It gave us some strange results on element length adjustment, until we added a few feet of line. Then the elements tuned up according to formula, and the setting of the "T" adjustment proved to be quite uncritical, the best position being at about 25 inches out from the center of the "T." Another source of trouble was the antenna relay. We found it much easier to flatten the line when it was connected directly to the transmitter coupling coil, instead of running it through the send-recv relay. Any relay we've yet seen affects the standing-wave ratio adversely, and makes adjustment of matching devices just that much more difficult. We want to use the relay, of course, but it is well to make adjustments without it and hope for the best when it is inserted. If the match is close, the result will not be too bad — we ended up with an indicated ratio of less than 2 to 1, even after the relay was inserted.

Standing-wave ratio can be checked in several ways. The field-strength indicator may be used, by running the pick-up antenna along the line and noting the variation in reading. Another and even simpler method is to grasp the line in one hand and note the variation in radiated power as indicated on the field-strength meter set up at a distance. If the line is flat there will be only a very small change as the line is gripped, and this change will be the same at any point along the line. Another method is the use of a fluorescent tube, the length of the illuminated portion giving a fairly sensitive indication. This is not suitable for low power, however, as no indication will be obtainable with low-powered rigs if the line is flat. None of these methods gives an accurate measurement of standing-wave ratio, but they serve well as a basis for comparison in making adjustments, and the best setting is readily discernible. Eliminating the last vestige of standing waves is not particularly important, as may be determined by examination of the tables<sup>3</sup> for losses with 300-ohm line at various lengths and ratios. A fairly close match will help in insuring a good frequency response, and if the antenna loads well over a

(Continued on page 128)

<sup>3</sup> "Standing Waves — Good or Bad?," *QST*, December 1946, page 56.

# The Old Stand-By

## A Four-Tube Regenerative Receiver

BY GEORGE D. KNIPE,\* W7IGE

**T**HE receiver to be described is a "new-and-improved" model of a receiver used at this station for about two years before the war. The old model used a 75 detector, two 6J5s as audio amplifiers and a pair of 6F6s in the output stage. There were several objections to that particular arrangement — it drew 120 ma. of plate current, it was large physically, and the audio gain was too low. The present model overcomes these objections by using only one 6F6 in the output stage and substituting 6SQ7s for the 6J5s, thus bringing the current demand down to 45 ma. No audio interstage transformers or cathode by-pass condensers are used, and the space saved allows the receiver to be housed in a 6 × 9 × 5-inch utility cabinet. The 6SQ7s give more gain than the 6J5s.

### The Circuit

The circuit, shown in Fig. 1, is conventional in most respects. The Type 75 tube was used in the detector stage because it proved to be very smooth in control of regeneration, the plate current is so low that resistance coupling can be used, a minimum of condensers and resistors are necessary with a triode, and the tube gives considerable gain. Condenser control of regeneration through  $C_5$  is smooth and noiseless, and with the

• The familiar regenerative receiver still has plenty of followers, even in these days of supersignal superhets and chromium-plated dial lights. Here is a description of a simple regenerative receiver designed by one of the faithful, and the design points are all good ones. W7IGE believes in a regenerative receiver with good bandspread, smooth regeneration control and plenty of audio gain, and in this story he tells how to build them all into a receiver.

resistance plate load,  $R_2$ , there are no troubles with fringe howl. A mica condenser,  $C_{15}$ , from one heater lead to ground, was included because it seemed to reduce the noise level. The 10- $\mu$ fd. bandspread condenser,  $C_4$ , gives full-scale coverage on the 7- and 14-Mc. bands and about half-scale coverage on the 28-Mc. band. On 3.5 Mc. the band-set dial must be reset once to cover 3500 to 3900 kc., and a second time to cover the 75-meter 'phone band. This method of coverage on 80 may seem objectionable, but in these days most amateurs seldom tune across more than half of the band when looking for an answer to a CQ, and many only tune a few kc. either side of their own frequency.

\*Route 3, Nampa, Idaho.

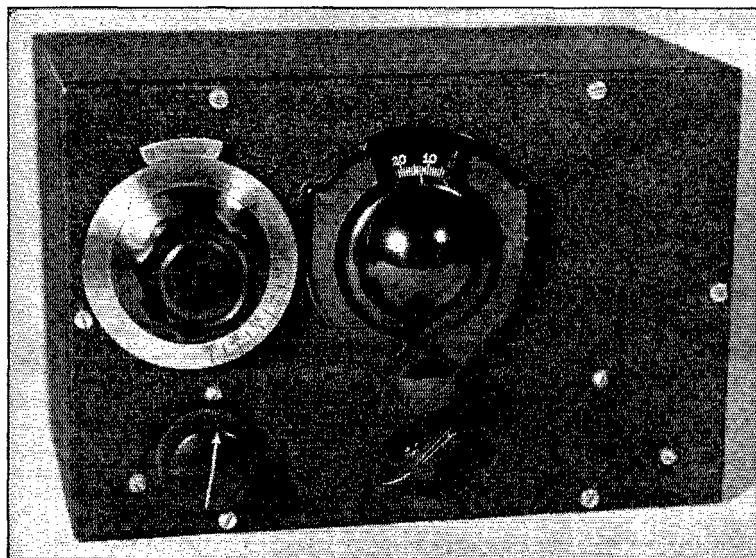

◆  
A four-tube regenerative receiver, all dressed up and ready to go places. The main tuning dial is in the center — the band-set dial is at the left. The lower knobs are for regeneration and audio gain control.  
◆



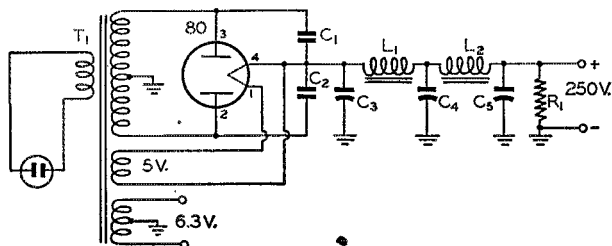

Fig. 2 — Circuit diagram of the receiver power supply.

$C_1, C_2$  — 0.002- $\mu$ fd. mica.  
 $C_3, C_4, C_5$  — 8- $\mu$ fd. 450-volt electrolytic.  
 $R_1$  — 50,000 ohms, 5-watt wirewound.  
 $L_1, L_2$  — 10-henry 50-ma. choke.  
 $T_1$  — Power transformer, 240-0-240 volts, 50 ma.; 5 v.; 6.3 v.

tude of the signal. This corresponds to a loaded condition of the detector — if the coupling is too loose the regeneration control will be quite touchy. The condenser is mounted in the receiver on the back lip of the chassis, and is adjusted with an insulated screwdriver.

The 6SQ7s make use of cathode degeneration to stabilize the amplifier and this, incidentally, eliminates the need for cathode by-pass condensers. The value of plate load resistor is low for these tubes, and this keeps the stage gain down to about 20, further adding to the stability of the amplifier. Decoupling networks in the plate leads furnish the final contribution to stability of the audio channel. Each 6SQ7 draws only about 1 ma., so the power-supply demand is insignificant.

The 6F6 used in the output stage provides plenty of audio power and drives a 6-inch p.m. speaker nicely. No 'phone jack was provided, but one could be added, as shown by the dotted lines in Fig. 1. The condenser should be 0.25  $\mu$ fd. or larger.

It will be noted that a wirewound resistor is called for at  $R_6$ . One was used in this receiver because a carbon resistor at that point was noisy.

It is probably not necessary to use a wirewound resistor, because the noise from the detector should be sufficient to mask any noise developed in later stages, but it is well to bear in mind that composition resistors *can* be noisy.

The receiver chassis measures  $7\frac{1}{2} \times 2\frac{1}{4} \times 4\frac{1}{2}$  inches. It must be at least  $2\frac{1}{4}$  inches deep so that the regeneration-control condenser can be unmeshed without the rotor plates touching the bottom of the receiver cabinet. The other two dimensions could vary slightly without causing any construction difficulty, so long as the chassis will fit conveniently into the cabinet to be used.

The placement of the parts is shown in the photographs. Referring to the bottom view of the chassis: the resistor between the volume control and the detector socket, just to the right of the 8- $\mu$ fd. condenser, is the detector decoupling resistor. The detector plate-load resistor is underneath the 8- $\mu$ fd. condenser just referred to. The heavy wire running from one of the lugs on the terminal strip to the detector decoupling resistor is the B+ line. The cathode bias resistors

(Continued on page 138)

The components are readily identified in this view of the regenerative receiver. A tube shield covers the detector tube. Note the hole on the back of the chassis through which the antenna coupling condenser is adjusted.

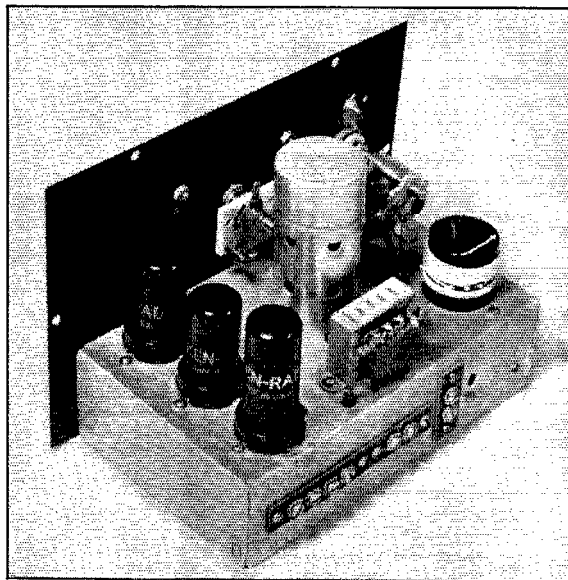

# Tenth ARRL Field-Day Results

*Hit of the 1946 Summer Season!*

**CAST:** Total of 1936 amateur radio operators, 187 portable stations and 53,622,879 (estimated) assorted insects.

**TIME:** June 22-23, 1946.

**PLACE:** Hamdom.

**SETTING:** "The Great Outdoors" — a canyon in Utah . . . lakes in New Hampshire, California, Michigan, Vermont, Ontario, Illinois and Massachusetts . . . Boy Scout camps in Ohio, Illinois, Connecticut and New Jersey . . . a Nova Scotia hill overlooking the Atlantic . . . mountains in California, Idaho, Arkansas, Oregon, South Carolina, Washington and Maryland . . . a university stadium in New York . . . a city zoo in Wisconsin . . . a prairie in Washington . . . a battlefield national park in Virginia. . . .

A reservoir in California . . . a ski-slide tower in Illinois . . . farms in Pennsylvania, Ohio, Illinois and New Jersey . . . a boat anchored at a Maryland yacht club . . . Skyline Drive, Virginia . . . a camp in Rocky Mountain National Park . . . California hills overlooking the Pacific . . . a state park in New York . . . a state forest in Illinois . . . city parks in Indiana and Connecticut . . . fair grounds in Minnesota, Iowa, Wisconsin and Ohio . . . a valley in California. . . .

A dock 300 yards out in Puget Sound, Washington . . . fire towers in Massachusetts and Maryland . . . an Army observation tower in California . . . a bluff on Long Island Sound . . . an abandoned air-raid warning tower in Washington . . . a National Guard camp in South Dakota . . . beaches in California and Nova Scotia . . . creeks in Wisconsin and Iowa . . . locations of every description, with elevations ranging from sea level to 9000 feet.

**PROPS:** Transmitters, receivers, genemotors, Vibrapacks, dynamotors, storage batteries, gas-driven generators, dry batteries, rotary converters, gas-driven alternators, antennas, poles, microphones, keys, sectional masts, crystals, rotary beams, headphones, meters, feed lines, enthusiasm. . . .

Battery chargers, spare parts, gasoline, funnels, wire, insulators, blow torches, BX, rope, Selsyns, ladders, guy wire, tools, Kytoons, oil, intercom systems, soldering irons, elbow grease. . . .

Chairs, stools, boxes, tents, tarpaulins, clocks, watches, oil lamps, blankets, flashlights, automobiles, mattresses, trucks, tables, benches, cots, oil stoves, trailers, electric heaters, pencils, paper, logbooks, station wagons, electric lights, Jeeps. . . .

## FIELD-DAY LEADERS

Class	Leader	Parti- cipants	Call Used	Contacts	Score
<i>Club Groups</i>					
One Transmitter	Narragansett Association of Amateur Radio Operators	7	W1LWA/1	199	3051
Two Transmitters	The Greater Cincinnati Amateur Radio Association	15	W8JIN/8	306	4320
Three Transmitters	Motor City Radio Club, Inc.	11	W8ONK/8	319	4500
Four Transmitters	Four Lakes Amateur Radio Club	16	W9RNX/9	308	4239
Five Transmitters	Northwest Amateur Radio Club	20	W9IT/9	511	6363
Six Transmitters	San Fernando Valley Radio Club	26	W6SD/6	350	5981
Seven Transmitters	Frankford Radio Club	25	W3BES/3	651	8568
Eight Transmitters	Jersey Shore Amateur Radio Association	27	W2FC/2	809	9621
<i>Nonclub Groups and Individuals</i>					
One Transmitter	W9RCQ	1	W9RCQ/1	132	2115
Two Transmitters	W8PWY-W8GW-W8GD-W8EBJ-W8BSS-W8AVH-W8QV	7	W8GW/8	167	2529
Three Transmitters	W9ERU-W9AIC-W9BRY-W9HOA-W9EZQ-W9NTV-W9MAP-W9AGV-W9YPE-W9BNO	10	W9ERU/9	198	2574
Four Transmitters	W3KHJ-W4IFV-W5EPJ-W6PXU-W7HDF-W8MHR-W8EYU-W9STB-W9VDV	9	W3KHJ/3	46	381
<i>V.H.F.-Only Groups</i>					
One Transmitter	W6SHD-Topp-Vallette-Shryock	4	W6SHD/6	45	756
<i>AEC Groups</i>					
One Transmitter	(Erie County (Pa.) AEC Members)	(12)			
	High Scorer — W3KLD	1	W3KLD/3	9	108
Two Transmitters	Warren County (Pa.) Emergency Corps	9	W8KYW/3	99	1368



Coffee, cameras, field kitchens, fly swatters, bottle openers, canned milk, sunburn lotion, "vittles," water (?), portable cook-stoves, field glasses, paper cups, first-aid kits, mosquito netting, sunglasses, cooking utensils, cigarettes, citronella, can openers and strong constitutions!

It would be pointless to compare prewar scores with those made in the '46 FD, since the operating conditions were so different. The Tenth FD found us without the 1.75-, 7-, and 14-Mc. bands, which served us so well in earlier years. So let's consider the results of the first postwar FD on their own merits.

Leading the entire field was the Jersey Shore Amateur Radio Association operating W2FC/2 on Crawford's Hill, believed to be the highest point in Monmouth County, N. J. Twenty-seven operators, manning eight simultaneously-operated rigs, made 809 contacts, 234 with FD stations, 575 with fixed stations. Final score was 9621. Power was obtained from two 5-kw. gas-driven generators. All available frequency bands were used from 3.5 through 144 Mc., 'phone and c.w. A 420-Mc. rig was also on hand. Antennas ranged from doublets on 3.5 Mc. to an 8-element rotary beam on 144 Mc. Incidentally, the J.S.A.R.A. crew placed second in the last three prewar FDs, and have set the postwar pace with a vengeance. The laurels are yours, Jersey Shore!!

Second-high was the Frankford Radio Club, that well-known group of Philadelphia contest experts. Operating W3BES/3 at Fairview, Pa., with seven rigs, twenty-five operators amassed 8568 points (651 contacts) under the F.R.C. banner. Transmitters were used simultaneously on 3.5-Mc. c.w., 3.9-Mc. 'phone, 28-Mc. 'phone and c.w., 50-Mc. 'phone, and 144-Mc. 'phone. Four

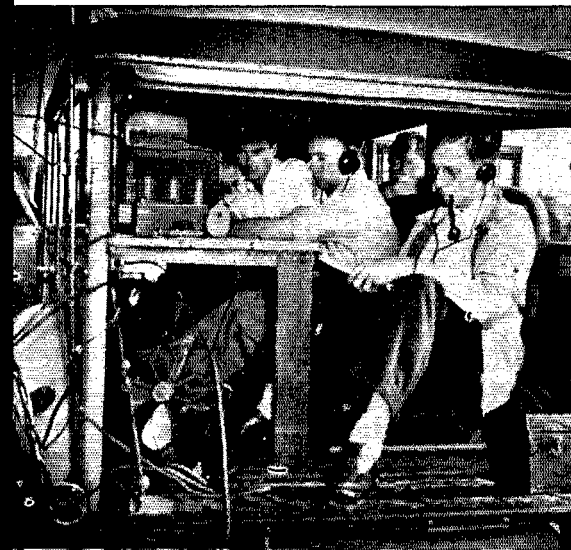

A typical FD operating position was that at W3LN/3, Lancaster Radio Transmitting Society. The one transmitter used is atop the S-20R receiver. Three operators manned the station in two-hour shifts, one at each receiver, one keeping the station log and records.

gas-driven 110-volt a.c. generators supplied all power. Perennial threat in all operating activities and winner in many, these lads will bear watching in the '47 FD. Nice work, Frankford!

The Tri-County Radio Association placed third with a score of 6921. A total of 544 contacts was made using 3.5-Mc. c.w., 3.9-Mc. 'phone, 27-Mc. 'phone, 28-Mc. 'phone and c.w., 50-Mc. 'phone, and 144 Mc. Eight transmitters were operated simultaneously. Power source was a 3-kw. gas-driven generator. The site was Watchung, N. J., the call W2KHK/2, and the personnel numbered twenty. A job well done brings its own reward. FB, T.C.R.A.

### TEN HIGH SCORES

Clubs		Others	
W2FC/2	9621	W9ERU/9	2574
W3BES/3	8568	W8GW/8	2529
W2KHK/2	6921	W9RCQ/1	2115
W9IT/9	6393	W6PNU/6	1978
W3AC/2	6237	W6STA/6	1877
W6SD/6	5981	W2FBA/2	1827
W6SIF/6	5549	W1MLT/1	1656
W6VX/6	5304	W3JYY/4	1629
W6RNQ/6	5234	W6NIK/6	1580
W8ONE/8	4500	W9VPD/9	1557

Top scorer among the nonclub groups was the gang at W9ERU/9 on the grounds of the Rockford (Illinois) Ski Club. The ten operators conducted their operations on 3.5-Mc. c.w., 3.9-Mc. 'phone, 28-Mc. 'phone and c.w., and 144-Mc. 'phone. Three transmitters were operated simultaneously. Two gas-driven generators furnished power for all equipment. The 28-Mc. 'phone rig, complete station, operators, antenna and all, were over 150 feet above the earth, atop the ski-slide tower. True to its name, the "plumber's delight" rotary beam was turned by means of a pipe wrench! Congratulations to the W9ERU/9 lineup: W9ERU, W9AIC, W9BRY, W9HOA, W9EZQ, W9NTV, W9MAP, W9AGV, W9YPE and W9BNO!!

Seven operators, who call themselves "The Old Timers" Group of the Cuyahoga Radio Associa-

The Mountaineer Amateur Radio Association, Fairmont, W. Va., operated W8BOK/8 with six transmitters running simultaneously. A 3.5-Mc. c.w. set-up was in a station wagon, which apparently provided comfortable, though compact quarters. Other rigs worked on 6-, 10-, 11-, and 75-meter 'phone.

**QST for**



The Inglewood Amateur Radio Club picked a site in the Palos Verdes Hills, Calif. The v.h.f. set-up included a 50-Mc. rig in the car and a 144-Mc. station in the tent. Antennas for each are shown. Used at other positions were 3.5-Mc. c.w., 3.9-Mc. 'phone, and 28-Mc. 'phone.

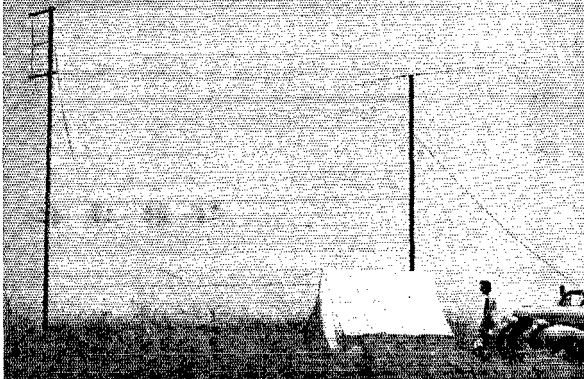

### AEC Members

tion," participated as an individual group at Montville, Ohio. These gents, W8PWY, W8GW, W8GD, W8EBJ, W8BSS, W8AVH and W8QV, placed second among nonclub groups. Tally: 167 contacts, 2529 points, only 45 points behind the top group! All operation was on 3.5-Mc. c.w. with two simultaneously-operated rigs. Power came from a 600-watt gas-driven a.c. generator. A mighty nice showing, OMs!!

Third-high in the nonclub category was one-operator W9RCQ/1 at Wayland, Mass. All operation was by "himself" on the 3.5-Mc. c.w. band. A total of 132 contacts resulted in a score of 2115. An unusual part of the set-up was use of a Kytoon-supported antenna, which also was used by W1LLX/1 and was described in *QST* (October '46, page 24). A 350-watt gas-driven generator supplied ample 110 a.c. to run the transmitter and receiver. Our best "well done" to W9RCQ for making the highest "one-man" score.

The highest one-band one-transmitter score was rolled up by twenty operators at W3LN/3, the Lancaster Radio Transmitting Society. This group made 156 contacts (115 field stations) on the 3.5-Mc. band with but one transmitter available at any time. Two receivers were running constantly. Operation was in two-hour periods with two operators and one log keeper on duty during each watch. Efficient planning and skillful operating produced for these brass pounders!

### V.H.F.-Only

Eight stations were entered in the v.h.f.-only classification. W6SHD/6 operating on 144 Mc. on Keller Peak, near San Bernardino, Calif., was top scorer, 756 with 45 QSOs by four operators. The 2.5-watt transmitter was powered from 6-volt batteries and generator. W6VQB/6 (two operators) was second with 729 points, all on 144 Mc. This was the first FD in which special listing for v.h.f.-only groups was announced. It is expected that competition in this classification will build up in future FDs.

The highest-scoring FD group, the Jersey Shore Amateur Radio Association, W2FC/2, scattered its eight transmitters at this location. Four of the operating positions are shown, as well as three masts. The generator may be seen in the foreground. J.S.A.R.A. is looking forward to defending its title in the 1947 Field Day!

Although most FD participation by ARRL Emergency Corps members was with clubs or other parties, a number took part as AEC groups. These are shown with special heading in the score listings. Leader among AEC groups was W8KYW/3, the Warren County (Pa.) Emergency Corps. The nine operators in this group made 99 contacts, 1368 points. They write, "Our Field Day operation demonstrated local ability to maintain contact with outside communities using our emergency equipment and power units."

### Miscellany

The activity at any Field Day station, whether a simple battery-powered rig or an elaborate lay-out backed up by a 10-kw. generator, would make an interesting story regardless of score. Space permitting, we would give you the details of all locations. However, that would take several issues of *QST*, so we'll do the next best and pass along a few sidelights.

The importance of advance planning, both for equipment and operation, cannot be overemphasized. Gear will pick an FD every time for "break-downs." With a number of operators available, a systematic plan of operations must be formulated *before* the event — either that, or confusion reigns. . . . To avoid duplication of contacts with stations worked before and to keep



contact lists up to date, the W3ZD/2 team used a card index system and an intercom system between tents. . . . W1GB/1 used an intercom system between transmitter and receiver locations for shifting frequencies and other instructions relative to adjustments. . . . We noticed a very descriptive report in the message from W3ZD/2, "Conditions primitive." That describes conditions at many FD locations! . . . Intercommunication between two units at W9RQM/9 was maintained by 144-Mc. transceivers. . . . The Cambridge (Ohio) Amateur Radio Club concluded the FD week-end with a picnic supper. . . . W4BLU/4, at Fort Story, Va., used an antenna 1000 feet long. One end was supported by an Army radar and observation tower, the other end hooked to a tree across a lake. . . . W4KZ/4, atop a mountain, had the services of two 144-Mc. mobile units for maintaining communication up and down the mountain and facilitating procurement of supplies. . . . The East Texas Amateur Radio Club reported an attendance of 186 at its FD location! . . . Several noteworthy v.h.f. contacts during FD were reported. The 2300-Mc. QSO between W1JSM and W1ILS, 1.6 miles, has been previously reported in *QST*. The 144-Mc. DX QSO for W1JCI/1, Waltham, Mass., was with Mt. Greylock, Mass., approximately 103 airline miles. W6TRK/6 worked 175 miles on 144 Mc. W6GM/6 worked 160 miles on 144 Mc., better than the then-current record. . . . W8BOK/8 in West Virginia made 50-Mc. contact with Kansas City. The W6BKZ/6 gang was thrilled to hear W1HDQ on 50 Mc. Outstanding event for the Hamilton Amateur Radio Club, VE3KM, was the first 144-Mc. contact between Hamilton and Buffalo. . . . The St. Paul Radio Club crew again used their "card-index-log" system, which proved so useful in previous FDs. They reduced their duplicate contacts to a negligible number by use of the system. . . . W3LN/3 was on a hilltop accessible by means of a farm tractor with trailer attached. Liaison with the farmhouse below was by means of 144 Mc. . . . Foul weather heckled some, but the Northwest Amateur Radio Club reported "no rains, no storms," for the first time in ten years of Field Days! . . . Members of the Seattle YMCA ham club (W7YC) used W7RT/7 as target in a hidden-transmitter hunt on FD Sunday. The winners found him in six hours. . . . The Victoria (B.C.) Short Wave Club participated in the Field Day by holding a hidden-transmitter hunt. VE7AAZ operated the concealed transmitter, which was located first by VE7CH and VE7HR. . . .

We had waited five years for the Tenth ARRL Field Day. The long wait made the affair doubly enjoyable, but some of us found that the intermission had slowed us down. We were out of practice in many of the fine points of FD preparation and participation. It will be different next

June, according to closing remarks on many logs. Experience gained in '46 will "pay off" in '47. Make your plans early!

— E. L. B.

### CLUB GROUPS

One Transmitter		QSOs	Power*	Score
W1LWA/1	Narragansett Association of Amateur Radio Operators <sup>1</sup> ..	199-	A-	3051
W3LN/3	Lancaster Radio Transmitting Society <sup>2</sup> .....	156-	A-	2664
W1EH/1	South Lyme Beer, Chowder and Propagation Society <sup>3</sup> .....	143-	A-	2372
W8SLO/8	The Greater Cincinnati Amateur Radio Association <sup>4</sup> .....	145-	A-	2313
W0RFT/0	North East Iowa Radio Amateur Association <sup>5</sup> .....	92-	A-	1737
W5IYJ/5	East Texas Amateur Radio Club <sup>6</sup> .....	133-	B-	1566
W2NNP/2	KBT Radio Club <sup>7</sup> .....	83-	A-	1350
W8HHK/3	Susquehanna Valley Amateur Radio Club <sup>8</sup> .....	101-	B-	1286
W8NLG/8	Detroit Amateur Radio Association <sup>9</sup> .....	67-	A-	1233
W4BLU/4	Ocean View Radio Club <sup>10</sup> .....	60-	A-	1026
W8AAB/0	Electron Club of Denver <sup>11</sup> .....	49-	A-	999
W7EMF/7	Butte Amateur Radio Club <sup>12</sup> ..	39-	A-	972
W1AQ/1	Associated Radio Amateurs of Southern New England <sup>13</sup> .....	40-	A-	945
W1LXT/1	Recreation Radio Club <sup>14</sup> .....	73-	A-	906
W9AKY/9	LaCrosse Radio Amateurs' Club, Inc. <sup>15</sup> .....	48-	A-	738
K6FAZ	Maui Amateur Radio Club <sup>16</sup> ..	46-	A-	716
W8RVU/8	Cambridge Amateur Radio Club <sup>17</sup> .....	28-	A-	702
W4NC/4	Winston-Salem Amateur Radio Club, Inc. <sup>18</sup> .....	79-	B-	576
K6QLG	Maui Amateur Radio Club <sup>19</sup> ..	39-	A-	540
W9HJJ/9	Delaware Amateur Radio Association <sup>20</sup> .....	48-	AB-	498
W5AQK/5	Corpus Christi Radio Club.....	75-	A-	484
W7WU/7	Gem State Radio Club <sup>21</sup> .....	13-	A-	378
W8INE/3	Boys' Club of St. Mary's Amateur Radio Society <sup>22</sup> .....	22-	A-	315
VE3BER	Clinton Amateur Radio Club <sup>23</sup> ..	67-	C-	276
W8TEW/2	Sidney Amateur Radio Club <sup>24</sup> ..	15-	A-	234
W9LX/9	The Chicago Amateur Radio Club <sup>25</sup> .....	13-	A-	216
W6TMK/6	Utah State Electronics Society.	9-	A-	203
<i>Two Transmitters Operated Simultaneously</i>				
W8JIN/8	The Greater Cincinnati Amateur Radio Association <sup>26</sup> .....	306-	A-	4320

\* The "power classification" used computing the score is indicated by A, B or C after the number of QSOs shown. A indicates power up to and including 30 watts (multiplier of 3); B indicates power over 30, up to and including 100 watts (multiplier of 2); C indicates over 100 watts (multiplier of 1). More than one letter means that at different times power inputs fell within different classifications.

*Club participants:* <sup>1</sup>W1KOG, KYK, LCH, LQL, LWA, MJL, MQF. <sup>2</sup>W3ADM, ADX, AXT, BTP, CEE, DEI, DFI, DRO, EOB, EWR, FHV, HOA, KAK, KBZ, KIE, KKW, LN, W4HXA, Simons, Carroll. <sup>3</sup>W1EH, BUD, DX, LVQ, PEK. <sup>4</sup>W8RSW, SLH, SLO, SMC, UOD, BFB, ODF, TEZ, TYM, Corcoran. <sup>5</sup>Nineteen. <sup>6</sup>186. <sup>7</sup>W2PZJ, NNP, IIE. <sup>8</sup>Six. <sup>9</sup>W8QQK, SCW, MGQ, GP, MCB, DPE, RMH, DOV, BIU, LSF. <sup>10</sup>W3JPO, W4DHZ, HPC, LJW, INJ, IPY, BLU, ISH, W8VVS, W9CIT, and two more. <sup>11</sup>W0YFJ, IXM, GYT, LYJ, ODV, AAB, JBI, Norborg. <sup>12</sup>Five. <sup>13</sup>Six. <sup>14</sup>W1EAX, LTY, LXE, MND, MSV, MVF. <sup>15</sup>K6FAZ, PHD, BJJ, QBI. <sup>16</sup>W1NQX/8, W8RVU, HDG, WAV, SGE. <sup>17</sup>Twelve. <sup>18</sup>K6QLG, THA, THF. <sup>19</sup>W9HJJ, HOG, DOK, EDU, JDW, MDL, FPN, OMD, VYQ, NQB. <sup>20</sup>W1NYG, W7IQG, W7IWU. <sup>21</sup>W3KXP, REE, W810I, IOH, NDE, HRW. <sup>22</sup>Eight. <sup>23</sup>W8TEW, URG, SYN, QOQ, KEP. <sup>24</sup>W9LRN, KXD, MBP. <sup>25</sup>W8JIN, MGR, LPD, PBU, POK, RSP, SLB, BCJ, BFB, BOJ, ODF, SEZ, TYM, Corcoran, Mink.

(Continued on page 134)

# Postwar Countries List

## Official List for ARRL DX Contest and the Postwar DXCC

MANY of the DX men have been at a loss to appraise accurately their postwar DX accomplishments because the last revised Countries List was made up back in 1939 and, since that time, many areas have been shuffled about and postwar stations have cropped up in locations never before considered. To reach as satisfactory a revision as possible, a committee made up of G2MI for the R.S.G.B. slant, W6QD and his advisory group of several prominent W6s, and a five-man ARRL Headquarters group has been collaborating during the past few months to

revise the list and polish off the rough edges. A number of changes have been made, but they have been made almost unanimously, so it is felt that the present list is a good cross-section of opinion. A careful check of the list will show that a number of countries have been added and that several have been deleted or combined.

Naturally there will be some difference of opinion by some of the DX men, and the collaborators will be pleased to entertain any criticisms. In the meantime, it becomes your yardstick in the ARRL DX Contests and DXCC.

Aden and Socotra Island.....	V89	Cocob Islands.....	ZC2
Afghanistan.....	YA	Colombia.....	HK
Alaska.....	KL7	Comoro Islands.....	
Albania.....	ZA	Cook Islands.....	ZK1
Aldabra Islands.....		Corsica.....	
Algeria.....	FA	Costa Rica.....	TI
Andaman Ids. and Nicobar Ids.....		Crete.....	SV
Andorra.....	PX	Cuba.....	CM-CO
Anglo-Egyptian Sudan.....	ST	Cyprus.....	ZC4
Angola.....	CR6	Czechoslovakia.....	OK
Argentina.....	LU	Denmark.....	OZ
Ascension Island.....	ZD8	Dodecanese Islands (e.g., Rhodes).....	SV5
Australia (including Tasmania).....	VK	Dominican Republic.....	HI
Austria.....	OE	Easter Island.....	
Azores Islands.....	CT2	Ecuador.....	HC
Bahama Islands.....	VP7	Egypt.....	SU
Bahrain Island.....	VU7	Eire (Irish Free State).....	EI
Baker Island, Howland Island and Am. Phoenix Islands.....	KB6	England.....	G
Balearic Islands.....	EA6	Eritrea.....	I6
Barbados.....	VP6	Ethiopia.....	ET
Basutoland.....	ZS4	Faeroes, The.....	OY
Bechuanaland.....		Falkland Islands.....	VP8
Belgian Congo.....	OQ	Fanning Island (Christmas Island).....	VR3
Belgium.....	ON	Fiji Islands.....	VR2
Bermuda Islands.....	VP9	Finland.....	OH
Bhutan.....		Formosa (Taiwan).....	
Bolivia.....	CP	France.....	F
Bonin Islands and Volcano Islands (e.g., Iwo Jima).....		French Equatorial Africa.....	FG8
Borneo, British North.....	VS4	French India.....	FN
Borneo, Netherlands.....	PK5	French Indo-China.....	F18
Brazil.....	PY	French Oceania (e.g., Tahiti).....	FO8
British Honduras.....	VP1	French West Africa.....	FF8
Brunei.....	VS5	Fridtjof Nansen Land (Franz Josef Land).....	
Bulgaria.....	LZ	Galapagos Islands.....	
Burma.....	XZ	Gambia.....	ZD3
Camerouns, French.....	FES	Germany.....	D
Canada.....	VE	Gibraltar.....	ZB2
Canal Zone.....	KZ5	Gilbert & Ellice Islands and Ocean Island.....	VR1
Canary Islands.....	EA8	Goa (Portuguese India).....	CR8
Cape Verde Islands.....	CR4	Gold Coast (and British Togoland).....	ZD4
Caroline Islands.....		Greece.....	SV
Cayman Islands.....	VP5	Greenland.....	OX
Celebes and Molucca Islands.....	PK6	Guadeloupe.....	FG8
Ceylon.....	VS7	Guantanamo Bay.....	NY4
Chagos Islands.....	VQ8	Guatemala.....	TG
Channel Islands.....	GC	Guiana, British.....	VP3
Chile.....	CE	Guiana, Netherlands (Surinam).....	PZ
China.....	XU, C	Guiana, French, and Inini.....	FY8
Christmas Island.....	ZC3	Guinea, Portuguese.....	CR5
Clipperton Island.....		Guinea, Spanish.....	
Cocos Island.....	TI	Haiti.....	HH
		Hawaiian Islands.....	KH6

Honduras	HR	Roumania	YR
Hong Kong	VS6	Ryukyu Islands (e.g., Okinawa)	ZD7
Hungary	HA	St. Helena	Y8
Iceland	TF	Salvador	Y8
Ifni		Samoa, American	KS6
India	VU	Samoa, Western	ZM
Iran	EP-EQ	Sarawak	VS5
Iraq	YI	Sardinia	
Ireland, Northern	GI	Saudi Arabia (Hedjas and Nejd)	HZ
Italy	I	Scotland	GM
Jamaica	VP5	Seychelles	VQ9
Jan Mayen Island		Siam	HS
Japan	J	Sierra Leone	ZD1
Jarvis Island, Palmyra group (Christmas Island)	KP6	Sikkim	(AC3)
Java	PK	Solomon Islands	VR4
Johnston Island	KJ6	Somaliland, British	VQ6
Kenya	VQ4	Somaliland, French	FL8
Kerguelen Islands		Somaliland, Italian	
Korea		South Georgia	VP8
Kuwait		South Orkney Islands	VP8
Laccadive Islands	VU4	South Sandwich Islands	VP8
Leeward Islands	VP2	South Shetland Islands	VP8
Liberia	EL	Southwest Africa	ZS3
Libya	(LL)	Soviet Union:	
Liechtenstein	HE1	European Russian Socialist	
Little America	KC4	Federated Soviet Republic	UA1-3-4-6
Luxembourg	LX	Asiatic Russian S.F.S.R.	UA9-#
Macau	CR9	Ukraine	UB5
Madagascar	FB3	White Russian Soviet Socialist Republic	UC5
Madeira Islands	CT3	Azerbaijan	UD6
Malaya	VS1, VS2	Georgia	UF6
Maldivo Islands		Armenia	UG6
Malta	ZB1	Turkoman	UH8
Manchuria		Uzbek	UI8
Marianas Islands (Guam)	KG6	Tadzhik	UJ8
Marshall Islands		Kazakh	UL7
Martinique	FM8	Kirghiz	UM8
Mauritius	VQ3	Karelo-Finnish Republic	UN1
Mexico	XE	Moldavia	UO5
Midway Island	KM6	Lithuania	UP
Miquelon and St. Pierre Islands	FP8	Latvia	UQ
Monaco		Estonia	UR
Mongolia		Spain	EA
Morocco, French	CN	Sumatra	PK4
Morocco, Spanish	EA9	Svalbard (Spitzbergen)	
Mozambique	CR7	Swan Island	KS4
Nepal		Swaziland	
Netherlands	PA	Sweden	SM
Netherlands West Indies	PJ	Switzerland	HB
New Caledonia	FK8	Syria	(AR)
Newfoundland and Labrador	VO	Tanganyika Territory	VQ3
New Guinea, Netherlands	PK6	Tangier Zone	EK
New Guinea, Territory of	VK9	Tannu Tuva	
New Hebrides	FU8, YJ	Tibet	AC4
New Zealand	ZL	Timor, Portuguese	CR10
Nicaragua	YN	Togoland, French	FD8
Nigeria	ZD2	Tokelau (Union) Islands	
Niue	ZK2	Tonga (Friendly) Islands	VR5
Norway	LA	Trans-Jordan	ZC1
Nyasaland	ZD6	Trieste	
Oman		Trinidad and Tobago	VP4
Palau (Pelew) Islands		Tristan da Cunha and Gough Island	ZD9
Palestine	ZC6	Tunisia	FT4
Panama	HP	Turkey	TA
Papua Territory	VK4	Turks and Caicos Islands	VP5
Paraguay	ZP	Uganda	VQ5
Peru	OA	Union of South Africa	Z8
Philippine Islands	KA	United States of America	W, K
Phoenix Islands (British)		Uruguay	CX
Pitcairn Island	VR6	Venezuela	YV
Poland	SP	Virgin Islands	KV4
Portugal	CT	Wake Island	KW6
Principe and Sao Thome Islands		Wales	GW
Puerto Rico	KP4	Windward Islands	VP2
Reunion Island	FR8	Wrangel Islands	
Rhodesia, Northern	VQ2	Yemen	
Rhodesia, Southern	ZE	Yugoslavia	YT-YU
Rio de Oro		Zanzibar	VQ1

# DX Operating

## A Poll of the Opinions of Foreign Amateurs

BY BYRON GOODMAN,\* WIDX

• Back in September a few of the Hq. gang were chinning about DX tactics and operating in general, and we got to wondering how the Ws and their practices look to some of the outstanding DX stations throughout the world. After a lot of conjecture which proved nothing, it was decided that the best way to find out would be to ask a few. (We were pretty brilliant on that particular day!) It didn't take very long to cook up a letter and a list of some of the most savvy DX stations, and the rest was left up to the air-mail service. In due time enough replies were received for the thing to shape up, and we were pleasantly surprised at the general uniformity of opinion of these old hands at the game. We think you'll be interested in the opinions of these fellows you've been calling and working — or not working!

IN MAKING a poll of opinion of some of the outstanding DX stations, we trust that none of the twenty or thirty other stations we might have asked will feel slighted because we didn't consult him, but space limitations precluded any such action. However, those we did ask are among the top operators and will require no introduction to any seasoned DX man. John J. Alvares, CR9AG, is one of the most consistent Asian signals, and is well known to prewar DX men as VS6AG. Arthur O. Milne, G2MI, is one of England's top DX men, and conducts the DX column in the R.S.G.B. *Bulletin*. Camilo J. Raffo, LU7AZ, is one of South America's outstanding signals and operators, and he will be found active in any contest. Jacques Mahieu, ON4AU, is an old timer who has stood high in DX circles for many years, and W. M. Richards, VK5WR, is probably the top DX station "down under." Rex Basman, ZS2X, was the No. 1 ZS in the prewar DXCC and does the DX column for the Port Elizabeth Radio Association *Bulletin*. O. W. Reid, ZS6DO, is not yet quite as well known under that call as he was with ZS2A before the war, but any old hand from the early 30s will tell you that when you worked a ZS it was probably ZS2A, and if you took the weights off the bug it was ZS2A!

Eight questions were asked of these friends across the seas. Their replies follow each question, in order.

\* Assistant Technical Editor, *QST*.

### Operating

The first question was, "What is your general reaction to the operating habits of W stations, prewar and postwar?"

**CR9AG:** Before the war the Ws were more spread out and didn't QRM each other as they do now. Even during the past DX Contests there was not as much QRM as we have now, and I can just imagine what it is like back there. At present when conditions are favorable you can hear only a jumble of signals at the edge and very few after that.

**G2MI:** It seems now that the only replies one receives are always on the exact spot of one's own frequency. I think I haven't had a single 14-Mc. c.w. contact that has been anywhere but on my own frequency. This is a bad practice because often a half-dozen Ws line their VFOs on the same frequency and I have to wait for the last man out in order to decipher a call sign. Balked of their prey, the unlucky ones usually start calling "CQ," thus mining my contact.

Would all Ws calling a G listen carefully when he replies with some other W call? He may answer three stations at once and ask the others to wait. I have tried this method of giving several chaps a break but usually only the first call in my list answers. The others, say a W2 and W3, will hear me start to reply to a W1 and then flip the dial, thus they never know that I called W1ABC/W3ADC/W2XYZ and gave reports to all three.

**LU7AZ:** I think there is no great difference except the new custom of asking for the operator's name!

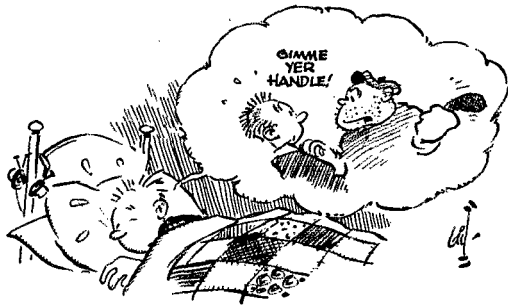

**ON4AU:** Generally W's operating habits were and are OK.

**VK5WR:** The operating habits of W stations postwar seem very much the same as they were prewar — perhaps more use is being made of VFOs.

**ZS2X:** There doesn't seem to be an appreciable change so far as I'm concerned. I do notice, however, that almost invariably one of the first questions put is, "QTH?" Before the war nobody seemed to worry what part of South Africa you were in. This sudden interest is probably only force of habit in our case and originated as a means to pinpoint all these new stations popping up in real out-of-the-way places for which there are no commonly-known calls.<sup>1</sup>

**ZS6DO:** Generally excellent, except for the 0.5 per cent who just don't know how. From what I have heard lately, postwar operating is still excellent if not better than prewar. Quite a few Ws are using break-in.

<sup>1</sup> And also because new *Call Books* are still scarce. — Ed.

## Likes & Dislikes

The next query was, "What operating practices of Ws do you like, and what practices do you dislike?"

**CR9AG:** Some of the Ws call you at the band edge and QSY when asked to do so and QSO, but others with crystals close to the edge will be QRMed so badly that every QSO is spoiled. The operating practice that I dislike is that some Ws call on the frequency of the station I am working before I am quite finished, and they cause unnecessary QRM.

**G8MI:** I have no serious criticism of W operating practices. I dislike this "handle" nonsense, but note that most Ws now ask for your name.

**L77AZ:** I like all operating practices with the exception of calling me on the same frequency of the station I am working, before I sign off, or calling me when I call a directional CQ. I don't like to call "CQ no Ws" as other fellows do, but I use directional CQ sometimes.

**ON4AU:** No special remarks against W practices. Always I find and have found Ws display excellent ham spirit and friendship, and are least exclusive in their working. I wish all DX stations would take W and K stations as their example!

**VK5WR:** First part no reaction. I dislike practice of some Ws with VFOs parking their signals on my frequency.

**ZS2X:** The practice which appeals most to me is the one of interspersing the Ws own call sign frequently, and soon after, commencing the calling of a DX station. With this method you don't have to sit for nearly three minutes wondering who is calling, and it gives the station being called an opportunity to take his choice.

The practices which I find really annoying are the utter disregard a lot of Ws have for directional CQs and the bad habit of continuing to call even after a QSO has started when they know they're on the same frequency as the W being worked. I, like many others, am trying to get back into the DXCC but would stand mighty little chance if I didn't rely on directional calls to raise the rare ones, especially when most of the ones I still want come through at the same time as the Ws, and the band isn't open very long.

**ZS6DO:** I like the chap who gets down to business, uses break-in and snappy operating procedure, and doesn't try to hold me when I say QRU. There are lots of these fellows on the air right now.

One thing I dislike intensely and which drives me almost nuts is to have Ws answer my calls made specifically to other countries. It would help a lot if certain Ws would make an effort to read what a chap says at the end of a CQ.

It is suggested that all stations should make a three-by-three call repeated thrice, listen for a reply for five seconds, and repeat the procedure if the called station is unheard. This can be kept up until the desired station is QSOed or heard to QSO elsewhere. Another thing that should be understood: When DX finishes off a QSO and makes "VA," it is to be understood that the station is now listening for a call. I do this myself and, if I am closing, I make "CL" and the time I shall be off the air.

## QRM

The third question may seem obvious, but it isn't necessarily. "How is QRM these days?"

**CR9AG:** QRM is terrific on the edge, and when the Ws are coming through well you hear a station for just a bit and then out.

**G8MI:** QRM is very fierce. Band-edge operation is a menace and merely renders the edge of the band unusable. I never look nearer than 20 kc. from the band edge on 14 Mc. because I know that if I land a QSO it will almost certainly be busted up within a few seconds. Our main source of QRM is the high-powered 'phones being operated by U. S. Army personnel in Europe.

**L77AZ:** In the 14-Mc. band the QRM is very heavy, being terrific in the 'phone portion. I suggest that the Americans can leave a few kc. in the clear on each band for foreign stations. This will permit better DX for you in the U.S.A. and everybody else. But this is only an opinion, and remember that I don't know how the QRM and other troubles are in the U.S.A.

**ON4AU:** Too bad, and we must do our best to minimize it.



**VK5WR:** QRM is very bad, especially on the low-frequency end of 14 and 28 Mc.

**ZS2X:** I'm afraid DX stations are soon going to experience trouble from QRM in another way. Owing to the rapidly-increasing use of VFOs it is possible, when conditions are good, for anything up to a dozen Ws to tune their transmitters to one DX station which they are all calling. With all of these stations on one frequency, it will be appreciated that more often than not it's just about impossible to unscramble anything in the dogfight that ensues.

**ZS6DO:** Seems to be just as bad as before the war but rarely worries me, as I normally pick the nicest S9 signal I can find! What makes me mad is the 'phone merchant (not the Ws) who ambles into the c.w. band to get away from the local, W and other 'phone QRM, and complains of c.w. QRM!"

## Tuning

Trying to wangle a few tips for our own operating, we next asked, "After a CQ, what is your tuning procedure? How does band-edge crowding by Ws affect you? How much of a band do you cover after a CQ, and how long does it take you?"

**CR9AG:** With the band as it is allocated now, if I am looking for W QSOs after a CQ I go to the band edge and look for calls, and if QRM is too heavy for a good QSO I continue up to where the QRM is not so bad. It takes me about 20 seconds, and if I don't locate any calls I come back the same way and listen around, just in case I missed someone the first time. I do more listening than transmitting.

**G8MI:** After a CQ I listen on my own frequency, then tune low of it, flick back and listen above it. When expecting Ws I never shift more than 20 kc. either side because it is a waste of time, but I deplore the fact that I cannot expect replies over the rest of the band. I usually give up after a minute's search.

**L77AZ:** After a CQ I tune from almost my own frequency. I don't answer stations who get exactly on my frequency. The band-edge crowding affects not only me but everybody. It is a prewar practice, not needed at present. I have no time to tune a great portion of the band, because generally many stations call me. It would take me about three minutes to cover the whole band.

**ON4AU:** I start to listen from the edge nearest to me to the center and continue to the opposite end until I find an interesting station. I have a frequency log scale with the best DX stations recorded, and I give special attention to these frequencies. I tune as fast as possible but I try to give maximum attention. I don't call CQ very often. I often listen for long periods to hear what happens on the whole

band, and when I discover an interesting DX I try to reply not far from that frequency.

**VK6WR:** I tune from the end nearest to that where the CQ was called to the other end. It takes about a minute on the average. Band-edge crowding by Ws and other countries tends to keep one off the edge when calling CQ, and to use the edge when answering CQs.

**ZS2X:** I have no definite tuning procedure. I generally start from the edge of the band inward, but if I know there is a station on that I want I always tune to his frequency first after a CQ, in the hopes that he has come back. Band-edge crowding, as far as I'm concerned, is just a waste of time — there's so much QRM there that no one gets anywhere. It takes me about one minute to cover 100 kc. on 20 or about 500 kc. on 10.

**ZS6DO:** After calling CQ I usually start from the low-frequency edge of the c.w. band and cover this band in about 5 or 10 seconds if no call for me is heard. When conditions are good, I rarely have to cover much more than about 50 kc. There are enough Ws in the first 50 kc. to keep one busy for hours. The only time I search around the whole band is during the DX Contest.

### Break-In

The next question was about a subject that has been harped on for years, but only the smart lads seem to recognize the advantages. "What do you think of Ws using 'break-in' when calling you? Would you encourage it?"

**CR9AG:** Very good, as it cuts down lots of QRM through repeats, and I would encourage it. I use it here to work W1FH during my skeds.

**G8MI:** I am all in favor of break-in but find few Ws who can work it. I should like to see it encouraged. Many Ws sign "BK," but if you try breaking them they carry blissfully on and sign in the usual manner.

**LU7AZ:** I think break-in is ideal and must be used by Ws when calling us, not only during responses but every time. It permits faster operation, and the stations occupy the channels a minimum amount of time.

**ON4AU:** I think it is the best system, and it should be encouraged. This method clears the band from QRM. When anyone is replying to a CQ, he will stop his call when he hears the station replying. You must run stories in QST about break-in, to teach its use to newcomers. I also suggest the use of HM, MH, LM and ML, for quick contact.

**VK6WR:** The use of break-in saves time in establishing contacts. I think the use of break-in should be encouraged.

**ZS2X:** I think the general introduction of break-in would be one of the greatest advances to be made in general operating procedure. It decreases QRM and saves time. It should definitely be encouraged.

**ZS6DO:** Break-in should be used wherever possible. In my case I use it all the time, so that I can be stopped when QRM becomes too bad. Encourage break-in all you can, as it is a great saver of time and power.

### CQ DX

The next question deals with a pet hate of many Ws and a favorite sport of many others. To find out how the DX feels, we asked, "How often do you answer a 'CQ DX' by a W?"

**CR9AG:** Seldom, unless those calling happen to be particular friends of mine.

**G8MI:** Hardly ever. Few Gs take any notice of Ws calling CQ. There are so many Ws that we can always bank on at least one reply. Ws would do well to listen for CQs from this side. During the DX Contest, for example, out of some 300 contacts only one was in answer to a W CQ, and that on an otherwise dead band.

**LU7AZ:** I don't often answer "CQ DX" by Ws, except when looking for a particular state or station.

**ON4AU:** Not very often, and sometimes I spend many hours working Ws.

**VK6WR:** On 14-Mc. c.w., very seldom.

**ZS2X:** I never answer "CQ DX" by Ws on c.w. because it's just a waste of time. Strangely enough, on 'phone it is possible occasionally to answer successfully a W's CQ.

**ZS6DO:** Very rarely do I answer any W calling "CQ DX." Any W making this call is, to my mind, wasting time and power. Ws stand a better chance if they answer foreign CQs. Most of my countries have been obtained by calling the country desired. It would be better for the rare DX to call "CQ DX."

### Speed of Calling

Out of curiosity about some of the calls sent at about 3 w.p.m., we asked, "At what speed do you think the stations answering your CQ should call you?"

**CR9AG:** The W6s should call about 20 w.p.m., but the rest, particularly the East Coast stations, should call about 15 w.p.m., as invariably they all come in here with an echo, especially in the early evenings.

**G8MI:** 20 w.p.m.

**LU7AZ:** I think the stations answering my CQ can call me at the same speed I used in the CQ. I regulate my speed to what I am able to copy, taking into consideration the conditions, QRM, QRN, etc.

**ON4AU:** At the same speed as my CQ.

**VK6WR:** Preferably at the same speed, but never faster.

**ZS2X:** In my opinion any reasonable speed is satisfactory provided characters are well spaced. In this regard I'm glad to say that on the whole Ws are not shoddy in their sending and most are a pleasure to listen to.

**ZS6DO:** The golden rule is to answer at the speed of the called station. I, personally, don't mind anything up to 50 w.p.m. and even more! Most of your speed merchants know me and give me the works!

### Signal Reporting

The last question dealt with that subject dear to the hearts of all DX men, the signal report. You will gather from the question that our suspicions have been aroused on several oc-

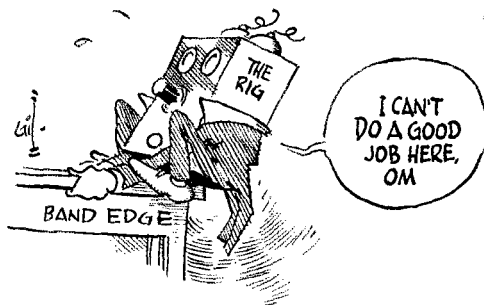

casions. "Do you have two scales of signal reports, one for domestic signals and one for DX stations, or do you try to be consistent? Have you any suggestions to make on signal reporting?"

**CR9AG:** No, since all signals from domestic stations are

about S8 to S9, so when I give a station an S7 or S8 they sound like domestic signals. The method we have been using for reporting signals is OK and I don't think any changes are necessary, although the tone report seems apparently useless, as 99 per cent of the signals heard here are T9 anyway. Once in a while you meet up with a T6 signal.

**G&MI:** I think everyone has a different scale for local and DX signals. Often unconsciously, but none the less true. Probably on 28 Mc. the local scale is used for W signals because they come in at such terrific strength.

I have one suggestion regarding signal reports. When reporting on 'phone, say "Your signals are R5 S7," not "Q5 R7." We have the RST system for c.w., why not use the appropriate part for 'phone? The height of absurdity is reached when some guy says, "You're R7 on my S-meter!"

**LUTAZ:** I use the same scale for reporting signals both domestic and foreign. Any difference is absurd.

I suggest the "QR" system used on 'phone be replaced by "RS," in an effort to standardize with the RST system. Perhaps it is possible to add a quality report of the modulation, as we do here in Argentina. We use the letter "M" to classify the quality from 1 to 9.

**ONAAU:** Consistent — it is not possible to use many scales. Yes, RST is too laconic or simple.

**VK5WR:** Yes, the DX report being one to two points higher up in the scale. I gave up trying to be consistent years ago.

**ZS2X:** One of the most difficult questions to answer!

Although I *try* to be consistent I'm afraid there are times when a candid report, in my opinion, would be misleading. Naturally, if carried to extremes, an exaggerated report is worse than useless and is decidedly unfair. If an abbreviated form of explanation could be coupled to the report to indicate that beams and proselectors are being used, it might also help to give a truer picture of how signals are actually breaking through.

**ZS6DO:** The old RST system still seems OK with me, although I prefer to leave out the "T" unless the note is bad. It is a sound idea to give the QSA at the end of an answering call and the rest later as the QSO develops. If this is done, the station called knows immediately what conditions prevail.

Well, there you are. It probably represents a good cross-section of opinion, and questioning of more stations would result only in elaboration on some of the ideas expressed. But notice that there are a few things about which our DX friends are unanimous: breaking up QSOs, calling on the exact frequency of the DX station, disregard of directional CQs, the use of break-in, "CQ DX" by Ws, and "RS" instead of "QR" for 'phone operating. The business on signal reports boomeranged — apparently it is too much a problem of individual cases!



FEBRUARY 1922 *QST* is a "Paragon Paul" issue, taking for its theme, "Welcome Home, Our Conquering Hero!" An amazed world learned last month of our accomplishment, but within our own circle there still are notes to be compared . . . congratulations proffered . . . bows taken . . . "What next?" weighed. This issue records for posterity the full account of our spanning of the North Atlantic. Paul Forman Godley is presented in full-page portrait along with the "Official Report on the Second Transatlantic Tests," Mr. Godley's story of how we fared at the receiving end. In "The Story of the Transatlantics," *QST's* editor recounts the work and planning which went into making our League's project a success, and he looks forward to an era of "international private radio." At press time word arrives that in January IAFV succeeded in transmitting 3 messages to W. W. Burnham in London!

Station IBCG, star c.w. performer during the Tests, is pictured on this issue's cover and described in detail within. Messrs. Armstrong, Amy, Grinan, Inman, Cronkhite and Burghard have reason to be proud of their handiwork. Built especially for the Transatlantics, the Greenwich, Conn. amateur station boasts a lofty T-cage antenna working against a radial counterpoise. The transmitter is a stabilized MOPA outfit employing a U.V. 204 oscillator, which

drives three similar tubes in parallel in the amplifier. A generator supplies the 990 watts plate power, 56% efficiency being realized in the rig. Reports have IBCG heard in practically every state, in Holland, and Vancouver, B. C.

There is room for only one technical article this month, Robert C. Higgy's "Practical Radio Amplification." Methods of using present-day receiving tubes in 200-meter r.f. amplifiers are discussed. Under the title "Governors' - President's Relay" we learn that in March we hope to deliver to President Harding 48 messages, one from the governor of each state. Traffic is off because of time spent on the Tests, but of the total handled, c.w. carried upward of 40% of the load! "Who's Who in Amateur Wireless" introduces Bob Trump, 9BT, now located at Ottawa, and Robert C. Higgy, 8IB, a new member of the *QST* staff. Stations described are 4GL, Savannah, 2BB, Ossining, and 2WM, Ridgewood, L. I.

Director Howard L. Stanley, 2FS, has resigned his League office because of new commercial affiliations, according to Strays. Other items tell us of 8LF's new c.w. DX record — 5500 miles on 46 watts! . . . Westinghouse announces a receiving tube which will operate from a single dry cell at a current of 0.2 amp. . . Reinartz, 1QP, reports that mice have been eating away the real spaghetti he has been using for insulation! . . . One ampere in the antenna on the extremely low wavelength of 125 meters is 9ZT's claim! Clapp-Eastham announces a new regenerative receiver and audio amplifier in an ambitious many-paged advertising campaign. Dealers across the country have tied-in in force — it should be emulated!



# Direct-Reading Modulation Meter

*Simplified Construction with the 1N34 Crystal Diode*

BY DANA W. ATCHLEY, JR.,\* WIHKK, AND RICHARD E. FRICKS,\* W6QUG

A METER presenting a visual indication of modulation percentage is one of the most essential instruments for the proper operation of an amplitude-modulated 'phone transmitter. A popular misconception, particularly among newcomers to the 'phone ranks, is that a modulation meter is only necessary to prevent overmodulation. It is true that the FCC — and hams operating on adjacent frequencies — frown on overmodulation, and it is further true that a visual indicating meter will greatly assist in keeping the splatter down, but what is overlooked by most is that a modulation meter will also allow the operator to keep his average level up in the fertile region between 50- and 95-per-cent modulation, allowing him to use his transmitter near its maximum effectiveness at all times. Yet a quick survey conducted any evening, on any 'phone band, will show that a majority of stations are not equipped to monitor their modulation in even a qualitative manner. One or two will mutter something about watching their Class B meters, but are completely unable to correlate that meter reading with what is actually taking place. Those rare stations that do have good modulation meters swear by them — and, incidentally, are not usually sworn at! It is felt that this universal absence of such an essential instrument is closely coupled with the complexity and expense of previously-described modulation meters. More than one potential builder has been frightened away from the story when he hit the "calibrate" section of a descriptive article.

The modulation meter described herein is simple, compact and inexpensive, and if the components recommended are used, the constructor can build an accurate-

• In these days of getting the most out of everything, a modulation indicator is a "must" for your 'phone rig. Here is a simple one that works well up to 54 Mc., and it has the important advantage that it requires no elaborate calibration procedure.

reading instrument with comparative freedom from subsequent calibration difficulties.

The inspiration for this meter came from the introduction to the amateur market of the new 1N34 germanium crystal diode, and an article entitled "Vacuum Tube Modulation Meter," by P. M. Honnell, in the *Electronics Engineering Handbook*. It seemed that a great simplification of the existing art could be accomplished by substituting a 1N34 for the vacuum-tube diode, such as the classic 6H6, with the redesign it permitted.

1) The useful frequency range of the meter was greatly extended over models utilizing conventional diodes. Two commercial modulation meters tested operated very erratically when used with carrier frequencies over 14 Mc., while the 1N34 allowed operation up through 54 Mc.

2) Utilization of the crystal diode eliminated the necessity for any plate or filament power supply.

3) The sensitivity of the 1N34 was sufficient to eliminate the triode amplifier stage customarily used in previous meters.

4) Finally, the 1N34s tested were sufficiently similar in characteristics to allow the builder to construct the modulation meter with "off-the-shelf" components without the necessity for an elaborate calibration procedure for each instrument.



A simple direct-reading modulation meter. The scale of the 1-ma. meter reads directly in percentage of modulation. The screwdriver adjustment on the side is for setting the r.f. level.

\* Sylvania Electric Products, Inc., Electronics Division, 70 Forsyth St., Boston 15, Mass.

**Fig. 1**—Circuit of the direct-reading modulation meter.

- C<sub>1</sub>, C<sub>4</sub>—1000- $\mu$ fd. ceramic.
- C<sub>2</sub>—100- $\mu$ fd. variable midget.
- C<sub>3</sub>—12- $\mu$ fd. mica.
- C<sub>5</sub>—470- $\mu$ fd. mica.
- R<sub>1</sub>—16,000 ohms, 5%,  $\frac{1}{2}$  watt.
- R<sub>2</sub>—11,000 ohms, 5%,  $\frac{1}{2}$  watt.
- J<sub>1</sub>—Closed-circuit jack.
- MA—0–1 ma., 100 ohms.
- RFC—20  $\mu$ h.
- S<sub>1A-B</sub>, S<sub>2</sub>—D.p.d.t. toggle.
- T<sub>1</sub>—Push-pull interstage transformer, 1:1 ratio (Stancon A-4711).

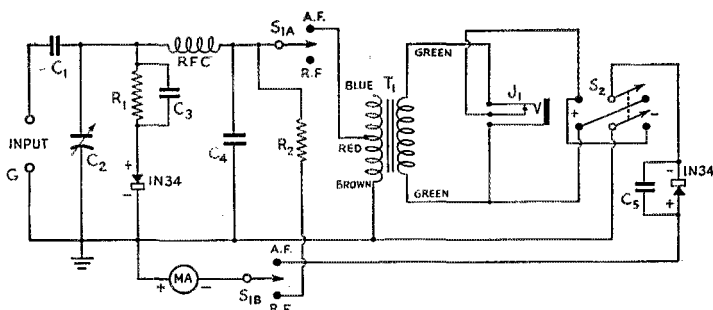

### Construction

The modulation meter shown in the photographs is straightforward in both circuit and construction. The whole unit is constructed in an ordinary commercial meter case, both for compactness and to ease the problem of procurement. The metal bottom (not shown in the photograph) was cut from a piece of sheet steel and mounted by four small angle brackets. Small rubber bumpers can be used in conjunction with the sheet-metal screws which secure the bottom plate, or a piece of felt can be glued on to protect the table top. The r.f.-input terminal strip is mounted on the upper rear of the case. The inner left-hand terminal is grounded to the case, and is bonded to the positive terminal of the meter, and in turn to all other grounds in the circuit.

Because of the compactness of the meter cabinet, precautions must be taken to prevent r.f.-energy coupling into the a.f. crystal circuit. All the components associated with the r.f. section of the meter are mounted on a common terminal strip which is located at the rear between the trimmer C<sub>2</sub> and the transformer T<sub>1</sub>.

The audio crystal and the a.f. by-pass condenser, C<sub>5</sub>, are mounted in the front of the case between the two switch terminals, as shown in the photograph. The reader is advised to adhere to the general layout shown, or troubles may be experienced in the form of r.f. leakage into the audio rectifier circuits at the higher frequencies.

### Installation

The size and general design of the unit are such that it will readily fit on even the most cramped operating table. Hence it is recommended that it be placed on the operating table in front of the microphone, in such a place that it can be easily seen by the operator. It is necessary to couple the unit to the modulated final by means of a one- or two-turn insulated link, and a suitable length of 75-ohm radio-frequency transmission link such as the currently-popular Twin-Lead type. In cases where the line is run close to high-powered buffer stages, it will be necessary to use a shielded coaxial line to prevent undesired pick-up. The use of a "haywire" line will greatly decrease the sensitivity of the meter. Fasten one side of the

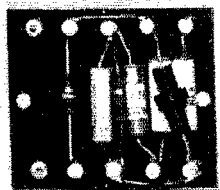

A view under the modulation meter with the bottom cover removed. An additional mounting board for the ceramic condensers, the r.f. crystal diode and other small components is also shown. The audio crystal and C<sub>5</sub> are mounted between the two toggle switches. Ground leads should be as short as possible, and the r.f. leads should be kept well separated from the meter and a.f. leads.

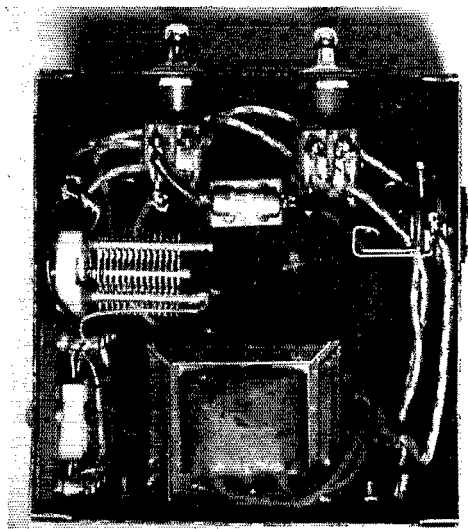

transmission line to terminal  $G$  on the rear of the case, and the other side to the other terminal. In addition, run a wire from terminal  $G$  to a good ground. Initially, place the pick-up link at the other end of the transmission line at least ten inches from the final tank coil. However, arrangements should be made to move this link closer if necessary.

It should be unnecessary to point out that to make full use of the meter over a long time, make the installation with the transmitter turned off!

### Operation

With both toggle switches in the upward position at "R.F." and "+," respectively, turn the transmitter on. In most cases, the meter will indicate some value. (If no reading is obtained, use closer coupling.) Next, peak the input circuit by means of the trimmer adjustment on the left side of the case. This trimmer is at ground potential; hence an ordinary uninsulated screwdriver, or a Spintite socket wrench, may be used for adjustment. With the input circuit peaked, the unit is in its most sensitive condition. Next the pick-up link should be varied until the meter reads exactly 1.0 ma. This establishes the correct reference point for voice modulation. In the event that sine-wave modulation is to be used, follow the procedure above, but set the meter at 0.71 ma. instead of 1.0.<sup>1</sup> The transmitter should be turned off whenever the link is handled for adjustment purposes. Normally, only a slight readjustment is necessary. Do not rely on the trimmer for more than small correction adjustments. Operating the unit off resonance at higher frequencies is apt to introduce r.f. leakage into the audio circuits and give erroneous readings.

After setting the carrier level to the prescribed reference point, throw the left-hand toggle downward to the "A.F." position. In this position, the meter will read directly the modulation percentage of the carrier envelope. Throwing the right-hand switch downward will cause the meter to read negative modulation. It will be noted that at high levels, the positive indications will normally exceed the negative. The meter is customarily operated in the "+" position. It is recommended that the speech-amplifier gain be adjusted so that on normal speech the meter needle swings to read an average of approximately 70-80 per cent on the average voice peak. The mechanical inertia of the meter movement is such that it is possible to overmodulate on short

<sup>1</sup> The amplitude and frequency in speech varies tremendously over the period of a single syllable. The average energy is considerably less than that of a sine wave, but the ratio of peak to average amplitude is greater. According to the ARRL *Radio Amateur's Handbook*, the average speech waveform contains only half as much power as a sine wave, both having the same peak amplitude. Expressed in voltage, this ratio is approximately 1.4 to 1. Hence this meter incorporates two "check points"; one for sine-wave testing (0.7 ma.) and another for voice operation (1.0 ma.).

bursts of voice energy without the meter so indicating. This is true of almost all types of modulation indicators utilizing direct-reading meters, which tend to integrate the high energy peaks of the complex human-voice waves. On sine-wave modulation, the above is not the case since the wave is uniform and symmetrical. The meter is so adjusted that it will follow the syllabic amplitude of the voice waveform. It is, of course, possible to connect the secondary leads of  $T_1$  incorrectly. This connection can be checked by throwing  $S_{1A-B}$  to "A.F." and  $S_2$  to "+" and applying modulation with the carrier off, to simulate a badly-overmodulated signal. If the meter reads up, the connection to  $T_1$  is correct.

Throw the left-hand toggle ( $S_{1A-B}$ ) to the r.f. position so that the meter reads the average r.f. carrier level. Then observe if this level changes under modulation. If the meter dips appreciably below the initial reference setting, carrier shift is taking place. This is attributable primarily to the poor line-voltage regulation and should be disregarded. If a serious shift is noted, the meter will not read accurately in the "A.F." position; in addition, it is a definite indication of trouble in the transmitter. Numerous causes are possible. The latest edition of the ARRL *Handbook* will supply the operator with much valuable data concerning carrier shift and its correction.

The unit can be used as an audio monitor by throwing the left-hand toggle switch to "A.F." and connecting a pair of high-impedance headphones to the jack on the right side of the case. It will be noted that the meter will not indicate modulation with the headphone plug inserted. Hence it is not possible to monitor by eye and ear simultaneously.

### Explanation of Circuit

To fulfill its function, any type of modulation indicator must compare the voltage of the average r.f. carrier to the voltage deviations from the average caused by positive or negative audio modulation. This involves a comparison of two voltage measurements. The meter consists essentially of two linear a.c. voltmeters, the first responding only to the average r.f. carrier, and the second measuring its audio-frequency component. Physically, one meter is used on both circuits by switching arrangements, since a simultaneous measurement of both values is not necessary in most cases.

Referring to the diagram, a portion of the modulated output of the radio-frequency amplifier is fed via the link circuit to the input terminal strip,  $C_1$  acting as a d.c. blocking condenser. The trimmer condenser,  $C_2$ , is utilized to balance out the reactive component in the transmission line, hence increasing the r.f. voltage applied across the first crystal diode.  $R_1$  and its shunting capacity,  $C_3$ , are placed in series with the crystal to

(Continued on page 144)

# Dishing Out the Milliwatts on 10 KMc.

## Equipment Used in the First 3-Cm. Amateur Work

BY JAMES A. McGREGOR,\* W2RJM, EX-W1LZV/2

**S**INCE the lifting of security regulations on most radar systems and devices, many interesting and revealing articles have been published concerning this new art. The radio amateur has been given due credit for his part in the development of this great weapon, and in addition has received official recognition of potential future contributions by the assignment of several microwave bands for amateur work. Articles have already been published describing the accomplishments of amateurs in using the newly-allocated bands at 13, 5.5 and 1.4 centimeters.

The remaining microwave band, that at 3 centimeters, provides a band of frequencies from 10,000 to 10,500 megacycles, where components such as wave-guides and reflectors are moderately-sized, and where at least one tube is available which requires only a very modest power supply and associated equipment for communication use.

The author, in conjunction with C. K. Atwater, W2JN,<sup>1</sup> set up and operated, on May 5, 1946, the

\* 57 Elmwood Road, Verona, N. J.

<sup>1</sup> 340 N. Fullerton Ave., Upper Montclair, N. J.

• We are prone to think of microwave work as a field for scientists working in laboratories equipped with vast quantities of costly apparatus. The equipment developed during the war was in this category, it is true, but here is proof that anyone who is willing to dig around in the surplus markets and exercise a bit of that well-known know-how can come up with workable gear for exploration of the amateur band at 3 centimeters.

equipment described herein, completing what is believed to be the first contact made by amateurs on 3 centimeters. The operating frequency was about 10,300 Mc., and the distance was 2 miles. The author operated W1LZV/2 from his home location, and W2JN was operated portable from an opposite hill, with the aid of a gasoline-driven generator. Since a minimum of equipment is required for operation at these frequencies, others are encouraged to experiment with similar methods. Results of the May tests indicated that, with proper selection of sites, ranges may be extended easily. Experimenters can well afford to be optimistic about possible results, as signals over the two-mile path were very strong.

### Equipment Details

The gear used for the initial contact is shown in the accompanying photographs. A thirty-inch paraboloid may be seen mounted on a tripod. This dish is fed by means of a section of wave-guide, terminating in a dipole and reflector, in the manner commonly used in 3-cm. radar equipment. Details of the antenna assembly are shown in Fig. 1. Immediately behind the dish is the preamplifier unit which feeds the

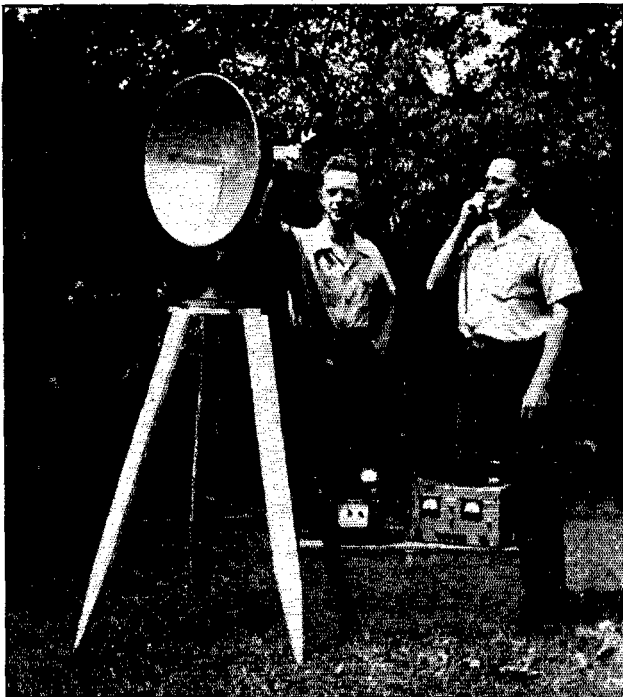

James A. McGregor, W2RJM, and Charles K. Atwater, W2JN, operating the 3-cm. communication equipment. Directly in back of the dish is the transmitter-preamplifier unit. The portable receiver is used as a 30-Mc. i.f. amplifier and audio system. At the right are the power supply and modulator.

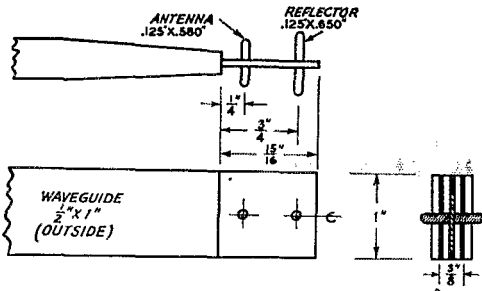

Fig. 1 — Details of the wave-guide feed, antenna, and parasitic element. The antenna element is positioned at the focal point of the parabolic reflector. The correct position may be determined by field-strength indication, using a crystal rectifier and a low-range milliammeter for field-strength measurement.

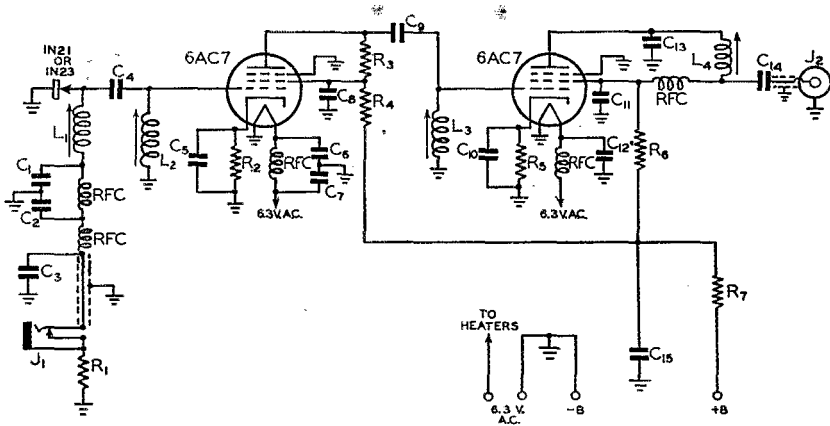

Fig. 2 — Schematic diagram of the 30-Mc. preamplifier.

- C<sub>1</sub>, C<sub>2</sub>, C<sub>5</sub>, C<sub>6</sub>, C<sub>7</sub>, C<sub>8</sub>, C<sub>10</sub>, C<sub>11</sub>, C<sub>13</sub>, C<sub>15</sub> — 0.001- $\mu$ fd. mica.  
 C<sub>3</sub>, C<sub>4</sub> — 47- $\mu$ fd. mica.  
 C<sub>9</sub>, C<sub>14</sub> — 100- $\mu$ fd. mica.  
 C<sub>13</sub> — 10- $\mu$ fd. mica.  
 R<sub>1</sub> — 330 ohms.  
 R<sub>2</sub>, R<sub>5</sub> — 51 ohms.  
 R<sub>3</sub> — 680 ohms.

- R<sub>4</sub>, R<sub>6</sub> — 220 ohms.  
 R<sub>7</sub> — 180 ohms.  
 All resistors 1 watt.  
 L<sub>1</sub>, L<sub>2</sub>, L<sub>3</sub>, L<sub>4</sub> — 9 t. No. 30 enamel, close-wound on  $\frac{3}{8}$ -inch form, core-tuned.  
 J<sub>1</sub> — Closed-circuit jack.  
 J<sub>2</sub> — Coaxial output jack.  
 RFC — 30 t. No. 24 enamel close-wound on 100-ohm 1-watt resistor.

communication receiver. In this case, a Hallicrafter S-29 portable was used. The preamplifier unit is shown in detail in the smaller photograph, and its schematic is given in Fig. 2. The portable meter which appears in the larger photograph is used to monitor the crystal current, and the power supply at the right provides the voltages for the r.f. tube, which is used as a transmitting oscillator and as a local oscillator for reception. The power supply also handles the two tubes used in the preamplifier unit. The small unit resting on the power supply is the modulator, shown in schematic form in Fig. 5. A single-button hand microphone is used.

The transmitting tube used is a war-surplus

Type 723A/B, also known as a 2K25. This is an s.h.f. oscillator, in which the resonant circuit and means of tuning are integral with the tube. It was designed to operate in a frequency range between 8500 and 9660 Mc. It is used with a modified wafer-type octal socket, the No. 4 pin being removed and a hole drilled to allow the coaxial line to pass through. This coaxial output line is designed for direct coupling with a suitable wave-guide, its inner conductor extending beyond the outer conductor to serve as an antenna when the line is projected through the wave-guide wall. The polystyrene insulator on this "antenna" should be kept clean, to avoid power loss in a conducting film. The tube may be mounted in either a vertical or horizontal position.

Referring to Fig. 3, it may be seen that two

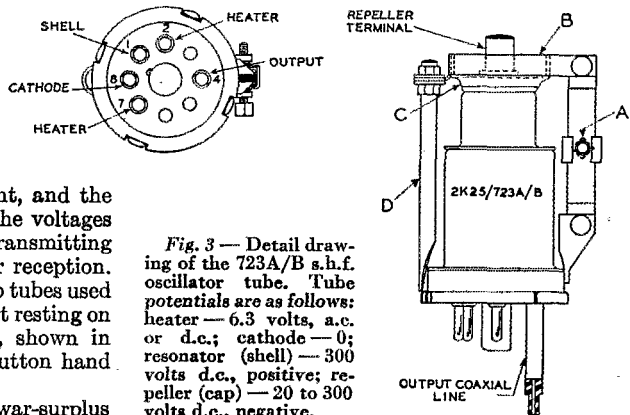

Fig. 3 — Detail drawing of the 723A/B s.h.f. oscillator tube. Tube potentials are as follows: heater — 6.3 volts, a.c. or d.c.; cathode — 0; resonator (shell) — 300 volts d.c., positive; repeller (cap) — 20 to 300 volts d.c., negative.

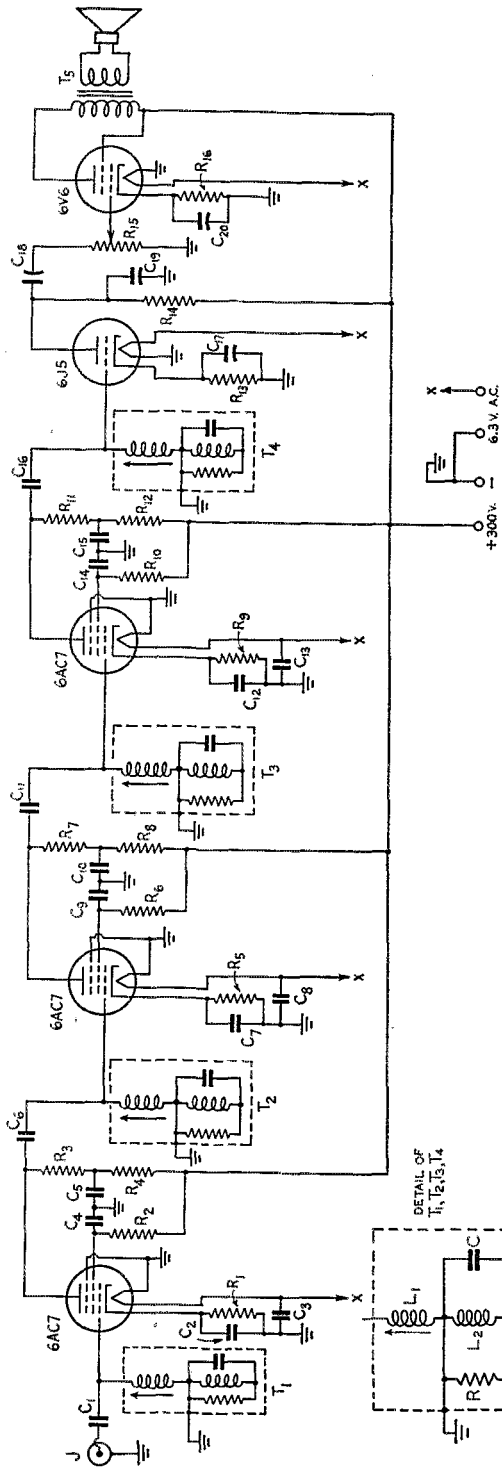

Fig. 4 — Schematic diagram of the wide-band a.m. i.f. unit used for reception of voice-modulated signals.

- C<sub>1</sub>, C<sub>4</sub>, C<sub>5</sub>, C<sub>6</sub>, C<sub>9</sub>, C<sub>10</sub>, C<sub>11</sub>, C<sub>14</sub>, C<sub>15</sub>, C<sub>16</sub> — 470- $\mu$ fd. mica.
- C<sub>2</sub>, C<sub>3</sub>, C<sub>7</sub>, C<sub>8</sub>, C<sub>12</sub>, C<sub>13</sub> — 0.001- $\mu$ fd. mica.
- C<sub>17</sub> — 0.5- $\mu$ fd. 400-volt paper.
- C<sub>18</sub> — 0.1- $\mu$ fd. 400-volt paper.
- C<sub>19</sub> — 0.001- $\mu$ fd. 400-volt paper or mica.
- C<sub>20</sub> — 25- $\mu$ fd. 50-volt electrolytic.
- R<sub>1</sub> — 150 ohms,  $\frac{1}{2}$  watt.
- R<sub>2</sub>, R<sub>6</sub>, R<sub>10</sub> — 68,000 ohms,  $\frac{1}{2}$  watt.
- R<sub>3</sub>, R<sub>7</sub>, R<sub>11</sub> — 2200 ohms, 1 watt.
- R<sub>4</sub>, R<sub>8</sub>, R<sub>12</sub> — 3300 ohms, 1 watt.
- R<sub>5</sub>, R<sub>9</sub> — 220 ohms,  $\frac{1}{2}$  watt.
- R<sub>13</sub> — 15,000 ohms, 1 watt.
- R<sub>14</sub> — 0.1 megohm, 1 watt.
- R<sub>15</sub> — 0.5-megohm potentiometer.
- R<sub>16</sub> — 390 ohms, 1 watt.
- J — U.h.f. connector, SO-239.
- T<sub>1</sub>, T<sub>2</sub>, T<sub>3</sub>, T<sub>4</sub> — Wide band-pass 30-Mc. i.f. transformer. (See below.)
- T<sub>5</sub> — Output transformer, 6V6 plate to voice coil.
- Insert — Detail of T<sub>1</sub>, T<sub>2</sub>, T<sub>3</sub> and T<sub>4</sub>.
- C — 22- $\mu$ fd. mica.
- R — 1500 ohms,  $\frac{1}{4}$  watt.
- L<sub>1</sub> — 30-Mc. permeability-tuned coil.
- L<sub>2</sub> — 25 turns No. 30 enameled wire on  $\frac{1}{4}$ -inch diameter form.

vertical struts are provided for tuning, one of which is already variable by means of the stud, A, which spreads or contracts the flexible strut on the right side, moving part B nearer to or farther from the tube base and compressing or stretching the bellows, C. When part B is moved away from the tube base, the frequency of oscillation is raised, and conversely, when part B is moved toward the base the frequency is lowered.

The upper limit of frequency range, reached by rotating the tuning stud A to the limit of its travel, will seldom be within the amateur 10,000-Mc. band, hence it is necessary to perform the following operation to extend the tuning range. It may be seen that part B is held in a fixed position on strut D on the left side of the tube, by two small nuts which, after having been tightened, have been spot-welded to each other and to part B. The spot weld should be filed away until each nut can be moved freely on the threaded stud. Next, the position of these nuts should be adjusted *very* carefully, to raise part B as was done on the other side. Extreme care should be used in this operation, as excessive stretching of the bellows may break some of the seals and render the tube inoperative. It is advisable to move the lower nut only until a firm resistance is felt. The operating frequency should then be checked, and if it is still below the limit of the band another tube should be tried, as any further attempt to raise the frequency will almost certainly ruin the tube.

The oscillator may be amplitude- or frequency-modulated, the former being used in our original tests, though frequency modulation is perhaps the more advantageous system. Amplitude modulation was used, as a receiving system was already available, and

The oscillator and preamplifier are built into one small unit which is mounted directly on the wave-guide at the rear of the parabolic reflector. The 723A/B, which serves as transmitting oscillator and as local oscillator for reception, is mounted horizontally, with its output probe projecting into the wave-guide. The device at the right is a 3-cm. wavemeter.

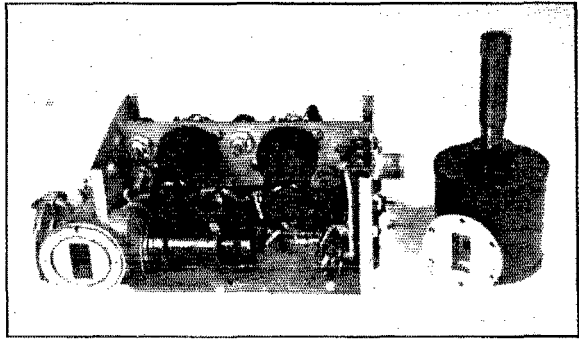

It was also desired to experiment with a converter feeding a communications receiver. Since the tube is inherently unstable when amplitude modulation is applied, some frequency modulation takes place also. For this reason the receiver should have a broad pass-band, except when A2 emission using a tone generator having a sharp square waveform is employed. When this type of modulation is applied to the reflector element of the 723A/B, frequency modulation is held to a minimum and the signal can be copied satisfactorily on a conventional communications receiver used for the i.f. system.

When voice modulation is used the i.f. pass-band must be of the order of 3 megacycles. Since this type of i.f. system was used extensively in radar systems, it is possible in some areas to obtain a receiver, or components for same, through surplus outlets.

### Receiving Systems

The receiver used as an i.f. amplifier will depend upon the type of modulation employed, and can be either a broad-band a.m.-f.m. super-heterodyne or a conventional communications receiver. The S-29 portable used with the converter in our initial tests was usable only with tone-modulated telegraphy, as previously explained, but it provided a simple and effective means of getting started on 3 centimeters. For voice reception the unit shown in schematic form in Fig. 4 has been used effectively.

Examination of the small photograph of the preamplifier unit will show a short length of wave-guide, mounted on the left side, terminating in a flange coupling. This length of wave-guide has a cartridge-type crystal, 1N21 or 1N23, mounted across the short dimension, to the rear. It is placed in such a position that the incoming signal is impressed across the crystal with maximum efficiency. It will be noted that the 723A/B,

mounted horizontally at the left, has its socket directly on the wave-guide, permitting the "antenna" of the tube to project into the guide through a small hole directly below the socket. This constitutes the oscillator coupling to the crystal mixer. Since the local oscillator is tuned to a frequency which is 30 megacycles above or below the signal frequency the resultant i.f., which is impressed on the grid of the first 6AC7, is 30 Mc. This signal is then amplified by the two i.f. stages, which provide a gain of about 35 db. and are about 3 Mc. wide in pass-band. The output of this preamplifier is fed to the main receiver unit by means of a length of coaxial cable.

The i.f. unit shown in Fig. 4 consists of three additional i.f. stages, employing 6AC7s, and providing an additional gain of about 60 db. These i.f. stages may be stagger-tuned to permit a bandwidth of about 3 Mc. The detector, which is a 6J5, provides a small additional gain. A conventional audio stage using a 6V6 provides sufficient gain to operate a small permanent-magnet speaker. The interstage coupling units, indicated as  $T_1$ ,  $T_2$ ,  $T_3$  and  $T_4$  in the schematic diagram, are small permeability-tuned assemblies of unknown type, which were picked up at low cost on the surplus market. There are several types of these assemblies currently available which should be suitable for this purpose, or a simple core-tuned coil which will resonate at 30 Mc. should suffice. In the alignment of such a system it would be necessary merely to apply a 30-Mc. signal to each stage, starting with the last, and peaking each adjustment for maximum output.

(Continued on page 148)

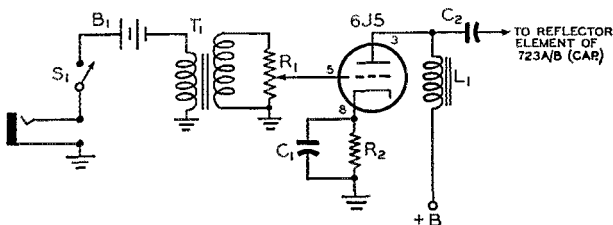

Fig. 5 — Circuit of the unit used for modulating the 723A/B oscillator.

$C_1$  — 10- $\mu$ fd. 50-volt electrolytic.

$C_2$  — 0.5- $\mu$ fd. 600-volt paper.

$R_1$  — 0.5-megohm volume control.

$R_2$  — 1500 ohms, 1 watt.

$L_1$  — 10-15-hy. 50-ma. choke.

$B_1$  — 3-volt microphone battery.

$S_1$  — S.p.s.t. toggle switch.

$T_1$  — Single-button-microphone-to-grid transformer (Stancor A-4706).

# How's DX?

**How:**

This is the month when the boys dive into the rig and clean out all the bugs, in preparation for the approaching DX Contest. Antenna insulators are washed and dried with alcohol, coil connections are polished to eliminate all resistance that might eat up valuable watts, and arrangements are completed for the rest of the family to spend the important weekends with the in-laws. DX Contests used to be a lot of fun before the war, but it is difficult to prognosticate about this one. The unpredictable factor is the operating technique that has cropped up among the DX hogs. If in the Contest they continue their stupid practice of breaking up contacts with continual calling, so that the necessary numbers can't be exchanged, the DX stations will quit in disgust and there just won't be any Contest! Have you noticed how many DX stations are quitting in the middle of an evening's work these days? They will get on with a CQ and after finding that they can't complete a single QSO, they quit cold. And who can blame them?



Several fellows have passed along one suggestion for the DX stations. They recommend that these fellows allow their oscillator stages to run all the time, thus making it impossible for them to receive on their own frequencies. If they do this, they are forced to listen off their own frequencies and it should tend to keep those frequencies clear, after the DX hogs wake up to the fact that no listening is being done there. This is

a wasteful use of our frequencies — it would be much better to use the procedure outlined by W1EH some months back, where you swing on to the station's frequency after you raise him — but no one seems to have enough initiative to try any other system.

There is a lot of agitation for the listing of violators of decent operating practices in a "Pig Pen," and there is talk of disqualifying these operators from any of the DX awards. Personally, Jeeves' boss would hate to see something like this come to pass, because he has always had a soft spot in his heart for DX men. But to like some of them the way they handle themselves these days, the soft spot would have to be in his head!

You know those take-them-yourself personality tests that appear in the magazines from time to time? Here's one you can take to find out what your "DX Personality" is. Just check off "yes" or "no" after each one.

- |  | Yes                      | No                         |
|--|--------------------------|----------------------------|
| 1) Do you call a DX station on the frequency of the station he's working before the DX station sends "SK"?.....  | <input type="checkbox"/> | 5 <input type="checkbox"/> |
| 2) Do you give the DX station a long song-and-dance when there is a long line waiting for a shot at him and he has indicated in no way that he wants to click the crockery?..... | <input type="checkbox"/> | 5 <input type="checkbox"/> |
| 3) When you spot a weak DX station do you immediately tune up on him, in the hope that no one else will find him?.....   | <input type="checkbox"/> | 5 <input type="checkbox"/> |
| 4) Do you insist on repeating your mail address three times, knowing full well that "QSL via ARRL" sent once is just as good?  | <input type="checkbox"/> | 5 <input type="checkbox"/> |
| 5) Is your signal clean enough to give other Ws a chance to work DX near you, or do you take up 10 kc. with clicks and chirps?   | <input type="checkbox"/> | 3 <input type="checkbox"/> |
| 6) When a DX station signs with "CL," do you continue to call him for another five minutes?.....   | <input type="checkbox"/> | 1 <input type="checkbox"/> |

Now turn to the end of this article to obtain your rating.

**What:**

The boys are having themselves a time on 80 c.w., this being the season for foreign DX on that band. W1HVF worked F3MS (3510), SM5JI (3510), and PAØNG (3530), while W2QHH got ON4AU (3510), G8TK (3515), G6RB (3520), and G6ZO (3520) with only 20 watts. Best DX heard of was WØTQD working G5LI..... W4HHH, W9JJD and W9NGS worked a VP6AE (3620 f) who claims to be in Suva and running 100 watts. Either we lose all faith in the W6 snoopers, who should have latched on to him immediately, or he is a Grade A phoney..... ON4AU has worked ZL4DQ, LU7AZ, LU1EP and KP4KD on 80.



Bert Brown sends in this shot of CR9AN, the 21-watt station of Adrian Rosario in Macau. The transmitter is a 6L6 with a 14-Mc. crystal, and the receiver is an all-wave h.c. job with h.f.o. added and ganged midgeet condensers included for hand-spread. The antenna is a single-section W8JK firing 25° east of north.

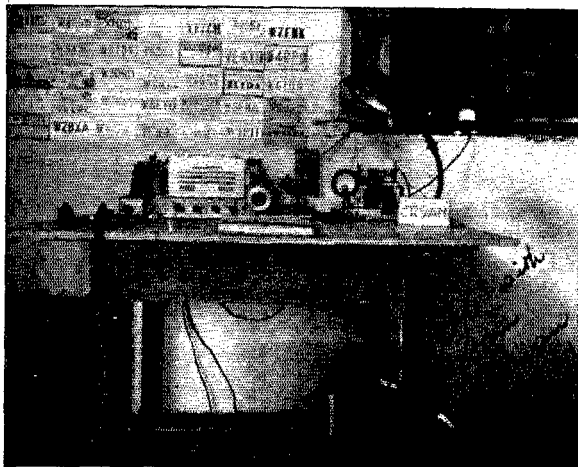

Some of the 75-meter 'phone gang are taking an interest in DX, with good results. W1IHI worked K6CGK, while W1IIM got PAØNG and G6AG, and heard OZ6AA, HB9FR, GM2IT and others. From W1DQ we learn that G6BY is using a large terminated rhombic and has been hearing 75 'phones from W1, W2, W3, W4, W8, WØ, VE1, VE2, VE3 and VO. Many have been worked 80-40 crossband after 20 'phone folds. W1DQ has worked G6BY 280 times since July 1, on 20 and 80-40 crossband.

The DX is good on 7 Mc. for those willing to dig a little. VE5MW came up with PJ9XX (7120 T6), XE2BC (7095), HH2JB (7140), G2FD (7150) and some ZLs and KH6s. LA3GA, HB9CS and HC3CH were heard. . . . . W2FQS has been hearing VKs and XUs in the early evening, coming around the long way, but hasn't been able to raise any yet. He did grab PAØYB (7160), I1ST (7140), UA6LB (7125), EI9F (7170), G5KW/ZC1 (7120) and ZD3AF (7120), however, and those last two ain't bad pickings. . . . . Another guy who has been doing a job on 40 is W6LHN, who knocked off ON4AU (7020), G6ZO (7005), G3SU (7025), LA90 and G5LI, and heard F3NF and SM3IK. . . . . W3GNW snagged OK1FF (7050) with only 30 watts to a crystal oscillator.

Some good stuff showed up on 28-Mc. c.w., what with some of the 14-Mc. regulars making a few passes at the higher frequency. W9KOK worked CR9AG (28,050), LX1AX (28,170), YR5X (28,000), CN8BK (28,165), FA3JY (28,165) and GI6YW (28,050) to bring his total to 84 on 10, and W8CVU got UA3KBC (28,175), HE1CE (28,060), W2CDJ/J2 (28,000), CN8HM (28,150) and ZD4AB. . . . . W5ACL added a few like CR7AD (28,020), ZE1JU (28,050) and OZ7G (28,040).

The 28-Mc. 'phone boys are well represented this month, and they managed to dig out some

nice tidbits. W8BKP opens the parade with W4FHX/J9 (29,025) in the Marshalls, W4BOW/Iwo Jima (28,500), VU2CQ (28,300), VU2AQ (28,225), ZD4AB (28,250), ZE2JA (28,400) and CR7AD (28,200). . . . . W2CYS concentrated on J9AAO (28,300), W2CDJ/J2 (28,450), YL2CA (28,380) and CP5EA (28,300), while W7DTB latched on to OQ5AR (28,200), I1SR (28,280), OZ7PH (28,130), ZB1AB (28,365), VS1BJ (28,360), LX1RB (28,240), PZ1RM (28,120), HR1MB (28,400), YN1LB (28,130), LA8M (28,250) and WØMCF/C1 (28,110). DTB's best WAC time on 10 'phone is 7 hours. . . . . W7JHB raised XZ2DN (28,180), XU1RP (28,230), PK1AW (28,450), XU6GRL (28,400) and CX5AP (28,485), and W9FNR snared OQ5BH (28,370), OX1B (28,460), PZ1A (28,300), ZB1E (28,460), ZB2A (28,220) and a flock of other stuff. . . . . W4BPD took a crack at the band and grabbed off VQ3HJP (28,450) and HP1A (29,400) and heard YN3BG (28,120). . . . . W6ITH scared up VP5RS (28,420), VP9F (28,150) and YN1RA (28,300).

The cream was on 20 c.w. this past month, with the smart lads scaring up those new ones that are becoming tougher every day to find. For instance, new ones at W2CYS include ZD2G (14,130), VP8AD (14,090), CR9AG (14,085), VS7ES (14,040) and VS9AU (14,010), while W8BKP raised VP5RS (14,060), ST2AM (14,005), HA4EA (14,110), UN1AO (14,080), G5KW/ZC1 (14,080), UAØKTU (14,120) and UB5KAE (14,100), and heard ZA2D (14,080). . . . . At W3KT it was EP1AL (14,090), XZ2KM (14,080), TF3A (14,025), VK4OS (14,160) in Papua and CX4CZ (14,050), and W2MEL found ZP2AC (14,060), KP6AB (14,140), ZB2B (14,150), FT4AE (14,190) and J3AAD (14,190). . . . . W4BRB rebuilt in time to garner VQ8AB (14,110), EK1AZ (14,110), KA1ZU (14,100), W8URU/C7 (14,100), W2JCT/C7 (14,100),

VP8AI (14,125), UAØKAU (14,120), OX1Z (14,120), VR4AA (14,130), RAEM (14,100) and I7AA/I6 (14,000 T6) . . . . . W2PRN squeezed in among the mob and clamped on to FG3FP (14,195), UA9CF (14,080), FA3JY (14,025), LX1AS (14,000), UA1AT (14,095), ZB1A (14,135), VP2AD (14,140), VP9K (14,060), VP4TR (14,360) and YR5M (14,025) . . . . . W7VY is up to an all-time of 148 with ZK1AB (14,110), VO6K (14,120), XAEG (14,085) in Trieste, LZ1XX (14,090), VU2XL (14,070), OX3GE (14,095), HZ1AB (14,075) and W6VKV/I6 (14,115) . . . . . W5ACL worked VP5AA (14,040), VS9AN (14,020) and TG9JK (14,000), and heard ZP6AB (14,050) and VS1AF (14,100) . . . . . W4BPD has been busy, with W3CRA as second op, so naturally you'd expect to find stuff like PK3TT (14,035), PK2AA (14,095), EP3D (14,195), PK4KS (14,040), VQ2GW (14,080), YU7LX (14,085), ZS4P (14,080) in Basutoland, UQ2AB (14,140), VS9AR (14,105) and J4AAC (14,080) already in the log, and FM8AC (14,080), XACP (14,100) in Sardinia, FO8ZW (14,105), VP6PM (14,065), LA4LA in Spitzbergen, and KV4AD (14,095) all spotted! . . . . . W2TXB added VQ5JTW (14,165 T8), OX1BC (14,070), NY4CM (14,150), CN8BI (14,080) and ZE1JI (14,025).

A few reports on 20 'phone indicate that there is plenty of the stuff there. Here's W1GKK with KA1CB (14,165), XZ2AA (14,325), ZB1AD (14,345), FF8FP (14,350), J5AAA (14,190), C8YR (14,310), ZB2A (14,335), W6ONP/KW6 (14,230), CN8MA (14,325), EK1ND (14,325) and VP5AL (14,200), while W2CHK got C7AA (14,370), VP2MY (14,390) and J2UVW (14,300) . . . . . W2MPA has his usual list, this month's including EL5B (14,330), EL4A (14,340), PZ1W (14,310), KA1AW (14,180), VQ2PL (14,190), ZB1L (14,120), ZE1JX (14,160) and a flock of ZSs.

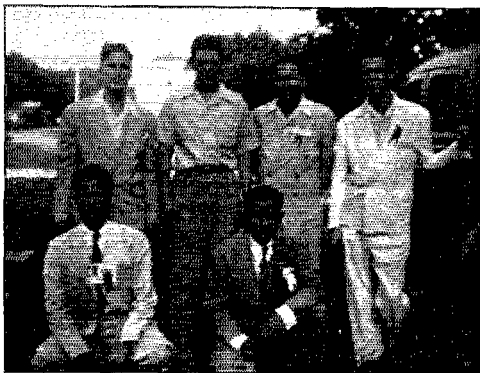

Here are a few CMs you have probably worked. The two fellows in front, from left to right, are CM2BT and CO2BZ, and those standing are CM2SW, CO2JK, CO2DM and CM2CT.

## Where:

If you have had any doubts about HZ1AB you can forget them. The station is in Saudi Arabia and is run by W4JMQ and (prewar) W3JEG. The lads run 300 watts to a pair of 813s and use a 40-foot vertical cage antenna. The receiver is a Super-Pro or SX-28. Cards, of which they have ordered a thousand, will be along shortly, via ARRL . . . . . You can get your QSL for prewar contacts with KF6JEG/KG6 or K6JEG/KF6 by writing to Henry K. Lee, KH6DE, 12 Kaula Street, Honolulu 52, T. H. He regrets that circumstances made it impossible to QSL all his prewar contacts before this time, but it's mighty nice of the guy to come through after all this, and you might tell him so when you write . . . . . You can QSL SU1US by sending your card to Saul Fingerman, W2PMX, 1165 Simpson Street, New York City. Yes, he's the one who confused some with his "QTH-Fingers" routine . . . . . W2ITD warns not to get too excited over ZB1A. Seems the guy is on a ship . . . . . W2GUR says send QSLs for D5FF via HB9AG, which indicates that the D is under cover. It may go tough on him when he gets caught . . . . . W6VFR drops the tip that VK4NV is in Port Moresby, Papua, and more active than VK4OS . . . . . W3YA clicked with a country we've all heard but never worked. He raised S2DU on 3655 who, when asked what country he was in, replied "QRM" and signed! . . . . . Speaking of countries, you will find the revised list in this issue, and let's hope it will meet with your approval. [You're new here, aren't you? — *Jeeves*] . . . . . HP2CA/MM is requesting QSL via ARRL, but so far we haven't heard a thing from him. He's supposed to be a ship of Panama registry, you know . . . . . A few addresses sent in by the gentry — From OK1WY: T1NS (14,100), c/o Signal Officer RAF, Castel Benito, MEF1, Tripoli, Libya. From W3EVW: LZ1XX, via HB9CE. FG3FP, via W2LFI. From W2ALB: ST2AM, RAF Station, Khartoum, Egyptian Sudan. VQ6HOS, via G2HOS, 46 Salisbury Road, Birmingham, England. From W6RGW: VP8AI, Alan Betts, Pebble Island, Falkland Islands. HA5X, Box 185, Budapest, Hungary. From W4GXB: W3KCG/VP2 (14,020), Bruce Williams, 155th AACs Det., Antigua, APO 855, c/o P. M., Miami, Fla. . . . . The op at EP1AL may be "Kilroy" as he says he is, but he also claims to be a second cousin of Jeeves, and that's open to question. [Obviously a falsehood. I don't have a first cousin yet. — *Jeeves*]

## When:

Now that QST told how to build a "Time Slide Rule" last month, we may be able to keep these times straight. But if you want to insure that nothing is lost in the translation to GCT, you had better do it yourself before you send it in to this department. We have already been accused of

dragging scarlet herrings across the path by fouling up the times!

From W4KIT in South Carolina, on 20 c.w.: ST2AM (0545), VQ8AB (0245), PK2AA (2330), OQ5BT (2000), XAEG (1930), ZC6AA (14,125 at 1030), W6VKV/I6 (2245), VQ2HC (0500) and FA1KF (1945) . . . . . From W0JNC in Minnesota, on 20 c.w.: LA4LA (0945), UA3AM (0045), CX1DZ (1200), ZS1AN (1745) and VPIHQ (0945) . . . . . From W7EYS in Washington, on 10 c.w.: VKs at 2330, South America at 0000, South Africa at 1630, Europe at 1730 . . . . . From W5EWZ in Texas, on 20 c.w.: VKs at 1500, VP8AD (0500), CN8MZ (1600), ZLs at 0500 and W6VKV/I6 (1615) . . . . . At W6LDJ in Santa Ana, on 20 c.w.: ZK1AA (0130), EL3A (2230), ZB1AD (1615), ST2AM (1530) and ZD4AB (1630) . . . . . Up in Massachusetts, at W1JYH on 20 c.w.: VQ3HJP (0400), VQ8AB (0400), VS9AU (1730), VQ2HC (0500), KL7AD (2150), UQ2AB (1045), EK1AZ (0000), KV4AD (1330) and WSURU/C7 (0045).

#### Who:

W6SAI, who is probably not a bad guy at all but who rubs it in by sending along a photostat of his QSL from AC4YN, says W8KPB's November QST story about radio conditions near Los Angeles had only one thing wrong with it — it de-emphasized the situation. Bill says it is much worse than that! . . . . . That OY3IGO mentioned last month has been heard by several Ws, including W1JLT, but so far no reports of QSOs. It isn't surprising, since W1DYV got a letter from the Faeroes station saying that his receiver won't separate the signals. Wait until he hears them during the Contest! . . . . . The story from VR2AB is that VR2AA is on 10, 20 and 40 c.w. and that VR2s AB, AC, AD, AF, AG and UH are on 10 . . . . . W7QAP in Arizona got off 6 meters when he got the urge to pound brass on 10, and is a good contact for anyone trying to fill on a WAS. Latest DX there includes F8EO, GI5TK, ON4BCK, CR9AG, HB9AC, GM6UC and ZS6IH . . . . . GI6TK (14,050) is looking for Arizona, Nevada and Utah between 1700 and 1900 GCT, according to W7EHT . . . . . W4EWY proves that Southerners just take things as easy as possible. One day on 10 'phone he made seven calls and worked six stations — one in each continent! The stations were LX1AY, ZS6S, LU4AP, W6VRF/KG6 and J9AGT. (Yes, we counted

only five there, too. He probably doesn't want to mention *North America!*) . . . . . Speaking of unique WACs, G5KW/YI worked it on 28 Mc. from a moving train! He installed a dipole atop a car and operated in motion, according to G6DH . . . . . Miles Weeks, who used to be W1WV and had worked more G stations than any other W, not to mention plenty of nice DX, is now matching wits with the W6s under the call W6ZZ. He threatens to repeat his G treatment on the Js and XUs . . . . . W6CLY, opping at J9ANA, was impressed when he had a solid contact with G4KY on 10 'phone, because the G runs 18 ma. at 200 volts to a 6J5 in the final! Shucks, that's overloading the tube . . . . . We misspelled the name of HR1MB — it should be Marion Brashear — and received a very nice letter for our trouble. Seems as how Marion is a guy who really gets around, having held nu7AJH, W7IB, K5AA (1931-34), W6LBE, K5AN (1937-39), W9DHR and now W4JKE. The present rig ends up with an HF-100 running 150 watts, and a three-element beam is used, supported by a mast made from salvaged packing crates in which the household furniture had been shipped . . . . . KL7AD sends a list of stations worked that must be a mile long, at least. But Dick is unhappy about the 32 cards he received in return for 387 sent, and promises that in the future he will send cards only after receiving the other guy's, which seems like the right way to do it. KL7AD is one of our pet stations, because he occasionally takes time out to lace the DX hogs who break up his QSOs. And his lacings are no amateur jobs! There should be more DX stations like him.

#### DX Personality Scoring:

If you have honestly checked off the test at the start of this column, add the numbers for every square you checked "Yes." If your total is 1, you're an optimistic stupe. If your total is 3, you're a selfish lid. If your score is 4, you're an optimistic, stupid, selfish lid. If your score is 5 or over, brother, you're a DX hog! If your score is zero, you're one of the *clean* operators who rates 100% with the rest of the gang. — W1DX

Most consistent VS7 this past year has been VS7ES, Emil Savundranayagam, Havelock Town, Colombo, Ceylon. He runs a kilowatt to a pair of 813s. The receiver is a National 120.



# "I Just Put Up Another Antenna"

Or, "I'm Up a Tree as to Why You're Not Hearing Me"

BY BILL LIPPMAN,\* W6SN

**M**Y WIFE once paid me the dubious compliment of opining that I was the only ham she had ever met who appeared to be a reasonably normal human being. There was another ham, a friend of mine, who was to receive that accolade later, but he had been off the air for seven years and was really disqualified.

That situation is about to change . . . for the worse. In fact, my wife says it already has. I have a wild look in my eye, she declares, and I sit up suddenly in the middle of the night and converse at length with spindly little men who seem to be made mostly of No. 12 hard-drawn copper, and whose heads are egg insulators. Last evening when I came into the house I spoke loudly to our small black cat, who was sitting on the porch. "Lo, Tops," I said. But it wasn't Topsy . . . it was a pair of rubber boots. You see what I mean?

I was ever a "one-antenna" man. Back in the early twenties I had only one antenna. It worked fine for spark and for c.w. (all we had to do was find the nodal point). Sometimes, even after we found the node, it wasn't in just the right place, and then we would do things with the counterpoise. This was easy because the counterpoise was chin-high — in fact, where it sagged it caught you just under the armpits.

After I started supplying my own back yards, I got along nicely on fifty-foot lots. I remember that every time I read an article on antennas that started, "For those city dwellers who must get the most out of a restricted space . . ." I immediately pulled the print closer to my already weak eyes and read on avidly. I was a suffering city dweller. People like W6GRL on the swamps of Ventura, W3EMM, who seems to own part of the south bank of the James, and HC1FG, who in my mind's eye occupies the top of a 12,000-foot peak with all of Columbia for his directionals, were dwellers in another world. So all I ever had was one antenna at a time, and being naturally lazy, I seldom changed that. I got out well enough, too (I know now).

During the war I had a chance to buy what I had always yearned for — what had always seemed the unobtainable — a quiet suburban home, surrounded by an acre and a half of luscious space. This, I counseled myself, is it! Here I will live out my reclining (or maybe I said declining) years in peace and contentment, surrounded by my family and my QSL cards. I will

\* 525 South Westgate Ave., Brentwood Heights, Los Angeles, Calif.

become, easily, the first guy to work 371 countries, and they will rule me out of future DX Contests so that W6QD, W1SZ, W2UK and the others won't bleat into their beer crying "professional" in piteous tones. I bought it.

To what I hoped would be our final resting place, I brought along the pair of thirty-five foot poles (badly travel-worn from being dragged all over Southern California for ten years), creeping along the side streets at 4 A.M. with red lanterns hanging at what seemed sixty feet ahead and behind. Into the weeds they went, and in that plethora of space they looked like the lumber shortage had even affected toothpicks. They had always been high enough before. But not now. You see how your sense of proportion is affected? So I bought some 2x4s and stretched the masts out to sixty-five feet, which seemed more in keeping with the surroundings. After all, there were trees *fifty* feet high on one side of the grounds!

After searching five months for No. 12 galvanized, I found miles of it in a hardware store six blocks away (where it had been all the time), and strung my eggs. On a dark wind-free night, assisted by a battery of flashlights and extensions, my brave, uncomplaining wife and I hoisted the first mast into the wild black yonder. Next day we found one guy had been tied to the leg of a sleeping pullet, but the pole was up — and stayed up. In the full sunshine, and with confidence, we started operations on the other one. Knowing what we were doing was our downfall. Part way up a guy slipped, the prop pole broke, and the upper twenty-five feet of the mast snapped off and fell all over my wife. Three weeks later we resumed operations, compromising on putting up only the remaining forty feet.

Now I had two masts, but being of different

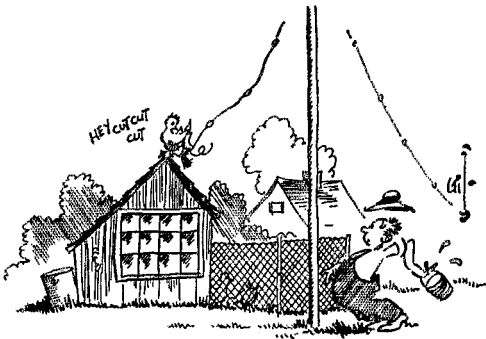

height they upset all my carefully-planned arrays. However, I was firmly resolved to go ahead in the face of all difficulties. But let me go back a bit. While the weeds were concealing the bare poles (awaiting guy wires), I had strung up among the trees a half-wave wire so I could while away the hours on 80 meters. This little gem was slightly under twenty feet off the ground at the ends, and fifteen at the middle. When the trees nodded to each other in the wind, my little boy and his friends played a sort of skip-rope with it.

Did this fence-wire work, you ask? Brother, ask W4FU of W9FS fame. All through June and July, bad low-frequency months, Bert and I worked nightly. When the California Kilowatts were struggling with W5 and W7, I was working the East Coast like crazy. According to The Book this is all wrong. Besides, it was only a temporary wire, so why should I keep it? Now the masts were up, no more of this freak stuff. We're UP, UP and AWAY-Y-Y.

Not right away, though. No copper wire. I searched around and found enough scraps (some saw duty in 1921) to piece together a little half-wave vertical for 14 Mc., just to keep the filaments from getting brittle. While stumbling from store to store in search of steel-core stuff, I found the little half wave doing yeoman duty. New countries dotted my log sheets. Fellows said, "My, my — you were never this loud before the war — even with twice the power, too!" I thought, boy — if a little temporary thing will do this well, what is to be expected from all the directionals I'm planning? Drooling, that's what I was doing — drooling. But wait.

The Book says, solemnly, "The greatest gain to be obtained from close-spaced elements is that to be had from the W8JK., etc., etc.," and here follows a rising curve of beautiful decibels. Well, I am no hog, so I choose 6 decibels as a nice round figure, and with some newly-acquired wire I build me a two-section dandy. This is a week's work, but when finished it is a heavenly thing to behold, of shiny wire with pole-vault type spreaders, taped between joints and the varnish gleaming in the sun. Lifting it out of the weeds dredged up a pair of wire cutters lost weeks before, and took the top off the brooder house, but you could see it five blocks away. Beautiful.

Feeding this behemoth was something else; something akin to prescribing nutrient for the finicky chinchilla. My dreams had involved nonresonant lines running into the shack from all over, from which I could select the desired one by nonchalantly pushing a small button. Hah! little did I know — I, who had never progressed beyond the single-wire-feeder-clipped-to-the-tank stage. I'll bet I ran that light bulb and wire up and down the quarter-wave matching section (it must have matched the power wires in the next yard) two hundred times — the feeder wires got so thin they were like a spider web. In

order to get it "shock-excited" I had to put 400 watts into a wire hung just off the ground. My ankles still bear r.f. scars. Spot looked like a zebra by the time I got him locked up.

Finally I decided the light was brighter — maybe less dim — in one place than any other, and proceeded to learn that that had been a breeze compared to hooking on the feed line. After half a day of moving the feeders up and down, up and down, and "adjusting" the stub, there were still standing waves. There were even a number sitting, and a few actually lying down. Tired, I supposed, from running up and down that hot wire. I dunno — these editors make it all sound so-o-o-o-o easy. You just do this, and you do that, and it happens. Well, it never seems to happen for me.

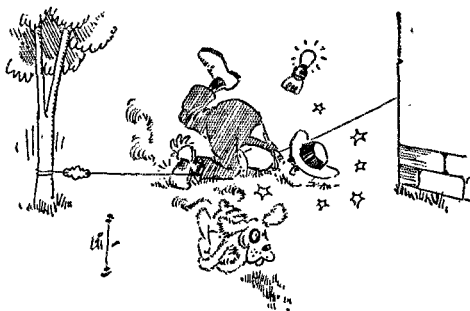

I hooked on the rig. Something is going on, all right, as I can draw big arcs off the feeders and the flat top, and the final is groaning with pent-up power. I take off. Does Europe come back? No! Does the ground wave ripple the harbor at Sydney? No! I'm still under three layers of QRM.

By getting up at an hour when even W6GAL is in bed, I eke out a QSO with an SM, who is S9 at my place. We try the 8JK against the vertical. Both the same — weak. With shrewd cunning I snag a VK who is trying to QSO his grandmother in the old country. We go through the same thing. He is also S9 with me. I am weak on both antennas. The 8JK is wonderful for receiving. "But what good is a contraption that throws shade all over the rose garden and is only good for receiving?" my wife asks.

About this time, despondent, I think I shall try a Lazy H. Everybody says they are the nuts, and I notice some people have three of them. W6CUH used to work WAC in 39 minutes with a Lazy H no bigger than the palm of your hand. But my masts aren't the same height. The Book doesn't say anything about a semienergetic H; only lazy ones. Mine would be up on one elbow, leering insolently around the neighborhood. It is not for me. My signals would not arrive round and full-bodied. They would be square.

Frank Lucas, who is now W3CRA, blocks my receiver with his Sterba. I work up the subject of antennas carefully, plying his ego in the hope that I might find out how he managed to lead the International League for so many years. "Long wires," says Frank with his Sterbas, "are my favorite. Put up a long wire and you will have no further trouble." He doesn't know what can happen to me. "You know how to tune 'em?" he asks. "Just prune the end until it stops af-

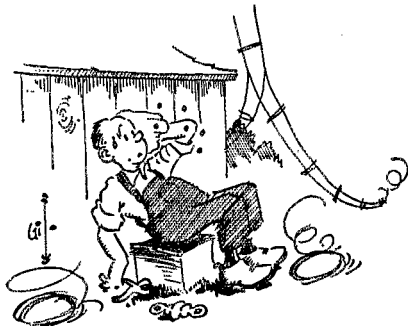

fecting your tank tuning." Just prune the end, he says.

Being gullible, I fight my way through eucalyptus trees and brush, and hang up five half-waves of wire. The far end is across what we call a dry gulch in California. The wire was tied to a tree limb. You remember Jimmy Durante's story about the woman that got on the streetcar? Well, twenty-one times I walked out the door, down the steps, across the grass, through the rosebushes, between the oleanders, over the weeds, down into the gulch, up the other side, up the ladder, out on the limb and pruned. Then back to the trunk, down the ladder, down into the gulch, up the other side, over the weeds, between the oleanders, through the rosebushes, across the grass, up the steps, in the door, press the key and look at the meter. Twenty-one times! "Just prune the end," he says.

And did the long wire work? You guessed it. It wasn't any better than the vertical.

"Ho," says W2CYS, "you should use a folded dipole." Why should I use a folded dipole? I've no reason to fold anything. Besides, folded dipoles always sounded to me like something from the infants department.

"Vertical half waves," sonorously intones my friend and former neighbor, W6ENV, "have only one outstanding advantage over other types. They are equally weak in all directions."

"But," buts Juan Lobo y Lobo, "I have always had much success with my vertical half wave." And who am I to argue with XE1A, the Pride of Pan-America, who carries off the honors in every contest?

By this time I am up to Chapter Ten, "V

Antennas." I have also obtained several hundred yards of new wire by exchanging a second mortgage on my home. I start on the "V." The first leg is easy, but the second (or left) leg has to cross that dangled gulch. This time I make the mistake of going up the tree 45 feet with the wire hooked to my belt and pulling my pants off every time I reach for a limb, without having a permanent helper on the ground. When I started up my seven-year-old was on tap, but when I reached the top, panting and bruised, he had departed to wherever it is that junior ops go when they are needed by their OM.

Trying to pull the wire tight, I hooked it into a branch across the gulch and it refused to let go. Spying an old man working some distance away, I hailed him. He must have thought me Death In a Tree, for he gingerly skirted the area for five minutes before deciding I was human and in distress. Would he throw a rope over the wire and pull it to one side for me? Yes, he would. He then proceeded to tie a tremendous rock to the rope, which somewhat hampered his efforts to get it over the wire. To further complicate matters, he stood on the rope during the first two tries, which resulted in the rock stopping short about 3 feet above his head and coming back down as fast as it went up. This brought forth some of the nimblest footwork I ever saw, Nijinsky and Astaire notwithstanding. Soon, however, he looped the wire and we got it straightened out. While sitting this performance out I carved my initials in the trunk at the fifty-foot level, but I was an old, old man when I reached the ground, and I'll never see those initials again in this life.



When I finished "matching" the stub it was 9 p.m. and no dinner. But what of it? I had a "V" beam! What is food and drink beside that? I sat down and listened, and lo, there was W5KGI/C7 in Peiping, China — right smack in the middle of my largest decibels. Back he came with an S7. "Wait," I said, "want to make an adjustment." I slipped off the "V" feeders and clipped the trusty old vertical onto the tank. "Do you notice any difference?" I asked him. "Oh, not much," comes back Glen, "maybe a point louder now. What did you do — raise the power?"



# The World Above 50 Mc.

CONDUCTED BY E. P. TILTON,\* WIHDQ

**A** NEGATIVE result is often important, and for this reason we should not feel that our inability to get across the Atlantic on 50 Mc. during the month of December makes the time spent in that endeavor wasted. There were quite a few in there trying; those who were caught napping on November 24th, when the first trans-Atlantic v.h.f. communication was carried on, were on the job for the recurrence of high m.u.f. on the 27-day cycle in the days just before Christmas, but no  $F_2$  DX was found in anyone's stocking. The m.u.f. rose on schedule, but not quite high enough to permit 50-Mc. DX work to Europe.

There was cooperation at the other end of the path, too. By special permission from his government, PAØUN, Eindhoven, Holland, was ready with 100 watts on the band's edge, a 4-element beam, and a converter which tuned the range from 30 to 60 Mc. In Capetown, South Africa, ZS1T was conducting regular 50-Mc. listening tests with W1PFJ. Down in Mexico City, XE1KE was running 125 watts to an 829 on 50.024 kc., feeding a 4-element array. CE3FV on 56.4 Mc. temporarily, was keeping skeds with W7QAP. As they have for months, G6DH and G5BY were monitoring the 50-Mc. band regularly, and G6DH and your conductor continued daily schedules on 28 Mc., exchanging information as to the m.u.f. on the North Atlantic path, as observed by noting the strength and time of appearance of various signals in the range between 40 and 50 Mc. at each end.

These daily checks, which have gone on uninterrupted since early November, showed that the m.u.f. came close to 50 Mc. for two days following the 50-Mc. break-through on November 24th, but then dropped off steadily, falling to about 38 Mc. in early December. By the 10th, however, WGTR (f.m. station at Paxton, Mass., on 44.3 Mc.) was being heard again at G6DH, and the English television station (sound channel on 41.5 Mc., video on 45.0 Mc.) was putting in an appearance at WIHDQ. These two signals were heard daily until Dec. 25th, often with a strength which gave the waiting 6-meter enthusiasts some optimism that this would be the day, despite the information from the Bureau of Standards that the m.u.f. for the path would be about 40 Mc. for December. The CRPL predic-

## RECORDS

### Two-Way Work

- 50 Mc.: W6NAW — W8CIR/1  
2590 Miles — July 5, 1946
- 144 Mc.: W3HWN — W1MNF  
390 Miles — September 29, 1946
- 235 Mc.: W9OAW/6 — W6WQN/6  
110 Miles — December 15, 1946
- 420 Mc.: W6FZA/6 — W6UID/6  
170 Miles — September 28, 1946
- 2300 Mc.: W1JSM/1 — W1LSL/1  
1.6 Miles — June 23, 1946
- 5250 Mc.: W2LGF/2 — W7FOF/2  
31 Miles — December 2, 1945.
- 10,000 Mc.: W4HPJ/3 — W6IFE/3  
7.65 Miles — July 11, 1946
- 21,000 Mc.: W1NVL/2 — W9SAD/2  
800 Feet — May 18, 1946

tions turned out to be accurate, considering the month as a whole, but signals were heard up to 47 Mc. by G6DH and to 48 Mc. by the writer on December 23rd. Test transmissions were made by numerous W1s, on the schedule which is now the accepted standard, on several days; not that anyone expected to get across, but to establish a "positively-negative" result. The test schedule used is as follows: if observation shows that the m.u.f. is well above 45 Mc., transmissions are made at 15-minute intervals, 5 minutes per transmission. A 50-Mc. listening period of 5 minutes follows, during which PAØUN (and anyone else who can take part in Europe) transmits. This is followed by a monitoring of 28 Mc. for a report from G6DH, or other interested European listeners who have facilities for reporting results on that frequency. By maintaining this schedule we at least have the satisfaction of knowing that no trans-Atlantic DX opportunity is missed because of lack of activity.

### 50-Mc. DX in Australia

It's summer down in Australia, and the 6-meter band is acting accordingly, with the result that interest in work on the band is rising sharply. VKs are experiencing their first taste of sporadic-E skip, and they like it! VK4ZU writes that VK3HK was amazed to hear the signal of 4ZU on

\* V.H.F. Editor, QST.

his mobile rig, when he was listening for another local on the evening of Nov. 31st. VE3PK later reported hearing 4ZU at the same time, and the following evening he was heard by 3MJ and 3LS, all of whom could hardly believe their ears at first, the distance being about 1000 miles from Melbourne (VK3s) to Brisbane (VK4ZU). On the same two evenings, VK2NO heard the fourth harmonic of a VK3 in the old 5-meter band, and VK2OC and VK2WJ heard VK3HK. The VK2s, in the vicinity of Sydney, are midway between Melbourne and Brisbane, so these reports represent a skip of only about 450 miles or so.

The first two-way interstate work was done on December 5th, when VK2NO worked VK3MJ, Melbourne, 450 miles, and VK4AW, Brisbane, 500 miles, was worked on the 7th, these being the first contacts with the third and fourth call areas made from VK2 on 50 Mc. Other Sydney-area stations in on the fun were 2WJ, 2AZ, and 2AHF, and they contacted 3MJ, 3HK, 3NW, 3GG, and 3YS, all in the vicinity of Melbourne. This activity took place between 6 and 9 P.M., and, reminiscent of many similar sessions in this country, the period was marked by a violent thunderstorm. On the 7th the band began to show signs of life at about 4:15 P.M., when the VK3s worked 4AW, 4ZU and 4FB, all of Brisbane, and 4UX of Bundaberg. Another contact between 2NO and 3MJ was made during this opening. All this created quite a rush to get on 6 on the part of numerous other VKs, including 7LL, of Tasmania, who happened to be visiting at 3MJ at the time.

This burst of sporadic-E skip, having caused greater interest in the possibilities of the 50-Mc. band, should do much to further the cause of VK-W attempts. There will be many more stations watching the band down there now, and they have more incentive to go to work on receivers and antennas. The coming year should see the VK-W path broken down, as it is expected that it will be open during most of the year, with the possible exception of our midsummer period. We should continue our efforts to contact Australia and New Zealand stations on the hour, at 2100, 2200, 2300 and 0000 GCT. VK2NO has an automatic transmitter in operation during this period each weekend, and during the first hour of the schedule period each day. The frequency is 50.4 Mc.

There were several sporadic-E openings in the United States during December, which is in line with our prewar experience on 56 Mc. On the evening of the 3rd, short skip was observed on 28 Mc. before that band closed for normal operation, and by 6:30 P.M. W4GJO, Orlando, Fla., had started to hear fading carriers on 50 Mc. Between 6:53 and 11 P.M., Grid was plenty busy, working, in the order given, W1HDQ, W1AEP, W1LLL, W1PFJ, W9ZHB, W1PFJ, W1JTB, W2KPC, W1HDF, W1DBM, W4FJ and W4CYW of

### V.H.F. MARATHON

Call	Contacts Through November		States Worked	
	50 Mc.	144 Mc. #35 Mc. Score	50 Mc.	144 Mc.
W1AEP	65		539	21
W1BCT*		258	1161	6
W1CGY	38		332	15
W1EHP		52	241	4
W1HDQ†	114	126	2158	25
W1KLR		118	705	5
W1LLL	106		1227	27
W1LMU		172	726	4
W1MBS*		131	432	2
W1PFJ	129		1305	25
W2AN	101		1072	24
W2AUF*		200	654	4
W2BQK	66		632	18
W2BYM	123		1182	25
W2COT	36	40	259	7
W2DZA		225	1007	2
W2JWO		269	1832	10
W2QVH		321	1505	8
W2RFO	6	71	591	3
W3BTP*		91	538	4
W3GKP*		128	952	6
W3HVN*		194	2040	9
W3KIE		145	931	6
W3RUE	36	24	600	16
W4CDG/3*	9	174	1239	6
W4HVV	32		574	15
W6BVG	54		201	2
W6HZ*	135	182	1002	5
W6NJJ*		288	1418	1
W6OVK	11	97	681	6
W6QG	60		621	9
W6TGY*		54	159	1
W6WNN	38		240	3
W7KAD	65		1322	19
W7QAP	37		643	11
W9AB	15		102	6
W9ALU	16		154	6
W9PK	76		988	19
W9ZHB				25
W0PKD	3		59	2
W0VUQ	77		1221	22
W0ZJB	113		1575	27

\* Includes portable or mobile work.

† Not eligible for award.

‡ November winner: W3KIE, 532 points.

Richmond, Va., W1HDQ (at which time we checked 29 Mc. and found that we could not get through on that frequency!), W2IDZ, W3OMY, W4CYW, and W8SFG. There was evidence of sporadic-E skip in England on Dec. 2nd, when G5BY heard a 57-Mc. harmonic of IRL, an Italian commercial commonly used as a check signal during the summer months.

December 19th provided a nice opening to the north for the W6s. Beginning at around 8 P.M., W6FPV, Van Nuys, Cal., worked W7ERA, W7DYD, VE7VY, VE7BQ, and W7HEA. W7DYD, Bothell, Wash., worked W6FPV, W6OLO, and W6JUM, and heard W6NAW and W6BRH. W7EUI, Kirkland, Wash., worked W6NAW and W6JUM. According to a report received via W0ZJB, W7ERA, Milwaukie, Ore., worked ten W6s during this session.

The appearance of short skip on 10, around 4:30 P.M. on December 22nd, sent the W1 gang scurrying for 50 Mc. As usual, the first contacts



were made by WILL, who heard a three-way local QSO going on in Cincinnati, Ohio. Brownie broke it up, and had made contacts with W8s NDN, ODF, and BFB before the rest of us got started. He also worked W8CYE, Miamisburg. Other W1s in this affair included W1PFJ, W8CIR/1, and your conductor.

### Here and There on Six

The term "DX" has always had a special meaning for v.h.f. men, who apply it to anything not worked during the normal course of events. Thus, DX can mean W8, W9, or W4 to a W1 or W2, and it is enough to get worked up over, too, under certain circumstances peculiar to v.h.f. operation. Now, however, DX is about to mean the same thing to 50-Mc. workers that it does to low-frequency men — remote countries, seldom-heard prefixes, and even WAC. More and more, we're hearing of some really choice DX now (or soon to be) available on 50 Mc. Some of it we can't give you all the details of, because the printing of everything we know might cause some fellows a bit of trouble, but here are a few legitimate samples: YI2CA, heard in this country daily on 28 Mc., is rigging up an automatic transmitter, and will arrange tests with interested operators who can transmit to him on 28 Mc. He will try to make it two-way as soon as he can get receiving facilities, but should have the transmitter, and a beam antenna to go with it, ready to go to work on 50 Mc. by the time this appears in print. VQ3TOM, Tanganyika, is angling for a receiver to cover both 50 and 58 Mc., and will be glad to talk v.h.f. with interested parties on 10. We have already mentioned PA0UN, who is the best prospect yet for trans-Atlantic work, being all set as to rig, receiver, and antenna system for work on 50 Mc. His authorization is a temporary one, but with the cooperation of the licensing authority who very kindly issued this special license, he hopes to continue tests through the spring peak period.

The period between Dec. 19th and 22nd looked good to W6OVK, Redwood City, Cal., who had a chance to check the band these days between 8 A.M. and 12 noon. Several weak fading signals were heard near the low edge of the 50-Mc. band, but none long enough to be identified. Jim says that more stations are showing up on 6 in the Bay area. W6NJJ has started a movement by which everyone gets on the band each Wednesday evening at 7:30.

Good news from Arizona — W7QLZ, first in the long line of Arizona DXperts, is back on the scene. Clyde has a portable rig with an 832 in the final, which is installed in his car, along with a 5-10 receiver. This rig can be used on 10, 6, or 2 meters, and will be available for fixed station use at Castle Hot Springs, if Clyde can find a suitable a.c. power plant. Signals were heard almost to 50 Mc. at peak periods in October and November.

### More 50-Mc. Frequencies

W1BDN Manchester, N. H.	50.48 Mc.
W1MZ Manchester, N. H.	50.6
W1OFV Rockville, Conn.	51.6
W1PBT Plaistow, N. H.	50.18
W2OMS Long Branch, N. J.	50.2
W7ACD Shelley, Idaho	50.08
W8ODF Cincinnati, Ohio	50.6
W9AKF Aurora, Ill.	50.45
W9RGH Washington, Ill.	50.48
PA0UN Eindhoven, Holland	50.00
XE1KE Mexico City	50.02

There is a prospect of activity in Utah, never before represented on 50 or 56 Mc., and in Idaho, if the plans of W7DTB, Lewiston, Utah, and W7ACD, Shelley, Idaho, materialize. Both have receivers for 50 Mc., and are working on rigs and antenna systems. They have W7EHP, Rigby, Idaho, W7DMZ, American Falls, Idaho, W7MAV, Logan, Utah, and W7JHH, Ogden, Utah, lined up, and are looking for converts in Salt Lake City and Provo. Since this area is just about the right distance for skip contacts to the Pacific Northwest, the California Coast, and the entire Middle West, these boys should not lack contacts when the major sporadic-E season rolls around next spring.

There is an active group centered around Pittsburgh, according to W3RUE, who writes that W3OMY, Pittsburgh (250 watts, 3-element beam), W3SSF, Colver (750 watts, 4-element array), W3KXI, Farrell (100 watts), W3KSP, Westview (50 watts), W3RUE, Pittsburgh (100 watts, 3-element beam), W8SFG, Hubbard, Ohio (100 watts, 3-element beam) and W8TDJ, Morgantown, W. Va. (100 watts, 4-element beam), are active regularly and will be glad to arrange schedules with interested parties in Western New York, Pennsylvania, Eastern Ohio, West Virginia, and Maryland, to increase their sphere of influence. Drop a card to W3RUE, 3036 Churchview Ave., to get things started.

What is probably the world's longest grapevine was responsible for spreading word of the trans-Atlantic work on November 24th, according to W9PK. At 10:35 CST, only 10 minutes after the G6DH-W1HDQ contact had gotten underway, Jack got word of it from ZS6DW, who had gotten it from another ZS that G5BY was also hearing your conductor. Later, in contact with VK5NR, he learned the rest of the details! Jack says that a few more Illinois stations are showing up on 6, recent arrivals being W9AKF, Aurora (p.p. 35TGs, 4-element array), W9RGH, Washington (60 watts, 3-element beam), and W9DXZ, Oak Park (30 watts, vertical coax). A number of the Chicago-area 2-meter gang are giving 6 a whirl, according to W9NFK's *Midwest VHF News*, which lists W9s YQI, EPM, VEZ, LWE, and ELV as prospects.

In the opposite direction from W9PK, the

Society for the Promotion of Activity on 6 holds forth, with some results and considerable promise, according to W9AB, Mishawaka, Indiana. Near Kalamazoo, W8CVQ, W8AKR, and W8HDM keep things going, with W8VIB at Three Rivers, Mich., W8JLQ at Toledo, Ohio, W9AB and W9ECH at Mishawaka, and W9QCY at Ft. Wayne comprising a network which functions each Monday night. Tying in with the stations around New Castle it should be possible to ring in the active group in the vicinity of Terre Haute. This whole great area was the scene of much fine long-haul work on 56 Mc. just before the outbreak of war; it should be possible to do even better on 50 Mc., if everyone will do his part in maintaining activity in his own locality and keep on the lookout for the signals from beyond the horizon. W9UIA is on down in Evansville, and is working W9CZD in Sullivan, W9IKI and W9ZHL in Terre Haute, and W9UNS in Marshall at frequent intervals. In New Castle, W9MBL and W9PHV have frequent contact with Dayton and Cincinnati, and the stations in this group listen for Mishawaka and Ft. Wayne stations at 7, 8 and 9 P.M. each Monday, and call in that direction five minutes later. This is the sort of thing that keeps the band active, and in shape to make the most of any unusual conditions which might otherwise go unnoticed, such as the opening to W1 on the evening of December 22nd.

An odd condition is showing up in the course of the regular evening contacts of the Eager Beavers of Missouri and Kansas. WØYUQ reports that WØZJB, formerly S5- to S9-plus in the summer and early fall, is now running at a barely-audible level much of the time, while WØJCC, who is farther from WØZJB, is hearing him better than he formerly did. WØPKD, still farther along, could not hear ZJB at first, but is now receiving him with an improved signal. Must be that new 3-element quarter-wave spaced array at Gashland!

Hunting harmonics and other commercial signals in and near the 50-Mc. band is getting to be quite a sport these days. Here are a few reported recently: By G5BY — WMZG calling WCC, S5 on m.c.w., 49.8 Mc.; NYQD on about the same frequency, also calling WCC, heard on Nov. 30th, at 1436 GCT. By ZS1T, Capetown, S. A. — unidentified weak signals just inside the low end of the band at 1628 GCT, Dec. 15th. By W1HDQ — CEC56, c.w. harmonic near 42 Mc., heard around 8 A.M. EST during late December; French commercial harmonics (reported by G6DH to be from around Dakar), near the signal of CEC, and at similar times; television video, 46 Mc., presumably Eiffel Tower, 9-11 A.M. EST. By many Eastern stations — television video channel on 45 Mc., London, heard daily for several days around 27-day peaks of sunspot activity. By W9ALU, Metamora, Ill. — c.w. on 50.9, sending

"543 543 QSV QSV K," heard at 1820 CST on Dec. 17th.

#### 144-Mc. News

With the passing of frequent openings of the 2-meter band, much of the activity of the summer and fall period has fallen off, or at least so it seems when one listens on the band. It is still possible to dig up contacts in most areas, however, and the use of improved gear in the form of crystal-controlled transmitters and superhet receivers has gone a long way toward holding the range of operation well above that achieved when we first made the changeover from 112 Mc. a little over a year ago. Organized operating activity is helping, and there is still quite a bit of activity on the appointed nights wherever such a program has been instigated. The boys want to use the band, and a surprising number will do so when the word gets around that activity can be found on certain nights. W1CTW, Arlington Heights, Mass., reports a spot-frequency net operating each Thursday evening at 9 P.M. on 147.96, the list including W1s AKD, IID, IKW, EU, PIJ and PKA, with more coming. Cal worked 16 different crystal-controlled stations during November.

Ever try straight c.w. on 144 Mc.? The few who have used a b.f.o. know that it is invaluable in locating weak signals. When one is using a highly-directive beam the b.f.o. is particularly handy, as it will help to spot activity which is going on in a direction away from the line of the array, when such signals would otherwise go unnoticed. W1LKH, Providence, R. I., reports that the stable signal from W1HDF, Elmwood, Conn. (a difficult hop under normal conditions) is often heard by the b.f.o. method, when Paul would never have known Carl was on. The weak b.f.o. beat serves admirably in centering the beam, after which the voice modulation can usually be copied.

Message handling can be carried on very nicely via 144 Mc. Originated by W2STZ, Fanwood, N. J., a message came to W1HDQ all the way on 144 Mc., the route being W2STZ, W2IRM, W2KU, W2NI, W2PCV, W1OGS, W1SF, W1EH. It related the story of W1KSF, who was flying from Baltimore to Washington at a height of 13,000 feet, working 2 meters en route. He was heard and called by numerous W2s, but the best DX known to have been worked was W2VX, Westville, N. J., who made contact with W1KSF over Baltimore, Washington, and Fredericksburg, Va., the distance to the last point being about 200 miles.

Here's a chance for Vermont contacts on 144 Mc. W1MEP, Bennington, Vt., who used to hold forth from Glastenbury Mountain in prewar days, is now operating on 2 from his home. He has a 6-element array, and will be glad to keep

(Continued on page 150)



# Correspondence From Members -

The Publishers of *QST* assume no responsibility for statements made herein by correspondents.

## HE'S HAPPY

1114 Wellington Court, Ann Arbor, Mich.

Editor, *QST*:

Now that I am back home again, with the same old rig on the air and getting my *QST* every month, I see the situation hasn't changed much with respect to the usual gripes and growls over what the ARRL is doing, has done, or is trying to do. I think you fellows ought to have a pat on the back once in a while for the way things are run.

I like the way things are run.

About all this fuss over Class D licensees — well, being a steadfast c.w. man I was against it, too, when I first heard about it, but now that I think it over perhaps you fellows were right and the thing should have gone through. Perhaps we will all be sorry yet, only time will tell. Anyway whatever the Board decides in the future, I am going along with lock, stock, and barrel.

And another thing, I like *QST* as it is. I don't see anything too technical about it. Isn't the purpose of *QST* to keep us informed of the latest? Heaven forbid the day when *QST* becomes a "build it" or "story" magazine. . . .

— S. S. Hatch, W8NDL

## ANSWERING CQs

114 Acacia Ave., San Bruno, Calif.

Editor, *QST*:

. . . It appears that a considerable amount of time and frequency spectrum are wasted in making the general call, "CQ," in order to arrive at a QSO. My plan, no doubt advanced many times in the past, is for the operator calling CQ to send the break sign "BK" after the third CQ and pause for a short interval to listen on his own frequency for other station or stations trying to "BK" in. If any BKs are heard the CQer will immediately send his call and give the "K" signal. In this way the length as well as the number of CQs made should be considerably lessened. This plan gives the first operator who hears the CQ a chance to make the contact, whereas his chances are lessened the longer the CQ is continued. This method should work equally well on radiotelephone, although I cannot by experience so advocate it.

A VFO would be necessary, or else a great number of crystals covering nearly all the band to make this plan work. VFOs are becoming more and more a necessity, however, to fully enjoy hamming in this postwar period. . . .

— Frank Hogan, W6ISX

## POWER FOR THE BC-375-E

Hardin, Montana

Editor, *QST*:

Regarding the article on the BC-375-E in December *QST*, it might be of interest to others that one can get a generator from war surplus which will give the necessary voltage for the 24/28-volt dynamotor. Its output is 200 amp., 28 volts, 5700 watts, d.c. It is made by Delco-Remy. Other specifications: 6 pole, shunt-wound, 2500-4500 r.p.m., shipping weight 53 lbs. The generator can be bought from Generator Sales, 1627-9 N. Damen Ave., Chicago 47, Ill. Price is \$8.95, F.O.B. Of course the driving power for this generator would be around 3 h.p. per 100 amp., but if one is to go portable-mobile it can be run from the fan belt of an auto, or on Field Day workings one could use a gas motor to drive it. I have one of the generators but as yet haven't been able to get the rig set up. . . .

— Charles B. Eder, W7JSQ

## THE DECEMBER ISSUE

Box 175 North St. Sta., Nacogdoches, Texas

Editor, *QST*:

Congratulations on having achieved an all-time high of 192 pages in the December issue. Lessee, now: 192 divided by 2 is 96, so the wire goes between pages 96 and 97. It's thinner and floppier than those which came with prewar binders. Hey! Instead of one of those cuts of the SX-42, why didn't you run instructions on how to cram this issue into the 1948 binder? Well, maybe if I move July over into the first half, I can . . . nope, that won't work either. If the prewar tie-rods were thicker, maybe the binders were too . . . nope, guess not; anyway the cover wouldn't match its neighbors. OK, Ed, you win. I give up. How do you cram it in?

Until I find out, I'm not ordering my '47 binder. I wouldn't suggest omitting any advertising, even though *QST* is beginning to resemble that lousy rag [Censored — Ed.], because I know that you (we) can use the neat little honorarium that Halligan coughed up. But if during 1947 we're gonna have a 192-page issue each time an SX-43 or HQ-173.25 is announced, please run all 102 cuts of whatever it is on the last 41 pages, so we can rip it out without spoiling any text. (After finishing page 15, we all knew what the SX-42 looks like, so the other 100 purty pitchers have no reference value.)

Very 73 for bigger (on second thought, I'll retract that word) and better *QSTs*.

— Basil C. Barbee, W1OCE/5

## PLUG FOR V.H.F.

3330 Lake Shore Dr., Chicago 13, Ill.

Editor, *QST*:

. . . The amateur society as a whole is passing up a wonderful opportunity by not occupying six meters. When I tune across a dead 6-meter band, night after night, it makes me very sad. Where is the old amateur experimental genius going? Let's get the lead out and start giving the ultrahigh frequencies hell. We all know what the 80-40-20-10-meter bands will do. We know very little the possibilities of the v.h.f. bands simply because we hams are just too damned lazy to warm up the soldering iron and think a little bit. . . .

Once upon a time they said 80-40-20-10 was no good, either, remember? Come on, you guys — devote some more time to operating the ultrahighs so we can prove the book wrong again. There is nothing complicated or mysterious about the subject at all. Just streamline your thinking to 1947 instead of 1937 and you are well on the way. . . .

— Louis J. Frenkel, jr., W9GUP

## THOSE EXTRA DITS

W1BMS, Friendship, Maine

Editor, *QST*:

Listened on 80 the other night and heard a couple of the boys gassin'. Thought I'd copy their stuff on the mill for a little practice and here's what I got:

"W1 — DE W1 — GE OM. UR HIGS 579X 5R 4Y FB. QTH 5R BOHTON MAHS. 5ANDLE IS 6ILL. USING 150 WATTH TO AN 813. ANT 5ALFWA4E CTR FED. WELL OM W5ATS 6E 5ANDLE TRF K."

Juht 8en 6e XYL called me to c5ow ho I 5ad to quit. I t5ink t5is mill eit5er neehd over5auling or 6e 5andle on t5at guyh 6ug wah loohe. 73.

— Bill Gall, W167



# Hints and Kinks

For the Experimenter



## A TRANSITRON UTILITY OSCILLATOR

THE wide-range transitron oscillator circuit shown in Fig. 1 serves a multitude of purposes around the ham shack, providing a simple means of measuring small capacitances, determining the resonant frequency of any coil with a known capacitance across it, and even measuring the stray capacitances present in an oscillator circuit.

The circuit will oscillate whenever a coil, or a resonant circuit, is connected across the terminals marked *L* in Fig. 1. The calibrated condenser provides a method of measuring small capacities by the substitution method, and of determining the resonant frequency of any coil with a given amount of *C* across it. The circuit will oscillate with almost any value of inductance, for example anything ranging from a filter choke to an i.f. transformer. The oscillator can be made to operate over a frequency range of about 20 c.p.s. to 10 Mc.

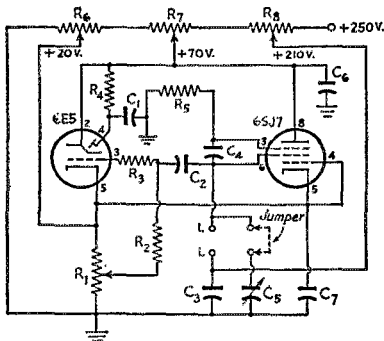

Fig. 1 — A wide-range transitron utility oscillator for the ham shack. The sliders on  $R_6$ ,  $R_7$  and  $R_8$  should be adjusted to give the voltages shown in the diagram.

$C_1$ ,  $C_7$  — 0.25- $\mu$ fd. 600-volt paper.

$C_2$  — 0.02- $\mu$ fd. 600-volt paper.

$C_3$ ,  $C_4$ ,  $C_6$  — 0.1- $\mu$ fd. 600-volt paper.

$C_5$  — 350- $\mu$ fd. receiving-type variable.

$R_1$  — 2000-ohm potentiometer.

$R_2$ ,  $R_4$  — 1 megohm,  $\frac{1}{2}$  watt.

$R_3$  — 0.18 megohm,  $\frac{1}{2}$  watt.

$R_5$  — 0.1 megohm,  $\frac{1}{2}$  watt.

$R_6$ ,  $R_8$  — 1200 ohms, 10 watts, with slider.

$R_7$  — 7000 ohms, 10 watts, with slider.

The 6SJ7 tube forms a conventional transitron oscillator, while the 6E5 magic-eye tube serves to indicate oscillation. Since the screen current for the 6SJ7 must flow between the *L* terminals, a d.c. path between these terminals must always be provided.

In use, the magic-eye angle is set to some convenient position by adjustment of the grid-

bias control,  $R_1$ . Then a coil, or a coil-and-condenser combination, is connected between the *L* terminals. Oscillation will produce fuzzy edges on the eye shadow, and may change the shadow angle. The frequency of oscillation may then be determined by any convenient method, such as an absorption wavemeter, heterodyne frequency meter, or a calibrated transformer. If a resonant circuit, such as an i.f. transformer, is to be checked for frequency, the jumper to the calibrated condenser should be removed. Allowance should be made for the distributed capacity across the *L* terminals, including internal tube capacities and stray wiring capacities.

The circuit may be used as a simple oscillator at any frequency within its range by winding a coil of suitable inductance for the frequency range desired, and connecting it across the *L* terminals. It is then tuned to the exact desired frequency with  $C_4$ . If the *L/C* ratio is kept within reasonable limits, the harmonic content will be very low. For example, with the set oscillating at 1 Mc. only the first six harmonics were audible on a nearby communications receiver. An old filter choke was found to be self-resonant at about 1300 cycles. Adding a little extra capacity caused it to be resonant at about 160 cycles.

The capacity of a small condenser may be found by noting the change of the calibrated condenser capacity required to keep the oscillator signal in tune (b.f.o. on) on a receiver when the unknown condenser is connected across a coil at the *L* terminals. Larger capacities may be determined by measuring the frequencies with and without the unknown capacity shunted across the coil, and then calculating the unknown capacity from the bandsread-condenser formulas. Similarly, the stray capacity of the oscillator circuit may be computed using the calibrated condenser to give a known capacity change.

— Henry L. Cox, jr., W8UPS/S

— . . . . —

## CENTER JOINT FOR 300-OHM FOLDED DOUBLET

FROM several sources we have received information on the use of 300-ohm Twin-Lead in folded doublets. All point out that because of the thermoplastic properties of the polyethylene dielectric used, excellent joints can be made between the flat-top portion of the antenna and the feed line by the application of heat. The process is illustrated in Figs. 2 and 3.

The wires of the feed line are soldered to the flat top as close to the right angle formed by the joint as possible. The soldering iron is then applied to the overlapping pieces — A and B — of the polyethylene in the center of the joint. The "poly" melts, bonding the flat top to the feed

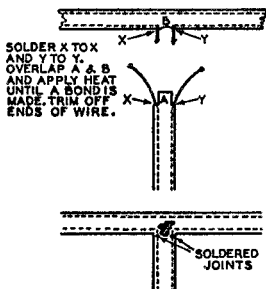

Fig. 2 — A center joint that is rugged, yet which adds no weight to the center of the antenna.

line in a rigid joint that adds no weight to the center of the antenna and is weatherproof and neat. The possibility of play in the joint, with resultant fraying and eventual breaking of the stranded wires, is eliminated.

At W2IJC, W0SRP and W2LMH tabs A and B in Fig. 2 are not used, separate scraps of the poly being used as the source of the bonding material. The scraps are heated and are worked around the joint with a hot blade. W2LMH suggests that splices may also be made in the Twin-Lead, "staggering" the points where the two wires are joined and bonding the adjacent portions of poly as shown in Fig. 3. W0SRP has also spliced RG-11U coaxial cable by similar means.

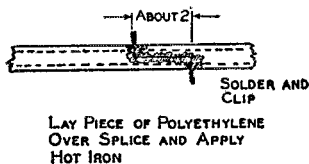

Fig. 3 — A splice between two pieces of 300-ohm Twin-Lead. The "staggered" joint adds strength to the splice.

The soldering iron should be cleaned before starting the operation and should not be allowed to become too hot. If the iron is not clean, some of the solder clinging to its point as tinning will come off and become embedded in the poly, forming a near-short-circuit right across the joint.

Once the joint has hardened, it may be trimmed with a penknife to make it neater looking. — Laverne T. Heaps, W0SRP; Bill Karsten, W2LMH; Rev. Victor W. Schoenberger, W2IJC; Harry H. Nocke.

### THREE-WAY CRYSTAL SOCKET

IN many ways adapters for fitting the new small-size crystal holders into standard UY 5-prong sockets are not the ultimate solution to the problem of how to use three styles of crystal holders in the same rig without using three sockets. The homemade socket shown in Fig. 4 handles all three of the currently-popular holders without requiring adapters, and does it without any forcing, pinching, or binding. Its construction is simple, and the parts required can usually be found in the junk box.

In this gadget, a portion of a 5-prong socket and a matching portion of an octal socket are cemented together to form a composite affair. The resulting pin spacings and contact diameters permit the use of the prewar "standard" crystal holders (0.125-inch diameter pins spaced  $\frac{3}{4}$  inch), the FT-243 holder (0.089-inch pins spaced  $\frac{1}{2}$  inch), and the CR-1A/AR holder (0.125-inch pins spaced  $\frac{1}{2}$  inch). The old-type holder plugs

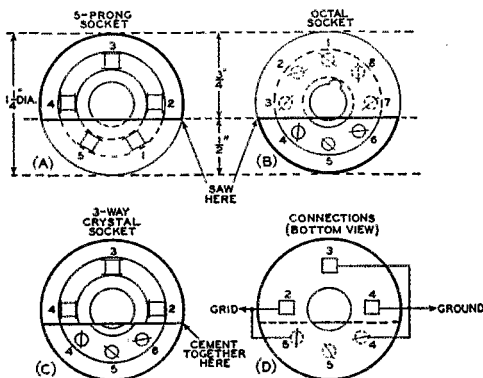

Fig. 4 — Method of constructing a 3-way crystal socket from portions of a 5-prong socket and an octal socket. The two are cut as shown in A and B, and are cemented together as shown in C. The socket connections to permit use of any of the three popular sizes of crystal holders are shown in D.

into Pins 2 and 4 of the 5-prong socket, the FT-243 goes into Pins 4 and 6 of the octal portion, and the CR-1A/AR into Pins 2 and 3 of the 5-prong portion.

To make the socket, remove the locking ring and mounting plate from the sockets. Needless to say, the sockets should both be of the same diameter and general type. Amphenol Types S-5 and S-8 fill this requirement nicely. Saw the two as shown in the sketch, being careful to keep the cut square. If you want to be extra cautious about it, leave a little extra portion on each one and finish it smooth with a file. This will assure a good fit, and will permit the surfaces to be squared up in the event that the hacksaw cut wasn't quite true. Cement the portions together as shown in

(Continued on page 158)



# Operating News



E. L. BATTEY, WIUE, Asst. Comm. Mgr.  
J. A. MOSKEY, WIJMY, Communications Asst.

F. E. HANDY, WIBDI, Communications Manager

GEORGE HART, WINJM, Communications Asst.  
LILLIAN M. SALTER, Communications Asst.

**ARRL's Thirteenth International DX Competition** is scheduled to start this month, the first c.w. period Feb. 14th to 17th and the first 'phone period Feb. 21st to 24th. Full details of this major postwar activity appeared last month. See page 16, January *QST*. Study the rules carefully for answers to any questions. These are week-ends of QSO opportunity. All set?

**Congratulations.** "Operating News" takes this opportunity to extend heartiest congrats:

- ... to the S8ers who worked all 71 ARRL Sections in the November contest . . . to all who took part and made it the "best ever" in League history. The 71-section men were W6KKG/7 (c.w.) and W6ITH ('phone).
- to W1HDQ for putting the first 50-Mc. signal across the Atlantic, Nov. 24, 1946. He was copied by both G6DH and G5BY — almost exactly 25 years after the successful 1921 ARRL Second Transatlantics, during which Godley copied 200-meter amateur signals from this side. This was an experimenter's job *par excellence*. W1HDQ's six-meter success required daily observation and plots of m.u.f. All credit to him as holder of OES appointment number one.

**Clubs and ECs:** ARRL Emergency Coördinators should strive to enlist the support of *all* active local amateurs in their AEC groups. The club is an excellent place to enlist assistance in planning amateur radio service emergency organization. Has your club had a meeting devoted to emergency organizing? When there is more than one club in a town or city, attempt should be made to invite a representative of *each* club or association to become an Assistant Coördinator or member of an amateur-service planning group. Is your club identified with the ARRL Emergency Corps? Is there a plan for disposition of portable or mobile amateur stations in event of local emergency? Which agencies would your group serve? Does every amateur know how he would serve best? How many hold AEC cards now?

**Emergency Coördinators, RMs, PAMs, Netters — Are You Ready?** Come crippling blizzard . . . wires down . . . spring flood . . . unexpected disruption or overload of communications anywhere for any reason and we have a communications emergency. Large or small emergency, are we really ready? We're kidding ourselves if we haven't made ourselves, as individual amateurs or groups, part of a plan. All net and drill (radio) operation is of course enjoyable and fraternal, be it for emergency preparation or

otherwise. *But let's make it count for Amateur Radio!*

Do we have existing nets *not* already dedicating at least part of their efforts to public-service objectives? Why not (NCS please note) consult with the nearest ARRL Emergency Coördinator (or SCM or SEC) and see if your net membership cannot be made AEC members? How best can some drills be devoted to advance planning for use of the net in any emergency? Work this out and send us a message as you progress, please.

All Emergency Coördinators have a January bulletin covering the necessary planning. Their problem is to translate from a generalized diagram of all *types* of organizations served, and with which we have liaison to create a local community plan. Over-all policy provides for use of every amateur-band group from 3.5-3.9 Mc. to and including 144 Mc. This plan as implemented should be put in diagram form and should name the stations in each band, include all clubs and networks, and the agencies served, *specifically*. Please help, everyone.

**Multiclub Communities.** In large cities there are sometimes two or more radio clubs to take care of amateur groups in metropolitan and suburban territory or because of special club-member objectives, number limitations, parking and working-time problems. When we have more than one club in a city, the groups should be joined in some of their major purposes and objectives, we believe. Annual or semiannual joint meetings, outings or hamfest plans will promote fraternalism and mutual understanding between different ages and groups of members. Friendly ARRL Field Day and other competitive activity may often be planned. Emergency planning, particularly, requires the fullest support of every active amateur and every group. Club program arrangers can assist by promoting a meeting — or allotting time at several successive meetings — to discussion of local plans, explanation of AEC and local organizing program by the appropriate ARRL Emergency Coördinator.

**More on Spacing.** Poor sending was mentioned in this column last month, with emphasis on the desirability of correct spacing. There are two types of spacing trouble: (1) no spacing, or too little spacing between words or letters, and (2) extra spacing between the parts of a character.

Your sending may make sense to you even if words are run together. However, when calls or words are run together the result is difficult to copy, and the calls become gibberish. Get some experienced operators to listen critically to your sending and ask them to be analytical and frank. Rhythm, and clean word spacing — not speed — should be the aim of both new and old-time operators. Actual smoothness and speed depend on the spacing and rhythm. The absence of need for repeat means speed. The flashy fast operator so often spends any time saved making repeats, except when in QSO with pals familiar with his idiosyncrasies. KA1AW may become A1AWKA1AWK with a chance of ending signals throwing in some added confusion, not to mention QRM effects! Other examples: (1) TEST becomes NST; W1TSU and W1MEX become W1BU and W1GX; (2) CQ becomes NNQ. Readjustment of the dash contact on a bug or closer key spacing may assist in overcoming the latter defect. Good sending requires rhythm all the way through, and control exercised over the spacing as well as the actual lengths of *dits* and *dahs*. One way to get good rhythm is to listen regularly to good tape (automatic) transmissions.

**BCI Circulars Needed?** Any amateur having local interference complaints is invited to indicate the frequency and mode of his transmission and the type of receiver used by the complainant in asking the ARRL Communications Department to send its suggestions and mimeographed information on this subject. It should be regarded as an individual responsibility to so conduct amateur operations, and provide information and advice to listeners, that public complaints to the FCC of any amateur interference will be completely avoided. Radio clubs should maintain alert interference committees to assist members, solicit local complaints, and insure good public relations for the whole amateur service insofar as their communities are concerned. ARRL will gladly provide its available helps on this subject to individuals or clubs.

**Did You Return the Operating Survey Card?** Tabulation of thousands of returns from the Operating Interest Registration Card which appeared in the January issue is just getting under way as you read these lines. If you missed this card or for any reason failed to return it, please complete the form now and mail it back. The survey is an opportunity to register the characteristics of every active operative amateur station. The cards indicate to us whether you are a high-power or low-power user of amateur frequencies, show how much you actually operated in the first 15 days of December, 1946, in which bands and by which methods, and indicate your *expected* operation in 1947 in the different c.w. and 'phone subbands. How's to send it in if you haven't?

— F. E. H.

## FREQUENCY-MEASURING TEST

February 4th

• Starting 11:00 P.M. EST (8:00 P.M. PST). W1AW — 3710, 7055, 14,025 and 28,070 kc. (approx.).

Last chance to get your entry in for the first-period 1947 Frequency-Measuring Test. See page 65, January QST, for details. Will you win the electric-clock prize?

## IDAHO-WASHINGTON EMERGENCY

In mid-November, 1946, the worst snow and ice storm in 44 years seriously disrupted communication facilities in Northern Idaho and sections of Washington. Radio amateurs provided communications for the Northern Pacific Railroad in dispatching trains in and out of Sandpoint, Idaho.

Carl Partlow, W7EEN, president of the Spokane (Wash.) Amateur Radio Operators Club, and James McGoldrick, W7ELN, drove to Sandpoint with portable gear and set up a station at the N. P. depot November 19th. Schedules were maintained with Chester Brown, W7NV, Spokane. Contact was maintained throughout the emergency period, until the storm had abated and train schedules returned to normal. Fred Arndt, W7IDA, Sandpoint, took over that end of the circuit at noon on November 20th, and Joe Davis, W7ICM, relieved W7NV at Spokane. Frank Burford, W7ELH, Moscow, Idaho, assisted in relaying some of the traffic.



HK3AB is a familiar call on 28-Mc. 'phone. Here is the man behind the mike, Hector McCormick, Bogota, Colombia. The receiver is an RCA-99 with Howard pre-selector. "Mac" runs 250 watts to his transmitter. W2NHB, in Colombia on business, tells of some pleasant visits with HK3AB. An experience to be long remembered was a contact between W2AYR and HK3AB, through which W2NHB talked with his wife and child on Staten Island, N. Y. A later contact with W2AYR enabled an associate of W2NHB to speak to his mother in Brooklyn. These are but two examples of similar incidents by which HK3AB maintains a reputation for "international friendships and hospitality."

## A.A.U. MARATHON

On Thanksgiving Day, 1946, the Twenty-Seventh Annual AAU Marathon was held at Berwick, Penna., with the outstanding runners of the United States and Canada entered. The course is a 9-mile cross-country run with mountains and hills being the main obstacles. The event was covered by amateur radio for the first time in the history of the race. Communication was maintained on 144 Mc. with Abbott TR4s being used exclusively. Three amateurs covered the race with W3KGA, Roland "Ed" Parson, operating portable-mobile in front of the runners. He transmitted a running commentary of the race indicating lead positions regularly. W3KQM, Forrest E. Campbell, located at the finish line, relayed W3KGA's commentary over the p. a. system. George H. Smith, jr., W3LGO, was in the press box and handled the contacting and monitoring of W3KQM and W3KGA in case of break-downs. Contact was continuous from start to finish. Race officials were very pleased with the set-up and plans are being made to cover next year's race.

## CODE PRACTICE

January *QST* (page 65) lists the schedules of stations transmitting code practice on 28 Mc. This month there are two additions.

W5LDH, Phil Slipakoff, 3312 Louisiana Ave. Parkway, New Orleans 15, La., 23,668 kc., Tuesdays, 7 to 7:30 P.M. CST.

W9ENB, Ward H. Fox, 321 W. Williams St., Fort Wayne 6, Ind., 27,260 kc., Monday and Wednesday, 7:30 to 8:15 P.M. CST. (27-Mc. band.)

## A.R.R.L. ACTIVITIES CALENDAR

Feb. 4th: Frequency-Measuring Test  
 Feb. 13th: CP Qualifying Run  
 Feb. 14th-17th: DX Competition (c.w.)  
 Feb. 21st-24th: DX Competition ('phone)  
 Mar. 5th: Frequency-Measuring Test  
 Mar. 7th: Frequency-Measuring Test  
 Mar. 14th-17th: DX Competition (c.w.)  
 Mar. 17th: CP Qualifying Run  
 Mar. 21st-24th: DX Competition ('phone)  
 Apr. 11th-13th: W/VE Contest  
 Apr. 18th: CP Qualifying Run  
 Apr. 26th-27th: CD QSO Party

Jan. 16th-Dec. 15th: 1947 V.H.F. Marathon

Jan. 1st-Dec. 31st: Most-States V.H.F. Contest

First Saturday Night Each Month:

A.R.R.L. OFFICIALS NITE (Get-together for SCMs, RMs, SECs, ECs, PAMs, Hq. Staff, Directors, Alt. and Asst. Dirs.)

## HAVE YOU RECEIVED YOUR CODE-PROFICIENCY CERTIFICATE?

The next opportunity to qualify for a certificate or endorsement sticker in the ARRL Code-Proficiency Program is on February 13th. At 10:00 P.M. EST that date W1AW transmits the monthly qualifying run at speeds of 15, 20, 25, 30, and 35 w.p.m. Frequencies: 3555, 7145, 14,150, 28,060, and 52,000 kc., simultaneously.

The text copied, received successfully by ear at the highest speed you can copy, should be sent to ARRL for checking. To avoid errors in recopying, send your original copy. *Attach a statement certifying over your signature that the copy submitted is direct copy, made from reception of W1AW by ear, without any kind of assistance, personal or mechanical.* If you qualify, you will receive your certificate, or appropriate endorsement sticker for certificate you already hold. Those who qualified in the past should submit copy only if speed is higher than indicated on certificate or endorsement sticker.

*QST* lists in advance the text to be used on several of the 10:00 P.M. EST (Monday through Friday) CP schedules. This makes it possible to check your own copy. It also provides a means of obtaining sending practice since it permits direct comparison of one's fist and tape sending. To get sending help hook up your own key and buzzer and attempt to send right in step with the tape transmissions. Adjust your spacing in the manner indicated as necessary for self-improvement.

Subject of Practice Text from  
 Dec. per *QST*

Date  
 Feb. 4th: Single Control . . . Bandswitching Transmitter p. 19  
 Feb. 7th: A Unique Five-Band Antenna System, p. 29  
 Feb. 10th: Five Are Better than Three, p. 32  
 Feb. 12th: The Most Inexpensive Transmitter, p. 33  
 Feb. 13th: Qualifying Run, 10:00 P.M. EST  
 Feb. 18th: What About the BC-375-EF, p. 38  
 Feb. 20th: Design of Cathode-Ray Tube Circuits, p. 45  
 Feb. 24th: Those Excellent C.W. Signals, p. 54  
 Feb. 26th: Standing Waves — Good or Bad?, p. 56

## BRIEFS

In the fall of 1946, Alaska's Bering Sea coast was swept by two of the worst storms in Alaska's history. Great damage was done to property and wintertime stores of supplies. At Moses Point, all Civil Aeronautics Authority facilities were washed out for four days. KL7BD reports that KL7CC came to the rescue and did a bang-up job on 7252 kc., maintaining communications with CAA stations at Galena, Fairbanks, Unalakleet, and Anchorage, using the call KMZZ/KL7CC. KI7CC's 6L6 worked at 100 watts input!

WICOI took a message from KA1SS, delivered by telephone, and sent an answer back to KA1SS, all in thirty minutes.



## YLs—AND WHERE TO FIND THEM

W1KUI	Ellen	3.5, 7 Mc., c.w.	7-11 P.M. EST, Sun.
W1MCW	Lou	28,584 kc., 'phone	
W2JZX	Viola	14,144 Mc., c.w./ 'phone	4-6 P.M. EST, Mon- Fri.
W2NFR	Helen	3.5, 7, 14 Mc., c.w./'phone	
W2OWL	Ruth	28,702 kc., 'phone	After 11:15 EST nightly
W2PMA	Lillian	28,732/29,200 kc., 'phone	8:15 A.M.—12:30 P.M. 5:00-8:30 P.M. EST
W2QCC	Pauline	3535 kc., c.w.	3-4:30 P.M. EST, Sun. 8-9:30 P.M. EST, week- days
W3AKB	Frances	3.5, 7, 14 Mc., c.w.	
W3CDQ	Elizabeth	7220 kc., c.w.	8 P.M. EST and later
W3JSH/ W3KWA	Dorothy	3.5 Mc., c.w.	8-11 P.M., EST, Mon- Fri.
W3VYU	Theresa	3631 kc., c.w.	3-5 P.M.; 9-11 P.M. EST
W3WKD	Jackie	14,295 kc., 'phone	Noon-6 P.M. EST
W4KMM	Ginny	28,550 kc., 'phone	4-10 P.M. EST, week- days All day, Sat. & Sun. Evenings
W4HWS	Jerrie	3918, 7177, 14,350, 28,784 kc., c.w./ 'phone	Evenings
W5JFW	Judy	7216 kc.	Evenings
W5HWK/4	Jessie	28,660 kc., 'phone	After 5 P.M. EST
W6PJF	Rosemary	3645 kc., c.w.	8:30 P.M.—Midnight PST Evenings
W6UXF	Enid	3.5 Mc., c.w.	
W6WQK	Ruth	28.5 Mc., 'phone	
W7HDS	Lizette	3.85, 14, 27, 28 Mc., 'phone; 3.5, 14 Mc., c.w.	
W7JWC	Manila	28,746 kc., 'phone	
W8WUT	Avis	28.5 Mc., 'phone	
W8YKU	Lura	3750 kc., c.w.	11 P.M.—1 A.M., Mon- Fri. 1-3:30 P.M. Sat. 10:30 A.M.—2 P.M. Sun., EST
W9EXM	Emily	28,830 kc., 'phone	10-11 A.M., 2-4 P.M. CST, daily except Sat. & Sun. 6 P.M.—Midnight
W9JTX	Louise	3.5 Mc., c.w.	
VE6MP	Maude	All 'phone bands	

The above tabulation was compiled with the cooperation of the Young Ladies Radio League. These "gals" may be found on the bands and frequencies indicated. Although complete information is not available, the following additional calls also belong to YLs. (If the call of an OM appears here in error, please forgive it, YLs!)

W1BDN FTJ GQT KKQ MDV MIM MPP MUW  
 NEN NSA OAK ZR  
 W2FKA HKX IXY KUG MEG MJS MWT NAZ NGO  
 NQC NSL OLB OVF OVV PBI PCU POT PVS PZA  
 QEJ QFN QGB QGK QJC QPA QVM QWL RAQ RBU  
 REY RUF RZV TBU TU  
 W3FXZ LVW LYB UUG UUY  
 W4GUZ HPK HWR JCR JWT  
 W5DEW HEK IKC IZL JAD JZQ/6 LVT UUY ZA  
 W6MWO NZP SGD TCH TCN TDL TMD UHA  
 UWR VWR WOL WRT WSG WSV  
 W7EJU/K7 GUQ HHH HYO IHK IOJ IXR JFB  
 W8GJK KNC VYU WTZ/1 YBL YGD YOJ  
 W9DXX EFW JPT JXF/1 KSA RNO/4 VQK  
 W9DBD JWJ OUD OWQ UA VQK  
 VE3AMC 4VO  
 G2YL G8LY K6ROJ KH6FD

3610 and 7220 kc. are the special frequencies used by YLRL members, and are good spots to watch when looking for the fair sex. YLRL officers are Lou Lacy, W5IKC, president; Louise Baker, W9JTX, vice-president; Helen Cook, W6MWO, secretary; Lou Littlefield, W1MCW, publicity chairman; and Clara Reger, W2RUF, editor *YL Harmonics*. The YLRL slogan is "QRV — I am ready." If you hear "33" being used in place of "73," it is not the

result of a poor fist. In YL parlance "33" means "Love Sealed with Friendship between one YL op and another." It's interesting to note that Vice-President W9JTX is assigned ORS certificate No. 33! She is active in the ARRL Illinois Traffic Net, Trunk Line "A," and the Atlantic-Pacific Trunk. VE6MP operates a general store in Chancellor, Alberta, a prairie town of 35 people. W3CDQ is planning a 27-Mc. 'phone-c.w. rig for a net composed of amateurs connected with the Central Radio Propagation Lab. (CRPL) ionosphere group. W2QCC is the wife of ARRL's Atlantic Division Director Ed Raser, W2ZL. W1MCW has worked 70 countries postwar on ten-meter 'phone. A word of caution to OMs when working the YLs . . . don't get overamorous . . . many of those listed have OMs of their own, some reputed to be equipped with electronic shotguns. Hi!

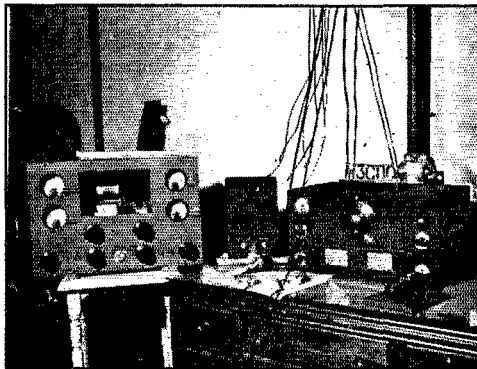

W3CDQ, Washington, D. C.

This is the station of Elizabeth Zandonini, well-known member of the YL ranks. The neat transmitter, built by W3AMQ and designed for 7 Mc., uses 6L6-807-100TH running at 210 watts input. The unit beside the HRO is a remote-control box.

## YL WAS

The Young Ladies Radio League offers a certificate to any amateur who qualifies for its YL Worked All States award. The following rules apply:

- 1) All licensed amateur radio operators, OM or YL, are eligible.
- 2) All contacts must be with YLs and must be postwar (from November 15, 1945).
- 3) Confirmation of contacts (QSL cards) with all states must be submitted to Lou Littlefield, W1MCW, 19 State Avenue, Queen Acres, Cape Elizabeth, Maine.
- 4) Return postage must be submitted for return of QSL cards.
- 5) YLRL will not be responsible in case of loss or damage to cards submitted.

## BRIEF

W4JRU advocates more general use of c.w. round-tables. He maintains that by several stations using the same frequency, and listening for each of the group in turn, instead of splitting up into a number of two-station contacts, QRM would be reduced. It's a channel conserver on 'phone, and should work on c.w. Any comments, gang?



#### The Youngest OM

Donald Joe Choice, W5LVZ, El Reno, Oklahoma is eleven years old. His Class B license was issued September 13, 1946, a few weeks before his eleventh birthday. W5LVZ is active on 28.5-Mc. 'phone with a kilowatt rig built by his father, W5LTB.

#### BRIEF

During late July, 1946, the Mike and Key Club of Santa Monica, Calif., furnished radio contact for the races held by the Aquaplane Association off Hermosa and Manhattan Beaches. The club assisted in laying out the course, and reported swimming, paddleboard, dory, and other races. For laying out the course, rigs were set up on the piers and in a boat, which was directed by radio to the correct position for dropping buoys. For night races, held on three evenings, one station was established on shore, and one in a boat at the seaward end of the course, for reports on the races. The shore rig was fed into the p.a. system. Three mobile-marine stations and two land stations handled the main events, held on a Sunday. On boats were W6ESR, W6NSC, and W6AQJ. On shore: W6CFI and W6PTR at finish line at end of pier, and W6RIU at judges stand and p.a. on beach. All operation was on 51.84 Mc. Others participating were W6VED and W6TVK.

#### BRASS POUNDERS' LEAGUE

(November Traffic)

Call	Orig.	Del.	Rel.	Extra Del.	Total
				Credits	
W7FST	151	109	703	—	963
W4PL	12	64	524	54	654
W6IOX	5	17	488	16	526
W8SAY	38	46	387	33	504
W2LTP	—	356	145	—	501

The following make the BPL with over 100 "deliveries plus extra delivery credits":

W1UE 219 W3MJK 123 W3BCP 102 W8SCW 102

A message total of 500 or more, or 100 "deliveries plus extra delivery credits" will put you in line for a place in the BPL. The Brass Pounders' League listing is open to all operators who qualify for this monthly "honor roll."



#### The Youngest YL

Georgette Ottney, VE3AMC, Almonte, Ontario is thirteen years old. Her transmitter is the old familiar 89-807 extiter. The 56-56 receiver and preslector have been replaced by an HQ-129X, if Santa Claus made the expected delivery. Antenna is a 3.5-Mc. center-fed Zepp. VE3AMC will be found on c.w.

#### BYRD ANTARCTIC EXPEDITION

At least two radio amateurs, W5AYR and W8DBD, are among the personnel of the Navy's 1947 Antarctic Expedition, headed by Rear Admiral Richard E. Byrd. Latest advices at this writing indicate that no amateur radio operation is contemplated. However, W8DBD writes that he will have a long list of calls heard. Should expedition plans for amateur radio be changed, the news will be carried in W1AW bulletins.

#### BRIEFS

The services to mankind we radio amateurs occasionally are able to perform constitute much of the "something" that makes ham radio the grandest hobby of them all! Back in October, 1946, W4JEF, Aiken, S. C., and G6WY were parties in just such a service. Gipsy Smith, jr., son of the famous evangelist, was on tour in the Southern States. He remarked to W4JEF that he was concerned over the health of his father, who was understood to be dangerously ill in London. Turning at once to amateur radio, W4JEF made contact with G6WY, who telephoned the home of Gipsy Smith, sr., and received the comforting news that the 80-year-old evangelist was home from the hospital and out of danger. This information was relayed back to W4JEF within thirty minutes of the initial contact.

November 23, 1946 was W5AZO's thirteenth wedding anniversary. Commenting to the XYL that, "We were in Keokuk, Iowa thirteen years ago, getting hitched," he turned on the 7-Mc. rig and called CQ. It couldn't have worked better had it been planned, for who answered but W9DUP with the opening remark, "Greetings from Keokuk!"

## HIGH 1946 "SS" SCORES

If there now breathes a ham in the 71 ARRL Sections who doesn't know how to send a message preamble, it certainly isn't the fault of the Sweepstakes Contest! The bands were alive with those familiar exchanges during the November 16th-18th and 23rd-25th weekends. Records were broken . . . greater participation, higher scores, improved operating skill, more fun!!

Each "SS" seems to reach the ultimate in operating capabilities, but each succeeding affair crashes through with new records, unbelievable records, yet very realistic! If you will look back on the results of the last prewar Sweepstakes (1941) you will find seven c.w. scores topping 100,000 and a high 'phone score of 53,680. In the 1946 fray we find *nineteen* (count 'em) claimed c.w. scores over 100,000!! And a high 'phone total of 56,800! There you have a summation of the magnitude of the affair. More words would be wasted.

Leading the c.w. list is Vic Clark, W4KFC (ex-W6KFC of earlier Sweepstakes). Vic set a new high in contacts of 869. W4FU (ex-W9FS) with 833 contacts just topped his 1941 record (831). W8JIN claims an even 800 QSOs.

In the 'phone ranks, Reg Tibbets, W6ITH, established a new high in SS scores — 56,800! Reg also worked all 71 Sections, being the only 'phone participant claiming this accomplishment although W9NDA lists 69.

The only c.w. contestant claiming all 71 Sections worked is W6KKG/7. Several claim 70 Sections, but the Philippines eluded most of them: W1ME, W1TS, W1UE, W2HHF, W2IOP, W4BPD, W5KC, W6HZT, W6NLI, W8JIN, W8WZ, and W9GRV.

The following listings show score, stations worked, and Sections worked. All figures are *claimed* by the contestants and subject to further checking. The final cheering must wait until official results are available.

### C.W.

W4KFC	147560-860-68	WSUFH	98222-733-67
W4FU	148692-833-69	W5KC	97825-559-70
W8JIN	139475-800-70	W9TWC	97070-573-68
W9RQM	132135-765-69	W9ERU	96807-708-69
W2IOP	129412-747-70	W9DUY	94775-559-68
W3BES	127995-742-69	W9GRV	94325-539-70
W9FOI	122475-711-69	W2MER	92690-593-62
W1BFT	116438-675-69	W1OTV	92462-572-63
W1LWA	116161-694-67	W9JRI	91080-660-69
W2SSC	112309-675-67	W3GHM	90915-551-66
W1TS	111650-639-70	W4KVX	90666-657-69
W8RSP	110925-670-68	W8ALZ	89442-539-67
W1KYK	109312-664-66	W9YCR	88489-650-69
W9ZAR	108715-630-68	W8ZFA	87750-540-65
W3FQZ	105190-630-67	W9CYU	87545-524-66
W1RY	103155-599-69	W6KKG/7	87472-618-71
W3GAU	102929-616-67	W8ROX	87040-518-63
W6HZT	101850-745-70	W9WFS	86775-537-65
W9VKF	100912-585-69	W9VTF	86542-528-66
W2OXX	99450-585-68	W3GHD	86262-515-67
W8DPA	99025-608-68	W9NCS	85819-499-69
W6JNC	98770-582-68	W8BXE	85425-511-67

W0DIR	85264-588-64	W2JAG	72500-500-53
W0MPW	85136-632-63	W5FRD	72420-430-68
W6BXL	84870-496-69	W3GVS	72400-463-64
W9UIT	84456-621-63	W8BQJ	72160-451-64
W1KQY	84320-496-68	W7KEM	71400-528-68
W8KT	83902-510-66	W9KGY	71362-433-66
W2RDK	83931-517-65	W9CFB	71190-457-63
W2QCM	83905-540-62	W8EJL	71154-531-67
W1EZ	81412-501-65	W2HHF	71120-512-70
W3MFM	81206-535-61	W7DZL	70752-537-67
W6EPZ/5	80920-595-68	W5KPV	70281-431-65
W4KFT	79852-507-63	(W5BSY opr)	
W2BDL	79282-481-66	VE3JJ	69806-548-64
W8OYI	78710-463-68	W9FKI	68765-407-68
W4BRB	78342-597-66	W9BGC	68735-530-65
W4YFA	77675-477-65	W9LAE	68541-514-67
W8IWS	77569-612-64	W7PZA	68392-420-66
W2PWP	77385-462-67	VE3BCO	68197-434-63
W6PUZ	77301-465-67	W9NLI	67480-422-64
W6NLI	76387-446-70	W2ENZ	67328-526-64
W4BPD	76300-456-70	VE4XO	67067-504-67
W6PBV	76075-450-68	W8GXX	67040-421-64
VE3KE	75159-599-63	W7QAP	67016-432-63
W1BIH	75107-564-67	W1ME	66780-477-70
W3ISE	74891-477-63	W8GKS	66229-432-63
W3KDP	73971-503-59	W2EWD	65641-435-61
W4BGO	73856-460-65	W2PGT	65565-423-62
W8SCW	73298-549-67	W2PZE	65336-461-57
W9WEN	73200-483-61	W5LGG	65258-474-67
VE3AVN	72807-463-63	W9KMN	65162-405-65
W3FLH	72600-440-66	W9VSO	65100-420-62

### 'PHONE

W6ITH	56800-400-71	W7DTB	20608-184-56
W4YNQ	45612-370-63	W9GWL	20459-194-53
W9NDA	45333-329-69	W6MLY	20410-160-52
W6OGZ	41133-351-59	W2EQ	20292-178-57
(W6UBT opr.)		W8DEI	20224-158-64
W6AM	33916-281-61	W5EHR	18381-133-57
W9YAK	33150-255-65	VE3AIU	18588-158-59
W6CHV	32177-211-61	VE2DD	18432-200-48
W8HHU	32096-274-59	W8EWS	18088-161-56
W4FLS	30391-268-57	W9KYM	17864-160-56
W0PV	28728-223-63	W7JHB	17766-143-51
W1ATE	28365-235-61	W6DUB	17600-160-55
W8EXJ	28121-232-61	W9ZTL	17272-152-47
W5FH	26845-228-59	W9QXK	16848-158-64
W1KQN	26624-209-64	W9NTA	16555-152-55
VE3HC	26304-207-64	VE2QG	16198-149-54
W5AIB	25085-175-58	W6VRC	15678-201-39
W2MIG	24957-213-59	W6GVM	15548-150-52
W9FUH	24720-208-60	W1MON	15216-159-48
W4AQR	23482-202-59	W8VNG	15134-161-47
VE3AQB	23256-204-57	W7GVX	15065-133-46
W8REU	23220-194-60	W8IMH	14892-149-51
W4GVD/9	23064-189-62	W2EGG	14382-141-51
W2SZ	22684-215-53	W5LRE	13824-132-62
(W2NSD opr.)		W9FNR	13520-130-52
W8FUV	22239-177-63	W4KQC	13395-143-47
W5IGS	22002-193-67	W1BFB	13144-124-53
W4BSS	21970-171-65	W3BET	12816-134-48
VE6FK	21808-192-58	W8NCV	12720-134-48
W8DD	21780-202-55	W6DPB	12648-124-51
W9OMG	21720-184-60	W1HRI	12575-117-43
W8EOZ	21597-163-53	W3MHD	12342-122-51
W8TRX	20900-202-52		

### BRIEF

W8WDQ and W3RCQ are forming a c.w. net on 7 Mc. for all present and former Coast Guard radiomen. They are especially interested in rounding up those who attended Groton, Curtis Bay, and Atlantic City radio schools. USCG hams should communicate with W3RCQ, Bob Brown, 623 Delaware Ave., Wilson, Pa., or W8WDQ, Bob Brewster, 2815 Euclid Hts. Blvd., Cleveland Heights 18, Ohio.

## DIRECTORY OF ACTIVE NETS

Alaska 'Phone Net	3940	6:30 P.M. Alaska Time, daily.
Alberta	3722*	7:00 P.M. MST, Mon.-Fri.
Arizona State Net	3515*	7:30 P.M. MST, daily.
Ark. Valley Emerg. Net	3860	7:00 A.M. CST, Sun.
Atlantic-Pacific Trunk <sup>1</sup>	3630	9:30 P.M. EST, Mon.-Fri.
Buckeye Net (Ohio)	3730	7:30 P.M. EST, Mon.-Fri.
Buzzards Roost Net (Mich.)	3930	5:30 P.M. EST, Mon.-Fri.
CCN-SFN (California)	3615	
Charter Oak Net (Conn.)	3950	9:00 A.M. EST, Sun.
Cracker Emergency Net (Ga.)	3995*	10:00 A.M. EST, Sun.
Dog House Net (Ohio, Ind.)	3890	6:00 P.M. EST, daily.
Eastern Massachusetts	3745	7:00 P.M. EST, Mon.-Fri.
Florida Emerg. 'Phone Net	3910	6:00 P.M. EST, Tues.
Gem Net (Idaho)	3743*	9:00 P.M. MST, Mon., Wed., Fri.
Golden State Net (Cal.)	3665	7:30 P.M. PST, Mon.-Fri.
Great Lakes Early Net <sup>2</sup>	3665	7:00 A.M. EST, Mon.-Fri.
Hit and Bounce Net <sup>3</sup>	3637	5:00 A.M. CST, daily.
Illinois	3785	6:45 P.M. CST, Mon.-Fri.
Indiana C.W. Net	3656*	6:30 P.M. CST, Mon., Wed., Fri.
Iowa 75 Net	3970	12:30 P.M. CST, Mon.-Sat.
Kentucky Traffic Net	3810*	7:30 P.M. CST, Mon.-Fri.
Maritime (Canada)	3545	
Maryland Emergency Net	3700*	10:00 A.M. EST, Sun.
Michigan QMN Net	3663	6:00, 7:00 P.M. EST, Mon.-Fri.
Minnesota State Net	3795	
Minnesota 'Phone Net	3970	
Mission Trail Net (Cal.) <sup>4</sup>	3854	6:50 P.M. PST, daily.
Missouri	3755	7:00 P.M. CST, daily.
Nebraska State Net	3745*	8:00 P.M. CST.
Nevada State Net	3660	
New England Net	3640	7:45 P.M. EST, Mon.-Fri.
N. H. Emergency Net	3735*	9:00 A.M. EST, Sun.
	3980*	9:30 A.M. EST, Sun.
North Dakota	3525	6:30 P.M. CST, Mon., Wed., Fri.
Northern New Jersey	3630	7:00 P.M. EST, Mon.-Sat.
North Central Texas Net	3935	9:00 A.M. CST, Sun.
Northern Texas	2657*	
Nutmeg Net (Connecticut)	3640	7:00 P.M. EST, Mon.-Fri.
N. Y. C.-L. I.	3710	9:00 P.M. EST, Mon.-Fri.
Ohio Emergency Corps	3725*	8:00 P.M. EST, Mon.
	3885	6:30 P.M. EST, Thurs.
	3550	
Pelican Net (Louisiana)	3725	7:00 P.M. PST, Mon.-Fri.
Pioneer Net (California) <sup>5</sup>	3550	7:00 P.M. EST, Mon.-Fri.
Pine Tree Net (Maine)	3635	7:30 P.M. CST, Mon.-Fri.
Rebel Net <sup>6</sup>	3540	7:00 P.M. EST, Mon.-Fri.
Rhode Island	3735	7:15 P.M. EST, Mon., Wed., Fri.
South Carolina		
Southern New Jersey	3700	8:00 P.M. EST, T-T-Sat.
Sidewinders Net (Arizona)	3865	7:45 A.M., daily.
Sagebrush Net (Nevada)	3998	
Texas Gulf Coast Emerg. Net	3840*	6:30 P.M. CST, Mon.
	3860	7:00 A.M. CST, Sat.
Traffic Outlet <sup>7</sup>	3705	10:00 P.M. EST, Mon.-Fri.
Trunk Line "A" <sup>8</sup>	3565	8:30 P.M. CST, Mon.-Fri.
Trunk Line "C" <sup>9</sup>	3790	8:30 P.M. EST, Mon.-Fri.
Trunk Line "I" <sup>10</sup>	3690	
Two Letter Call Net	3690	9:00 P.M. EST.
Vermont C.W. Net	3740	6:30 P.M. EST, daily.
Vermont 'Phone Net	3860	6:00 P.M. EST, daily.
Western Massachusetts	3760	7:00 P.M. EST, Mon., Wed., Fri.
Western New York	3720	7:00 P.M. EST, daily.
Western Pennsylvania	3750	6:30 P.M. EST, Mon.-Fri.
West Virginia	3770	6:30 P.M. EST.
Wisconsin	3775	6:00 P.M. CST, Mon.-Fri.
YLRL	3610	

\* Subject to change.

<sup>1</sup> Conn., Mass., N. Y., N. J., D. C., Md., Pa., Miss., Calif., Ohio, Mich., Ill., Wis., Iowa, Nebr., Colo., Ky.  
<sup>2</sup> All ARRL Sections bordering on Great Lakes.  
<sup>3</sup> Tenn., Calif., Tex., Mich., W. Pa., Miss., Mo., N. N. J., N. Y. C., Mass., Hawaii.

## ELECTION RESULTS

Valid petitions nominating a single candidate as Section Manager were filed in a number of Sections, as provided in our Constitution and By-Laws, electing the following officials, the term of office starting on the date given.

Nebraska	Roy E. Olmsted, W6POB	Oct. 15, 1946
Eastern New York	Ernest E. George, W2HZL	Oct. 15, 1946
Rhode Island	Clayton C. Gordon, W1HRC	Oct. 15, 1946
Mississippi	Harold Day, W8IGW	Oct. 15, 1946
Saskatchewan	N. E. Thompson, VE5CO	Oct. 15, 1946
Oklahoma	Bert Weidner, W5HXI	Oct. 15, 1946
Kansas	Alvin B. Unruh, W9AWP	Oct. 29, 1946
Oregon	Raleigh A. Munkres, W7HAZ	Nov. 22, 1946

In the South Carolina Section of the Roanoke Division, Mr. Ted Ferguson, W4BQE/ANG, and Mr. J. C. Whittington, W4FNC, were nominated. Mr. Ferguson received 35 votes and Mr. Whittington received 34 votes. Mr. Ferguson's term of office began December 2, 1946.

## A.R.R.L.-NET "QN" SIGNALS

QNA	Answer in alphabetical order of calls.
QNB	Act as relay between . . . and . . .
QNC	All Net stations copy.
QND	Net is directed.
QNE	Entire Net please stand by.
QNF	Net is free.
QNG	Leaving Net until . . . ; please guard.
QNH	Your Net frequency is high.
QNI	Report into Net or I report into Net.
QNJ	Can you copy . . . ?
QNK	Transmit message (s) (for . . .) to . . .
QNL	Your Net frequency is low.
QNM	You are QRMing . . . ; please stand by.
QNN	Net Control Station is . . . (on . . . kc.)
QNO	Going out of Net.
QNP	Unable to copy you due to poor conditions; will call you later (or at . . .)
QNQ	Send you information "QNC" or May I transmit message "QNC"?
QNR	Answer . . . and relay (or receive) traffic.
QNS	Following stations in Net . . .
QNT	Leaving Net temporarily (or for . . . minutes) or I request to leave Net temporarily, etc.
QNU	. . . has traffic for you; await instructions (or QNU QNR).
QNV	Please request . . . to QSV.
QNW	Through whom shall I relay message for . . . ?
QNX	You are excused from Net or I request to be excused.
QNY	Please shift to another frequency (or to . . . kc.) to prevent QRMing other Net stations (or to clear traffic with . . .)
QNZ	Following new member(s) now in Net.

The above list of special "QN" signals has been devised to facilitate net operation. It is used in all ARRL Traffic Nets, and most of the signals are applicable to other types of networks as well. Use of this list aids speedy and orderly net sessions. Every net operator should post a copy at his operating position. Mimeographed copies are available upon request to the Communications Department. Where possible, it is suggested that net managers or net control stations obtain sufficient copies for all stations and distribute them locally.

<sup>4</sup> Calif., Oregon, Wash., Nev., Utah, Colo., Mont., Ariz.  
<sup>5</sup> Northern Calif., with connections to Wash., Idaho, Colo.; Alberta.  
<sup>6</sup> Tex., Miss., Ark., Okla., La., Ala., Tenn., Ga., Fla.  
<sup>7</sup> Conn., N. N. J., S. N. J., E. N. Y., W. N. Y., E. Pa., W. Pa.; Md., Va., Mich., W. Va.  
<sup>8</sup> Trunk Line, N. J. to Wash.  
<sup>9</sup> Maine, N. H., Conn., N. Y., Md.; S. C., Fla.  
<sup>10</sup> All Canada, Maritime to B. C.

## MEET THE SCMs

Clayton C. Gordon, WIHRC, Providence, Rhode Island, is one of our real old-time SCMs, having held this post continuously for "Little Rhody" since April 15, 1935.

Born in Bethlehem, New Hampshire, September 10, 1901, he now is engaged as transmission manager for the American Telephone and Telegraph Company.

Although he first became interested in amateur radio in 1915, it was not until September 30, 1933, that he received his first license, at which time he received the call he has held ever since, WIHRC. In 1940 he was issued a Code Proficiency certificate for copying on a typewriter at 25 w.p.m. HRC has been very active in field-organization affairs, having held office as president, vice-president, and treasurer of the Providence Radio Association, in addition to appointment as R.M. At present he holds appointment as ORS and has just finished a term as alternate director of the New England Division. He took part in prewar Sweepstakes, Field Days, and other contests, and is active in AEC organization and participation.



The shack, which is located in the basement, contains a 6AK5 VFO, 6L6 doubler, 807 buffer-doubler and HF-100 p.p. final with a Class B modulator for 3.5, 7, 14, and 28 Mc. Maximum c.w. power is 450 watts. Receiver is an HRO. Antenna regularly used is a 7-Mc. center-fed all-band installation with tuned feeders. Portable equipment consists of a vibrator-110 a.c. combination pack to power a Pierce oscillator-6L6 final and a three-tube superhet.

Outside of amateur radio WIHRC's pet hobby is taking Kodachrome 35 mm. stills. He is very enthusiastic about mountain climbing, a sport in which he engages with his two daughters, and in which he usually beats the book time on trails.

Clayt makes a serious effort to keep amateur radio a hobby and tries to follow the "Amateur's Code." Therefore, he attempts to maintain an interest in many things. In QSOs it is quite common for him to draw out the other fellow and get him to talk about his interests, thus contributing to Clayt's knowledge of his fellow amateurs.

## BRIEF

W3VQX, Franklin, Pa., had a three-way QSO on 3.85-Mc. 'phone with W8AW, Franklin, Mich., and W9UGH, Franklin, Indiana. W8AW says there are about 31 Franklins in the 48 states so . . . you guessed it, he's going to try to WAF (Work All Franklins).

## NEW A.R.R.L. SECTION

Welcome is extended to the Yukon Section of the Vanalsta Division. The new Section was created by joint action of the CGM and CM, in recognition of the activity consistently reported from the Yukon. Reports of the Yukon activity should be sent to the Acting SCM until an election has been completed. His address appears this month on page 6.

The Yukon Section becomes effective with publication of this notice in QST. Nominations for SCM in conformance with the ELECTION NOTICE should be submitted at once. With Minnesota a single Section (Dec. QST, page 72) we had one less Section. With the new Yukon Section we are back at 71 ARRL Sections.

## ELECTION NOTICE

(To all ARRL Members residing in the Sections listed below:)

You are hereby notified that an election for Section Communications Manager is about to be held in your respective Sections. This notice supersedes previous notices.

Nominating petitions are solicited. The signatures of five or more ARRL full members of the Section concerned, in good standing, are required on each petition. No member shall sign more than one petition.

Each candidate for Section Communications Manager must have been a licensed amateur for at least two years and similarly a full member of the League for at least one continuous year immediately prior to his nomination.

Petitions must be in West Hartford, Conn., on or before noon on the closing dates specified. In cases where no valid nominating petitions were received in response to previous notices, the closing dates are set ahead to the dates given herewith. The complete name, address, and station call of the candidate should be included with the petition.

The following nomination form is suggested:

Communications Manager, ARRL (Place and date)  
38 La Salle Road, West Hartford, Conn.  
We, the undersigned full members of the.....  
.....ARRL Section of the.....  
Division hereby nominate.....  
as candidate for Section Communications Manager for this  
Section for the next two-year term of office.

Elections will take place immediately after the closing dates specified for receipt of nominating petitions. The Ballots mailed from Headquarters to full members will list in alphabetical sequence the names of all eligible candidates.

You are urged to take the initiative and file nominating petitions immediately. This is your opportunity to put the man of your choice in office.

— F. E. Handy, Communications Manager

Section	Closing Date	SCM	Present Term Ends
Southern Texas	Feb. 3, 1947	James B. Rives	Feb. 15, 1947
Philippines	Feb. 17, 1947	George L. Rickard	Oct. 15, 1938
Maine	Feb. 17, 1947	Grover C. Brown	June 15, 1946
Maritime*	Feb. 17, 1947	Arthur M. Crowell	.....
West Indies	Feb. 17, 1947	Mario de la Torre	Deceased
Washington	Feb. 17, 1947	O. U. Tatro	Resigned
Minnesota	Feb. 17, 1947	Vernon G. Pribyl	.....
Michigan	Feb. 17, 1947	Harold C. Bird	Resigned
Wisconsin	Feb. 17, 1947	C. C. Richelieu	Resigned
Western Penna.	Mar. 17, 1947	Ray Rosenberg	Apr. 1, 1947
Yukon	Mar. 17, 1947	.....	.....

\* In Canadian sections nominating petitions for section managers must be addressed to Canadian General Manager Alex Reid, 169 Logan Ave., St. Lambert, Quebec. To be valid such petitions must be filed with him on or before the closing dates named.

• All operating amateurs are invited to report to the SCM on the first of each month, covering station activities for the preceding month. Radio Club news is also desired by SCMs for inclusion in these columns. The addresses of all SCMs will be found on page 6.

### ATLANTIC DIVISION

**EASTERN PENNSYLVANIA** — SCM, Jerry Mathis, W3BES — Ex-3BYS now is 4KWA and hopes the fellows in this section will keep an ear peeled for him. Ex-3DUI now is 3LQV. 3DUI now has been issued to ex-3DUI in Western Pennsylvania. 3MJB, after having had his ticket only one week, chalked up fifteen states and all districts except 6 and 6 and handled 20 messages with 20 watts input. 3OML has schedules on 3590 kc. at 9:30 p.m. Wednesdays. 3AQN is on 28.9-Mc. 'phone these days. He also busted a couple of vest buttons when he saw his QSL card on the cover of the November issue of QST. 3GMK is looking for traffic schedules, especially with Penn Yan, N. Y. 3FPC engages in round-table rag-chews after midnight on 28,746 kc. Four stations now participate but more are desired on at that time. 3MAL is using a one-tube receiver while waiting for his S-38 to come through. 3QEW keeps a fine list of schedules on 3705 kc. Mondays through Fridays at 10 p.m. 3QLW is using an HT-6 and an SX-28 on 3.9, 3.5, and 14 Mc. He schedules 3YA Tuesdays at 9:30 p.m. 3ID is rockbound and complains that the net stations will not listen off their frequencies during traffic hours. 3QP is plugging along with his international traffic schedules and sets a postwar Eastern Pennsylvania traffic record. 3EU says that the "Traffic Outlet Net" needs a schedule in Philadelphia on 3705 kc. 10 p.m. Mondays through Fridays. 3KT is recovering from the SS Contest by staying on 14 Mc. all night. Jess has snagged some might fine pieces of DX lately, such as XZ, VP8, and ZC1. 3BXE is building four separate rigs to work all bands with the flip of a switch. The section showed its usual activity in the SS Contest and a flock of large numbers came out of Eastern Pennsylvania. The Frankford Radio Club put in its bid of some 1,800,000 points for its seventh straight SS gavel award. A move is afoot to reestablish an Eastern Pennsylvania traffic net on 3785 kc. A lot of antennas came down in the recent 50-mile-an-hour blow. 3MFM, an LSPH, made over 500 contacts in his first SS Contest. Traffic: W3QP 91, EU 41, QEW 26, AQN 17, KT 6, BXE 5, QLW 4, ID 3, MJB 2.

**MARYLAND-DELAWARE-DISTRICT OF COLUMBIA** — Acting SCM, Eppa Darne, W3BWT — KMR, Hancock, Md., is on the air with a 125-watt rig, using 3.5-Mc. c.w. LVY and ECP turned in nice totals for the month. LVY has been appointed to Trunk Line C. EIS and MAR tested a gas-engine-powered portable rig built up for next Field Day, and averaged eight QSOs per hour for a 25-hour period. MSK has worked twenty countries with over 100 QSOs using 10 watts on 28-Mc. c.w. The Acting SCM would like reports from all members in the section regularly. Write in and let the rest of the gang know what you are doing. Traffic: W3LVY 297, ECP 238, BWT 3, AKB 2.

**SOUTHERN NEW JERSEY** — SCM, Ray Tomlinson, W2GCU — SEC: BAQ, EC: SAK, PZB, ASQ. DVRA enjoyed a discussion of u.h.f. antennas by CHO. ASG is new OBS. HDW works out FB on 14 Mc. with indoor antenna. HBV has 100 watts on 3.9 and 14 Mc. CFB schedules DJ, in Hornell, N. Y. New officers, Trenton Radio Society: CHO, pres.; KWE, vice-pres.; RYB, corr. secy.; STU, treas.; CFB, rec. secy. New officers, Hamilton Twp. Radio Assn.: SVV, pres.; GSF, vice-pres.; ASQ, treas.; Earle Van Horn, secy. ORS endorsements: RXL, CFB. OXX resumed OBS schedules on 7 Mc. GWW has 616

crystal rig on 3.5-Mc. Ex-3ETL's correct call is 2QKA. QKY has four-element close-spaced 28-Mc. rotary. RG schedules 3BFH, 8DYB, 8BTV, and 3ECP. SMP worked his first "Zedder," ZLIBG, on 28-Mc. 'phone. Ex-3CFT, D4AQW may be addressed: T/Sgt Stephen Jesso, Hq Trp., 5th Con. Regt., APO 178, U.S. Army. PSZ uses 144-Mc. mobile. 2QCL is on 3.5, 7, 14, and 28 Mc. TNN covers Glassboro in SNJ Net. OXX is on 3.5, 7, 14, and 144 Mc. FXN missed WAS in one SS week end by North Dakota. ZI worked 26 countries on his DX spree. 2ORS is on 3769 and 7251 kc. SAK is on 3900 kc. and 147 Mc. BEI schedules G6BY daily at 0600. CFB and CJ schedule on Tuesdays and Sundays. PIN's new e.o.o. is the "nuts" on 7 Mc. QCM works 3.5- to 14-Mc. c.w. using a 4D32. The club transmitter of W2ZQ has placed in operation Dec. 7th, just five years to the day since the last QSO under the call 3AQ. AQW sports a new 14-Mc. beam with the new kw. kicking it. 3EKK is on from Japan with 400 watts and a whip antenna. PRG enjoyed QSOs with LU2DM. GXJ is back on 14-Mc. 'phone. DX Special! PFQ (SNJ) worked Philadelphia on 14-Mc. c.w. IZI is QUIH's alternate for the Traffic Outlet, 3705 kc. Traffic: W2FXN 51, RG 31, AQW 21, ORS 13, OXX 7, GWW 4, CFB 3, BEI 2, Ray.

**WESTERN NEW YORK** — SCM, Charles I. Otero, W2UPH — The 144-Mc. contest held by the Rochester gang was a big success. The RARA awarded two prizes, one for DX and the other for the highest number of contacts. RSL, Rochester EC, is working out drills on 144 Mc. with the Syracuse gang. Buffalo 144 Mc.-ers, please take note. There is plenty of activity in the Rochester area on 144 Mc. RTB is rebuilding; RSL has a six-element beam; OVE has a three-element beam; TXB works with a vertical; PHT has a corner reflector; and REA is working out with one-tenth of a watt. TEX spoke on plumber's delights for 28 Mc. at the RARA meeting. TXB has a new "harmonic." 1PKL, formerly 8MBT of Rochester, now is at East Norwalk, Conn., working on 14,143 kc. with 80 watts to an 829B. Bill says the DX in that locality is unbelievable. He wants to get in touch with the Rochester gang. Attendance at the RAWNY hamfest at Buffalo was near 400. ROL won first prize, an HQ-129X. UPH and Alternate Director 8BHN attended. Speakers were R. Rowe, 2FMF, W. C. Louden, Lt. Comdr. C. Cummings. UXL now is JR; QDN is OI. UVV and RUI are mobile on 28 Mc. While on vacation FMH kept schedules with ROL from various places. BAG, SOK, IRU, and QAG have crystal-controlled rigs on 144 Mc. as well as superhets. At the last meeting of the KBT Club, Ernie Graf gave a very interesting talk on scopes together with sound films. RGJ and LFQ have new "harmonics." PXN, PUG, UYV, VEX, CUU, and PUT are on 28 Mc. PMA is on c.w. on all bands. PQI now is OY. OSK is on 3.5-Mc. c.w. FOH, VTH, UHI, and PXB are on 7-Mc. c.w. An urgent message from Niagara Falls was delivered in two hours to an Army captain in Manila, P. I. OVP contacted KH6FE at Hawaii, who in turn contacted an amateur at the captain's Army base in the Philippines. The next morning Manila called OVP but a W2 in New Jersey offered to take the message. The W2 called Niagara Falls via land wire and let the original sender of the message talk with her husband direct. The same evening another message was received by OVP via 6TIK but because of OVP's low power he used WHO's rig. OVP would like to hear from the W2 station who called Niagara Falls via land line. While in Havana, Cuba, your SCM met CO2PLL, CO2MF, CO2MG, CO2CR, CO2CT, CO2UP, CO2SG, and CO2JK. Time alone did not allow meeting the rest of a fine bunch of fellows. Several contacts were made with stations on the continent, particularly FBA, VTR, and QAA in the Rochester area. 73. *Charlie.*

**WESTERN PENNSYLVANIA** — SCM, R. R. Rosenberg, W3NCJ — Section EC: AVY. New appointments: EC: WBM, Erie County; MJK, Somerset County. OO: RIS. OPS: RIS and QEM. TOJ reports improved activity on the Western Pennsylvania ORS Net. Net sessions held

(Continued on page 86)

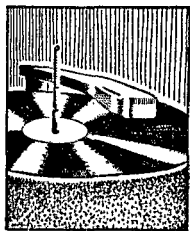

IN THIS SERIES of articles about phonograph reproduction, we have said very little about speakers. They are, of course, one of the most important (and most expensive) elements in the entire reproducing system, and we can hardly finish off this series without saying anything about them.

If you are a perfectionist in phonograph reproduction who spends all his spare time tinkering with turntables and amplifiers, who guards each record from even a fingerprint lest it increase surface noise, who won't allow furniture to be moved because it will change acoustics and who reads the *Journal of the Acoustical Society* for relaxation, then we will not tell you what speaker to use, for you will disagree with us. We have the greatest respect for you, for we admire your technical skill and enjoy listening to your instruments, but this page is not for you.

This page is for the men who like to listen to records but with whom phonographs are neither a hobby nor a profession. If you fall in this class, there is some advice we can give you.

Whatever speaker you use, do not drive it to the limit. Speakers overload, and they will give objectionable distortion long before they rattle. For instance, even at volume levels you might use in your own living-room, half a dozen 12-inch speakers will give purer tone than one 12-inch speaker. You probably will not care to go this far, but for the best tone you will want generous speaker capacity, no matter what type of speaker you use.

You should expect to do a bit of tinkering with the balance between highs and lows. You will have to make adjustments to suit the speaker you use, the acoustics of your room and the make of records you prefer. This sort of tinkering is rather good fun, if there is not too much of it. You will find that your difficulties increase with the frequency range you mean to reproduce. If you aim for a range up to fourteen thousand cycles, you will find that you have a real job on your hands, while if you cut off at about five thousand cycles it is easy. Between these two extremes there is a lot of ground and you can suit your own preference. However, remember that most of the records you buy over the counter have little useful range above eight thousand cycles and many of the poorer records sound best with an even narrower range.

Having given a lot of reasons why it is sensible not to aim for too fancy a job in record reproduction, we confess that we are going to shoot the works ourselves. We may report to you on our results some day, but only after we have carried out a lot of experiments. We try to keep our advice on this page accurate and this is a field where it is easy for a man to fool himself. In the meantime, we shall study up on the *Journal of the Acoustical Society*.

WILLIAM A. READY



during November: 17. Messages handled totalled 117, with the following stations participating: KWL (alt. NCS), LQQ, LOD, MJK, NCJ, KQD, 2SZE, 2NWA, 8MPG, TWI/4, and TOJ (NCS). The newly-elected officers of The Amateur Transmitters Assn. of W. Penna. include: NUG, KSP, MPO, KWA, UST, UHN, LAH, UL, OB, LEM, SGH, and BWP. Meetings are held on the first Friday of each month in the Buhl Planetarium, Pittsburgh. RUE reports the members of the Pittsburgh area "50-Mc. Gang" include: 8SFG, OMY, SFF, KSP, KXI, RUE, and STDJ. Power inputs range from 40 to 750 watts, with all stations using horizontal antennas. Anyone interested in arranging schedules on 50 Mc. is requested to contact RUE. KWA worked G2CYV on 3.5 Mc. TTD now is 7KIY, and operates on 3.5 Mc. from Glenrock, Wyo. QEM is constructing c.c., 144-Mc. transmitter with 832A final. LYC has been trying to remove parasitic oscillations from a pair of 807 tubes in 28-Mc. 'phone transmitter, and is installing noise limiter in HRO receiver. First postwar DX contact for YA was with ON4AU on 7 Mc. OFO worked twelve countries in one week. BWP is doing fine job as OO on 14-Mc. 'phone. KWL is member of TLAP. UVM is heard working 3.9-Mc. 'phone. CB worked "FB9" station on 7 Mc. with his new exciter. LOD has been getting good results from new 3.5 Mc. rig using 809 final. BOZ, 9EXW/3, KQD, MIE, YA, KWL, MUE, NDG, and NCJ were among the Western Pennsylvania stations heard during the SS Contest. QKI has completed c.c., 144-Mc. transmitter with 829 final, and with newly-erected horizontally-polarized antenna, has been making daily contacts with 8UKS at Cleveland, Ohio. Erie amateurs making frequent 144-Mc. DX contacts with Westfield, Buffalo, and Niagara Falls, N. Y., include: GV, LTN, NBV, QKI, and WBM. Call changes: 8MBF/8GEJ, 3MED/8KGB, 3KSP/8EYS. Traffic: W3KWL 154, MJK 138, KWA 123, TOJ 102, KQD 21, NCJ 19, LOD 14, YA 13, W9EXW/3 8, BWP 7, AVY 4. 73. Ray.

## CENTRAL DIVISION

ILLINOIS — SCM, Wesley E. Marriner, W9AND — Northern Section RM: Lloyd Hopkins, EVJ, 27 Lynch St., Elgin. Southern Section RM: Louise Baker, JTX, 635 North 53rd, East St. Louis. Write them regarding your traffic problems. Appointments are open for PAMS as well as ORS, OBS, OPS, EC, and OES. Let's get active, fellows. WES worked eighteen DX stations one morning on 28 Mc. CKM has new p.p. 809s final and likes to chew the rag on 3.5 Mc. ACU still is working DX on 28-Mc. 'phone c.w. but now is interested in traffic. The YL Club meeting held Dec. 1st, at JTX was attended by 8DBB, 8PFO, 9JPT, and 8IKC. Another visitor at JTX was FLQ. 2LZO now is 9GDX at Chicago and you will find him on 7 Mc. GMV is doing swell Official Observer work but gets discouraged with so many bad signals, operating practice, etc., on the air. Let's all cooperate for better conditions. MUX sends in following news: NQP rebuilt to 813 final. HLS is building super-duper super. GLU now is in W7 Land. YBY will be on 7 and 3.5 Mc. by this time. FKI finished 3.5-Mc. c.w. WAS begun in July. QLZ is trying to rebuild and still stay on the air. QLZ, TLC, NIU, BIN, YBY, ATA, JAU, and ZEN were on hand to keep the Starved Rock Radio Club station, MKS, on during SS Contest. An antenna was raised at 2:30 a.m. KA is doing OO work on 14 Mc. The Cahokia Amateur Radio Club would appreciate it if amateurs living in Madison, Monroe, and St. Clair Counties would contact the secretary, ENI. After the first of the year EBX will have a line of schedules. NIU converted b.c. 348J to a.c. FDF is new ham in Elgin. EVJ worked 7 Mc. DX, HH, CM, and NY4CM, and reports out-of-state nets cooperating very nicely with Illinois Net, which operates on 3765 kc. The Elgin Amateur Radio Society is building its own ham shack in nice location. Majestic Radio donated a two-story building which was torn down and used for material. VES and NUF operated NUF in SS Contest but couldn't get out on 7 Mc. BRX is using 100-watt exciter stage on 14 Mc. until new final is finished. JMG installed change-over relays in rig and receiver. SYZ sends nice letter. He is active on 14 Mc. UPW has a new HQ-129X, doublet antenna and Millen exciter on 28-Mc. 'phone. FCN writes to voice his pleasure with new ARRL plan for 28 Mc. He is using narrow-band f.m. YTV had nice time in SS Contest though limited to time and 25 watts. AND has new Gonset 28-Mc. converter and Millen e.c.o. AWA, GNU, and AND are in a neck-and-neck DX race. GNU has new Millen e.c.o. OMA says he

will go to 28 Mc. for DX if local boys get too far ahead. AHV visited 6NDG while on vacation in Arizona. ERU and AIC are in'ham gear business in Rockford. SQA has trouble with rig. SGL works out fine on 28-Mc. ground wave. FW is on 3650 kc. ZRB has new 28-Mc. converter. AWA has the XYL run the HRO on broadcast during the day so receiver will be warm for night DX. SXL found his net crystal three kilocycles off. HON has shack built but needs skyhook. QKJ is using both calls, QKJ/D4 and D4AON, from Germany. He hears good signals on 7 and 3.5 Mc. from the States and hopes for schedule. Peoria hams will soon have ZD2K, Lagos, Nigeria, Africa, among them for six months visit. YBY writes to say he thinks the ARRL plan for 28 Mc. will help. VJN has BCI key click troubles. Traffic: W9EVJ 222, DXL 150, JTX 132, FKI 76, SXL 30, MRQ 13, QLZ 13, YTV 13, AND 8, MUX 7, JMG 7, EBX 5, NUF 5, WFS 5, MKS 4. 73. "Wes."

INDIANA — SCM, Ted K. Clifton, W9SWH — RCB is our high traffic man again. KYM had open house for the South Bend hams in honor of IGS. The South Bend Radio Club will be known as the Michiana Amateur Radio Club. Following are officers: DCM, pres.; RZO, vice-pres.; PDS, secy.; AB, treas. Meetings will be held the last Wednesday of each month at 528 East Colfax Avenue. NGR was appointed Club OO. DMH will be in charge of the code class. ARE, our new director, gave a talk at the November 27th meeting. The u.h.f. boys are concentrating on Monday nights for contact work on 50 Mc. HUV worked PZ1 for his 88th country. AMM received the Charles A. Coffin Award from General Electric, NXU, ex-FEB, has 180 watts on 14- and 28-Mc. c.w. with 813 final, antenna three-element rotary. KQU is on 144 Mc. UNS has 100 watts to 829B on 50 Mc. ENB is putting code lessons on the air Mondays and Wednesdays at 7:30 to 8:15 CST on 27,280 kc. UKT, our OO, is putting out his notifications via QIN. QLW is leading the DX for the State. NZZ worked sixty-two sections in the SS Contest. UKV is using an 814 for brass pounding. The Delaware Amateur Radio Association and the Muncie Radio Club meet every other Tuesday. IFU is instructor at Purdue. OSA is at WLBC. UCT says there's nothing like 50 Mc. and narrow-band f.m. DOK has a new 14-Mc. beam. HOG is staying on 50 and 144 Mc. FJI is our newest OES. YWE has a TZ40 on 7 Mc. with 175 watts. VMG has returned to the 3.9-Mc. band. KPD was back in the State for a visit and now is with Lear. OFG and his XYL paid a visit to the SCM. YQV now has e.c.o. UUN is trustee for the Fort Wayne Radio Club transmitter. SLA is leaving Fort Wayne. JJI returned to the air for the first time since Pearl Harbor. NXW is on 3.9 Mc. with 20 watts. PMT is having trouble copying on mill because of interference from the electric mill. JLT was home from college the other week end working locals on 50 Mc. and became disgusted with his dad's (CLF) receiver when he failed to hear a K7 call him. FMJ is in the hospital. Traffic: W9RCB 191, DEJ 17, HUV 12, UKT 12, NGS 8, DGA 6, PMT 6, SWH 6, ENB 5, NZZ 4, QLW 4, UNS 4. 73. Ted.

WISCONSIN — SCM, C. C. Richelieu, W9ARE — RQM heads the State in the SS Contest with 766 contacts in 69 sections. UIT is a close second. LFK reports the Wisconsin Net functioning with SZL, HUI, DKH, NWM, and IQW attending regularly. DKH is western manager of new Trunk Line "A." GDD sends an excellent report on the Superior gang. RJT operates from Superior. DXI is working ZEs regularly. GDD worked W0MCF/CI in Shanghai and received QSL in the form of a Chinese \$5 bill with call inscribed. PDK and AOW are active on 28, 7, and 3.5 Mc. GDD reports hearing QHR, ZIE, NJT, EWC, ROQ, and HB — all on 28-Mc. ground wave in Superior. CIH has new 14-Mc. Triplex beam up and reports R9 on 'phone from all continents the first week. MUM is holding down the traffic net for Eau Claire. JNU, ASQ, and NBN are back on the air. BXM, in Owen, has a new antenna up

### WIS. QSO GET ACQUAINTED PARTY

Feb. 23 — Sunday — 8 A.M. to 8 P.M.  
Call — CQ Wis for all badgers or ex-badger hams.  
Place — 3500 to 4000 kc.  
Conclusion — No contest, just a friendly get-together and general bull session. 73. W9DKH, Acting Wisconsin SCM.

(Continued on page 88)





# HQ-129-X

*choice of* **THOUSANDS**



Hams are pretty shrewd individuals when it comes to selecting the gear they use. Many thousands knew what they wanted — they're using HQ-129-X receivers on the air every day. That, we believe, is one of the finest endorsements any product can achieve. Materials are still hard to get but hundreds of HQ-129-X's are being shipped every month.

**36**  
BACKED BY

**YEARS OF KNOW HOW**

SEE THE HQ-129-X AT YOUR DEALER'S



# HAMMARLUND

THE HAMMARLUND MFG. CO., INC., 460 W. 34<sup>TH</sup> ST., NEW YORK 1, N.Y.  
MANUFACTURERS OF PRECISION COMMUNICATIONS EQUIPMENT

and reports two new hams will be on soon. MUM teaches code at Eau Claire Vocational. ARJ is getting ready to blossom forth with a kilowatt. The Racine gang held a QSO party on the air recently which was a great success. Your SCM spoke at Racine on Nov. 25th, along with GPI. Your SCM also enjoyed appearing at the South Bend Club's meeting on Nov. 25th. OOL has visited many clubs in the Wisconsin area. YFP sends in a nice report on the Madison gang. 9SYA/2 is a cadet at West Point and is operating as 9SYA/2 or 2KGY and wants Wisconsin contacts on week ends on 14-Mc. 'phone. The MRAC held an annual bowling party Dec. 7th with a big turnout. By the time you fellows read this, I will have given up the job of SCM of Wisconsin and will be active as your new Central Division Director. I ask you at this time to please cooperate with your new SCM and give him the same assistance as that tendered me during the past several months. Traffic: W9LFK 104, DKH 44, SZL 22, NWM 13, ARE 12, RQM 8, IQW 2. 73. Rich.

## DAKOTA DIVISION

**NORTH DAKOTA** — SCM, Raymond V. Barnett, W9EVP — The North Dakota Net has been reactivated with schedules at 6:30 p.m. Mondays, Wednesdays, and Fridays on 3525 kc. with later contact with Minnesota and Montana. We need more ORS. Let's hear from you on net schedules or send an application by mail. YIZ reports a newly-formed club at Jamestown with EOZ, GWU, WXS, JWY, and YIZ as charter members. The Cendak Club received log books, message blanks, *Handbooks*, etc., ordered from ARRL, and they sold like hotcakes. DAK is attending the university in Minneapolis. RJF moved to Minneapolis. GMY is active at Williston on 3.5-Mc. c.w. AFK is active on 7 Mc. ZLP moved to Dayton, Ohio. SSW lacks only Nevada and South Carolina for WAS with 15 watts input. HBR has a new home at Watford City and has 40 watts on the air. We need more reports by the fifth of each month. A card will do. How about it, fellows? Traffic: W9PDN 21, SSW 15, EVP 6, 73. Roy.

**SOUTH DAKOTA** — SCM, P. H. Schults, W9QVY — ZAL, ZBU, and DJM are taking care of the emergency net in Charles Mix County. ZBU is experimenting with 28-Mc. antenna. WUU put up 256-ft. center-fed antenna. IWE is a new ham in Rapid City. NGM is running 275 watts to an 813 on all bands and has a 25-watt emergency rig using a gas-engine generator. VQC has an 8X-25 waiting for R.E.A. line to come near him. INT, LBU, YTN, and ZTR are Huron Club members. The Sioux Falls Club now has thirty-five members. Permanent meeting place is in the recreational room of Episcopal Church. The theory class, under IPB is building a 100-watt station for the club. CRY has worked ten countries on 28 Mc. ZRA is on with a BC-610. JLI reported for the club. FAX has an S-40 receiver and is on 7 Mc. with 6L6. He uses 1-kw. motor generator for power. KP4KD, Acting SCM West Indies, will look for 14- and 28-Mc. 'phone contacts with South Dakota on both week ends of DX Contest. 73. Phil.

**MINNESOTA** — Acting SCM, Vernon G. Pribyl, W9OMC — SJZ finished a new final using push-pull 812s. He checked with several locals for harmonics. Incidentally, it would not be a bad idea for the rest of us to do that. Several stations have been logged with strong second harmonics. DNY got in on the SS Contest and now is rebuilding his receiver pending more activity. The JCN is operating every Sunday on 3530 kc. GBZ had fun with his 15 watts in the SS Contest, making 10,000 points. LID reports this month that he got on early in November with an 809 final using an extended double Zepp for 7 and 14 Mc. He has a BC-348Q receiver and says that the Mesabi Range Wireless Club is becoming active again. JNC says he had a nice time in the SS Contest and that he never ran across so many crazy people in his life! He reports that he won SS honors for Southern Minnesota with 98,770 points. Congrats! He has thirty-five countries, but will not get many more for some time as the "U" is keeping him pretty busy. YXO's antennas blew down a few hours before the SS Contest but he went to work and got them up in time for a little operating. GRJ reports this month and says he is operating on 28 Mc. exclusively with 85 watts. WQF has a complete new rig on 28 Mc. with 50 watts to an 807. FCC is back on the air, being active on 28 Mc. also. GRJ reports that local rag-chews are held every night on 28 Mc. with the Minneapolis gang. CGK has an RK-39 final with 50 watts on 3.5-Mc. c.w. He's looking for a new receiver. BOL is on 3.5-Mc. c.w. with a BC-375 transmitter and a

BC-348 receiver. He is working on a 60-ft. rainpipe mast antenna for 3.5 Mc. OMC finally got the bugs out of his antenna system and is active on 3.5 and 7 Mc. with 125 watts to push-pull T220s. Both Minnesota nets are going great guns now, with a near-perfect attendance at all seasons. Your activities reports are to be sent to W9EVP at Mound, Minnesota, who will act as your SCM until an election has been held. Traffic: W9OMC 28, EPJ 26, GRJ 6, JNC 2, RJF 2. 73. Fern.

## DELTA DIVISION

**ARKANSAS** — SCM, Marshall Riggs, W5JIC — LUX is on all bands with 50 watts to an 807. LQG is on also. LQN has new HQ-129X and is threatening to vacate 3.9 for 14 Mc. LLO has cathode-modulated rig on 28 Mc. HAT has new receiver. LVB has new frequency meter, so watch your step, boys. He also worked a VQ4 the other day on 28,280 kc. AYH ruined his modulator working ZK1AA. He has that faraway look. LSH is in on DX also, such as PZICA and VO6. LMO is working on f.m. rig for 28 Mc. The Texarkana Club is really going to town in new members. More power to you, W.D. LBO and AKB are on 27 Mc. with HT-9s. EA is rebuilding c.c.o. The youngest ham in Little Rock is LUY with 60 watts on 7 Mc. LQZ has mobile rig. Better watch that battery. DFY is rebuilding his beam. DVI is constructing rhombic on 14 Mc. ENH is on all bands. LCO is experimenting on housewiring as radiator. FN is new in Fort Smith. IYW is back in town. HYS is dreaming of 14-Mc. beam. HOT is on with p.p. VT-127A. Watch that transformer, Paul. ARX is on 14 Mc. at last. Traffic: W5EA 98, LSH 21, LVB 7, JIC 4, LQN 3, HAT 1. 73. Marshall.

**LOUISIANA** — SCM, W. J. Wilkinson, jr., W5VT — KTE, RM and chief of LSN, 3550 kc., is looking for schedules leading to Panama and South America. GAD has new Millen unit. GUK is on 7-Mc. c.w. JET is on 3.5- and 14-Mc. c.w. HUQ is on 14-Mc. 'phone. JET has new antenna and rig. EGK is on 14-Mc. c.w. MAV, MAA, and LVG are new calls. KMR, LXU, KRY, and JEY are having QSOs on 28 Mc. LUU is on 7 Mc. BLQ and LER have new 28-Mc. beams. FJW got on 7 Mc. with new rig. ANA has a new receiver. The OVARC held a banquet to promote more club interest. CEW is building new rig using 250TH. LYY and MEJ are on 28-Mc. 'phone. DXB is back on 28 Mc. AKI and QH worked China on 28-Mc. 'phone. The Caddo Amateur Radio Club has been re-revived. IJJ is working all bands. KEK is building a modulator for kw. rig. IOP is working 28- and 14-Mc. 'phone. JFF is trying to work out an antenna for 3.9-Mc. 'phone. KXO has an 8X-28. LEJ has new 28-Mc. rig. LDH continues OBS schedules Tues., at 7 p.m. IVS, LAY, KTB, ABS, and HHT have portable mobile rigs on 28 Mc. LJY, Loyola University Radio Club, has new BC-610E. BUK, UK, and IN are QRMing on 14 Mc. JPJ is active on 3.5-Mc. c.w. LV is ex-GJO. ZV has new HT-9 on 28 Mc. YU, Tulane University Radio Club, is operating 28 and 14-Mc. 'phone. Operators are KXP, JYK, ISF, KUW, and IMU. JFZ has new HQ-129X. KYK is on 7 and 28 Mc. with new 60-watt rig. LXX is call assigned to LDH for his rig near Thibodaux. FYS had plenty of QRM in SS Contest. FPX/5 is ex-9DFF in Lafayette. Traffic: W5VT 89, KUG 82, IYL 77, KTE 55, IBL 34, GUK 12, JET 5, BSR 5. 73. Dub.

**MISSISSIPPI** — SCM, Harold J. Day, W5IGW — Active on 3.9-Mc. 'phone are LN, IZS, VJ, BOT, GG, ANT, FSS. DEF is on 3.9-Mc. 'phone with 200 watts to T55, modulated with 807s in ABZ. CUU is on 3.9 Mc. with a kw. DNV has new "band switching" rig using 813 final; he also has new 28-Mc. three-element beam. FQ is back on 7 Mc. HKJ has new rig on 3.9 Mc. Mississippi stations handling traffic with the Rebel Traffic Net, are EGE, LAK, WZ, IGW, DEJ, and DNS. HTL now is WZ. LAK runs 750 volts to pair 6L6s in final. GG is Class B modulated with nice quality. IGW has burned-out power transformer in modulator. BK was in SS Contest. GXO reports that EWD is pounding through with his HK354 final; BK is working DX on 28 and 14 Mc.; JHS and JSE, Class A, are on 3.9 and 14 Mc.; FSS is on 3.9 and 14 Mc.; KCI, KYC, and DNV had a round table on 28 Mc. recently; HQQ works DX using new four-element beam. Traffic: W5IGW 307, LAK 52, WZ 49, EGE 27, DEJ 5.

**TENNESSEE** — SCM, James W. Watkins, W4FLS — The members of the Chattanooga Radio Club had the pleasure of a visit from Mr. Leroy Waggoner, WIPEK, Assistant Secretary of the League, on December 2nd and a

(Continued on page 90)

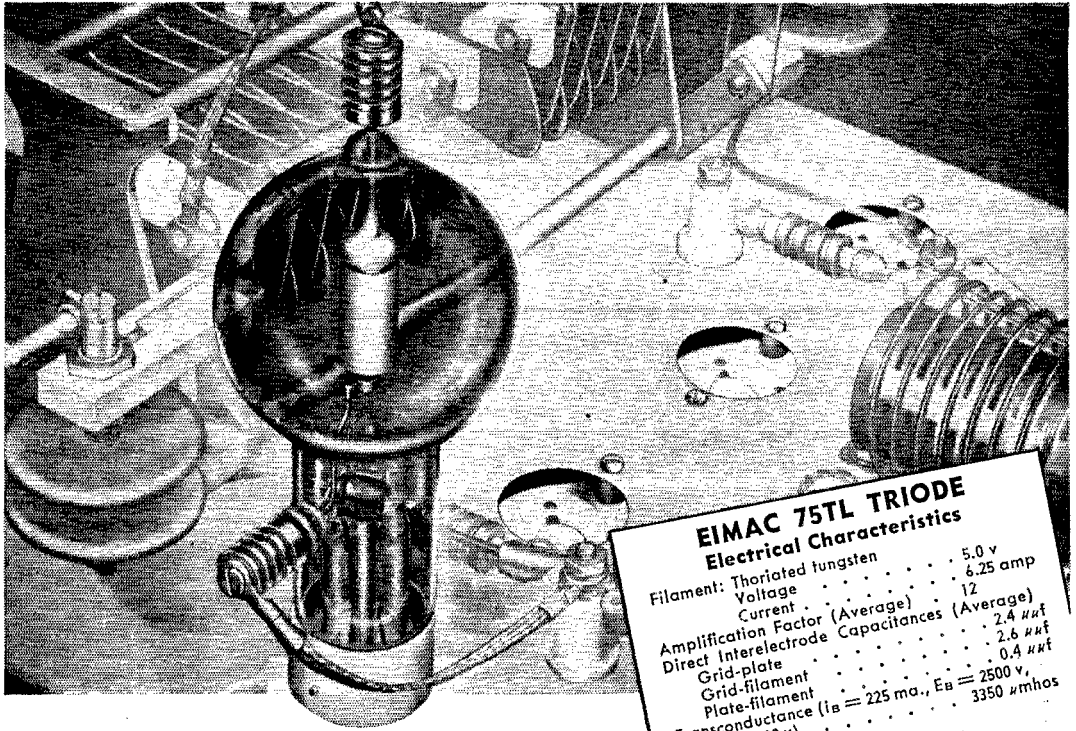

## EMPTY SOCKETS with a purpose

These spaces are reserved for three more Eimac 75T triodes.

Putting a transmitter together by the following steps cuts several financial corners. Starting from 250 watts input and going to 1000, there is no need to discard any parts as you go along:

1. As illustrated above, space is left in the original layout for four Eimac 75T triodes but only one is used—input: 250 watts.
2. A second Eimac 75T is added to operate in push-pull with the first—input power: 500 watts.
3. Finally, another 75T is put in parallel with each of the original pair and the ultimate kilowatt of input is attained.

Whether a transmitter is built by this system or with full power right from the start, Eimac 75T's offer a number of remarkable advantages. These include:

- ★ Exclusive emission-controlled grids for stability and efficiency.
- ★ High power gain.
- ★ Low interelectrode capacitances.

### EIMAC 75TL TRIODE Electrical Characteristics

Filament: Thoriated tungsten	5.0 v
Voltage	6.25 amp
Current	12
Amplification Factor (Average)	2.4 $\mu$ mf
Direct Interelectrode Capacitances (Average)	2.6 $\mu$ mf
Grid-plate	0.4 $\mu$ mf
Plate-filament	2500 v, 3350 $\mu$ mhos
Transconductance ( $i_b = 225$ ma., $E_b = 2500$ v, $E_c = -182$ v)	

### Maximum Ratings

Plate voltage, d-c	3000 v
Plate current, d-c	225 ma.
Plate dissipation	75 w
Grid dissipation	13 w

- ★ Low plate-voltage operation.
- ★ Optimum grid, plate, and cathode geometries from aspects of transit time, electron migration, and thermionic efficiency.
- ★ Ability to withstand momentary overloads without damage.
- ★ Moderate cost — \$10.50.

Write for full details on the Eimac 75T triode and the add-a-tube transmitter.

## EITEL-McCULLOUGH, INC.

1294M San Mateo Ave., San Bruno, Calif.  
Export Agents: Frazer and Hansen, 301 Clay St., San Francisco 11, Calif., U.S.A.

Follow the leaders to

**Eimac**  
REG. U.S. PAT. OFF.  
**TUBES**

very informative discussion was held after his interesting talk on League affairs. FGD is active on 3.9 Mc. and has a new YL jr. operator. KGY is active on 7 Mc. FTL is moving to Fort Wayne, Ind. Best of luck, Wayne. KFF is new call at Crab Orchard and he is active on 7 Mc. using a single 6L6. He now has thirty-three states, a few VEs, and Cuba on his "worked" list. Since we do not have access to a crystal ball, we are unable to know what is happening and where. Unless reports are sent to your SCM it is impossible to fill our allotted space. If the present trend is any indication, it is easy to understand why there was no Tennessee activity report in so many issues of *QST*. Traffic: W4PL 654, KGY 8, FLS 3. 73. Jim.

## GREAT LAKES DIVISION

**KENTUCKY**—SCM, Joseph P. Colvin, W5IEZ/4—It is now 4CDA. 4WYW/4 is on 3.9-Mc. 'phone at Centre College. Where is W9EDQ? 4AHL is on 3905 kc. with 40 watts to 807, and would like to QSO 9JON/8. 4MO, ex-9VBN, has HT-9 on 28, 14, and 3.5-Mc. 'phone and c.w. 4FU, ex-9FS, has given Kentucky a place in the Brass Pounders League. 4MO reports that ex-4RBN now is D4ARN in Frankfurt, Germany, and can be worked between 10:45 and noon CST on approximately 28.35 Mc. 4AHL needs a good receiver. 4FBJ is interested in contacts on 144 and 420 Mc. 4FKM has a new 28-Mc. beam. 4JTB is on 7207 kc. with 60 watts. 4KLP rebuilt his speech amplifier. 9EYV runs 600 watts to a pair of T200s and is working on a beam for 14 Mc. 9OEE has a nice little mobile rig in his car on 28 Mc. and does a swell job with only a 6V6 in the final. 4KCS is 4MLI's jr. operator. The other son is KH6 and schedules are maintained on 28 Mc. 9HOE/4 is operating at Ft. Knox with 500 watts on all bands. 8YHL/4, Louisville, is active on 28 Mc. 4QJU has a new beam on 28 Mc. and would appreciate any contacts. 4AXY has a new band-switching transmitter on the air. 4YAL has moved. 4QJU is keeping schedules with Gs, PAs and Ds using his new Stone beam. 4FEB is now lighting his porch light with 7-Mc. r.f. 4KFI, KFH, KLK, and KMJ are sporting new beams on 28 Mc. 4BAZ has been heard on the air again. The University of Kentucky Amateur Radio Club has been organized with 4IMC as president. New ham: 4KAE, Lexington. Ex-9BUE is 4KQK. 73. Joe.

**MICHIGAN**—SCM, Harold C. Bird, W8DPE—8URM sends congratulations and thanks for ORS. 8TBP reports that Mr. Weston and Jerry Beetley visited the Muskegon Club recently. 8FWU is handling traffic in QMN. 8FX has been working on a pi-network four-ft. rod antenna for receiving for the traffic man. 8UCG worked 43 sections during SS Contest on 14, 7, and 3.5 Mc., 'phone and c.w. If any of you fellows in the Muskegon area wish to contribute news for his bulletin, please write to Chuck Scheeter, RFD 2, Muskegon. 8NXT reports working 28 Mc. but has no coils for other bands yet. 8SCW is assistant general manager of QMN and is running schedules on TLA and the Traffic Outlet. 8UGR is experimenting with receivers now that he has heard the Hallcrafters SX-28 work. 8SWF schedules 9JAAI and handles traffic for Detroit on 28 Mc. He wants to schedule the Byrd Expedition. 8NQ reports that his 6L6 built for QMN gets out even better than expected. 8WWL reports working KH6AR through 8VDC relay. 8QZE says there are openings with Pan-American Worlds Airways for qualified men. 8DAQ is not on until the early morning hours. 8ABH worked VP6AE, Suva, Fiji Islands, on 3.5 Mc. using only 50 watts. 8UFH handled traffic from Greenland for Detroit on 14-Mc. c.w. 8IHN reports that 8ZGW and 8YFF are new Bay City hams. 8YFT reports the following new calls in the Copper Country: 8EGF, 8ZNM, 8ZML, 8IIT. 8EGF has little time for anything but round table on 3.9-Mc. 'phone Sundays. 9DVJ is on 28-Mc. 'phone. 8ZNM is on 28-Mc. 'phone and 7-Mc. c.w. 8ZML is on 28-Mc. 'phone but soon will be on 7-Mc. c.w. 8YKS now is ORS. 8OOC is having good luck with new rig; it is an all-band affair. 8ZHB is working on QMN and looking for schedules. 8KNP expects to be heard on QMN from Cleveland. 8NCB did not intend working in SS Contest but got in and did not want to leave. 8UKV would like to start five o'clock net on QMN. 8TRN scored 20,496 points in SS Contest. Well, gang, the time has come for me to sing my swan song. I sincerely thank all of you for your fine support during the past ten years and hope my successor will receive the same cooperation. I hope to serve you to the best of my ability in my new position. Traffic: 8SAY 804, 8SCW 375, 8DAQ 101, 8ABH 60, 8TBP 55, 8UGR 52, 8JUQ 51, 8FX 39, 8YKS 37, 8IHR

34, 8DPE 29, 8TYE 29, 8RYP 28, 8UFH 21, 8RJC 11, 8SPVB 10, 8WWL 10, 8DNM 9, 8URM 8, 8OCC 4, Hal.

**OHIO**—SCM, William D. Montgomery, W8PNQ—The Buckeye Net (c.w.) on 3730 kc. meets every weekday night at 7:30 P.M. More outlets are needed throughout Ohio, especially in the southern section and around Cincinnati. Recent net certificates for the BN include PIH, VHT, and UPB. This net has outlets to most surrounding states, and to the long-haul coast-to-coast trunk lines, so get your traffic into the net for prompt handling. On the 'phone side of the ledger, the Dog House Net meets every Monday at 6:00 P.M., on about 3.885 Mc., but most of the stations usually are on every night. Net certificates have been awarded to WEV, THJ, EQN, STZ, TRX, HFR, SPT, VUS, PUN, TJD, and ABO. This is a good net on which to put your 'phone traffic. Information is requested on any 3.5-Mc. c.w. or 7-Mc. c.w. traffic nets, or stations operating into traffic nets. Recent ORS appointments include BUM, GVL, and VWX. OPS certificates have been issued to PSE, PBX, and WSC. How about more of you applying for OES or OO? ITR is now an OO in Lakewood. CBI reports that QDI is now with Raytheon at Bedford, Mass., and is on 3625 kc. AQ reports working ZLs on 3.5-Mc. c.w. Looks like 80 is a good DX band after all. DAE is putting out a tilted wave on 14 Mc. these days. He lost the rope on his mast, and the dipole does a little downward slanting. A new c.w. club, the Cleveland Brasspounders Assn. has been started in Cleveland. UZJ and ROX are the founders. EQ says that NN came home from Germany with an HRO which had been built for the German P.O. Plans for the formation of an amateur club and an emergency organization are progressing at Delaware. Anyone interested contact OUR, CNY, ZLR, ARF, etc. ZLR, heard nightly on 3.5-Mc. c.w. is the former 9ZAK. AVH, former director of the Central Division, wishes to express to all Ohio amateurs his appreciation for the cooperation extended him during his term of office. CJR, formerly of Euclid, is calling Cleveland from Shanghai regularly on 28 Mc. Give a listen for him, boys. UKS, an OES in Cleveland, reports 44-Mc. activity there is booming, and urges the gang to get on the band wagon. MFV is pounding brass on 3.5 and 7 Mc. and has recently added an HRO, a Panadapter, and some snazzy frequency standards. SVI moved out in the country. WRN reports from Dayton that nightly schedules are held on 144 Mc. at 7:00 P.M. The stations reporting in are increasing in number, but they are still after more. WAB formerly was 6UQY. A new addition to the Columbus fraternity is ZOE. WSC, in Stryker, sold his 400 watts, and is after a BC-610. He is using a 25-watt rig in the meantime. From Greater Cincinnati, PNJ says his beam quit working, but we think someone else just found his hole in the band. JFC heard YI2CA, VS9AB, and VU2CQ on 28-Mc. 'phone. NDN says 50-Mc. activity is good hereabouts, but he wants more participants. UPB, our SEC, now has four receivers running at the same time so he can watch all the nets. New QCEN officers for 1947 are 4NRA, pres.; MEU, vice-pres.; LeRoy Dieselberg, secy.; 4EAV, treas. TQS, retiring president, showed up for the last meeting. JIN is leading the Ohio portion of the "25 or better" listing of countries worked (in *Mike and Key*), as he is just about at the century mark. SEZ still burns the midnight oil trying to figure out what to print in the *Mike and Key*. Your SCM signs with the report of the arrival here of the fifth jr. operator. Traffic: W8ZAU 70, RN 69, CBI 46, EQ 39, MPG 38, UPB 33, ROX 23, YPS 15, EQN 14, PNQ 14, PIH 11, DAE 10, PUN 10, ZFA 6, EFW 5, AQ 4, LCY 4, ZIF 4, BUM 3, PNJ 3, NDN 2, TGU 2. 73. Bill.

## HUDSON DIVISION

**EASTERN NEW YORK**—SCM, Ernest E. George, W2HZL—IXK reports from the Poughkeepsie area that NOF is hoisting a sixteen-element beam. The Middletown gang is going great guns on 144 Mc. and challenges the Mid-Hudson area on v.h.f. RMA, Schenectady, is active on 144 Mc., crystal from 8211 with an 832. GYV, on 144 Mc. with 300 watts, is burning up all receivers in town. 8SV, CRE, and MXR make up the rest of the Schenectady gang. DC embarrassed his friends by asking them to help him put up a new antenna pole which turned out to be no stiffer than a good piece of new 2" rope. He still can't figure how the Army used those poles. The ENY traffic net now is operating on a small scale under the direction of ITX. NJF reports activity low this month in the lower part of the division.

(Continued on page 98)



# Be Right with.. OHMITE

## AMATEUR ITEMS

Accurate—Dependable—Long Lived

### Vitreous Enameled Rheostats

Available in 10 sizes, from 25 to 1000 watts. Winding is permanently locked in vitreous enamel. The metal-graphite brush provides unmatched smoothness of action. Engineered for long, trouble-free life.

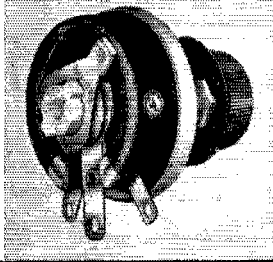

### Non-inductive Resistors

Used as dummy antennas, load resistors, and terminating resistors. Available in vitreous-enamel type wound on a tubular ceramic core, and in hermetically sealed-in-glass type. Sizes from 50 to 250 watts.

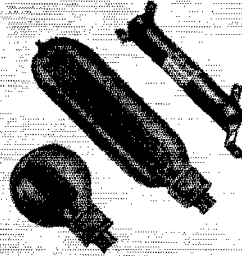

### Transmitter Band Change Switch

For the rapid, convenient changing of transmitter frequency by front-of-panel knob control. Designed for circuits up to 1 kw rating. Low loss porcelain and metal construction. Units can be mounted in tandem on a single frame.

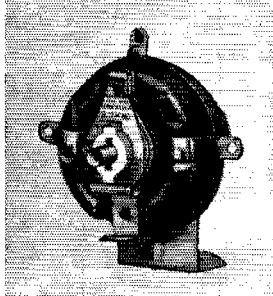

### Parasitic Suppressor

Designed for the suppression of unwanted ultra-high frequency parasitic oscillations. Consists of a 50-ohm vitreous enameled non-inductive resistor supporting a choke of 0.3 microhenries and .003 ohms d-c resistance.

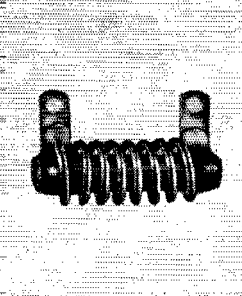

### Radio Frequency Plate Chokes

These chokes have a single layer winding on a steatite core, protected by a moisture-proof coating. Five sizes available to cover 2½, 5, 10-20, 20-40, 20-40-80-160 meter bands. All chokes have a 1000 ma rating.

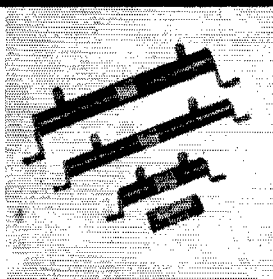

### Dependable Resistors

A complete line of wire wound vitreous enameled resistors, from 10 to 200 watts. Available in the fixed type and adjustable "Dividohm" type. "Little Devil" ½, 1, 2-watt composition resistors also available.

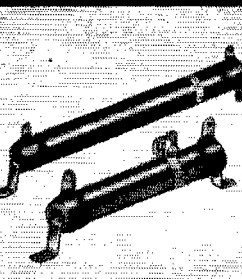

OHMITE MANUFACTURING CO., 4864 Flournoy Street, Chicago 44, U. S. A.

# OHMITE

Write for Catalog No. 18

Provides useful data on the selection and application of rheostats, resistors, tap switches, chokes, attenuators, and other components.

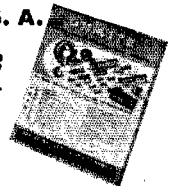

RHEOSTATS

RESISTORS

TAP SWITCHES

CHOKES

QQQ now is on the air, thanks to the editor of *WARA Bandspread*. Traffic: W2ITX 20 NAI 6.

**NEW YORK CITY & LONG ISLAND** — SCM, Charles Ham, jr. W2KDC — From Suffolk, DOG reports increasing interest in the 144-Mc. EC Net. ADW is using 604s while OQI has replaced the HY75 with p.p. 6C4s. EBT is using the same set-up in a mobile rig. LUD is using a DK2. OEO returned to the hospital following an appendectomy. UX holds very reliable 3.9-Mc. 'phone schedules. PDU is on again at Blue Point. TIA, ex-9ZHC, is active at Bayport. FCH worried about his chimney during windstorm and regrets putting up the big stick that gave such good results on 144 Mc. US is active on 144 Mc. using both fixed and portable surplus gear. KOA is working hard calibrating a 144-Mc. rig while DOG carries on very successfully as EC. In Queens County BSP calls in to say he averages seventeen stations and twenty practice messages handled during the month. Of the twenty-four regular EC stations there are four portables and six mobiles with new ones every month. A drive for a Queens 3.5-Mc. c.w. net is on, with BSP and BDN all set up. From Brooklyn, OHE is convalescing, but reports that while activity continues at a good level, pack and mobile sets are sorely needed. The average weekly roll call is twenty stations. A new operating procedure which streamlines activity has made drill nights more interesting. DUS's new jr. operator helps daddy modulate the rig. NKT says mix on publicity. NQQ keeps 28 Mc. warm with his QSOs with 5LVT. BPV and his nephew, ODS, are conspicuous by their absence on 144 Mc. LTK's 144-Mc. rig is one of the neatest in these parts. The MARS, a new radio club, is developing rapidly. For data, contact any AEC 144-Mc. station in Brooklyn, or OHE. (How about sending the QTH to the poor SCML?) NWA and EGI, assisted by KU, put out a strong signal on 144 Mc. How about joining the Emergency Corps, fellows? 8FLX/2 now has call JBQ, which he held long ago. The 3.5-Mc. section net was joined by KTF with BO, LNO, BDN, BGO heard regularly on drill periods. 3600 kc. 3 p.m. Sundays will do it. More stations are needed. PNB sends a fine letter from Southampton reporting activity of UX, NMP, TLB, ex-9TGP, NMZ, CKU, KDN, RDO, and LEB. Others are working on licenses and rigs. NZL is back at sea. CRZ is on daily from Amagansett, where he operates WSL. PNB is doing well on 3.5 Mc., having worked G8, F3, VP8, etc. 3AIX, of Philadelphia and Long Island, also holds 2TMQ. BTU now is VV. OBU increased power and is alternate station on Trunk Line C in addition to NYC-LI Net. LGK would like to see net frequencies in QST. PJP is on 14-Mc. c.w. and 28-Mc. 'phone using low power. The local gang has given him a good reception, however. OWG was forced to resign as ORS because of pressure at school. KYV is never going back to 28 Mc. now that 7 and 3.5 Mc. are open. JAU added an 807 and is running a "cool" 100 watts. BGO is ORS in addition to his other offices. The NYC-LI Net averages four stations and traffic averages four messages each evening. The members are looking for additional coverage. See or call OBU. EC is proud of new HRO-5TA. JAU put up new antenna between Sweepstakes week ends. RQJ is helping new ham, TDY. Joe also worked YR, HB, ZL, KP4, and XE during the month. BTH is operating on 3750 kc. from Brooklyn in New Utrecht H.S. using B-19 Army transmitter. MZB is on 3.5, 7, and 14 Mc. with 60 watts. His new rig, using p.p. 807, is almost finished. Karl worked fifty districts and 230 stations during SS Contest. BO has a new Super-Pro and is plaguing the SCM for an OO appointment. BOT is using Collins 32RA and HQ-120 on 3.5, 7, and 14 Mc. KDC is QRL. Traffic: W2BO 191, OBU 49, EC 43, QYZ 37, SKV 17, RQJ 14, LGK 13, BGO 6, BOT 5, KYV 4, JAU 3, MZB 2.

**NORTHERN NEW JERSEY** — SCM, John J. Vitale, W2IIN — Assistant SCM, W2NKD. SEC: GMN, CGG, of NJN Net, is NCS on 3830 kc. and recently worked VKZLC on net frequency. The Net is on at 7 p.m., Mon. through Sat. At a meeting of the Bloomfield Radio Club, held in the Community House, the SCM spoke on "The Much Needed Activities on Six Meters." JME demonstrated his new transmitter. ANG will report club activities to the SCM. JC is back on the air. MYY and EZY piled up a creditable SS score for the club. JTM is doing a swell job as recording secretary. ISU recently visited the North Jersey gang. He is on 7- and 3.5-Mc. c.w. ANG became a 20-year man. SVX is rebuilding his 813 final. CO is pounding brass and is an active club member. EKU is the publicity mainstay of the North Jersey gang. EY is club's chief code

instructor. JIB is in the final stages of completing his new rig. GC has converted his BC-312 to a.c. MIG, who operated 30 hours in the Contest, reports one 807 and two 600-volt power transformers lost in action. SNJ received a crystal mike from Santa and hooked it up to his 100 watts on 28 Mc. SX-28A receiver with folded dipole antenna. The Somerset Hills Radio Club held its hamfest, drawing a packed house. ZD is the club president. SOX was speaker at Monmouth County Radio Assn. get-together. LLVQ, of ARRL Headquarters, was speaker at a joint meeting of the Union County Amateur Radio Assn. and the Staten Island Amateur Radio Club. NKD works Cuban and English stations on 7 Mc. HXM worked 3FRY, who claims to be the originator of the QSL card. QJY is on 3.5, 7, and 144 Mc. NIY worked 8KCG/VP2 on 7 Mc. CJX handles traffic from GIs overseas. NGY has a 75 GA Temco and an SP 400X Super Pro. MTV is on 144 Mc. with RK-34 and 955 super-regen. receiver and J antenna. BIM has u.h.f. four-element beam. The Bergen County Amateur Radio Assn. is building up membership. GHV schedules a K7 on 28 Mc. APL is on 235 Mc. LTP holds nightly schedules with EL4AB for traffic. OXL was AUP in Linden. EBR is on 3.5 Mc. with p.p. 807s in final. The Jersey Shore Amateur Radio Assn. issues a club bulletin known as *Meter Beat*. AIW and DIH are 20 Year Club members. BZJ, RM, spoke on traffic handling in the NNJ Net. Others in the Net are: OCC, HEW, 3ABL/2, CQB, PAT, OUS, NCY, NIY, and KTR. The JSARA 28-Mc. net operates on alternate Tuesday nights. BYM is giving code practice. OFM is erecting a tower. EG was CGY. The "TO" Net has BZJ and MLW (alternate) as NNJ representatives. 3JPA/2 is on 7-Mc. c.w.; his DX is TI5 and HC2. BLC is on 28 Mc. and 144 Mc. MUP is club president. GVZ, on 14-Mc. with 100 watts, worked 12 countries. The Irvington Intercity Radio Club meets every Tuesday. The club conducts a code class. PQC is on 14-, 7-, 3.5-Mc. c.w. RXE is on same bands with 75 watts. CGG's receiver is the RME-89 that he won at a prewar UGARA hamfest. EWL worked WAC on 28-Mc. 'phone in less than four hours. HZY schedules XU1YR. Traffic: W2LTP 501, LFR 207, CGG 187, BZJ 67, PQC 50, OCC 45, MLW 41, NIY 25, NKD 20, NWA 19, GVZ 19, CJX 16, HZY 14, APL 12, BRC 11, IIN 8, MIG 3, QJY 2, ANW 1, 73. John.

## MIDWEST DIVISION

**KANSAS** — SCM, Alvin B. Unruh, W6AWP — PAH, the new Section EC, announces he intends to keep essentially the same set-up in the organization of the section as was used prewar. He urges all former Corps members and ECs to write him for reactivation of appointments. And of course he wants to hear from new ones, also. Down Coffeyville way, LQS and his YF announce the addition of a jr. operator to the staff. A YL! YLY is working some choice DX with his 700-watt c.w./grid-modulated 'phone. BPL has T40s final modulated with TZ40s on 3.9-Mc. 'phone, and is building high frequency rig. HEC built mobile converter for 28 Mc. FLZ is using 813 to drive the p.p. VT-127s. EQD also is active on 28-Mc. mobile. GLV built new shack and 28-Mc. 8JK beam. EPX is new ORS and AEC member. ICV has six-element 28-Mc. beam, and is trying to contact old FRC in Germany. He gave a lecture at the club meeting on tuning beams, and new three-element beams sprang up around Topeka like mushrooms. DJL has crystal-controlled 144-Mc. rig. UNQ has beautiful four-element 28-Mc. rotary, and QMB has new three-element rig almost done. BCY, DMF, and DJL had ham station at Boeing Hobby Show. Drop us a line. 73. Abie.

**MISSOURI** — SCM, Mrs. Letha A. Dangerfield, W6OUD — A number of fine letters were received from which we sifted the following operating news: Ex-9CCZ, now 7JUP in Vancouver, Wash., is on 28- and 3.9-Mc. 'phone. ENP got his call after moving from Ohio and has applied for ORS renewal. YHZ received OPS appointment, and now is on 11 Mc., which he finds fairly active. CRM, who was invalidated by a heart attack three years ago, is running 75 watts to a pair of 807s on 7 Mc. JWW is having a little harmonic trouble. OWQ had her rig ready to go when she left home to take a position as dormitory hostess at Christian College. She has a receiver with her but no time for transmitter. GBJ spends his time hunting DX and did nicely in the SS Contest. Ex-9OFB, now 5AZO in Oklahoma City, is on 7 Mc. every evening. HPK uses a 6L6 Pierce to

(Continued on page 34)

# BLILEY AX2

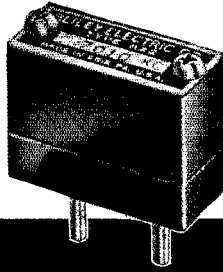

*First for amateur frequencies*

## TINKERING WITH THE TRI-TET

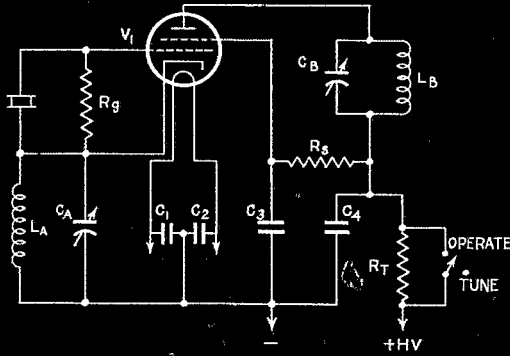

$V_i = 6V6, 7C5, \text{ etc.}$   
 $R_s = 12,000 \text{ ohms}$   
 $R_g = 25,000 \text{ ohms}$   
 $R_T = 3,000 - 6,000 \text{ ohms}$   
 $C_A$  - See table  
 $L_A$  - See table  
 $C_1, C_2, C_3, C_4 = .005 - .01 \text{ mf}$

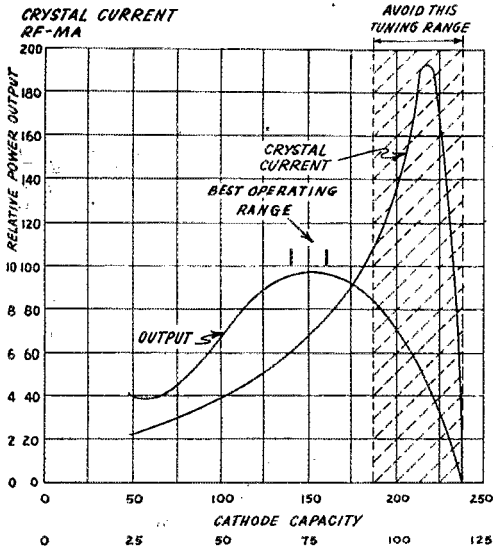

The Tri-tet crystal oscillator can be a source of pride and joy—or it might be a first-class rock crusher. This has been discussed in many articles over the past years. Completely satisfactory performance, without casualties, can be obtained if you:

1. Use reduced plate and screen voltages when you tune up and whenever you change the cathode tank tuning.
2. Always tune from the low C side until maximum output is obtained. See curve shown on this page and avoid cross-hatched danger zone.
3. Unless you have a well screened tube such as an 802, never use a Tri-tet for straight through operation without shorting out the cathode tank. Use a switch, not a bent plate on the cathode condenser. Tuning through full capacity to short out the cathode circuit by means of a bent condenser plate takes the tuning through the danger zone.

FOR 80 $\lambda$  CRYSTAL - 40 $\lambda$  OUTPUT

FOR 40 $\lambda$  CRYSTAL - 20 $\lambda$  OUTPUT



CRYSTAL FREQ	*L <sub>A</sub> $\mu$ h	1/2" DIAMETER COIL SPEC	C <sub>A</sub> mmf	OUTPUT FREQ
80 $\lambda$	4.0	10 TURNS - #18 E CLOSE WOUND	250	40 $\lambda$
40 $\lambda$	2.0	6 TURNS - #18 E 5/8" COIL LENGTH	125	20 $\lambda$
20 $\lambda$	1.0	3 TURNS - #18 E 1/4" COIL LENGTH	60	10 $\lambda$

\* CATHODE INDUCTANCE

BLILEY ELECTRIC COMPANY • UNION STATION BUILDING, ERIE, PENNSYLVANIA



**WHEN YOU NEED A  
PAPER TUBULAR FOR YOUR  
RIG, SPECIFY MALLORY  
FOR DEPENDABILITY**

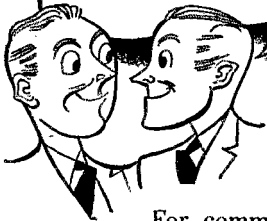

For communication work you need the best. Failure takes you off the air, and it may result in damage to other valuable components. That's why experienced communication engineers specify Mallory T P Condensers. They give an added margin of safety, but they cost no more.

And here are the reasons why Mallory T P Condensers last longer:

1. Better impregnation eliminates moisture absorption
2. Better sealing produces longer life
3. Better quality control during manufacture produces longer life

You can find the size and value you want in the Mallory Approved Precision Products Catalog. No other manufacturer's line is more complete. Order from your Mallory distributor.

**P. R. MALLORY & CO., Inc.**  
INDIANAPOLIS 6 INDIANA

**P. R. MALLORY & CO. Inc.**  
**MALLORY**

(Continued from page 92)

drive an 807. CU is building an e.c.o. for his all-band kilowatt rig. QXO again made highest traffic score. KIK ran into trouble trying to rebuild power supply for SS Contest and made only nine contacts. DEA applied for ORS and OBS renewals; he relayed three messages on 7 Mc. GCL worked twenty stations the first week end of SS Contest, using 807, but missed the second week end. EYM had antenna trouble from high winds. QJP says a number of the fellows in the Joplin area have a round table on 28-Mc. 'phone almost every night. OUD still is working on the Missouri traffic net on 3755 kc. at 7 p.m. nightly. The net needs more operators and more traffic. Traffic: W8QXO 80, KIK 30, CRM 14, OUD 8, DEA 8, EYM 3.73 and HNY to all.

NEBRASKA — SCM, Roy E. Olmstead, W8POB — Was certainly surprised to learn that I had been nominated (and elected) as your SCM. My first thought is to express the thanks and appreciation of all Nebraska amateurs to Art Gaeth, W8FQB, for the superb management and service he has given us during the past term. BQP is working on 3.5 and 14 Mc. and wants traffic. TRE is active on 7 Mc. ESX has new NC-240D and an 807 on 7 Mc. MLB, SEC, wants used receiver. EWO says DDT is no good for bugs in his rig. JYJ is on 29-Mc. f.m. 'phone. GTC owns new SX-42. YKT transferred to Cleveland. FQB's 28-Mc. beam was KOed by wind, and was replaced with 7-Mc. doublet. The Ak-Sar-Ben Radio Club elected FQB, QXR, EKK, and VHS as officers for '47; KBS, after service in the merchant marine, is planning ham activity with AR-88 and ART-13; DNW is active with pair of 24Gs. GPX has new HT-9 rig. EXP is erecting novel 14-Mc. beam. COU has WAA rig. BIW's 28-Mc. rotary still is grounded. SAI is active on 7 Mc. TMK put DB-20 ahead of his Howard receiver. OHU swapped his multi-crystal exciter for an e.c.o. UBN is rebuilding. RQK is doing FB job reporting from North Platte sector. DLX and LWV are about to push switches on rigs. YLC is home from war work in Washington. GBK is active on 7 Mc. at Hastings. Several section appointments have expired and will be cancelled if not returned for endorsement. For the present the State Net is 3745 kc. at 8:00 CST. TQD will act as net control and handle your traffic. Traffic: W8TQD 366. "Pop".

#### NEW ENGLAND DIVISION

CONNECTICUT — SCM, Edmund R. Fraser, W1KQY — RM VB has the Nutmet Net operating smoothly. Stations are needed in Stamford, New Britain, Waterbury, Wallingford, New London, Bristol, and Norwich. Club News: SARC: PLI is on 7 and 144 Mc. Corliss has an HRO and a TR-4. OGQ, EC, has FSY, OGS, AZP, KPN, KBZ, BRL, and NWQ assisting him in Red Cross weekly drills. BARA: ACV, now FC, runs a kw. into 4-125As. OPG completed buffer and 854 final. NHARA: 1PHX and 2PHX visited KAT. JHN's new antenna works fine. AMM is starting new code and theory classes. FMV operated GB during the SS. NARL: DXT reports the club now is an ARRL affiliate. AVN, EC, requests cooperation of Newington hams. General news: CTI is building a 10 x 14 shack in the basement. FSH has new Meissner transmitter. DJC and KQY worked XU6GRL, ex-W8GRL, in Nanking. KKS reports: KV4AD and HB9BG visited AW. MHF has a new shack, SX-25, and Millen exciter. ERY has an 812 on 3.5 Mc. PDZ is using p.p. 812 final and two-element beam on 28 Mc. DJC is using cathode modulation with p.p. 616s on 14 and 28 Mc. IJO is building a kw. EJT has 250TH on 14 Mc. DAV and LMK are having private DX contest. FVF has new HRO 5TA. BAX is on 7 Mc. KKS has 37 countries on 28 Mc. with 30 watts. JTD has 210 Hartley on 3.5 Mc. OND has two-element beam on 28 Mc. BEQ WACed in four hours on 28 Mc. 'phone with his XYL, NJJ, at the mike. 2AMD/1, EPC, EME, and ATE are on 14 Mc. 'phone. KAK, BPY, KHM, and PHE are on 28-Mc. 'phone. The Screwball Net (NNQ NCS) is active from 10 to 11 nightly on 28 Mc. ABU has two-element beam building p.p. 813s for 28-Mc. 'phone. HVF has over sixty countries postwar with kw. on 14 Mc. The Manchester Radio Club meets at the YMCA every other Monday night. EDL and ITI have new Super-Pro receivers. SGS has three-element beam on 28 Mc. JPB has kw. on 14 Mc. LXX is on 28 Mc. with 15 watts. FTX is working DX on 14 Mc. JJR has new v.f.o. FVF has HRO 5TA and multivibrator. Former Navy

(Continued on page 93)



# Why DX is EASY with TEMCO TRANSMITTERS

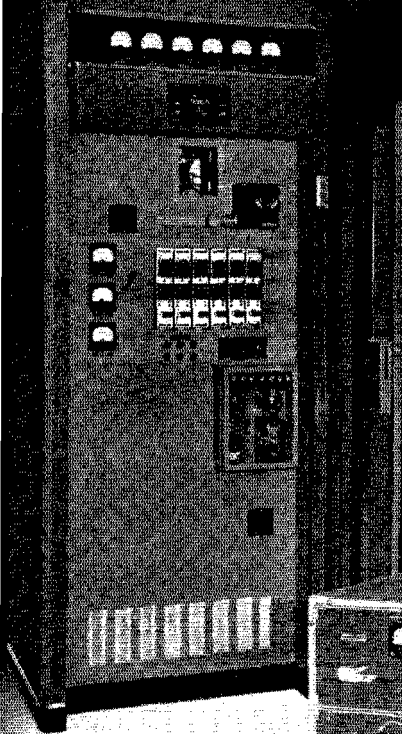

A.

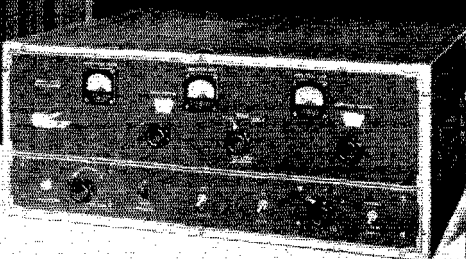

B.

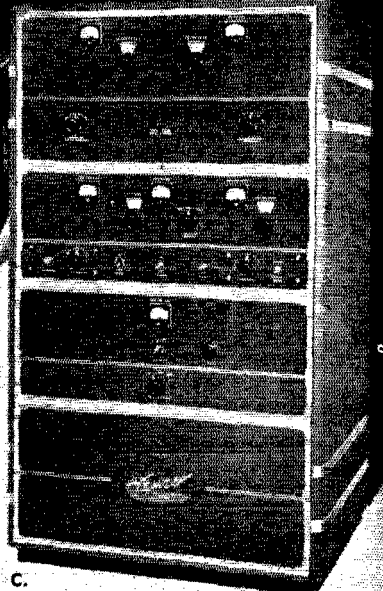

C.

TEMCO TRANSMITTERS are top notch DX performers and here are the important reasons why. Every amateur knows that power input does not govern the DX capabilities of a transmitter . . . power output is the determining factor. That's why Temco stresses engineering for higher circuit efficiency — to assure maximum power output for every power input rating — and every Temco is conservatively rated.

Frequency flexibility is another reason, for, every Temco features a VFO with crystal-like stability always enabling you to find a spot for a QSO no matter how congested the bands may be. And the distinctive, clear-cut, clickless keying of a Temco assures a fine signal for the CW operators.

Add to this, strength and stability of the carrier . . . freedom from hum and spurious radiations . . . complete absence of splashing and you have additional reasons why Temco Transmitters pull in the DX everytime you tune over the band.

Let these reasons be your reasons for selecting a Temco and then settle down to a lifetime of "fine business" and R-9 pluses.

- A. 1000-J6 For point-to-point commercial service featuring Temcomatic Instantaneous Frequency Selection. You turn the switch . . . the Temco does the rest, 1 KW output.
- B. 75-GA Amateurs have already reported WAC on phone with this mighty little powerhouse of the air waves.
- C. 500 GA Originally underrated at 750 watts input. Actually performs at a conservative 1 KW input . . . a bonus of 250 watts at no extra cost



TRANSMITTER EQUIPMENT MFG. CO., INC.  
348 HUBBARD STREET NEW YORK, N.Y.

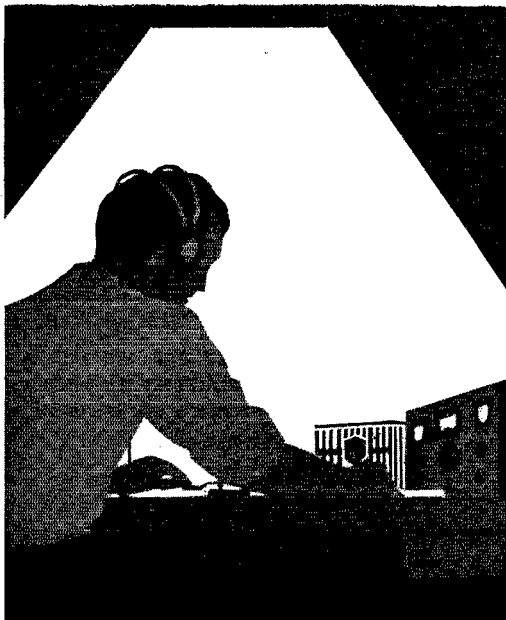

**PREFERRED  
BY ENGINEERS**

# BURGESS BATTERIES

**RECOGNIZED BY THEIR  
STRIPES • REMEMBERED  
BY THEIR SERVICE**

(Continued from page 94)

radio men, interested in maintaining their rates and advancement, are invited to join the organized Naval Reserve unit of Hartford. Members are paid for each weekly drill attended aboard the USS LST 722. Navy communication equipment is available and a Navy network is planned. There are two week-end cruises per year with full pay and allowances. If you are a Veteran of World War II and interested in your Navy whether a licensed amateur or not, communicate with John M. Murray, W2AMD/1, 47 Keeney Ave., West Hartford, stating your experience and rate. Traffic: WIUE 413, VB 295, EFW 197, KQY 148, JMY 104, CTI 66, DAV 64, ORP 52, AW 48, NJM 47, LOP 35, AFB 28, AMQ 27, OS 17, TD 9, IC 8, BHM 8, BIH 6, CJA 6, ITI 5, GB 5, 73. Ed.

**MAINE** — SCM, G. C. Brown, W1AQL — The U. of M. Radio Society has been revived with a fine membership of twenty-five, ten of which are licensed operators. MBL has been elected president of the club. EZR reports that AWC and CPS are engineers at WAGM, Presque Isle; COM is engaged in radio sales and service, assisted by COV; the Lewiston-Auburn Club has joined the League; KTT is on 3.5- and 28-Mc. 'phone. IST works DX on 7 Mc. with 6L6. A nice letter was received from LIP, now located with the Magnavox Company in Fort Wayne, Ind. Bob says he is planning a 28-Mc. mobile job. LKP still is interested in making schedules during the afternoons. AI is busy these days servicing oil burners. BCU recently visited the XYL's folks in Canada. FQ is back with the New England Tel. & Tel. Co. and has a position on the staff of the Eastern Division. ERO was a visitor in Brewer recently. BLF is on 14-Mc. 'phone. We are pleased to report that MAW has returned home from the sanatorium and is much improved in health. EZR visited OHT recently. If present plans materialize you will have a new SCM in the near future. GKJ, Old Orchard, has consented to be a candidate for the job. Your present SCM wishes to thank all of the gang who were so cooperative in making it possible to have a worthwhile Maine Section. Best of everything to all of you. Traffic: W1MXT 9, LKP 6, 73. "G.C."

**EASTERN MASSACHUSETTS** — SCM, Frank L. Baker, jr., W1ALP — New ORS: LML and CCF. AAR, WI, and HA renewed ORS appointments. KTG and KYX are carrying on as ECs. The following have been issued new Section Net certificates in the Eastern Mass. Net: KZT, EPE, FGT, EMG, OUD, JYJ, KJU, JCK, BDU. Ex-2CLM has new call, 1CLM. Ex-5FKV now is PMJ. 5GFR is on 28 Mc. FJA and OBY are on 3.9-Mc. 'phone. HB9BG was a visitor at the Eastern Massachusetts Club meeting. PMD and JLR are on 144 Mc. DFS/2 is on 3.9-Mc. 'phone. PFQ and HYK are on 28 Mc. Louis Giovanini now is PJB. Ex-3HJG, now 1PKW, is on 3.5 and 7 Mc. FDN applied for ORS appointment. Ex-8HMJ, now 1PLX, gave a talk before the EMC on crystals. ONZ is on 14-Mc. c.w. and 28-Mc. 'phone. He has a new four-element beam on 28 Mc. JXU has a Workshops beam on 28 Mc. OJM made 344 contacts the first week of the SS Contest. New officers of Yankee Radio Club: NLU, pres.; NVB, vice-pres.; AMT, treas.; LQQ, secy. CTW gave a talk before the Brockton Amateur Radio Club. OEK is on 144 and 3.5 Mc. Ex-9JSU now is PFK on 144 Mc. NXJ is working on 144-Mc. crystal job. KYX is on 7-Mc. c.w. and 144 Mc. AAR and MON want to get a net going on 28 Mc. in New England. KTG is working DX. The T-9 Radio Club had a Christmas Party at IBF's. AR, JLK, JXU, JCX, and MZF renewed OPS appointments. Deke is on 144 and 50 Mc. with explorations into the 220- and 400-Mc. bands, and has applied for OES appointment. FVD is building a rig for 28 Mc. LZL and MMY have a rig on 1 1/4 Mc. PMM and PIM are on 144 Mc. WI gets on 7 Mc. week ends. MRQ worked two new countries and 53 sections in SS Contest. FDN, new ORS, is open for reliable traffic schedules on 3579 kc. for Middlesex County. KKJ has schedules in Maine from 5 to 7 p.m. MDV has several in Maine, New Hampshire, and Vermont. OUD worked VK2LC on 3.5-Mc. c.w. LML and CCF are operators on Trunk Line "C," now operating from Maine to Florida, Mondays through Fridays. MNK is on 7 Mc. BBL is on 14- and 7-Mc. c.w. GOU renewed OPS appointment and is working 27 and 28 Mc. OEK is Taunton EC. HIL renewed OPS and EC appointments and is PAM for 28 Mc. OUD is RM for 7 Mc. KB renewed EC appointment. HPC is in the TLAP Net. KTE reports the Parkway Radio Club meets the 2nd and 4th Thursdays at Fedelia

(Continued on page 98)



Send the good wife a valentine . . . show her that romance still lives . . . and make this February memorable! Then, if you'd like to do something a little more practical to make the XYL happy, modernize the family phonograph with a new Astatic Pickup Arm.

Hams, as a rule, like things to operate smoothly, and if the phonograph is "off color or acting up," Astatic's new Model Nylon-508 Pickup, equipped with the very latest Nylon 1-J Cartridge may not alone enhance the appearance of your set but improve, appreciably, the fidelity of reproduction. See your Radio Parts Jobber or write for literature.

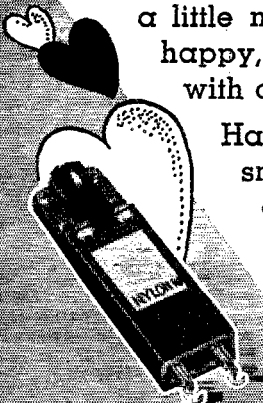

Nylon 1-J Crystal Pickup Cartridge with matched Nylon Chuck and Sapphire-tipped, replaceable Nylon Needle.

Astatic Crystal Devices manufactured under Brush Development Co. patents.

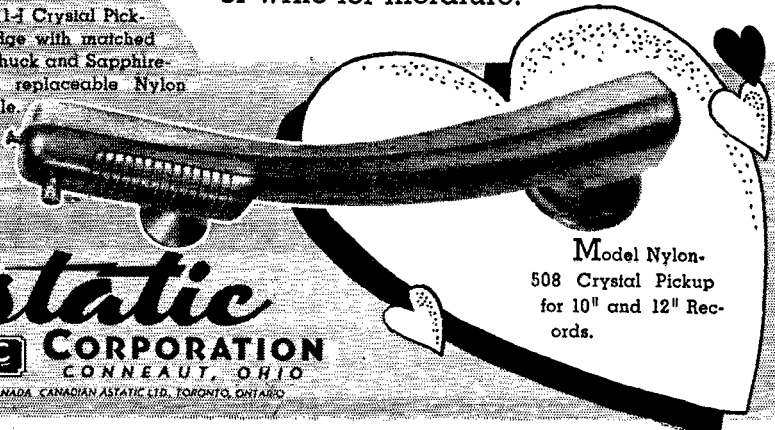

Model Nylon-508 Crystal Pickup for 10" and 12" Records.

**THE Astatic CORPORATION**  
 CONNEAUT, OHIO

IN CANADA: CANADIAN Astatic LTD., TORONTO, ONTARIO

# Now—Plan for a Good-Paying Career Job in TELEVISION



New CREI Home-Study Course in Practical

## Television ENGINEERING

Be in a position to command a "key" job in the growing TELEVISION Industry by preparing now with the type of thorough, practical TELEVISION Engineering training that the industry requires. The new CREI TELEVISION Engineering course is (1) A complete well-coordinated course of study that covers the entire field of practical TELEVISION Engineering, (2) Presented in CREI'S professional and proven home study form, (3) Prepared by CREI'S experienced staff, based on actual experience in our own TELEVISION Studios and Laboratories, plus years of close contact with leaders in television development. Here's your opportunity to be prepared for television well ahead of competition, if you start NOW!

**JUST OFF THE PRESS! MAIL COUPON FOR COMPLETE FREE DETAILS AND OUTLINE OF COURSE**



If you have had professional or amateur radio experience and want to prepare for opportunities in TELEVISION, let us prove to you we have the training you need to qualify. To help us intelligently answer your inquiry — PLEASE STATE BRIEFLY YOUR BACKGROUND OF EXPERIENCE, EDUCATION AND PRESENT POSITION.

CAPITOL RADIO ENGINEERING INSTITUTE  
Dept. Q-2, 16th & Park Road, N. W.  
Washington 10, D. C.

Q-2

Gentlemen: Please send me FREE BOOK describing the new CREI home study courses in Practical Television Engineering. I am attaching a brief résumé of my experience, education and present position.

NAME.....  
STREET.....  
CITY.....ZONE.....STATE.....  
OCCUPATION.....

I am entitled to training under the G. I. Bill.

(Continued from page 98)

Hall, 7 Rockland St., West Roxbury. The station, HOB, is on 3.9-Mc. 'phone with 250 watts. OWM and PNH are on 144 Mc. KTE has TR4. 6KA sold BB the idea of rotary beams. DJ is getting back on 50 Mc.; sky hook is up. NXY has coaxial receiver on 144 Mc. OAI has a pipe receiver. MRK and MME are back as OPS. MTQ is ORS. MRQ applied for OPS appointment. JXU also is PQA in Derry, N. H. Ex-5JLO now is 1POL. PNK is new ham in Weymouth. KTU is new ORS. Newton hams had an EC drill with these taking part: HPC, LIO, DMU, FVL, and LMU. LMU has a new NC-200 and AGR a new HRO. OKB is on 3.5 Mc. PIJ is a new ham in Arlington. HQY has new sixteen-element beam. Traffic: (Oct.) WICCF 16. (Nov.) W1BDU 200, CCF 103, OUD 95, LML 37, EMG 35, KKK 35, MDV 30, EPE 27, BB 17, LM 17, OEK 11, HPC 10, JDP 9, HIL 7, FDN 5, HWE 3, LXQ 2, MNK 2, ALP 1, LLL 1, OJM 1.

WESTERN MASSACHUSETTS — SCM, Prentiss M. Bailey, WIAZW — RM; BVR. SEC: BJSJ. Our SEC, BJSJ, has his ECs all lined up and it looks like an FB organization. CKJ is EC for Hampden County; LUD covers the Pittsfield area; NGH handles Hampshire County; BIV takes in Gardner and vicinity. BVR still is doing a nice job of NCS of West. Mass. Net and also takes a crack at NCS for the N.E. Net. He has an 8-40 as a standby receiver and an HT-6 to excite his final. BIV reports he still has some bugs in his 'phone rig. He is new OPS. NKN has new Vibroplex — a Christmas present from the XYL. JAH has nice sounding 'phone. He has heard G2PU on 3780-kc. 'phone but couldn't raise him. EOB went all out in SS Contest but cold WX will curb activities as operating the rig in the attic is rather chilly. COI did some long-haul traffic work. He took a message from KA1SS, telephoned it to destination, and had the answer back to KA1SS, all in a half hour. JLT has over forty countries postwar. JGY is new ORS. LUA again is ORS. JLT, BKG, and AZW lead in the Pittsfield Radio Club WAS Contest. The Pittsfield Radio Club station, OSA, is on the air. The 144 Club of Springfield pulled off another emergency drill with great success. NY is 3.5-Mc. tie-in, relaying messages to Hartford and Pittsfield. BJSJ sends in plenty of news. PDF has new Premax three-element beam for 28 Mc. installed like an "amateur's dream." MBT has worked the world with 175 watts and a "Folded Dyer" but still is not satisfied and is rebuilding for 500 watts. CJK is not having too much luck with 40 watts on 28 Mc. so is dreaming up a kw. rig. ESG is active on 3.5-Mc. c.w. BJSJ was copied in England with 12 watts and "plumbers delight." OPA takes a crack at all the 'phone bands with great success. AZW worked HP2CA on 3552 kc. Traffic: W1BVR 44, IHI 34, JAH 24, AZW 22, NY 12, JGY 8, BIV 5, COI 5. *Prent.*

NEW HAMPSHIRE — SCM, John H. Stoughton, W1AXL — Well gang, we waited until the last day before sending our report in. We received one report, GTY is on 7.1 Mc. and expects to be on 28 Mc. soon. That's all there is. There is no more. No reports from you means no activities report in QST.

RHODE ISLAND — SCM, Clayton C. Gordon, W1HRC — 5BKH/1 now is 1AJQ. MKK worked G6BY cross-band. MKK is on 3.9 Mc. and G6BY is on 7 Mc. Power used — 125 watts input. CPI worked G2PU on 3.9-Mc. 'phone and claims it is the first 3.9-Mc. 'phone contact between our two countries since the war. He has a stacked six-element 28-Mc. array nearly completed. ALJ is doing an excellent job on 28-, 14-, and 3.9-Mc. 'phone with Harvey 1-kw. rig. He rates with the South County gang as an expert on antenna calculations and crystal-grinding. FOV is very active on 14-Mc. 'phone running 900 watts to a beam and is rated a "real DX hound." BXZ is active on 28-Mc. 'phone and is doing a good job. He is being urged by those in the know to put up a rhombic, since his location is exceptional for it. The above news came through the helpfulness of CPI, who has been made the official correspondent for South County. MIJ now is on 144 Mc. with HY-Q-75 oscillator and S reports and stability have gone away up. DWO has been trying out several new e.c.o. circuits. QR still is receiving fine compliments for his work in the traffic nets. INU wants to work a lot of traffic schedules if he can get them. Traffic: W1QR 17, DWO 13.

VERMONT — SCM, Gerald Benedict, W1NDL — PAL has a new jr. operator who arrived the 13th of November. MMU got 4-5 report from England with 25 watts on 3.9-

(Continued on page 108)

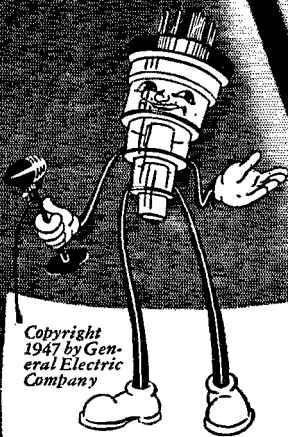

Copyright  
1947 by General Electric  
Company

## KEN-RAD Radiogram

### Lighthouse Larry Comments:

HERE'S an interesting slant for users of metal tubes: . . . Judging from mail received, the average ham is exceedingly anxious to get the most out of his present receiver. This can be done by feverishly plugging tube after tube into the set until satisfactory results are secured—but why go about things the hard way? . . . For example, is the 6AC7/1852 metal tube better than the 6SK7? Let's take a close look. The r-f stage in your receiver undoubtedly uses a remote-cut-off pentode. This means, in most cases, a 6SK7 or 6K7. A lot of us have replaced these tubes with a 6AC7/1852 and been overjoyed to find we hear more signals. Fine business—but what actually has been changed? For one thing, a 6AC7/1852 is a sharp-cut-off pentode, definitely not what we want in the r-f stage. Probably the apparent increase in signals was due to cross-modulation, not to more sensitivity. Signals which formerly were separated, now arrive on the same frequency. A-y-c action also probably is out of kilter, again due to the sharp-cut-off tube.

Reference to the diagram will explain this better. Let's assume you are receiving a moderately weak signal. Tube operation then would be at point "A" for most tubes. The few microvolts' input from the signal causes this point to remain relatively fixed. Suddenly, on comes that new ham next door with his kw-rig, and only 100 kc away from where you are tuned! This local signal now is impressing *volts* on your defenseless r-f tube. Modulation of this local signal causes your r-f tube to operate back and forth on its respective operating line.

With a 6SK7, if operation is from "A" to "B", tube action is linear, as may be seen from the straight line on the graph. In the case of the 6AC7/1852, a much different effect takes place. As soon as grid voltage tries to swing from "A" toward "B" the tube becomes completely cut off, distortion takes place, and cross-modulation has become a new annoyance in your receiver.

Well, then—how about using a 6AB7/1853? This looks like a better choice, and one I'll discuss later. . . . Meanwhile, remember I'm at your service to help you with any special data you may wish about Ken-Rad's *value-giving* line of metal tubes for amateurs!

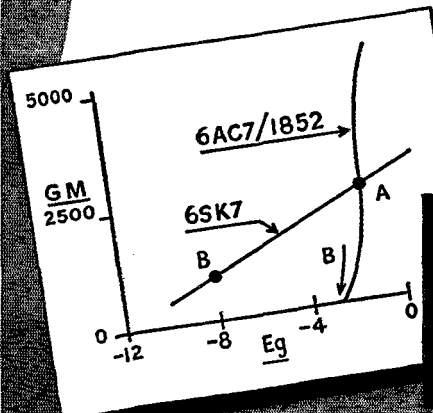

*Lighthouse Larry*

176-FE-8850

# KEN-RAD

DIVISION OF GENERAL ELECTRIC COMPANY  
OWENSBORO, KENTUCKY

Make the nearest Ken-Rad distributor or dealer your preferred source for amateur tubes

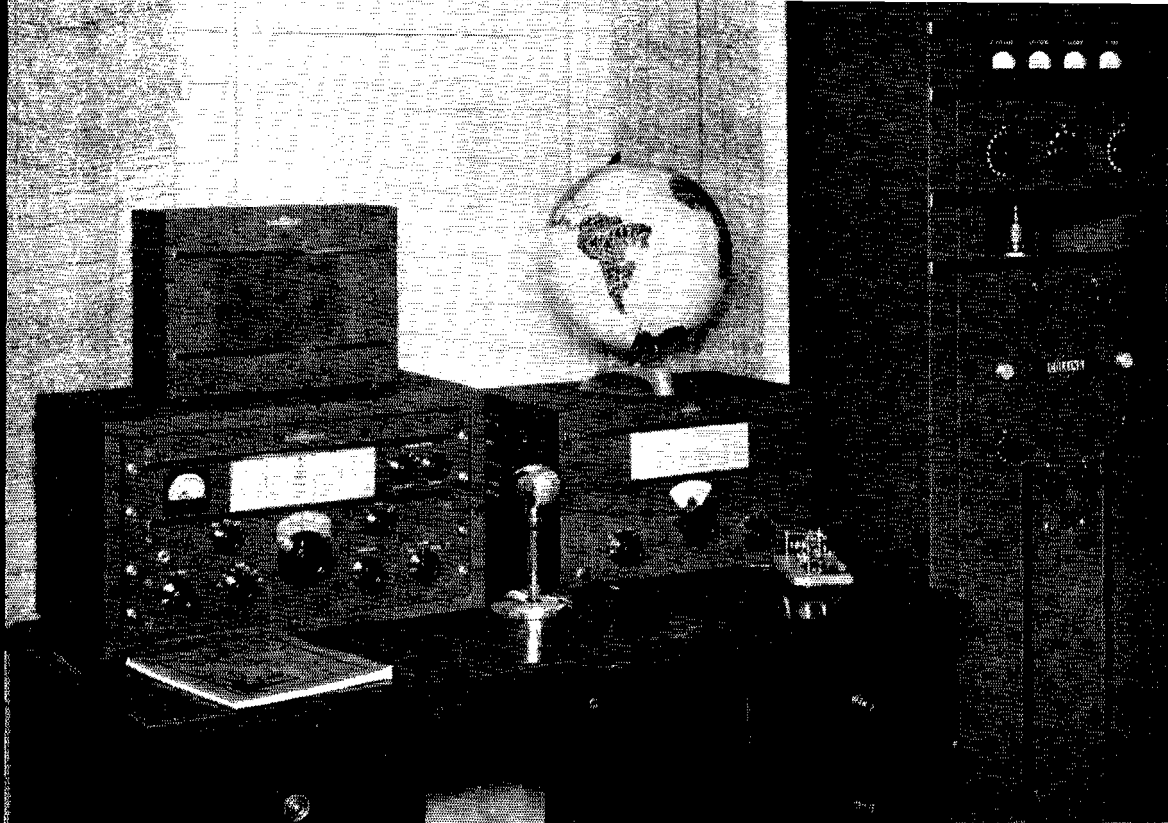

# The world is at your fingertips with Collins ....

Snap on the filaments, settle yourself at the controls, and enjoy a most satisfying world tour—by radio. Listen to the musical CQ from Latin America, the cheerful hello from Canada. Hear the eagerness in the voice of the American operating portable from Casablanca or Tinian. Maybe you're searching the DX bands for the G4—or was it an HB9—that you used to work every Saturday. Or perhaps your next door neighbor wants to send a message to his aunt in Phoenix.

Sharpen up the incoming signal you've selected on the Collins 75A receiver. You have a crystal filter that you can adjust with ease. The r-f gain control does not affect the pitch of a cw note. And the receiver is so stable that line voltage fluctuations—or the slam of a door—will not require frantic retuning to find the signal again.

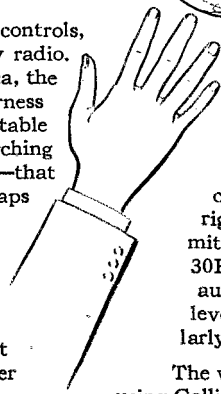

Even under adverse conditions your reception will be better with the 75A. Then switch the Collins 30K transmitter to the Operate position and you're on the air. Use either fone or cw. You can change frequency quickly if you desire. The permeability tuned oscillator (PTO) controlled exciter—the Collins 310A—sits right on the operating desk. Both transmitter and exciter are bandswitching. The 30K transmitter has a speech clipper in the audio circuit to keep the modulation at a high level. Notice how it helps your signal, particularly in QRM or QRN.

The world is truly at your fingertips when you're using Collins equipment. Write for illustrated bulletins describing Collins ham gear.

FOR BEST RESULTS IN AMATEUR RADIO, IT'S

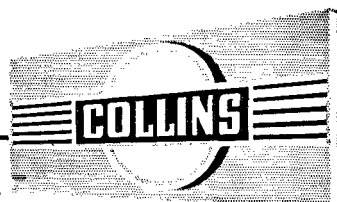

**COLLINS RADIO COMPANY, CEDAR RAPIDS, IOWA**

11 West 42nd Street, New York 18, N. Y.

458 South Spring Street, Los Angeles 13, California

# Order Your Collins Ham Gear From These Dealers

(Additional dealers will be announced as they are appointed)

## CALIFORNIA

Electrical Supply Co.  
149 12th Street  
Oakland  
Sacramento Electric Supply Co.  
711 Capitol Avenue  
Sacramento  
Frank Quement  
146 W. San Fernando Ave.  
San Jose  
Henry Radio Co.  
2331 Westwood Blvd.  
Los Angeles  
Kierulff Co.  
828 W. Olympic Blvd.  
Los Angeles  
Radio Television Supply Co.  
1509 S. Figueroa Street  
Los Angeles  
Zack Radio Supply Co.  
1426 Market Street  
San Francisco  
San Francisco Radio Supply Co.  
1284 Market Street  
San Francisco

## COLORADO

Radio Products Sales Co.  
1237 16th Street  
Denver

## CONNECTICUT

Hatry & Young  
203 Ann Street  
Hartford  
1172 Chapel Street  
New Haven  
363 Bank Street  
New London  
542 E. Main Street  
Bridgeport  
89 Cherry Street  
Waterbury  
525 Main Street  
Stamford

## DELAWARE

Radio Electric Service Co. of Penn.  
219 W. Eighth Street  
Wilmington 22

## GEORGIA

Henry L. Reid Co.  
1103 Peachtree St., N. E.  
Atlanta  
Geer's Appliance Service Co.  
Colquitt  
Damascus  
Edison

## ILLINOIS

Allied Radio Corporation  
833 W. Jackson Blvd.  
Chicago  
Newark Electric Company  
323 W. Madison Street  
Chicago  
Tri City Radio Supply  
1919 4th Avenue  
Rock Island

## INDIANA

Van Sickle Radio Supply Co.  
34 W. Ohio Street  
Indianapolis

## IOWA

Iowa Radio Corporation  
1212 Grand Avenue  
Des Moines  
World Radio Laboratories  
744 W. Broadway  
Council Bluffs

## KENTUCKY

Universal Radio Supply  
715 So. 7th Street  
Louisville

## LOUISIANA

Radio Parts, Inc.  
807 Howard Avenue  
New Orleans  
Interstate Electric Co.  
Shreveport

## MARYLAND

Wholesale Radio Parts Co., Inc.  
311 W. Baltimore Street  
Baltimore

## MASSACHUSETTS

Radio Shack  
167 Washington Street  
Boston  
Hatry & Young  
42-44 Cornhill  
Boston  
639 Essex Street  
Lawrence

## MICHIGAN

M. N. Duffy & Co.  
2040 Grand River  
Detroit

## MINNESOTA

Lew Bonn Company  
1211 La Salle Ave.  
Minneapolis  
506 Robert Street  
St. Paul  
228 E. Superior St.  
Duluth

## MISSISSIPPI

Cabell Electric Company  
422 So. Farish Street  
Jackson

## MISSOURI

Henry Radio Shop  
211 No. Main Street  
Butler  
Walter Ashe Radio Co.  
1125 Pine Street  
St. Louis

## NEBRASKA

Leuck Radio Supply  
243 So. 11th Street  
Lincoln

## NEW HAMPSHIRE

Evans Radio Company  
8 No. Main Street  
Concord

## NEW JERSEY

Aaron Lippman & Co.  
246 Central Avenue  
Newark  
Radio Electric Service Co. of Penn.  
513-15 Cooper Street  
Camden

## NEW YORK

Harrison Radio Corp.  
12 W. Broadway  
New York  
Harvey Radio Co., Inc.  
103 W. 43rd Street  
New York  
Newark Electric Company  
115 W. 45th Street  
New York  
Masline Radio & Electronic Equip-  
ment Co.  
192-196 Clinton Avenue No.  
Rochester  
E. E. Taylor Company  
465 Central Avenue  
Albany

## NORTH CAROLINA

Johannesen Electric Co., Inc.  
312-14 No. Eugene Street  
Greensboro  
Southeastern Radio Supply Co.  
411-15 Hillsboro Street  
Raleigh

## NORTH DAKOTA

Fargo Radio Service  
515 3rd Avenue  
Fargo

## OHIO

Progress Radio Supply Co.  
413-15 Huron Road  
Cleveland  
Hughes Peters, Inc.  
101 E. Long Street  
Columbus  
725 So. Main Street  
Dayton  
The Mytronic Company  
121 W. Central Pkwy.  
Cincinnati

## OKLAHOMA

Radio Electronics  
1032 E. Broadway  
P. O. Box 708  
Enid  
Radio Supply, Inc.  
724 No. Hudson Street  
Oklahoma City

## OREGON

United Radio Supply Co.  
22 N. W. 9th Ave.  
Portland

## PENNSYLVANIA

Radio Electric Service Co. of Penn.  
701 Arch Street  
Philadelphia  
1042 Hamilton Street  
Allentown  
Cameradio Company  
963 Liberty Avenue  
Pittsburgh

## TENNESSEE

Chemcity Radio & Electric Company  
12 Emory Parkway  
Knoxville  
Bluff City Distributing Co.  
905 Union Avenue  
Memphis

## TEXAS

Wilkinson Bros.  
2406 Ross Ave.  
P. O. Box 1169  
Dallas  
Electronic Equipment & Engineering  
Co.  
1310 So. Staples Street  
Corpus Christi  
R. C. & L. F. Hall  
1015-17 Carolina St.  
Houston  
2123 Cedar Springs Ave.  
Dallas  
1803 Fremont St.  
Galveston  
961 Pearl St.  
Beaumont

## UTAH

Radio Supply Company  
45 E. 4th South Street  
Salt Lake City

## VIRGINIA

Radio Supply Company  
711 Granby Street  
Norfolk  
3002 W. Broad Street  
Richmond

## WASHINGTON

Northwest Electronics Co.  
North 104 Monroe Street  
Spokane  
Western Electronic Supply Co.  
2609 First Avenue  
Seattle

## WISCONSIN

Radio Parts Company  
536 W. State Street  
Milwaukee

## WEST VIRGINIA

King & Irwin  
316 11th Street  
Huntington

# SILVER

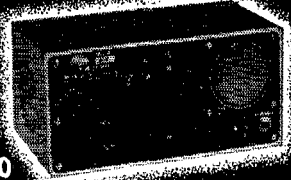

## MODEL 800 U. H. F. RECEIVER

E. P. Hilton's Feb., 1946 QST non-radiating super-regenerative receiver — with inductive tuning and 88" of bandspread for 144-148 and 235-240 mc. bands. Built-in PM speaker and VR tube. Big home station performance in portable-mobile size.

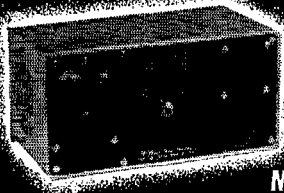

## MODEL 700 U. H. F. XMITTER

Only 5" x 10" x 5 1/4", new "ATOM-X" construction. Xtal controlled output at 144-148 and 235-240 mcs. Built-in 14-watt modulator, four plate current indicators. Long line push-pull 832 final. Matches Model 800 to make ideal home-station or mobile rig.

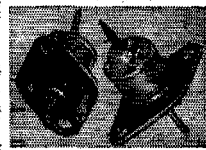

## HI-Q AIR CAPACITORS

Good to 500 mcs. Compact, efficient, light. Ideal for trimming or tuning in high quality circuits. 3-30 uufd. in 1080 rotation. With phenolic mounting plate only \$.30 net.

Send postcard for catalog of new measuring equipment, communication receivers, transmitters, kits, parts. See them at your favorite jabber.

OVER 35 YEARS OF RADIO ENGINEERING ACHIEVEMENT

*McMundo Silver Co., Inc.*

1240 MAIN ST., HARTFORD 3, CONNECTICUT

(Continued from page 98)

Mc. 'phone. FSV has new Navy type frequency meter. NWW has new 28-Mc. antenna fed with coaxial cable. NDJ has NC-200. 73. Jerry.

## NORTHWESTERN DIVISION

**ALASKA** — SCM, August G. Hiebert, K7CBF — The Anchorage Amateur Radio Club now has its own room in the News Building, 3rd and F Streets. CX donated an NC-100A. Ralph Walker and CA have the rig ready to go as soon as the station license is issued. At the last meeting EU was named to the program committee, replacing BH. Movies from the Kuskoquim were shown by EU. AJ, secretary, has married GVG. BD reports a new 813 in the final at Moses Point. Stateside DXers should watch 28 and 14 Mc. for the following Adak amateurs: BP, DM, 1JNK, 2SLW, 3FQS, 3KOY, 3KTS, 5JWN, 6UXL, and 7ELJ. Ex-SCM PQ is operating J2AAT in Japan. ENA has a 4,000-ft. mountain in his Juneau back yard shielding against Eastern DX. BA works all bands with 30 watts into 46s. AB is active from West Juneau on 28 and 7 Mc. using 807s. ED, using fleapower at Annex Creek, hopes to recover his BC-810, now strike-bound in Seattle. Traffic: KL7CF 3. 73. *Agie.*

**IDAHO** — SCM, Alan K. Ross, W7IWU — IYG is new OBS. Move OBS and OO are needed. JPV sends in nice report of 28-Mc. activity mentioning a three-way with ZL1HY and VR2AB and daily round table with 9RUO and 9MPA in Chicago. 50-Mc. activity in Southern Idaho promises to be good soon. ACD plans on 300 watts, ditto for EHP. FOF, JPV, GPM, and IWU are planning on 50 Mc. shortly. Let's hear from Northern Idaho. IY/7, at Mountain home on 7 Mc. at present, was active in SS. He also visited JMH, Boise. 5CAJ/7 now is KJO and is running 5 watts on 4-Mc. 'phone. JMH schedules VE6AO as well as NCS in Gem Net. Each local ARC area should have an Emergency Coördinator. You fellows with portables who like to get out for Field Days are the logical choice for ECs. Drop me a line. What are you doing and what are your interests? EMT, former Idaho SCM, paid me a visit. Gem Net 3743 kc. Mon., Wed., and Fri. 9 p.m. MST. Traffic: W7JMH 44, IWU 23, IY/7 1. 73. *Alan.*

**MONTANA** — SCM, Albert Beck, W7EQM — Section EC: BWH. *Thumps*, the club paper of SMARA, is FB for news from Billings. How about *Klicks*, *Bumps*, or what have you from other Montana clubs? GBI is back in Montana. CRD is studying hard and on the air rigged up in trailer house on MSC Campus. HEM is on 144-Mc. 'phone. New hams in Great Falls are: KAQ and JVN. BXL, JVN, GBI, and DSS are working on 144 Mc. JGG has parasitic troubles. JHR is on 3.9-Mc. 'phone. Lewistown reports JRM is new operator. CAL is on 3.9 and 28 Mc. FTO has new plumber's delight beam on 28 Mc. and gets R9+ from England, KKB, new call from Butte, works 144 Mc. and how! EMF, KKB, JFR, and CJN, Butte's EC Net, call CQ on 144 Mc. in Butte, QSO guaranteed! The Butte Club held an installation party Jan. 4th. FLB needs Delaware for WAS. First QSO was "Bourbin," Mich., second, "Champaign," Ill., by JFR one evening. Would like to hear from any Montana c.w. nets. Thanks for FB reports, gang. 73. *Al.*

**OREGON** — Acting SCM, Cliff Tice, W7BEE — AYY reports on Astoria activities. He is on 7 Mc. mostly, occasionally on 14 Mc., c.w. exclusively. BOO is on all bands. COU is on 7 and 3.5 Mc. EBD has 400 watts on 14 Mc. COZ is on 28-Mc. 'phone and 3.5-Mc. c.w. with an HT-6. EBQ is working on a frequency standard. FKZ is very active on 3.9 and 14-Mc. 'phone. HQL and IRV are heard. COZ called CQ the other night and while listening for a call he heard AEF. AEF was in a car cruising along the highway toward Astoria. COZ gave him a buzz and guided him right into the shack where a minor hamfest was being held. Forest Grove's hams now are boosted to nine with the arrival of 7BFO on 7 Mc. with a half kilowatt. FBX is on 7 Mc. with an 807. Klamath Falls now boasts a ham club with the following officers: GML, pres.; GLF, vice-pres.; HDU, secy-treas. The membership includes FWC, GLF, GML, HDU, HMG, IDJ, IQM, JBF, JEB, JRU, JWM, IRT, KCI, HVD, QP, 6VKS/7, and 6OTQ/7. At the invitation of Bill Sanders, the Salem Club spent an evening on a tour through the State Forestry Department Laboratory. Some of the new calls are KBS, KGU, and JSW. They are on 3.5- and 7-Mc. c.w., and KGU is on 28-Mc. 'phone, also. ASG is

(Continued on page 104)



# TRIGGER TUBE...

## SYLVANIA'S NEWEST



HEIGHT — 1 1/2"  
DIAMETER — 3/4"

—made specifically  
for electronic  
relay applications...

### PHOTOCELL TRIPPING CIRCUIT FOR ELECTRONIC FLASH TUBE

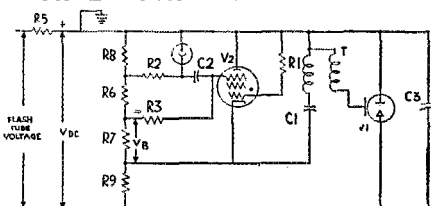

R <sub>1</sub>	Keep-alive current limiting resistor	20 megohms
R <sub>2</sub>	Phototube resistor	0.25 megohm
R <sub>3</sub>	Grid current limiting resistor	10 megohms
R <sub>4</sub>	Power supply limiting resistor	
R <sub>6</sub> , R <sub>7</sub> , R <sub>8</sub> , R <sub>9</sub>	Phototube and Triggertube voltage divider	
C <sub>1</sub>	Anode discharge condenser	0.25 $\mu$ fd.
C <sub>2</sub>	Trigger grid condenser	0.01 $\mu$ fd.
C <sub>3</sub>	Flash tube condenser	
T	Ignition coil condenser	
V <sub>1</sub>	Trigger grid bias voltage	
V <sub>2</sub>	Flash tube type R4330	
V <sub>3</sub>	Type OAS Triggertube	

HERE'S a new 5-element, inert-gas filled, internally triggered cold cathode relay tube designed for operation up to 1000 volts on the anode, with a positive pulse on the control or trigger grid—a tube made specifically for triggering.

Its cathode structure is similar to that utilized in the well-known 1D21, SN4 type strobotron tubes which are mostly used for stroboscopic applications. This cathode design is characterized by its ability to furnish extremely high instantaneous peak currents—hundreds of amperes.

However, the design of the new Trigger-tube varies in that the delay time—time required to initiate the arc—as well as the deionization time, is greatly reduced as compared with previous triggering tubes. In addition, since this tube has been especially designed for trigger applications—applications which do not utilize the light flashes produced by the arc—it can be ideally utilized wherever stable characteristics and low switch current are important.

For example: electronic flash equipment in which externally triggered flash tubes can be readily controlled by a hand trip switch, built-in shutter synchronizing switches, or by a photocell.

Write address below for full specifications.

The OAS is licensed under the tube patents of Edgerton, Gerneshausen and Grier, but no license is implied under their circuit patents

# SYLVANIA ELECTRIC

Emporium, Pa.

MAKERS OF RADIO TUBES, CATHODE RAY TUBES, ELECTRONIC DEVICES, FLUORESCENT LAMPS, FIXTURES, WIRING DEVICES, ELECTRIC LIGHT BULBS

# ATTENTION AMATEURS

*Outside of  
the U.S.A.*

Just as rapidly as world conditions permit PR will establish jobber stocks in principal cities of all countries where amateur radio is permitted. Jobbers are already operating in some countries. Meanwhile, for best service, *Send Your Inquiries and Orders Direct to Our Export Representatives in New York:*

ROYAL NATIONAL COMPANY, Inc.

75 West Street, New York, N. Y.

U.S.A.



**PR** Precision  
CRYSTALS

(Continued from page 102)

working Africa consistently on 14-Mc. c.w. BVV has worked all continents on 28 Mc. since return from down the Coast, and is working on a field strength meter to improve that record. FRT finds 28 Mc. ideal for that schedule. JAA has purchased an SCR-522. The Pendleton Club is quite active. Keep the reports coming, gang. *Cliff.*

WASHINGTON — Acting SCM, Lloyd Norberg, W7EHQ — New appointments: CKZ as OO, OBS, and OPS; HAD as OO; BL as OPS; FWD as OBS and ORS; ACF as ORS. KP4KD writes he will be on 14- and 28-Mc. 'phone in the DX Contest looking for Washington stations for WAS. CZY reports Cascade Radio Club going strong with 35 paid members. Congrats. HGC is on 3.5, 7, and 14 Mc. with 90 watts. IOC, on 7 Mc. with 15 watts, holds weekly schedules with W1NKN, also chief operator at KREM. IDZ reports HXP and BQX are on 28 Mc. HGU is on 3.9 Mc. The Port Angeles gang is interested in 50 Mc. YARC officers are: KFM, pres.; CAM, vice-pres.; JPA, secy-treas. FCZ is on 28-Mc. 'phone. GMC is on 14, 28 and 144 Mc. CAM, JVB, FIV, JPH, AVE, ARF, ALH, AWX, KFM, IYB, ITR, JFD, ECR, and JCC are on various bands and especially on TW0! The Yakima gang is hot! DGN reports nice SS Contest. The Walla Walla Radio Club elected new officers: EMB, pres.; DTK, vice-pres.; KBA, secy-treas. DTK is on 7 Mc. with 75 watts. FDN is on 7 and 14 Mc. with 400 watts. KBM works his OM, GW, on 28 Mc. 6V6 puts out now for KBL. KBA gets frightened when someone answers his CQs. New ham? EMP has new beam on 28 Mc. DCV repairs radios when not on 3.9 Mc. IXR is going to town on 3.5-Mc. c.w. much to FPP's disgust. DRD is working a heap of DX with BC-610. ERH reports 28 and 14 Mc. very good for rag-chews. FDD is on 3.9 Mc. exclusively. Orchids to DP for fine reporting and operation on 28 Mc. Trunk Line. "A" is on 3565 kc. CZY needs more ORS. BTV has new QTH. DAI is fixing BCLs for a living now. 29300 kc., the net frequency for local rag-chewing in Tacoma, is called the Hillbilly Net. LB acquired a new Gonset converter. FNC has new XYL from Australia and new QTH at La Grande power house. ARN has new HT-6 and HQ-129X on 28 Mc. AEA is busy at KMO site-testing. EHQ installed neg-clipper after the 3.9-Mc. gang had planned a lynching party. Traffic: W7DGN 32, CZY 6. 73. *Lloyd.*

## PACIFIC DIVISION

HAWAII — Acting SCM, John Souza, KH6EL — FE blew filament and h.v. plate transformer on new kw. but is back on 28 Mc. FD has managed 8251 QSOs since Dec. 8, 1945 and has pushed through 621 messages with her single 807. AF is holding schedules with his brother, W8VAW, in Cincinnati. AI increased power from 28 to 125 watts. BI is rebuilding to pair of 813s. BW is building low-power rigs for 3.5, 7, 14, and 28 Mc. CN is rebuilding to 35TG after raising three-element beam. EI is using 807 buffer stage. EN maintains nightly schedules with J7AAA. DF, Navy Electronics School club station, is capable of simultaneous operation on 3.5, 7, 14, and 28 Mc. GE is using single 829 while rebuilding. W3KIB/KH6 is coaxing a BC-610 down on 28 Mc. K6CGK, FF, and AR are down on 3.5 Mc. AA is listening on 50 Mc. using S-36 atop his perch 12,000 feet above sea level. EM schedules AA on 50 Mc. using single 829. Traffic: KH6AF 150, DF 22. 73. *Johnny.*

NEVADA — SCM, N. Arthur Sowle, W7CX — Asst. SCM, Carroll Short, jr., 7BVZ. RM: 7PST. EC: 7JU. 7TJY. Asst. EC: 7OPP. OBS: 7JUO. OES: 7TJL. 6GSX is on 3.5-, 7-, 14-, and 28-Mc. c.w. with p.p. 35Ts. TJI reports v.h.f. experiments. 7QYK reports a new e.c.o. along with a 100-watt rig on c.w. TQZ reports a new lattice 30-ft. tower complete with FB 28-Mc. beam. GC has a 14-Mc. beam. HCT is on 3.9 Mc. JYS is on 3.5 Mc. c.w. JNZ is on 3.5-Mc. c.w. and 28-Mc. 'phone. BVZ is on 28, 14, and 3.9-Mc. 'phone with new BC-610E, PGD, ONG, KIW, and KEV are new AEC members. The Las Vegas Amateur Radio Assn. held its first meeting Dec. 2nd. High Southern Nevada scores in SS are KEV, JU, and JUO. Southern Nevada AEC drills are held the 1st Monday of the month on 3660 kc. at 7 P.M. BVZ, JU, PGD, and PZY are Nevada members of the City of Los Angeles Water and Power Dept. Net, 7170 kc., 9 A.M. Saturdays. RXG is active in the Nevada Sagebrush Net, 3898 kc. 73. *Art.*

SANTA CLARA VALLEY — SCM, Roy E. Pinkham, W6BPT — Asst. SCM, Geoffrey Almy, 7BK. PAM: QLP.

(Continued on page 106)

# Minimum DRIFT with maximum HEAT!



Crystals in amateur service take a beating! To get high output, crystal currents run high . . . voltages on the basic exciter stage are pushed to the limit. To have real stability with high output you want a rugged rock, one that will take the highest allowable heating without undue drift. That's where PRs come in. Even on the higher frequencies PRs stand firm . . . with less than 2 cycles drift per MC per

degree Centigrade. With PRs you get everything . . . stability . . . long life . . . high activity . . . moisture and contamination-proof. **EXACT FREQUENCY (INTEGRAL KILOCYCLE) AT NO EXTRA COST.**

Get PRs at your jobber's. Accept no substitute! They're unconditionally guaranteed. — Petersen Radio Company, Inc., 2800 West Broadway, Council Bluffs, Ia. (Telephone 2760)



SINCE 1934

# PR Precision CRYSTALS

**10 METERS**  
PR Type Z-5.

Temp. coefficient less than 2 cycles per MC per degree centigrade. High activity. Heavy drive without crystal damage. . \$5.00

**20 METERS**  
PR Type Z-3.

Temp. coefficient less than 2 cycles per MC per degree centigrade. High power output. High activity . . . . . \$3.50

**40 & 80 METERS**  
PR Type Z-2.

Rugged. Low Drift (less than 2 cycles per MC per degree centigrade). High keying activity. High power output. Accurate calibration . . . . . \$2.65



**Opportunity  
Ahead...  
FOR TRAINED MEN  
ONLY!**

**Enjoy Security and Good Pay!  
Step Ahead of Competition Into a  
Better Radio Job with CREI Technical  
Home Study Training**

PROTECT your future today. Enjoy the recognition, the interesting, well-paid positions that Radio-Electronics offers men who meet the challenge with modern technical training. FM, Television, Facsimile and other electronic communications systems for both government and industry will require thousands of highly trained expert radio communications engineers and technicians.

NOW is the time to take the time to prepare yourself for these important career jobs. CREI home study training can show you the way by providing you with the "tools" with which to build a firm foundation of ability based on a planned program of modern technical training. This is real, honest-to-goodness practical engineering training that leads to better jobs and more rapid promotions... the type of training for which many thousands of professional radiomen have enrolled during the past 19 years.

It costs you nothing to read the interesting facts. Mail coupon for free booklet today.

**VETERANS!**

**CREI training is available under the "G.I." Bill!**

**CAPITOL RADIO ENGINEERING INSTITUTE** Q-2  
Dept. Q-2, 16th & Park Road, N. W.  
Washington 10, D. C.

Gentlemen: Please send me FREE BOOK describing the new CREI home study courses in PRACTICAL RADIO AND TELEVISION ENGINEERING. I am attaching a brief résumé of my experience, education and present position.

NAME.....  
STREET.....  
CITY.....ZONE.....STATE.....  
OCCUPATION.....

I am entitled to training under the G.I. Bill

(Continued from page 104)

The SCCARA elected officers for the coming year: UGF, pres.; MUR, vice-pres.; ZZ, recording secy.; HGW, treas.; KG, NYS, MDY, 9FAV/6, and BPT executive board. The latter two will hold office for two years. The club plans radio lectures at the business meetings. Any expressions of ideas for keeping up interest in club activities should be given any board member. WUI and KG both worked Burma on 28-Mc. 'phone. NYS now is running his jug full and was heard working 6GRL portable in Nanking, China. Joe uses a three-element beam. WNM has a new beam using quarter-wave spacing. QLP is QRL with his work so has little time to be on the air. ZZ sends in a nice list of stations worked on SS for a total of 22,243 points. Miles now has worked forty-eight states from the West Coast for his WAS certificate. His country total is forty-two. PBV reports 76,075 points in SS. Bob's father is new ham with call YEZ. New officers of San Mateo Club: TFZ, pres.; DXB, vice-pres.; BPV, treas., and PBV, secy. BPT spent a week in the hospital. LCF gets PB reports on 3.9-Mc. 'phone. Well, gang, the reports were slim this month. How about you fellows around San Bruno? Anything interesting in your QTH? Traffic: W6ZZ 14, PBV 8, TBK 4, 73. "Pinky."

EAST BAY — SCM, Horace R. Greer, W6TI — At the close of this year 1946, I would like to take the opportunity to list the complete East Bay Section ARRL field organization. They are the boys that will help to keep our section on the map during 1947. SCM: TI. Asst. SCM: EJA. RM: ZM. SEC: OBJ. EC: QDE. Asst. EC u.h.f.: OJU. OO: ITH. OBS: TT, IDY, ZM, ITH, RMM, UZX, AKB, TI. ORS: LMZ, EY, EJA, QDE, TT, ZM, RMM, OJU, TI, QXN, DDO, WNI, DUB, NRM, QUL, KEK. OPS: EY, ITH, TT, QDE, OJU, ZM, CRF, CDA, TI, DUB, RMM, EJA, QUL, KEL. Now that our bands are back the ARRL is promoting traffic once again. Therefore, anyone interested may apply for ORS and OPS appointments. Please send in the number of messages you handle each month. If you need extra forms please ask me for them. Each monthly report starts at the beginning of the month and ends the last day of the month. Please make sure that I receive all information by the 5th or 6th as all reports are sent to ARRL the 7th of the month. You will note that OBJ has taken over the post of Section EC formerly held by EE. You also will note that the office of Phone Activities Manager has not yet been filled and anyone interested should apply to yours truly. The PAM has authority to sponsor 'phone operating activities in his territory in the name of the ARRL and helps to build the ARRL section 'phone organization. The Oakland Radio Club has elected new officers. The SARO is having a club DX contest. TI and ITH were elected directors of the Northern California DX Club, Inc. Every member belongs to ARRL and six members of this organization alone totaled over 169,000 points in the SS Contest. ITH, on 'phone, worked all sections with 400 QSOs, winning for East Bay and with possibilities of winning for the entire country. TT, on c.w., was an East Bay section winner, working 68 sections and having 454 QSOs. HN is in Iowa City on 7-Mc. c.w. EJA added three new countries this month, and reports that the Richmond gang has changed its club name to Richmond Amateur Radio Club. MJF has a new shack using a new vertical "J." LMZ has new VT27A final. NRM is on 3.5-Mc. c.w. CDA has not much time for operating. QXN is on Pioneer Net. KEK is on 28-Mc. mobile 'phone. SS scores: ITH, 56,800; TT, 61,744; TI, 23,028; DUB, 18,240; EJA, 9,630; QLH 160; KEK 45,315; LMZ 15,120; MVQ 52,098 points. BUY and PB are building three complete finals for 28, 14, and 3.5 Mc. Traffic: W6QXN 199, ITH 25, NRM 10, KEK 6, EJA 4, TI 3, LMZ 2, 73. "TI."

SAN FRANCISCO — SCM, Samuel C. Van Liew, W6NL Phone JU 7-6457. — Asst. SCM, Joseph Horvath, 6GPB, RM: RBQ. ECs: DOT, KZP, LLJ, SRT, UHN, VCG, QFX. OOs: NJW, WB. OBS: FVK, KNE, DJI, OZC, BVS. ORS: RFF, BIP, ATY, RBQ, CVP. OPS: OZC, NYQ. Our new director, RBQ, is active visiting the various clubs in this division. The CCN & SFN traffic nets are rapidly forming. Those who wish to join should contact the RM, RBQ. CIS now has his final in operation, 750 watts to a pair of 813s. DJI has new HQ-129 receiver. Johnny and several others in this area got a chance to work their first maritime mobile station, W1HEN, aboard the S.S. *Hovenwest*, as it came into port here. The first of the season's storms claimed several antennas around the Bay area. PTS's antenna was

(Continued on page 108)

# Amphenol

## ALL-WAVE ANTENNA

### GETS ALL THREE!

Purchasers of modern radios deserve good reception on all three bands—standard broadcast, short wave and frequency modulation. Until Amphenol engineers perfected this new all-wave unit, the only way to achieve this was to install three separate antennas, a costly and unsightly solution.

The FM section of this new 3-way antenna is a horizontally polarized dipole. It operates most efficiently between 88 and 108 mc.

A 65-foot length of Amphenol Polyethylene covered copper wire serves as the standard broadcast and short wave antenna. The polyethylene covering minimizes precipitation static and assures long life.

A specially designed series M derived low-pass filter automatically switches the energy from the proper antenna to receiver input.

Installation is simple. The mounting is a 1-inch steel mast 5-feet in length. All hardware is included. A guy clamp bolted to the mast provides for tripod guying.

Vinyl-jacketed Amphenol 52 ohm coaxial transmission line serves as a low-loss lead in and eliminates interference from transmission line pickup. Noisy areas are not a problem with this antenna.

In a comparative test with the best available standard double doublet (with matching transformer) the Amphenol All-Wave Antenna proved far superior in gain—as well as being interference free.

Write for complete technical data, or see your jobber for full information.

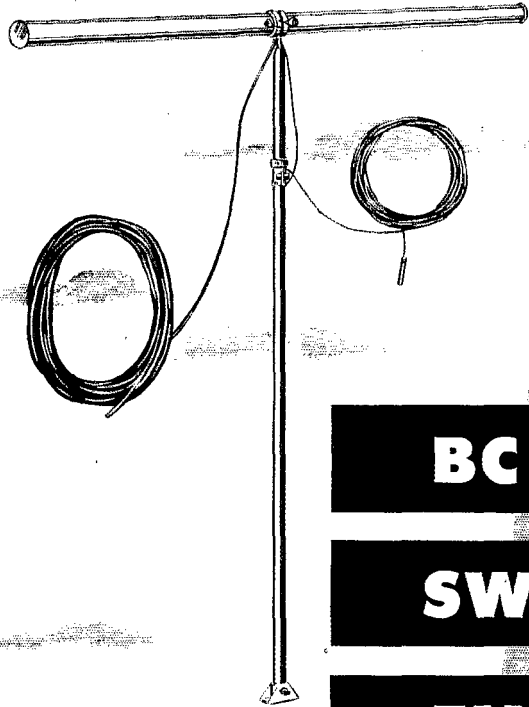

### BC

### SW

### FM

#### AMPHENOL ALL-WAVE ANTENNA UNIT INCLUDES:

- ★ FM dipole with molded phenolic weatherproof filter housing
- ★ Steel mast 5-feet long with guy clamp and adjustable insulator
- ★ 50-foot Amphenol BG-S/U 52 ohm coaxial cable
- ★ Antenna wire polyethylene covered
- ★ Built-in M derived network

# AMPHENOL

AMERICAN PHENOLIC CORPORATION  
CHICAGO 50, ILLINOIS

COAXIAL CABLES AND CONNECTORS • INDUSTRIAL CONNECTORS, FITTINGS AND CONDUIT • ANTENNAS • RF COMPONENTS • PLASTICS FOR ELECTRONICS

# STATION TESTED\*

... an added  
proof of Quality!



\*Pres. W. A. Kuehl is shown at his amateur radio station W9EZN. With the war over, Walt is again pursuing his favorite hobby.

## DRAKE RADIO SOLDERING IRONS

Yes, Drake IRONS are right for radio. And these sturdy irons have proved their dependability and worth in use on countless other jobs, too, for over 25 years. That's why we say—whatever your needs, you are certain to find a Drake iron that fills the bill exactly!



**600-10**—the Drake No. 600-10 is ideal for those all important connections when rewiring your rig. Get back on the air fast. Make good dependable connections with this 100 watt  $\frac{3}{8}$ " tip.



**400**—the Drake No. 400 is the perfect iron for work in small places. Only 9 inches long, it is especially designed for tight corners and delicate connections. 60 watt,  $\frac{1}{4}$ " tip.



Ask your nearest supplier or write for the name of the distributor nearest you . . . and give yourself the advantages of these superior irons.

**DRAKE ELECTRIC WORKS, INC.**

3636 LINCOLN AVE.

CHICAGO 13, ILL.

(Continued from page 106)

down. DJI lost his 8JK antenna, 6VPJ and 6TLQ lost their three-element beams. VIZ now is on 3.9-Mc. 'phone net. NPO returned to San Francisco and is on the air again after a month's absence in southern California. NYQ is building a 350-watt rig for his summer QTH. The rig will cover 3.5-28-Mc., c.w./'phone, a.m. and f.m. The new call for this QTH will be a two-letter one, SR. ART says he will have everything all set for the spring DX contest. GPB has a new BC-348Q on the air now. OZC worked nine new countries in Europe on 28-Mc. 'phone. PVC seems to have licked his troubles in the BC-610, and it sounds fine now. The SS Contest brought out many contestants in this section and many fine scores. Among the best from this section were BIP, RBQ, and WB. The Marin Radio Club held its annual Christmas party December 14th, at the Mill Valley Country Club. Dinner was served and Christmas gift boxes and prizes were distributed. A swell time was had by all. The San Francisco Radio Club held its monthly meeting November 22nd. The speaker of the evening was Phil Gardner. An interesting talk was given on various subjects. Thanks for your reports. Traffic: W6RBQ 20, EYY 16, BIP 2. Sam.

**SACRAMENTO VALLEY**—SCM, John R. Kinney, W6MGC—AF, who engineers giant a.c. super Diesel locomotives through the Feather River Canyon for the W.P.R.R., is our new OBS for Oroville with 6L6, 807, and 810s p.p. Class C, with 750 watts input and operates on 7126 kc. at present between runs. He has invited MGC to go fishing with him. REB, organizer of the Pioneer Net, has been appointed as ORS and RM. The net includes connections with the Alberta and Gem Nets. OJW, an ORS, reports having regular schedules with KL7CF, but no traffic as rig is being rebuilt to work all bands on c.w. OJW has been appointed Official Observer to the Sacramento Valley. A new Army/amateur call for the HQ, 51st. AACSS group of McClelland Field, should be of interest to Army men. GZY reports official broadcasts sent on 3620 and 3790.5 kc. on c.w. IOB is active on 3.5-Mc. 'phone with rig in rebuilt chicken shack that is now ham shack. MWM and YKZ, brothers, share time on the same rig. RAQ, Chico, has new HQ-129X with a 40-watt rig and a tuned doublet on 3540 kc. on c.w. WTL reports schedules with J9AND, KL7FL, 8MXX, 6CZB, 6OPA, and 5HHR. 7JFE/KG6 has a three-element beam for 14 Mc. and another dipole for 27 Mc. up 50 feet. PIV, ORS and member of the Pioneer Net, besides working 140-44 Mc. 'phone, plans to go on 50 Mc. At the regular meeting of the SARC in November, HB, QNQ, and KFQ, from Eitel-McCullough, Inc., put on a special show for the gang. Best wishes for the New Year. Traffic: W6REB 204, PIV 116, WTL 9. Jack.

**PHILIPPINES**—Acting SCM, Craig Kennedy, KA1CB—The Philippine Amateur Radio Association is endeavoring to arrange for licensing of U. S. Citizens in P. I. Bands now open in the Philippines are as follows: 7100-7300 (A1); 14,100-14,300 (A1); 14,150-14,250 (A3); 28,000-29,700 (A1, A3); 50,000-54,000 (A1, A3).

**SAN JOAQUIN VALLEY**—SCM, James F. Wakefield, W6PSQ—PCS has 87 postwar. The Fresno gang is on 144 Mc. every Wednesday at 8:00 p.m. UID, in Porterville, and JPU, in Fresno, have heard but not worked each other on 144 Mc. VLS has p.p. 7193s on 144 Mc. JCB has 100 watts on all bands to 829. WKT, ex-5JOF, has full gallon on 3.9 Mc. into top-loaded vertical. KTW, in Coalinga, has BC-474A with 8 watts on 3.9 Mc. KPW has 300 watts into 100T with HY-40Z modulator. WXZ has mobile rig which is a converted TBY. Other 28-Mc. mobiles are JPU and PXP. Emergency work in Fresno is progressing and any of the gang interested in joining 3.5-Mc. net should contact KUT, 73, and let's get the reports in by the first of each month. Jimmie.

### ROANOKE DIVISION

**NORTH CAROLINA**—SCM, W. J. Wortman, W4CYB—A new club has been formed in Winston-Salem known as the "Key and Mike Radio Club." BYA is pres.; NI, vice-pres.; and 2BCS/4, secy-treas. Following are members: HUL, IDO, IFS, DGV, DCW, IZR, 2DFG, 2JEB, and 2HEQ. AEH is on 14 Mc. and is building a kw. rig. AYA is increasing power for 7-Mc. work. DCW is working an 814 grid-modulated on 28 Mc. FDV is EC for Raleigh and vicinity: FVD, BWT, DPF, WL, CVU, TF, and FRH are active on 28-Mc. 'phone. QA, IRY, and CXZ are working mobile on 28 Mc. EGJ, at Moore General Hos-

(Continued on page 112)

# MORE REMARKABLE SAVINGS WITH RADIO SHACK CHOICE SURPLUS

## ★★★ SCR-274-N COMMAND SET

consisting of

- 3 RECEIVERS** — covering frequencies of 190-550 kc; 3 — 6 mc; and 6 — 9.1 mc; tubes included are: 12SK7 — RF amp; 12K8 — mixer; 12SK7 — 1st IF; 12SK7 — 2nd IF; 12SR7 — diode det & CW osc; 12A6 output or AF.
- 2 XMTRS** — covering frequencies of 3 — 4 mc and 4 — 5.3 mc; tubes included are 1626 master oscillator driving two parallel 1625's; a 1629 magic eye tube and a calibrating crystal are also furnished.
- 4 DYNAMOTORS** — for 24-volt d-c service; each receiver has its own dynamotor and another dynamotor powers the transmitters and modulator.
- 1 MODULATOR** — with carbon mike input to 1625 screen-grid modulator with 12J5GT side-tone oscillator and VR150-30 regulator.
- 29 TUBES** — a complete set for each unit.
- 2 TUNING CONTROL BOXES — 1 ANTENNA COUPLING BOX with RF ammeter, antenna relay, and 5000 volt, 50 mmfd. W.E. vacuum condenser.**

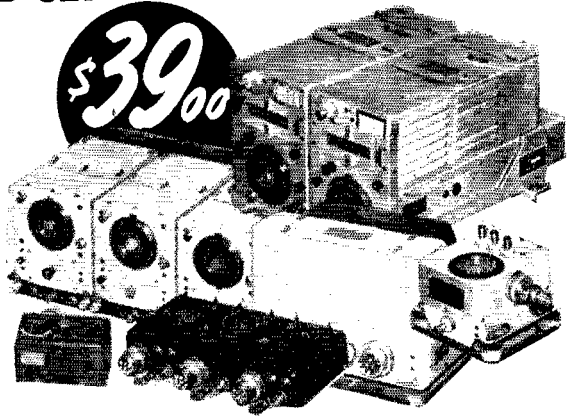

You'll find a myriad of uses for this stack of gear, the parts of which are in themselves worth many times the price at which the Radio Shack brings you the entire assembly. The receivers are great for stand-by use — effective on 40 and 80 meters — with ample bandspread — usable on phone or CW — output at 8000 or 600 ohms. The amazingly low price is possible because the equipment is slightly used — but it's in first class shape ready to give you many years service. **DON'T MISS THIS TREMENDOUS BARGAIN!**

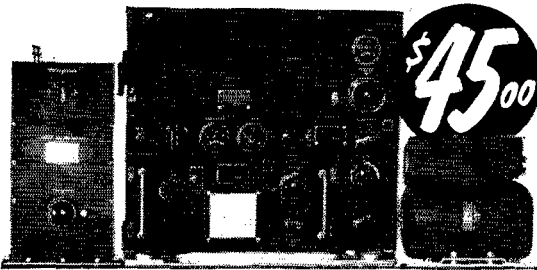

## ★★★ AAF XMTR BC-375-E

We're back again with more of these exceptional values in transmitting gear. Complete outfit includes, seven of the tuning units, covering 200 kc to 12,000 kc (except broadcast band), plus antenna tuning unit BC-306-A with variometer and tap switch, plus dynamotor unit PE-73-C with relay, fuses, and filter. Power output is 30 to 75 watts, depending on frequency; RF meter reads antenna current; plate meter range is 0-500 milliamperes.

Price, complete — only **\$45.00**.

Remit in full — No C.O.D.'s.

The whole rig weighs over 400 pounds so it's shipped by freight.

This brand new gear is furnished complete with five tubes — 211 master oscillator, 211 RF power amplifier, 10 speech amplifier or tone oscillator, 2 — 211's PP modulators. 100-page AAF Manual covers every detail of use and maintenance. **ORDER NOW!!**



### TUBE SPECIALS

807 West'hse	\$1.35	872A GE	\$2.95
811	2.29	211 GE	4.95
813 RCA	9.95	829B Kenrad	4.95
832 Kenrad	5.95	VT-127A Eimac	3.45

Speed delivery and save C.O.D. charges — send full amount with order; 50% deposit required on all C.O.D. orders.

# The RADIO SHACK

★ 167 WASHINGTON ST. ★  
BOSTON, MASS., U.S.A.

# REAL SATISFACTION *is yours for years...*

## ★★★ SCR-522 VHF XMTR-RCVR

The ALL-PURPOSE RIG  
for your work in the  
100-156 MC SPECTRUM

### Proposed F.C.C. Allocations in the SCR-522 Spectrum

100 mc	F M Broadcast
106 mc	Facsimile Broadcast
108 mc	Air Navigation Aids (Localizer)
112 mc	Air Navigation Aids (Ranges)
118 mc	Aeronautical Mobile (Airport Control)
122 mc	Aeronautical Mobile
132 mc	Government Aeronautical Mobile • Government Fixed
144 mc	Amateur
148 mc	Gov't Aero. Mobile • Gov't Fixed
152 mc	Railroad • Relay Press Relay Broadcast Urban Telephone Police • Fire • Maritime Geophysical Experimental
156 mc	



**4-CHANNEL PUSH-BUTTON OPERATION CRYSTAL-CONTROLLED AM PHONE MOBILE or FIXED STATION SERVICE.** Ideal for AMATEUR, EXPERIMENTAL, AIRCRAFT, MARINE, RAILROAD, POLICE, and EXPERIMENTAL WORK.

Here's the set that is so good it was made standard equipment in all American or British planes — and now you can have it at only a few percent of its original cost.

### THIS VERSATILE SET GIVES YOU

A 10-tube superheterodyne receiver that includes a squelch circuit with sensitive relay to kill background noise when no signal is being received; 3 microvolts sensitivity at 10 milliwatts output.

A 7-tube, temperature-stabilized Xmtr delivering 15 watts.

A remote control box giving push-button selection of four sending and receiving channels.

A 28-volt d-c dynamotor to power the entire outfit in mobile service.

*Furnished with full set of tubes, connecting plugs, and detailed instructions, as published in Radio News, for converting to a-c powered amateur service. Condition — like new; total weight — about 100 pounds. (Incidentally, there's no extra charge if you find eight crystals in your shipment).*

### TUBE LINE-UP RECEIVER

9003 RF amp  
9003 Mixer  
9002 Harm. Gen.  
9003 Harm. Amp.  
12SG7 1st IF  
12SG7 2nd IF  
12SG7 3rd IF  
12C8 Det, 1st IF  
and AVC  
12J5GT 2nd AF  
12AH7GT Osc and  
AF squelch

### TRANSMITTER

6G6G Osc  
12A6 1st harm: amp  
832 2nd harm. amp  
832 Pwr. amp  
6SG7 Speech amp  
2 — 12A6 PP mod

Speed delivery and save C.O.D. charges — send full amount with order; 50% deposit required on all C.O.D. orders.

As COLLINS distributors we are ready to serve you in all your needs for this dependable radio line.



with these superlative values in permanently usable gear brought you at amazing savings by the RADIO SHACK!

## ★★★ BC-221 FREQUENCY STANDARD

Now it's easy to meet FCC Regulations par. 12.135 for regular measurement of your frequency. This extremely stable, heterodyne frequency meter readily checks up to 5th harmonic on most receivers and up to 125th harmonic on the better receivers.

Fundamental ranges 125-250 & 2000-4000 KC.

Stability better than .005%.

Works on 110 v. a-c, vibrapack, or batteries.

Can be used as a signal generator — and you'll be seeing articles telling how to make it into a VFO that can't be duplicated in today's market.

Furnished complete with tubes, original crystal and calibration charts. First quality — can hardly be told from new. Immediate express shipment.

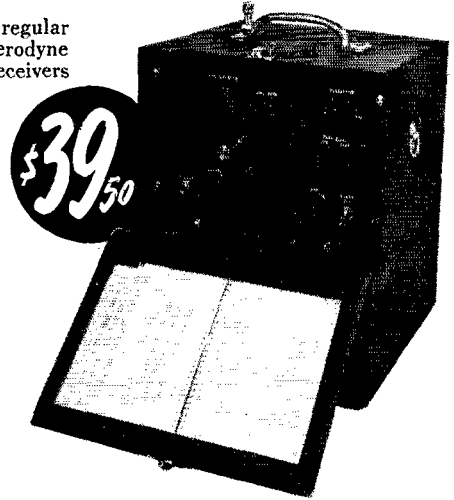

## ★★★ BC-348 RECEIVER



"The best military receiver for amateur use" is what many wise hams say about this sensitive, smooth-operating, heavily-built, 6-band receiver. Check these features and you'll see why!

6-band switching—200-500 kc: 1.5 — 3.5 — 6 — 9.5 — 13.5 — 18 mc.

Constant sensitivity on all bands.

Automatic noise compensator.

Temperature-compensated oscillator.  
Crystal filter · AVC · MVC · BFO.  
Output at 300 or 4000 ohms.

Smooth vernier tuning; 90 turns of tuning knob for each band. Furnished complete with built-in dynamotor for 28-volt d-c use and detailed instructions for change-over to 110-volt a-c supply. ORDER NOW for immediate express shipment. Conversion kit available.

### TUBE LINE-UP

1st RF — 6K7  
2nd RF — 6K7  
RF Osc. — 6C5  
1st Det. — 6J7  
1st IF — 6K7  
2nd IF — 6F7  
CW Osc — 6F7  
3rd IF — 6B8  
2nd Det. — 6B8  
Aud. Out — 41  
V.R. — 991

### AAF HAND MIKE and PHONES

Type T-17 mike with push-to-talk switch, cord, and plug. This is a carbon mike. Only **\$1.29.**

Type HS-33 phones with head-band, rubber cushions, cord, and plug. Only **\$1.95.** Used, but in A-1 condition.

### CAPACITORS

Oil Xmtg types by leading manufacturers.

Mfd.	Volts d-c	Net ea.
2	4000 (GE)	\$5.95
2	2000	2.95
2	1000	.71
4	1000	1.19
4	600	.71
6	600	.79
8	600	1.19
10	600	1.29

ALL POPULAR RECEIVERS are now available thru the Radio Shack.

The RADIO SHACK  
167 WASHINGTON ST.  
BOSTON, MASS., U.S.A. ★

HERE'S MORE

# POWER

FOR YOU  
and YOUR STATION

Knowledge is power, the power to enjoy your work in radio, whether it's a career or a hobby. The two books briefly described here are compilations from many outstanding radio minds. They are written so their signals will come in strong, clear, and easily understandable for any amateur.

We can't but touch lightly on the contents of these books, but we will gladly send them to you to look over personally. If you decide they should be in your shack within your reach, OK, buy them. If you decide you can get along without them, OK again, just send the books back within five days.

## ELECTRONIC CONTROL HANDBOOK



The true facts, without dramatics, regarding the fundamentals of electronic control principles. Section I, Basic Elements of Control; Section II, Conversion Elements; Section III, Electronic Modification Circuits; Section IV, Activation Elements; Section V, Control Applications.

350 Pages • \$4.50 • Hundreds of Illustrations

## ELECTRONIC ENGINEERING HANDBOOK



Completely covers the basics of communication equipment design. It links up theoretical knowledge with the equipment and applications of the engineering world. Also a working reference for all applications of electron tubes. Section I covers Vacuum Tube Fundamentals; Section II, Electronic Circuit Fundamentals; Section III, Electronic Applications; Section IV, Vacuum Tube Data.

456 Pages • \$4.50 • 560 Illustrations

Send This 5 Day No Risk Coupon Today

### CALDWELL-CLEMENTS, INC.

480-K Lexington Ave.  New York 17, N. Y.  
Publishers to the electronic industries since 1925

Send books checked. If not satisfied, will return within five days. Otherwise will remit payment.

- ELECTRONIC ENGINEERING HANDBOOK \$4.50  
 ELECTRONIC CONTROL HANDBOOK \$4.50

Name.....

Address.....

City and State.....

Company Name.....

(Continued from page 108)

pital, is on 28 Mc. FSE says that JCS, ex-8SSV, and JCR, ex-8TAY, have moved to Asheville. ABN is busy with police radio work. AXZ is still dreaming up a rig. EJ is a roving engineer for four or five b.c.o. stations. ESL is a big service man. FCY keeps busy repairing intercoms and p.a. stuff. GNK is busy at service work, GW moved to Miami and HJ to New York. ZM is taking communication engineering at Ohio State. HX has his shop going again. ECW sent in a fine report. AAK is kicking again after a siege in the hospital. CVQ is back on after a long layoff. NC and the Winston Club are putting up a new steel tower. That transmitter sounds like a California kw. now. There was plenty of activity from this section in the SS. A good time was had by those who attended the hamfest in Charlotte on December 1st. Registration was 253, and prizes valued at over a thousand bucks went out. Keep the news coming in, gang. 73. "Buck."

**SOUTH CAROLINA** — SCM, Ted Ferguson, W4BQE/ANG — GMO is back in the section and is operator at WAIM. BPD reports that he worked 435 contacts in 68 sections in the Sweepstakes. FMZ works 3.5-Mc. c.w. and has regular schedules with DXF. CZA and FNS are coming along nicely with their 3.5-Mc. c.w. net. Join them on Mondays, Wednesdays, and Fridays at 7:15, fellows. If you plan a new crystal for this net, make it 3735 kc. This is to be our net frequency. The Palmetto Amateur Radio Club, Inc., of Columbia, now has the call MN. HMG has just about turned to c.w. entirely. FNS reports he has several new prospects for his net. Another nice letter was received from FNT reporting a nice batch of DX from the rock of Okinawa. AFQ is doing a nice job as OO Class 1. The Palmetto Amateur Radio Club started a radio school on Nov. 11th and has thirty-six on the roll. BZX, FMZ, BEN, HEV, FAL, and BQE are instructors. The school will last six months. Your SCM hopes that other clubs in this section will follow suit. Did you read about yourself in December *QST*? Bet your life you didn't because you failed to report your activities. Let's start 1947 off by reporting and keep it up. Traffic: W4HMG 48, BPD 14, FNS 12, CZA 8, 73. *Ted.*

**VIRGINIA** — SCM, Walter R. Bullington, W4JHK — JZA and IDA have a breakfast club schedule every morning at 7:30 on 28 Mc. KAO and KIL also are members. JFZ is on 28 Mc. and has a new HQ-129X. KAK is active on 3.9 Mc. and is completing a high-power 144-Mc. rig. JXE is knocking them off on 7 Mc. JHI has an 803 on 7 Mc. KQB, a new ticket, has an 807 on 7 Mc. BTL is vice-president of Roanoke Club and has a pair of 8005s on 3.9 Mc. JDT, president of Roanoke Club, is DXing on 14 Mc. KQC has a 6L6 on 7 Mc. KHE is active on 144 Mc. JGW is doing fine on 7 Mc. with a 6L6. JXJ is working some real DX on 28-Mc. 'phone. IWF is trying to get used to his new call and is on 7 Mc. now. ISA has a converted Mark II tank job on 144 Mc. JQK is attending V.P.I. EPK is active on 3.9-Mc. 'phone. JGO has a new RME-46 and a converted GP-7 on 7 Mc. CZK has a new BC-221 frequency meter. JXQ is active on 7 Mc. CA has a new BC-375 which he is converting. Fred recently acquired an XYL. Congrats from the gang! BUR has an 807 on 7 Mc. JSF has p.p. 812s on 28 Mc. KQF is on 7 Mc. and is conducting code classes. KPZ and KQD are on 7 Mc. KJR is ex-3FQY. We have a new club, the Ocean View Amateur Radio Club. Officers are: IQL, pres.; IYL, vice-pres.; BLU, treas.; DEZ, custodian; and R. S. Deacon, secy. Welcome, fellows! IQL has a 144-Mc. beam atop his 28-Mc. beam. JTC is leaving us — he is Panama-bound. JWA has new beam on 28 Mc. EOP is rebuilding his receiver but swapped an amplifier for an RME-70 so he still could listen. JJJ is on 14 Mc. WF has his 813 going. IPZ has a kw. with RK-63s. KFC had 889 QSOs in the SS and rolled up 147,000 points. Traffic: W4KFC 76, EOP 32, 73. *Monk.*

**WEST VIRGINIA** — SCM, Donald B. Morris, W8JM — The Kanawha Valley Amateur Radio Club meets the first and third Wednesdays of the month at D. Boone Hotel, Charleston. New officers are CSF, pres.; VAN, vice-pres.; SHU, secy-treas. FFO now is 3FFO, located in Baltimore. New hams are ZOW, Morgantown; ZOJ, Princeton. FMU keeps 'phone schedule with D4AAB for traffic. 2PTC now is 8OAP, located at b.c. (f.m.) station in Beckley. The MARA increased interest in the club by having an auction and swapfest. JM has new homemade e.c.o. which netted him forty-one states in twenty hours in the SS Contest. KWI has new rig, receiver, and beam. UYR, located in

(Continued on page 114)

# COMPLETE-COMPACT and INEXPENSIVE!

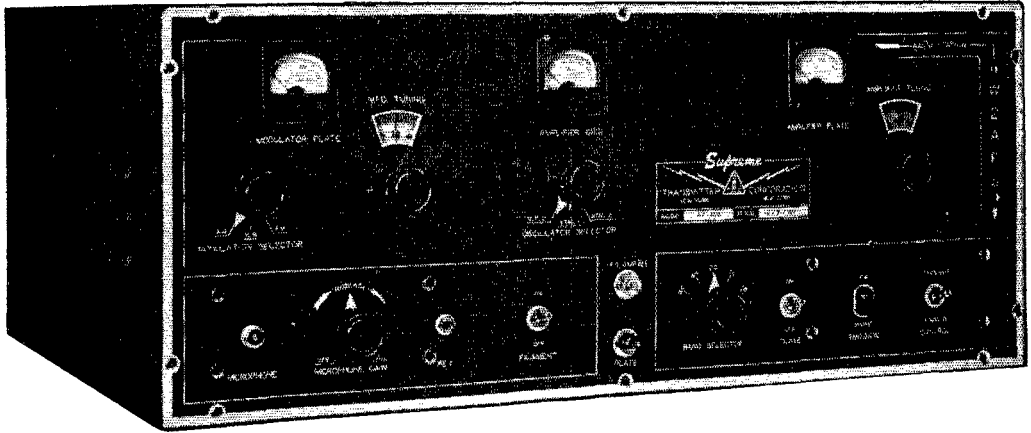

**SUPREME TRANSMITTER Model AF-100, 6-Band, 100 Watt (output) Desk Type Transmitter.** Embodies ALL the features most desired by the majority of the amateurs. Designed to cover the amateur bands most frequently used: 10, 11, 15, 20, 40 and 80 meters for CW, ICW, AM and FM Phone transmission. This is the very first transmitter offered to the amateur which has the new feature of Frequency Modulation in the band of frequencies assigned for this purpose, namely 27.185 to 27.455 and 29 to 29.7 megacycles. Model AF-100 is continuously tunable throughout the range of each of the amateur bands. A highly stable variable oscillator followed by slug-tuned buffer and doubler stages which are ganged to the oscillator dial simplifies the problem of working through

severe QRM and further enhances the pleasures of easily establishing and retaining QSOs. Band changing is easily accomplished in the exciter by a band selector switch and in the final by the plugging in of a coil for the particular band selected. This unit is one of the simplest to operate—and highly efficient on all bands, for all types of emission.

**Front Panel Controls:** Oscillator Dial; Final Amplifier Dial; Oscillator Selector Dial; Modulation Selector Dial; Microphone Gain Control; Band Selector Switch; Filament Power Switch; Plate Power Switch; Emission Selector Switch; Standby Control.

**Metering:** PA Plate Current; PA Grid Current; Modulator Plate Current.

## TUBE COMPLEMENT

Type	Function
1—6AC7	Reactance Tube Modulator
1—6J5	Variable Frequency Oscillator
1—6AC7	Class "A" Amplifier or Crystal Oscillator
1—6L6	80 meter Buffer or 40 meter Doubler, or 30 meter Tripler
1—6L6	20 meter Doubler
1—6L6	15 meter Doubler
1—6L6	10 meter Doubler
1—3D23	Final Amplifier
2—807	Class AB <sub>2</sub> Modulators
1—6J5	Modulator Driver
1—6SJ7	Speech Amplifier
2—866A	High Voltage Rectifiers
1—5R4GY	Low Voltage Rectifier
1—5R4GY	Modulator Rectifier
1—80	Speech Rectifier
1—6X5GT	Bias Rectifier
1—VR 150	Voltage Regulator
1—6SN7GT	Audio Oscillator

## ELECTRICAL CHARACTERISTICS

Frequency Range:	Amateur Bands—10, 11, 15, 20, 40, 80 meters
Output Power:	100 watts on CW, ICW and Frequency Modulation 100 watts Amplitude Modulation
Method of Modulation:	AM—High Level Class AB <sub>2</sub> FM—Reactance Tube Modulation
Modulation Capabilities:	AM—100% FM—100% = ±75 kilocycles (variable from 0 to 75 kc)
Input Audio Source:	High Impedance Crystal or Dynamic Microphone. Level 60 DB down
Audio Frequency Response:	AM—±2DB, 200 to 6000 cps FM—±1DB, 100 to 7500 cps
Noise Level:	AM—Minus 45DB below 100% modulation FM—Minus 60DB below 100% modulation (±75 kilocycles)
Audio Frequency Distortion:	AM—5% at 85% modulation for 100 watt output FM—1.5% at 100% modulation
Frequency Control Elements:	Stabilized Variable Frequency Oscillator or two (2) crystal controlled positions

**COMPACT:** 29 3/4" long, 11 3/4" wide, 18 3/4" deep.

**Power Source:** 110-117 volts 50/60 cycles AC.

**Economical — Power Consumption:** 325 watts.

**Approximate Weight:** 125 lbs.

**COMPLETE:** The only items needed to get "on the air" are a key, a mike and two crystals.

**INEXPENSIVE: A WONDERFUL VALUE!**



Write for detailed information and catalog  
**DESIGNERS AND BUILDERS OF BROADCAST STATION EQUIPMENT,**  
 250 WATTS to 50 KW — AM and FM  
**SUPREME TRANSMITTER CORPORATION**  
 280 NINTH AVENUE, NEW YORK 1, N. Y.



## TUBE SPECIALS

- TAYLOR T-40...\$2.95
- JAN 813..... 9.95
- RCA 829B.... 4.95
- RCA 806.....15.00
- DU MONT
- 3GP1..... 4.95
- EIMAC 304TH.. 9.95
- Socket for above .90

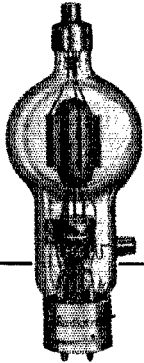

Every "Ham" Needs One  
As Required by F.C.C.

### FREQUENCY STANDARDS

Giving check points every 1,000, \$29.95  
100, 10 KC up to 45,000 KC...

## Oil-Filled FILTER CAPACITOR SPECIALS

All new, in rectangular cans. Standard brands with mounting brackets or feet.

- 2 mfd 600 W.V..... \$ .95
- 4 mfd 600 W.V..... 1.95
- 1 mfd 1000 W.V..... .79
- 2 mfd 1000 W.V..... 1.95
- 4 mfd 1000 W.V..... 2.95
- 8 mfd 1000 W.V..... 3.75
- 4 mfd 2000 W.V..... 3.95

### Transmitting Type Mica Capacitors

- 0.024 1500 V.D.C. ....
- 0.033 1500 V.D.C. .... **79¢**
- 0.056 1000 V.D.C. ....  *Ea.*

## TELEVISION EQUIPMENT

- 8 mc IF transformer for sound channel, 2 winding permeability tuned..... \$ .95
- 12 mc, IF transformer for video single winding permeability tuned..... .55
- 14-prong sockets for television tubes.... .60
- Birnbach adjustable dipole antenna, perfect for 60-66 television band..... 3.30
- SHUR 2-element beam for locations with low signal strength..... 5.70

National, Hammarlund, RME, Hallcrafters, and Temco Receivers and Transmitters... Send for Big, Free Bulletin TODAY!



7TH AND ARCH STREETS, PHILA. 6, PENNA.  
Branches: 5133 Market St. and 3145 N. Broad St. in Phila.  
Also in Wilmington, Del., Easton, Pa., Allentown, Pa., Camden, N. J.

(Continued from page 118)

Jackson County, is the only amateur in the County and is quite popular in the WACWV. All West Virginia hams should start getting their rigs in shape for the 3rd West Virginia QSO Party in April with rules similar to those in April '41 QST. Besides winning a prize this will be a swell time to pick up new counties. WSL is DX'ing on 7 Mc. with low power. CCN, an old-timer, is on 3.5- and 7-Mc. c.w. again after an absence of twenty years. YCK is active with Trunk Line traffic. MOL renewed OPS appointment and reports Huntington Radio Club activity is on the increase. Traffic: W8DMU 11, CSF 4, DFC 3, LXF 2, JM 2. 73. Don.

### ROCKY MOUNTAIN DIVISION

**COLORADO** — SCM, Glen Bond, W8QYT — The San Isabel Amateur Radio Association in Pueblo is on the way to reorganization and reports a good turnout of members the last three meetings. JVJ plans to transmit a series of code practice lessons on 11 Mc. at 7:30 p.m. week nights. 8UEL and JVA worked Alamosa on 3.5 Mc. with six inches of antenna wire. All this was done with their SCR-248As with ten watts input. The Western Slope Radio Club is gradually increasing its membership and hopes to increase its ham activity after the first of the year. IQZ did some nice emergency message-handling with Okinawa this month. It seems that regular commercial communication wasn't getting results but Mitch did it on 28-Mc. 'phone. KP4KD asks that Colorado stations on 28 and 14-Mc. 'phone answer his calls when possible as he needs Colorado for WAS on both bands. 9EHC, in Oklahoma City, has applied for a W5 call. The Electron Club Emergency Net holds its first drill Dec. 16th at 8:00 p.m. As soon as the net is operating others besides club members will be invited to join. OWP, in Brush, is on 3.5 Mc. with 50 watts. 9APZ, also of Brush, is on 3.9-Mc. 'phone and 7-Mc. c.w. with a new HT-9. Traffic: W8WAP 47, 8UQZ 10, 9EHC 4, JBI 2. 73. Glen.

**UTAH-WYOMING** — SCM, Victor Drabble, W7LLH — 7UOM is designing the rotating rig for his beam antenna. 7DTB has been appointed OPS and is working DX on 28 Mc. 7DLR is helping 6GPI get his kw. rig built. 7MQL is Ogden EC. 7JQU is rag-chewing on 3.5 and 7 Mc. 7FST is getting the FARM (Friendly Amateur Radio Mission) net whipped into shape. 7GBB was appointed ORS. Flash! Trunk Line "A" made its grand opening on Dec. 2nd and operators in Utah and Wyoming are needed to handle traffic. Holders of ORS appointment are urged to write the SCM if interested. Trunk Line "AP" also is in need of operators. KP4KD, Puerto Rico, wants to schedule Utah and Wyoming stations on 14- and 28-Mc. 'phone and c.w. in the February/March Contest. Write the SCM for his address. 6KKK can run a kw. on 14 or 28 Mc. 7STB has an FB 200-watt rig with a pair of TZ-40s and modulates with a pair of HY-40s. 8KCT got back on the air on c.w. 7STB reports building a field-strength meter and has his 28-Mc. beam antenna working. 7NPU won a 500-mil. transformer at the Ogden Amateur Club Annual Dinner. The Ogden Amateur Radio Operators Club reports FB comments on its code practice program which is sent on 3825 kc. at 8 p.m. MST. Mondays through Fridays. Traffic: W7FST 963, DTB 26, GBB 2. 73. Vic.

### SOUTHEASTERN DIVISION

**ALABAMA** — SCM, Lawrence J. Smyth, W4GBV — Through donations by KF, EVJ, FZC, EWR, ex-5GDD, FMR, 3EAV, CDC, GOF, and Mr. Skelnick, the Muscle Shoals Amateur Radio Club, JNB, built three different rigs and has the parts to build a 200-watt 'phone rig. The Anniston Club now has twelve members. GVP has a new rig with pair of 100THs in the final on 14 and 28 Mc. GYD is on 14 Mc. with a pair of TZ-40s. HLU is looking for a 250-watt modulation transformer. HZT is on 7 Mc. with an 813. BCU is active on 3.9 Mc. IRX is using a pair of 100THs. BHY is sporting a new call, BA. Officers of new Ben Lane Club of Dothan are: GRJ, pres.; HDF, vice-pres.; KTP, secy-treas.; DMV, emergency chairman. The club meets at the Dothan Recreation Center. The Montgomery Club had as its guest IPEK, of ARRL. Visitors at this club meeting were JLU, FGT, FVT, KTP, ex-BBU, HDF, and FEQ. JYB has a Meissner 150B with an 813 in the final and is building a 28-Mc. job for his car. ECF is rebuilding for the 28 and 14 Mc. bands using a pair of 100THs in the final. 9YET/4 is at Maxwell Field. KWG and 5DHH/4 are at

(Continued on page 118)

# TRANSMITTING TUBES!

WAR SURPLUS STOCKS!  
ALL NEW! ALL GUARANTEED!  
AT FRACTION OF ORIGINAL COST!

**\$7.05**

## A Steal! 807 TUBES

If you could steal these widely used power tubes, it would still pay you to buy them at Newark at this rock bottom price.

**\$6.75**

## Big Saving! 813 TUBES

Popular Beam Power tubes. Factory-sealed cartons. Guaranteed. At a price that took a nose-dive from original cost. Price to you now.

**EF-50 69¢**

## SENSATIONAL BARGAINS!

Mark II Tube Replacements

These tubes are all Brand New, in factory-sealed cartons, and perfect. Order a pair at this amazingly low price.

**E-1148 99¢**

TYPE	DESCRIPTION	PRICE
2AP1	Cathode Ray	\$ 2.25
2C40	Receiving UHF Triode	2.63
2X2/879	Diode Rectifier	.90
3E29/879	Trans. twin pentode amplifier	2.99
100TH	Trans. triode modulator amplifier	4.13
211	Trans. triode amplifier oscillator	1.13
250TH	Trans. triode amplifier oscillator	9.00
304TH	Trans. triode power amplifier	12.00
800	Trans. triode amplifier	2.25
801A	Trans. triode amplifier	1.73
803	Trans. pentode amplifier	9.00
810	Trans. triode amplifier	2.63
811	Trans. triode	1.95
814	Trans. triode amplifier	4.50
815	Trans. HF twin pentode	2.25
826	Trans. UHF triode	2.25
829B	Trans. UHF twin pentode amplifier oscillator	5.25
830B	Trans. triode amplifier	5.25
832A	Trans. twin pentode amplifier	4.05
838	Trans. triode amplifier	3.75
860	Trans. triode amplifier	3.00
861	Trans. tetrode amplifier	90.00
865	Trans. tetrode amplifier	1.50
872A	Trans. diode gas rectifier	2.25
931A	Vacuum multiplier phototube	1.88
2050	Grid-controlled gas rect. (tetrode)	.90
2051	Grid-controlled gas rect. (tetrode)	.90

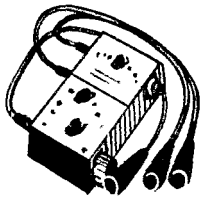

## TWO-CHANNEL INTERCOM CONTROL BOX

This 2-channel control box has wide & varied application in Ham shacks, P. A. & intercom work. Incorporates 4P. DT gang switches, 3 terminal plugs, several 1/4-watt resistors and illuminated dial light including bulb, three 5-foot cables and plugs. Brand new—a terrific buy!

**49¢**

## T-17B MICROPHONE

Sturdy, high quality, lightweight 200 ohm single button carbon mike with press to talk button for transmitters, P. A., etc. Built-in filter to suppress carbon hiss. 5-ft. rubber covered cable and PL-88 3 circuit plug, moisture proof cover.

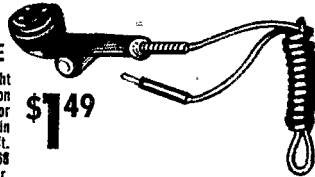

**\$1.49**



## DYNAMOTOR POWER SUPPLY

A fortunate buy enables us to offer a sensational new low price. All brand new. Operates from 6-12 Volt battery. Delivers 500 V DC at 160 ma. Special, your cost

**\$9.95**

- MAIL ORDERS FILLED FROM EITHER NEW YORK OR CHICAGO
- Write: 242-S W. 55th St., N. Y. C. OR 323-S W. Madison St., Chicago
- Send 20% deposit with order. Prices subject to change.

NEW YORK  
Offices & Warehouse  
242 W. 55th St., N.Y. 19

**NEWARK**  
ELECTRIC COMPANY, INC.

CHICAGO  
323 W. Madison St.  
Chicago 6, Ill.

New York City Stores: 115-17 W. 45th St. & 212 Fulton St.

- VISIT OUR BOOTH AT THE IRE SHOW

designed for

# modern amateur **MEISSNER** *Signal Shifter*

Designed to meet the most exacting requirements of the modern amateur, the new Meissner Signal Shifter has built-in band-switching. No coils to change . . . six position switch. Normally equipped with five sets of coils for 10, 15, 20, 40 and 80 meter bands plus a blank strip for any additional new band. All controls placed on front panel. Reduced warm-up time. Minimum power output six watts on all bands.

Choice of built-in or separate power supply.



For complete specifications . . .  
write to the address below today.

EXPORT SALES DIVISION  
**SCHEEL**  
**INTERNATIONAL**  
INCORPORATED  
4237-39 N. LINCOLN AVENUE  
CHICAGO 18, ILLINOIS, U. S. A.  
CABLE ADDRESS  
HARSHEEL

**MAGUIRE**

936 N. MICHIGAN AVENUE,

# requirements!

# THORDARSON

# *Transformers*

Power your new rig with Thordarson . . .  
the transformer that has been helping to  
make and break DX records since radio  
began. New Thordarson designs now  
available to match the newest tubes.

Ask for them at your dealers today.

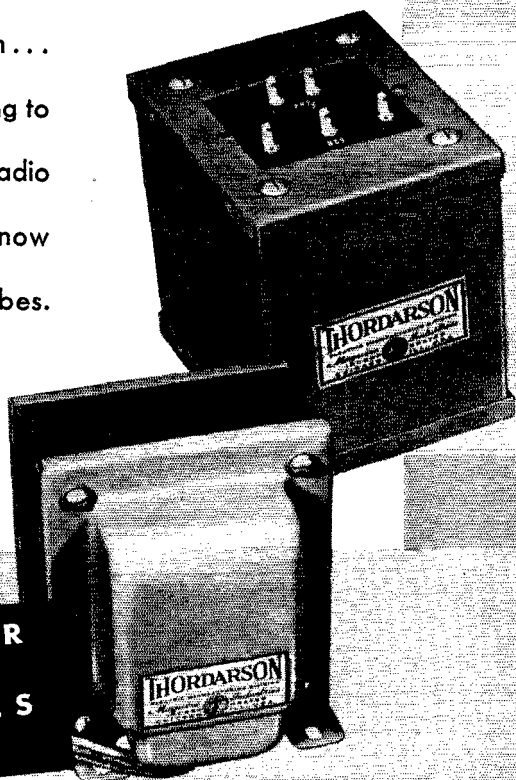

**ELECTRONIC DISTRIBUTOR  
AND  
INDUSTRIAL SALES  
DEPARTMENT**

**INDUSTRIES, INCORPORATED**

**CHICAGO 11, ILLINOIS**

# FIRST

FOR THE  
GREATEST NAMES  
IN  
**HAM RADIO**

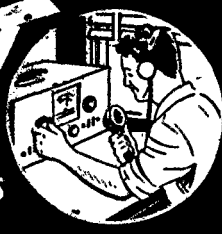

Here they are—the newest Post-War "Ham" Receivers with all the latest improvements in technique and design.

C  
A  
M  
E  
R  
A  
D  
I  
O

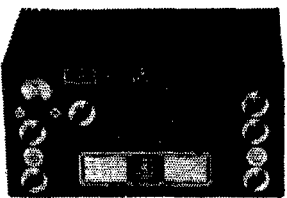

**NATIONAL HRO-5TA-1 • Net \$274.35**  
697 Power Unit \$20.36 • MCS Speaker \$12

A Receiver, designed for the Amateur, to provide dependable communications, under most severe conditions. New Noise Limiter incorporated. Band spread on all "Ham" Bands—Coverage 1.7 to 30 MC.

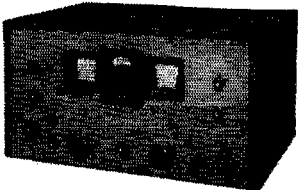

**HAMMARLUND HQ-129-X • NET \$173.25**  
Price Includes Cabinet Speaker

A "Ham" Receiver with the professional touch, providing flexibility of operation. Six bands for easy location of stations. Has all "Ham" features with sensitive and stable performance.

**HALLICRAFTER S-40 • Net \$79.50**  
With Built In Speaker

Performance and beauty are combined in this outstanding Receiver value. Many circuit refinements never before available at this price. Electrical Bandspread Dial—Coverage 540 KC to 43 MC.

HAM RADIO SUPPLIERS SINCE 1919

**CAMERADIO CO.**  
963 LIBERTY AVE. • PITTSBURGH 22, PA.

(Continued from page 114)

Gunter Field. JZD is on 3.9-Mc. 'phone. JLB's traffic total is 12. EVJ, FMI, and ATF of the Rebel Net handled traffic. 73. Larry.

**EASTERN FLORIDA**—SCM, Robert B. Murphy, W4IP—ACZ is doing his part to push our emergency net along. AAO is in San Juan beating out on the 14- and 28-Mc. bands. A new club, the Tropical Radio Club, has been formed in Miami. AKV is having trouble with RCA's v.f.o. in the Ham Guide. Any of you fellows want to help him out? Comdr. McGlathery is secretary of the Key West Ham Club, which is very active. IPEK spent a few days in Jacksonville and Tampa with the ham clubs. DOO has accepted appointment as ORS and OPS and is getting set for EC. Looks like AXX is getting ready for OES appointment. AYW is working e.c.o. and getting in on the CD and SS Contests. IJE, son of AR, now is at the U. of F. and writes for the Gator Club there. DFU is the new call assigned the club station. EZT is president and active members are EPT, HRB, IIO, IJE, JAS, JPY, KCR, KKM, and SZGA/4. KWA is ex-3BY5 and is getting lined up for ORS appointment. DKA is working everything he can get on 28 Mc. and has eighty-two countries to date. 8NGR is in Orange City. HGO has moved and CPG will move his 80-ft. steel poles to Orlando. IMJ has a new DB20. IML is in Washington and is working over 3IAL with 75 watts on 14 Mc. BXL worked a 66-year-old ham, HRA, on Pine Island. 9ZVO/4 is making his first OPS report from Boca Raton; he is on 14-Mc. 'phone. FWZ is doing 95 per cent rag-chewing and is bragging about DU being back on the air. The Dade Radio Club, with BYF as president, held a real c.w. meeting the first of the month and took a count of c.w. men wanting to have our 7-Mc. band stay as such. They are: GOG, BYF, IKI, IP, KPW, FPK, FIR, ITT, CNZ, INR, KMM, DYZ, JIS, SLVV, 2GTW, JIP, KMV, 8OYY, FCL, HWG, IPJ, 2DBS, DEP, BTM, KES, and JZS. I have been on the high end of 7 Mc. and think I'll stay there, so let me hear from you. Traffic: W4BYF 47, 9ZVO/4 6, IP 5, BXL 4, AYW 3, FWZ 1. 73. Merf.

**WESTERN FLORIDA**—SCM, Lt. Comdr. Edward J. Collins, W4MS—DAO and DZX took the Class A and B exams. BCC's ART-13 is perking FB. PGN is going to high with a pair of 100THs. KFP has a new beam. EQR has new three-element beam. FHQ and JPA are on 7 Mc. DAO has been working schedules with ex-EAD up in Wθ Land. HJA has his four-element beam up but is going to raise it to the top of a 65-foot windcharger tower. CNK has been getting the DX cards. JV spent his vacation putting up antennas. 0MEI/4 has been working 14-Mc. 'phone. DZX has a new pair of 810s. 5KXM/4 sounds FB on 3.9 Mc. Please send reports to the new QTH, 1003 E. Blount St. MS has been on 14 Mc. The 50-Mc. Gulf Storm Net is getting under way. JBJ is getting the bugs out of his FB 813 rig. KIK lost a plate transformer but JV came to the rescue with a spare. HWA picked up an FB bunch of DX QSLs for the Jax gang. EQR works the gang at Fairhope on 28-Mc. ground wave (60 miles). Traffic: W4AXP 19. 73.

**GEORGIA**—SCM, Thomas M. Moss, W4HYW—HKA advises that the Albany Radio Club meets on alternate Tuesdays at his shack. GLB is pres., and DIA, secy. ADH, GZV, and IPV are in Albany now. GHU is sporting a concrete block shack. The Valdosta Amateur Radio Club has been formed with JZV, pres.; AAZ, vice-pres.; and APS, secy-treas. The club had a station in operation at the South Georgia Fair. GCD has opened a b.c. station at Palatka, Fla. BC is at Moody Field. CFT has returned to Atlanta. GPQ is back in Valdosta. GIA has been working on installation of WDAR, new b.c. station in Savannah. ICC and JOP are with CAA at Hunter Field. 2DGM is with RMCA and KOP with State Police at Savannah. IAB is chief engineer at WBHF in Cartersville, with GQR and GEG also on staff. ERS is invading the "ultra highs." His jr. operator is out of the Navy and probably will get a ticket. GRU and 5LMN are students at Georgia Tech. KMC, at Brunswick, is ex-6TVE and 2GLB. FME, with FCC, has been transferred to KP4. FIN, of Eastern Air Lines, also is in KP4 now. KRL/TG9OC has been on vacation in Atlanta. 8SYW now is 4JUG. ILH is with wholesale supply house in Atlanta. Our Class I OOs are: BOL, EWY, IKJ, and KAD. They'll help you out on frequency checks. DXI also is OO (Class II). BYY is EC for Clinch County. BQU, EGX, GGD, and EMC are new stations in Cracker Emergency Net. KL is in Old Timers Club. Section RCC members are: DJT, HAH,

(Continued on page 120)



# *A PROFESSIONAL TRANSMITTER* *for the* *Amateur!*

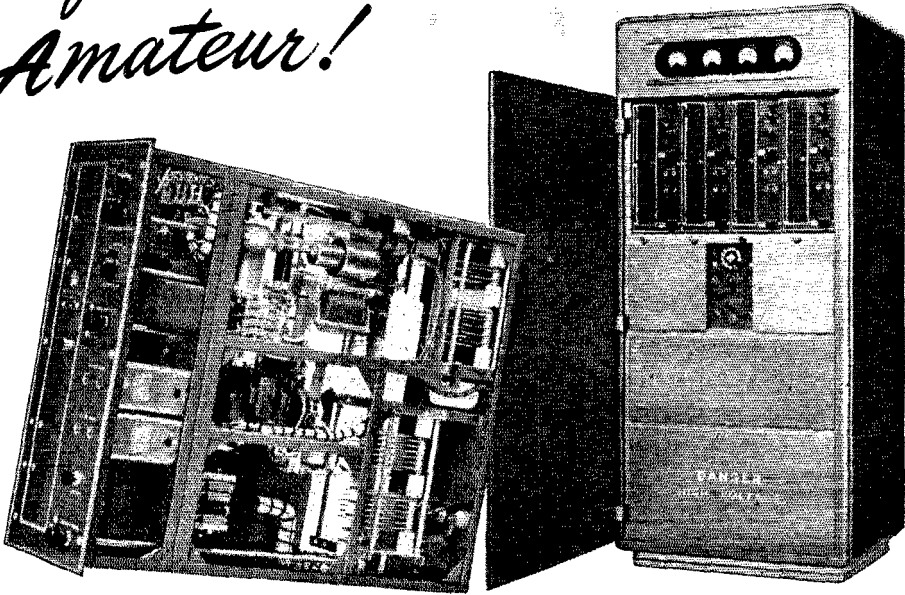

The latest developments in communication science are incorporated in the Wilcox 99A Transmitter. This advanced multi-frequency, 400 Watt carrier unit is now in use by major airlines in the United States. Rectifier, Modulator, Remote Control equipment, and four R.F. Transmitter Channels are housed in one modern steel cabinet. Bands can be instantly selected by telephone dial. Write for complete information.

## **WILCOX STAFF DEVELOPING AMATEUR EQUIPMENT**

A staff of 22 licensed amateurs under the direction of "Vince" Dawson, W9ZJB/3JSL, is developing amateur equipment of the same high quality that has brought fame and universal use to Wilcox commercial and airline products. Watch for these developments from Wilcox.

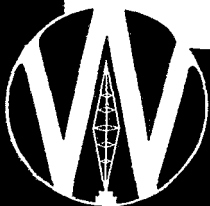

*Amateur Division of*  
**WILCOX ELECTRIC COMPANY, INC.**  
14th AND CHESTNUT STS. • KANSAS CITY 1, MO.



**M & H HAS THE  
FAMOUS MAKE  
Ham Equipment  
YOU'RE LOOKING FOR**

**SURPLUS SPECIALS**

- RK60 Rectifier . . . . . \$1.45
- GL446A . . . . . \$ 2.95
- 354E . . . . . \$ 8.95
- 250TH . . . . . \$18.75

**TRANSMITTING MICAS**

- 5000 V. DC Working
- |            |            |           |               |
|------------|------------|-----------|---------------|
| .0001 MFD  | } 98c EACH | .001 MFD  | } \$1.19 EACH |
| .00025 MFD |            | .0015 MFD |               |
| .0004 MFD  |            | .002 MFD  |               |
- .0003 3000 V. DC Working . . . . . 98c  
 .006 3000 V. DC Working . . . . . \$1.19

**TRANS-METER**

- Complete Transmitter Tester . . . \$49.50

**MILLEN ECO #90700**

- Frequency Shifter . . . . . \$42.50
- Sonar FM Exciter . . . . . \$39.45

**THORDARSON TRANSFORMERS**

- T68R26, 5 V., 3 A.  
150 MA, 7.5 V., 2.5 A. . . . . \$6.17
- T19M14, Universal modulation,  
30 W. . . . . \$7.49

**G. E. TELEVISION CAPACITOR**

- .1 MFD, 7000 V. . . . . \$3.45

**RECEIVERS IN STOCK**

- National HRO-5TA-1 . . . . . \$274.35
- Hammarlund HQ-129X . . . . . \$173.40
- Hallcrafters S-38 . . . . . \$ 47.50
- Hallcrafters SX-42, less Speaker . \$275.00

**MICROPHONES**

- Astatic, JT30, Crystal . . . . . \$10.17
- Universal "KD" Dynamic . . . . . \$10.65
- Electro-Voice 902 "COMET" . . . \$ 7.95

Wholesale  
Radio Parts Division

**M & H**

**SPORTING GOODS COMPANY**

512 MARKET ST., PHILADELPHIA 6, PA.

(Continued from page 118)

HYW, IEO, ILP, IRA, IRL, and IRT. Thanks for the news, fellows. Traffic: W4KV 77, HYW 44, JBM 29. 73. Tom.

WEST INDIES — Acting SCM, Everett Mayer, KP4KD — W8VAJ/KP4 made his debut on 28-Mc 'phone. AK, BK, KD, and NY4CM were active in SS Contest. BE gets out FB on 28-Mc. 'phone with 15 watts. AU contacts W8FFB regularly on 28-Mc. 'phone and replaced 811s with 805s. JA and UG are running 500 watts on 'phone. JA is building combined 14- and 28-Mc. rotary two-element beam. AJ has bisquare beam working FB and made WAC in three hours with W9UGU operating. KD was on 7 Mc. in SS. KP4BJ QSPed following from CM2SW: CM2BZ, BT, CT, and 2SW are rebuilding to higher power. 2BX and 2SW are tied at sixty-nine postwar countries. 2CT worked CR9AG, VS7ES, CR7AD and made WAC in six hours. KP4BC has new call, KV4AD, for Virgin Islands QTH. KB4ERY, Virgin Islands, is KV4AC. KP4BJ is putting finishing touches on 1/2-kw. rig. K4HWO is active on 14 Mc. c.w. The QSL Manager has many cards on hand but few envelopes have come. Traffic: KP4AM 11. 73. Ev.

**SOUTHWESTERN DIVISION**

LOS ANGELES — SCM, Ben W. Onstenk, W6QWZ — The Inglewood Amateur Radio Club now has a combination rag-chew and AEC net going on 50 Mc. Some of the boys are using MBFs and some are using a rig and converter designed by SJF. They are using their old WERS crystals. The Los Angeles Emergency Council is using 50 Mc. for its net operations. RZK is the new EC for Inglewood, MSO having resigned to take over duties as club president. JQB, Box 235, Lone Pine, is Assistant SCM for the Owens Valley area and will handle the work from Lone Pine. SUD is new OO as are TPB and NHF. SUD is ex-XU8OZ. IOX is busy with traffic on the Hit and Bounce Net. The Mission Trail Net started on Dec. 7th using a frequency of 3854 kc. ERT reports a regular schedule with J9ANA, who is ex-CLY. UFJ reports a few of the active CAA hams are: UTD, VU, AGF, SPL, CHC, POM, WTO, OEN, QAE, RXT, JI and 5JBC. BUK is on 28-Mc. 'phone with 400 watts. PNH reports the CCN soon will open again on 3.5 Mc. DEP now is UG. SUD and BQ worked 2450 Mc. from Mt. Wilson to Pasadena. The Mike and Key Club holds open meetings in Santa Monica on the first and third Fridays. That's all the news on hand at this time. If you think that it is not enough, write in next month. Traffic: W6IOX 526, SN 46, OGM 35, ERT 17, NGK 6, EBK 4, UFJ 3, BUK 2, NHF 2, ON 2, MJU 1, VQO 1, VXM 1. 73. Ben.

ARIZONA — SCM, Gladden C. Elliott, W7MLL — Arizona SS entrants were QAP, JPY, MLL, and JEB. QAP was high with 67016. TJG is new vice-president of Phoenix Club. Both Tucson and Phoenix have local nets on 29 Mc. JOK, Phoenix, works PDA, Ajo, on 28 Mc. Ex-IXC is JUY and has a new Super-Pro. GV has a two-element rotary on 28 Mc. RU has an 813 final on all bands. TBJ has a new half-kw. rig. UPM uses a long transmission line in Bisbee Canyon for reception. JMQ has a 28-Mc. mobile rig. New calls are KLA, ex-LPV; KHY; EYT, ex-6EYT; and KFD. Another OM-XYL team is JYH and SHR. OMH has done a fine job with radio classes at Tempe and the boys now are awaiting tickets. JGB has an HY75Q and 1-10 on 144 Mc. in Tucson. JMO has a new boy and JJJ a new girl. SCK and SBN are working in the 3865 Net. KAD and KAE have a new 60-ft. tower on 28 Mc. PBD reports Pacific traffic has fallen off. Bisbee-Douglas Rag-Chew Net includes KAE, KAD, KGT, JXL, JMQ, and UPR. JEY has a new 350-watt rig on 28 Mc. 1MMQ/7 is on 7-Mc. c.w. 5JSF/7 now is KKH. MNH is in Veteran's Hospital in Tucson. Arizona will have a QSO Contest every third Sunday. Points will be given for Arizona contacts only. 73. Glad.

SAN DIEGO — SCM, Ralph H. Culbertson, W6CHV — 9JHD/6 now is 6YDM and is active on 28 Mc. 8BDU now is located in Santa Ana. BAG will be on with a Meissner 150-B. BWO and HWJ are Orange County delegates to new Council of Radio Clubs. QG worked 4GJO on 50 Mc. and has six districts on 50 Mc. using a pair of 24Gs. OEF got back his old call, AWE. QKT is active on 3.5 Mc. in Orange with TIK and UPP on 28 Mc. YBI is on 3.5 Mc. with Signal Shifter. ALO and HAA are on 28 Mc. with MQF sticking to 14-Mc. 'phone. GUMU is on 28 Mc. at La Habra. BFE is on 14-Mc. c.w. at Tustin. PEJ is mobile on 144 Mc. with TR-4.

(Continued on page 123)



# W9FHZ

## Up and Coming!

W9FHZ—Louis McCoy, of Blue Island, Illinois. Listen for him on 10 meters; hear him occasionally on 20 meter CW.

**Order Your Communications Receiver**  
*from ALLIED*  
**IMMEDIATE DELIVERY**  
 on most models  
 Time Payments Available  
 Trade-Ins Accepted

**NEW! HALLICRAFTERS SX-42 \$275.00. Order yours now!**

Hallcrafters S-38 . . . . . \$47.50	RME DB-20 Presselector \$ 68.20
Hallcrafters S-40A . . . . . 89.50	Hammarlund HQ-129X . . 173.25
Hallcrafters S-41G . . . . . 36.75	RME-45 . . . . . 196.70
National NC-46 & Spkr. . 107.40	National HRO . . . . . 274.35
RME-84 . . . . . 98.70	National NC-240D . . . . 225.00
RME VHF-152 Converter 86.60	Hammarlund SPC-400X . 342.00

Net F.O.B. Chicago. Prices subject to possible change.

### • • • ALLIED HAM "FLASH"

**NEW!**  
**2-Meter**  
**Transceiver**  
**Kit**

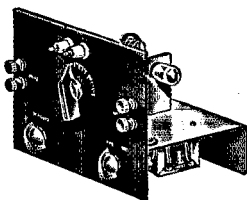

- For the new 2-meter band! Uses 6N4 as mod.-osc. in transmit position and as super regen; det. in receiver position; 7C5 as mod. in transmitting, and as power audio amp. in receiving.
- Supplies current for single button carbon mike; has output transformer for coupling to speaker or headphones. Requires 250 v. at 75 ma., 6.3 v. at .65 amp. for power.
- Kit when completed measures 6" x 5" x 9". Includes all necessary parts and tubes (less mike, speaker and power supply). No. 83-220. NET . . . . . \$18.95
- **Power Supply Kit.** Includes all parts necessary to build power supply for transceiver. No. 83-371. NET . . . . . \$10.25

"Mac" is a "post-war" newly licensed Amateur who received his ticket in September, 1946, and immediately put a 15 watt 'phone transmitter on 10 meters using narrow band FM. From this modest beginning, W9FHZ has grown to full-fledged rating as an up and coming Ham, now using a 600 watt 'phone rig of his own construction. Primarily a ten meter DX-er, "Mac" can point with pride to a total of 34 countries worked in his first two months of operation. As a secondary activity W9FHZ can also be heard doing an occasional bit of brass-pounding on the twenty meter CW band . . .

Newly licensed Amateurs are our pride and joy. Just as in the case of W9FHZ, we take to them and they take to us. We get as much real satisfaction out of helping to build "up and coming" stations as we have in serving our old-time Amateur friends.

"Equipped by ALLIED" is more than just a popular phrase. Behind these words are the whole-hearted interest of ALLIED's hams, the personal service, the vast stocks of station equipment and supplies, the speedy action and the help of a veteran Amateur institution.

### Everything for the Amateur

Catalog No. 111

Here's the Buying Guide that lists everything for the Ham . . . communication receivers, xmitters, Ham gear, code apparatus, parts, kits, tubes, test instruments, etc. Send for your FREE copy.



**ALLIED RADIO CORP., D. L. Warner, W9IBC**  
 833 W. Jackson Blvd., Dept. 27-BB-7  
 Chicago 7, Illinois

- Enter order for . . . . . Model . . . . .
- Enclosed \$ . . . . .  Full Payment  Part Payment (Balance C. O. D.)
- Send Literature on Receivers and Time Payment Plan.
- Send FREE 1946 Catalog.
- Send special bulletins on Surplus Equipment.

Name . . . . .

Address . . . . .

City . . . . . Zone . . . . . State . . . . .

# ALLIED RADIO

*Everything for the HAM*

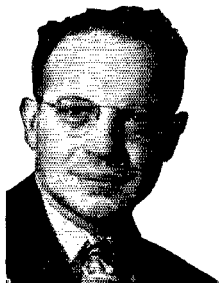

# LEO, WOGFO

**FIRST for SAVINGS**

**FIRST for SERVICE**

The only "personal service" radio parts mail order house in the nation.

## WRL GLOBE TROTTER TRANSMITTER KIT



**Field Reports Testify to Its Superior Performance**

*From Sandusky, Ohio* — "May I congratulate you on turning out such a hot little rig as the 'Globe Trotter'. It's amazing the way this flea-power transmitter bucks the heaviest QRM." — JAY LEIBACH.

*From Bethany, W. Va.* — "I am very well pleased with my WRL Globe Trotter (616-307). My first call resulted in a daytime report of 10db over R9 at 60 miles on 75 meter phone. The quality is excellent, and no hum is reported." — J. S. V. ALLEN, WBUNS.

*From Sandy City, Utah* — "The particular feature of the 'Globe Trotter' that appeals to me is its versatility. With a mere flip of a switch emission can be changed to any desired band, and to either CW or PHONE. For the money charged for these sets in these days of high prices for everything else, it really is a buy!" — O. W. DEKEMER, WFRST.

### IMMEDIATE DELIVERY

Many other actual field reports of amateurs using the Globe Trotter testify to its excellent performance. It's the hottest ham equipment on the market today. The WRL Globe Trotter is capable of 40 watts input on C.W. and 25 watts input on phone on all bands from 1500 KC through 28 Megacycles. Incorporates the Tritet Oscillator using a 40 meter Xtal; Heising choke modulation; three bands, all pretuned; 10, 20, and 80 meters; two power supplies, one for 807 final and modulator tubes, one for speech amplifier and oscillator stage.

**IMMEDIATE DELIVERY — 40 Watt Input. Cat. No. 70-300..... \$69.95**

Complete including all parts, chassis panel, streamlined cabinets, less tubes, coils, and meter.

No. 70-312 same as above, wired by our engineers, \$79.50  
1 Set Coils, Meter, Tubes.....\$15.15 Extra

### New Type PHONO OSCILLATOR



No aerial required. Utilizes high quality loop both as part of oscillator circuit, and radiating medium. Trimmer provided to adjust frequency to any portion of broadcast band between 1250 KC and 1700 KC. Uses 35L6 and 35Z5 tubes.

Wired, less tubes. Cat. No. 16-191..... **\$5.25**

All well-known Receivers available on easy payment plan. Liberal trade allowance. Write us for your wants. All prices quotes are domestic. Write for export prices.

### Get Our New Flyer! Just Printed! FREE!

Giant Radio Map (size 3 1/2 ft. x 4 1/2 ft).....15c  
Handy Tube-Base-Calculator.....25c  
Tube and Circuit Book.....10c



Formerly Wholesale Radio Laboratories  
Address Dept. QST-2, Council Bluffs, Iowa

(Continued from page 180)

MKW is getting up new coaxial antenna for 144 Mc. JDJ is on 14 Mc. c.w. VSG is on 3.5 Mc. YCJ is on 14 Mc., and WRM is on 28 Mc. DEY is on 3.5, 7, and 14 Mc. ROA is on 7 Mc. occasionally. BWO, DHP, HWJ, and MKW remain on 3.9 Mc. IZ is heard on 3.9 Mc. once in a while. VQI has a new SX-42. 9DUC/6 is on 3.9 Mc. from Guatay. 9QAZ/6 is YDS in San Diego. SIG, the R.I., has been signing new call, ML OIN now is KD. 5KFA/6, in El Centro, now is YES. QUS is active on 3.9 Mc. GC reports the newly-formed San Diego Amateur Radio Club meets monthly. 8ALG, now WXW, is active on 28 Mc., as is WUW. FVQ is working plenty of ZLs and VKs. KW is on 3.5-Mc. 'phone with about 25 watts. LUJ worked 2CDJ/J2 in Yokohama and had a nice rag-chew with VESAW, at Whitehorse. JUM has finished new rig for 50 Mc. with a pair of 35Ts about 300 watts, with four-element beam and new 50-Mc. super. VJQ has regular schedules with 1PLY, Rhode Island, and 9SJ, Chicago, Ill., and is building a new rig with a pair of 813s on narrow-band f.m. VJQ is putting out code practice on 28 Mc. Mondays, Wednesdays, and Fridays 1900 to 2000. Participants in the SS Contest include LUJ, MI, VJQ, KSE, and CHEV. RPJ and VJQ are new OPS and VJQ also is OBS. Traffic: 6WVJQ 24. 73. Ralph.

### WEST GULF DIVISION

**NORTHERN TEXAS** — SCM, N. C. Settle, W5DAS — SEC: QA. PAM: ECE. LLV has a BC-610 and an HRO. FDI worked a J9. KPV has a 28-Mc. beam. BSY is looking for QSLs. The ECE Net meets Sunday mornings at 9:00 on 3930 kc. HAJ is on 3.9 Mc. BNQ works real DX on 28 Mc. CPQ is on 28 Mc. JSS has a 28-Mc. beam. EDW, HCA, BNG, LTY, and HAE are back on 28 Mc. GVX is with FBI. IYJ is as loud as ever on 3.9 Mc. FKH is on 28 Mc. LHF has a nice signal on 28 Mc. KRZ is doing a nice job on traffic for GIs overseas. KOA is on 3.9 Mc. HPG, MAW, HFD, FFX, APW, DXR, JQH, and DUZ are on 3.9 Mc. DYK has his old call, DJ, back. TS has a pair of 805s. LTY has a three-element beam, 250-watt 813. CHU is on f.m. GVZ has BCL. JSS has three-element beam. LGM has another call. MAG has an HT-9 at home and a BC-610 at the office. If any members would like some wall paper such as OPS, OBS, OO, Net, or ORS certificates, write us. We have plenty. If you held appointment before the war, please renew same. Do you have a club in your town? Let us know. Activity has been resumed on NTX frequency on 3657 kc. for traffic and EC work. Traffic: W5OJ 46, CDU 21, HCH 17, BYX 10, ARV 8, HCH 7. Skippy.

**SOUTHERN TEXAS** — SCM, James B. Rives, W5JC — HQR reports the Corpus Christi Club sponsored a contest for participants in the AEC simulated emergency tests and GEL, KSS, GMT, FH, and HQR were the most active. BUV took time out to go deer hunting. AYR, formerly connected with the communication facilities of the San Antonio Police Department, advises that he is making the trip to the South Pole with Admiral Byrd and would like to contact stations in this section. EUJ has a new four-element beam. EYB is back in San Antonio on terminal leave and will be on the air soon. HBQ, LGG, HLK, and LHC were active in the SS Contest. KTL is adding another 813 to his final and incorporating compression in the speech amplifier. HBQ has a new three-element beam in operation. LCU, FAH, EWZ, EMV, and FND participated in a fifteen-minute program over a Harlingen broadcasting station featuring a 28-Mc. QSO with a mobile station in Chicago. ARRL Assistant Secretary IPEK and your SCM were recent visitors at a meeting of the Houston Amateur Radio Club. BHO is active on 144-Mc. 'phone. GWL is out of the service and has a new rig on all bands in Houston. AOK is operator for KWBU and has a pair of 35Ts and a four-element beam on 50 Mc. and is interested in schedules with other stations in this section. ACL has 200 watts input and a "V" beam on 14 Mc. 6UBP has been issued the call EMV and now is located in Harlingen. EWZ worked VPSAD for country No. 43. JPC is active on 3.5 and 7 Mc. between shifts at the broadcasting station. MN is maintaining daily traffic schedules. 73. Jim.

**NEW MEXICO** — SCM, J. G. Hancock, W5HJF — VN is active in traffic work on 7 Mc. KXX reports a new YL jr. operator to help jr. operator Jimmy. HJF was active in Sweepstakes with forty-six sections worked out of ninety-five contacts in sixteen hours, twenty-five minutes. Traffic: W5VN 10, HJF 4. 73. Jake.

(Continued on page 184)

# SPRAGUE TRADING POST

**WANTED** — Used Meissner signal shifter. State coils, condition and price. Ted Chartrand, 707 E. Spruce St., Sault Ste. Marie, Mich.

**FOR SALE** — HRO receiver 6 coils, speaker and power supply, covers broadcast & s-w, 430 kc to 30 mc. S-w coils have bandspread on 80-40-20-10. Good condition. \$200. E. Shafer, 2389 E. 116 St., Cleveland 20, Ohio.

**WANTED** — BC610 amateur xmitter. Will trade radio servicing eqpt. and BC-375-E also good radio correspondence course and books. K. H. Stello, Box 1293, Hollywood 23, Calif.

**WANTED** — Communications type receiver, Sky Champion or what have you? Have German Welta Camera and case to swap. Orville C. Stone, P. O. Box 775, Rapid City, So. Dak.

**WILL SWAP** — New Eimac 450TL and GE 872A tubes for plate transformer 3000-2500-2000v. d-c at 600 to 800 ma. with 110-220 primary (Thermador B-44 or equivalent). Need 4 mfd. 4000v. Spracol condensers. Jack Simpson, W3514 Lacrosse, Spokane, Wash.

**SWAP OR SELL** — QST's in perfect condition from Jan. 1922 to Dec. 1946; one pr. National lead through bushings, new, Type XS-3; collection amateur station photos, over 1100, value over \$100. W. Morris Harwood, 3104 Edgewood Ave., Richmond 22, Va.

**FOR SALE** — Millen exciter with power supply, tubes, crystals, coils. Also BC221 Frequency; 36" Bud relay rack (enclosed); tubes, condensers, transformers, misc. parts. Write for list. Howard O. Severid, 2924 Station St., Indianapolis 1, Ind.

**SWAP OR SELL** — SCR 284A with dynamotor, couple of extra com. receivers. Want 5" C. R. scope, test eqpt., and freq. meter. I. Lass, W2BTH, 1859—62 St., Brooklyn 4, N. Y.

**FOR SALE** — 2-meter outfit complete with TR-4 AC and vibrator supplies, mike, di-pole ant., 2 bias bat. and about 40' co-ax cable. John F. Powers, 82 Columbia St., Adams, Mass.

**FOR SALE** — New Biley SMC-100 100kc frequency std. crystal, \$16. Never used. Proper inductance coil and socket included. William H. Sypher, 133 Walnut St., Milton, Pa.

**FOR SALE** — Complete ham station. Extremely compact 100W phone-w/ xmitter, custom built by engineer. Also HQ-120 receiver. E. Harris, W9KNK, 3319 Catalpa ave., Chicago 25, Ill.

**FOR SALE** — Hallicrafters Super Defiant with or without matching speaker. Used 1100 logged hours, tubes replaced at 1000. Has switch key for locking ON-OFF. Cash or trade. Willard Bedwell, 1204 Laurel Ave., Knoxville, Tenn.

**WILL SWAP** — 30-watt phone transmitter; 200-300mc receiver, etc. and many other radio parts. Want high-voltage power supply components, meters, etc. Send your list for mine. George R. Cryder, Delaware, Ohio.

## BUY • SWAP • SELL

**WANTED** — Receiver such as S19R, S20R or SX24. Describe fully. Also want de luxe signal shifter. Will trade pair of 809's for what have you? W9M10, 919 W. Fourth St., Mt. Carmel, Ill.

**WANTED** — Rotary beam motor geared from one to two r.p.m. Must be in good operating condition. Describe fully. John Stiness, 116 Blaisdell Ave., Pawtucket, Rhode Island.

**FOR SALE** — BC-375-E with or without dynamotor. Compl. with tuning units and antenna tuner. Also 10-meter rotatable dipole with 1 r.p.m. motor drive. A. Harris, 10722 Lee Ave., Cleveland 6, Ohio.

**FOR SALE** — BC375 xmitter with tubes, a-c filament supply, selenium rectifier, mike, bug key, \$50. Complete 175-watt CW transmitter beam final, 1500v. and 400v power supplies, with crystals, \$65. T. E. Powers, 2330 18th St., San Pablo, Cal.

**FOR SALE** — Stancor 100MB 100-watt bandswitching CW 6L6-807pp transmitter, complete, \$95; Stancor 20P 20-watt phone/cw 6L6-807 xmitter complete, \$35. Composite 30-watt phone/cw 6V6G-807 xmitter, \$75. All prices f.o.b. Stewart S. Perry, 36 Pleasant St. Wintrop, Mass.

**FOR SALE** — PR-16 communications receiver with Jensen baffle and 12" speaker; also portable phono recorder assembly. F. F. Knapp, 6508 Montgomery Rd., Cincinnati 13, Ohio.

**FOR SALE** — Entire foundation unit for Hallicrafters HT-9 xmitter. Cabinet has hinged top and interlock switch. 4" punched chassis fitted to cabinet, etc. V. Harris, 6748 N. Ashland, Chicago, Ill.

**FOR SALE** — Navy long wave receiver model RBL-3, \$50; SW3 receiver complete, \$25; complete Instructograph code outfit, \$25; 1939 Buick car radio, \$20; SX25 Hallicrafter receiver, \$30. Douglas Phelps, 10 Smith St., Sidney, N. Y.

**SWAP OR SELL** — Esaco motor generator d.c. volts 500, d-c amps. 1/4. Need power transformer 1750, 1500, 1250 volts d.c. R. H. Brothers, 1915 Muscatine, Iowa City, Iowa.

**WANTED** — 800v 350 to 400 ma. out-put belt-driven d.c. motor generator or 110v a.c. belt-driven alternator 1500 to 2000 watts. Edmund Hassing, Jackson, Minn.

**FOR SALE** — 2-meter transceiver; pair new RCA 8005 tubes; new Thord. 10v 8A fil. transformer for above tubes; new RCA 815; new Hytron HY31-Z; new HY69; set of Coto coils and Cardwell tank cond. for 300-watt phone rig. L. R. Mitchell, 4 Sidney St., Wakefield, Mass.

**FOR SALE** — S-9 Skyrider, S-19-R Sky Buddy; Browning Proselector, RCA-ACT-40 nearly converted to 400-watt phone. \$225 for all, or will accept small 10 or 20 meter xmitter and receiver as partial payment. R. F. Burns, 1161 Eaton Ave. Beloit, Wis.

# SPRAGUE **KVO**

KILO-VOLT-OIL  
TRADEMARK APPLICATOR

## TRANSMITTING CAPACITORS

THINK of getting a .1 mfd. 7500 v transmitting capacitor in a size no larger than 2 1/4" wide x 3 3/4" wide x 3 3/8" high — conservatively rated and fully guaranteed in the bargain! Or a 2 mfd. 1000 v round job that is only 2" diameter x 2 1/8" high!

These sizes are typical of the new Sprague types filled and impregnated with KVO, the famous wartime oil development. They're absolute tops for performance and they're modest in price. See them at your jobber's today. Streamline your new rig with compact, modern components that give you full benefit of engineering progress achieved during the critical war years!

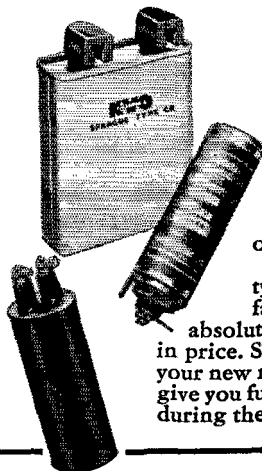

### YOUR OWN AD RUN FREE!

Sprague will gladly run your own TRADING POST ad free of charge in the first available issue of one of the six radio magazines in which this feature appears. WRITE CAREFULLY or print. Hold it to 40 words or less and confine it to

radio subjects. Sprague reserves the right to rewrite ads as necessary, or to reject any that do not in our estimation fit in with the spirit of this service.

*Harry Nathan* Sales Manager

DEPT. Q-27, SPRAGUE PRODUCTS CO., NORTH ADAMS, MASSACHUSETTS

# Get back on the AIR with . . . SHURE STRATOLINER MICROPHONE

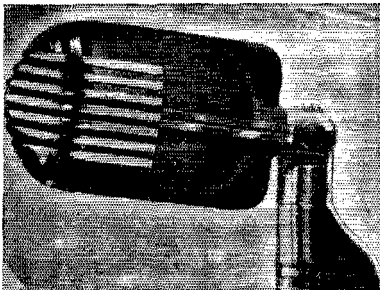

This expensive-looking, low-cost Microphone reproduces your voice clearly and fully. High output level with sharp speech response. Designed especially for Communications, Recording and Public Address. Has all the features of more expensive Microphones such as swivel-head, built-in cable connector. Genuine Bimorph Crystal. Model 708A.

List Price . . . . . \$21.35

# SHURE 707A CRYSTAL MICROPHONE

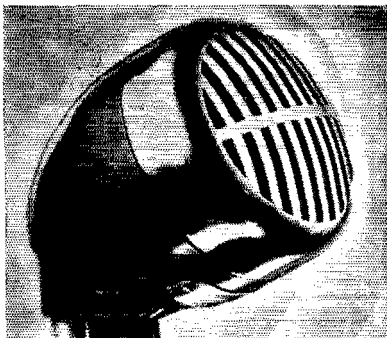

A quality Microphone at low-cost—has long been a favorite among HAMS for dependable service and clear speech reproduction. High output. Attractive modern die-cast case in Iridescent Gray finish with highly-polished plating on front grille. Model 707A.

List Price . . . . . \$13.50

Available at Shure Distributors  
everywhere

Licensed under the Patents of the  
Brush Development Company.



# SHURE BROTHERS, Inc.

Microphones and Acoustic Devices  
225 W. Huron St., Chicago 10, Illinois  
Cable Address: SHUREMICRO

(Continued from page 122)

## CANADA

### MARITIME DIVISION

**M**ARITIME—SCM, A. M. Crowell, VE1DQ—EY, our RM, is net control station for Maritime Net on 3545 kc. with 400 watts input looking for some live schedules. He now schedules VE2UO daily at 7:25 P.M. AST. PV says he has a tough time contacting Cape Breton boys on 3.5 Mc. OK and OM were recent visitors of DZ and HR in Trenton, N. S. The Halifax Ladies Dit and Dah Club is showing an increase in members and code class is making good progress. GI was a recent visitor at LCARC meeting. JO is on 3.8-Mc. 'phone now. LZ got the new "scope" working. IE has the new 500-watt "rockcrusher" putting out FB on 3.8-Mc. 'phone. Secretary Inglis of the Lakeburn Radio Club reports FB progress with thirty members. LO and QT request more 50-Mc. activity. PA is once again active on 3.8 and 14 Mc. IU's very FB commercial-looking job is going strong on 3.8, 7, and 14 Mc. TN still gets good reports from the BCIs. RE is lining up the high power—looks like an 813. QT snagged a few Gs on 3.8 Mc. BF, who works on 14 and 28 Mc. has some good DX and twenty-five countries so far. VE3AHA hopes to hit the air with a small half-kw. soon. QS gets out well with the three element, and just finished 16-tube super. Traffic: VE1HJ 26, EY 13.

### ONTARIO DIVISION

**O**NTARIO—SCM, David S. Hutchinson, VE3DU—I would like to see all the Ontario boys qualify for a Code Proficiency Certificate, and each month will give the calls and speeds of those who qualify. The following qualified during Aug., Sept., and Oct.: BCS, 15 w.p.m.; AEBZ, BAJ, AMI, SF, 20 w.p.m.; BIN, AFY, BAJ, 25 w.p.m.; EF, AXQ, ATR, 30 w.p.m.; and EF, IA, 35 w.p.m. OJ is on 3.5 and 28 Mc. with QRP job. BDX's score in the SS was 23,997. BBR, ex-VE4, snagged a few new states. UD is on 28-Mc. 'phone with 807. The OARTA had a social on Dec. 11th. BEB is using 814 on 14 Mc. and is proud of his first ZS. VD is working 7-Mc. DX with low power. OI has a new HQ-120X receiver. BCS is keeping schedules with HP and GN. ATR has his code up to 35 w.p.m. now. QK schedules WX and 2DR. WB with 75 watts, has knocked off twenty-eight countries on 28 and 14 Mc. and is located at Pagwa Radio Range Station. BAJ, also of Pagwa, has 6F6 on 7 Mc. with 8 watts input and is looking for QSOs. HP schedules Montreal, North Bay, Stratford, and Dundas on 3.5 Mc. Don Gunn is new ASC for Toronto East Squadron AFARS. AEM, BKS, and UT are on 112 Mc. UO is back on 3.5-Mc. 'phone. CP reports two 'phone nets formed on 3.5 Mc. Net A consists of CP, AEBZ, APM, AKR, GO, TG, IO, OI, QB, and UA. Net B consists of NX, AIV, AOQ, FP, JH, KE, KM, and YI. UA and JH are on Trans-Canada net. Ontario is claiming the youngest YL operator in the person of Georgette Ottney, VE3AMC. WSRG is looking for permanent club room. 2XR, ex-3LR, donates a cup for the SS Contest. AEM is building sixteen-element beam for 112 Mc. AIB says his antenna pole looks like a cross-bow. The Intercity ARA now is split into two clubs, London and St. Thomas. Traffic: (Oct.) VE3BDX 20, JT 4, (Nov.) HP 134, QK 36, VD 8, BDX 7, BCS 5, OJ 3, ATR 2. Dave.

### VANALTA DIVISION

**A**LBERTA—SCM, W. W. Butchart, VE6LQ—New officers of the CARA are: AO, pres.; ZL, vice-pres.; DF, secy.; AY, treas.; AS, act. mgr. HQ bought a BC-375E. SB, AP, and WL have BE-375Es. GH is using 814s in final. XZ is getting out with single 6L6. JB is working out FB on 3.7 Mc. GD, WG, AO, FK, TM, BU, QS, and AF helped the CARA out in the SS. GD is using 810s final. The NARC accepted an offer from D.N.D. of a club house and 300-watt rig. EA has an 813 on 3.9 Mc. with 150 watts input. EB is one of the most consistent 3.9-Mc. signals heard in Edmonton. MJ bought 6AL's old rig and AL now has an HT-9. OG is using single 807 running 30 watts on 3.9 Mc. 6LA has new three-element beam. VE7WP is using BC-375E converted for ham use. SZ is on 14-Mc. 'phone. LG has an 813 rig and is using "plug-in" exciter units. Ex-4IN now is VE7ZQ. 6BW is building a new 100-watt heap. 6HM is installing pair of 3BTGs in final. WG is attempting to get traffic moving on 7 Mc. AO ties in with W7JMH, W7IEE,

(Continued on page 126)

# NEW! 152-162 Mc fm

Specifically designed for the Urban Mobile Service Band



## KAAR

### Radiotelephones

**INSTANT HEATING**



POLICE



FIRE

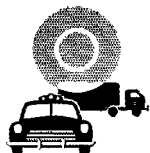

TRANSPORTATION



FOREST & RANGE

- ★ Improved Voice Quality
- ★ Higher Sensitivity
- ★ Greater Noise Rejection
- ★ Lower Battery Drain

Tested and proved equipment specifically designed for the 152-162 Mc band is now brought you by the engineers who made instant-heating FM practical. The new KAAR FM-175X transmitter and FM-40X receiver are thoroughly engineered to do a better job in the urban mobile service band.

You will hear a startling improvement in voice quality. A special circuit boosts the low tones, rounding out the voice quality to a naturalness that actually permits recognition of the speaker's voice! Controls are reduced to a minimum, making operation almost automatic!

Service men will find that this new KAAR equipment requires a minimum of upkeep and repair. For quick checking and servicing dust covers can be removed by a quarter turn of two airlock fasteners. The entire chassis can be released simply by freeing two slide catches.

KAAR instant-heating transmitters with zero standby current eliminate the need for costly special generators or extra batteries. Only about 4% of the current used by conventional equipment is needed.

#### IMPROVED OVER-ALL FREQUENCY RESPONSE THROUGH KAAR FM TRANSMITTER AND RECEIVER

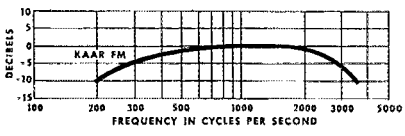

#### SEND FOR NEW BULLETIN

Write today for illustrated bulletin number 26-47 giving complete details of the FM-175X transmitter and FM-40X receiver. No obligation, of course. KAAR ENGINEERING CO., 605 Emerson St., Palo Alto, California.

READY TO GO... INSTANTLY! **KAAR**

**KAAR ENGINEERING CO.**  
PALO ALTO, CALIFORNIA



# AMATEUR GEAR

## CONNECTICUT AND MASSACHUSETTS HAM STORES

### FEBRUARY SPECIALS

- Speed Key—J-36 Army Bug. Regular Price \$13.95. New.....**\$7.95**
- Gorgeous 25-ft. Sectional Field Antenna Pole. 14 Sections. Reduces to Any Length, with Guys, Worth \$40. Immediate Shipment Prepaid: Dozens of Uses. **\$11.50**
- 4 mfd. 600 V Oil Cond.....**60¢**
- 2 mfd. 600 V Oil Cond.....**50¢**
- 3 mfd. 1200 V Oil Cond.....**90¢**
- **TUBES! TUBES!**
  - 6AG7.....**49¢**    834.....**\$3.95**
  - 6AC7.....**49¢**    832.....**\$5.50**
  - The Best 807's Only.....**\$1.60**
  - 5BP1—90-day Guarantee.....**\$6.50**
  - 3E29—829....**\$3.95**    6B4G.....**\$1.25**
- Russian Tank Job—Complete—As Army packed—All Parts and Tubes.....**\$78.50**

**CONNECTICUT:**  
Hartford, New Haven, Bridgeport, New London,  
Stamford, Waterbury. **MASSACHUSETTS:** Boston  
and Lawrence

**HATRY & YOUNG**  
**The Elect in Electronics**

### EASY TO LEARN CODE

It is easy and pleasant to learn or increase speed the modern way — with an Instructograph Code Teacher. Excellent for the beginner or advanced student. A quick, practical and dependable method. Available tapes from beginner's alphabet to typical messages on all subjects. Speed range 5 to 40 WPM. Always ready, no QRM, beats having someone send to you.

#### ENDORSED BY THOUSANDS!

The Instructograph Code Teacher literally takes the place of an operator-instructor and enables anyone to learn and master code without further assistance. Thousands of successful operators have "acquired the code" with the Instructograph System. Write today for full particulars and convenient rental plans.

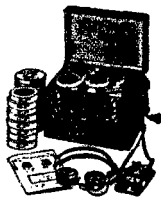

### INSTRUCTOGRAPH COMPANY

4709 SHERIDAN ROAD, CHICAGO 40, ILLINOIS

(Continued from page 104)

and VE7AEU on Mondays, Wednesdays, and Fridays at 2000 and schedules VESAL at 2230 three times weekly. AO participated in SS Contest. WG has schedule with W3OE. MJ increased power to 180 watts. Traffic: VE6AO 48, LQ 32, WQ 18, MJ 4.

YUKON — Acting SCM, W. R. Williamson, VESAK — A meeting of the YARC is held every two weeks at different homes in Whitehorse. Regular attendants are BB, AS, AJ, AG, AK, and AY. AS is on 14-Mc. c.w. AY uses 813 on 14 and 7 Mc. AW operates 14-Mc. c.w. AG uses pair 807s on 3.8-, 14-, and 28-Mc. 'phone. AJ rebuilt rig to 809 final, and is getting out FB on 3.8-, 14-, and 28-Mc. 'phone. AK has rack-mounting rig, using a single 807 on 'phone and c.w. on 3.8, 14, and 28 Mc. AR is using 6L6. AO can be heard on all bands, 'phone or c.w. AL and AI operate from Teslin Lake. AM is heard with low power on 3.5-Mc. c.w. Look for VESs between 3.8 and 3.58 Mc. on 'phone. On 14 Mc. most of the Whitehorse VESs operate between 14,150 and 14,200-kc. 'phone, while on 28 Mc. they operate from 28,200- to 28,500-kc. 'phone. 28 Mc. has been very disappointing, as far as DX goes. Forward reports to VESAK the first of the month.

### PRAIRIE DIVISION

MANITOBA — SCM, A. W. Morley, VE4AM — Traffic is on the upgrade but we can use some more CD men. What appointment meets your qualifications and interest? KC, at Rivers, left for Lethbridge. BD is rebuilding to p.p. parallel 807s. TV has been changing antennas. KD is still popping crystals. ET, of Rathwell, is on 7 Mc. JN, Waskada, is putting in p.p. 807. DG, our 60-Mc. expert, is spending some time on 3.5 Mc. WF is running p.p. 813 on all bands. XO went to town in SS. FW moved from the shack to house because of cold. EH, Berens River, is on 7 Mc. RH, Dauphin, is building single 813 when time allows. AW runs 2A5, 807, p.p. T40. XP is never satisfied and is rebuilding again. PA is working on new final but won't let us in on it until it is finished. CN is new call and runs 807, p.p. 807. KW also is new. Welcome, fellows. AC is our PAM and has been doing FB work on a trans-Canada 'phone net. It's kinda late but HAPPY NEW YEAR ALL. Traffic: VE4AM 68, KD 35, AC 8, HS 5. Art.

SASKATCHEWAN — SCM, Arthur Chesworth, VESSY — MP is on 28 Mc. and worked a G. GA has been made a life member of the Regina Radio Club. RB has a 5-watt rig on the air. CI is looking for a new RME-84. RP is building a new super. HI is working a net out of Meadow Lake. EV is having trouble with 28-Mc. oscillator. MW and 4AU have a schedule at high noon. GU is building a speech amplifier. LM gets out FB with his 10-watter. JS was heard just inside the band. RD has 8HJK beam working nicely on 28 Mc. and has an 813 in the final. QT is waiting for a new generator so he can increase his power. AU is on the air from Brandon with 500 watts. Heddie Sinclair, R.I. of the Saskatoon district, has recovered from a serious illness. A large number attended the recent Regina Club meeting. KE is going strong at Wilcox. Thanks, RD, for the above news. JP has applied for ORS appointment. TX is doing good on 28 Mc. with 35 watts. ML is very busy on 5-kw. job. JV has 28-Mc. beam. The Moose Jaw Club held an enjoyable meeting recently with a good turnout. N. E. Thompson, VE5CO, is your new SCM. Please give him all possible support. The new QSL Manager is Fred Ward, VE5OP. Traffic: VE5MW 7, 73. Ches.

### "It Seems to Us . . ."

(Continued from page 14)

Obviously the operator of a club station or one with more than one operator might occasionally engage in "we" if that's what he means, but there is no excuse otherwise for we-weing all over the place. And if he can't shake the ham-radio jargon during his operating, he should at least try to get back to "I" during his off-the-air hours. Otherwise, when he comes up with "we," people will think he has little men surrounding him or perched on his shoulders. We don't know — maybe he has!

B. G.



# HARVEY for COMPLETE RIGS...

You've been waiting for it and here it is—the complete Collins line. Harvey is now taking orders for quick delivery on the entire line.

**The Model 30K-1 Xmitter complete with 310A-1 Exciter and all tubes. 500 watts input on cw, 375 watts on phone....\$1250**

**32V-1 150-watt Xmitter (120 watts on phone) Complete with tubes, using the stable and accurate Collins VFO.....\$475**

**70E-8, a VFO that is really engineered. It is new, versatile and extremely accurate. Overall accuracy and stability are within 0.015%. Can be used for all bands with appropriate doublers up to 3/2 meter. Complete with calibrated dial. One of these is the heart of a good band switching exciter unit that will make multifband operation a pleasure.....\$40.00**

**The receiver to end all receivers...the Collins 75A. 80-40-20-15-11-10 meter bands. Straight line tuning, dial calibrated directly in frequency. 50db image rejection on all bands, uses double conversion. Permeability tuned. Extremely high stability, uses separate oscillator for mixers. Complete with tubes, crystals and speaker..... \$375.00**

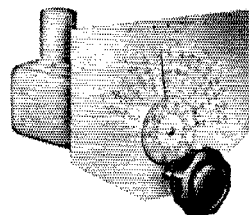
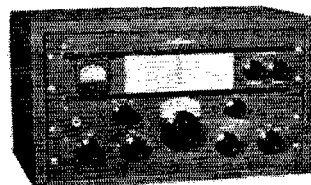
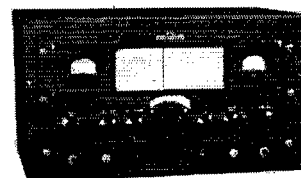
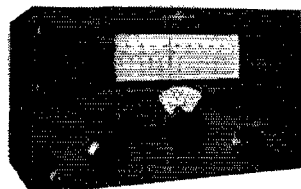
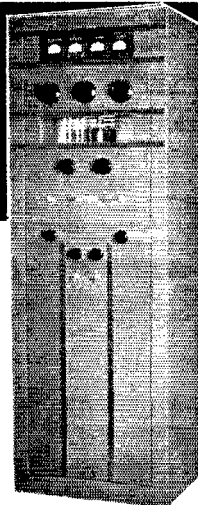

## HARVEY'S HITS OF THE MONTH

Harvey has 20 meter crystals for a buck! Mounted in holder with 1/2" pin spacing. Also 40 and 80 meter and 6 and 13 mc bands at the same low price.....\$1.00

Special 8 mc. xtals for 2 meter xtal control, only.....\$1.50

Also in stock complete line of Billey AX-2 xtals.

Include 10¢ postage with your crystal order.

## HARVEY'S HAMFESTIVAL OF VALUES



**Type 1616 Half wave high vacuum rectifier. Quantities limited on this excellent value so order at once. Characteristics: Filament, 2.5 volts, 5 amps; Peak inverse, 5500 volts; Peak current, .8 amp; Surge current, 2.5 amp; Average plate current, .130 amps. List price \$7.50... Harvey Special Price, 95¢**

**Handy-Talky HT-144... a 1947 engineered transceiver for the 2 meter band. Completely telescoping antenna actuates on-off switch. Press-to-talk single hand control. 45 to 75 hour B-battery life, A battery 10 hours. Rapid change battery compartment. 6C4 and 1S4 tubes. Weighs 4 pounds with batts. HT-144... \$31.50, A batt. 50¢, B batt. \$1.75, tubes \$2.49 set.**

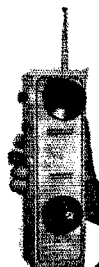

**Millen 90700 ECO in stock for immediate delivery. Quantity limited. Complete with tubes and output coupling.....\$42.50**

(Quantities limited on some items, send your order at once.)

**Note: All prices quoted are Net, F.O.B. New York City and are subject to change without notice.**

Telephone: 7-1000 Longacre 3-1800

**HARVEY RADIO COMPANY INC.**

103 West 43rd St., New York 18, N. Y.

# Feather Light MINIATURE Test Meter

Dependable accuracy plus convenient pocket size make these little instruments most useful and popular aids to better amateur station performance. Self contained standard size batteries supply current for resistance readings. Three models are available in this small size: 3 15/16" x 2 3/4" x 2".

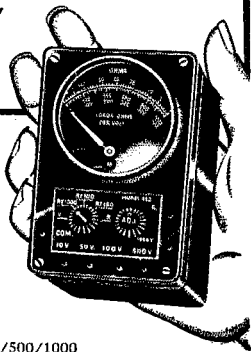

### Model 450A Volt-Ohm-Milli-ammeter

The outstanding value in the test equipment field. D'Arsonval movement. Zero adjustment. Rotary range switch. 1000 Ohms per volt.  
Volts DC: 0-5/10/50/500/1000  
Mils DC: 0-1  
Ohms: 30/300/3000/5000/50,000/500,000

### Model 451A AC-DC Volt-Ohmmeter with Output Ranges

Shipping weight 2 lbs. Price only \$9.75 net  
Volts DC: 0-10/50/100/500/1000  
Volts AC and Output: 0-10/50/100/500/1000  
Ohms center scale: 7200 Price only \$13.65

### Model 452A High Sensitivity Volt-Ohmmeter

10,000 Ohms per Volt  
Volts DC: 0-10/50/100/500/1000  
Ohms full scale: 2000/20,000/200,000/2,000,000  
Ohms center scale: 30/300/3000/30,000  
Price only \$13.65

Ask your Jobber or write direct for circular

America's Pioneer Makers of Pocket Test Equipment

**CHICAGO INDUSTRIAL INSTRUMENT CO.**

219 West Chicago Avenue

CHICAGO 10, ILLINOIS

## 813 Amplifier

(Continued from page 87)

ating it at full input and then suddenly removing both excitation and load. The cathode current should immediately fall to a very low value, about 15 or 20 ma., and it should remain at that value regardless of any setting of the grid or plate tuning condensers. This and only this is the real indication of stability. If the cathode current shows the slightest tendency to "kick" at any setting of the dials, the neutralization is probably incomplete, and it should be rechecked after disconnecting the plate voltage.

### Operation

The new published ratings for c.w. operation of the 813 permit plate input to be run as high as 500 watts for intermittent commercial and amateur service. To obtain this input, the tube ratings are 2250 volts on the plate, 400 volts on the screen, -155 volts grid bias. Plate current under these conditions should be no more than 220 ma., screen current no more than 40 ma., and grid current 15 ma. With lower plate input, the grid current and grid bias can be less. For example, with a 1500-volt plate supply, the operating conditions are as follows: screen voltage 300, grid bias -90, plate current 180 ma., screen current 30 ma., grid current 12 ma. (if a 7500-ohm grid resistor is used). The new 'phone ratings permit a maximum plate input of 400 watts, secured as follows: plate voltage 2000, screen voltage 350, grid bias -175 volts, plate current 200 ma., screen current 40 ma., grid current 16 ma. (assuming a grid resistor of 11,000 ohms). For 1600-volt operation the values are reduced as follows: plate voltage 1600, screen voltage 400, grid bias -130, plate current 150 ma., screen current 20 ma., and grid current 6 ma. (assuming a grid resistor of 21,600 ohms).

The amplifier should remain stable under all operating conditions. Under plate modulation the plate current should remain constant up to 100-per-cent modulation unless the grid drive is inadequate or unless the screen is not operating under the proper conditions. Again it should be stressed that the adjustment of the screen voltage in a tube of this sort is almost the key to success or failure. If the screen is given the kind of treatment it demands, no troubles should be encountered.

### A Stacked Array

(Continued from page 41)

wide range either side of the cut frequency that is all one need worry about.

The ease with which the system takes power should not be regarded as an indication of proper matching; in fact, it may be quite the opposite. Moving the "T" clips close to the center will increase the loading, but it will be noted that when this is carried too far the standing-wave ratio will go up sharply. Broad frequency response and low standing-wave ratio are the things to watch

(Continued on page 150)

PRECISION MOVEMENT  
DEPENDABILITY UNLIMITED

**Burlington**  
INSTRUMENTS



- Alnico Magnets in all DC Instruments—phosphor bronze control springs—perfectly aligned jewel supports—non-shifting balance weights—added to many other superior construction features enables Burlington to maintain critical characteristics.

All ranges AC or DC available in 2 1/2", 3 1/2", 4 1/2" sizes, rectangular and round.

Inquiries invited for your specific requirements.

**BURLINGTON INSTRUMENT COMPANY**  
813 Fourth Street • Burlington, Iowa

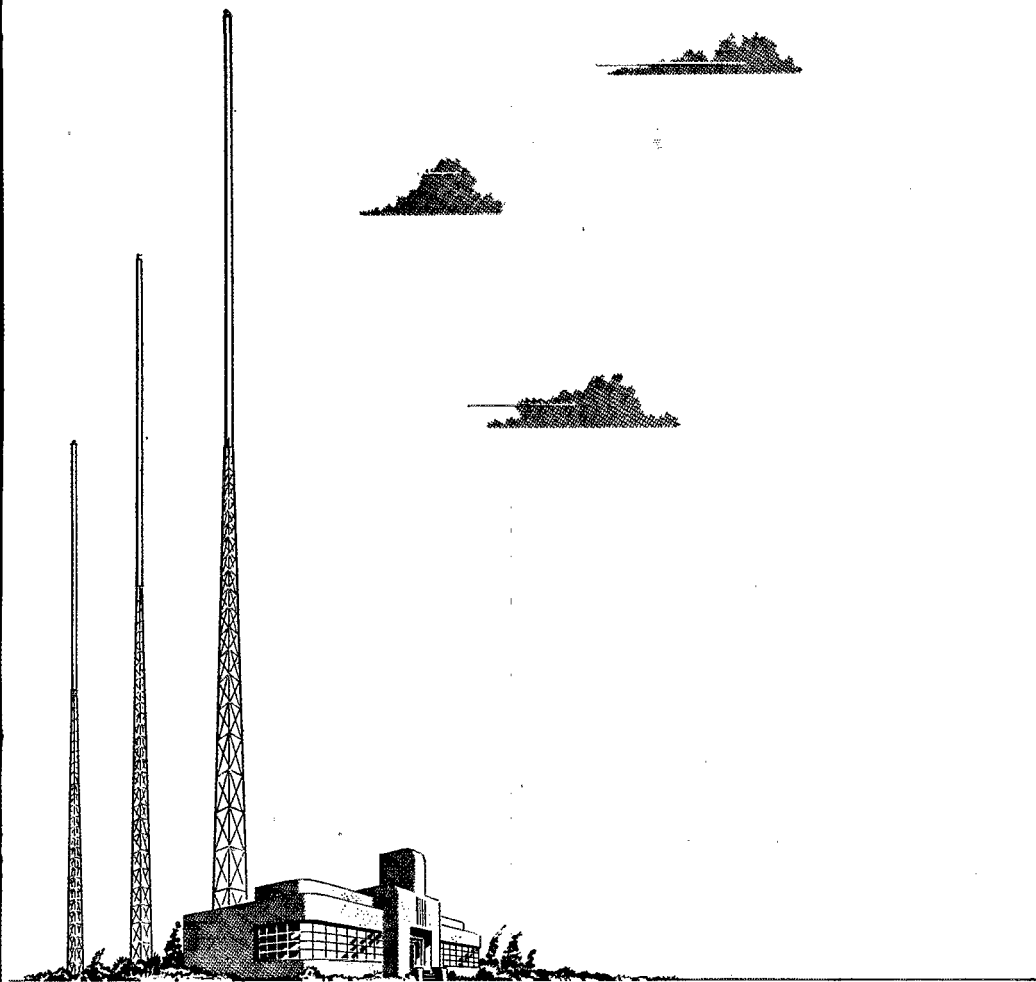

# ALSIMAG

TRADE MARK

**CUSTOM MADE TECHNICAL CERAMICS**

**FOR ELECTRONIC AND ELECTRICAL USES**

**SOLD ONLY TO MANUFACTURERS**

**AMERICAN LAVA CORPORATION**

**CHATTANOOGA 5, TENNESSEE**  
**44TH YEAR OF CERAMIC LEADERSHIP**



## Inspection Lite Chemical Laboratory Ruf-Koat • Coil Dope Kit

### G-C COIL DOPE KIT



Thinner.

No. 888-kit. . . . . List 65¢

### G-C INSPECTION LITE

Ideal for service work. Lights up hard-to-see corners. Perfect for experimenters.  
No. 705.

. . . . . List \$1.50



Handy, contains 2-oz. bottle Polystyrene Q-Dope, 2-oz. bottle Q-Dope

### G-C RUF-KOAT AIR DRY WRINKLE FINISH

The only finish that will air dry without baking. Easy to use. Gives professional wrinkle finish.

No. 60-2. 1/2 pt. . . . . List 45¢



### G-C ELECTRONIC CHEMICAL LABORATORY

Ideal for all Hams and Experimenters. 19 different bottles and chemicals in heavy steel rack (free rack). Perfect chemical set-up for servicing.

No. 998. . . . . List \$11.12

Available at all leading distributors. Write for catalog.



RADIO DIVISION DEPT. C

GENERAL CEMENT Mfg. Co., Rockford, Ill., U. S. A.

Manufacturers of over 3,000 products • Sales offices in principal cities

(Continued from page 188)

for. Don't worry if the system appears to require fairly close coupling, as compared to resonant-line antennas having tuning devices.

No adjustment of the 50-Mc. array should be necessary. We made provision for adjusting the elements, and many workers will wish to do this, but be assured that it is not mandatory. This array, as finally erected, was an exact duplicate of the 4-element job erected last March, except for the use of 1-inch tubing for all elements.

### Performance

In stating performance data, we would like to point out that no directive array is a worker of miracles. We hear of beams which give 20-db. gain over a comparison antenna, and some receivers have given these arrays that sort of report, but it just doesn't happen. When it appears to it is certain that the S-meter in question is lying, or the comparison antenna is no good. These arrays have been tested in comparison with good dipoles using receivers with carefully-calibrated meters, and the gain in both cases is close to the theoretical limits for 3- and 4-element arrays. The 50-Mc. array shows a gain of approximately 10 db., and a front-to-back ratio of 15 db. The 10-meter section exhibits a gain of 7 db., and a front-to-back ratio of 12 db. The front-to-back figures could be improved somewhat by retuning slightly, but we aimed for maximum gain, the primary object in the erection of such systems. The 50-Mc. array can be made to take power over a range from 50 to 53 Mc., and its performance is good over a range from 50 to 51.5. On 10 we regularly use 28,580 and 29,116 kc., with no change in coupling. Schedules are kept with KH6AR on 29.4, and we have gone as high as 29.6 on occasion. There is enough loading on 28,002 to do a creditable job in working c.w. DX. Such ranges are well beyond the capability of a close-spaced system which is tuned "on the nose," and being able to cover this much territory is of great value in receiving, especially in these days of full use of the 10-meter band.

These performance figures have been checked with numerous stations at all distances, the most reliable checks being made over a 90-mile path during the evening hours, when conditions are stable. Fortunately, a somewhat similar antenna installation is in use at W1PFJ, Waltham, Mass., and both stations have carefully-calibrated receivers. The signals over this path are reliable on both bands, and checks have been made under all conditions of propagation. The 10-meter section of the array has boosted our success in working DX, and the performance of the 6-meter job leaves nothing to be desired, in comparison with the former single array for that band.

We wish to thank Bud Barnard, WINSS, for his days on end of working with us on the development and erection of this array, and to Doc Farrar, W1PFJ, for the hours we have taken from his operating time in the course of nightly testing on 6 and 10. The cooperation of scores of other stations, local and DX, is greatly appreciated.

## CAST ALUMINUM CALL LETTER PLATES

W8ENH

\$2.50

Add 20c  
for Packing  
and Postage

Cast aluminum, letters and borders raised and satin finished. Background — baked crackle enamel. Black is standard—red, gray or blue 40c extra. Dimensions 2 3/4 x 8 1/4".

FOR YOUR CAR — Type A-18

Cast with brackets for auto mounting and two 6-32 x 3/8" threaded studs for panel mounting.

FOR PANEL MOUNTING — Type A-19

Same as above, but without auto brackets. Equipped with studs for panel mounting.

LAPEL BUTTONS Actual Size

Type A-26 — Expertly etched with letters raised, sharp and clear, and highly polished. Screw type backing for lapel.

W9HKZ

\$1.00

Add 10c for  
Packing  
and  
Postage

TERMS: Orders under \$3.00, cash with order; orders over \$3.00 require 25% deposit — balance C. O. D.

SREPCO

STANDARD RADIO  
& ELECTRONIC PRODUCTS CO.

135 East Second Street, Dayton 2, Ohio

# TERMINAL Radiogram

## WEATHER REPORT

Monday, windy, followed by Tuesday.

Check your guy wires!

TERMINAL RADIO CORP.

85 CORTLANDT STREET, NEW YORK 7, N. Y.

## NEWS and NOTES ACROSS the COUNTER

Frank Miller, W2BUS

Fellows who attended last Hudson Radiotelephone League meeting saw what ham harmonics could do to television reception . . . isn't there enough BCL trouble now? . . . observing post-war broadcast receivers there seems to be less use of an RF stage than before — and that was about non-existent . . . will they never learn? . . . and those slug-tuning midgets . . . shudder to think what even a 50 wattter will do to them . . . many apartment house boys (cliff dwellers) are using the Sonar for narrow-band FM transmission during BCL hours . . . (Sonar XE-10 — 39.45 — adv.) . . . helps a lot . . . would like to see it made lawful for the lower frequency bands . . . 73.

## STANDARD LINES

### INVENTORY RISES

You'll always find complete stocks of standard radio equipment at TERMINAL! Everything for the radio amateur, from nuts and bolts to complete ready-to-operate transmitters!

## INSIDE STORY OF TERMINAL'S SURPLUS

Only a small percentage of Government surplus passes inspection of Terminal's purchasing men — and then we buy! Careful examination by our men who know the values hams look for results in Terminal handling only new and useable equipment, requiring little or no alteration to make them suitable for our customers.

For example, when we examined a quantity of brand new, boxed 0.1 milliamperes G.E. meters, we knew that at \$2.98 we had a terrific value to offer hams who would build field strength meters and frequency meters, besides their many everyday applications. The bakelite case is 1 3/4" square, with a black luminous scale and pointer. For a compact D.C. voltmeter, add 1000 ohms per volt for desired scale reading. One of our 0.1 meg., 1% accurate resistors (95c—adv.!) in series makes this a cute 0-1000 volt D.C. Meter.

We set high standards on the choice surplus equipment we sell and guarantee each surplus item with the same warranty that backs the thousands of standard parts we sell regularly.

## MAY WE HELP?

Most of our counter salesmen are active hams whose friendly service is yours for the asking.

## SOUND STUDIO GOES HI-FI NEW RECEIVERS

### Altec-Lansing, Pickering and Brook Thrill Visitors

A high fidelity chain of audio units including the Pickering pickup, Brook amplifier and Altec-Lansing reproducers is on demonstration in Terminal's Sound Studio in conjunction with other new equipment. The new Browning AM-FM tuner can be heard at its best by the most critical ears.

Engineers who want to be shown are invited to bring along their own test records. If unable to visit us in New York, send a letter or postcard for descriptive literature.



"Hear it at Terminal" are the buy-words of value-wise sound equipment customers. All well-known makes of amplifiers, speakers, microphones and pickups are carried in stock.

### ON DEMONSTRATION

Our Ham Shack is a cozy room where you may see and hear all the new communications receivers. Also on display are the latest amateur transmitters from flea-power up to a half-kilowatt.

If you're interested in a "ham" receiver, don't wait. but come in NOW!

Sets shown are the latest models made by Hallcrafters, National, Hammarlund, RME, Gon-Set, TMC, Gross Communications and RTL.

## CHOICE BUYS NOW AVAILABLE AT TERMINAL

Brand New! Fully Guaranteed! Low Prices!

### C-D Oil-Filled CAPACITOR

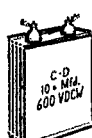

10 Mfd. — 600 Volts DCW  
Husky, hermetically-sealed  
Choice Surplus condensers  
built for heavy duty and  
priced far below its  
regular value! Each **98c**

### General Electric 0-1 Ma. Miniature Meter — 1 7/8" Sq.



Compact and accurate!  
Mounts in 1 1/2" hole. Complete with faceplate and mtg. hardware. Ideal for innumerable applications!  
Our special. Each **2.98**  
only

### Leach Antenna Relay Handles up to 400 Watts

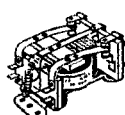

115 volt AC coil, all-ceramic insulation. DPDT contacts, plus SPDT for break-in. Your cost, each only **2.95**

### Sprague Fixed Koolohm Resistor

10,000 ohms — 120 Watts. Completely insulated, easy to mount. Some value! Each **39c**

### PETERSEN CRYSTALS—YOU NAME YOUR FREQUENCY!

40 & 80 meter bands.....**2.65** ea.  
20 meter band.....**3.50** ea.  
10 meter band.....**5.00** ea.  
Special frequency crystals for working into 2, 6 & 11 meter bands .....**3.50** ea.

## TUBES

Transmitting & Special Types  
RELEASED BY GOVERNMENT  
through War Assets Administration  
Made by nation's leading tube plants! All new! JAN Approved!  
Buy now and save — Order spares at these low prices! Following are only some of the popular types we have in stock:

802 .....	<b>\$1.58</b>	816 .....	<b>\$ .60</b>
805 .....	<b>3.75</b>	866A .....	<b>.75</b>
807 .....	<b>1.05</b>	884 .....	<b>.75</b>
811 .....	<b>1.95</b>	2AP1A .....	<b>5.25</b>
813 .....	<b>6.75</b>	3E29 .....	<b>3.00</b>
815 .....	<b>2.25</b>	VR 90 .....	<b>.75</b>
832A .....	<b>4.05</b>	VR 105 .....	<b>.75</b>
250TH .....	<b>9.00</b>	VR 150 .....	<b>.75</b>

Write for complete JAN tube list

### New Items — In Stock

10.7 MC IF Transformers NC-IFN **6.45**  
NATIONAL IFM **6.45**  
NC-IFL (discriminator) **6.90**  
Sylvania Modulation Meter.....**29.50**  
B & W Baby Coils — 25 Watts, all bands ..... **1.04**

If unable to visit our store, send us your mail orders with 25% deposit. Remit in full all orders under \$5.00. Prices are F.O.B., New York.

## TERMINAL RADIO CORP.

85 CORTLANDT STREET  
PHONE: WOrth 2-4415

NEW YORK 7, N. Y.  
CABLE: TERMRADIO



## TRYLON ROTARY BEAM ANTENNA SUPPORT

for 4-element 20-  
meter array

Quick, easy to install on any tower. Stainless steel, spot-welded construction. 19' 2" long, yet weighs only 30 lbs. Adaptable to either manual or motor drive. Ball bearing design provides full 360° traverse. Support can be tilted in either direction for easy accessibility. Has ample safety margin to withstand severe wind and icing conditions. Write for descriptive circular.

### RADIO TOWERS

Standard and special types for amateur and commercial requirements.

**TRYLON TOWER AND ANTENNA DIVISION**  
Wind Turbine Co., West Chester, Pa.

## GON-SET CONVERTERS

Now available for 20, 10-11,  
or 6 Meters

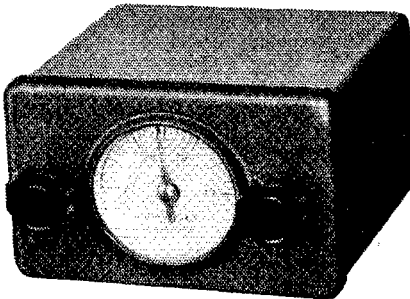

Immediate Delivery

Price Complete, \$39.95—Special Noise Silencer, \$8.25—High Frequency Antenna Lead Cable, 8 Cents Foot

See Your Dealer

Manufactured by

**WATERPROOF ELECTRIC CO.**  
BURBANK, CALIFORNIA

## Old Stand-By

(Continued from page 44)

are located along the right-hand side of the chassis and are not visible. The placement of the rest of the components can be determined by inspection of the photographs.

It is recommended that double-bearing condensers (rotors supported at both ends of the shaft) be used in the detector circuit to minimize modulation of the received signals because of mechanical vibration.

The detector-tube socket must be set below the chassis about an inch, so that the tube will fit into the cabinet. The exact distance can be determined when the parts are mounted.

The coils are all close-wound on 1 3/8-inch diameter forms (tube bases) with No. 22 d.c.c. wire. With the 80-meter coil in the socket, 3500 kc. should be found at about 50 on the band-set dial, with the vernier set at maximum capacity. With the 40-meter coil, 7000 kc. will be around 40 on the band-set dial. With the 20-meter coil, 14,000 kc. will be about 20 on the band-set dial, and 10 meters will be covered by the bandspread dial when the main tuning condenser is at minimum capacity.

The terminals for turning off the B+ to the detector during transmitting periods are not shown. However, they were placed directly below the two 'speaker terminals, and a twisted pair connects them to the proper point in the circuit. Incidentally, if the send-receive switch were placed in the B+ line feeding all the tubes (between the power supply and the decoupling filters) it would take several seconds for these filters to charge up each time the switch was closed. In a congested band this might confuse the operator sufficiently to cause him to completely lose the signal. This difficulty is avoided if the switch is placed as shown in the diagram.

### Performance

For c.w. operation this receiver will equal the sensitivity of some of the best superhets on the market. It, a Super Pro, and an NC-2-40D were placed side by side and the weakest signal audible on either of the superhets could be copied on the regenerative receiver with no difficulty. This was on 40 meters.

### Strays

The first annual dinner dance of the Northern New Jersey Radio Assn. will be held on the evening of Feb. 15th at the Teterboro Golf Club, Route 6, Teterboro, N. J. Good eats, entertainment and prizes are on the program. Hams from far and wide are invited. Tickets \$3.50. Further information and tickets may be obtained from the Northern New Jersey Radio Assn., YMCA, Hackensack, N. J.

— . . . —

G6 --- needs "New Mexico and Omaha for 28-Mc. 'phone WAS," according to his recent letter.



# ONE HAM TELLS ANOTHER... "I Got It from Walter Ashe"

You'll hear it in many a QSO—you'll overhear it at Hamfests... "I got it from Walter Ashe." And more and more—one Ham tells another what a time and money saving habit it is to order from Walter Ashe for both standard and hard-to-get items—delivered in a hurry.

## Receivers for Immediate Delivery

This is no dream. In stock now—for INSTANT delivery—these popular makes of receivers. And we are giving trade-in allowances you won't want to pass up!

**HAMMARLUND HQ-129-X**—with much-praised noise silencer. Complete for... **\$173.25**  
**NATIONAL NC-240-D**—outstanding stability and built-in quality. A value... **\$241.44**

**RME 45**—one of the first entirely re-designed Ham receivers of post-war era... **\$198.70**  
**NATIONAL HRO-5TA**—one of the leaders in the field. Less speaker and power supply... **\$274.35**

Write for Free Catalog

### DELUXE AMPLIFIER CHASSIS

Number	Size	Reg. Price	Sale Price
3973	7 x 17 x 9	\$4.95	\$3.72
3974	10 x 14 x 9	5.40	4.05
3975	10 x 17 x 9	5.70	4.28
Standard style with cover. Gray enamel.			
3983	10 x 14 x 9	\$3.51	\$2.64

### TRANSFORMERS and CHOKES

Thordarson Smoothing Choke, 200 Mills, 12 Hy. **\$3.50**  
 Surplus Filament Transformers, 110 V AC pri., sec. 6.3 V @ 3.6 A, 6.3 V @ .6 A... **\$1.18**  
 Surplus Filament Transformer, 110 V AC pri., sec. 6.3 V @ 3 A... **\$1.08**  
 Midget Transceiver Transformer, Mike to Grid, Plate to Voice Coil... **74c**  
 Thordarson Heavy Duty Broadcast Type Plate Transformer, 115 or 230 V pri. 1510-0-1510 V @ .5 A former, 115 or 230 V pri. 1230 V, easily worth 3 sec. tapped at 1330 and 1230 V, easily worth **\$39.50**  
 Times our low price of... **\$39.50**  
 Thordarson Heavy Duty Swinging Choke, 500 Mill, 5-16 Hy 7500 V RMS. This choke is rated at 500 Mills continuous. Intermittent (Ham) use should be considerably higher. Ideal companion piece for 2 KVA Amertran. **\$11.85**

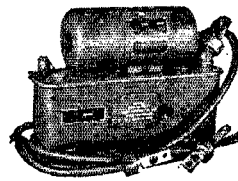

**DYNAMOTOR  
POWER  
SUPPLY  
\$11.95**

LIMITED QUANTITY

Brand new, U. S. Army PE-103 operates from 6 or 12-volt battery, will deliver 500 volts DC at 160 Ma. A real value.

## Other Outstanding Bargains

**SELSYN MOTORS**, type 5G, special per pair. **\$12.50**

**REVERSIBLE MOTOR**, 1/2 to 2 r.p.m., with conversion instructions for rotary beam drive, has 50-inch pounds torque... **\$4.95**

**MODEL 905 "TRANS-METER"** transmitter tester. **\$49.50**

**MOSLEY STATION QSO BOOK**, new indexed type... **\$1.25**

**SONAR FM EXCITER**, price complete, less crystal **\$39.45**

**RCA 1 KW. MODULATION TRANSFORMER**, pri. will match class B P-P tubes up to 10,000 ohms plate to plate. Sec. No. 1 450 Ma for beam tube plate. Sec. No. 2 80 Ma for screen grids... **\$25.00**

GET ON OUR MAILING LIST

**RADIO CO.**

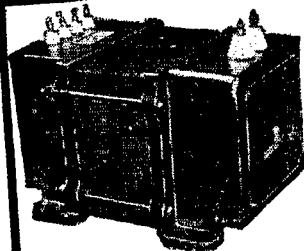

**FOR YOUR  
DREAM RIG  
AMERTRAN  
PLATE  
Transformer  
\$39.95**

Free Delivery in  
Continental U.S.A.

Rated at 2 KVA. Pri. 105-110-115, 60 cycle.  
Sec. 3100-0-3100, full voltage across sec. 6200  
V @ 700 Ma.

*Walter Ashe*

**1125 PINE ST. ST. LOUIS, MO.**

W8YD W8PGI W8ZP  
W8LDO W8GTF W8ULH

**Now**  
The TOWER  
You've Been  
WANTING!

For Directional  
Beam Antenna  
and dozens of  
other uses.

**RUGGED**  
Aluminum alloy throughout. Guaranteed to support 200 lbs. with an area of 5 sq. ft. in 70 mile wind!

**SIMPLE**  
Triangular, tapered, self-supporting, light weight. 30 ft. tower can be assembled anywhere, using only wrenches, erected by hand.

**SIZE**  
Triangular Base 3 ft. 4 inches on a side; top 1 ft. 4 inches. Ladder rungs 15 inches apart.

**ECONOMICAL**  
Buy the height you need: 10, 20 or 30 feet. All fastenings and metal parts of footing finished. Reasonably priced.

Write immediately for Brochure **FREE!**

**FABRICATED LIGHTMETALS CO.**  
42 West 15th St. New York City 11, N. Y.

## Field Day

(Continued from page 48)

Two Transmitters		QSOs	Power*	Score
W9RQM/9	Wisconsin Valley Radio Association <sup>24</sup>	293-	A-	4266
W8OC/8	Mon-Yough Amateur Transmitters Association <sup>27</sup>	198-	A-	3267
W3ATR/3	Beacon Radio Amateurs <sup>24</sup>	201-	A-	2907
W5AA/5	Fort Worth Kiloocyte Club <sup>24</sup>	132-	AB-	2142
W8BK/3	South Hills Brass Founders and Modulators <sup>24</sup>	129-	A-	2061
W9MKS/9	The Starved Rock Radio Club <sup>24</sup>	106-	A-	1710
W8CHE/8	Fort Stouben Radio Club	107-	A-	1611
W3FXG/3	Philadelphia High Frequency Radio Club	114-	A-	1539
W8OAJ/8	Mercer County Radio Association <sup>24</sup>	146-	AB-	1509
W7LT/7	Portland Amateur Radio Club <sup>28</sup>	88-	AB-	1472
W1JCI/1	Waltham Amateur Radio Association <sup>24</sup>	116-	A-	1385
W9DXU/9	The Pole Cats, Hamfesters Radio Club, Inc.	104-	A-	1359
W7UOM/7	Ogden Amateur Radio Club	86-	AB-	1328
W6KUT/6	San Joaquin Valley Radio Club <sup>24</sup>	106-	AB-	1274
W4KZ/4	Greenville, S. C. Amateur Radio Club <sup>28</sup>	133-	B-	1104
W3BKB/3	York Amateur Radio Club <sup>27</sup>	65-	A-	1089
W4CO/4	Palmetto Amateur Radio Club	102-	AB-	1002
W1NDS/1	The Norwalk Amateur Radio Association <sup>28</sup>	82-	A-	914
VE1FO	Halifax Amateur Radio Club <sup>29</sup>	51-	A-	900
W8TH/8	Inter-City Radio Club <sup>29</sup>	58-	A-	891
W9REC/9	Chicago Radio Traffic Association <sup>41</sup>	36-	A-	873
W4FLS/4	Chattanooga Radio Club <sup>24</sup>	95-	AC-	807
W5HOT/5	Fort Smith Amateur Radio Club <sup>24</sup>	74-	A-	756
W8WOG/8	Muskegon Area Amateur Radio Council	90-	AB-	624
W5AQE/5	Oh-Po-Kah Club <sup>44</sup>	106-	J-	617
W7EUZ/7	Shy-Wy Radio Club <sup>45</sup>	89-	AC-	617
W9UNL/9	Iowa-Illinois Amateur Radio Club <sup>46</sup>	42-	A-	583
W8ADJ/8	Black Hills Amateur Radio Club <sup>47</sup>	40-	B-	501
W8KEE/8	Bear Butte Amateur Radio Club <sup>48</sup>	67-	B-	477
W8AQ/8	Medina County Radio Club <sup>49</sup>	53-	B-	396
W4DUG/4	Tampa Amateur Radio Club	33-	B-	74
<i>Three Transmitters Operated Simultaneously</i>				
W8ONK/8	Motor City Radio Club, Inc. <sup>50</sup>	319-	A-	4500
W8OBM/8	Minneapolis Radio Club <sup>51</sup>	251-	A-	2961
W8DM/8	Kalamazoo Amateur Radio Club <sup>52</sup>	229-	A-	2817
VE3JJ	West Side Radio Club <sup>53</sup>	197-	A-	2655
W1MWN/1	Bridgport Radio Amateur Club <sup>54</sup>	182-	A-	2565

<sup>25</sup> W9CFT, ESV, FZC, LJB, JBF, LED, PRM, QJB, RLB, RQM, SMP, Plautz, Madsen, Britton. <sup>27</sup> W3NWB, KQF, USJ, VJY, RUM, TFI, KPO, KSJ, TZK, W8OC, UGJ, RNO, RCQ, VYP, KPL, OV, SFL, MKP, UED, KSW, AJV, UST, JBD, QZM, UGJ. <sup>28</sup> W3HTF, HTM, IKP, ATR, GRF, IDQ, FLY, ETA, CNP, DYL. <sup>29</sup> W5DFU, HCH, KVA, AAE, BNG, CVV, BBH, KBZ, KXW, JSS, JOU, LHF, GDV, VQ, APW, ELC, SE, FRD, W9DIN/5. <sup>30</sup> Eight. <sup>31</sup> Twelve. <sup>32</sup> Sixteen. <sup>33</sup> Fifteen. <sup>34</sup> W1DMG, OGV, IPG, JOC, KLY, JCI, MYD, LUW, LHV, W9ECO. <sup>35</sup> W6PCS, PXP, UVN, NJQ, KUT, LTA, PSQ, LTO, JPU, KPW, K6RLG/6. <sup>36</sup> Forty. <sup>37</sup> Twelve. <sup>38</sup> Ten. <sup>39</sup> VEIEK, DB, KB, HJ, TH. <sup>40</sup> W8TH/8, GFB, VTP, WXV/8, PIH, TTS. <sup>41</sup> W9REC, KLB, HPG, YDV, ADF, IYP, FEX, AAW, Sando. <sup>42</sup> Eight. <sup>43</sup> W5HOT, JIC, ICS, HNU, GTS, IWL, IYV, HPL. <sup>44</sup> W5HBB, BBM, KEY, CYV, EST, BMK, GTU, AQE, YLs, Lou Lacy, Grace Elkan. <sup>45</sup> Ten. <sup>46</sup> Fifteen. <sup>47</sup> Nine. <sup>48</sup> Nine. <sup>49</sup> W8AQ, EBI, KNF, LFJ, LAV, GAV, KYI. <sup>50</sup> Eleven. <sup>51</sup> W3KAI/8, W7LAI/8, W9KXM, WEF, LFI, ZXV, DIQ, VHQ, DOB, ITQ, JBX, DEX, BP, AXS, YLZ, VER, FEH, GHK, W8OWK, OBM, EQH, MCY, GQK, NFD, DBC, YDD, RVS, JCF, JNC, MIN, YPN, WAB, IRO, CUD, IPX, VVX, EOP. <sup>52</sup> W8BKX, TJQ, YLA, WZD, CTC, HDM, DM, VMI, DUA, W9TZN/8. <sup>53</sup> Fourteen. <sup>54</sup> Sixteen. <sup>55</sup> Fifteen.

(Continued on page 158)

## GET YOUR FCC Commercial Radio Operators' LICENSE

How To Pass  
FCC  
LICENSE  
EXAMINATIONS  
CLEVELAND INSTITUTE  
OF RADIO ELECTRONICS  
Terminal Tower, Cleveland, Ohio

Now...

IT'S EASY IF YOU FOLLOW OUR PLAN! Thousands of new jobs are opening up — FM, TELEVISION, MOBILE COMMUNICATION SYSTEMS, are only a few of the new radio fields which require licensed operators.

Don't Delay—  
Write Today!

**FREE BOOKLET** Tells you the requirements for all classes of commercial licenses. Saves you many hours of

random, undirected study. Assures a minimum of time in getting your ticket.

### CLEVELAND INSTITUTE OF RADIO ELECTRONICS

QT-2, TERMINAL TOWER CLEVELAND 13, OHIO  
Approved for Veteran Training under GI Bill of Rights

MAIL THIS COUPON

Cleveland Institute of Radio Electronics  
QT-2, Terminal Tower, Cleveland 13, Ohio  
Gentlemen: Please send your FREE Booklet, "How to Pass FCC License Examinations." (NOTE: This booklet does not cover examinations for Amateur Licenses.)

Name..... Address.....  
City..... State.....  
 Check here, if a veteran



**Bob Henry says:**  
**MOST MODELS**  
**IN STOCK**



**FOR**  
**IMMEDIATE**  
**DELIVERY**

*Most models listed below are in stock . . . ready for immediate delivery:*

Hallicrafters S38 complete . . . . .	\$47.50
Hallicrafters S40A . . . . .	89.50
Hallicrafters SX 42 . . . . .	275.00
Hammarlund HQ-129X and speaker . . . . .	168.00
Hammarlund SP-400-X and speaker . . . . .	342.00
National NC-2-40D (complete with speaker) . . . . .	241.44
National HRO-5TA1 and HRO-5RA1 . . . . .	274.35
National NC-46 . . . . .	97.50
National 1-10A with tubes and coils . . . . .	67.50
RME-45 complete . . . . .	198.70
RME-84 complete . . . . .	98.70
Pierson KP-81 complete . . . . .	342.00
Panoramic panadapter complete . . . . .	99.75
Temco 75GA transmitters . . . . .	495.00
Meck 60T transmitters . . . . .	150.00
Millen 90800 ECO . . . . .	42.50
Millen 90800 exciter . . . . .	37.50
Millen 90281 power supply . . . . .	84.50
Millen 90902 scope . . . . .	42.50
Gordon, Amphenol, other rotary beams . . . . .	

*The new Hallicrafters and Collins receivers, transmitters, VFO, etc. as fast as available. Prices subject to change.*

The delivery situation is much improved. I can make immediate delivery of most receivers and other apparatus. Take advantage of the extra service and selection you get by dealing with me, based on my reputation as the world's largest distributor of short wave receivers. Send me your order now. Send five dollars and I will ship at once C.O.D. Or order on my 6% terms, I finance the terms myself to give you better service and save you money. Trade-ins accepted. Tell me what

you have to trade, and let's make a deal. Besides having all amateur receivers and transmitters, I also have a complete stock of all other amateur apparatus and parts, also test equipment, etc. I have real bargains in the really good war surplus. Write, phone, wire or visit either of my stores.

*Bob Henry*  
**WØARA**

Butler, Missouri **HENRY RADIO STORES** Los Angeles 25, Calif.  
**"WORLD'S LARGEST DISTRIBUTORS OF SHORT WAVE RECEIVERS"**

# QUARTER CENTURY



## OF SERVICE

Having passed the quarter century mark, we feel like "Old Hands" at giving our customers better service and more for their money, with only one purpose in mind; keeping our customers satisfied.

Because of our long experience, we feel we are more able now, than ever before, to help the amateur in all of his radio needs.

Remember . . . when you see "KIERULFF", think of FAST SERVICE and QUALITY MERCHANDISE.

**KIERULFF AND COMPANY**  
828 W. Olympic Blvd.,  
Los Angeles 15, California

# LEARN WIRELESS and TELEGRAPHY!

A BOOK EVERY AMATEUR SHOULD HAVE —

*Send Now!*

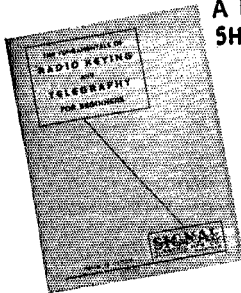

Hundreds of amateurs have learned from this book so can you.

**15¢**  
POSTPAID  
COIN, OR  
STAMPS

This book gives you the fundamentals of wireless and telegraphy. It contains the codes and how to learn them. Mail your order now to:

**SIGNAL ELECTRIC MFG. CO., Menominee, Mich.**

ESTABLISHED  
1892



(Continued from page 154)

Three Transmitters		QSOs	Power*	Score
W3AQ/2	Delaware Valley Radio Association <sup>58</sup> .....	156-	A-	2538
W9SYT/9	Milwaukee Radio Amateur Club.....	176-	A-	2538
W9GV/9	York Radio Club <sup>58</sup> .....	153-	A-	2502
W9TCK/9	Cahokia Amateur Radio Club <sup>57</sup> .....	193-	AB-	2427
W2PY/2	North Newark Amateur Radio Club <sup>58</sup> .....	175-	A-	2322
W9HVZ/9	Joliet Amateur Radio Society.....	254-	AB-	2181
W8ARF/8	Toledo Radio Club <sup>58</sup> .....	204-	A-	2061
W0LFB/0	Iowa City Radio Club <sup>59</sup> .....	306-	BC-	2040
W2BUX/2	Amateur Radio Club of North Hudson <sup>61</sup> .....	163-	AB-	1941
W1HNE/1	Pittsfield Radio Club <sup>58</sup> .....	127-	A-	1935
VE3BK	Key Klick Klub <sup>58</sup> .....	125-	A-	1791
W0JA/9	CQ Club of Gary, Indiana.....	246-	AB-	1725
W2NNK/2	Utica Amateur Radio Club.....	103-	A-	1656
W2SV/2	Sunrise Radio Club <sup>54</sup> .....	116-	AB-	1566
W9PWJ/9	Racine Megacycle Club <sup>58</sup> .....	152-	AB-	1557
W9KWX/9	Elgin Amateur Radio Society <sup>58</sup> .....	247-	AC-	1353
W2EQC/2	Sperry Radio Club <sup>57</sup> .....	134-	AB-	1299
W2US/2	Eastern Suffolk Radio Club <sup>58</sup> .....	117-	AB-	1290
W7JLL/7	Radio Club of Tacoma, Inc. <sup>59</sup> .....	89-	AB-	1215
W8DEL/8	Dayton Amateur Radio Association <sup>70</sup> .....	243-	AC-	1182
W1DJC/1	Manchester Radio Club <sup>71</sup> .....	80-	A-	1044
W7FWD/7	Olympia Radio Club <sup>72</sup> .....	31-	A-	1030
W1KYF/1	Candlewood Amateur Radio Association <sup>73</sup> .....	131-	AB-	567
W8ITZ/3	West Philadelphia Radio Association <sup>74</sup> .....	85-	AB-	362
W2IAT/2	Raritan Valley Radio Club <sup>75</sup> .....	39-	AB-	204

### Four Transmitters Operated Simultaneously

W9RNX/9	Four Lakes Amateur Radio Club <sup>76</sup> .....	306-	A-	4239
W8BSO/3	The Amateur Transmitters Association of Western Pennsylvania <sup>77</sup> .....	245-	A-	3249
W6IAS/5	Tulsa Amateur Radio Club <sup>78</sup> .....	151-	AB-	2876
W6SJT/6	Amateur Radio Researchers <sup>79</sup> .....	104-	A-	2727
W1GB/1	New Haven Amateur Radio Association <sup>80</sup> .....	137-	A-	2106
W8FSS/8	South Cleveland Radio Club <sup>81</sup> .....	165-	A-	1953
W8LEH/2	Niagara Radio Club, Inc. <sup>82</sup> .....	142-	A-	1764
W8WVG/8	Queen City Emergency Net <sup>83</sup> .....	143-	AB-	1608
W9JU/9	Prairie Dog's Group, Ham-fester's Radio Club, Inc. <sup>84</sup> .....	98-	A-	1557
W8EXI/8	Buckeye Radio Club <sup>84</sup> .....	108-	A-	1440
W6ICV/6	Kaw Valley Radio Club <sup>85</sup> .....	116-	ABC-	1176
W8AL/8	Canton Amateur Radio Club <sup>86</sup> .....	168-	ABC-	999
W8W8X/8	Civilian Amateur Radio Monitoring and Relay System <sup>86</sup> .....	40-	A-	747

### Five Transmitters Operated Simultaneously

W9IT/9	Northwest Amateur Radio Club <sup>87</sup> .....	511-	A-	6363
W6SIF/6	The Mike and Key Club of Santa Monica <sup>88</sup> .....	279-	A-	5549

<sup>58</sup> Twelve. <sup>57</sup> Twelve. <sup>56</sup> W2PJI, JUU, IXD, IYQ, JSF, LTY, PY. <sup>59</sup> W8QUL, QWR, HSW, ARF, UEL, EVV, WEW, BHL, TKS, WUF, VDV, JEX, RRR, TLB, LVU, HWF, AVB, BIQ, BN, TLF, UUC, TIV, NGU, WDL, ELP, QUO, SMN, IME, PCS, W4JG, Best, Schnell, Poucher, Buck, Jarvis, Hillebrand, Denis, Sanford, Brown, Zautner, Wiley, Lewis. <sup>60</sup> Fourteen. <sup>61</sup> Twelve. <sup>62</sup> W1BKG, JLT, LUD, OKA, OAZ, AZW, IZN, OMF, HAZ, LKO, HNE, JGY, KVN, KZS, W7EZT/1. <sup>63</sup> Nine. <sup>64</sup> Twenty. <sup>65</sup> Ten. <sup>66</sup> Six. <sup>67</sup> Fifteen. <sup>68</sup> W2ADW, BFA, CKU, DOG, EBT, FCH, JEP, LUD, OEO, OQI, NMP, PDU, US, UX, Guyer, Prehmus, Rogers. <sup>69</sup> Thirty. <sup>70</sup> W3BGD, AYS, W8VMJ, RHH, CBI, FDR, PTF, WXA, QUS, QHV. <sup>71</sup> Fifteen. <sup>72</sup> W7FWD, HMJ, ILC, W9TRL. <sup>73</sup> Ten. <sup>74</sup> W3ITZ, EVH, KGL. <sup>75</sup> W2BAI, NAU, CWK, GPV, CBT, IAT, NTW. <sup>76</sup> W9HCR, OME, LNM, WON, MRY, FTG, HHR, RNX, RBI, NAK, FGY, JEK, GRT, HEK, Harris, Bade. <sup>77</sup> Twelve. <sup>78</sup> Thirty. <sup>79</sup> W6SJT, NAT, RMK, RUY, RCH, SOY, DYW, CNJ, QOR, CL. <sup>80</sup> WILZM, AGT, JUN, KQY, OXX, TD, LTB, BYW, EUG, LTZ, FMV, MEF, AMM, Cohen, Lolisa, Valley, Sid Cohen, Murdock, Libertino. <sup>81</sup> W8FSS, IKP, CMB, QJL, PXX, ICS, LXR, PMO, SAB, OBG, RPG, BVM, LYO. <sup>82</sup> Fifteen. <sup>83</sup> Twenty-three. <sup>84</sup> Twelve. <sup>85</sup> W8EXI, VQI, BSR, BSH, SLF, PWA, LBH, LHU, NYP, NYY, JTI, POZ, JY, KMP. <sup>86</sup> Twenty. <sup>87</sup> Six. <sup>88</sup> W8BN, ESN, TWD, VTL, WRQ, VDD, VDR, WIT, KPH, Kloefer, and five others. <sup>89</sup> W9NJZ, EWE, IT, MAY, LVD, VJC, NZS, PKW,

(Continued on page 158)



# "Buck" Stretcher's NEW FLYER (FOR HAMS ONLY)

IS  
FULL

OF

MONEY

SAVING

SPECIALS

MAIL

COUPON

FOR

IT

TODAY!

COMPARE THESE TYPICAL SUN RADIO VALUES!

## KENYON FILAMENT TRANSFORMER

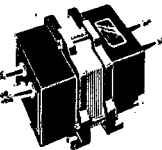

Primary 115 Volt,  
Secondary 2 1/2 Volt,  
center-tapped (w/ 10  
amps; 10,000 V insulation. Husky, fully  
cased, teatite terminals.

\$4.95

A real buck stretcher at.....

## WESTINGHOUSE METER 0-150 VOLTS AC



25-125 cycles. Bakelite  
case. 3 1/2" face. Mounts  
in 2 1/16" hole. A "must"  
for every rig to measure input line  
voltage.

\$5.25

Special Price.....

## BUCK'S FEATURE LINE OF THE MONTH

(James Millen Mfg. Co.)

- #37001—High Voltage Safety Con-  
necting Terminal. 2 for..... \$ .80
  - #59001—Panel Making Decalcoman-  
ia Kit..... \$1.25
  - #74001—Permeability Tuned Shield-  
ed Form..... \$1.85
  - #69041—Permeability Tuned Midget  
Isolante Coil Form (VHF)..... \$ .60
  - #10012—Right Angle Gear Drive,  
1:1 ratio..... \$3.75
  - Accessory Coils for Millen Exciter; 80,  
40, 20, 10 Meters.....each \$1.25
- You can always use a better receiver!

- SX-42.....\$275.00
- HQ 129-X.....\$173.25
- SPC 400-X (w. spkr. in cab.).....\$347.25
- HRO 5TA1.....\$303.00
- NC 2-40 D.....\$240.00
- RME DB-20 Preselector.....\$ 68.20
- RME VHF 152 Converter.....\$ 86.60
- Millen Exciter.....\$ 37.50
- Sonar FM Exciter.....\$ 39.45
- Halli. Sky rider Pan. Adaptor.....\$ 99.50

FOR  
FUTURE  
HAMS

LEARN  
RADIO  
CODE

TO  
REFRESH  
OLD HAMS

With This Signal Corps Practice Kit

Learn radio code from the ground up by the same method, and with the same equipment, used at home by thousands of Signal Corps trainees.

No other home training system will enable you to learn radio code faster and better than this course. It's actually the same as getting private instruction in a classroom.

Faithful and consistent practice will enable you to receive code messages accurately up to the speed of 10 words per minute. This can be increased by continued practice.

Each set comes complete with:

- 17 unbreakable 12" records (34 sides), produced by RCA Victor. Instructor's voice anticipates your questions and clearly tells you just what to do. Code signals give you plenty of practice in receiving. Crammed full of instruction and self-testing exercises. Records can be played on any standard 78 r.p.m. record player.

Two beautiful record albums, bound in simulated leather and stamped in gold.

10 self-scoring practice pads (50 sheets per pad).

Package of printing charts showing you how to write letters and numbers when receiving code. Also has names for letters of the alphabet.

This course meets the highest standards of educational experts.

Only a limited number available. Order yours now. They cost the government \$35.00 per set. Sun Radio brings them to you for only

\$14.95

If you already know radio code, tell your friends about this offer.

## FOR W2'S ONLY!

When hams want to get together these days, they come up to Sun Radio, New York's most popular rag-chewin' rendezvous. C'mon up, meet W2LBF, W2KY0, W2NSX, W2QJE and W2JUX, and see all our unadvertised "buck stretchers"

## PLEASE PRINT PLAINLY

SUN RADIO & ELECTRONICS CO., Inc.  
122-124 DUANE STREET  
NEW YORK 7, N. Y.

Dear Buck:

Please send me your flyer as soon as it is printed.

Name .....

Call .....

Address .....

City .....

Zone ..... State .....

# SUN RADIO

& ELECTRONICS CO., Inc.

ESTABLISHED 1927

122-124 DUANE ST. · NEW YORK 7, N. Y. · BARclay 7-1840

# NOW & LATER

*Now...* STANDARD ARCTURUS can supply you with many hard-to-get tubes from its diversified stock of W.A.A. surplus and regular tubes.

*Later...* STANDARD ARCTURUS can offer you a complete line of electronic tubes of every type and description—known the world over for high-fidelity tonal quality and long, dependable service.

*Now...* is the time to align yourself with ARCTURUS—the oldest name in radio tubes. Mail us your tube requirements immediately... and you will receive our monthly bulletins on available tubes.

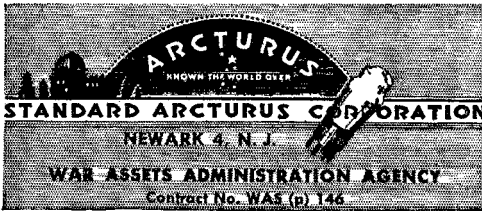

## ANNOUNCING—

The 1st volume in the Massachusetts Institute of Technology Radiation Laboratory Series, bringing you —

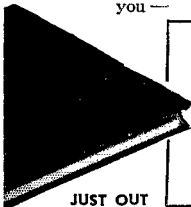

the engineering data  
you need to design  
**RADAR SYSTEMS**

JUST OUT

This important book presents the general principles of the design of various radar systems. From the standpoint of the designer, it discusses the basic considerations which underlie systems design.

## Radar System Engineering

Edited by L. N. Ridenour, Associate Professor of Physics, University of Pennsylvania. Over 900 pages. \$7.50. This book takes up design considerations for the important components that make up a radar set. Detailed examples of actual systems are included. Two new and important auxiliary techniques — moving target indication and the transmission of radar displays to a remote indicator by radio means — are fully treated.

**EXAMINE TO DAYS FREE — MAIL COUPON**

McGraw-Hill Book Co., 330 W. 42nd St., New York 18  
Send me M.I.T. Radiation Laboratory Series, Vol. 1 — Radar System Engineering for 10 days' examination on approval. In 10 days I will send you \$7.50 plus few cents postage or return book postpaid. (We pay postage on cash orders.)

Name.....  
Address.....  
City and State.....  
Company.....  
Position..... QST. 2-47

(Continued from page 136)

Five Transmitters		QSOs	Power*	Score
W6RNQ/6	Inglewood Amateur Radio Club <sup>91</sup>	384-	ABC-	5234
W3ZD/2	Somerset Hills Radio Club <sup>92</sup>	339-	A-	3978
W3IU/3	York Road Radio Club <sup>93</sup>	299-	A-	3879
W8TUD/3	Steel City Amateur Radio Club <sup>94</sup>	295-	A-	3875
W6TRK/6	Glendale Amateur Radio Club <sup>95</sup>	289-	A-	3132
W2FJV/2	Northern Nassau Wireless Association <sup>96</sup>	212-	A-	2907
W6GM/6	Citrus Belt Amateur Radio Club <sup>97</sup>	204-	ABC-	2790
VE3KM	Hamilton Amateur Radio Club <sup>98</sup>	147-	A-	2013

Six Transmitters Operated Simultaneously				
W6SD/6	San Fernando Valley Radio Club <sup>99</sup>	350-	A-	5981
W6VX/6	Society of Radio Amateur Operators <sup>100</sup>	296-	A-	5304
W6BKZ/6	Palomar Radio Club <sup>101</sup>	206-	A-	3787
W8BOK/8	Mountaineer Amateur Radio Association <sup>102</sup>	256-	A-	3555
W10MI/1	El Ray Amateur Radio Club <sup>103</sup>	231-	AB-	1950

Seven Transmitters Operated Simultaneously				
W3BES/3	Frankford Radio Club <sup>104</sup>	651-	A-	8568
W3AC/2	Monmouth County Amateur Radio Association <sup>105</sup>	467-	A-	6237
W9KYC/8	St. Paul Radio Club <sup>106</sup>	367-	A-	4338

Eight Transmitters Operated Simultaneously				
W2FC/2	Jersey Shore Amateur Association <sup>107</sup>	809-	A-	9621
W2KHK/2	Tri-County Radio Association <sup>108</sup>	544-	A-	6912

### A.R.R.L. EMERGENCY CORPS GROUPS

One Transmitter	QSOs	Power*	Score
Erie County (Pa.) AEC Members:			
Field Stations — W3KLD/3	9-	A-	108
W3NCJ/3	8-	A-	99
W3KQP/3	7-	A-	81
W8QJ/3	6-	A-	72
W8NMP/3	4-	A-	45
Home Stations — W3KKJ 5, W3KKT 5, W3KQB 3, W8AAQ 3, W8NBV 3, W8RHK 2, W8KOH 1.			
W4ISS/4	3-	A-	27
Ga.)—W4ISS			

Two Transmitters Operated Simultaneously				
W8KYW/3	Warren County Emergency Corps	99-	A-	1368
W8TOJ (EC)—BOZ (Asst. EC)—KYW—HKU—J8Q—PHC—PMY—NTJ—RMM				

### NONCLUB GROUPS AND INDIVIDUALS

One Transmitter	QSOs	Power*	Score	
W9RCQ/1	W9RCQ	132-	A-	2115
W2FBA/2	W8FLX—W2FBA	113-	A-	1827
W1MLT/1	W1LED—MLT—W3EHW/1	107-	A-	1656
W3JYY/4	Four oprs.	158-	B-	1629

RJS, NII, GTM, RLW, LIP, POP, PFD, W3BSO/9, and four others. <sup>90</sup> Sixteen. <sup>91</sup> W6VBQ, AOA, MNC, UXN, QIR, RNQ, QVS, RNN, NXW, Pellock. <sup>92</sup> W2COT, GZZ, IZP, MVP, BCC, W3GQT, GIZ, ZD, HPX, GNY, MI, IMU, and seven others. <sup>93</sup> W3FZQ, GNF, EHZ, AJF, JPP, ETM, BWQ, ALB, HIO, DPU, ED, ERF, GRY, GUB, HFE, HRV, HZS, IU, JAY, KCR, KIK, KKN, PG, KQK, KRF, IGR, ALE, CXU, BEW, W8GWZ/3, Edwards. <sup>94</sup> W3DNO, VKH, TVG, W8RIK, RXT, RBO, OKU, Haughney. <sup>95</sup> W6UP, MKP, DSP, NLZ, RIP, BXR, LCY, Marchmont, and sixteen others. <sup>96</sup> W2AYJ, DUA, LYG, ICO, LZP, MJY, HYJ, INF, AZS, DJO, AHC, DXO, IRY, BJB, WQ, MET, Ohman, Graef. <sup>97</sup> W4FWT, W6EAR, UZL, GM, SEY, OJB, and six others. <sup>98</sup> Eighteen. <sup>99</sup> Twenty-six. <sup>100</sup> Twenty-six. <sup>101</sup> W6APG, BKZ, BOS, BTP, CHV, CLT, DWE, EPM, JOY, LKC, LYF, MHL, MMO, NWI, OFT, RPJ, RMN, SIG, SKZ, VJA, VTV, W8VLZ, W9WSC, EWU. <sup>102</sup> W8BOK, WSL, REH, SPY, GBE, JM, FMU, PQQ, RCN, KWI, ESQ, NEU, EBG, MIS, KWL, EHA, Rhodes, Aull, Groves. <sup>103</sup> Forty. <sup>104</sup> W2HEH, OXX, W3BXE, BES, ENX, GHD, HJE, HXA, HOJ, HFD, HYT, ILK, AGV, KT, DMQ, DOU, IKN, JUC, JSU, DGM, GYV, GQW, JBC, W8JSU, W3EHR. <sup>105</sup> Thirty. <sup>106</sup> W9NCS, YCR, MPW, OCN, BHY, JIE, ZWW, OYC, TOZ, BBL, SBO, MPI, PKO, IBD, W6JRI, MTH. <sup>107</sup> Twenty-seven. <sup>108</sup> Twenty.

(Continued on page 140)

# PLASTICON\* ASG Silicone-Filled GLASSMIKES



1-3/8 x 3-1/2

## FOR HIGHER VOLTAGES

*Extreme Temperature Range  
from Minus 60° C to Plus 125° C*

From 600 to over  
30,000 Volts

*Modern functionally designed capacitors. Metal ferrules are soldered to silver bands fused to each end of heavy-walled glass tubes. This vacuum tight assembly is fungus-proof and passes Signal Corps, Air Corps and Navy thermal cycle and immersion tests.*

**Announcing an illustrated technical booklet on uses of Plasticon\* Glassmikes.**

**Contains the following subjects: —**

- Glassmike characteristics and design data
- Comparison of Glassmikes and Mica Capacitors
- Uses of Glassmikes for improved RF and Audio bypassing
- Use in Audio and RF coupling
- Glassmikes in television power supplies
- Video coupling
- Vibrator buffer applications
- Geiger Counter Capacitors
- Instrument capacitors
- And many other applications

\*PLASTICONS: Plastic-Film Dielectric Capacitors

Write for above free booklet on your firm letterhead or give your call letters

**Order from your jobber: If he cannot supply you, order direct**



## Condenser Products Company

1375 NORTH BRANCH STREET • CHICAGO 22, ILLINOIS

# TOP QUALITY



## STOCK SYLVANIA

Model X-7018 MODULATION METER



See your modulation percentage and hear your rig through a good monitor. Extremely compact. . . . No batteries or external power supply. . . . \$29.50

**KIERULFF'S HAM SHACK**  
828 W. Olympic Blvd.,  
Los Angeles 15, California

## Prepare NOW for a Better Job in RADIO ENGINEERING



Don't Delay - Write Today!

### ADD TECHNICAL TRAINING TO YOUR PRACTICAL EXPERIENCE

Cleveland Institute offers these three outstanding courses—

1. Elementary Technical Radio Course.
2. Advanced Radio and Communication Engineering.
3. Specialized Television Engineering.

### All Courses Include

The Remarkable Workbooks of Instructional Aids, prepared by the instructing staff of Cleveland Institute

Write for descriptive literature

**CLEVELAND INSTITUTE OF RADIO ELECTRONICS**  
QT-2 Terminal Tower Cleveland 13, Ohio  
Approved for Veteran Training under G-1 Bill of Rights

Cleveland Institute of Radio Electronics  
QT-2, Terminal Tower, Cleveland 13, Ohio

Gentlemen: Please send information about your home study courses in Radio Electronics.

Name.....Address.....

City.....State.....

Check training desired 1 , 2 , 3

Check here, if a Veteran

(Continued from page 158)

W6NIK/6	W6NIK-JQX-K7GOM (ex-W6KBD)	72-	A-	1580
W8FBC/8	W8LEV-FBG-JNJ	93-	A-	1467
W1LLX/1	W1LLX-W9YBT/1	118-	B-	1428
W1BDI/1	W1AOK-BDI-JMY-JTD-UE-AFB	114-	A-	1428
W7RT/7	W7RT	58-	A-	1425
W7CGL/7	W7CGL	68-	A-	1121
W1GKJ/1	W1DFC-GKI-NKM-NXX	58-	A-	1116
W4ILL/4	W4ILL-W3JZK/4-W0PGU/4-WOYKA/4-W8RQA	66-	A-	1107
W1JWG/1	W1EZ-JWG	53-	A-	1058
W8VME/3	W8TJU-OML-JHP-VMF	54-	A-	1044
W6PMU/6	W6PMU	30-	A-	891
W3ETS/3	Four oprs.	41-	A-	833
W8LS/8	Seven oprs.	61-	A-	828
W9FVU/9	W9FVU-JVQ	36-	A-	729
W9NNE/9	W9NNE	43-	A-	693
W9NXU/9	W9NXU-HUV	30-	A-	693
W3KKP/3	W3KKP-JFI	34-	A-	675
W6OKK/6	W6OKK	18-	A-	675
VE2CO	VE2GE-SU-IE-CO-WW	40-	A-	657
W5JUZ/3	W5JUZ-W9AQW	64-	B-	630
VE3BF1	VE3BF1-YY	21-	A-	486
W4FIN/4	W4FIN-ELQ-GTS	38-	A-	477
W8SFZ/9	W8SFZ-KXJ	29-	A-	450
VE1FB	VE1RP-OP-QG-PV-PB-FB	28-	A-	402
W9AB/8	W9ZYK-AB	21-	A-	309
W3GFZ/3	W3GFZ-GKR-AFA	25-	A-	261
W8QCH/1	W8QCH	33-	A-	255
W1QJH/6	W1QJH	8-	A-	176
W1MCO/1	W1KJG-MCQ	32-	AB-	146
W3DWX/3	W3DWX	2-	A-	18

### Two Transmitters Operated Simultaneously

W8GW/8	W8WPPY-GW-GD-EBJ-BSS-AVH-QV	167-	A-	2529
W6PNU/6	W6BAM-LHN-QLA-PNU	91-	A-	1978
W6STA/6	W6STA-PNV-TFP	107-	A-	1877
W9VPD/9	W9AMP-CEO-MMH-VPD	92-	A-	1557
W2LMO/2	W2LMO-NEH-FDL-JSE-JFB	100-	AB-	1320
W8UPS/4	W4CPW-IPB-ERG-W8UPS-G2JK-Houston-Mr. & Mrs. Streyer	98-	AB-	1170
W4HHK/4	W4HCU-HHK-IGP-IDI	60-	A-	963
W6ULE/6	W6ULE-UXC	46-	AB-	733
W8SJV/2	W8SSC-BJV	22-	A-	586
W9GYZ/9	W9GYZ-ZUP-ZXS-ZVM-W8ZVJ	61-	AB-	555
W9ESJ/9	W9ESJ-MTM	41-	A-	549
W3EYX/4	W2ODW-W3EYX-KUX-AKB-BWT-KAU-KBE	8-	A-	135

### Three Transmitters Operated Simultaneously

W9ERU/9	W9ERU-AIC-BRY-HOA-BZQ-NTV-MAP-AGV-YFB-BNO	198-	A-	2574
W9PEK/9	Eleven oprs.	110-	A-	1512
W9AVE/9	W9AVE-BDK-JAN-LNK-YXJ-UUM-W3FVW/9	93-	A-	1431

### Four Transmitters Operated Simultaneously

W3KHJ/3	W3KHJ-W4IFV-W5EPJ-W6PXU-W7HDF-W8MHR-W8EYU-W9STB-W9VDV	46-	ABC-	381
---------	---	-----	------	-----

## V.H.F.-ONLY PARTICIPANTS

One Transmitter	QSOs	Power*	Score	
W6SHD/6	W6SHD-Topp-Vallette-Shrock	45-	A-	756
W6VQB/6	W6VQB-URA	22-	A-	729
W3GKP/4	W3GKP	15-	A-	405
W2MLX/2	W2MLX	29-	A-	333
W2PCQ/2	Orange County Amateur Radio League-W2JRX-KW-MJH-OKO-BN	5-	A-	90
W6OXQ/6	W6BLZ-VGD-OKQ	5-	A-	68
W8FLX/2	W2FBA-W8FLX	4-	A-	63
W1BB/1	W1BB	4-	A-	44

## HOME-STATION SCORES

W2IOP.....	87	W6URW.....	27	W1BCP.....	18
W8ROX.....	85	W2NWA.....	25	W2BWC.....	18
W8UZJ.....	74	W2GVZ.....	24	VE3APF.....	17
W8JAK.....	54	VE1RC.....	23	W9SXL.....	16
W8VUT.....	53	W2OAE.....	23	W3FY.....	15
W1NKW.....	45	W8SYJ.....	22	W3ADE.....	13
W9NPC.....	36	W2KVV.....	21	W8LCY.....	13
W6VBD.....	34	W6PBV.....	21	W8MPG.....	13
W3GJY.....	32	W1AW.....	20	W2GHK.....	12
W1BII.....	30	W2AA.....	19	W1EMG.....	11

(Continued on page 148)

# Modulate Your Rig with

# TAYLOR 805's

Whether it's a 1/2 KW or a 1 KW—  
These Tubes Will Do it Efficiently

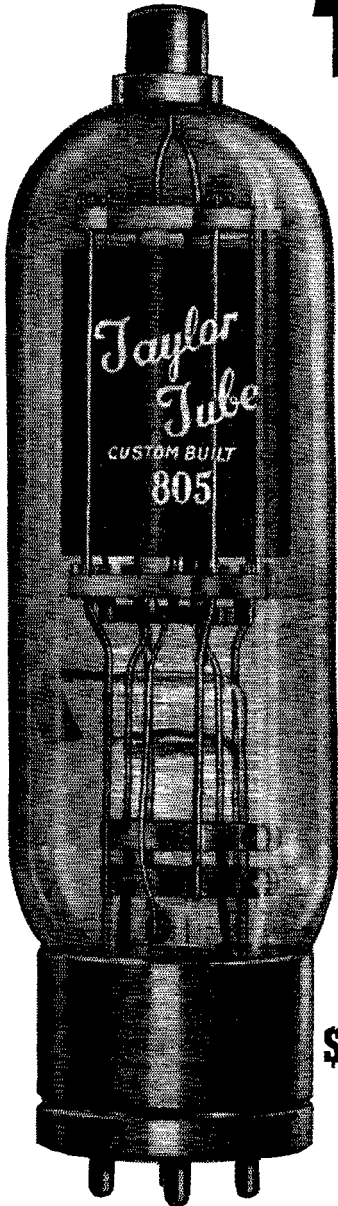

The 805 is a high mu zero bias tube of popular type incorporating the use of the famous heat tested Speer processed carbon anodes together with the Taylor Floating anode type of construction. The plate lead is brought out at the top greatly minimizing the chances of voltage breakdowns.

The no-signal or static plate current is about 55MA per tube at 1250 volts (zero bias) and about 30MA per tube at 1500 volts when 15 bias volts are added. Because the 805 is a zero bias tube, or practically so, grid current flows during nearly all of the input cycle. Due to this, the input transformer design requirements are less involved and excellent frequency response with minimum distortion is easily realized. The maximum average grid driving power is approximately 8 watts. Low impedance triodes such as 2A3's or 6A3's should be used in the driver stage.

### 805 CLASS B AUDIO DATA

Supply Voltage ↓	275	325	400	450	← Audio Watts Output
1750		270MA 15,000	330MA 12,000	390MA 10,000	← Max. Av. Ip ← Plate to Plate Load ← Watts Drive
		4.5	6.0	9.0	
1500	276MA 12,000	330MA 10,000	420MA 8,000	420MA 9,350	← Max. Av. Ip ← Plate to Plate Load ← Watts Drive
	5.0	7.0	9.5	10.0	
1250	335MA 8,000 6.25	395MA 6,800 8.5	← Max. Av. Ip ← Plate to Plate Load ← Watts Drive		

**\$10<sup>00</sup>**

The chart above gives proper Class B Audio operating conditions for various outputs at different plate voltages. The most important value is the reflected load impedance which is given for the entire primary or plate to plate. The current value is the maximum average value as would be indicated on the plate current meter with sine wave input. For the same peak output with voice input the maximum average plate current will be approximately 50% to 60% of this value.

*"More Watts Per Dollar"*

**AVAILABLE NOW**  
At All Leading Parts Distributors

**Taylor** HEAVY **CUSTOM BUILT** DUTY **Tubes**

TAYLOR TUBES INC., 2312-18 WABANSIA AVE., CHICAGO 47, ILL.

**IN STOCK READY FOR  
IMMEDIATE SHIPMENT**

400 ma. Smoothing and Swinging Filter  
Chokes—Thordarson 19C37 and 19C44.

**\$12.45 Net**

...

Stancor Poly-Pedance 60-watt Modu-  
lation Transformer A-3893.

**\$7.29 Net**

...

*Mail orders given prompt attention*

**ALL PRICES FOB OAKLAND, CALIFORNIA**  
**ALL SUBJECT TO PRIOR SALE**

**W. D. BRILL CO.**  
198 TENTH ST • OAKLAND 7, CALIFORNIA  
**WGKLO W6SSN W6FJX**

**Mass. Radio School**

271 Huntington Ave., Boston 15, Mass.

For over 27 years the educational radio center of New England. Prepares for all U. S. Government Radio Operators' Licenses. Also gives Radio Technician Training. Approved courses for Veteran Training under G.I. Bill.

*Licensed by Commonwealth of Mass.  
Department of Education*

**CUT Any SIZE\* HOLE  
TO Any DEPTH IN WOOD**

Something new in wood-boring toolst! Bruno Expansive Bit works like a lathe... requires less pressure... actually pulls itself through. Positive lock with patented triangle blade. Diamond grind on lead screw prevents splitting. Wide throat for chip clearance. Easy-to-read scale. All cutting surfaces of high grade tool steel. Replaceable blades.

**\*Wide Cutting Range!**  
No. 200-B cuts 1/4" to 1 1/4" Diameter **\$2.45**  
No. 201-B cuts 1 1/2" to 3 1/2" Diameter **\$3.45**  
Each comes with 1 long, 1 short cutter.

Ask your jobber, or write Bruno Tools,  
Beverly Hills, California, Dept. QST-2



**NO. 200-B  
\$2.45  
COMPLETE**

**BRUNO TOOLS** Beverly Hills California

(Continued from page 140)

W1HRC.....	11	W3WGL.....	8	W6EJA.....	3
W4DXP.....	11	W2CJF.....	7	W8WKE.....	3
W3RSP.....	10	W7GNJ.....	5	W4KPU.....	3
W2ORS.....	9	W11CU.....	5	W2MEW.....	1
W3QLW.....	9	W2DBL.....	4	W4BYT.....	1
W3CBI.....	9	W2NKL.....	4	W7AEC.....	1
W8PUN.....	8	W1KKY.....	3		

**WWV Schedules**

**S**TANDARD-FREQUENCY transmissions are made available as a public service by the National Bureau of Standards over its standard-frequency station, WWV, on the following schedules and frequencies:

- 2.5 Mc. — 7 A.M. to 9 A.M. EST (0000 to 1400 GCT).
- 5.0 Mc. — Continuously, day and night.
- 10.0 Mc. — Continuously, day and night.
- 15.0 Mc. — Continuously, day and night.

The 10- and 15-Mc. radio frequencies are modulated simultaneously at accurate audio frequencies of 440 and 4000 cycles. Five Mc. carries both frequencies during the daytime but only 440 cycles from 7:00 P.M. to 7:00 A.M., EST, while 2.5 Mc. carries only the 440-cycle modulation. A 0.005-second pulse may be heard as a faint tick every second, except the 59th second of each minute. These pulses may be used for accurate time signals, and their one-second spacing provides an accurate time interval for physical measurements.

The audio frequencies are interrupted precisely on the hour and each five minutes thereafter, resuming after an interval of precisely one minute. This one-minute interval is provided to give Eastern Standard Time in telegraphic code and to afford an interval for the checking of radio-frequency measurements free from the presence of the audio frequencies. Ionospheric disturbance warnings applicable to the North Atlantic path are given at 20 and 50 minutes past each hour. If a disturbance is in progress or is anticipated within 24 hours, the time announcement is followed by 6 Ws; if conditions are quiet or normal, the time announcement is followed by 8 Ns. The announcement of the station's services and of the station's call (WWV) is given by voice at the hour and half hour.

The accuracy of all the frequencies, radio and audio, as transmitted, is better than a part in 10,000,000. Transmission effects in the medium may result in slight fluctuations in the audio frequencies as received at a particular place; the average frequency received, however, is as accurate as that transmitted. The time interval marked by the pulse every second is accurate to 0.00001 second. The 1-minute, 4-minute and 5-minute intervals, synchronized with the second pulses and marked by the beginning and ending of the periods when the audio frequencies are off, are accurate to a part in 10,000,000. The beginnings of the periods when the audio frequencies are off are so synchronized with the basic time service of the U. S. Naval Observatory that they mark accurately the hour and the successive 5-minute periods.



# The West's Largest Radio Parts Distributor — Established 1932

## NATIONAL'S HRO RECEIVER

A receiver designed primarily for Amateurs. Recognized as the finest communications receiver available. Complete with four sets of coils having handsread on Amateur bands as well as general coverage. HRO-5TA Table Model or HRO-5RA Rack Model (less speaker and power supply). Price...\$274.35



### 4E27 (8001) TUBE

New—JAN 4E27 (8001) Beam power amplifier tube. 300 watts input at 75 Mc. with only 1.4 watts drive. Regular \$27.50 tube. Only .....\$6.95



### 1625 TUBE

New R.C.A. 1625 Tube. (Same as 807 type but with 12V. Fil.) Regular \$2.30 net. Special .....\$1.29



### FAN MOTOR

Small, compact, 110 A.C. induction motor. Quiet, 2400 RPM. Ideal for cooling transmitting tubes. Complete with fan.....\$2.19



### VR-150 VOLTAGE REGULATOR TUBE

New JAN series VR-150 tubes. SPECIAL 97c



### MINIATURE TUBES

New R.C.A. Miniature Tubes. Unboxed. Lots of 50 or more assorted, 10% additional discount. 12AT6..75c 12BA6..89c 12BE6..89c 35W4..57c 50B5..89c



### SANGAMO MICA CONDENSER KIT

Kit consists of 1 each: .0005, .0007, .002, .0035, .0045, .007, @ 1000V. .001, .02, @ 1200V. .0001, .0005, .001, .005 @ 2500V.

A real Amateur buy.....\$2.95



### SELENIUM RECTIFIERS

Emby Selenium Rectifiers take up to 10 V. A.C. giving low D.C. voltages at 10 Ma. maximum. Excellent for obtaining D.C. bias voltages from filament supplies. With mounting bracket. Complete .....49c

### LEACH AC RELAY

Type 2123G. 110 Volt A.C. coil. Four pole double throw. Heavy 1/4" 10 Amp. contacts.

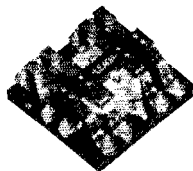

Excellent for plate transformer primary switching, antenna changeover, break-in relay operation. Double throw arrangement on each pole allows various combinations for multi circuit switching. Relay complete .....\$2.95

### TRIPLETT METER

New 2" round Triplett O-35 D.C. Ma. meter. Navy type. Bakelite case. Handy as a test meter. Mounted on black crackled metal box. Removable.

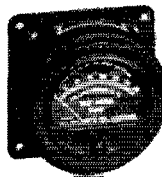

A real bargain .....\$2.50

### R. F. AMMETER

\$3.95



General Electric O-4 R.F. amps. Built-in thermocouple. 2" meter in bakelite case. A popular Amateur item.

Each .....\$3.95



### COLLINS MBF TEST METER

1" diameter, O-2 D.C. Ma. test meter. Mounted in square bakelite box equipped with 30" cord and PL68 plug. Same type as used with the Collin's "MBF" units.

Each .....\$2.95



### HS-32 HEADSET

Low impedance single receiver type headset complete with head band, 36" cord and PL-55 plug.

Complete .....99c

We carry in stock all standard brands. Regular shipments are being received of communications receivers:

- |               |            |
|---------------|------------|
| RME           | COLLINS    |
| MILLEN        | PIERSON    |
| CARDWELL      | NATIONAL   |
| HALLICRAFTERS | HAMMARLUND |

— and all other major lines.

Orders filled promptly

COMPLETE EXPORT FACILITIES. CABLE "RASPEC"

BROADCASTERS: WE CARRY A FULL LINE OF CANON "X," "XL," AND "P" PLUGS AND RECEPTACLES.

## RADIO SPECIALTIES COMPANY

(Dept. 73) 1956 So. Figueroa Street, Los Angeles 7, Calif.

- |  |  |        |
|--|--|--------|
| Please Ship.....                                       | Cash \$.....                                 | C.O.D. |
| <input type="checkbox"/> HRO-5TA TABLE MODEL           | <input type="checkbox"/> HRO-5RA RACK MODEL  |        |
| <input type="checkbox"/> 4E27 TUBE                     | <input type="checkbox"/> 1625 TUBE           |        |
| <input type="checkbox"/> TRIPLETT METER                | <input type="checkbox"/> COLLINS "MBF" METER |        |
| <input type="checkbox"/> LEACH AC RELAY                | <input type="checkbox"/> R. F. AMMETER       |        |
| <input type="checkbox"/> CONDENSER KIT                 | <input type="checkbox"/> FAN MOTOR           |        |
| <input type="checkbox"/> 12AT6 TUBE                    | <input type="checkbox"/> 12BA6 TUBE          |        |
| <input type="checkbox"/> 12BE6 TUBE                    | <input type="checkbox"/> 35W4 TUBE           |        |
| <input type="checkbox"/> 50B5 TUBE                     | <input type="checkbox"/> SELENIUM RECTIFIER  |        |
| <input type="checkbox"/> VR150 VOLTAGE REGU-LATOR TUBE | <input type="checkbox"/> HS-32 HEADSET       |        |

NAME.....  
 ADDRESS.....  
 CITY..... ZONE..... STATE.....

# RADIO SPECIALTIES COMPANY

# No Spreading Ourselves Out Too Thin!

Certainly, we could expand our facilities and offer you a more complete line. But, then, we couldn't do as well on deliveries as we're now doing!

So to serve you best, we are continuing our present maximum production on a limited line — thus assuring you the usual prompt and efficient Kenyon service.

THE MARK OF  EXCELLENCE

**KENYON**

**TRANSFORMER CO., Inc.**

840 BARRY ST., NEW YORK, N. Y.



## RCA INSTITUTES, INC.

Offer thorough training courses  
in all technical phases of

**RADIO and TELEVISION**

WEEKLY RATES DAYS—EVENINGS

**VETERANS:** RCA Institutes is approved

under G. I. Bill of Rights

For Free Catalog write Dept. ST-47

**RCA INSTITUTES, INC.**

A Service of Radio Corporation of America

75 Varick Street, New York 13, N. Y.

## Sending Made Easier!

Genuine Easy-Working

SEMI-AUTOMATIC  
RADIO KEY

# VIBROPLEX

Reg. Trade Marks: Vibroplex, Lightning Bug, Bug

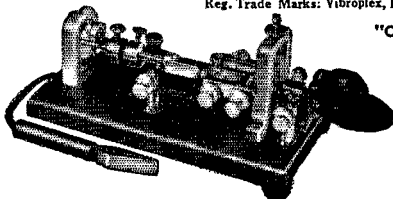

"Original" DeLuxe  
Model

WITH  
PATENTED  
JEWEL  
MOVEMENT

**\$19.50**



The "BUG"  
Trade Mark  
identifies the  
Genuine  
Vibroplex.  
Accept No  
Substitute

**PATENTED JEWEL MOVEMENT** is an exclusive DeLuxe Vibroplex feature—a feature that has so completely eliminated tiring sending effort that sending is no longer a task but astonishingly easy. No special skill required. Polished chromium base and parts. DIE CUT contacts and main spring. Colorful red switch knob, finger and thumb piece. 3/16th contacts. Circuit closer, cord and wedge. DeLuxe finish also available in "BLUE RACER" and "LIGHTNING BUG" models. Get a DeLuxe JEWELLED movement Vibroplex NOW! Money order or registered mail. FREE catalog.

**THE VIBROPLEX CO., Inc.**

833 Broadway

New York 3, N. Y.

## Modulation Meter

(Continued from page 57)

compensate for a slight change with frequency in the rectification efficiency of the 1N34. The crystal acts as a shunt diode detector, and with the left-hand toggle switch at "R.F.," serves as a peak-reading r.f. voltmeter. The r.f. choke, in conjunction with the by-pass condenser,  $C_4$ , serves to separate the radio-frequency voltage from the d.c. current passing through the meter. The resistor,  $R_2$ , in series with  $MA$ , acts as the diode load. The value of  $R_2$  is chosen so that when sufficient energy is fed into the unit to obtain a reading of 1.0 ma. for voice (0.7 ma. for sine wave), the meter will read directly in percentage-modulation when switched to the "A.F." position. With the constants given, 1.0 ma. represents 100 per cent, 0.9 shows 90 per cent, etc., in linear fashion.

With the switch in the "A.F." position, the primary of transformer  $T_1$  becomes the diode load. Thus, the detected audio component of the carrier is passed to the secondary, and thence through the reversing d.p.d.t. switch,  $S_2$ , to the second 1N34 and its load, the meter. The audio-frequency component is then rectified and appears as a d.c. current through  $MA$ . This current is directly proportional to the a.f. voltage applied, for percentages of modulation over 10.

The condenser,  $C_6$ , serves to by-pass stray r.f.  $S_2$  is connected so that in the upward position, positive modulation is rectified, and in the downward position, negative. Since in passing through  $T_1$  the exact d.c. level, representing average r.f.-carrier level, is lost, the unit will only give a qualitative picture of the difference between positive and negative peaks. To have designed the meter to give exact readings would have necessitated the incorporation of a d.c. restoring circuit which would greatly increase the meter's complexity and consequent cost. The type of modulation in which loss of the d.c. level would cause a serious error is almost never encountered in amplitude-modulated radiophone installations. It is felt that the present system, if utilized in conjunction with the frequent observations of "carrier shift," will serve to help the amateur in detecting asymmetry in his modulation.

The jack,  $J_1$ , is arranged to disconnect the a.f. rectifier and meter circuit when the headphone plug is inserted, thus allowing the audio-frequency voltage in the secondary to be applied directly across the operator's headphones.

### Accuracy

The accuracy of the modulation meter is determined by several factors. First, it has been proven by experiment that if the components listed in the parts list are used, it is not necessary to calibrate each individual meter. However, it is absolutely necessary that  $R_1$  and  $R_2$  be within 5 per cent of their nominal value. The ordinary run of resistors is not within this tolerance and will render the instrument inaccurate. Many

(Continued on page 148)

# SUN RADIO - HOME OF NATIONALLY KNOWN RADIO PARTS!

**Brand New  
RADIO  
TUBES**  
UP TO  
**80% OFF!**

## WAR SURPLUS EQUIPMENT!

AT A FRACTION OF THEIR ORIGINAL COST!  
FOR IMMEDIATE DELIVERY

### HALLICRAFTER SP44 PANORAMIC ADAPTER

The least expensive panoramic adapter available. Easily installed in any Set

**\$99.50**

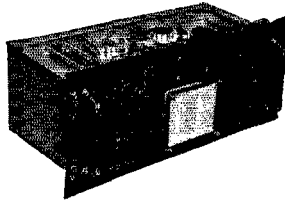
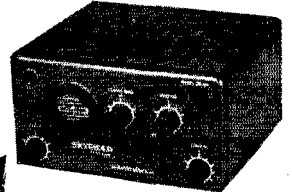

### R. F. TUNING UNIT

Black cracked aluminum cabinet with 2 Variable Transmitting Condensers and 2 Vernier dials, 1 heavy duty ceramic 4 position wafer switch, 2 or more mica condensers, 2,500 Working Volts and coils wound on porcelain ribbed forms. Only..

**\$3.89**

No. TU5B, 1500 to 3000 KC  
No. TU6B, 3000 to 4500 KC  
No. TU7B, 4500 to 6200 KC  
No. TU8B, 6200 to 7700 KC  
No. TU10B, 10,000 to 12,500 KC

Please specify model

### Navy ANEMOMETER

Beautiful precision designed instrument that will enable you to determine the Wind Velocity in miles per hour. Complete instructions, 8 Volt battery operated.

Brand new. **\$14.95**

8 Volt Battery... \$0.60

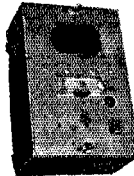
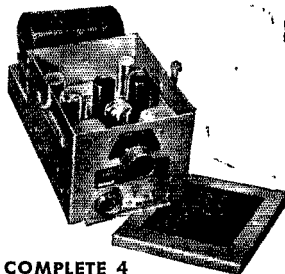
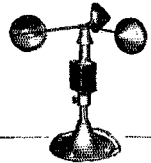

### NAVY V.H.F. RADIO TRANSMITTER

BRAND NEW

**\$14.95**

Battery operated (67 1/2 V.B. and 1 1/4 V.A.). Frequency 80 to 105 M.C. Complete with 2-1G4 tubes and full instruction manual.

### COMPLETE 4

#### TUBE INTERPHONE AMPLIFIER

Comes in an aluminum cabinet 9 1/4 x 4 1/4 x 5 1/2 inches with two 12J5GT tubes and two 12A6; also General Electric Dynamotor 28DC Volt input and 250 VDC output at 60 MA. Complete instructions and diagram for high fidelity phonograph or speech for 110 Volt operation. Greatest offering ever made in War Surplus Electronics. **\$8.95**

Only

Number	Price	Number	Price	Number	Price
OZ4	\$1.45	6F8	\$1.10	12SL7GT	\$1.20
1A5GT	1.00	6C6	1.00	12SN7GT	.95
1A7	1.80	6H6	.75	12SQ7GT	1.10
1B4	.80	6J5	.80	12SE7	1.00
1C5GT	.80	6L7	1.15	14A7	1.50
1D5	.80	6J8	1.30	14B8	1.40
1D7	.85	6K6	.85	14B8	1.60
1D8GT	1.10	6K7	.85	14C5	1.60
1E4	.80	6K8	1.30	14C7	1.60
1E5	.80	6L5	1.10	14F7	1.60
1F7	1.00	6L6G	1.50	14H7	1.60
1F4	.80	6L7	1.40	14J7	1.60
1F5	.80	6N7	1.40	14N7	1.60
1F7	.90	6P5	.80	14Q7	1.20
1G4	1.30	6P7	1.40	14R7	1.60
1G6	1.25	6Q7	1.30	14W7	1.85
1H4	.70	6R7	1.40	14Y4	1.60
1H5	1.50	6S7	1.20	18	1.25
1J5	.75	6SA7	1.00	19	1.00
1J6	.80	6SF5	.70	20	1.75
1LA4	1.95	6SJ7GT	.70	22	1.00
1LB4	1.95	6SK7GT	.80	24A	.90
1LC5	1.95	6SL7GT	1.00	25L6GT	1.10
1LD5	1.95	6SN7GT	.85	26	.75
1LH4	1.95	6SQ7GT	1.00	27	.70
1LN5	1.95	6T7	1.00	30	1.00
1NS	1.30	6C35	.95	31L7GT	1.00
1N5	1.30	6C6GT	1.00	32	1.95
1R4	1.25	6U7	1.00	33	1.00
1R5	1.25	6V6	1.10	34	.80
1T4	1.25	6V7	1.00	35Z5	1.00
1T5	1.50	6X5GT	1.00	35W4	1.08
1V	1.00	6Y6G	1.00	35Z5	1.30
2A7	.75	7A4	1.00	37	.75
2B7	.75	7A5	1.00	38	.85
2E5	.85	7A6	1.00	39/44	.80
2X2/879	.90	7A7	1.00	41	.85
222/G84	.45	7B4	1.00	42	.85
3C5	1.00	7B5	1.00	45	.80
3E4	1.25	7B6	1.00	46	1.00
5U4	1.00	7B8	1.00	49	.95
5V4	1.60	7C5	1.30	50	1.75
5X4	1.10	7C6	1.00	50L6	1.24
5Y3GT	.70	7C8	1.30	55	.50
5Y4	.75	7C7	1.00	56	.80
5Z3	.95	7D6	1.00	57	.75
6A5	1.70	7E7	1.30	59	.80
6A6	.80	7E7	1.30	76	.75
6A8	1.00	7E7	1.30	77	.75
6A5G	1.70	7J7	1.50	78	.75
6AC5GT	1.00	7L7	1.50	79	.85
6A75	1.00	7N7	1.50	80	.60
6A8G	1.60	7N7	1.00	81	1.50
6B4	1.50	7R7	1.30	82	.85
6B7	.95	7S7	1.50	83	1.30
6B8	1.00	7V7	1.80	83V	1.95
6C5	1.00	7W7	1.00	84/624	1.10
6C6	1.00	7Z4	1.30	89	.40
6C7	.45	12BE6	.44	99	1.50
6C8	1.25	12BF6GT	1.00	117L7GT	2.35
6D6	.75	12J5GT	1.00	117Z6GT	1.60
6D7	1.00	12SA7GT	1.30	XXB	1.50
6E5	1.00	12SB7GT	1.00	XXFM	1.50
6E8	.95	12S7GT	1.10	XXL	1.50
6F7	1.50	12SK7GT	1.10		

## FOR IMMEDIATE DELIVERY!

OR YOUR MONEY REFUNDED

Hallcrafter S40..... \$79.50

Hammarlund H.Q. 129X.. \$173.25

Hammarlund S.P. 400X.. \$347.50

Prices subject to change

# SUN RADIO

OF WASHINGTON, D. C.

938 F STREET, N. W. WASH. 4, D. C.



*First* WITH DISCRIMINATING  
AMATEURS

ON STANCOR'S PROGRAM  
Transformers and Reactors of all types  
... Versatile Line of Transmitter Kits,  
Audio Amplifier Kits, and other  
Electronic Devices to serve the  
Discriminating Amateur.

**STANCOR** STANDARD  
TRANSFORMER CORP.  
ELSTON • KEDZIE AND ADDISON, CHICAGO, ILL.

**COMPLETE RADIO TRAINING!**

Prepare now to accept a responsible position in Commercial Radio. New developments will demand technicians with thorough basic training, plus a knowledge of new techniques discovered during the war. Training open to high school graduates or those with high school equivalency. Courses 6 to 18 months' duration in RADIO AND ELECTRONICS. Approved Veteran training in Radio. Write for Particulars.

VALPARAISO TECHNICAL INSTITUTE  
Dept. TN Valparaiso, Ind.

**HAM'S  
HERE** Immediate  
Delivery

Nationally Known Amateur  
Gear — Receivers, Transmitters,  
Tubes, Equipment.

ASK FOR OUR BARGAIN BULLETIN

Write • Telephone • Wire

**R. G. SCELİ & CO.**

317 Asylum Street      84 Elm Street  
Hartford (3) Conn.      • Bridgeport (3) Conn.  
Telephone 2-1144      Telephone 6-1811

(Continued from page 144)

1N34 diodes were tested and were found sufficiently linear to cause negligible error, even at low levels of modulation. The transformer recommended is loaded in such a way that ordinary off-the-shelf transformers gave very reproducible readings. The frequency characteristic of the transformer is such that it gives quite linear modulation readings from 200 to 4000 c.p.s., which adequately cover the voice range. The accuracy of the modulation meter with 1000-c.p.s. sine-wave modulation is better than 10 per cent, from 30 Mc. to 3.9 Mc., and 20 per cent up to 54 Mc.

If the reader desires to check the calibration of his instrument, it is suggested that he compare it with an oscilloscope at some other shack. Experience has proved that comparison with a good sine-wave pattern on a 'scope is the simplest and most accurate method.

When the modulation meter was demonstrated, almost invariably it evoked such comments as, "Why not use it for a field-strength meter, too?" or, "Put a dial on it, add plug-in coils, and use it for an absorption wavemeter." It may be possible to do these things and more, but the writers feel that to combine too many such features in this article would confuse the issue, and their efforts were devoted to the original problem of constructing a simple but accurate modulation meter.

This meter has been tested on all amateur 'phone bands from 3.85 to 54 Mc. In many instances it is satisfactory up to 148 Mc., but above 54 Mc. the performance is sometimes erratic. The model in the photographs has now replaced a much more complex vacuum-tube modmeter at the operating position of W1HKK. It has been found to be an indispensable adjunct to that station, and it is hoped that it will give other 'phone operators equal pleasure.

The writers wish to thank Mr. Robert Moses, W1MHM, for valuable aid rendered in the development of the modulation meter.

**Strays**

The Amateur Radio Assn. of Bremerton will hold its annual hamfest on February 8th. Registration will be held at the Enetai Inn, with banquet and dance at Rau's Chicken Dinner Inn. Prizes, contests and big doings! Admission \$3.50, by ticket only. Make reservations in advance through A. Swan, A.R.A.B. Secy.-Treas., 1133 Trenton, Bremerton, Washington.

Some call ex-W9TSA has now, gang — WØTSA?

A prospective Young Squirt recently wrote us, "I am *mortally* interested in radio and television and most of all in amateur radio." (Italics ours.) Gosh, we hope so!

W6HOG ran into W6STY — on 7 Mc.

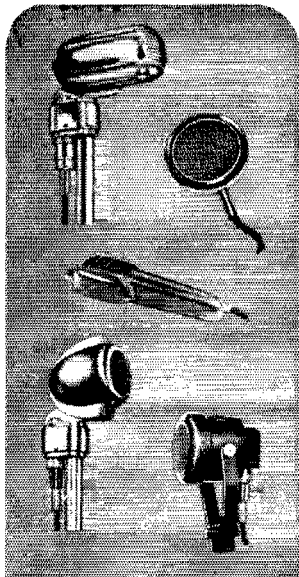

## ACE HIGH with Amateurs

### The Turner Model 22

Crystal or Dynamic

Turner Microphones need no introduction to veteran amateurs. They're known all over the world for accurate pick-up and smooth even response to voice and music without distortion. Take the Model 22. Its high quality crystal or rugged dynamic circuit is precision engineered to deliver ace high results. It has every worthwhile feature you want plus modern eye appealing styling. And the cost is attractive too. When buying for your rig—investigate and select a dependable Turner Model 22.

At your dealer's or write for specifications

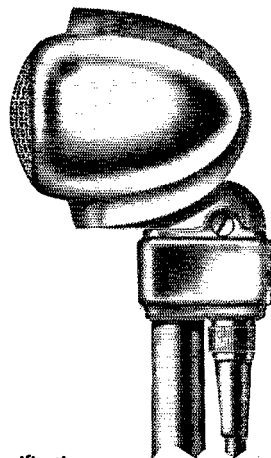

## THE TURNER COMPANY

917 17th STREET, N. E. • • • CEDAR RAPIDS, IOWA



# Microphones BY TURNER

Microphones licensed under U. S. patents of the American Telephone and Telegraph Company, and Western Electric Company, Incorporated. Crystals licensed under patents of the Brush Development Company.

*Are you sure you're in the band?*

You Can Now Build A Secondary  
Frequency Standard At Low Cost  
With A JK Stabilized

**100 KC CRYSTAL**



Here, at last, is a precision 100 KC crystal that the amateur can afford.

It can be used to excellent advantage when building a Secondary Frequency Standard to work the edge of the bands and check points throughout all of the bands.

In spite of its low price, the finest techniques known to the industry today are employed in its construction. The crystal has extremely low drift, the electrodes are pure silver and mounting wires are soldered directly to the silver plating. Result: A rugged unit that will stand vibration without changing frequency, nor will it age or increase frequency with use. Holder is completely sealed against dust and moisture.

Don't let the low price deceive you — it's a beautiful item — has eye appeal and a performance record that will please you for years to come!



Amateur Net Price **\$6.95**

**CIRCUIT DIAGRAM FURNISHED**

A circuit is supplied with each crystal giving complete information on how to build an inexpensive Secondary Frequency Standard.

**the JAMES KNIGHTS Co.**  
SANDWICH, ILLINOIS

(Continued from page 61)

# A NEW HIGH "Q" TWO METER RING-TUNER

A COMPLETE variable tuning unit having a tuning range of 140 m.c. to 160 m.c. (with 3.5 uuf tube capacity) designed for single hole mounting on receivers, wave meters, frequency meters, low power transmitters and oscillators. Manufactured expressly for use in the amateur 144 m.c. to 148 m.c. band. Compact and easy to assemble . . . no condensers to trim, no coils to wind, no sliding contacts. "Q" is many times greater than conventional condenser combinations. Send check or money order for a Clarkstan Ring Tuner today! Write for free technical bulletin 110Q.

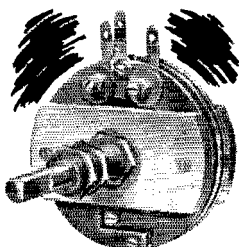

**YOUR NET PRICE**  
**\$4.80 NO C.O.D.s**

## CLARKSTAN

CORPORATION  
11927 W. Pico Blvd.  
Los Angeles 34, Cal.

## W8CFK

**Aluminum Call Plates**

Your call cast in aluminum with black background and polished 1 1/4" letters. Plate size 2" by 6 1/2", 3 styles; P for panel mounting, L for car license and D for desk use. \$1.75 each, postpaid.

P & H SALES CO.

619 Jasper St.

Kalamazoo 31, Michigan

## ANTENNAS!

FM TELEVISION and AMATEUR ROTARY BEAMS; FIXED BEAMS; 2-6-10-20 METERS.

ELEMENTS, COAXIAL CABLE. Send for Circulars.

S/C LABORATORIES, INC.

20-22 Van Wagenen St., Newark 4, N. J.

## CODE SENDING RECEPTION SPEED

**Have Skill, Accuracy**

Be a "key" man. Learn how to send and receive messages in code by telegraph and radio. Commerce needs thousands of men. Expansion of air commerce and freight after war should create an even bigger peacetime demand for operators. The famous Candler System, maker of world's champions, teaches you the "knack" of sound sense and sound consciousness that is the secret of speedy sending and receiving. Good pay, adventure. Learn at home quickly.

**FREE 52-PAGE BOOK** explains extra course of training. Rush name for it today. It's absolutely free.

**CANDLER SYSTEM CO.**

Dept. 4-B, P. O. Box 928, Denver 1, Colo., U. S. A. and at 121 Kingsway, London, W.C. 2, England

### Operation

To transmit, modulation need only be applied to the 723A/B tube which is used for the local oscillator. It is not necessary to remove or change any of the applied voltage, except to apply modulation as shown in Fig. 5. Since the waveguide section is already coupled to the antenna, the modulated signal is propagated in a concentrated beam. Since the two stations operate 30 Mc. apart, duplex operation is possible. All tuning may be done at one of the stations, as this will automatically compensate the other station. Technically speaking, this method of operation is somewhat inefficient, as compared with the use of a separate transmitter and receiver, or some means of r.f. switching. A portion of the signal is dissipated across the crystal, but this does not appear to be a serious handicap in actual operation, as the received signal is very strong over visual paths. Transmitter power output is of the order of 35 milliwatts.

The modulator used in our first tests was the conventional choke-coupled system, the output of which is applied between the cathode and reflector elements of the 723A/B tube. The gain control should be operated at the lowest possible setting, as the amount of frequency modulation is dependent upon how hard this system is driven. To cause intentional frequency modulation, the system described by Sharbaugh and Watters<sup>2</sup> may be used to good advantage.

For those interested in conducting further tests with amplitude modulation, an alternative method might be tried. It has been observed in past experience with this tube that shifting the potential on the resonator element will change the frequency in one direction, while variation of the voltage on the reflector element will move the frequency in the opposite direction. Since a positive potential is applied to the resonator and a negative voltage is applied to the reflector, it is apparent that if the modulation voltage applied to these two elements is out of phase the effect of the frequency shifts will be canceled. Since the sensitivity of the two elements to voltage changes is unequal, the applied modulation must be in the ratio of this difference, which is approximately 5 to 1, the reflector element being the more sensitive. With the modulation applied in this manner, and the amplitude held at the proper level, resultant frequency modulation should be held to a minimum.<sup>3</sup>

The author wishes to acknowledge, with thanks, the wholehearted interest and cooperation of Charles K. Atwater, W2JN, without whom these experiments could not have been carried out.

<sup>2</sup> "Our Best DX — 800 Feet," Sharbaugh and Watters, QST, August, 1946.

<sup>3</sup> This 5-to-1 ratio is not always constant, and may vary widely with different tubes. — Ed.

# Workshop BROAD BAND ANTENNAS

10 METER BEAM ANTENNA

In the design of the 10 meter beam, our engineers have considered the band width of the antenna to be a very important factor. The impedance match, gain, and "front to back" ratio of the antenna should remain constant over the entire band, particularly with ECO operation.

Workshop's 10 meter beam has been designed to meet these conditions. After extensive measurements, the element spacings and lengths were selected to give relatively constant impedance match, gain and front to back ratio over the band.

The graph shows the small variation in standing wave ratio over the entire band. This means optimum performance over the whole band instead of sacrifice of signal strength due to a detuned antenna. Structurally, as well as electrically, the Workshop beam is far ahead of the field. The entire antenna assembly is built with utmost care so as to deliver continual service and withstand severe weather conditions.

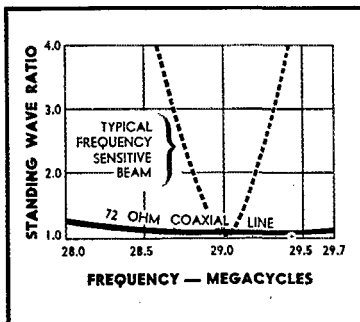

## The WORKSHOP ASSOCIATES, INC.

Specialists in High-Frequency Antennas

66 NEEDHAM STREET, NEWTON HIGHLANDS 61, MASSACHUSETTS



### Workshop Antennas and Equipment

**2-Meter Beam Antenna Model #146AB**  
High-gain, directional, 6 element array with two driven elements..... \$19.00

**6-Meter Beam Antenna Model #52AB**  
High gain, directional, 3 element antenna to be used with Workshop rotating mast....\$8.00

**10-Meter Dipole Antenna Model #29AD**  
Bi-directional antenna for 27 to 30 mc band. Adjustable elements..... \$6.75

**10-Meter 3-Element Beam Conversion Kit Model #29B**, converts dipole #29AD to a 3-element beam.....\$27.50

**20-Meter Beam Antenna** (To be announced soon)

**Antenna Mast Kit Model #AM**. Two sections complete with all mounting accessories. A stationary mast for all Workshop antennas. \$7.25

**Model #AM1**. Extra 4-foot sections to lengthen the above mast.....\$1.30

**Rotating Accessory Kit Model #AM2**. To convert Model #AM mast to a manually rotated mast, complete with instructions..\$4.25

**Workshop Rotator**. Remote control reversible electric motor drive with 360 degree azimuth dial indicator.....\$142.50

Available at better dealers

The above are the amateur net prices — slightly higher in the Far West. Prices are subject to change without notice.

## Electronic Volt-Ohmmeter, Model 406



We invite comparison of this instrument with any at any price for appearance, ruggedness, accuracy, stability. 0-1 to 1,000 volts U.H.F., A.C., D.C. 0-1,000 megohms. Pen-type dual-diode A.C. probe. No extras to buy. Send for details or order today.

**\$89<sup>50</sup>**  
NET

from jobber or  
F.O.B. Cincinnati

# Clippard

## INSTRUMENT LABORATORY, INC.

Dept. 4, 1127 Bank Street, Cincinnati 14, Ohio



U.H.F. RESONATOR CO.

**3 ELEMENT  
4 ELEMENT  
AND  
5 ELEMENT  
TEN METER BEAMS  
3 ELEMENT 20 METER BEAM**

These wide-spaced beams are made of Duralumin, are guaranteed to withstand wind and ice, are made by amateurs for amateurs, and are completely pretuned as to spacing, element lengths, and matching. You do not have to worry about your antenna when you use one. Results are proven by a large number of letters in from several hundred customers who have sent in their orders and checks, received their beams in a strong wood box by Railway Express, assembled the beam with a screwdriver and pliers, put it up on a light mast, connected the feed line, and used. Typical reports, "Worked WAC in 1 hour and 32 minutes on C.W."; another, "It really is a swell beam. First three stations worked were D4AMK, SM3IL, GW8NP"; also "Since I put it up I have had wonderful success, hearing and working countries I never could before."

Amateur net prices, 10-meter beams: 3 el. beam, length 12 ft., weight 3 1/2 lbs., \$35. 4 el. beam, length 21 ft., weight 13 1/4 lbs., \$50. 5 el. beam, length 30 ft., weight 25 lbs., \$65. 3 el. 20-meter beam, 23 ft. long, 39 lbs., \$100. For shipping prepaid anywhere in U.S.A. or Canada add \$10 deposit on strong wood box. Refund on return of box, less outgoing shipping chgs. Beams available for all amateur bands from 14 m.c. up, including 16 and 32 element beams for 2 meters. Send for literature. Our 3 inch diameter Dural tubing mast, electrically rotated, for installing on roof, ground, or tower, is now in production also.

**U.H.F. RESONATOR CO.**

W.F. Holsington, 2 BAV

GUION ROAD, RYE, N. Y.

Telephone Rye 2030

Factory at Portchester, N. Y.

**• LEARN CODE •**  
SPEED UP YOUR RECEIVING  
with  
**G-C Automatic Sender Type S**  
\$20.00 Postpaid



Housed in Aluminum Case, Black Instrument Finished. Small—Compact—Silent induction type motor. 110 Volts—60 Cycle A.C.

Adjustable speed control, maintains constant speed at any setting. Complete with ten rolls of double perforated tape. A wide variety of other practice tapes available at 50c per roll.

If your dealer cannot supply you—write

**GARDINER & COMPANY • Box 56**  
STRATFORD, N. J.

**ELECTRICITY**

FOR RADIO AND ELECTRONIC APPLICATIONS

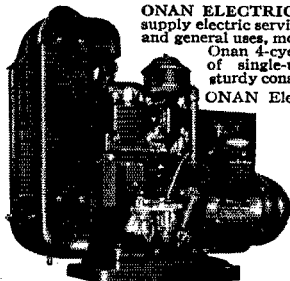

ONAN ELECTRIC GENERATING PLANTS supply electric service for electronics applications and general uses, mobile or stationary. Driven by Onan 4-cycle gasoline engines, they are of single-unit, compact design and sturdy construction.

ONAN Electric Plants are available in many sizes and models.  
**ALTERNATING CURRENT:** 350 to 35,000 watts in all standard voltages and frequencies.  
**DIRECT CURRENT:** 600 to 10,000 watts, 115 and 230 volts.  
**BATTERY CHARGERS:** 500 to 3,500 watts; 6, 12, 24 and 32 volts. Write for detailed literature or engineering assistance.

**D. W. ONAN & SONS** 4655 Royalston Ave. Minneapolis 5, Minn.

150

50 Mc.

(Continued from page 78)

schedules with interested parties. He has a 10-meter rig which can be used for crossband checking, and a 6-meter job is under construction. The gear is made in such form that it can be taken to mountain tops when the right weather for that sort of activity comes around again.

There is quite a bit of activity within reach of Wilmington, Del. W1NSS, returning from Wilmington, brought back a list of 53 stations heard on 144 Mc. by W3DQZ, who complains that many stations are heard from distant points, but that it is often difficult to raise them because they are not expecting to hear anything from outside their own locality and are not tuning the band frequently or carefully enough.

There was a time when it was impossible to use a selective receiver on 144 Mc., even in the populous areas, but the advent of more such receivers and a few converters which are operated in conjunction with low-frequency receivers is forcing the trend to crystal control, according to the *Midwest VHF News*. A few of the boys who had good intentions but hadn't gotten around to doing anything about it have had a chance to hear the signals from unstable stations, as they are received on selective jobs, and the result is enough to start anyone working on a crystal rig. They really do sound pretty awful—even the two-stage MOPA rigs which come through quite cleanly on the broader supers—and the quality with which the crystal rigs may be received is quite a revelation. Narrow-band f.m. is received well on the sharp receivers, in contrast to the appearance of unmodulated carrier which such emission produces in the superregens.

**At Last—a Record for 235 Mc.!**

The one v.h.f. band which has been missing from our two-way records has now been supplied with a contact worthy of being listed as a record. On Dec. 15th W9OAW/6 atop Mt. St. Helena maintained contact with W6WQN/6 at Mt. Hamilton on 237 Mc., a distance of 110 miles, with S9 signals. Identical crystal-controlled transmitters (832-A in final, 15 watts input) and superhet receivers (11-tube jobs with 6AK5s in r.f. and i.f. stages) were used by both stations. W9OAW/6 had a 6-element array, while W6WQN/6 used a 3-element job. Both vertical and horizontal polarization were tried, with very little difference noted, as long as the same was used at each end. Cross-polarization dropped the signal from over S9 down into the noise.



Definition of a good c.w. operator, gleaned from reams of Headquarters correspondence: feller who can come in at 5 A.M., after an all-night party, and copy 40 w.p.m. in Old English with a six-inch paint brush.



# MODERNIZE *your rig with* BAND SWITCHING!

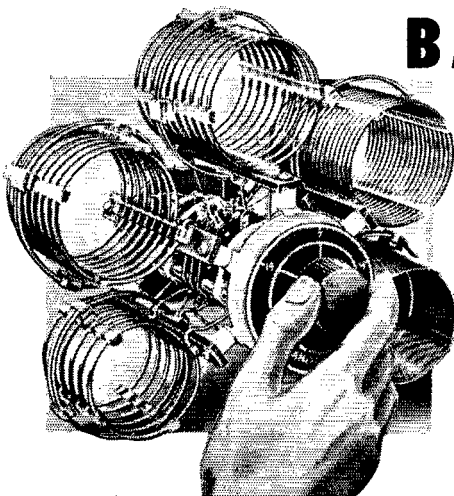

Treat your layout to fast, positive-acting band switching. B & W Turret Assemblies make it easy. They're a cinch to install—moderate in cost—adaptable to any bands—highly efficient in operation. Write for bulletin giving full details on

B & W "BABY" TURRETS (up to 35 watts)  
 B & W "BAND HOPPERS" (up to 75 watts)  
 B & W 75-WATT TURRETS • B & W 150-WATT TURRETS

It takes an Air-Wound Inductor to assure full efficiency for modern rigs!



**BARKER & WILLIAMSON**

237 FAIRFIELD AVE., UPPER DARBY, PA.

# WATERMAN DOES IT AGAIN!

A NEW PORTABLE

INDUSTRIAL AND TELEVISION

**POCKETSCOPE**

AN OSCILLOSCOPE  
 of UNUSUAL VERSA-  
 TILITY AND UTILITY

MODEL S-11-A

LIGHT... COMPACT  
 EFFICIENT

A 3-inch oscilloscope for measuring AC and DC... Amplifiers for vertical and horizontal deflection as well as intensity... Linear time sweep from 4 cycles to 50 kc with blanking of return trace... Sensitivity up to 100 mv/in... Fidelity up to 350 kc through amplifiers... Attenuators for AC as well as for DC... Push-pull amplifiers... Anti-stigmatic centering controls... Trace expansion for detail observations.

Direct connections to deflecting plates and intensity grids accessible from rear... Retractable light shield... Detachable graph screen... Handle... Functional layout of controls.

Light weight: 8¾ lbs. \$99  
 ... Portable size:  
 11" x 7" x 5" ... F.O.B. PHILA.

...and the GENERAL PURPOSE

**POCKETSCOPE**

MODEL S-10-A

Widely known, widely used by engineers, industry, amateurs and laboratories for convenient, efficient and accurate testing and measuring requirements... an instrument of versatile application and dependable performance.

\$66 F.O.B. PHILA.

**WATERMAN PRODUCTS COMPANY**  
 INCORPORATED  
 PHILADELPHIA 25, PENNSYLVANIA

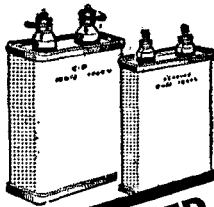

10 MFD.—1000 volts, No. 17A268 .....\$3.95  
 4 MFD.—1500 volts, No. 18A227 .....\$2.94  
 Plus 20c each postage and pkg. charges.

## OIL FILLED • HI-VOLTAGE CONDENSERS

### EXTRA SPECIAL VALUE

Limited quantity of these fine condensers with ceramic insulated terminals. Place your order at once.

## 18 YEARS IN RADIO

Latest developments in radio and electronic parts and devices, newest "Ham" gear, gadgets to delight the heart of the experimenter, bargains in selected war surplus radio items. Some of the best values we have offered in our 18 years in business.

### WRITE FOR CATALOG

Get on our mailing list and receive our bulletins and catalogs as issued.

**BURSTEIN-APPLEBEE CO.**  
 1012T McGee, Kansas City 6, Mo.

## QST YEARLY BINDERS

**ARE WE RIGHT?** You should have at least two of them—one for your complete 1946 file of copies, and one for each 1947 issue as published. **Price \$2.00 postpaid.** Available Only in United States and Possessions. **THE AMERICAN RADIO RELAY LEAGUE, West Hartford 7, Connecticut.**

## VIDEO

Amazing Television Handbook. How to construct, install, operate, service, sight and sound receivers. How video is growing. How a modern transmitting station works. How receiver works. How to build receiver. How to erect antenna. How to install. Trouble shooting. Video dictionary. Three separate 15" x 18" assembly stage diagrams. Written by a master, in simple language. 96 pages, 71 illustrations, heavy glossy paper, spiral binding lies flat. Only \$1. Your money back in 10 days if not delighted. **HURRY.** Write Norman W. Henley Publishing Co., Dept. ST, 17 West 45th St., New York 19, N. Y.

# Ham Post!

"ARE YOU TROUBLED WITH BC1?  
 Use Sonar Narrow Band F.M.—Tune above  
 29 MC for solid contacts. Model XE-10  
 (less xtal) \$39.45

Distributors of Nationally Known  
 'Ham' Sets and Equipment."



**CONTINENTAL SALES COMPANY**  
 195-197 CENTRAL AVENUE, NEWARK 4, N. J.

## Hints and Kinks

(Continued from page 75)

the sketch, and reassemble them in the mounting plate. If the two "halves" match well, the locking ring will hold them securely in place, and the socket can then be mounted in the chassis as any other socket would be. If you are extra careful to get a perfect fit, the mounting plate may be eliminated and the assembly can be mounted in a  $1\frac{1}{4}$ -inch hole with the locking ring alone.

Ceramic sockets cannot be used in this gadget because they are impossible to saw. If, however, low-loss mica-filled bakelite sockets are used, the losses should be low enough to make the unit entirely satisfactory. It makes about the only satisfactory three-way crystal socket seen here to date. — *Basil C. Barbee, W5FPU; ex-W2MWX, W1OCE.*

## BOOK REVIEW

**Basic Mathematics for Radio Students**, by F. M. Colebrook. Published by Iliffe & Sons Ltd., London, England. 270 pages,  $4\frac{3}{8} \times 7$  inches, illustrated. Price 10/6.

Mr. Cosgrove has chosen as the title for his book *Basic Mathematics for Radio Students*; however, as pointed out by him in the introduction and in the foreword by Mr. G. W. O. Howe, the treatment is not that specific in its applications. In this reviewer's opinion, except for the material in the last chapter, the application is both broad and general. Here is a book which is not a text in the ordinary sense; more properly it should perhaps be titled, "An Introduction to the Philosophy of the Mathematical Approach." The author is obviously completely at home with his subject. His discussions of mathematical truths and basic concepts will be startling to the reader who feels that he is well grounded in mathematics but who in reality is familiar only with the manipulations of mathematical symbols and who knows little or nothing about the theory of the game he is playing — like the chap who buys his transmitter, turns his dial and dips that meter because it will get him on the air, but who is ignorant of the "why."

The book discusses the essential notions and fundamental operations of algebra, and logarithms, equations and complex algebra. The section on continuity, limits and series is sufficient and stimulating. The chapters on geometry and trigonometry treat vectors and the operator  $j$  in an interesting and somewhat unusual way. The treatment of the differential and integral calculus is brief but will serve to acquaint the serious student with the basic concepts of this absorbing branch of mathematics. The final chapter deals with the application of mathematical methods to radio problems. No more adequate treatment of the subjects covered would seem to be possible in the 263 pages of this little book.

*Basic Mathematics for Radio Students* is recommended to those who are interested in elementary mathematics and who have a good acquaintance with the subject. It is not a self-teaching text but it will serve as an excellent auxiliary to supply insight into the mathematical method. There are far too few practice problems and the author's suggestion that the student make up his own problems for drill is not believed to be a satisfactory substitute for this lack, except possibly for the exceptional student. The subject matter will certainly stimulate the imaginations of those who recognize the usefulness of mathematics as a tool, and will afford any thinking reader many hours of pleasure. This reviewer has been impressed frequently with the comprehensive and thorough treatment of radio and allied subjects by British writers and this book is no exception. Mr. Cosgrove may well feel proud of his contribution.

— *E. B. Redington, W1AM*

# HARRISON HAS IT!

# HARRISON HAS IT!

## ALL STANDARD LINES

We are Factory Authorized Distributors for the top quality manufacturers and we now have in stock lots more new, latest improved production Ham gear! Visit our stores today, for everything you need. We promise you fresh, clean material—quicker—at the lowest current prices—and, above all, our sincere desire to be of friendly, helpful service.

As one of the world's largest distributors of Communications Equipment, we are delivering plenty of

### RECEIVERS

Right Now! ALL MAKES — practically all models. If you want your new set in the quickest possible time send your order to HARRISON! For example:

<b>HALLICRAFTERS —</b>	
S-38.....\$39.50	S-40.....\$79.50
S-36A, FM-AM-CW — 27.8 to 143 Mc.....	\$37.50
S-37 — 130 to 210 Mc.....	\$91.75
SX-42 — New FM-AM, — .54 to 110 Mc.....	\$250.00
<b>HAMMARLUND — New "Super-Pro"</b>	
SPC-400-X — .55 to 30 Mc.....	\$334.05
Speaker in Cabinet —	\$13.20
HQ129X, complete with speaker in cabinet....	\$173.25
<b>NATIONAL —</b>	
NC-240-D — Complete with speaker.....	\$241.44
HRO-5TA-1 — Complete with pack and speaker	\$303.00
RME-45 — Complete with speaker.....	\$198.70
RME-84 — Complete with speaker.....	\$98.70
Collins 75A-1.....	\$375.00
Panoramic Adapter.....	\$99.50

### TRANSMITTERS

Meck 60T.....	\$150.00	Sonar Narrow Band FM	
Temco 75-GA.....	\$95.00	E-sciter.....	\$39.45
Collins 32V-1.....	\$75.00	Collins 70 E 8 VFO Unit.....	\$40.00
Temco 500 GA.....	\$1800.00		

### TEST EQUIPMENT ?

Certainly! Harrison has it! We can supply practically anything for the Amateur, Serviceman, and Laboratory. Here are a few of the many items we have in stock right now for immediate delivery to you — (Even if what you want is not listed here, send us your order — we'll do the rest!)

### MULTIMETERS

Supreme 543.....	\$18.95	RCP 424 AP.....	\$33.50
Precision 832-S.....	\$35.00	Simpson 260.....	\$8.95
Supreme 542 M.....	\$26.15	RCP 461 AP.....	\$43.50
Weston 504.....	\$28.80	Triplet 625-N.....	\$45.00
Triumph 333-S.....	\$29.70	Triplet 2405.....	\$56.75
Simpson 215.....	\$32.50	Supreme 592.....	\$58.95
Precision 844.....	\$33.20		

### OSCILLOSCOPES

National CRU.....	\$39.90	RCA 155-C.....	\$115
Dumont 274.....	\$9.75	RCA 160-B.....	\$185
Waterman Pocketscope.....	\$66.00		

### VACUUM TUBE VOLTMETERS

Silver "Vomax".....	\$59.85	Jackson 645.....	\$75.00
RCA 195-A.....	\$69.50	Hickok 203.....	\$79.80
Hickok 125.....	\$94.75		

### SIGNAL GENERATORS

Jackson 640.....	\$49.00	Supreme 576.....	\$68.95
RCP 705.....	\$49.50	Triplet 2432.....	\$8.50
RCA 167-B.....	\$63.75	Billey 1A Crystal Oscillator.....	\$69.50

### TUBE CHECKERS

RCP 315.....	\$59.50	Jackson 636 CP.....	\$62.50
Precision 912.....	\$1.20	Precision 915.....	\$4.41

### TUBE AND SET TESTERS

Hickok 534.....	\$138.30
Silver "Sparx" Signal Tracer.....	\$39.90
Supreme 562 Andolyzer.....	\$127.00

## HARRISON SELECT SURPLUS BARGAINS

The cream of the surplus market! Good — new — guaranteed material. Top value, always. You don't "take a chance" when you buy anything from Harrison!

★ **TUBES — 3C24/24G HF Triode.....\$1.49**  
 FIVE for \$5.96  
 3E29/829B.....\$3.89  
 9002, 9003 FIVE for \$2.49

★ **ANTENNA TUNER — BC 939-A (Hallicrafters AT-3) Complete with condensers.....\$29.95**

★ **TELESCOPING ANTENNA — Brass, plated, Lightweight, 15 inch, extends to 12' 10", 3/4" dia. FB for mobile, or rotary elements SIX FOR \$10.44 Each \$1.95**

★ **VARIABLE CONDENSERS — Dual 150 mmf per section, .175" gap. Johnson 150 DD70.....\$7.95**  
 Cardwell XE-240-XD, Dual 240 mmf, .100" gap.....\$9.95

★ **ROTARY COAXIAL COUPLING — Continuous rotation, 52 ohm constant impedance — coaxial sockets each end. Lapp.....\$7.75**

★ **CRYSTAL CONTROLLED CALIBRATOR AND MONITOR — Navy CGQ-61033, With spares.....\$4.95**  
 (With batteries \$5.95)

★ **KW MODULATION TRANSFORMER — 1:1 ratio, Conservative 550 Watt Audio rating, Screen winding, 38 1/2 lbs.....\$24.75**

BC 610 (HT4) TU Tuning Units.....\$2.50  
 Final Tank coils, THREE (our assortment) for.....\$1.98  
 Antenna Wire, No. 10 Phosphor Bronze, stranded, 125 feet (2 insulators at 75 feet) \$1.97  
 Stranded No. 8 copper wire, Heavy insulation, 125 feet in 7 foot lengths.....\$1.19

(Please see our previous ads for full descriptions of above items)

### ● COMPACT VIBRATOR PACK

FB for transceivers, portable receivers, etc.! Delivers 135 volts at 30 ma; 67 1/2 volts at 8 ma; 1.5 filament or 6.3 heater, bias, and microphone voltages. Completely filtered — neon tube voltage regulator — remote load-start relay — ruggedly made for dependable Navy use. 1 3/4" x 3 3/4" x 4". Weighs only 2 lbs.! Works on any 6 volt DC source.

Complete vibrator pack, less only battery (use it on four flashlight cells, your car battery, etc.).....\$3.95

With a clip-in RECHARGEABLE Willard Storage Battery. Unbreakable, NON-SPILL, plastic case \$5.50  
 (110 V AC .2 Amp. Trickle charger).....\$3.45

With TWO clip-in Willard Primary batteries. (See our Dec. QST ad.).....\$5.75

### ● Leach ANTENNA RELAY

Ceramic insulation for low loss. Heavy silver DP-DT Antenna contacts plus SP-DT for control of receiver, etc. 115 volt AC coil. HSS value! \$2.79

**MAIL ORDERS ?** Certainly! Just list everything you want (items in this ad, or any ad, magazine, or catalog) and include remittance. Prompt shipment.

Vy 73 de

*Bil Harrison, W2AVA*

**HAM HEADQUARTERS**  
 Since 1925!



**HARRISON RADIO CORPORATION**

12 WEST BROADWAY • NEW YORK CITY 7

PHONE — BR 4-9854 • EXPORT DEPT. — CABLE — "HARRISONRAD"

[JAMAICA BRANCH — 172-31 Hillside Ave. — REpublic 9-4102]

N  
A  
R  
R  
O  
W

# REMEMBER YOUR NEW YEAR RESOLUTION..

- ★ ELIMINATE BCI
- ★ REDUCE QRM
- ★ INCREASE DX

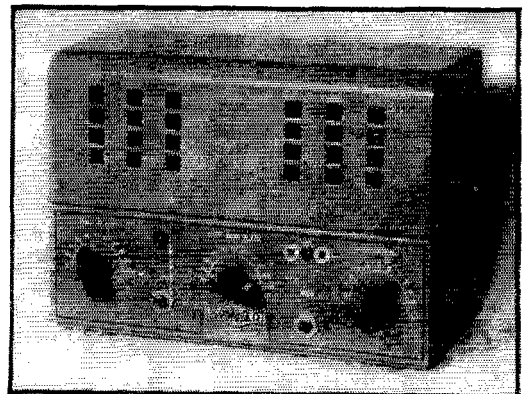

CONVERTS ANY CW RIG TO N.F.M. FONE  
CAN BE RECEIVED WITH ANY AM RECEIVER

SEE JANUARY 47  
QST FOR DETAILED  
STORY OF N.B.F.M.



"SONAR MAKES  
A NEW TRANSMITTER  
MODERN"

P. O. BOX 445

SONAR RADIO CORP.

BROOKLYN 1, N. Y.

B  
A  
N  
D  
.  
F  
.  
M

## The Radio Amateur's Library

These are the publications which every amateur needs. They form a complete reference library for the amateur radio field; are authoritative, accurate and up to date

Title	Price	Title	Price
QST.....	\$2.50 per year*	Hints & Kinks for the Radio Amateur.....	50c
Operating an Amateur Radio Station — Free to members; to others.....	10c	Lightning Calculators:	
The Radio Amateur's Handbook,	\$1.25**	a. Radio (Type A).....	\$1.00
The Log.....	35c each; 3 for \$1.00	b. Ohm's Law (Type B).....	\$1.00
How to Become a Radio Amateur..	25c	A.R.R.L. Antenna Book.....	50c
The Radio Amateur's License Manual.....	25c	The Minilog.....	25c
		Learning the Radiotelegraph Code ..	25c
		A Course in Radio Fundamentals...	50c

\*Subscription rate in United States and Possessions, \$2.50 per year, postpaid; \$3.00 in the Dominion of Canada, \$4.00 in all other countries. Single copies, 35 cents.

\*\*Postpaid in U.S.A. Proper — \$2.00, postpaid, elsewhere. (No stamps, please.)

THE AMERICAN RADIO RELAY LEAGUE, *Incorporated*  
WEST HARTFORD 7, CONNECTICUT

# *The* 1947 HANDBOOK

**T**HE LATEST EDITION of THE RADIO AMATEUR'S HANDBOOK is postwar in content, containing the kind of information which has made the HANDBOOK world-famous. To maintain the high standard of practical usefulness set by previous editions, a new treatment of the constructional sections of the HANDBOOK has been accomplished. The theory and design sections cover every subject encountered in practical radio communication. Completely sectionalized by topics with abundant cross-referencing, and fully indexed. The HANDBOOK continues to be the world's most valuable and widely-used radio book.

POSTPAID IN  
U. S. A. PROPER

**\$1<sup>25</sup>**

\$2.00 ELSEWHERE  
BUCKRAM BOUND  
\$2.50 in U. S. A.  
\$3.00 Elsewhere

**AMERICAN RADIO RELAY LEAGUE**

» » » » » » »

**WEST HARTFORD 7  
CONNECTICUT**

# HAM-ADS

(1) Advertising shall pertain to radio and shall be of nature of interest to radio amateurs or experimenters in their pursuit of the art.

(2) No display of any character will be accepted, nor can any special typographical arrangement, such as all or part capital letters be used which would tend to make one advertisement stand out from the others.

(3) The Ham-Ad rate is 30¢ per word, except as noted in paragraph (6) below.

(4) Remittance in full must accompany copy. No cash or contract discount or agency commission will be allowed.

(5) Closing date for Ham-Ads is the 25th of the second month preceding publication date.

(6) A special rate of 7¢ per word will apply to advertising which, in our judgment, is obviously non-commercial in nature and is placed and signed by a member of the American Radio Relay League. Thus, advertising of bona fide surplus equipment owned, used and for sale by an individual or apparatus offered for exchange or advertising inquiring for special equipment, if by a member of the American Radio Relay League takes the 7¢ rate. An attempt to deal in apparatus in quantity for profit, even if by an individual, is commercial and all advertising by him takes the 30¢ rate. Provisions of paragraphs (1), (2), (4) and (5), apply to all advertising in this column regardless of which rate may apply.

(7) Because error is more easily avoided, it is requested signature and address be printed plainly.

(8) No advertiser may use more than 75 words in any one issue.

*Having made no investigation of the advertisers in the classified columns, the publishers of QST are unable to vouch for their integrity or for the grade or character of the products or services advertised*

**QUARTZ**—Direct importers from Brazil of best quality pure quartz suitable for making piezo-electric crystals. Diamond Drill Carbon Co., 719 World Bldg., New York City.

**CRYSTALS:** Precision low drift units. Type 100A in 80, 40, and 20 meter bands. Two units plug in one octal socket. One dollar each. Rex Bassett, Inc., Ft. Lauderdale, Fla.

**QSLs** in colors. Stamp for samples. Glenn Griffith, W3FSW, 1042 Pine Heights Ave., Baltimore 29, Md.

**COMMERCIAL** radio operators examination, questions and answers. One dollar per element. G. C. Waller, W5ATV, 6540 E. Washington Blvd., Tulsa 15, Okla.

**QSL** cards that stand out. Individualized, original, cartoon by W2EA (ex-8EA) incorporating your ideas, personality, etc. Reasonable, but not cheap. Send stamps for specimens. Harrison Radio Corp., 10 West Broadway, New York City.

**METERS** repaired and converted. Correspondence invited. Haledon Electrical Instrument Co., 319 Belmont Ave., Haledon, N. J.

**CALL** letters, very attractive white letters on blue desk stand. All "Lucite". \$2.50 postpaid. Bernard Hartz, W. Pine, Frackville, Pa.

**WANTED:** "Wireless" apparatus prior 1925; early books, catalogs, magazines, etc., Franklin Wingard, Rock Island, Ill.

**CQ** and test records. Your call, \$1.00. Jack, W2NRM, Tenafly, N. J. **RADIO** TELEPHONE first class sample tests, \$10. We correct. New correspondence course. Box 1298, Hollywood, Calif.

**QSLs**, highest quality, samples free. VYS Print, 1704 Hale Ave., Ft. Wayne, 6, Ind.

**AMATEURS**, experimenters, industrial and export accounts write for catalog and monthly bulletins. Buy the "TB" guaranteed way and save. TAB, Dept. Z, 6 Church St., New York 6, N. Y.

**AUTO** xfrms, 115-volt, 60 cycle, 16 amp. output. An ideal way to raise line voltage or increase or decrease power. By means of taps output of 12 to 140 watts available in approx. 8 volt steps based on input of 90 to 115 volts. Instructions. Gray steel case, 5 1/2 x 7 x 10. \$4.95. E. Doherr, W8CIR/1, 131 State St. Boston 9, Mass.

**SURPLUS** tubes: Four GL-869-B rectifiers at \$50 each; two 892 triodes at \$95 each, guaranteed. Sale: Howard 430 receiver, good condition, \$20. B. W. Smith, W9WGF, Wausau, Wis.

**SELLING** out: new National AC broadcast to 30 Mc. communications receiver, \$235 complete, prepaid U.S.A. Original packing, used 30 hours. Also K. Kw. parts. Write Geo. E. Hoadley, 943 So. Main, Adrian, Michigan.

**SELFSYNs:** for your remote indication requirements: 115-volt 60 cycle Bendix type 1, 1 1/2" x 7 1/4", \$7.50 per pair, f.o.b. Shipping weight approximately 1.5 lbs. per pair. Oscilloscope, 3" CRT, BC-412. New, complete with tubes. \$48.28 f.o.b. Shipping weight approx. 200 lbs. Cambridge Electronics Corp., 208 So. Pulaski St., Baltimore 23, Md.

**NEW** regulated power supplies, 100-130 volt AC, 130 to 230 volt DC, 50 Mill, 6.3 volt 3 amp. Excellent regulation, extremely low hum level. Beautiful chassis, black or gray crackle 9" x 5" x 4". Price \$37.60. Pan American Electric, 132 Front St., New York 5, N. Y.

**NEWEST** Hallcrafters receivers: for best delivery order from "Edison's". Crystals where quality and not price is the main consideration demand Edison crystals. Fine commercial units for Aircraft, police, marine, geophysical and other services. Highly accurate. Fully dependable and strong in output. Over a decade of satisfaction and fast service! Edison Electronic Company, Temple, Texas.

**FOR** Sale: HRO, just been checked by National, 2 B.C. coils, one Radio Range coil, speaker and power supply, Portable xmr 110 AC and 6 V. DC, two stage, hand switching, full audio, 807 in output. Station xmr 300 w. output 100% Class B modulation, built by Henry Radio, in rack and cabinet, 5 ft. high. This is a honey, \$650 for all. Write for detailed photographs. First come, first served. George W. Chamberlain, W.S.P.I., Rock Port, Mo.

**ALASKAN** hams: Here is a source of supply closer to home. Stocking leading brands of gear, comm. rcvrs, parts, accessories, engine generators. Save time, money. Robbie's Radio Supply, Alaskan jobbers. P. O. Box 1835, Anchorage, Alaska.

**SALE** or trade for test on photographic equipment. 5 Kw. oil transformer, 10,000, 5,000 1,250 volt with 110-220 volt primary, new. 805 tube, new. W9EWV.

**WANTED:** Back copies of Proceedings of IRE, Electronics, RCA Review and QST; also binders and textbooks. State price and condition. Box 349, Forrest City, Ark.

**IN** Stock: new and used Hallcrafters, Hammarlund, National, Pierson, RME, Collins, Temco, other rcvrs and xmtrs. All other amateur parts. Trade-ins accepted. Terms financed by me. Write: Henry Radio, Butler, Mo. and Los Angeles 25, Calif.

**SELL** SX-28A, like new, with spkr, \$225. Lyte Dunlap, 806 No. Main St., Abington, Ill.

**FOR** Sale: TR-4, complete, \$28. HQ-75 long-line oscillator, \$8. Beam 2-meter 5-element, \$5. Misc. articles. Howerdell, 102 Hancock Ave., Jersey City, N. J.

**MODEL** NC-100AC, National manufacturer, good condition, encase spkr and spare set of tubes. Consider best offer. Simms, 14 Nichols Road, Reading, Mass.

**FOR** Sale: 3-1000 Watt xmtrs, 250TH tubes final, modulators, pair 810s, 6L6 Osc., pair 812 drivers. No junk. Best of parts complete with all power supplies and spec. speech amplifiers and mikes. Will sell separately. Best offer. W9GPC, Box 113, Steelville, Mo.

**TELEVISION** parts: 10" and 12" cathode ray tubes very reasonably priced and following parts in kit form: deflecting coils-focusing coils, picture and sound IF channels using latest circuits with the newest miniature tubes, RF high voltage power supplies and RF tuners. Send these units built on sub-chassis for mounting on main chassis. Send them your price list now. Television Specialties Co., 315 Madison, Oak Park, Ill.

**3"** cathode ray scope, radar ID-93/A PG-13A, 115v, 400 cps. New, complete with 11 tubes, 1 set 3BP1, \$25. Send for list. Rubin Radio, Shrewsbury, N. J.

**SUPER-PRO**, new army model. First \$195 takes it, also Pierson Delane Model PR-15, \$65. Ex-W9HEX, Rt. 10, Minneapolis 16, Minn.

**SALE:** Natl. NC-101X, just built by National Co. and noise limiter added, \$75 less spkr. Sig. Corp panadapter BC-1031-A perfect, \$75. Instruction book with each. W3BOU, 647 Carroll Ave., Takoma Park, Md.

**SELL:** RME converted DM36A, covers 50-54 28-29.7, works fb, \$48. Sell new. Thordarson T17S13, T14C70, T68Co8, Hytron, 3-HY13, 1-HY69, 1-HY31Z, 1-HY60, W9ARN, Bartonville, Ill.

**TRANSFORMERS:** Filament, stepdown, special types built to order. Bargain! Solid copper antenna wire, No. 14 enamel, 120 ft. on form, \$1.25 postpaid. J. E. Reidel, 1523 41st St. Brooklyn 18, N. Y.

**WAVE** filters, audio chokes and transformers, power transformers and filter chokes built to your specifications. Communication Specialties Co., 2924 Alabama Ave., St. Louis Park, Minn.

**4** mid 600 V. oil-filled condensers, 75¢ each, postpaid. Strom, WIHXT, 45 May Ave., Brockton 38, Mass.

**WANT** National NC-200 rcvr and 500-watt class "B" xfrms. Sell or swap National 1-10 with National power supply, in excellent condition. Best offer. Albert Weiss, 2115 F St., NW, Washington 7, D. C.

**QSL?** OSL? SWL? No cheap trash! Samples 10¢. Bilecy Crystals? RME-45? RME-84? VHF-152? Sackers, W8DED, Holland, Mich. (Veteran).

**SELL:** New RME-45, spkr, \$160; Millen xctr, tubes, xtal, 10-meter coils, \$30; Turner 22X mike, stand, switch, \$15; Workshop 10-meter dipole and 85 ft. heavy coaxial, \$10; Simpson, Mod. 240 ham-meter, \$20; UTC VM-1, \$5; noise-limiter, \$8; Wave-meter, P. 401 Hand-book, 10-20 meter coils, \$15; 0-25 mill. meter, \$3.50; Jewel 0-2 R meter, Thermo, \$10; power supply 450 v., 250 milla, \$10; power supply 750-1000 300 milla, best of materials, \$30. Misc. parts. W. L. X, 334 Bolton, So. Boston, Mass.

**FOR** Sale: HQ-120X rack mount, less spkr, \$100. Good condition, 102 So. Kilmer St., Dayton 7, Ohio.

**BC610E** complete, converted for 28 Mc. Hot Super-Pro needs converter for 28 Mc. Great combination for any band. Bring two men, small truck and \$738 and it's yours. Ready to go. Nothing else required. W3BTQ, 912 W. 30th St., Wilmington, Del., Phone 2-8843.

**SELL:** tubes, meters, xfrms, power supplies, electric drills, hundreds other parts. Free list. Marks, 97 South 8, Brooklyn, N. Y.

**WANTED:** HRO coils, types A, B, and C. R. Graham, Box 261, Absecon, N. J.

**SELL:** transformers and chokes 1470 VCT 1.2 amperes 1250 VDC 600 ma \$8.25, 2-12 henry swinging choke 750 ma 3500 volts test \$8.50, 1039, 945, 851 VCT 363 ma \$5.50, 2.5 VCT 11 amperes for 8666 \$2.50, 67 henries 215 ma \$2.50, 10-10 henries at 150 ma or 5 henries at 300 ma \$2.50, 20¢ per henry. Also ARC-5 crystal controlled 100-150 mc. Variable Hf. 6v, vlv 832 832 with four crystals and tubes for \$30. Condition like new. W1IAP, 75 Simonds Road, Lexington, Mass.

**WANTED:** Master Telexcode machine in good condition. W6BHZ, 14553 Dickens St., Sherman Oaks, Calif.

**WANTED:** Transmitter HT6 or Meisner 150B. State condition and price. Double, W3MJW, Slippery Rock, Pa.

**FOR** Sale: 50-watt Millen xctr, complete with 750 volt power supply and modulator. Needs cabinet or rack for mounting. Best offer over \$85 takes it. W. AVF, 5312 Murdoch St., St. Louis 9, Mo.

**WANTED:** Weissner signal shifter. Murray Vogel, 248 New Lots Ave, Brooklyn, N. Y.

**SELL:** Spare tubes, xfrms, relays, xtals, and lots small parts. List. WIHIL, Wakefield, Mass.

**NATIONAL** FBXA: complete, 10, 20, 40, 80 bandspread, crystal filter, pre-selector, A-1 condition, \$40 takes it. WSHQM, Charles Maupin, 117 No. Public, Tonkawa, Okla.

**W3PVO** 1 Kw. 75 meter fone xmr for sale. For details, write Mr. Mildred Schell, Myerstown, Pa.

**QSTs**, Extra set, 1926-1938 for sale or trade. Thordarson T83M22 modulation, Hickok 203 test meter, \$70. W2SFI, 841 Western Ave., Albany 3, N. Y.

**SELLING shack:** Stancor 60-P xmttr, minus coils, xtal, \$90. Miscellaneous parts. Interesting, useful Jap radio equip. Want to dispose of same as quickly as possible. Call Joe to 6-1544 7 to 9 PM, N. Y. C. Home only. W2CBI

**HQ-129X** rcvr, practically new and all major components for 600-watt P. P. 813 w. xmttr, inc. all tubes, xfmtrs, chokes, chassis, relay rack, condensers, etc.; and complete V.F.O. exciter (per R.C.A. xmtg tube manual P. 52) all for \$350. Details on request. Also Precision 844P V.O.M., measures to 10 Megs, 6000 V. A.C. and D.C., \$25; I.C.A. Deluxe cde oscillator, \$8.50; Instructograph with 5 tapes, \$10; Wayne Phelps, 1710 Richmond, Houston 6, Texas.

**FOR Sale:** 1/40 H. P. motors, 3600 rpm, 110-volt, 60-cycles, 3-phase, instantly reversible. Will run on 110-volt, 60 cycle single phase. Suitable for gear reducers to drive Rotary beam antennas. \$3.50 each. Postage paid. Draper-Weatherly, Anniston, Alabama.

**SELL:** Stancor 100-MB 100-watt band-switching CW xmttr 80/40/20 6L6-807PF complete in cabinet. Fine appearance. \$95. W1BB.

**SALE:** Hallicrafters S-38 rcvr. Been used only four months. Bobby Hankins, Conway, Ark.

**TRADE:** New Leica with case for new Hammarlund 400X or same type of rcvr. Russell Stelle, McLeansboro, Ill.

**HRO-STAI** National rcvr for sale or trade at best offer. Perfect condition, complete with breadboard coils, noise limiter, power supply, etc. Also new HRO-W. R. W. Yeager, 4423 Sheridan Rd., Chicago, Ill.

**UTC** plate xfrmer 3000-40-3000 v. 300 Ma. model S50, very good condition, little used. \$20. HRO in good condition with power supply, spkr, and 6 coils 2 broadcast and 4 SWL 480 Kc. to 30 Mc. SW coils have breadboard for 80, 40, 20, 10. Price, \$200. E. Shafer, W8MSG, 2889 East 116th, Cleveland, Ohio.

**TRANSMITTER** for sale. Harvey 80-T. Like New. Xtals, tubes, coils, complete for 80 to 10-meter bands. Xtal mtk. 20 watts phone, 30 watts c-w. 125 watts input. Price: \$95. W1KC, 240 Moreland St., Worcester, Mass.

**FOR Sale:** BC-610-D xmttr. New as purchased in original box. Beck, 7007 No. 33rd, Omaha, Neb.

**QSLs**, samples. Albertson, W4HUD, 705 So. Hamilton, High Point, N. C.

**PRE-INVENTORY** specials: xfmrs: 1000-CT-1000 V., 250 Ma. 5 volts 3 amp. primary, 115 volts, 60 cycles \$9. 1600-CT-1600 volts, 250 Ma. secondary, 105 to 125 volts 60 cycles secondary, \$15.95; modulator (4 6L6s, P.P.; P.L.) and power supply (400 volts, 500 Ma) as in BC-669, \$49.50. 813 tube and socket, modulation and driver xfmrs; P.B. for a 200 to 300-watt rig, only \$12.75 for all four items. Write for W9YCP's new Call Area map and our new bargain bulletin. Gifford-Brown, Inc., Cedar Rapids, Iowa.

**Will sell** or trade for ham equipment model 11A Riders Chalmist only slightly used for spare time servicing during war — \$85. K. M. Jessup, W5EJO, Box 1963, Oklahoma City, Okla.

**WANTED:** HQ-120X. State exactly condition and price. All letters answered. W1CBV, 26 13th St., Bangor, Me.

**WANTED:** Collins radio type 700K C-5 and 14S-J coils. State price and band. William E Lynch, W3JKM, 7261 Bradford Road, Upper Darby, Pa.

**BEST** equipment, tube testers, oscilloscopes, volt-ohm milliam. meters, frequency meters. 0 to 5 Weston model 507 RF amp meter, \$3.75. 0 to 150 Weston model 506 Ma. meter, \$3; SCR-522 transceiver \$45; 304 TL tubes, \$3.75; 832 tubes, \$4.95; 250 R Tubes, \$3.25; 813 tubes, \$3.50; recg tubes all types including 6AC7, 60E, 6AG, \$1.59; 60E, 80E, 6AS, 80E, 7E7, 90E, 6S8, \$7.00. Write or wire J. E. Keller, 1636 Light St., Baltimore, Maryland.

**BC-221B** frequency meters. Range 125 to 20,000 Kc and to 80,000 Kc by harmonics. Accuracy better .03% Navy surplus. Complete with crystal, tubes and calibration book. Original cost over \$400. Price, \$95. Pan American Electric Co., 132 Front St., New York 5, N. Y.

**QSLs**. Samples for stamp. Scalvac, W9GIL, Lincoln Printing Co., 305 W. Wells St., Milwaukee 3, Wis.

**SURPLUS** radio parts; free circular. Alco Electronic Lab., Box 214, Lawrence, Mass.

**WANTED:** Factory-built xmttr, large or small. Must be bargain. Harvey Cunningham, Zapata, Texas.

**WANTED:** Hallicrafters HT-6 transmitter with coils. Must be in A-1 condition. Cash. Have new Speco signal tracer A-C model, \$39.95. Donald R. Keller, 200 2ea St., Strasburg, Va.

**KALIM** is back home at W3ILD and will QSL all of his 4000 contacts. Look for me from W3ILD on 14012 kilocycles CW. Xmttr IEMCO 500GA. Rcvr HROSTAD. Will measure your frequency to exact kilocycle on request. 4912 Quebec Northwest, Washington 16, D. C.

**SWAP** those extra parts for needed ones. Send your list and a stamp for my list of extras. George Cryder, Delaware, Ohio.

**WANTED:** BC610 transmitter. C. G. Becker, 319 Market, Effingham, Ill.

**SELL:** American Radio Institute amateur Home Study course, \$8. Jack Penderly W9WJQ, Palm Springs, Calif.

**FOR Sale:** HRO with new coils (general coverage from 1.7 to 30 Mc. and breadboard on 80, 40, 20, and 10). "S" meter, crystal, gray crackle finish. Completely overhauled at National factory in Dec. '46. Best offer over \$200 (and all letters answered). Fahnestock, 268 Littleton, West Lafayette, Ind.

**SW-3** complete with coils and tubes. Best offer takes. W7ACQ, Box 301, Okanogan, Wash.

**WANTED:** RCA 1847 iconoscope tube. State condition, price. W1AS, Louisville Ky.

**SELL:** Abbott TR-4, same as new, used less than 15 hrs, comp. with tubes \$8.50; also new BC-348-Q rcvr, converted for A.C., comp. with shock mount, plug and a L-57 spkr, \$85. D. F. Cordell, 1204 East 21, No. Kansas City, Missouri.

**BEAM** antenna, all aluminum. High efficiency with minimum weight and torque. 2 to 20-meters. Write for information. Housekeeper, WZKMQ, 956 Paulding, Peekskill, N. Y.

**QSL** catalog with 6 ham cartoons for shack. 10¢ to Chas. Merchant, Box 1592, Rapid City, So. Dakota.

**SELL:** Hallicrafters SX-24 rcvr and loud spkr, like new; xtal phasing, S-meter \$75. Meissner De Luxe signal shifter, \$45. A. Lukach, 35 East 84th Street, New York City.

**SET** of nine Hexagon keys for hollow head set screws with holder, 75¢ postpaid. Drill and tap sets. Write for folder. Riverside Tool Co., P. O. Box 87, Riverside, Ill.

**SELL** Mark IV tank set. A. C. supply. Best offer. New condition. W9HUV.

**SELL** or trade RRH10, Type RHO complete with power supply. Rack mounting, 80-meter coils only. J. C. Walker, Ranger, Texas.

**FOR Sale:** Hallicrafters SX-16 rcvr with matching speaker. Factory reconditioned in Oct. 1946. Best offer. W0WPF, Brush, Colorado.

**SELL:** National RAS-4 rcvr (like HRO), 190 Kc. to 30 Mc. No. 357 table rack mounted speaker, power supply and coil container; also spare parts kit, instruction book, perfect condition. Best offer; two R.R. 10-11 meter transmitter rcvrs, 6, 12, 24 volt, DC input, one with extra 110 V.A.C. power supply, make excellent mobile rig, selling commercially for \$80. Sacrifice \$50 each; BC-221, \$45; W2OXR, 71 Crosshill St., Staten Island, N. Y.

**SELL** for best offer: Hallicrafters S-40, 9 tube rcvr. Complete with tubes, instruction manual. Three month company guarantee still valid. W6WSU, 451 Terrace, Altadena, Calif.

**PR.** of 861s, \$25 ea., three 860s, \$5 ea; all almost new. Also: Valiant Dual "Bug", \$25. Cash with order, no C.O.Ds. W3HAN, Box 1115, Lancaster, Pa.

**FOR Sale:** Meissner 150B, 300-watt xmttr. \$175. Complete set of drafting instruments. Write for details. Don Kadish, 9 Peters St., Cambridge 39, Mass. W10LR.

**KENTUCKY** Values! 3500 cycle speech clipper filter kit, instruction book, \$2.40; 1500 cycle filter rcvr, \$2.40; 357 panel cabinets, \$17.85; 20 H 200 Ma. choke, \$2.85; 6.3 V. 8.5 amp. xfmrs, \$2.40; 4520 volt C. T. 700 Ma. Kenyon, \$49.95; KW modulation xfrmer, \$24.75; 2 ufd 4000 volt Pyranols, \$5; In stock: all makes of mikes, 300 ohm line, Superior, B&W, Valpey, Taylor, Gon-Set, Marion. Inquiries answered. Kentucky Radio Supply Co., Lexington, Ky.

**FOR Sale:** high power equipment: UTC PA-306 plate xfrmer 2000 v. 500 Ma. \$20. UTC PA-120 filament xfrmer 2.5V with 1100V insulation \$6.00; 2 UTC LS-980 14 HV Flyter chokes, 400 Ma., \$18 ea.; B & W butterfly condenser, BX-120, \$20; Two G-E 813 tubes, \$14.50 ea.; One C.D. TJU-30020 2 ufd 3000 V. cond. \$15. One TJU30040 4 ufd, 3000 V., \$20. Plate xfrmer tubes and condensers new, others excellent condition. Transportation extra. Carl Arnold, Middletown, Pa.

**FOR Sale:** Stancor 60N xmttr kit, partly built, tubes and meter, \$50. Also QSLs for December '25 to January '46, \$10. Write Melvin Creighton, Burkham Court, Wheeling, W. Va.

**QSLs**. Exclusive design. J. A. Rademacher, W0KDT/7, Missoula, Mont.

**FOR SALE:** BC 610 \$750. 5.5 h. p. Wisconsin gasoline engine, new, \$140. Farrell, 225 Newport, Rumford, R. I.

**COMPLETE** low power xmttrs, tubes, parts of all kinds. Write us for the equipment you need. QSLs! GM Radio Products Co., Lake Crystal, Minn.

**DEKA-XTAL**. New compact 10-crystal unit for standard 5-prong socket. Looks and operates like a dial-knob. Just plug it in and turn to any of 10 frequencies, your selection. Ask your dealer or write us. Also other low TC ham crystals in FT cases to fit octal sockets. 80 and 40 = 1 Kc., \$2.65; 20 = 4 Kc, \$3.50. Scientific Radio Products Co. 738 1/2 W. Broadway, Council Bluffs, Iowa.

**SELL** for best offer, separately or trade for good camera. ARR/5 rcvr AM and FM 27 to 140 Mc. B19 tank xmttr rcvr with dynamotor headsets, etc. Meissner xtal calibrator and BC939 antenna tuning unit complete with vacuum condensers. W9PKW, Hammond, 5 Salem Circle, Evanson, Ill.

**EQUIPMENT** custom-built, inquiries invited, free list surplus bargains. HamRad, Box 33, Bedford, Mass.

**28 Volt** xfrmer to operate surplus equipment. 115-volt primary, 200 watts, fully shielded, porcelain terminals. \$10. W2CRB, 1523 41st St., Brooklyn, N. Y.

**TELEVISION** receiver easily constructed from our plans. Vision Research Laboratories new line of books written and edited especially for the ham experimenter. Booklets now available (\$2 each): "Design and Construction of a 7" Television Receiver" and "Visual Alignment Sweep Generator". Books contain theory, practical details, illustrations, schematic diagrams, etc. Vision Research Laboratories, P. O. Box 52, Kew Gardens, 15, N. Y.

**CRYSTALS:** Where quality and not price is the main consideration demand Eidson crystals. Fine commercial units for Aircraft, Police, Marine, Geophysical and other services. Highly accurate, fully dependable and strong in output. Over a decade of satisfaction and fast service! Send for our new L-6 catalog. Eidson Electronic Co., Temple, Texas.

**10-11 meter** beam kits, four elements. Light weight. Fit any rotating mechanism. \$18.75 prepaid. Craft Company, Box 848, Brady, Texas.

**SELL:** brand new Meissner signal-shifter, complete with tubes, power supply, six sets coils, range 1.4 to 13.0 Mc. First \$95 takes it. Cardwell SCR-211 (or LM-14) frequency meter, complete with tubes, original crystal and calibration book, new, \$85. Want: Good used ham receiver, 833A, 450TH, 250TH power tubes. Knochel, W9YJE, Lincoln, Ill.

**CRYSTALS:** low drift fundamental oscillators for operation on 20-10-6-2 meter bands, holder fits five-prong socket, 14-15 Mc., \$2.50, 16-16.5 Mc., \$3.50, 16.67-18 Mc., \$4.50. Henry S. Palmer Co. 744 Marietta Ave., Lancaster, Penna.

**SELL** new 288X Hickok universal xtal controlled signal generator, only \$140. F.o.b. Hibbing, Minnesota. Write Bill Ryder, jr., W0UCV. ONLY \$69.95 complete WRL 40-watt phone c-w. kit. Other low-priced units soon. All models receivers, new and reconditioned. Trade with Leo at largest personalized ham house in the country. Easy payment plan, best trade-in. 15¢ for giant map, also calculator, other items. Write Leo, W0GFO for flyers and best deal. World Radio Labs, Council Bluffs, Iowa.

**WANTED:** Meissner 150B, Hallicrafters BC-610 or other transmitter. State condition and price. W2GL, 61 Chatham St., Chatham, N. J.

**SELL:** QST March, 1928, to date, complete run. Make offer. Wiseman, W9FKO, 1416 Loveland, Springfield, Ill.

**QSLs**. Samples, 25¢, refunded first order. Quick service. Sunland, Box 662, Haleah, Fla.

**SELL:** BC348. Converted to A.C., new condition, \$75. N. H. Roth, W8UFR, Wauseon, Ohio.

Designed for

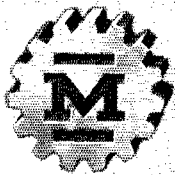

Application

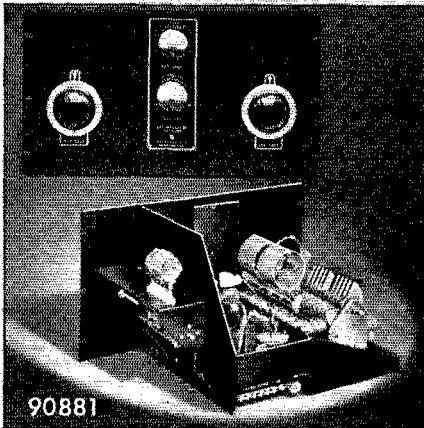

90881

**The No. 90881  
RF POWER AMPLIFIER**

This "500" watt, RF power amplifier unit may be used as the basis of a high power amateur band transmitter or as a means for increasing the power output of an existing transmitter. As shipped from the factory, the No. 90881 RF power amplifier is wired for use with the popular RCA or G.E. "812" type tubes, but adequate instructions are furnished for re-adjusting for operation with such other popular amateur style transmitting tubes as Taylor TZ40, Eimac 35T, etc. The amplifier is of unusually sturdy mechanical construction, on a 10 1/2" relay rack panel. The panel contains the grid and plate tank tuning capacitor dials, as well as the grid and plate current milliameters. Plug-in inductors are available for operation on 10, 20, 40 or 80 meter amateur bands, from stock, as well as special coils to order for commercial frequencies. The standard Millen No. 90800 exciter unit is an ideal driver for the new No. 90881 RF power amplifier.

**JAMES MILLEN  
MFG. CO., INC.**

MAIN OFFICE AND FACTORY  
**MALDEN  
MASSACHUSETTS**



**Index to Advertisers**

	Page
Allied Radio Corp.	121
American Lava Corp.	129
American Phenolic Corp.	107
Ashe Radio Co. Walter	133
Astatic Corp., The	97
Barker & Williamson	151
Bliley Electric Company	93
Brill Co., W. D.	142
Bruno Tools	142
Burgess Battery Co.	96
Burlington Instrument Co.	128
Burstein-Appleebe Co.	152
Caldwell-Clements	112
Cameradio Company	118
Candler System Co.	148
Capitol Radio Engineering Inst.	98, 106
Chicago Industrial Instrument Co.	128
Clarkstark Corp.	148
Cleveland Inst. of Radio Electronics	134, 140
Clippard Instrument Laboratory, Inc.	149
Collins Radio Company	100, 101
Condenser Products Co.	139
Continental Sales Co.	152
Drake Electric Company	108
Eitel-McCullough, Inc.	89
Electro-Voice	Cov. II
Fabricated Lightmetals Co.	134
Gardiner & Co.	150
General Cement Company	130
General Electric Co.	1
Hallcrafters Co.	4, 5
Hammarlund Mfg. Co.	97
Harrison Radio Co.	153
Harvey Radio Co.	127
Hatry & Young	126
Henry Radio Stores	135
Henley Publishing Co., Norman	152
Instructograph Co.	126
Jensen Manufacturing Co.	160
Kaar Engineering Co.	125
Ken-Rad	99
Kenyon Transformer Co.	144
Kierulff & Co.	136, 140
Knights Co., James	147
M & H Sporting Goods Co.	120
Maguire Industries	116, 117
Mallory & Co., P. R.	94
Mass. Radio & Television	142
McGraw-Hill Book Co.	138
McMurdo Silver Co., Inc.	102
Millen Mfg. Co., Inc., James	158
National Company, Inc.	85, Cov. III
Newark Electric Co.	115
Ohmite Manufacturing Co.	91
Onan & Sons, D. W.	150
P & H Sales Co.	148
Petersen Radio Co.	104, 105
Radio Elec. Serv. Co. of Penna.	114
Radio Mfg. Engineers	159
Radio Shack Corp.	109, 110, 111
Radio Specialties Co.	143
RCA Institutes, Inc.	144
RCA Mfg. Co.	Cov. IV
S/C Laboratories, Inc.	148
Scelli & Co., R. G.	146
Shure Brothers	124
Signal Elec. Mfg. Co.	136
Silver Co., McMurdo	102
Solar Capacitor Sales Co.	2
Sonar Radio Corp.	154
Sprague Products Co.	123
Standard Arcturus Corp.	138
Standard Radio & Elec. Prod. Co.	130
Standard Transformer Corp.	146
Sun Radio & Electronics Co.	137
Sun Radio of Washington, D. C.	145
Supreme Transmitter Co.	113
Sylvania Elec. Prod. Co.	103
Taylor Tubes Co.	141
Terminal Radio Co.	131
Transmitter Equip. Mfg. Co.	95
Turner Co., The	147
U H F Resonator	150
United Electronics	7
Valparaiso Technical Inst.	146
Vibroplex Co., The	144
War Assets Administration	8, 9, 10, 11
Waterman Products Co.	151
Waterproof Electric Co.	132
Wilcox Electric Co.	119
Wind Turbine Co.	132
Workshop Associates, The	149
World Radio Laboratories	122



# RME Announces CAL-O-MATIC

TWO SPEED TUNING  
AND  
CALIBRATED  
BANDSPREAD



CONSTANTLY IMPROVED —  
BUT NO YEARLY MODELS

In the RME 45 you will now find:

**1 Two Speed Tuning.** A dual drive mechanism is now provided, in line with the calibrated, bandspread scale, which gives rapid tuning to cover the band, slow tuning to locate that station. Smooth, effortless, single dial control, calibration on five amateur bands, plenty of spread and real efficiency.

**2 Voltage Regulation.** Incorporated as an added feature, the RME 45 is now equipped with a VR-150 regulator tube to further reduce any drift to an absolute minimum and to stabilize the overall performance of an already fine instrument. You will like this addition.

**3 Improved Noise Limiter.** To make operation in a noisy location more enjoyable, a series noise limiter with an ON-OFF switch is being built into the RME 45. It works exceptionally well on all types of interference and goes after the spark-plug type with a vengeance.

Now more than ever, you MUST hear the RME 45 perform!

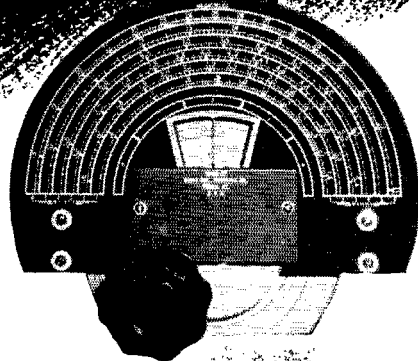

View of the translucent calibrated bandspread scale.

The two speed dial and calibrated bandspread scale provide the maximum in mechanical and electrical efficiency!

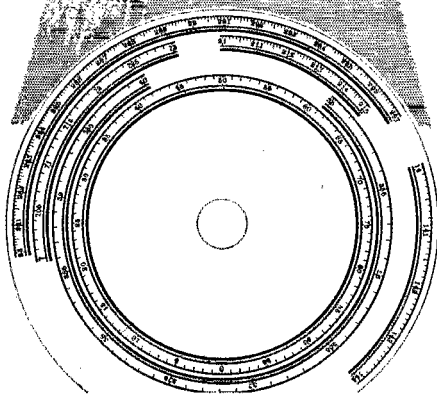

Specification Sheet  
on Request



## RME

FINE COMMUNICATIONS EQUIPMENT

RADIO MFG. ENGINEERS, INC.  
Provia 6, Illinois U. S. A.



*Listen*  
... IT'S A  
**Jensen**  
**SPEAKER!**

## MODEL VH-91 *Hypex*\* PROJECTOR

This latest addition to the famous JENSEN Hypex line meets a real need for paging and intercommunication applications. Particularly efficient in the voice frequency range, it delivers clear, intelligible speech with maximum "punch" to override high noise levels.

By reason of an extremely clever mounting bracket, this projector can be pointed in any direction and securely locked into position with a single wing nut. Two holes in the bracket are provided for mounting on table, wall, ceiling or a post.

The diaphragm is cloth base, phenolic impregnated. Nominal voice coil impedance, 8 ohms; power handling capacity, 15 watts maximum speech signal input. Two-wire RC cable is provided for connections. Mounting facilities are also provided on the bracket for a  $\frac{3}{8}$ " x  $\frac{1}{4}$ " core or smaller transformer. Because of the Hypex flare formula, useful output is attained for a 100° total angle.

*This new Hypex projector is now in production; deliveries are expected early in 1947 and literature will be available shortly.*

### JENSEN MANUFACTURING COMPANY

6611 S. LARAMIE AVE., CHICAGO 38, U.S.A.

In Canada: Copper Wire Products Ltd., 11 King St. W., Toronto, Ont.

\*Trade Mark Registered



**Jensen**  
SPEAKERS WITH *ALNICO 5*

*Designers and Manufacturers of Fine Acoustic Equipment*

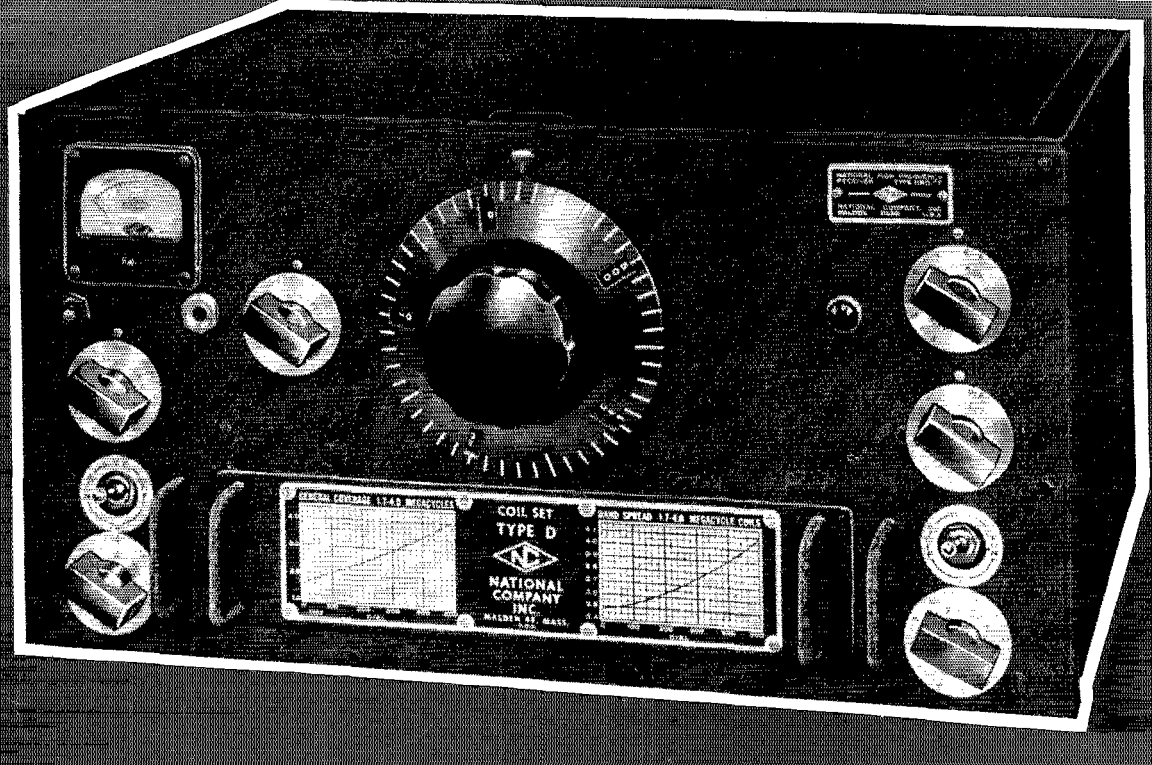

# HRO-5A1

WHEREVER the choice of a communication receiver is based on proven performance, the HRO is a logical selection. For the HRO is cleanly designed for crack operators, free from superfluous tubes or details, yet including everything that can aid the user's skill. The HRO combines ease of operation with brilliant performance and superb reliability.

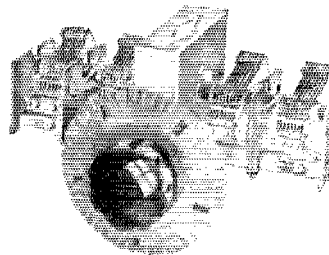

FOUR SECTION  
PRECISION CONDENSER



GANGED PLUG-IN COILS

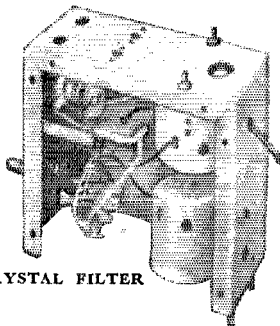

WIDE RANGE CRYSTAL FILTER



**NATIONAL COMPANY, INC.**  
**MALDEN, MASS.**

# PACK YOUR RIG WITH **POWER**

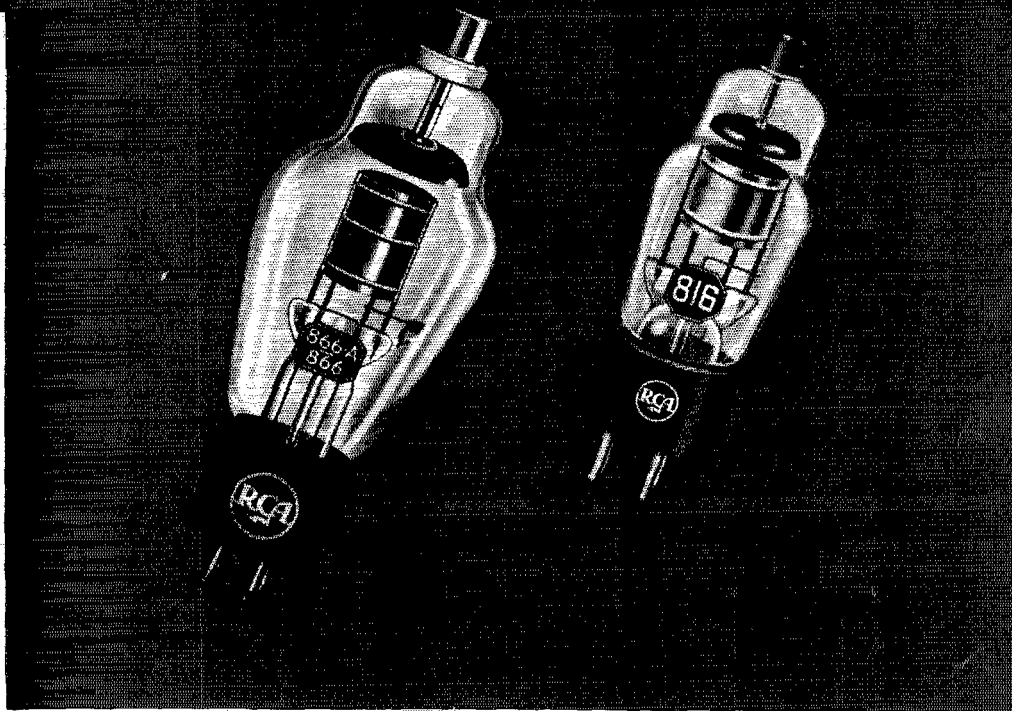

## These RCA mercury-vapor rectifiers deliver steady, dependable power—and more of it

**RCA-866-A/866** and **816** half-wave mercury-vapor rectifiers give you a full measure of power, a longer useful life, and extreme ruggedness at no extra cost. Their unusual performance records in prewar rigs and in wartime service explain why experienced amateurs power their transmitters with these time-proven types.

Both types are characterized by their ability to withstand high peak inverse voltages and to start conduction at low plate voltage. The internal voltage drop is approximately 15 volts.

**RCA-866-A/866** combines the best features of the earlier 866 and 866-A types. Its edgewise-wound coated filament, drawing 5 amps. at 2.5 volts, has enormous emission reserve—hence, greater *useful* life. High-voltage insulation is provided by bringing the plate lead out at the top of the bulb. Two **RCA-866-A/866's** in a full-wave circuit will de-

liver 500 ma. dc at 3100 volts—more than enough power for a full kilowatt final.

**RCA-816** has the same rugged design features as its big brother—including an edgewise-wound filament that draws 2 amps. at 2.5 volts. Though the 816 is no larger than a receiving tube, two of them in a full-wave circuit will deliver 250 ma. dc at 1500 volts and will handle transmitters up to 400 watts input!

For further details on these low-cost, heavy-duty rectifiers, see your local RCA Tube Distributor, or write RCA, Commercial Engineering, Section M54B, Harrison, N. J.

Have you seen **HAM TIPS?**  
Get a free copy from your local RCA Tube Distributor

**THE FOUNTAINHEAD OF MODERN  
TUBE DEVELOPMENT IS RCA**



**TUBE DEPARTMENT**

**RADIO CORPORATION of AMERICA**

**HARRISON, N. J.**