

QST

august, 1946

25 cents

35c In Canada

devoted entirely to

amateur radio

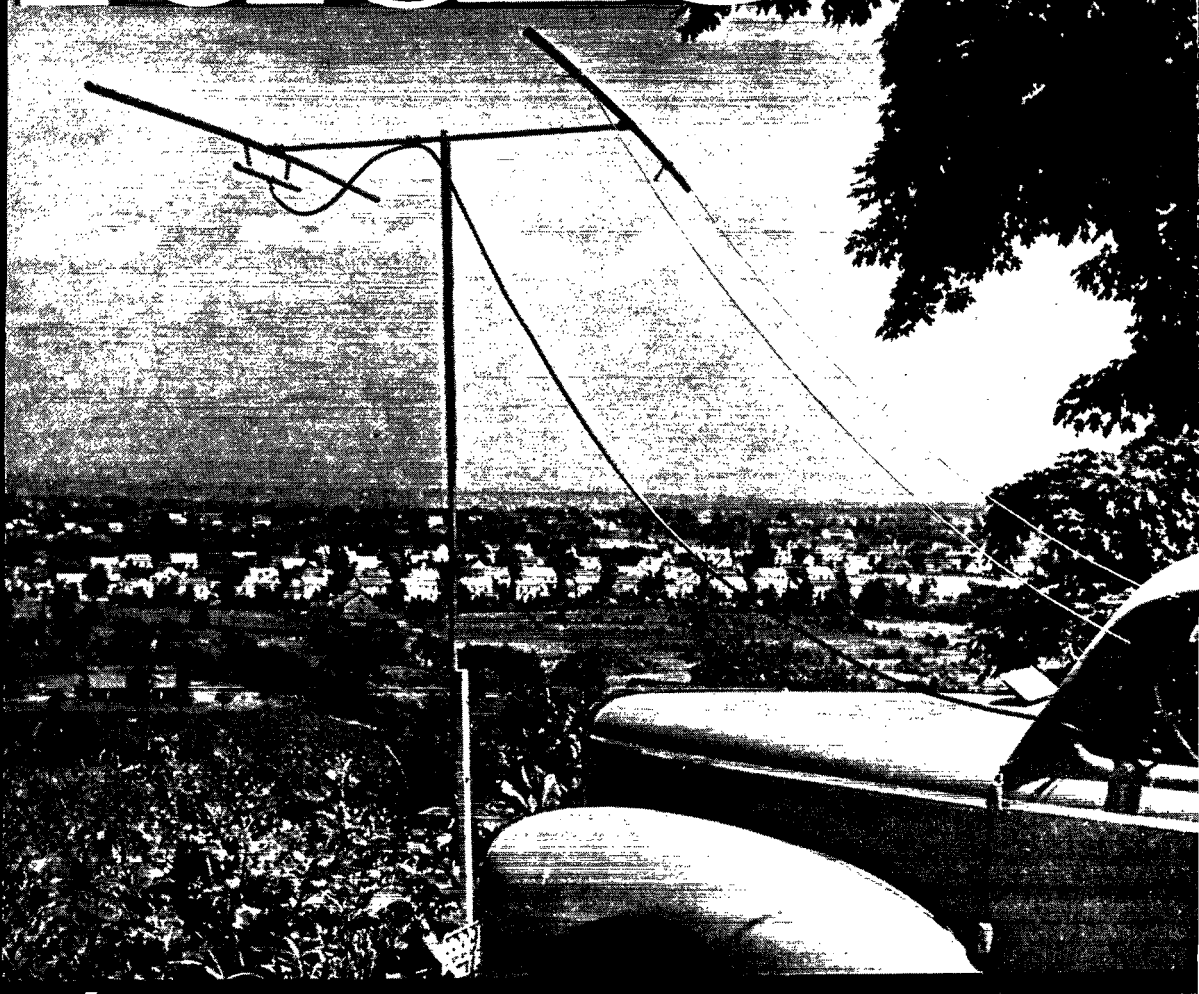

PUBLISHED BY THE AMERICAN RADIO RELAY LEAGUE

Something's always going on

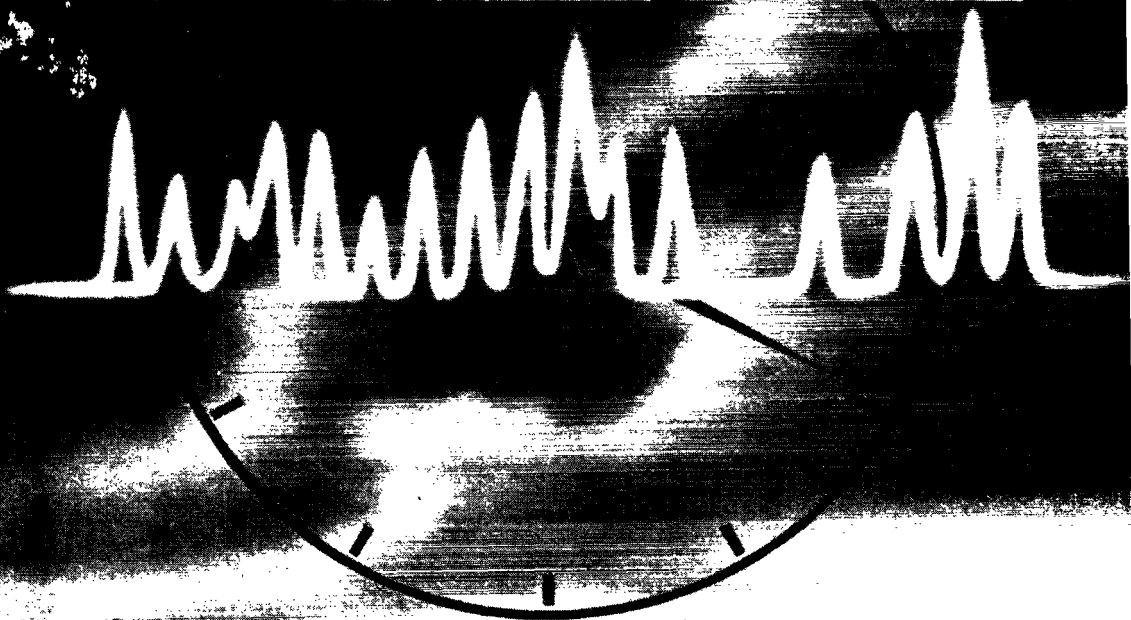

..and you're missing most of it

Amateur Radio Is Alert . . . Alive . . . Full of Action. Twenty-four hours a day the air is filled with signals . . . many of them of interest to you. But while you listen to one, you are virtually blindfolded, you can't know about the activity of the others . . . so you miss them . . . that is, without Panoramic Reception.

Only with Panoramic Reception can you see a continuous visible picture of band activity. Only with Panoramic Reception can you see stations come on the air, identify them and tune them in quickly, accurately, while looking at the other signals. Yes, only with Panoramic Reception can you see signals you might otherwise miss, signals you want to hear.

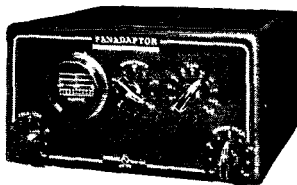

Get what you're missing . . . with PANADAPTOR

The PANADAPTOR is a 10 tube electronically tuned superheterodyne with a self-contained 'scope, complete for 115V, 50-60 cycle operation, at ONLY \$99.75 net.

GUARANTEED FOR ONE YEAR.

PANORAMIC

CABLE ADDRESS
PANORAMIC, NEW YORK



RADIO CORPORATION

242-250 WEST 55TH ST., New York 10, N.Y.

Exclusive Canadian Representative: Canadian Marconi, Ltd.

**You've been wanting—
so G. E. has ready for you—**

a real HIGH-POWER TETRODE

**with frequency range that
includes the 6-meter band!**

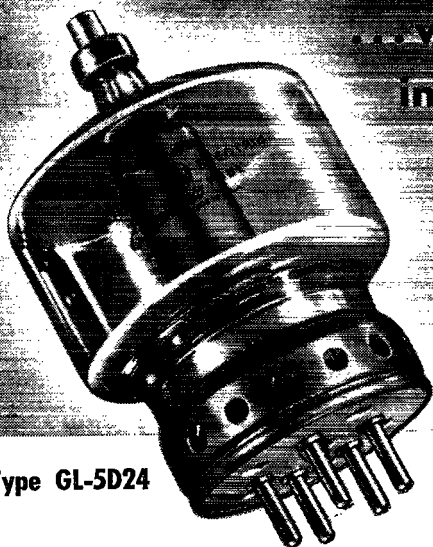

Type GL-5D24



ELECTRICAL CHARACTERISTICS

Filament voltage	5 v
Filament current	14.1 amp
Avg inter-electrode capacitances:	
grid-plate	0.06 mmfd
filament-grid	12.7 mmfd
filament-plate	4.5 mmfd

MAXIMUM RATINGS (ICAS)

Plate voltage	4,000 v
Screen voltage	600 v
Plate current	350 ma
Plate dissipation	250 w

THIS "Mr. Big" at a price you can afford, requires for its 1-kw max plate input (Class C telegraphy) a driving power of only some 5 w—spelling real operating economy for the radio amateur who wants his rig to pack a man-size wallop!

Clean, compact, *modern* design, fits the GL-5D24 for efficient use in the high frequencies. The large bulb gives better-than-average heat radiation. Extra-short leads mean minimum lead inductance. Because of the low grid-plate capacitance (0.06 mmfd), no neutralization normally is required.

Type GL-5D24, at top ratings, will operate at frequencies up to 85 megacycles, or well beyond the 6-meter band's requirements. Due to its compact construction the tube requires

a very limited amount of forced-air cooling for the base (1 cfm), and if operated at or near max ratings the bulb needs some forced air also. However, an ordinary small household fan will more than satisfy both of these requirements.

See your G-E tube distributor for price and further facts about this husky, up-to-the-minute power tube that *does a big job economically*. Or write to *Electronics Department, General Electric Company, Schenectady 5, N. Y.*

Your G-E distributor has the latest "HamNews" ready for you.

ELECTRONIC TUBES OF ALL TYPES FOR THE RADIO AMATEUR

GENERAL  ELECTRIC
161-ET-8880

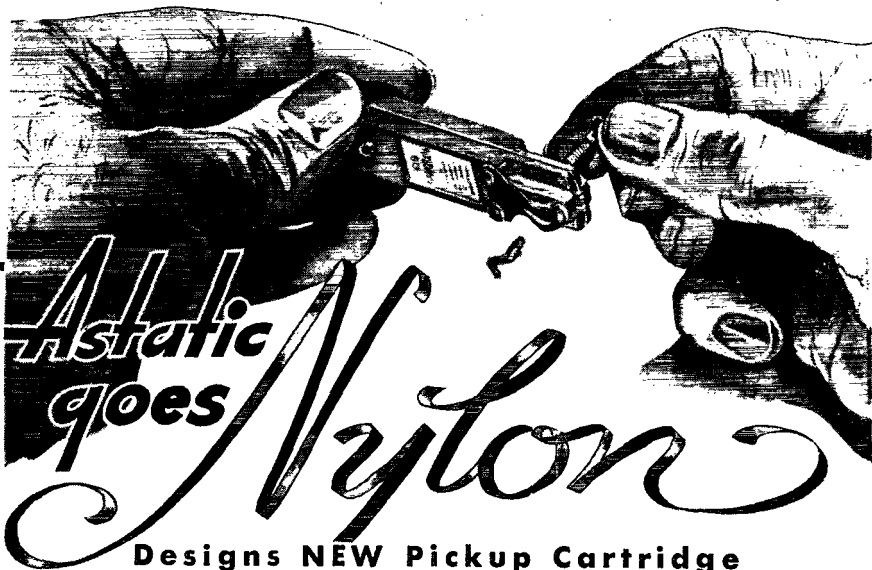

**Designs NEW Pickup Cartridge
with NYLON Chuck and REPLACEABLE,
Long-Life, Sapphire-Tipped NYLON Needle**

▶ Constantly alert to the possibilities for improvement in the design and performance of phonograph pickup cartridges, Astatic research has disclosed a material, other than metal, for the better transmission of signals from the record grooves to the crystal element. That material is NYLON! No other known substance possesses all the properties which make Nylon ideal for this purpose. Astatic, therefore, has employed this revolutionary material in the manufacture of a new crystal pickup cartridge known as Astatic Nylon 1-J . . . a low pressure, wide-range, general purpose cartridge incorporating a Nylon chuck and Nylon, sapphire-tipped needle.

Quality of Reproduction

In using this Nylon 1-J Crystal Pickup Cartridge, the phonograph manufacturer, as well as the user, is assured that the quality of reproduction will REMAIN CONSTANT regardless of needle replacements, because the Nylon needle is matched to the cartridge and NO other type of needle may be used.



Interior View
showing crystal element,
Nylon chuck and
sapphire-tipped, knee-
action Nylon needle
and metal needle
guard.

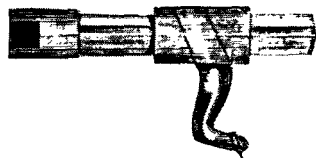

Phantom View
showing how tapered
shank of Nylon needle
fits into tapered hole in
Nylon chuck.

THE Astatic CORPORATION
ASTATIC CONNEAUT, OHIO
IN CANADA: CANADIAN ASTATIC LTD., TORONTO, ONTARIO

Astatic crystal devices
manufactured under
Brush Development Co.
patents.

AUGUST 1946

VOLUME XXX

NUMBER 8



STAFF

Editorial

KENNETH B. WARNER, WIEH
(Managing Secretary, ARRL)
Editor

HAROLD M. MCKEAN, W1CEG
Assistant to the Editor

GEORGE GRAMMER, W1DF
(Technical Director, ARRL)
Technical Editor

DONALD H. MIX, W1TS
BYRON GOODMAN, W1JPE
Assistant Technical Editors

RICHARD M. SMITH, W2FTX
Technical Assistant

EDWARD P. TILTON, W1HDQ
V.H.F. Editor

WALTER E. BRADLEY W1FWH
Technical Information Service

Production

RALPH T. BEAUDIN, W1BAW
Superintendent

ELSIE C. HOCHMEISTER
Assistant

Advertising

F. CHEYNEY BEERLEY, W1GS
Advertising Manager

Circulation

DAVID H. HOUGHTON
Circulation Manager

RALPH T. BEAUDIN, W1BAW
Assistant Circulation Manager



OFFICES

38 La Salle Road
West Hartford 7, Connecticut

Subscription rate in United States and Possessions, \$2.50 per year, postpaid; all other countries, \$3.00 per year, postpaid. Single copies, 25 cents. Foreign remittances should be by international postal or express money order or bank draft negotiable in the U. S. and for an equivalent amount in U. S. funds.

Entered as second-class matter May 29, 1919, at the post office at Hartford, Connecticut, under the Act of March 3, 1879. Acceptance for mailing at special rate of postage provided for in section 1103, Act of October 3, 1917, authorized September 9, 1922. Additional entry at Concord, N. H., authorized February 21, 1929, under the Act of February 28, 1925.

Copyright 1946 by the American Radio Relay League, Inc. Title registered at U. S. Patent Office.

QST

devoted entirely to

AMATEUR RADIO

PUBLISHED, MONTHLY, AS ITS OFFICIAL ORGAN, BY THE AMERICAN RADIO RELAY LEAGUE, INC., AT WEST HARTFORD, CONN., U. S. A.; OFFICIAL ORGAN OF THE INTERNATIONAL AMATEUR RADIO UNION



CONTENTS

"It Seems to Us"	11
An Amateur-Band Eight-Tube Receiver <i>Byron Goodman, W1JPE</i>	13
Maritime Division Convention	18
Rocky Mountain Division Convention	18
Our Best DX — 800 Feet! . . . <i>A. H. Sharbaugh, W1NVL/2, and R. L. Watters, W9SAD/2</i>	19
Unstable Signals <i>Donald Mix, W1TS</i>	23
An Inexpensive 3-Element Beam for 28 Mc. <i>Charles E. Nichols, jr., W1MRK</i>	27
It's Fascinating Work <i>Keith S. Williams, W6DTY</i>	32
Frequency Meters as Master Oscillators <i>Commander E. H. Conklin, USNR, W3JUX</i>	34
Happenings of the Month	36
In QST 25 Years Ago This Month	41
Permeability-Tuned Oscillators . . . <i>T. A. Hunter, W0NTI</i>	42
Silent Keys	46
Propagation Predictions Now Available	46
Foreign Notes	47
Raising the Efficiency of the V.H.F. Linear Oscillator <i>George D. Perkins, W1IVU, and Harry G. Burnett, W1LZ</i>	48
Wanted — Hams for Overseas	52
For Beginners Only <i>W. H. Fraser</i>	53
Applying A.M.D. to the Communications Receiver <i>D. A. Griffin, W2AOE, and L. C. Waller, W2BRO</i>	56
How's DX?	62
New Apparatus	65
The World Above 50 Mc.	66
Hints and Kinks	70
Correspondence from Members	72
Operating News	74
Station Activities	84
WWV	138
ARRL QSL Bureau	152

FIRST OF A LONG LINE...



Model S-38

Four tuning bands, 540 kc to 32 Mc, CW pitch control adjustable from front panel, automatic noise limiter, self contained PM dynamic speaker, "Airo-dized" steel grille are some of the attractive features... **\$39.50**



Model S-40

Finest performance ever presented in the popular price field. 540 kc to 43 Mc, RF section uses permeability adjusted "micro-set" inductances. A. N. L., temperature compensated RF oscillator, beat frequency oscillator, separate RF and AF gain controls..... **\$79.50**

WORTH WAITING

Due to industry-wide circumstances Hallicrafters production and distribution of new models is necessarily running far behind the demand.

Radio components are difficult to obtain. Production has been especially slow on components of the high quality and precise design needed for completing Hallicrafters high frequency circuits.

Models S-38 and S-40 are only the beginning. When parts become available Hallicrafters will have many more bigger and better sets. The S-38 and the S-40 are still not available in quantity but production on these beginning models is improving. Just as soon as humanly possible, Hallicrafters will have ready for you the equipment you want at the price you want to pay.

NEW OFFICIAL SERVICE
CENTERS FOR
hallicrafters
EQUIPMENT

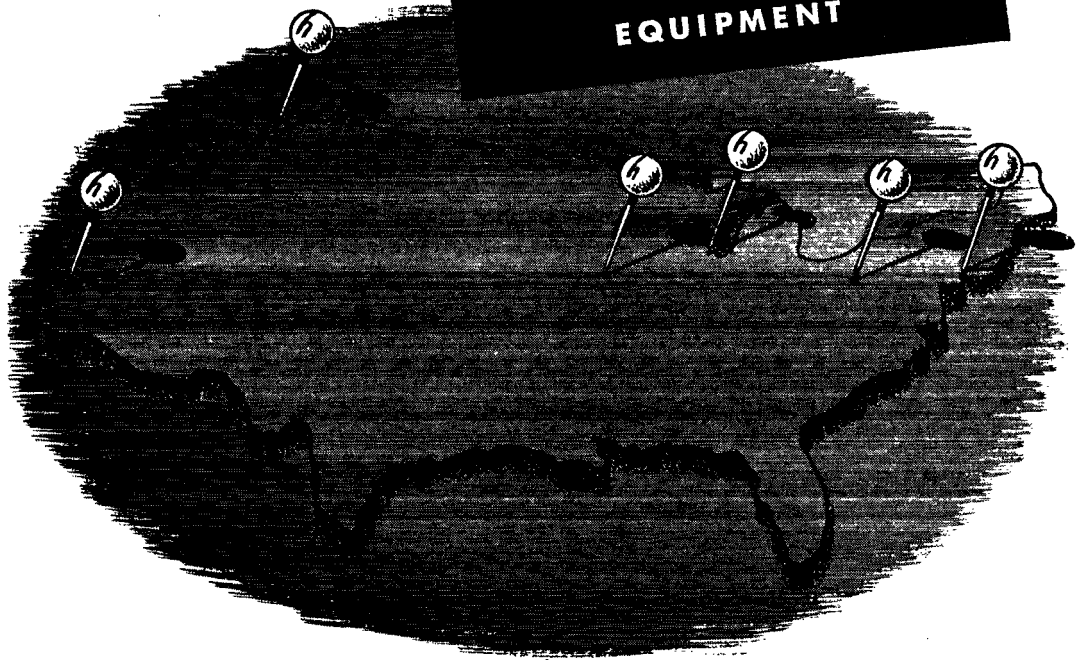

hallicrafters establishes national network of strategically located SERVICE CENTERS

The Hallicrafters Co., Chicago, announces the beginning of a new national network of official service centers to specialize in repair and servicing of all Hallicrafters communications equipment: marine and aviation radio, ham transmitters and receivers. Service centers have already been established at New York, Pittsburgh, Kansas City, Mo., Los Angeles and Seattle. Service at these locations will be equal in every way to that offered by the Chicago factory.

As production and distribution can be increased, more such centers will be established so that Hallicrafters users everywhere will be given the fastest, most efficient service possible.

See your local Hallicrafters distributor to learn how and where you can benefit from this new service system. Your high precision Hallicrafters equipment deserves the finest care . . . put your repair and service problems in the hands of specialists: Hallicrafters official service centers.

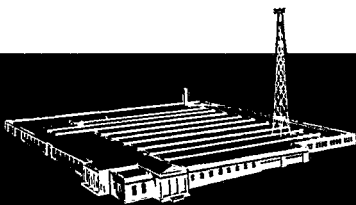

hallicrafters RADIO

THE HALLICRAFTERS CO., MANUFACTURERS OF RADIO
AND ELECTRONIC EQUIPMENT, CHICAGO 16, U. S. A.

Section Communications Managers of the ARRL Communications Department

Reports Invited. All amateurs, especially League members, are invited to report station activities on the first of each month (or preceding month) direct to the SCM, the administrative ARRL official elected by members in each Section. Radio Club reports are also desired by SCMs for inclusion in QST. All ARRL Field Organization appointments are now available to League members. These include ORS, OES, OPS, OO, and OBS. Also, where vacancies exist SCMs desire applications for SEC, EC, RM, and PAM.

ATLANTIC DIVISION				
Eastern Pennsylvania	W3BES	Jerry Mathis	623 Crescent Ave. 9701 Monroe St.	Glenside Gardens
Maryland-Delaware-District of Columbia	W3CIZ	Hermann E. Hobbs	Silver Springs P. O.	Linden, Maryland
Southern New Jersey	W3CCU	Ray Tomlinson	623 E. Brown St.	Trenton 10
Western New York	W8UPH	Charles I. Otero	4158 Ridge Road, West	Spencerport
Western Pennsylvania	W3NCJ	R. R. Rosenberg	927 East 23rd St.	Eric
CENTRAL DIVISION				
Illinois	W9NUX	David E. Blake, II	4501 N. Malden St.	Chicago 40
Indiana	W9SWH	Ted K. Clifton	550 Eben St.	New Haven
Kentucky	W5IEZ/4	Joseph P. Colvin	1653 Beechwood Ave.	Louisville 4
Michigan	W8DPE	Harold C. Bird	R. F. D. 2, Box 228	Pontiac 2
Ohio	W8MFP	Carl E. Wiehe	122 St. Albert St.	St. Bernard 17
Wisconsin	W9RH	Emil Felber, Jr.	1625 N. 18th St.	Milwaukee 5
DAKOTA DIVISION				
North Dakota	W9EVP	Raymond V. Barnett	406-17th St.	Bismarck
South Dakota	W9QVY	P. H. Schultz	118 N. Yankton Ave.	Pierre
Northern Minnesota	W9FUZ	Armond P. Brattland	230 E. Westan	Los Angeles, Calif.
Southern Minnesota	W9OMC	Vernon G. Pribyl	15 Glen St., South	Hutchinson
DELTA DIVISION				
Arkansas	W5JIC	Marshall Riggs	4405 Howell Ave.	Fort Smith
Louisiana	W5DWW	W. J. Wilkinson, Jr.	Room 313, Jefferson Hotel	Shreveport
Mississippi	W5HAV	P. W. Clement	524 Santini St.	Biloxi
Tennessee	W5ASP	James B. Witt	R. F. D. 6, Shady Dell Trail	Knoxville
HUDSON DIVISION				
Eastern New York	W2HZL	Ernest E. George	2044 Lexington Parkway	Schenectady 8
N. Y. C. & Long Island	W2KDC	Charles Ham, Jr.	151-06 84th Drive	Jamaica, L. I., 2
Northern New Jersey*	W2IIN	John J. Vitale	57 Sayre St.	Elizabeth 3
MIDWEST DIVISION				
Iowa	W9PJR	Leslie B. Vennard	2712 Washington St.	Burlington
Kansas	W8AWP	A. B. Unruh	1617 S. Seneca St.	Wichita 12
Missouri	W9OUD	Mrs. Letha A. Dangerfield	411 Moffett Ave.	Joplin
Nebraska	W8PQB	Arthur R. Gaeth	6105 N. 37 St.	Omaha 11
NEW ENGLAND DIVISION				
Connecticut	W1KOY	Edmund R. Fraser	48 Willow St.	West Haven 16
Maine	W1AOL	A. B. Brown	379 No. Main St.	Brewer
Eastern Massachusetts	W1ALP	Frank L. Baker, Jr.	91 Atlantic St.	North Quincy 71
Western Massachusetts	W1JAH	William J. Barrett	239 Columbia St.	Adams
New Hampshire	W1AXL	John H. Stoughton	RFD 2	Claremont
Rhode Island	W1HRC	Clayton C. Gordon	70 Columbia Ave., Gaspee	Plateau, Providence 5
Vermont	W1NDL	Gerald Benedict	23 Foster St.	Montpelier
NORTHWESTERN DIVISION				
Alaska	K7CBF	August G. Hiebert	c/o KFAR	Fairbanks
Idaho	W7AVP	Don D. Oberbillig	P. O. Box 486	Boise
Montana	W7EQM	Albert Beck	18 Laird St.	Ramsay
Oregon*	W7BEE	Cliff Tice	McKay Dam	Pendleton
Washington	W7FWD	O. U. Tatro	513 N. Central	Olympia
PACIFIC DIVISION				
Hawaii	K6RLG	Howard S. Simpson	2068 Wells St.	Wailuku, Maui
Nevada	W6CWF	N. Arthur Sowle	Box 2025	Reno
Santa Clara Valley	W6BPT	Roy E. Pinkham	1061 Fremont St.	Santa Clara
East Bay	W6TI	Horace R. Greer	414 Fairmount Ave.	Oakland 11
San Francisco	W6CVP	Samuel C. Van Liew	215 Knowles Ave.	Daly City
Sacramento Valley	W6MGP	John R. Kinney	5240 Jay St.	Sacramento 16
Philippines	KA1GR	George L. Rickard	Box 849	Manila
San Joaquin Valley	W6PSQ	James F. Wakefield	1548 L St.	Fresno
ROANOKE DIVISION				
North Carolina	W4CWF	W. J. Wortman	c/o Duke Power Co.	Charlotte 1
South Carolina	W4BOE/ANG	Ted Ferguson	3422 Roswood Drive	Columbia 25
Virginia	W3GKL	Walter R. Bullington	1203 E. Brookland Pk. Blvd.	Richmond 203
West Virginia	W8JM	Donald B. Morris	323 Home St.	Fairmont
ROCKY MOUNTAIN DIVISION				
Colorado	W9OYT	Glen Bond	2550 Kendall	Denver 14
Utah-Wyoming	W6LLH	Victor Drabble	1024 Oak St.	Ogden, Utah
SOUTHEASTERN DIVISION				
Alabama	W4CBV	Lawrence J. Smyth	808 Winona Ave.	Montgomery
Eastern Florida	W4IP	Robert B. Murphy	3302 S.W. Grapeland Blvd.	Miami 33
Western Florida	W4MS	Lt. Comdr. Edward J. Collins	1215 N. 12th Ave.	Pensacola
Georgia	W4HYW	Thomas M. Moss	570 Oak Drive	Hapeville
West Indies (Cuba) (Puerto Rico-Virgin Islands)*	K4KD	Everett Mayer	P. O. Box 1061	San Juan 5, P. R.
SOUTHWESTERN DIVISION				
Los Angeles	W6QWZ	Ben W. Onstent	9631 3rd Ave.	Inglewood
Arizona	W6MLL	Gladden C. Elliott	1408 West Fresno St.	Tucson
San Diego	W6CHV	Ralph H. Culbertson	7172 Eads St.	La Jolla
WEST GULF DIVISION				
Northern Texas	W5ALA	Jack T. Moore	4529 Fairway Ave.	Dallas 4
Oklahoma	W5AYL	Ed Oldfield	2141 N.W. 35th St.	Oklahoma City 6
Southern Texas	W5JC	James B. Rives	1721 Kentucky Ave.	San Antonio 1
New Mexico	W5HJF	J. G. Hancock	110 S. E. Nevada St.	Portales
MARITIME DIVISION				
Maritime	VE1DQ	A. M. Crowell	69 Dublin St.	Halifax, N. S.
ONTARIO DIVISION				
Ontario	VE3DU	David S. Hutchinson	827 Lovett St.	London, Ont.
QUEBEC DIVISION				
Quebec	VE2CO	L. G. Morris	4114 Hingston Ave.	Montreal 28, Que.
VANALTA DIVISION				
Alberta	VE6LQ	W. W. Butchart	10740-107 St.	Edmonton, Alta.
British Columbia	VE7WS	W. W. Storey	3915 W. 32nd Ave.	Vancouver
PRAIRIE DIVISION				
Manitoba	VE4AM	A. W. Morley	26 Lennox St.	St. Vital
Saskatchewan	VE4SY	Arthur Chesworth	1084 Redland Ave.	Moose Jaw

*Officials appointed to act temporarily in the absence of a regular official.

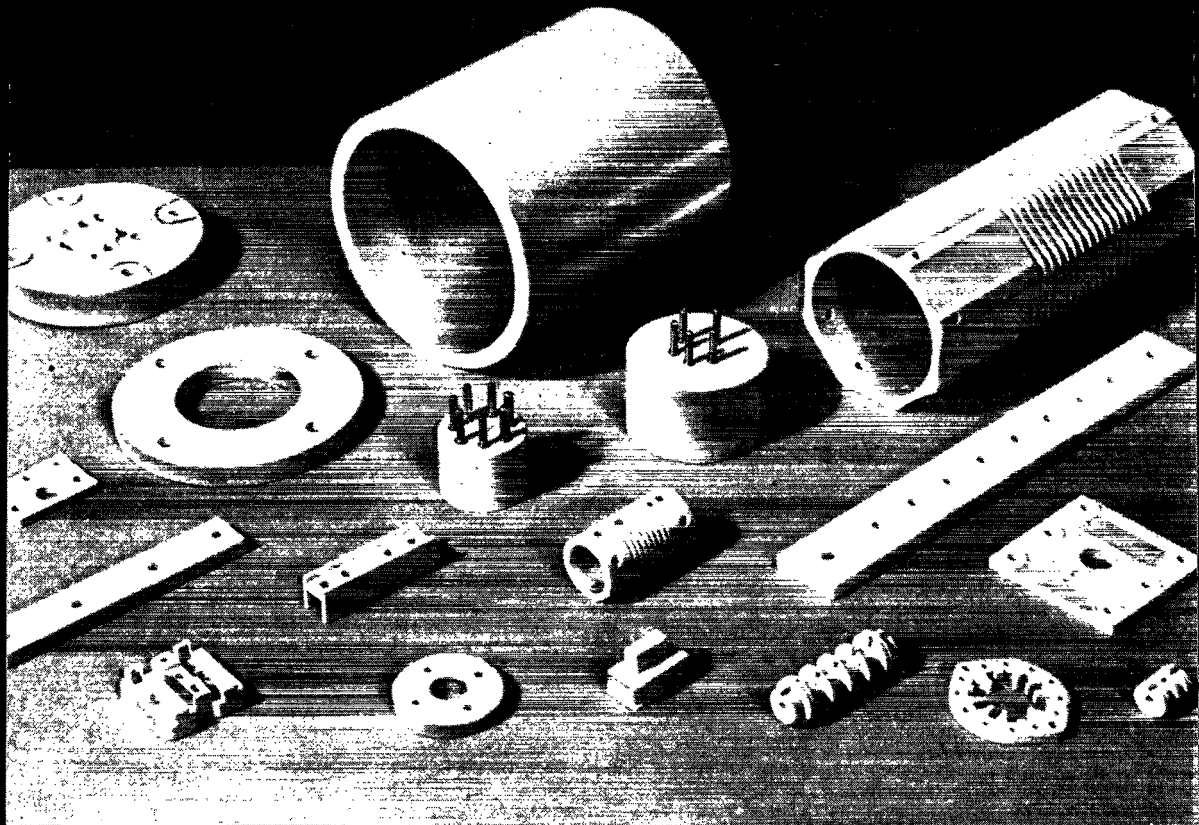

PRECISION MADE TECHNICAL CERAMICS

What advantages will you find in AISiMag technical ceramics? AISiMag is the trade name of a large family of technical ceramic compositions or bodies. These permanently rigid bodies are ageless, non-corrodible, non-clogging, hard, chemically resistant.

Each body has definite physical characteristics which have been precisely determined. These characteristics cover a wide range of requirements. Among the most notable features are bodies with unexcelled dielectric characteristics for HF and UHF applications, bodies with unusual resistance to high temperatures and thermal shock. The characteristics of the more frequently used bodies are detailed in the AISiMag property chart, sent free on request.



Original Award July 27, 1942
 Second Award February 13, 1943
 Third Award September 25, 1943
 Fourth Award May 27, 1944
 Fifth Award December 2, 1944

AMERICAN LAVA CORPORATION
 CHATTANOOGA 5, TENNESSEE
 43RD YEAR OF CERAMIC LEADERSHIP

ENGINEERING SERVICE OFFICES:

ST. LOUIS, Mo., 1123 Washington Ave., Tel: Garfield 4959 • NEWARK, N. J., 671 Broad Street, Tel: Mitchell 2-8159
 CAMBRIDGE, Mass., 38-B Brattle St., Tel: Kirkland 4498 • CHICAGO, 9 S. Clinton St., Tel: Central 1721
 SAN FRANCISCO, 163 Second St., Tel: Douglas 2464 • LOS ANGELES, 324 N. San Pedro St., Tel: Mutual 9076

Amphenol

provides the link in

AM

FM

TV

A complete range of electronic components to serve the entire range of frequencies in use today.

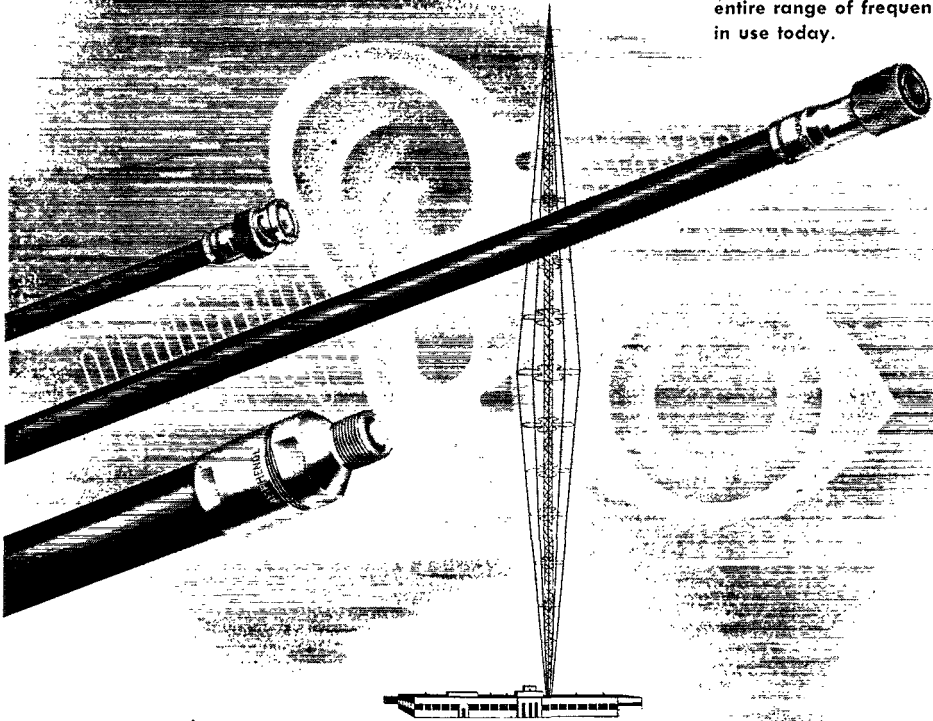

• As the emphasis in communications development shifts more and more to the higher frequencies — notably FM and Television — the electrical circuits and the component parts involved require ever greater accuracy in performance. Amphenol engineers have always worked to help push forward the frontiers of the science of electronics — the unrivalled production facilities of Amphenol have supplied the quality components required by new developments in this field.

Among the newest Amphenol products that will be of interest to amateurs and to manufacturers of elec-

tronic equipment are: electrically better Hi-Q tube sockets, octal angle sockets for cathode ray and other tubes — Twin-Lead parallel transmission line — several FM receiving antennas — new cables, including some special ones for Television color cameras and for Facsimile work. Write for complete information.

AMERICAN PHENOLIC CORPORATION

CHICAGO 50, ILLINOIS

In Canada • Amphenol Limited • Toronto



COAXIAL CABLES AND CONNECTORS • INDUSTRIAL CONNECTORS, FITTINGS AND CONDUIT • ANTENNAS • RADIO COMPONENTS • PLASTICS FOR ELECTRONICS



$CQ (bsmc) + ed + \frac{73c}{7s(8at)} + 4(ii) = (Tfp + eoi)(iyUHFe) *$

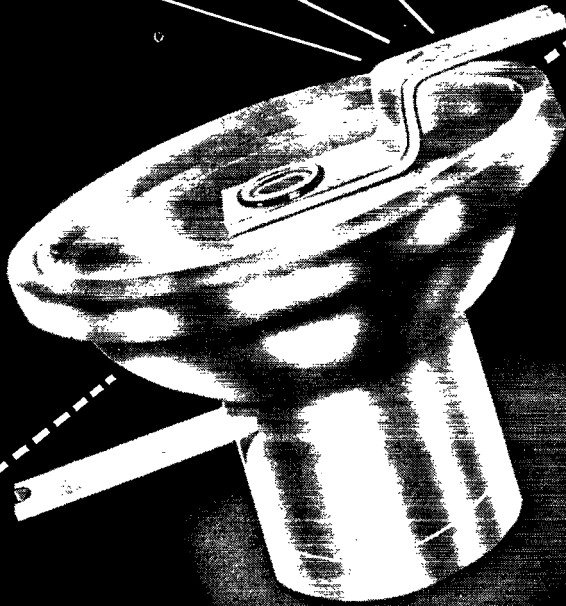

* CENTRALAB Quality button silver mica capacitors + early delivery + 73 combinations made up of 7 styles with 8 available terminals + 4 individual inspections (capacitance, power factor, voltage breakdown and leakage resistance) = Trouble free performance and ease of installation in your Ultra High Frequency equipment.

Send for Bulletin 586

Centralab

Division of GLOBE-UNION INC., Milwaukee

PRODUCERS OF

Silver Mica Capacitors
Bulletin 630

Ceramics
Bulletin 720

Ceramic High Voltage Capacitors
Bulletin 630

Ceramic Trimmers
Bulletin 630

Radiohms
Bulletin 697

Tubular Ceramic
Capacitors
Bulletin 630

Ceramic Plate Capacitors
Bulletin 630

Selector Switches
Bulletin 722

THE AMERICAN RADIO RELAY LEAGUE, INC.,

is a noncommercial association of radio amateurs, bonded for the promotion of interest in amateur radio communication and experimentation, for the relaying of messages by radio, for the advancement of the radio art and of the public welfare, for the representation of the radio amateur in legislative matters, and for the maintenance of fraternalism and a high standard of conduct.

It is an incorporated association without capital stock, chartered under the laws of Connecticut. Its affairs are governed by a Board of Directors, elected every two years by the general membership. The officers are elected or appointed by the Directors. The League is noncommercial and no one commercially engaged in the manufacture, sale or rental of radio apparatus is eligible to membership on its board.

"Of, by and for the amateur," it numbers within its ranks practically every worth-while amateur in the nation and has a history of glorious achievement as the standard-bearer in amateur affairs.

Inquiries regarding membership are solicited. A bona fide interest in amateur radio is the only essential qualification; ownership of a transmitting station and knowledge of the code are not prerequisite, although full voting membership is granted only to licensed amateurs.

All general correspondence should be addressed to the Secretary at the administrative headquarters at West Hartford, Connecticut.



Past Presidents

HIRAM PERCY MAXIM, WIAW, 1914-1936
EUGENE C. WOODRUFF, W8CMP, 1936-1940

Officers

President.....GEORGE W. BAILEY, W1KH
Washington, D. C.
Vice-President.....J. LINCOLN McCARGAR, W6EY
Oakland, California
Secretary.....KENNETH B. WARNER, W1EH
West Hartford, Connecticut
Communications Manager.....F. E. HANDY, W1BDI
West Hartford, Connecticut
Treasurer.....DAVID H. HOUGHTON
West Hartford, Connecticut

General Counsel.....PAUL M. SEGAL
1026 Woodward Building, Washington 5, D. C.

Directors

President
GEORGE W. BAILEY.....W1KH
1630 P St., N.W., Washington 25, D. C.

Vice-President
J. LINCOLN McCARGAR.....W6EY
66 Hamilton Place, Oakland 12, Calif.

Canadian General Manager
ALEX REID.....VE2BE
240 Logan Ave., St. Lambert, P. Q.
Alternate: Leonard W. Mitchell.....VE3AZ
78 Raglan Ave., Toronto, Ont.

Atlantic Division
EDWARD G. RASER.....W2ZI
315 Beechwood Ave., Trenton 8, N. J.
Alternate: J. Victor Brotherson.....W8BHN
1743 Ottawa Drive, Erie, Pa.

Central Division
JOHN A. KIENER.....W8AVH
3462 Edison Rd., Cleveland Heights,
Cleveland 21, Ohio
Alternate: Earl S. Nelson.....W8DS
22,551 Hadden Rd., Euclid 17, Ohio

Dakota Division
TOM E. DAVIS.....W9VVA
915 W. Becker Ave., Willmar, Minn.
Alternate: Harold B. Love.....W9ZRT
Box 426, Mandan, N. D.

Delta Division
GEORGE S. ACTON.....W5BMM
Plain Dealing, La.
Alternate: Eugene H. Treadaway.....W5DKR
P. O. Box 44, La Place, La.

Hudson Division
ROBERT AKERIDGE KIRKMAN.....W2DSY
1910 Oak Drive, West Belmar, N. J.
Alternate: George Rulfs, Jr.....W2CJY
38 Brookwood Drive, Manhasset, L. I., N. Y.

Midwest Division
FLOYD E. NORWINE, JR.....W6EFC
7405 Hiawatha Ave., Richmond Heights 17, Mo.
Alternate: C. A. Colvin.....W9VHR
% Omaha & Council Bluffs St. Railway Co.,
Omaha 2, Nebr.

New England Division
PERCY C. NOBLE.....W1BVR
37 Broad St., Westfield, Mass.
Alternate: Clayton C. Gordon.....W1HRC
70 Columbia Ave., Warwick, R. I.

Northwestern Division
KARL W. WEINGARTEN.....W7BG
3219 N. 24th St., Tacoma 7, Wash.
Alternate: R. Rex Roberts.....W7CPY
110 W. Brennan St., Glendive, Mont.

Pacific Division
J. L. McCARGAR.....W6EY
66 Hamilton Pl., Oakland 12, Calif.
Alternate: Elbert J. Amarantes.....W6FBW
1675 Dale Ave., San Jose, Calif.

Roanoke Division
H. L. CAVENESS.....W4DW
2607 Vanderbilt Ave., Raleigh, N. C.
Alternate: J. Frank Key.....W3ZA
Box 707, Buena Vista, Va.

Rocky Mountain Division
Acting Director:
HOWARD R. MARKWELL.....W9TFP
355 Monroe St., Denver 6, Colo.

Southeastern Division
WILLIAM C. SHELTON.....W4ASR
527 Revilo Blvd., Daytona Beach, Fla.
Alternate: William P. Slides.....W4AUP
Fleming Road, Montgomery, Ala.

Southwestern Division
JOHN E. BICKEL.....W6BKY
1834 E. Whittier Blvd., Whittier, Calif.
Alternate: Eldridge E. Wyatt, Jr.....W6ARW
P. O. Box 3597, Long Beach 3, Calif.

West Gulf Division
WAYLAND M. GROVES.....W5NW
% Humble Pipe Line Co., Odessa, Texas
Alternate: Jennings R. Poston.....W5AJ
P. O. Box 848, Curundu, Panama Canal Zone

"It Seems to Us..."



MIDSUMMER DAYDREAMING

We've been hitting the stuff again, fellows, and doing some further dreaming about the kind of hamgear that might help to make contacts and reduce the interference from unnecessary calling and hopeless operating practices. You may remember our piece on this page a couple of months back, when we suggested that each pair of stations in QSO occupy the same frequency but that initial responses be made on frequencies slightly different from the caller's. A few more ideas have come our way and we've been trying to fit them together into some sort of a vision of a more or less idealized station of the future. We'll tell you about them and see what you think.

It all began when Joe dropped in one morning and said that, having lent his VFO to his wife, it occurred to him to couple a pick-up coil to his receiver's local oscillator and try it as a VFO. It worked pretty well, although tuning back and forth was inconvenient. Well, we thought, we have good oscillators in our receivers, so why couldn't they be planned to do double duty right from the start and serve on the transmitting side as well?

Then we read the advertisement of a new receiver. Eight watts of undistorted audio output, it said. Just what we need for a speech amplifier. Why should we have one 8-watt amplifier in the receiver and another just like it for the transmitter, when we can't use both at once? In other words, in a well-organized world the receiver's audio system would be separately available as the station's speech amplifier, it seemed to us.

Thinking of plugging the mike into the receiver of course reminded us of the BC-342, where key and mike and transmitter power controls all shove into one corner of the box, so that the receiver acts also as the control position. Well, why not? When we make one set of motions turning off or altering the receiver, why do we have to make another set to turn on the transmitter? The receiver we were reading about was said to have the shafts of several of its controls run right through the

cabinet, so that they could be mechanically or electrically linked at the rear to do things to the transmitter. We put that down as another of our dreamy ideas: the receiver must also provide the change-over controls for our future station.

About that time W5CAT's rather gorgeous idea which we published in "Hints & Kinks" last month drifted into the office to give a further boost to our thinking. He uses the i.f. crystal from his receiver filter in a transmitter frequency-controlling oscillator, working into a mixer which obtains its heterodyning frequency by a pick-up loop coupled to the receiver's local oscillator. The resultant carrier frequency is exactly that to which the receiver is tuned, the transmitter then automatically following the receiver up and down the band — within limits, of course. It is a very pretty method but to our mind it has a couple of serious defects. In the first place we don't go along with him on robbing the receiver of its crystal filter. That crystal belongs right in the filter — we emphatically need single-signal reception these days. Again, we were distressed by the thought of always being inescapably dead on the other fellow's frequency, it being part of our philosophy that initial answers should be 1 to 5 kc. away, then moving to the caller's frequency after one has been "selected." The simple answer to both objections is not to crystal-control the first oscillator but to make it a VFO at the receiver intermediate frequency, adjustable just a few kilocycles in each direction. Suppose, for example, you have found that you get best results in raising 'em by answering $3\frac{1}{2}$ kc. on the high side of the caller's frequency. You just set the snivvy on the VFO to $+3\frac{1}{2}$ and automatically your transmitter frequency is 3.5 kc. higher than every signal to which you tune. No stopping to readjust the VFO for each station you want to answer. No fiddling with a separate monitor that has to be brought back on to frequency. And if you are "selected" by the caller, a simple return of the VFO pointer to the mid-scale zero puts you on the caller's frequency

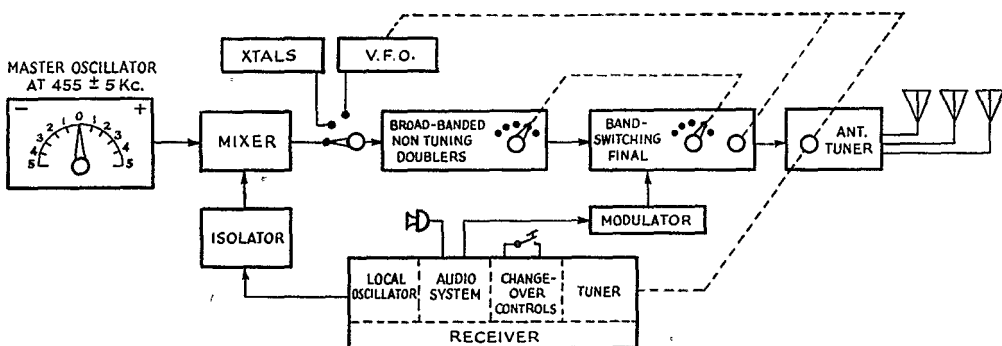

for a unifrequency QSO. Time has been saved, interference has been reduced — the two most important considerations in an evening's operating. We think this idea has sweet possibilities* but we admit our technique must improve before it is thoroughly practicable. For instance, if either transmitter drifts, the two stations will go galloping across the band like a couple of bum transceivers chasing their own tails on 2 meters. We'll need nice stability. And if receivers aren't to leap four feet off the table they'll need limiters to facilitate monitoring and break-in on unifrequency work. Incidentally, George Grammer's limiter in the little black box with the double crystal diode, from May *QST*, can become the most invaluable piece of apparatus in your station.

Now it's time for confession. While we think these are interesting ideas of great potential usefulness, they are essentially refinements and niceties that can have no great play until we lick some underlying technical problems that we haven't yet mastered. The advantages of VFO operating technique are available today only over a small part of one band. Any great frequency departure makes it necessary to retune the final amplifier and reload the antenna and probably also involves trimming the buffer or doubler stages to recover excitation. What we need is a ganged single-control transmitter with the antenna included in the ganging,

simple and inexpensive enough to lie within amateur reach, that performs properly over an entire band and that is instantly switchable-overable to other bands with the same order of performance. Then we would really have the advantages of VFO and unifrequency operation. As we have only makeshifts until then, this is a subject that warrants some serious amateur thinking and development work. One useful idea in such a transmitter might be to broad-band the doubler stages by overcoupling and resistance-loading, so that the number of stages necessary to reach the desired band could simply be switched in, with no need for tuning. It would then be easy to link such a selector switch mechanically to a bandswitching final that would also choose the proper capacitance range for its tuning condenser. That final condenser can readily be ganged with the VFO; ganged transmitters themselves are not new and in fact are easier to adjust than a ganged receiver. So that still isn't the problem. The real difficulty arises when we aspire to making the antenna circuit part of the ganging job. To accomplish what we wish it is necessary that the antenna tuning and the antenna coupling should vary smoothly with the movement of the frequency control to keep the antenna loading constant, so that the rig works both efficiently and safely over the whole bandwidth — and whether that frequency control comes from the receiver after W5CAT's idea or from the necessary separate oscillator for working in other parts of the band, with the latter either crystal-controlled or VFO. And not on just one band but on all the h.f. ones. Some of these requirements are suggested in our diagram.

About the most we can say today is that if we knew how to build such a transmitter and if our manufacturers would give us such receivers, we'd be able to accomplish some such hook-up as that of our drawing and thereby we would be able to add immensely to the effectiveness and enjoyment of operating effort. We believe the receiver manufacturers would

(Concluded on page 124)

* While W5CAT's idea serves very well to illustrate the general scheme we are seeking, the caution is in order that it is only illustrative. It will probably work very well on 80, it is just possible that it will do so on 40, but on 20 and lower it rather certainly won't — because the sum and difference frequencies are too close percentage-wise to separate without elaborate filters. And the other products of the first oscillator may give trouble on all bands. Considerable care should be used to guard against spurious emissions. To escape them it might be a better idea to apply the principles of a.f.c., mixing the receiver's oscillator frequency and a rather "soft" VFO at the operating frequency, then relying on a discriminator and reactance modulator to hold the VFO precisely i.f. away from the receiver oscillator. But with any a.f.c. we can imagine the VFO would then have to be ganged with the receiver, even though only approximately tracking, and the result is complicated and costly. So, except for better glimpsing what we'd like to do, we're not much forwarder.

An Amateur-Band Eight-Tube Receiver

More "Performance per Dollar" by Building Your Own

BY BYRON GOODMAN,* WIJPE

THERE are a number of reasons for the popularity of "store-bought" receivers in amateur circles. Buying a receiver saves a lot of wear and tear on one's hands and brain, and there is no doubt that building a decent receiver takes quite a bit of time and effort. Building a decent transmitter also takes a lot of time, but no one seems to consider that, possibly because there aren't as many good transmitters commercially available as there are receivers. A fair percentage of amateurs are frightened away from a receiver-construction project because of the apparent complexity, but this is either a psychological block or an admission that our transmitters have not progressed as far as our receivers. Some hardy souls have even advanced the thesis that a commercial receiver is cheaper than one built at home, and that is where we begin to get into this argument.

If one is willing to do without bandswitching — a very nice convenience, we admit, but far from a necessity — he can build a receiver of any given quality for less money than he can buy it. Take the receiver to be described, for example. With coils for four amateur bands the total cost runs around \$70 at current prices, using all new parts. In return one gets a receiver that has direct calibration on the amateur bands from 80 to 10 meters — and the calibration stays put! — good mechanical and electrical stability, variable selec-

• If you are not satisfied with the performance of the low-priced receivers on the market and you can't afford one in the higher brackets, or if you plain just want to build your own, the receiver described in this story is worth your reading time. Although it is dressed up a little with some of the newer gadgets available, it boils down to a reasonable design for the not-too-elaborate home-grown receiver.

tivity through the use of a regenerative i.f. amplifier, excellent a.v.c. and gain-control characteristics, an audio noise limiter, and adequate audio for loudspeaker operation. Signals are stable and are d.c. on the 10-meter band.

A big advantage of the receiver built at home is that the amateur can include in it what he feels necessary and desirable, not what the manufacturer must include to enjoy the highest possible sales. The sales advantage of including the broadcast band and general coverage in a commercial receiver is obvious, but it might be difficult to demonstrate how the operation of an amateur station is handicapped by not being able to listen to "Joyce Jukebox, Girl Riveter," or to some short-wave service between the amateur bands. The one exception to this is WWV, but a simple t.r.f. or two-two regenerative will serve admirably for receiving the standard frequency transmissions.

* Assistant Technical Editor, *QST*.

An amateur-band eight-tube receiver. The knobs on the left control audio volume (upper) and b.f.c. pitch, and the two on the right handle r.f. and i.f. gain (upper) and i.f. regeneration. The knob to the left of the large tuning knob is fastened to the "MAN.-A.V.C.-B.F.O." switch, and the one on the right is for the antenna trimmer. The toggle switch under the dial throws high negative bias on the r.f. stage during transmission periods.

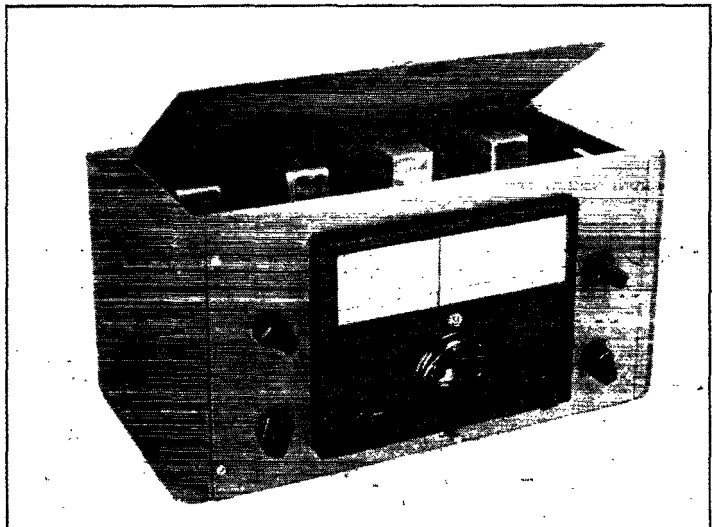

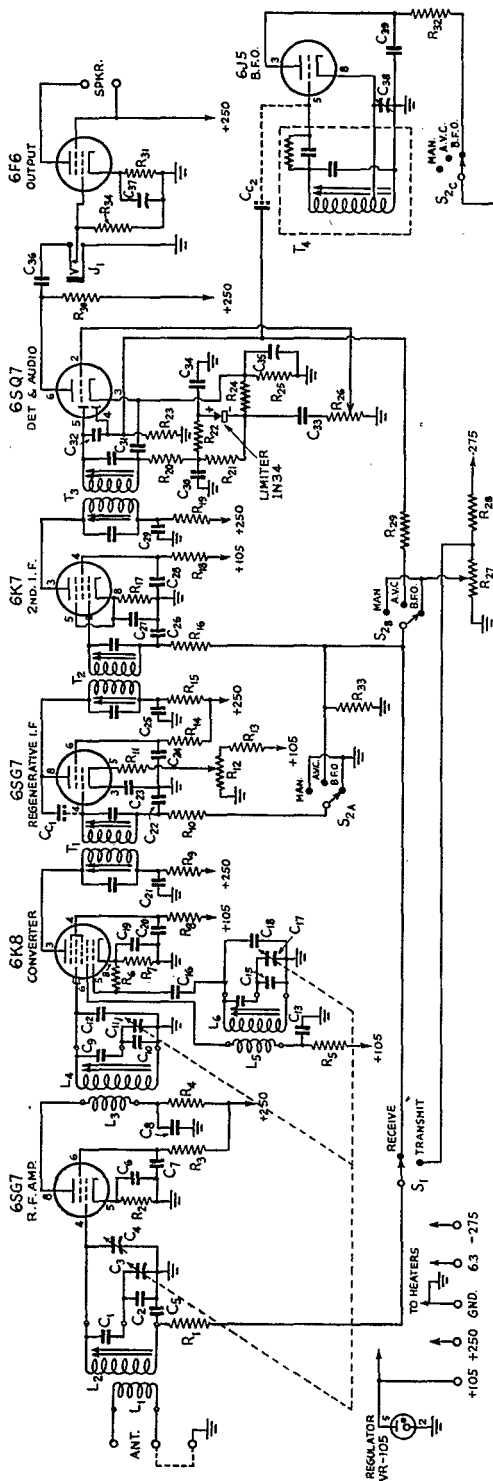

Because the commercial receiver must include a number of unnecessary — to the amateur — refinements, it is apparent that one probably doesn't get his full money's worth except in the higher-priced receivers. The wide frequency coverage required by an "all-wave" receiver generally precludes accurate tracking and highest performance throughout the entire range, and the smart amateur will generally realign his commercial receiver to track best in the amateur bands and let the sensitivity fall where it may in the other ranges. The receiver to be described was designed to include what we felt were desirable features for an amateur-band receiver, with no thought about broadcast-band or general coverage. In giving up these two "features" we gained good amateur-band spread, local-oscillator stability and direct frequency calibration.

The Circuit

There is nothing radically new in the circuit, and every effort was made to keep it as fool-proof as possible. As can be seen from Fig. 1, a 6SG7 pentode is used for the tuned r.f. stage ahead of the 6K8 converter. An antenna com-

- Fig. 1 — Circuit diagram of the eight-tube receiver.**
- C₁, C₉, C₁₄ — See Table I.
 - C₂, C₁₀, C₁₂, C₁₈ — 10- μ fd. ceramic.
 - C₃, C₁₁ — 15- μ fd. midget variable (National UM-15).
 - C₄ — 15- μ fd. midget variable (Hammarlund HF-15).
 - C₅, C₆, C₇, C₈, C₁₃, C₁₉, C₂₀, C₂₁, C₂₂, C₂₃, C₂₄, C₂₅, C₂₆, C₂₇, C₂₈, C₂₉, C₃₀ — 0.01- μ fd. mica.
 - C₁₅ — 37- μ fd. ceramic (10 and 27 in parallel).
 - C₁₆, C₃₀, C₃₂ — 100- μ fd. mica.
 - C₁₇ — 35- μ fd. midget variable (National UM-35).
 - C₃₁ — 250- μ fd. mica.
 - C₃₃ — 0.05- μ fd. paper, 200 volts.
 - C₃₄ — 0.1- μ fd. paper, 200 volts.
 - C₃₅, C₃₇ — 10- μ fd. 25-volt electrolytic.
 - C₃₆ — 0.1- μ fd. paper, 400 volts.
 - C₃₈ — 35- μ fd. midget variable (Hammarlund HF-35).
 - CC₁, CC₂ — See text.
 - R₁, R₁₀, R₁₆, R₃₀ — 0.1 megohm.
 - R₂ — 68 ohms.
 - R₃, R₁₄ — 33,000 ohms.
 - R₄, R₅, R₆, R₈, R₉, R₁₃, R₁₅, R₁₈, R₁₉, R₂₀, R₂₁ — 47,000 ohms.
 - R₇ — 220 ohms.
 - R₁₁ — 180 ohms.
 - R₁₂ — 2000-ohm wire-wound potentiometer.
 - R₁₇ — 330 ohms.
 - R₂₂, R₂₃, R₂₉, R₃₃ — 1.0 megohm.
 - R₂₄, R₂₈ — 0.15 megohm.
 - R₂₅ — 2700 ohms.
 - R₂₆ — 1.0-megohm carbon potentiometer.
 - R₂₇ — 25,000-ohm carbon potentiometer.
 - R₃₁ — 470 ohms, 1 watt.
 - R₃₂ — 27,000 ohms.
 - R₃₄ — 0.2 megohm.
- All resistors $\frac{1}{2}$ watt unless otherwise noted.
- L₁ through L₆ — See Table I.
- J₁ — Closed-circuit telephone jack.
- S₁ — S.p.d.t. toggle switch.
- S_{2A-P-C} — Three-pole 3-position wafar switch (Centralab 2507).
- T₁, T₂ — 456-kc. interstage i.f. transformer, permeability tuned (Millen 64456).
- T₃ — 456-kc. diode transformer, permeability tuned (Millen 64454).
- T₄ — 456-kc. b.f.o. assembly, permeability tuned (Millen 65456).

pensator, C_4 , controlled from the panel, allows one to trim up the r.f. stage when using different antennas that might modify the tracking. The cathode bias resistor of the r.f. stage is made as low as possible consistent with the tube ratings, to keep the gain and hence the signal-to-noise ratio of the stage high. The oscillator portion of the 6K8 mixer is tuned to the high-frequency side of the signal except on the 28-Mc. band, the usual custom nowadays in communications receivers. The oscillator tuning condenser, C_{17} , is higher capacity than the r.f. and mixer tuning condensers, in the interests of better oscillator stability. This is something that can't be obtained in a wide-range receiver unless each tuning range is reduced considerably below the usual 3-to-1 or 2-to-1 ratio.

The i.f. amplifier is tuned to 455 kc., and the first stage is made regenerative by soldering a short length of wire to the plate terminal of the socket and running it near the grid terminal, as indicated by C_{e1} in the diagram. Regeneration is controlled by reducing the gain of the tube, and R_{12} , a variable cathode-bias control, serves this function. The second i.f. stage uses a 6K7, selected because high gain is not necessary at this point.

Manual gain-control voltage is applied to the r.f. and second i.f. stages. It is not applied to the mixer because it might pull the oscillator frequency, and it is not tied in with the first i.f. amplifier because it would interlock with the regeneration control used for controlling the selectivity. However, the a.v.c. voltage is applied to the r.f. and both i.f. stages, with the result that the selectivity of the regenerative stage decreases with loud signals and gives a measure of automatic selectivity control. Using a negative-voltage power supply for the manual gain control is more

expensive than the familiar cathode control, but it allows a wide range of control with less dissipation in the components. The a.v.c. is of the delayed type, the a.v.c. diode being biased about $1\frac{1}{2}$ volts by the cathode resistor of the diode-triode detector-audio stage.

The second-detector-and-first-audio is the usual diode-triode combination and uses a 6SQ7. A 1N34 crystal diode is used as a noise limiter, in a circuit described by W9KPD/6 in "Hints & Kinks" in the May issue of *QST*, and is left in the circuit all of the time. As is common with this type of circuit, it has little or no effect when the b.f.o. is on, but it is of considerable help to 'phone reception on the bands where automobile ignition is a factor. It may be bad psychology not to include a switch for removing it from the circuit, since one cannot readily demonstrate how effective the limiter is, but the constructor can satisfy himself on this point when first building the receiver and working on it out of the case. By leaving one end of the 1N34 floating and touching it to the proper point in the circuit, a marked drop in ignition noise will be noted.

The b.f.o. is capacity coupled to the detector by soldering one end of an insulated wire to the a.v.c. diode plate and wrapping several turns of the wire around the b.f.o. grid lead. This capacity is designated C_{c2} in the diagram. The wire was connected to the a.v.c. diode plate lead for wiring convenience—the a.v.c. coupling condenser, C_{32} , passing the b.f.o. voltage without appreciable attenuation.

Headphone output is obtained from the plate circuit of the 6SQ7 at J_1 , and loudspeaker output is available from the 6F6 audio amplifier stage. High-impedance or crystal headphones are recommended for maximum headphone output.

◆

This view of the receiver chassis shows the mounting of the tuning condensers and the placement of most of the large components. The three shielded plug-in coil assemblies can be seen to the left of the tuning gang. The 6K8 converter is the tube on the left nearest the panel.

The antenna terminal strip, power supply plug, headphone jack and speaker terminals are mounted on the rear (foreground in this view) of the chassis.

◆

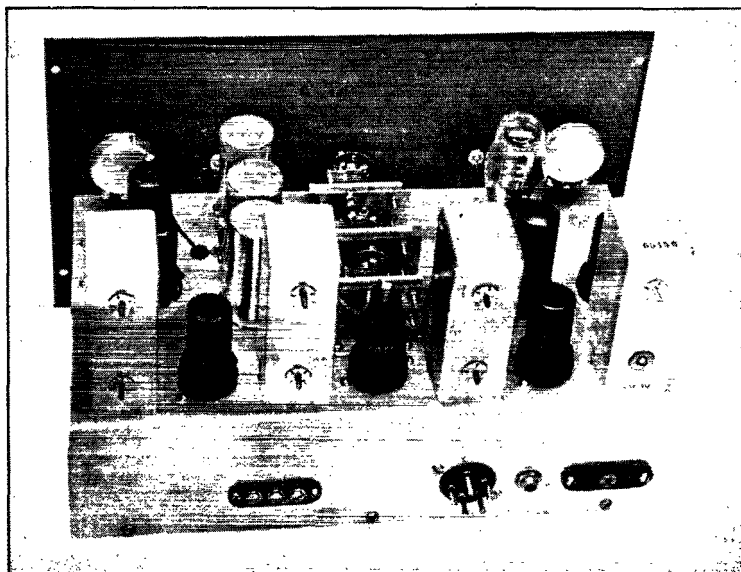

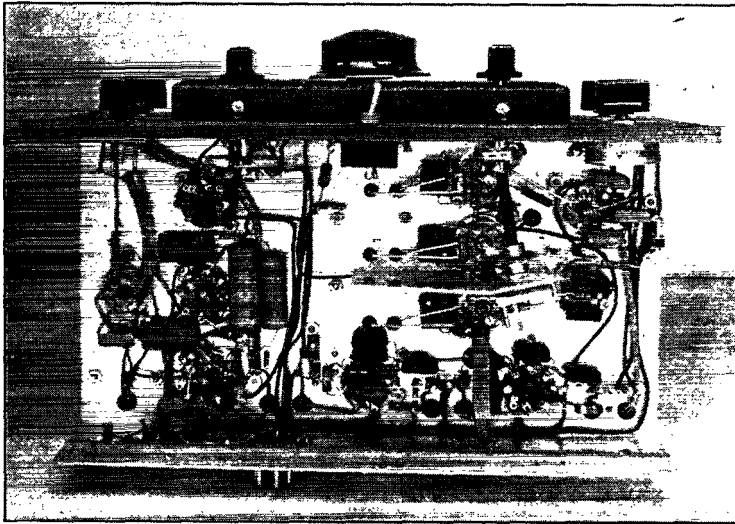

Construction

The receiver is built on an aluminum chassis mounted in a Par-Metal CA-202 cabinet and one of the new Millen 10035 dials is used for tuning. The chassis is made of $\frac{1}{8}$ -inch-thick stock, bent into a U-channel and measures 13 inches wide and $7\frac{1}{4}$ inches deep on the top. It is $3\frac{3}{8}$ inches deep at the rear and $\frac{1}{8}$ inch less at the front. The rear edge is reinforced with a piece of $\frac{3}{8}$ -inch square dural rod that is tapped for screws through the bottom of the cabinet, further to add to the strength of the structure when finally assembled. The various components that are common to the front lip of the chassis and the panel are used to tie the two together.

The shield panel used to mount the antenna compensator condenser is also made of $\frac{1}{8}$ -inch aluminum with a $\frac{5}{8}$ -inch lip on the side for mounting. Part of the lip must be cut away to clear wires and mounting plates on some sockets, so it is advisable to put in the panel after most of the assembly and wiring has been completed. Flexible couplings and bakelite rod couple the condenser to the panel bushing.

The three tuning condensers are mounted on individual brackets of $\frac{1}{8}$ -inch aluminum. The brackets measure $2\frac{1}{2}$ inches wide and $1\frac{3}{4}$ high, with $\frac{1}{2}$ -inch lips. A cover of thin aluminum—not shown in the photographs—slides over the condenser assembly to dress-up the top view a bit. The dust cover is not necessary for the satisfactory operation of the receiver.

Ceramic sockets are used for the coil sockets and for the r.f. amplifier, converter and b.f.o. tubes. Mica condensers were used throughout the receiver for by-passing wherever feasible, primarily because they lend themselves well to compact construction. Paper condensers could be used in the i.f. amplifier but they would crowd

The mica by-pass condensers used throughout the r.f. and i.f. stages are grouped around the sockets of their respective tubes. Tie-points are used wherever necessary to support small resistors and condensers. The antenna trimmer condenser is mounted on a bracket which also serves as shielding between the mixer- and r.f.-coil sockets, and it is offset to allow access to the trimmer screws on the coil forms. The plate and B+ leads from the first i.f. transformer, T_1 , are run in shielded braid, as are the leads from the b.f.o. pitch-control condenser and the volume control.

things a bit more.

In wiring the receiver, small tie-points were used wherever necessary to support the odd ends of resistors and condensers, and rubber grommets were used wherever wires run through the chassis, with the exception of the tuning-condenser leads. The latter leads, being of No. 14 wire, are self-supporting through the $\frac{5}{16}$ -inch clearance holes and do not require grommets. The same heavy wire was used for the grid and plate leads of the r.f. stage and the plate lead of the oscillator, to reduce the inductance in these leads. The tuning condensers are grounded back at the coil sockets and not above the chassis as might be the tendency. Screen, cathode and plate by-pass condensers are grounded at a single point for any tube wherever possible, although C_2 is grounded at the r.f.-coil socket, C_3 is grounded at the converter-coil socket, and C_{13} is returned at the oscillator-coil socket. The plate and B+ leads from T_1 are brought back to the converter socket through shield braid, and C_{21} is returned to ground at the converter socket.

The b.f.o. pitch condenser, C_{38} , is insulated from the chassis and panel by fiber washers, and the rotor is connected back to the tube socket by braid that shields the stator lead. This is done to reduce radiation from the b.f.o. which might get in at the front end of the i.f. amplifier.

The coils are wound on Millen 74001 permeability-tuned coil forms, according to Table I. Series condensers are mounted inside the forms on all bands except the 80-meter range, where no condenser is required and the tuning condenser is jumped directly to the grid end of the coils. In building the coils, the washers are first drilled for the leads and then cemented to the form with Duco or other cement. Some care is required in handling the washers, since it is not too difficult

TABLE I—COIL DATA

Coil	3.5 Mc.	7 Mc.	14 Mc.	28 Mc.
L_1	15 t	9 t	6 t	4 t
L_2, L_4	76 t	33 t	19 t	8 t
C_1, C_9	short	27 μ fd.	15 μ fd.	20 μ fd.
L_3	25 t	11 t	7 t	4 t
L_5	10 t	8 t	4 t	2 t
L_6	47 t	32 t	14 t	6 t
C_{14}	short	42 μ fd.	27 μ fd.	51 μ fd.

All coils wound on Millen 74001 forms, close-wound. 3.5-Mc. coils wound with No. 30 enam.; 7-Mc. coils wound with No. 30 d.s.c.; 14- and 28-Mc. coils wound with No. 30 d.s.c. on primaries and ticklers and No. 24 enam. on secondaries. C_{14} for 7-Mc. range made by connecting 27- and 15- μ fd. condensers in parallel. C_1, C_9 and C_{14} Erie Ceramicons mounted in coil form.

to break them with careless handling. The bottom washer is cemented close to the terminal pins, leaving just enough room to get the soldering iron in to fasten the coil ends and to leave room for the series condenser. The large coils, L_2, L_4 and L_6 , were wound first in every case, and then a layer of polystyrene Scotch Tape wrapped over the coil, after which the smaller winding was put on and the ends of the windings soldered in place. Since for maximum range of adjustment it is desirable to allow the powdered-iron slug to be fully withdrawn from the coil, keeping the coils at the base end of the form allows the iron slug to travel out at the other end, under which condition the adjusting screw on the slug projects the least. To secure the wires after winding, drops of cement should be placed on them where they feed through the polystyrene washers.

Adjustment

If a signal generator is available, it can be used to align the i.f. amplifier on 455 kc. in the usual manner. If one is not available, the coupling at C_{e1} can be increased to the point where the i.f. stage oscillates readily and the b.f.o. transformer is then tuned until a beat note is heard. The other transformers can then be aligned until the signal is loudest, after which C_{e1} should be decreased until the i.f. oscillates with the regeneration control, R_{12} , about 5 degrees from maximum. The trimmers on T_1 then should be tuned to require maximum advancing of the regeneration control for oscillation, with a set value of C_{e1} . When properly tuned, the oscillation frequency of the i.f. stage and the frequency for maximum gain in the regenerative condition, will be the same.

With a set of coils in the front end, set the tuning dial near the high-frequency end and tune in a strong signal or marker with the adjustment screw on the oscillator coil. The converter and r.f. coils can then be peaked, with the antenna compensator set at about half-capacitance. Then tune to the other end of the band and see if you have enough bandspread. If the bandspread is inadequate, it means that C_{14} is too large, and it

should be reduced by using a smaller size of condenser or a combination that gives slightly-less capacitance. The tracking of the converter and r.f. coils can be checked by repeaking the position of the slugs in the coils at the low-frequency end. If the converter or r.f. coil tuning slug has to be advanced further into the coil (to increase the inductance) it indicates that C_9 or C_1 should be larger. If adjustable series condensers could be included in the coils the job of tracking would be a cinch, since tracking by the method described is at best a compromise, although to all intents and purposes the loss from some slight misalignment is completely unimportant. Another method might be to tap the tuning condensers on the coil in the familiar bandspreading manner, but this requires considerable time and patience. However, with the series condensers as used in this receiver, the tuning curve is more crowded at the high-frequency end of a range than at the low, and this would be reduced somewhat by the tapped-coil method of bandspread.

The adjustment of L_5 can be made, if deemed necessary, by lifting the cathode end of R_6 and inserting a 0-1 millimeter. If the tickler coil has the right number of turns, the current will be from 0.15 to 0.2 ma., and it won't change appreciably over the band. Although such a grid-current check is a fine point and not really necessary, it is a simple way to determine that the oscillator portion is working, since the cold ends of L_5 and L_6 are at the same end of the form — the plug end — and this necessitates winding the two coils in opposite directions.

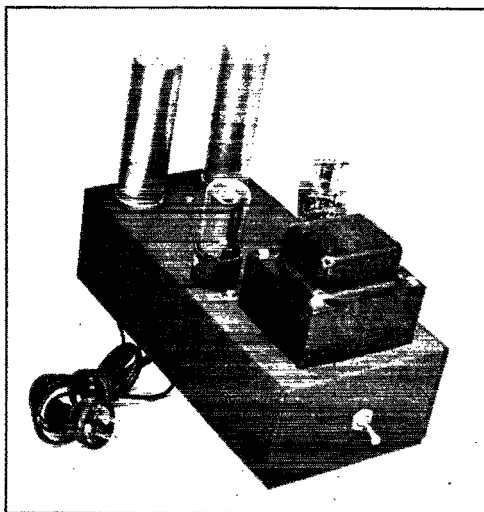

The power supply for the eight-tube receiver. Two rectifiers are required because a separate supply is incorporated for gain-control purposes. The filter choke and the negative-supply filter condensers are mounted under the chassis. At the rear of the chassis is the socket for the power cable.

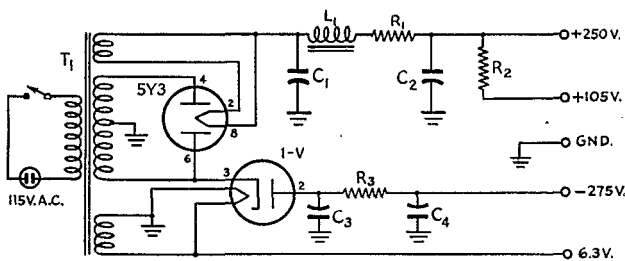

Fig. 2 — Power-supply wiring diagram.

- C_1, C_2 — 16- μ fd. 450-volt electrolytic.
 C_3, C_4 — 8- μ fd. 450-volt electrolytic.
 R_1 — 500 ohms, 10 watts, wirewound.
 R_2 — 5000 ohms, 10 watts, wirewound.
 R_3 — 0.1 megohm, 1 watt, composition.
 L_1 — 30-henry 110-ma. filter choke (Stancor C-1001).
 T_1 — 350-0-350 volts, 90 ma.; 5 volts at 3 amp., 6.3 volts at 3.5 amp.

Some trouble was experienced with the r.f. stage at 28 Mc. because it wanted to oscillate. However, a grounding strap of spring brass mounted under one of the screws holding the mixer-coil socket now grounds the shield when the coil is plugged in, clearing up the trouble. Inadequate coupling to the antenna will also let the r.f. stage oscillate under some tuning conditions, and close coupling is highly recommended for stability in this stage and also for best signal response. A 10-ohm resistor from L_2 to the grid of the 6SG7 will also do the trick, but it was against our fierce-burning pride to imitate the commercial receiver manufacturers in this respect.

It will be found that the over-all gain of the receiver is quite high on the lower-frequency bands, requiring that the r.f. gain be cut down to prevent overloading on strong signals. This is not a particularly-undesirable condition, however, and should cause no worry once understood. For c.w. reception, the regeneration control is advanced to the point just below oscillation and the b.f.o. is detuned slightly to give the familiar single-signal effect. For 'phone reception, S_2 is switched to "A.V.C." and volume control adjustments made with the audio control, R_{26} . If desired, the regeneration control can be advanced until the i.f. is oscillating weakly, and then a heterodyne will be obtained on weak carriers, making them easy to spot. Strong carriers will pull the i.f. out of oscillation because the developed a.v.c. voltage reduces the gain, and hence a simple form of automatic selectivity control is obtained. If it is considered desirable to reduce the i.f. gain when switched to the "A.V.C." position, the regeneration control can be used for this purpose. The "MAN." position permits manual-gain-control operation with the b.f.o. off.

The switch S_1 is used for receive-transmit and throws about 40 volts negative on the grid of the first r.f. stage, saving the first tube a little if the transmitter is pouring some power into the receiver.

We tried to put as many necessary features into the receiver as possible without running the cost up too high. The individual constructor may think of other "musts" he will want to include, but we feel that the receiver is satisfactory as it stands, incorporating as it does the prime requisites of good sensitivity, selectivity and stability with the features of direct calibration, good band-spread and wide-range gain control.

Power Supply

The power supply is built on a separate chassis and requires little discussion. The circuit is shown in Fig. 2, and an idea of the parts arrangement can be obtained from the photograph. The filtering is quite adequate and no trace of hum could be found in the completed receiver when used with this power supply.

Maritime Division Convention

Halifax, N. S., Aug. 31st, Sept. 1st-2nd

FIRST CONVENTION of the Fall season is that of the Maritime Division, scheduled over the Labor Day week end at the Nova Scotian Hotel, Halifax. Starting in grand style with a banquet Saturday night, the program changes Sunday to informal visiting and picnicking with "open house" observed by the Halifax gang. On Monday, hidden-transmitter hunts are planned for 6 and 2 meters.

In addition to availability of accommodations in larger hotels when reserved in advance, the committee reports it is arranging reservations at smaller hotels, tourist homes, and cabins. Convention registration is \$3.00, only \$2.00 for the ladies; and 50¢ additional after August 10th. Write the convention secretary, E. F. Harrington, VE1NQ, 8 Murray Place, Halifax.

Rocky Mountain Division Convention

Denver, Colo., Sept. 14th

ROCKY MOUNTAIN MEMBERS: It's here in Denver, the 1946 ARRL Convention! For a renewal of those good times, be with the YL or XYL at the Shirley Savoy Hotel on Saturday, Sept. 14th, by 1:30 p.m. A deluxe Vibroplex for the top man in a c.w. contest, a grand prize to be announced later, breakfast in the mountains, and a really full program. Until the hidden transmitter is found Sunday morning, yours for a whale of a time with the Electron Club of Denver as your host. Write convention chairman, R. G. Green, WØLYJ, 627 Oneida St., Denver, 7.

Our Best DX—800 Feet!

Duplex 'Phone on 21,900 Mc.

BY A. H. SHARBAUGH,* WINVL/2, AND R. L. WATTERS,* W9SAD/2

ON MAY 18, 1946, two-way voice communication over a distance of 800 feet was successfully established for what the authors believe to be the first time on 21,900 Mc., in the highest frequency band allotted to amateurs. Previously, on May 16, 1946, one-way transmissions had been received over a distance of one-half mile.

The equipment used for this contact was identical at both stations, being built around a developmental-type tube, the Z-668. As may be seen from the photographs, this equipment resembles nothing ever seen before in a ham shack, and it is not the intention of the authors to describe it so that it might be duplicated—even if you are handy at a lathe—as microwave technique is still rather involved for the average ham.

Plumbing and Circuit Description

Building up transmitting and receiving gear at these frequencies has resolved itself mainly into fitting together so much hollow circular or rectangular pipe that the very appropriate name of "plumbing" has been adopted for the operation. To propagate radio waves at 21,900 Mc. (1.37 cm.) it is necessary only to use a rectangular wave guide a little over one-fourth inch wide (inside measurement) and with the other transverse dimension just great enough to prevent voltage

arc-over—about one-eighth inch. Actually, we used a guide $\frac{1}{2}$ by $\frac{1}{4}$ inch, and having a 0.040-inch wall, which still makes a very conveniently-manageable system. This size guide will propagate waves (TE_{1,0} mode) up to 2.14 cm. in wavelength.

We decided to make a single tube serve as both oscillator and transmitter so that the transmitting and receiving units would be compact enough to be loaded into a truck without too much difficulty. This cut the necessary equipment by half and worked quite satisfactorily for our short-range QSOs.

A schematic diagram of the circuit¹ we used is shown in Fig. 1. At Station 1, the Z-668 feeds power at 21,900 Mc. through a matching network, through the crystal mixer and on to space. When Station 2 is tuned to 21,930 Mc., 30 Mc. away from the Station 1 frequency, the Station 2 crystal mixes the signal and local oscillator frequencies and thus a 30-Mc. difference frequency is generated which may be amplified and converted into intelligence. This arrangement is simple but has several disadvantages. First, during transmission, considerable tube power is dissipated in the crystal and hence is not radiated into space. Second, in the receiving circuit some of the received signal passes through the crystal and is lost in the tube, reducing the over-all sensitivity. The latter objection can be overcome by inserting a high-*Q* tuned circuit, which will tend to pass 21,900 Mc. but reject 21,930, between the tube and crystal. We succeeded in doing this to

*Research Laboratory, General Electric Co., Schenectady, N. Y.

¹For a description of similar duplex arrangements see R. V. Pound's forthcoming article in *Proc. IRE*, and E. E. Suckling, *Proc. IRE*, 33, 33 (1945).

◆
A close-up of the "plumbing" system with the horn antenna. With the exception of the wavemeter, which is not shown in this photograph, the various sections of the assembly can be identified by reference to Fig. 1.
◆

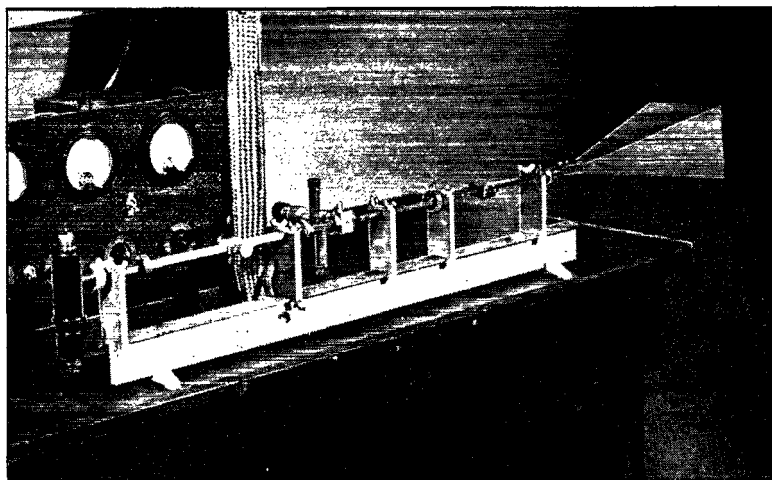

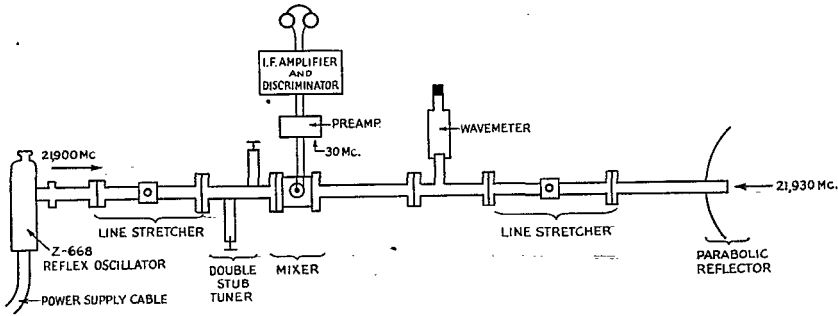

Fig. 1—The "plumbing" system in the 21,900-Mc. transmitter-receiver.

some extent with the use of the line stretcher and tuning stubs located between the crystal mixer and tube.

The first objection could be overcome quite easily by the use of a switching arrangement which would effectively remove the crystal from the transmitting circuit and replace it in the circuit during receiving. Undoubtedly, our range could be considerably improved by these simple refinements.

A brief description of some of the less conventional components of the identical (except for antennas) systems may be in order here.

The line stretcher is a section of guide slotted on two opposing sides so that its cut-off dimension may be varied by squeezing the two non-slotted sides. This varies the length of the wave inside the pipe without changing the free-space wavelength.²

The tuning stubs consist of two probes located a certain distance apart, the depth of insertion of which may be varied by turning thumbscrews. We may regard such a stub as a capacitance shunt across the line, with the plates of the capacitor formed by the end of the probe and the opposing guide wall.

Fig. 2 shows a cross-section of the mixer unit, which consists of a section of guide across which the crystal rectifier is connected. The connector on the side serves to take off the difference frequency.

The wavemeter is a cylindrical resonant cavity connected in series with the guide by a "T" joint, as shown in Fig. 1. The resonant cavity is formed by a section of circular guide whose length may be varied by moving, at one end, a piston connected to a micrometer screw head. A type of resonant mode ($TE_{0,1,1}$) is excited which has no component of current flowing between the piston and the cylinder walls, with the result that sliding contact is unnecessary between these two surfaces.

The standing-wave detector is a section of slotted guide equipped with an arrangement for moving an electrostatic probe in the slot along the length of the guide. This probe is connected to a crystal rectifier and galvanometer to give a

measure of the flatness of the line. Of course the standing-wave detector can be inserted into other parts of the line to check the matching but it may be replaced by a section of guide of the same length.

The horn used as a radiator on one transmitter-receiver to match to space gave approximately a 20-degree beam. A parabolic reflector which would give a 2-degree beam, if uniformly illuminated at its focal point, was used on the other system. Actually, for short-distance transmission (200 feet) we simply allowed the end of the guide to radiate into space.

Since the type of tube used is very frequency-sensitive to voltage changes, voltage-regulated power supplies were used. These supplies were fed by a.c. voltage regulators which delivered 115 volts \pm 1 per cent for a total primary variation of 30 per cent. The supplies held the voltage con-

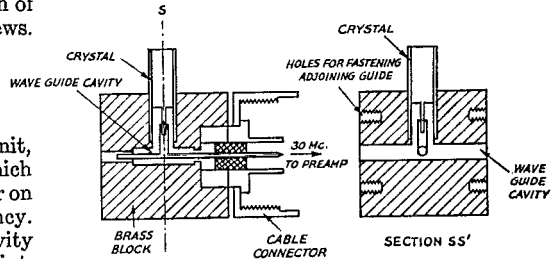

Fig. 2—Cross-section of the crystal mixer.

stant to one part in 20,000, or 0.005 per cent.

The i.f. amplifiers had band widths of one and two megacycles, respectively. This meant that our two tubes had to be kept $30 \pm \frac{1}{2}$ Mc. apart, corresponding to a frequency control of better than 0.005 per cent. By shielding the tubes from air currents and allowing them to come to thermal equilibrium under fixed input conditions, we were able to hold to these limits without the use of any automatic frequency control. Slow drifts, occurring over about one-half minute, were compensated for by adjustment of the focus or reflector voltages on the tube. Certain parts of the Z-668 are constructed from a special low-expansion alloy which keeps the thermal drift down to 20

² For a discussion of the difference between wavelength in a guide and wavelength in space, see "Technical Topics," QST, December, 1945. — Ed.

The authors (Bob Watters at the microphone and Harry Sharbaugh adjusting the line stretcher) and one of the 21,000-Mc. stations. This set-up uses a parabolic-reflector antenna.



Mc. per degree centigrade change in ambient temperature. With the scheme used here the sole requirement is that the frequencies be held 30 Mc. apart (staying within the 21,000-22,000-Mc. limits of the band of course) and therefore automatic frequency control is necessary for only one transmitter-receiver.

R.F. Generator

The r.f. generator for transmitting and receiving was the General Electric Z-668 velocity-modulated tube of the reflex type. This tube, developed during the war, was designed by J. M. Lafferty³ of the General Electric Research Laboratory. It is tunable from 21,900 to 26,100 Mc. by a thumbscrew located at the top of the metal housing, which is a standard 6L6 metal envelope. Thus, the low-frequency end of the tuning range falls nicely into the 21,000-22,000-Mc. amateur band. The maximum output is 20 milliwatts, available at the center of the tuning range; however, we estimated that our power was of the order of several milliwatts under the conditions used. Briefly, the operation of the tube shown in Fig. 3 is as follows: Electrons are emitted from the hot cathode "K," and travel toward the cavity "C," which is 1700 volts positive with respect to the cathode. For safety to the operator, cavity "C" is connected to the exposed metal housing and held at ground potential, with the result that the cathode operates at a negative voltage. The focusing electrode "F," confines the electrons to a small beam, most of which passes through two orifices located along the center axis

of the radial cavity "C." This cavity provides the inductance and capacitance which mainly determines the frequency at which oscillations occur. The reentrant portion of the cavity provides capacitance loading and by varying the gap separation "D," with an external thumbscrew, one may tune the tube. The electrons pass on through this cavity approaching the reflector electrode "R," which, as seen from Fig. 3, has a negative potential with respect to the cathode.

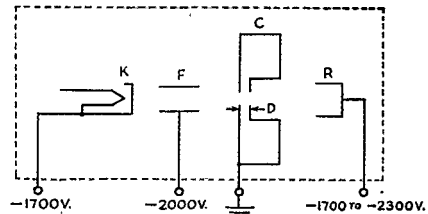

Fig. 3—This diagram illustrates the basic construction of the Z-668 reflex oscillator tube.

This negative potential exerts a repelling action on the negatively-charged electrons and causes them to slow down, stop, and reverse their direction of travel back through the holes in the resonator, "C." When the resonator "C" is oscillating it develops an r.f. voltage across the gap "D," and some of the electromagnetic energy contained in its field is coupled through a small aperture in the side of "C" into the wave guide. The electron beam is velocity modulated as it passes the resonator gap and bunching occurs during the transit time in the retarding space. With sufficient beam current, oscillations occur if the phase of the reflected electrons is correct

³The authors acknowledge their indebtedness to Mr. Lafferty for the loan of several of these tubes.

when they pass across the resonator gap. This phase is determined by the resonant frequency of the cavity, the beam voltage, and the reflector voltage. Thus, as may be seen in Fig. 1, the tube may be fastened directly on the end of the wave guide without the use of any intermediate transmission lines. To gain some idea of dimensions involved to produce oscillations at these frequencies, cavity "C" has a radius of 0.108 inch and is 0.080 inch deep. Gap separation "D" is of the order of 0.008 inch and when this distance is changed by an amount equal to the wavelength of sodium light (0.000023 inch), the frequency is changed by 5.7 Mc.! A cross-sectional view of the tube is shown in Fig. 4.

Maximum beam power input to the Z-668 is 15 watts. With 20-milliwatts output the efficiency is 0.13 per cent. This is certainly in contrast to what is generally thought of as oscillator efficiency at lower frequencies.

Modulation Circuit

Since the change in frequency with reflector voltage is about -1.0 Mc./volt and the reflector draws no current, frequency modulation is easily produced by varying the reflector voltage. Fig. 5 shows the modulation circuit. The value of resistor R is 100,000 ohms, and the capacitors,

C , isolate the microphone circuit from the high voltage. The transformer, T , is an ordinary carbon-microphone transformer with low-voltage insulation between primary and secondary windings.

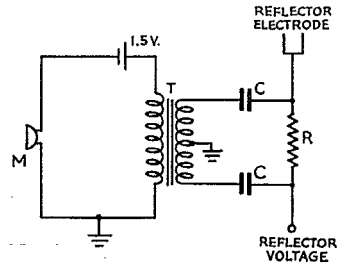

Fig. 5 — Circuit for frequency modulating the Z-668 oscillator.

C — 2- μfd . 2000-volt isolating condensers.

M — Microphone, single-button carbon.

R — 0.1 megohm.

T — Microphone transformer, to match 200 ohms to 0.1 megohm, center-tapped secondary.

Range Calculations

Although it is not well known to the average ham, there is a theoretical maximum range of transmission for a given frequency and power.

In considering the maximum range to be expected at these frequencies, it is necessary to take into account the attenuation caused by water vapor in the air. We have derived the following equation, assuming the water-vapor attenuation to be exponential and the energy in the beam to be distributed according to the familiar inverse square law in optics:

$$\log_{10} \frac{P_R}{P_T} = -0.0491\alpha d + \log_{10} \frac{r^2}{d^2 \tan^2 \theta (5280)^2}$$

where P_R is the minimum power detectable by the receiver (watts), P_T is the radiated power (watts), α is the attenuation due to water vapor (db./mile), r is the radius of the parabolic receiver (feet), d is the maximum distance which may be covered (miles), and θ is the radiation angle (radians).

From classical optics, we have the following expression for the radiation angle between half-power points for a parabolic reflector uniformly illuminated at its focal point:

$$\theta \text{ (ra.)} \approx \frac{\lambda}{2r}$$

where λ and r are the wavelength and radius, respectively, and are expressed in the same units.

In our case, we used a dish with radius $r = 20.5 \text{ cm.}$, hence $\theta = 0.033$ radians or approximately a 2-degree beam. Using the values $\alpha \approx 1 \text{ db./mile}$ for 100 per cent humidity, $P_R = 10^{-12}$ watts, $P_T = 10^{-2}$ watts, we find a theoretical limit of about 50 miles for operation in this band. We were able to communicate only one way at a

(Concluded on page 124)

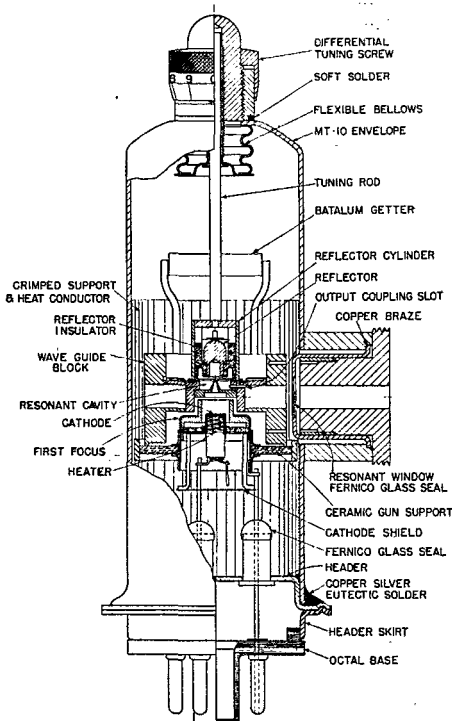

Fig. 4 — Cross-sectional drawing showing the construction of the Z-668 tube.

Unstable Signals

Some Suggestions for Eliminating Them

BY DONALD MIX,* WITS

AN HOUR or two of listening to signals in the reopened bands will convince anyone who did any operating before the war that although the war may have resulted in improved gear, the average quality of signals is now worse instead of better. It is probable that much of this is a result of carelessness — the natural urge to get some kind of a signal back on the air with a minimum loss of time. "We'll fix it up later." A considerable number of those chirpy r.a.c. signals may be caused by hastily-constructed VFO units cooked up from parts in the junk box to combat the QRM arising from the operation of amateurs inside the 3.5-Mc., and temporarily-narrowed 7- and 14-Mc. bands. However, obviously, crystal-controlled transmitters are contributing their share. We presume also that some hams are working these frequencies for the first time and that some of them may not be too familiar with the adjustments necessary to obtain satisfactory signal characteristics. More operators are recognizing the advantages of break-in operation and this often opens up new problems when attempts are made to key the oscillator for the first time.

Monitoring

Regardless of the cause of objectionable signal characteristics, it is obvious that much can't be done about it without a monitoring system of some kind because, unfortunately, only occasionally can signal reports be relied upon to any degree of accuracy. A communications-type receiver makes a satisfactory monitor only when precautions are taken to eliminate any effects which operation of the transmitter may have upon the stability of the receiver. This may be

IT IS OBVIOUS
YOU CAN'T DO MUCH
WITHOUT A MONITOR

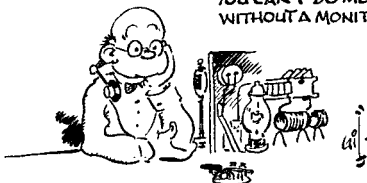

done usually by short-circuiting the input terminals of the receiver, and making sure that the r.f. gain control is turned down below the point where blocking occurs. The load of the transmitter on the power line may be sufficient to

* Assistant Technical Editor, QST

• Objectionable keying or modulation characteristics aren't necessary. Most of them are the result of carelessness but for those who haven't had the experience, this article tells where to look for troubles and suggests how they may be cured.

cause a frequency change in the oscillator of some receivers. This can be checked by tuning in a steady carrier and listening to it while some appropriate load, such as a flatiron or toaster, is plugged in and out. If the carrier frequency varies when this is done, the receiver will not make a very accurate monitor unless the voltage to the receiver oscillator is stabilized. Most amateurs will doubtless consider it preferable to do a little

"WE'LL FIX IT UP LATER"



work on the receiver than to build a separate well-shielded monitor. Not only is blocking apt to be less, but a more accurate check on the transmitter signal is possible when the receiver is tuned to a harmonic of the transmitter frequency, whenever this is possible. The general-coverage range of the receiver should be used to make it possible to check for parasitic signals outside the ham bands. If the receiver is unshielded or otherwise unsuited for use as a monitor, the signal may be checked on a neighboring ham's receiver while *he* pounds the key of your transmitter. You'll do it this way if you want to know what your signal really sounds like.

The monitor may show that you are lucky and that your signal is clean and requires no further attention. However, you shouldn't be content to check it once on one frequency in one band unless you plan to do all your operating there. Signals should be checked frequently on all bands and in different parts of each band. If crystal control is used, each crystal should be tested, since the characteristics of individual crystals may vary widely. What the monitor

shows when the oscillator or exciter alone is keyed should not be taken as an indication of what the signal may sound like on the air when the entire transmitter is operating with the antenna connected.

Keying Crystal Oscillators

The keying of an oscillator is something to be avoided if you want to have a signal free from "yoops" and "chirps." Unfortunately, however, the oscillator must be keyed for break-in operation if you want to work near your own frequency, which seems to be the only way to work anyone these days. Most crystal oscillators do not key well unless care is exercised in adjusting their tuning. The Tri-tet and grid-plate circuits key well without critical adjustment so long as the output circuit is tuned to a harmonic of the crystal frequency. However, most crystal oscillators in 3.5-Mc. transmitters are being operated at the crystal fundamental frequency and under this condition the regenerative circuits have little advantage, so far as keying is concerned, over the simple triode or tetrode circuits unless a very well-screened tube is used. The usual 6V6 and 6L6 do not fall in this category. With any of these circuits, oscillation ceases or is erratic whenever the plate circuit is tuned near resonance where best output is obtained. To obtain good keying characteristics at the fundamental, the plate circuit must be tuned so far off resonance on the low-capacitance side that the useful output from doubling oscillators is often less at the fundamental than at the second harmonic.

To adjust such a circuit for clean keying, it isn't sufficient to hold the key closed and tune the plate tank circuit to the point on the edge of oscillation where the output is greatest. With such an adjustment a loaded oscillator seldom will key well, if it starts again at all, once the

¹Middelton, "A Beginner's Two-Stage Transmitter," QST, July, 1946, page 16.

key is opened. The only way to adjust the oscillator tuning is to listen to the signal while it is being keyed as the plate circuit is tuned to the point where the circuit keys well, regardless of the output. It is impossible to determine this point from meter readings. Depending upon how heavily the oscillator is loaded, it may be necessary to detune the plate circuit considerably to avoid chirps.

An oscillator-amplifier arrangement which eliminates keying difficulties when working at the crystal fundamental is shown in Fig. 1. A simple Pierce oscillator, whose output circuit is not tuned, is capacitance coupled to a tetrode amplifier. It is the same arrangement used in the beginner's transmitter described in the July issue.¹ Since the tuned circuit is in the amplifier, its adjustment does not affect the crystal, regardless of whether the circuit is tuned to the fundamental or to a harmonic.

Amplifier Instability

Parasitics or unstable amplifier stages can foul up a signal no matter how good the oscillator may sound by itself. The parasitic oscillation may not be self-sustaining when the stage is biased beyond plate-current cut-off from a fixed supply, although usually it will show up as a continuous oscillation if the bias is lowered so that the tube draws a fair amount of plate current. Under normal operation, however, the oscillation often takes place only as excitation is applied or removed. The result is a bunch of "blurpy" clicks, sometimes well removed from the carrier frequency, when the transmitter is keyed. In 'phone transmitters parasitics can result in hash on either side of the carrier, greatly increasing the normal transmitter bandwidth.

Parasitics usually are not hard to find if you want to look for them. Plate voltage should be removed from all excitation stages but these units should not be disconnected from the amplifier being tested. The plate voltage of the amplifier should be reduced if possible and the bias reduced to the point where the tube draws a fair amount of plate current. If the tube has a screen, lowered voltage should be applied. If the oscillation is at or near the operating frequency it is usually a t.p.t.g. type of oscillation. This can be checked by tuning the plate tank condenser through its range at different settings of the grid tank condenser. As the capacitance of the grid tank condenser is increased, the capacitance of the plate tank condenser must be increased to restore oscillation. This, of

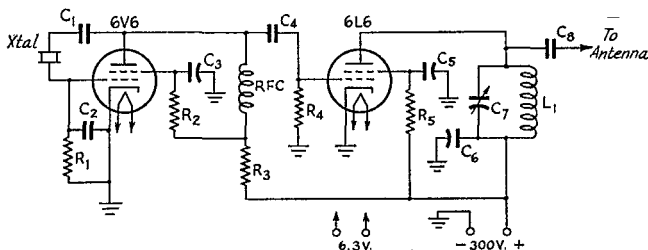

Fig. 1 — Single-control oscillator-amplifier combination.

- | | |
|---|--|
| C ₁ — 0.001- μ fd. mica. | L ₁ — 3.5 Mc. — 30 turns, 1½-inch diameter, 1½-inch long. |
| C ₂ , C ₄ , C ₈ — 100- μ fd. mica. | — 7 Mc. — 15 turns, 1½-inch diameter, 1½-inch long. |
| C ₃ , C ₅ , C ₆ — 0.01- μ fd. paper. | — 14 Mc. — 8 turns 1½-inch diameter, 1 inch long. |
| C ₇ — 100- μ fd. variable. | RFC — 2.5-mh. r.f. choke. |
| R ₁ , R ₂ , R ₄ — 47,000 ohms. | |
| R ₃ — 15,000 ohms. | |
| R ₅ — 22,000 ohms. | |

course, means insufficient isolation between input and output circuits, i.e., either inaccurate neutralization or inductive feed-back between the external circuits. In the case of triodes, shielding between input and output tank circuits is desirable but not always a necessity if the tank coils are of small diameter, well spaced and placed with their axes at right angles. In cases where an amplifier shows incomplete isolation even when the neutralizing condenser is set for minimum reaction, a baffle shield consisting of a sheet of metal erected between the two coils may be sufficient to reduce the residual reaction to a negligible level.

Shielding is always required with screen-grid amplifiers. Starting with the tube, the lower portion up to the bottom edge of the plate should be covered with a shield. This may be in the form of a short can, or the socket for the tube may be placed below the chassis so that only the upper portion of the tube protrudes. The plate lead should be as short as possible and kept well spaced from the tube. If at all possible, the grid tank-circuit components should be placed underneath the chassis. If a plug-in system requires that the grid coil be mounted on top, it should be of the shielded type. The plate tank-circuit components should be mounted above the chassis. This includes the plate-circuit r.f. choke if one is used.

V.H.F. Parasitics

If the parasitic is of the v.h.f. type, it can be detected by a neon lamp, or touching a tube grid or plate terminal with an insulated screwdriver may cause a change in plate current. It may take momentary application of excitation to get it going.

The parasitic circuit is made up of connecting leads; the normal tank circuits usually can be short-circuited without effect upon the oscillation. An absorption-type wavemeter, such as the one described in the January, 1946, issue of *QST* is useful in determining the frequency of the parasitic. A wavemeter without an indicator usually cannot be coupled closely enough to the oscillatory circuit to give an indication on the plate milliammeter. Experience has shown that most v.h.f. parasitic oscillations take place at a frequency within the range of 100 to 150 Mc. in average amplifier arrangements. From the viewpoint of reducing the possibility of conditions favorable toward t.p.t.g. oscillation, it is best in laying out the amplifier to keep the grid leads as short as possible and permit reasonably-long plate leads to keep the resonant frequency of the plate-circuit leads low in respect to that of the grid leads. The logical cure for v.h.f. parasitics lies in the use of a small r.f. choke at the grid terminal of the tube. The size of the choke should be no larger than that necessary to suppress the parasitic, otherwise it may offer an impedance for

the excitation frequency, particularly if the amplifier is operated at 28 Mc. A 1-watt resistor of 50,000 ohms or more makes a convenient winding form for the choke. It may be connected directly across the terminals of the resistor, if desired.

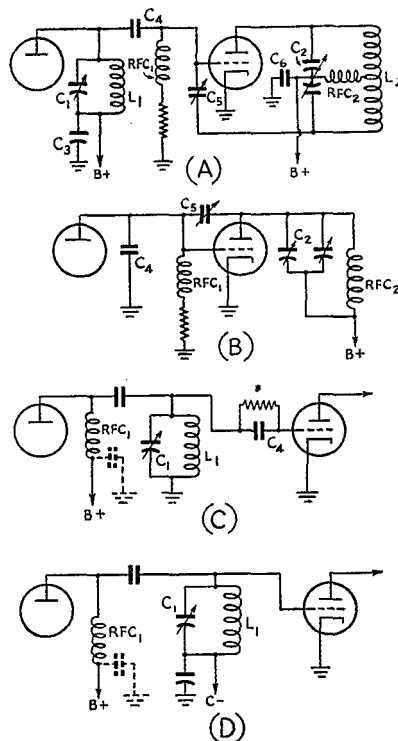

Fig. 2 — (A) Usual capacitance-coupled triode amplifier circuit with insulated plate-tank condenser. (B) The resulting low-frequency parasitic circuit. (C-D) Circuits which eliminate low-frequency parasitic grid tanks.

If you haven't the patience to fuss with the number of turns in the choke, a wavetrap may be used instead. This will consist of a few turns of heavy wire shunted by a 30- μ fd. ceramic-mica trimmer condenser. It may be adjusted with an insulated screwdriver while the amplifier is oscillating. When the trap tuning hits the parasitic frequency, the oscillation will cease. If it is impossible to hit the right frequency with the first trial coil, the number of turns may be changed or a change in the spacing of the turns may be sufficient. In the case of a push-pull amplifier, chokes or traps should be placed in both grid leads and the traps adjusted simultaneously.

Low-Frequency Parasitics

Low-frequency parasitics are common in the type of circuit shown in Fig. 2-A. The reactance of the tank coil L_1 , C_1 , and the by-pass condenser, C_3 , becomes negligible at low frequencies so that they act merely as a wire connecting C_4 across

RFC_1 to form the tuned grid circuit as shown in Fig. 2-B. In the plate circuit, L_2 has negligible reactance at low frequencies and therefore acts merely to connect the two sections of C_2 in parallel across RFC_2 , forming the tuned plate circuit to complete the familiar t.p.t.g. oscillator. In case the grid-plate capacitance of the tube isn't sufficient to provide adequate feed-back to sustain oscillation, in the case of the neutralized amplifier, the neutralizing condenser (C_5) completes the requirements for oscillation by getting itself connected between grid and plate. The same condition holds, of course, in a push-pull amplifier,

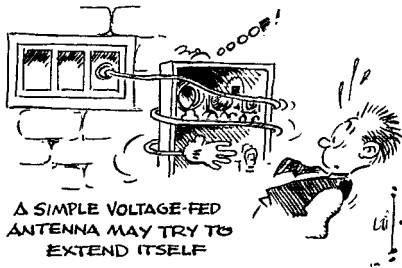

the only difference being that the second tube is effectively in parallel with the first for low frequencies. This condition is not difficult to overcome. If the grid choke, RFC_1 , is moved to provide parallel feed for the plate circuit of the driver, the grid circuit of the amplifier may be series fed, as shown in Fig. 2-C and 2-D. In either arrangement the low impedance of C_1L_1 effectively grounds the grid of the amplifier for low frequencies.

Screen-Grid Amplifiers

Screen-grid amplifiers are not so easily handled as triode stages. In the first place, they have high power sensitivity which means that a very small amount of feed-back will suffice to sustain oscillation. While the shielding between grid and plate within a well-screened tube is sufficient to prevent this capacity from acting as a path for feed-back, it doesn't take much in the way of coupling between external circuits to start oscillation. Also, the screen must be maintained as close as possible to ground potential if it is to provide an effective shield. This means that the screen terminal should be by-passed to ground as close to the terminal as possible. It is not an uncommon experience to find that the substitution of a mica by-pass condenser, with its lower inductance, for a tubular paper by-pass will spell the difference between an unstable stage and one which shows no tendency to oscillate.

Nothing can be done, however, about the length of leads inside the tube which too often is sufficient to give a v.h.f. parasitic a chance to do its dirty work. A remedy which works in most cases is to insert a small 50-ohm resistor between

the screen terminal and the by-pass condenser. Fortunately, there is little opportunity for the existence of low-frequency parasitics in a screen-grid amplifier because even if the commonly-used values of choke inductance and coupling and blocking capacitances were suitable for t.p.t.g. oscillation, the plate-grid capacitance of the tube wouldn't provide the required feed-back for these frequencies.

Antenna Effects

Another source of trouble which is probably more common than realized is the antenna system. Simple voltage-fed half-wave antennas are perhaps the worst offenders. If such an antenna isn't cut to the correct length, it may try to extend itself to the right dimensions by including part of the transmitter and power line. When this happens, the entire transmitter and part of the power line may be "hot" with r.f. The same thing can happen with a Zepp antenna which has been cut, for instance, for the high-frequency end of the band when an attempt is made to operate it at the low-frequency end. In the case of a VFO, especially, this condition can easily lead to roughening of the note.

VFO Operation

VFOs in general are much more susceptible to the effects of instability and loading of following stages. It is not uncommon to find that an ECO sounds like crystal when it is operated alone and yet it does not sound good when it is connected to the rest of the transmitter. A VFO shouldn't be keyed unless it is necessary for break-in work. Also, it is almost as bad to key the stage immediately following the oscillator tube, since the change in load will cause a change in frequency unless the oscillator is more stable than most simple oscillators. It takes only a few cycles change to produce a noticeable chirp and this is what makes it so difficult to obtain perfect keying characteristics when the oscillator is keyed. If the keying circuit has no lag, there usually is no opportunity for a chirp caused by voltage change on the oscillator to show up, since the increase in plate voltage from zero to the operating value takes place so quickly that the ear can't detect the change in frequency. However, if lag is introduced in the keying circuit to eliminate clicks, the chirp is drawn out over a length of time which will cause it to become noticeable. The only remedy for this seems to lie in the development of an oscillator circuit whose frequency doesn't change with plate voltage over a wide range. A certain degree of compensation for this has been claimed for the electron-coupled circuit by a careful adjustment of the screen voltage, but experience has failed to show that the compensation is adequate to have appreciable effect upon chirp. Regulation of both screen and plate

(Continued on page 188)

An Inexpensive 3-Element Beam for 28 Mc.

Simple Construction with Direct Drive

BY CHARLES E. NICHOLS, JR.,* W1MRK

• The problems of rotating mechanisms, remote indicators, and the like usually are uppermost when the rotary-beam bug starts to bite. But like cutting the Gordian knot, they fall away under the direct approach. Maybe your location won't allow it — but if it will, the beam described here may be what you're looking for.

EVER since the 10-meter band was reopened for amateur use last fall the crying need has been for more and better antennas.

You've overhauled your transmitter, replaced tired condensers and resistors and in the rush to get on the air, thrown up almost any kind of simple skywire. Probably a half-wave in the attic, judging from conversations over the air.

You fire up the rig, and after a few false starts you manage to coax a few bedraggled amps into the antenna. Hesitatingly you falter out the first CQ in five years. Your confidence is restored and the old ego considerably inflated when you're called by a W5 down in Texas and given a QSA 5, R7 report.

Hurray, you're back on the air! QSOs galore, just like the old days. Your jubilation knows no bounds; until the next day when the band really opens up for short-skip. Woe is you. You call till you're hoarse, wonder if the old rig is still putting out (everything looks OK), light up a butt and try again. A crisp voice announces that you are coming in R9 down in Frog's Foot, La., and will you please give him a call. This you do and stand by for the return, but after an interminable wait he comes back calling another W1. Did this happen to you? Well, brother, old man QRM has got his heavy foot on your bowed head and is pushing it down into the mud.

A few days of the above and the XYL makes you wear a hat in the shack to prevent your becoming bald prematurely. You've made 286 calls, established contact 31 times, and had three 100-per-cent QSOs, except on ground wave. There you get out fine, but you might just as well be back on 2 meters for the sum total of results.

Gray Matter to Work!

The brute-force method has produced mostly negative results so you now sneak up with a more

* 57 Hancock St., Auburndale, Mass.

subtle approach. You try listening for a while. See what fellows are getting the most QSOs, and find out that those same hams are using directive arrays of one sort or another. A bright light strikes with blinding force. Birth of an idea. With exultation you scream, "a three element beam, that's for me!"

The author went through all the labor pains enumerated above and brought forth the same brain-child as yours.

I have a large yard so I immediately started dreaming of masts, towers, poles, automatic rotating mechanisms and remote indicating devices. The more I dreamed and pondered, the more complex and involved the whole problem became. There just didn't seem to be any easy way out of it. It all looked like *so much* work (for a lazy man) and involved a considerable expenditure of cold cash. The first I was averse to on general principles, and the latter found me considerably understocked.

A little more cudgeling of the gray matter and we had the answer. *The roof*. It was high enough. As a matter of fact, I found it to be higher than anything else in the house. A shack in a room directly under the antenna. Direct drive. No electrical equipment or remote indicating devices.

If you own your own home or have an indulgent landlord, the following may be a solution to your problem.

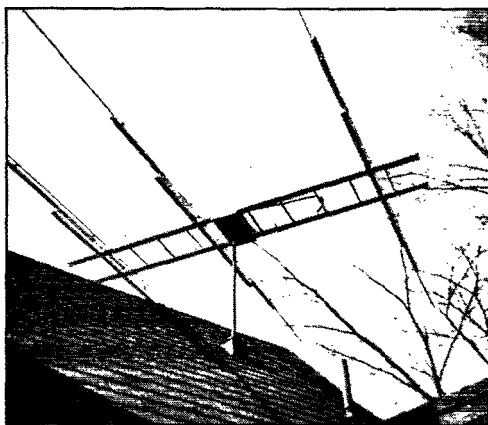

The ladder-supported three-element beam. The pipe mast projects through the roof and rests on a bearing made from pipe flanges. A housing of larger pipe, inside the attic, serves as a sleeve in which the mast can rotate.

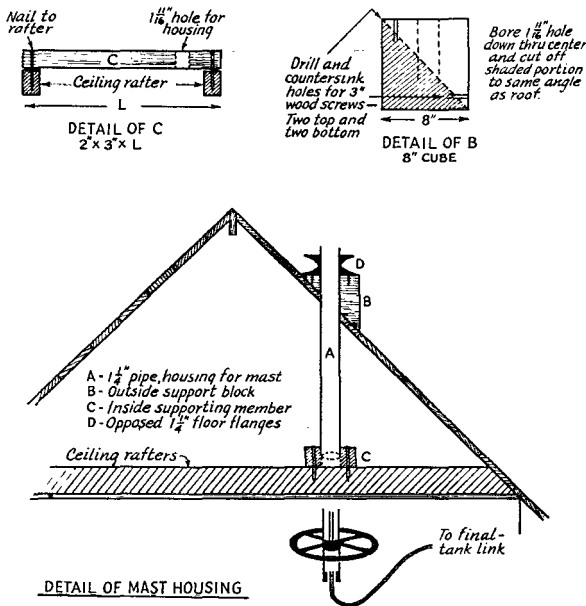

Fig. 1 — Sketch showing the attic housing, with the mast protruding through the operating-room ceiling and automobile steering wheel for turning the antenna. Dimensions of the housing and mast will depend on the individual location.

Through the Roof

It was decided to use 1-inch water pipe for the antenna mast and a piece of $1\frac{1}{4}$ -inch pipe for a housing, as the former fitted into the latter fairly snugly. Regular floor flanges would take care of the mounting and bearings.

Your own particular house and room will determine the lengths of both pieces of pipe. I would advise that you use not more than four feet of mast above the roof housing unless you go into heavier pipe than used in this installation. The length of mast below the roof bearing can be as much as necessary. The length of the housing must be determined by the distance between the top of "D" and the bottom of "C" in Fig. 1.

After procuring the pipe (black iron is cheaper than galvanized) from the plumber, go to the local woodworking mill and get an 8-inch cube of fir (hard pine will do just as well). Locate the center of the block and bore a hole $1\frac{1}{16}$ inches in diameter about two thirds of the way through. Take care to keep it vertical. An ordinary expansion wood bit and brace will do this job nicely. Now cut the block in half on the angle that corresponds with the pitch of your roof. The pitch of most roofs is 45 degrees, and can easily be checked by means of a level and protractor; however, if you doubt your ability to do the job, your mill can do it for you at a reasonable cost.

Spot the place on the roof where you want the mast to come through. (Make sure the element

tips will clear the chimney when the beam is in place. A radius of at least ten feet should be allowed.) This should be done from the attic in order to avoid ceiling and roof rafters. Make a hole about three inches long and two inches wide by boring through with a one-inch bit in diagonally-opposite corners and cutting out with a keyhole saw.

Cut lower brace "C" in Fig. 1. This should be a 2-by-4, two or two-and-one-half feet long. Bore a hole for the housing in the longitudinal center at a point where it will be under the hole in the roof and yet leave the ends of the brace extending over adjoining ceiling rafters for nailing.

Place the upper end of the housing (threaded long enough to accommodate two flanges) through a hole in the roof, and the lower end through the brace "C."

Take a two-foot square piece of zinc sheeting and form it around the roof block to make flashing. This is added insurance against leaks and also will protect the block from rot. The method of forming will suggest itself to you when you start in at your work bench.

A pair of heavy shears, a chisel and a hammer are all the tools needed. Leave plenty sticking out on all four sides to tuck under the shingles and be sure to cut out the hole for the housing with the chisel before taking it up on the roof.

Now let's go topside with the block, flashing, screws, screwdriver and a can of heavy roofing cement. Before you start, nail a length of 2-by-4 strip across the top of a ladder and hook it over the ridgeboard next to the hole. This will give you a firm footing to work from. Play safe. A dead ham never derived any good from a three-element beam!

Clean away any shingle debris from around the hole to leave a level surface for the block. Smear the surface liberally with cement, place the block down over the housing and screw to the roof, using 3-inch wood screws. Smear all the joining surfaces between the block and the roof with cement and put on the prepared flashing. Tuck the side and top edges under the adjoining shingles and nail them down with galvanized shingle nails. Put a gob of cement over all nail heads and around all edges and joints in the flashing. Do the same around the housing where it projects through the block and then screw on the first flange. You may need a helper inside the attic to hold the housing with a pipe wrench. Make small punch-holes through the flashing and screw the flange to the block with $1\frac{1}{2}$ -inch screws (NOTE: Both bottom flanges, where opposing flanges are called for, must be tapped out to remove the taper. Your plumber or trade school

can do this by running a tap through from the flat side of the flange.)

Screw the bearing flange on with the flat side up. If any of the housing projects above the top of the flange it must be removed with a hacksaw, and filed to leave a smooth surface. A little care in judging the length of thread required, when cutting, will make this step unnecessary.

Back to the attic. "True" the housing to the perpendicular with a square and nail down the bottom brace.

The worst part is done so you can now stop for a breather.

Making the Mast

Now for the mast. Measure down four feet, or the height you choose to have the antenna above the bearing block, and drill opposing holes, as shown in Fig. 2. Use a Size D drill for $\frac{3}{8}$ -24 bolts and tap with a $\frac{3}{8}$ -24 tap. Screw the bolts in slightly more than the thickness of the pipe. Take a 1-inch bearing flange, which has previously been bored out to slide over the pipe and notched as shown in Fig. 2, and slide it on to the bottom of the mast with the notched side up to accept the bolts. The heads of the bolts will come close enough to the upper surface of the flange, when it is in position, to keep them from turning out. Drop the mast into the housing and let

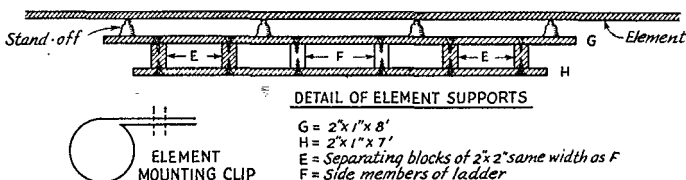
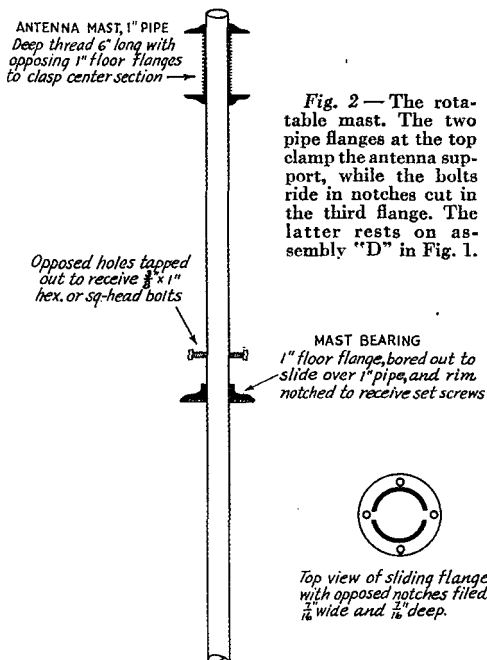

Fig. 3 — The element supports. These mount at right angles to the adder (indicated in cross-section at "F").

it rest on the top surface of the ceiling. Mark and cut a hole through the ceiling just big enough to let the mast slide through. A nicked floor plate on the pipe inside your shack will dress it up and keep the hole from showing. Fiber wheel grease should be smeared on the lower bearing flange before the mast is finally dropped into place. It keeps out moisture and allows for easier turning.

A steering wheel procured from the local junk yard can be put on the bottom of the mast for easy turning. The hub should be bored out to pass the mast, and should also have a tapped hole for a $\frac{3}{8}$ -inch setscrew to hold it tightly. A "dimple" drilled into the mast where the setscrew is to go will insure a nonslip fit. Paint the section of mast which comes inside the room, as well as the wheel, with enamel. A strip of white tape around the wheel, at the point corresponding to the direction in which the array is pointed, effectively completes the job. Incidentally, the wheel should be about 2 feet down from the ceiling, if it is going to be over your operating position, where it can't be walked into.

Supporting Structure and Antenna Elements

The main support for the beam is a ladder approximately ten feet long, with cross-pieces supporting the antenna elements.

Make up the antenna element supports as shown in Fig. 3. Use 2-inch wood screws throughout and drill a small hole for each screw before installing. Soap each screw and use a brace with a screwdriver bit. This will avoid splitting the wood and will eliminate a lot of hard work with a screwdriver.

Screw the four stand-offs to the top of the support. Use stand-offs having a metal base because the all-porcelain variety fractures easily under a slight strain.

For elements you can use electrical conduit, aluminum or duralumin tubing, or thin-walled hard-drawn copper water pipe. The latter is probably the best and can now be obtained from Sears, Roebuck & Co., at a cost of \$2.90 per 20-foot length, $\frac{3}{4}$ inch in diameter. In addition to three lengths of pipe, you will need four sleeve-type elbows for the tuning stubs.

The reflector should be made one-half wavelength long at the operating frequency, the driven

element 95 per cent of a half-wave, and the director 92 per cent of a half-wave. A half wavelength may be determined by dividing the frequency in megacycles into 492, with the answer given in feet. For a frequency of 28.5 Mc. the reflector would be 17-feet 4-inches, the radiator 16-feet 5-inches, and the director 15-feet 11-inches.

To figure the lengths of tubing to be used for each half of the reflector and director, subtract 16 inches from the total length as obtained from the formula above, and divide the result by 2. Cut two pieces to this length. Clean the ends of tubing and the insides of elbows with steel wool, and flux with No-Korode. Sweat on a 10-inch piece at right angles to each long length, using one of the elbows at the joint. This can easily be done over the gas stove. The short lengths, which form the tuning stub, should be separated by 6 inches when installed on the supports as indicated in Fig. 4. The original length of the element will be obtained with the shorting bar at the midway position on the stub. The elements may be mounted with $\frac{3}{4}$ -inch cable clips, or straps can be made from 4-inch strips of copper or aluminum as shown in Fig. 3.

Slide the supports with the mounted elements onto the ladder, spacing the reflector and director equally from each end of the ladder. Assuming that you have a 10-foot ladder, they would be about eight inches from either end. The

director should be 0.1 wavelength (3-feet 5 $\frac{1}{2}$ -inches at 28.5 Mc.) in front of the radiator and the reflector 0.15 wavelength (5-feet 2-inches) to the rear of the radiator.

Find the balance point of the array by placing it across a sawhorse or 2-by-4 on the ground. Mark the balance point and the positioning of the elements with small nails or notches, and then remove the elements.

Cut two center-support pieces ("A" in Fig. 4) and screw to the ladder, one on top and one on the bottom so that the holes are opposite each other and at the balance point of the array. These pieces can be made from 1-inch board 6 or 8 inches wide and of a length equal to the over-all width of the ladder. Holes to pass the 1-inch mast are bored in the center.

After this is done give all wooden parts two coats of paint to protect them from the weather.

Final Assembly

Up on the roof again with your ladder. Screw the tapped-out flange onto the mast with the flat side up, and drop the ladder in place. Screw on the top flange fairly tightly and put one 1-inch wood screw through each flange into the center section to keep the flanges from turning.

Slide the elements on and screw the supports in place (top and bottom) on the ladder, making sure that the spacing is correct.

A piece of garden hose about 5 feet longer than the mast is now pushed down through the mast so that it protrudes through the lower end about one-half inch. This hose serves three purposes. It spaces the Amphenol 300-ohm Twin-Lead transmission line away from the sides of the pipe, protects it from chafing, and protects it from the weather. The last is important as this line changes its characteristics when wet. Feed the transmission line down through the hose. Have it long enough so that there will be about 20 feet between the bottom of the mast and the transmitter, for checking standing waves.

The top end of the hose should run toward the reflector and then down over a rung in the ladder as shown in Fig. 4. The V of the delta match should start just inside the hose at a point about 45 inches from the radiator. When properly positioned the springiness of the hose where it is bent down over the ladder rung will keep the wires taut. Use large copper battery clips on the ends of the wires while adjusting the delta spacing, which should be close to 19 $\frac{1}{2}$ inches either side of center. Adjust the spacing to get the minimum standing-wave ratio as determined by a flashlight bulb and loop on the extra length of line left

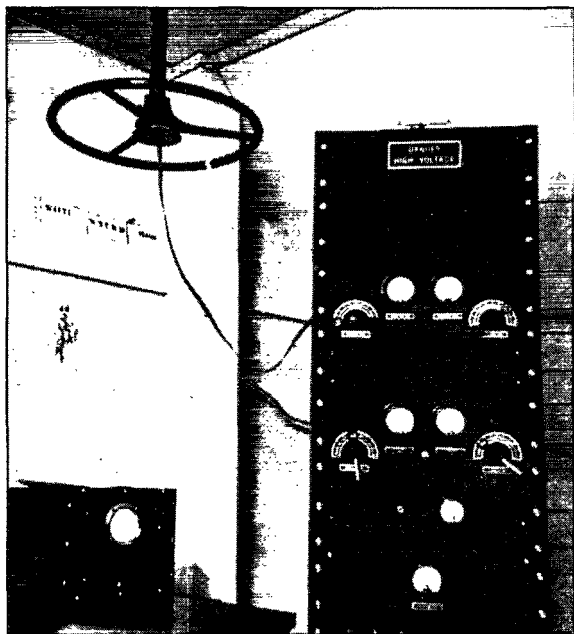

The end of the mast projects through the operating-room ceiling. An old automobile steering wheel provides the means for directing the antenna. The Twin-Lead feeder hangs in a loop to provide slack for rotation.

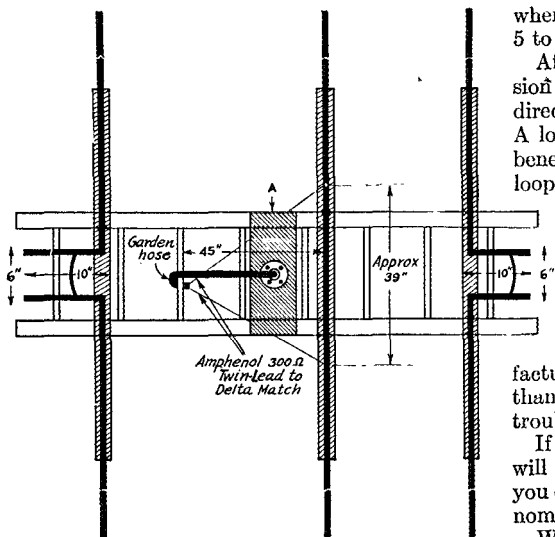

Fig. 4 — Top view of the assembled beam, showing the method of running the 300-ohm transmission line through garden hose for protection against weather and abrasion.

inside the shack. Once the proper tap positions have been determined, remove the battery clips and fasten the wires permanently with self-tapping metal screws, after drilling a $\frac{1}{8}$ -inch hole for a starter.

Adjusting Element Lengths

To tune the array get the cooperation of another amateur, a mile or so away, who has a calibrated S-meter on his receiver; or use a field-strength meter at about 100 yards, with your friend to read it and give appropriate hand signals. A couple of walkie-talkies would come in handy at this point. You can even do the job alone if you have a pair of powerful field glasses with which to read the distant field-strength meter.

First leave the shorting bar on the director open and tune the reflector for greatest signal strength, then tune the director for greatest field strength. Attenuation can be checked by turning the beam around and adjusting the elements for minimum signal strength. Be sure that both shorting bars are closed while adjusting the delta for minimum standing waves.

After these adjustments have been determined, shorten the director 1 per cent and lengthen the reflector 1 per cent. This will not reduce the gain appreciably but will make the array operate well over a wider frequency range.

The Q of the finished array is high, which means that it will be fairly selective as to frequency, although I have had very good results and no difficulty with loading when working a couple of hundred kilocycles either side of the resonant frequency of the antenna. This array

when properly adjusted will give a gain of from 5 to 7 db.

After cutting off the extra length of transmission line used for tuning, the line may be coupled directly to the adjustable link on the final tank. A loop a foot or so long should be left hanging beneath the lower end of the mast. With this loop the line is flexible enough to allow the array to be turned two or three complete revolutions in either direction without kinking.

A few notes:

Before drilling holes to pass the two sizes of pipe used, be sure to check the outside diameters as there may be some variation in size with different manufacturers. Bore your holes at least $\frac{1}{32}$ -inch larger than the outside diameter of the pipe to avoid troubles due to a too-close fit.

If you have a trade school in your vicinity it will very likely take care of any machine work you cannot handle yourself for free — or at a very nominal cost.

When larger sizes of pipe are used, the space between the outside diameter of the smaller pipe and the inside diameter of the larger may be greater than can be tolerated. If this is the case it would be possible to make a good fit by taking two reducing fittings (larger to smaller) and boring out the smaller ends to pass over the smaller pipe. Cotton waste soaked with grease should be

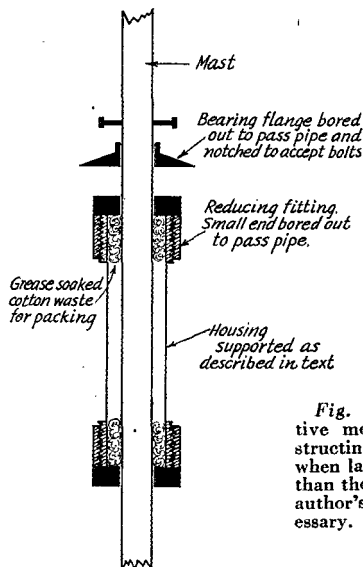

Fig. 5 — Alternative method of constructing the housing when larger pipe sizes than those used in the author's beam are necessary.

packed in before screwing on the reducers at either end of the housing. This makes a water-tight packing similar to that used in centrifugal water pumps. See Fig. 5.

The first call made using this antenna was to W7IXQ/6. Chuck gave me an R9-double-plus

(Concluded on page 126)

It's Fascinating Work

(If You Can Do It)

BY KEITH S. WILLIAMS, * W6DTY

THOUSANDS and thousands of people have apparently found great satisfaction and a good deal of pleasure in amateur radio. I congratulate them. As for myself, I've been knocking away at radio since 1921 and let me tell you it's been pretty terrible all the way through. Seems just like a long, horrible dream.

Perhaps I've never happened to quite hit on the thing; I don't know. I've struggled and groped and threshed around for years with tuned circuits, transformers and vacuum tubes, and to date have accomplished nothing. The only results have been frustration, solder on the front-room rug, contusions and abrasions, arguments with my wife, and several boxes of radio parts that have absolutely refused to work like it said in *QST*.

Sometimes I wonder if I am alone in my hopeless misery. Most everyone I meet who is interested in radio seems to know all about radio and has built perfectly marvelous pieces of gear and had thousands of QSOs with all the foreign countries in the world and besides all that, they know what makes the thing tick. All I have to do is ask, "Say, Wilburforce, would you happen to know what makes the plate current in my transmitter flow backward instead of forward?"

"Oh, that," he says. "From your description of the trouble it seems to me the phase relation between your tuned fummadiddle and the inverse feed-back voltage is all shot to hell."

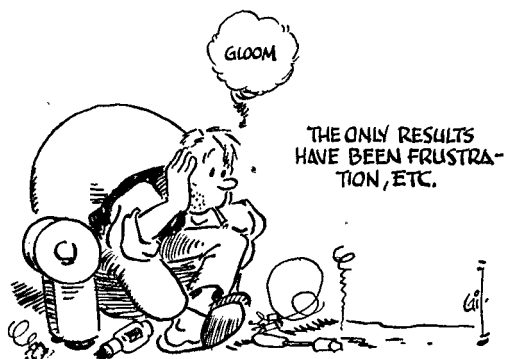

But it makes me feel pretty silly when somebody asks me a question like that.

Some kid says to me, "Pop, do you know what makes a tube oscillate?" Oh the shame of it all! The humiliation! After 24 years of effort, all I can answer is "Now, let me see . . . tube oscillate,

* Route 5, Box 544, Bakersfield, Calif.

huh? Well, now . . . the thing acts as a sort of gimmick that . . . it gets some feed-back from somewhere and . . . then . . . first, of course, you have to have it plugged in and . . . then — it just sort of oscillates." The sneering laugh that follows this explanation is what chills me. I don't think I can stand it much longer.

Let me go back over the years and relate some of my troubles. The whole thing started in 1921 when, my brain probably softened by an attack of the vapours, I put together a transmitter and receiver and hoisted an antenna. That antenna did look nice but I took it down after it nearly killed me. I had it only about five feet off the ground, in the back yard up in Walla Walla, and one night while I was gambling on the green (as a matter of fact some young hoodlums were chasing me) I ran into the confounded thing. It caught me on the Adam's apple and I've never been the same since. The transmitter and receiver never did work. I never found out why.

However, that only spurred me on to greater effort. By 1928 I had learned to take code at better than seven words a minute and had finally begun to get Ohm's Law straightened around in my mind . . . you know . . .

$$I = \frac{R}{E}, E = \frac{I}{R}$$

and all that stuff. And I had built scores of radio gadgets, none of which worked. At last came a great day. In 1930 I built a two-tube regenerative receiver with a couple of UV-199s and by the summer of 1931 had got the thing so well perfected that I heard W6FAU in Long Beach, California (I was also living in Long Beach at the time, by a strange coincidence). He was either on 80, 40 or 20 meters at the time, I believe. (He couldn't have been on ten meters because the ten-meter band hadn't been used much yet. That was to come in later years, and did me no good whatsoever as I never could raise anybody on that band either.)

This success cheered me a good deal and I also came into possession of three old broadcast sets, which set me up nicely in spare parts and I launched out in ham radio with vim and vigor. My success, however, was shortlived.

Frankly, gang, I don't think there's much future in radio. Nothing works like it is supposed to work, in spite of *QST*, and such a state of affairs naturally limits the usefulness of the "art."

I built a transmitter using push-pull 45s just

like you people showed in your magazine. To be honest, I must say that I really did work a guy with it . . . but he said it sounded terrible and thought he ought to report me to the R.I. Besides, my antenna fell down without provocation and I was practically electrocuted three times. So then I decided I'd throw away all this old junk and buy some new parts and build a modern foolproof crystal-controlled set. I was determined to lick the thing, see? Everybody else was busy working DX stations and hiring secretaries to take care of their QSL cards. I wasn't working a soul and only had one QSL card and that was obtained by fraud when I was still an SWL. I got desperate one night and wrote to W6AM (who also lived in Long Beach at the time) and told him I had heard him QSA5 R9 on the 80-, 40- and 20-meter bands. Don sent me a card, bless his heart. I never really heard him at all but I should have, we were so close together.

So I built that doggoned crystal-oscillator power-amplifier rig. And . . . as I expected . . . it wouldn't work. The oscillator wouldn't "osc"! I tried everything . . . putting more solder on the joints, thumping the tube with a screwdriver handle, pulling Ohm's Law on it, and even sneaking up and kicking it. It just wouldn't work. And look! *QST* said it was foolproof, perfectly conventional and straightforward! What a laugh! Just what kind of mularky were you guys trying to hand out anyway? And that monstrosity never did work, either.

So I decided that what I needed was a period of intensive and well-ordered study in electricity and radio. I bought two books and a correspondence course and renewed my subscription to *QST* (that last was the fatal step . . . *QST* has always been the insidious drug that has kept me sweating away at this pipe dream. Twenty-four long, hard, sorry years of radio!). But, after a couple of years where was I? I'll tell you where. Down at Medley's place on Main Street in Ventura, sobbing softly over my glass of suds in a corner booth, a broken man. Kirchoff's Laws, Ohm's Law, Lenz's Law, the Law of Gravity, feed-back, degeneration, positive temperature coefficients, neutralizing capacity, impedance matching, antenna loading, resonance curves . . . all that stuff still didn't mean a thing to me. The harder I studied, the more ignorant I became. I got the kit of parts that came with the correspondence course and, Doc, I swear, honest, I built those little gimmicks exactly like it said in the picture diagrams and *they would not work!* I was born under an evil star!

Thinking a change of scene would help, I got a commercial license, radiotelegraph second (thought you had me there, didn't you? I just memorized all the answers in Nilson and Hornung and only had to take the code test over five times; Mr. Chapple is a nice guy). Got a job on a tanker and after we'd been at sea two-and-a-half days I

finally discovered how to start the motor generator. I didn't find out about the antenna change-over switch until two weeks later and by that time it was almost too late as I hadn't heard any signals at all up to then.

My seagoing life was a failure. I never could quite get the hang of "the thing". The emergency batteries went dead, never to revive again. Someone later told me that I should have put some water in them, but I have never checked up on this as I never got further in the book on batteries than the charge and discharge formulas which stopped me as I never understood mathematics much beyond the third grade. And then too, members of the crew kept bringing me radios to fix and I couldn't fix them. The humiliation of the thing finally drove me ashore. I'll never forget the Skipper's last words as he gave me a farewell boot down the gangway, ". . . and if I ever see you again on or near any ship of mine, I'll shoot you dead, so help me!"

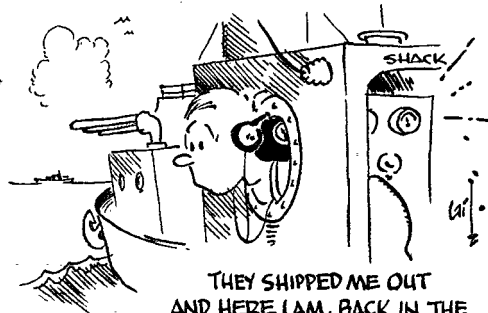

Then followed several years of increasing difficulty. I finally did get a crystal oscillator to perk and it worked pretty well until the crystal cracked up under the strain. The push-push doubler never did work though (by the way, can you explain to me again how a push-push doubler is supposed to work? I never quite understood it. Something about grids in parallel and plates in push-push or something like that, I think, and the electrons travelling from the space-charge to the anode set up a . . . well, something like that anyway). My 6L6 buffer oscillated at four or five frequencies at once and I couldn't neutralize it. Seven 866As went up in flashes of flame and showers of sparks before I was told by 12-year-old Billy Boston that I had a shorted filter condenser. (Surprise! Surprise! Now, why didn't I think of that myself!) My little nephew broke the glass out of the grid-current meter in the final amplifier and made a pretzel out of the meter needle. I was practically electrocuted five or six times (my wife would look up from basting the baby as I came staggering out of the back room and say, "What's the matter, dear? You look pale or something."). I

(Concluded on page 123)

Frequency Meters as Master Oscillators

An Easily-Constructed Amplifier for Use with Surplus Units

BY COMMANDER E. H. CONKLIN,* USNR, W3JUX

THERE is an old saying that if you want a really good frequency standard—oscillator or crystal—don't make it drive a transmitter, too. This saying has its value, to be sure, but from time to time new developments make it possible to get some usable power out of a frequency standard. For example, many Navy-transmitter master oscillators perform every bit as well as many crystal stages, once set on the right frequency, and the Navy's best shipboard frequency meter—Model LR—produces several watts of power.

A less-complicated frequency meter, the Navy's Model LM series and the Army's Type SCR-211, has occasionally served as a master oscillator by driving an amplifier with its normal output. This model has already appeared in the surplus market at a price around \$20 (without calibration). The meter is being handled by Hoffman Radio Corp., 1601 East 16th Street, Los Angeles 25, California, and by Hallicrafters in Chicago, as agents for the RFC, at somewhat higher prices (subject to service discounts), but comes complete with instructions and book of individually-calibrated dial settings.¹ Large quantities appear in the Navy's allowances of radio material for Naval Reserve members. It has a crystal-controlled calibrator oscillator to provide check-points, and a tunable oscillator with tone modulator to interpolate

* Conklin Radio Co., 6800 Clarendon Road, Bethesda 14, Md.

¹ According to information at the time of writing. Changes in the surplus picture may modify these prices considerably.

between check-points, all built into a nice unit approximately 8-inches cube, weighing 11½ pounds.

Some of these units are operated from an aircraft power supply, while others are mounted in a battery case or are provided with a 110-volt a.c. power supply. In the absence of the latter, it is necessary to provide only ¼ ampere at 12-volts a.c. or d.c. for the heaters and 10 ma. at 180 to 475 volts for the plates—the first readily obtainable from a small filament transformer and the second from a receiver. If the less-expensive meter without the power supply is purchased, Type CQC-20104A power units can be obtained separately at only \$7.50 as Item G2F-1 on the surplus list of Communications Measurements Laboratory, 120 Greenwich Street, New York 6, New York.¹

The tunable oscillator uses a Type 77 tube, the crystal oscillator and harmonic generator uses a 6A7, and the tone modulator a 76. The 2000-4000-kc. output for driving an external amplifier is taken from the arm of a potentiometer connected between the tunable-oscillator plate blocking condenser and ground.

A Choke-Coupled Amplifier

An amplifier that will permit controlling a transmitter from the output of the frequency meter, based on a circuit furnished by Lt. Col. Byron E. Hargrove, W9LFU (who spent his Army career in the Bureau of Ships, Navy Department, after leaving the Signal Corps labora-

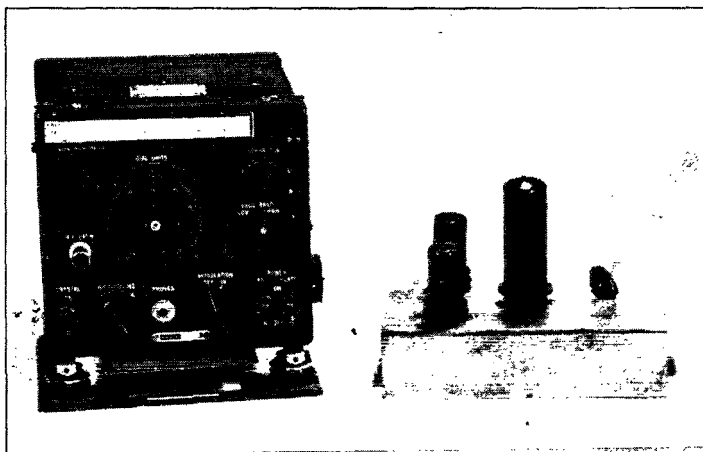

◆
The amplifier described in the text alongside the Model LM frequency meter which drives it. It is built on a chassis 8 inches wide, 4 inches deep, and 2 inches high. Parts layout is not critical, since only the last stage operates as a tuned amplifier.
◆

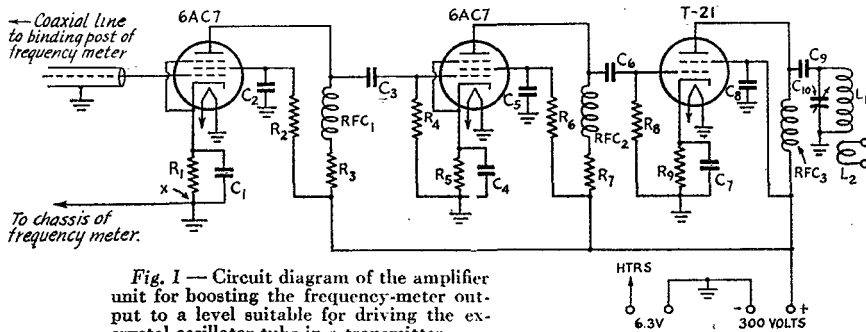

Fig. 1 — Circuit diagram of the amplifier unit for boosting the frequency-meter output to a level suitable for driving the ex-crystal-oscillator tube in a transmitter.

C_1 to C_9 , inc. — 500- to 1000- μ fd. ceramic, 600 volts.
 C_{10} — 100- μ fd. variable.
 R_1, R_5 — 300 ohms, 2 watts.
 R_2, R_6 — 60,000 ohms, 2 watts.
 R_3, R_7 — 1000 ohms (or higher), 2 watts.
 R_4, R_8 — 0.1 megohm, $\frac{1}{2}$ watt.
 R_9 — 500 ohms, 2 watts.

L_1, L_2 — 3.5-Mc. coil with link, such as a junior transmitting coil or receiver-type plug-in coil. Suitable dimensions for a $1\frac{1}{2}$ -inch diameter coil form are 50 turns of No. 22 enameled, closewound, for L_1 , and 5 or more turns of the same wire for L_2 .
 RFC_1, RFC_2, RFC_3 — 2.5-mh. r.f. choke.

tories at Fort Monmouth) is shown in the photograph. The wiring diagram differs from Lt. Col. Hargrove's circuit chiefly in the use of r.f. chokes instead of simple resistance coupling in the plate circuits of the two 6AC7 amplifiers. The Taylor T-21 output stage is used on the 3.5-4.0-Mc. band, although it could operate at 1.7-2.0 Mc. as well. The latter range will be preferred where it is intended to drive an existing 3.5-Mc. crystal stage as an unneutralized doubler.

For break-in, the key should be connected between the bottom of R_1 and ground (point "X" on schematic), opening the d.c. cathode circuit of the first 6AC7. The coaxial cable from the frequency meter to the first amplifier tube is desirable to reduce radiation which might be picked up by the station receiver when operating break-in on the transmitter frequency. However, its capacity by-passes some of the r.f. input to the first amplifier and, therefore, it should be kept reasonably short. If the shielded coax is omitted, a common ground should connect the frequency meter and the amplifier in order to provide an r.f. return.

The resistor and capacitor values were found to be not at all critical. Inasmuch as no grid current flows in the grid leaks of the second and third stages when plate and screen voltages are applied and when cathode-bias resistors are used, the grid-leak values are selected purely to avoid loss of r.f. and not for operating bias. Grid chokes in series with them were found to cause a modest improvement in gain, as measured by the grid current of the next stage when no plate and screen voltages are applied to it, but not enough to justify their cost. So long as the grid-leak resistors are not by-passed, the use of grid chokes does not increase the tendency for the amplifier to oscillate at a parasitic frequency as a tuned-plate tuned-grid oscillator, with the chokes form-

ing the inductances.

The by-pass and coupling condensers used are actually 680- μ fd. axial-lead ceramic capacitors, plus or minus 180 μ fd., which are available for a few cents from a mail-order radio supply house. They are shorter than a $\frac{1}{2}$ -watt resistor and can be mounted directly on the socket terminals in an extremely-compact arrangement with very short leads. The reactance of a by-pass circuit is probably less with these condensers than it is with common 0.1- μ fd. paper by-pass condensers which cost several times as much.

The use of radio-frequency chokes instead of plate resistors increased the stage gain very much — at least a third — without losing any plate voltage in the resistors which otherwise would happen. With Type 6AC7 tubes in the first two stages, there was no tendency toward oscillation in the second and third stages through the r.f. chokes but later, when trying other types of tubes, this form of oscillation occurred. It is deemed to be desirable, therefore, to insert resistors of 1000 ohms or more in series with the chokes. These resistors are in series with the tuned circuits of the parasitic oscillations through the chokes and, therefore, suppress the tendency completely.

Link-coupled output is used, although normally it will be more convenient to locate the amplifier reasonably close to the former crystal-oscillator stage of the transmitter and to feed the latter capacitively, operating the stage as a doubler unless it is a pentode or tetrode, with no tendency toward oscillation when worked straight through as an amplifier.

A voltage of only 300 was used on this unit, although it is recognized that a higher voltage may be used, with adjustment of the screen and plate resistors to the necessary higher values. It will then be necessary also to increase the cathode

(Continued on page 130)

Happenings of the Month



HALF OF 40 & 20 RETURNED! — 75' & 10' PHONE CHANGED

Through the collaboration of the Allied military forces in their respective areas around the world, half of the 7- and 14-Mc. bands were returned to United States amateurs at 3 A.M. EST on July 1st, by means of FCC's Order No. 130-H. The United Kingdom and the British dominions generally, including Canada, acted simultaneously or a few hours earlier. Simultaneously the same frequencies were opened to GI operation in the occupied countries and to the amateurs of the Netherlands, Belgium and France — except that in the latter case it covers only the 14-Mc. frequencies. Thus we are back in the DX business again and a very important restoration has been made in our operating rights.

C.w. may be used on the frequencies 7150-7300. No 'phone will be authorized in that band until all of it is returned to us, at which time we may hope for favorable action on our Board's request to open 7200-7300 to voice. C.w. may also be used on 14,100-14,300 kc. The upper half of this range, 14,200-14,300, is also open to Class A 'phone under all the usual Class A restrictions. When the entire band is returned it is expected that the portion opened to 'phone will be 14,200-14,400. The old authorization, which began 'phone at 14,150, is no longer valid, and United States 'phone operation begins only at 14,200.

Simultaneously FCC acted on two ARRL requests for alteration in the 'phone bands. The 75-meter Class A 'phone allocation is expanded to read 3850-4000 kc. For reasons explained in another item in this department, the 10-meter 'phone band is shortened to begin at 28,500 kc. American amateurs may use the frequencies 28-28.5 Mc. for c.w. only.

In the same order, FCC at our request opened another right specified in our actual rules but not previously granted us under the controlling orders: Type AØ emission, permitting duplex 'phone, is now authorized in the bands 144-148, 235-240 and 420-430 Mc.

From this latest FCC order summarizing our current operating privileges as of July 1st, we quote the ordering section:

IT IS HEREBY ORDERED THAT the second ordering clause of Order No. 130-A, as amended by Orders Nos. 130-B, 130-C, 130-D, 130-E and 130-G, be and it is hereby further amended to read as follows:

2. (a) The following frequency bands are available for use for amateur station operation, subject to the limitations and restrictions set forth herein:

(1) 3500 to 4000 kc., using type A1 emission, and, on

frequencies 3850 to 4000 kc., type A3 emission, subject to the restriction that A3 emission may be used only by an amateur station which is licensed to an amateur operator holding Class A privileges and then only when operated and controlled by an amateur operator holding Class A privileges. Use of this band is restricted to amateur stations within the continental limits of the United States, the Territory of Alaska, Puerto Rico, and the Virgin Islands.

(2) 7150 to 7300 kc., using type A1 emission.

(3) 14,100 to 14,300 kc., using type A1 emission, and, on frequencies 14,200 to 14,300 kc., type A3 emission, subject to the restriction that A3 emission may be used only by an amateur station which is licensed to an amateur operator holding Class A privileges and then only when operated and controlled by an amateur operator holding Class A privileges.

(4) 27.185 to 27.455 Mc., using types AØ, A1, A2, A3 and A4 emissions, and also special emissions for frequency modulation (radiotelephone transmissions and radiotelegraph transmissions employing carrier shift or other frequency modulation techniques). This band is subject to use also for operation of scientific, industrial and medical apparatus.

(5) 28.0 to 29.7 Mc., using type A1 emission.

(6) 28.5 to 29.7 Mc., using type A3 emission.

(7) 29.0 to 29.7 Mc., using special emission for frequency modulation (radiotelephone transmissions and radiotelegraph transmissions employing carrier shift or other frequency modulation techniques).

(8) 50.0 to 54.0 Mc., using types A1, A2, A3 and A4 emissions and, on frequencies 52.5 to 54.0 Mc., special emission for frequency modulation (radiotelephone transmissions and radiotelegraph transmissions employing carrier shift or other frequency modulation techniques).

(9) 144 to 148 Mc., using types AØ, A1, A2, A3 and A4 emissions and special emissions for frequency modulation (radiotelephone transmissions and radiotelegraph transmissions employing carrier shift or other frequency modulation techniques). The portion of this band between 146.5 and 148 Mc. shall not be used, however, by any amateur station located within 50 miles of Washington, D. C., Seattle, Washington, or Honolulu, T. H.

(10) 235 to 240 Mc., using types AØ, A1, A2, A3 and A4 emissions and special emissions for frequency modulation (radiotelephone transmissions and radiotelegraph transmissions employing carrier shift or other frequency modulation techniques).

(11) 420 to 430 Mc., using types AØ, A1, A2, A3, A4 and A5 emissions, and special emissions for frequency modulation (radiotelephone transmissions and radiotelegraph transmissions employing carrier shift or other frequency modulation techniques). Peak antenna power shall not exceed 50 watts.

(12) 1215 to 1295 Mc., 2300 to 2450 Mc., 5250 to 5650 Mc., 10,000 to 10,500 Mc., 21,000 to 22,000 Mc., and on any frequency or frequencies above 30,000 Mc., using on these frequencies types AØ, A1, A2, A3, A4 and A5 emissions, special emissions for frequency modulation (radiotelephone transmissions and radiotelegraph transmissions employing carrier shift or other frequency modulation techniques), and pulse emissions.

(b) No frequencies other than those assigned in this order shall be used for amateur operation.

BOARD MATTERS

After the League directors had returned to their homes from their annual meeting, and the

news was abroad of the decisions taken at that meeting, there were some expressions of disapproval of the requests made of FCC on the part of both individual amateurs and clubs. We suppose it will always be that way in matters this complex, in that whichever way a decision is made there will be some amateurs who do not like it. However, some of the directors felt it desirable to seek the Board's reexamination of these matters by mail, and this was done on several occasions in the month following the annual meeting. Each director was able then to appraise these matters in terms of the reaction of

his division members to the known requests, and it was decided by the Board that they all should stand. Notably in the case of all of the requests involving frequency allocations for 'phone, the reaffirmations received a much heavier majority than they did at the meeting itself. The Board is convinced that its decisions represent the greatest good to the greatest number of amateurs.

At Headquarters we have been somewhat puzzled to receive some protests from 'phone men over the request that the lowest 500 kc. of the 10-meter band be exclusively c.w. in this country, i.e., that they not be open to 'phone here. Of



TWENTY-SEVEN AMATEURS ON "CROSSROADS" ELECTRONIC SHIP

Playing important roles in "Operation Crossroads" are 27 amateurs aboard the U.S.S. *Avery Island*, electronics control ship, upon which will be centered all electronic activities in connection with the two atomic bomb tests taking place during July on Bikini Atoll. Television, numerous varieties of radar, elaborate radio communications, "telemetering" or instrument-reading by radio, and a long list of scientific devices using electronics will all play a part in the two atomic tests. Captain Christian L. Engleman, USN, has been assigned as Electronics Coördinating Officer, and the preparation and installation of electronic equipment has been under way for several months under his direction. Captain Engleman and his staff composed of Army, Navy and civilian scientists and technicians sailed from San Francisco May 6th enroute to Pearl Harbor and Bikini. Captain Engleman's present call is W6UQR. He formerly held calls 7QQ (in 1920), W1LOC and W3IVO. Here are the hams aboard:

Top row, l. to r.: M. F. Oertel, W3ESO; R. D. Ewing, W9YFY; C. A. Debel, W9PYF; Lt. (jg) H. W. Masterman, W7EAD; Lt. J. A. Webster, W1FAS; Lt. R. L. Nichols, W9KXU; W. E. Taylor, W4JLK; R. H. Mellen, W1JJD.
 Second row: J. W. Fraumann, W8PMI; J. K. Gosland, W2BJK; W. J. Moore, W8UAQ; J. F. Dickson, ex-W8BFS; G. A. McDaniel, W3EHG; Lt. B. G. Lewis, W2HJK; D. Williams, W1HJE; H. E. Inslerman, W2CPL; Lt. Comdr. H. C. Wagar, ex-W2AQ.

Third row: Lt. Comdr. R. M. Haylor, W4INE; Comdr. J. L. Miller, W5LD; D. G. Fink, W2AFX, ex-W1SG; Captain C. L. Engleman, USN, Electronics Coördinating Officer, Joint Task Force ONE, Operation Crossroads, W6UQR; Will Whitmore, ex-W2DVI; A. J. Waite, jr., W2OAI; C. W. Baechler, jr., W3KAR.

Front row: D. G. Parks, AETM2c, W4HCO; F. L. Wiley, AETM2c; H. W. Kuoebel, AETM1c, W9MBD.

ARE YOU LICENSED?

• When joining the League or renewing your membership, it is important that you show whether you have an amateur license, either station or operator. Please state your call and/or the class of operator license held, that we may verify your classification.

course it is true that those lowest frequencies open first and stay in longer, but if one values slightly lower frequencies there is the 11-meter band crying for occupancy; and the point is that this request was made almost exclusively in the interests of 'phone men themselves. C.w. did need more space, it is true, but not that much, and will generally congregate at the low edge of the band. The request was made primarily to provide a place where foreign 'phones can come through without being buried in our own QRM — just the way the band was arranged prior to the war. No foreign 'phone amateur in his right mind will work in an American 'phone band if there be any other place to work. When the band comes back strong this autumn we expect it will divide up about this way: the first 200 kc. chiefly c.w., the next 300 kc. chiefly foreign 'phone, then American 'phone the rest of the band. And, by the way, there is lots of unused space at the higher end of that band — and it should be good next autumn.

The proposal of the Board for a Class D license (without code test and good only above 200 Mc.) was the target of most of the objections voiced — although the Headquarters also received letters and resolutions of approval from many amateur groups. The Board's proposal is designed exclusively to attract microwave technicians to participate in the development of communication on these higher frequencies in the name of amateur radio. It has no commercial implications and is believed necessary in our own interests, since we must have occupancy and show contributions if we are to hold these new frequencies. Code is practically never used on such bands and there is evidence that the entrance of desirable new people is held up by the present code requirement. On the other hand, the Board believes that such amateurs must have the same knowledge of theory and laws and regulations as other amateurs and does not advocate the general lowering of our standards, work on our other bands to be permissible only after passing the code test and getting a Class B endorsement. It is not believed that the number of such licensees will ever be very great; in fact, we fear it will be quite a scramble to get decent occupancy on those frequencies. Nonetheless, the fear being expressed that such amateurs would be so numerous as to gain control of the League

and lower all our standards, the Board has decided that a Class D licensee should not be eligible to full membership in the League, with the right to vote and hold office — although it is expected that they will have voice as concerns the regulations for those frequencies. The Board moreover decided to ask FCC to assign distinctive station calls to Class D licensees, preferably of such nature that the distinctive indicator could be dropped, without otherwise altering the call, when the licensee qualifies for Class B and, finally, the Board is now examining whether it wishes to raise the beginning frequency for its proposal to 1215 Mc. instead of 200 Mc.

STAFF NOTES

We are pleased to report the return of Lt. Comdr. Arthur L. Budlong, W1JFN, as senior assistant secretary of the League, after nearly four years of duty at the Washington headquarters of the Coast Guard. During his war service Commander Budlong became a recognized allocation expert and his return to ARRL Headquarters will considerably strengthen the League staff. Chief of the Coast Guard's Frequency Section since its inception in January, 1943, he took an active rôle in the allocation planning for national and international communications. As Coast Guard alternate on the Interdepartment Radio Advisory Committee since 1942 and as chairman of IRAC's technical subcommittee for the past two years, he has participated in all the technical committee work preparing for the next world conference, and served on committees of both the Combined Communications Board and the Joint Communications Board. Shortly before his separation he returned from the London conference on radio aids to marine navigation, and he also attended the Third Inter-American Radio Conference at Rio and the Anglo-American Telecommunications Conference in Bermuda last year. He was a member of the committee that developed communications and d.f. set-ups for air-sea rescue operations and was personally largely responsible for the development of the modified "Gibson Girl" transmitter adopted as standard equipment for lifeboat rescue communications.

We regret to announce the resignation from our Technical Department of A. David Middeltown, W2OEN/1.

FINGERPRINTS ELIMINATED

Last January, by its Order 75-D, FCC relaxed its wartime requirements for proof of citizenship by applicants for or holders of operator licenses but retained its requirement that fingerprints be submitted. That, too, proving unnecessary, the Commission went the rest of the way on June 5th when its Order 75-E canceled Order 75-D, and the whole wartime requirement has now disappeared. It should be understood, however,

that licenses are still issued only to citizens, that being a requirement of the basic law.

ACTIVITY WAIVED UNTIL DECEMBER

FCC has again waived the proof of use of operator licenses, normally required as a condition to their renewal, awaiting more of a return to normal conditions. The new waiver, accomplished by Order 77-F on June 20th, is effective until the end of this year, unless sooner ended by the Commission. In executing applications for renewal, the question relating to this matter may be ignored.

However, in an accompanying public notice the Commission emphasized that it is expected that there will be no further suspension of this requirement after December 31st. Quoting from the notice, "Therefore, it is essential that all amateur . . . radio operators who will file renewal applications after December 31, 1946, be prepared at that time to show compliance with the service or use requirement of the Commission's rules." The requirement then will be contacts by radiotelegraphy with three other U. S. stations within the last six months of the license term.

NOTE YOUR RENEWAL DATE

The first amateur licenses, as extended, will begin to expire in December. Renewal applications may be filed 120 days in advance. That means beginning in middle August. Look up your date and make a note to write your inspector for a form and file your renewal application well before your expiration.

CHANGING OPERATING ADDRESS

If you ever operate portable, either at your fixed station because you have changed address or with truly portable gear, be sure you are complying with the important notice we detailed on page 26 of our June issue.

FCC Order 132 temporarily requires that notice of true portable operation be filed with your inspector for any frequency whatever.

More important to many amateurs, it substitutes a simplified system for complying with the requirements for operation in portable status while awaiting modification of a fixed license — but requirements with which many amateurs have not yet complied. See our reference article, including the areas of each radio district and the inspectors' addresses. If you will operate at an address other than the registered one shown in your station license, on any frequency whatever, it is necessary that you send two written notices in advance, one to the inspector in charge of the district for which the original station license was issued, the other to the inspector in charge of the district in which the operation is intended. One such notice does for all time and does not have to be renewed monthly. The required notice is

very simple: it need only state the station call, the name of the licensee, and the location where operation will now occur. If you move again, send two more such notices. Be sure your notices go to the right inspectors. Sign the portable indicator for the area in which you are operating.

It is easy to comply but you are likely to be in serious difficulty if you do not.

STATE GUARD STATIONS

It will be remembered that State Guard stations were authorized to continue operation on 3655 and 3825 kc. until July 1, 1946, under WERS regulations. The War Department has requested FCC to permit the continued operation of State Guard stations in WERS status for a further temporary period pending reactivation of the National Guard. But meanwhile the 80-meter band has been returned to us. As a result, FCC Order 127-B, dated June 6th, continues such State Guard stations and regulations until July 1, 1947, but only on the frequency 5500 kc., sharing with War Department stations. Thus the State Guard stations have now disappeared from our band.

POLICE PERMITS

Several states have laws prohibiting the use of automobile mobile apparatus capable of receiving police transmissions, unless a permit therefor is first obtained from the police. The purpose is to prevent the use of such apparatus by the criminal world. Such laws are a legitimate exercise of the police power if the required permit is not unreasonably withheld from reputable citizens, including FCC-licensed amateurs.

With the rapid increase in v.h.f. services, particularly the mobile radiotelephone service to trucks, buses and taxicabs, the state of New Jersey has just made an interesting amendment of its applicable law. A permit is now required only for a "shortwave radio receiver operative on frequencies assigned by the Federal Communications Commission for fire, police, municipal or other governmental uses." This pattern will probably be followed in other states. Where this is the practice, you will not need a permit if

DX QSLs

• "Claim your old QSL cards now or never," says page 31 of July *QST*, because all prewar cards not applied for by next January 1st will be disposed of at that time, by order of the ARRL Board of Directors.

If you did any hamming prewar, some of these DX cards may be for you! Look up the July article and submit the required self-addressed stamped envelope to your QSL Manager now.

your mobile apparatus receives only the ham frequencies.

EXECUTIVE COMMITTEE MEETINGS

The following is an abstract of the minutes of the Executive Committee of the League during the past year between Board meetings, as ratified by the Board at its recent meeting, here published for your information by the order of the Board.

Meeting No. 186, Aug. 10, 1945. Authorized Leroy T. Waggoner, an Assistant Secretary, to sign checks on behalf of the Secretary, under bond.

Meeting No. 187, Oct. 5, 1945. Examined nominations in regular autumn elections, determined eligibility of candidates. In cases where there was only one eligible candidate, declared him elected without balloting. Ordered ballots sent on others. Ordered further solicitation of nominations for Delta and Midwest Division alternate directors.

Meeting No. 188, Nov. 20, 1945. Opened and counted ballots in regular autumn elections, certifying winning candidates.

Meeting No. 189, Dec. 20, 1945. No Delta division nominations for alternate director being received, ordered a further solicitation. Declared the only eligible candidate for alternate director of Midwest Division elected without balloting. In compliance with the expressed opinions of directors, authorized the Secretary to conclude a lease for the Headquarters office property for a further term of 5 years.

Meeting No. 190, April 1, 1946. Examined nominations for alternate director of Delta Division, determined eligibility, ordered ballots sent Division membership. Affiliated two clubs. Authorized membership emblems with blue field for station SCM appointments, with green field for leadership SCM appointments.

SPECIAL ELECTION NOTICE

To All Full Members of The American Radio Relay League Residing in the Pacific Division:

You are hereby notified that a special election is about to be held in the Pacific Division to elect a new director to succeed J. Lincoln McCargar, W6EY, who has resigned to accept the vice-presidency of the League. He continues in his duties as director until his successor is chosen. The election will be for the unexpired remainder of the 1946-1947 term. Your attention is invited to Sec. 1 of Article IV of the Constitution, providing for the government of ARRL by a board of directors; Sec. 2 of Article IV, and By-Law 12, defining their eligibility; and By-Laws 13 to 24, providing for the nomination and election of division directors. Copy of the Constitution & By-Laws will be mailed to any member upon request.

Voting will take place between September 1 and October 20, 1946, on ballots that will be mailed from the headquarters office in the first week of September.

Nomination is by petition. Nominating petitions are hereby solicited. Ten or more Full Members of the League in the Pacific Division may join in nominating any Full Member of the League residing in that division as a candidate for director therefrom. The following form is suggested:

Executive Committee

*The American Radio Relay League
West Hartford, Conn.*

We, the undersigned Full Members of the ARRL residing in the Pacific Division, hereby nominate
..... of, as a candidate for director from this division for the remainder of the 1946-1947 term.

(Signatures and addresses)

The signers must be Full Members in good standing. The nominee must be a Full Member and must have been both a member of the League and a licensed radio amateur operator for a continuous term of at least four years immediately preceding receipt by the Secretary of his petition of nomination, except that a lapse of not to exceed ninety days in the renewal of the operator license and a lapse of not to exceed thirty days in the renewal of membership in the League, at any expiration of either during the four-year period, will not disqualify the candidate; provided that if a candidate's membership has been interrupted by reason of service in the armed forces of the United States, he shall not be deemed to be disqualified so far as concerns continuity of membership if he has, since May 7, 1943, renewed his ARRL membership within ninety days of discharge from the military service. He must be without commercial radio connections: he may not be commercially engaged in the manufacture, selling or renting of radio apparatus normally capable of being used in radio communication or experimentation, nor commercially engaged in the publication of radio literature intended, in whole or part, for consumption by licensed radio amateurs. Further details concerning eligibility are given in By-Law 12. His complete name and address should be stated. All such petitions must be filed at the headquarters office of the League in West Hartford, Conn., by 11 A.M., EST, of the 20th day of August, 1946. There is no limit to the number of petitions that may be filed on behalf of a given candidate but no member shall append his signature to more than one such petition. To be valid, a petition must have the signature of at least ten Full Members in good standing; that is to say, ten or more Full Members must join in executing a single document; a candidate is not nominated by one petition bearing six signatures and another bearing four. Petitioners are urged to have an ample number of signatures, since nominators are frequently found not to be Full Members in good standing.

League members are classified as Full Members and Associate Members. Only those possessing certificates of Full Membership may nominate candidates, or stand as candidates; members holding certificates of Associate Membership are not eligible to either function.

This election provides the constitutional oppor-

(Concluded on page 132)



25 Years Ago this month

“COME to the Convention!” Thus the leading article in our August, 1921, *QST* invites us to Chicago to the First National ARRL Convention and Radio Show. Thousands of amateur radio folk are expected to attend. Secretary of Commerce Hoover heads the list of top-notch guests invited. *QST* anticipates, “If Mr. Stone accepts the invitation, there will probably be a debate on power factor between him and Mr. West — Oh Boy!”

We are further introduced to the techniques of “Modulation in Radio Telephony,” by R. A. Heising, constant-current modulation of an oscillator and master oscillator being described. “The C.W. Transmitter at 8ZV,” by Henry L. Ley, features an adaption of the Meissner circuit, using W.E. VT-2 or Radiotron U.V.202 tubes in parallel, Heising-modulated for speech or i.c.w. by another pair. “Reception of 200-meter Signals by Means of a Loop and an Armstrong Super-Heterodyne,” by Leroy M. E. Clausing, presents a receiving system with many advantages. We hesitate to adopt it, though, because of the great number of tubes required. “Spark Reception on Honeycombs,” by Chas. Kinyon, and “Amateur Quenched Gap Problems,” by H. J. Tyzzer, combine to make the spark gang’s lot an easier one.

The Old Boy has “A Dream.” Falling into the hands of Morpheus, he finds himself at the court of the “Congregated Hams of the Universe,” with T.O.M. himself on the bench. He’s charged with QR Ming, and is sentenced to be electrocuted. Just as 600,000 amps rend his body, he awakens, and discovers he is holding the secondary terminals of his flivver coil. Harken all ye young squirts and let not T.O.M.’s vengeance fall upon you for QR Ming!

There’s a handsome picture of “Our Board of Direction” in this issue. We see Messrs. Kruse, Stanley, Camp, Smith, Schnell, Maxim, Warner, Hebert, and Stewart, in session at the Engineers’ Club, New York City. Mr. J. O. Smith is leaving our ARRL board because of his new commercial affiliation with the Radio Corporation of America.

“Salem: A Comedy.” A forceful editorial that tells us the city fathers of Salem, Mass., have passed an ordinance that reads, “No person shall set up, install or maintain a wireless apparatus connected with a current of electricity without first having obtained therefore a permit in writing from the City Electrician.” Local amateurs are up in arms. The law is full of loop-holes and in conflict with Federal regulations. There is uncertainty as to whether the law means you need

a permit for a receiving station. Or did the Salem Council neglect to mention transmitters specifically? Says *QST*’s editor, “Gentlemen of the Salem Council, the radio world is laughing at you.” . . . We’re growing and feeling our organized strength. “Mr. Manufacturer, isn’t there some way in which you can take care of us radio amateurs in our need for radio-frequency amplification?” asks the editor. . . . And again, “Have you fellows noticed the way radio interest is keeping up this summer?”

Traffic-handling certainly did a “Carpentier” last month, losing out to time spent rebuilding to c.w. Top man: Ostman, 20M, with 296 messages. Old faithful, Vermilya, reports “only” 258! . . . Eunice Randall, the first district’s new OW operator, has completed installation of her own station. . . . Records: 9LW has been heard 2200 miles; 2RK has been heard by 6ALE; 2JJ has been heard by 7ZJ. The League’s Operating Department has adopted T.O.M.’s suggestion that quiet hours for listening be observed.

Bob Emerson’s 5ZG, Dallas, is pictured on this month’s cover and described in detail within the issue, along with such outstanding stations as Wm. E. Arnold’s 1BDC, Rev. Sebastian Ruth’s 7YS, and Robt. F. Gowan’s 2XX.

Troubled by hand-capacity and the critical sharpness of c.w. in receiver tuning, OM? “Strays” says a handy trick is to place the eraser end of a pencil between the periphery of your receiver’s tuning dial and panel. A twist of the pencil and you have a smooth vernier action without hand-capacity effects. Other “Strays” tell us KBW has been sent one of T.O.M.’s power tubes by 7KM. The envelope bears a striking resemblance to the glassware that usually carries the Heinz 57 Varieties label. Paul Oard of Stockton, Calif., has been conducting successful tests with a receiving set installed in an auto. He uses an aviator’s helmet to cut out external noises.

Strays

Taking advantage of the fact that radar waves can be directed in a manner similar to sound issuing from a horn, an enormous horn-shaped antenna was installed in England during the war. The antenna was made of wire netting supported on telephone poles, was 150 feet long and had a mouth 6 by 18 feet. It was used to “jam” the radars of German night fighters. Birds flying into the horn were killed and cooked by the radio frequency power. — Ohmite News

Permeability-Tuned Oscillators

A Comparison with Condenser-Tuned Circuits

BY T. A. HUNTER,* WØNTI

IT IS THE purpose of this article to compare condenser-tuned and permeability-tuned master oscillators. *QST* has had several very excellent articles on condenser-tuned oscillators, but none has appeared concerning permeability-tuned circuits. Since each method of tuning has points in its favor, it would seem desirable to discuss the merits of each system to see whether either system of frequency control has decided advantages over the other.

During the war the author designed oscillators using both systems of tuning.¹ In this article the design considerations and results obtained from both types of tuning will be presented for the benefit of the amateur fraternity.

To elaborate on all of the various factors involved in the oscillator circuit would require too much space, hence this discussion will be confined to the following considerations:

- 1) Tuning range
- 2) Operating frequency
- 3) Humidity
- 4) Temperature coefficient

*Project Engineer, Collins Radio Co., Cedar Rapids, Iowa.

¹ Early Collins units in which these master oscillators were used are the Navy Type TCS series, the TDO and TDH transmitters, and the AN/ART-13 transmitter. All of these except the TCS are permeability tuned. Newer units not familiar to most Service personnel have been designed using permeability tuning.

• New light on the old but vital problem of getting maximum frequency stability from the VFO. In comparing the performance of condenser-tuned and permeability-tuned oscillator circuits the author gives us something to think about in our planning of future frequency-control units.

- 5) Vibration
- 6) Warm-up
- 7) Keying ability
- 8) Calibration

Let us consider first:

Tuning Range

When the tuning range of the oscillator is an important factor, the condenser-tuned circuit has an advantage since small minimum-capacities can be obtained, and by using variable capacitors with large maximum-capacities, tuning ranges in excess of 4 to 1 can be attained. Permeability tuning is limited to about 3 to 1 in tuning range and is practical for use on the broadcast band, 500 to 1500 kc. The tuning ratio possible is reduced at high frequencies. In passing, we should mention a variable-inductor tuner (slider on a turning coil) designed for television use which has a tuning range of about 9 to 1.

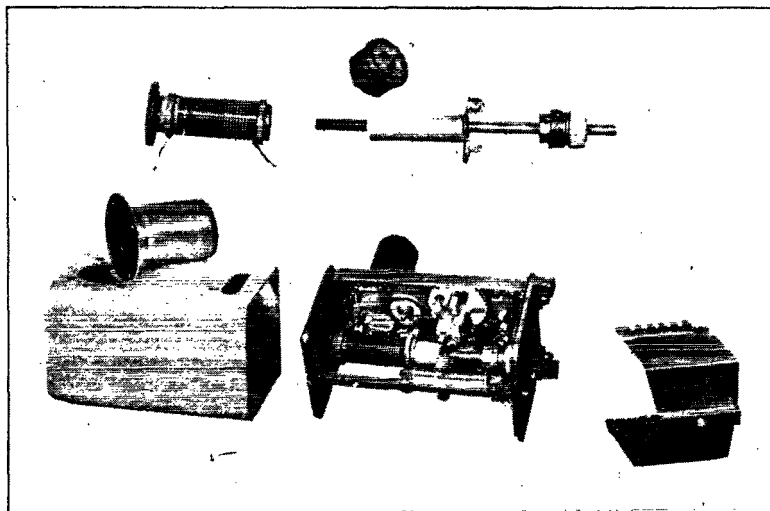

A view of the oscillator with the shields removed to show the internal arrangement. The disassembled permeability-tuned coil and the ceramic tank condenser are shown at the top.

In amateur applications the tuning range need not be more than 1.25 to 1, and either condenser or permeability tuning will satisfy this requirement. The photograph shows a view of circuit components used in a 1 to 1.5 megacycle permeability-tuned oscillator.

In condenser tuning this restricted tuning range allows the use of large values of fixed capacity, and hence frequency variations caused by tube-interelectrode and circuit-capacity variations are minimized. In permeability tuning comparable advantages are obtained; in fact, much higher values of fixed capacity can be used because the value of fixed capacity does not determine the tuning range.

Operating Frequency

A second factor affecting oscillator stability is the operating frequency. The best operating frequency is that frequency which yields the best stability, in parts per million, consistent with the desired output frequency of the equipment. This frequency of maximum stability is obtained empirically through designing and building a large number of oscillators in different parts of the frequency spectrum and then measuring warm-up changes, instantaneous flutters, and other shifts in oscillator frequency. The best frequency stability can be obtained in the range from 500 kc. to 3 Mc. Coils in this range can be of the single-layer solenoid type, which have better dimensional stabilities than the pie-wound coils necessary at lower frequencies. Also, temperature-inductance curves are more linear over a wide temperature range for solenoids.

The upper limit of this region is determined by warm-up and frequency flutter. Warm-up shifts are controlled mainly by the ratio of circuit capacities to fixed tank capacity. The higher operating frequency requires the use of lower values of tank capacity, and consequently frequency variations caused by tube and circuit capacity are increased.

With respect to these changes, permeability tuning has a distinct advantage because larger values of tank-circuit capacity may be used for the same operating frequency. The capacity-tuned oscillator can only approach the permeability-tuned oscillator in this respect where very small tuning ranges are used.

Humidity

In regard to frequency changes due to humidity, the condenser-tuned oscillator does not offer good competition to the permeability-tuned oscillator. When subjected to humidity of 95 per cent a condenser will show a large variation in capacity. This is caused by the variation in the dielectric constant of air because of the presence of moisture. Oscillators using this method of tuning will usually display a frequency shift of approximately 0.1 per cent. In addition, under

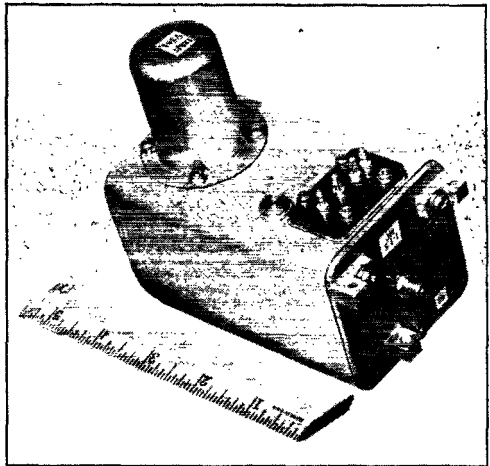

A completely-assembled oscillator made for Service applications. This assembly is sealed against moisture and humidity and covers a frequency range of 1 to 1.5 megacycles.

humidity variation each new subsection of the equipment will give a different answer. With permeability tuning, the changes in frequency under humidity variations are only about one-tenth those of capacity-tuned oscillators, assuming that the tank condenser of the permeability-tuned oscillator is of the sealed type. The main change that occurs is attributable to circuit-capacity variation and leakage. Obviously, increasing the tank capacity increases the stability under humidity variations.

There is only one good way to eliminate humidity effects completely, and that is to design the oscillator so that moisture cannot enter. The photograph shows a view of such a sealed oscillator. However, the cost of producing a unit sealed against moisture is not justified in amateur applications.

Humidity variations are very erratic and unpredictable, but unless this effect is eliminated, other factors in the oscillator cannot be accurately evaluated.

Temperature Coefficient

Temperature coefficients in oscillators are dependent upon the combination of temperature coefficients of the various components used in these circuits. It would be desirable to use zero-coefficient parts throughout, but this is nearly impossible for all components. Hence the experimenter has to use opposite compensations to obtain an over-all zero-frequency variation with temperature. Unfortunately, however, the different components are not linear with respect to temperature, and therefore one has to resort to compensating components with opposite degrees of curvature.

Let us consider the condenser-tuned circuit

first. In this case the variable condenser has to have a zero coefficient in order for us to be able to temperature-capacity compensate the circuit for different condenser settings. If such a variable condenser were available then the procedure would be to compensate the circuit for any setting of the variable condenser and the circuit would be compensated at all settings. However, the construction of most condensers is such that they have positive coefficients ranging from about 10 to 40 parts per million per degree centigrade. There is some variation between condensers because of mechanical strains set up during manufacture. Coefficients vary somewhat as the condenser plates are engaged, being of a higher value with the plates disengaged. In condenser tuning the minimum capacity resulting from feed-throughs, switches, or other small insulators can cause considerable departure from uniformity. A seemingly inoffensive small button-type feed-through insulator can have a capacity of several micromicrofarads with a positive coefficient as high as several thousand, depending upon the material used.

To sum up the compensation problems of a condenser-tuned oscillator: (1) The only way in which capacity compensation can produce uniform results across the tuning range is with a zero-coefficient tuning condenser. (2) When the tuning condenser does not have a zero coefficient, then both capacity and inductive compensation are required for a good temperature coefficient.

The permeability-tuned oscillator requires very careful control of all of the components used. Core mixtures have considerable effect on the temperature coefficient obtained with core "in" and core "out" positions, and powdered-iron

cores do not have a linear relationship with respect to temperature. These variations are not as large as those normally encountered in condenser-tuned oscillators, and it is possible to obtain over-all temperature coefficients of less than two parts per million per degree centigrade over the temperature range of -50 to $+50$ degrees centigrade. This can be accomplished only for tuning ranges of the order of 1.5 to 1 or less. An interesting observation has been that the temperature coefficient is usually better at the high-frequency end of the tuning range than at the low-frequency end, which tends to give a constant frequency change with temperature irrespective of the output frequency.

In permeability tuning the tank circuit can be designed with a low L/C ratio. Large values of tank-circuit capacity permit better control of the temperature coefficient. It should be said that the ceramic engineers have provided some very fine ceramic condensers for use in master oscillators. The cost of the condensers is not great in comparison with their accuracy. As an example, 1000- $\mu\text{mfd.}$ condensers, tested 100 per cent over the temperature range of -50 to $+90$ degrees centigrade, with an accuracy of ± 5 parts per million per degree centigrade, will cost between \$5.00 and \$10.00 each, depending upon the quantities used. While this may sound like a large sum of money for a condenser, still, when it comes to buying a good heart for radio equipment, one should be willing to pay the price. The cost of the condenser is greatly reduced when the ambient-temperature range is restricted. Such a condenser is shown in the photograph.

As an added comment, long-term stabilities of the order of 10 parts per million are obtained for operation over periods of several weeks with temperature-controlled oscillators.

About the Author

• Theodore A. Hunter, WØNTI, was formerly W9NBZ. His interest in radio dates back to his days at the University of Iowa, where he was graduated in 1923 with a B.S. degree in E.E. He received his M.S. in physics a year later. WØNTI's main amateur activities are rag-chewing and experimenting. At present a project engineer for the Collins Radio Co., the author has pursued a varied and successful career. He has been a research assistant in gynecology, obstetrics, psychiatry, and speech correction at the U. of Iowa. He later became a transmission-line inspector for the N. W. Bell Telephone Co., followed by an association with the Crosley Radio Corp. in charge of loudspeaker development. Mr. Hunter has also taught at the University of Pittsburgh and at Rose Polytechnic Institute. He is now serving as chairman of the Cedar Rapids section of the IRE.

Vibration

While vibration is not of too much concern to the amateur, still he wants a VFO that will not require pussyfoot tactics on the part of those entering or leaving the shack.

A method for studying this factor is to place the oscillator on a vibration table and vibrate it between 0 and 60 cycles per second. The frequency flutter is studied by means of a discriminator. A full amplitude of the order of $3/32$ inch is sufficient to make a proper study of this problem.

One of the first things to be observed (using a stroboscope) is the fact that wiring must be carefully tied down, leads must be short, and all components rigidly fixed with respect to each other.

The variable condenser turns out to be the real offender in this problem. It is essential that the condenser be centered electrically in order that it be reasonably free from frequency-modula-

tion effects. Electrical centering can best be obtained by adjusting the axial position of the rotor during vibration in such a way that minimum frequency-modulation occurs. The amount of frequency shift depends somewhat upon the degree of engagement of the condenser plates. Frequency shifts of from one-half to ten kc. will occur at 10 Mc. for 10*g* of vibration. The lower figure is for well-constructed condensers with wide plate spacing, while the larger figure is for close spacing, thin plates and a flimsy frame.

The permeability-tuned oscillator has a problem in vibration in that the core must not change its position inside the coil, otherwise a small amount of frequency flutter will be observed. This flutter can be caused either by axial or sidewise motion of the core with respect to the coil structure. A shift in frequency of about one-tenth to one-fiftieth the amount obtained with condenser tuning is usually obtained for the same vibrational conditions. Here again short leads are essential.

The permeability-tuned oscillator is very much superior to the condenser-tuned oscillator with respect to vibration.

Warm-Up

Since frequency variations during warm-up depend upon the ratio of tube-and-stray-circuit capacity to fixed-tank capacity, the permeability-tuned oscillator is superior to the condenser-tuned oscillator because lower L/C ratios may be used. Permeability-tuned oscillators may be designed with warm-up variations of less than 40 parts per million, the exact value depending upon the type of circuit used and the L/C ratio. Obviously a low value of warm-up drift cannot be obtained unless the temperature coefficient is properly adjusted first.

Keying Ability

Among other factors affecting the keying ability of a transmitter using a master oscillator, there are two which have more importance than the others: first, the frequency of the master oscillator should be independent of plate voltage variation; and second, the keyed wave must be shaped so as to not create transients of such a nature that key clicks will be objectionable.

Considering the first requirement, an oscillator having a limited tuning range such as that required for an amateur application can be made to key equally well whether the tuning be permeability or capacity. In either type of oscillator the variation of frequency with respect to plate-voltage variation should be as small as the designer can make it. As an example, for a plus or minus variation of 10 per cent in the plate voltage the shift can be made to be less than 5 parts per million in either type of oscillator. This is neces-

sary in order that frequency shift or chirp may not be objectionable at the higher orders of multiplication.

In oscillators having tuning ranges of the order of 2 to 1 the condenser-tuned oscillator is superior because of its better plate-voltage coefficient, and variations of the order of 20 parts per million are to be expected for this tuning range for plus or minus 10-per-cent change in plate voltage.

Assuming that the plate-voltage coefficient is satisfactory, then the other important factor in good keying is wave shaping. By this we mean the rounding off of the keyed wave shape in such a fashion that undesirable transients are not present to an objectionable degree.

Keying filters can be designed which will allow keying of the oscillator B+ with a reasonable degree of success. However, the best method of keying seems to be that of allowing the oscillator to run all the time on a subharmonic and then key the amplifier or multiplier stage in some manner. Cathode keying in these stages seems to work well; in this method of keying, the shape of the wave on make and break may be controlled in a satisfactory manner. This form of keying assumes that the oscillator is well shielded and operates at a low power level. Unwanted back waves or interfering signals are not present if this is properly done.

In connection with good keying a word must be said concerning the fact that the master oscillator must be used as a frequency-control device only. It must be expected to deliver but little power to the stage immediately following.

Calibration

The ideal VFO is one that has an accurate direct-reading dial. The problem is simplified if the relationship between frequency and the positioning of the tuning control is linear. In condenser tuning this is very difficult to secure. Permeability tuning offers an excellent opportunity to obtain this desirable feature by using a coil having a variable-pitch winding and carefully-controlled core material. An accurately-made core-positioning mechanism is also necessary.

Absolute linearity cannot be achieved, of course, but calibration errors can readily be reduced to 0.02 per cent or less. Improvement in this figure will be possible with new mechanisms and developments. This value is also dependent upon the tuning range covered; for an amateur oscillator with a tuning range of 1600 to 2000 kc. a possible deviation from linearity would be of the order of 0.01 per cent or less.

If a lead-screw type of positioning mechanism having 16 turns to cover the range of 1600 kc. to 2000 kc. is used, then the following frequency

coverage per division of a 100-division-per-revolution dial would be obtained:

Band, Mc.	Cycles per dial division
3.5	500
7.0	1000
14.0	2000
21.0	3000
28.0	4000

With an oscillator having a maximum linearity error of 0.01 per cent an amateur can rely on his dial reading to within one dial division at 30 Mc., or 4 kc. This assumes that one point on the dial is checked against WWV at the time of operation.

By this time "youse guys" should have gleaned the fact that this old fossil believes permeability tuning to be considerably superior to capacity tuning for ham-oscillator service. All this is in keeping with K. B. Warner's philosophy that each kilocycle of spectrum has the same communication value as expressed in a *QST* editorial several months back. Progress in the frequency-control portion of the amateur's equipment is a foregone conclusion. It is believed that the permeability-tuned master oscillator represents a considerable advance in this portion of the ham gear. One derives considerable satisfaction from being able to select any frequency at random and know that it can be obtained with an error of only 0.01 per cent. In order to obtain this degree of accuracy the operator must of course use intelligence in the installation and operation of the frequency-control device.

Silent Keys

IT IS with deep regret that we record the passing of these amateurs:

W1AHW, Howard A. Brown, Everett, Mass.

W1MLN,* Warren O. Richardson, Waltham, Mass.

W5KWU, Sidney Carroll Enochs, Amarillo, Texas

W6BXB, Edward H. Noack, Stockton, Calif.

W8PSJ, Arthur E. Frankel, Cleveland, Ohio

W9CWG, E. F. Alberts, Keokuk, Iowa

W9NCA, Irving J. Rose, Maplewood, Mo.

VE5LD, D. G. Sturrock, Winnipeg, Manitoba

VK6AZ, J. H. Ager, Youanmi, W. A.

VK6GR, A. H. G. Rippen, Fremantle, W. A.

VK6KS, K. S. Anderson, Nedlands, W. A.

* Erroneously listed as W1LMN in June *QST*.

Propagation Predictions Now Available

ON July 1, 1946, the Interservice Radio Propagation Laboratory ceased to exist as such. At that time, the duties and functions of the IRPL were absorbed by the Central Radio Propagation Laboratory, established at the National Bureau of Standards on May 1, 1946, to act as an organization for centralizing and coordinating basic research and prediction service in the field of radio wave propagation.

The IRPL-D series, *Basic Radio Propagation Predictions*, are, commencing with the July, 1946, issue, now known as the CRPL-D series, and the issue bears the designation CRPL-D23.

Beginning with the July, 1946, issue the CRPL-D series, *Basic Radio Propagation Predictions*, are available on a purchase basis from the Superintendent of Documents, U. S. Government Printing Office, Washington 25, D. C., on the following terms:

Single copy	\$.15
Annual subscription (12 issues)	1.50

The rules of the Superintendent of Documents require that remittances be made in advance, either by coupons sold in sets of 20 for \$1.00 and good until used, or by check or money order payable to the Superintendent of Documents. Currency, if used, is at sender's risk. Postage stamps, foreign money, and defaced or smooth coins are not acceptable. Postage is not required in the United States, to United States possessions, and to countries extending franking privileges. For mailing to other countries, an additional amount of about one-third of the purchase price is required. Remittances from foreign countries should be by international money order payable to the Superintendent of Documents, or by draft on an American bank.

Each issue of the D series gives complete information enabling the user to calculate best sky-wave operating frequencies over any path at any time of day for average conditions for the month of prediction. Predictions are issued three months in advance; thus CRPL-D23 gives information concerning optimum working frequencies for October, 1946.

Although the CRPL-D series is considered to be a monthly supplement to the *IRPL Radio Propagation Handbook, Part I*, nevertheless each issue of the D series is complete in itself, so that it is possible to calculate the best sky-wave operating frequencies without reference to any other publication. The techniques given are improvements on those outlined in the Handbook; some of the CRPL techniques and explanatory material were given in the article by William R. Foley in *QST* for February, 1946. "Forecasting Long-Distance Transmission," and Figs. 6, 7 and

(Continued on page 158)

Foreign Notes

ARGENTINA

The *Radio Club Argentino* is sponsoring a nationwide speed contest both in telegraphy and radiotelegraphy, sending and receiving. Various departments of the government have donated a total of \$8000 to be used as prizes divided among the various classes, including pencil copy, type-writer copy, slip copy, hand sending and semi-automatic sending. The qualifying runs will be held over a long period, to give everyone a chance to compete. The society intends to set up rules for the contest sufficiently similar to American standards so that a fair comparison can be made between top speed records in the various countries.

AUSTRALIA

Easter week-end saw the sixteenth federal convention of the W.I.A., attended by delegates from all districts. In its annual report, the *Institute* stated that 47 per cent of the total membership had entered the armed forces, again proving the value of amateur radio as a training medium. The remaining members formed and operated emergency communications networks in the larger centers, instructed for the military or took jobs in

the factories producing communications equipment for war.

Plans for return to the air were started in May, 1945, and met with wholehearted response from the active members — so much so that the present membership is at an all-time high. Licensing commenced in December, and soon afterward the new regulations were issued which raised amateur standards slightly above prewar requirements.

CUBA

"Cuban hams are just as enthusiastic as ever, and I predict a great future for ham radio here," says R.C.C. President James Bourne, CM2AZ. "Once our bands are clear, things are going to hum here." He refers, of course, to the interference from foreign broadcasting in the 7-Mc. range, which should be disappearing by the time this reaches print. Bourne also notes a strong trend in his country toward radiotelephony, with no special assignments for each class of service.

The society's headquarters station is being rebuilt and soon will be on the air transmitting bulletins of interest to amateurs, to keep in touch with them and keep up their interest in the club's affairs. It is also planned to transmit code practice.

FRANCE

R.E.F. has decided to organize propagation tests during the period of the Bikini atomic bomb trials. Listeners will be "on watch" throughout French territory in Europe and North Africa, planning to follow the transmissions of WWV. They would like to know of any amateurs planning special transmissions during the period. For their own part, French hams will transmit on 14 and 28 Mc. in the hope that foreign amateurs will be listening to observe possible effects on wave propagation.

GLEANINGS

The privileges of Eire amateurs have been extended to 30 Mc. as the upper 10-meter limit, and now include 1.8 to 2 Mc. by special application. They will probably be on the newly-released portions of 20 and 40 before long. . . . From President Montú of the Italian society comes word that amateur licenses for 28 Mc. will be issued very soon in his country, and a government decree to that effect is in the making. In the meantime, fifty provisional licenses will be granted to society

(Concluded on page 184)

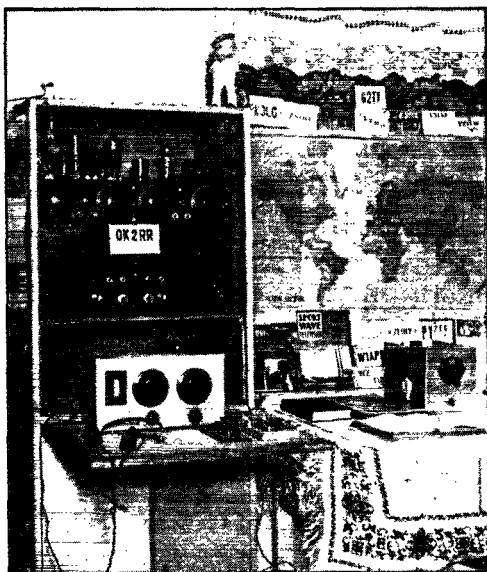

This neat-looking layout belongs to Otakar Halas, OK2RR, secretary of "Sektion Brno" of the Czech society. With 50-watts input and a 58-58-59 receiver, Halas made WAC in 1937.

Raising the Efficiency of the V.H.F. Linear Oscillator

Some Constructional Ideas for Improving Performance

BY GEORGE D. PERKINS,* WIIVU, AND HARRY G. BURNETT,* WILZ

ALTHOUGH parallel conductors of large diameter have long been used as tuning elements in very-high-frequency oscillators, results have often been disappointing — apparently in contradiction of the fact that the linear type of tank circuit has an inherently high Q . Extensive investigations show clearly that the fault does not lie in the linear tank circuit itself, but in the other components to which it is connected.

It is the intent of this article to point out where some of the difficulties lie, and to describe a 140–250-megacycle oscillator which minimizes them. The unit in the photograph has been specifically designed to give optimum performance with the Hytron Type HY75, but the recommendations are equally applicable to oscillators using other v.h.f. tube types.

In analyzing a typical oscillator circuit (Fig. 1) it is seen that there are two inductances, one connected (so far as the determination of oscillator frequency is concerned) directly from the grid to the cathode, and the other from the plate to the cathode. This means that the length of lead that exists between either tube electrode and its associated inductance, whether inside or outside the tube envelope, adds to the total inductance of the circuit. Accordingly, the external tank circuit is always less than a quarter wavelength long; the difference between the actual length and the computed quarter wavelength is determined by the amount of internal inductance and capacitance inherent in the tube. In tubes designed specifically for use at very-high frequencies, interelectrode capacitance and internal lead length have been

kept to a minimum commensurate with manufacturing techniques and selling price.

Nothing can be done about the internal inductance of the lead from the grid structure to the

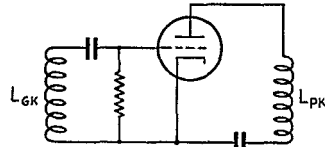

Fig. 1 — Fundamental oscillator circuit.

grid connection cap, but for connection from the grid cap to the line rod, as short and large a conductor as is practical should be used. Obviously, the best connection would be one which connected equally from the circumference of the cap to the circumference of the line, but flexibility would be sacrificed and probably it would become impossible to change tubes. Well-tinned or plated braid with a cap connector which contacts most of the surface of the cap is a satisfactory compromise method. The same type of analysis and treatment applies to the plate connection.

The Filament Circuit

The filament or cathode of an oscillator must be at the proper r.f. potential with respect to the grid and plate for greatest operating efficiency. Usually the filament should be at or near ground potential. This condition, however, cannot be achieved merely by grounding the filament, because the filament has connection leads to it and the filament wire itself has considerable length

*Engineering Dept., Hytron Radio and Electronics Corp., Salem, Mass.

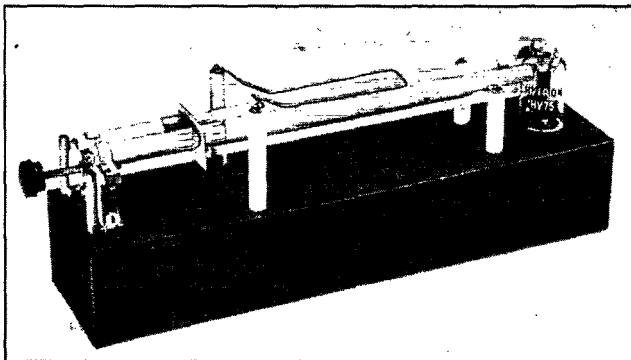

⋄

A linear oscillator with a tuning range from 140 to 250 Mc. and incorporating a number of features that improve operating efficiency in this v.h.f. region. Careful attention to detail results in considerably-enhanced output over ordinary linear-oscillator circuits.

⋄

and consequent inductance. Certain steps are necessary, therefore, to eliminate or minimize the effects of the inductances appearing within the tube. When such measures are taken, it is possible to improve performance remarkably.

Given a length of wire on which standing waves are present, it is possible to locate two points a half wavelength apart that are at the same potential, as shown in Fig. 2. If one of these points is grounded, then the other point will assume the same potential as the ground. By adding enough inductance to the existing inductance of the filament in the form of r.f. chokes to produce this standing-wave effect, and then by grounding the ends of the added inductances, the filament can be brought to ground potential. The inductance required in each filament lead may vary from one tube type to another, dependent upon the length and size of the filament wire used in the tube. Like other tuned circuits, the chokes are somewhat critical as to dimensions.

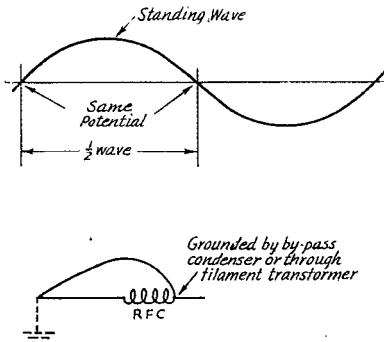

Fig. 2 — Voltage distribution on a line and an equivalent half wavelength obtained by adding concentrated inductance to a short line. The inductance loading provides a means for bringing two physically-separated points, such as the tube filament and ground, to the same r.f. potential.

Experience proves the filament chokes serve efficiently at frequencies higher than the one for which they were designed, but very poorly below that frequency. In the oscillator shown in the photograph and in Fig. 3, the chokes work well from 140 to 250 Mc., but for the higher frequencies of this range an increase in output power can be obtained when chokes are especially wound for the frequency used. As an example of the results that can be accomplished when care is taken in tailoring the chokes, the useful output from the oscillator — for the same d.c. input — varies from about 8 to 14 watts when only the inductances of the chokes are varied.

The Blocking Condenser

In order that the tube may supply energy to the oscillating circuit and antenna, it must be furnished d.c. power at the proper potentials for

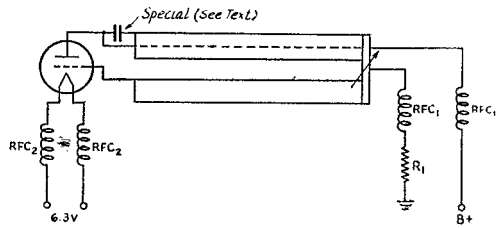

Fig. 3 — Circuit diagram of the 140-250-Mc. oscillator shown in the photograph. The line is constructed of $\frac{1}{2}$ -inch tubing, silver-plated, the grid tube being 15 inches long and the plate tube $14\frac{1}{2}$ inches long. Length in use is adjusted by the shorting bar shown in Fig. 5. Center-to-center spacing of the conductors is 1 inch. R_1 — 5000 ohms, 10 watts. RFC_1 — 40 turns No. 28 spaced to occupy a length of $1\frac{1}{8}$ inch on $\frac{1}{4}$ -inch diameter form. RFC_2 — 27 turns No. 18 enameled closewound on $\frac{3}{8}$ -inch diameter form.

Construction of the plate blocking condenser is shown in Fig. 4 and described in the text.

the respective electrodes. The plate potential is determined by the supply voltage, but since the tank circuit is connected directly from plate to grid for r.f., the d.c. plate voltage must be prevented from reaching the grid. A blocking condenser is the answer. Choice of the type of condenser is probably the most important single factor in determining the ultimate successful operation of the circuit. Until recently, fixed or variable condensers with losses low enough to be considered for use at these very-high frequencies had lead inductances great enough to offset seriously the advantages of the linear circuit.

The requirements of the ideal condenser are high capacitance (for low reactance drop), low losses, compactness, mechanical rigidity, high-voltage break-down, and zero lead inductance. All of these features have been achieved in a special condenser, the construction of which is shown in Fig. 4. The two plates of this condenser are the plate line itself and a short length of tubing inside and concentric with the plate line.

This blocking condenser's high capacitance and low reactance result from the close spacing of two concentric lines separated by material with a high dielectric constant. The insulation is polystyrene, and its low-loss factor, combined with silver-plating of the concentric plates of the condenser, reduces losses to a minimum. The condenser is

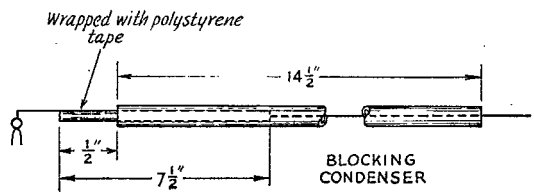

Fig. 4 — Construction of the plate blocking condenser. The inner tube has a diameter of $\frac{3}{8}$ inch and, like the resonant line, should be silver-plated.

compact, mechanically strong, and has no lead inductance, because it is an integral part of the linear tank. Consequently it requires no additional space and has the same rigidity as the tank. The value of capacitance (approximately 500 $\mu\mu\text{fd.}$) is large enough to give maximum feed-back, but not so large as to cause the "blocking" that results from a long time constant in the circuit formed by the condenser and grid-leak resistance.

The construction of the blocking condenser must be carried out with care. The polystyrene tape should be overlapped as it is wrapped around the inner tubing. It should not be pulled too tight, however, or stresses will occur in the outer layer at the edge of the underlying turn, with consequent possibility of voltage break-down. Be sure the wire for the plate supply is soldered into place before beginning the condenser winding. If the tape is wrapped smoothly and without wrinkles, you will find that the width of overlap increases steadily. With $\frac{1}{4}$ -inch tape, nevertheless, the winding can be done without starting a second overlap. The smaller diameter tubing should slide freely within the outer line with clearance enough for the wrapped polystyrene tape, but the fit should not be wobbly or loose. Use great care in sliding the wrapped tubing into the outer tube so that no breaks or tears will occur.

Proper spacing between the inner and outer tubing, plus careful handling of the insulation problem, give this condenser a large safety factor for the normal voltages encountered when a tube such as the HY75 is operated at maximum rated input.

Tank Construction

While the values and dimensions used in the oscillator pictured are not the only ones which will work, it has been found through a long period of experimentation and by making innumerable measurements that this set of values and dimensions contains the optimum for each component when combined with all the others.

The length of the linear tank determines the frequency of oscillation. The tank can be tuned by varying its effective length by adjusting a multi-contact sliding shorting bar. The construction of a good shorting bar represents the most complicated mechanical problem in building a linear oscillator, because the bar must be smooth in operation and have low contact resistance. The shorting bar shown in Fig. 5 is built entirely of brass and requires some machining. The short lengths of tubing are of thin-wall brass. Slots are cut in the ends of the tubing — preferably on a

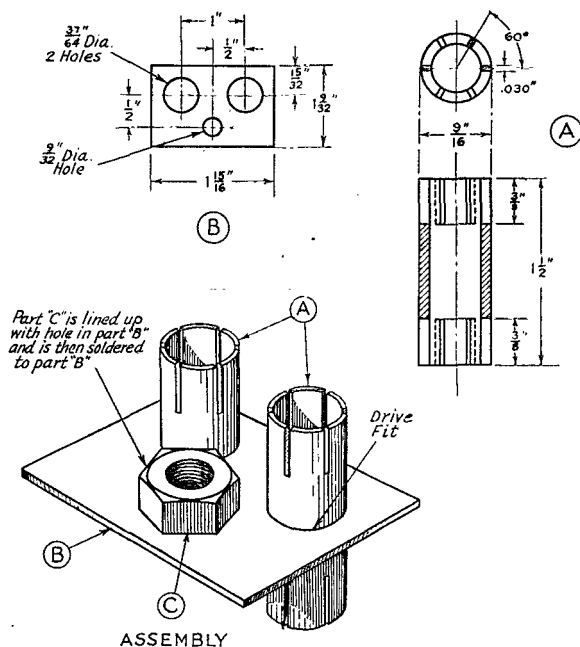

Fig. 5 — Shorting-bar details. "C" is a $\frac{1}{4}$ -inch brass nut serving as part of the drive mechanism. It is engaged by a threaded fiber rod, mounted as shown in the photograph, for knob tuning.

milling machine — although they can be cut with a hacksaw and cleaned up with a fine file.

The r.f. assembly is supported at one end by an insulating block of bakelite or some similar material. Inasmuch as this end of the line is cold with respect to r.f., low-loss insulation is not necessary. The line supports close to the tube, however, are at a high r.f. potential, and should be made of low-loss material. Losses are reduced by a long insulation path such as is obtained with the stearite stand-offs. The insulating block which supports the linear tank should be carefully cut and filed to shape, so that the lines will maintain correct alignment for smooth operation of the shorting bar.

Dimensions given for the diameters of the tubing used in making the tank circuit may not be identical with those of tubing you will find available. Some judgment must be exercised in making a choice. The clamps for mounting the lines on the stand-offs can be bent and drilled from sheet brass; the same type of clamp is used to hold the lines to the insulating block. Bend the clamps to fit smoothly around the tubing. When all metal parts have been cut to size, the braid, cap clips, mounting clamps, and connecting lugs soldered or brazed into place, and the shorting bar assembled and soldered, it is well to have all these parts silver-plated. In time all metals will oxidize, but the oxides and sulphides of silver have less resistance than do those of other commonly-

used metals, and a silver-plated tank will maintain high operating efficiency almost indefinitely. Most shops equipped to silver headlight reflectors will silver-plate all the parts to a thickness of 0.001 inch for approximately \$2.50 to \$3.00.

Make the tuning drive of any insulating rod that will take a thread. Metal should not be used for this purpose, because it absorbs too much energy from the circuit. Fiber rod can easily be threaded with a 1/4-inch-20 die if the rod is held in a vise so that only a small portion of it is worked on at a time; when the portion being worked on is too long, the rod has a tendency to twist and break. If it is intended that the unit be operated only on the lower-frequency band, the length of the rod can be decreased. A piece 8 inches long will be satisfactory up to approximately 160 Mc. The rod is prevented from sliding back and forth in the supporting block by nuts on each side of the block; these nuts should be tightened sufficiently to prevent back-lash, but not enough to cause binding. A further refinement is the use of a spring washer against one side of the block. Any knob which fits a quarter-inch shaft is satisfactory for the tuning control.

The r.f. chokes may be wound on high-value resistors or the special forms now available for this purpose — or simply on any insulating material of the correct dimensions. The wire of the filament chokes is large enough to be self-supporting, but the plate and grid chokes must have heavier supporting lead wires than the wire used for their windings.

In the oscillator shown, grid and plate leads are brought through the chassis by the machine screws which hold the supporting block. These screws must, therefore, be insulated by means of fiber shoulder washers. The grid resistor must be mounted close to its feed-through connections, because a long connecting wire at this point upsets the operation of the grid choke. In fact, if the resistor is mounted down near the tube socket, satisfactory operation cannot be obtained because of interaction between the resistor and the filament r.f. chokes.

Tuning Up

The correct d.c. grid potential for the oscillator is obtained by utilizing the rectified grid current flowing to cathode through a resistor. A grid resistor value of 5000 ohms is best for most HY75s, but in individual cases an improvement may occasionally be made by changing to a somewhat higher or lower value. For optimum performance the grid current should be 20-25 milliamperes when the circuit is loaded to 80 milliamperes with 450 volts on the plate.

The value of grid resistor to some extent controls the amount of grid excitation. At a lower value of grid resistance in a given circuit, a higher value of grid current is obtained, whereas, with a higher value of resistance, lower current

results. In different transmitters employing the HY75, it may be found that there is a wide-variation of the optimum grid resistance. This is because the individual circuits have different values of feed-back to the grid circuit. With the coaxial plate-blocking condenser, a high value of circuit feed-back is obtained, accounting for the fact that the recommended value of grid leak in this circuit is somewhat higher than values commonly used for the HY75. It should be noted also that, for optimum performance, the grid leak should be varied for changes in plate voltage. Remember, too, that a slight adjustment of the grid-leak resistor may provide improved modulation capability.

It is advisable to use a 10-watt resistor as the grid leak, because when the oscillator is unloaded (such operation is definitely not recommended) the power dissipated in this resistor rises to values above 6 watts. When the tube is operating under the conditions given above — which, incidentally, are the maximum ratings without modulation — the oscillator will supply about 14 watts to the load.

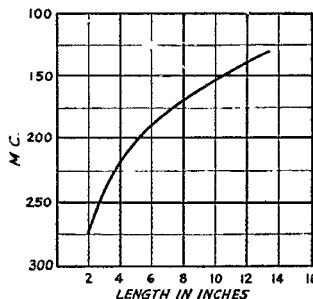

Fig. 6 — Oscillator frequency as a function of line length. This curve is indicative only, since the exact frequency will depend upon the individual tube and line.

If the tube is operated as a modulated oscillator at maximum ratings, the plate potential should be reduced to 400 volts when operation is to be at 2 meters. A plate current as high as 80 milliamperes is permissible if a high operating efficiency is obtained. Useful power output (total plate power less grid drive and circuit and radiation losses) should be approximately 11 watts. Modulation capabilities, as indicated by a cathode-ray oscilloscope, show that good linearity is possible up to almost 80 per cent modulation, which is sufficiently high for a modulated oscillator. Any 15-watt modulator for operating into a 4000- to 6000-ohm load should work nicely.

The antenna can be your own choice. The size of the pick-up loop and its distance from the lines will permit matching to transmission lines of almost any impedance. The higher the impedance, the larger the loop required.

The curve shown in Fig. 6 gives the length of line actually in the circuit for any frequency with-

in the oscillator's range. Since individual tubes will vary in interelectrode capacitances and lead inductances, the performance of each transmitter will vary slightly from that indicated on this curve. The curve should not be used until the frequency of your unit — with your particular tube — has been accurately checked at a few points. A correction factor can then be applied to the curve. If more than one tube is likely to be used, this correction factor must be determined for each combination of unit and tube. All frequency measurements should be made with the antenna connected, because whatever reactance the antenna presents, however small, will cause a change in the oscillator's frequency. Measurements should be made from the end of the grid-line tubing to the nearer side of the shorting bar.

While a modulated-oscillator transmitter ob-

viously cannot compare with a crystal-controlled transmitter at the very-high frequencies, this unit is a relatively stable and reliable performer. Although the total plate power input is modest, the useful power output is sufficiently great to command attention on the "ham" bands. In addition, the transmitter can be used as a stable oscillator to drive an amplifier to really husky output on the v.h.f. bands. For example, two HY75 tubes in a neutralized push-pull amplifier can be driven to a useful output approximately three times that of this oscillator. Tubes in push-pull operate somewhat more efficiently, and in addition, the grid drive and bias losses of the amplifier are supplied by the driver. These reasons account for the multiplying factor of three — rather than slightly more than two — times the output from a single-tube oscillator.

WANTED — HAMS FOR OVERSEAS

A DEPARTMENT of the United States Government has need for civilian radio operators, technicians, and operator-technicians for interesting overseas duty. Men with appropriate experience will be selected to operate and maintain radio-telegraph stations in various parts of the world, qualifying and operating under Civil Service regulations, with attendant benefits.

The work, involving considerable travel, has particular appeal to radio amateurs, often calling for the special sort of ingenuity with which hams are endowed. The pay is good, ranging from \$2600 for apprentice operator-technicians to \$3499 for assistant chief operator-technicians, *plus* generous subsistence allowances of from \$1000 to \$2000, depending upon location. There is opportunity for further promotion within the organization, to such grades as chief operator-technician at considerably-higher salaries. All transportation is furnished. It is expected that living quarters and transportation for families will be available at a few locations. Men employed for this work will be sent, whenever possible, to a country of their choice. The normal period of overseas service is eighteen months.

Requirements range upward from the minimum (apprentice operator-technician): code speed of 18 five-letter groups per minute, one year's experience in professional or amateur radio, ability to handle simple maintenance.

At the top of the list is chief operator-technician, for which applicant must hold, or have held, a radiotelegraph 1st or 2nd class or radiotelephone 1st class license, and he *must* hold, or have

held, an amateur radio ticket, must be thoroughly familiar with maintenance of communications-type receivers and able to design and construct c.w. transmitters of medium power. He also must be familiar with common models of commercial and military equipment and be well versed in radio propagation, including ability to make practical use of Bureau of Standards publications on that subject. Code speed requirement is 25 code groups per minute (typewriter). He must be able to supervise a large radio station (up to 30 positions).

Ratings in between apprentice and chief operator-technician require a proportionate amount of experience and operating ability. Any ham who is interested should be able to qualify quite easily for one of these ratings, particularly if he has recent military communications experience.

Incidentally, many hams now employed in foreign lands by this department find ample opportunity and leisure to do a bit of ham operating "on the side," signing calls the ardent DXer dreams of.

If you are *genuinely* interested in applying for one of these openings, please write "Overseas Operation," c/o ARRL Headquarters, stating fully what radio experience you have had, how long licensed and what grades, code speed (groups, using pencil and/or typewriter), age, marital status, etc. The government department requesting our help in obtaining personnel is not able to engage in lengthy correspondence with applicants so please describe your qualifications fully.

For Beginners Only

The Prevention of Growing Pains Without Surgery

BY W. H. FRASER *

THE NEWCOMER to the ranks of radio-receiver construction-at-home is very likely to be stalled sooner or later — usually sooner, as many veteran blooper-builders will recall — by some minor problem in this most entertaining and interesting hobby. He will be stopped like a new bus testing its vacuum brakes on an uphill run, and all by some point that is a mystery merely because he is a beginner and the writer of the how-to-make-it article took it for granted that his readers knew the meaning of the minor point in question. Quite obviously, however, authors of such set-building descriptions could not explain in full everything about all parts, currents and connections in every radio manuscript without making each issue of this magazine slightly larger than a thick telephone directory.

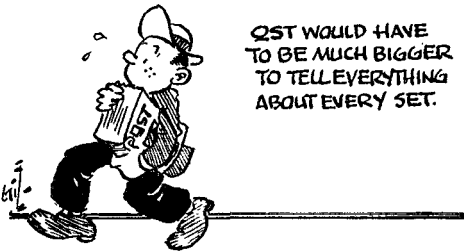

On the other hand, since our tyro kilocycle catcher will be living without sleep once he gets bitten by the set-building bug, he must at all costs be kept happy though sane by feeding him goodly portions of practical tips, kinks and circuit explanations — hence this story. At the start our newcomer needs a peculiar blend of information about parts, testing without special meters and fancy equipment, and wiring *plus* certain timely pointers which will, in one uneasy lesson, allow him to blossom forth in the necessary working combination of electrician, carpenter, plumber and barber. So we can picture our eager reader as an average citizen who has just found one or two \$8 bills and who knows that at long last he can buy those few parts needed — if the store has them in stock — and actually make a real radio with his own little solder-scarred hands and elbows.

Our reader knows — we're telling him — that wood, glass, rubber and bakelite, not to mention porcelain, steatite and mica, are all *insulators* (nonconductors) of varying degrees of excellence.

* 30 Eastmount Ave., Toronto, Ont., Canada.

• Many of us are inclined — and eager! — to forget our early trials and tribulations with radio theory and practice, when practically everything from “A” battery to Zepp feed was a mysterious never-never land where the language was Greek, to say the least. The author of this story apparently hasn't forgotten, and has taken the time and trouble to show our newcomers that one needs mostly patience and no fear to get a rough idea of what goes. Reading this won't necessarily qualify you for a Ph.D., but it may help to start you on the road.

Wood is not very good as insulation, and when wet is almost no good . . . and while glass is good it is not very useful for our work, because it is a little difficult to saw, bend or drill. Our reader also hereby knows that copper wire, steel, aluminum, solder, brass and man are as a rule good *conductors* of electricity. The latter animal is also both a resistor and a condenser, in some respects, as one who continues to experiment will soon learn.

Luckily for us, the average small radio is composed largely of resistors and condensers, both fixed and variable, and of copper-wire coils (inductances) such as your tuning coil or an r.f. choke. And “r.f.” simply means “radio frequency,” the high-frequency alternating current

GOODLY PORTIONS
OF THE RIGHT STUFF WILL
KEEP HIM HAPPY
THOUGH SANE.



that is coming in from your antenna. The antenna wire connects to your receiver's ANT binding post, and this post in turn must be *insulated* from the metal panel or base. The metal panel and base are useful because not only are they used for the necessary *shielding* from undesirable outside signals not coming in through the antenna, but any wire that goes to “ground” in the wiring diagram can be a short lead connected to a bolt

in the metal or soldered directly to the metal. Many receivers do not need an external ground connection — a wire from the metal receiver base to a water pipe — because it sometimes reduces the signal strength, but you can soon tell which is best for your particular receiver by trying the connection. Sometimes an external ground connection is necessary to reduce hum picked up from nearby electric-light wires, and also additional shielding may help to reduce hum. Getting back to antennas, you can often hear many signals with but 5 to 20 feet of wire draped around the room for an antenna, but usually a connection to an outdoor "sky hook" means better DX.

Those various resistors are obstacles in the way of electric current, and any given value of resistor — values are expressed in "ohms" — will require a higher voltage across it to push a given amount of current through the resistor than would a resistor of lower resistance or ohmic value. The text books call this Ohm's Law and will worry you with equations about the action, but visualize the resistor as a current stopper and you will have won half the battle. In a resistor, the above remarks apply to any current regardless of frequency, but a condenser is a slightly different horse. A good condenser actually blocks d.c. (direct current), while in an a.c. (alternating current) circuit it acts more like a resistor, and for high frequencies any given condenser will require less voltage to push a given current through than it will at low frequencies. R.f. (radio frequency) is only a high-speed (or high-frequency) kind of alternating current. The *Handbook* and other texts will give you a more complete story on condenser action with a.c. applied to it.

Capacitor is another term for condenser, and they are made in fixed, variable and adjustable types, as are inductors and resistors. A variable unit in radio terminology is one having a movable element whose control shaft, arm, slider or wire with spring clip on one end lets the operator change the capacity, resistance or inductance of the unit, as is required in tuning, changing output volume, control of regeneration or the like. Any such variable component is shown in circuit diagrams with an arrow or pointer to indicate that it is capable of variation. In practice, a tuning condenser, for example, has as its control a metal shaft which is joined to the rotor (movable) plates. If the shaft bushing goes through a hole in a receiver's metal panel, with a nut holding the bushing securely to the panel, the shaft and rotor section is well grounded, without any wire connection, and this is the correct procedure except at frequencies above 28 Mc., where it is often necessary to run the ground connection through a short heavy lead back to the coil and other components instead of depending upon the panel and chassis for the connection. One case where the rotor is not grounded, however, is that of a small antenna-coupling condenser. As a general

rule, the stator (fixed plates) is never grounded, and of course the rotor and stator plates should not touch or scrape during any point of the rotor's travel.

In the usual volume control (high-resistance variable unit of 50,000 ohms to 1.0 megohm or thereabouts) the *arm* terminal is usually the central one of three terminal lugs. No lug on this unit, nor wire leading from a lug, should touch any other lug or wire lead on the unit. Practically all variable units of this type, with three connections, are called "potentiometers" and more familiarly "pots." Low-value variable resistors are sometimes used in filament circuits of vacuum tubes, and in this application they are often called "rheostats." A rheostat will control filament power (to increase tube life) where, for example, one has two dry cells of 1½ volts each connected in series (to give 3 volts) and the tube filament requires only two volts. The resistance of the rheostat connected in series is adjusted until the voltage across the tube filament is two volts and you are in business. And you should know that the "volt" is the unit of electrical pressure, the "ohm" is the resistance unit and the "ampere" or "amp" is the measure of current flow. If you didn't know that microfarads or micromicrofarads refer to condenser *capacity*, and inductance is measured in henrys and fractions of henrys, just read on and tell no one.

The smart lads may try to confuse you with some of these units, but they are pretty simple when you get down to it. High values of resistance may be given in "megohms," which means "millions of ohms," and hence a 2-megohm resistor is a 2,000,000-ohm resistor. The same prefix ahead of cycles signifies "millions of cycles," and most of our high-frequency bands are identified in megacycles, or "Mc." In the broadcast band, frequencies don't run as high and thus the station frequencies are given in "kilocycles," or "thousands of cycles." But no matter where you run into them, a *meg* is a million and a *kilo* is a thousand. Another dodge they have for confusing you is in the small values. For example, if Joe Key tells you to use a "point (decimal) triple-0-one mike condenser," he is talking about a 0.0001-microfarad condenser — it might be fixed or variable — but Jim Switch might come along five minutes later and call the same condenser a "100 micromicromike" unit. What he means is 100 micromicrofarads. The farad is the unit of capacity but is much too large and is seldom if ever encountered in practical work. The prefix "micro" means "one millionth" and "micromicro" means "one millionth of a millionth." Microfarad is abbreviated "μfd." and micromicrofarad is abbreviated "μμfd." The same condenser can be 0.0001 μfd. or 100 μμfd. because you get from one system to the other by moving over the decimal point an even six places.

Neither need you fret nor give up at the mention

Fig. 1 — Some of the common symbols used in wiring diagrams. These will vary slightly in different publications, but usually they can be easily recognized.

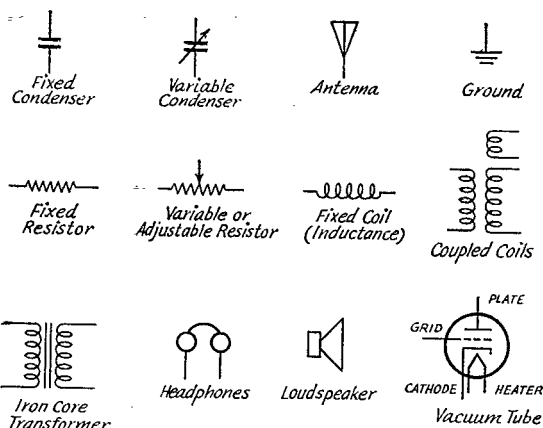

of parts, tube filaments or batteries in *series* or *parallel*. There is an easy way to picture these two important distinctions in your mind: think of a *series* connection as a string of beads, or perhaps as a row of men holding a rope for a tug-of-war. If one bead, or one man, and the portion of string or rope attached thereto is removed, the chain is broken — and so is our series electrical circuit. Then picture a parallel hook-up as a ladder with two equal sides and several parallel rungs. Removing one rung does not prevent the other rungs from functioning in the ladder, and removing one unit from a parallel circuit does not impair the operation of the other units nor open the circuit.

Short direct leads are best in radio construction, and sometimes are absolutely essential in grid and other r.f. circuits. Filament and other power-lead connections need not be short for electrical reasons, but they help to keep the work neat if they can be made not too long. When wiring small mica condensers into circuits, it doesn't matter which end of the condenser is connected to the part of the circuit involved, but paper condensers should be installed with the lead marked "Outside Foil" connected to ground where the condenser is used as a by-pass. The polarity of electrolytic condensers is important and should be observed if they are used in the equipment. A simple test for a condenser that will save your burning out valuable parts is to connect temporarily the condenser, a "B" battery (45 volts or more) and a small lamp all in series. If the condenser is not shorted, the lamp will not light, but if the condenser is shorted the lamp will flare up and possibly burn out, but you will know that the condenser is not to be used. This test should not be made with large condensers of 0.5 μ fd. or more, since it is possible to burn out the lamp without the condenser being shorted. You will understand the reason for this when you learn about "charging current" and other details of condenser operation.

But away with theory and inspection and test, you say, and let's get this first little gadget *wired!* The circuit diagram shows that a certain terminal on one unit is connected to a certain terminal on another unit or several units. Remembering to run our wires as short and direct as possible, we want also to remember that soldered connections

are much less likely to give us trouble with poor contact than plain mechanical connections. Proceed as follows: clean (with knife, file or sandpaper) the wire end and the lug to be joined, unless either or both are of the tin-dipped variety, make a snug but not complicated mechanical junction or union of wire and lug, and then apply heat with a clean soldering iron. A second or two later touch your rosin-core solder to the heated junction, via the hot tip, and when the solder has made a smooth pool, remove the solder and iron and stand back and admire your handiwork. If you are honest, it will be a little easier to admire your work after the tenth or twentieth connection, but it isn't much of a trick to do a neat job, once you get used to the flow of solder and the amount of heat necessary for the job. If you make plug-in coils, be careful about soldering the wire ends in the prongs of the coil forms. The prongs should be cleaned inside and the wire scraped clean, because it is necessary to flow the solder *inside* the prong, and solder will only flow over a *clean* surface. If you leave any blobs of solder on the outside of the prongs, you may find the coil can't be plugged into the socket so a neat job really pays off.

Thus endeth the first lesson. Keep a pilot light burning in the dial window, and don't forget to write!

About the Author

• W. H. Fraser has been a contributor to almost 50 different publications during his writing career, and though he knows the code, has built lots of gear, and was engaged in radar parts inspection work during the war, he has not as yet succumbed to the urge to get a ham ticket. He admits to a gradual weakening on this point, however, and we may be hearing a new VE3 in the near future.

Applying A.M.D. to the Communications Receiver

An Adapter Unit for B.F.O.-less C.W. Reception

BY D. A. GRIFFIN,* W2AOE, AND L. C. WALLER,* W2BRO

THE BASIC principles of *audio modulated detection* have already been discussed.¹ This article will describe a practical A.M.D. adapter unit with which almost any conventional communications or short-wave broadcast receiver can quickly and easily be converted to the new system, provided that the receiver employs a diode second detector.

There are numerous ways in which the design of an A.M.D. adapter might be approached. For example, it can be made with a single fixed-frequency audio oscillator, with an oscillator having several spot frequencies selectable with a switch, or with one having continuously variable frequency. The adapter can be used with or without a selective a.f. filter, although the ability to use a good audio filter is one of the outstanding advantages of A.M.D. The filter can be built into the adapter unit, or it can be inserted separately between the receiver and the 'phones or loudspeaker.

An adapter unit constructed by the authors is shown in several views in the accompanying photographs. The schematic circuit is shown in Fig. 1. Basically, the adapter consists of five parts, four of which are shown in the block diagram of Fig. 2 and the fifth in the schematic of Fig. 5. Each part will be discussed in detail.

The Audio Oscillator

The performance requirements for the a.f. oscillator are as follows:

- 1) Variable frequency from 350 to 1100 c.p.s.
- 2) Fairly good waveform.

*Communication Measurements Laboratory, 120 Greenwich St., New York 6, N. Y.

¹See article, "Audio-Modulated Detection," *QST*, July, 1946, by the same authors.

• Following up the article by the same authors in July *QST* describing the principles of modulated detection of c.w. signals, this article discusses practical circuit details and operation. A.M.D. can be used with most communication receivers without a single change in the wiring of the set.

Before attempting to use A.M.D., go back and reread the July article so you'll know what it is and how it works.

- 3) Output impedance suitable to work into a 0.5-megohm load.
- 4) Reasonably-constant output voltage of about 40 volts r.m.s. over the entire frequency range.
- 5) Fairly independent of tube characteristics.

A 6SL7 tube connected as a phase-shift cathode-coupled oscillator, as shown in Fig. 1, meets these requirements very nicely. The main frequency-determining components are the condensers C_3 , C_4 and C_5 , and the resistors R_5 , R_6 and R_7 . Normally, these resistors would all be ganged potentiometers of equal value, but for the limited frequency range desired it was found adequate to make R_7 fixed and employ ganged potentiometers for R_5 and R_6 only. The value of capacitance to be used at C_3 , C_4 and C_5 is approximately determined by the relation $C = 10^6 / 4\pi Rf$, where C is in microfarads, f is in cycles per second, and R is in ohms. Each of the three resistance branches is normally made equal to R . For example, if R is made 50,000 ohms in all three branches, and a midrange frequency of 800 c.p.s. is chosen, substitution of these values in the equation given above produces a value of 0.002 μ fd. for C . The actual frequency range obtained using 0.0022 μ fd. turns out to be 340 to 1150

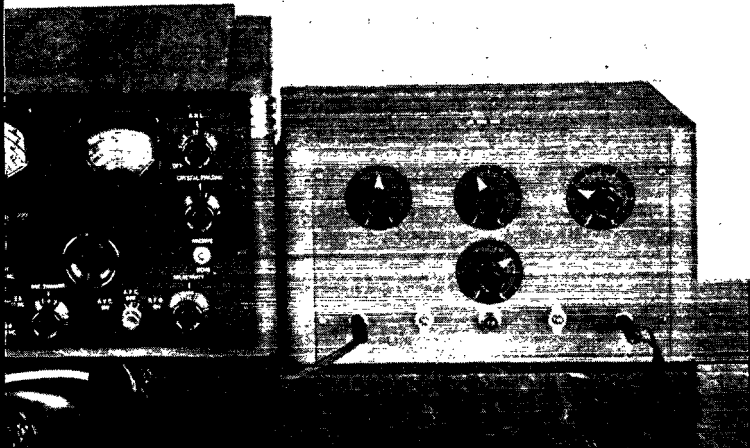

The A.M.D. adapter unit, complete with power supply in a metal cabinet, can be used with any communications receiver having a diode second detector. No wiring changes need be made in the receiver.

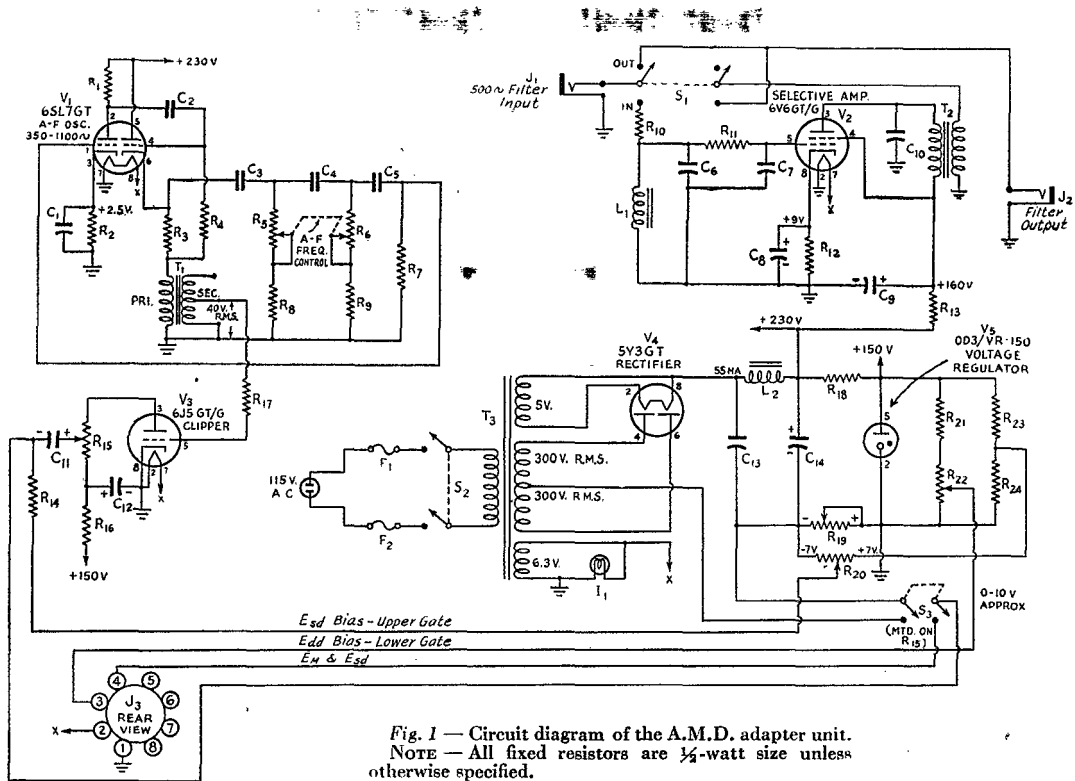

Fig. 1 — Circuit diagram of the A.M.D. adapter unit.
NOTE — All fixed resistors are $\frac{1}{4}$ -watt size unless otherwise specified.

- C₁, C₆, C₁₀ — 0.5- μ fd. paper.
- C₂ — 0.001- μ fd. mica.
- C₃, C₄, C₅ — 0.0024- μ fd. mica, $\pm 5\%$.
- C₇ — 0.004- μ fd. mica.
- C₈ — 25- μ fd. 25-volt electrolytic.
- C₉, C₁₄ — 16- μ fd. 450-volt electrolytic.
- C₁₁, C₁₂ — 20- μ fd. 450-volt electrolytic.
- C₁₃ — 1- μ fd. 500-volt paper.
- R₁ — 0.15 megohm.
- R₂, R₁₄ — 10,000 ohms.
- R₃ — 1000 ohms.
- R₄ — 1 megohm.
- R₅, R₆ — 0.1-megohm carbon potentiometers, ganged.
- R₇ — 50,000 ohms, $\pm 5\%$.
- R₈, R₉, R₁₀ — 15,000 ohms, $\pm 5\%$.
- R₁₁ — 0.1 megohm.
- R₁₂ — 500 ohms.
- R₁₃ — 4000 ohms, 10 watts.
- R₁₅ — 500-ohm wirewound potentiometer.
- R₁₆ — 1300 ohms.
- R₁₇ — 0.5 megohm.
- R₁₈ — 1750 ohms, 20 watts.

- R₁₉ — 200-ohm wirewound potentiometer.
- R₂₀, R₂₂ — 5000-ohm wirewound potentiometer, $\pm 5\%$.
- R₂₁ — 68,000 ohms, 1 watt, $\pm 2\%$.
- R₂₃ — 15,000 ohms, 10 watts $\pm 5\%$.
- R₂₄ — 1100 ohms, $\pm 5\%$.
- L₁ — 0.2 henry ($Q = 12$ at 500 c.p.s.).
- L₂ — 10-henry filter choke, 65 ma., 460 ohms.
- F₁, F₂ — 3-amp. fuse
- I₁ — Pilot lamp, 6.3-volt.
- J₁, J₂ — Single-circuit jack.
- J₃ — Octal socket (for cable-to-diode adapter).
- S₁ — D.p.d.t. switch, toggle.
- S₂ — D.p.s.t. switch, toggle.
- S₃ — D.p.s.t. switch, volume-control mounting on R₁₈.
- T₁ — Audio transformer (see text).
- T₂ — Audio transformer, primary inductance 0.2 henry ($Q = 8$), secondary to match 5000 ohms from 6V6 plate.
- T₃ — Power transformer, 300 v. each side c.t. at 60 ma., with 5-volt 2-amp. and 6.3-volt 2-amp. filament windings.

c.p.s. Resistors R_8 and R_9 are necessary as minimum circuit values, because the oscillator does not work properly if the resistance is made too low in any branch. Neither frequency range nor voltage output is greatly affected by tube characteristics. The output from the secondary of T_1 is about 80 volts r.m.s. Transformer T_1 can be any ordinary interstage a.f. transformer having a turns ratio of 1.5 to 1 (step-up). In this adapter a 3 to 1 transformer is employed, but only one-half of the secondary is used. This arrangement provides about 40 volts r.m.s. for the input circuit of the clipper tube, V_3 .

The Clipper

The performance requirements for the clipper stage, or square-wave shaper, are about as follows:

- 1) Same frequency range as the audio oscillator.
- 2) Peak square-wave output range of 0 to 4 volts.
- 3) Excellent output-voltage stability.
- 4) A square-wave voltage having a not-too-rapid rise and decay time.
- 5) Low output impedance suitable for working into a 10,000-ohm load without appreciable effect on the waveform.

A 6J5 type tube connected as a sine-wave

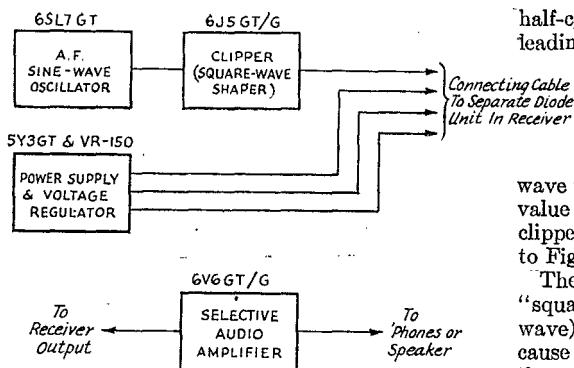

Fig. 2 — Block diagram of the main A.M.D. adapter unit.

clipper (see V_3 in Fig. 1) serves the purpose very well. This tube is operated with zero bias so that under no-signal conditions it draws about 16-ma. d.c. plate current. On the positive half cycles of the a.f. grid signal supplied from T_1 , the grid draws a small amount of grid current, which develops a negative bias across the grid leak R_{17} . This bias tends to cancel the instantaneous a.f. voltage, with the result that the grid remains substantially at zero potential during the entire positive half of the a.f. cycle. The voltage at the plate of V_3 thus is $E_b - R_p I_p = 130 - 8$ or 122 volts, and remains there for the entire duration of the positive half cycle. This action forms the negative peak of the square wave.

When the grid signal goes negative, the plate current of V_3 rapidly approaches cut-off, which occurs with the 6J5 at about -9 volts for a plate-supply voltage of 130 volts. The plate current remains at cut-off and the voltage at the plate rises to 130 volts for the time it takes the negative

half-cycle of voltage to go from -9 volts on the leading edge of the wave to -9 volts on the trailing edge. This action forms the positive half-cycle of the output square wave, which is slightly shorter in duration than the negative half-cycle.

For all practical purposes, the square wave thus formed is symmetrical and has a peak value of about 4 volts. The operation of the clipper can better be understood by reference to Fig. 3.

The rise time and the decay time of the "square" wave (it is more nearly a trapezoidal wave) are important in A.M.D. operation, because if the voltage rises and falls too rapidly, the steep wave-fronts will generate an interfering "hash" which can be heard over a wide frequency range in a sensitive communications receiver. Tests have shown that a rise time of 25 to 50 microseconds causes no audible interference. Inasmuch as a 500-cycle wave has a time period of $1/f$, or 1000 microseconds per half-cycle, a rise and decay time of 50 microseconds shortens the "A" portion of the square wave (see Fig. 3) to 900 microseconds, against 1000 μ s. for the "B" portion. This amount of asymmetry can be tolerated.

The question naturally will arise as to how to obtain the desired rise time under any fixed set of conditions. If we assume that the input wave is sinusoidal, the rise (and decay) time is a function of frequency, peak a.f. voltage (E_{max}), and the cut-off grid bias value of the clipper tube. Referring to Fig. 3, we note that E_{max} is the only unknown factor. It may be calculated as follows:

The time for a half-cycle at 500 c.p.s. is 1000 μ s., as mentioned above. In this time, the wave travels an angular distance of π radians, or 180° . The

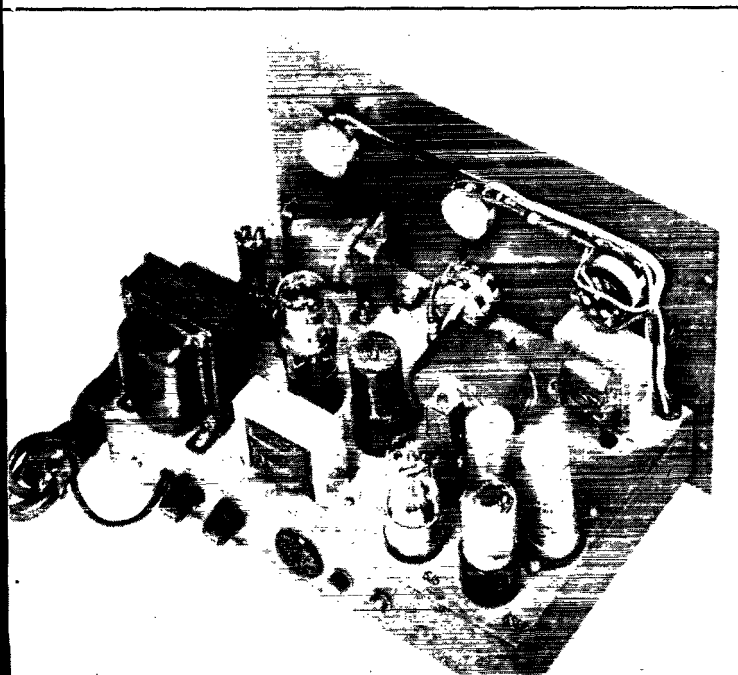

A view of the chassis layout. The two inductances in the audio filter circuit are the ones with the coils wound on the upper leg of the core. The socket for the detector-tube adapter extension is on the rear chassis wall.

Underneath the chassis. Placement of parts is not critical since there are no r.f. circuits in the unit proper.

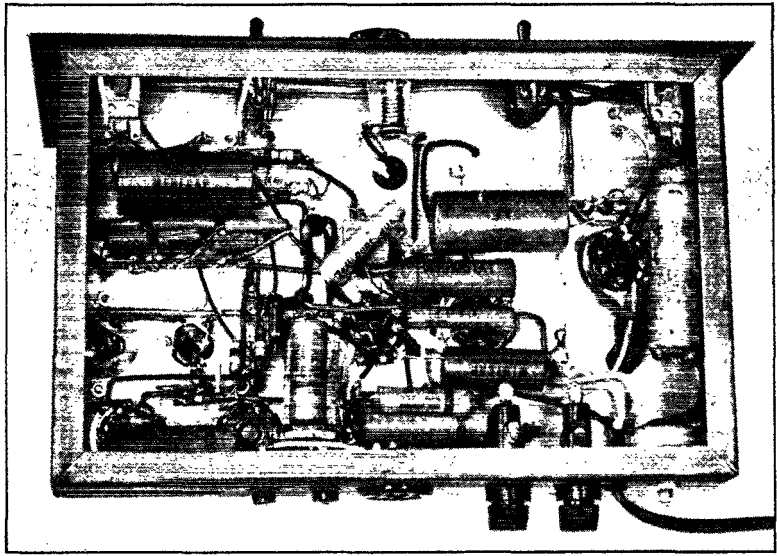

instantaneous audio voltage e is given by the relation,

$$e = E_{\max} \sin \theta \quad (1)$$

where θ is the angle through which the wave has traveled at any particular instant. Therefore

$$E_{\max} = e / \sin \theta \quad (2)$$

Since we want e to be -9 volts (the cut-off bias for the 6J5 at 130 plate volts) when t is $50 \mu\text{s.}$, we have to find the value of the angle θ which corresponds to $t = 50 \mu\text{s.}$ When $e = E_{\max}$, we know that $\theta = 90$ degrees and $t = 500 \mu\text{s.}$ Therefore, when $t = 50 \mu\text{s.}$, $\theta = (50/500) (90^\circ) = 9^\circ$. From a table of natural sines, we find that the sine of $9^\circ = 0.156$. Substituting this value of $\sin \theta$ in equation (2), we get

$$E_{\max} = \frac{9}{0.156} = 58 \text{ peak volts (approx.)}$$

The r.m.s. value of the a.f. voltage which should be applied to the clipper grid circuit is therefore, $E_{\text{rms}} = (0.707) (58) = 41$ volts (approx.).

The Selective Amplifier

In order to obtain the maximum signal/noise ratio with A.M.D., it is necessary to employ some kind of highly-selective audio filter tuned to the frequency at which it is desired to modulate the c.w. signal. This filter should have an attenuation in the order of 40 db. at frequencies of $\frac{1}{2}f_0$ and $2f_0$, where f_0 is its resonant frequency. It should have a pass-band from 20 to 50 cycles wide at 3 db. down, the bandwidth depending on the maximum keying speed likely to be encountered. A pass-band of 35 or 40 c.p.s. is usually adequate for hand keying. In addition, a good filter should have negligible loss at resonance — or better yet, a small voltage gain.

The filter circuit employed in this adapter is shown in Fig. 1, and consists of a 6V6GT/G (V_2) connected as a selective amplifier. This amplifier has a parallel-resonant grid circuit and a tuned output transformer, both of which are tuned to resonate at 500 c.p.s. A choice of several other filter frequencies could be obtained, if desired, by adding a two-circuit switch to change the tuned-circuit capacitances C_6 and C_{10} . Additional attenuation of undesirable high-frequency voltages is obtained by means of the RC filter, made up of R_{11} and C_7 . Resistor R_{11} also serves another useful function, inasmuch as it limits the grid current and output of V_2 in the event that the input signal is excessive. Switch S_1 enables the operator to throw the filter out of operation when he is listening to a signal that already provides a good signal/noise ratio. The unfiltered audio signal delivered from the re-

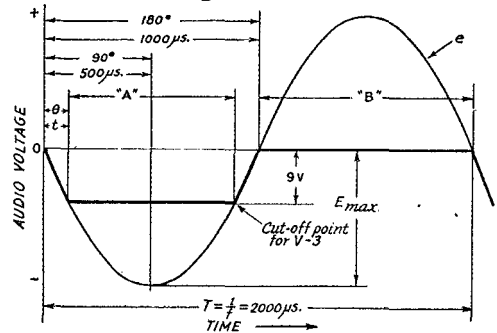

Fig. 3 — Action of the clipper or square-wave shaper tube. The output is an inverted version of the trapezoidal wave shown in heavy lines. $f = 500$ c.p.s.; $t =$ rise time of plate-circuit wave; $e =$ instantaneous a.f. voltage applied to grid circuit. The voltage at the grid does not rise substantially above zero because of the biasing action of R_{17} .

ceiver is in the form of a distorted square wave, rich in harmonics, and is often a pleasant relief to copy as compared to the relatively pure tone delivered from the selective amplifier or from a b.f.o.

The Q of the grid coil, L_1 , and of the output transformer, T_2 , is very important. If the Q is too low the selectivity of the amplifier will be inadequate; if the Q is too high, the pass-band will be too narrow, with the result that dots and dashes will not be faithfully reproduced at normal hand-keying speeds. The Q of L_1 should be about 12 to 14. The Q of the primary of T_2 , with the secondary loaded by the 5000-ohm 'phones or speaker, should be about 6 to 8. (All Q measurements were made at a frequency of 500 c.p.s.) The response curve of the amplifier is shown in Fig. 4.

The selective amplifier has a voltage gain of about 3 at all input voltages up to 25 volts r.m.s. Its output is amplitude-limited at 80 volts, because of the action of the series grid resistor, R_{11} . This resistor prevents the grid voltage from rising substantially above +9 volts, which is equal to the cathode bias supplied by resistor R_{12} . The output wave remains sinusoidal for

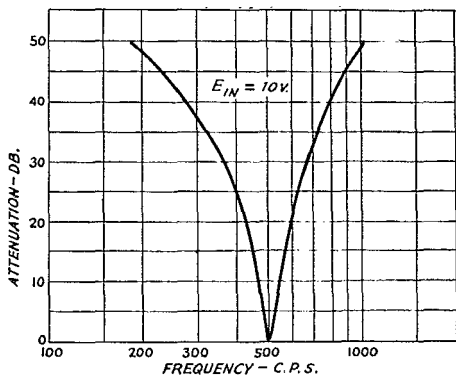

Fig. 4 -- Response curve of the selective audio amplifier shown in Fig. 1.

input voltages up to 150 volts r.m.s. because of the filtering action of the resonant plate circuit.

The output winding of transformer T_2 is designed to work into either a 5000-ohm speaker or a pair of 'phones having an impedance of approximately 5000 ohms, at 500 c.p.s. The measured maximum power output is in the order of 1.25 watt.

The Power Supply

The power supply is fairly conventional in most respects. It must be capable of delivering about 230 volts d.c. with a d.c. load current of 55 to 60 ma. The audio oscillator and the selective amplifier are operated from the unregulated +B output, inasmuch as they can tolerate

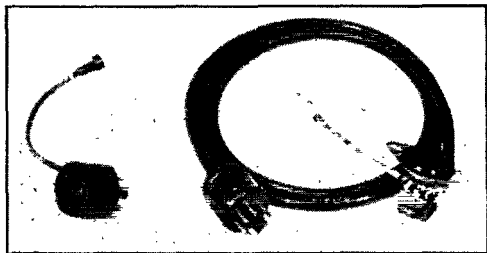

The adapter plug and extension cable. The 6IH6 socket, at the right, should be grounded at a convenient point on the receiver near enough to the second-detector socket to permit joining the pin-jack and prod.

some change in plate voltage.

The VR-150 voltage regulator gives a high degree of amplitude stability to the square-wave modulating voltage, E_m . It also helps to minimize variations in the upper-gate and lower-gate diode bias voltages, E_{sa} and E_{da} . These three voltages *must stay constant*, once they are adjusted, because proper operation of A.M.D. depends on their having a definite, fixed relationship to each other.

Potentiometer R_{20} (Fig. 1) is connected between plus and minus voltage points in the bleeder system, giving it a ± 7 -volt range. This arrangement is designed to make the A.M.D. adapter applicable to receivers having different types of diode-detector circuits. The reason for the dual-polarity range will be explained in the following section.

The A.M.D. Diode and Cable Unit

The audio-modulated detector consists of a 6H6 diode (V_6), which is mounted in the receiver near the normal detector tube by means of a simple bracket. The A.M.D. diode is connected to the adapter unit through a short piece of 3-wire shielded microphone cable. The circuit connections are shown in Fig. 5. By-pass condensers C_{15} and C_{16} are mounted directly on the 6IH6 socket, as shown in the photograph.

In order to bring out the "hot" secondary lead of the last i.f. transformer, which must be connected to point "X" (see Fig. 5), a simple tube adapter is used. This gadget consists of a molded tube socket glued to the top of an empty tube base (see photograph). All tube-base terminals are connected to the like-numbered terminals on the socket, except one, which is brought out with a flexible lead about four inches long. This lead is terminated by a telephone-tip jack, and is connected to the base-pin terminal(s) which corresponds to the second-detector anode (or anodes) in the receiver itself, i.e., that terminal which is tied to the "hot" secondary lead of the last i.f. transformer. This means, of course, that the *wiring* of the tube adapter and the *type* of tube base and tube socket employed must

necessarily be correlated with the type of tube and circuit used in the second detector of the particular receiver in use.

Adapter-Receiver Interconnections

After the A.M.D. diode is installed in some convenient spot close to the receiver's second-detector tube, the following steps are required:

- 1) Remove second-detector tube from set.
- 2) Insert proper tube adapter in detector-tube socket.
- 3) Insert second-detector tube in tube adapter.
- 4) Connect the tip-jack on the tube adapter to the tip-plug on the A.M.D. diode unit.
- 5) Connect plug on diode cable to socket J_3 on the A.M.D. adapter chassis.
- 6) Plug 'phones into receiver 'phone jack.

Operation

Before any attempt is made to operate the receiver, it is first necessary to determine what type of second-detector circuit the set employs, with particular reference to the d.c. potential, if any, appearing at the point to which the receiver's diode load resistor is returned. There are two types of diode-detector circuits in common use. These are shown in Figs. 6-A and 6-B. In the first, the diode load resistor returns to ground. In the second, the load resistor returns to a self-biased cathode which, in a typical case, might be at +8 volts potential with respect to ground.

With the circuit of Fig. 6-B, the +8 volts is applied to the A.M.D. diode's plate terminal No. 5 and cathode terminal No. 4. If we desire to operate the A.M.D. detector with zero lower-gate bias (E_{da}) and -4 volts of upper-gate bias (E_{sa}), we must then adjust R_{22} and R_{20} (Fig. 1) to give +8 volts and +4 volts, respectively. This set-up puts both the anode and cathode of the A.M.D. detector diode at +8 volts, i.e., zero volts lower-gate bias. It also puts the squelch-diode's plate at +4 volts, which, with its cathode at +8 volts (Fig. 6-B), provides the -4 volts of upper-gate bias desired. This all sounds somewhat complicated, but a little operating experience with a specific receiver will readily show

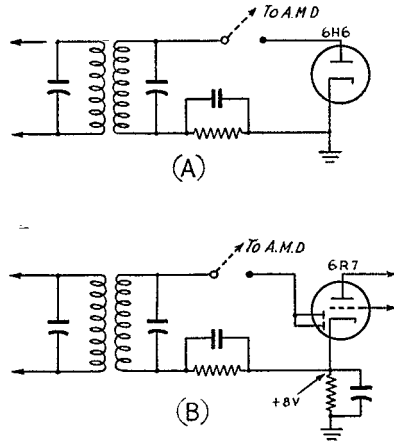

Fig. 6—Diode-detector circuit commonly used in receivers. The circuit at A uses a separate diode rectifier while that at B uses a combination diode-triode tube. In the latter case, the diode plates, in the absence of signal, are given a positive voltage with respect to the chassis by the voltage drop across the cathode resistor. This bias must be compensated in the adjustment of the A.M.D. adapter.

that the proper settings can be made in a few seconds.

The set-up is much more simple with circuits of the type of Fig. 6-A. In this case, R_{22} is set at zero volts, for zero lower-gate bias, or at +1 volt, for a -1 volt lower-gate bias. The seeming discrepancy in the previous sentence as regards polarity is because R_{22} is supplying voltage to the cathode of the A.M.D. detector diode, rather than to the anode. R_{20} is set at -4 volts, for a -4 volt upper-gate level, at -3 volts for a -3 volt upper-gate level, and so on.

The actual value of the upper-gate bias (E_{sa}) is not critical, unless i.f. signal limiting at a specific i.f. level is desired, for test purposes. Usually, E_{sa} can be set at -3 to -4 volts and left there. The lower-gate bias (E_{da}) is not used if the normal noise level is low and if extremely weak signals are being copied. If a signal is being received which is fairly strong compared to the natural noise level, E_{da} can be set at -1 to -2 or more volts, with the result that the receiver sounds completely dead in between dots and dashes; perhaps this action might be referred to as "inter-character silencing," a take-off from the "inter-channel noise suppression" of broadcast-receiver fame.

The audio modulating voltage, E_M , is adjusted (by means of R_{15}) in all cases so that no appreciable "back-wave" is heard when no r.f. signal is being received. If E_M is set too high, the A.M.D. squelch diode will rectify on the positive half-cycles of audio and put a steady a.f. signal into the receiver's

(Continued on page 184)

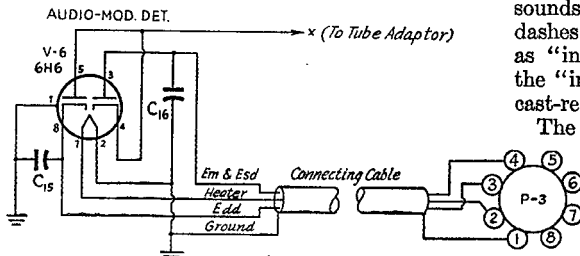

Fig. 5—Circuit diagram of the A.M.D. diode adapter and connecting cable to main unit. C_{15} —0.01- μ d. mica. C_{16} —0.004- μ d. mica.



How's DX?



How:

Well, here it is copy time and the nurse just wheeled us into the room where the typewriter and paper are. Yes, thanks, we feel a lot better and should be up and around in a week or two. What happened? Nothing serious — we just got caught in the rush on 14 Mc. reopening day and didn't get out of the way in time!

But the opening on July 1st was something we wouldn't have missed for the world. The old familiar DX calls . . . the old fists and a lot of new ones . . . and just a *slight* trace of QRM. (OK, nurse, I'll take it easy.) We have a hunch that if we could have unpeeled several layers of that QRM we would have found some real juicy ones, but there were enough on top to keep any ordinary five-operator station as busy as a Good Humor man on a hot July Sunday. The band has only been open a few days at this writing, so we don't have much to tell you about it this month, but if you haven't picked up 25 to 50 countries by the time this hits your mail box you have been spending too much time away from



the shack. Don't be afraid to tell us about it — your radio work, that is — and next month we'll try to have some real stuff to pass along.

And now for a real operating hint. Stroll down to the nearest radio store and ask the man for a switch. It doesn't matter much what kind, so long as you come home with a switch. Then put this new switch in the primary of your final plate transformer, so that your final supply can be

turned off while the rest of the rig is still running. Then next time you shift the VFO to land on — or preferably near — a guy, turn off the switch until you call the DX. The other fellows listening will thank you. And the smart lads who follow the swishes won't be tipped off quite as fast. This business of a switch for turning off a power supply has apparently been kept secret, but now it can be told. Ain't science wonderful?

What:

The 80-meter band never was counted as a summer DX band, but things do happen up there. W3EHW/1 heard a couple of ZLs in QSO at 0430 EST, for proof that signals get through from the Antipodes. And ZS6DW (3515 f) says that all W districts except W7 are coming through on 75 'phone. Look for the ZS 'phones between 3.5 and 3.7 Mc. . . . W4FEE, op at KZ5AD (3855) has worked all W districts and VO6F (3795), and W1BFA held on to VO8AR (3580) for a two-hour QSO one evening . . . W600U (ex-W7LXX), writing from Germany, suggests that Ws take a listen for Europeans on the low-frequency band. LA4S, D4AUF, SM4KL and HB9EL are active in the 3.5 end, and Ws start coming through over there from about 0200 GCT on . . . But the only European contacts reported are by W1ZL, who has been working CSZ (3895) in Lisbon, EA1D (3895) and WLGO (3895) in Paris, along with W8LZK/NY4 (3505) at Guantanamo Bay in Cuba. The old reliable on 80, W8QEN/CT2 (3790), will probably be spending his time on 7 and 14 Mc. now that they are available. But when he's on 80 he really knocks them off.

It was there on 10 right up to copy time, although the midsummer conditions weren't making it a push-over. To give you a forinstance, W6PUZ/Tinian worked EZ4X (28,000 T7) and OD2AC (28,060 T5). The OD gave his QTH as Lebanon, and we understand from the ZS gang that one QSLs EZ4X via HB9J. Don also has a question mark after VQ5PP (28,200 T7) because VQ4ERR and VQ4EDD think there are no legit VQ5s on the air yet. Still more at Tinian include PA0TC/PK6 (28,060), CR9AG (28,060), VS4JH (28,140), W6SKI/VK9 (28,330 f) in the Admiralty Islands, and ET6MI (28,000). PUZ was hoping to hit the century mark on 10, and his score stands at 84 worked, a very reasonable start in the right direction . . . W6TZB/K6 snuck in a few this month, fat ones like PK6VK (28,040), AK1LO (28,600 f) in Korea, W2OAA/J8 (28,045) also in Korea, VS1BA (28,400 f), VS1BG (28,190 f) and XZ4AQ (28,400 f). The mix-up on the

Korea prefix is because no one over there can decide which to use. Don't tell us there's a place in the world where people can't agree on something! W6UUQ/3 has been busy with CX2AX (28,140 f), CX4CZ (28,020), LU9AX (28,000), YV5ABS (28,160 f) and FM8AC (28,040), while at W6PBV stuff was heard like VP9F (28,055 f), PK6TC (28,055), W9SUI/KP6 (28,050) and W9SMA/KP6 (28,150 f) And "push-pull rhombics" W6ITH added a few: HK3AB (28,000 f), VR2AC (28,310 f), ZK1AA (28,320 f), W8CJR/XU8 (28,760 f) and TG9PB (28,110 f). Reg says a lot of the PAA boys get calls in TG through the radio club down there, provided they are qualified amateurs.

Where:

We have the dope on PX1A and PX1B. They are legit but strictly undercover, and all cards should come to ARRL for forwarding. Sending them to some place you think may get them through only increases the chances for losing a couple of very juicy contacts Speaking of undercover, we would like to remind the old hands and some of the new ones that cards for anything you work that isn't in the *Call Book* or isn't in a country that has a QSL Bureau (these are listed in IARU News several times a year) are best sent to ARRL for QSP unless, of course, the station gives you his QTH over the air and says it is OK to mail cards direct. Before the war there were some countries where amateur radio was not looked on too favorably, and amateurs in those spots had to be very careful. Generally they were more than willing to confirm contacts but they had to remain under cover. They usually told us their story and we handled the cards for them. In a few cases, however, W amateurs got them into trouble or at least under surveillance by sending cards addressed "Amateur Radio EZ4U, Upper Slobovia," or something to that effect, which resulted only in building a fire under the authorities. So, if you enjoy DX at all, give the other fellow a break and be careful. On the other hand, we have no sympathy for stations bootlegging in countries where they can get a license through regular channels, and their correspondence is filed in the waste basket with nary a qualm or tear W4IKL passes along the QTH of VR2AB (28,000): Box 338, Suva, Fiji Islands Don't pass up LU1ZX as just another LU. It is the yacht *Gaucha* on a world cruise and is liable to be any place where there's enough water to float the ship. They have a 20-watt rig on all the ham bands and are out for a year's jaunt The VP5s are back on with a 25-watt limit, but they expect new regulations to be drafted presently, along the lines of the G regs, which will allow them 100 watts, says VP5AD According to word received from the Chinese Amateur Radio League, Chinese amateur stations are using the prefix

"C" instead of the old familiar "XU." With our 28-Mc. underground receiving antenna we are in no position to dispute this at the present time, but 20 and 40 meters will tell us more about it. But if we know the DX gang, they won't pass up anything signing "XU" or "C."

Who:

If you've wondered why W9QMD/KJ6 hasn't been quite so active lately, W6TZB/K6 has the answer. QMD is on a small island across the reef from Johnston, and he has to ride a boat over to the shack every time he wants to operate Speaking of troubles, WSQEN/CT2 has a beaut. He uses a rhombic for receiving and his transmitter is several miles away. He always monitors his sending — which is of the best, by the way — by listening to the transmitter direct. But on 20 the signal is fairly weak in his receiver, and he is often troubled by QRM during his monitoring! However, that still doesn't unseat us on having a set-up like his W3AG had himself quite a time around the world, operating 3AG under VS, MX, XU, XE and YS prefixes. He says he really got a boot out of being the called instead of the caller. Do you suppose there is a ham who hasn't dreamed more than once of a similar deal? VP3DA, formerly operated by W2MQB, is now off the air and MQB is back in the States mailing out the cards Along the same lines, W9JYF/J can now be reached at Route 1, Woodstock, Ill., and W8RWW/J9 at A. M. Magagna, 94 East 7th St., Wyoming, Pa. JYF in Tokyo had 350 contacts in three months, and RWW on Kwajalein worked 27 countries and 39 states during his two-month sojourn WIMBR, ex-D4ACT, says don't give up on QSLs from his D station. They'll be along as soon as he finds out the brand of cigar his printer likes The only thing that ever convinces us that this column is read by anyone other than *Jeeves* and his grandmother is the amazing speed with which we get jumped on for a bull. Like,

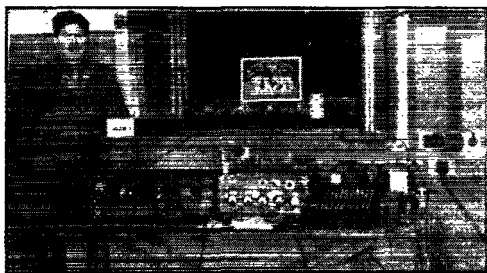

Major J. M. Kirk and his rig at G6ZO/1 — XAZO at Caserta, Italy. The transmitter used a pair of 807s in the final, and the signal was given a good boost toward North America via a rhombic. Major Kirk was trying hard for a postwar WAS but had to quit at 37 states when he left Italy.



❖

Here is a tasty Swiss and ham combination you won't find on any menu. In the accepted manner: HB9CX, HB9U, HB9DO, W9VND, HB9AG and HB9CE. Although he didn't say so, W9VND was probably wearing the dark glasses because he had just finished looking at the DX records of his Swiss friends.

❖

for example, we said in June that W6ITH worked W4GFK/J9 at Bikini Atoll, which was the way Reg sent us the call. Right off W4GFK writes to tell us he was never near the place, and then W4GMK/J9 writes a very nice letter telling us he is the only ham at Bikini, and was shut down for security reasons after a pleasant three weeks of 10-meter work, during which he QSOed some 50 stations. Next time we pull a bull, please enclose a check for a buck with your justifiable boobing. We will use the fund either to buy a new mill for W6ITH or a new rig for ourself so that we can personally check on all DX reported W4BRB has a switch on that cross-band stuff mentioned last month. He raised YV5ABX (28,050 f) on 10 and got him to listen on 75, with an immediate reply and report of 88, which is not too bad at all On 80 with 55 watts and an SW-3, W3IEM has worked 37 states, VP3DA and G6VS F3SI (28,300) was 'phone WAC two days after the Fs got back on. The rig is 30 watts to an 807 and F3HL was doing the operating And KP4AZ, formerly K4FAY, knocked off a 'phone WAC in 5 hours and 20 minutes. The stations were F8QD, VS1BA, W9BSS, OQ5AE, CE1AO and ZL2BN, with W9SMA/KE6 on Christmas Island thrown in as a bonus CE1AR (14,296 and 14,134 f) would like to work 20-meter 'phones or work cross-band with 10-meter 'phones in El Paso; Urbana, Ill.; Del Mar, N.Y.; and New York City, so that friends there can talk with friends and relatives in the above cities. If interested, snag him on the air or write to Arthur G. Bard, Chile Exploration Co., 25 Broadway, N.Y.C., giving your frequency and a schedule in EST about three weeks after the date of your letter W2BXA worked VK2AHA on 10 when

W8OSL was at the key down there. Jules hopes to operate from YJ, FK8, VP1 and VR4, on 20, to give the gang a crack at four new countries. We hereby appoint W8OSL our South Pacific representative for DX Expeditions, Inc., provided that he reports direct by radio at least once from each island The new power designation, the "gallon," seems to be taking the 10-meter band by storm. A gallon is a kilowatt and a very convenient designation, since QRP rigs are half-pint or jigger size, etc. A few fellows we know have hogshead rigs, a very appropriate title!

— W1JPE

Strays

Sacrilegious, we say! W9MDF, W9JCL, and W9LLC have pooled their rigs, funds and skills. "For a ham club station, of course?" Nosiree . . . for a b.c. station! They're owners and staff members of the new WSIV, Pekin, Ill., which in these days of commercial-equipment shortages operates with a transmitter and associated apparatus that is composite of the finest ham parts and techniques. Seriously, though, we wish 'em the best o' luck.

— . . . —

Three-letter Z calls are regularly assigned as normal station calls to scores of stations in the W9 area but there are only half a dozen or so in all the rest of the country. The latter fellows have a hard time, particularly on v h.f., since they are commonly mistaken as phonies. Years back, all portable stations had separate calls, taken from this series, and some of them finally became the regular station calls, even though the Z series hasn't otherwise been reached in those areas. They're OK if they're in the Call Book.

New Apparatus

New Decalcomanias for Panel Marking

THE average amateur takes a good deal of natural pride in the appearance of his equipment — the widespread use of metal chassis, panels and cabinets is by no means based entirely on utilitarian considerations. In fact, it would be pretty safe to say that hams want their home-built equipment to have as "commercial" an appearance as it is possible to attain.

Dials, knobs, panels and the like meet the requirements, but there is one commercial practice that it has been difficult to duplicate at home. This is the marking of panels and chassis with the functions of controls and terminals — the thing that adds that final touch both in appearance and utility. Manufacturers use engraving and silk-screen methods as a general rule, but during the war large quantities of decalcomanias were used for the purpose because they can be quickly and easily applied and provide permanent markings closely resembling engraving.

There is now available a decalcomania set made expressly for amateur use, consisting of a sheet containing about two hundred of the commonly-used markings, from complete combinations such as "Antenna Tuning" to single numbers for voltages, etc., plus a bottle of solution used in application and an instruction sheet. Markings are suitable for transmitters, receivers, speech and power-supply equipment, and measuring gear such as oscilloscopes, and many are duplicated where more than one of the same combination is likely to be required. The letters are white, one-eighth inch high, and in the style of ordinary engraving. The decalcomanias will "take" on either crackle-finished or smooth panels and chassis.

The new "decals," which are being marketed by the James Millen Manufacturing Co., Malden, Mass., provide the dress-conscious ham with an inexpensive and easy means for achieving that professional finish on his equipment.

— G. G.

A New Six-Element Beam for 144 Mc.

ANY faithful follower of W1HDQ's v.h.f. column is fully aware of the many advantages of a beam antenna at 50 Mc. and above, and the various shapes and forms of the homemade versions are usually effective electrically but not always decorative mechanically. Without access to elaborate workshops it is often a difficult task to build a rotatable beam antenna that will not instigate some degree of domestic dissension and neighborhood comment. A new antenna kit, just

announced, should go a long way toward improving any such family situations as well as the station's signal strength on the 144-Mc. band.

As shown in the photograph, the antenna sys-

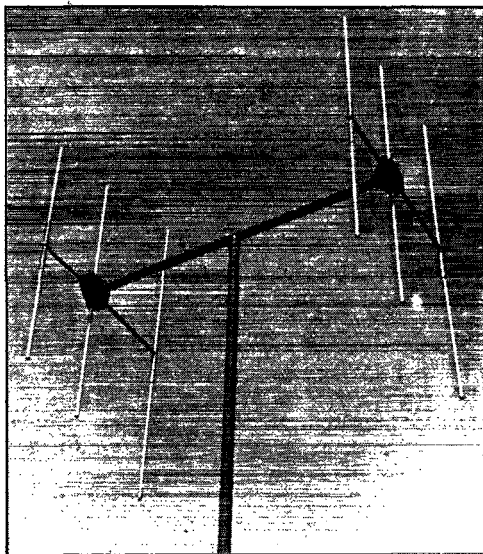

tem is two vertical three-element beams spaced one-half wavelength and excited in phase. The resultant beam pattern is 64 degrees wide at the half-power points, in the horizontal plane, and in the vertical plane the radiation is concentrated along a low vertical angle, reaching the half-power point 34 degrees above the horizon. The claimed power gain of six is quite conservative, since it is well known that the effective *communications gain* usually exceeds the theoretical power gain in antenna systems of this type. The antenna uses coaxial-line feed, and the coaxial line is run through the supporting mast further to add to the clean appearance of the system. Using 50-ohm coaxial cable like RG-8/U, the standing-wave ratio (in power) varies between 1.14 and 1.24 over the 2-meter band, and if 70-ohm cable (RG-11/U) is used the ratio varies between 1.2 and 1.32.

The elements and supporting structure for the system are made of aluminum tubing. The mast and crossarm are lightweight steel tubing finished in grey enamel. Plastic housings at each end of the crossarm support the driven elements and the supports for the parasitic elements, and the joints between the plastic housings and the metallic parts are made weatherproof by the use of rubber gaskets.

(Concluded on page 148)



The World Above 50 Mc.

CONDUCTED BY E. P. TILTON,* WIHDQ

JUNE, 1946, was quite a month in v.h.f. circles! A transcontinental QSO on 50 Mc., 2200-mile work in the middle of a 14-hour DX session, and several new 144-Mc. records made and broken — these were among the month's highlights. After a slow start in May, when DX opportunities were few and far between, 50 Mc. went on a rampage in June, and DX contacts were made on at least 26 of the month's 30 days. On 144 Mc. several groups in California, tiring of seeing East Coast stations credited with the DX records, combined efficient gear, high-gain antennas, and California topography, to produce some new records which are close to the maximum distance ever worked on 112 Mc.

The first 50-Mc. transcontinental QSO, and the second such contact in v.h.f. history, was made on the evening of June 14th, when W6OVK, Redwood City, California, raised W2BYM, Lakehurst, N. J., on a CQ at 7:00 P.M. PST. At nearly this same time, W8CLS/1, Waltham, Mass., was heard by W7QAP, Tucson, Ariz., but was not in long enough to permit a contact. The 50-Mc. gang were alert to the possibilities that night, as many had noted that 28 Mc. was open to Southern Europe, South America, nearly all W call areas, and even Australia, during parts of the evening. Skip contacts were made on 50 Mc. in all call areas except W4 (and this one was missed only because of lack of activity there, no doubt), though the opening was generally rather spotty, and no signal was heard in any one place for more than a few minutes at a time.

Sunday, June 23rd, was a Field Day in more than one sense for the gang on 6, as it was the occasion of the longest and most satisfactory opening of the postwar period. Contacts were made in all call areas, in a session which was underway by 10 A.M. and lasted until well after midnight. At 1:00 P.M. EDST, WØZJB alerted the W1 gang with the news that W7QAP, Tucson, Ariz., was hearing East Coast stations. A mad scramble ensued, W8CLS/1 coming out on top with the first W1-W7 contact on 50 Mc., the QSO lasting from 1:04 to 1:11 P.M. The signals of W7QAP were heard in Springfield, Mass., by W1AEP, and in Hartford, by W1LLL. Your conductor also ran — and was heard by W6BKZ/6 near San Diego, Calif., at 1:15!

Close observation of v.h.f. propagation phe-

* V.H.F. Editor, QST.

RECORDS

Two-way Work

- 50 Mc.: W6OVK — W2BYM
2500 Miles — June 14, 1946
- 144 Mc.: W6RBQ/6 — W4TZ/6
230 miles — June 9, 1946
- 420 Mc.: W4TZ/6 — W9OAW/6
52 miles — June 26, 1946
- 2300 Mc.: W1JSM/1 — W1LS/1
1.6 miles — June 23, 1946
- 5250 Mc.: W2LCF/2 — W7FOF/2
31 miles — December 2, 1945
- 10,000 Mc.: W1LZV/2 — W2JN/2
2 miles — May 5, 1946
- 21,000 Mc.: W1NVL/2 — W9SAD/2
800 feet — May 18, 1946

nomena for more than ten years, and a study of reports turned in by v.h.f. enthusiasts over all the years since v.h.f. DX was first observed, indicate that, contrary to our early anticipations, the peak of a sunspot cycle is productive of less sporadic-E skip than a sunspot minimum. Even though we are operating six megacycles lower in frequency, the maximum frequency for sporadic-E skip often does not quite reach our band. This was particularly noticeable during the first weeks of the DX season, when, on several occasions, frequencies as high as 48 Mc. were open and nothing came through on 50-54. When skip did move into our band it was usually for only a brief period, with the area affected shifting rapidly, so that only the most alert operators were able to bag any of the elusive signals.

June was a big improvement over May in this respect. As has been noted above, the band was open almost every day in some parts of the country, but the strength and steadiness of the signals did not compare with the big splurges of 1938-40. In those days plenty of skip was worked with low power and simple dipole antennas. This can still be done, on occasion, but the boys who are really knocking them off are the ones with the high-gain antennas. Working skip on 6 has not been easy — but it is fun of the highest order. The old hands are like so many cats watching a rat hole, and when an unsuspecting neophyte so much as sticks out a whisker he is promptly pounced on by the hungry watchers!

Fig. 1 — Detail drawing of the collapsible 50-Mc. array shown on the front cover. All parts except the vertical support are made of $\frac{3}{4}$ -inch duralumin tubing. For carrying purposes it is taken apart at points "A" and "B," inserts of slotted dural tubing being used at points "A" to hold the sections together. All extensions are the same length, the difference in element length being provided by the length of the center sections. For details of the "T" match, see "Hints and Kinks," April QST, page 144. The feeder is RG-11-U coaxial line.

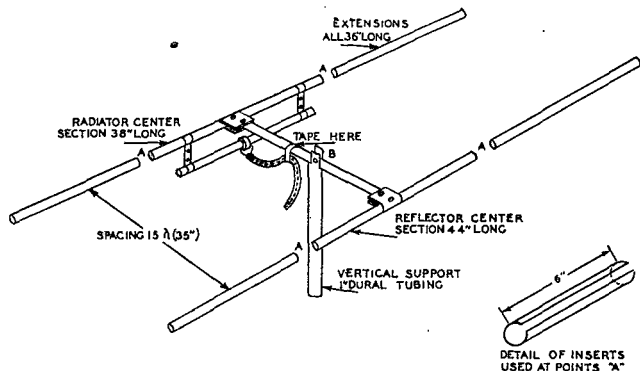

During the Field Day opening, signals were in for hours at a time, though the strength was never quite up to the peaks they used to hit in prewar days on 5. The area affected shifted several times during the day and evening, providing an opportunity for stations in the central part of the country to work almost anywhere in the United States, as demonstrated by WØZJB, who had 33 contacts with 30 different stations in 11 states and Canada! Vince now has all call areas but W9. That last one is going to be hard, as the activity in W9 is too far for "local" and too near for skip work.

The strongest signals and the best DX have often come through during the period around midday, accentuating the possibility that DX opportunities are being missed during the daylight hours on weekdays. Quite a few fellows now make a practice of checking the band during noonhour, and more daytime contacts are being reported daily. Several have mentioned finding the band apparently well open, judging from the presence of commercial harmonics, yet they were unable to raise anyone. Check the band during the day when you can, gang, and don't just listen — get on there and make some noise!

As to activity on 50 Mc., it appeared that equipment shortages were going to hold down occupancy of the new band for a while, but the recent burst of activity and rapidly-growing interest in the possibilities of the band have exceeded expectations. The boys are finding that there are ways to do anything you really want to do, and it appears that plenty of us want to get on 6. Not only is there a heartening interest in DX work, but the possibilities of the band for extended local work are being exploited in many places. Daily activity on the band, regardless of conditions, is becoming more popular as the distances up to 100 miles or more are covered with a degree of reliability which puts low-frequency bands to shame.

Along the Upper Mississippi, for instance, is

¹ For stations in the new WØ call area, the WØ prefix is used only if the call was changed officially at the time of publication.

a chain of stations including W9s¹ DWU, QIN, NCS, TOZ, and IFW in Minneapolis, DZM in Anoka, JHS in Champlin, and SV and HXY in St. Cloud. When the band is open this group is always in there, and when there is no DX they are working together. Several of them use an antenna system called the Bi-Square. It consists of two full-wave sections bent near the middle, to form a 9-foot square. The array is bi-directional, and exhibits considerable gain on horizontally-polarized signals which are broadside to the plane of the array.

In Western Minnesota and Eastern South Dakota, the 50-Mc. population is greater than that existing on 56 in prewar days. Several are v.h.f. veterans, and the list includes WØBJV, Watertown, S. D., W9TI and WØDB at Millbank, W9USI and W9MSJ at Brookings, W9KQO, Conde, S. D.; and WØAZE, Bellingham, W9EOJ, Madison, and W9QIQ, Marshall, all in Minnesota. All operate near the middle of the band, a laudable practice, now that the low-enders are beginning to push each other around a bit.

Washington, D. C., and surrounding territory have the last holdouts using vertical polarization, the gang in W1 and part of W2 having almost standardized on horizontal after a long struggle. Activity in that area is maintained almost entirely by outstanding v.h.f. DX men from other sections, and the list includes such well-known calls as W3AIR, W4EDD, W1DEI, W1QB, and W9STX. From Washington up to around Philadelphia most stations are still using verticals, and their success in working distances up to 150 miles or more proves that nice work *can* be done with vertical polarization, provided good antennas are used. Their range of operation stops abruptly at Central New Jersey, which is the present polarization borderline.

The Pacific Northwest has some familiar calls back in circulation on 50 Mc. Around Seattle are W7s DYD, CEC, AXS, EUI, and BQX. Portland, Oregon, has W7DNB and W7AVV. Quite a few contacts are being made with California and Arizona stations.

In Northern Indiana are W9AB and W9ECH

V.H.F. MARATHON

Call	Contacts Through May			Score	States Worked	
	50 Mc.	144 Mc.	235 Mc.		50 Mc.	144 Mc.
W1BCT		34		141		4
W1CGY	7			41	4	
W1FJN	14			79	4	
W1HDQ*	31	31		324	8	5
W1JNX	7	44		150	1	1
W1KLR		29		113	1	2
W1LLL	26			167	8	
W1LMU		51		160		1
W1MBS		72		191		2
W2AMJ	24			121	5	
W2AUF		82		220		3
W2BQK	18			87	4	
W2BYM	17			88	4	
W2DZA		49	2	174		2
W2LXO		69	1	242		3
W2OQI		30		136		2
W3BTP		19		82		1
W3CGY	1	16		93		3
W3GEJ		4		18		1
W3GKP		27		144		4
W3HDJ	16			71	3	
W3HOH		82		281		3
*W3HWN		41		270		5
W3KTE		45		206		3
*W3LN		58		210		4
W4CDG/3		27		144		4
W5VV	2			22	2	
W6ANN	19			54	1	
*W6BS/6		28		289		1
W6NJJ		108		314		1
*W6RVL	39	68		225	1	1
W9LLM/6 3				6	1	
W7QAP	1			11	1	
W8NEJ	8	4		31	2	1
W8NOR		11		56		1
*W8WKE		7		25		1
W9PK	5			25	2	
WØZJB	1			11	1	

* Includes mobile operation.

† Winner of Certificate Award for May.

* Not eligible for a award.

in Mishawaka, and W9LMX at Elkhart. These fellows work W9QCY at Fort Wayne, some 60 to 70 miles to the southeast, and W8VIB in Three Rivers, Mich., but yet have to do much business with the Chicago area, where many of the old 5-meter group are getting back on.

Many of our old 5-meter regulars are "displaced persons," but that has not kept them off 6. W6SLO/5, formerly of Tucson, Ariz., is on at Ingleside, Texas. W5JGV/7, who meant "New Mexico" in prewar days, is now at Douglas, Ariz., with 450 watts and a 4-element array on 51.6 Mc. Wayne gladdened your conductor's heart on the afternoon of June 28th, answering his CQ at 5:30 p.m. EDST, at a time when we would have sworn that 6 was not open, judging from the indifferent sound of 10 at that moment. W5EHM who has moved from Dallas to San Antonio, provided the first Texas contacts for W8CLS/1 and W1HDQ on the morning of June 30th, when our best north-south opening to date occurred. W1NWE/4, who worked in W1 for

months as W4GJO/1, finally getting his W1 call in time to take it back to Orlando, Fla., made the first Florida contacts possible for scores of W1s, 2s, 3s, 8s, and 9s on this same day. W9WMI/4, Raleigh, N. C., did likewise in North Carolina.

Activity in California, now W6 all by itself, appears to be better now than in prewar 56-Mc. experience. Around San Francisco are W6MZQ and W6PZB, San Mateo, W6OVK, Redwood City, and W6QT, Berkeley. In Southern California, upward of 30 stations are reported active in the Los Angeles area, and quite a few are getting on around San Diego. The transcontinental work of W6OVK, and the reception of your conductor's signals by the Palomar Radio Club during Field Day operations, have stirred up increasing interest in 50-Mc. DX. W6ANN, San Pedro, works nightly with W6QUK at San Bernardino, 70 miles to the East, but had not heard San Diego stations up to early June.

A few fellows are trying f.m., and it appears that narrow-band f.m., at least, is quite readable on even the sharpest communications receiver. The principal difficulty in using f.m. is not in getting through, but in getting the gang to tune above 52.5 Mc. for the f.m. stations. W3IUN, at Washington, D. C., is having his troubles in that respect, as is W9ETJ, St. Louis, Mo. Echoing these sentiments is W8CVQ, Kalamazoo, Mich., a v.h.f. enthusiast from way back. He has two frequencies above 52 Mc., and pleads for more balanced distribution of the stations throughout the whole 50-Mc. band.

In prewar days we used to look upon mid-August as the end of the DX season, for by that time the sporadic-E skip openings had fallen off to a marked degree. Very likely this will be true

More V.H.F. Records Fall!

As we go to press we have news of new records for 144 and 420 Mc., plus another 50-Mc. transcontinental QSO. On the afternoon of July 5th, W6URA/6, operating from Mt. Diablo, worked W6VQB/6 on South Butte, 12 miles northwest of Yuba City, Calif., on 420 Mc. The distance is 96 miles, airline.

The same afternoon, W1LLL, Hartford, Conn., worked W6NAW, Los Angeles, Calif., on 50 Mc. for the second 50-Mc. transcontinental QSO, and a tie for the existing 2500-mile record. W6NAW was heard by several other W1s including AEP, Springfield, W8CLS/1, Waltham, and W8CIR/1, Boston, Mass.

The night of the 5th and the early hours of the following morning brought some fine temperature-inversion bending to the 144-Mc. gang along the Atlantic Seaboard. Many contacts beyond 200 miles were made, the best one reported being a solid QSO between W3HWN, Mechanicsburg, Penna., and W1KOE, Wakefield, R. I. — another new 144-Mc. record, 310 miles!

We have another report, as yet not fully confirmed, of reception of G5BY by W6OJV, Long Beach, Calif., on July 1st.

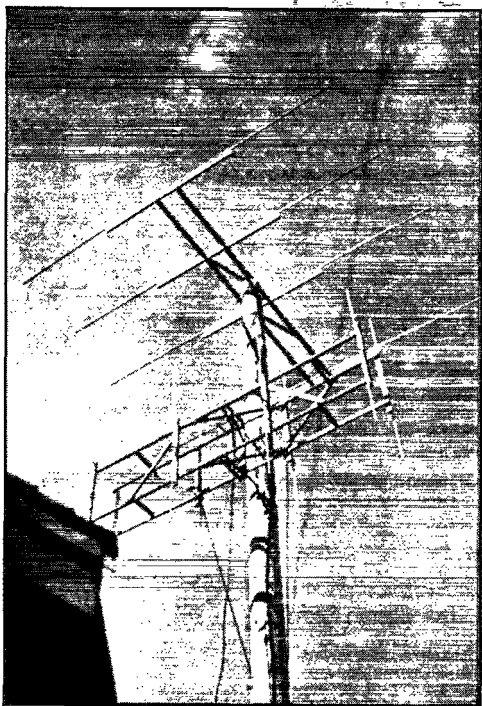

With this 16-element 2-meter array, VE7AEC, Duncan, B.C., hopes to work 144-Mc. stations in the vicinity of Seattle, 130 miles distant.

in 1946 also, but it will not be the end of DX possibilities by any means. The approaching sunspot peak will be pushing the maximum usable frequency for F_2 -layer work well above 50 Mc. by September, and international and even worldwide work is in prospect. There is worldwide interest, too, and on a scale we never knew before.

International Notes

American amateurs are still spread over the face of the earth, and many of them have kept their interest in v.h.f. work. By the time this appears in print, W9SMA/Christmas Island will be on his way home, but many of us have heard that he has been listening on 50 Mc. out there. At last report he had heard unidentified signals in the 50-Mc. range, and was listening at 5:00 and 8:30 CST regularly. W6TZB/K6 reports that W8WSY, also on Christmas Island, is getting on 50, and that KA1CB is putting on a pair of 450THs. The rig at W6TZB/K6 runs 600 watts to a pair of 127-As, with an S-36 and a concentric-line converter feeding a low-frequency receiver. He is on 51.84 and will run skeds with KA1CB or other interested parties. His address: Capt. R. A. Mitchell, VMR 352, c/o FPO, San Francisco.

The G5BY schedules are running each Sunday (see July *QST* for details) but no reception across the Atlantic has been accomplished, as far as is

known. Skip-DX has been worked by G5BY on several occasions, however, the latest being a contact with FA8B on June 24th at 2025 GCT., reputedly the first work over this path on 5. Signals were 579 each way over the 1000-mile hop.

From "down under," VK2NO sends us the latest doings in Australia. He has 100 watts on 50.4 Mc. and is on automatic c.w. sending "CQ SILX DE VK2NO" every Saturday and Sunday from 1100 to 1300 and 1500 to 1600, Eastern Australian Time. Occasional announcements are made on voice, and short listening periods are interspersed, "just in case." VK2WJ has 50 watts to a pair of 807s on 52.8 Mc. Other VK frequencies: VK2ABZ 50.45, VK2NP 53.0, and VK2DF 51.5. VK2LZ puts an S9 signal into Sydney, a distance of 70 miles, from his mountain location at Wentworth Falls at an elevation of 3000 feet. Still higher is VK2AFO, at Katoomba, a location which will be remembered by GIs who had leave in the Sydney area. Other VK2s on 50 include AZ, EM, CP, AEX, and CI. Another station running automatic transmission is VK3MJ, who has 50 watts and a 4-element horizontal rotary on 51 Mc. No contacts have yet been made between VK2 and VK3, but VK3s JD, NW, GG, LS, YJ, BW, XA, and AFQ are in there trying. Over in Western Australia is VK6FL. VK2NO has heard U. S. services as high as 40 Mc., pointing up the possibility of a VK-W QSO on 50 Mc. this fall. Don suggests that interested Ws watch for Australian air beacons, which operate around 34 Mc., signing two-letter calls such as SY for Sydney, HK for Holbrook, etc.

Skip contacts between W and VE stations have been made on several occasions recently. Apparently Canadian regulations permit the use of modulated-oscillator rigs, and the copying of their transmissions is well-nigh impossible with our sharp receivers. It is hoped that the boys up there will see the light, and that more will get going with improved gear, in order that the full possibilities for international work may be realized. There is considerable 50-Mc. activity in Toronto, according to VE3AEU, who has a 3-stage rig with an 807 in the final, running 40-watts input. He has worked WØZJB, WØYUQ, and W9ZHB.

144-Mc. Record Moves West!

Though all the records for 144-Mc. work which have been recognized as official have been the work of stations in the East, we have felt that the 144-Mc. enthusiasts in California were just waiting for the record to go high enough to make it worthwhile breaking. When W3HWN and W2BRV got up to 200 miles (no mean accomplishment, in view of their both being at home locations) the West began to be heard from.

(Continued on page 148)



Hints and Kinks

For the Experimenter



MORE ON THE HY-75

IN *QST* for March, 1945, mention was made in "Hints and Kinks" of steps to be taken in resoldering the top cap leads of the HY-75. The explanation of the need for resoldering took into account only the actual melting of the solder. It did not explain the underlying cause for its occurrence.

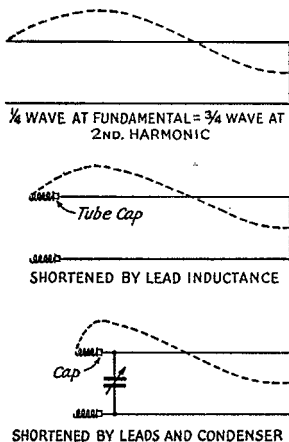

Fig. 1 — Current distribution at the second harmonic along a "quarter-wave" line. If peak current occurs at or near the tube cap, as shown in the bottom sketch, overheating and consequent melting of the solder can occur.

In an attempt to discover this reason, I have spent about 500 hours in experimenting with the HY-75 in various v.h.f. circuits. The results of these experiments show that the melting is not the result of heat generated by the tube elements during normal operation, but is caused by abnormally high r.f. currents, usually at a harmonic of the fundamental frequency, stemming from improper design of the oscillator circuit. These currents are high enough to cause considerable heat to be generated when flowing through even the small resistance presented by the soldered connection.

Fig. 1 shows the current distribution at the second harmonic on a quarter-wave tank circuit under various conditions of added inductance and capacitance. The portion of the line shown between the condenser and the shorted end of the line could be replaced by a coil and the analysis would still hold. The curves illustrate

that as the line is shortened, the current maximum moves closer to the soldered connection at the tube caps. Under certain conditions it can be right at the caps, and if the tuning capacitance is at the same time large enough to offer a very low reactance at the second harmonic (or at a parasitic frequency) the amplitude of the current flowing at the caps may be great enough to cause the solder to melt.

In the commonly-used coil and condenser circuit, one other source of trouble may be present. If the tuned circuit is so adjusted that the portion of the coil between the condenser and the plate-supply lead can act as an r.f. choke at the undesired frequency, the condenser may then look like a short-circuit across the end of a line made up of the tube-lead inductance plus the lead to the tuning condenser, and abnormal heating will result.

The cure for these troubles will vary with different circuits, but some generalizations can be made. The use of filament chokes (27 turns of No. 18 closewound on a 3/8-inch form) eliminates the trouble in HY-75 oscillators in the 2-meter band. Possibly the tuned-choke system shown on page 29 of *QST* for April, 1946, might work as well, but this was not tried.

The L/C ratio of the tuned circuit can often be altered to shift the current loop. The tuning condenser can be completely eliminated and the frequency adjusted by varying the L to resonate with the tube capacitances at the desired frequency. Tuning a quarter-wave line with a relatively large condenser replacing the usual shorting bar also provides proper operation. The most straightforward method is to use a shorting bar for tuning, with a high-quality blocking condenser of about 500 μfd . The condenser must have low lead and internal inductance.

With the HY-75 operating in a properly-designed circuit the solder at the tube cap will not melt. Any softening of the solder is a sure warning that something is wrong with the circuit, with either harmonic trouble or a parasitic oscillation being the usual cause. Other changes may be necessary in particular circuits, but the suggestions given above should clean up the difficulty in most cases. Although these tests were made only with the HY-75, it is possible that similar conditions may exist in v.h.f. circuits using other tubes. — George D. Perkins, W1IVU.

SIX OSCILLATOR INPUT CIRCUITS ON ONE SOCKET

THIS circuit permits the first tube in a transmitter (such as a 6F6 or 807) to be used with equal convenience as an oscillator or as a buffer-amplifier. The circuit shown in Fig. 2 has been built into several transmitters during the past three years, and has proven entirely satisfactory.

The cathode bias resistor and condenser are sometimes at a moderate r.f. voltage above ground, therefore they should be insulated accordingly. The value of cathode resistance is just sufficient to limit the plate current (zero signal) to a safe value. Since the cathode resistance used will vary with the type of oscillator tube and other circuit conditions, no value for R has been specified.

The plugs are old six-prong tube bases. The Tri-tet coil was wound on a homemade fiber bobbin, which was cemented in a tube base. The components for the grid-plate oscillator circuit were made to go into a tube base by using a very small size mica condenser and a single-pie r.f. choke. All of the tube bases were covered with thin bakelite discs cemented in place.

Although a coaxial-cable connector is provided, the tube may be driven by plugging an exciter output cable directly into the crystal socket, and providing a plug with suitable jumpers. If the coaxial-cable connector can be insulated from ground, it might be better to return the outer-shield connection to Pin 6 (the key jack) rather

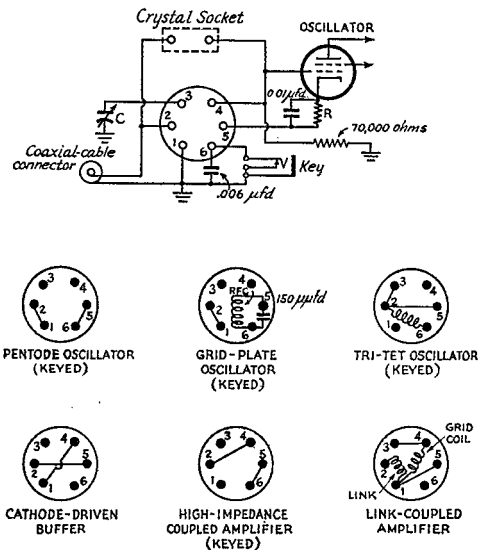

Fig. 2 — Six different oscillator-circuit arrangements are available in this oscillator socket layout worked out by W8UPS. Condenser C must be large enough (100 to 250 $\mu\text{fd.}$) to resonate the Tri-tet coil or the link-coupled amplifier grid coil. The value of R will vary with various tubes and should be the normal cathode resistor for the tube selected.

than to ground. This would permit using the tube as a cathode-keyed buffer or doubler. — *Henry L. Cox, jr., W8UPS/B*

ELIMINATING STAND-BY DRIFT IN A VFO

SOME of the drift in a VFO can be avoided by permitting the oscillator tube to run continuously. However, in spot-frequency operation,

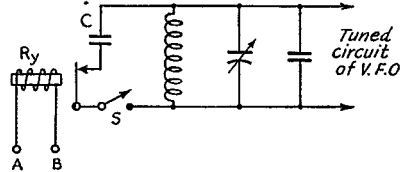

Fig. 3 — Elimination of drift during VFO stand-by. The relay (operated by a source of power available when the transmitter is on) removes the padding condenser C from across the VFO which then returns to the desired operating frequency. When the transmitter is turned off the relay closes and the padder lowers the VFO frequency sufficiently to move it out of the way of the incoming signal in the receiver.

This method of moving the VFO frequency is *not recommended* for keying the oscillator, as the contact capacity of the relay will make signal chirp or "yoop."

even the weak signal from the oscillator is not desired and must be removed. Cutting the plate voltage allows the tube to cool and when turned on again, the output may be on a different frequency. The scheme shown in Fig. 3 eliminates this drift. After the oscillator has reached normal operating temperature its frequency may be shifted off the band by closing S , thus placing the condenser C across the tuned circuit. This capacity should be enough to move the oscillator frequency out of the band being worked. When the transmitter is on, the relay opens this padder circuit and the oscillator returns to the desired transmitting frequency. When the transmitter is switched off, the relay operates and connects the padder back into the circuit and the operating frequency is clear for reception. This scheme keeps the oscillator plate current constant.

The circuit may be modified to cut some portion of the oscillator tank capacitance in and out, in which case the relay would normally be open and would close the circuit on transmit, thus placing the stand-by signal higher than the operating frequency.

Such a device will not work as a method of keying as the opening and closing of relay contacts will make "yoops" in the oscillator signal.

A suitable d.c. relay can be connected in series with the cathode of a buffer or amplifier tube. An a.c. relay should be connected in parallel with the antenna relay or across some other circuit that is energized when transmitting. — *J. W. Brannin, W6OVK*

(Continued on page 140)



Correspondence From Members -

The Publishers of *QST* assume no responsibility for statements made herein by correspondents.

ON OPERATING

525 So. Westgate Ave., Los Angeles, Calif.

Editor, *QST*:

... Why is it necessary for some people (who seem to be otherwise decent c.w. operators) to repeat back everything you just said? Do they talk like that in real life? Picture meeting some total stranger who enjoys with you a common interest in, say, gardening. You talk about a number of things, and he comes back with, "OK, OK, thanks for all the dope on that. OK on disbudding your delphiniums on May 15th. OK on the using mulch on your roses. OK on the probable relation of *imbregardus novellium minor* to the common or garden variety of pelargonium." Why, you would either clip the guy with the nearest flower pot, or run for your life. Or both.

That's the way I feel when one of these fellows spends 80 per cent of his transmission time telling me what I just said. It makes you wonder if he is just killing time while he frantically gathers up the little gears that have fallen out of his so-called brain and gets them adjusted so he can carry on the conversation. Whatever it is, I'm for any law that decrees burning at the stake for the "OK on the this and OK on the that" operators. If they heard what you said, why can't they just say OK once at the beginning and carry on from there?

My second screamer has to do with this postwar development of "What's your handle?" For some reason, it has suddenly become a matter of first importance, ranking with your signal report, to know the first name of some joker whom you will probably never again QSO in this life. Why this sudden desire for intimacy? Up to the start of the war we were quite happy — indeed, proud — to be called "OM," and in moments of jocularity "OB" or the even more British "OC." And after you had worked somebody often enough to expect to do so again, you paid him the compliment of using his first name. Certainly nobody ever went around feverishly collecting given names like foreign postage stamps. Well, maybe the custom will die a natural death after these autograph-grabbers get a few thousand contacts in their logs, and searching thru a mess of pages to find the last QSO with somebody so you can call 'em quick (like Lillenthal or Bastanchury) won't be so easy.

This brings to mind my last half-gripe, which is the word "handle." I have taken the trouble to explain to several people, none of whom got the point, that a handle is part of a pot or implement, and that what I had was a "name." The origin of "handle" as related to names seems attributed by western story scribblers to old-time cowboys, along with "dogie," "pardner," and other terms peculiar to the days of Tombstone and Dodge City. But how it was ever transplanted into amateur radio is beyond me, and I wish DDT or 2-2-4 would eradicate it, so we could go back to "OM" again. . . .

— Bill Lippman, W6SN

Box 362, Drumright, Okla.

Editor, *QST*:

I am only an humble SWL now, but I believe I can speak for a great number of hams in this part of the country regarding the published comment on a "handle exterminator" in June *QST*. My receiver registered many of the W8s' and W9s' heated comments concerning what was probably thought an insignificant little "Stray." Nevertheless, my feelings are with them. I don't know, but I suspect there are those who would suggest a tuxedo for formal introductions

over the ether if television is ever extensively used by amateurs.

— Bill Jones

5949 Orchard Court, Des Plaines, Ill.

Editor, *QST*:

As a suggestion toward eliminating the use of such childish and asinine expressions as "handle," etc.: remove the nut that holds the microphone or/and key and subject it to a mental test.

— K. M. Hedrick, W9LVD

4622 Korte Ave., St. Louis 15, Mo.

Editor, *QST*:

... Just what is your reason for considering this (handle) "the most distasteful word in all the language of amateur radio?" Personally, I don't find anything distasteful about it at all. I think the majority of hams will agree with me.

If the use of "handle" has served us this long, why attempt to exterminate it? My feeling is that it is another of the many traditions of ham radio that make it so enjoyable.

— Herman E. Plew Jr., W0YHZ

2289 Commonwealth Ave., St. Paul, Minn.

Editor, *QST*:

For years *QST* has worked to build and maintain legal and common-sense operating procedures on the amateur bands, yet today the situation is at an all-time low. Back in the days of the Wouff-Hong and the Rettysnitch we thought things were tough, but this op is convinced that things have really hit bottom in the postwar era.

What to do about it? I believe the only answer is to appeal to FCC to further regulate our operation. The only positive way to stop a CQ hound from a fifteen-minute CQ is to limit him by law to a procedure similar to that set forth in *The Radio Amateur's Handbook*. The only way to take care of the guy who comes back "R R R sorry OM QRM and QRN pse rpt" is to classify hams by code speed and operating ability and relegate about 40 per cent of the type mentioned above to the great open frequencies above 30 Mc. until they have had sufficient practice working each other to come back down and provide a worthwhile QSO for someone. . . .

The important thing is that unofficial pleas by the ARRL and various clubs have done little or nothing over a period of years to alleviate the situation, and with the bands becoming even more crowded than before the war I feel it is imperative that ARRL appeal to the FCC for restrictions governing the brevity of calls, and degrees of proficiency necessary to work the lower-frequency bands (meaning 28 Mc. and down). I earnestly hope that I can enlist some whole-hearted support in this crusade, and I also hope that the newcomers will realize the necessity behind it, and that operation on the longer-range bands should be in the nature of a reward for having properly qualified themselves for such operation.

— J. H. Paist, W0RBA/Ø

80 Federal St., Boston, Mass.

Editor, *QST*:

... As our crowning contribution to mankind, including even the hams — for they must be people, even though they

don't talk like them — why don't we cook up a couple ultra-special "Z" signals for the use of inarticulate hams? (This applies equally well to the 10-word c.w. men, and to the 1,000,000-word 75-meter men.)

Let's take the famous Army "ZZZ" to mean, "rig running hr abt umpty watts — also have a receiver, goody goody, es ant half-wave Houdini — wl guess tis abt story hr — QRU?" And "ZQQ" might stand for, "es if trs ntg more tr I think I'll QRT so vy best 73 es WBCNU, best of luck for now, 73 es CUL AR SK 73 GE SK dum ditty dum dum etc." Think of the thousands of man-hours, the millions of watts, that would be saved. And the QRM problem would be killed to pieces. There might even be a chance for me, with my little sixty watts, to make myself heard after 7 P.M.!

But it wouldn't be ham radio, God bless 'em, so why should one manic complain about having to listen to the other maniacs? If I had brains I'd have realized long ago that all I had to do was throw the switch!

— Fred C. Hall, W1MZE

6902 Colby St., Lincoln, Nebr.

Editor, QST:

Just read the article in April QST about "Good Operating Pays Off," and wish to let you know that it really hits the spot. I have never in 20 years of hamming called a new operator a "lid" until I had satisfied myself that he was not interested in learning to operate better. I remember my first contact back in 1927 when the fellow on the other end was an old timer and I was just a "lid" as many would class all beginners. He really did me a wonderful thing by coming down to me and taking things easy so I could get by. Had he been "hard-nosed" I can imagine how I would have felt had he snubbed me and signed. I never have failed to help a beginner because I feel that in so doing I have had more thrills than from any other thing I could have done.

— J. H. Leacock, W9EDI

QST AND THE RADIO AMATEUR'S HANDBOOK

4215 S. 32nd Rd., Arlington, Va.

Editor, QST:

I surely was glad to see a "Gil" cover on QST after having missed it since October, 1941. It was like an old friend returning home from the war. Let's have more of them like the good old days.

— Lester Harlow, W5CVO/4

5993 Myrtle, Long Beach, Calif.

Editor, QST:

The first chapter of the 1946 issue of *The Radio Amateur's Handbook* is an editorial, if I may use the word, that is extremely exciting. When I had finished reading it I had a strong feeling of pride to call myself a member of the growing groups of world amateurs. It is truly a scientific movement. It has, in addition, the appeal of adventure — this amateur radio. I wish to compliment the writer of Chapter One for an inspiring rendition of the history of amateur radio.

— K. C. Rasmussen, W6URK

RAISING 'EM ON "ELEVEN"

Box 493, Sanatorium, Texas

Editor, QST:

So you don't get any answers to your "CQ 11," huh? This is to let you know that there is one other station on 11 besides you — me! I have contacted all stations that I have heard on 11 meters — and that with my 25 watts to a 6L6 and a vertical half-wave antenna. I guess you just haven't been on when I was. The band really isn't dead, though. Since March 30th, I have had 56 QSOs with 29 different stations. This accounts for 9 states, Hawaii, and one Canadian district (no locals) — not bad for a "dead" band.

I have a system for raising someone on 11 when I don't

hear anyone on, and I don't run out of breath yelling CQ, either. Because of the $\Delta\theta$ privilege on this band I just turn on my carrier and leave it on for about 5 minutes, then give a short CQ and sign. This brings very good results and even if it doesn't work the first time I still have plenty of breath and patience left to try it again.

I'm crystal controlled — 27,300 kc. See you on 11!

— Lucius Smith, W5FXO

TEST-OSCILLATOR COMMENTS

44 Prospect Hill Rd., Lexington, Mass.

Editor, QST:

I noted with interest the informative article, "A Wide-Range Test Oscillator," by Charles F. Lober, in the May issue of QST. I have built an oscillator of a similar nature with excellent results, and can surely recommend the circuit as trustworthy.

There are two comments I'd like to make on the text of the article — additions rather than criticisms. First of all, the statement is made that "The output of the 6K6 is fed back to the 6SJ7 exactly 180° out of phase." Of course the question arises: out of phase with what? Actually, the output of the 6K6 is fed back to two different points. The feed-back through the frequency-determining RC combination is positive feed-back, and the frequency is such that the control-grid-to-ground voltage applied to the 6SJ7 is exactly 360 (or zero) degrees out of phase with the 6K6 output. This feed-back is what maintains the oscillation.

The other feed-back is to the 6SJ7 cathode, and this is negative feed-back, applied for the purpose of maintaining a good frequency-response characteristic for the two stages and to reduce the internal impedance of the 6K6. A proper balance must be maintained between the positive and negative feed-backs in order that the output be sinusoidal, hence the rather critical adjustment mentioned in the article.

The other comment is in connection with use of the circuit as a square-wave generator. Although it doesn't say so in the article, the impression may be left that the dial calibration (for output frequency) made for sinusoidal waves will also hold for square-wave output. My experience has been that it does not — by a rather large factor. When the circuit is used as a square-wave generator it tends to act like a multi-vibrator, and the frequency is no longer determined as it was when sinusoidal output was obtained. I suspect that the square-wave frequency for any given setting of the tuning circuit will be 25 to 50 per cent lower than that obtained for sinusoidal output. At least, a word of caution to prospective users of the circuit may be in order lest some erroneous conclusions be drawn.

— James N. Thurston, W1NCH

MARCONI AGAIN

5235 Cote St. Luc Rd. No. 45, Montreal, Que.

Editor, QST:

... C. G. Wisdom stated in the May issue that "None of the components conceived by him (Marconi) were invented by him." All the books I have read on this subject credit Marconi with the invention of the magnetic detector. This is, roughly, an endless loop of wire on wheels which travels around and affects certain magnets and coils. The mechanism which powers this device is housed in a box to the top of which the wheels are attached. It was superseded by crystal detectors, but was certainly an invention by Marconi.

— Allan Bernfeld

CODE TRANSLATORS

663 Spitzer Bldg., Toledo 4, Ohio

Editor, QST:

Two or three years ago I had some correspondence with you regarding an oscillator circuit. At the same time I included what apparently was a far-fetched piece of fiction about a translator which picked up code but the spoken word came out the speaker.

(Continued on page 154)

Operating News

F. E. HANDY, WIBDI, Communications Mgr.
E. L. BATTEY, WIUE, Asst. Comm. Mgr.

J. A. MOSKEY, WIJMY, Communications Asst.
LILLIAN SALTER, Communications Asst.

Vacation Time. Summer, in years long gone by, was referred to as the time of the "summer slump." This was the time when radio activities were subservient to static; when traffic and reports fell to their lowest marks of the year; when the Circulation Department heaved a sigh of relief and expected to catch up with its incoming mail. Many hams headed for the lakes and woods without a thought to radio.

Times and much of this picture have changed. In our postwar Amateur World a lively station rehabilitation program is in full force. The Circulation Manager has to circulate as never before! Postwar nets are getting started in many sections. Noise limiting, v.h.f.-u.h.f., f.m., and directive arrays are available to overcome static. Summer is here, and with the trek to the wide-open spaces, portable and mobile amateur radio are going along. Result . . . *no slump!*

By the time these words appear in print our own vacation opportunity, the first after four vacationless summers, may be here if certain housing promises work out. It's to be a rest, not an intensive effort. Nevertheless, portable and Field Day type equipment will be carried for casual fun and a sked with home. Vacation and Amateur Radio go well together, in 1946! We hope you find it so.

On Good 'Phone Operating. Efficient voice communication, like good c.w. communication, demands good operating technique. Your ARRL Board has recommended the transfer of more frequencies from strictly c.w., to include voice operation, as you will note in connection with the Board's minutes in last *QST*. At the same time the Directors instructed us "that the League shall promote the economical use of 'phone frequencies by an educational program of good operating technique and constructional design to minimize the channel width required. . . ." This design problem is not a simple matter, but all amateurs who use voice can improve results without delay by reviewing their operating methods and adhering to the proven principles for efficient communications work. Remember that the ability to phrase clearly and concisely counts but that push-to-talk technique differs from broadcasting.

Adherence to the seven points "on getting results," that we suggested in this section in April *QST*, will go a long way toward improving

our 'phone-band operating conditions. Let us brief these points:

- 1) Listen *much*.
- 2) Make *short* calls, with breaks to listen.
- 3) *Time* calls intelligently; call when a station is free, not while it is still sending.
- 4) Transmit in intervals when your frequency seems open.
- 5) Speak clearly at all times. "Say it with connected phrases," not by disconnected words. Talk at moderate speeds.
- 6) Save local rag-chews on DX frequencies for times when the bands are dead to DX.
- 7) Don't repeat needlessly when you can get through without repeats.

Some practical suggestions can be added to the principles set down above. They mostly relate to the make-up of conversations and station conveniences that will insure a maximum exchange of intelligence.

Use push-to-talk technique. Where possible arrange on-off switches or controls for break-in and fast back-and-forth exchanges that emulate the practicality of the wire telephone. This will help reduce the length of transmissions and keep brother amateurs from calling you a "monologist" — a guy who likes to hear himself talk!

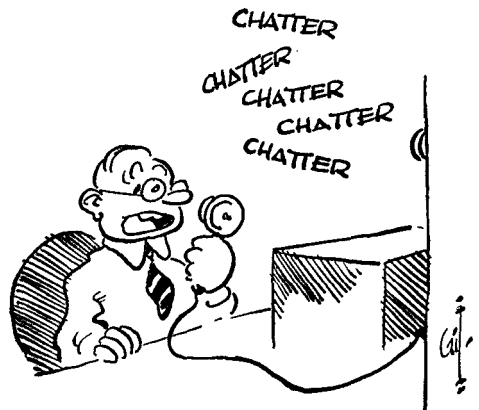

USE PUSH-TO-TALK AND AVOID BEING CALLED A MONOLOGIST

Listen with care. Carelessness in listening is intolerable. If one has time to operate at all, he should look over his operating practices and "do it right." Noise and other diversions must

not be permitted to interfere with the primary objectives in the operating room. Communication is the aim. "Writing down" on a note pad has been credited with improving the intelligence exchanged above casual listening by as much as 50 per cent, in some cases less of course, where transmissions are properly short.

Interpose your call regularly and at frequent intervals. Three short calls are better than one long one. In calling CQ one's call should certainly appear at least once for every five or six CQs. Calls with frequent breaks to listen will save time and be most productive of results.

Monitor your own frequency. This helps in timing calls and transmissions. Send when there is a chance of being copied successfully . . . not when you are merely "more QRM." Timing transmissions is an art to cultivate.

Tune the band well. After calling cover the band well on your receiver. It will pay dividends.

Speak near the mike. Don't let your gaze wander all over the station causing sharply-varying input to your speech amplifier. Keep a proper distance from the mike, and keep an eye on any modulation indicator used. Change distance or gain only as necessary to insure uniform transmitter performance without overmodulation, splatter, or distortion.

Make connected thoughts and phrases. They gain in intelligibility that way. Don't mix disconnected subjects. Ask questions consistently. Pause and get answers.

Have a pad of paper handy. It is convenient and desirable to jot down questions as they come in the course of discussion in order not to miss any. It will help you to make intelligible to-the-point replies. Too many voice contacts that we hear are wordy generalizations. Some answers miss questions posed altogether! Courtesy requires that we do *not* trust everything said to memory; that we make notes; that we raise the standard of our operation by formulating notes (including new topics) to assist in composing concise transmissions.

Steer clear of inanities and soap-opera stuff. Our amateur radio and also our personal reputation as a serious communications worker depend on us. Decent citizens are not guilty of "exhibitionism" in public. Likewise, decent amateurs contribute to building up the reputation of the fraternity by their general friendliness, cooperation, restraint, dignity on-the-air, etc., striving

to promote constantly the knowledge of and value in amateur radio.



"EXHIBITIONISM" IS OUT

Use phonetics only as required. When clarifying genuinely-doubtful expressions and in getting your call identified positively we suggest use of the ARRL Phonetic List. Limit such use to really-necessary clarification.

Operating an Amateur Radio Station. The Communications Department booklet by this title has just been published in its 25th edition. It is free on request to ARRL Members, available at 10¢ (to cover mailing and incidental costs) to nonmember amateurs. The book has been revised to include new postwar data on such things as FCC regulations, OES appointment, and the new provisions in set-up of the ARRL Emergency Corps.

Ten sections of this 19-page booklet deal consecutively with Operating Practice, Emergency Communication, Operating Activities, ARRL Field Organization, Leadership Appointments, Station Appointments, Handling Messages, Network Organizing, Abbreviations and Prefixes, FCC Regulations, Orders and Miscellaneous. Helps available from ARRL Headquarters are listed. An application form for appointment, applicable for either "station" or "leadership" ARRL posts is included. There should be such a reference book in every amateur station. It will answer many questions on the above subjects. If you are a Member and would like a copy, just send along a radiogram or postal card request with your address, and we'll see that you get your copy.

— F. E. H.

BRIEFS

Use the W1AW practice. Get your CP certificate at the first opportunity. Do you know your actual solid-copy speed? Find out on a Qualifying Run!

— . . . —

The York Amateur Radio Club is holding a hamfest Sunday, August 18th, at Kellers Park,

Dallastown, Pennsylvania, on Route 24, seven miles south of York. Personalities, prizes, and a banquet will top off a day of ham gear, games, and gab. All amateurs are invited. Advance tickets \$1.75, at gate \$2.00. Contact Elmer Hauer, W3IXG, 49 Columbia Ave., York, Pennsylvania.

PRIZE ARTICLE CONTEST

• Mr. J. M. Smith, W4CNZ, is a winner in the CD Article Contest. His article on "Speed-Key Adjustment" deserves the attention of all "bug" users.

The Communications Department conducts a continuing Article Contest in which the author of each article used is awarded a \$10 prize, consisting of \$5 in Victory Stamps and \$5 in ARRL supplies or publications (except *QST*). Contributions may be on any subject of interest to amateur radio operators. Articles are selected on originality and value to the fraternity.

Give this contest a try. You are not limited; make your contribution on any topic relative to ham operating or organization. Entries should be not over 500 words long. Please mark your contribution "for the CD Contest."

SPEED-KEY ADJUSTMENT

By J. M. Smith,* W4CNZ

Correct sending with a semi-automatic speed key requires considerable manual skill which can only be acquired by practice. However, no amount of practice will produce accurate sending if the key itself is improperly adjusted.

The inked-line tape recorder provides an accurate and graphic means for "bug" adjusting. Such a recorder was described in *QST*¹ for April, 1943. Another method, using a milliammeter as an indicator, was described in *QST*² for February, 1934.

Preliminary Adjustments

The contact points should be carefully cleaned using a relay burnishing tool or crocus cloth. If the points are pitted, an initial dressing-off with an oil stone may be necessary, in which case care should be taken to keep the entire surface of the contact flat against the stone.

Occasionally a "bug" will sound "scratchy," particularly when keying an audio oscillator. If the dots are poor, the trouble is generally dirty or poorly-aligned contacts. If the trouble is on the dash side, it may be due to high resistance between the dash lever and the shaft pivot. A flexible by-pass conductor from the dash contact adjusting screw to the frame should give a permanent cure.

Make sure that the movable and fixed dot contact points are parallel and have good con-

tact over their entire surface. Horizontal adjustment of the movable dot contact is made by loosening the screw "L." Vertical adjustment is accomplished by means of the pivot bearings "J." The pivot bearings should be adjusted so that no play can be felt when finger pressure is applied vertically to the shaft at its outer end.

For the preliminary adjustments, the weights should be at least halfway down the shaft. For a given speed, the exact position will vary considerably with the stiffness of the flat spring "M."

Back off the screw "B" until the end of the shaft is resting against the damper weight "C." Apply pressure to the thumb paddle "K," moving the shaft slowly toward the dot side, without allowing it to vibrate. If the adjustment is correct, the entire shaft will remain straight as it leaves the stop screw and the damper weight. If screw "B" is backed off too far, the flat spring will bend to the left before the end of the shaft clears the damper weight. The stop screw should be backed out as far as possible to allow good damping action by the weight "C" without bending the flat spring when the thumb paddle is pressed slowly to the dot side. This adjustment is somewhat critical and should be carefully made.

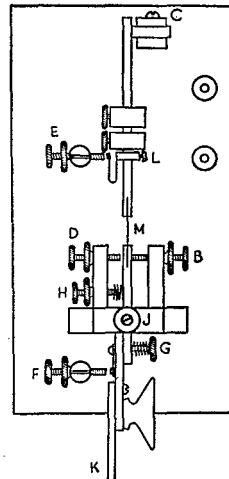

Again press the shaft to the dot side without allowing it to vibrate. Vary the stop screw "D" until there is a gap of approximately 1/8" between the side of the shaft and the damper weight. This determines the total swing of the shaft. The exact amount is somewhat a matter of personal preference, but the 1/8" separation will be satisfactory to most operators. In any case, the swing should not be much greater or less than this figure.

The dash adjustment is made by varying the screw "F" until the operating paddle moves the

* Instructor, Radio Training School, Pan American World Airways, 3051 Grand Ave., Miami, Florida.

¹ J. P. Gilliam, W9SVH, "A Siphon Tape Recorder . . ." *QST*, April, 1943.

² F. H. Schnell, W9UZ, "How's Your Fist," *QST*, February, 1934.

same distance to the left of center to make a dash as it moves to the right to make dots. If the paddle travel is excessive on the dash side, choppy sending is almost sure to result with spaces too wide between successive dashes. If the travel is too small, the dashes may be insufficiently spaced.

The coil springs "G" and "H" should be adjusted to approximately the same tension. This will vary with the individual operator, but in any case the spring "H" should have sufficient tension to return the shaft quickly and positively from the dot side to the rest position against the damper weight. The dash spring is then adjusted to a corresponding tension. Operators of fixed stations will generally prefer a comparatively light adjustment to minimize arm fatigue, particularly if a large amount of traffic is handled. Flight operators of Pan American Airways have found that a rather stiff adjustment is necessary, otherwise, when flying in rough air, sudden motions of the aircraft will result in unwanted dots. Marine operators will find that a medium stiff adjustment will compensate for the ship's roll.

Final Adjustment

The final adjustment of the dot contacts should be made with the "bug" operating a tape recorder, if available. The shaft is moved slowly to the left without allowing it to vibrate. The dot contact "E" is then moved to a position where it will just make contact with the movable point without noticeably bending the U-shaped dot spring. Start the recorder, pulling the tape through the machine at the rate of at least 20 feet per minute. Press the operating paddle smartly to the dot side. The resulting dots on the tape should be "square," that is the length of a dot should be equal to the space between two dots. If the paddle is held to the dot side, a series of at least 15 to 20 dots will be made with most "bugs" before there is any noticeable reduction in spacing between dots. If the dot adjustment is screwed in too far, a short series of heavy dots with very little separation will result, after which the points will remain in contact even though the shaft continues to vibrate. If the adjustment is screwed out too far, very light dots with excessive spacing will result. This adjustment is extremely critical, the allowable deviation of the screw "E" being only a small fraction of a turn.

With the recorder still operating, shift the weights along the shaft according to the speed desired. Many "bugs" are set to make excessively-fast dots. It will be found that most keys having a normal stiffness in the flat spring can be operated at a speed of about 30 w.p.m. with both weights toward the outer end of the shaft. Most operators cannot properly control a "bug" if the dot speed exceeds 11 per second. The rate at which your "bug" is adjusted can be easily

determined by making a string of dots on the recorder tape for 3 to 5 seconds, timing with a stop watch, and counting the dots.

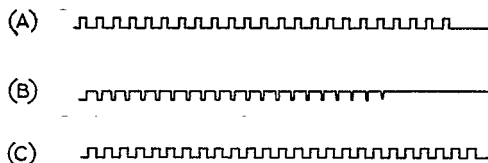

(A) Dot contacts too far apart. (B) Dot contacts too close. (C) Dot contacts correctly adjusted.

The milliammeter method of adjustment involves connecting a battery (or any suitable source of d.c.), rheostat, and milliammeter in series with the bug contacts. A typical set-up might employ a 22½-volt battery, a 1000-ohm rheostat and a 0-100 milliammeter. With the key contacts closed, adjust the rheostat (start with all the resistance in the circuit to avoid burning out the meter!) until the meter reads 100 ma. A string of dots is then produced with the bug and the average-current reading on the meter is noted. If the dots are too light, the reading will be less than 50 ma.; if too heavy, it will be more than 50 ma. The dot contact "E" is then adjusted, as previously described, until the meter reading hovers at approximately 50 ma. Any combination of voltage, resistance and milliammeter range may be used with this method, provided the meter reading noted during a string of dots is half that observed when the key contacts are held closed.

Obviously, there is no point in making dots faster than the operator is able to make dashes to correspond. The purpose of any telegraphic communication is to convey intelligence. Mistakes in sending have no meaning and confuse the receiving operator. The time taken to repeat an incorrectly-transmitted word will result in a net loss in speed of about two words per minute on the average. Set your "bug" for a speed at which you can handle it easily and without an appreciable number of errors.

Beginners with a "bug," and some old hands too, will do well to imitate the 15 w.p.m. transmissions of W1AW or some press station using punched tape at moderate speed. Confine your practice to an audio oscillator until you are able to send correctly for at least two or three minutes at a rate of 20 w.p.m. During the initial practice stages, the dots should be slowed down to not more than 6 per second. Every effort should be made at the start to achieve good control rather than speed.

BRIEF

KLPO, MacMillan's Bowdoin, listens on "20" or "40" and answers on 12,480 kc. and 8250 kc. (4150 alt.). "Bill" (opr.) is W1KKS/MM on 28,014!

SUSQUEHANNA EMERGENCY-NET OPERATION

The flood of the Susquehanna River and its tributaries on May 28th and 29th resulted in overloading of telephone and telegraph lines and pertinent information on flood progress was often delayed. The Susquehanna Emergency Net, on 3.9-Mc. 'phone, started operations at 10:50 A.M., May 28th, with the purpose of alleviating the condition and being in a position to assist with communications should the need arise.

At this time, communication to the towns of Wellsboro, Renovo, Lock Haven, and Coudersport already had failed. Realizing the situation, the Pennsylvania State Police requested W3IBM, Harrisburg, to assist and to contact and work with the S.E.N. Control Station, W3UA, ARRL Regional Coördinator, Susquehanna Watershed, at Safe Harbor, Pa. He was then instructed to tie in with the Federal Flood Forecasting Radio service and act as a common interchange point.

Arrangements were made to handle Red Cross traffic in Washington. Contact was made with Mr. Elliot of the ARC and arrangements completed on the conference line between Safe Harbor, Baltimore, and Alexandria, Va. With the announcement of completed arrangements, the first message to the ARC at Alexandria was sent through at about 1:30 P.M., consisting of a report on conditions at Elmira, N. Y.

The following cities were represented in S.E.N. by 18 amateur stations: Binghamton, N. Y.: W8CNA, W2EJC/8; Waverly, N. Y.: W8AVD; Elmira, N. Y.: W8CHU, W8UBU; Towanda, Pa.: W3PUZ; Wilkes-Barre, Pa.: W8QPU, W8EUI; Bradford, Pa.: W8CFU; Danville, Pa.: W3TIZ; Williamsport, Pa.: W8UFP, W3RFN; Sunbury, Pa.: W8HHK; Lewistown, Pa.: W8-

CHR; Harrisburg, Pa.: W3DJZ, W3IBM; Lancaster, Pa.: W3AXT; Washington, D. C.: W3HN. Outside assistance was given by W3BEI, W2BO, W8BWH/3, W8EU, and others.

River-stage readings were collected by the amateur radio operators and passed through to the control station. This served as a medium for holding the members in a regular reporting form, and assisted materially in keeping the channels from 3905 to 3915 kc. free from outside interference. Since the war no effort had been made to officially reinstate the S.E.N. due to lack of time for preparation. However, the net responded with 90 per cent of the members active by common necessity.

Toward evening of May 28th, when the telephone line between Safe Harbor and Baltimore became loaded, W3AXT, Lancaster, was tied in with W3HN, Washington, D. C. The Red Cross traffic was then routed over land line between Safe Harbor (W3UA) and Lancaster, thereby reducing operating time on the S.E.N. frequency. About twelve messages were handled between the outlying chapters and National Red Cross Headquarters.

At 11:30 P.M., a short news summary was made from W3UA over the NBC Coast-to-Coast Network, the connection completed through W3HN at Washington.

W3AXT, ARRL Emergency Coördinator of Lancaster County, supplied two relief operators, W3KBZ and W3KIE, to assist operations at Safe Harbor. Operation of S.E.N. continued until 2:00 A.M., May 29th, at which time control was transferred to W3IBM, Harrisburg.

W8CHU, Elmira, was flooded out and operated his emergency transmitter from the second floor of his garage. His signals had to be relayed by W3PUZ at Towanda. W3RFN had to move to the second floor of his home and his family was evacuated.

The operation of the old members of S.E.N. together with a few new stations in the region was spontaneous with a mutual desire to be prepared to handle emergency communications in the event that normal channels failed entirely. The close coöperation between Penna. State Police, the Federal Flood Forecasting Service, and amateur radio operators was particularly noteworthy. Much credit is due the supporting members of the S.E.N., and the amateur fraternity in general in keeping the channels 3905-3915 kc. clear for the period of emergency.

In recognition of the above work, Headquarters, the Pennsylvania State Police, has written the League as follows:

Harrisburg, Pa.

The Secretary, ARRL:

I wish to express the appreciation of the Pennsylvania State Disaster Committee for the excellent coöperation from the amateur radio operators of the Susquehanna Emergency Net during the recent flood in the Susquehanna River Basin in Pennsylvania.

AMERICAN RADIO RELAY LEAGUE	
EMERGENCY CORPS	
FOR PUBLIC SERVICE	
This Certifies that <u>John J. Doe</u>	
is a <u>Full</u> member of the ARRL Emergency Corps for one year from date below or endorsement on reverse side.	
In the event of failure of regular communication facilities due to storms, floods, and similar disasters, this operator offers the use of his amateur radio station and services to his country and community.	
He will cooperate closely in Emergency Corps activities, such as plans for rendering emergency communications service, and will participate as possible in appropriate preparedness drills and tests.	
Dated <u>Jan. 1, 1946</u>	
<i>R. J. Clark</i> A.R.R.L. Emergency Coördinator	<i>J. E. Handy</i> Comms. Mgr. A.R.R.L.

AEC Membership Card

The first step in effective organization for service in communication emergencies is to join the ARRL Emergency Corps. Each member receives one of these cards, which have proven valuable in the past as a means of identification when passing police lines in stricken areas. Don't put off making application for AEC membership. Forms are available from your local Emergency Coördinator, any ARRL-affiliated club, your SCM (address page 6), or League Headquarters. Line up *today* for the public-service opportunities of tomorrow!

This group gave willingly of their personal service and equipment and were able in several instances to establish emergency radio communications at places where normal communications had failed.

Inasmuch as it is physically impossible to thank each and every participant individually, it would be appreciated if you would do so through the medium of your organization's publicity channels.

— Colonel C. M. Wilhelm, Chairman,
The Pennsylvania Disaster System

WIAW OPERATING SCHEDULE

Official ARRL Bulletins containing latest FCC information relating to amateur operation and reactivation, and other bulletins on matters of general amateur interest are transmitted on regular schedules, as follows:

Frequencies: 3555, 7145, 14,150, 29,150, and 52,000 kc.

Times: 8:00 and 11:30 p.m. EDST, Monday through Friday. (0000 and 0330 GCT, Tuesday through Saturday.)

Starting at the times indicated, bulletins are transmitted by telegraph simultaneously on all frequencies. Bulletins are sent at 25 w.p.m. and repeated at 15 w.p.m. to facilitate code practice. Telegraph bulletins are followed in turn, by voice transmissions, except that 3950 is substituted for 3555 kc., and 14,280 is substituted for 14,150 kc.

Code-Proficiency Program: Practice transmissions at five speeds, 15 through 35 w.p.m., are made Monday through Friday on the above-listed frequencies, starting at 10:00 p.m. EDST (0200 GCT, Tuesday through Saturday). Approximately ten-minute practice is given at each speed. Next certificate-qualification run is scheduled for Monday, August 19th.

General Operation: WIAW engages in two-way work with amateurs, dividing time between 3825, 7250, 14,150, 28,060, and (on voice) 3950, 14,280, 29,150, and 52,000 kc.

OHIO EMERGENCY CORPS NET

Organization of an Ohio Emergency Corps Net is off to a good start with the following cities and stations represented as of June 7th: Columbus—W8HXQ, Control Station, and W8QQ, ARRL Emergency Coördinator; Cincinnati—W8UPB, and W8VZF; Springfield—W8WXG, and W8EQN, ARRL EC; Findlay—W8MEN and W8QC; Dayton—ARRL ECs W8CBI and W8RHH; Portsmouth—W8UKY. The net operates on 3885 kc., Mondays and Thursdays, 8:00 p.m.

BRIEF

The Citrus Belt Amateur Radio Club (Colton, California) has a net operating on 28.24 Mc., Wednesdays at 8:00 p.m. It is known as the C-BAR-C Net and includes the following: W6CUT, SEY, QL, UZL, QQP, UKX, HDY (NCS) and W4EJQ. Plans are under way to move to 50 Mc.

ALASKAN EARTHQUAKES

"On April 1st, at 0230 GT we had an earthquake, 10 minutes later another, 20 minutes later than that a third, and at 0330 GT a fourth, followed by a tidal wave which reached a crest of 60 feet here at Ikatan, Alaska.

"One home was washed out into the bay and three other buildings were demolished totally by ice that the tidal wave washed out of a lake and onto the surrounding ground. The water reached a depth on the level of about 12 feet. One small boat and two skiffs were washed out into the bay. We had to take our families up to the hills in the early hours of the morning and stay there until daylight, as in the darkness we were not able to see what was going on.



"At daylight we went back home and I immediately got on the air at 0600 GT, calling 'QRR de K7FFG.' I did not contact any station until 1000 GT, when I finally got in touch with KNLL, a government station operated by the Alaska Native Service. I gave them all of my reports and kept in constant communication with the Signal Corps through the kind help of KNLL. I was requested by the Signal Corps station, WXFP, to keep a constant radio watch and report every 15 minutes for 24 hours. After the 24-hour period I reported all shocks twice a day for the next two days. We had a total of about 70 shocks up to April 7th.

"After being up for 72 hours and on the radio for most of the time I was a pretty sleepy boy, believe me. The fourth night I slept through everything. The residents of Ikatan and False Pass were relieved to know that amateur radio K7FFG was in constant contact with the Signal Corps and could get help at any time if needed."

— Henry W. Peterson, K7FFG

BRIEF

During Field Day we noticed cases of the incorrect use of the portable designator, e.g., /2 in Delaware, /3 in New Jersey. The portable designator indicates the call area in which you are operating at the time, and must be in terms of the new or present call areas, not the old ones.

MEET THE SCMS

Indiana's newly-elected SCM, Ted K. Clifton, W9SWH, was born in Van Wert, Ohio, on May 8, 1910.

Upon graduating from high school, he attended General Electric Apprentice School (tool and die-making), then obtained occupation as tool designer and engineer. He now is co-owner of the New Haven Tool Company of New Haven, Indiana.

After a long interest in amateur radio dating from 1919, he received his first license, in 1930, at which time he was issued the call W8DLS. W9SWH's receiving speed is estimated at 25 w.p.m.

Clifton was a participant in prewar Sweepstakes Contests, and at the time of Pearl Harbor he held ORS and EC appointments. During the wartime period he took an active part in the War Emergency Radio Service. "Ted" is past-president and vice-president of the ARRL-affiliated Fort Wayne Radio



Club and at present is trustee of the club station. W9SWH, located in the upstairs part of the house, is composed of the following equipment: Transmitter — 6L6, 807, p.p. 812s r.f., audio p.p. 811s Class B, for use on 10, 20, 40, and 80 meters, 'phone and c.w. Receivers — SX-25 and *Handbook* Single-Signal. Antenna — 80-meter half-wave center-fed. A QSL-40 rig and MTR mobile unit are available for use in emergency.

Clifton holds membership in several professional, fraternal, and civic organizations. His spare time is taken up with tennis, fishing, and skating.

"Ted" is endeavoring to follow in the footsteps of his predecessor, Herbert S. Brier, W9EGQ, to the best of his ability, which augurs well for the future of the Indiana Section.

VFO TECHNIQUE

Increasing interest is expressed in the method for more efficient use of VFOs proposed in June *QST* ("It Seems to Us . . ."). The basic thought back of the proposal, reduction of QRM, is receiving a hearty "Hear! Hear!" from all hands.

If you missed the original discussion of the matter in the June issue, haul out your copy and read it now. The principles of the technique involve (1) general use of VFO, (2) calling close to, but not on, the frequency of the station called, and (3) shifting to zero-beat with the station called *after contact is established*.

It is apparent that we need certain procedure

signals in applying this VFO method of operating. First off, we want somehow to announce that we are using this system. In his DX column, July *QST*, W1JPE suggested the signal "NS" for this purpose. Used after your call during a CQ this would indicate that you will *not* listen for answers "smack on" your frequency, but rather that you expect to be called at least 1 kc. off your frequency. So let's give NS the following meaning:

NS — I shall listen for answers close to, but not on, this frequency. Call me 1 to 5 kc. on either side.

There will be cases where we do not know if the other fellow is equipped with VFO. When necessary to determine this, we suggest the following signals:

Question: VF? — Are you using variable frequency control?

Answers: VF — I am using variable frequency control.
CC — I am using fixed (crystal) frequency control.

Once we are sure the other fellow is equipped with VFO, we can ask him to shift to our frequency. But we must have a simple, concise way of asking. Or, if we intend to shift to the station whose CQ we answered, how to tell him so? We suggest the signal QZF, which means:

Question: QZF? — Shall I zero-beat (tune) my transmitter to your frequency (or to the frequency of . . .)?

Answer or Request: QZF — Zero-beat (tune) your transmitter to my frequency (or to the frequency of . . .).

These signals, NS, VF, CC, and QZF, give us the necessary tools to apply the technique previously outlined, and will go a long way in our campaign to reduce QRM. Try them out and let us know which you find most useful. Voice operators will, of course, "say it with words," using the meanings rather than the c.w. abbreviations.

A word of caution: VFO is a blessing in these days of heavy QRM, but it can be a curse if misused. We refer now to the thoughtless lads who swish through the bands with the final "putting out." Provide yourself with some means of eliminating radiation from the antenna while shifting frequency with VFO. A simple switch that isolates all stages after the VFO itself is a simple answer. The boys with the ganged-tuned transmitters must be particularly careful to cut power to later stages while cruising the band. Once the VFO is tuned to the desired frequency, a quick adjustment of later stages with the power on is usually necessary, except where frequency change is minor or ganged-tuning is used.

All the foregoing relates to the use of this new operating technique with existing equipment. Our ultimate aim must be transmitters that can be set with rapidity and precision in any part of

(Continued on page 82)

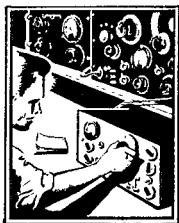

You may have noticed that when receivers are advertised in *QST*, the manufacturer rarely gives exact figures for the sensitivity and usually makes only a general statement that the receiver is "very sensitive." There is a good reason for this and we think it can stand a bit of airing.

First, let us take a look at the standard IRE test for sensitivity. A signal modulated 30% at 400 cycles is applied to the receiver. With the receiver controls adjusted for *maximum gain*, the signal is adjusted until the output is one watt. The sensitivity is defined as the signal required to produce this one watt at the speaker. However, if the receiver cannot deliver one watt, 50 milliwatts output is used instead.

This definition says nothing about noise. Most communication receivers can deliver this much output in noise alone when the gain is wide open, so no input signal is needed. By IRE definition, such a receiver could be said to have infinite sensitivity. To be on the conservative side, it is more common to claim "better than 1 microvolt sensitivity" or something similar.

Obviously, the standard IRE test tells practically nothing about the ability of a receiver to bring in weak signals. The Army and Navy bought a lot of receivers during the war and, as might be expected, their specifications called for a test that really did give a measure of the weak signal capabilities of a receiver.

Stated briefly, the Navy definition for sensitivity is the weakest input signal that is 10 db. stronger than the noise. The test consists of adjusting the gain of the receiver and the strength of the test signal so that with an unmodulated carrier there is 0.6 milliwatts output to the speaker (noise) and with a modulated carrier the output is 6 milliwatts (signal and noise). The carrier strength in microvolts for 6 mw signal is the receiver sensitivity.

Notice that the carrier is never shut off, only the modulation. If the carrier is turned off for noise measurements, the signal-to-noise ratio will appear to be much better than it actually is.

The test as described is for phone. On CW, the carrier is shut off for noise measurements to simulate operating conditions, but in this case the Navy requires 20 db. difference. This figures out at .06 milliwatts carrier-off and 6 milliwatts carrier-on.

The Navy considers a receiver with 10 microvolt sensitivity, as measured above, a good job. The HRO, so tested, is about 3 microvolts throughout most of its range. This figure for the HRO applies strictly to Navy test conditions. The sensitivity can be made to look much better by changing test conditions, for instance, by switching the carrier on and off instead of the modulation.

The point is that there is no generally accepted sensitivity test that means much. There is now a program by the RMA to set up new specifications for communications receiver performance. We have high hopes that this will result in an unequivocal definition of sensitivity and we are sure that amateurs will join us at National in wishing the program every success.

WILLIAM A. READY



(Continued from page 80)

the band, with no delays for retuning. When we're all so equipped, we'll automatically move frequency to meet each other and we'll need no special abbreviations. In the meantime they'll serve to mark the forward-looking amateur who is pioneering in this approach to better operating.

ELECTION NOTICE

(To all ARRL Members residing in the Sections listed below:)

You are hereby notified that an election for Section Communications Manager is about to be held in your respective Sections. This notice supersedes previous notices.

Nominating petitions are solicited. The signatures of five or more ARRL full members of the Section concerned, in good standing, are required on each petition. No member shall sign more than one petition.

Each candidate for Section Communications Manager must have been a licensed amateur for at least two years and similarly a full member of the League for at least one continuous year immediately prior to his nomination.

Petitions must be in West Hartford, Conn., on or before noon on the closing dates specified. In cases where no valid nominating petitions were received in response to previous notices, the closing dates are set ahead to the dates given herewith. The complete name, address, and station call of the candidate should be included with the petition.

The following nomination form is suggested:

Communications Manager, ARRL (Place and date)
38 La Salle Road, West Hartford, Conn.

We, the undersigned full members of the.....
..... ARRL Section of the.....
Division hereby nominate.....
as candidate for Section Communications Manager for this
Section for the next two-year term of office.

Elections will take place immediately after the closing dates specified for receipt of nominating petitions. The Ballots mailed from Headquarters to full members will list in alphabetical sequence the names of all eligible candidates.

You are urged to take the initiative and file nominating petitions immediately. This is your opportunity to put the man of your choice in office.

— F. E. Handy, Communications Manager

Section	Closing Date	Present SCM	Present Term of Office Ends
Illinois	Aug. 1, 1946	David E. Blake, II	Aug. 15, 1946
Oklahoma	Aug. 1, 1946	Ed D. Oldfield, jr.	Aug. 15, 1946
Western Mass.	Aug. 1, 1946	William J. Barrett	Aug. 17, 1946
Ohio	Aug. 1, 1946	Carl F. Wiehe	Aug. 17, 1946
West Indies	Aug. 15, 1946	Mario de la Torre	Deceased
Philippines	Aug. 15, 1946	George L. Rickard	Oct. 15, 1938
Tennessee	Aug. 15, 1946	James B. Witt	Nov. 15, 1944
Mississippi	Aug. 15, 1946	P. W. Clement	Apr. 1, 1945
Rhode Island	Aug. 15, 1946	Clayton C. Gordon	Apr. 15, 1945
No. Minnesota	Aug. 15, 1946	Armond D. Brattland	June 15, 1945
San Diego	Aug. 15, 1946	Ralph H. Culbertson	Apr. 15, 1946
Maine	Aug. 15, 1946	Grover C. Brown	June 15, 1946
Maritime*	Aug. 15, 1946	Arthur M. Crowell
Quebec*	Aug. 15, 1946	Lindsay G. Morris
Saskatchewan*	Aug. 15, 1946	Arthur Chesworth
Eastern New York	Oct. 1, 1946	Ernest E. George	Oct. 15, 1946
Nebraska	Oct. 1, 1946	Arthur R. Gaeth	Oct. 15, 1946
Northern Texas	Oct. 1, 1946	Jack T. Moore	Oct. 15, 1946
South Carolina	Oct. 1, 1946	Ted Ferguson	Oct. 16, 1946
Wisconsin	Oct. 1, 1946	Emil R. Felber, jr.	Oct. 16, 1946
Kansas	Oct. 15, 1946	Alvin B. Unruh	Oct. 29, 1946

* In Canadian Sections nominating petitions for Section Managers must be addressed to Canadian General Manager, Alex Reid, 169 Logan Ave., St. Lambert, Quebec. To be valid such petitions must be filed with him on or before the closing dates named.

CODE PROFICIENCY PRACTICE

WIAW conducts practice transmissions nightly Monday through Friday, 10:00 p.m. EDST, at speeds of 15, 20, 25, 30, and 35 w.p.m. Once each month a special transmission is made to enable you to qualify for a CP certificate or endorsement sticker indicating progress above your first certified speed. See WIAW Schedule for details on frequencies. The next qualifying run will be on August 19th.

QST lists in advance the text to be used on several of the CP schedules. This makes it possible to check your own copy. It also provides a means of obtaining sending practice since it permits direct comparison of one's fist and tape sending. To get sending help hook up your own key and buzzer and attempt to send right in step with the tape transmissions. Adjust your spacing in the manner indicated as necessary for self-improvement.

Date	Subject of Practice Text from June QST
Aug. 2nd:	"It Seems to Us," p. 11
Aug. 5th:	High Power in Two Stages, p. 13
Aug. 7th:	A Mobile Rig for 60 and 88 Mc., p. 31
Aug. 13th:	A Field-Intensity Meter for V.H.F., p. 40
Aug. 15th:	Getting Started on 480 Mc., p. 43
Aug. 19th:	Qualifying Run, 10:00 P.M. EDST
Aug. 20th:	Frequency-Shift Keying, p. 46
Aug. 23rd:	Making the Most of It, p. 49
Aug. 26th:	Long Leads Aren't Necessary, p. 55
Aug. 29th:	Miniature Tubes in a Six-Meter Converter, p. 18

ELECTION RESULTS

Valid petitions nominating a single candidate as Section Manager were filed in a number of Sections, as provided in our Constitution and By-Laws, electing the following officials, the term of office starting on the date given.

Alberta	William W. Butchart, VE6LQ	May 1, 1946
Ontario	David S. Hutchinson, VE3DU	May 1, 1946
Manitoba	A. W. Morley, VE4AM	May 1, 1946
British Columbia	W. W. Storey, VE7WS	May 1, 1946
Eastern Florida	Robert B. Murphy, W4IP	June 1, 1946
Nevada	N. Arthur Sowle, W6CW	June 15, 1946

In the Eastern Massachusetts Section of the New England Division, Mr. Frank L. Baker, jr., W1ALP, and Mr. Robert G. Ling, W1IBF, were nominated. Mr. Baker received 367 votes and Mr. Ling received 121 votes. Mr. Baker's term of office began May 15, 1946.

In the Maryland-Delaware-District of Columbia Section of the Atlantic Division, Mr. Hermann E. Hobbs, W3CIZ, and Mr. Albert E. Hayes, jr., W1IIN/3, were nominated. Mr. Hobbs received 166 votes and Mr. Hayes received 80 votes. Mr. Hobbs' term of office began June 14, 1946.

In the Arkansas Section of the Delta Division, Mr. Marshall Riggs, W5JIC, and Mr. Walter D. Cox, W5KKM, were nominated. Mr. Riggs received 40 votes and Mr. Cox received 11 votes. Mr. Riggs' term of office began June 14, 1946.

In the North Carolina Section of the Roanoke Division, Mr. W. J. Wortman, W4CYB, and Mr. William J. Speed, W4BIP, were nominated. Mr. Wortman received 77 votes and Mr. Speed received 68 votes. Mr. Wortman's term of office began June 14, 1946.

In the Virginia Section of the Roanoke Division, Mr. Walter R. Bullington, W3GKL, and Mr. Fred W. Martin, W3HLC, were nominated. Mr. Bullington received 73 votes and Mr. Martin received 54 votes. Mr. Bullington's term of office began June 14, 1946.

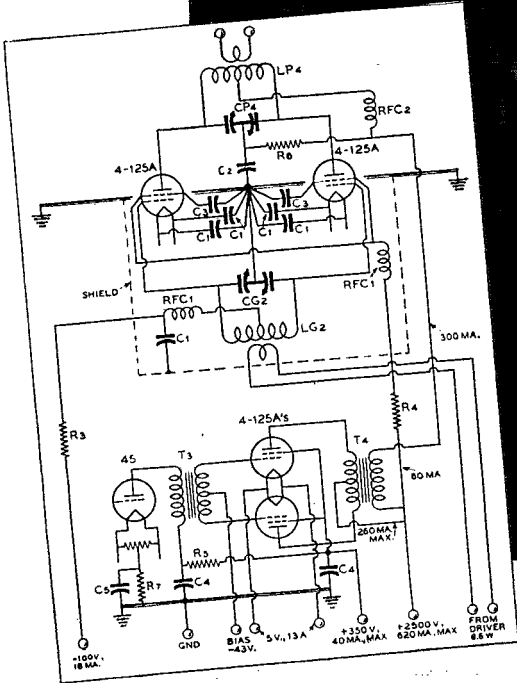

Typical High-Level Modulated R-F Amplifier Circuit. (Note: Separate screen winding not required on modulation transformer.)



PLUS PERFORMANCE... with Eimac 4-125A Tetrodes

Modulator power output of 375 watts with ZERO watts audio drive, 100% modulating a 750 watt input r-f amplifier, is achieved with EIMAC 4-125A tetrodes in a typical high-level modulated r-f amplifier circuit illustrated at left.

Here are three reasons why this tetrode provides plus performance for this and many other uses:

1. R-f amplifier plate input of 750 watts is achieved with less than 7 watts r-f driving power.
2. Neutralization not required at frequencies below 100 Mc; greatly simplified at higher frequencies.
3. 4-125A tetrodes are compact—outside dimensions less than 6" by 3"—and they're ruggedly built to insure long-term, trouble-free service.

FOLLOW THE LEADERS TO

Eimac
REG. U. S. PAT. OFF.
TUBES

EIMAC's 4-125A data sheet contains complete application information, and circuit diagrams, (including the above illustrated circuit and parts list). For full technical details of the 4-125A and other dependable EIMAC tubes, see your dealer, or write direct to

EITEL-McCULLOUGH, INC., 1277M San Mateo Ave., San Bruno, Calif.
Export Agents: Frazar and Hansen, 301 Clay St., San Francisco 11, Calif., U.S.A.

SCM — AEC — ORS — CP — SEG — OBS — TLS — OO
 RAM — WAG — NETS — WAG
 OBS — AIOPR — EC — DXCG — CLUBS — RA — OPS — RCC

Station Activities

REPORT YOUR ACTIVITIES

• All operating amateurs are invited to report to the SCM on the first of each month, covering station activities for the preceding month. Radio Club news is also desired by SCMs for inclusion in these columns. The addresses of all SCMs will be found on page 6.

ATLANTIC DIVISION

EASTERN PENNSYLVANIA — SCM, Jerry Mathis, W3BES — The Eastern Pennsylvania operators did an important bit of emergency communication work during the Susquehanna flood. The S.E.N. group in particular, headed by 3UA, turned in a notable performance. The S.E.N. members are as follows: 8UFP, CFU, AVD, CNA, CHU, HHK, CHR, EUI, UBU, QPU, 3IBM, PUZ, TIZ, RFN, DJZ, HN, AXI, and 2EZC/8. 8EU gave additional help and stood by to assist. 3IXN and 3BES are helping to live up the 50-Mc. band. 3GEM is back home from LEDO and is on 3.5-Mc. 3DGM is giving 28-Mc. 'phone a whirl! 3HXA has closed down and will not be on in the U.S. for at least three years. 3BXE has a new rig using a 4D32. 3ENX uses a "Clipter" in his new 'phone rig. 3AOC complains that his 807 doesn't make much of a hole in the 3.5-Mc. QRM. The Field Day spirit was on a high level among the local Philadelphia area clubs. The Lancaster Club was to be reckoned with this year. The Reading gang competed in the u.h.f. group. The Chester Club missed 3DGM this year; he was visiting the VE7s. 3FLH is showing signs of life and is rebuilding. The York Road Radio Club boasts a four-element 28-Mc. beam for Field Day. 3LN is getting super results from his square corner beam on 144 Mc. 3UX worked 8LZK/NY4 on 3.5 Mc. 3HFJ has a new 144-Mc. f.m./a.m. rig. 8WKE reported that operation this month was on 28-Mc. 'phone (locals only), 3.5-Mc. c.w., 3.9-Mc. 'phone, using 30 watts to the final, and 144-Mc. 'phone, about 3 watts to mod. oscillator. ORS and OPS are requested to send their certificates for postwar endorsement. Note that ARRL membership must be maintained. Hope to see you all in the July ORS/OPS Party. There are twenty-one active ORS in the section as of this date. Traffic: W3BES 18, 3BXE 8, 8WKE 4, 8EU 2. 73. Jerry.

MARYLAND-DELAWARE-DISTRICT OF COLUMBIA — SCM, Hermann E. Hobbs, W3CIZ — It was the opinion of all attending that the Washington Radio Club's hamfest on June 1st and 2nd was a great success. There were 380 hams present. Prizes ran from toasters and radio equipment to nylons. President Bailey, 1KH, gave a short talk on the Class D license. Among the other interesting speakers was Chief Radio Electrician George Ray Tweed, who told of his eluding the Japs on Guam. On June 2nd, visits were made to various interesting ham shacks around the city — beginning with a trip to "WAR." The following are back, or soon will be back, on 3.5 Mc.: AB, CAB, CJT, JJD, DTO, IEM, AKR, 2CGG, 1BDU, 4PL. IEM reports that he has had over 300 QSOs since April 1st and his best DX was G6VX and a VPS. Col. Van Deusen expects to be retired this fall after twenty-nine or more years in the military service. His son graduated on June 4th from West Point. Van expects to be ORS and active as OO as soon as he gets some necessary equipment completed. DTO has retired from Naval service after twenty-two years. Another interesting note from the D. C. Radio Club indicates that at the May 25th regular meeting Capt. Eric Hott, G2JK, spoke on, and demonstrated, the "Magnetic Wire Re-

order." At the June 1st and 2nd hamfest Capt. Hott told of his present assignment in the U.S.A. New officers of the D. C. Club for the coming year are: 8UUC, pres.; 4GPW, vice-pres.; 9GBA, secy.; and 4GQT, treas.

SOUTHERN NEW JERSEY — SCM, Ray Tomlinson, W3GCU — Section EC, BAQ; ECs, ABS and JNZ. The DVRA hamfest has been cancelled. QQS has published a swell new QSO index. ABS and GQS are getting swell results on 144 Mc. with the revamped 1068A radar receiver. HYT is on the air with p.p. 810s from 28 to 3.5 Mc. JNZ is active on 28 Mc. 2OXX and EPF are active in traffic circles. New calls: 3ATF, now 2PHN; 3HAZ, now 2HAZ; 3DCQ, now 2DCQ; FTQ, now 2PAZ; 1IRV, now 2PAU; AVA, now 2PBW; JJJ, now 2FFQ; ILX, now 2OZO; 9ENK, now 2PBX; and brand-new call 2OXF. 2HAZ has taken over the editorship of the DVRA News. Ex-8BRJ recently received his CPO 1st-class ticket. JAG is heard on 28- and 3.5-Mc. c.w. between runs with the merchant marine. It is rumored that Bee Wentzel is designer of several 85-Mc. rigs to be used by the Navy in the coming A-Bomb test. Please send in the self-addressed envelope to your QSL Manager; there may be something in his prewar files for you. Among those present at the April meeting of the SJRA were two ex-SCMs, BEI and ZX. Three new members were welcomed into the fold: 2ORC, 2OQH, and JQX. Meetings are held each third Wednesday at 8 p.m. at I.O.O.F. Hall, 5 Haddon Ave., Haddonfield. GU finally got his 3.5-Mc. squirter going. CYT is about set with his HT-9 and HQ-129-X. VX, FBZ, and AGZ are readying the equipment for the 144-Mc. transmitter hunt to be held on July 21st. Norman Plumb has received a brand-new ticket, 3KDH. 2PBR is a new Trenton ham. Traffic: W3CCC 32, HYT 6, 2OXX 4, 3EPF 1. 73. Ray.

WESTERN NEW YORK — SCM, Charles I. Otero, W8UPH — AFQ, BLP, and CYG now are "2s," BLP having held that call for twenty-five years. Certificatees now being received for reactivation will be returned as soon as possible, but it is suggested that new certificatees be requested as soon as the new calls are assigned. RGH reports the following stations active in the Binghamton area: SOZ; CVB, with a new e.c.o. on all bands; CNA, with a three-element beam and a kw.; UVQ; WRH; QZX; IRH; QWK; AON; IMR; DII; 5OV; 6TVE; 2WZC; 8FCG; BTO; DHO; and RGH. OQD sends word from Stillwater, Okla., that he is a student of electrical engineering at A. & M. College. The college has an amateur radio club and station, 5YJ, which includes a 300-watt 28-Mc. 'phone rig and a 125-watt 3.9-Mc. 'phone rig. TEP is ready to operate 28-Mc. 'phone with 250 watts input. WJA, who went on the air for the first time the day before Pearl Harbor, is back in Lowville after service with the Navy. UFJ, ex-Ohioan, in Lowville permanently, is on 3.5-Mc. c.w. WRC is out of the Army and learning more about radio at Clarkson Tech. KWS reports the Niagara Radio Club is going strong after being inactive since February, 1942. KWS is heard frequently on 3.9 Mc. 2OVP is new amateur in Niagara. Active on 3.9-Mc. 'phone are SEF, PNA. Active on 28 Mc., also in Niagara, are IGL, FMF, and WOH. JIW/2 worked HH5PA on 3.5 Mc. with 17 watts. The hamfests always are powerful attractions. At the recent RARA hamfest, the committee counted on 175 attending. You can imagine their surprise when 260 turned out. SJV was appointed Section EC that night and on top of that got the biggest prize of the hamfest; he took home a complete transceiver. PAN is the new secretary of the RAWNY. NNP, NVJ, PCN, and SJV, of the KBT Club, visited the Niagara Falls Radio Club and heard an entertaining and enlightening discussion and demonstration on oscilloscopes. At the next meeting of the KBT Club, Mr. Lidbury of the Falls Club returned the visit. At this meeting an interesting

(Continued on page 88)

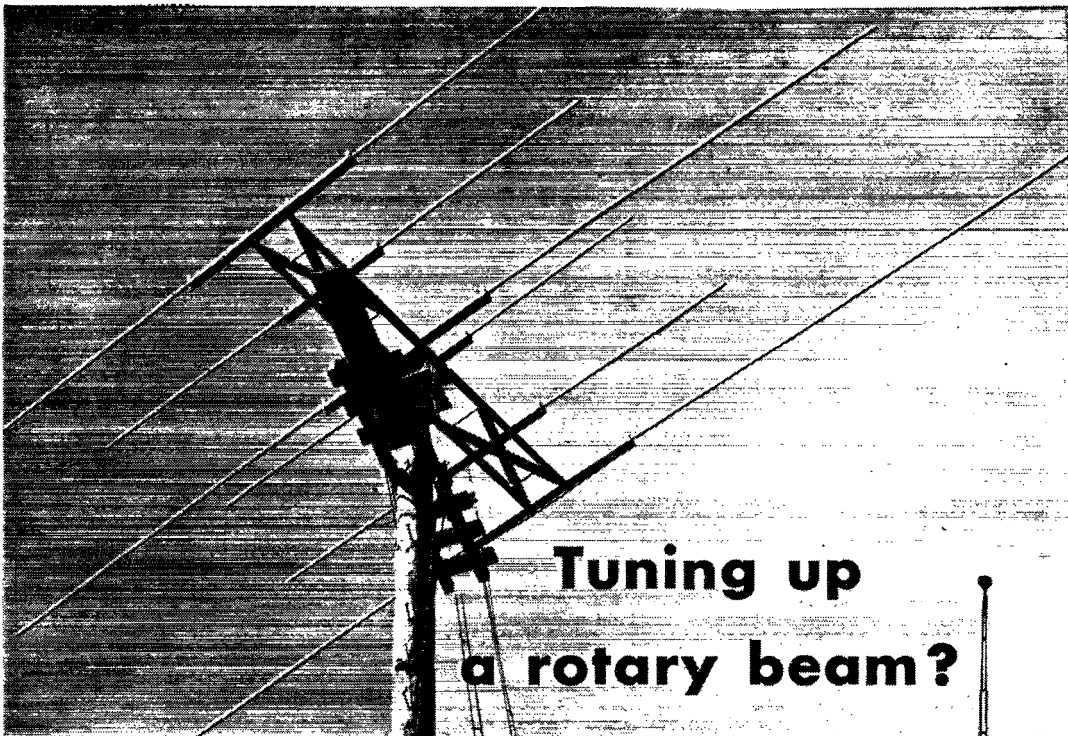

Tuning up a rotary beam?

FIELD STRENGTH METER CIRCUIT

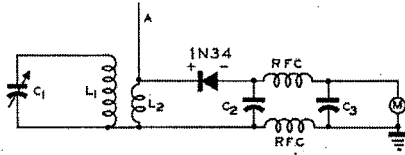

- A Telescopic pick-up antenna
- C₁ 100 μ fd variable capacitor
- C₂ 0.001 μ fd mica capacitor
- C₃ 0.001 μ fd mica capacitor
- L₁ Barker and Williamson type JEL plug-in coil
- L₂ Link on above
- RFC 2.5 mh. r.f. choke
- M Simpson 0-100 μ a microammeter

Diagram Courtesy W1MXX

Try the new Sylvania



1N34 Germanium Crystal Diode

in this super-sensitive field
strength meter for a pattern . . .

and watch your QRK
go up!

*Inquiries
are invited*

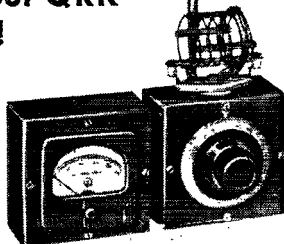

**Save Wheat And Fats—
Fight Famine!**

SYLVANIA ELECTRIC

Electronics Division . . . 500 Fifth Avenue, New York 18, N. Y.

MAKERS OF ELECTRONIC DEVICES; RADIO TUBES; CATHODE RAY TUBES; FLUORESCENT LAMPS, FIXTURES, WIRING DEVICES; ELECTRIC LIGHT BULBS

(Continued from page 84)

talk was given by Mr. Riggs on the subject of "Wurlitzer Sound Systems." NOR puts a tone on 144 Mc. for anyone wishing to find the band and peak up superhets. UJR is working 28 Mc. portable-mobile. I have received two letters from Colin L. Sutton, Listening Post Operator, New Zealand, one addressed to UXE and the other to WSY. Please drop me a card with your address so that I may be able to forward these letters to you. 73. *Charlie*.

WESTERN PENNSYLVANIA — SCM, R. R. Rosenberg, W3NCJ — Section EC, AVY. RMs, TOJ, AOE, KWA. The Western Pennsylvania ORS net operates on 3750 kc. Monday through Friday at 6:30 P.M. EDST. NCS, TOJ. Alternate NCS, AOE, TOJ submits May net report: Net sessions, 20. Average number stations per net session, 4.3. Average number messages handled per net session, 4.1. Stations reporting into net and number of times reporting: AXD-11, AOE-14, CKO-1, KHU-15, EYY-16, TXQ-9, TOJ-19, MJK-1, AKE-1, Radio Assn. of Erie officers are: QJ, pres.; Harold Loomis, vice-pres.; NMP, secy.; JWZ, treas. Directors: William Sommers, MZI, GU, BHN, SLC, and TXZ. SER is scribe and WBM chairman of membership committee. Newly licensed Erie amateurs are: KJT, KKI, KKT, KKQ, KKS, KLF, KLU, KLD, KLI, KLT, KKJ, KPE, and KKY. BOZ, now active on 3.9-Mc. 'phone, reports Warren news. RMM has new HQ-129-X and PMY has RME receiver. TXQ is new ORS in Altoona. TWI/4 has received radiotelephone 1st and amateur Class A tickets. HKU is having better success working out from new Bradford QTH. EUG has received his old call, DV. TTD/8 is pleased with performance of new SW-3. UVD and TTN are working out nicely. WMQ has 81X receiver and is studying for Class A ticket. RAP is using "tank" transmitter with 15-foot rod antenna. TVA has a new rig, but lacks power supply. OMG gets on 3.5 Mc. for occasional QSO. New stations: KJI, Williamsport; KFL, Shenandoah. DVA is well pleased with new Sky Champion receiver and Speed-X bug. Bob Maxwell (LSPH) is constructing 28-Mc. 'phone transmitter. QCN is interested in OES appointment. The McKean County Radio Club has been reactivated with CPU, president. UAJ has transmitter on the air with HKU's assistance. JWZ and NMP are heard regularly on 144 Mc. GEG, president of Mercer County Radio Assn., was elected vice-chairman of Pittsburgh Area Radio Clubs Council, with which MCRA is affiliated. MKJ keeps daily traffic schedules with 4PL, 2CGG, and 1BDU. The Pittsburgh Area Radio Clubs Council will hold hamfest on Aug. 4th at Spreading Oaks, South Park, Pittsburgh. Traffic: W8TOJ 104, EYY 34, HKU 34, AOE 19, AXD 10, TXQ 10, MJK 9, NCJ 2, BOZ 1. 73. *Ray*.

CENTRAL DIVISION

INDIANA — SCM, Ted K. Clifton, W9SWH — New calls recently issued are JLT and JSM. CXJ has moved up on 3.5-Mc. c.w. VKH is getting a 65-ft. tower on which to mount a 28-Mc. rotary beam. FJT is operating 3.9-Mc. 'phone and has good results with 30 watts. PMT is on 3.5-Mc. c.w. IEM is joining the Army. ENB is waiting for that new RME-45 he ordered in January. PWZ has a mobile rig on 28 Mc. DAG worked Delaware for WAS. QLW lost his beam. EHU has a pair of 807s. YB has 600 watts on 3906 and 3894 kc. using WBAA's old antenna. CB is president of Purdue Radio Club. NXU has an 813 with 200 watts. JDW is on 3.9 Mc. ENH, who has worked forty-four states since April 1, 1946, is an authority on tropical fish. JVL, of South Bend, has new license and is interested in OES. KEZ is new ham in Valparaiso. MVZ is building sixteen-element beam for 144 Mc. PBS has new HQ-129-X. WHN and SNF have HT-9s. VAW now is at Texas City, Tex. EGQ still needs a 3.5-Mc. antenna. MKM, who is the proud parent of a new 8-lb. jr. operator, is on 3938 kc. and is trying to locate RTH and YCU. NZZ has an RME-45. DDH now is at Evansville. NNX is experimenting with turnstile and four-leaf clover antennas on 144 Mc. The following stations are active ORS: EGQ, HUV, TBM, IU, DGA, NZZ, ENH, SAG. ALM is on 3.5-Mc. c.w. BKH has an FB 400-watt 3.9-Mc. 'phone. EJK is on 3.9 Mc. EGV is an early riser. TJN is having BCL troubles. MHE has old call back and a new 28-Mc. transmitter but no receiver. The *Bison*, which has been suspended

temporarily because of the change in SCMs, will be resumed at an early date. Hams who have enjoyed reading the *Bison* do hereby give Herb, EGQ, a vote of thanks. Traffic: W9SAG 6, NXU 4, ENH 2, ENB 2. 73. *Ted*.

MICHIGAN — SCM, Harold C. Bird, W8DPE — W8FWU is doing lots of listening. 8RJC says there is too much QRM to do much. SCW is doing a fine job on Michigan QMN Net and also in handling traffic. 8FX is trying end-loading antenna which seems to work better than regular bottom-loading. 8WVL is on 3.9-Mc. 'phone and 3.5-Mc. c.w., and is building equipment for 7 Mc. and 3.5 Mc. 8UGR reports the Early Bird Net is on Mondays through Fridays at 7 A.M. EST. All who can, please report in this net. 8NXT finally got his 28-Mc. coils and now is contacting the gang on that band. 8JD reports two Ann Arbor police operators who, if they had not been amateurs would not have recovered a lot of stolen amateur equipment. 8UXS is back from sailing the Seven Seas and now is working the amateur bands again. Mile Stelmack has not received his ticket as yet from Washington but has renewed his QST subscription. 8IHR sends his traffic report by radio. 8PVB/8 writes that two new rigs are expected at the commercial station where he is employed and that he gets time to work the net in Michigan. 8SAY is doing nice work on the net and putting a fine signal over this way. 8MGQ is doing a nice job for DARA as purchasing agent and public relations officer. 8TBP, a steady reporter in QMN, is handling a nice lot of traffic. 8DAQ is not in stride as yet but expects to make BPL almost any time now. 8OCC is getting his rig tuned up for all bands and puts in a nice signal over here. 8AHV held a meeting in Lansing June 7th to organize the Emergency Corps. 8COW is now touring the East. 8QF reports into the net from Saginaw now. 8DEH says business in RME sales is rather slow these days. He would like hamfest this year at Ypsilanti. DARA held an open meeting June 20th with our Director. At the June 3rd meeting the Oakland County Radio Club voted to hold a picnic to organize an auxiliary to the club. The usual refreshments were served after the meeting. Send in your reports now, boys, either by card or by radio. Would like all members of the Michigan QMN Net, past and present, to get in the net. We wish to start drills for Emergency Corps. Traffic: WSSAY/8 78, 8SCW 58, 8TBP 49, 8FX 33, 8QK 23, 8IHR 14, 8UGR 14, 8MGQ 12, 8MGB 8, 8PVB/8 7, 8DAQ 6, 8RJC 4, 8OCC 1. Thanks and 73. *Hal*.

OHIO — SCM, Carl F. Wiehe, W8MFP — DAE reports twenty-three countries, including VK, ZS, KB6 and K7, worked on 28 Mc. with 200 to 300 watts into a 100TH and a doublet antenna. ROX and UZJ have formed a new club of c.w. operators, consisting of ORS-AARS contest hounds, named the Greater Cleveland Amateur Radio Assn. JFC has a new location, "Electronic Heights." Benny chose a bare field in a sparsely settled section with the very best of radio characteristics and thereon built his shack, antennas, etc. He should have called it "Ham's Heaven." P.S.: Benny is a bachelor. APC says he expects some pretty fine hamming since he moved to Columbus especially to get a decent place for an antenna. He is using a 3.5-Mc. half-wave antenna with 150 watts to pp. 807s and a pepped-up SX-28A. RN says he is having lots of fun working through QRM with 7 watts from his Meissner Signal Shifter. His big rig is a pair of 807s on 28 Mc. with 80 watts c.w. and 'phone. GVL has an 813 on 3.5 Mc. DZH says he wants the gang to know that he is still able to move around. He's on 3.9-Mc. 'phone from Beverly. Traffic: W8RN 48, ROX 23, WE/8 15, PUN 9. 73. *Carl*.

WISCONSIN — SCM, Emil R. Felber, jr., W9RH — SZL is on the air with new 3.5-Mc. rig and looking for traffic. The Wisconsin Valley Radio Association has elected the following officers: RQM, pres.; QJB, vice-pres.; ESV, treas.; JBF, secy.; and LED, director. FZC is the new club EC. SHL has a new HT-9 fired up but still is waiting for a receiver. IGC is the only active station at Rhinelander at present but HBE, OPO, and WBD will be on soon. PMH is radio operator on TWA Constellation plane. PNU moved to Wausau. AJV and GZG are at Kenosha. LFK is interested in RM appointment for this district. DKH has worked EWC, Hilbert, JAW and OVE, Two Rivers, and CCI, Oshkosh. ZBY, HWX, ZDY, ELV, KPC, all on ground

(Continued on page 88)

ONE INSTRUMENT. .. FILLS THESE FOUR NEEDS

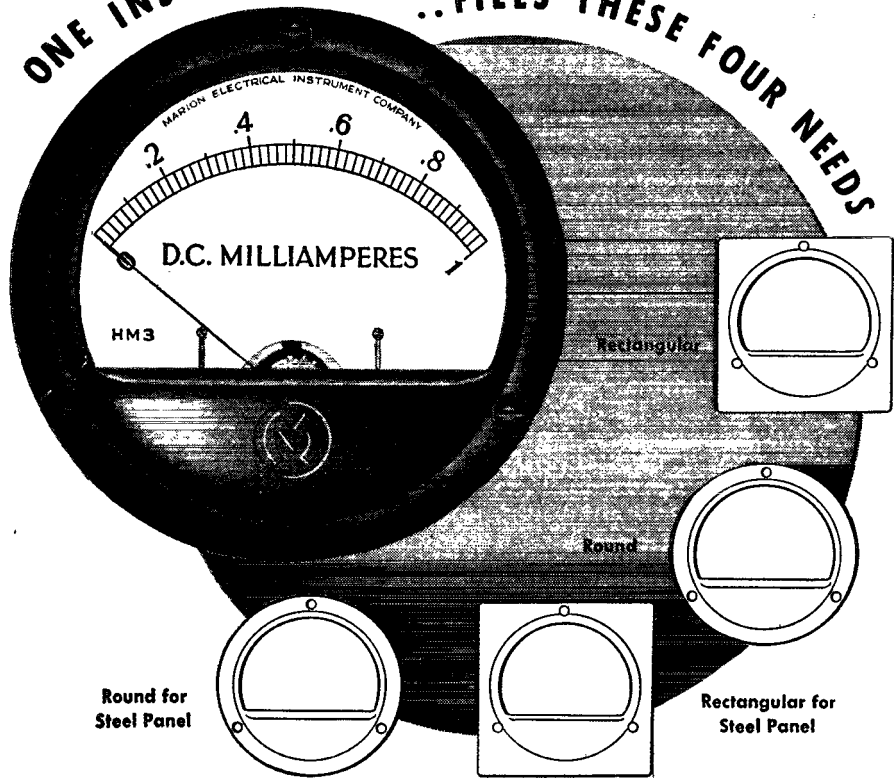

**THE "4 FOR 1" APPLICATION ADVANTAGE OF
Marion Glass-to-Metal Truly Hermetically Sealed
2 1/2" and 3 1/2" Electrical Indicating Instruments**

Marion "hermetics" offer new flexibility in application, stocking and sales. Just one instrument, with its appropriate flanges, fills four different requirements . . . the only thing that's necessary is to fit the flange to the need in question. In addition to being truly hermetically sealed, these instruments are magnetically and electrostatically shielded. And are supplied with

Interchangeable Round and Square Colored Flanges

. . . which are the key to the "4 for 1" Advantage. With these, it is possible to order a minimum number of instruments in the most popular ranges, and apply either the round or square flange according to usage. This feature simplifies ordering and inventory procedures for the manufacturer . . .

and stocking and selling for the jobber. Besides black, the flanges are available in 12 iridescent colors — including red, blue, green, gold and silver. The use of color has been found to add to the eye-appeal and, consequently, to the sales value of otherwise drab equipment.

100% GUARANTEED

for six months — after that, regardless of condition and provided the seal has not been broken, we will replace any 2 1/2" or 3 1/2" type from 200 microamperes upward for \$1.50; any 2 1/2" and 3 1/2" type with sensitivity greater than 200 microamperes for \$2.50.

MARION ELECTRICAL INSTRUMENT CO.
 MANCHESTER, NEW HAMPSHIRE
EXPORT DIVISION • 458 BROADWAY • NEW YORK 13, N. Y. U. S. A. • CABLES: MORMANEX

IN CANADA: THE ASTRAL ELECTRIC COMPANY, SCARBORO BLUFFS, ONTARIO

(Continued from page 86)

wave on 28 Mc., can work into Fox River Valley and ARE, of Milwaukee, has been heard there. New officers of the Milwaukee Radio Amateurs' Club are: RUF, pres.; SZH, vice-pres.; HRM, secy.; and ANA, treas. The club has adjourned for the summer and will resume its weekly meetings every Thursday night beginning in September. 73. Emil.

DAKOTA DIVISION

NORTH DAKOTA—SCM, Raymond V. Barnett, W9EVP—W0JWY and W0WXS are new calls in Jamestown, where the boys are working toward rejuvenating the James River Radio Club. WFO/KAIAN reports from Guam on his activities since November from Manila using BC610 rig with 16-element 8JK array. SSW is at his new QTH in Bismarck and already has a skyhook up for 28 Mc. EVP has completed his 70-foot self-supporting tower made of 2 x 2 lumber and has finished power supplies and r.f. sections of a new 300-watt rig. KZL has been very active on 3.9 and 3.5 Mc. while confined at home with a broken ankle. He keeps daily schedules with PJT and SWC and is having good luck at halving frequency, using his 7-Mc. crystals on 3.5-Mc. The ARRL charter has been received by Cen-Dak Radio Club. At a recent meeting we were honored by the presence of four visiting hams: HDD, SWC, ZZA, and ZTL. Traffic: W9KZL 2, SWC 2, EVP 1. 73. Ray.

SOUTH DAKOTA—SCM, P. H. Schultz, W9QVY—ZAL has moved to Ravinia from Delmont, and is working 3.9-Mc. 'phone. ZBU is back on the air, working 3.5-Mc. c.w. Sorry, but I received no other reports this month so have nothing further to pass on to you. 73. Phil.

NORTHERN MINNESOTA—SCM, Armond D. Brattland, W9FUZ—The SCM is back at Lake Bemidji for the summer, so fire your reports in here on the first of each month to meet new QST production schedule. Also stir up all the activity reports you can on clubs and pass the word along. EHO has moved to new QTH at Lake Lillian and is putting up new sky hook. TED is back from service and again at Red Lake Falls. TEF, back from service, is married and located at Crookston. HZM, discharged from the Army, is doing radio service work at Thief River Falls. WUQ, discharged from the Army, is back at Gilbert—quite a transition in climate from Puerto Rico. WPR and GKO are discharged and back "on the range." In packing for the flight back from the East your SCM mislaid several FB reports from range hams. If these are not included in the next report, please send them to me again. Thanks. JNC operated in the fourth district, thence was transferred to the second district.

SOUTHERN MINNESOTA—SCM, Vernon G. Pribyl, W9OMC—GRJ is active on 3.9-Mc. 'phone and is new OPS. WQF is on 3.5-Mc. c.w. as are LRV, EGT, JHF, RJE, WEF, FGP, and VSQ, all of Minneapolis. TOZ has an FB mobile rig on 28 Mc. using an 815 final. JNC sends in a nice report this month and has been reinstated as ORS. QIN really has the amateur spirit; he built a rig for LXR, who is incapable of building any equipment, using a TB-35 final for use on all bands. RZU and HMB, formerly of Illinois, are now in Minneapolis and are active on 3.9-Mc. 'phone and 3.5-Mc. c.w. DKL, an old-timer, is back on 3.9-Mc. 'phone. QIN is knocking them off on 50 Mc. with an East Coast contact. YZL and DZM also are active on 50 Mc. JNC finally got his high voltage transformer and is on with 500 watts input. Northwest Airlines amateurs meet on 3890 kc. and are organizing an emergency net to cover the area from Seattle, Wash., to New York. Jim Faist, RBA/0 got out the first bulletin for the net. Get those reports in early, fellows! 73. Vern.

DELTA DIVISION

ARKANSAS—SCM, Marshall Riggs, W5JIC—HTX is assembling a 600-watt rig on 28 Mc. CEQ is putting 400 watts with p.p. 805 on 3.9-Mc. 'phone. ABZ was in town visiting recently and has p.p. T20 100 watts on 3.9-Mc. 'phone. DGL is really tearing up the country on 3.5-Mc. c.w. KXG has been having a big time on 3.5-Mc. c.w. with his p.p. 807 rig. BCZ evidently is very active on 28 Mc. as I hear the other end of several contacts quite often. JPY has

his HT-4 on 3.5 Mc. and is also working 28 Mc. when there is any activity. FXJ has p.p. T40 on 3.5 Mc. and is having some trouble getting the antenna to load in tiptop shape. DQV has become a civilian again and is making preparations to get the big rig on. HYS has erected full-wave antenna and is pushing some r.f. out over countryside. GQG, who was in town recently, is holding down several jobs. JIC is 3.5 Mc. with p.p. 24Gs at 150 watts and a hat full of crystals, and is going to remodel the big rig into an all-band affair. GTS is in the process of construction. GWT is away on business. Sure would like you boys to send in a little information on yourselves. 73. Marshall.

LOUISIANA—SCM, W. J. Wilkinson, jr., W5DWW—The Tulane Radio Club of New Orleans has suspended meetings for the summer, but the club station, GWZ, is kept active. LDH reports that the more consistent 28-Mc., boys in New Orleans are HHT, IMT, JFZ, JPJ, KXP, KTB, and GWZ. Among the fellows at GWZ are GHP, GTB, HTU, KXP, LAF, KUA, FZW, HLL, and LDH. On 3.9-Mc. 'phone in New Orleans are IN, GST, and KXP. The 3.5-Mc. c.w. boys are JYK, KTE, KYK, BPL, KOU, and SUW/5. JYK is running 60 watts from a single 6L6. The New Orleans Radio Club meets every two weeks on Friday evening. KTE and LAE have new HT-4E transmitters. KXP, a 16-year-old, holds Class A ham and 2nd-class radiotelephone tickets. KTB, HOU, JFZ, GHF, and BMM have new rotary beams. JYK is trying for WAS on 3.5-Mc. c.w. with 60 watts to single 6L6. HHV is getting th. Lake Charles gang going. AXU is building rig for 14-Mc. 'phone. CEW is on 3.5 and 28 Mc. with 'phone. ABA is going strong on 3.5-Mc. c.w. QH works DX with 28-Mc. 'phone. CNG, ILB, IOP, KEK, KKI, and KMD are active. ACY is OBS and sends b.c. on 3.9-Mc. 'phone. KZM is a member of the Emergency Corps. JFJ is on with one-half kw. A club has been organized in Shreveport. LBA is QRL b.c. work. KHC is using low power on 3.5-Mc. c.w. 6SWL was a visitor in South Louisiana. GHF has been working Shreveport on 28 Mc. ground wave. LAX is new in Shreveport. 9JWB/5, 7JIY/5, and 6MRY/5 operate portable in New Orleans. Traffic: W5GHF 15, CEW 2, ACY 1, LDH 1

HUDSON DIVISION

EASTERN NEW YORK—SCM, Ernest E. George, W2HZL—The bulletin from the Westchester Amateur Radio Association makes the announcement of their new officers; NJF, pres.; KQO, vice-pres.; OXD, secy.; BWS, treas.; 1LAS/2, activities mgr.; and IRP, sergeant at arms. A special vote of thanks was given KPY and LSO for steering the club through since Pearl Harbor. LMH is using wire recorder to give you the low-down on your signals. This should be a worthwhile contact. IXE is giving super accurate frequency checks. Between the two a ham cannot err. AN was feted by his XYL at a surprise "oldest and most useless junk" party. HZL was elected to run SARA Field Day in Schenectady. BWS was in charge at Westchester Radio Club. Please get your traffic reports in to the SCM if you want renewal of OPS and ORS. None have been received to date. Schenectady first again! First ham contacts on 21,000 Mc. between 9SAD/2 and 1MVL/2 establishes a new record. GYV is working on 50-54 Mc. converter for his HQ-129. BKW was chosen to head up the 1946 hamfest in Schenectady. HF is operating on 144 Mc. from Mt. Kisco every evening at about 10 p.m. with a sixteen-element beam headed toward New York City and a five element headed toward the first district. He reports hearing some signals from New York City.

NEW YORK CITY AND LONG ISLAND—SCM, Charles Ham, jr., W2KDC—BGO reports that the Bronx has four fixed and one mobile station. NXQ operates from subways, trains, etc. with OJR, OJA, and LKP on the receiving end. LYC and BGO are on 3.5 Mc. in Supporting Division. From Brooklyn HZX, PFA, PBH, NOL, and OZI are welcomed to the EC net. PPB, ODS, and FPA took a handie-talkie to the giant ferris wheel at Coney Island. OZI has both fixed and mobile units. JSJ is reported to have a sixteen-element beam. DIO's mobile operation reminds the gang of tank warfare due to a blown muffler. MWA celebrates a double event—a jr. operator and a new m.o.

(Continued on page 80)

**WOUND WITH
CERAMIC
INSULATED
WIRE**



**DOUBLY
PROTECTED
by glazed
CERAMIC SHELLS and
MOISTURE-PROOF END SEALS**



**MOUNT 'EM
ANY WAY...
ANYWHERE!**

Sprague KOOLOHM
Wire-Wound Resistor Con-
struction allows units to be mounted
directly to metal or grounded parts
—even in high-voltage circuits.

**SAFE! COMPLETELY INSULATED!
"TOPS" FOR HIGH-VOLTAGE USES!**

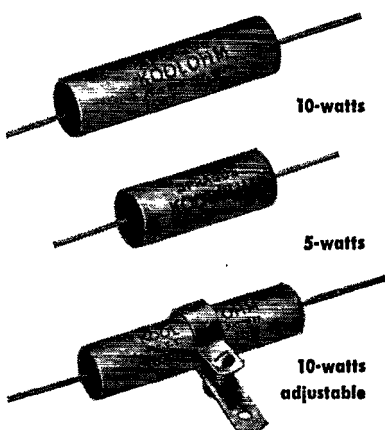

10-watts

5-watts

10-watts
adjustable

Koolohms are made in a complete range of standard sizes from 5 to 120 watts as well as in many special industrial types.

... Use 'em at Full Wattage Ratings!

For safety on high voltages, use Sprague Koolohms! The wire itself is insulated with 1000° C. heat-proof ceramic—then doubly protected by a glazed outer ceramic shell. Insulation resistance from the outer surface of the shell to the resistance element is 10,000 volts or better!

And don't forget that Koolohm wattage ratings mean what they say. No need to buy a larger unit than you actually need. Use Koolohms at full wattage ratings—even in enclosed spaces.

Moreover, standard Koolohms have the same high degree of humidity protection formerly obtainable only on special order to meet the most exacting military specifications.

Write for Catalog C-306 of Sprague Capacitors and Koolohm Resistors for all amateur, radio service and experimental uses.

SPRAGUE PRODUCTS CO., North Adams, Mass.

SPRAGUE KOOLOHMS

TRADEMARK REGISTERED U.S. PAT. OFF.

The Greatest Wire-Wound Resistor Development in 20 Years

BETTER
than ever
and here's why



- Heavy frame holds springs in permanent alignment
- Extra heavy cans insure better sound deadening
- High-grade clock spring steel eliminates reed breakage
- Precision measurements in increments of .0001" insure long life
- 105 strand lead wire defies vibration—connections stay intact
- Optical adjustment methods insure accuracy not obtainable with unaided eye
- Individual testing for output, starting voltage and wave form assures high quality

There is a Mallory Replacement Vibrator for your automobile receiver and for most vibrator-powered equipment. See your nearest Mallory distributor or write direct for a free copy of the Mallory Vibrator Guide.

P. R. MALLORY & CO., Inc.
INDIANAPOLIS 6 INDIANA

P. R. MALLORY & CO. Inc.
MALLORY

(Continued from page 88)

p.a. NSD and NYC like their altitude but it's hard to find in Brooklyn. NXT uses f.m. A new club is being formed, the All-Band Society. NQQ's 832 now is under control. OHE, the EC, wants to band from 28- and 3.5-Mc. operators on expanding the EC nets. BO is the initial station in the Supporting Division. AJR is a real live wire and is leading the Down East gang for our organization. GAH, with 95' tower, is the latest addition to the net. PDU and OQI are a father and son combination. JFP and OQI are 144-Mc. mobile champs. FCH has new receiver and also new HY-75 transmitter. All interested operators should contact their ECs for affiliation regardless of their operating band. Portable and mobile operation is needed mostly. NAZ now has Class A license and has been battling the QRM on 3.9 Mc. ERY is organizing the Sperry Radio Club at Garden City; 100 applications at the first meeting. AJI is on 28 Mc. Ex-IUB, who hopes to get his call back, is rebuilding for 28 Mc. IAG tried 144 Mc. UK, formerly of Eastern Long Island, was heard on 28-Mc. 'phone from Brunswick, N. J. HSP still is grinding crystal. AFR has high Q uppers, reportedly giving a velvety tone. NBQ uses HYJ's mobile rig on 28 Mc. JEP has novel sound effects, he is the zoo keeper at Central Park. HXT reports long distance harmonics in the 7-Mc. band of 3.5-Mc. signals. The Federation of Long Island Radio Clubs reports the following new officials: BAA, KB, DKH, and AVI, in the usual order. The Nassau Communicating Association has a new name, Nassau Radio Club, and has thirty-five members. OZE, a new station at Laurelton, is on 144 Mc. BSP has m.o.p.a. 9CYU/2 also has an m.o.p.a. on 144 Mc. DGJ's antenna is down again and OIE loaned Johnny another one for 99 years. OTA is eliminating broadcast trouble by reducing from 50 to 15 watts. OKX is building. BNK cannot work DX on 144 Mc. and is heading for 400 Mc. He and NZJ are feuding with the 144-Mc. gang about broad signals. The Nassau County Police Station, NUA, is on 3.9 Mc., usually operated by BXO and HSO. The Tu-Boro Radio Club now is located at 8713-87th St., near Jamaica Avenue, in Woodhaven, and meets the 2nd and 4th Fridays. NYC and NSD will head for the mountains of New Hampshire where they will run 1/2 kw. on all bands with several antennas and transmitters. LR has been on 3.5 Mc. since the band operated. He is being reappointed ORS. NAB offers to lecture on panoramic reception before any club or other group. IOP, on 28 and 3.5-Mc. c.w. only, with antenna lying on roof, has a 19-volt drop in a.c. line of his apartment house. JBP is running 300 watts on 3.5 Mc. and is getting ready for 7 and 14 Mc. BO will be reappointed ORS; he also is seeking Official Observer appointment. 2EC reports that TLAP discontinued on May 31st and will resume operation September 15th. BO took traffic from the emergency flood net via 3IBM and advised the United Press via land line. PF requests reactivation of ORS and OPS. Traffic: W2EC 38, JBP 10, BO 7, IOP 6, KDC 4, LR 4, LPJ 1.

MIDWEST DIVISION

KANSAS — SCM, Alvin B. Unruh, W6AWP — Top news this month is from Topeka, where the Kaw Valley Radio Club is making preparations to hold the Midwest Division Convention in October. The KVRG deserves, and no doubt will receive, the complete and enthusiastic support of the Kansas gang. It takes stout souls to put on a convention in times like these. IOL and KRZ are new Topeka calls. AGC has new HQ-129-X. A number of the good brethren are sporting W6 calls. IJK has been back from India over a year and is stationed in Florida. He has parts for a rig and an SX-28 receiver. MAE, who reports traffic, is active on 4 and 28 Mc. BCY has a nifty new rig, built with the help of DMF. OUU has been on 3.9 Mc. since it opened, and is looking for traffic. OZN, BCY, DJL and OKD have purchased new homes and it appears your SCM will be forced to do the same. VBQ has that wild DX gleam in his eye, and has purchased a new country auto-QRM-free location near Lawrence. KUU has a score of thirty countries worked on 28-Mc 'phone-c.w. using an HT-9 rig and vertical J antenna. IGV has Collins rig on 4 Mc. and composite p.p. 75Ts on 28 and 50 Mc. Let's hear from you. Traffic: W9-MAE 3, 73. "Abie."

MISSOURI — SCM, Letha A. Dangerfield, W9OUD — PXH sends in an FB report on St. Louis activity with his ORS application. He says FBR is on 28 Mc. with an HT-9; EYV is using PXH's 7-Mc. super on 28-Mc. 'phone; NRW is QRX until he gets permission to put antenna on apart

(Continued on page 92)

IT'S AS GOOD AS IT LOOKS

The Cardwell Fifty-Four

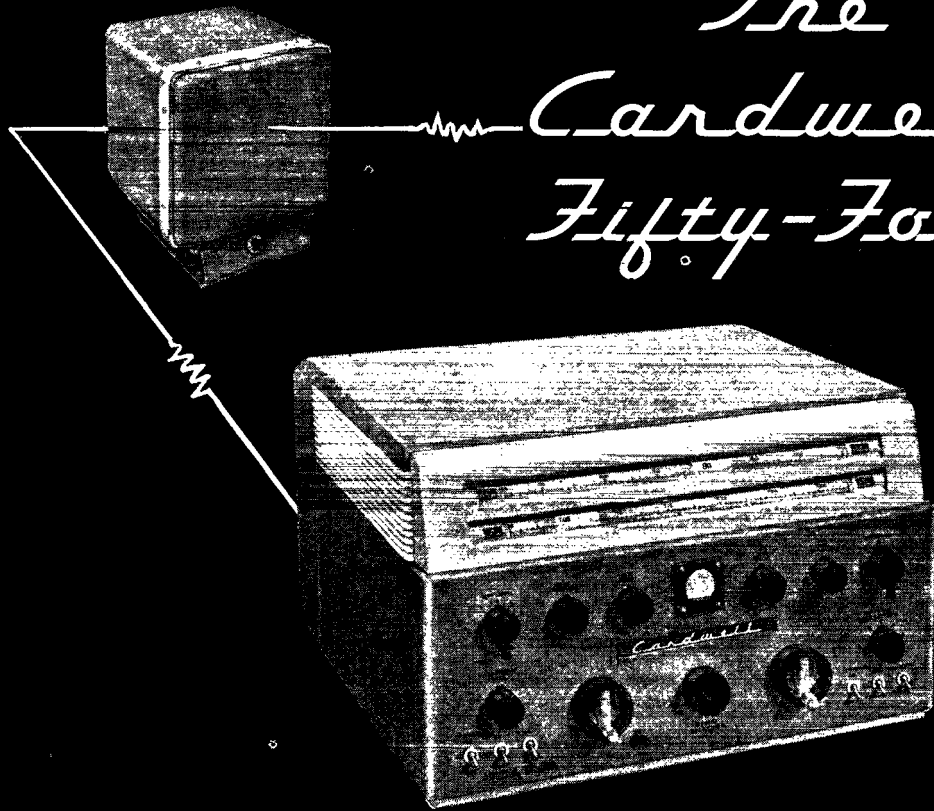

the first really new communications receiver in years

The crowd was so dense around the Cardwell Fifty-Four at the Radio Parts Show in Chicago that we thought it would be only fair to give you another look at it. Here it is. Compare these 16 features:

- 1. Full Turret Type R. F. Section.**
(Sturdy cast aluminum construction.)
- 2. Wide Frequency Coverage.**
(Range .54 to 34.0 mcs. Basic turret covers .54 through 40 mcs. in six bands. Extra coil strip supplied with set extends range to 54 mcs.)
- 3. Secondary Frequency Standard.**
(Unique type crystal calibrator provides check points of either 100 or 1000 kcs.)
- 4. Variable Selectivity Crystal Filter.**
(Choice of 5 degrees of selectivity—three with crystal, two without.)
- 5. Exceptional Signal to Noise Ratio.**
(Receiver noise less than 6 db above thermal!)
- 6. New Type Noise Limiter.**
(A really effective aid in reducing local ignition interference and similar noises.)

- 7. Electrical Band Spread.**
(Band spread scales calibrated directly. Arbitrary scale 0-100 also visible on each setting.)
- 8. Direct Reading Precision Dials.**
(Excellent visibility—pointer travel better than 10½ inches—velvet smooth dial action.)
- 9. Temperature Compensated Oscillator.**
(Stability is better than 25 parts per million per degree centigrade. V.R. tube maintains maximum frequency stability against line voltage fluctuations.)
- 10. Mechanical Coupling Provisions.**
(Control shafts are brought out at rear for linkage to other units such as a transmitter exciter.)

- 11. All Aluminum Unit Construction.**
(Receiver and power supply combined in one sturdy lightweight unit 18¼" wide x 16" deep x 11" high. Weight approximately 70 lbs.)
- 12. Heavy Duty Speaker.**
(Compact tilting unit 9¼" wide x 8¼" deep x 11" high for wall or table mounting.)
- 13. Eight Watts Audio Output.**
(Push-pull class AB—with four output impedances. Connections provided for phono-pickup or microphone input.)
- 14. 18 Tubes—All Miniature.**
- 15. Threshold Squelch.**
- 16. Panoramic Adaptor Jack.**

WRITE FOR COMPLETE TECHNICAL BULLETIN

THE ALLEN D. CARDWELL MANUFACTURING CORP.

MAIN OFFICE
& FACTORY:



97 WHITING STREET
PLAINVILLE, CONN.

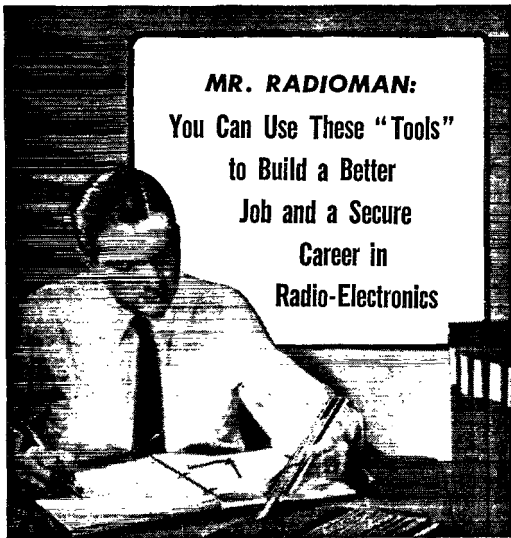

CREI Home Study Training in Practical Radio Electronics Engineering Combined With Your Own Experience Assures You of Post-War Security and an Interesting, Profitable Career.

Today, it is "the survival of the fittest." Employers are once again "choosey." Only the best qualified men will be selected for the best jobs.

NOW is the time to take the time to prepare yourself for these important, career jobs in radio-electronics engineering. CREI can show you the way by providing you with the "tools" to build a firm foundation of ability based on a planned program of technical training.

In our proved home study course, you learn not only *how* . . . but *why!* Easy-to-read-and-understand lessons are provided you well in advance, and each student has his personal instructor who corrects, criticizes and offers suggestions on each lesson examination. This is the successful CREI method of training for which thousands of professional radiomen have enrolled since 1927.

Investigate now the CREI home-study course best suited to your needs, and prepare for security and happiness in the New World of Electronics!

● WRITE FOR FREE BOOKLET

Tell Us About Yourself so we can intelligently plan a course best suited for your needs. Write us now and let us prove to you we have something you need to qualify for a better radio job. To help us intelligently answer your inquiry—please state briefly your background of experience, education and present position.



Capitol Radio Engineering Institute

E. H. RIETZKE, President

Dept. G-8, 16th and Park Road, N. W., Washington 10, D. C.

Branch Offices:

New York (7): 170 Broadway Chicago (2): 30 N. LaSalle Street
San Diego (1): 316 C Street San Francisco (2): 760 Market Street

Members: National Home Study Council; National Council of Technical Schools

(Continued from page 90)

ment roof; VLP is known as "The Mole" because of his underground shack; VNU and VCD are on 28-Mc. 'phone; FFB works K4s almost daily on 28-Mc. 'phone; CZH erected a 67-foot all-band sky wire; EVJ works European DX with new 28-Mc. antenna; PNO works out westward. ZBJ worked the 144-Mc. transmitter that was the prize in the HARC Field Day at Swope Park. Transmitter was located in twenty minutes. AHZ is using square antenna on his car. SKP is on 50 Mc. YHZ is using both a.m. and f.m. on 28 Mc. and heard a W2 on his new HRO but no QSO. KEI and GBJ are first to receive ORS endorsements. EYM is going strong on 3.9 Mc., wants his OPS renewed, and wants the ORS/OPS party in July. KPM is back from Japan and on 3.5-Mc. c.w. ARK is pleased with his new Millen exciter; he worked only three countries on 28 Mc. this month. TGN has erected a coaxial antenna on 28 Mc. QJP is gloating over his new HQ-129-X and having fun with short skip on 28 Mc. 4JLN/9IGW will be using parts of the old OUD rig from Springfield, where he is with Highway Patrol again. OUD gets out best on the low end of 3.5 Mc. WIS listens for the old Missouri gang but no luck so far. Tnx, gang. Traffic: WØKEI 8. 73.

NEBRASKA — SCM, Arthur R. Gaeth, WØFQB — DMV, using 150 watts to 100TH in final, and a new HQ-129-X, is operating on 3.5-Mc. c.w. and has been endorsed as ORS. JNN is on 3.5-Mc. c.w. VTQ, who has moved from Council Bluffs to Plattsmouth, reports a pair of 6L6s on 3.5-Mc. c.w. Ex-LPA now is 6UKC, and ex-LTL is 6UZU. OKF is working with v.h.f. equipment. Because of antenna wire troubles EWO has one ampere running into his roof from his 803 on 3640 kc. QMA is planning a rig with a pair of T65s. Ex-3WJV is now WØJSM, Omaha, and is using 807 rig with 60 watts input on 28 Mc., plus voice carrier control. CQX has 115 watts to a single HY4OZ. EUT is planning XH array for two telephone poles he acquired and has BC-348Q receiver. RUH has an 812 rig that UFD built for him and new HQ-129-X. We welcome KPO to the ranks of hamdom; he sports a 125-watt 812 rig. SHH and SHF are installing three-element beam for 28 Mc. a full wave up. GTC is planning XH array for 28 and 14 Mc. RGK is using a pair of 811s to modulate a single 811 on 28 Mc. ZGA was tagged with the handle of Ogallala Sa (Red Indian) by Sioux Indians. HGV is looking over acreage in Arkansas and planning to squirt some r.f. into home grown vegetables down there. IJF has some lumber and metal, which look like the makings of a three-element beam for 28 Mc., piled on the roof of his apartment. LVS reports new officers of the Western Nebraska Radio Amateurs: KQX, pres.; RQK, vice-pres.; LWS, secy.-treas.; MTI, historian; MGV, Emergency Coördinator.

NEW ENGLAND DIVISION

CONNECTICUT — SCM, Edmund R. Fraser, W1KQY — DWP is on 3.5 Mc. using Meissner S.S. and 500-watt final. ADW is out of USN and back in Danbury. He reports the formation of a radio club there. CJD is on 3.5 Mc. and reports formation of a radio club in Middletown. GPF, formerly of Maine, is located in Torrington using p.p. 807s and an HRO receiver on 3.5 Mc. QO has his rig in the fingerprint room at the Winsted Police Dept., where MTR, HVS, CNF, and UZ meet for ham sessions. 3EHW/1 visited old QTH in Washington. AKG and SF have their old calls back. TD and LVX now are Class A amateurs. EFW is running 125 watts with 6L6-804. Milt visited AUC while in Bar Harbor. BGJ is operating 3.5 Mc. BTU and BQQ are working plenty of DX on 28 Mc. IKX and GTH are on 50 Mc. 60TA/1, now located in Hamden, recently became a member of GB. OGG and MSB are new members of GB. HYF attended the New England Division Convention at Framingham with NEQ, JMI, and OBS. TD has all West Haven hams lined up in Emergency Corps. EAO and FMP are on 3.9-Mc. 'phone. MPW reports EUG, KNM, IAR, HUI, FUW, and MMN putting a good signal in his shack on 28-Mc. 'phone during short skip. BPU, former Nutmeg Net member, now is located in Acton, Mass. MMN/1 and his XYL (OPLO) are at Camp Hood, Tex., using 807 on 28 Mc. BQQ, DHS, BTU, IYQ, and FUW have been contacted. BIH reports e.c.-807 working fine on 28 Mc. KKS writes that he met IIRT in Italy along with 5NH and ran into 6JSN in Baltimore. When 80 meters opened he was 400 miles east of Azores; he turned on the receiver and recognized the fist of LOP before he heard the call. SF is on 144 Mc. working Paterson, Montclair, and two other towns

(Continued on page 94)



TOPS IN...

Techniquality

THE WORLD OVER!

With Bliley techniquality "at the controls" frequency precision on the amateur bands is never a problem.

This newest Bliley achievement in technical skill and frequency control engineering is the first *plated* crystal designed for the 80-40-20 meter bands. It provides positive assurance of better grid-current stability over a wide temperature range plus improved frequency stability under high drive conditions.

In addition to the plated feature type AX2 embodies a long list of other Bliley accomplishments that have made the name Bliley a by-word for top performance throughout the amateur radio field.

Nothing has been overlooked or omitted in type AX2 to give your equipment the ultimate in frequency control under all conditions. Type AX2 and other Bliley amateur crystals are fully described in Bulletin 31, available at your authorized Bliley distributor.

Bliley CRYSTALS

Type AX2 units, 80-meter band \$2.80 Ea.

Type AX2 units, 40-meter band \$2.80 Ea.

Type AX2 units, 20-meter band \$3.95 Ea.

The JOHNSON "Q"

CONDENSERS
INDUCTORS
TUBE
SOCKETS
INSULATORS
PLUGS
AND
JACKS

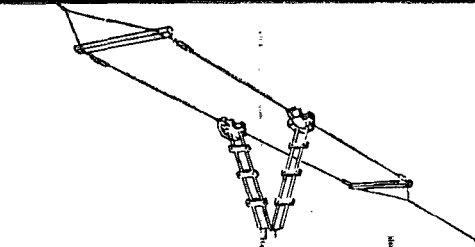

THE JOHNSON Q BEAM

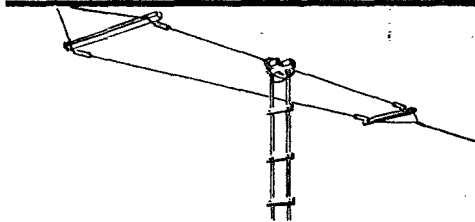

THE JOHNSON Q WITH REFLECTOR

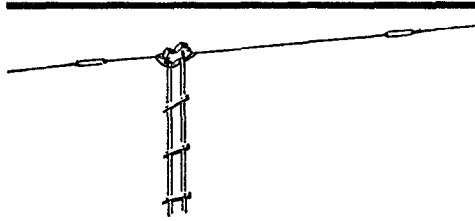

THE JOHNSON HARMONIC RADIATOR

This highly efficient system is applicable to a wide variety of antennas, including the sensational "Q" Beam, Radiator-Reflector and Radiator-Director Beams, Harmonic Radiators, "V" Beams and many others. With all these the following advantages are realized:

- Matched impedances throughout with greater radiation from the same transmitting power than may be obtained with ordinary non-matched antenna feeder systems.
- Permits use of open wire line resulting in exceptionally low transmission line loss — about 1/10 that of "twisted pair" lines.
- No exact or critical overall line lengths. Line may be several hundred feet long if desired.
- Easily installed and adjusted — complete data supplied.
- Available for all the radio amateur bands from 80 to 1 1/4 meters.

JOHNSON
a famous name in Radio



E. F. Johnson Co. Waseca, Minn.

(Continued from page 82)

in New Jersey with his 16-element beam and TR-4. HDQ keeps 9 P.M. nightly schedule on 50 Mc. with 8CLS/1 in Waltham, Mass. He is building a mobile converter-receiver unit for 28 and 50 Mc. ON's OO report indicates many cases of minor infractions of FCC rules and regulations, the most predominant being emission of harmonics. New ORS: DWP, EFW, BIH, and JMY. New OES: JXP. Traffic: W1VB 69, KQY 38, CTI 35, EFW/1 28, UE/1 26, 8HCO/1 17, BDI 16, AW 16, 3EFW/1 15, ITI 14, LFK 12, FMV 11, TD 8, GOTA/1 3, JMY 2. 73. Ed.

MAINE — SCM, G. C. Brown, W1AQL — MXT sends in his ORS ticket for endorsement and gives us the following items: KEZ has a pair of 809s on 3.5 Mc.; HSD is on 3.5 Mc.; MDK is doing service work in Winn and has a beam on 28 Mc., AWN is on 28 Mc. and has a new RME-45; ANU has his rig on 28 Mc. ISH has an 807 on 3.5 Mc. LKP reports that he has a new HRO. GKJ sends in his ORS certificate for endorsement; he also says that NXX is running 25 watts to an 807 on 3717 kc., DFC has 50 watts to an 807 on 3877 kc., and NKM is putting 10 watts to a crystal oscillator on 3650 kc. DHH says his new QRA is RFD 1, Gardiner, and he and NIQ are making big plans for the near future. George Kemp and CBV recently spent a few days in New York City. ERO was home recently on shore leave from the merchant marine. The radio club recently organized in Brewer has been named, The Eastern Maine Amateur Radio Club. Some of the gang are quite loyal in sending in their reports each month, but there still is plenty of room for more, so why not get busy? Also don't forget to send in your report on any traffic handled. 73. "GC".

EASTERN MASSACHUSETTS — SCM, Frank L. Baker, jr., W1ALP — Thanks to all for my reflection as SCM. New ECs: LAZ, New Bedford; NSP, Fairhaven; HUP, Weston. Is there an Emergency Coördinator for your town? If not, how about some volunteers; it is interesting work, gives you a chance to work with the hams in your own town and various organizations, and a chance to build and try out portable rigs. Drop me a card if interested in EC appointment. 5HQN/1 is ORS; LMU is OES; IID is OPS. LXQ sent his OPS certificate in for endorsement; also BDU renewed ORS and RM appointments. A new club, the Watson Laboratories Cambridge Field Station Amateur Radio Association, has been organized. Officers are: HZ, pres. and trustee; 4IHA, 1st vice-pres.; LLY, 2nd vice-pres.; Guy Migliore (LSPH), treas.; NRU, secy. Other hams working there are: AAA, ADP, AYH, ex-DSR, FWK, GFF, IIP, ILP, INA, IPZ, ex-IWN, MMY, MZT, NEX, MPB, NPB, NPF, OAI, OEY/ex-7IJZ, 4BKN, 5FKW, 6IOJ, 2LEN, and Ray Berube, of K6LBY. New hams on 28 Mc. are: OAP, Dorchester; ODF, Milton; OAE, Weymouth; OGM, Milton; NYG, OBI, Somerville; OFY, Marblehead; ZCC, 4COW, Waltham. SS worked D4ACX and made arrangements to sell him a rig when he arrived in this country, which he did. Madison is living in South Boston and working at Lafayette Radio in Boston. LBC is back in North Abington. D4AIA is ex-LIQ. Correction of error in June QST: NWH lives in Worcester and NIW in Gloucester. 6EFC, of Raytheon, gave a talk at the Eastern Massachusetts Amateur Radio Club meeting. DVC is now working in the antenna group at N.R.L. in Washington, D.C. More ECs: BCF, Attleboro; PZ, Lynnfield; MIH, Hyannis; LVN, Falmouth; AWA, North Reading. CTW gave a talk on 144-Mc. transmitters before the Eastern Massachusetts Amateur Radio Association and South Shore Amateur Radio Club. FDN and EMG are on 3.5-Mc. c.w. Capt. Jot is having trouble getting on 28 Mc. JCK and IUQ are back on 3.5-Mc. c.w. HWE is on 28 Mc. IID has 150 watts on 144 Mc. and a rotary array under construction. 5HQN is building a 1-kw. band-switching v.f.o. rig. HXK reports the first postwar meeting of the Suburban Net was held at ELL's QTH. Those present were: KMR, pres.; NBV, vice-pres.; ODV, secy.; NSX, treas.; OEY, HRK, IW, Art Pugsley, Dick Freeman, Gene Rock. LXQ is on 3.9-Mc. 'phone. 5GNV reports that the Raytheon Amateur Radio Club is affiliating with ARRL. 9CWX has a 100-watt rig on 28 Mc. and a three-element beam. 8CLS, in Waltham, is on 50 Mc. 5FWD has moved in with 5GNV and they have two stations on the air. 9ECO has an e.c.o. and 807s on 28 Mc. 9ECV has an 813 on 28 Mc. out in Belmont. 9CPD, in Wellesley, is on 3.5 Mc. with a new transmitter and receiver. 5GNV is working on some compact exciters for 50 and 144 Mc. BDU is on 3.5-Mc. c.w. and has schedules with 2GG, 3MJK, 4PL, and Connecticut Net. HUV, as OO, reports things much better on the bands. The 56 Mc. Minutemen

(Continued on page 98)

Now...

a complete line of

OHMITE

RESISTORS

for the Radio Amateur

"RITEOHM" PRECISION RESISTORS

Six types—including non-inductive hermetically sealed glass units. Tolerance $\pm 1\%$. Five types available from stock in $\frac{1}{2}$ - and 1-watt units, 0.10 to 2,000,000 ohms.

NON-INDUCTIVE RESISTORS

For r. f. circuits where practically constant resistance and impedance are required. Available in vitreous-enamel type and in hermetically sealed glass type with vacuum tube base.

"DIVIDOHM" ADJUSTABLE VITREOUS ENAMELED RESISTORS

Used for multi-tap resistors or voltage dividers and for obtaining odd resistance values quickly. Winding is exposed along one side for contact with adjustable lugs.

"BROWN DEVIL" AND LUG TYPE VITREOUS ENAMELED RESISTORS

A dependable general-purpose resistor. Available in ratings from 10 to 200 watts. Smaller sizes have tinned copper wire terminals.

"LITTLE DEVIL" INSULATED COMPOSITION RESISTORS

An extremely small, sturdy resistor. Three sizes— $\frac{1}{2}$, 1, and 2 watt, in 10 ohms to 22 megohms. Tolerance $\pm 10\%$. Easy to install. Available only from Ohmite distributors.

Write for Catalog 18

Contains helpful information for the radio amateur.



OHMITE MFG. CO.

4865 Flournoy St., Chicago, 44

U. S. A.

Be Right with

OHMITE

RHEOSTATS

RESISTORS • TAP SWITCHES

STOCK OR SPECIAL UNITS AVAILABLE

**FOR YOUR
ELECTRONIC**

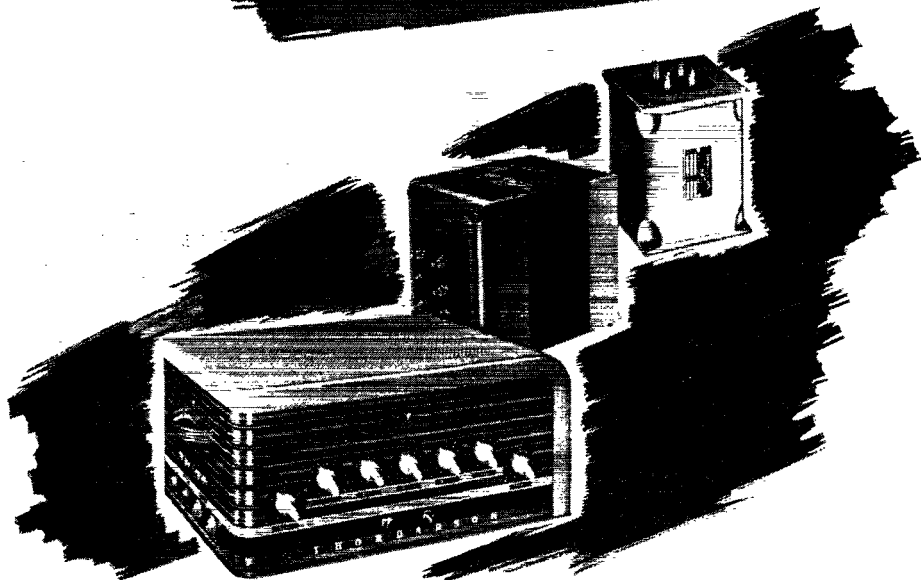

THORDARSON

TRANSFORMERS for all requirements . . . communications, sound amplifier, industrial, experimental and amateur.

TRU-FIDELITY AMPLIFIERS with advanced tone compensation, conservative ratings, multiple input channels, low hum level, etc.

**ELECTRONIC DISTRIBUTOR AND
INDUSTRIAL SALES DEPARTMENT**

EXACTING REQUIREMENTS!

MEISSNER COMPONENTS. Standard, plastic and Ferrocart transformers; antenna, R. F. and oscillator coils; accessories.

SERVICE INSTRUMENTS. Meissner Analyst... a complete servicing instrument; Signal Calibrator... self-contained and portable.

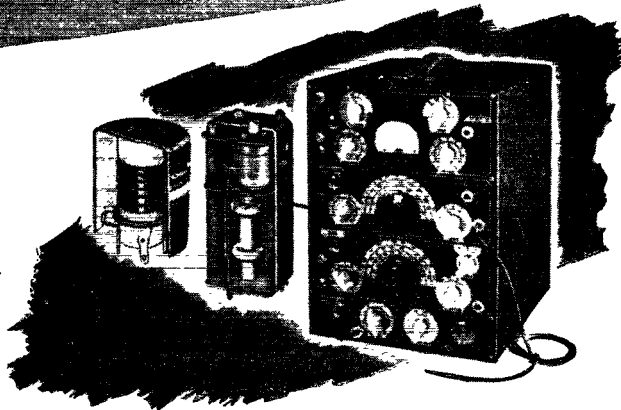

MEISSNER

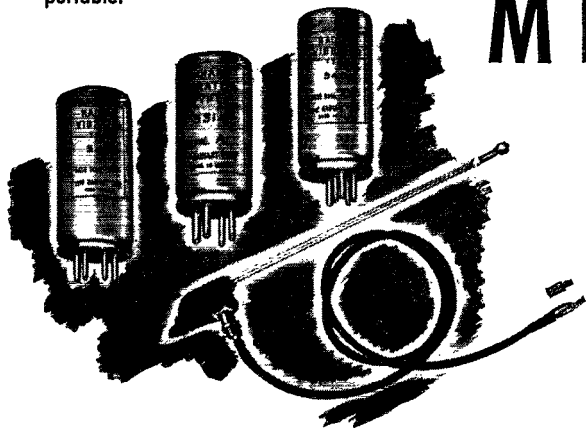

RADIART VIBRATORS. Exact duplicate Vibrators, individually-engineered... long life, low noise level, minimum interference.

RUST-PROOF AERIALS. A complete line, newly designed to fit all cars... cowl, hood and under hood types. Many exclusive features.

RADIART

MAGUIRE INDUSTRIES, INC.

936 NORTH MICHIGAN AVENUE, CHICAGO 11, ILLINOIS

VALPEY CRYSTALS

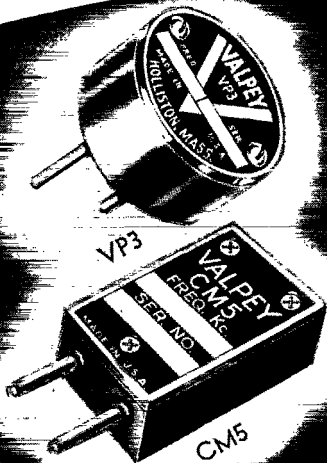

The Answer
to Crystal Control on the
New 2, 6 and 11 METER BANDS

Ready for IMMEDIATE DELIVERY and furnished in your choice of frequency ranges:

	Amateur Net Price		
80 meters,	3500 Kc to	4000 Kc	\$2.80
40 "	7000 " "	7425 " "	2.80
20 "	14000 " "	14850 " "	3.50
10 "	28000 " "	29700 " "	4.50
6 "	6250 " "	6750 " "	2.80
6 "	12500 " "	13500 " "	3.50
6 "	25000 " "	27000 " "	4.50
11 "	6796.25 " "	6863.75 " "	2.80
11 "	13592.5 " "	13727.5 " "	3.50
11 "	27185 " "	27455 " "	4.50
2 "	9000 " "	9250 " "	2.80
2 "	12000 " "	12333 " "	3.50
2 "	24000 " "	24666 " "	4.50

Write for prices on spot frequency "nets". Specific frequency prices on request. Contact Your Local Dealer.

VALPEY CRYSTAL CORP.
Craftsmanship In Crystals Since 1931
HOLLISTON, MASSACHUSETTS

Valpey CRYSTALS

WIATP • WIBZJ • WIHVP • WILQI • W8HMJ

(Continued from page 94)

meeting was held at IN's QTH. AWA is working on a new 16-element beam and will be 72 ft. up in the air. Traffic: WIBDU 11, 5HQX 4, EMG 2.

WESTERN MASSACHUSETTS — SCM, William J. Barrett, W1JAH — First appointment as official Experimental Station goes to DQH. BSJ reports appointment of new ECs with line-up at present: Hampden County — GKY; Worcester County — IHI; Hampshire County — NGH; Pittsfield — LUD; Gardner — BIV. BSJ, NLE, and LDE report improved stability in TR-4 rigs after installing Reinartz-type coils. EOB is rebuilding rig with bandswitching v.f.o. and 800 watts on all bands. BVR worked 7DCB on 3.5 Mc. NKN sports new HQ-129-X, and 815 final on 3.5 Mc. BIV is building modulator for 3.9 Mc. Pres now has new 1st-class 'phone ticket. KF6SJJ/W1 is running p.p. 35TG final at 400 watts. Bob worked SV1EC and XACP to run his total to thirty-two countries on 28 Mc. GJJ is building 813 final. IOZ and AVK are rebuilding kw. jobs. CWP is on 28 Mc. with 807s and new SX-28A. Earl reports two new calls, NZK and EZZ, both operators at WBZA. FOI and JMP picked up 2nd-class 'phone tickets recently. Hank worked 9FOI, first time he had heard similar call since being on air. Pittsfield Radio Club had a bang-up Field Day, with rigs on 3.5, 27, 28, and 144 Mc. They operated from Mt. Greylock, and hope to set some 144-Mc. records with new sixteen-element rotary built by 7EZZ/1 and IZN. Club used call HNE/1. BKG is completing radio control for model plane. JAH put up full wave for 3.5 Mc., which helps the ten-watter a little. That is the mailbag for this trip. Please time your reports to arrive here right after the first of the month. Traffic: WINKN 4, EOB 2. 73. Bill.

NEW HAMPSHIRE — SCM, John H. Stoughton, W1AXL — Congratulations to CUF, at Keene, who announces the arrival of a YL jr. operator born on May 31st. ADR, APQ, and EDN are active on 28 Mc. EAK has returned from Army duty on Okinawa and will be on 3.5-Mc. c.w. as soon as he can get up a couple of masts. JSL is enjoying terminal leave from the Army. BFT is sporting a new four-element all-aluminum beam on 28 Mc. MLW and GEY have new RME-45 receivers. CNX has his new HT-4E transmitter working on 3.9-Mc. 'phone. LVG joined the ranks of the benedicts on June 1st. MMG has gone to the West Coast to get married. FFL has signed up for another hitch with Uncle Sam and will be stationed overseas. Where are all the reports? We receive reports every month from one or two of the gang and that's all. How about sending in the news each month? The rest of us would like to know what you are doing. The New Hampshire Hamfest will be held in Manchester this fall. Be on the lookout for the date in QST and from New Hampshire OBS on the air. Old #4.

RHODE ISLAND — SCM, Clayton C. Gordon, W1HRC — QR has nightly schedule with the Connecticut Nutmeg Net and is looking for a 3640-kc. crystal to spot him on the net. He has had his ORS appointment reinstated. DWO is new ORS. Highlight of the month was AFO's talk and demonstration at the PRA on designing and building a v.f.o. It was very impressive and some special features include extensive use of relays in the separate power supply for remote control and interlocking of controls, and his method of supporting the grid lead of his oscillator to prevent vibration. Traffic: W1QR 7.

VERMONT — SCM, Gerald W. Benedict, W1NDL — A. R. Evans, a new ham in Essex Junction with the call OHK, has a rig with 6L6 final on 3.5-Mc. c.w. OAB has 144-Mc. rig. NDB has new rig with p.p. 100T in final. AVP has renewed his OPS, OBS, and OO appointments and is on 28 and 3.9 Mc. over week ends. NDL visited EKU at Chelsea. Correction: The local radio club will be known as the Barre-Montpelier Radio Club. Present meeting place is the Memorial Room, Montpelier City Hall. Please send more activity reports to your SCM. Traffic: W1AVP 6. 73. Jerry.

NORTHWESTERN DIVISION

ALASKA — SCM, August Hiebert, K7CBF — First KL7 calls are now being issued to new and transferred Alaskan hams. Reporting in so far are AO and AC (new), of Fairbanks; AI, of Barrow; AD, of Tanacross; and AF of Juneau. Recent visitors of CBF, en route to the States, were HUN of Holy Cross and 9VJE of Nenana. 5JIZ flew with the Navy from Kodiak for a personal QSO, and 3HWJ, of Adak, dropped in while on an Army flight. Fellows on the Aleutian chain interested in local club organization or "chain broadcasting" should look for him on the air. Formerly active in

(Continued on page 100)

MAKING TUBES IS EASY... IF YOU KNOW HOW!

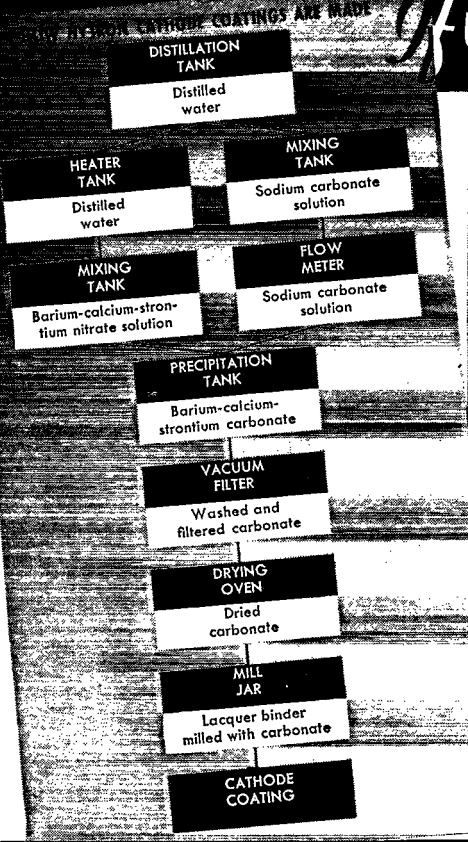

First floor of Hytron chemical precipitation system. Note the flow meter, precipitation tanks, and ceramic vacuum filters. Spotless cleanliness is vital to avoid contamination of carbonates precipitated for cathode coatings.

AGAIN HYTRON KNOW-HOW WORKS FOR YOU...

THIS photograph and flow chart may look strange in an advertisement on radio tubes. Chemistry and metallurgy, however, are a vital part of Hytron engineering. The picture illustrates the first of three floors used by Hytron's chemical system which precipitates the carbonates for cathode coatings.

Prewar, Hytron purchased such carbonates—as did most other tube manufacturers. Wartime mass production demanded much better quality control than suppliers offered. By doing the job itself, Hytron gained extra know-how which serves you in peacetime.

For these carbonates, absolute control is required of formulation, crystal size and shape, density, and

viscosity. Most cathode coatings are prepared from carbonates compounded of barium, calcium, and strontium. The percentage of each of these elements affects the performance of different types of tubes. Crystal size and shape, density, freedom from impurities, all determine the degree of electronic emission. Variations in viscosity must be minimized to assure uniform application of coating on the cathode.

There is still much "black magic" in obtaining proper cathode emission. But Hytron makes easier the problems involved by accurate chemical and metallurgical controls. No research is too tough or too unrelated, if it leads to know-how which will give better performance of the Hytron tubes you buy.



OLDEST MANUFACTURER SPECIALIZING IN RADIO RECEIVING TUBES

HYTRON

RADIO AND ELECTRONICS CORP.

MAIN OFFICE: SALEM, MASSACHUSETTS



SILVER

ANNOUNCES—



MODEL 800 • 144-148 and 235-240 mcs. U. H.F. receiver. E. P. Tilton's Feb. 1946 QST design modified by Byron Goodman's inductive r.f. tuning, built-in PM speaker, 88" band-spread, all in new "ATOM-X" construction. Factory built or kit for easy home construction, compact.

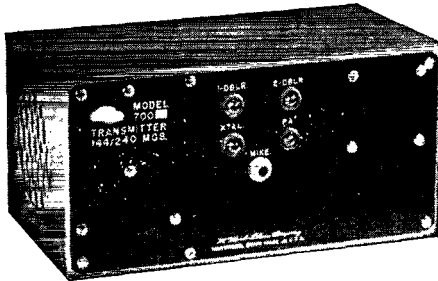

MODEL 700 xtal controlled transmitter. 144-148 and 235-240 mcs. 6AQ5 Tritet drives 6C4 doubler, 6C4 doubler/tripler, 832 long-line push-pull final. Built-in 14 watt 6AQ5 push-pull voice modulator. New "ATOM-X" construction, size only 5" x 10" x 5/4". Matches MODEL 800. Makes serious home-station or mobile rig. Factory built or kit.

• • •

Illustrated and high spotted above are but two of many fresh, post-war receivers, transmitters, factory built or kits and parts designed by and for serious amateurs. Prices are as low as quality is high. A penny post-card will bring you catalog of what's new . . . your favorite jobber will have them soon.

OVER 35 YEARS OF RADIO ENGINEERING ACHIEVEMENT

McMurdo Silver Company

1249 MAIN ST., HARTFORD 3, CONNECTICUT
In Canada—McMurdo Silver Division, General Radionics Ltd.
463 Church Street, Toronto, Ontario

(Continued from page 98)

the Territory, then Stateside during the war, and now back burning up the 3.5-Mc. 'phone band, are FID, at Adak, and H.A.R., Bjork Island. HMS just ended his 3.5-Mc. c.w. problems by getting a Class A ticket. He also has two wolf pups to give away. Let's have some reports, fellows, and data on new calls. Tnx.

MONTANA—SCM, R. Rex Roberts, W7CPY—Section EC, B.W.H. FXO is new EC for Daniels, Sheridan, and Roosevelt Counties. The Butte Club held its annual ham-fest at Basin, June 22-23. The Northern Montana Radio Club was organized at CVQ's shack in Shelby on May 17th. Officers are: CVQ, pres.; ISU, secy-treas. ISU has new bug. JIZ is new ham at Oilmont. CVQ has made more than one hundred 28-Mc. contacts with low power; he has now increased power. The SMARC are holding lively and instructive meetings with a number of technical subjects being discussed at each meeting. FVT and EJF are building mobile 28-Mc. equipment. Heard on 3.5-Mc. band from Billings are CT, HBV, and 9OQE/7. JFR, president of the Butte Club is a shut-in and he had a receiver that wasn't so good. At the May 31st meeting of the club a beautiful birthday cake for Jack was in evidence plus a new Hammerlund HQ-129-X. To the Butte Club a thank you from all Montana amateurs and to you, Jack, we hope the club's thoughtfulness will make your days more pleasant. Well, fellows, I have been your SCM for more than five years and wish to thank you all for your splendid support. I "chose not to run" and EQM is your new SCM. 73. Rez.

OREGON—Acting SCM, Cliff Tice, W7BEE—Through the courtesy of GLE, we have news of the Klamath Falls gang. QP, an ex-Navy man, is the high-power station there, operating a radio shop, looking after both police and Forest Service equipment. He is active on the 3.9- and 28-Mc. bands as time permits. Others on 35 Mc. include IDJ, HGF, GLX, and GLE. Like the 28-Mc. band, on for a while and then silent, are HKO and JBF. From Bend we hear that GNJ and HHH are vacationing on the Coast at Wheeler and operating portable from there. GNJ heard his own station for once, and intends to park his "mike" in the garbage can as soon as he returns to Bend. There is not much activity around Pendleton at this time. MQ expects to take delivery of a 500-watt 'phone and c.w. rig in a few days. This will be used on all the bands open by MQ and the XYL, GPO. BEE is now without a receiver; his SX-28 is on the way to Akita, Japan, in the custody of his son, who expects to contact the home folks by radio as soon as he gets a license and a rig built. As he will be a communications officer there, he should be able to get some of the few parts not on hand. From the amount of literature he is packing back, studying seems to be indicated. On the 23rd of June, the Pendleton Radio Club and the Walla Walla Club held a get-together and a picnic near the top of the mountains at Langdon Lake, with portable operation, a swapfest, and an auction of unneeded parts. XYLS, harmonics and sub-harmonics also attended. 73. Cliff.

WASHINGTON—SCM, O. U. Tatro, W7FWD—Former ORS and OPS, send your certificates to this SCM for endorsement with a report covering two consecutive months of postwar station operation. Would also like to hear from former RMs and PAMs. These posts will be held open for a limited time only. 6OJW, Dixon, Calif., wants traffic from this section on 3790 kc. Everest: K7CZY/7 has schedule with JBH, IOQ, and DYD on 144 Mc. and reports JFC on 28 Mc. DYD, IOQ, and JFB have 4-element, and K7CZY/7 a 16-element beam. Seattle: IDZ, secretary of Electron Club of YMCA, reports meetings every Wednesday P.M. at the "Y," to which all hams are invited. The station, YC, with two transmitters, has the following operators: RT (trustee), VG, AGV, BST, HXA, IDZ, and ISV. CWN is on 3.5 Mc. and looking for traffic. HDC can't find housing so is going mobile on 144 Mc. HQR is on 3.5, 28, and 144 Mc. HOL stopped 3.9-Mc. operations to put up a temporary OD antenna to work yours truly on 144 Mc. on our recent visit to Seattle. EOP keeps a schedule in an attempt to reach Canada on 144 Mc. Mercer Island: AXS is the first to be endorsed as OPS and is operating on 3.5, 28, and 50 Mc. He has finished his Marine Mobile 28-Mc. rig and is building a 144-Mc. walkie-talkie. Colfax: EQN is putting a rig together. ELH worked small portable 3.5-Mc. rig in car on trip from Washington, D.C. After making contact he calls on his victim in person. CSN is on again. DRD has kw. rig ready for 3.5-Mc. c.w. as soon as new sky-wire and poles can be hoisted. ERN is building for 3.5-Mc. c.w. ERO is building 'phone with a pair of 811s. DP is active on 3.5-Mc. c.w.

(Continued on page 108)

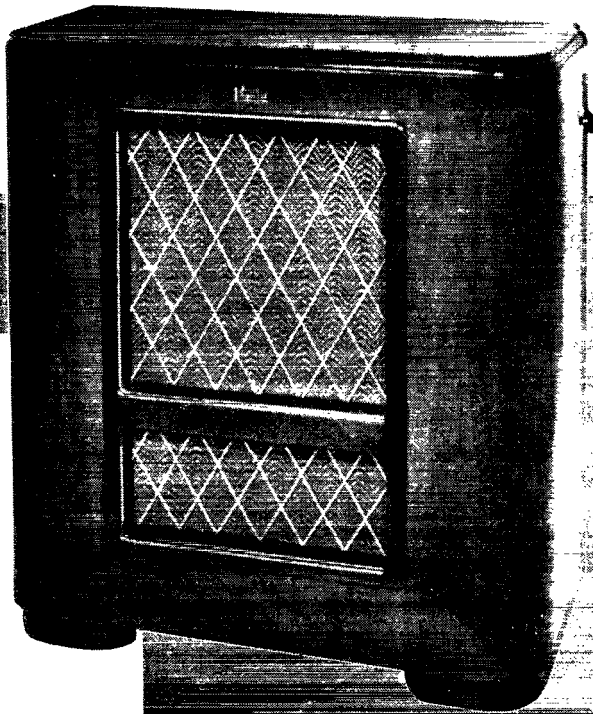

Jensen
 TYPE "RD"
Reproducer
 WITH THE NEW TYPE "H"
 ARTICULATED
Coaxial

This new Reproducer, combining the Type "H" Coaxial speaker with the new Jensen Type "D" Bass Reflex cabinet, offers superior reproduction of your favorite program material and is unconditionally recommended for FM receivers, high quality phonograph reproduction, reviewing studios, monitoring, and home and public entertainment generally.

The cabinet is beautifully styled and fashioned of satin finish striped walnut. The harmonizing grille fabric is overlaid with a protecting pattern of flat, interlaced bronzed strips.

The Type "H" Coaxial, with all **ALNICO 5** design, employs a h-f horn and 14 (15-inch) cone which are electrically and acoustically coordinated to achieve brilliant and natural response throughout the entire useful frequency range. The frequency dividing network has variable control in the range above 4,000 cycles. Nominal input impedance to dividing network, 500 ohms; maximum power handling capacity 25 watts, in speech and music systems.

Model RD-151 Reproducer complete, approximate list price \$180. *Trade Mark Registered

JENSEN MANUFACTURING COMPANY
 6611 S. LARAMIE AVE., CHICAGO 38, ILLINOIS
 In Canada—Copper Wire Products, Ltd., 11 King Street, West, Toronto

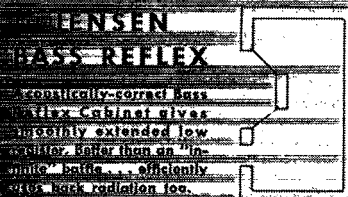

*Specialists in Design
 and Manufacture of Fine
 Acoustic Equipment*



**PREFERRED
BY ENGINEERS**

**BURGESS
BATTERIES**

**RECOGNIZED BY THEIR
STRIPES • REMEMBERED
BY THEIR SERVICE**

(Continued from page 100)

with TZ40s and building new speech for cathode modulation and is using JHP's BC312 worked over for a.c. while he is busy at Presque Isle, Maine. Rosalia: FDD is active on 3.5 Mc. Spokane: QB is on 28 Mc. and is handling traffic. FLQ is on 28 Mc. with an eight-element beam. NV narrowly escaped death from throwing an antenna wire over an HT wire thinking it was a fire alarm circuit. JEM has a new license and fine location. IOT is on 3.5-Mc. c.w. with a 6L6 and is building for 450 watts with 812s. Olympia: AIU has originated "horizontal operation" by using self-synchronizing motors from an old gun mount and now "rests while he works" on 3.9-Mc. 'phone. 9TRL/7 is on 28 and 3.5 Mc. and is building a beam. FWD worked FOSFN on Bora Bora, near Haiti in the Society Islands, on 3.5 Mc. with 180 watts. Kelso: JLF is on 3.5 Mc. Traffic: W7FWD 8, QB 4. 73. *Tate.*

PACIFIC DIVISION

HAWAII — Acting SCM, John F. Souza, jr., K6PHD — RLG, your SCM, has moved to Fresno and expects to be on the air in W6-Land as soon as he can unpack the rig. MVV is proud recipient of first active KH6 call and is giving KH-6AR a good workout with 750 watts on 28 Mc. PLZ is firing up a pair of Eimac 327As on 28 Mc. ROJ needs Europe for WAC on 28 Mc. with 40 watts to single 807. OQM, the OM, expects to catch up with her when he fires up his pair of 4-125As to a "cool" 900 watts. FAZ is using three-element beam to work DX with 35 watts to 815 on 28 Mc. and is getting a pair of HK24As for 14 Mc. SNA is on 28 Mc. with single 807. AYD has single 829 on 50 Mc. and is building a super. QLG and THA are building kw. as fast as parts come in. BJJ is feeding p.p. 100THs to three-element beam atop 35-ft. tower. LIA, holding down maintenance job with CAA at Makena Radio Range, is enviously sizing up his five 135-ft. towers. 73. *Johnny.*

NEVADA — SCM, N. Arthur Sowle, W6CW — Asst. SCM, Carroll Short, jr., W6BVZ. RM, PST. ECs, MRT, TJY. 1MSP now is 7JLM, 500 watts on 28 and 3.9 Mc. Wilson (LSPH) is 7JKD, at Fallon. TJE is home from the services and setting up his station. UHR has 50 watts on 3.5-Mc. c.w. in Truckee. TEI has new HQ-129-X and is on 3.9 and 3.5 Mc. GFZ is on 3.5-Mc. c.w. at Alturas. HHY, of Hawthorne, now is at McGill. KOZ reports on 3.5-Mc. c.w. at Fallon. 8ERZ is with CAA at Fallon. SVI was in Reno for a while on 144 Mc. UIZ is still huba-hubaing the gang to get back on 144 Mc. JYA is back from Japan with some slant-eyed radio gear. LENU has 950 watts on 3.9 Mc. UGA, back from the Army in Alaska, built a new radio shack with one room attached for living. FVO has 400 watts on 3.9 Mc. PST has new folded doublet on 3.9 Mc. which is very hot. TQZ has new S-20R with homemade preslector. 73. *Art.*

SACRAMENTO VALLEY — SCM, John R. Kinney, W6MGC — The Sacramento Valley Section is getting started with the following appointments: GZY is OBS in Sacramento on 3.5-Mc. c.w. and 140-Mc. 'phone. HIR is ORS on 3.5-Mc. c.w. with 6L6G, 807, into a pair of 812s in push pull. OJW, in Dixon, is ORS on 3.5-Mc. c.w. with 6L6, 807, into a 35T with 100 watts, and is looking for traffic schedules. OJW reports that he and POA, TXL, LNN, 2VY/6, ex-6PLU, and ex-8ACO are operators of the NBC short-wave transmitting station in Dixon. VBU, an old-timer with a new call, has a 6L6 into an 814 with 150 watts c.w. The Sacramento Amateur Radio Club, Inc., announces that it will have an Old-Timers Night on August 21st., also that PBO has been appointed QSL Manager of the SARC, and IJSU/W6 has been appointed activities manager of the club. New members of the club include DLB, RSZ, LGD, OWM, GHN, LHB, TYW, ULO, 8RZY, and 9OZW. Most of these amateurs have returned from the services. It has been announced that QDT and EY have been appointed to Governor Earl Warren's State Radio Advisory Committee. Activity has been very good on 144 Mc. in the Sacramento section with CLV, QDT, MIW, PIV, QKJ, GZY, QDJ, KME, AUO, PNC, and BVK. AP reports that he has had some very fine contacts with VK3OP in Australia and ZL2JA in New Zealand on 28-Mc. 'phone. MGC reports his activity — he expects to have a jr. operator in August. Please send in your monthly reports, fellows. Traffic: W6AP 8, GVM 4, HIR 1. Vy 73. *Jack.*

SANTA CLARA VALLEY — SCM, Roy E. Pinkham, W6BPT — The SCCARA held its monthly dinner on May 6th with thirty-six attending. TBK and 1WV/6 were visitors from Menlo Park. Dr. William Warren of the University of

(Continued on page 106)

Save Weight! Save Space!

- IN THE SHACK
- WORKING PORTABLE
- WORKING MOBILE

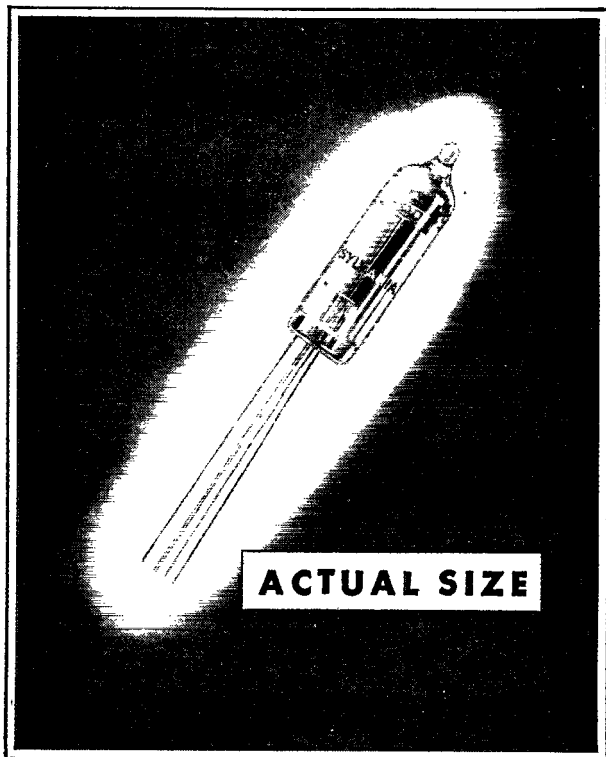

New T-3 tube ideal for high frequency operation

You remember the tiny tube that became the heart of the famous proximity fuze—the complete radio transceiver capable of being fired from a gun!

Well, the commercial version of this Sylvania achievement is now being produced. It has a life of hundreds of hours and is ideally suited for high frequency operation. Its extremely small size will directly contribute to the compactness and lightness of your rig.

Write Sylvania Electric Products Inc., Emporium, Pa., for details.



SYLVANIA ELECTRIC

Emporium, Pa.

MAKERS OF RADIO TUBES; CATHODE RAY TUBES; ELECTRONIC DEVICES; FLUORESCENT LAMPS, FIXTURES, WIRING DEVICES; ELECTRIC LIGHT BULBS

Why

THIS TEAM IS

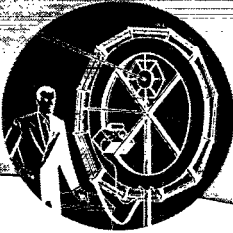
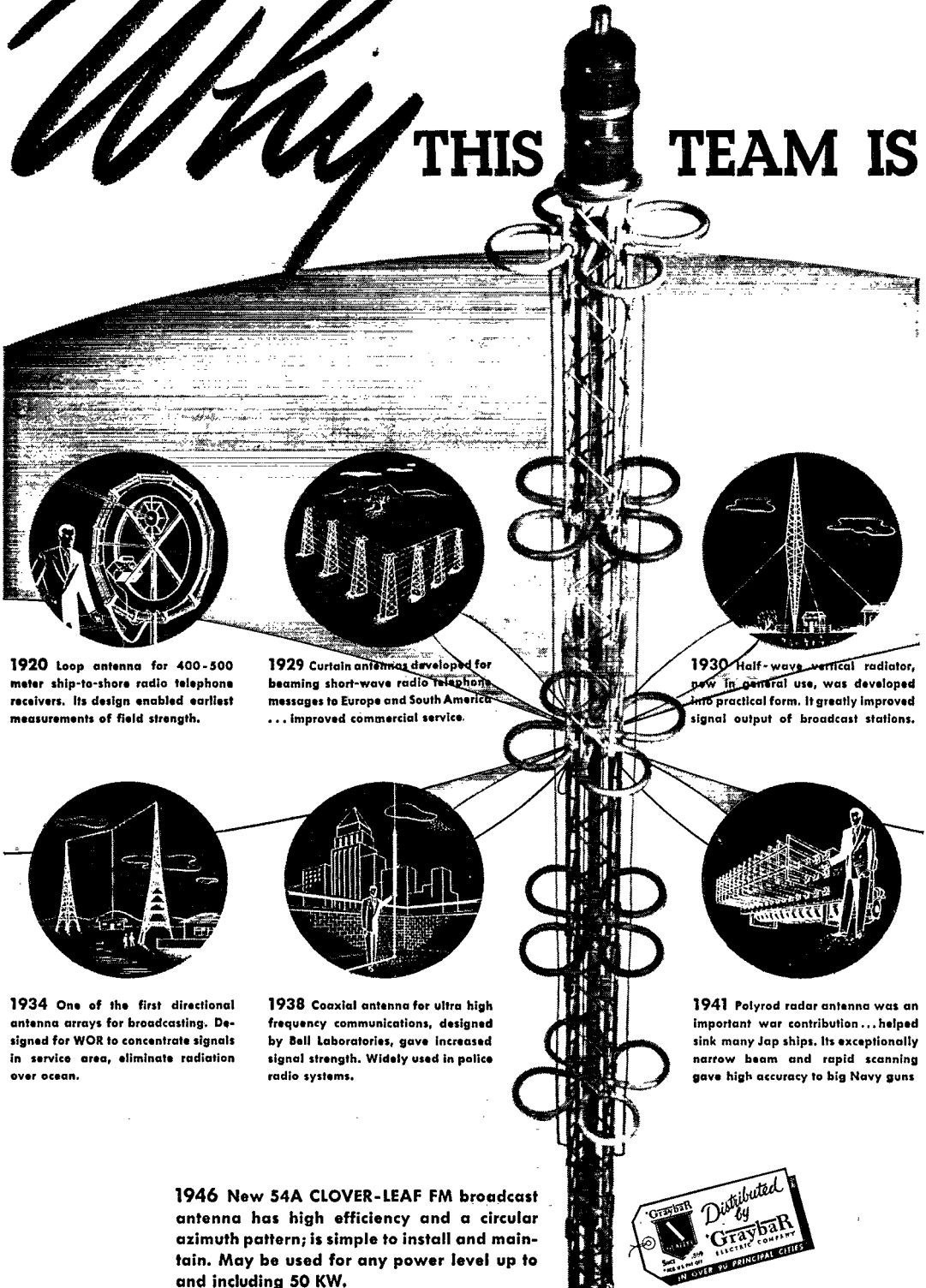

1920 Loop antenna for 400-500 meter ship-to-shore radio telephone receivers. Its design enabled earliest measurements of field strength.

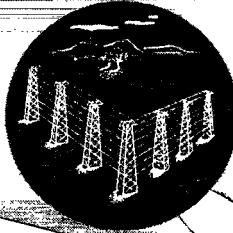

1929 Curtain antennas developed for beaming short-wave radio telephone messages to Europe and South America ... improved commercial service.



1930 Half-wave vertical radiator, now in general use, was developed into practical form. It greatly improved signal output of broadcast stations.

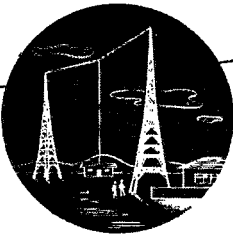

1934 One of the first directional antenna arrays for broadcasting. Designed for WOR to concentrate signals in service area, eliminate radiation over ocean.



1938 Coaxial antenna for ultra high frequency communications, designed by Bell Laboratories, gave increased signal strength. Widely used in police radio systems.

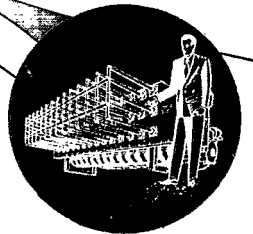

1941 Polyrod radar antenna was an important war contribution ... helped sink many Jap ships. Its exceptionally narrow beam and rapid scanning gave high accuracy to big Navy guns.

1946 New 54A CLOVER-LEAF FM broadcast antenna has high efficiency and a circular azimuth pattern; is simple to install and maintain. May be used for any power level up to and including 50 KW.



UP ON ANTENNAS

As pioneers and leaders in radio, Bell Telephone Laboratories and Western Electric have been vitally concerned with the development of improved antennas for more than 30 years.

From the long-wave days of radio's youth, right through to today with its microwaves, this team has been responsible for much of the progress in antenna design.

Progress based on Research

Following their long-established method of attack, Bell Laboratories scientists are continually *observing, investigating and measuring* the action of radio waves in space. Their research has covered wave lengths ranging from hundreds of meters to a fraction of a centimeter. In over a quarter-century of intensive study, they have learned how radio waves behave, day and night, under all sorts of weather conditions.

Out of this fundamental research have come such outstanding developments as the rhombic antenna, horn antenna, vertical half-wave radiator, curtain antenna, directional array, the polyrod and other improved radar antennas, the metal lens for microwaves and the new CLOVER-LEAF antenna for FM broadcasting.

What this means to YOU

Whether you are interested in AM or FM—equipment for broadcasting, point-to-point, aviation, mobile or marine use—here's the thing to remember. Every item of radio apparatus designed by Bell Laboratories and made by Western Electric is backed by just such thorough scientific research as has been given to antennas. It's designed right and made right to give you years of high quality, efficient, trouble-free service.

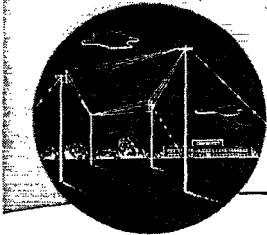

1930 Rhombic (diamond-shaped) antenna for 14-60 meters. It covers wide frequency range without adjustment. Still standard for this band.

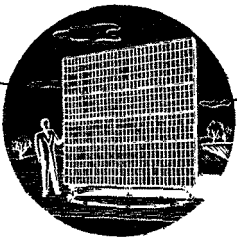

1944 Metal lenses, another Bell Laboratories development, focus microwaves like light. One type has a beam width of only 0.1°—or less than that of a big searchlight.

BELL TELEPHONE LABORATORIES

World's largest organization devoted exclusively to research and development in all phases of electrical communications.

Western Electric

Manufacturing unit of the Bell System and the nation's largest producer of communications equipment.

STATION TESTED*

*... an added
proof of Quality!*



*Pres. W. A. Kuehl is shown at his amateur radio station W9EZN. With the war over, Walt is again pursuing his favorite hobby.

DRAKE RADIO SOLDERING IRONS

Yes, Drake irons are *right for radio*. And these sturdy irons have proved their dependability and worth in use on countless other jobs, too, for over 25 years. That's why we say—whatever your needs, you are certain to find a Drake iron that fills the bill exactly!



600-10—the Drake No. 600-10 is ideal for those all important connections when rewiring your rig. Get back on the air fast. Make good dependable connections with this 100 watt $\frac{3}{8}$ " tip.



400—the Drake No. 400 is the perfect iron for work in small places. Only 9 inches long, it is especially designed for tight corners and delicate connections. 60 watt, $\frac{1}{4}$ " tip.



Ask your nearest supplier or write for the name of the distributor nearest you . . . and give yourself the advantages of these superior irons.

DRAKE ELECTRIC WORKS, INC.

3656 LINCOLN AVE.

CHICAGO 13, ILL.

(Continued from page 102)

Santa Clara gave a short talk on color television. San Mateo County has organized a radio club with VEN as chairman. JSB worked station STORK and received a QSL; it's a girl. 71KU/6 worked the same station and his QSL was a girl. Lee is building a kw. final using 250THs. OKQ has new rig on the air. HBB is working 3.5-Mc. c.w. LX.A has a kw. 'phone on 28 Mc. Elmer uses 250THs in final. VHE is new call on 28-Mc. 'phone. TBK is building final for 28 Mc. using 100THs. CFK writes an amateur column in a Sunday morning paper. Ex-CKD is located in San Carlos with 20NN/6 as his call. CEO is heard calling CQ DX on 28-Mc. c.w. DZE has worked the Aleutians on 3.9-Mc. 'phone. AHZ is operating in a broadcast station in Sacramento. BON is operating at KFRC in San Francisco. KG is running 813s in final. 9FAV/6 has rig on 3.5 Mc. QLP uses Amphenol 300-ohm twin lead to feed his beam. MOV is working 3.9-Mc. 'phone. QLN has new Techrad transmitter on 28 and 3.5 Mc. PBV hears San Anselmo, San Rafael, Richmond, and Casterville on 50 Mc. from his location in San Mateo. R.X is taking traffic from the Pacific Islands. 1WV/6 reports MWK back in Atherton awaiting discharge from the Army. We would like reports from the Watsonville area. How about it, gang? Traffic: W6RX 38, PBV 20. 73. *Pinky.*

EAST BAY — SCM, Horace R. Greer, WGTI — Section EC, EE; RM, ZM; EC, QDE; EC v.h.f., FKQ; Asst. EC v.h.f., OJU; OO, v.h.f., ZM; OO, ITH; OBS, TT, IDY, ZM, ITH. CDA is on 28-Mc. 'phone with 100 watts. TI is on 28-Mc. 'phone with 600 watts to a 250TH and 750 watts on 28- and 3.5-Mc. c.w. LMZ is on 3.5- and 28-Mc. c.w. running 30 watts to an 807. EJA is modulating an 813 with a pair of 811s on 3.9-Mc. 'phone and using same final on 3.5-Mc. c.w. ITH is pouring FB signals into ZLs with 500 watts on 28-Mc. 'phone. Keep an eye out for 6SQ/1 on 28,752 kc. at Darien, Conn., on week ends. Gordon will be using this call until new W1 is received. The SARO's long distant record for 28-Mc. mobile f.m. is shared jointly by BUY, NQJ, and OCZ with 3 watts at fifty-four miles. Over fifty members have bought these small Army f.m. surplus jobs. Two frequencies are used by the gang, 29.4 and 29.6 Mc. On May 10th SSN, while working K6ROJ with his big rig, asked Paul to stand by for the three-watter and received an R4 to R5. For such low 'phone power this is really FB. The SARR, near the top each year, hopes to cop first place in the ARRL Field Day this year and there is a big chance this will be the pay-off year as the boys are really keyed up for this event. JEE is building new 1-kw. rig. EY, our new vice-president, is getting ready for all-band 'phone and c.w. operation. Remember, the Oakland Radio Club is giving an FB certificate to those working all California Counties. This is open to anyone anywhere except that they (California) must be worked from one county QTH. Send all QSL cards to ZM, secretary. Only seven have been issued to date. Check over all your old cards and get started again using 'phone or c.w. or both. AKB, while rebuilding c.w. rig, is having lots of fun on 28-Mc. 'phone with new 30-watt rig. With 7 and 14 Mc. just around the corner it will seem like old times. So let's have the news. What are your plans? Traffic: W6ITH 26, TI 8, TT 2, AED 2, IKQ 2. 73. "TI"

SAN JOAQUIN VALLEY — SCM, James F. Wakefield, W6PSQ — The San Joaquin County Amateur Radio Operators' Assn. held its first regular meeting on June 7, 1946, in Stockton with a swell turnout. From Turlock comes the information that SKH is using a 35TG with 150 watts on 28 Mc. UBQ is on 28 Mc. with a pair of 6L6s. QER has an HK-154 on 28 Mc. and FYM has a Signal Shifter on 3.7-Mc. c.w. RTF, at Ceres, has been knocking them over with a pair of RK12s running 100 watts into a four-element rotary. In Modesto UOO is on, and ONO and AYQ are on 3.9 Mc. with a cool half-kw. into p.p. 100THs. NGT and LEF are on 3.9 Mc. LMT is moving to Covina. QJP is busy most of the time keeping KTRB on the air but has built an FB shack and is working on 500 watts for all bands. RFO has sold out and he and his XYL are turning gypsy. FNO has RFO's 807 rig now and AXI now has FNO's 25-foot tower. OKK and SQP, of Escalon, still are at it with the converted Mims Squirter and brag about most of the Pacific stuff with G and ZS as chasers. SQP lives in Modesto but commutes to Escalon just to work the stuff. AXI has XU1YO on the book with an R-9. Skinny runs 90 watts to RK11s with a three-element rotary. More of the Fresno boys are getting back on. The SJRC now has 125 members. We regret to report the death of one of our most cherished brothers. BXB, "Pop" Noack of Stockton, passed away recently after a period of

(Continued on page 108)



"I'm using a
CARDAX"

... say Hams on the air!

THE NEW

Cardioid Crystal Microphone

with Revolutionary New **MECHANOPHASE*** Principle of Unidirectivity ... Dual Frequency Response ... High Output ... and other big features!

Here, for the first time, you get *all* these features in *one* microphone! With amazing flexibility, new **CARDAX** efficiently serves many applications ... easily solves everyday problems of sound pick-up and reproduction!

★ **TRUE CARDIOID POLAR PATTERN** New E-V Mechanophase* principle gives wide-angle front pick-up in true cardioid pattern over wide frequency range. Sound at rear *dead zone* cancels out and is not reproduced.

★ **STOPS FEEDBACK—CUTS BACKGROUND NOISE AND REVERBERATION PICK-UP** Permits nearly double usable loud speaker volume. Simplifies microphone and speaker placement. Assures finer reproduction of just the sound wanted.

★ **DUAL FREQUENCY RESPONSE** Screw control on back gives (a) Wide range flat response for high fidelity sound pick-up or (b) Wide range with rising characteristic for extra crispness of speech or high frequency emphasis.

★ **HIGH OUTPUT LEVEL** —57 db for flat frequency response. —48 db for rising frequency response.

★ **VOICE AND MUSIC PICK-UP EXACTLY AS DESIRED** Ideal for public address, recording, remote broadcast, communications ... indoors and outdoors.

★ **FULLY EQUIPPED FOR CONVENIENT OPERATION** Tilting head. Built-in "On-Off" switch. Dual frequency range selector switch. Cable connector. 20 ft. cable. Bimorph crystal. $\frac{5}{8}$ "-27 thread. New modern functional design. Satin chrome finish. **CARDAX Model 950, List Price..... \$37.00**

Licensed under Brush Patents. Electro-Voice Patents Pending.

EXCLUSIVE NEW
MECHANOPHASE*
PRINCIPLE
DEVELOPED BY
Electro-Voice

Utilizes a phase shifting diaphragm to produce a high degree of unidirectivity at all frequencies. Gives true cardioid characteristic by nullifying back pick-up. Unlike any previous method of obtaining unidirectivity and has many important advantages.

*Patents Pending

Authorized
Distributors
Everywhere



SEND FOR BULLETIN NOW
Get full facts about amazing new **CARDAX!** Describes *Mechanophase*. Shows how dual frequency response selector works. Includes diagrams and response curves.

NO FINER CHOICE THAN

Electro-Voice

M I C R O P H O N E S

ELECTRO-VOICE, INC., 1239 South Bend Ave., South Bend 24, Indiana
Export Division: 13 East 40th St., New York 16, N. Y., U.S.A.—Cables: Arlab

For CW Only or
For CW and FONE Operation

The HARVEY 100-T TRANSMITTER

Is Immediately Available

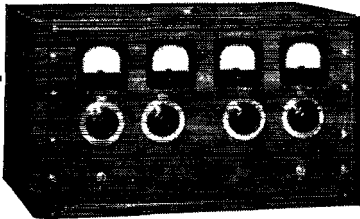

Sturdy, efficient, thoroughly dependable for CW operation when supplied without modulator. Modulator may be added later when phone operation is desired.

SPECIFICATIONS

Frequency Range—3.5-30 mc.
Power Input—175 watts to final amplifier.
Radio frequency tubes: 6V6 Crystal oscillator, 6L6 Doubler, 814 Final amplifier.
Rectifier Tubes: 2-866 Final amplifier supply, 83V Oscillator doubler supply.
Net weight—80 lbs. with cabinet.

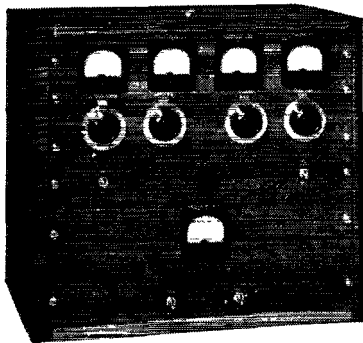

The HARVEY 100-T with modulator, complete, ready for radio telephone and telegraph operation. A plate modulated unit of effective power (175 watts input on CW, 130 watts input on phone) the 100-T has 5-band operation, quick frequency shift, reliability, compactness, and ease of tuning.

For further information on the 100-T and other HARVEY Transmitters write for Transmitter Bulletin.



**HARVEY RADIO
LABORATORIES, INC.**
451 Concord Ave., Cambridge 38, Mass.

(Continued from page 106)

illness. This is a great loss to all of us as "Pop" was one of the stand-bys. 73, "Pop," from the gang. *Jimmie.*

ROANOKE DIVISION

SOUTH CAROLINA — SCM, Ted Ferguson, W4BQE- /ANG — FNS is working on 28- and 3.5-Mc. c.w. New Greenville calls are IKH, ILQ, ILY, IMW, and IMX. EJH is working 28- and 3.5-Mc. c.w. HCZ is on 144- and 28-Mc. 'phone and is building a 250-watt rig. ILQ is on 3.5 Mc. c.w. and 144-Mc. 'phone. GBY works 28-Mc. 'phone. KZ is on 3.5-Mc. c.w. and is building a rig for 3.9-Mc. 'phone. AZT is on 28- and 3.5-Mc. 'phone. HMG works 3.5-Mc. c.w. and 28-Mc. 'phone. EGH works 28-Mc. 'phone and 3.5-Mc. c.w. CZA and the gang at Charleston are doing a good job getting the Charleston club back in order. AFQ has been reappointed OO Class I and will be glad to check with any of the boys. FXH can be heard beating them out on 3.5-Mc. c.w. MJ is on 3.5 Mc. FNC is to be heard from Ware Shoals. HVG is on 28-Mc. 'phone and 3.9-Mc. c.w. BEN is new secretary of Palmetto Amateur Radio Club, Inc. Other new Officers are: HEV, pres.; and HMG, vice-pres. FHE is building a new kw. rig and has bought an HT-4. On May 5th the South Carolina hams enjoyed a day of fun and frolic at Fort Jackson, planned by Col. 9QHS/4, Capt. R. A. Smith, Lt. Jack Clark, and the men of the Signal Section of the 5th Army Corps. 73. *Ted.*

WEST VIRGINIA — SCM, Donald B. Morris, W8JM — MOP has a new BC-610 on 3940 kc. WSD/8 is working in Akron and is on 3.5 Mc. Roy Heck, ex-CLQ, now is 3KNR, in Baltimore. GBF has a schedule with 8VZD/3 in Baltimore and was visited by BTV. Director Caveness, 4DW, visited the MARA in Fairmont on June 7th and reported on the Board Meeting. WSL has thirty-nine states toward WAS and has been elected secretary of the MARA. VAN met two old friends on the air, 4ECB/8 and 4IUK. LS is on 3.9 Mc. with 600 watts and UEB is active in Charleston. CFB, BYI, and WHR should get lots of QSOs in WACWV on account of their location. DFC visited hams in Charleston and Beckley. YBQ is a new station in Clarksburg. CSF is chief engineer at WCHS and is rebuilding for high power. New OOs: PQQ, GBF. ORS: GBF, DFC, VAN. OBS: VAN, PQQ. HI has a new 610-E transmitter. SFT is active as SFT/4. JM has new portable rig running 3 watts input on 3.5 Mc. MIS operates daily from midnight until noon and has worked all states on 3.9-Mc. 'phone. SGO is stationed at Norfolk and operating from there on 3.5-Mc. c.w. REH has a new rig on 3.5 Mc. DMF is located in Charleston, working at WGKV. VUM is a new station located at Jere. Traffic: W8GBF 5, REH 2, KWL 2, JM 2.

ROCKY MOUNTAIN DIVISION

COLORADO — SCM, Glen Bond, W9QYT — A few of the hams are getting the mobile bug since summer has set in. Any time now you may hear AAB, VGC, YFJ, or other Colorado hams calling you and signing mobile. 28 and 50 Mc. seem to be the favorite bands at present but 144 Mc. is sure to be represented. The Electron Club of Denver is putting on the Rocky Mountain Division convention at the Shirley Hotel, Sept. 14th, with a big breakfast Sunday morning followed by a transmitter hunt. Oodles of big prizes and a swell dinner Saturday is included, all for \$3 a ticket. If you miss it you will be sorry. **DON'T FORGET THE DATE.** 4AXG/Ø has moved to Canon City from Jacksonville, Fla., and is on 28 Mc. with a pair of 807s. Clav has retired from the Navy after twenty-three years. Notice to all 3.5-Mc. traffic men, I have a few requests for schedules from the West Coast; also I would like to get your reports on traffic and schedules. QDC is taking an engineering course in his spare time. The University of Colorado Radio Club in Boulder is doing a swell job and has over forty-seven members, of which thirty-two are hams. 6QJI is pres.; 9DZB, vice pres.; and 9FDD, secy. Code practice is given three times a week. The Western Electronics Lab is donating a prize to each of the Denver clubs to be given away as a door prize once each month so be sure to attend your club meetings. You might be lucky. 73. *Glen.*

UTAH-WYOMING — SCM, Victor Drabble, W6LLH — New appointees: 6SID, Section EC; 9FVO, EC; 6CKI, OO; 6TMK, OBS. Endorsements: 7HDS, OPS; 6SID, ORS. The Utah Amateur Radio Club held its Field Day outing in Little Cottonwood Canyon. 6QQD, 6FRL, and 6QAA are doing FB on 28-Mc. short skip work. 6ONH and 6QOO have FB mobile rigs. 4GFC has his 3.5-Mc. rig on both 'phone and

(Continued on page 118)

Buenos tardes, amigo...
 "Good evening, my friend..."

For more and clearer QSO's



Reception will be crisp, clean, sure! Chile will come through to you as clear as the signal from a local rig! *Ken-Rad tubes are ready to help you span the earth*—tubes tested by the million under war's toughest conditions, now available to you for better performance than you've known before. The 6L6 beam power amplifier typifies the ruggedness, compactness, improved shielding, and short lead-length design of Ken-Rad all-metal tube construction. Basic ratings are given below. For more complete information see your Ken-Rad distributor or dealer.

Ratings of Type 6L6

Heater voltage	6.3 v	Max plate dissipation	... 18.5 w
Heater current	.9 amp	Max screen dissipation	... 2.7 w
Max plate voltage	350 v		
Max screen voltage	250 v		

176-E2-8850

KEN-RAD

DIVISION OF GENERAL ELECTRIC COMPANY
 OWENSBORO, KENTUCKY

Make the nearest Ken-Rad distributor or dealer your preferred source of supply for amateur tubes

THE NEW **TEMCO'S** PUT...

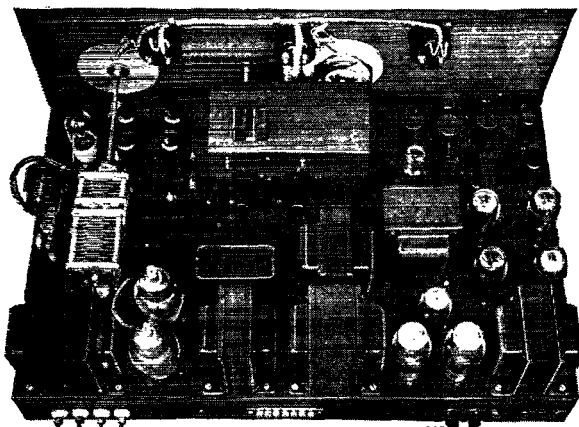
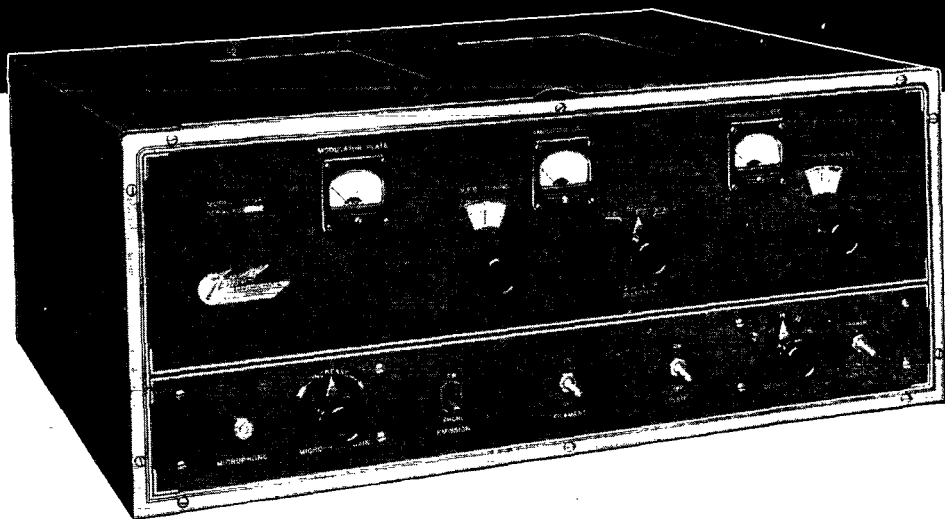

Combination Transmitter and Exciter Permanently Protects Your Investment

The 75 GA is also the exciter unit for the 500 watt transmitter pictured at the right. This means that your investment in a Temco 75 GA is good forever and represents a substantial savings when stepping up to 500 watts. For further details see previous ads in this publication.

TEMCO 75 GA Telephone & Telegraph 75/100 Watt Output TRANSMITTER

It's a rare pleasure to operate the TEMCO 75 GA for it is engineered and designed to combine into one cabinet all the conveniences and high performance qualities desired by the most discriminating amateur. When you snap on the switch and go on the air here's what you have at your fingertips — 75 Watts output on Phone — 100 Watts output on CW. Multi-frequency VFO with crystal-like stability. 5 band operation covering 3.5-7-14-21-28 megacycles. Crystal control with front of panel selection for two crystals.

Unusual Operating Simplicity

One dial operation when on crystal frequency control. All controls adjacent meters. Switch controlled built-in antenna relay for Standby-Transmit. Metering of grid and plate currents of the final amplifier and plate current of modulator.

Front panel connection for high impedance crystal or dynamic microphone. Compact construction without sacrificing accessibility for easy servicing. Selected components rated in excess of requirements to afford long trouble-free performance. Craftsmanship of the highest order which has been Temco's distinguishing mark throughout the world.

WITH KEY—MIKE AND ANTENNA YOU'RE ON THE AIR

everything at your fingertips and everything in one cabinet

TEMCO 500 GA 500 Watt Output Telephone & Telegraph TRANSMITTER

Rated Output: 500 watts on both radio telephone and telegraph.

Frequency Range: 3.5—7—14—21—28 m.c. amateur bands (other harmonically related bands within 2 to 30 m.c. can be supplied on special order).

Type of Modulation: High Level Class B.

Modulation Capabilities: 100%.

Emission: A1—A3.

Input Level: From high impedance crystal or dynamic microphone, level of approximately -60 db.

Audio Frequency Response: ± 2 db from 100 to 6000 c.p.s.

Noise Level: -50 db below 100% modulation.

Audio Distortion: Less than 5% at 90% modulation.

Custom Built Quality Throughout

Frequency Control: Variable frequency oscillator or crystal control with positions for two crystals.

Front of Panel Control: VFO dial—IPA tuning dial—PA grid selector switch—PA grid tuning—PA plate tuning—PA variable link control—VFO or crystal selector switch—Exciter band switch—Transmit-standby switch—Phone CW switch—Line Switch—Overload relay reset button.

Metering: IPA grid—IPA plate—PA plate—PA grid—Modulator plate current—Class A driver plate current.

Tube Complement: In addition to the tubes contained in the 75 GA exciter, the tube line-up of the 500 GA is as follows:

Final amplifier and Modulator Section

Type	Function
2-100TH	Push-pull final amplifier
2-100TH	Class B Modulator
2-872A	Final amplifier and modulator power supply
1-5U4	Final amplifier and modulator bias supply

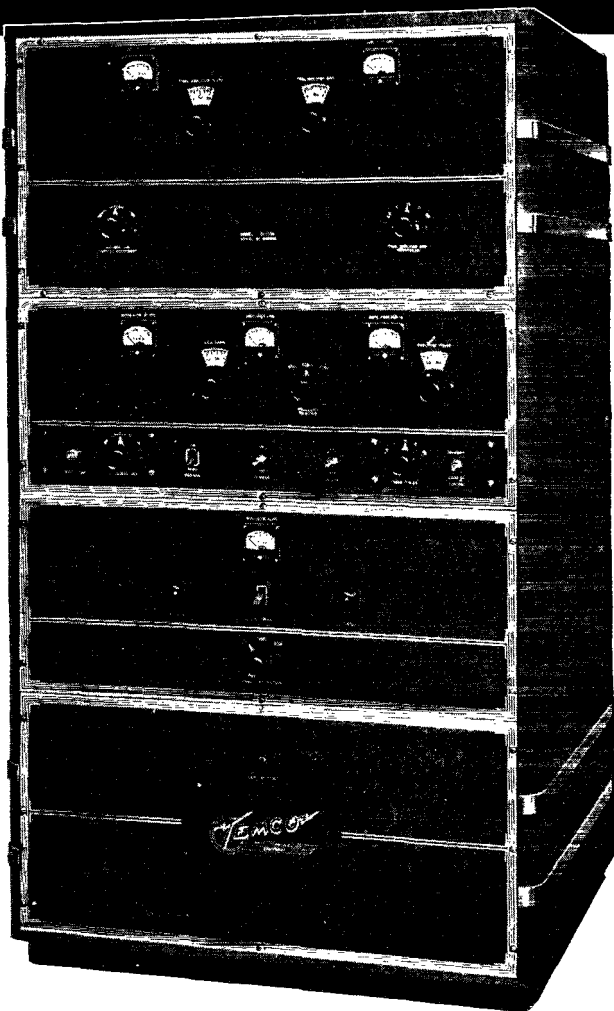

Handsome Enough for the Library

Power Consumption: Approximately 2 KW.

Power Factor: Approximately 90%.

Power Source: 110-115V, 50/60 cycles AC.

Measurements: Approximately 55" high x 31" wide x 24" deep.

Ask Your Dealer for a Demonstration



*everything at your fingertips
and everything in one cabinet*

TRANSMITTER EQUIPMENT MFG. CO., INC.
345 HUDSON STREET • NEW YORK 14, N. Y.



IMMEDIATE ATTENTION

given short order
samples and special
transformer runs!

Power transformers up to 5 KW and audio transformers in a complete range to suit any specification.

Peerless maintains many thousands of specifications on file—many with tooling already set up... thus your transformer development cost can often be reduced through modification of Peerless standard tooling. Call or write

PEERLESS

**ELECTRICAL
PRODUCTS CO.**

6920 McKinley Avenue
Los Angeles 1, California

Send today for
your copy of
FREE CATALOG



(Continued from page 108)

c.w. New officers of the Shy-Wy Club are: 7EUZ, pres.; 7HRM, vice-pres.; 7HDS, secy-treas. 7IPQ gets his rig on 3.9-Mc. 'phone. 6DLR is building a rig for 28 and 144 Mc. and will use an 829 in the final. He is building a superhet for 144 and 50 Mc. 6RIM gets on 3.5-Mc. c.w. with an 812 bottle with about 100 watts input. 7JIO is building an FB rig with an 829 in the final. 9FVO is on the air with an 807 and running about 40 watts. 6TMK, USAC Club transmitter, is an HT-4 running 500 watts on 3.9 Mc. 6CKI, the new OO, is prepared to make frequency checks for the gang. 6UOM is building a converter for 144 Mc. and has plans for a 100-watt job for 144 Mc. using 829s in the final. 9GZA just finished his 144-Mc. rig and has FB QSOs with 6LLH. 6RIZ has a 144-Mc. rig and the three stations have a round robin in a QRM-free band. At present 7HZI is D4AHZ in Germany. Traffic: W4GFC 9, 7DXV 4, 73. Vic.

SOUTHEASTERN DIVISION

ALABAMA—SCM, Lawrence J. Smyth, W4GBV—Asst. SCM, Charles L. Herman, jr., W4APJ. IVC and IQQ are new Montgomery calls. IVC is on 3.5-Mc. c.w. and IQQ plans to be there soon. HEK drops in on the gang at WMPM often. Shades of something or other—ATF threatens to build a modulator. 6ANM/4 is on 3.9 Mc. and looking for all of his W6 friends. DPX, back at WMPM, has a super-duper band-switching rig with push-pull 813s in final under construction. EW is swapping 28-Mc. 'phone for 3.9 Mc. FMW has taken unto himself a wife. IMM has joined the Army. IDZ, busy reconverting to civilian life, now is at WSPA. GOX is shopping around for a receiver. FUM has retired and now lives in Florida. 3GME/4 pounds out on 3.5 Mc. with 250 watts. ECF is very active on 28 Mc. GBV is on c.w. and 'phone regularly. The Muscle Shoals Amateur Radio Club recently was organized. EWR is chairman; KF, vice-chairman, and EVJ, secy-treas. CDC, DAT, EUT, FMR, FZC, GDD, and GOF are members. AUP and GBV were present at the first meeting. The club has made application for affiliation with ARRL and for a club station license. GOX has returned to Washington after a brief visit to Montgomery. Drop us a line, fellers. *Charlie.*

EASTERN FLORIDA—SCM, Robert B. Murphy, W4IP—GVC is doing a very nice job on the Emergency Net. ACZ can be heard doing his stuff on 3910-kc. 'phone and seems to be organizing a good net for emergency 'phone. IP is on 3511-kc. c.w. AYV is hollering for OO and ORS appointments. BYF is getting the crowd together in the Miami area. They are planning on getting on 144 Mc. for car-to-car and some point-to-point work with some of the War Surplus gear. DKA is running a hotbox on 28 Mc. with an 806 and 400 watts. QN is planning an emergency rig to be operated on dry batteries. HRN has nice rig on 3.5 Mc. K6IRS/4 must be planning to stay in Key West as he is getting ready for the storms that may blow in that direction. 5DFZ/4 and EFH are doing some nice QSO on 28 Mc. ASR will be signed up as EC for Volusia County soon. It looks as though QN will be EC of Orange County. GVC says new-comers to Orlando are 2KXM and 2MOF, both on 28 Mc. CLW, QW, BJC, GVC, IJM, and HGO are on the air with ex-Russian tank gear. The Miami gang is using the ARC/4 Navy high-frequency set for 144 Mc., crystal-controlled, and a spot net is being set up. QN and IIX are competing for QSLs from "furriners." They have over fifty contacts to date. ISR is setting up an emergency rig. DQW is getting into traffic handling. The Dade Radio Club elected new officers; BYF pres.; FVW, vice-pres.; NB, secy.; and Mrs. BYF, treas. BYS, formerly of West Palm Beach, is working at WSV, Savannah, Ga., in the traffic department. After 9½ years at sea he decided to settle down at home. Seven years of his sea time was spent on the SS *Tulsa*. He hopes to be back on the 7-Mc. band before long if things open up. You Florida boys keep an eye open for him. Station address will be Box 77, Pooler, Ga. Traffic: W4BYF 13, DQW 8, 73. *Merf.*

WESTERN FLORIDA—SCM, Lt. Comdr. Edward J. Collins, W4MS—KB's death was a great blow to the section. GAA is on 28 Mc. with HT-9 and HQ-129-X. 9SAA/4 is on 28 Mc. HHX is active on 3.9 and 28 Mc. with HT-4 and HQ-129-X. GQN needs antenna space. LT keeps Panama City on the map with his FB rig. IPV has moved back to Georgia. AXP is getting stage after stage added to transmitter. 3IHC/4 is improving his Spanish with South American QSOs. EGN is our big DX boy. DAO is president of Pensacola's new radio club. BKQ is getting his 250THs ready. HIZ is rebuilding the rig into FB cabinet. JV gets a

(Continued on page 114)

VALUES *You May Never See Again*

Surplus Specials — selected by the Radio Shack and priced to give you more for your money. Don't miss this money-saving opportunity.

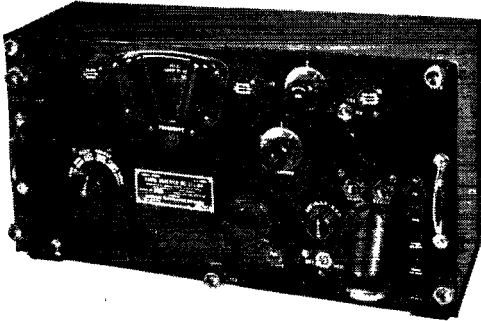

Signal Corps Communications Receivers
BC-342-N (110 v. a-c) BC-312-HX (24 v. d-c)

Built to guarantee communication when lives depend on it, these receivers will give you *results* in either fixed station or mobile operation. High sensitivity — extreme stability — remarkable "re-setability" — these are outstanding features of these "built to take it" receivers. Continuous coverage 1500 to 18,000 kc in 6 bands; frequency-calibrated dial; antenna compensator; xtal filter and phasing control; send-receive relay; 250 and 4000 ohm output; sturdy and compact; smooth operating on phone and CW; BC-342-N has built-in 110 volt a-c supply; BC-312-NX has built-in 24-volt d-c dynamotor. **ORDER TODAY!**

BC-342-N . . . \$64.50 BC-312-HX . . . \$59.50

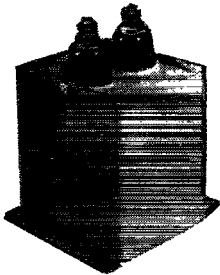

**G. E. Pyranol
 Xmtg Capacitor**

4000 volts d-c
 2 microfarads

only \$5.95 each

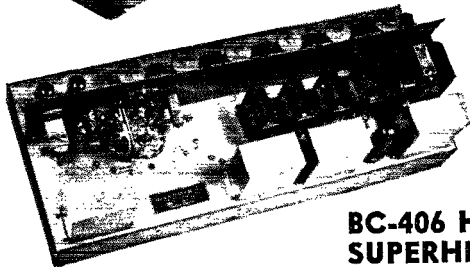

**BC-406 HF
 SUPERHET**

Fully described in our ad. QST July. We have a few more of these 15-tube receivers.

**Genuine EIMAC VT-127A
 HF TRIODE**

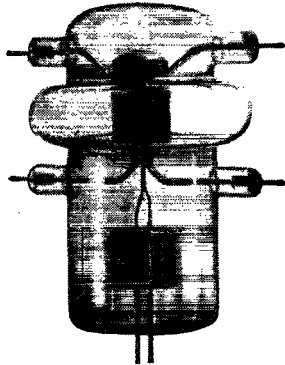

**ONLY
 \$3.50
 EACH**

Balanced grid and plate structure makes this tube ideal for Class C and long-line oscillator service; can be used in any oscillator circuit — amateur or industrial. Electrically equivalent to 100TL (see ARRL handbook for ratings) and can be used up to 300 mc at full rating; 70 watts (prox) is ample drive for 800 watts input; a pair of these tubes will "loaf" along at a full kilowatt input. **BRAND NEW * FACTORY SEALED * SIGNAL CORPS INSPECTED * AN AMAZING VALUE * ORDER NOW ***

G. E. Type 211

Brand new, first quality tubes. First come — first served! Only **\$4.95 each**

Our Surplus Division — now in operation — has thousands of **VALUES** in condensers, tubes, transformers, receivers — and all sorts of gimmicks and gadgets. Send for free bulletin 8-S. And pay us a visit — everything on display for easy choice.

The **RADIO
 SHACK**

**167 WASHINGTON ST.
 BOSTON, MASS., U.S.A.**

ALL MAIL ORDERS FILLED PROMPTLY

ONLY \$150
Postpaid in U.S.A.

Our Engineering Department
is available
for consultation
on any
commercial crystal problem.
Write us!

(Continued from page 112)

power leak and lots of DX. We regret the death of FHQ's father. VR was heard on 3.5-Mc. c.w. Yerby finally received his call, IVY. ECT-FJR will really go when 7 Mc. opens. HJA has the finest transmitter in Pensy. CNK keeps nice schedules on 3.5-Mc. c.w. HYB is going back to W6-Land. MS has put 100TLs in final. 73 de MS.

GEORGIA — SCM, Thomas M. Moss, W4HYW — Reactivation of our section nets is under way, and early renewal of prewar ORS and OPS appointments is urged. RM, PAM, ORS, and OPS appointments are being made. Present ORS: VX and HYW (RMs), MA, GXU, and DXI. OPS: FWD and HYW (PAMs), DXI and FDX. Look for BIW, BPT, IPF, and BOL with mobile rigs. 2PAF, 5GRF, and AAY have returned to civilian life. MJ is at Ft. Jackson. HDM, HKQ, IEO, IRA, 2PAF, FZE, and 9BMC are students at Ga. Tech. DYH, of Ga. Tech., is chairman, Atlanta Section. IRE. BCR is radio instructor at Tech. Hi (YC). Other YC operators are IRT and HAH. IDY is with FCC. New ECs: AAY, Richmond; RD, Jefferson; GKQ, Screven; FCC, Polk; GQR, Bartow; HKA, Dougherty; HYN, Troup; and HBE, Coweta. Goal of the Emergency Corps is "a station in every community and a Coördinator in every county." Is your community represented? IEN is in Cuba with CAA, IPF, CMA, EFS, CNV, and 8SYW are with wholesale houses in Atlanta. 3GXS, with FCC at Savannah, is transferred to K4. IDF is moving to Savannah and ADF to Thomasville. 9GZR is to return to Missouri. GWI goes to Cincinnati. We need additional OOs for 'phone and c.w. Inquiries are invited. The Savannah club is making progress in Emergency Corps work. The club turned out seven new hams recently. The boys are active on 28 Mc., both stationary and mobile. Several have two-way units in their cars with FB results. Best of luck in the Code Proficiency Program. Traffic: W4HYW 12, GXU 4.73. Tom.

WEST INDIES — Acting SCM, Everett Mayer, K4KD — The following new KP calls have been received: KP4AE, ex-K4EVC; KP4AG, ex-K4GGG; KP4AJ, ex-W3ICS; KP4AK, ex-W4IKC; KP4AM, ex-W3HUN; KP4AO, ex-K4DTH; KP4AU, ex-W5EVN; KP4AV, ex-K4FSP; KP4AX, ex-K4ENT; KP4AZ, ex-W4FAY; KP4RJ, ex-K4RJ. New calls: KP4AF, KP4AP, and KP4AQ. KP4AM has fourteen countries on 'phone and probably is first KP4 to operate portable, having changed QTH subsequent to application and prior to receipt of new license. KP4AZ went to town with new call, worked thirteen countries and twelve states and made WAC in two days. Installed new plumber's delight beam which is working out FB. Poor conditions have K4HEB's schedule with W3IMU stymied. W4DYX/K4 is silent waiting for KP4 call. W4BZA/K4 continues to work out FB with HT-4. The board of directors of the inactive Puerto Rico Amateur Radio Club held a meeting at K4KD's home and made plans to reactivate. 73. Ev.

SOUTHWESTERN DIVISION

LOS ANGELES — SCM, Ben W. Onstenk, W6QWZ — The Southeast Radio Club transmits code practice nightly at 7:30 p.m. on 3605 kc. SMK is OBS in the Los Angeles area on 28- and 3.9-Mc. 'phone. OPS appointees are: IWU, BUK. ORS appointees include UYP, OJW, AAE, and UFJ. DFO is doing OO work in Huntington Park. KTY is OBS in South Gate. The new meeting place of the Inglewood Club is the Inglewood Women's Club at Hillcrest and Redondo Blvds. RNN reports that the Inglewood Club has a BCI committee in operation. Club attendance is running consistently over eighty. The Citrus Belt Amateur Radio Club has a net going on 28.24 Mc. Wednesdays at 8:00 p.m. It is called the C-BAR-C net. CUT, SEY, QI, UZL, QQP, 4EJQ, UKX, and HDY, as control, formed the net to begin with and plans are to move up to 50 Mc. The Foothill Radio Club still meets the second Thursday of the month in the YMCA Bldg., Covina. ON reports that EBK won the code contest held at the last meeting. LGO is president of the reactivated Tri-County Club, which meets on the second Wednesday in the Pomona Boy Scout Headquarters. The San Fernando Valley Club, with MEP as president, has an attendance of over 125. The Pasadena Short Wave Club elected OGM, pres.; NBF, secy-treas.; KWC, vice-pres. RBH reports that the Glendale Radio Club has decided to withdraw its previous application to hold the convention and in its place plans to have a one-day barbecue. The Mike and Key Club would like it to be known that its receivers are crystal-controlled on 51.84 Mc. and calls cannot be heard on other frequencies. The club

(Continued on page 116)

GET THESE

NEW NATIONALS NOW!

at the RADIO SHACK



HRO-5TA-1

This latest version of your old favorite HRO has all the familiar features PLUS new ANL circuits that make it even more efficient in pulling in those QSL's. For the ham who appreciates high quality in radio gear — with truly professional performance — the HRO-5TA-1 is the receiver.



NC-46

And here's another brand new National that is sure to gain wide acceptance among discriminating amateurs. New, modern styling adds beauty to ease of handling—while National-engineered circuits assure the sensitivity, stability, and dependability that mean consistent, day-in-and-day-out satisfaction.

TIME PAYMENT SCHEDULES

	Net Cash	1/3 down
HRO-5TA1	\$274.35	\$92.35
NC-46	\$107.40	\$36.40

	6 monthly payments	9 monthly payments	12 monthly payments
	\$31.24 ea.	\$21.13 ea.	\$16.07 ea.
	\$12.67 ea.	\$ 8.60 ea.	\$ 6.62 ea.

And all these Standard Receivers!

- NATIONAL
 - NC-2-40-C \$225.00
 - NC-1-10 56.10
 - HAMMARLUND
 - HQ-129-X complete 139.50
 - New Super-Pro's
 - SPC-400-SX 310.05
 - SPR-400-SX (Rack Model) 320.55
 - SPC-400-X 334.05
 - SPR-400-X (Rack Model) 344.55
 - Speaker, in Cabinet 18.45
 - R. M. E.
 - RME-45 complete 186.00
 - HALLICRAFTERS
 - S-22R Skyrider Marine 74.50
 - S-36A VHF FM-AM 307.00
 - S-38 39.50
 - S-39 Sky Ranger 110.00
 - S-40 Complete 79.50
 - S-41G Complete 33.50
 - SX-25 Super Defiant 109.50
 - SX-28A Super Skyrider 238.00
- All prices net FOB Boston

Both of these new receivers can well be classed "Worth waiting for" — and you needn't wait any longer because you can get them *right now* at the Radio Shack—cash down, or choice of three time schedules!

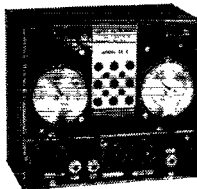

ABBOTT TR-4

The best-known rig for 2-meter use; immediate delivery from the Radio Shack.

Net price \$43.00
Kit of tubes \$8.30

All Mail Orders Filled Promptly!

The RADIO SHACK

★ 167 WASHINGTON ST. ★
BOSTON, MASS., U.S.A. ★

COMING SOON! A new Radio Shack Catalog 49-A. Register now—we'll send your FREE COPY when available

At Last! Practical F-M For Every Ham!

IMMEDIATE DELIVERY

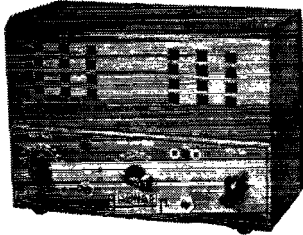

SONAR F-M EXCITER Narrow Band (2-3 kc deviation)

Convenient and economical method for adapting any CW or phone xmttr for 10 meter-F-M transmission.

- Any conventional AM receiver can hear your without distortion
- Eliminates speech amp., modulator, and associated power supplies, saving 60% in building costs
- Eliminates all broadcast interference
- Penetrates QRM
- More output from your final than any other phone xmttr
- Occupies less space in the radio spectrum
- Self contained power supply, 110 v., 60 cycle
- Compact, only 9 5/8" x 7" x 5"

NET, less xtal..... **\$3945**
3.5 MC xtal..... **\$ 2.60**

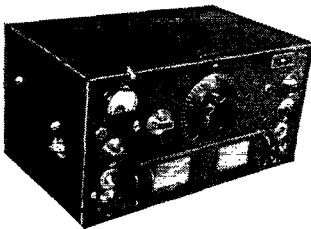

IMMEDIATE DELIVERY

NEW! NATIONAL HRO5TA1

2 RF stages. High degree of operating stability. Supplied with 4 sets of coils covering the frequencies of 1.7 to 30.0 MC. Each coil set covers two amateur bands and the spectrum in between. By a simple change-over operation, the amateur band at the high frequency end of each range may be expanded to occupy approximately 400 of the 500 divisions of the instrument type PW main tuning dial. Latest type tubes used.

NET, WITH POWER SUPPLY AND SPEAKER **\$30300**

SUN RADIO

& ELECTRONICS CO., Inc.

122-124 DUANE ST.

NEW YORK 7, N. Y.
BARCLAY 7-1840

(Continued from page 114)

is using MBF's for its AEC net. KEY spoke on 8-cm. radio-telephone before the Long Beach club. BOB is starting the 400-Mc. Club in Redondo Beach. VIX, VDE, and TJZ attended the first meeting. MLA writes of the Munich Radio Club, D4AIE; all the members are of the 65th ACCS. AAE has p.p. 807 on 3.5-Mc. c.w. OJW is on 3790 kc. in Dixon and is looking for traffic schedules. UYP, in Redlands, is now ex-9VWY. CV is back and is going to handle AEC in Redlands. HJP has p.p. 35Ts on 3.5 and 28 Mc. running 300 watts c.w. TCG is out of the Navy. QIL is back in as AETM1c. AM had a cable from QZG, in Bahia, Brazil, saying 3.5-Mc. 'phone signals were outstanding there. FMO has a regular schedule with 4DSA on 28 Mc.; FMO uses 2 watts. This is one place where no news is not good news, so send in your reports, please. Traffic: W6IWU 4, AAE 2. 73. Ben.

ARIZONA — SCM, Gladden Elliott, W6MLL — Arizona hams mourn the passing of Bob Carlson, JFO. First 144-Mc. tests failed to give results. Tests will be held on the first Sunday of each month. SAM (Sunday a.m.) net now is in operation every Sunday a.m. on 75-80 meters for traffic and rag chewing. 3.5-Mc. stations are OAS, UPW, NRI, PDA, KMM, MDD, QWG, TCO, 9QEH/6. The 25 Club of Tucson held its picnic June 2nd on Mt. Lemon. The old 56-Mc. gang is getting on 50 Mc. QAP, in Tucson, worked OVK in San Francisco on 50 Mc., first contact for both of them. 50-Mc. stations are QAP, OWX, and PBD. QLZ has an HY75 144-Mc. rig in his car for QSOs while he travels the State. LPV and QPI are portable-mobile and QNC is airborne. PEY has a new Meek transmitter. New calls are 7JKK (Kemmeries), 7PDA, 7SNI, and 7JFT. OZM and his XYL attended the parts show in Chicago. JFW is on 28 Mc. at Sasabe using car radio power supply as he has no a.c. SNI, RLC, and LNJ report best results by calling with horizontal beam and QSO on vertical for 144 Mc. PUM has 500 watts on 28 Mc. Listen for GG Breakfast Club on 3850 kc. in memory of Charles Blalack. OWX is portable-mobile on 50 and 28 Mc. 73. GC.

SAN DIEGO — SCM, Ralph H. Culbertson, W6CHV — DUP left for a month's vacation in Minnesota and has a new 28-Mc. mobile rig in his car. KSE is back on 28 Mc. after moving to new QTH away from BCL trouble. JH is on 3.5-Mc. c.w. with about 30 watts but is having a little trouble with antenna. New calls heard on 28-Mc. 'phone are VJT, VDM, VCD, VJQ, and VEP. 9LLM/6 left San Diego for a month's vacation in the Chicago area. FMJ has schedule every Friday with ELK and is open for traffic to Los Angeles. LKC reports he is very busy working and not operating much but was able to hook a VK9, a boy from Riverside, Calif. He also worked 4FGW/J2, in Yockasuka, Japan, and KA1ABD, in Manila. Received a card from OJW, of Dixon, who is looking for some schedules and traffic on 3.5-Mc. c.w. Anyone interested, please drop him a card at Box 861 or look for him on 3790 kc. OXQ has transferred to the Electronic Lab. KW is with Convair, working as a radio engineer. PAX has a new portable rig on 28 Mc. and is in Los Angeles, where he is going to school. TBI is back on 28-Mc. 'phone with a new rig and an FB four-element beam. EDJ and LAM have combined their efforts and put an FB new rig on 28 Mc. RPJ is sporting a new HQ-129 receiver and now perhaps he can work some DX. EDJ is building a new rig for 50 Mc. and will be on the air some time in July. The May meeting of the Palomar Radio Club was held at Escondido with CLT, BGL, and BOS as hosts and an FB turnout of about fifty. OPS certificate for FMJ and ORS certificate for BAM have been endorsed. Don't forget, fellows, we need more ORS and OPS for this section. Please send in applications so we can build up the San Diego section. Traffic: W6LKC 20, FMJ 4, CHV 4. 73, gang, till next month. Ralph.

WEST GULF DIVISION

NORTHERN TEXAS — SCM, Jack T. Moore, W5ALA — Ex-IA is now 9EHB/1 and would like to arrange schedules on 3.5 Mc. with some of the old AARS gang. Claude's present QTH is 51 Hillhouse Ave., New Haven, Conn. JAD sends the following on Pampa-Phillips activity: On April 5th, the following hams met and organized a club: JHA, JZB, IZW, IWQ, HVP, HCR, JJQ, JAD. JJQ is president and JAD, secretary-treasurer. HVP is doing OK with a vertical until he can get his beam up. SH now has an HT-4 and a DB-20. JJT is increasing power. ALA had a visit from 4HKJ. ECE renewed OBS, PAM, and OPS appointments, and reports that IKI is the only other active

(Continued on page 118)



for Modern **REMOTE** Broadcasting..

YOU'RE RIGHT ON THE SPOT WITH
GATES FOR THOSE SPECIAL EVENTS!

For showmanship, efficiency, portability and compactness, these GATES Units forearm you for dependable broadcasting from right on the spot, where you must move fast, for those special events programs. They're the keynote in your success.

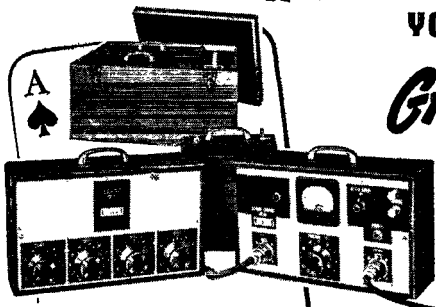

The **NEW FOURSOME**
REMOTE
AMPLIFIER

Completely assembles in rugged, handy Carrying Case as shown.

A new development, and one that is bidding strongly for first place in popularity with the Dynamote is the new Foursome. It consists of three major units, a 4-channel Mixer, Amplifier and Power Supply that all fit into a trim, sturdy carrying case. The Mixer has two stages of amplification whose output plugs into the amplifier unit. On remotes where the four mixer feature is not required, just take the amplifier and power supply. A standard Cannon microphone plug fits the same receptacle as is used for the Joiner cable. The Foursome can be used for any job—large or small. Size: Mixer and Amplifier each approximately 12 in. long, 7 in. high, 4 in. wide.

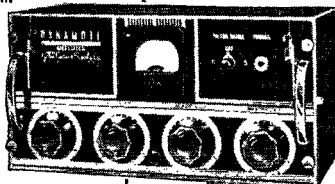

The **DYNAMOTE**
REMOTE
AMPLIFIER

This is the most popular Unit in the line of Remote units. It is a 4-stage high gain Unit containing the mixing system, VU meter and all other circuits associated with the amplifying circuit. The front panel is so designed to make it adaptable to any operating condition. Both the amplifier and power unit supply fit into the airplane type carrying case that is weather resistant and ruggedly built to withstand hard usage. Compactness is its keynote. Size 14½ in. long; 7 in. high, 8 in. deep.

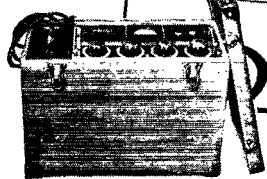

Dynamote and Power Supply in Carrying Case

The **REMOTE**
CONDITIONER



This Unit is a 3-stage Amplifier complete with power supply housed in one cabinet.

This in itself is an accomplishment in high quality in remote amplifier design, and is the result of diligent research and experimentation. Its operation is extremely simple. The only controls are the on-and-off switch and the gain control. Compact and easily portable. Size 17 in. long, 7 in. high, 4 in. deep.

LOOK TO GATES FOR LEADERSHIP

NEW YORK OFFICE:
9th Floor
40 Exchange Place

GATES

RADIO CO.
QUINCY, ILL.

SOLD IN CANADA by:
Canadian
Marconi Co., Ltd.
Montreal

EXCLUSIVE MANUFACTURERS OF RADIO TRANSMITTING EQUIPMENT... SINCE 1922

Try Walter Ashe for fast delivery of

● Test Equipment

195 RCA Voltohmmist, newest model....	\$57.50
Robson-Burgess MT 100, VOM.....	18.75
Robson-Burgess MT 200, VOM.....	22.95
Triplett 666-H.....	20.00
Triplett 625-N.....	45.00
Silver Vomag, VTVM.....	59.85
Simpson 260.....	33.25
Simpson 240, new Ham model.....	26.40

● Receivers

Hammarlund HQ 129-X with Speaker..	\$173.25
RME 45 with Cal-O-Matic Dial and Speaker.....	186.00
Hallcrafters S-40.....	79.50
Hallcrafters S-38.....	39.50
National HRO 5TA, 1.7 mc to 30 mc with Band Spreader and Noise Limiter, less Speaker and Power Supply.....	274.35
Speaker, type MCS.....	12.00
Power Supply, type 697.....	20.36
National NC 240-D, new amateur model, complete.....	241.44

GENEROUS TRADE-IN ALLOWANCES

We Stock Thousands of Items. Send In Your Order.

● Hot Specials

750-0-750 @ .3 Amp. Plate Transformer, made by Thordarson for Western Electric. Excellent for 807's, T-20's, 6L6's. **\$6.50**

Amertran Plate Transformer, rated at 2KVA. Primary 104/110/115, 60 cycle. Secondary 6200 V. ct. Freight prepaid anywhere in Continental U. S. A.... **\$39.95**

AMERTRAN PRIMARY CONTROLS

To Adjust Your Input Voltage!

Primary from 95 to 130 V. at 9½ Amps. Type 32415 at.....	\$14.95
Primary from 102 to 128 V. at 16 Amps. Type 31970 at.....	\$17.95

Xtal Adapter for using new type holder in old sockets..... **\$.35**

Another ASHE "Hit!"

4 mfd. 2500 V. GE Pyranol Condensers, new stock..... **\$3.75**

GET ON OUR MAILING LIST

W8LDO W9QDF W9ZIP W8BYD W9ULH W9GTF

WALTER ASHE RADIO CO.
1125 PINE STREET ST. LOUIS 1, MO

(Continued from page 116)

station in Ranget. HZB says that he and HYE, HTIH, JLK, KXL, and FED live in the same dormitory at Texas A. & M. Jack also reports that he has a new Signal Shifter. FRE has a new HQ-129-X, and HYE is having BCL trouble. FAO would like to see 'phone allowed on the lower half of 7 Mc. GJG has returned to KGNC. AJ recently visited Galapagos Islands and Peru. Pronto also visited 8MTP/marine, who is using an HT-6, and called OA4I in Lima. AJ says that KZ5AA and KZ5AW are on the air. The SCM was proud of his HT-9 until he worked 9WKN, who is using an HT-9 as an exciter! DLC is on 28 Mc. with an NTX-30 and a new HQ-129X. KI and DMR are working lots of DX on 28-Mc. 'phone with serious competition from FRD, CVW, KL, and JSS, of Ft. Worth. The Dallas Amateur Radio Club liked the Board action and looks forward to the FCC orders opening more frequencies.

OKLAHOMA — SCM, Ed Oldfield, W5AYL — The OCARC really is "buzzing" on the coming West Gulf Division Convention, Sept. 21-22. Your early registration is requested and a very suitable prize will be given in a special preregistration drawing. Plan early to have a good time at the first postwar division convention. AQE reports for the Bartlesville area. 28 Mc. is paramount in this locality with GAE, EST, GTU, and BMK. AQE works c.w. only on 28 Mc. and now that 3.5 Mc. is back, the local organization is being reactivated. HGC, AHT, IFD (Pawhuska), and CYV (Dewey) are operating on 3.5 Mc. IKC is first YL operator in this area. NW, "Soupy," attended meetings of a number of the clubs in the Division, including the OCARC and TARC, in order to get information on the desires of the amateurs in regard to the bands, etc. LMD is newly licensed at Tulsa. INIV now is 6KW1. ERX and ESV have new 28-Mc. four-element beams. 4GYO/5 lost that part of the anatomy called the appendix but now is fully recovered. AXA is on terminal leave and is located in Tulsa. A number of the locals and families had a pro-Field Day picnic at Lake Claremore on May 26th. FFW boasts a new HRO and a 28-Mc. three-element beam. 73. Ed.

SOUTHERN TEXAS — SCM, James B. Rives, W5JC — SREC/5, at Brownsville, received his W5 call and now is LDD. He is an active OBS and desires traffic for K6 and K4. LDD flies with Pan-American and sometimes operates TG9RC and TG9JK while in that area. EWZ is active at Harlingen and reports that 4AZY/5, GAV, and GJM are in the radio service business there. LCU has moved to Harlingen and EMV, ENG, IRF, and BGJ will be on as soon as parts are available. BUV is busy with SEC functions and is on the air consistently. New EC appointees are: KTL, for San Antonio; HQR, for Corpus Christi; and HAQ, for Houston. Let's give them all the cooperation possible. GEL and HIF are active in Corpus Christi with 'phone and c.w. LBQ is a new call in El Paso and has a 6L6 on 28 Mc. ESZ has a new sixty-foot steel tower. EVJ is using a v.h.f. mobile rig in his car. The El Paso Club held a reorganization meeting recently and is all set for lots of activity. 3IVT/5, DDJ, and ZG, in Galveston, report activity on a new relay net operating on 3865 kc., which includes HGG, in Houston; GEL, Corpus Christi; HBQ, San Antonio; CUQ, Austin; and BD, Angleton. FNH has a new shack and is building a wooden tower for his latest model rotary beam at Kerrville. He reports FNX, AKF, and BSF are active. DSH has a new Toler beam at Legion. 73. Jim.

NEW MEXICO — SCM, J. G. Hancock, W5HIF — KWR, Francis Gormley (LSPH), and KWP, Clarence Fields (LSPH), are new stations in Santa Fe. 9NGL is active on 28- and 3.5-Mc. c.w. and 'phone from Portales and hopes to get a W5 call to use while finishing his stretch as a professional soldier. Sam has only five years to go. 2JXH stopped by to visit this SCM on his way to Arizona. 2OYE also paid a visit on his way home to New York City from his separation center at Ft. Bliss, Texas; he was making the trip by motorcycle. DER has completed the overhaul job on the SCM's rig and HJF now boasts 375 watts 'phone and 450 watts c.w. on all bands with a pair of T55s. Quite a few fellows around this section are heard on the air but no reports are received. Whatsa matter, gang, let's get those cards in. 73. Jake.

CANADA MARITIME DIVISION

MARITIME — SCM, A. M. Crowell, VE1DQ — The HARC has made application to hold an Official ARRL Maritime Division Convention at the Nova Scotian Hotel, Halifax, on Aug. 31-Sept. 1-2. Preparations now in
(Continued on page 120)



RME Owners Say!

Registration Card

YOUR RME 45 SERIAL GG122A IS GUARANTEED

A complete and accurate laboratory test record is on file in our office denoting the various measurements made on this instrument. It left our shop only after having been tested carefully. Please fill out and mail this card at once so that we can assist you in any problems that may arise regarding it and so that we can identify it for you if lost or stolen. (Please print.)

Unit Purchased From CHI-RAD On 5-1-46
(Distributor) (Jobber) (Date)

Your Name THEO S. NIOSKOWICZ Call W9EHS

Street 4522 N. SPALDING AV.

City CHICAGO 25 State ILL

We invite you to write to us at any time regarding your RME. When writing, be sure to give us the serial number.

Boy WAT A RCVR - WOW.

RADIO MFG. ENGINEERS, INC.
Peoria, Ill.

Registration Card

MA. 29 1948

YOUR RME 45 SERIAL EG26 IS GUARANTEED

A complete and accurate laboratory test record is on file in our office denoting the various measurements made on this instrument. It left our shop only after having been tested carefully. Please fill out and mail this card at once so that we can assist you in any problems that may arise regarding it and so that we can identify it for you if lost or stolen. (Please print.)

Unit Purchased From TYDINGS COMPANY On 4-3-46
(Distributor) (Jobber) (Date)

Your Name RUSSELL ANDERSON Call NONE YET

Street MORTIMER AVE EXT, RD. 3-B-289 JUST A LISTENER
HOPE TO HAVE ONE SOON

City TURTLE CREEK State PENNA

We invite you to write to us at any time regarding your RME. When writing, be sure to give us the serial number.

DO YOU BUILD Q.M.T.R.S. IF SO PLEASE SEND DETAILS. (OR CATALOG) (THIS RME IS REALLY WONDERFUL)

RADIO MFG. ENGINEERS, INC.
Peoria, Ill.



FINE COMMUNICATIONS EQUIPMENT

RADIO MFG. ENGINEERS, INC.

Peoria 6, Illinois U. S. A.

**AARON LIPPMAN HAS
IN STOCK at all Times
RADIO PARTS and
ELECTRONIC COMPONENTS**

produced by the leading manufacturers in America today; namely

CARDWELL	NATIONAL
HAMMARLUND	PAR-METAL
I.R.C.	R.C.A.
KENYON	STANCOR
P. R. MALLORY	THORDARSON
MILLEN	U.T.C.

AND OTHERS

Quantities are still limited in many items but we will endeavor to fulfill as many orders as we receive, promptly.

Here are just a few values!

SIGNAL CORPS KEY.....J-38

3/8" Contact; shorting arm; beveled bakelite base; rugged construction. Special..... **95¢**

TWO NEW BRENTWOOD AMPLIFIERS

MODEL K-14. Complete with 6 tubes. Power output 10 watts. Complete price... **\$34.50**

MODEL K-25. Complete with 6 tubes. Power output 20 watts. Complete price... **\$43.50**

New NATIONAL NC46 RECEIVER

Now available. Frequency range 540 Kc. to 30 Mcs. in 4 bands. A really good Ham Receiver at a very moderate price.

\$97.50 net (Speaker \$9.90 net)

Special Value in
OIL FILLED TRANSMITTING CONDENSER

Type TJL 6060—6MFD5. 600 Volts

Special Price **\$1.45**

We are Radio Parts Jobbers of all standard nationally known brands of merchandise especially adapted to "Hams" and Shortwave listeners. We welcome your mail order trade.

PUT YOUR NAME ON OUR MAILING LIST

Send your name and address on post card and receive all our announcements of special bargains and available new items from time to time.

AARON LIPPMAN
and COMPANY

246 Central Ave. Newark 4, N. J.
Mitchell 2-3065-6-7

(Continued from page 118)

progress point to a most outstanding success, and include the mailing of circular letters to all hams in the division. Keep those dates open for your division convention and make your reservations early. Full dope will be mailed you by the time you read this. Field Day preparations were headed by HJ and DB, and the club station, FO, was well represented. Two separate groups were in action. Local activity has been mostly on 3.9 Mc. with 28 Mc. suffering the usual "dead" periods. Still active on 28 Mc. are EP, DB, QG, VB, HO, and QZ. On 3.9 Mc. are EY, HJ, PV, CW, KJ, DW, BH, BW, MA, EO, EK, LH, and DZ. MZ recently made some nice contacts with VO on his 3.9-Mc. 'phone. ET waits for new mod. transformer. Wanted: One receiver — DQ. Dope on the P.E.I. boys was received via CW, who is active on 3.5 Mc. Ex-AF has been assigned new call, RG. BD is on 28 Mc. with a pair of T40s in final. CO has been busy grinding crystals. Traffic: VE1EY 9, HJ 6, PV 4. "CU at the HAMFEST." Art.

QUEBEC DIVISION

QUEBEC — SCM, L. G. Morris, VE2CO — Congrats to ex-3AKO, who was married recently. BR resigned as MARC treasurer and SM was elected to fill the position. Club publicity is handled by TH, who is on the announcing staff of CJAD, while entertainment is in charge of GE. CS and GA are active in Wrightville, and BN is back on at St. Eustache. CD and KH have f.m. rigs going on 50 Mc. DR and GE are building homes at Pointe Claire. Both boys must be planning on beams, for their lots are each 250 feet long! Many of the gang will be interested to know that ex-2EE has accepted a position in Edmonton and will likely be heard from there before long. Best of luck to you, Stan, and let's hear your new call. Recently returned on 3.5 Mc. is DX with FB 'phone signal. DR and LC enjoyed an FB QSO with 3BDX, ex-2JK. Congrats to BN on being the oldest VE ham; we wish you many more years of ham radio. Pop, II, formerly of Sherbrooke, now is in Montreal. Welcome to the fair city, Sarge. Now that the 3.5-Mc. band is open, let's hear from you traffic hounds. Contact Bill Stephen, LC, at 1175 Union Avenue, Montreal, phone Plateau 9442. Let's have some applications for appointment as RM, ORS, OO, OBS, etc. This report is compiled by LC, now on c.w. 3581 kc. Traffic: VE2DR 14.

VANALTA DIVISION

ALBERTA — SCM, W. W. Butehart, VE6LQ — The NARC staged a Hidden Transmitter Hunt on May 24th. JP has new SX-28A. BV ferried Taylorcraft plane from Winnipeg to Edmonton. HM rebuilt final amplifier and is looking over the new receivers. BW has rebuilt rig back on 3.9-Mc. 'phone, using p.p. 807s at 100 watts input. UP has daily schedule with his brother, PR, at Lacombe. CE uses modulator on small p.a. jobs. AL will visit RME labs while on trip East to ferry back a plane. JG is consistent 3.5-Mc. c.w. station in Edmonton. LA moved his rig to new radio shack in back yard. Power leaks cause LL to lose good QSOs. AO has daily traffic schedule with LQ and 7SC (Kelowna). He has new jr. YL operator at his shack. EO is new QSL Manager for VE8, and is also D.C.M. under new CAROA set-up. 5DW (ex-4ADW) works 3.9-Mc. 'phone from Saskatoon after midnight. EA won first prize in photographic contest sponsored by Edmonton Ciné Club. DV has freak antenna for 3.9 Mc. using "clothesline reflector"! AC worked home station from 7XQ. LL's new QTH is Grimshaw. UT got first HQ-129 delivered in Edmonton. JJ phoned HQ long distance to tell him 8AJ (Bill's son) wanted QSO. Traffic: VE6AO 32, LQ 28.

PRAIRIE DIVISION

MANITOBA — SCM, A. W. Morley, VE4AM — Another month with no traffic reports. This section is hitting an all-time low. Report your traffic. Several new calls appeared on 3.5 Mc. during last month. Ex-5CV is now 4CV, ex-6EU is now 4DM. Brand-new hams include BN, BC, FW, and JG. Welcome, fellows. Neepawa had KD on. MM, at Portage, rebuilt. AN is busy with new house. QV works c.w. for a change. KF uses both on all bands. WF was heard on 3.9-Mc. 'phone. Several prominent hams have left Winnipeg for eastern points. SO was transferred to Moncton and SR to Montreal. AO, the 5-meter king, also left for Montreal. Visitors to Winnipeg included 6NT, 3AZA, and W3GNU, who is working portable at Gimli. The WARC held its first banquet. What a night! Several recordings of various fellows, made by WH, were played back and many of the boys and their XYLs had very red faces. Plans are well under way for a picnic to be held soon. Send some news from Dauphin and Flin Flon, please. Art.



Now!

**RESISTANCE RANGES RIGHT AT YOUR FINGERTIPS
EASY TO TELL AT A GLANCE!**

**NEW...
HANDY...
QUICK...
ACCURATE...**

HERE'S SOMETHING NEW—The RESIST-O-GUIDE, a practical aid in resistor range identification for every Radio Serviceman, Ham, Electrical Designer and Electronic Engineer.

To use the pocket size RESIST-O-GUIDE simply turn its three wheels to correspond with the color code on any composition-type resistor—the standard RMA range is automatically and accurately indicated. Readings are direct... no cumbersome calculations! Or, turn the wheels to indicate any desired standard range, and you are immediately shown the correct color coding.

The RESIST-O-GUIDE is convenient and accurate—and varnished for durability. To get the RESIST-O-GUIDE contact your IRC distributor—it's not sold elsewhere.

THE
Resist-O-Guide
10c at all IRC Distributors



INTERNATIONAL RESISTANCE CO.

401 N. BROAD ST., PHILADELPHIA 8, PA.

Canadian Licensee: International Resistance Co., Ltd., Toronto

TERMINAL OFFERS YOU MORE IN QUALITY — VALUE — SERVICE

Once you try Terminal, you'll agree that Terminal is your best bet for the best in radio equipment! Whether it's a new communications receiver or a bargain surplus part, you can be sure the quality has been ascertained by our own discriminating ham purchasing men!

HEADQUARTERS
FOR THE BEST
AMATEUR RADIO
EQUIPMENT

BARKER & WILLIAMSON TRANSMITTING COILS

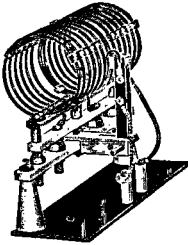

TYPE BVL—150 W. Input

Band	Type	Net
5	5BVL	\$1.93
10	10BVL	1.93
15	15BVL	2.00
20	20BVL	2.00
40	40BVL	2.28
80	80BVL	2.61

Base Assembly and Swinging Link for BVL Inductors.

Net.....\$3.44

TYPE TVL—500 W. Input

Band	Type	Net
10	10TVL	\$2.20
15	15TVL	2.28
20	20TVL	2.28
40	40TVL	2.61
80	80TVL	2.96

Base Assembly and Swinging Link for TVL Inductors.

Net.....\$5.50

TYPE HDVL—1000 W. In.

Band	Type	Net
10	10HDVL	\$4.48
15	15HDVL	5.16
20	20HDVL	5.16
40	40HDVL	5.50
80	80HDVL	6.19

Base Assembly and Swinging Link for HDVL Inductors.

Net.....\$6.88

All B & W Inductors and Tank Condensers in stock! Write for complete B & W catalog!

KENYON UNIVERSAL MODULATION TRANSFORMERS

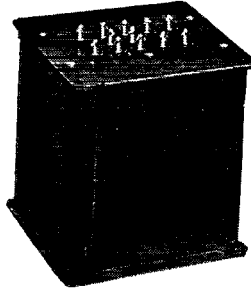

Type No.	Audio Watts	Net Price
T-489	15	\$ 4.03
T-493	40	5.88
T-494	75	8.82
T-495	125	19.46
T-496	300	29.55

Will match any Class B tube or tubes to any Class C load!

MILLEN EXCITER

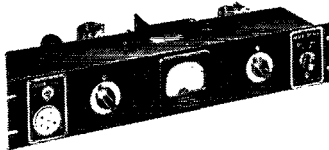

50 WATT TRANSMITTER

Based on an original Handbook design, this flexible unit is ideal for either low power amateur band transmitter use or as an exciter for high power PA stages. Model 90800, less tubes.. \$37.50



MILLEN'S NEW COIL FORM ASSEMBLY

Shielded plug-in type, permeability tuned. 1/2" form, suitable up to 35 mc.

No. 74001. Net \$1.85

We carry all Millen products

LOW LOSS STEATITE SOCKET

for 829 and 832 tubes.

Complete with aluminum base shield. Net.....75¢



NEW TRANSMITTING TUBES—IN STOCK!

UNITED

812-H 6.3 V fil. Net \$5.90

V-70-D 7.5 V fil. Net \$5.90

EIMAC

4-125A Net \$25.00
4-250A Net 36.00

CARDWELL V.H.F. KIT

All parts and special fittings, including 3 sets of coils covering 144-148 mc., 220-225 mc., 420-450 mc. bands. Less 6F4 tube.

Your cost.....\$10.80



IN34—SYLVANIA'S

Versatile CRYSTAL DIODE

Brand new! Now available!

Your cost, only.....\$1.80

IN STOCK! NEW!

SONAR F-M EXCITER

NARROW BAND (2-3 KC Deviation). For use with any CW or Phone Transmitter.

Model XE-10, complete, but less crystal \$39.45

NATIONAL ACN DIALS

IN STOCK—
AGAIN!

ideal for many ham applications. Extra scales furnished free with each dial. Your cost...\$3.00

Other National products in stock!



TERMINAL RADIO CORP.

85 CORTLANDT STREET, NEW YORK 7, N. Y.

PHONE WORTH 2-4415

Amateurs-

A NEW MULTIPLE CRYSTAL UNIT

Specially Designed for
Amateur Use

Multixtal

Multixtal is a wonderful performer, with positive contacts, low capacity, excellent for switching to four different frequencies instantly and accurately. Operates in any position and requires very small space. Will improve the appearance of any transmitter, either in front or behind panel mounting. Frequency range 3000 KC to 9000 KC supplied in any combination. Frequency marked name plate. Fits octal socket.

Type 275-M—Prices will depend on your specifications as to frequencies and tolerance. Contact us or your distributor at once for full information. Please list frequencies.



Type 275-M
Actual Size

 **Crystal**
PRODUCTS COMPANY

MAIN OFFICE 1519 MCGEE STREET
Phone: Victor 1686
KANSAS CITY 8, MISSOURI

Canadian Distributors:
MEASUREMENT ENGINEERING
61 Duke Street
Toronto 1, Canada

SENSATIONAL VALUE *at* RADIO ELECTRIC

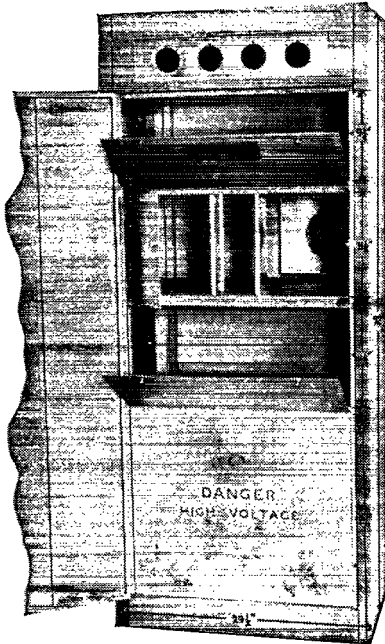

U. S. GOVT. SURPLUS

CABINET only \$79.95

No. 16 gauge steel, gray crackle finish, scratch proof. Ideal for your kilowatt transmitter. SPECS: Height 72" — Depth 24 $\frac{5}{8}$ " — Width 29 $\frac{1}{2}$ ".

- RG—8/U Coaxial Cable, 52 ohms....7c ft.
- BC—224 Receiver. 200–500 KC; 1500–18,000 KC.....\$59.95

Mail Orders Shipped in 24 Hours

SEND FOR FREE FLYER TODAY

RADIO ELECTRIC SERVICE CO. OF PENNSYLVANIA, INC.

N. W. COR. 7th and ARCH STREETS
PHILADELPHIA 6, PA.

CAMDEN, N. J.

ALLENTOWN, PA.
EASTON, PA.

WILMINGTON, DEL.

It Seems to Us

(Continued from page 18)

find it profitable to take the ball as concerns their part of the story. The transmitter part seems to be a typical amateur problem of the sort we should solve ourselves. Some of the requirements seem definitely difficult to satisfy and we'll say frankly that we don't know how to do it. Our readers, we think, will have some ideas of their own. The promised results seem to be worth striving for. We commend the problem to our more enterprising readers as being well worthy of serious exploration.

Edgar

Our Best DX—800 Feet!

(Continued from page 22)

distance of one-half mile because of the lack of sensitivity of one of our i.f. amplifiers. Furthermore, the radiated power was less than 10 milliwatts.

The quality of the speech was good, being typical of the usual carbon-microphone performance. Several QSOs were made at short range to get the equipment adjusted, and the contact at 800 feet lasted for about an hour. The authors plan to make some of the improvements mentioned in the plumbing discussion and thereby substantially increase the range.

About the Authors

● Dr. A. H. Sharbaugh, WINVL/2, and Robert L. Watters, W9SAD/2, both worked on radar countermeasures at the G-E Research Laboratory during the war. They are members of the Schenectady Amateur Radio Assn.

WINVL/2 received his A.B. at Western Reserve University in 1940, and his Ph.D. at Brown University in 1943, where he was awarded the Potter Prize for outstanding research in chemical physics. Dr. Sharbaugh is a member of Sigma Xi, Phi Beta Kappa, and Delta Phi Alpha honorary fraternities. His first call, W8QPT, was issued in 1937. He is a charter member of the Willard (Ohio) Radio Club.

W9SAD/2 is a graduate of the University of Notre Dame, with a B.S.E.E. degree, class of '41. He holds amateur Class A and radiotelephone first-class tickets, and is partial to 'phone operation and general experimentation. At G-E he is engaged in advanced circuit technique development.

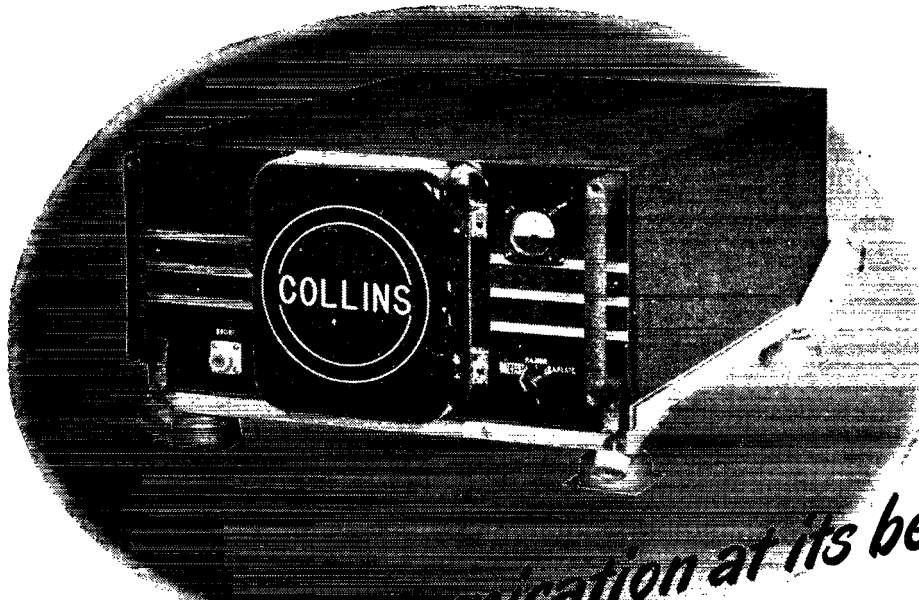

Aircraft communication at its best

THE COLLINS 18S-1 transmitter-receiver is engineered for highest performance in aviation communications. It is specifically designed for commercial airlines and executive aircraft. Reflecting years of experience and proved dependability in the field of aircraft radio, the 18S-1 is new in every respect, and has performed superbly under flight tests.

Ten channels, with twenty crystal controlled frequencies are available for transmission between 2.5—10.0 mc. Power output from the transmitter is more than 100 watts. The receiver is controlled by a separate group of 20 crystals, and does not necessarily operate on the transmitting frequency. Quick, automatic frequency selection is provided, with all circuits tuned and ready to operate. Remote control encourages locating the unit with respect to proper weight distribution within the plane. The 18S-1 works into a 50 ohm transmission line.

A single 1½ ATR unit cabinet contains transmitter, receiver, and dynamotor power supply for the transmitter. The receiver operates directly from the 26.5 volt d-c source. The entire weight, including shock mount, is 60 lbs.

The first group of these equipments is scheduled for delivery to airlines in September of this year. Write today for further information.

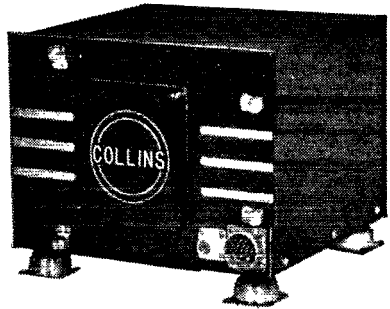

THE 18OK-1 antenna loading unit efficiently transfers the power output from the 18S-1 to any standard commercial fixed antenna. Remote controlled, pretuned operation for ten channels is provided. The nominal input impedance is 50 ohms. Weight, 10 lbs. Size, 7½" h, 10½" d, 12" l.

**COLLINS RADIO COMPANY
CEDAR RAPIDS, IOWA**

11 West 42nd Street
New York 18, N. Y.

458 South Spring Street
Los Angeles 13, California

— IN RADIO COMMUNICATIONS, IT'S... —

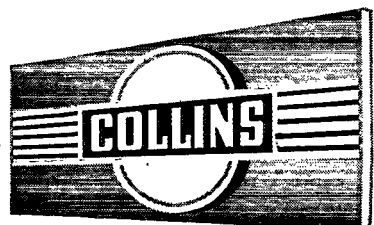

FIRST

FOR THE
GREATEST NAMES
IN
HAM RADIO

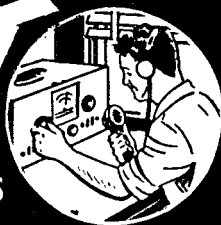

C
A
M
E
R
A
D
I
O



Here they are—the newest Post-War "Ham" Receivers with all the latest improvements in technique and design.

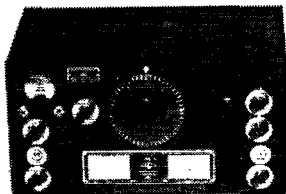

NATIONAL HRO-5TA-1 • Net \$274.35
697 Power Unit \$20.36 • MCS Speaker \$12

A Receiver, designed for the Amateur, to provide dependable communications, under most severe conditions. New Noise Limiter incorporated. Band spread on all "Ham" Bands—Coverage 1.7 to 30 MC.

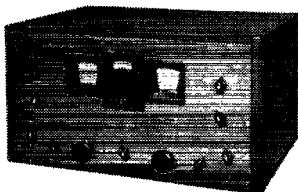

HAMMARLUND HQ-129-X • NET \$173.25
Price Includes Cabinet Speaker

A "Ham" Receiver with the professional touch, providing flexibility of operation. Six bands for easy location of stations. Has all "Ham" features with sensitive and stable performance.

HALLICRAFTER S-40 • Net \$79.50
With Built In Speaker

Performance and beauty are combined in this outstanding Receiver value. Many circuit refinements never before available at this price. Electrical Bandsread Dial—Coverage 540 KC to 43 MC.

HAM RADIO SUPPLIERS SINCE 1919

CAMERADIO CO.

963 LIBERTY AVE. • PITTSBURGH 22, PA.

Unstable Signals

(Continued from page 26)

voltages usually is worth while simply from the consideration that the supply voltage is kept from soaring when the key is open.

Loading effects can be minimized by the use of r.f.-choke coupling between the oscillator and a following stage which is adjusted so that it draws no grid current. This is especially true when the output circuit of the stage is tuned to the second harmonic of the oscillator frequency. Listen to the harmonic at 14 or 28 Mc. while the output circuits of succeeding stages of the transmitter are tuned through resonance. If you can find a stage whose tuning does not affect the oscillator frequency noticeably, key the stage following it if you want to keep chirps to a minimum.

Serious frequency drift in VFO units can be avoided by building the power supply as a separate unit which includes all voltage dividers and voltage-dropping resistors. It is preferable also to have the tube or tubes on the outside of the enclosure, rather than inside a cabinet where the circulation of air is poor. Frequency changes caused by mechanical vibration can most easily be eliminated by mounting the entire unit on sponge rubber or in aircraft shock-mounts.

3-Element Beam

(Continued from page 31)

report and we had a really swell QSO. The second call, a CQ on the following day, was answered by W6SMV/K6 in Oahu. Don gave me an S8-9 report, with the signal staying as solid as a rock throughout a twenty-minute QSO. Since then I have worked several European and Latin American stations, all with R8 reports or better, using 110-watts input to the final stage.

About the Author

Charles E. Nichols, jr., W1MRK, has as his main ambition in life the working of 144 Mc. portable-mobile from the cab of his locomotive on the Boston & Albany R. R., where he works as a fireman. He is an ex-Marine (1928-1932), serving in the West Indies. During World War II he was connected with the underwater sound division of the Submarine Signal Co., Boston. Licensed in 1939, W1MRK is a confirmed rag-chewer, and ex-treasurer of the Waltham Amateur Radio Assn. & Newton Amateur Radio Assn.

SWITCH TO SAFETY!



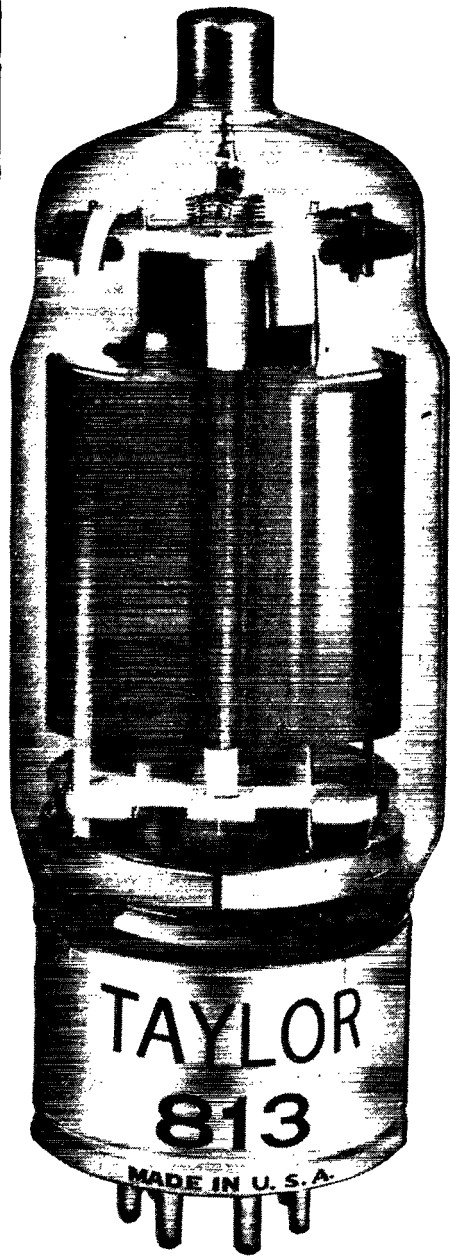

*"More Watts
Per Dollar"*

THE POPULAR

TAYLOR 813

NOW

\$14⁵⁰

**360 Watts Input with
less than 1 Watt Drive**

Use these brand new post-war **Guaranteed** 813's in that easy-to-drive, quick band-change rig you are planning.

NEW PRICES

866 Jr.....	\$1.25
866A.....	1.75
T-20—TZ-20.....	2.75
T-40—TZ-40.....	3.95
T-55.....	6.50
203Z.....	9.00
805.....	10.00
810.....	12.50

AVAILABLE NOW • At All Leading Parts Distributors

Taylor HEAVY **CUSTOM BUILT** DUTY *Tubes*

TAYLOR TUBES INC., 2312-18 WABANSIA AVE., CHICAGO 47, ILL.

(Continued from page 55)

An
**OUTSTANDING
OFFER**

to Ham Customers

We will calibrate your eco's, audio oscillators and other instruments, run performance tests, check your xtal frequencies, measure your frequencies on the air (reports by mail only) and perform many other laboratory services designed to promote better operation of your station—all without cost to you.

Being hams ourselves we know the value of these extra services. We believe they warrant your cooperation in buying all your supplies from us. Our stocks are large and practically 100% complete thereby making deliveries fast and efficient.

We are equipped to give you remarkable all-round service.

SEND IN YOUR ORDERS
WE'LL DO THE REST

**RADIO-
ELECTRONICS, INC.**

1032 East Broadway
Enid, Oklahoma

TOM W5GHN • BILL W5DET • BOB W5HLD

put up an antenna mast made of one-inch iron pipe and it fell down one night and poked a hole in my neighbor's roof right over the kitchen. My receiver went haywire and, as usual, I couldn't fix it so had to throw it away and buy a new one.

Then the FCC sent me a letter claiming they heard me just outside the band with a note like a buzz saw. They got pretty nasty about it, and I suppose they were right. I didn't have the spirit to argue. And I used to go to hamfests and buy raffle tickets by the yard and never won a single cockeyed thing. All I ever got out of those shindigs was a mashed right-front fender and indigestion. My youngest offspring crept around on the floor of the radio shack and ate a pound and a half of solder droppings. Things like that. See what I mean? Never a single moment of ham life as shown in pictures in *QST* or as described in its reading matter. Sometimes I think I'll give the whole thing up.

When the war came along I thought perhaps at last my big chance had come. I enlisted in the Navy and struck for yeoman. But no! Evil fate that is mine; my past record caught up with me and I was forced to strike for radio. They sent me to a materiel school. As in the past, I learned absolutely nothing . . . only grew more confused. I graduated from radio school (that was easy; you didn't have to know anything at all). They shipped me out and here I am, back in the same old rut. Honest, Doc, I just don't get this stuff! I tell you I don't know what makes this junk work! My only out is to hold daily prayer services and hope for the best. Maybe they'll let me be Master-At-Arms in a chow hall. Do I have to work at radio the rest of my life? Isn't there any way out but . . . No! No! I won't think of that yet. Maybe I'll find a way.

 **Strays** 

A new process for production of synthetic mica, perfected in the laboratories of the KWI Ceramics Institute in Germany, is reported by U. S. investigators to result in a product that is as good as natural mica. The synthetic mica consists of mixed oxides, fluorides, and silico-fluorides containing such metals as aluminum, magnesium, iron, chromium, and vanadium.

— . . . —

W9JVI of Roodhouse, Ill., reminds us of an old trick that still works. It might save you a bit of bother. Jever try to put a 6-32 nut into a spot where your fingers or your "long-noses" wouldn't go? Just take a short length of solder, flatten the end a bit and force it part way into the nut threads. Bend the solder into the form necessary to get down to that inaccessible bolt, and there you have it. Now all you have to do is to get at the bolt head with a screwdriver! If you can't do that — you had better move the whole works.



Communications Equipment

for earliest delivery order from **ALLIED**

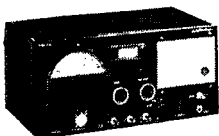

S-40



RME-45

Time Payments Available
Trade-Ins Accepted

Hallicrafters S-38.....	\$ 39.50
Hallicrafters S-40.....	79.50
National NC-46.....	97.50
NC-46 Speaker.....	9.90
RME-84.....	98.70
RME VHF-152 Converter.....	86.60
Hammarlund HQ-129X.....	168.00
RME-45.....	186.00
National HRO.....	197.70
National NC-2-40C.....	225.00
Hammarlund 400X.....	342.00
BC-610 (HT-4E Xmitter).....	535.00

Net F. O. B. Chicago. Prices subject to possible change.

HAMFEST? Not exactly . . . it's just any hour of the day at the ALLIED "Ham Shack" in Chicago. Here, local amateurs as well as hams from miles around come in to chew the fat with ALLIED'S licensed lads. Amateurs have always found a real welcome at ALLIED, a welcome based on common interests. Whether you visit the ALLIED "Ham Shack" in person or whether you shoot the dope to us by mail, we hope you'll always feel "at home" with us.

OLD-TIMERS: Whether you plan to rebuild that old rig . . . or want to try a new Ham band in the U. H. F.—you can count, now as always, on ALLIED for fastest delivery on latest available components.

BEGINNERS: For years, ALLIED has encouraged and helped thousands of beginners to become licensed radio amateurs. Let our Ham specialists help you get a good start. We're ready to serve you.

Send for Allied's 1946 Radio Catalog

Here's the Buying Guide that lists everything for the Ham . . . communication receivers, xmitters, Ham gear, code apparatus, parts, kits, tubes, test instruments, etc. Send for your **FREE** copy.

FREE



ALLIED RADIO CORP., D. L. Warner, W9IBC
833 W. Jackson Blvd., Dept. 27-HH-6
Chicago 7, Illinois

- Enter order for..... Model.....
 Enclosed \$..... Full Payment Part Payment
 (Balance C.O.D.)
 Send Literature on Receivers and Time Payment Plan.
 Send **FREE** 1946 Catalog.

Name.....

Address.....

City.....Zone.....State.....

ALLIED RADIO

Everything for the HAM

TYPE--750 Overload Relay

with Electrical
Reset

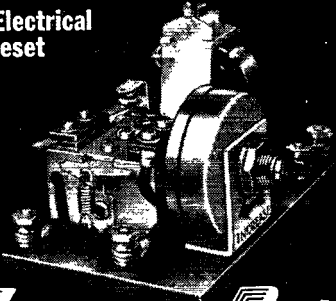

Advance Relays

The Advance type "750" relay is designed for accurate and positive protection against current surges and continuous overloads. Safeguard your expensive power tubes in radio transmitters.

Type 750 overload relay is supplied in either of two groups: type A, which allows the relay to open the contact circuit on any current value between 250 and 500 mills, and, type B for any setting between 500 and 1000 mills. Both types supplied as DPST with $\frac{1}{4}$ " pure silver contacts and 110 v A.C. (or specified voltage) reset coil.

A manual reset relay (Type 700) of similar characteristics is also available.

Amateur Net Price (At Your Jobber)—
Type 750A or 750B... \$7.92
Type 700A or 700B... \$6.10

Advance Relay Catalog free on request.

 **ADVANCE**
ELECTRIC & RELAY CO.
1260 West 2nd Street
Los Angeles 26, Calif., U. S. A.
Phone Michigan 9331

Now • QUICK SERVICE

ON

HALLICRAFTERS • NATIONAL • RME • HOWARD
ALIGNMENT and REPAIRS

CML Service Laboratory will check sensitivity, signal to noise ratio, and selectivity, with laboratory standard test equipment, to insure maximum performance.

Factory Service Division

COMMUNICATION MEASUREMENTS LABORATORY
120 GREENWICH STREET NEW YORK 6

Frequency Meters as Oscillators

(Continued from page 85)

resistor in the final amplifier to provide the bias voltage necessary to hold the plate current of this tube within its rating.

At 300 volts, a 6V6 produces nearly as much output as a T-21 or 6L6, but the latter are to be preferred for higher plate voltages. Triodes and tetrodes were also tried in the untuned stages, with good results but with reduced voltage gain. The 6V6 and 6J5 required an increase of the cathode resistor to 500 ohms to hold the plate current within the ratings. It is evident that this amplifier can be built up from almost any triode, tetrode, or pentode tubes that are on hand and which have fair power-handling ability.

Operation

The presence of the r.f. amplifier attached to the output of the frequency meter does not in any way detract from the value of the latter for its originally-intended purpose. Whether used as such or to drive the transmitter, the operating procedure is the same although, with well-shielded leads, it is necessary to clip a wire on to the frequency-meter output or even to couple it to the receiving antenna, to check the frequency of an incoming signal.

After the frequency meter has warmed up, the dial on the tunable oscillator should be set at the nearest check-point. The crystal oscillator in the meter is then turned on, and the "corrector" is adjusted until the tunable oscillator is in zero beat with a harmonic of the crystal frequency which provides the check-point, while listening with headphones that are plugged into the frequency-meter 'phone jack. If low audio beat frequencies cannot be heard, the exact dial setting of zero beat can be estimated with satisfactory accuracy by noting the dial settings on each side which produce the same low-frequency audio tone, the midpoint of these two settings being used. The crystal oscillator is then turned off, and the tunable-oscillator dial is returned to the desired setting between check-points.

The accuracy of this type of frequency meter depends upon the accuracy of the crystal oscillator and its harmonics which serve as check-points, and upon the ability of the tunable oscillator to retain a calibration between the check-points. Under severe changes of temperature, humidity, tubes and so on, the cumulative error should be well within 0.01 per cent at any point, which is 100 cycles per megacycle. It should be very much better at the check-points, which generally fall at the edges of the amateur bands. In practice, the errors will be compensating to some extent, so that a frequency can be determined within a few hundred cycles. The tunable oscillator was not built to maintain this accuracy under large temperature or humidity changes, while warming up, or for long periods of time, without being

(Continued on page 132)



War Surplus Equipment

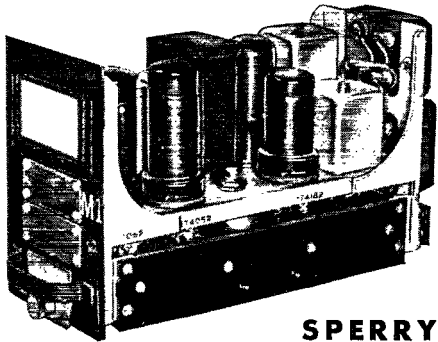
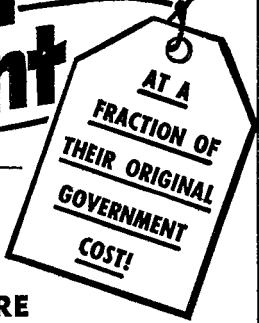

SPERRY AMPLIFIER

Manufactured by Sperry Gyroscope Co. as an elevator servo control amplifier for the U. S. Army Air Forces . . . tooled to exacting design these amplifiers contain 2 beam power output tubes (1632) similar to 25L6, 2 twin triodes (1633 and 1634) similar to 6SC7, 2 mica condensers, dozens of color coded half watt resistors, 3 bathtub condensers, 2 dual bathtub condensers, 1 bathtub condenser with 4 sections, 3 hermetically sealed transformers, 2 wafers shielded rotary switches with resistor assembly, 1 volume control, 4 octal sockets, measurements 9 1/4" x 5 1/2" x 3 1/2". These units are brand new in their original factory cartons. They are beautifully designed and may be easily converted to an audio amplifier . . . brought to you at a very small fraction of their original cost with the radio parts worth many times the total purchase price . . . ORDER EARLY TO INSURE GETTING ONE!!!! **\$3.95** COMPLETE WITH TUBES.....

Please enclose 20c to cover Mailing and Insurance.

Write us your radio needs and problems, Sun Radio has the parts and the answers. We carry a complete line of the trade-named products in the border of this ad . . . and best of all . . . Sun can usually supply them!!!!

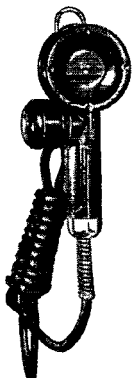

SHURE SINGLE BUTTON CARBON MICROPHONE

Mike comes complete with push to talk switch, cable and plug . . . BRAND NEW. Please enclose .20c in stamps or coin to cover mailing and **\$1.99** insurance.....



SIGNAL CORP 4000 OHM MAGNETIC HEADPHONES

This double headphone set comes complete with phone-plug, cord and leather covered headband . . . BRAND NEW. Please enclose 20c in stamps or coin to cover mailing and **\$1.87** insurance....

SET ANALYZER Triumph No. 333 . . . complete and ready to operate . . . 0-3000 Volts D.C. and 0-600 Volts AC, 0-10,000,000 Ohms, 0-15 Amps. Meter movement 425 micro Amps . . . beautiful 4" square meter backed with mirrored glass for easy, accurate reading. Metal black crackle portable case 9 1/4" x 9 1/4" x 4 1/2". Net F.O.B. Washington, D. C. — 25% must accompany all C.O.D. orders.

\$29.17



SUN RADIO

OF WASHINGTON, D. C.

938 F STREET, N. W. WASH. 4, D. C.

DeLuxe SPEED KEY

Model
CP 810

Amateur
Net Price
\$9.75

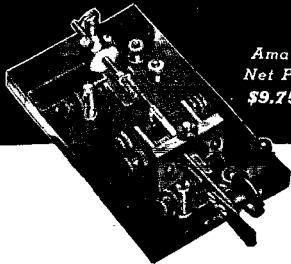

One of the finest commercial or amateur bugs available. Chrome finished base and superstructure. Springs made of selected blue spring steel for uniform performance in all keys. Nine points of adjustment to suit the most critical touch. Fully adjustable. Silver contacts 3/16" diameter.

MODEL CP 510 SPEED KEY • Similar to above except the base is Battleship gray wrinkle finish. Amateur Net Price \$6.75.

TELEGRAPH *Apparatus Co.*

412 SOUTH GREEN ST.

CHICAGO 7, ILLINOIS

ELECTRICITY

FOR RADIO AND ELECTRONIC APPLICATIONS

ONAN ELECTRIC GENERATING PLANTS supply electric service for electronics applications and general uses, mobile or stationary. Driven by Onan 4-cycle gasoline engines, they are of single-unit, compact design and sturdy construction.

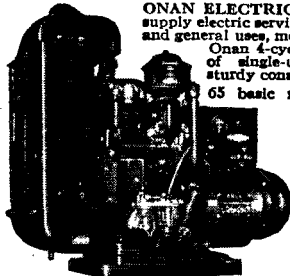

65 basic models ranging in capacity from \$50 to 35,000 watts. Standard A.C. models, 115-volt, 60-cycle, single-phase. Standard D.C. models, 32 to 115 volts. Special voltages to 660 A.C., and 6 to 4000 volts D.C. 5 KW to 35 KW units available in 3-phase. High frequencies to 800 cycles. Combination A.C.-D.C. types. Write for detailed literature or engineering assistance.

D. W. ONAN & SONS 2638 Royalston Ave. Minneapolis 5, Minn

Mass. Radio School

271 Huntington Ave., Boston 15, Mass.

For over 27 years the educational radio center of New England. Prepares for all U. S. Government Radio Operators' Licenses. Also gives Radio Technician Training. Approved courses for Veteran Training under G.I. Bill.

Licensed by Commonwealth of Mass.,
Department of Education

(Continued from page 130)

rechecked against the crystal harmonics and, therefore, it falls short of the performance of the best Navy-transmitter master oscillators. However, it will compare very favorably with almost any similar piece of equipment constructed by amateurs at a similar cost, and at much more trouble.

About the Author

• Commander Elmer H. "Bill" Conklin, W3JUX, admits his best claim to fame is being the husband of W9SLG/3! That is, when he isn't devoting his time to conducting u.h.f. columns for magazines such as the prewar *Radio*, working on the development of u.h.f. antennas, talking 44 miles on crystal-controlled 'phone on frequencies above 5000 Mc., or serving in the Fleet Technical Section, Chief of Naval Communications, Navy Dept., Washington, D. C. A graduate of Northwestern University with a B.S. degree, "Bill" has been licensed since 1922, his first call being W9DBF. He holds WAC and RCC certificates.

Happenings

(Continued from page 40)

tunity for members to put their representation in the hands of a member of their own choosing. Full Members are urged to take the initiative and file nominating petitions immediately.

For the Board of Directors:

June 1, 1946

K. B. WARNER,
Secretary

Propagation Predictions

(Continued from page 46)

9 of the article are from the report IRPL-D15. The charts in the article by E. H. Conklin in January, *QST*, "The Bright New World — of Sunspots," are also from IRPL reports.

The CRPL hopes that in making available to the general public the radio wave propagation information and techniques which were so widely and so successfully used by the Army and Navy during the war, the radio amateur's understanding of propagation conditions and his enjoyment of the time he is on the air will be significantly increased.

Strays

"KC," writing in *APCO Bulletin*, says "A short time ago I heard one station ask: 'WX?', and the queried station cracked back: 'It's dark here.'"

THE RADIO AMATEUR'S LIBRARY

These are the publications which every Amateur needs. They form a complete reference library for the Amateur Radio field; are authoritative, accurate and up to date.



<i>Title</i>	<i>Price</i>
<i>QST</i>	\$2.50 per year*
Operating an Amateur Radio Station	Free to members; to others 10c
The Radio Amateur's Handbook.....	\$1.00**
The Log.....	35c each; 3 for \$1.00
How to Become a Radio Amateur.....	25c
The Radio Amateur's License Manual.....	25c
Hints & Kinks for the Radio Amateur.....	50c
Lightning Calculators:	
a. Radio (Type A).....	\$1.00
b. Ohm's Law (Type B).....	\$1.00
A.R.R.L. Antenna Book.....	50c
The Minilog.....	25c
Learning the Radiotelegraph Code.....	25c
A Course in Radio Fundamentals.....	50c

* In the United States and Possessions—
other Countries \$3.00 per year.

** Postpaid in Continental U. S. A.—
\$1.50, postpaid, elsewhere. (*No stamps, please*)



THE AMERICAN RADIO RELAY LEAGUE, INC.

WEST HARTFORD 7, CONNECTICUT

World Radio Leads in

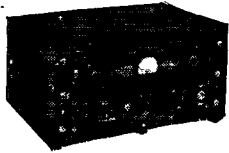

READY NOW!
AMATEUR
Sensation
of the Year!
WRL Globe
Trotter



TRANSMITTER KIT

Complete including all parts, chassis panel, streamlined cabinet, less tubes, coils, and meter.
Cat. No. 70-300 **\$59.95**
Cat. No. 70-312 Kit same as above wired by our engineers \$75.00
All necessary accessories \$13.85 Extra
Here is the latest most outstanding transmitter value on the market today. Capable of 40 watts input on C.W. and 25 Watts input on phone on all bands from 1500 KC through 28 Megacycles. Incorporates Tritet Oscillator using a 20 meter X-tal; three bands: 10, 20, and 80 meters; two power supplies.
National Headquarters for Ham Needs. **FOR EARLIEST DELIVERY** on your favorite receiver place your order now with World Radio. All makes and models.



Formerly Wholesale Radio Laboratories
Address DEPT. Q8 COUNCIL BLUFFS, IOWA

FREE!

OUR LATEST FLYER
OF RADIO PARTS
Giant Radio Reference
Map 3½x4½ ft. . . 15c
Tube Base
Calculator 25c

COMPLETE RADIO TRAINING!
Prepare now to accept a responsible position in Commercial Radio. New developments will demand technicians with thorough basic training, plus a knowledge of new techniques discovered during the war. Training open to high school graduates or those with high school equivalency. Courses 6 to 18 months' duration in RADIO AND ELECTRONICS. Approved Veteran training in Radio. Write for Particulars.
VALPARAISO TECHNICAL INSTITUTE
Dept. TN Valparaiso, Ind.

THE RADIO AMATEUR'S LICENSE MANUAL

Before you can operate an amateur transmitter, you must have a government license and an officially assigned call. These cost nothing — but you must be able to pass the examination. The examinations are based on the multiple-choice type of questions. The "License Manual" has been written to make it as easy as possible for the individual to acquire the necessary knowledge to pass the examination with flying colors. Whether you are going up for your Class C, B or your Class A ticket, "The License Manual" will provide the most direct path to getting that ticket. If you are one of the thousands who always wants a "License Manual" around the shack for ready reference for amateur regulations, it will please you to know that the regulations are very thoroughly indexed.

25 cents • **POSTPAID ANYWHERE**
(No Stamps, Please)

AMERICAN RADIO RELAY LEAGUE
WEST HARTFORD, CONNECTICUT

Foreign Notes

(Continued from page 47)

members. It will be the first time in many years that Italian amateurs have been able to tack up licenses on the walls of their shacks! . . . In addition to channels on 20 and 40, South African amateurs may now use 1.8-2 and 29-30 Mc., following the British pattern (including a power limit of 10 watts on 160, the band privileges subject to withdrawal without hearing). . . . By official act of Parliament, New Zealand has changed its standard time to be exactly 12 hours ahead of GCT, instead of 11½ as before. . . . R.S.G.B. intends to publish 10,000 copies of a booklet describing in simple terms how one can become an amateur.

Applying A.M.D.

(Continued from page 61)

a.f. system, whether an r.f. signal is tuned in or not. This characteristic of A.M.D. causes no trouble, however, because its cause is audibly obvious and its cure a slight adjustment of R_{15} .

It is important to remember that, regardless of the lower-gate bias setting, any increase in the upper-gate bias (E_{ad}) must be accompanied by an equal increase in E_M . Otherwise, the i.f. signal will not be fully modulated. Conversely, if E_{ad} is reduced, E_M must also be reduced; otherwise, an a.f. "back-wave" will be produced.

After R_{15} , R_{20} and R_{22} have been properly set and a signal tuned in, the 'phones should be transferred to the filter output jack, J_2 . A patch cord with a 'phone plug on each end is required to connect the receiver to J_1 , the filter input. With S_1 in the "out" position, the same signal should be heard, unchanged in tone or volume (the tone will be that of a somewhat distorted square wave). With S_1 in the "on" position, a pure tone will be heard with greater volume, provided that a.f. oscillator control R_5/R_6 is set at 500 c.p.s. to correspond to the resonant frequency of the filter. The filter frequency can be "found," if R_5/R_6 is misadjusted, by merely rotating the frequency control until the a.f. signal is maximum.

Realignment of I.F. Amplifier

When the "hot" secondary lead of the last i.f. transformer is brought out through the tube adapter and connected to the A.M.D. diode, some additional stray capacitance is shunted across the secondary. To compensate for the slight detuning which occurs it is necessary to readjust the secondary trimmer condenser. To make this adjustment, first insert a small signal (two or three microvolts) from a signal generator or other suitable signal source into the receiver's input circuit. Set the crystal filter to its sharpest position and adjust the r.f. gain control so that the i.f. signal is below its upper-gate "ceiling."

(Concluded on page 136)

Convert Your 5 Prong Crystal Sockets for Both Old and New Type Holders in *3 minutes*

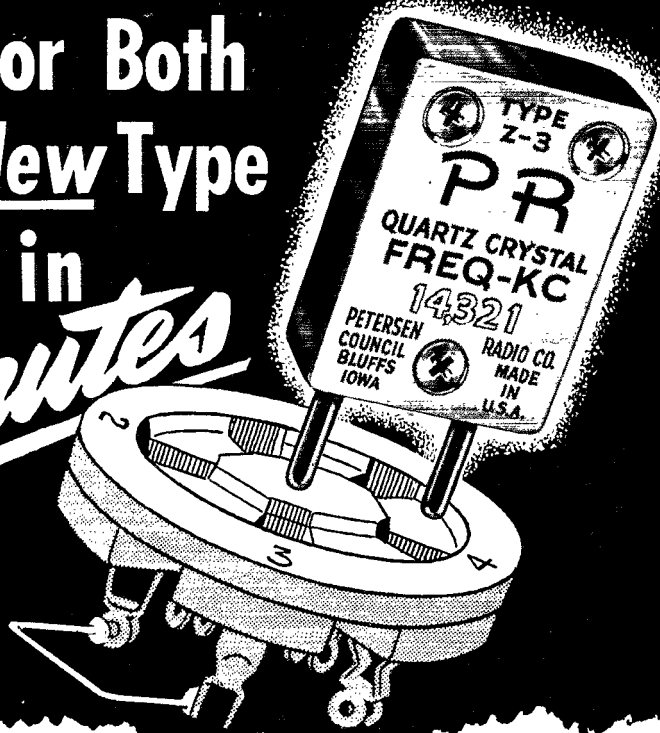

It isn't necessary to build complicated adapters or install new octal sockets in your transmitter to use the new $\frac{1}{2}$ inch pin spacing on modern crystal holders. You can convert standard 5-prong sockets to accommodate BOTH old and new types in three minutes. Just do this: Solder a jumper between the No. 2 pin receptacle and No. 3 as indicated in the drawing above. Then pinch the sleeves of 3 and 4 slightly so they will grip the new, smaller pins.

That's all there is to it. Plug the new-type holder pins across 4 and 3. Old-style holders are plugged in the ordinary manner. This is a practical tip from PR. And here's another: Get the new PR Precision CRYSTALS for accuracy . . . maximum power output . . . activity . . . stability . . . low drift . . . even on the highest frequencies. At your jobber's . . . for ALL BANDS. PETERSEN RADIO COMPANY, 2800 WEST BROADWAY, COUNCIL BLUFFS, IOWA. (Telephone 2760)

 SINCE 1934

PR

Precision

CRYSTALS

10 METERS PR Type Z-5.	Temp. coefficient less than 2 cycles per MC per degree centigrade. High activity. Heavy drive without crystal damage. .\$.50
20 METERS PR Type Z-3.	Temp. coefficient less than 2 cycles per MC per degree centigrade. High power output. High activity\$.350
40 & 80 METERS PR Type Z-2.	Rugged. Low Drift (less than 2 cycles per MC per degree centigrade). High keying activity. High power output. Accurate calibration\$.2.65

Quality PRODUCTS
Since 1923

A complete line of
WIRES, CABLES, HOOK-UP WIRES,
RADIO HARDWARE, SHIELDED
MICROPHONE CABLE and S. J. CABLE
Complete Stock of Your Dealer

BIRNBACH

BIRNBACH RADIO CO., Inc.
145 HUDSON ST. NEW YORK 13, N. Y.

Here's a New **POWER CUTTER KIT**
with a cutting range of 5/8" to 2 1/2"

Two Bruno Adjustable Hole Cutters in one convenient kit. High speed steel blades cut clean, fast holes in metal, wood, plastics. Quickly adjustable and easily sharpened. Designed by tool engineers to operate efficiently in bench drill, drill press or portable drill. Ask your jobber, or write Dept. Q-7

Only **\$7.85** Complete

MODEL	SHANK SIZE	EXPANSION	PRICE
100	1/4" straight shank	5/8" - 1 1/2"	\$3.00
101	3/8" straight shank	1" - 2 1/2"	\$5.00
		5/8" - 2 1/2"	\$8.00*

*Fair Trade Minimum \$7.85

BRUNO TOOLS 9330 Santa Monica Blvd. Beverly Hills, Calif.

CODE SENDING SPEED
CODE RECEIVING SPEED

Have Skill, Accuracy

Be a "key" man. Learn how to send and receive messages in code by telegraph and radio. Commerce needs thousands of men. Expansion of air commerce and freight after war should create an even bigger peacetime demand for operators. The famous Candler System, maker of world's champions, teaches you the "knack" of sound sense and sound consciousness that is the secret of speedy sending and receiving. Good pay, adventure. Learn at home quickly.

FREE 52-PAGE BOOK explains extra course of training. Rush name for it today. It's absolutely free.

CANDLER SYSTEM CO.
Dept. 4-J, P. O. Box 928, Denver 1, Colo., U. S. A.
and at 121 Kingsway, London, W.C. 2, England

(Continued from page 134)

Then alternately peak the audio output signal by tuning the vernier frequency dial of the receiver and by adjusting the proper i.f. trimmer capacitance. Only a slight adjustment should be required. It is not necessary to retune the primary of the last i.f. transformer. An a.f. output meter is very useful for making this adjustment, although a sufficiently good job can be done by ear.

The receiver is now ready for A.M.D. operation on c.w. signals. A little operating experience is necessary before the operator can learn which gate adjustments give optimum results for various receiving conditions. In general, in a noisy location a lower-gate bias of one to two volts will be found desirable. The upper gate bias can usually be kept at about -4 volts. The audio level at which audio limiting occurs can be controlled by the setting of the receiver's a.f. gain control, as well as by the setting of the upper-gate level. In a quiet location and where it is desired to receive very weak signals, the lower gate bias should be set at or near zero, inasmuch as this provides maximum sensitivity. Whenever the lower-gate bias is shifted from some negative value to zero, it is necessary that E_M be increased slightly, to maintain full modulation of the signal.

When it is desired to receive a 'phone signal, R_{15} is turned to its maximum counterclockwise position. This action opens switch S_3 , which removes the plate supply from the adapter and takes the squelch diode effectively out of the circuit. The receiver can then be used in its normal manner, without the b.f.o. for 'phone, or with the b.f.o. for c.w.

The numerous advantages of A.M.D. as compared to the b.f.o. method of reception were covered in detail in our previous article, and will not be repeated here. The authors do feel, however, that going back to the b.f.o. would be analogous to hooking up old Dobbin to a high carriage complete with black silk tassels.

Strays

QST has been selected as recommended reading for radio-inclined high school students by Laura K. Martin, chairman of the Evaluation Committee of the American Association of School Librarians.

"High school students are avid readers and their tastes embrace practically all magazines — but in the radio field, *QST* remains the favorite with the seriously interested boy," Miss Martin stated in her survey, which considered each of the 5,982 different magazines she says are now published in the United States.

— . . . —

Sez a fone man to a c.w. fella, "If the good Lord intended us to whistle at each other, He would have made us that way."

— W1BHD

Exclusive
at NEWARK

SURPLUS SPECIALS

**MOBILE 40 & 80 METER
XMTR - RCVR SET**
famous
MARK II only \$34.50

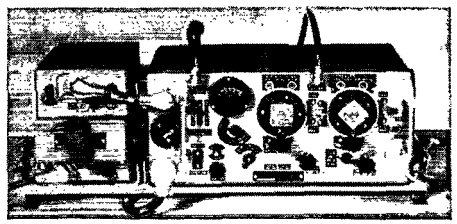

Hams! It's unbelievable but true! You can now own a complete 40 and 80 meter mobile rig for only \$34.50. Here's what you get: Two sets in one. Phone and CW on 2 to 8 Mc (Right Smack in the 40 and 80 meter bands!) 6 tube Super Receiver, 6 tube MOPA Xmtr. Also, a complete 235 Mc transceiver. Included in this wonderful buy is: 1 pair headphones, 1 key, 1 "A" set antenna with variometer, 1 "B" set antenna, 1 control box, 1 microphone, 1 Dynamotor power supply kit, plus all the plugs, cable connectors, etc., that are needed for operation. And this rig can take it. It was originally designed for tank operation. Remember: Nothing else to buy. You're on the air with a mobile job you've been longing for. AT THIS SENSATIONALLY LOW PRICE.

HAMS! EXPERIMENTERS!

make a
10 Meter FIELD INTENSITY METER
from this Signal Corps Test Set!

Unusual instrument, offers wonderful possibilities for very high frequency work. Meter alone (0-250 RF mils) worth more than price of complete unit. Only a few left. **BRAND NEW!** Sale Price

\$9.95

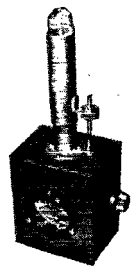

OUR PLEDGE
NEWARK WILL
HOLD THE LINE
ON PRICES OF
ALL SURPLUS
AND REGULAR
MERCHANDISE

**BRAND NEW DYNAMOTOR
POWER SUPPLY**

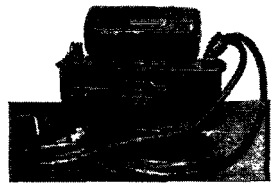

Don't confuse this fine apparatus with second hand surplus now on the market. It's brand new, in original Signal Corps Carton.

Supplies 500 volts at 160 mils DC from any 6 volt or 12 volt battery source. A typical Newark VALUE!

\$14.95

FILTER SPECIAL
1 MFD-1000 V.DC

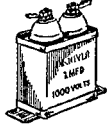

Terrific buy. Famous Make, Brand New Xmitting Capacitor, in metal case with porcelain insulators.

You can't beat this for VALUE!

49¢

NEW YORK
115-17 W. 45th St.
New York 19, N.Y.

NEWARK

ELECTRIC CO. INC.

Branch: 212 Fulton St., New York 7, N. Y.

CHICAGO
323 W. Madison St.
Chicago 6, Ill.

LEARN WIRELESS and TELEGRAPHY!

A BOOK EVERY AMATEUR SHOULD HAVE —

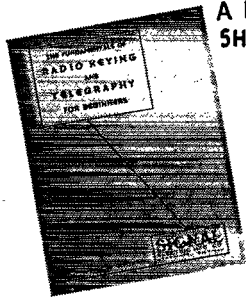

Hundreds of amateurs have learned from this book, so can you.

Send Now!

15¢
POSTPAID
COIN, OR
STAMPS

This book gives you the fundamentals of wireless and telegraphy. It contains the codes and how to learn them. Mail your order now to:

SIGNAL ELECTRIC MFG. CO., Menominee, Mich.

ESTABLISHED
1892



HOW TO PASS Commercial Radio Operators' FCC LICENSE EXAMINATIONS...

How To Pass
FCC
LICENSE
EXAMINATIONS

CLEVELAND INSTITUTE
OF RADIO ELECTRONICS
Terminal Tower - Cleveland, Ohio

Don't Delay —
Write Today!

FREE BOOKLET

Tells you the Government Requirements for all classes of commercial licenses. Saves you many hours of random, undirected study. Assures a minimum of time in getting your ticket!

CLEVELAND INSTITUTE of RADIO ELECTRONICS

Successors to Nilson Radio School, founded 1939;
Smith Practical Radio Institute, founded 1934

QT-8, TERMINAL TOWER CLEVELAND 13, OHIO

Approved for Veteran Training under GI Bill of Rights

MAIL THIS COUPON

Cleveland Institute of Radio Electronics
QT-8 Terminal Tower, Cleveland 13, Ohio

Gentlemen: Please send your FREE Booklet, "How to Pass FCC License Examinations." (NOTE: This booklet does not cover examinations for Amateur Licenses.)

Name.....Address.....

City.....State.....

Check here, if a veteran

WWV Schedules

STANDARD-FREQUENCY transmissions are made available as a public service by the National Bureau of Standards over its standard-frequency station, WWV, on the following schedules and frequencies:

- 2.5 Mc. — 7 P.M. to 9 A.M. EST (0000 to 1400 GCT).
- 5.0 Mc. — Continuously, day and night.
- 10.0 Mc. — Continuously, day and night.
- 15.0 Mc. — Continuously, day and night.

The 10- and 15-Mc. radio frequencies are modulated simultaneously at accurate audio frequencies of 440 and 4000 cycles. 5 Mc. carries both audio frequencies during the daytime but only 440 cycles from 7:00 P.M. to 7:00 A.M., EST, while 2.5 Mc. carries only the 440-cycle modulation. A 0.005-second pulse may be heard as a faint tick every second, except the 59th second of each minute. These pulses may be used for accurate time signals, and their one-second spacing provides an accurate time interval for physical measurements.

The audio frequencies are interrupted precisely on the hour and each five minutes thereafter, resuming after an interval of precisely one minute. This one-minute interval is provided to give Eastern Standard Time in telegraphic code and to afford an interval for the checking of radio-frequency measurements free from the presence of the audio frequencies. Ionospheric disturbance warnings applicable to the North Atlantic path are given at 20 and 50 minutes past each hour. If a disturbance is in progress or is anticipated within 24 hours, the time announcement is followed by 6 Ws; if conditions are quiet or normal, the time announcement is followed by 8 Ns. The announcement of the station's services and of the station's call (WWV) is given by voice at the hour and half hour.

The accuracy of all the frequencies, radio and audio, as transmitted, is better than a part in 10,000,000. Transmission effects in the medium may result in slight fluctuations in the audio frequencies as received at a particular place; the average frequency received, however, is as accurate as that transmitted. The time interval marked by the pulse every second is accurate to 0.00001 second. The 1-minute, 4-minute and 5-minute intervals, synchronized with the second pulses and marked by the beginning and ending of the periods when the audio frequencies are off, are accurate to a part in 10,000,000. The beginnings of the periods when the audio frequencies are off are so synchronized with the basic time service of the U. S. Naval Observatory that they mark accurately the hour and the successive 5-minute periods.

Of the frequencies mentioned above, the lowest provides service to short distances and the highest to great distances. In general, reliable reception is possible at all times throughout the United States and the North Atlantic Ocean, and fair reception over most of the world.

HARVEY has narrow band F. M. EQUIPMENT

To adapt any C.W. or phone transmitter for frequency modulation transmission conveniently and economically . . .

SONAR F. M. EXCITER—Model XE-10

Narrow Band (2-3 kc. Deviation)

- Positively eliminates broadcast interference.
- Penetrates GRM.
- Greater signal to noise ratio.
- Maximum economy — saving about 60% over AM transmitters.
- More output from your final than can be obtained from any other phone transmitter.
 - Compact — only 9 $\frac{3}{8}$ " x 7" x 5" overall.
- Any AM receiver can be used. (Deviation — 2-3 kc.)
- More DX.
- Occupies less space in the radio spectrum than conventional AM transmitters.
- Self-contained power supply, 110 V., 60 cycle.
- No more silent hours.

PRICE, LESS CRYSTAL, \$39.45

A COMPLETE RIG READY TO GO ON THE AIR

. . . with 10 meter narrow band F.M. phone, the F.M. exciter described above, and the ever popular versatile Millen 90800 exciter unit. Output is 50 watts; compact relay rack mounting unit using 6L6 and 807 output tubes. Complete with set of coils for 10 meter operation. Net, \$37.50
Kit of tubes. Extra, \$3.55 Other coils available for all bands. Per Band, \$2.50

HARVEY'S HIT OF THE MONTH

A very fortunate purchase enables us to offer you precision made Low Drift X-ray Oriented Crystals produced by the latest and most scientific methods. These crystals are not to be confused with surplus equipment, but are post-war manufactured and are cut specifically for us. They come mounted in the new half-inch spacing holder to fit in an octal socket. A wide range of frequencies are in stock in the 40 and 80 meter bands. HARVEY SPECIAL. . . . Each, \$1.00

HAMFESTIVAL OF VALUES

TEST EQUIPMENT DEPARTMENT

HARVEY'S stocks include almost all models and makes of instruments . . . with many of the more popular types available without delay. Place your order promptly for early delivery!

COMPLETE LINE OF RECEIVERS

In stock at all times at HARVEY are all standard lines of receivers. We are delivering them NOW! Send in your order for immediate delivery . . . and remember, you get the best trade-in allowance at HARVEY.

6.3 volt (not center tap) Heavy Duty Filament Transformers, built to Navy specifications and completely cased in a water-tight hermetically sealed unit. Physical dimensions: 5 $\frac{1}{2}$ " x 4 $\frac{1}{2}$ " x 2 $\frac{3}{8}$ ". They are conservatively rated at 10 amps. and can be 50% overloaded with perfect safety. Very well insulated internally; produced by nationally known manufacturer. 115 volt primary. A rare buy! \$2.85

To the Ham interested in photography, we now have in stock for immediate delivery the brand new **Weston Model 735 Master II Exposure Meter**. Comes with High-Light Scale and Low Light Scale to make small details easily and clearly discernible. Specially corrected for color and black-and-white. Highly accurate meter with easy-to-read dial. \$29.67

A long sought item — **Sylvania 1N21 V.H.F. Crystals**. These crystals were used in radar equipment as the detector unit for 10,000 megacycles. They are rated at 2 mils peak current, and are just the thing you have been wanting for that field strength meter you had in mind. They have a thousand and one other uses, too. Supplied with gold plated contacts . . . and shipped in small lead containers for maximum protection. HARVEY SPECIAL. . . .3 for \$1.25

Telephone

Longacre 3-1800

HARVEY
RADIO COMPANY INC.

103 West 43rd St., New York 18, N. Y.

MODULATION & DRIVER TRANSFORMERS

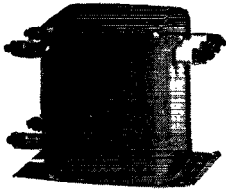

These transformers are suitable for use with type 811, 809, TZ40, TZ20, etc. to modulate either triode or beam tube amplifiers. Two secondary windings. Impedance ratio, primary to secondary number one, 2 to 1. Primary to secondary number two, 16 to 1. Will modulate up to 300 watts input.

Modulation transformer, driver transformer, circuit diagrams and other information all for..... **\$6.90**

Please include 50 cents for postage and handling.

Aerovox 1 Mfd. 5,000 Volt Oil-filled Condenser..... **\$4.90**

Please include 30 cents for postage and handling.

Other items available. Write for list

ELECTRONIC NAVIGATION, INC.

Box 126 • Woodside, Long Island, N. Y.

Hints and Kinks

(Continued from page 71)

AN UNTUNED PRESELECTOR

ALTHOUGH the old adage concerning the impossibility of "getting something for nothing" still holds, the addition of a simple untuned 6AC7 preselector has been found to add much to the sensitivity and selectivity of small communications receivers without a tuned r.f. stage ahead of the converter. For best results the preselector should be connected to the receiver with the antenna coil of the superhet directly in the plate circuit of the preselector as shown in Fig. 4-A. This arrangement was found to be much better than the alternative choke-condenser coupling shown in Fig. 4-B.

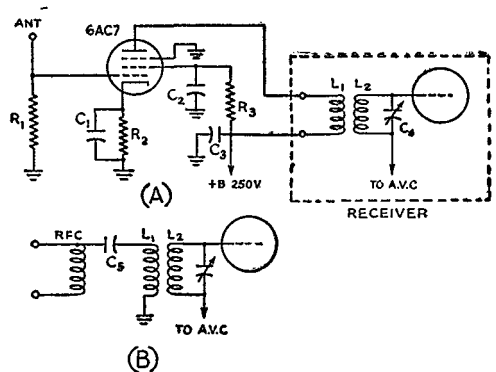

Fig. 4 — This untuned preselector requires only a few components and a 6AC7 yet it will improve the performance of the ordinary variety of communications receivers having no preselection. An alternate method of coupling to the receiver is shown in (B) where an r.f. choke replaces L_1 in the circuit shown in (A) and is capacity coupled to the antenna winding of the receiver.
 C_1, C_5 — 0.01 μ fd.
 C_2, C_3 — 0.1 μ fd.
 C_4 — converter grid tuning condenser, in receiver.
 R_1 — 1 megohm

In receivers with separate antenna coils (for use with doublet antennas) the connections are quite easily made, and even in those with internal grounds it is a simple job to unsolder the grounded end, and bring it out for use with the preselector. With such connections the reflected impedance in the plate circuit of the preselector is maximum at the frequency to which the mixer grid circuit is tuned, and therefore maximum gain is achieved at that frequency alone. The grid of the 6AC7 may be returned to the a. v. c. line if it is desired to make this additional change in receiver wiring, but it is not essential for smooth operation of the preselector. — *Herbert L. Ley, jr., 349 Vanderbilt Hall, Boston 15, Mass.*



W9NZW lives on Interference Street, Kelley, Iowa. Another housing-shortage casualty!

PRE-EXAM TESTS

For Commercial Radio Operator

FCC LICENSE EXAMINATIONS

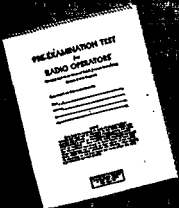

Don't Take A Chance!

Avoid Failure On FCC Commercial Radio Operator License Examinations!

Use NILSON'S COMPLETE PRE-EXAMINATION TESTS AND COACHING SERVICE

Enables You To

REHEARSE the FCC license examinations • PRACTICE the procedure • PRACTICE the multiple-choice examination methods used by FCC • CHECK your knowledge • LOCATE your weak points • CORRECT your weak points before taking the actual examination

Prepared by Arthur R. Nilson, Famous Co-Author of Nilson and Hornung's Radio Questions and Answers.

Use Coupon or write for Descriptive Folder
No obligation—no salesmen

CLEVELAND INSTITUTE OF RADIO ELECTRONICS

Successors to Nilson Radio School, founded 1939;
Smith Practical Radio Institute, founded 1934.

QT-8 TERMINAL TOWER

CLEVELAND 13, OHIO

CLEVELAND INSTITUTE OF RADIO ELECTRONICS

QT-8 Terminal Tower, Cleveland 13, Ohio

Gentlemen: Please send information about Pre-Exam Tests.

Name..... Address.....

City.....Zone.....State.....

**FOUR BANDS IN FOUR SECONDS!
TWO ADJACENT FREQUENCIES IN EACH BAND!**

Plus
**400 WATTS
ANTENNA POWER!**
with the
**WILCOX TYPE
99A TRANSMITTER**

A commercial equipment for the amateur who desires the ultimate in a four-band transmitter for use on any frequency between 2 Mc and 144 Mc.

Four fixed-frequency R.F. Units, each with a dual crystal plus a telephone-type dialing system, gives you your instantaneous choice of four bands, *with both phone and C. W. on each.*

Single 250TL final on medium frequency and Push Pull 4-125A's on VHF.

Complete remote control facilities are included, so that you may select any function, including channel selection, start and stop, etc., by an ordinary telephone dial.

Truly a deluxe transmitter for the discriminating amateur who wants the maximum in operating satisfaction from his hobby.

Complete engineering and installation service, including antenna systems, is available to you, to insure that you will realize the maximum benefit from this fine equipment.

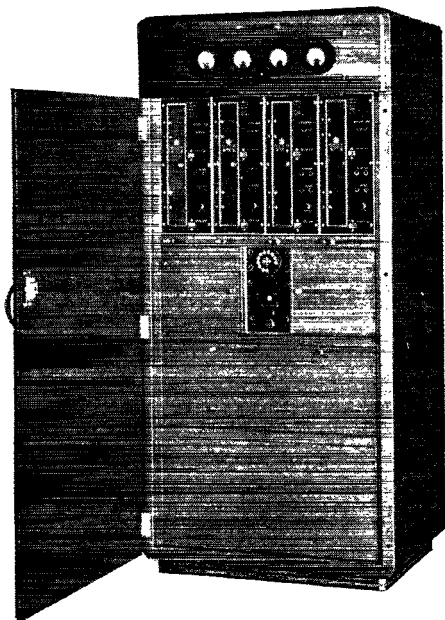

Wilcox 99A Transmitter with 4 R.F. Units.

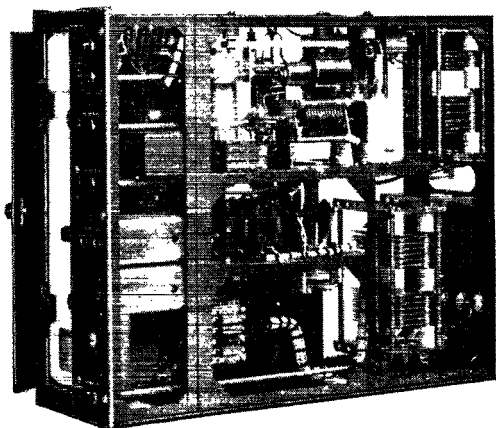

Interior View Removable R.F. Unit.

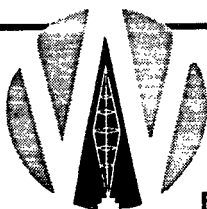

WILCOX ELECTRIC COMPANY, INC.
Manufacturers of Radio Equipment
Fourteenth and Chestnut
Kansas City, Mo.

*We are pleased to announce
that we have taken on the
U.I.C. line of transformers.
A post card will bring you the
new U.I.C. catalog.*

**SYLVANIA 1N34's
NOW IN STOCK**

ORDER NOW \$1.60 NET

MAIL ORDERS PROMPTLY FILLED

W. D. BRILL CO.

198 TENTH ST. OAKLAND 7, CALIFORNIA

W6KLO

W6SSN

W6FJX

RADIO

RADIO Technician and Radio Communications courses.
Register now for new classes starting first Monday of each
month. Day and Evening Classes.

AMERICAN RADIO INSTITUTE

101 West 63d St.

New York 23, N. Y.

Approved under GI Bill of Rights

CONNECTICUT HAM HEADQUARTERS

Complete stocks of nationally known
amateur gear — radio electronic parts
— tubes — sets and equipment.

Wholesale Only

R. G. SCELİ & CO.

Pete De Pasquale, W1GUC Roger Amundson, W1HYF
George Lappe, W1LWW Roy Watkins, W1MHH
Forher Noe, W1LWZ Ernie Johnson, W1FSY
Art Lundeen, W9PZI John Yacovelli, W1IKB

317 Asylum St.
Hartford 3, Conn.
Tel. 2-1144

84 Elm St.
Bridgeport 3, Conn.
Tel. 6-1811

ASK FOR OUR BARGAIN BULLETIN

New Apparatus

(Continued from page 65)

Complete hardware and assembly instructions are furnished with the kit, and additional four-foot sections of mast are available. Brackets for mounting the mast on the side of a house are furnished with the mast kit, for either fixed or rotatable operation. Rotating mechanisms will be available in the fall, but the light weight of the entire structure makes turning it by hand no problem, and a locking device furnished with the fittings for the rotatable mast allow it to be locked at any position. The strength of the mast is such that it should be readily possible to extend the mast 12 or 16 feet above the top supporting bracket without any danger of storm or other failure.

The kit requires no tune-up procedure, since all of the elements are cut to exact length for the center of the band. This kit is one in a series of coordinated v.h.f. antenna systems that includes a three-element 50-Mc. antenna and a 28-Mc. dipole, and the masts, plastic housings and some of the fittings are all interchangeable. The kit and mast are products of The Workshop Associates, 66 Needham Street, Newton Highlands 61, Mass.

— B. G.

World Above 50 Mc.

(Continued from page 69)

Realizing that working beyond 200 miles on 144 Mc. is no matter for a flea-powered transceiver and a quarter-wave rod, W6RBQ assembled a 16-element array which could be knocked down and carried to the top of Mt. Diablo, 30 miles east of San Francisco. The W6RBQ rig is a 50-watt crystal-controlled job, powered by a gas-engine generator. Working with Bill was W4TZ/6, who has a 12-watt crystal rig and a 3-element parasitic array, arranged for mobile work. The first try was scheduled for June 2nd, with W4TZ/6 driving up into the King's River Canyon country for tests at two distances, the first at 190 miles. Contact was made easily at this distance, but car trouble (including two flat tires!) delayed W4TZ/6 in getting to the second point which was a 240-mile distance, and W6RBQ/6 at Diablo had given up before Hunter was set up at the second test point.

Refusing to give up after this disappointment, the boys went at it again the next weekend, June 9th. This time, W6RBQ/6 drove to Grant National Park Lookout, a 7500-foot elevation 60 miles east of Fresno, taking along the equipment mentioned above, plus an S-27 and a new converter! W4TZ/6 was set up at Goat Mountain, a 6120-foot elevation west of Willets. Contact was established without difficulty, and maintained for more than an hour. The distance was

(Continued on page 144)



New

a Compact Single-Unit 60-WATT TRANSMITTER

★ Metal Cabinet, 15" x 11" x 9".

★ Plug-In Coils for Band Selection. 1 Set of coils covering 10- and 11-meter bands furnished. Coils for other bands available at additional cost.

★ Combined Plate and Screen Modulation.

★ Two Complete Built-in 60-Cycle Power Supplies, 1 for final RF and 1 for Modulator . . . Speech Amplifier . . . Oscillator.

NEW COMPACT SINGLE UNIT

This new compact single-unit transmitter is extremely simple to operate yet flexible in application.

TRANSMITTER

A 6L6G tube is used in a regenerative oscillator circuit which operates with the output of the crystal frequency on all bands except 10 meters. For operation on 10 meters the plate of the oscillator is tuned to the second harmonic of the crystal with ample driving power because of the regenerative oscillator circuit. This oscillator drives two 6L6G's operating as push-pull doublers in the final RF amplifier. This provides an efficient method of doubling in the final on all bands.

MODULATION

The microphone preamplifier consists of a single 6SN7 GT/G connected as a cascaded amplifier. This is followed by another 6SN7 GT/G which functions as a phase inverter. Two

6L6G's in push-pull, operating as class AB amplifiers, are used as modulators. Any crystal or high impedance dynamic microphone may be used!

ADDITIONAL FEATURES

Built-in antenna changeover relay; provisions for plug-in Battery or Vibropac operation; meter switching to final amplifier grid or plate circuits for tuning; crystal socket on front panel for rapid frequency changing; send-receive switch equipped with extra contacts wired to terminal strip on rear of chassis for receiver stand-by.

TUBES FURNISHED

1-6L6G Oscillator (oscillator-doubler on 10 meters), 2-6L6G final amplifier doubler, 1-6SN7 GT/G cascaded 2-stage speech amplifier, 1-6SN7 GT/G phase inverter driver, 2-6L6G push-pull modulator, 1-5U4G final RF amplifier rectifier, 1-5U4G modulator, speech amplifier and oscillator rectifier.



MECK TRANSMITTERS

J. M. I. SALES CORPORATION • 35 E. WACKER DRIVE, CHICAGO 1, ILL.

REGULATION

§12.136. LOGS. Each licensee of an amateur station shall keep an accurate log of station operation, including the following:

(a) The date and time of each transmission. (The date need only be entered once for each day's operation. The expression "time of each transmission" means the time of making a call and need not be repeated during the sequence of communication which immediately follows; however, an entry shall be made in the log when signing off so as to show the period during which communication was carried on.)

(b) The signature of each licensed operator who manipulates the key of a radiotelegraph transmitter or the signature of each licensed operator who operates a transmitter of any other type and the name of any person not holding an amateur operator license who transmits by voice over a radio-telephone transmitter. The signature of the operator need only be entered once in the log, in those cases when all transmission are made by or under the supervision of the signatory operator, provided a statement to that effect also is entered. The signature of any other operator who operated the station shall be entered in the proper space for that operator's transmission.

(c) Call of the station called. (This entry need not be repeated for calls made to the same station during any sequence of communication, provided the time of signing off is given.)

(d) The input power to the oscillator, or to the final amplifier stage where an oscillator-amplifier transmitter is employed. (This need be entered only once, provided the input power is not changed.)

(e) The frequency band used. (This information need be entered only once in the log for all transmission until there is a change in frequency to another amateur band.)

(f) The type of emission used. (This need be entered only once until there is a change in the type of emission.)

(g) The location of the station (or the approximate geographical location of a mobile station) at the time of each transmission. (This need be entered only once provided the location of the station is not changed. However, suitable entry shall be made in the log upon changing the location. Where operating at other than a fixed location, the type and identity of the vehicle or other mobile unit in which the station is operated shall be shown.)

(h) The message traffic handled. (If record communications are handled in regular message form, a copy of each message sent and received shall be entered in the log or retained on file at the station for at least 1 year.)

Convenient ————— Complete

THE ARRL LOG BOOKS

Regular Log, 8½ x 11
35¢ each, 3 for \$1.00

Mini-Log, 4 x 6¼
25¢ each

American

RADIO RELAY LEAGUE
WEST HARTFORD, CONN., U.S.A.

(Continued from page 148)

280 miles airline! The existing record was also surpassed by W6RBQ/6 in working W9MQZ/6, W6CAN/6, and W6NJJ/6, all operating on Mt. St. Helena, a distance of 240 miles. Also contacted were W6PTS/6 on Mt. Diablo, 185 miles, W6CIS/6 near Yosemite, 90 miles, and W6MEL/6, near the base of Mt. Frazer, 125 miles. The last two stations were using 615 rigs, running very low power. Another nice DX contact was made this same day by W6IBS/6, operating mobile on Point Loma, San Diego, working W6ULE/6 on Mt. Frazer, a distance of 175 miles.

As this material is being prepared we have a telegraphic report of a Field Day contact between W6MYC and W6TCP, operating from Mt. Waterman, and W6NNS and W6UZX, working together on Mt. Diablo. Two contacts were made, one on the afternoon of the 22nd, and another on the morning of the 23rd, but unfortunately 3.5-Mc. c.w. was used for one side of the circuit on both occasions, though each end used 144 Mc., one way, for the two contacts. As our officially-recognized records carry the designation "two-way work," this 345-mile DX cannot be listed in the box. Both rigs were crystal controlled (those W6 boys really do it up brown!) and employed coaxial antennas with square-corner reflectors. The rig on Mt. Waterman ran 25 watts to an 832A, while the boys on Mt. Diablo had 300-watts input to a pair of 3D23s.

Not all the interesting work in California is being done from the mountain peaks. Operating from his home location, 50 feet above sea level in Redwood City, W6OVK is working W6BVK in Sacramento, also at a low location. The distance is approximately 85 miles, and the mountains of the Coast Range, running up to 2000 feet, are directly in the path. The boys who still think it necessary to have an antenna 100 feet in the air should note that these two have antennas 15 feet off the ground! Both have high-gain receivers, and the array at W6BVK is a 16-element job. The receiver at W6OVK is a 4-tube converter using two r.f. stages with 6AK5s, working into the f.m./a.m. i.f. unit recently described by him in QST. W6BVK has concentric-lines in his two r.f. stages, mixer and oscillator. Some of the boys who have been driving to Mt. Diablo in order to work Sacramento are finding this contact hard to believe, so W6OVK and W6BVK are making it a nightly schedule to determine the reliability of the circuit, and to sell the local gang on the possibilities of home-station work with high-efficiency gear.

Along the Southern California coast, the temperature inversions of the summer months are making contacts between Los Angeles and San Diego an almost daily matter. Even with very low power, strong signals are being exchanged quite regularly over this 100-mile-plus path.

June brought temperature inversion to the East, too, and 200-mile contacts were made between stations in Eastern New England and

(Continued on page 148)



R. C. (Dick) Hall
W5EIB

R. C. & L. F. HALL, INC.

“THE HAM SHACK”

HOUSTON: 1015-17 Caroline St. • Telephone C-9731

DALLAS: 2123 Cedar Springs Ave. • Telephone

As this is written (6-19-46), it appears that deliveries in August should be very good. We call your attention to the rather complete listing of receivers and transmitters and particularly request that you ask for catalogues on any line in which you are interested. Our own 100 page catalogue is now available and will be sent upon request. Our new store in Dallas is now open. Drop in to see us.



L. F. (Lillian) Hall
W5EUG

SEND MAIL ORDERS AND INQUIRIES
TO HOUSTON

RECEIVERS

HALLICRAFTERS

SX-42 — 540 KC to 110 MC.....	*\$250.00
SX-43 — 540 KC to 108 MC.....	* 150.00
SX-46 — 540 KC to 43 MC.....	* 115.00
S-38.....	39.50
S-40.....	74.50
HT-9 — Transmitter (1500 KC to 28 Megs).....	250.00
S-37 (130 Megs to 210 MC).....	591.75
S-36A (27.8 MC to 143 MC).....	307.50
S-47 (535 KC to 108 MC).....	135.00

*Speakers not included (\$15.00 and Up)

HAMMARLUND

HQ-129-X — less speaker.....	\$168.00
HQ-129-X — with speaker.....	173.25
Super Pro — SP-400-X with speaker.....	342.00

MECK TRANSMITTER

Model T-60-1. Efficient performance on any Amateur Band, 10 to 80 Meters. Phone or CW, 60 Watts.....	\$150.00
--	----------

NATIONAL

HRO-5TA-1 — 4 sets coils (including speaker and power supply).....	\$303.00
HRO-5RA-1 — 4 sets coils (including speaker and power supply).....	327.16
NC-2-40 C — less speaker.....	225.00
Speaker.....	15.00
NC-2-40 D — (Amateur Band Spread).....	225.00
1-10 less tubes, speaker and power supply.....	56.10
5886 Power Supply for 1-10.....	19.10
Tubes for 1-10I.....	9.48
NC-46, less speaker.....	97.50
Speaker.....	9.90

RME

RME-45 with crystal, meter and speaker.....	\$186.00
RME-84 with self contained speaker.....	98.70
DB-20 Presselector.....	59.30
VHF-152 (2-, 6-, and 8-Meter Converter).....	86.60
LF-90 (100-580 KC Converter).....	29.70

PANADAPTER

Panadapter, PCA-2 Complete.....	\$99.75
---------------------------------	---------

Wire, write or phone your order. We will ship C.O.D. with a \$5.00 deposit. We also offer easy terms and trade-in allowances for used equipment. State Tax not included in above figures.

TEST EQUIPMENT IN STOCK

Monitor Crystalizer, Signal Generator.....	\$57.50
Silver Vomax, V. T. M., and V. O. M.....	59.85
Silver, Model 904, Capacitance-Resistance Bridge.....	49.90
Silver, Model 905 "SPARX," Signal Tracer.....	39.90
Silver, Model 906 FM/AM, Signal Generator.....	89.90

Ask for Complete Silver catalogue showing radically new receivers, transmitters and components.
Ask for other brands and models, since Test Equipment is arriving in larger shipments.

PUBLICATIONS — NOW IN STOCK

Radio Amateur Handbook — 1946 Edition.....	\$1.00
Radio Amateur Call Book.....	1.25
The Radio Handbook — 10th Edition.....	2.00
Fundamentals of Radio — Compilation.....	5.00
How To Become a Radio Amateur.....	.25
License Manual — Postwar Edition.....	.25
Log Books.....	.35
Learning the Radiotelegraph Code.....	.25

(Add 10¢ for postage)

CRYSTALS

BLILEY

80 Meter.....	\$2.80
40 Meter.....	2.80

PETERSEN

80 Meter.....	\$2.65
40 Meter.....	2.65
20 Meter.....	3.50
10 Meter.....	5.00

NEW CATALOGUE IS READY

Our complete catalogue for 1946 is just off the press and a postal card addressed to Dept. Q will place you on our mailing list.

“ACROSS THE OPERATING TABLE”

Our latest amateur bulletin is now off the press and a postal card addressed to Dept. Q will place you on our mailing list.

• • • • • A FEW OF THE MANUFACTURERS WHOSE PRODUCTS WE DISTRIBUTE • • • • •

Aerovox	Clarostat	GE	Kaar	Meissner	Pioneer	Setchell-Carlson	Trimmm
Amphenol	Drake	Hallcrafters	Kalner	Millen	Precision	Silver	Triplettt
Astatic	Dumont	Hammarlund	Keinoor	Mueller	Premax	Simpson	Turner
B&W	Echophone	Hytron	Kwikheat	National	Radel	Speed-X	Vaco
Belden	Eimac	Instructograph	Leach	Newcomb	Raytheon	Stancor	Vibroplex
Bliley	Electronics Lab.	Insuline	Lectrohmm	Ohmite	RCA	Supreme	Walsco
Bud	Erie	Jensen	Les Logan	Panoramic	Robson-Burgess	Taylor	Ward
Centralab	Gammatron	JFD	Littelfuse	Peerless	RME	Thermador	Weller
Cinaudagraph	General Cement	Johnson	John Meck	Petersen	Sangamo	Thordarson	Weston

Now!
A Better Soldering Tool...

THE **KWIKHEAT**
VANATTA
THERMOSTATIC SOLDERING IRON

**Has Built-in
 Thermostat
 Control!**



6 TIP STYLES

- #0—\$1.25
- #1—\$1.25
- #2—\$1.25
- #3—\$1.25
- #4—\$1.25
- #5—Melting Pot for tinning—\$1.25

HOT, READY FOR USE ONLY 90 SECONDS after plugging in! Kwikheat is the only soldering iron with a thermostat built into the tool itself—maintaining the proper level of heat for most efficient, economical operation. **SAFE!** ... Cannot overheat—**ECONOMICAL!** ... Lasts longer—saves tips and requires less retinning. **POWERFUL!**—225 watts—yet exceptionally light weight (14 oz.). Well-balanced with cool protecting plastic handle. Modern streamlined design. Six interchangeable tip styles adapt one Kwikheat Iron to all your soldering jobs. You will be proud to own America's finest and most versatile soldering tool... from tip to plug Kwikheat is in a class by itself. Ask your dealer to demonstrate the quick-heating feature now!

*patented
 Kwikheat Iron complete with #1 tip... **\$11.00**
 Set of 5 tips consists of #0, 2, 3, 4 and 5 \$ **5.50**



6 TIP STYLES—QUICK HEATING ELEMENT—BUILT IN THERMOSTAT—WELL BALANCED—COOL PROTECTING HANDLE—LIGHT WEIGHT

Dept. Q-8, Kwikheat Division of
SOUND EQUIPMENT CORP., 3903 San Fernando Rd., Glendale, 4 Calif.

• Ted McElroy
 World's Largest Manufacturer of
 Wireless Telegraphic Apparatus
 COMPLETE CENTRAL OFFICE EQUIPMENT
McElroy Manufacturing Corp.
 82 Brookline Avenue • Boston, Massachusetts

U P A N ' A T ' E M



Full trussed wooden towers for your rotary.
 Priced for the amateur.

Write for Bulletin T-101

SKY-LANE PRODUCTS
 IRONWOOD, MICHIGAN

(Continued from page 144)

those in New York, New Jersey, and Pennsylvania on several nights. What was probably the greatest temperature inversion of the postwar period made an almost unbelievable bedlam of the 144-Mc. band on the night of June 25th. On that occasion New England was covered with an overrunning mass of very warm moist air, and at dusk that evening the base of this air mass was marked by the most pronounced smoke-dust layer² ever seen by the writer. Throughout the night and into the next day signals on both 50 and 144 Mc. were spreading out over the northeastern part of the country with almost no attenuation. There were numerous instances of signals from 100 miles or more arriving with a strength exceeding that normally received from stations only a few miles away over line-of-sight paths. Elevation meant almost nothing, and intervening hills were of no consequence.

Low-powered stations were receiving S9-plus reports at 150 miles. A number of 144-Mc. stations in the Boston area and farther north worked stations in New York and New Jersey. Typical contacts: W1KTJ, Stoneham, Mass. — W2FJQ, South River, N. J., 210 miles; W1JFF and W1LPO, Newport, R. I. — W3GQS, Feasterville, Penna., 210 miles; W1HDQ, West Hartford — W2GSO/2 in Southern New Jersey, 200 miles; W1IGD, Gloucester, Mass. — W1LAS/2, Bedford, N. Y., 185 miles. W1IGD is located on Merchant's Island, north of Gloucester, where no a.c. is available. He runs a 15-watt MOPA and has a 16-element array which is only 20 feet above the ocean at high tide! He was hearing W2FJQ, more than 240 miles distant, at times when no other signals were audible. The degree of reflection was such as to produce a sort of skip effect. Several times at W1HDQ we would hear Boston-area stations calling W2s when the latter were inaudible at our location, which is midway along the path between Boston and New York. Within a matter of minutes the condition would reverse itself, and the W2s would come roaring in *off the back* of our 16-element array, with the Boston stations dropping almost to inaudibility off the front of the beam! Reports of S9-plus were received at intervals from both ends of the path, though there were other times when no stations could be raised in either direction.

Some idea of the coverage now being obtained on 144 Mc. can be gained from the fact that on several occasions W1s, W2s and W3s have been able to work as many as six states in the course of one evening. W1LPO, Newport, R.I., worked 15 W2s and one W3 (W3GQS, 210 miles) on June 16th. W2AES, Seaford, N.Y., has worked W3HWN, Mechanicsburg, Penna., 180 miles, on several occasions. This is quite a different matter from the work mentioned above, in that both stations use high-gain superhet receivers, and are working across difficult terrain and through heavy QRM. W3HWN has heard numerous W2s

(Continued on page 148)

² See, "On the Very Highs," *QST*, July, 1944, for explanation of visible evidence of temperature inversions.

A Triumph in
COMMUNICATIONS ENGINEERING

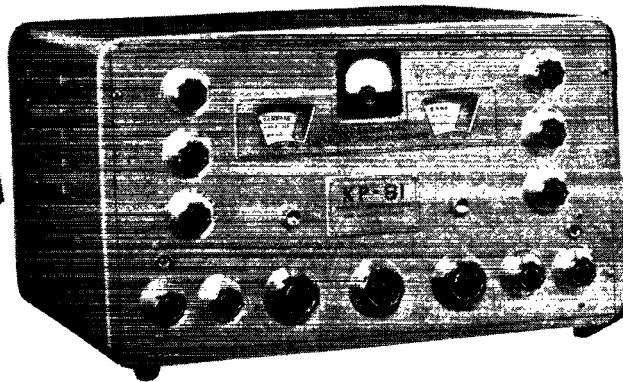

The New Improved
KP - 81
Receiver

DESIGNED by Karl E. Pierson, creator of the famous PR series of receivers, the new KP-81 is now in production. We promise you this receiver will establish new standards of excellence in the field of radio communications. KP-81 incorporates many of the advanced features born of wartime research, and is years ahead in design, engineering and performance.

We are making every effort to meet the heavy demand for the new KP-81 receivers. However Pierson Electronic Corporation will adhere to their policy of precision construction, and suggest that you place your order well in advance.



New Automatic Noise
Silencer
Two Pre-Selector Stages
Turret Band Change
Four Gang Tuning and Band
Spread Condensers
Series Parallel Crystal Filter
Calibrated Band Spread
Built-In Crystal Calibrator
Single Signal At All Times
Variable Hi and Lo Pass
Audio Filters
550 Kilocycles to 40
Megacycles

PIERSON ELECTRONIC CORP.

533 EAST FIFTH STREET • LOS ANGELES 13, CALIF.

Manufacturers of Communication and Commercial Radio Equipment

Export Department: FRAZER & HANSEN, 301 Clay St., San Francisco 11, Calif., U. S. A



Founded in 1909

**RADIO TELEPHONY
RADIO TELEGRAPHY**

Courses ranging in length from 7 to 12 months. Dormitory accommodations on campus. Advanced students eligible for practical training at KPAC, 1 KW broadcast station owned and operated by Port Arthur College. New students accepted monthly. If interested in radio training necessary to pass F.C.C. examinations for first-class telephone and second-class telegraph licenses, write for details.

PORT ARTHUR COLLEGE PORT ARTHUR TEXAS
Approved for G.I. training

ATTENTION HAMS!

Learn all about radio's latest development—the **IRON CORE TUNER**. Replaces 2-gang condenser and the oscillator. A complete, tracked unit. Try it yourself. Prepare to deal with it in servicing or on your job. Write for details.

MAGNA-METAL PRODUCTS CO.
70 East 45 St., New York City MU 4-0432

COMMERCIAL RADIO INSTITUTE

A RADIO TRAINING CENTER FOR 26 YEARS

Resident Courses Only • Broadcast, Service, Aeronautical, Television, W.H.F., Freq. Modulation and Marine telegraphy classes now forming for fall term Oct. 1.

Literature upon request. Veteran training

Dept. B, 38 West Biddle Street, Baltimore 1, Maryland

**TRANSMISSION
LINE SPACER**

- Low Loss • Easily Attached • No Metal Contact

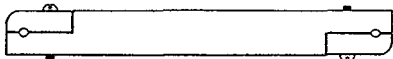

PATENT APPLIED FOR

Type LX-2 (2 in.) Type LX-4 (4 in.)
Type LX-6 (6 in.)

- Fabricated from Amphenol 912-B (low moisture absorption—low power factor—low loss factor)
- Easily attached to line wires without threading through holes
- No metal contact between line wires and spacer to cause noise or changes in line characteristic

SEE THEM AT YOUR DISTRIBUTORS!

**THE Arthur L. Munzig
MANUFACTURING COMPANY**

The Arthur L. Munzig Mfg. Co., Redlands, Calif.

(Continued from page 146)

up around the New York area, but only the few who have selective receivers are ever able to hear him through their local QRM. Paul has also heard W1CLH and W1OFS, but has yet to work into the first call area. He runs crystal control on 144.048 and 145.0 Mc.

Even on poorer nights, W1JFF, Newport, R.I., is able to hear signals out to 100 miles or so quite regularly. There appears to be a pick-up in signal strength around 11 o'clock nightly, and at this time quite a few stations along Long Island Sound may be heard. On the better nights numerous W2s from New Jersey come through with good strength, and Pennsylvania and Southern New Jersey are being heard more often.

Out in the Middle West, W9ZHB and W9HQAQ find time in between 50-Mc. DX contacts to work on 144 Mc. By using crystal control, horizontal beams and superhet converters, they have made the Davenport, Iowa-Zearing, Ill. circuit a reliable proposition, with signals approaching those obtained on 50 Mc.

The 16-element beam idea has really taken hold. There is little doubt that this sort of array, using stacked elements fed in phase and backed up by reflector elements (or better still, a plane reflector), is one of the most effective radiating systems for vertical polarization. Not only has this type of array been used with outstanding success by dozens of stations in the East, but we find it responsible in part for the setting of the West Coast record of W6RBQ/6-W4TZ/6, and finding increased favor in many other quarters. The accompanying photo shows the 16-element array erected by VE7AEC, at Duncan, British Columbia. The Sands Point Tower, near Seattle, 120 miles distant, is heard on 142 Mc. consistently but no contacts have been made with amateurs in the Seattle area, though schedules have been maintained with W7EOP, who also has a 16-element array. VE7AEC will be glad to keep schedules with any stations in that area, for two-way work on 144, or for cross-band contacts with 10- or 75-meter 'phone stations. Active stations on 144 include K7CZY/W7; W7s EOP, DYD, HOL, IOQ, EUI, JIE, JFB, IOQ, CGL, JKB; VE7s QS, NV and AEC. The VE's listed are all in Duncan, which is on Vancouver Island, due east of Bellingham, Wash.

New Records for 420 and 2300 Mc.

As if setting a record for 144-Mc. work were not enough, W4TZ/6 has done it on 420 Mc., too. Operating from Twin Peaks, San Francisco, on June 26th, W4TZ/6 made solid contact with W9OAW/6 on Mt. Hamilton, 52 miles distant.

And here is an extension of the existing record for microwave communication on 2300 Mc. which was accomplished in connection with Field Day activities. On June 23rd, W1JSM/1 and W1LS/1, operating on 2375 and 2350 Mc., with a power of 100 milliwatts, maintained contact over a distance of 1.6 mile. An unsuccessful try at 40 miles was made the previous day.

(Continued on page 160)

HARRISON HAS IT!

ALL STANDARD LINES

We are

Factory Authorized Distributors

for the top quality manufacturers and we now have in stock lots more new, latest improved production Ham gear! Visit our stores today, for everything you need. We promise you fresh clean material—quicker—at the lowest current prices—and, above all, our sincere desire to be of friendly, helpful service.

As one of the world's largest distributors of Communications Equipment, we are delivering plenty of

Receivers

right now! **ALL MAKES**—practically all models. If you want your new set in the quickest possible time send your order to HARRISON!

For example:—

- NATIONAL HRO-5TA-1. New model with noise limiter, metal tubes, ham bandspread coils, etc. Complete with pack, speaker, and coils 1.7 to 30 Mc. \$303.00
- HAMMARLUND new Super-Pro. SPC-400-SX. 1.25 to 40 Mc. \$310.05
- HALLICRAFTERS—Model S-36-A. FM-AM-CW with peak performance on 10 and 6 meters, a swell police job, a beautiful high-fidelity FM receiver for both old and new bands, an excellent piece of Lab equipment—all in one! Acorn tube RF section, noise limiter, 15 tubes. 27.8 to 143 Mc. \$307.50
- S-37. 130 to 210 Mc. \$591.75
- RME 45. New, revised model with calibrated ham bandspread. With speaker \$186.00

LITERATURE ON ANY RECEIVER GLADLY SENT UPON REQUEST

The PANADAPTOR

has earned its acceptance as a decidedly worth-while adjunct to any Ham Shack! Harrison has it—in stock. \$99.75

Millen 50 Watt Transmitter-Exciter

Four bands on one crystal No. 90800, with one set of coils. \$37.50

1N34 Crystal Diode

Specified in recent articles for noise limiters, field strength meters, etc. \$1.80

NARROW BAND FREQUENCY MODULATION WITH YOUR CW TRANSMITTER

The Sonar Exciter feeds into the crystal socket of any power rig. Eliminates BC Interference! Sensational results!

Harrison Has It. \$39.45
Complete with tubes

ASK FOR LITERATURE

MAIL ORDERS? Certainly! Just list everything you want (items in this ad, or any ad, magazine, or catalog) and include deposit.

73 de

Bill Harrison, W2AVA

HARRISON HAS IT!

HARRISON SELECT SURPLUS

Your assurance of good, usable, guaranteed, surplus material at sensationally low prices—TOP VALUE ALWAYS! Come in and browse through our large HSS Department.

BEAM POWER TUBE VALUES

- 807 Always popular! New amateur net—\$2.30. HSS—\$1.75 each! Three or more at. \$1.47
- 814 Can give 160 watts output with only 1 1/2 watts drive. Net price \$14.00, reduced from \$17.50. HSS. \$7.45
- 257-B (4E27) Full power up to 150 Mc! 1.4 watts drives 230 watts output. Amateur net price is \$24.50. Harrison sells them for only \$6.90

O-1 DC MILLIAMMETERS

Flush panel mount bakelite case, 3/4 inch diameter. D'Arsonval movement with jeweled bearings, 2% guaranteed accuracy. FB for multi-meter, field strength, etc. Excellent value at only. \$4.75

.0001 MF 9000 VOLT

peak working mica condensers—Sangamo Type F3L, 3" x 2 1/4" x 3" body. List price \$25.15. HSS. \$5.67

2 METER RF CHOKES

Ward-Leonard type Z-O. Per Dozen. \$1.00
(\$5 per Thousand)

COAXIAL CABLE!!

All new, perfect, and at lowest prices!

Type	Impedance	O.D.	Price per foot
			1-100' 100' and up
RG-8/U	52 Ohms	.405"	9c 6c
RG-11/U	75 Ohms	.405"	10c 7c
*RG-13/U	74 Ohms	.420"	14c 10c
*RG-39/U	73 Ohms	.312"	11c 8c
RG-58/U	53 Ohms	.195"	8c 5c
RG-22/U	95 Ohms	.405"	25c 25c

*Double Shield.
Furnished in one piece within +/-0% to +/-20% of length ordered. Full measure!

24G TUBES

(3C24)

An FB tube for VHF. 90 watts rated class C output. Compact size. Ham net was \$9.00, reduced to \$6.00, but Harrison sells them for only \$1.69 each. Three or more at. \$1.48

XTALS

Here is the VALUE in Ham band xtals that tops anything you have ever seen! Made for Signal Corps—so they must be good! A fully mounted and sealed crystal for less than the blank alone.

40 METERS in DC-35 and 80 METERS in DC-34. Three or more postpaid. Specify frequency range when ordering. Holders.90c

BC-406 15-TUBE UHF RECEIVERS

Been getting such FB reports from our customers about these swell Signal Corps Radar receivers that we just had to get more for you.

Six acorn tube RF circuit, tuned to 205 MC; four IF stages; Thordarson heavy duty power transformer delivering 350 volts at 145 MA; four choke and oil condenser filters; 115 volt 60 cycle operation; chassis 10 1/2" x 25 1/2", in metal case. Slightly used but fully guaranteed. Complete with tubes; 5—954, 1—955, 4—6SK7, 2—6S7, 1—6X4.

Instructions and diagrams for easy conversion to a hot 10 (also 6 and 2) meter superhet receiver are included. The parts alone are worth much more than \$21.98 our low HSS Price. \$21.98

HAM HEADQUARTERS
Since... 1925!



HARRISON RADIO CORPORATION

12 WEST BROADWAY • NEW YORK CITY 7

BARCLAY 7-9854

JAMAICA BRANCH — 172-31 Hillside Ave. — REPUBLIC 9-4102

What is the V.H.F. DX Limit?

If it is possible to cover better than 300 miles from ground locations, how far can one work from a plane? W6TZB/K6 suggests the possibilities when he describes his experiences in flying in from over the Pacific to the West Coast. Coming in at 9000 feet on June 1st, he heard Alameda Tower while 20 miles southwest of Point Loma, San Diego. Their 142-Mc. signal was so strong at this level that it drowned out the signal from Camp Kearney, only 30 miles away. The Alameda signal was very strong down to 5700 feet, when it cut off abruptly. As the horizon is only about 125 miles distant at 9000 feet, and the distance from San Diego to Alameda is more than 450 miles, this would indicate that the signal from Alameda was trapped in an atmospheric duct, the base of which was at 5700 feet. If this be true, who can say how far the Alameda signal might have been heard at the 9000-foot level? Such a condition may occur fairly often along our coasts in warm weather, pointing up the possibility of contacts being made at distances of 1000 miles or more on frequencies of 144 Mc. and higher!

Calling all...

FM

AMATEURS HF

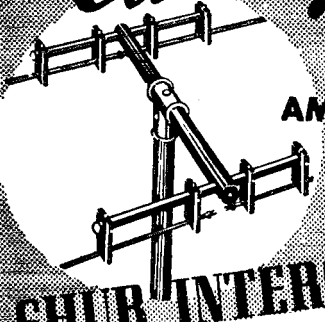

SHUR INTERCEPTOR

(Patent Pending)

ALL

Tuning Factors

Simply • Easily • Adjustable

Models ready — 54MC — 56MC 144MC — 148MC 167MC — 168MC

Easily assembled — marked for middle of the bands • Adjustable Spacing • Adjustable Lengths • Screw "Lead In" Connections • Dural Elements • Treated for Weather Endurance • Low Loss Insulation — Synthane • Lightweight Ideal As Transmitting Antenna

SHUR-ANTENNA-MOUNT INC.

Eastern Division Western Division
SEA CLIFF, N. Y. PORTER BLDG. KANSAS CITY, MO.

More 50-Mc. Frequencies

- W1BB Winthrop, Mass., 52.0 Mc.
- W1FJN Scituate, Mass., 50.113
- W2BYW Tenafly, N. J., 50.2
- W2EUI Roselle, N. J., 51.3
- W2FID Montrose, N. Y., 50.4
- W2GYV Schenectady, N. Y., 51.45
- W2KFG Brooklyn, N. Y., 50.8
- W2MLX Mountain Lakes, N. J., 50.7
- W3BYF Allentown, Pa., 50.5
- W3CUD Collingswood, N. J., 50.3
- W3EUY Riverton, N. J., 52.0
- W3IUN Washington, D. C., 52.5 (f.m.)
- W3AIR Takoma Park, Md., 50.007, 50.17
- W3EIS Beltsville, Md., 50.1
- W1KMZ/3 Washington, D. C., 50.008
- W4EDD/3 Washington, D. C., 50.61
- W1DEI/3 (mobile), 51.02
- W1QB/4 Arlington, Va., 51.02
- W1LNC/3 Washington, D. C., 50.7
- W9STX/3 Washington, D. C., 50.27
- W1NWE/4 Orlando, Fla., 50.18
- W9WMI/4 Raleigh, N. C., 50.5
- W5AJG Dallas, Texas, 50.216
- W5FRD Fort Worth, Texas, 50.016
- W5HF Amarillo, Texas, 50.08
- W5HYT Amarillo, Texas, 50.06
- W5WX Amarillo, Texas, 50.1
- W6MZQ San Mateo, Calif., 51.0
- W6PZB San Mateo, Calif., 50.4
- W6QT Berkeley, Calif., 50.1
- W6SLO/5 Ingleside, Tex., 50.4
- W5JGV/7 Douglas, Ariz., 51.6
- W8CVQ Kalamazoo, Mich., 52.33, 52.54
- W8NOR Buffalo, N. Y., 51.68
- W9ETJ St. Louis, Mo., 52.5 (f.m.)
- W9DWU Minneapolis, Minn., 51.0
- W9DZM Anoka, Minn., 50.15
- W9IFW Minneapolis, Minn., 50.4
- W9JVE St. Louis, Mo., 51.8
- W9JHS Champlin, Minn., 50.38
- W9NJT Watertown, Wis., 50.852
- W9NCS Minneapolis, Minn., 50.02
- W9SV St. Cloud, Minn., 50.06
- W1KTF/9 Chicago, Ill., 51.6
- W9OBW Chicago, Ill., 50.65
- W0QIN Minneapolis, Minn., 51.2

High Forward Gain, Wide-Spaced, 4-Element, All-Aluminum

10 METER BEAM

Weights only 15 lbs. l. Puts terrific sig. where you want it. No insulators, no adjustments of any kind! Just attach 2-inch line or twin 300 ohm line and use! Easily supported and rotated with a 1 1/4 inch round wood pole. Up to ten times power gain over 1/4 wave ant. Greatly reduces ignition and other QRM. Package has elements; hor. sup. member; delta terminal panel; all hardware; complete instructions and clear print. Amateur net price \$50.

Send for literature on the above, our beams for 30, 144, 235 and 425 Mc., and High-Q tuned circuits for the U.H.F. bands and the new 20-METER BEAM. Wide-spaced, high forward gain, all-aluminum, 3 element, no insulators, no wood! Light weight, high strength, easy to mount.

U.H.F. RESONATOR CO.

GUION ROAD, RYE, N. Y. • Telephone Rye 2030

Chief Specials

- 10 h, 250 ma. Chokes — fully shielded — made by GE — 1500 volt (conservative rating) insulation \$2.95
- 7.5-20 mnmfd. UHF Tank Tuning Cond. rated at 1750 volts rms — A Real Buy at only 95¢
- 0-156 volts AC Triplet 351 meters \$4.65
- 10 mfd. 600 volts Sq. Can Cond. Special \$2.25
- RCA 813's — NOT SURPLUS \$14.50
- HYTRON HY-O-75 Kits \$9.95
- HYTRON HY-75, HY-615, HY-114B, 2E30 in stock. Our stock includes a complete line of RCA Power Tubes — MILL-EN — RADIANT — HAMMARLUND — IRC — AEROVOX — CLAROSTAT parts. Write Irv. Wolfe, W2APJ for our latest list of specials.

CHIEF ELECTRONICS

"Mid-Hudson Valley's Only Ham Distributor"

Wholesale Only

104B Main Street Poughkeepsie, N. Y.



B&W COAXIAL CABLE CONNECTOR

EASY TO INSTALL - ABSOLUTELY WATER-TIGHT - SEALS CABLE ENDS - SERVES AS CENTER INSULATOR OF A HALF-WAVE DOUBLET

No more inefficient, home-made co-ax cable connections. The new B & W CC-50 Coaxial Cable Connector does this all-important job in a jiffy and does it right. Made of cast aluminum with forged steel eyebolt with easy soldering connections and steatite insulation. Weighs only 12 ounces—priced at \$5.00 amateur net. See it at your jobber's or write for details.

BARKER & WILLIAMSON
237 FAIRFIELD AVE., UPPER DARBY, PA.

THE TURNER 34X

SEMI-DIRECTIONAL CRYSTAL MICROPHONE

Here's both beauty and performance for your rig. The ultra modern design of the Turner 34X results in a semi-directional unit with remarkably low feedback characteristics. Its high quality crystal and Turner precision diaphragm produce a smooth, even response that varies only ± 5 DB from 30-10,000 cycles. Ideal for both voice and music pickups. Output level is -52DB. Crystal is moisture, blast, and mechanical-shock proofed, and equipped with automatic barometric compensator. Finished in rich brushed chrome, complete with 90° tilting head and 20 ft. removable cable set.

ASK YOUR DEALER OR WRITE
Licensed under U. S. Patents of the American Telephone and Telegraph Company, and Western Electric Company, Inc.

TURNER
Pioneers in the communications field
Microphones

THE TURNER COMPANY
917 17th Street N.E.
CEDAR RAPIDS, IOWA

Complete Microphone Catalog
Write for Copy Price 60¢

Crystals licensed under patents of the Brush Development Co.

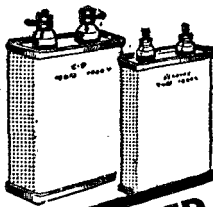

10 MFD.—1000 volts,
No. 17A268\$3.95
4 MFD.—1500 volts,
No. 18A227\$2.94
Plus 20c each postage
and pkg. charges.

OIL FILLED • HI-VOLTAGE CONDENSERS

EXTRA SPECIAL VALUE

Limited quantity of these fine condensers with ceramic insulated terminals. Place your order at once.

18 YEARS IN RADIO

Latest developments in radio and electronic parts and devices, newest "Ham" gear, gadgets to delight the heart of the experimenter, bargains in selected war surplus radio items. Some of the best values we have offered in our 18 years in business.

WRITE FOR CATALOG

Get on our mailing list and receive our bulletins and catalogs as issued.

BURSTEIN-APPLEBEE CO.
1012T McGee, Kansas City 6, Mo.



RCA INSTITUTES, INC.

Offer thorough training courses
in all technical phases of

RADIO and TELEVISION

WEEKLY RATES

DAYS—EVENINGS

VETERANS: RCA Institutes is approved
under G. I. Bill of Rights
For Free Catalog write Dept. ST-45

RCA INSTITUTES, INC.

A Service of Radio Corporation of America
75 Varick Street, New York 13, N. Y.

CUT SENDING EFFORT IN HALF

WITH
THE GENUINE
EASY-WORKING

VIBROPLEX

Reg. Trade Mark: Vibroplex, Lightning Bug, Bug

Original DeLuxe
Model

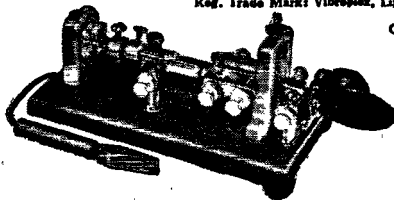

WITH
PATENTED
JEWEL
MOVEMENT

\$19.50

For downright easy sending — there's nothing to equal this "ORIGINAL" DeLuxe Vibroplex key.

Famous the world over for its feather-touch action, superior signals and ease of operation. Equipped with the sensational and exclusive PATENTED JEWEL MOVEMENT this key develops the highest degree of sending skill attainable, prevents "glass" arm and cuts sending effort in half. Chromium finished base. Bright machined parts. Colorful red switch knob, finger and thumb piece. 3/16th contacts. Circuit closer, cord and wedge. DeLuxe finish also available in "BLUE RAGER" and "LIGHTNING BUG" models. Act wisely! Order yours to-day! Money order or registered mail. FREE catalog.



The "BUG" Trade Mark identifies the Genuine Vibroplex. Accept No Substitute

THE VIBROPLEX CO., Inc.

833 Broadway

New York 3, N. Y.

ARRL QSL BUREAU

FOR the convenience of American and Canadian amateurs, the League maintains a QSL-card distributing system which operates through volunteer "District QSL Managers" in each call area. To secure such foreign cards as may be received for you, send your district manager a standard No. 10 stamped, self-addressed envelope. If you have reason to expect a considerable number of cards, put on an extra stamp so that it has a total of six cents postage. Your own name and address go in the customary place on the face, and your station call should be printed prominently in the upper left-hand corner. If you have held other calls in previous years, submit an envelope for each such call to the proper manager — there are many thousands of un-called-for cards in the files. All incoming cards are routed by Hq. to the home district of the call shown in the address. Therefore, cards for portable operation in other districts should be obtained from the home-district manager.

W1 — Jules T. Steiger, W1BGY, 231 Meadow St., Wilimansett, Mass.

W2 — Henry W. Yahnel, W2SN, Lake Ave., Helmetta, N. J.

W3 — Maurice W. Downs, W3WU, 1311 Sheridan St., N. W., Washington 11, D. C.

W4 — Edward J. Collins, W4MS, 1215 North 12th Ave., Pensacola, Fla.

W5 — L. W. May, jr., W5AJG, 9428 Hobart St., Dallas 18, Texas.

W6 — Horace R. Greer, W6TI, 414 Fairmount Ave., Oakland, Calif.

W7 — Frank E. Pratt, W7DXZ, 5023 S. Ferry St., Tacoma, Wash.

W8 — Fred W. Allen, W8GER, 1959 Riverside Drive, Dayton 5, Ohio.

W9 — F. Claude Moore, W9HLE, 1024 Henrietta St., Pekin, Ill.

W0 (as established) — Alva A. Smith, W9DMA, 238 East Main St., Caledonia, Minn.

VE1 — VE1FQ will resume service soon.

VE2 — C. W. Skarstedt, VE2DR, 3821 Girouard Ave., Montreal 28, P. Q.

VE3 — W. Bert Knowles, VE3QB, Lanark, Ont.

VE4 — c/o ARRL.

VE5 — J. A. Bettin, VE5YR, P. O. Box 55, Togo, Sask.

VE6 — W. R. Savage, VE6EO, 329 15th St. North, Lethbridge, Alta.

VE7 — H. R. Hough, VE7HR, 1785 Emerson St., Victoria, B. C.

VE8 — Yukon A. R. C., P. O. Box 268, Whitehorse, Y. T.

K4 — E. W. Mayer, K4KD, P. O. Box 1061, San Juan, P. R.

K7 — J. W. McKinley, K7GSC, Box 1533, Juneau, Alaska.

Strays

Here's an announcement received at Hq., via W8JM, regarding W8WNO's new xmtr: "QTH, 87 Randolph St., Buckhannon, W. Va. Completely finished, 12:45 p.m., Jan. 26, 1946. Weight fully equipped, 9 lbs. Ken Burroughs, designer and chief engineer; Ruth Burroughs, production manager; Dr. J. C. McCoy, distributor. Features of new model: white cabinet, two-lung power supply, one tube (water cooled), trade name, Gary Allen, p.d.c. note, two blue-eyed meters, no QRH."



For the Man Who Takes Pride in His Work

**FM and Television Band Coverage on
Strong Harmonics. Strong Fundamentals to 50 MC.**

Another member of the Triplet Square Line of matched units this signal generator has features normally found only in "custom priced" laboratory models. **FREQUENCY COVERAGE** — Continuous and overlapping 75 KC to 50 MC. Six bands. All Fundamentals. **TURRETTYPE COIL ASSEMBLY** — Six-position turret type coil switching with complete shielding. Coil assembly rotates inside a copper-plated steel shield. **ATTENUATION** — Individually shielded and adjustable, by fine and coarse controls, to zero for all practical purposes. **STABILITY** — Greatly increased by use of air trimmer capacitors, electron coupled oscillator circuit and permeability adjusted coils. **INTERNAL MODULATION** — Approximately 30% at 400 cycles. **POWER SUPPLY** — 115 volts, 50-60 cycles A.C. Voltage regulated for increased oscillator stability. **CASE** — Heavy metal with tan and brown hammered enamel finish.



**MODEL 2432
SIGNAL GENERATOR**

Triplet

ELECTRICAL INSTRUMENT CO., BLUFFTON, OHIO

HAM HEADQUARTERS FOR *Equipment and Information*

EXTRA SPECIALS

- J-38 Key with Switch..... \$.80
- TAC MS700. Master Code Practise Oscillator.... 10.25
- Aero—Running time meter, 60 cycle A.C..... 3.50
- Meters 2" case, 0-150 V-AC, 0-30V DC-5 MA Movement, Each..... 2.25
- DPDT Relay 5 V. DC..... 1.75
- 2 Mfd.—1000 V. Round can..... 1.50
- 3 x 3—600 V., oil filled..... .99
- Air Trimmers 100 MMfd..... .50

MAIL ORDERS PROMPTLY FILLED

Amateurs to Serve You

(20% Must Accompany All C. O. D. Orders)

Write to Dept. QST

W6SCQ • W6UXN • W6NAT • W6SSU

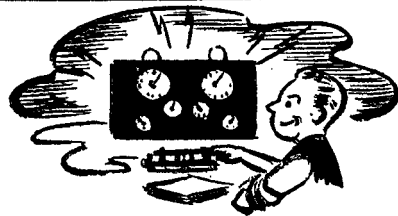

FOR YOUR NEW RIG

**We Have a Good Stock
of All Standard Lines**

SUPER BUY!

Army BC-611F Handie-Talkie, complete with Tubes and Batteries.... **\$49.50**

Radio Product Sales Company

238 WEST 15TH STREET

LOS ANGELES 15, CALIFORNIA

PRospect 7471

SREPCO SPECIAL

ROTARY BEAM INDICATOR

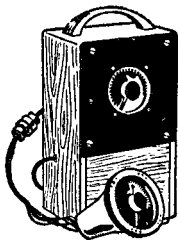

Selsyn Transmitter and Indicator Set. Ideal for indicating direction of rotary beam antennas. Indicator mounted in attractively grained wood cabinet. Furnished with 5 feet of 4 conductor cable, disconnect plug and socket and wiring diagrams. Operates on 6 volts AC.

ONLY
350 PER SET

Standard
RADIO & ELECTRONIC
PRODUCTS COMPANY

135 E. SECOND STREET • DAYTON 2, OHIO

RADIO INSTRUCTORS ●

Receiver servicing experience. College degree preferred. \$3600 a year to start, \$4200 after four months. Work in the heart of the Radio Industry. We will teach you practical television. Write Raleigh G. Dougherty, 158 Market Street, Newark 2, New Jersey, c/o New York Technical Institute of New Jersey. America's foremost Television school.

AMATEUR GEAR

8 CONNECTICUT AND
MASSACHUSETTS
HAM STORES

CONNECTICUT:

Hartford, New Haven, Bridgeport, New London,
Stamford, Waterbury. MASSACHUSETTS: Boston
and Lawrence

HATRY & YOUNG
The Elect in Electronics

Correspondence

(Continued from page 73)

Maybe it wasn't so far-fetched after all. In June *Electronics* is an article by Horace W. Babcock of Mt. Wilson Observatory titled "Electronic Code Translator," and darned if it isn't pretty nearly the same thing. In his unit, however, the code comes off typed with the letters of the printing being governed by the weight — yes, weight — of the characters.

A-ha! The hams are again two years in front of the pros.
— Frank J. Beahn, W8UNM

F.S.K.

4696 Brown Rd., Avoca, Mich.

Editor, *QST*:

A hasty perusal of an article in June *QST* might lead one to believe that frequency-shift keying as practiced by some commercial stations was something new.

I used such a method for several months about 1926 and since I was introduced to it by a real old timer I judge it is about as old as c.w. transmission. It was called "compensated keying" then and was usually accomplished by shunting a very small capacity across one or two turns of the tank circuit in the self-excited rig of that day. It had a number of advantages amongst which I remember greater stability and less interference with broadcast reception. I abandoned it after a few months, however, and the method was soon outlawed by the radio division of the Department of Commerce because it reduced the number of usable channels by about one half.

— Charles H. Vincent, W3RD

[Editor's Note: The new thing about f.s.k., of course, is the receiving method, not the fact that a backwave is transmitted.]

AND NOW, SPHERICAL BANDS

1036 Mariposa Ave., Berkeley, Calif.

Editor, *QST*:

As has been true of all scientific discoveries, the "circular band theorem" is already the subject of refinements by contemporaries. Shuart, W2AMN, came up with a proposal in the June issue, recommending a system of vertical modulation.

This is an important step forward, though a trifle hard to visualize. It would seem that if we are to avoid interference with other services, the Shuart system would actually *have* to be applied vertically. In effect, this gives us "cylindrical" bands. But it does overlook an inevitable situation: no matter how long the cylinders are made, somebody is sure to overmodulate! Even if power limitations are strictly observed, such a system is bound to get unwieldy.

With this consideration in mind, it seems that nothing will suffice except *spherical* bands. Overmodulation will become a physical impossibility. The only requirement is that one side of the carrier be shifted 90° in phase. This is necessary because with really heavy modulation, the wave envelopes would meet at the band antipodes and cause severe distortion due to cancellation. However, if we take the precaution to shift the phase of one component 90°, interference cannot take place. This is analogous to the well-known situation with polarized light waves, where it is shown that light waves do not interfere provided their planes of polarization are mutually perpendicular.

Immediately, other advantages become obvious. For one thing, the number of available channels is enormously multiplied, since there are so many more points on a sphere than on a circle. This should take care of any foreseeable increase in the number of hams.

It is also a boon to the chap with only one crystal. He can now operate with impunity on the same frequency with a full kw., without a trace of interference: all he has to do is orient his signal, adjust the phase so that the necessary condition of 90° obtains, and the channel is effectively all his very own! Once you get the slant, it's easy.

Will somebody please help me recalibrate my receiver?

— Harold R. Fearon, W1KYT/6



World's Largest DISTRIBUTOR OF SHORT WAVE RECEIVERS

Do business with the biggest and one of the best in the field. Enter your orders for the following:

Hallcrafters S38 complete.....	\$39.50
Hallcrafters S40 complete.....	79.50
Hallcrafters S36A.....	307.50
Hallcrafters SX42.....	approx. 250.00
Hammarlund HQ-129X complete.....	173.25
SP-400-SX Super Pro complete.....	318.00
SF-400-X Super Pro complete.....	342.00
National NC-46 complete.....	107.40
HRO Sr., noise silencer, 4 bandspread coils.....	274.35
National NC-2-40D complete.....	240.00
National I1-10A.....	56.10
RME-45 complete.....	186.00
RME-84 complete.....	98.70
Pearson KP-81 complete.....	318.00
BC-348Q 110 V AC model NEW.....	85.00
SCR-211 NEW.....	86.50
Tamco 75GA transmitter.....	495.00
Panoramic PCA-2 panadaptors.....	99.75

Prices subject to change.

Other receivers, transmitters, etc., as available

Delivery of receivers is much better. Many models I can ship at once from stock. By dealing with the world's largest distributor of short wave receivers you are assured of the fastest delivery and the best service.

Send your orders now. Trade-ins solicited. You can buy on my 6% terms. I have a large stock of test equipment, amateur transmitters and parts, government surplus bargains, etc. Write for lists. Let me know your needs. I will try to give you better service and help. Your inquiries and orders invited. Write, phone, wire or visit either of my stores.

Bob Henry

W3ARA

BUTLER, MISSOURI

HENRY RADIO SHOPS

LOS ANGELES 25, CALIF.

"WORLD'S LARGEST DISTRIBUTOR OF SHORT WAVE RECEIVERS"

DEAL
CREEK & RIDGE AVENUE
Philadelphia, Pennsylvania

Lumber and More

Crystal Research Laboratories
29 Allyn Street
Hartford 3, Connecticut

Gentlemen:
I am not very good at composing letters of appreciation, but I want to let you know that in every respect, I am satisfied with your products.

A short time ago, I purchased one of your Crystal Kits and have had a lot of pleasure grinding Xtals to the frequency that I desire. I had never ground any Xtals before but by following the instructions in your simplified instruction book, my Xtals work like a charm.

It would be appreciated if you would let me know if you are going to put out any kit with Xtals in the 90 meter band.

Very truly yours,
Paul Brooks
2714 Onaga Avenue
Phillips, Pa.

Member of Farm Buildings

THANKS

W3 AOE for your kind letter. Crystalab skill and experience is your assurance of continuous high quality and exacting standards.

Crystalab Crystal Kit No. 3 contains all components needed to grind your crystals to desired frequencies, \$5.00 net. Crystal Cards, each with 5 blanks supplied at random frequencies throughout one Amateur band, calibrated to within ± 5 KC, \$5.00 net price per card. See your local radio jobber.



CRYSTAL RESEARCH LABORATORIES, INC.

29 ALLYN ST., HARTFORD, 3, CONN., PHONE 7-3215

HAM-ADS

(1) Advertising shall pertain to radio and shall be of nature of interest to radio amateurs or experimenters in their pursuit of the art.

(2) No display of any character will be accepted, nor can any special typographical arrangement, such as all or part capital letters be used which would tend to make one advertisement stand out from the others.

(3) The Ham-Ad rate is 30c per word, except as noted in paragraph (6) below.

(4) Remittance in full must accompany copy. No cash or contract discount or agency commission will be allowed.

(5) Closing date for Ham-Ads is the 25th of the second month preceding publication date.

(6) A special rate of 7c per word will apply to advertising which, in our judgment, is obviously non-commercial in nature and is placed and signed by a member of the American Radio Relay League. Thus, advertising of bona fide surplus equipment owned, used and for sale by an individual or apparatus offered for exchange or advertising inquiring for special equipment, if by a member of the American Radio Relay League takes the 7c rate. An attempt to deal in apparatus in quantity for profit, even if by an individual, is commercial and all advertising by him takes the 30c rate. Provisions of paragraphs (1), (2), (4) and (5), apply to all advertising in this column regardless of which rate may apply.

(7) Because error is more easily avoided, it is requested signature and address be printed plainly.

Having made no investigation of the advertisers in the classified columns, the publishers of QST are unable to vouch for their integrity or for the grade or character of the products or services advertised.

QUARTZ—Direct importers from Brazil of best quality pure quartz suitable for making piezo-electric crystals. Diamond Drill Carbon Co., 719 World Bldg., New York City.

AMATEUR radio licenses. Complete code or theory preparation for passing amateur radio examinations. Home study and resident courses, American Radio Institute, 101 West 63rd Street, New York City.

WRL Transmitting kits—15, 35, 70, and 150-watt units—low priced. All makes of receivers, both new and reconditioned. Leo offers best trade-in deal, and easy time payment plan. One of the country's largest parts supply houses. Write today for free catalog special radio map offer, tube-base calculator offer, and other items. Leo, at World Radio Labs, Dept. HA, Council Bluffs, Iowa.

RADIO tubes, parts, condensers, free bargain lists. Potter, 1314 McGee, Kansas City 6, Mo.

YOUR station call plate beautifully cast in aluminum, size 2" x 5 1/4". Two styles, Type C, with tapped bosses for panel mounting. Type D for desk use. Price either type, \$1.50. Duplicates of same type, 75c each. Print your call plainly. P & H Sales Co., 619 Jasper Street, Kalamazoo 31, Mich.

HAM crystals: \$2.50 within 10 kc. of specified frequency; excellent oscillators guaranteed: 3500 kc. to 8000 kc.; Army type, FT 243 holders. L. Kipp, 277 Broadway, N. Y. C. 7.

QSLs samples. H. L. Carter, Jr., W8JOT, 749 S. Plymouth, Rochester 8, N. Y.

QSLs. Samples. Glenn Printer, 1042 Pine Heights Ave., Baltimore 29, Md.

COMMERCIAL radio operators examination questions-and-answers. One dollar per element. G. C. Waller, W5ATV, 6540 E. Washington Blvd., Tulsa 15, Okla.

QSLs. Samples free. Radio Headquarters, 1217 So. Calhoun Street, Fort Wayne 2, Indiana.

CRYSTALS, 40-80 meters, 5 kc. of desired frequency, calibrated, holder fits 5-prong socket. \$2.85 postpaid. Immediate delivery. Borri Electric Co., Granville, Ill.

KALAF will QSL all his QSOs. Any station not receiving a QSL should notify KALAF by QSL or postal, giving call and QSL OTH. Thanks, v. 13a. Judy. Address: KALAF Lt. Julius M. Hoffer, W8UFH, 3217 Leslie Avenue, Detroit 6, Michigan.

SX-28 Hallicrafter receiver and speaker. Perfect. Excellent 1000-watt transmitter. New 125 high-frequency transmitter. Station equipment, power supplies, tubes, back QSTs. Write Lee B. Forte, W9ZHY, Neosho, Mo.

OLD amateur, commercial radio sets, parts, catalogs, wanted. Will trade new gear or pay cash. McMurdo Silver, Simsbury, Conn.

ELECTRICAL Instrument Service, 15 Howard Avenue, Vallejo, Calif. Send us your meters and instruments for fast and reasonable repair, calibration and conversion. Write for estimates.

WALKIE-Talkie wanted, or small transceiver. Hulse, 1547 Cole St., Baltimore 23, Md.

HEADQUARTERS in the Pike's Peak region for amateur gear. Write for catalog and free IRC Resist-O-Guide. Mail orders given special attention. Large stock Hammarlund, RME, Taylor, Elmac, etc. Complete stock Petersen Crystals. Don (W8HDU) at Murray Radio Co., 502 West Colorado Ave., Colorado Springs, Colo.

ALASKAN hams: Here is a source of supply closer to home. Stocking leading brands of ham gear, communication receivers, parts accessories, engine generators. Save time and money. Robbie's Radio Supply, Alaskan Jobbers, P.O. Box 1835, Anchorage, Alaska.

WANTED: antique radio material, old radio books, magazines, for ham collection. Have some old duplicated items; will exchange for wanted items. Answer all letters. Write: Corpe, W6LMM, Box 132, Wrightwood, Calif.

CRYSTALS: low drift, each finished to your exact frequency, 40 and 80 meters. The new FT-243 with socket, \$2.50. Regular ham size to fit 5-prong socket, \$2.80. 24 hour service. Tedford Crystal Labs (Ted, W8AKW) 1626 Chase St., Cincinnati 23, Ohio.

CONDENSERS G-E Pyranol 3 μ fd 1000 vdc, working two for \$2.50; 2 μ fd 2000 vdc working 2 for \$4.30; Autosyns Bendix Hobart 110 volt 60 c. Synchro transmitters. New guaranteed, pair, \$18; radar beam transmitting constant impedance rotatable coupler good for all frequencies, \$3.95; two pair each crystal IN21 and holder, \$1.25; Acorn tube sockets, 3 for \$1; G-E thermomammeter, 5 amp, 2 1/2" B.C. \$3.50; same 1 amp., \$3.50; same 100 milliamperes, 3 1/2" B.C. \$3.95; G-E 1 1/2" B.C. 1 milliampere 100 ohm miniature meter ideal portables easily shunted, \$3.25; combination two RCA 866As and Raytheon filament 866 transformer; 115 v. 60 c input, \$5.90; transformer only \$3.25; 25 μ fd — 5000 v. working condenser 39c or 3 for \$1.00; Electronic v.t.v.m. S.C. 1 — 107F new, complete, \$29.70; oscilloscope BC412. New, complete, guaranteed, \$65.00; crystals, complete, active, guaranteed oscillators 2-10MCS, \$1.40; tubes: new government inspected, guaranteed 5AP1, 5BP1, 5BP4, \$9.95; 872A, \$4.50; 866A, \$1.40; 807, \$1.95; 6J4, \$2.49; 3A4, 60c; VT127A, \$4.95; 304T4 used, tested, guaranteed, \$13.95; chokes hermetically cased 4HY 1/4 A \$2.95; 10HY 1/4 A, \$1.89. Write for catalogue, specialists in guaranteed tested war surplus material. Let us know your requirements. Export inquiries invited. "Tab," Dept. 27, Six Church St., New York 6, N. Y. Enclose postage, deposit with order.

ADJUSTABLE hole cutter 3/4 to 5 in. High speed steel blade. Entire tool hardened and ground for long accurate service on sheet metals, plastics. Drillpress model 3/4" round shank, \$1.75. With square shank for brace, \$2.00. Action Tools, 725 West 112 Street, Los Angeles 44, Calif.

FOR SALE: Hallicrafter HT-6 transmitter with complete tuning units 80 and 10 meters. Also Hallicrafter S2OR receiver. Both purchased brand new less than two months ago. Will consider trade commercially built equipment with higher power output. J. Bamberg, WSKVM, Box 307, Navasota, Texas.

CRYSTALS: Precision low drift units. Type 100A in 80, 40, and 20-meter bands. Two units plug in one octal socket. One dollar each. Rex Bassett, Inc., Fort Lauderdale, Florida.

WANTED: One set each A, B and C coils for National AGS receiver. McCasland, WINFE, WHOI, Woods Hole, Mass.

WANTED: Riders manuals. Write Jess Bailey, Route 4, Perry, Okla. **RECEIVERS:** New RME-45, NC-240D, HRO, HQ-129X, Super-Pro. Rotobeams. Conklin Radio, Bethesda, Md.

PRACTICALLY new BC-610 Hallicrafter transmitter and RME-45 receiver for sale. Good buy. Leonard Ullom, 408 Main St., Richmond, Ind.

FOR SALE: Unused army microphone and receiver headgear No. 1 assembly, (Zenith) for \$4.50. E. C. Halline, Lewisburg, Penna.

NEW: unused Dumont 5J1P cathode ray oscillograph tube; 1 500 v. plate transformer C. T. Best offer. Hank Zoeller, 8710 Clover Hill Rd., Hollis 7, L. I., N. Y.

WILL pay cash for old type radio gear built before 1924; Grebe, Paragon, Kennedy, Mignon, E. L. Colby, E. I. Co., and Wm. Duck catalogues, loose covers, tuning coils, honeycomb coils and odd parts. Send lists stating make, model, condition, etc. T. E. Tappan, W8AVD, Waverly, N. Y.

FRITZ on vacation.

FOR SALE: RME-69, new speaker and mtg. alignment, \$90; Howard Model 438, \$60; Meissner Signal Shifter and all the coils, \$50. 20 Watt phone and c.w. xmtx complete for 6 v. battery or 110 c. from 20 meters up, \$50. Navy TAV-3 portable radio and xmtx. Receive 300 to 4525 Kcs, xmtx 2000 to 4525 Kcs, complete in one case. Also F. B. generator All for \$60. A. Bargain. At above A-1 condition. Going to hi-power. Write Fred W. Rudolph, W8WUO, Stryker, Ohio.

SELL on trade: Collins transmitter 32G-4, pp 8078, phone c.w., modulation indicator, coils, tubes, Stantone 110 ohm transmitter, new, cathode modulation; want Hallicrafter SX-28, signal generator or what have you. Kimeldorf, 446 Kingston Ave., Brooklyn 25, N. Y.

COLLINS "MBF" xtal-controlled xmtx and Rcvr. with power supply for 115 v. ac/dc. "Perfect," \$95. R. I. Powell, 2035 Broadway, San Diego, Calif. Ex W6MJC, NW W6VRO.

"LICENSE holder" Plex-O-View, shows both sides. Neat wall mounting. Dollar postpaid. Delos P. Trim, W6QKI, 245 Los Alamos Drive, San Diego 2, Calif.

WANTED: coils for FB7 receiver covering 10-meter band, No. FBAA, N. W. Temple, W2EFC, 1001 No. Yakima Ave., Tacoma, Wash.

PERSONALIZED QSL cards. H. G. Turner, W3AOT, Box 308, Petersburg, Va.

CANADIANS: transmitters and test gear engineered and built to your specifications. Highest quality workmanship. Snelgrove, VESGM, 21 Hanna Road, Leaside, Ontario.

QSLs? QSLs? QSLs? Stamps for samples. Bileey crystals? Sakkers, W8DED, Holland, Mich. (Veteran).

SELL: 6L6-807 transmitter-exciter, two sets of coils, tubes. Excellent construction, 19" x 7" panel. \$35, less power supply. Morton Bardfield, 4 Brinsley St., Dorchester, Mass.

ARMY portable receiver-transmitters near eighty meters. Easily converted into emergency station. \$5. Wesman, W9PFR/7, 3911 Bagley, Seattle, Wash.

FOR SALE: Millen ECO 80-40 meters; perfect, unused. First \$25 gets it postpaid, insured, W2MQB.

SURPLUS BC-348 receivers, two stages tuned r.f., 3 stages I.F., beat osc. xtal filter, 200 Kc. to 18 Mc., less b.c. band. Original government cost, over \$200. Instructions furnished conv. to 110 v. a.c. Also E C-1, best offer. H. C. Ford, Jr. W5XHE, Granite, Okla.

FOR SALE: Harvey UXH35, phone/c.w. xmtx. Two RX-omitting equipment. Prefer local. Best offer. Mrs. Walaitis, 222 Linden St., Brooklyn 21, N. Y.

FOR SALE: TR4 and MRT No. 3, complete, with tubes, less power supplies, \$35 and \$25. Howard W. Andrews, W1GRU, Easton, Conn.

WANTED: Signal Corps frequency meter. SCR-211. State condition and price. Richard S. Baker, W8DRG, 513 N. Main St., Orrville, Ohio.

McELROY xtr-442B automatic keyer; cost \$390; sell \$135 or swap for good receiver. Also have Weston DB and RF meters. W8MGQ, 1745 W. Boston Blvd., Detroit 6, Mich.

FOR SALE: New: 803s, 814s, 801As, 837s, 6C4s, 6J6s, 6AG5s, also other parts. Donald Russell, Jr., 7112 Crestheim Rd., Phila., Penna.

SELL: Teleplex, phones, 9 tapes, like new. \$25. Wolff, W9SXL, 108 Packard, Bloomington, Ill.

FOR TRADE: 100-watt Thordarson multiband phone c.w. xmtr, 6L6 osc, 807 buffer, TZ40 final; 6L6's modulator, complete, less xtals and mike. Want: signal shifter, VHF 52, H10 or other small rig or what have you? B. Marschner, 128 Buins St., Hampton, Virginia.

FOR SALE: Hallicrafters SX-28A receiver, used 5 months. Like new. #190, W. L. Reger, W3JTK, 749 Colonial Ave., Union, N. J. Telephone Unionville 2-4380-W.

HRO pre-war, 4 sets coils, xtal filter, velvet power supply, dynamic speaker, phones, highest offer. J. Collingwood, RFD Mendham, N. J. CRYSTALS: new sealed RCA precision 100 Kc. standard, temperature coefficient 0.1 cycle per degree, \$6.25. Laboratory resistance decade boxes; 6 decades 10 ohms to 10 megohms, accuracy 0.1%. \$20. G. V. Hill, Box 381, Berwyn, Penna.

FOR SALE: 40-watt 10-meter phone xmtr, \$30. QSTs 1932 to 1945. Make offer. Wm. Lafferty, Fix Road, Grand Island, N. Y.

QSLs. Samples. Patterson, W6OKK, Box 133, Escalon, Calif.

WAR Surplus: free descriptive list. Engineering Associates, Far Hills Branch, Box 26, Dayton, Ohio.

SELL transmitter, never used. BC373E, 7 plug-in units, VFO 150 to 12500 Kcs, fone-c-w. Ideal for 75-meters with conservative 75-watt output. This rig cost U. S. Govt. over \$2000. Complete with dynamotor, antenna unit, spare parts, etc., \$140. John Elrod, W2MRV, 10 Monroe St., N. Y.

QSTs, 1930 through 1941. Complete. Make offer. W4GXU, 846 Va., Hopeville, Ga.

TRADE: Brand new S40, some cash for new-used SX-25, SX-28, HQ-120X or better receiver. Also have 200 watt Thordarson modulation xfmtr impedance ratio 2.25 to 1, 10-key 9-col. Remington adding machine. What have you? Jack Watt, W9H9Q, Ontonagon, Mich.

WANTED: DB20-70 Black Cabinet. Carl Rossbach, 94 Montgomery St., Gloversville, N. Y.

BC348Q: Built-in AC supply; 5 and 10 converter: \$100. C. Marzmark, 401 Hamline, Grand Forks, N. D.

WANTED: For cash: Stancor 40P xmtr or similar xmtr or will trade some high power equipment. State needs. H. S. Weber, 313 N. Tusc. Ave., Dover, Ohio.

5G SELSYN motors, H10 AC 60-cycle, 3 1/2" x 5 1/2". Ideal antenna or wind direction indicator. Diagram furnished, \$12 per pair. New meters. Low prices. Write for list. Westchester Electronic Products, 29 Milburn St., Bronxville, N. Y.

WE Stock: Hallicrafters, Hammarlund, National, RME, Pierson, other receivers; test equipment, transmitters, parts, government surplus bargains, etc. Terms financed by us. Trade-ins solicited. Send for list. Write, fone, wire. Henry Radio, Butler, Mo. or Los Angeles, Calif.

WANTED: 5-gang variable condenser each section approx. 15-400 uuf. Body length less than 9". Your price. F. W. Huster, 806 Fordham Ave., Pittsburgh 26, Penna.

FORCED to move, selling: xmtr, 2-210s, push-pull BB mounted, 500 volt power supply; cookie can monitor; half assembled receiver; miscellaneous gear; any reasonable offer considered. Philip Ide, 187 Holden St., Worcester 5, Mass.

WANTED: Multi-match driver transformer, 500 ohm primary to class "B" grids, T15D82 or equal. W2PPS, 175 Maplehurst Ave., Syracuse, N. Y.

50 WATT 6 band phone transmitter and Hallicrafters S-29 rcvr, \$150. Walter A. Bernath, 92 Elm St., Maplewood, N. J.

BC-348Q Army receiver, 110 v. a.c., 2 stages, r.f., 3 i.f., \$67.50. W5MA, 6262 Revere, Dallas, Texas.

FOR SALE: Three good used BC-348 receivers, tubes and dynamotor complete, \$35 each. John Melhorn, Herrin, Ill.

TRADE over \$275 worth HQ gauge model railroad equipment; kits, trackwork, books, etc., for SX-28 or equivalent. Buckley, 51 Green St., Fairhaven, Mass.

VHF Heterodyne frequency meter. 280-3000 Mc. Accurately calibrated. Described March Radio News. \$10 plus postage. W2HKU 144 West 92nd St., N.Y.C. 25.

SX-36 Hallicraft receiver for sale or swap for general coverage communication receiver. L. D. Chipman, 425 Ridge Road, 6A North Arlington, N. J.

WANTED: National NHU in good condition. Roger Medlin, W6OTV, 1729 Pierre St., Manhattan, Kansas.

SELL Trans. pp HK54s, TZ40 buffer, pr. TZ40 mods. 1000-1250-v. power supplies in Par-metal 66" cabinet; best components, speech amp. in Par-metal cabinet; Meissner sig. shifter, B & W coils 160, 80, 40, 20, 10; Browning freq. meter; Millen exciter unit; D104 mike, antenna coils, condensers, Johnson 10Q antenna, etc. McCollum, W8VBQ, Cosadale, Ohio.

SELL: Two TBV2s, xmtr and rcvr, walkie-talkie covers 28-80 meg. One power supply for same includes 4-v. storage battery and vibrator, \$75 complete. Pr. 814s new, \$5 ea. Wanted: TRK 120 television chassis, any condition. E. Schwinge, 38 Silver St., Patchogue, N. Y.

500 KC Crystals. Accurate to approximately 100 cycles. Fb for harmonic reference points. New, in orig. unopened cartons. \$1.50 each, postpaid. W9KRRK, Edward Engebretsen, 4040 Montrose Ave., Chicago 41, Ill.

WANTED: NC100XA for cash or swap. Have an HRO, Jr., with 3.5 to 7.3 coil, power supply and R meter or make an offer. G. W. Leahy, RR2, Spring Lake, Mich.

CATHODE-RAY Tubes, new 5CP1s, \$7.95 ea., socket when bought with tube, 45c; otherwise 90c. Include 5-lb. shipping postage in your money order. 5CP1 steel shields, 85c 3-lb shipping. New 954 and 956 Acorn tubes, not rejects, 89c ea. postpaid in U. S. Electronic list free. Ohmeyer Engineering, Dept. A., Fairview Blvd., Hempstead, N. Y.

QSL-SWL Cards. Pleasant, W9UDZ, Mattoon, Illinois.

CALL Letters for car or shack window. Professional type Imm. Gold leaf with black border 2" high. Not Decals. 20c ea. letter. Send calls and cash to D. I. Cole, W2PIY, 127 Murray St., Elizabeth 2, N. J.

QSLs-SWLs. Meade, W6KXL, 1507 Central Ave., Kansas City, Kans.

NAVY Model TBV (walkie-talkies) 28-80 Mc., with M.C.W. telegraph, 7 tubes, fones, microphone, instruction manual. \$32.50 to \$60.00, depending on model number and conversion to 2 meters. Arrow Appliance and Radio, Co. 391 Broad Street, Lynn, Mass.

COMPLETE scaled plans and specifications how to build rotating mechanism for beam antenna, using surplus material and easily obtainable parts. \$1 for plans alone or \$5 complete with a pair of selsyn generators. Hold wire or write the J. M. Morel Co., 1949 Woodward Ave., Berkley, Mich. Phone Lincoln 2-1790.

G. E. Pyranol condensers: 2 uuf, 4000 v.d.c. \$5.50; 2 uuf, 1000 v.d.c., 95c. 1 uuf, 1000 v.d.c., 75c. 0.05 uuf, 1000 v.d.c., 115 v. A. C. DPDT relay Dunco, \$1.75; 18-28v. D. C. DPDT relay Allied, \$1; 26v. D. C. 4 PDT relay Allied, \$1.25; 2 section circuit-breaker 8A; 25A, \$2.25; 866 filament xfmr, Kenyon T389, 2.5v; 10A, \$3.95; 304 TL power tube assembly: includes tube filament xfmr, by-pass condensers, tube socket, plate cap, wired and ready to use, \$15; 37-0-4000 v.d.c. meter, with external series multiplier (0-1 mil. basic movement) Roller Smith, \$5.75; power transformer 425-0-425 @ 1.0 amp., 115 v. pri., \$7.50; Linemaster foot treadle switch; Step to make, step to break, 15 A @ 125 v., \$6; 866/866A Jan, \$130; 25% with orders, balance C.O.D. Greenwich Sales Co., 57 Cortlandt St., NYC 7.

BRAND new Western Electric type 241-A double plug, 2 ft. patch cords, \$7 ea. Also brand new 30" 2 conductor type PL-55 patch cords, \$2 ea. Limited quantity General Electric DB meters, 3" rectangular case, \$10 each. All orders shipped prepaid upon receipt of check with order. Broadcast Equipment Co., Box 222, Evanston, Ill.

ELECTRONIC volt-ohmmeter, \$11.85 postpaid, 20 ranges. 5000 volts AC and DC. Billion ohms. 110 v. AC operation. Complete kit including tubes, chassis, panel. Sterling Electronic Co., 166 No. Sierra Bonita, Pasadena, Calif.

CRYSTAL filter IF stage (470 Kc) for BC-312, BC-342 receivers slug tuned, \$9.95. Cardwell xmt condenser, TC-300-US 300 uuf. Max. 42 uuf/d min. 35 plates, 0.2 in. spacing. List \$40.50; price \$14.85. Send for catalog "Q." Communication Equipment, 131 Liberty St., NYC 6.

COAXIAL Cable, RG8/U, 7¢ per ft. RG59/U, 6¢ per ft. See QST April '51 for detailed description. Thordarson, 1944 chokes, new, 12h 400 ma. \$6.50. Coaxial Cable Co., Box 19, Woodside, N. Y.

WVYCF says "There's a lot of junk being pushed off on you fellows under the guise of War Surplus but at Gifford-Brown you can get good usable parts, 2.5 volt 10 amp. xfmtr, cased, hi-voltage inductor @ \$3.75; 1 henry 250 MA choke @ \$3.00; 550 MA chokes by Thordarson, both smoothing and swinging @ \$6.95; 750-CT-750 volts, 350 MA plate xfmtr @ \$7.50; 25 watt c.w. xmtr in cabinet, \$37.50. We are distributors for leading manufacturers. Big stock on hand. Write for Bargain Bulletin. Gifford-Brown, Inc. Cedar Rapids, Iowa.

TELEVISION magnetic deflection yokes. For new 50° tubes and all other types. \$14.75 ea. Blocking oscillator xfmrs, \$3.95 per pair. Fully guaranteed. Teletron, 1988 E. 59th, Cleveland 3, Ohio.

FOR SALE: Complete McElroy professional tape-recorder outfit. Extra tubes, tape-puller parts, pens and parts for recording head, 100 rolls tape, large supply ink. Practically new. Ready to hook up. Discarding for teletype system. Cost \$350. Sell \$185. f.o.b. Cordova Daily Times, Cordova, Alaska.

4520 CT 750 Ma., Kenyon, \$49.95. SB carbor hand mike with switch, cable, jack, plug and matching input xfmr, \$3.89. 900 CT 250 Ma., \$4.25. 807, \$1.90 pairs, \$3.60; RG8/U, 10c ft. B&W coils. RME rcvr, Stancor 6L6 driver xfmtr, \$2.75. Shure crystal mike, table stand and cable, \$7.50. Metal chassis 12 x 15 x 4 1/2. 55c. four for \$1.75. Exide 6 v. 102-amp. hour drycharge radio batteries, \$4.75. Willard 6v. 288 amp. hour drycharge radio batteries, \$17.50. Write, state needs, Kentucky Radio Supply Co., 519 Georgetown St., Lexington 24, Ky.

ADJUSTABLE hole-cutter, 3/4 to 5". Hi-speed steel blade. Entire tool hardened and ground for long, accurate service on sheet metals, plastics. Drillpress model 3/8" round shank, \$1.75. With square shank for brace, \$2. Action Tools, 725 West 112th St., Los Angeles 44, Calif.

INCREASE DX, preselector specially designed for the receiver that loses sensitivity on 15 and 20 meters, frequency 13 to 32 Mc. No plug-in coils; neatly designed in 6x6 crinkled cabinet, self-contained power supply. New with 955, 3525, AC/DC operated, \$14.95; sensitive 2-meter super-regen, capacitive and permeability tuned giving wide frequency coverage. New in crinkled cabinet with 955, 12J5, 35Z5 less phones, AC/DC, \$16.50. Constant Electric, 112 Cornelia St., Brooklyn 21, N. Y.

DYNAMOTORS

to Power Your Mobile Rig

Get lightweight, efficient, dependable rotary power for your mobile rig. Choose from a wide range of Carter Dynamotors, magmotors, DC to AC Converters and Gunmotors to meet every receiving and transmitting need. Used by leading State and City Police networks. Write for Free Bulletin.

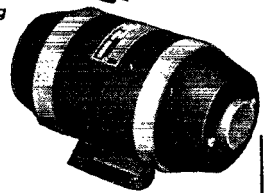

Carter Motor Co.

(A Well Known Name in Radio for Over 20 Years)

2645 N. Maplewood Ave. • Chicago 47, Illinois

Designed for



Application

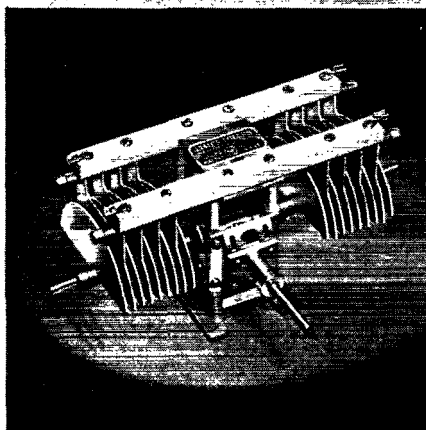

**04000 Series
Transmitting Condensers**

A new member of the "Designed for Application" series of transmitting variable air capacitors is the 04000 series with peak voltage ratings of 3000, 6000, and 9000 volts. Right angle drive, 1/1 ratio. Adjustable drive shaft angle for either vertical or sloping panels. Sturdy construction, thick, rounded, polished aluminum plates with 1 3/4" radius. Constant impedance, heavy current, multiple finger rotor contactor of new design. Available in all normal capacities.

**JAMES MILLEN
MFG. CO., INC.**

MAIN OFFICE AND FACTORY

**MALDEN
MASSACHUSETTS**



Index to Advertisers

	Page
Advance Electric & Relay Co.	130
Allied Radio Corporation	129
American Lava Corporation	7
American Phenolic Corporation	8
American Radio Institute	142
Aslie Radio Co., Walter	118
Astatic Corporation, The	2
Barker & Williamson	151
Birnbach Radio Co.	136
Bliley Electric Company	93
Brill Co., W. D.	142
Bruno Tools	136
Burgess Battery Co.	102
Burstein-Applebee Co.	152
Cameradio Co.	126
Candler System Co.	136
Capitol Radio Eng. Institute	92
Cardwell Mfg. Co., Allen D.	91
Carter Motor Co.	157
Centralab	9
Chief Electronics	150
Cleveland Institute of Rad. Electronics	138, 140
Collins Radio Co.	125
Commercial Equipment Co.	144
Commercial Radio Inst.	148
Communication Measurements Labs.	130
Crystal Products Co.	123
Crystal Research Labs.	155
Drake Electric Company	106
Eitel-McCullough, Inc.	83
Electronic Navigation, Inc.	140
Electro-Voice Corp.	107
Gates Radio Company	117
General Electric Co.	1
Hall, R. C. & L. F.	145
Hallcrafters Co., The	4, 5
Harrison Radio Co.	149
Harvey Radio Company	139
Harvey Radio Labs.	108
Hatry & Young	154
Henry Radio & Elec. Corp.	152
Hytron Rad. & Elec. Corp.	99
International Resistance Co.	121
Jensen Radio Mfg. Co.	101
Johnson Co., E. F.	94
Ken-Rad	109
Kwikheat Soldering Irons	146
Lippman & Co., Aaron	120
Magna-Metal Products Co.	148
Maguire Industries	96, 97
Mallory & Co., P. R.	90
Marion Elec. Instrument Co.	87
Mass. Radio & Elec. School	132
McElroy, Ted	146
Meck Industries, John	143
Millen Mfg. Co., The James	158
Munzig Mfg. Co., Arthur L.	148
National Co., Inc.	81, Cov. III
Newark Electric Co.	137
New York Technical Inst.	154
Ohmite Mfg. Co.	95
Onan & Sons, D. W.	132
Panoramic Radio Corp.	Cov. II
Peerless Elec. Prod. Co.	112
Petersen Radio Co.	135
Pierson Electronic Corp.	147
Port Arthur College	148
Radio Electric Service Co. of Penna.	124
Radio-Electronics, Inc.	128
Radio Mfg. Engineers	119, 159
Radio Products Sales Co.	153
Radio Shack, The	113, 115
RCA Institutes	152
RCA Mfg. Co.	Cov. IV
Sceli & Co., R. G.	142
Shur-Antenna Prod. Co.	150
Signal Elec. Mfg. Co.	138
Silver Co., McMurdo	100
Sky-Lane Products	146
Sprague Electric Co.	87
Standard Radio & Elec. Prod. Co.	154
Sun Radio & Elec. Co. of N. Y.	116
Sun Radio of Washington	131
Sylvania Elec. Prod. Co.	85, 103
Taylor Tubes Co.	127
Telegraph Apparatus Co.	132
Terminal Radio Co.	132
Transmitter Equip. Mfg. Co.	110, 111
Triplet Elec. Instr. Co.	153
Turner Co., The	151
UHF Resonator Co.	150
United Electronics	160
Valparaiso Tech. Institute	134
Valpey Crystal Co.	98
Vibroplex Co., The	152
Western Electric Co.	104, 105
Wilcox Electric Co.	141
World Radio Labs.	134

Precision *
•

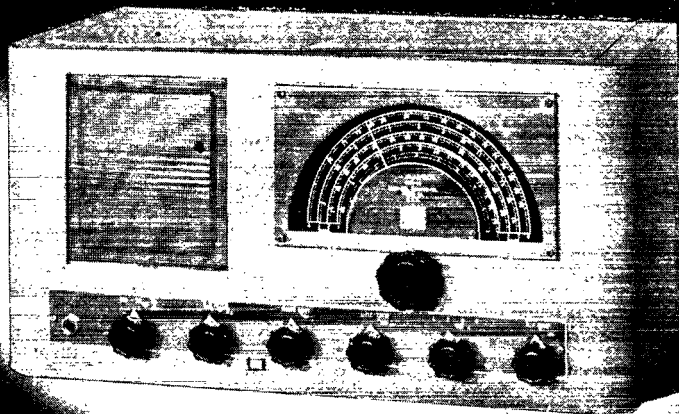

• *the New RME 84*

High In Quality - Low In Cost!

You'll find that the new RME 84 is a precision instrument — built to RME's rigid specifications of quality components and quality workmanship.

No low priced, "average" components are used anywhere in this instrument. The vernier bandsread scale, for instance, is operated integrally with the main scale indicator through a planetary drive mechanism, spring loaded to eliminate all backlash. This feature means accuracy and ease of tuning. What's more, you'll be delighted with the calibration — held to an accuracy of one-tenth of one per cent in the final test procedure.

PORTABILITY BUILT IN

For portable operation, the RME 84 is a natural for those many field days to come.

Provision is made for connection to either a B battery and an A battery supply or a vibrapack. Drain on the B battery is only 22 mils at 135 volts, on the A but 1.2 amps.

To mention but a few of the other features there's a new series noise limiter that really works on cw as well as fone, sensitivity of two microvolts over the entire range, provision for doublet or single wire antenna, provision for an S meter, and a host of others.

You'll find that the RME 84 is full of pleasant surprises, the receiver in the lower priced field which will give you the most for your money.

NET PRICE **\$98.70**

Subject to change

Specification Sheet
on Request



RME

FINE COMMUNICATIONS EQUIPMENT

RADIO MFG. ENGINEERS, INC.
Provia 6, Illinois U. S. A.

Almost Unbelievable!

Only 8 Watts Drive for 1/2 K.W. Phone Input with NEW UNITED GRAPHITE TRIODES

Highest Ratings On Record for Graphite Anode Tubes Made Possible by New Getter Trap

A great development in graphite anode tubes ... the United *Isolated Getter Trap* ... has resulted in new, clear glass tubes free from the familiar dark metallic deposit on the bulbs, and utilizing for the first time all the superior advantages of graphite.

The net result of this United achievement in the two types illustrated is a very low cost replacement for lower rated tubes of the 40 or 55 watt plate dissipation class as well as original tubes for new equipment with minimum driver construction cost.

Choice of two types, V-70-D and 812-H bridge many replacement needs with little or no circuit changes. *A pair of either type will take 1/2 K.W. phone input at 30Mc—up to 60Mc with reduced input. Available now at all leading Radio Parts Distributors.

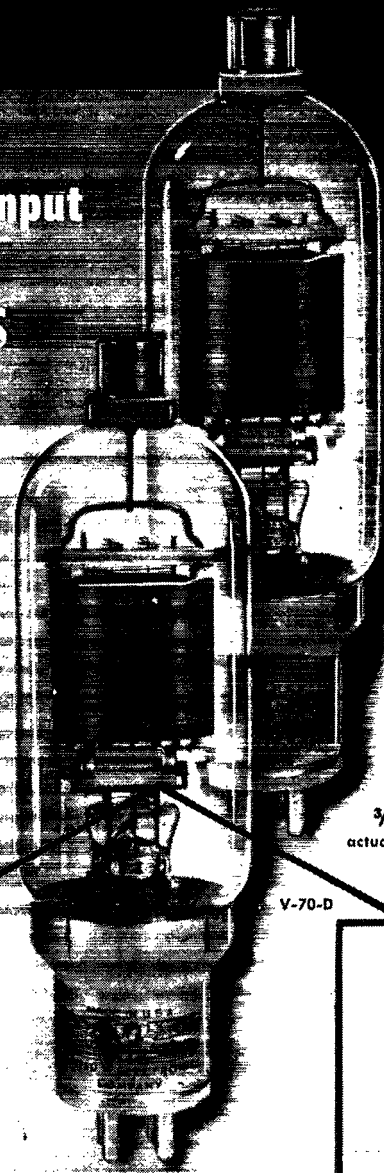

Type	Filament		Max. Plate Dissipation	Capacitances uuf			Max. input per tube	Max. Plate	
	Volts	Amps		cgp	cgf	cpf		Volts	Mils
V-70-D	7.5	3.25	85 Watts	4.5	4.5	1.7	300 Watts	1750	200
812-H	6.3	4.0	85 Watts	5.3	5.3	0.8	300 Watts	1750	200

LOOK FOR THIS
GETTER TRAP
in all UNITED TUBES

\$6.90
ea.



UNITED ELECTRONICS COMPANY
AMATEUR RADIO DEPARTMENT

42 SPRING ST. • NEWARK 2, N. J.

Transmitting Tubes EXCLUSIVELY Since 1934

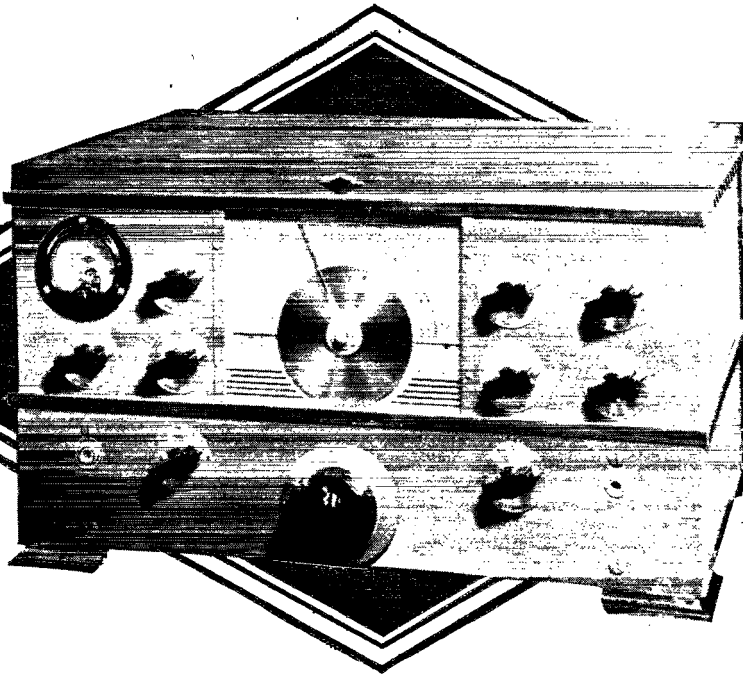

THE NC-2-40C RECEIVER

Back of the superb NC-2-40C receiver stands National's twenty-five years of experience in building to the highest quality. In the NC-2-40C as in other products, National has excellence for sale. Stability and sensitivity are outstanding. Controls are convenient to the hand and smooth in operation. All important auxiliary circuits — wide range crystal filter, noise limiter, S-meter, beat oscillator, AVC — are present in advanced design. You will find the operation of the NC-2-40C a gratifying pleasure and its ownership a source of pride. See it at your dealer's.



NATIONAL COMPANY, INC.  MALDEN, MASSACHUSETTS

Now— Greater performance at less cost

**THE
OUTPUT IS UP**

from 260 watts* to

375 Watts*

*CLASS C TELEGRAPHY, ICAS

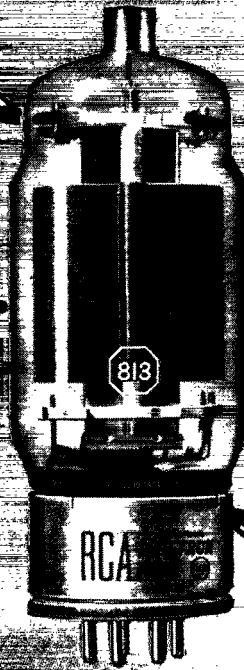

**THE PRICE
IS DOWN**

from \$18.00 to

\$14.50

More reasons why the RCA-813 beam power tube is preferred for amateur transmitters

1. Power Input: A single RCA-813 at its new ICAS rating will take 225 ma at 2250 volts in Class C telegraphy, or 200 ma at 2000 volts in Class C telephony.

2. Power Output: 375 watts RF output in Class C telegraphy, or 300 watts RF output in Class C telephony is possible with one RCA-813 at the new ICAS ratings.

3. Push-Pull Operation: A pair of RCA-813's will take 800 watts on phone or a full kilowatt on CW for that high-power final.

4. Easy to Drive: Two RCA-813's can be driven by a single RCA-807 doubler with power to spare.

5. High Efficiency: RCA-813's will operate at full plate circuit efficiency as high as 30 Mc.

6. No Neutralization: RCA-813's ordinarily require no neutralization in "all-band" transmitters.

7. Features: The 50-watt thoriated-tungsten filament, hard-glass dome-top bulb and graphite anode all combine to make the RCA-813 an exceptional value.

For further details, see your local RCA Tube Distributor or write RCA, Commercial Engineering Department, Section A-21H, Harrison, N. J.

Have you seen Ham Tips? Get a free copy from your local RCA Tube Distributor today.

**THE FOUNTAINHEAD OF MODERN
TUBE DEVELOPMENT IS RCA**



TUBE DEPARTMENT

RADIO CORPORATION of AMERICA

HARRISON, N. J.

ELECTION NOTICE

To All Full Members of the American Radio Relay League residing in the Central (including prospective new Great Lakes Division), Hudson, New England, Northwestern, Roanoke, Rocky Mountain, Southwestern and West Gulf Divisions.

You are hereby notified that, in accordance with the constitution, an election is about to be held in each of the above-mentioned divisions to elect both a member of the ARRL Board of Directors and an alternate thereto for the 1947-1948 term. Your attention is invited to §1 of Article IV of the constitution, providing for the government of ARRL by a board of directors; §2 of Article IV, and By-Law 12, defining their eligibility; and By-Laws 13 to 24, providing for the nomination and election of division directors and their alternates. Copy of the Constitution & By-Laws will be mailed to any member upon request.

The new Great Lakes Division comes into existence January 1, 1947. For the purposes of these elections, Full Members residing in the states of Kentucky, Michigan and Ohio will nominate and elect a director and an alternate from their number to serve for a one-year term during the year 1947, to be followed next year by a two-year election. Similarly, for the purposes of these elections, the Central Division is to be considered as consisting only of the states of Illinois, Indiana and Wisconsin, and Full Members residing therein will nominate and elect a director and an alternate from their number to serve for the usual two-year term, 1947-1948.

All steps in the election process now occur one month earlier than heretofore. Voting will take place between October 1 and November 20, 1946, on ballots that will be mailed from the headquarters office during the first week of October. The ballots for each election will list, in one column, the names of all eligible candidates nominated for the office of director by Full Members of ARRL residing in that division; and, in another column, all those similarly named for the office of alternate. Each Full Member will indicate his choice for each office.

Nomination is by petition. Nominating petitions are hereby solicited. Ten or more Full Members of the League residing in any one of the above-named divisions may join in nominating any eligible Full Member residing in that division as a candidate for director therefrom, or as a candidate for alternate director therefrom. No person may simultaneously be a candidate for both offices. Inasmuch as all the powers of the director are transferred to the alternate in the event of the director's death or inability to perform his duties, *it is of as great importance to name a candidate for alternate as it is for director.* The following form for nomination is suggested (except that in the case of the Great Lakes Division it should read "for the 1947 term"):

Executive Committee

*The American Radio Relay League
West Hartford 7, Conn.*

We, the undersigned Full Members of the ARRL residing in the Division, hereby nominate of as a candidate for director; and we also nominate of as a candidate for alternate director; from this division for the 1947-1948 term.

(Signatures and addresses)

The signers must be Full Members in good standing. The nominee must be a Full Member and must have been both a member of the League and a licensed radio amateur operator for a continuous term of at least four years immediately preceding receipt by the Secretary of his petition of nomination, except that a lapse of not to exceed ninety days in the renewal of the operator's license and a lapse of not to exceed thirty days in the renewal of membership in the League, at any expiration of either during the four-year period, will not disqualify the candidate; provided that if a candidate's membership has been interrupted by reason of service in the armed forces of the United States, he shall not be deemed to be disqualified so far as concerns continuity of membership if he has, since May 7, 1943, renewed his ARRL membership within ninety days of discharge from the military service. He must be without commercial radio connections: he may not be commercially engaged in the manufacture, selling or renting of radio apparatus normally capable of being used in radio communication or experimentation, nor commercially engaged in the publication of radio literature intended, in whole or part, for consumption by licensed radio amateurs. Further details concerning eligibility are given in By-Law 12. His complete name and address should be stated. The same requirements obtain for alternate as for director. All such petitions must be filed at the headquarters office of the League in West Hartford, Conn., by noon EDST of the 20th day of September, 1946. There is no limit to the number of petitions that may be filed on behalf of a given candidate but no member shall append his signature to more than one petition for the office of director and one petition for the office of alternate. To be valid, a petition must have the signature of at least ten Full Members in good standing; that is to say, ten or more Full Members must join in executing a single document; a candidate is not nominated by one petition bearing six valid signatures and another bearing four.

Petitioners are urged to have an ample number of signatures, since nominators are frequently found not to be Full Members in good standing. It is not necessary that a petition name candidates both for director and for alternate but members are urged to interest themselves equally in the two offices.

League members are classified as Full Members and Associate Members. Only those possessing Full Membership may nominate candidates or stand as candidates; members holding Associate Membership are not eligible to either function.

Present directors and alternates for these divisions are as follows: Central Division (presently including the states that for the purposes of this election comprise the Great Lakes Division): director, John A. Kiener, W8AVH; alternate, Earl S. Nelson, W8DS. Hudson Division: director, Robert Akeridge Kirkman, W2DSY; alternate, George Rulffs, jr., W2CJY. New England Division: Percy C. Noble, W1BVR, alternate, Clayton C. Gordon, W1HRC. Northwestern Division:

Karl W. Weingarten, W7BG; alternate, R. Rex Roberts, W7CPY. Roanoke Division: Hugh L. Caveness, W4DW; alternate, J. Frank Key, W3ZA. Rocky Mountain Division: acting director, Howard R. Markwell, W9TFP; alternate, none. Southwestern Division: director, John E. Bickel, W6BKY; alternate, Eldridge E. Wyatt, jr., W6ARW. West Gulf Division: director, Wayland M. Groves, W5NW; alternate, Jennings R. Poston, W5AJ.

These elections constitute an important part of the machinery of self-government of ARRL. They provide the constitutional opportunity for members to put the direction of their association in the hands of representatives of their own choosing. Full Members are urged to take the initiative and to file nomination petitions immediately.

For the Board of Directors:

K. B. WARNER,
Secretary

July 1, 1946