

January, 1946

25 cents

35c In Canada

QST

devoted entirely to

amateur radio



In This Issue:

Amateur Duplex Phone
on 5.6 Cm.

10-Meter Predictions

Continuous Power
on Microwaves

The New F. M.
Ratio Detector

UNUSUAL DESIGNS AT

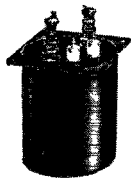

RESONANT TRANSFORMERS

This high voltage application involved a minimum size requirement. For maximum compactness, the final transformer produced has a turns ratio of 115/5,800, but a voltage ratio due to resonance of 115/10,000 V.



VARIABLE AC SATURATED INDUCTOR

This inductor is part of a voltage sensitive non-linear network. By adjustment of the inductor with a specific capacitor, peak non-linearity can be adjusted over a substantial range in voltage.

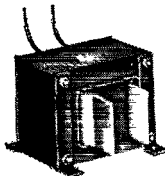

CONDENSER-PULSE WELDING TRANSFORMER

This transformer is designed for a small precise spot welding set. For this type of application, design factors include High Q and maximum surge power transfer. The transformer shown is the equivalent of 100 VA in size, but handles 1,000 VA pulses.

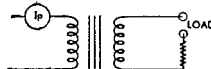

SPECIAL CONTROL TRANSFORMER

In this odd application, the requirements were that the primary current go down with increase in load current. In actual practice, when normal load is placed on the secondary, the primary current drops 50%.

The UTC application engineering section is available for your problem.

United Transformer Corp.

150 VARICK STREET

NEW YORK 13, N. Y.

EXPORT DIVISION: 13 EAST 40th STREET, NEW YORK 16, N. Y., CABLES: "ARLAB"



NEW CHAPTER...



Amateurs will write the exciting new story of radio communications

The log books are opening up all over the world. Once again the fascinating data on stations heard or worked will be set down by amateur operators as they establish new records in radio communications. The reopened log books mark a new chapter in the development of radio.

Hallicrafters...as prime producers of amateur radio equipment...will play a prominent part in the new chapter. Hallicrafters high frequency transmitters and receivers will provide the instruments that will outline the future development of all radio science... especially in the VHF and UHF fields.

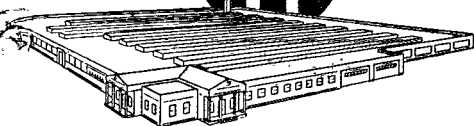

hallicrafters RADIO

COPYRIGHT 1945 THE HALLICRAFTERS CO.

THE HALLICRAFTERS CO. • MANUFACTURERS OF RADIO AND ELECTRONIC EQUIPMENT • CHICAGO 16, U.S.A.

home

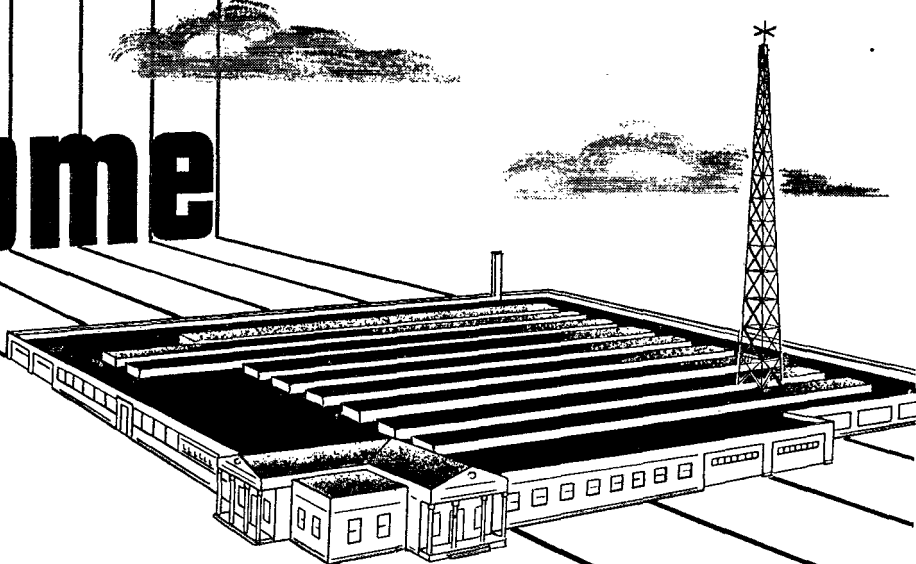

high frequency headquarters

Hallicrafters will shortly have a new home. Big, new headquarters for the further development of high frequency communications equipment are under construction in the heart of Chicago's great West Side industrial section.

Here, under the most advanced conditions, the science of radio will be brought to new heights of perfection by Hallicrafters engineers. In this \$600,000 modern plant, the finest of its kind, all operations will be combined under one roof. Straight flow production on one floor will assure constant economy and efficiency.

On this spot Hallicrafters engineers will apply their research techniques to the most extreme problems in FM, television, and high frequency development work. Here "the radio man's radio" will continue to be turned out with strict attention to the maintenance of custom built quality in each unit.



hallicrafters RADIO

THE HALLICRAFTERS CO., MANUFACTURERS OF RADIO AND ELECTRONIC EQUIPMENT, CHICAGO 16, U.S.A.

COPYRIGHT 1945 THE HALLICRAFTERS CO

JANUARY 1946

VOLUME XXX

NUMBER 1



STAFF

Editorial

KENNETH B. WARNER, W1EH
(Managing Secretary, ARRL)
Editor

GEORGE GRAMMER, W1DF
(Technical Director, ARRL)
Technical Editor

DONALD H. MIX, W1TS
BYRON GOODMAN, W1JPE
Assistant Technical Editors

A. DAVID MIDDELTON, W2OEN
Department Editor

EDWARD P. TILTON, W1HDQ
V.H.F. Editor

WALTER F. BRADLEY, W1FWH
Technical Information Service

Production

RALPH T. BEAUDIN, W1BAW
Superintendent

ELSIE C. HOCHMEISTER
Assistant

Advertising

F. CHEYNEY BEEKLEY, W1GS
Advertising Manager

Circulation

DAVID H. HOUGHTON
Circulation Manager

RALPH T. BEAUDIN, W1BAW
Assistant Circulation Manager



OFFICES

38 La Salle Road
West Hartford 7, Connecticut

Subscription rate in United States and Possessions, \$2.50 per year, postpaid; all other countries, \$3.00 per year, postpaid. Single copies, 25 cents. Foreign remittances should be by international postal or express money order or bank draft negotiable in the U. S. and for an equivalent amount in U. S. funds.

Entered as second-class matter May 29, 1919, at the post office at Hartford, Connecticut, under the Act of March 3, 1879. Acceptance for mailing at special rate of postage provided for in section 1103, Act of October 3, 1917, authorized September 9, 1922. Additional entry at Concord, N. H., authorized February 21, 1929, under the Act of February 23, 1925.

Copyright 1946 by the American Radio Relay League, Inc. Title registered at U. S. Patent Office.

QST

devoted entirely to

AMATEUR RADIO

PUBLISHED, MONTHLY, AS ITS OFFICIAL ORGAN, BY THE AMERICAN RADIO RELAY LEAGUE, INC., AT WEST HARTFORD, CONN., U. S. A.; OFFICIAL ORGAN OF THE INTERNATIONAL AMATEUR RADIO UNION



CONTENTS

It Seems to Us	11
QRM — The Electronic Life Saver — Part I Paul Robbiano, W6PKM	12
Duplex Phone on 5300 Megacycles Reuben Merchant, W2LFG and A. E. Harrison, W6BMS	19
WWV	24
Christmas, 1944 S/Sgt. R. H. Newkirk, W9BRD	25
A New F.M. Detector Circuit	26
The Half-Rhombic Antenna Capt. John H. Mullaney, SC, W4HGU	28
A Small Oscilloscope Using the 913 . . . E. M. McCormick	32
Extended-Range Television Reception — Part II Marshall P. Wilder, W2JLK	35
Happenings of the Month	41
The Bright New World — of Sunspots Commander E. H. Conklin, USNR, W3JUX	43
Foreign Notes	47
The "Little Gem II" Byron Goodman, W1JPE	48
In QST 25 Years Ago This Month.	50
Hints and Kinks	
Link Coupled Modulator — V.H.F. Modulator with A2 and A3	51
The World Above 50 Mc.	52
Loran — the Latest in Navigational Aids — Part II Alexander A. McKenzie, W1BPI	54
How's DX?	58
Listening in on the Stars Oswald G. Villard, jr., W6QYT, ex-W1DMV	59
The Crystal Ball	61
A Radio-Frequency Auto-Resonator Pfc. John F. Clemens, W9ERN	65
Correspondence from Members.	67
Strays	70
Operating News	71
Station Activities	75
Silent Keys	110
Ham-Ads	124
QST's Index of Advertisers	126

The Mark of Quality



The initials "CRL" in the Diamond stand for Central Radio Laboratories.

They are an integral part of the Centralab name, and for more than a quarter of a century have represented the utmost in engineering skill and precision . . . the height of manufacturing perfection.

Both in original equipment and in replacements, the symbol "CRL" is the Mark of Quality.

. . . Always specify Centralab.

Centralab

Division of GLOBE-UNION INC., Milwaukee

PRODUCERS OF

Ceramic High Voltage Capacitors
Bulletin 814



Ceramic Trimmers
Bulletin 695



Variable Resistors
Bulletin 697



Tubular Ceramic Capacitors
Bulletins 630 and 586



Selector Switches
Bulletin 722



THE COUNTERSIGN OF DEPENDABILITY IN ANY ELECTRONIC EQUIPMENT

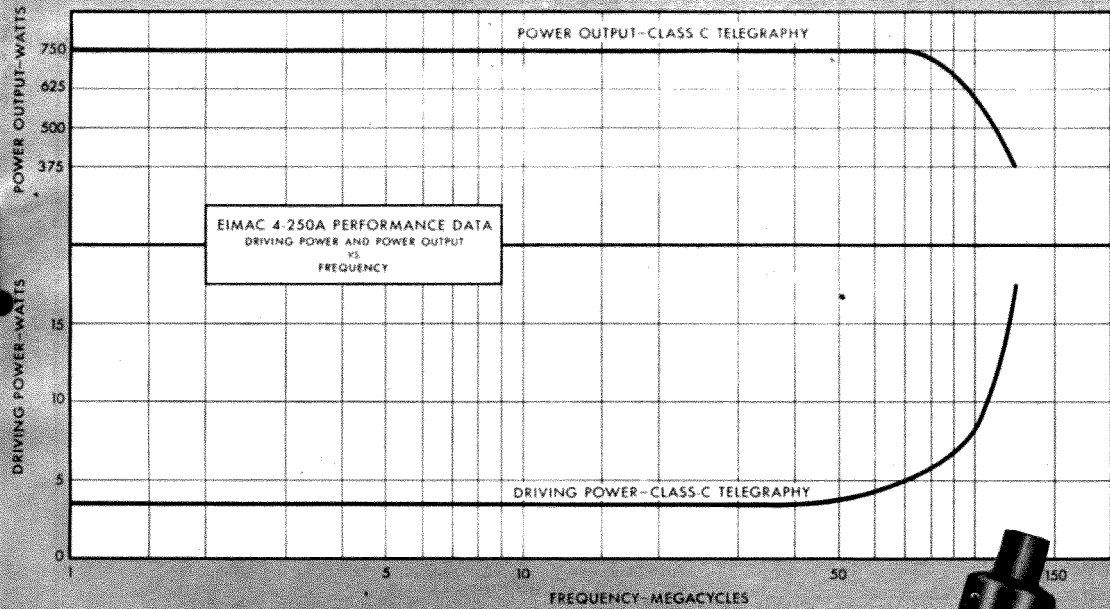

NEW EIMAC 4-250A TETRODE

Heading a parade of sensational new tubes now in production, the Eimac 4-250A Tetrode—introduced several months ago—is already in great demand. It may pay to check these performance characteristics against your own requirements.

As can be seen by the chart above, the new Eimac 4-250A Tetrode will deliver 750 watts output at frequencies up to 70 Mc. with a driving power of only 5 watts. At frequencies up to 40 Mc. an output of 750 watts may be obtained with a driving power of 3.5 watts.

The grid-plate capacitance of 0.12 $\mu\text{ufd.}$ is extremely low, allowing operation at high frequencies without neutralization. Use of Eimac "X" process control grid reduces both primary and secondary emission which provides utmost stability.

You are invited to supplement the information given here with a technical bulletin on Eimac 4-250A Power Tetrode. It contains an elaboration of the tube's characteristics and constant current curves. Send your name and address and a copy will go to you by return mail.

The Lid's Coming Off...

Watch your favorite trade journals for announcements of other new Eimac tubes to be released this year.

CAUTION! Check serial numbers on Eimac tubes before you buy. Be sure you're getting newest types. Look for latest serial numbers.

FOLLOW THE LEADERS TO



EITEL-McCULLOUGH, INC., 1086 San Mateo Avenue, San Bruno, Calif.

Plants located at: San Bruno, California and Salt Lake City, Utah

Expert Agents: Frazer & Hansen, 301 Clay St., San Francisco 11, Calif., U. S. A.

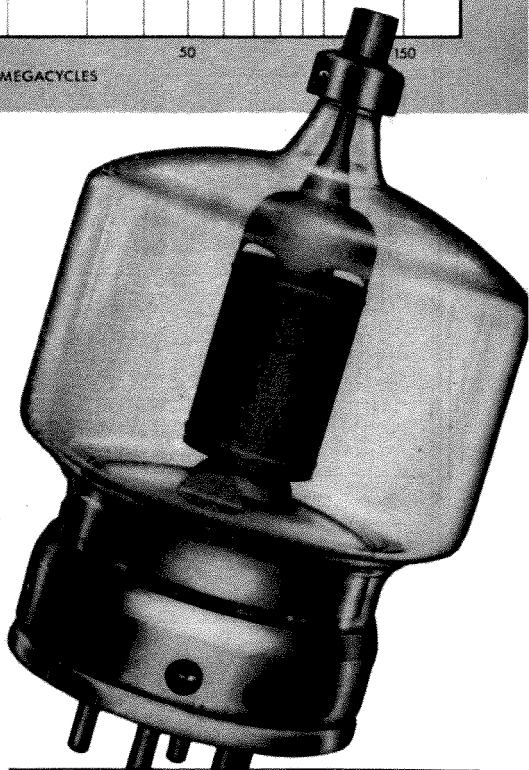

TYPE 4-250A—POWER TETRODE ELECTRICAL CHARACTERISTICS

Filament: Thoriated Tungsten	
Voltage	5.0 volts
Current	14.5 amperes
Plate Dissipation (Maximum)	250 watts
Direct Interelectrode Capacitances (Average)	
Grid-Plate	0.12 $\mu\text{ufd.}$
Input	12.7 $\mu\text{ufd.}$
Output	4.5 $\mu\text{ufd.}$
Transconductance ($i_b = 80 \text{ ma.}$)	
$E_b = 3000 \text{ v., } E_{c2} = 500 \text{ v.}$	4000 μmhos

Section Communications Managers of the A.R.R.L. Communications Department

Reports Invited. All amateurs, especially League members, are invited to report station activities each mid-month (16th of the month for the last 30 days) direct to the SCM, the administrative official of ARRL elected by members in each Section whose address is given below. Radio Club reports are also desired by SCMs for inclusion in QST. New ARRL Field Organization appointments, with the exception of SEC, EC, OBS, and OO are not at present being made. See Operating News.

ATLANTIC DIVISION				
Eastern Pennsylvania	W3BES	Jerry Mathis	623 Crescent Ave.	Glenside Gardens
Maryland-Delaware-District of Columbia	W3CIZ	Hermann E. Hobbs	9701 Monroe St.	Linden, Maryland
Southern New Jersey	W3GCU	Ray Tomlinson	Silver Springs P. O.	Trenton 10
Western New York	W8KPH	Charles I. Otero	623 E. Brown St.	Spencerport
Western Pennsylvania	W8NCJ	R. R. Rosenberg	4158 Ridge Road, West	Erie
			927 East 23rd St.	
CENTRAL DIVISION				
Illinois	W9NUX	David E. Blake, II	4501 N. Malden St.	Chicago 40
Indiana	W9EGQ	Herbert S. Brier	385 Johnson St.	Gary
Kentucky	W9ARD	Harrell A. Downard	2077 Sherwood Ave.	Louisville 5
Michigan	W8DPE	Harold C. Bird	R.F.D. 2, Box 228	Pontiac 2
Ohio	W8MFP	Carl F. Wiehe	122 St. Albert St.	St. Bernard 17
Wisconsin	W9RH	Emil Felber, Jr.	1625 N. 18th St.	Milwaukee 5
DAKOTA DIVISION				
North Dakota	W9EVP	Raymond V. Barnett	406-17th St.	Bismarck
South Dakota	W9QVY	P. H. Schultz	118 N. Yankton Ave.	Pierre
Northern Minnesota	W9FUZ	Armond D. Brattland	Birchmont Drive	Bemidji
Southern Minnesota	W9YNQ	Millard L. Bender	608 N. Huron Ave.	Spring Valley
DELTA DIVISION				
Arkansas	W5GED	Ed Beck	2503 Bishop St.	Little Rock
Louisiana	W5DKR	Eugene H. Treadaway	P. O. Box 44	LaPlace
Mississippi	W5HAV	P. W. Clement	524 Santini St.	Biloxi
Tennessee	W5ASP	James B. Witt	R.F.D. 6, Shady Dell Trail	Knoxville
HUDSON DIVISION				
Eastern New York	W2HZL	Ernest E. George	2044 Lexington Parkway	Schenectady 8
N. Y. C. & Long Island	W2KDC	Charles Ham, Jr.	151-06 84th Drive	Jamaica, L. I., 2
Northern New Jersey	W2CQD	Winfield G. Beck	617 Spruce St.	Roselle
MIDWEST DIVISION				
Iowa	W9PTJ	Leslie B. Vennard	2712 Washington St.	Burlington
Kansas	W9AWP	A. B. Unruh	1617 S. Seneca St.	Wichita 12
Missouri	W9OTD	Mrs. Letha A. Dangerfield	411 Moffett Ave.	Joplin
Nebraska	W9FQB	Arthur R. Gaeth	6105 N. 37 St.	Omaha 11
NEW ENGLAND DIVISION				
Connecticut	W1KOY	Edmund R. Fraser	48 Willow St.	West Haven 16
Maine	W1AOL	G. C. Brown	379 No. Main St.	Brewer
Eastern Massachusetts	W1ALP	Frank L. Baker, Jr.	91 Atlantic St.	North Quincy 71
Western Massachusetts	W1JAH	William J. Barrett	239 Columbia St.	Adams
New Hampshire	W1FTJ	Mrs. Dorothy W. Evans	P. O. Box 312	Concord
Rhode Island	W1HRC	Clayton C. Gordon	70 Columbia Ave., Gaspee	Plateau, Providence 5
Vermont	W1NLO	Burtis W. Dean	P. O. Box 81	Burlington
NORTHWESTERN DIVISION				
Alaska	K7GNN	James G. Sherry		Homer
Idaho	W7AVP	Don D. Oberbillig	P. O. Box 486	Boise
Montana	W7CPY	Rex Roberts	Box 1088	Glendive
Oregon	W7GNJ	Carl Austin	1137 Federal	Bend
Washington	W7FWD	O. U. Tatro	513 N. Central	Olympia
PACIFIC DIVISION				
Hawaii	K6RLG	Howard S. Simpson	2668 Wells St.	Waikuku, Maui
Nevada	W6CWW	N. Arthur Sove	Box 2025	Reno
Santa Clara Valley	W6IUZ	Earl F. Sanderson	600 Acacia Ave.	San Bruno
East Bay	W6TI	Horace R. Greer	414 Fairmount Ave.	Oakland 11
San Francisco	W6RBO	William A. Ladley	200 Taylor St.	San Francisco 12
Sacramento Valley	W6MDI	Vincent N. Feldhausen	113 South Quincy St.	McCloud
Philippines	KA1GR	George L. Rickard	Box 849	Manila
San Joaquin Valley*	W6XB	Edward H. Noack	811 West Magnolia St.	Stockton
ROANOKE DIVISION				
North Carolina	W4CYB	W. J. Wortman	P. O. Box 566	Morganton
South Carolina	W4BQE/ANG	Ted Ferguson	3422 Rosewood Drive	Columbia 25
Virginia	W3AKN	Walter G. Walker	217-51 St.	Newport News
West Virginia	W8JRL	Kenneth M. Zinn	P. O. Box 132	Clarksburg
ROCKY MOUNTAIN DIVISION				
Colorado	W9VGC	H. F. Hekel	2743 Julian St.	Denver 11
Utah-Wyoming	W6LLH	Victor Drabble	1024 Oak St.	Ogden, Utah
SOUTHEASTERN DIVISION				
Alabama	W4GBV	Lawrence J. Smyth	808 Winona Ave.	Montgomery
Eastern Florida	W4IP	Robert B. Murphy	3302 S.W. Grapeland Blvd.	Miami 33
Western Florida	W4MS	Lt. Edward J. Collins	1409 N. 10th Ave.	Pensacola
Georgia	W4FDJ	Ernest L. Morgan	R.F.D. 2	Lyons
West Indies (Cuba) (Puerto Rico-Virgin Islands)*	K4KD	Everett Mayer	P. O. Box 1061	San Juan 5, P. R.
SOUTHWESTERN DIVISION				
Los Angeles	W6QVV	H. F. Wood	429 So. Fairview	Burbank
Arizona	W6RWW	Douglas Aitken	341 S. Mt. Vernon Ave.	Prescott
San Diego	W6CHV	Ralph H. Culbertson	7172 Eads St.	La Jolla
WEST GULF DIVISION				
Northern Texas	W5ALA	Jack T. Moore	5712 Berkshire Lane	Dallas 9
Oklahoma	W5AYL	Ed Oldfield	2141 N.W. 35th St.	Oklahoma City 6
Southern Texas	W5JC	James B. Rives	1721 Kentucky Ave.	San Antonio 1
New Mexico	W5HJF	J. G. Hatcock	110 S. E. Nevada St.	Portales
MARITIME DIVISION				
Maritime	VE1DQ	A. M. Crowell	69 Duplin St.	Halifax, N. S.
ONTARIO DIVISION				
Ontario	VE3EF	Wing Commander Donald R. Gunn	c/o Canadian Bank of Commerce	New Toronto, Ont.
QUEBEC DIVISION				
Quebec	VE2CO	Lieutenant L. G. Morris	4114 Hingston Ave.	Montreal 28, Que.
YANALTA DIVISION				
Alberta	VE4GE	C. S. Jamieson	581 W. Riverside Drive	Drumheller, Alta.
British Columbia	VE5DD	C. O. I. Sawyer	2634 West 31st Ave.	Vancouver
PRAIRIE DIVISION				
Manitoba	VE4AAW	A. W. Morley	26 Lennox St.	St. Vital
Saskatchewan	VE4SY	Arthur Chesworth	1084 Redland Ave.	Moose Jaw

*Officials appointed to act temporarily in the absence of a regular official.

McELROY "400" SERIES

COMPLETE AUTOMATIC RADIO AND TELEGRAPH TRANSMITTING AND RECEIVING EQUIPMENT

New designs, new features, new low prices. Immediate delivery, in any quantity. Illustrated catalog and technical manuals available in all commonly used languages.



McELROY TAPE PULLING HEAD
TPH-400

Admits tape from any angle from the right; prevents breakage; permits tape to come from any level on receiving table. \$45.00

McELROY WHEATSTONE CODE TAPE PERFORATOR
PFR-400

Designed to modernize small stations, at sea, ashore or on the air. For 110-120 volts, AC or DC. \$95.00

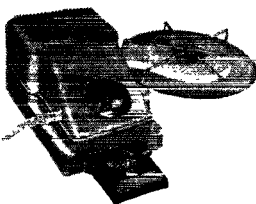

McELROY KEYING HEAD
HED-400

Complete with built-in polarized relay. Made without a Star Wheel opening in contact case; this assures clean contacts. \$240.00

McELROY UNIVERSAL DRIVE
MSD-400

Permits rapid interchangeability of keying head and tape pulling head. Save money on maintenance and spares. \$195.00

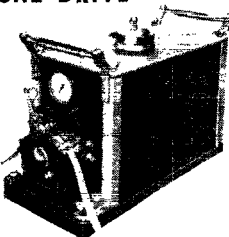

McELROY INK RECORDER
REC-400

Capable of speeds up to 700 words per minute. Tape holder, which is part of equipment, may be attached to right or back of case. \$195.00

McELROY RECORDER AMPLIFIER
MRD-400

Designed to drive the Ink Recorder at speeds to 300 words per minute. Cabinet or rack mounting. \$195.00



McELROY PHOTOTUBE KEYS
PTK-400

Delivers a tone code signal to from 1 to 50 headphones for operator training, and runs at low or extremely high speeds. \$45.00



McElroy engineers never copy, never imitate. We create, design, build . . . we are never satisfied with mediocrity.



McElroy MANUFACTURING CORPORATION

82 BROOKLINE AVENUE

BOSTON, MASSACHUSETTS

Must we go back?



THE EVOLUTION of electronics will always remain a bright page in the history books of science. And the record has been significantly brilliant during the past four years when improvements and developments were advanced at a faster rate than normal. With the ending of the war, there may be a few who do not feel the urgency to progress at a similar pace . . . who will be willing to relax the rigid wartime standards. Or there may be those who do not too accurately gauge the temper of the consumer, now in a mood to anticipate only the best from an industry which has accomplished such miracles in the past few years.

Along with many other far-sighted producers, we here at Marion fully intend to maintain our wartime quality pattern, and to cooperate in every known way to provide even better products for a peaceful world. We endorse the postwar standardization program of the Army and Navy Electronics Standards Agency, and will continue to manufacture all Marion electrical indicating instruments in conformity with JAN specifications. Our customers have a right to expect nothing else.

It is important to note that continued adherence to the Electronics Standards Agency program need not result in increased costs, either to the manufacturer or the consumer . . . while it will definitely result in improved product performance wherever such standardized components are used.

We, the manufacturers, engineers, consumers of electronics, are part of a vital, daring, visionary industry. It is with this realization that we are faced with the responsibility of deciding, at this time, whether we can relax, or whether we shouldn't give as much to a world at peace as we gave to a world at war.

Your comments will be welcomed.



MARION ELECTRICAL INSTRUMENT CO.

MANCHESTER, NEW HAMPSHIRE

EXPORT DIVISION 458 BROADWAY · NEW YORK 13, N. Y., U. S. A.

CABLE ADDRESS: MORMANEX



... For Progress in Radio

Here are views of the just-completed Collins hangar at the Cedar Rapids Airport, and the company's 18S twin-engined Beechcraft. The installation is dedicated to constant advancement in the design and performance of radio communication and navigation equipment for aviation.

The wing to the right of the hangar contains laboratories for Collins physicists, engineers, technicians and mechanics engaged in specific projects that require much space and the use of the plane.

Customers of Collins equipment are invited to remember that these facilities are available for installation and service. The Cedar Rapids Municipal Airport, with its 5400 ft. runways, will accommodate the largest aircraft. Collins Radio Company, Cedar Rapids, Iowa; 11 West 42nd Street, New York 18, N. Y. In Canada Collins equipment is sold by Collins-Fisher Limited, Montreal.

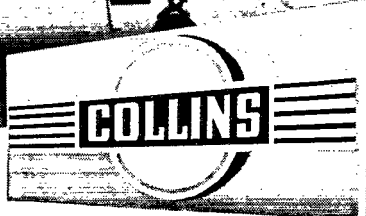

IN RADIO COMMUNICATIONS, IT'S . . .

THE AMERICAN RADIO RELAY LEAGUE, INC.,

is a noncommercial association of radio amateurs, bonded for the promotion of interest in amateur radio communication and experimentation, for the relaying of messages by radio, for the advancement of the radio art and of the public welfare, for the representation of the radio amateur in legislative matters, and for the maintenance of fraternalism and a high standard of conduct.

It is an incorporated association without capital stock, chartered under the laws of Connecticut. Its affairs are governed by a Board of Directors, elected every two years by the general membership. The officers are elected or appointed by the Directors. The League is noncommercial and no one commercially engaged in the manufacture, sale or rental of radio apparatus is eligible to membership on its board.

"Of, by and for the amateur," it numbers within its ranks practically every worth-while amateur in the nation and has a history of glorious achievement as the standard-bearer in amateur affairs.

Inquiries regarding membership are solicited. A bona fide interest in amateur radio is the only essential qualification; ownership of a transmitting station and knowledge of the code are not prerequisite, although full voting membership is granted only to licensed amateurs.

All general correspondence should be addressed to the Secretary at the administrative headquarters at West Hartford, Connecticut.



Past Presidents

- HIRAM PERCY MAXIM, W1AW, 1914-1936
- EUGENE C. WOODRUFF, W8CMP, 1936-1940

Officers

- President** GEORGE W. BAILEY, W1KH
Washington, D. C.
- Vice-President** CHARLES E. BLALACK, W6CG
Yuma, Arizona
- Secretary** KENNETH B. WARNER, W1EH
West Hartford, Connecticut
- Communications Manager** F. E. HANDY, W1BDI
West Hartford, Connecticut
- Treasurer** DAVID H. HOUGHTON
West Hartford, Connecticut

General Counsel PAUL M. SEGAL
1026 Woodward Building, Washington 5, D. C.

Directors

- President**
GEORGE W. BAILEY W1KH
1530 P St., N.W., Washington 25, D. C.
- Vice-President**
CHARLES E. BLALACK W6GG
Box 108, Yuma, Ariz.
- Canadian General Manager**
ALEX REID VE2BE
240 Logan Ave., St. Lambert, P. Q.
Alternate: Leonard W. Mitchell VE3AZ
78 Raglan Ave., Toronto, Ont.
- Atlantic Division**
EDWARD G. RASER *W3ZI
315 Beechwood Ave., Trenton 8, N. J.
Alternate: J. Victor Brotherson W8BHN
1743 Ottawa Drive, Erie, Pa.
- Central Division**
JOHN A. KIENER W8AVH
3462 Edison Rd., Cleveland Heights,
Cleveland 21, Ohio
Alternate: Earl S. Nelson W8DS
22551 Hadden Rd., Euclid 17, Ohio
- Dakota Division**
TOM E. DAVIS W9VVA
915 W. Becker Ave., Willmar, Minn.
Alternate: Harold B. Love W9ZRT
Box 426, Mandan, N. D.
- Delta Division**
GEORGE S. ACTON W5BMM
Plain Dealing, La.
Alternate: Samuel H. Dowell W5ERV
1057 Mildred St., Shreveport 15, La.
- Hudson Division**
ROBERT AKERIDGE KIRKMAN W2DSY
Werah Pl., R.F.D. No. 1, Box 61, Long Branch, N. J.
Alternate: George Rulfs, jr. W2CJY
38 Brookwood Drive, Manhasset, L. I., N. Y.
- Midwest Division**
FLOYD E. NORWINE, JR. W9EFC
7405 Hawatha Ave., Richmond Heights 17, Mo.
Alternate: C. A. Colvin W9VHR
% Omaha & Council Bluffs St. Railway Co.,
Omaha 2, Nebr.
- New England Division**
PERCY C. NOBLE W1BVR
37 Broad St., Westfield, Mass.
Alternate: Clayton C. Gordon W1HRC
70 Columbia Ave., Warwick, R. I.
- Northwestern Division**
KARL W. WEINGARTEN W7BG
3219 N. 24th St., Tacoma 7, Wash.
Alternate: R. Rex Roberts W7CPY
110 W. Brennan St., Glendive, Mont.
- Pacific Division**
J. L. McCARGAR W6EY
66 Hamilton Pl., Oakland 12, Calif.
Alternate: Elbert J. Amarantes W6FBW
1675 Dale Ave., San Jose, Calif.
- Roanoke Division**
H. L. CAVENESS W4DW
2607 Vanderbilt Ave., Raleigh, N. C.
Alternate: J. Frank Key W3ZA
Box 707, Buena Vista, Va.
- Rocky Mountain Division**
Acting Director:
HOWARD R. MARKWELL W9TFP
355 Monroe St., Denver 6, Colo.
- Southeastern Division**
WILLIAM C. SHELTON W4ASR
527 Revilo Blvd., Daytona Beach, Fla.
Alternate: William P. Sides W4AUP
Fleming Road, Montgomery, Ala.
- Southwestern Division**
JOHN E. BICKEL W6BKY
1834 E. Whittier Blvd., Whittier, Calif.
Alternate: Eldridge E. Wyatt, jr. W6ARW
P. O. Box 3597, Long Beach 3, Calif.
- West Gulf Division**
WAYLAND M. GROVES W5NW
c/o Humble Pipe Line Co., Odessa, Texas
Alternate: Jennings R. Poston W5AJ
P. O. Box 848, Curundu, Panama Canal Zone

"IT SEEMS TO US—"

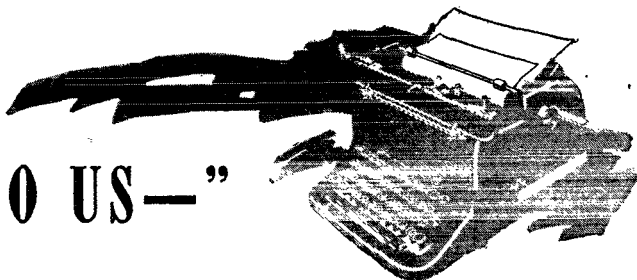

REBIRTH PAINS

WHAT SPORT! After all these years of ham silence the old gang is getting back, and what a struggle it is! Nobody can remember his circuit diagram. The radio stores are mad-houses and on Saturdays you have to stand in line. Everybody's mast is down and you can't buy any decent manila rope. You can spot the houses where amateurs live by observing the rooftop activity, as necks are risked to get that skyhook a foot higher before winter sets in. What fun!

While we're waiting for "80, 40 and 20" to come back to us we're a busy crew, with all these other bands opening at the same time. The new 2-meter band has taken a bit of a beating in the scramble to get going on 10, but actually the two bands make an exceedingly neat combination for "before and after," it seems to us. The never-die 5-meter gang has been delighted to get going on its old frequencies, postponing its reconversion headaches until March. It's 10 that has taken most of the attention, because of the DX it offered. And has it been swell to meet old friends again! We suppose you're in on the fun; if you aren't, you're missing a lot, for actually the band has been performing much better than anybody hoped and the propagation predictions for coming months are even more encouraging. The boys are knocking them off right and left and we expect to hear any minute of the first postwar WAC application.

Most fellows will tell you that they found it a bit more rugged to get going again than they had expected. We certainly did. We'd been running a WERS puddle-jumper during the war and since August we'd had it fired up on 112 (if you can fire up anything that pulls only 10 watts). But the matter of 28 Mc. called for the big rig that had been sitting idle through the war, and doggone if we could remember which end of it was which. It used to eat out of our hand but now it just stood there blandly smiling out of its motionless meters and defying us to remember which knob was the cathode tuner and what that extra flipswitch was for. We had to learn all over again the hard way, getting the bugs out of each successive stage, replacing the parts that had gone wrong during the

war — until finally we had grid mills in the final and amps in the feeders and we were in business again. It was only after we'd worked from EA to K6 that we discovered that one side of the V was down — over in that swampy patch, too, of course. There used to be an old Headquarters smartercrack that there's no antenna so good as a bad rhomboid, provided it's bad enough. Maybe the same thing applies to Vs, but we figure we're going to have to fix it. Anyway, we like to think how much better our signal is going to be after we do.

Well, in the process of tuning up we had a narrow escape from getting bitten by the final tank, just because we'd forgotten our wiring diagram. And suddenly we knew what we wanted to talk about on this page this month. It's safety.

Men, amateur radio has always had its dangerous side. But these old prewar rigs of ours are likely to be particularly poisonous, and we want to urge you to use the greatest care in getting going again. Insulation has deteriorated and

(Concluded on page 98)



**ALWAYS
BE
CAREFUL**



★ ★ ★

(A) Kill all transmitter circuits completely before touching anything behind the panel.

(B) Never wear 'phones while working on the transmitter.

(C) Never pull test arcs from transmitter tank circuits.

(D) Don't shoot trouble in a transmitter when tired or sleepy.

(E) When working on the transmitter, avoid bodily contact with metal racks or frames, radiators, damp floors or other grounded objects.

(F) Keep one hand in your pocket.

(G) Develop your own safety technique. Take time to be careful.

★ ★ ★

Death Is Permanent!

QRM—The Electronic Life Saver

How Enemy Radar was Foiled by Jamming

In Two Parts — Part I

BY PAUL ROBIANO,* W6PKM

• Some one has observed that whenever a new weapon of war is developed it is only a matter of time before countermeasures are devised to render it relatively ineffective. So it was with radar in this war. Radar countermeasure work, concentrated at the Radio Research Laboratory at Harvard, has led to the development of equipment which has more immediate application to communication in the microwave field than anything else so far disclosed. Here's a preview of the probable ham microwave gear of the future.

THIS IS the story of radar countermeasures in the war, a tale of the development and use of equipment to search out, jam and deceive the enemy's radar systems. The part of the ham in this vital activity was an essential one, for he brought to the job a know-how and a feel for tubes and circuits which no amount of high-powered graduate study alone could have produced. Since over half of the technical research staff which developed RCM (radar countermeasures) apparatus at Harvard University's Radio Research Laboratory was composed of hams, or ex-hams, it is easy to realize the significant contribution of amateur training to this supersecret war activity. For the past three years the engineers of this laboratory have made Cam-

* Radio Research Laboratory, 18 Divinity St., Cambridge, Mass.

bridge, Massachusetts, the noisiest city, electronically speaking, in the United States. This electrical plague has dwarfed all previous amateur efforts in the creation of QRM — but for once with a useful end in view.

Before U. S. entry into the war, some attention had been given to radar countermeasures by the Naval Research Laboratory and the Radiation Laboratory at Massachusetts Institute of Technology. By the end of December, 1941, the U. S. Services, aware of the need of a greatly expanded RCM program, formally requested the National Defense Research Committee of the OSRD to undertake a separate project in the field of radar countermeasures. The project was originally assigned to Radiation Laboratory, but shortly afterwards, it was found desirable to move it to an entirely separate laboratory. This led to the founding, early in 1942, of Radio Research Laboratory, an entirely new and separate radar countermeasures laboratory located at Harvard University. Late in 1942 the Radio Research Laboratory was placed under the supervision of the newly formed Division 15 of NDRC.

Chosen to create and direct the organization was Dr. Frederick E. Terman, then head of the Department of Electrical Engineering at Stanford University. Dr. Terman is well known professionally to all radio engineers because of his authorship of radio engineering books, such as "Radio Engineering" and "The Radio Engineers' Handbook," as well as many articles in leading radio engineering periodicals. Not so widely known is the fact that in his early days in

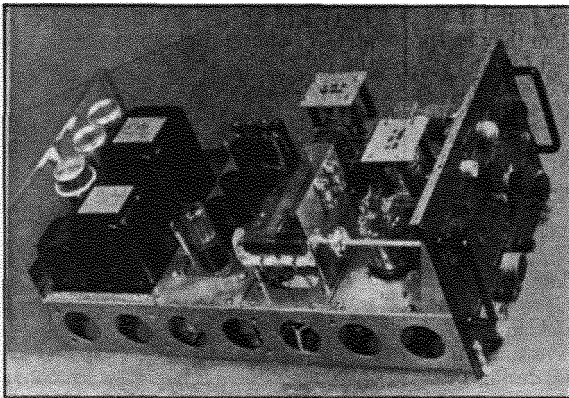

✎

The "Mandrel" jamming transmitter, covering 85 to 135 Mc., was one of the first jammers developed at the Radio Research Laboratory to go into mass production. Immediately behind the front panel is the r.f. power amplifier, which uses an 829 tube. The next three sections contain the oscillator, modulator and power supply.

⤴

An amplifier unit using continuously-variable inductance tuning to cover the range from 26 to 105 megacycles. Two HK-257Bs are operated as Class-B amplifiers to deliver a modulated output of 150-200 watts.

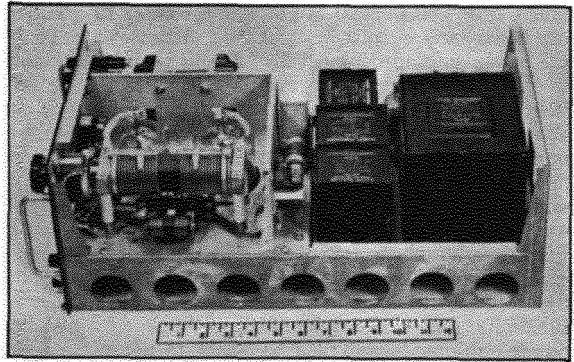

radio Dr. Terman was well-known in amateur circles, particularly on the west coast. His amateur activities started back in 1913, and in 1916 he was issued the call 6FT. After the conclusion of the World War in 1919, Dr. Terman was issued the call 6AE, the fifth one issued in the 6th call district after the war, and later he held the call 6XH jointly with Herbert Hoover, Jr., son of the former president. Subsequent demands of his work at Stanford University forced Dr. Terman to give up his amateur activities. Fortunately, however, his contributions to both amateur and professional radio circles have continued both directly and through the medium of his students.

One of the most secret of all the war enterprises, the Laboratory that Dr. Terman had been chosen to direct was responsible for the development of the greater part of all the radar countermeasures equipment used by the U. S. armed forces. Starting with a very small group, Radio Research Laboratory became a vast establishment employing at one time as many as 873 people and having an annual expenditure of \$5,000,000. Only about one-fourth of this number were engineers and technicians, to be sure, but an unusually high percentage of machinists and draftsmen and other facilities personnel were provided in order to give each researcher every opportunity to turn out his maximum product. What a ham paradise, with any amount of special tubes and parts and almost unlimited test equipment! But before discussing the technical achievements of this group, let us review the problems with which they were faced.

At the time that Radio Research Laboratory was founded, little or nothing was known about specific details concerning enemy radar equipment. Information on countermeasures which the British had developed to neutralize this equipment was likewise meager. It was mandatory that this situation should be alleviated as soon as possible in order to determine the course that radar countermeasures research and development should follow in the United States. The best solution was to establish close liaison with British circles who had already had operational experi-

ence with radio and radar countermeasures. With this in mind, Dr. Terman flew to England in April, 1942, and obtained the vital information which was to determine the immediate future of Radio Research Laboratory's activities.

As a result of RCM liaison with the British, reports from British sources and American observers began to come to the United States concerning German radar equipment. At first the information consisted primarily of that which the British had managed to obtain with their radar search equipment flown by the RAF and by monitoring stations that had been set up along the Northeast and Channel coasts of England. Later this information was supplemented by that obtained from captured enemy equipment. Through this early intelligence work, interested Allied personnel were able to gain an idea of the magnitude of Germany's preparations for a radar war. Continued investigation by Allied scientists revealed that the Germans were equipped with five major types of radar operating at frequencies from 100 to 600 Mc. These were being used for Early Warning (early detection and plotting of planes), Coast Watching (plotting movement of ships at sea), Aircraft Interception, Anti-aircraft Gunfire Control, and Ground Control of Interceptors. Aircraft Interception, or AI radar, was installed in German night fighter planes to enable them to intercept night bombers. Probably the most dangerous of the German radars was the Small Wurzburg set which was used to control anti-aircraft guns. The task facing the Radio Research Laboratory in 1942 was to devise equipment capable of neutralizing all of the known German radar systems plus any that might appear at higher frequencies at later dates.

The Problem

Many new technical problems faced the Radio Research Laboratory in its development of radar countermeasures equipment. Of the three frequency ranges for which equipment was required, only the lowest (up to 200 Mc.) presented problems which could be met with standard tubes and lumped-constant circuits. In the second

range, from 200 to 2000 Mc. it was necessary to use linear tank circuits, coaxial tank circuits, or the newly developed "butterfly" circuit in order to obtain satisfactory performance. Furthermore, there were no really good tubes for operation above about 600 Mc., although there had been a number of experimental developments. For the microwave region above 2000 Mc. it was necessary to develop the use of cavity resonators and wave guides. Although all of these techniques were already known, few of them had ever been exploited from the points of view required in countermeasures equipment, namely, wide-range tunability and the development of large c.w. power outputs. It was also necessary to devise methods of obtaining wide-band modulation. That all of these problems were solved for frequencies up to the microwave region is clearly shown by the success of the many developments actually carried through into Service procurement.

Jamming transmitters were the most obvious need of the RCM program; low frequency ones were needed for operation against known enemy early-warning sets, while jammers in the next range of frequencies were required to counter coast watching, searchlight control, gun-laying, ground-controlled interception, and airborne interception radar. Transmitters for both frequency ranges were to be designed to meet two basic requirements. First of all, each transmitter should have the widest possible tuning range in order that maximum versatility be realized from each piece of equipment, thus reducing the number of transmitters required to cover all enemy radar frequencies. Standardization was also important to expedite mass production of RCM equipment once it was developed. The second basic requirement was that the transmitter have sufficient modulated power output to provide an effective jamming signal while maintaining the important properties of light weight and compactness. Light weight and compactness were important because almost all of the jamming equipment was intended for airborne installations. The problem of realizing the most effective modulation for radar jamming proved to be one whose solution came after much thought

and exploitation of techniques previously untried. To begin with, it was desirable to have each jamming signal cover as wide a bandwidth as possible, something in the order of 5 Mc. If such a bandwidth could be achieved it would mean that each jamming transmitter might conceivably jam several radar stations operating within several megacycles of each other; moreover, relatively few such broad band transmitters would be required if it were desired to jam an entire radar band 50 or more megacycles wide. Such broadband characteristics are readily obtainable by mechanical frequency modulation of the carrier at low sweep rates or by a combination of frequency modulation and sine-wave amplitude modulation; however, these types of modulation did not prove as satisfactory for radar jamming as wide-band amplified noise. Wide-band noise, because of its complex electrical characteristics, is not susceptible to anti-jamming techniques as are the simpler types of modulation. As a result, when a noise-modulated jamming signal of sufficient intensity is tuned to the same frequency as the receiver of a radar system, the effect of the jamming signal is to decrease the signal-to-noise ratio to the point where the desired radar signal is completely buried in the high noise level. On the scope this interference appears in the form of a random "grassy" pattern. This results in the complete masking of the all-important radar "pips." If such thorough jamming occurs in a radar set controlling flak batteries, for instance, it means that unless the weather is clear enough for effective optical ranging, the aiming of the flak guns will border on pure guess work. Such proved to be the case in bombing missions over Germany. The possession of the "Mickey" radar bombing aid, which the Germans never were able to jam, permitted the U. S. Air Forces to bomb through clouds while at the same time their airborne RCM gear was thoroughly jamming German flak-control radar.

Noise modulation for radar jammers was first used by the British, who used a "noisy diode" circuit as a source of noise. Since the initial noise output was so low, an enormous amount of amplification was necessary to obtain a usable amount of noise power. Later investigations carried on at

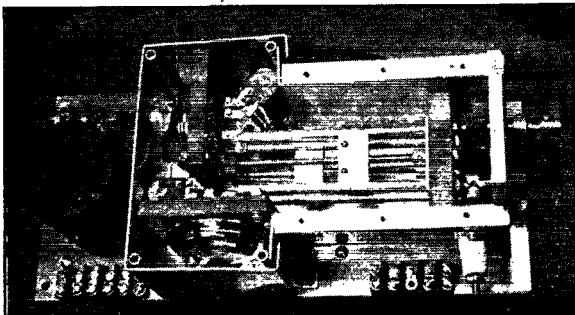

A close-up view of the oscillator section of the "Carpet I" transmitter, showing the "doorknob" tubes in place. The sliding shorting bars are driven by the threaded shafts, in turn controlled by tuning knobs on the front panel. The blower motor at the left provides forced-air cooling. This oscillator operates over the range 470-720 Mc., with outputs up to 6 watts.

the Radio Research Laboratory showed that the 931 photo-electric tube was a good source of electronic noise. Because of its very high amplification of electron "shot" effect, made possible by its generous secondary emission characteristics, the 931 had far greater output than the British scheme and proved to be readily adaptable for use in the wide-band modulators used in radar jamming transmitters. More recently, an even better source of noise was found in the 6D4 miniature gas triode working in a magnetic field.

While a great amount of laboratory time was being taken up in the development of transmitters and modulation systems, development of radar receivers was an equally important laboratory activity. Receivers were given high priority from the very beginning since they provided the best means of maintaining a close watch on enemy radar frequencies to check frequency distribution of signals and to detect any new enemy radar frequencies. To carry on such a radar monitoring program effectively, it was necessary to cover frequency ranges from the lowest commonly used in radar work (30 Mc.) to the highest permitted by the state of the art. Effective use of these transmitters and receivers required the development of numerous antenna systems, some having special characteristics such as broadband coverage, vertical, horizontal, or circular polarization, and particular types of pattern. From the receiver and antenna development at Radio Research Laboratory evolved a series of direction-finding (DF'ing) systems operating over a wide range of frequencies. Installed in planes and ships, such systems were responsible for the location and neutralization of numerous dangerous enemy radar-controlled weapons.

Another project involving a considerable amount of laboratory effort was the program undertaken at Radio Research Laboratory to develop "confusion reflectors." While these were mechanically and electrically simple when compared with the electronic jamming equipment

conceived at this laboratory, their effectiveness in jamming enemy radar systems was considered reason enough to devote some 2,000,000 pounds of aluminum foil each month toward their manufacture.

The most widely used of the "confusion reflectors" consisted of simple strips of aluminum foil code-named "window." Each strip of "window" was about an eighth of an inch wide and was cut to be a half wave-length long for the frequency of the radar band to be jammed. Operationally, packages of "window" were tossed out of Allied bombers as the target area was approached. As each package dropped, it came apart and released thousands of strips of aluminum foil. The ultimate result of dropping thousands of such packages was the forming of clouds of "window" which were capable of reflecting radar echoes. Enemy radar operators were then faced with the problem of distinguishing between clouds of these reflectors and the bombers. This they ultimately were able to accomplish with limited success by judicious use of special anti-jamming devices; however, once the Allies began to make use of "window" in conjunction with large scale use of electronic jamming transmitters, the resulting predicament of enemy radar operators became extremely difficult.

Transmitters

The development of practical radar jamming transmitters for frequencies below 200 Mc. did not present the problems that were to be encountered for the higher-frequency transmitters since a number of tubes were available which had already found use in amateur equipment and had proved satisfactory for frequencies up to 200 Mc. As time went on, double beam-power tetrodes, such as the 829 and 832 series, virtually became the standard for low-power oscillators and amplifiers for frequencies up to 200 Mc. Tuning in this frequency range was generally accomplished by use of the familiar coil and condenser combina-

Partly exploded view of a coaxial-line oscillator covering 300 to 2700 megacycles in two ranges. Immediately to the left of the 2C39 lighthouse tube is the grid contact ring for operation from 300 to 1000 Mc. The three discs on the circumference provide capacity feed-back between the plate and cathode circuits. The grid contact ring for 1000-2700 Mc. is to the right of the tube; it has three inductive loops to provide feed-back for operation in this range. The output is coupled to a coaxial line through the small condenser which is part of the fitting to the right of the housing; the coupling can be varied by means of the gear. The plate contact ring is shown at the lower left.

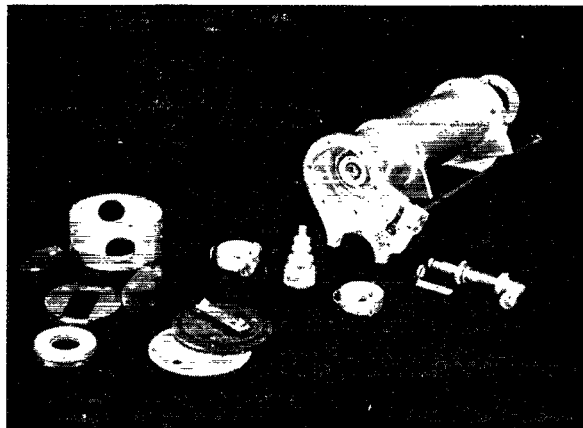

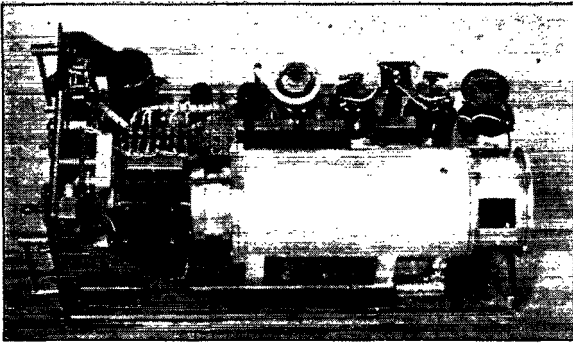

▽

The "Carpet IV" transmitter, capable of outputs up to 30 watts over a frequency range of 350 to 1400 Mc. The coaxial-line oscillator is in the foreground; visible through the rectangular slot at the right-hand end are the cooling fins of the lighthouse tube. The modulator occupies the section in the background.

△

tion or else by a continuously variable inductance working across tube and circuit capacities. With the latter method of tuning, it was possible to obtain a frequency tuning range of almost 4 to 1 (highest frequency four times the lowest frequency). Electrically, these variable inductances were no more than simple open-wire transmission lines wound on a circular tube of good grade Formica or Micalax, contact being made through the use of silver-plated sliders or rollers.

A good example of equipment utilizing such techniques was the earliest of the jamming transmitters to go into large-scale production, code-named "Mandrel," which covered a frequency range of 85 to 135 Mc. by the use of two plug-in coils. The r.f. section consisted of an 832 push-pull oscillator driving a grid-modulated 829 push-pull r.f. amplifier to approximately 20 watts output. This particular transmitter was designed to jam low-frequency German early warning radar. Variable inductances, or "rollo" coils as they were called, were almost exclusively used in high-power Class B r.f. amplifiers which were developed to amplify the modulated output of "Mandrel" and other low-power jammers operating below 225 Mc. Three such amplifiers covered the range from 30 to 225 Mc. with no plug-in coils being used. Outputs of over 180 watts were realized in the vicinity of 100 Mc. with efficiencies in the neighborhood of 50%. All of this was accomplished with conventional Eimac 35TG's and Gammatron HK 257B's.

Development of transmitters operating above 200 Mc. proved to be a formidable problem since in 1942 there were very few vacuum tubes capable of operating with good efficiency and output at higher frequencies. In fact, the only tubes that showed immediate promise of being practical for operation above 200 Mc. in the early jamming transmitters were the already available "door-knob" tubes. From these tubes came the oscillator of the "Carpet I" jamming transmitter which tuned as high as 720 Mc. with outputs up to 6 watts. Basically, the oscillator circuit was a simple push-pull t.p.t.g. circuit using open-line tank circuits. The efficiency of this oscillator was greatly enhanced by completely enclosing the

oscillator in a shield box to prevent loss of output power through stray radiation from the open lines. (This, incidentally, is an important step which was rarely ever followed in the average pre-war ham rigs on 112 Mc.) The lower frequency limit of the "Carpet" I oscillator was about 470 Mc. This range was obtained merely by the continuous tuning of the plate and grid lines with appropriate antenna tuning adjustments. While this procedure in itself sounds quite simple, there is no way of evaluating the time that was taken in the development of "Carpet I" to make such a relatively simple tuning procedure possible! It is sometimes quite an accomplishment to obtain oscillation at a single high frequency; however, realizing stable oscillation over wide tuning range is a far greater problem, largely because of the trouble caused by "loop resonance" effects taking place on unused portions of the open tuning lines. This trouble was cured by properly designed filament chokes and proper r.f. by-passing, but only after much experimentation. A transmitter of similar design with an output of approximately 20 watts was used to cover the range from 200 to 550 Mc. Like "Carpet I," this transmitter, "Rug," used "door-knob" tubes; however, they were tubes designed for lower-frequency work and were larger with appropriately larger power capabilities.

Following "Carpet I" and "Rug" came the "Carpet III," which was a transmitter designed to jam German flak-control radars operating from 460 to 585 Mc. This transmitter used RCA 8012 tubes for the oscillator and had a nominal output of 20 to 30 watts. Like "Carpet I," this piece of equipment found wide usage in the 8th and 15th U. S. Air Forces during the latter part of the war against Germany.

Early in 1942, research work was started at Radio Research Laboratory on concentric line oscillators which would tune up to 1000 Mc. and higher. This work has continued up to the present time. In March, 1944, the first successful model was being produced commercially for use in a new jamming transmitter capable of tuning well above 1000 Mc. with outputs of about 30 watts. This oscillator made use of a single "lighthouse"

One of several types of tunable magnetrons operating in the 2000-4000 Mc. range, capable of c.w. outputs from 50 to 85 watts. These tubes, or comparable types, may be the amateur transmitting tubes of the future in the superhigh range.

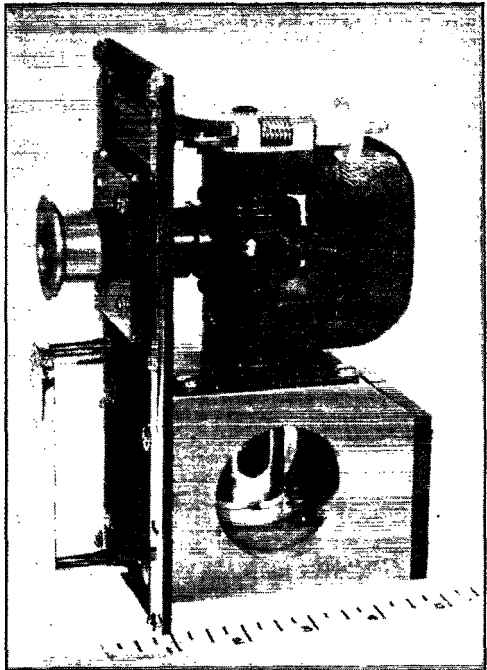

triode, the 3C22, which had been specially designed by General Electric Company for concentric line oscillators. Electrically, this oscillator was relatively simple, the tuning being accomplished in the cathode and plate circuits; however, the care that had to be taken in the design of the tube contacts and sliding contacts on the tuning plungers more than made up for the electrical simplicity. A later version of this concentric-line oscillator has recently been developed with an improved type of tube, the 2C39, which makes possible greater output at better efficiency. This latest oscillator has a continuous tuning range from 300 to 2700 Mc. Other types of oscillators have also been developed at Radio Research Laboratory which are capable of average outputs greater than one kilowatt at frequencies considerably above 1000 Mc. This was possible through the use of strapped-multi-cavity tunable magnetrons, developed by industrial laboratories under contracts with NDRC, Division 15.

Undoubtedly the most spectacular development to come out of Radio Research Laboratory during its existence came about as a result of British interest in December, 1942, in a superhigh-power radar jamming system. It was thought that such a jammer could be put to good use in Great Britain where it would be installed on the English Northeast Coast, with the sole intention of jamming the airborne radar sets carried by German night fighter planes, which were at that time accounting for many British night bombers. To produce sufficient signal strength for effective jamming over a 200-odd mile path leading into Germany required an enormous amount of power, even though the contemplated antenna system provided a power gain of 180 to 1. About the only tubes that gave any promise of generating the many kilowatts of r.f. that were required

at frequencies from 400 to 600 Mc. were the so-called "Resnatron" tubes. Research on this type of tube was originally started at the University of California. When the war came along, the NDRC awarded a contract to Westinghouse Electric Company to carry on further development and eventual manufacture of these tubes. As a result, when British interest was shown in a high-power jammer for operation in the 400- to 600-Mc. region, tubes were ready for trial. The design and development of a suitable oscillator, along with associated equipment which would handle the terrific r.f. power expected, was up to a group of engineers and physicists detailed to work on this project at the Radio Research Laboratory. (With an eye toward the parabolic antenna that was to be used as radiator, this project was code-named "Tuba.") To begin with, average r.f. power outputs of 30 kilowatts or better were expected! This meant the design of a suitable power supply which would be capable of 100 kilowatts or more. Moreover, the "Resnatron" tubes were to undergo continual pumping in order to maintain their working vacuum, since there was no vacuum sealing in the tubes. The terrific powers involved made a circulatory liquid cooling system mandatory. Forty gallons of water per minute were later found to be necessary. In addition to problems concerning power supplies and vacuum and water-cooling systems, there was the question of coupling kilowatts of r.f. power from the "Resnatron" oscillator to the antenna. After some mishaps, this was successfully accomplished

using a wave guide as the transmission medium. Since the experimental laboratory oscillator was located in the basement of Radio Research Laboratory, r.f. power was piped up seven stories to a parabolic reflector antenna located on the roof of the laboratory.

In spite of the many initial problems, the "Tuba" boys had their monstrosity generating unheard of high-frequency power by April of 1943. Subsequent tests showed the power output to be consistently around 50 kilowatts into a dummy load over a frequency range of 480 to 600 Mc. The greatest output reached was 87 kilowatts delivered into a dummy water load! At this point it must be stressed that this power is *average* c.w. power and is *not* peak pulse power! The modulation consisted of video noise which was obtained by methods previously discussed. While almost all of the generated r.f. power from "Tuba" was successfully piped either into a dummy load or to the antenna, there was usually enough power floating around to cause some amusing incidents. In one case, a visiting engineer was being conducted on a tour of the "Tuba" project when he suddenly found his necktie clip becoming unduly hot. Unfortunately, his tie clip happened to be of such a size as to resonate with the "Resnatron" oscillator frequency. On another occasion while the oscillator was being tuned, a harmless hacksaw hanging on a nearby tool board suddenly came into loop resonance. In a very short time it had melted into uselessness.

The construction of the "Tuba" equipment was

carried on under Lend-Lease arrangements initiated by the British. In the early months of 1944, the original "Tuba" project went overseas and was set up on the Northeast coast of England. At the same time a contract was established, under Division 15 of the NDRC, with the Delta Star Electric Co. of Chicago for the construction of two additional units which were delivered to the British late in 1944; however, at that time the German air force was already so depleted that the jamming of German night-fighter radar sets had lost its initial importance.

Although not having had much operational use, the "Resnatron" transmitter should undoubtedly prove to be one of the revolutionary developments of the war, inasmuch as the effective radiated c.w. field strength from the parabolic reflector antenna at Radio Research Laboratory was probably greater than ever realized from any other transmitter at any frequency. Normal r.f. power output varied between 30 and 50 kilowatts when operating into the antenna as load. The gain from the parabolic antenna was about 600 to 1, giving a field strength equivalent to 24,000 kilowatts radiation from a simple half-wave dipole antenna! The oscillator efficiency under such conditions varied between 40 and 80 per cent, depending on the details of modulation.

At present, further "Resnatron" research and development is being carried on at a well-known radio company in the Midwest. Given a little time to iron out some of the early difficulties such as maintenance of vacuum pressure and of transferring generated power more efficiently to the load, there is no telling what the ultimate power output capabilities of the original "Tuba" may become. At least now it can be said that the days of "flea power" above 300 Mc. have ended.

(Part II of this article will appear in an early issue.)

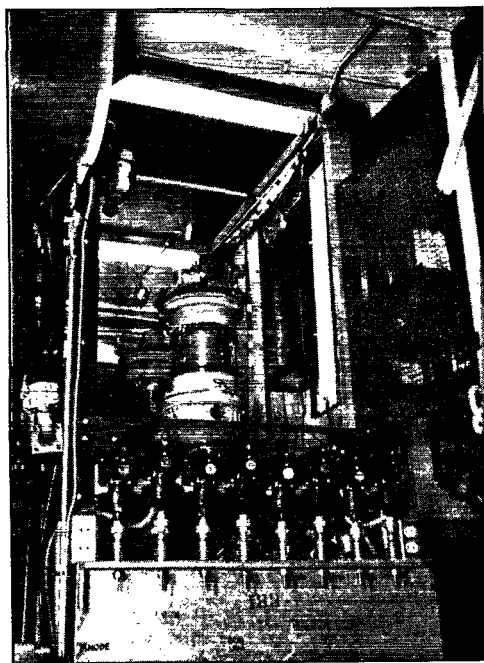

Resnatrons in the high-power "Tuba" jamming transmitter. Developing 85 kilowatts of c.w. power at 400 to 600 megacycles, these tubes are no mid-gets! The piping in the foreground is part of the water-cooling system.

Duplex Phone on 5300 Megacycles

Frequency Modulated Klystron Transmitter and Receiver

BY REUBEN MERCHANT,* W2LFG and A. E. HARRISON,** W6BMS

A NEW TYPE of amateur communication became available with the opening of the superhigh frequencies to amateur use on November 15. Listed as amateur bands are 2300 to 2450, 5250 to 5650, 10,000 to 10,500 and 21,000 to 22,000 megacycles. Before the war these frequencies were seldom talked of in practical terms, but now tubes and equipment are available which make operation possible on these bands. The system described here is one which was put together to show that amateur communication in the microwave region is feasible. Refinements were left out and no attempt was made to construct compact transmitters or receivers. Rather, it was thought that at this time the principal interest is in the application of techniques used in the superhigh-frequency ranges.

Two similar stations were built, each having a transmitter and receiver operating continuously so that two-way duplex operation is possible and switching is unnecessary. Highly directive antennas eliminate interference between the transmitter and receiver. Since the two stations were built in approximately the same form a description will be given of only one.

Reflex Klystrons

The heart of both the transmitter and receiver is the Sperry 2K43 reflex klystron. Its frequency range as listed on the characteristics sheet is from 4200 to 5700 megacycles, so it very nicely fits the 5250-5650-Mc. band. Before proceeding further it might be well to include a very brief description of the reflex klystron and its operation.

A reflex klystron is a vacuum tube with the radio frequency circuit built into the tube itself. Three different sections of the tube will be considered separately in order to simplify the discussion of its operation. These sections are an elec-

tron gun, a single cavity resonator which is the complete radio-frequency circuit, and a reflector electrode. The arrangement of these parts is shown in Fig. 1.

The electron gun consists of a cathode *K*, focusing ring *G*, and the anode plane. The cathode is the source of electrons which are attracted to the anode plane. The anode has an open-grid structure so that a beam of high-speed electrons can continue along the tube and pass through the resonator grids. The focusing ring acts as an electron lens and focuses the beam so that it passes

through the anode plane and past the resonator grids.

When the electrons pass the resonator grids their velocity is changed periodically by the radio-frequency voltage between the grids. After going through the grids they continue toward the reflector electrode, some travelling faster than the average and some moving more slowly. The beam is reversed in direction by the reflector, which is given a more negative voltage than the cathode. When the beam returns to the resonator grids it is bunched by

the action of the velocity modulation. If the bunches return in phase with the resonator voltage they will build up considerable r.f. power in the cavity, and this power can be withdrawn through the coaxial output line.

Since there is only a single circuit involved in a

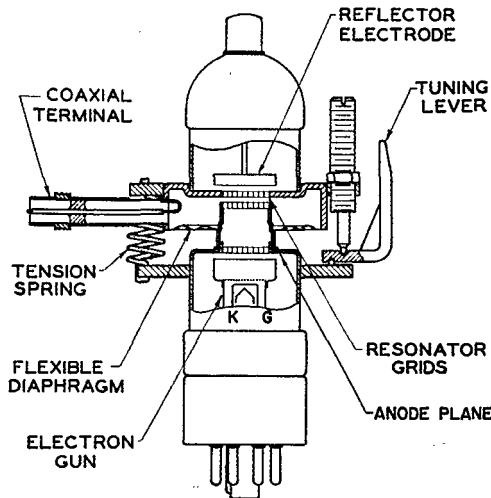

Fig. 1 — Reflex klystron in cross-section

• When amateur frequency allocations in the microwave region were announced some months ago, W2LGF and W6BMS made up their minds to be the first to establish communication on at least one of them. And that is exactly what they did — by opening the 5300-Mc. band on November 15th. The equipment — surprising in its simplicity — is described in this article.

* Nassau, N. Y.

** 175 Maple Ave., Rockville Centre, N. Y.

reflex klystron oscillator, the frequency of oscillation will be determined primarily by the tuning of the cavity resonator. However, the phase of the returning bunches is controlled by the beam and reflector voltages. Let us consider a case when the beam voltage is constant and the reflector has a slightly more negative voltage than the cathode. The electrons will almost reach the reflector before being turned back, and will return to the resonator grids several cycles later. The phase of the returned bunches will depend upon the time the electrons spend in the reflection space. The klystron will oscillate if this phase is correct.

If the reflector voltage is now made somewhat more negative, the electrons will be reversed sooner and the bunches might arrive 180° out of phase with the resonator voltage. Oscillation cannot occur under these conditions; in fact, the beam does not even become bunched. When the reflector voltage is made much more negative, the returning bunches may arrive one complete cycle earlier, and the phase will again be correct for oscillation. This behavior explains the appearance of "voltage modes" in the output of a klystron oscillator. This simply means that varying the reflector voltage will produce oscillation at various points, known as the voltage modes, and the output will drop off to zero between these points. The way in which the output varies is shown in Fig. 2.

The same type of curve could be drawn for the beam voltage with the reflector voltage held con-

stant. The beam voltage is the voltage applied to the resonator body, which is positive with respect to the cathode. It can be seen that the klystron is unlike the ordinary oscillator where a continual rise in applied potential causes a constant increase in output.

Another important characteristic of reflex klystrons should be mentioned before giving a description of the system itself. The frequency of oscillation is not determined exclusively by the resonator tuning but also by the beam and reflector

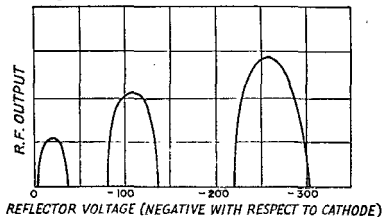

Fig. 2 — Output vs. reflector voltage characteristic of a reflex klystron. At certain voltages the reflected electrons are not properly bunched or in the right phase to sustain oscillation, consequently the output is zero.

tor voltages. Changing the reflector voltage varies the frequency by as much as one percent. This characteristic is illustrated in Fig. 3 for a single mode, but the effect occurs on all modes.

It can be seen that amplitude modulation of the output would cause a wide frequency variation of several megacycles. The greatest degree of amplitude modulation also is obtained near the edge of oscillation, where the output curve is steep, but this region is rather unstable. However, if frequency modulation is chosen, one can work well away from the points where oscillation drops out and at the same time be in the center of the curve where the amplitude is most nearly constant. The klystron, therefore, lends itself nicely to frequency modulation, but is not very satisfactory for amplitude modulation.

Tuning is accomplished by varying the separation of the resonator grids. This is possible because a flexible diaphragm forms one side of the resonator. As the distance between the grids is increased the capacity between them is decreased and the frequency increases. Screws are built in for making adjustments. For very fine control, vernier tuners may be used.

The Transmitter

It might be thought that a transmitter operating at 5300 Mc. would have to be an elaborate affair, but quite the opposite is true. The klystron has all of its tuned circuits built in, in the form of a resonator, so all that is necessary is a power supply, modulator and radiator. If the reflector is modulated, no modulation power is needed because the reflector operates at a negative potential and draws no current.

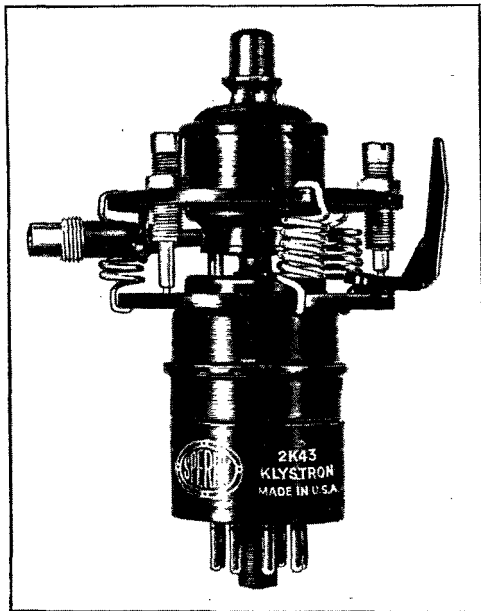

The 2K43 reflex klystron used in the W2LGF-W6BMS/2 5300-Mc. communication. This tube is used both as a transmitter and as a receiver local oscillator.

Two types of modulation have been tried, one at each station. The two methods, shown in Fig. 4, produce the same results and differ only in their methods of isolating the microphone from the high-voltage circuit. In each case an ordinary carbon mike is connected across a small audio transformer with a 1.5-volt battery in series. Method 1 is straightforward and uses a transformer with high-voltage insulation directly in the reflector lead. Method 2, using blocking condensers, was tried to show that transformers with low-voltage insulation might be used. In each case it was found advisable to put a resistor of a few thousand ohms across the secondary of the transformer. This cuts down the audio voltage developed and prevents overmodulation, and at the same time stops noise pick-up in the modulation circuit. With a low impedance in the reflector lead the modulation may be applied anywhere along the reflector line, but if a high impedance is used it may be found necessary to hook in the modulation at the reflector cap. The microphone case should be grounded as a safety precaution.

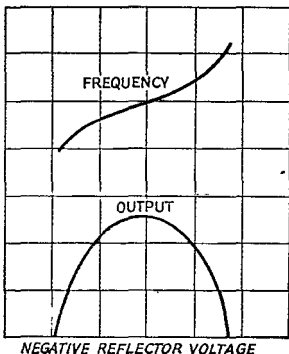

Fig. 3 — Generated frequency vs. reflector voltage. The frequency curve is practically straight over a considerable portion of its range, indicating the possibility of linear frequency modulation.

The transmitters are operated with approximately 1000 volts and 50 milliamperes on the beam. With this amount of power it is necessary to cool the klystron. This is done by means of a small blower which is mounted directly in front of the transmitter klystron. The focusing ring is run at cathode potential and reflectors at about -150 to -400 volts. The heater of a 2K43 requires 6.3 volts at 1.3 amperes. With the potentials listed approximately one watt output is obtained.

Since variations in the beam and reflector voltages can cause both amplitude and frequency modulation it is advisable to have voltage-regulated power supplies. The ripple must be a small fraction of a volt. In this set-up a Sperry SX-11 power supply is used for one of the transmitters and an SX-121 supply for the other; these units were used because they furnish a well-



The transmitting klystron and its blower mounted on the antenna support. The wave-guide starting section is not visible in this photograph, as it is on the other side of the 2-by-4 support.

regulated source of beam voltage and reflector voltage. Smaller power supplies with equally good regulation were used for the receiver klystrons. It is necessary to vary either the beam or the reflector voltage to select the proper voltage mode. The power supply units used at these stations have both voltages variable, but usually the beam is set at a fixed value and the reflector voltage is varied to bring the transmitter into operation.

Power is fed from the klystrons to the parabolic reflectors by means of 1- by 2-inch rectangular wave guide. This size was chosen because it was the smallest available size which would pass 5300 megacycles. The use of wave guides for transmission lines may be new to some readers, but at these frequencies the guide is quite often used in place of coaxial line. A wave guide acts as a high-pass filter and will transmit a signal so long as the wavelength is less than the cut-off wavelength. For the frequencies used in this system any wave guide 1.2 inches or wider is acceptable. The height

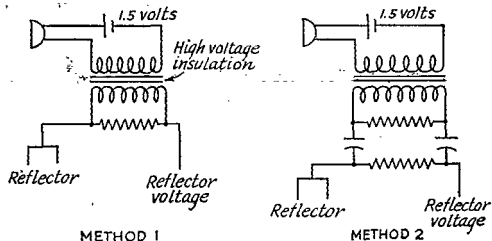

Fig. 4 — Modulation circuits are simple, consisting chiefly of a microphone and microphone transformer. Method 2 gives d.c. isolation from the transmitter.

of the wave guide determines the power-carrying capacity of the line and since only low power is used here this dimension is not critical. The signal is introduced by means of a simple wire probe inserted in the wave guide as shown in Fig. 5.

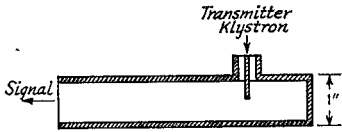

Fig. 5 — The signal starting section consists of a length of wave guide, closed at one end, excited by a probe from the klystron oscillator. The open end of the guide is directed at the center of the parabolic reflector shown in the photograph.

For a short-range system it would be possible to point the wave guide output at the receiver. However, this produces a broad antenna pattern which is not very satisfactory for point-to-point communication. In order to obtain a beam, the wave guide output is placed at the focal point of a 30-inch aluminum parabola. Parabolas of this type have been used extensively during the war and it is hoped that they may be available to amateurs as government surplus. No accurate checks have been made as to the beam pattern obtained but it appears that about a 10-degree beam is produced. This gives considerable gain and at the same time permits contact when the stations are not oriented exactly right.

The Receiver

The receiver works on the heterodyne principle. A signal differing from the received signal

by approximately 45 megacycles is generated at the receiving station. These two signals are mixed and the 45-Mc. signal obtained is then fed to a standard frequency-modulation receiver for detection. It does not matter whether the f.m. receiver tunes to the present standard of 45 megacycles or to the future standard around 100 megacycles, as the only difference is in the frequency setting of the local oscillator. The receiver discriminator circuit has been altered slightly so that a simple automatic frequency control can be used to keep the separation between the local oscillator and the received signal constant.

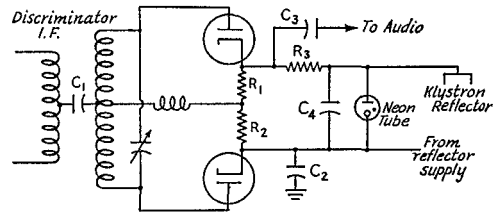
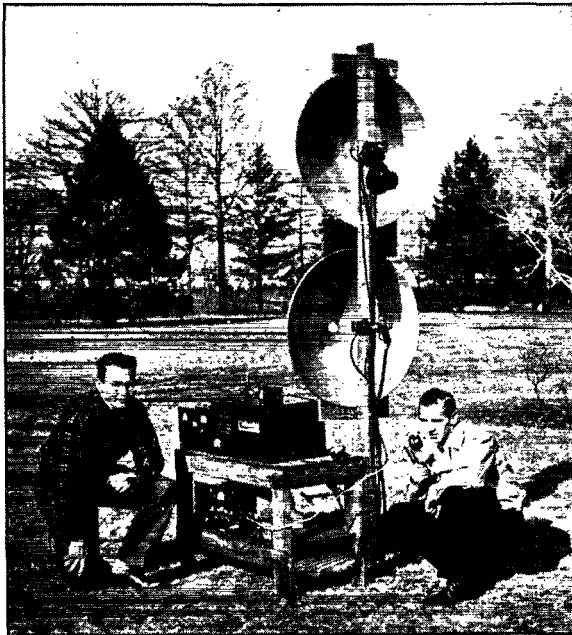

Fig. 6 — Modified discriminator circuit for automatic frequency control of the local-oscillator klystron. Constants are discussed in the text.

The way the a.f.c. is hooked up is shown in Fig. 6. The reflector supply is tied directly to one cathode of the discriminator while the reflector is tied to the other through an *RC* filter. Any d.c. voltage which the receiver impresses on the resistances R_1 and R_2 is added to the applied reflector voltage. If the transmitter frequency varies, the difference frequency between the local oscillator and the transmitter is no longer correct and a voltage is immediately developed across resistors R_1 and R_2 . This voltage is added to the reflector voltage; if the voltage is negative it will increase the frequency as shown in Fig. 3. Provided the polarity of the cathode connections is correct the local oscillator will be brought back to the proper frequency. Tests have shown that the receiver will keep locked in with a received signal which has drifted as much as 10 megacycles from its original setting. If the polarity of the connections to the cathode is incorrect it will be immediately evident, because the receiver will detune the local oscillator whenever a signal is received. One of the receivers has a three-position switch which will give either polarity or will disconnect the a.f.c. entirely.



W6BMS and W2LGF (holding the microphone) with one of the 5300-megacycle stations hurriedly assembled to open the band on November 15th. The transmitter, with a blower for cooling the klystron, is mounted in front of the upper "dish." The receiver local oscillator and mixer similarly are mounted in front of the lower parabolic reflector.

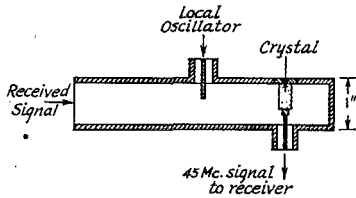

Fig. 7 — The r.f. mixer circuit, built in a section of 1- by 2-inch wave guide. Local oscillator voltage is injected by means of the probe shown at the top. The 45-Mc. i.f. signal is taken from the crystal detector through a coaxial line to the standard f.m. receiver.

Since the cathodes of the discriminator are now at a high potential with respect to ground, certain isolation features have been incorporated. An additional heater transformer has been put in for the discriminator to isolate it from the other heaters in the receiver. The voltage rating of condenser C_1 connected between the windings of the discriminator i.f. has been increased to 1500 volts. Condenser C_2 has been put in the cathode ground return and condenser C_3 installed in the audio lead. R_2 and C_4 keep any of the audio signal from reaching the reflector. The use of the neon tube from the reflector to the reflector supply is common practice when a high impedance is inserted in the reflector lead. In case the reflector should draw current for any reason it prevents excessive voltage from being developed across R_1 , R_2 and R_3 .

The tuning-eye circuit has been disconnected because the discriminator is now operated considerably above ground. A microammeter inserted in the grid lead of the limiter tube acts as a tuning indicator.

In order to obtain the difference signal between the local oscillator and the received signal, a crystal mixer of the type shown in Fig. 7 is used. This is built in 1- by 2-inch wave guide in much the same form as the transmitter starting section. The open end of the wave guide is located at the focal point of the receiver parabola. The local oscillator signal is fed into the guide by means of a wire probe. Near the closed end of the guide a crystal is in-

An f.m. receiver (used as the i.f. in reception) and two power supplies constitute the main body of the equipment. All of the r.f. circuits are mounted in the radiators.

serted. Type 1N23 crystals are used, but other cartridge-type crystals of the 1N series would be satisfactory. The actual mixing occurs in this crystal. The difference signal is fed by means of a coaxial line to the input of the f.m. receiver. This difference signal is approximately 45 megacycles and contains the frequency modulation which is on the carrier of the received signal. From this point on the system is similar in operation to any ordinary f.m. receiver.

The local oscillator is run at about 500 volts and 20 milliamperes and no cooling is necessary.

Operation

One accessory needed with this system is a wavemeter in order to be sure that both the transmit-

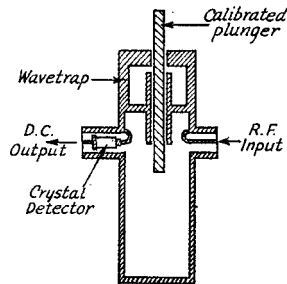
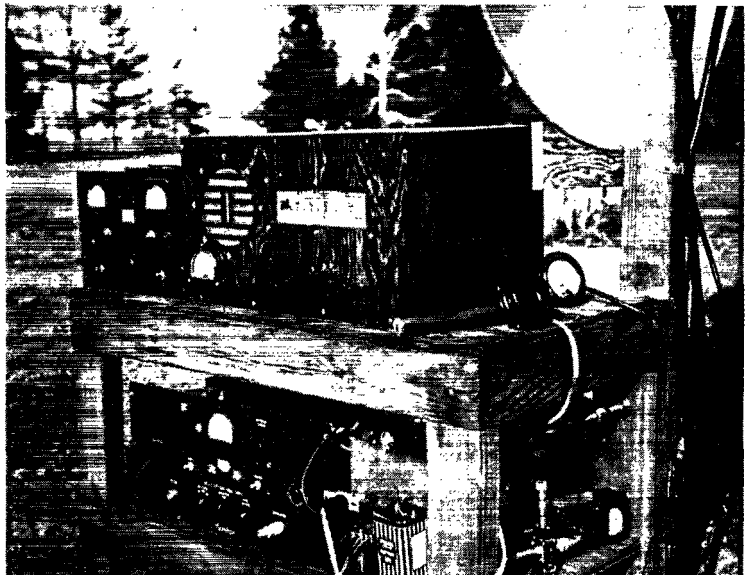

Fig. 8 — Essentials of the coaxial wavemeter used for 5300-Mc. work. The calibrated plunger does not make contact with the sleeve, but the large capacitance between these two elements is an effective short-circuit. The rectified output of the crystal detector is fed to a d.c. micro- or milliammeter used as a resonance indicator.

ter and the local oscillator are on frequency. Various methods may be used for determining the



frequency but perhaps the most convenient for this application is the quarter-wave concentric line resonator. This is a wavemeter which uses a cavity with a plunger inserted coaxially in it as shown in Fig. 8.

R.F. is fed through a coupling loop on one side of the cavity while a crystal detector is connected to a coupling loop on the opposite side. A milliammeter is connected across the output of the crystal detector. When the plunger is moved to the position corresponding to the input frequency, r.f. will feed into the output loop and a reading will be obtained on the crystal meter. The trap shown in the top section of the wavemeter stops r.f. leakage along the plunger, which might otherwise act as a coaxial line and conduct the energy out of the cavity.

The wavemeters used in conjunction with the system described are Sperry MK. C-27 wavemeters, which use a micrometer screw to move the tuning plunger. The scale of the micrometer is calibrated in terms of frequency. The plunger is moved until a reading is obtained, then the frequency is read from a calibration chart. Difference frequencies can be measured within two megacycles with this type of wavemeter. To use the wavemeter, a quarter-wave probe (length $\frac{1}{2}$ inch) is attached to the input line of the wavemeter. The probe is held directly in front of the wave guide to measure the local oscillator frequency, but it should be held somewhat farther away to prevent damage to the detector crystal when measuring the frequency of the transmitter because of the higher power.

First contacts were made at 7:46 p.m. on the evening of November 15, 1945. The two stations were set up on roofs with W2LGF operating in Garden City, New York, and W6BMS/2 operating in Great Neck, New York, which is about five miles away. This is almost a line-of-sight path, with the signal cutting through the tree tops. W2LGF operated on a frequency of 5390 megacycles while W6BMS was on 5280 megacycles. Several QSO's have been held since, lasting as long as two hours at a time. During this time the a.f.c. stayed locked in continuously except when tests were made to determine characteristics of the system or when someone stepped in front of a parabola. Quality is as good as is usually obtained with a carbon microphone. A small amount of hum has been noticed on the carriers but this has been traced to vibration caused by the blowers. This can be corrected by mounting the blowers on rubber shock mounts, although the hum is not strong enough to be bothersome.

It should again be pointed out that the equipment was put together in a hurry to open up the 5300-megacycle band. The methods discussed do not represent the ultimate in microwave communication but rather are presented to start the ball rolling on a new phase of amateur radio.

WWV Schedules

STANDARD-FREQUENCY transmissions are made available as a public service by the National Bureau of Standards over its standard-frequency station, WWV, on the following schedules and frequencies:

2.5 Mc. — 7:00 P.M. to 9:00 A.M. EST (0000 to 1400 GMT).

5.0 Mc. — Continuously, day and night.

10.0 Mc. — Continuously, day and night.

15.0 Mc. — Continuously, day and night.

The 10- and 15-Mc. radio frequencies are modulated simultaneously at accurate audio frequencies of 440 and 4000 cycles. 5 Mc. carries both audio frequencies during the daytime but only 440 cycles from 7:00 P.M. to 7:00 A.M., EST, while 2.5 Mc. carries only the 440-cycle modulation. A 0.005-second pulse may be heard as a faint tick every second, except the 59th second of each minute. These pulses may be used for accurate time signals, and their one-second spacing provides an accurate time interval for physical measurements.

The audio frequencies are interrupted precisely on the hour and each five minutes thereafter, resuming after an interval of precisely one minute. This one-minute interval is provided to give the station announcement and to afford an interval for the checking of radio-frequency measurements free from the presence of the audio frequencies. The announcement is the station call (WWV) sent in code, except at the hour and half hour, when it is given by voice.

The accuracy of all the frequencies, radio and audio, as transmitted, is better than a part in 10,000,000. Transmission effects in the medium may result in slight fluctuations in the audio frequencies as received at a particular place; the average frequency received, however, is as accurate as that transmitted. The time interval marked by the pulse every second is accurate to 0.00001 second. The 1-minute, 6-minute and 5-minute intervals, synchronized with the second pulses and marked by the beginning and ending of the periods when the audio frequencies are off, are accurate to a part in 10,000,000.

Of the frequencies mentioned above, the lowest provides service to short distances and the highest to great distances. In general, reliable reception is possible at all times throughout the United States and the North Atlantic Ocean, and fair reception over most of the world.

Information on how to receive and utilize the service is given in the Bureau's Letter Circular, "*Methods of Using Standard Frequencies Broadcast by Radio*," obtainable on request. The Bureau or special applications of the service. Correspondence should be addressed to the Director, National Bureau of Standards, Washington, D. C.

Christmas, 1944

A heart-warming yarn involving a combination of the Amateur and the Christmas Spirit in far-off Hollandia

BY S/SGT. R. H. NEWKIRK,* W9BRD

IN A wartime world the singular and exclusive camaraderie that exists in the hobby of amateur radio results in so many unexpected and coincidental meetings between good friends, who have previously never seen each other, as to make such happenstance fairly commonplace. But I boast a tale in which time, place and circumstance combined to cause a similar occurrence to be most extraordinary.

The Liberty ship *El Segundo Ruiz Belvis* lay at anchor in the murky waters of Humboldt Bay, New Guinea, on a tepid, tropical night in '44. In the absence of the moon, the Dipper and the Southern Cross scintillated bewitchingly. On the shore, the lights of the army base of Hollandia burned steadily in contrast to the varipowered signal blinkers which intermittently pierced the opaque darkness throughout the harbor. The latter were visual communication between ships and shore plus an admixture of ship-to-ship chatter, official and otherwise. There was an underlying tense tinge to the atmosphere and the stillness was broken only by the occasional clank of ship gear and the sharp staccato of the *Belvis'* blinker shutters as the signalman transacted port business with the powerful land station.

This was rendezvous. Our Liberty, with scores of army personnel aboard, had here become a unit in the formation of a huge convoy. Crammed into holds, on hatches and into every available nook and cranny of the steel deck, we were Leyte-bound. Stuffed, sweaty and hungry on our two meals per day, we wore out deck after deck of pinochle cards and read every available piece of literature over and over again. It was almost a month since we had left Sansapor, scene of our last operation. We were exuberant in the knowledge that we were soon to leave New Guinea.

Christmas was but a few days away and we had had no mail for weeks. Men leaned languidly on the rail and thought of home while others dreamed of the same in their cramped quarters. The circumstances certainly made this Yuletide one to be long remembered. Nevertheless, all that would feature this day for us would be a possible piece of priceless turkey added to the usual dehydrated viands. Just another dragging equatorial day to be piled atop hundreds just like it.

It was ten o'clock. I was wide awake; only my eyes were tired. Presently, I found myself detachedly reading the blinkers which poked their

focused fingers indiscriminately about the bay. My quarters, in the cab of a 399, were on the port rail amidships and afforded a good view across the water. I became absorbed in various bits of chatter between nearby vessels. It struck me that QRM was quite heavy tonight — a sort of an optical 80 meters. I saw one of the lights sign off with a "73." This was interesting as among the host of merchant marine signalmen, hams are spread pretty thinly. I seized my M-1 torch and focused an insipid beam in the direction of that ship. I sent *CQ CQ CQ K*. A ham call sign is a cumbersome thing to handle with a blinker. Furthermore, I had no faith in the DX powers of my 3-volt flashlight bulb. I was therefore elated when a bright interrogatory sign beamed forth, aimed obviously in my direction. Contact! True, it was far outside the hambands, but band divisions in the microwave region are indefinite anyway.

I was still dubious as to whether my man was an amateur. Rather than complicate matters immediately, at this speed of 8 words per minute, I began in the language of the layman: *HELLO PAL WHERE YOU FROM? K*. Back in an agreeably rhythmic style came: *R TULSA OKLA NAME IS HAL K*. The given name and place struck a subconscious responsive inner chord vaguely. Next, I blinked: *GE HAL IM ROD FROM CHGO K*. There was a pause. He re-oriented his beam to compensate for tidal drift and then startled me with: *W9BRD DE W5EKA K*.

The night quickly took on an exhilarant aspect as we lapsed into ham vernacular, spiced with many Morse slaps on the back. Hal Franks was no other than an old c.w. crony of mine. We had heckled each other on 80, 40 and 20 a countless number of times in the prewar days. In memory I was hearing again that beautiful swing and T9X sledge-hammer signal off his three-element rotary. We discovered mutual ham friends and we exchanged much welcome information and recounted bygone days. He was quite amazed to learn that I was behind a mere GI flashlight (with low batteries at that). The QSO continued far into the night — the next and the next.

We seemed destined to rot in our anchorage. The convoy movement was postponed from day to day. However, this Christmas season took on a much different aspect for me as arrangements were made and, at 0900 Christmas Day,

*APO 74, c/o PM, San Francisco, Calif.

(Concluded on page 102)

A New F.M. Detector Circuit

Ratio Detector Makes Limiting Unnecessary in F.M. Receivers

IN THE ordinary f.m. discriminator circuit, shown in simplified form in Fig. 1, a properly-centered unmodulated carrier results in the appearance of equal rectified voltages across R_1 and R_2 . Since these voltages have opposite polarity with respect to the mid-connection between the two resistors the voltage across the output terminals is zero.

When the carrier frequency deviates under modulation the r.f. voltage applied to one diode increases while the voltage applied to the second diode decreases.¹ As an illustration, suppose that the carrier alone develops a d.c. voltage of 10 volts in each load resistor, the voltage in R_1 being positive and that in R_2 negative with respect to ground. Then if the carrier deviates in such a way that the voltage applied to diode No. 1 increases and that applied to No. 2 decreases, the rectified voltage in R_1 may increase to +15 volts while that in R_2 decreases to -5 volts. The output voltage is now +10 volts, the difference between the two.

Now, to take another case, suppose the carrier strength is such that under no-modulation conditions 20 volts appears across each load resistor. The same frequency deviation as in the first case now will cause the rectified output voltage to rise to +30 volts in R_1 and to decrease to -10 volts in R_2 . The output voltage is now +20 volts for the same frequency deviation. In other words, the discriminator is sensitive to amplitude changes except when those changes occur exactly at the center of the discriminator characteristic. At that point, of course, the output voltage is zero regardless of the amplitude of the r.f. voltage, within the limits of linearity and balance in the particular set-up.

As is well known, a discriminator will respond quite nicely to an amplitude-modulated carrier when the receiver is detuned so that the carrier is not centered. This characteristic makes it necessary to use limiting ahead of the discriminator in an f.m. receiver, to wash out the amplitude variations which otherwise would appear in the rectified output. If an f.m. detector could be made unresponsive to amplitude changes the full benefits of f.m. reception could be obtained without the necessity for limiting, and the large amount of r.f. and i.f. gain required for good limiter operation would not be needed.

¹ The method by which these voltage shifts come about is described in *The Radio Amateur's Handbook*, in the chapter on Receiver Principles and Design.

² 711 Fifth Ave., New York. The information presented here is taken from Report LB-645, "Ratio Detectors for F.M. Receivers," by permission.

The Ratio Detector

A practical f.m. detector having these characteristics has been developed by the RCA Laboratories, Industry Service Division.² It is based on the idea of dividing a fixed d.c. voltage into two parts having a ratio which is equal to the ratio of the amplitudes of the two i.f. voltages that are applied to the separate diodes in the ordinary discriminator circuit. In the examples above, this ratio increased from 1:1 with an unmodulated carrier to 3:1 with frequency deviation in one direction. Note that the ratio was the same in both examples — 15/5 in the first and 30/10 in the second — although the differing amplitudes gave rise to an output signal twice as large in the second case as in the first. If the detector responds only to a change in this *ratio*, the signal amplitudes may vary over a wide range, in the practical case, without causing a change in the output voltage. In other words, the detector will respond to f.m. but not to a.m.

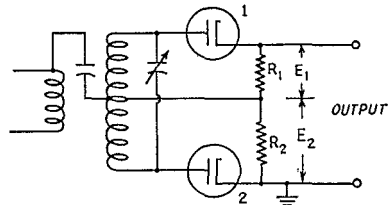

Fig. 1 — Elementary discriminator circuit.

The operating principles can be explained with the help of Fig. 2, an elementary form of ratio detector. In this circuit a battery supplies the fixed d.c. voltage, E . The polarity of the battery voltage is such that the two diodes are non-conducting in the absence of an i.f. signal. Under these conditions, the two voltages E_1 and E_2 will be equal (if the two condensers have equal capacitances) and there will be no difference of potential between points A and B, the latter being a center-tap on the battery.

When i.f. signals of equal amplitudes are applied to the two diodes, current will flow around the loop formed by the battery and the diodes but there will still be no difference of potential between A and B. However, if the i.f. voltage applied to one diode — the upper one, say — is greater than that applied to the lower one, E_1 will increase and E_2 will decrease, the ratio of E_1 to E_2 becoming the same as the ratio of the two i.f. voltages. But the total voltage, E , is still the same. The situation is quite comparable to that which would exist should two similar rectifier

power supplies be connected in series with a battery as a load; if the primary voltage on either or both is changed the proportion of the total voltage that each supplies changes correspondingly, but the total voltage could not change, assuming that internal resistance of the battery is negligible.

A Practical Circuit

The elementary circuit of Fig. 2 would not be entirely satisfactory for practical work. The diodes do not conduct until the rectified voltage is great enough to overcome the battery voltage, which means that the battery voltage must be very small if the detector is to operate on weak signals. On the other hand, the audio-frequency output is limited to a peak-to-peak amplitude equal to the battery voltage, so that a relatively large fixed d.c. voltage is desirable if strong signals are to be fully utilized. This problem is solved in the practical form of the circuit shown in Fig. 3. The i.f. circuits are those of the familiar discriminator, and the i.f. voltages applied to the two diodes vary as usual with frequency deviation from the center frequency. The rectified output of the diodes is fed in series through a resistor, R_1 , causing a d.c. voltage drop which replaces the battery voltage in the elementary circuit of Fig. 2. R_1 is by-passed for audio frequencies by C_1 so that the voltage drop is constant whether or not the i.f. carrier is being modulated. The value of the d.c. voltage developed in R_1 obviously depends upon the carrier strength, so that the voltage will be small if the signal is weak and large if

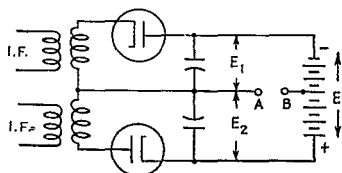

Fig. 2 — The ratio detector in simplified form.

the signal is strong, thus overcoming the objection to the use of a d.c. voltage that is independent of the signal strength. For any given carrier, of course, the voltage is fixed, and the detector works on the ratio principle just as in Fig. 2.

The value of R_1 is somewhat critical if best results are to be secured. If the resistance is too small the detector will be insensitive because the rectified voltage will be small. On the other hand, if the resistance is too large the immunity to amplitude-modulation effects is reduced. A compromise value is indicated under the circuit diagram, although the choice of an exact value should depend upon the results of measurements made on the actual receiver set-up.

It should be noted that since the voltage developed in R_1 is proportional to the carrier amplitude it is possible to use it to provide a.v.c. for the r.f. and i.f. stages in the receiver. It is also

of interest to note that a receiver using this type of detector behaves much like an ordinary a.m. receiver in that signals that are not strong enough to give full a.v.c. give less audio output. Further, the side responses that are characteristic of the usual limiter-discriminator combination are much reduced by the ratio detector; this is because the ordinary discriminator is very sensitive to the amplitude changes that occur when the carrier is tuned through the sloping sides of the i.f. resonance curve, while the ratio detector responds only to changes in the ratio of the i.f. voltages applied to the diodes. This ratio peaks on either side of the resonance curve so side responses are still present, but they are smaller than in the case of the limiter-discriminator.

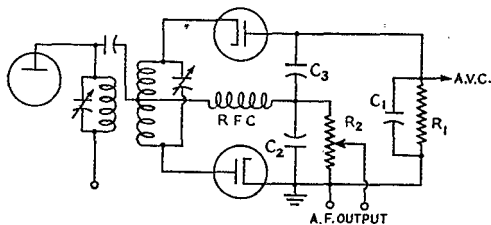

Fig. 3 — Practical circuit of the ratio detector. The i.f. circuit constants will depend on the intermediate frequency and band-width in the same way as in conventional discriminator circuits.

- C_1 — 8- μ fd. electrolytic
- C_2, C_3 — 0.004 μ fd.
- C_4 — 0.0001 μ fd.
- R_1 — 30,000 ohms
- R_2 — 1-meg. volume control

In general, the ratio detector is said to be somewhat harder to adjust than the ordinary discriminator, but the advantages of the circuit would appear to outweigh this disadvantage. The reduction of side responses alone would appear to make it particularly interesting for amateur f.m. work, as the three-spot tuning of the limiter-discriminator arrangement is definitely detrimental to selectivity. In addition, it is certainly not unwelcome news that less instead of more r.f. and i.f. gain is required for good f.m. reception. It is stated that broadcast receivers using this circuit, having one r.f. and only one i.f. stage, are equally as sensitive as more elaborate receivers of conventional design, and frequently give better performance on the weaker signals. All of which sounds as though the circuit is a good bet for amateur f.m. receivers.

— G. G.

• Many of the design requirements in f.m. receivers are based on the necessity for eliminating amplitude modulation before the signal is applied to the discriminator. Inherently insensitive to amplitude modulation, the ratio detector promises to effect a marked simplification in f.m. receivers.

The Half-Rhombic Antenna

A Directive System for V.H.F.

BY CAPT. JOHN H. MULLANEY, S.C.,* W4HGU

THE FIRST practical form of a half-rhombic antenna was the tilt wire or inverted V-type antenna shown in Fig. 1. Gains comparable to a rhombic of the same dimensions are sometimes obtained, but because of variations in ground resistance with changing weather conditions a low-resistance ground generally is not realized. This, of course, detracts noticeably from the gain of the antenna. Consequently the use of this type of antenna has been discouraged unless the ground resistance for a particular locality is extremely low. Many experiments have been conducted using large ground screens under the antenna, and extending a half-wavelength or so beyond the wire in all directions. This provides a low-resistance ground, but the construction entailed is usually impractical. To alleviate this difficulty, the basic design was modified and a solid conductor or counterpoise was stretched under the antenna as shown in Fig. 2. This provides a good electrical ground of low resistance. A counterpoise in combination with an inverted-V-type antenna is called a half-rhombic antenna.

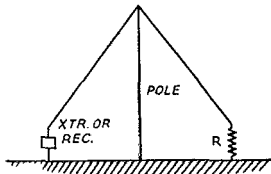

Fig. 1 — The tilted-wire or inverted-V antenna.

The triangle of Fig. 3 represents an antenna of the half-rhombic type. The triangular dimensions are mathematically related to the operating frequency and physical height of the antenna support. The height of this support varies inversely with frequency; that is, the lower the operating frequency used, the higher the antenna pole or support must be, while, on the other hand, the higher the frequency, the lower the pole. At frequencies above about 30 megacycles, the required height of the support or antenna pole becomes a practically attainable value so that small poles, masts or trees may be used.

Also, a direct relationship exists between the required length of each leg of the antenna, the height of the upper angle (apex angle) above ground, and the length of the counterpoise. The dotted line represents the height of the triangle. The wire length in wavelengths as indicated on the left leg of the triangle is a measure

* HQ. USASTAF, Communications Office, A.P.O. 234, c/o Postmaster, San Francisco, Calif.

• At lower frequencies the half-rhombic antenna is impractical for amateur use because of the required height of the support. However, at v.h.f. it provides a relatively simple means of obtaining high directivity and gain with vertical polarization. This article gives complete design data for constructing an antenna of this type.

which may be used for the design of any given half-rhombic. How to convert it to feet will be given later in this article. The tilt angle is of great importance in the design, and must be correct for maximum antenna gain. The counterpoise length is determined by the leg length and the tilt angle.

Pointers on Choosing Size

At any given frequency there are several half-rhombic sizes which may be used. They vary from a minimum at which the beam will work to a size limited only by the height of the antenna pole, the weight of the wire the pole will support, and the amount of wire available. The larger the size for a given frequency, the sharper will be the beam produced, and the greater the gain realized within the beam.

In practice various half-rhombic sizes are identified by referring to the number of full electrical wavelengths in one leg of the antenna at the frequency at which the antenna is being operated. The following formula may be used to convert full wavelengths to feet:

$$\text{Length of } \lambda = \frac{984}{f_{Mc.}} \text{ ft.}$$

Generally the smallest size at which a half-rhombic will perform satisfactorily is one having a single full wavelength on a leg, or side, at the average frequency at which it is to be operated.

Fig. 4 shows a half-rhombic antenna design chart. From this chart the triangular dimensions of any half-rhombic antenna may be quickly determined. The tilt angle is plotted against the wire length for one leg measured in wavelengths. For example, let us determine the dimensions of a half-rhombic antenna having 2 wavelengths per leg for 41 Mc.

$$\text{Length} = \frac{984}{41} = 24 \text{ ft. per } \lambda$$

Each leg of the antenna would then measure

24 × 2 (for two wavelengths) or 48 feet. From Fig. 4 the tilt angle, ϕ , for an antenna with two wavelengths per leg is shown as approximately 49 degrees. Since the tilt angle is exactly half the apex angle, the angle formed by the two legs will be 98 degrees. The correct counterpoise length will be that required to complete the base side of the triangle of Fig. 3.

Determining Counterpoise Length and Pole Height

To avoid trigonometric functions, the following Table I keys all dimensions of the antenna triangle to the length of a side. Note that each dimension is expressed in wavelengths at the desired frequency. This is readily converted to linear feet by the formula given previously. Using this method, any size half-rhombic antenna may be designed for any frequency by no more than multiplication.

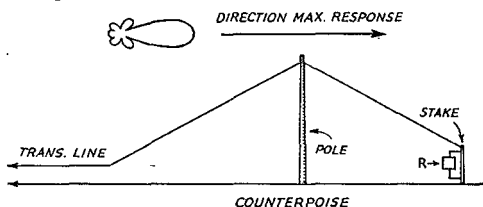

Fig. 2 — The inverted-rhombic antenna with counterpoise. Directivity is in the direction of the terminated end.

For example, the half-rhombic antenna using 2 wavelengths on a side at 41 Mc. was found to require 48 feet on a leg. Glancing at Table I, it can be seen that an antenna with two wavelengths on a leg has a tilt angle of 49 degrees, the pole height required is 1.3 wavelengths, and the overall counterpoise length 3 wavelengths. Since the length of a wavelength at 41 megacycles is 24 feet, the height of the pole required will be $24 \times 1.3 = 31.2$ feet, and the counterpoise length $24 \times 3 = 72$ feet.

Where the size of the antenna will be governed wholly by the height of the supporting pole, tree

λ per leg	Tilt Angle ϕ°	Pole Height in λ	Counterpoise length in λ
1	30	0.87	1
2	49	1.3	3
3	57	1.6	5
4	62	1.9	7
5	65	2.1	9
6	67	2.3	11
7	68	2.6	13
8	70	2.7	15
9	70.5	3.0	17
10	71	3.3	19
11	72	3.4	21
12	73	3.5	23

Fig. 3 — Antenna triangle representing the half-rhombic antenna with the important factors labeled.

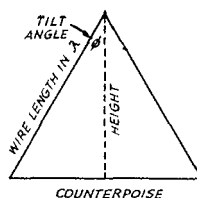

or mast, quick calculations can be made using the tabular column showing the required pole height so the maximum size antenna (thus the greatest gain) may be designed for the available mast height. For example, a 70-foot tree which appears to offer an excellent half-rhombic antenna support may be available. If the mean operating frequency to be used is 36.4 megacycles, dividing 984 by 36.4 shows a full wavelength to be approximately 27 feet at that frequency. Table I indicates that an antenna having two wavelengths on a leg requires a mast or pole height of 1.3 wavelengths, or 35.1 feet. Since the tree is taller than 35.1 feet, a larger antenna is possible. Therefore the table is re-examined for an antenna having six wavelengths on a leg which, the table indicates, requires a pole height of 2.3 wavelengths or 62.1 feet. Simple multiplication then shows that the antenna will have 162 feet on each leg and 297 feet for its counterpoise. The beam produced by this antenna may be pointed in any direction simply by rotating the antenna around the tree.

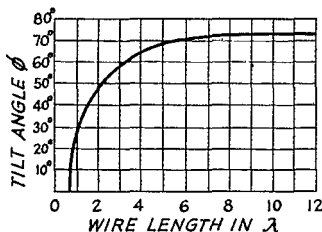

Fig. 4 — Chart showing the tilt angle, ϕ , for various leg lengths in wavelengths.

Terminating Resistors

The terminating resistor plays a dual function in the operation of a half-rhombic antenna. Upon it depends the unidirectivity of the antenna and the absence of any resonant effect. When a half-rhombic antenna is properly terminated it will offer a constant input impedance. This allows it to be operated over a wide band of frequencies without the necessity for readjusting the coupling at the transmitter.

This resistor should be a non-inductive type and it may have a resistance between 400 and 700 ohms without adversely affecting its terminating properties. It must be rated to handle approximately one-half the transmitter input power to the antenna. When using a half-rhombic for re-

ception only, the resistor power rating is not important. The terminating resistor should be mechanically suitable for outdoor installation. Common practice dictates that it should be placed in a weatherproof box for protection from the elements.

It should be noted that the terminating resistor affects neither the strength of the signal nor the field distribution in the forward direction. Its primary function is to decrease the radiation and reception from the back or reverse direction when it is connected. This power is wasted only in the sense that it is not radiated in the reverse direction, because it would not be radiated in the forward direction with or without a terminating resistor. In other words, the terminating resistor is the factor responsible for making a half-rhombic a unidirectional antenna. In cases where interference is negligible it is possible to remove or short out the terminating resistor and make the antenna bi-directional. Fig. 5 illustrates the principle of the terminating resistor.

Transmission Line

The characteristic impedance of a half-rhombic looking into the sending or input end when properly terminated in a resistance at the far end is of the order of 400 to 500 ohms. The resonance curve of a half-rhombic antenna is quite broad. If the broad frequency characteristic is to be properly utilized, the feeder system used with it must also be broad. The transmission-line impedance should equal the characteristic impedance of the antenna which is 400 to 500 ohms. The proper spacing for a transmission line of this impedance is rather awkward because of the mechanical difficulties involved in construction. Table II shows wire size and spacing for 400-, 500- and 600-ohm lines.

Table II — Transmission-Line Dimensions for Two-Wire Lines			
Wire Size	Spacing in Inches		
	400 ohms	500 ohms	600 ohms
6	2 3/4	5 1/2	11 1/2
8		4 1/2	9 3/4
10		3 1/4	7 3/4
12		2 1/2	6

Standard matching stubs can be used to provide an impedance transformation to a more desirable line impedance. Of course this limits the frequency characteristic of the line to that for which the stub is adjusted. If the standard 600-ohm line is used, the small mismatch encountered should not adversely effect the over-all efficiency of the antenna, because the standing-wave ratio is quite low. The primary disadvantage of mis-

matching any transmission line is the necessity for readjusting the transmitter coupling to the line at certain frequencies to maintain a constant input.

Selecting a V.H.F. Site

Maximum effective range and signal strength are obtained at v.h.f. when two sites are selected between which there is an unobstructed transmission path. At these frequencies radio waves tend to travel in straight lines, thus line-of-sight transmission paths are of major importance because the signal strength attenuates rapidly over paths which have obstructions between the transmitter and receiver. Although the radio waves bend slightly around these obstructions, reliable communication generally is obtained only over

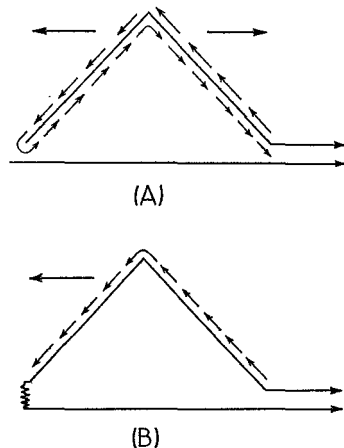

Fig. 5 — Sketch showing the current path and directivity of (A) an unterminated half-rhombic and (B) one which is terminated.

line-of-sight paths. This condition is obtained when the transmitter antenna is theoretically within optical range of the receiver antenna.

The curvature of the earth limits the distance over which a line-of-sight path is possible. For example, with both transmitting and receiving antennas located 40 feet above sea level, the maximum distance which can be spanned before the line-of-sight is intercepted by the curvature of the earth is approximately 18 miles. This assumes the altitude of the intervening terrain also to be at sea level. To determine the maximum distance between two radio stations with intervening terrain at sea level, the following formula is used:

$$D = H_T + H_R,$$

where D = distance in miles,

H_T = height in feet of transmitting antenna,

H_R = height in feet of receiving antenna.

Another factor detrimental to line-of-sight transmission is intervening hills. Intervening hills in a transmission path will reduce the signal

strength when they obstruct the line of sight. Radio waves bend over these obstructions slightly, but bending is accompanied by a loss in signal strength; the greater the bending, the greater the loss. Certain combinations of communication sites and intervening hills may provide satisfactory signals because of reflections, but this condition is realized only by luck, or by calculation with detailed terrain maps.

As a general procedure, the distance between two stations should be calculated on the basis of a path with no obstacles intervening. Then, within the limit of this distance, the two stations should be sited with a view to obtaining the smallest angle of diffraction over any intervening obstacle. When the sites have been determined, and the equipment set up, a test receiving antenna should be moved to different positions, usually within a radius of a hundred feet or so, until the strongest signal is received. This indicates that a point has been found where the dominant multipath rays are nearest in phase. This point will provide the greatest signal strength and maximum operating efficiency.

If it becomes necessary to operate in an area which is densely wooded, the best location for a site is in a clearing with a radius in the order of ten or twelve wavelengths. When using a half-rhombic antenna it should be placed as close as possible to a point in the clearing farthest from the transmitter or receiving building, and as equidistant as possible from the sides of the clearing. A knowledge of the field pattern of a given half-rhombic is helpful in determining the proper placement.

If a half-rhombic antenna is installed in keeping with the pointers listed above, it is one of the most effective types of beam antennas for the transmission and reception of high-frequency, vertically-polarized signals. The use of this type of antenna will increase the signal strength many times over and above that provided by a simple vertical half-wave dipole at the same average height above ground. Gains as high as 15 db. can be obtained.

Beam Width

The widths of the beams produced by half-rhombic antennas of various sizes are shown in Fig. 6. They represent an average over varying terrain and soil conditions. They are drawn to half power; in other words, signals sent at any angle within the spread indicated will be more than half the beam's maximum power.

Fig. 7 illustrates the directions of the main lobes for each wire for legs two wavelengths long when the tilt angle, ϕ , is adjusted for alignment of the lobes.

Several tests using a modified or compromise half-rhombic antenna were conducted with a transceiver rated at 2-watts output, operating in a frequency band of 27 to 38.9 megacycles. This

antenna had approximately 46 ft. in each leg, the pole height was 24 ft., the counterpoise 88 ft. and the tilt angle approximately 30 degrees.

The primary reason for conducting these tests

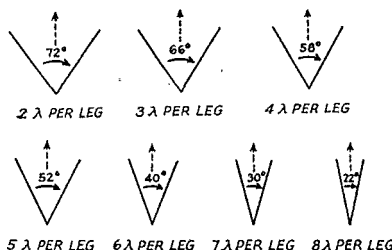

Fig. 6—Approximate beam widths to the half-power point for half-rhombic antenna of various sizes.

was to determine the effects of decreasing the physical height of the antenna. It is possible to operate a compromise half-rhombic antenna and achieve fairly suitable results.

Field-intensity measurements were taken at approximately every 30 degrees; these measurements showed that the beam width of the pattern exceeded 40 degrees in all cases. If successful point-to-point communication is to be maintained relatively free from adjacent sideband and "brute-force" interference within range, the beam width of the antenna must be corrected to within 20 degrees of the operating direction. Under some conditions it is feasible to have a beam width as great as 90 degrees.

It follows that maximum antenna gain will not

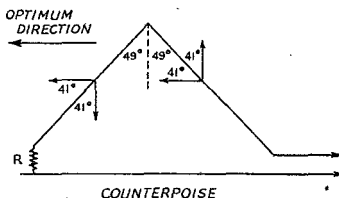

Fig. 7—Sketch showing the angles of radiation from each leg of the half-rhombic which combine to give the resultant pattern.

be realized in a compromise antenna but, on the other hand, the modified half-rhombic continues to retain the ability to accept power on any frequency for which the legs will be resonant and radiate this power in a fairly predictable pattern. It is better to compromise on the height of a half-rhombic rather than the length of its legs. Height has a much smaller effect upon the gain of a half-rhombic antenna than length. Thus, in the design of a modified or compromise half-rhombic antenna the length of each leg should be at least two wavelengths at the lowest operating frequency.

The gain realized with a compromise design is in the vicinity of 10 db.

A Small Oscilloscope Using the 913

Versatile 'Scope Performance With the 1-Inch Tube

BY E. M. McCORMICK*

THE more meticulous an amateur becomes in the testing of his receiving, audio or transmitting equipment the more apparent becomes the need for an oscilloscope. The prospect of a large expensive 'scope usually discourages the average amateur, and that is why we thought the description of a simple, inexpensive oscilloscope would be of interest to the fraternity. The 'scope to be described is small and uses readily-available parts, and it has many of the features of larger and more expensive units. We used a 1-inch 913 cathode ray tube, but a 2-inch 902 type could be used. The image on the 1-inch tube is satisfactory for most work, and a small magnifying glass can be used if greater detail is desired. The most serious limitation of this small oscilloscope is the frequency range of the amplifiers which, while quite satisfactory for audio work, is not adequate for handling the higher video frequencies.¹ However, when the amplitude of the video frequencies is sufficient, they can be applied directly to the deflection plates, and even an r.f. signal can be observed satisfactorily in this manner.

*3350 Cedar St., Riverside, Calif.

¹ The range of the amplifiers can be extended at the price of reduced gain by following the principles outlined in Noll, "Video-Amplifier Design," *QST*, Sept., 1944. — Ed.

• Too often a 'scope with the 1-inch tube is little better than a toy, but the unit described in this article will do almost everything a large oscilloscope will do except give a big picture.

The Circuit

The circuit is somewhat novel in its absence of transformers other than those used for furnishing heater voltages. As can be seen in Fig. 1, the d.c. is furnished by two 6H6s connected as half-wave voltage doublers. One supplies 300 volts positive for the amplifiers and sweep generator, and the other furnishes 300 volts negative for the cathode ray tube voltage-divider network. Since the current drain is only 2 ma. from the positive and 0.75 ma. from the negative supply, the 6H6s are not overloaded in their use as rectifiers. The combination of R_1 and C_5 contributes additional filtering to the positive supply.

The horizontal sweep generator is a small 1/25-watt neon bulb (General Electric NE-51) used in the conventional saw-tooth oscillator circuit. The frequency is determined by R_{24} plus R_{25} and the shunt capacity selected by S_3 , and it

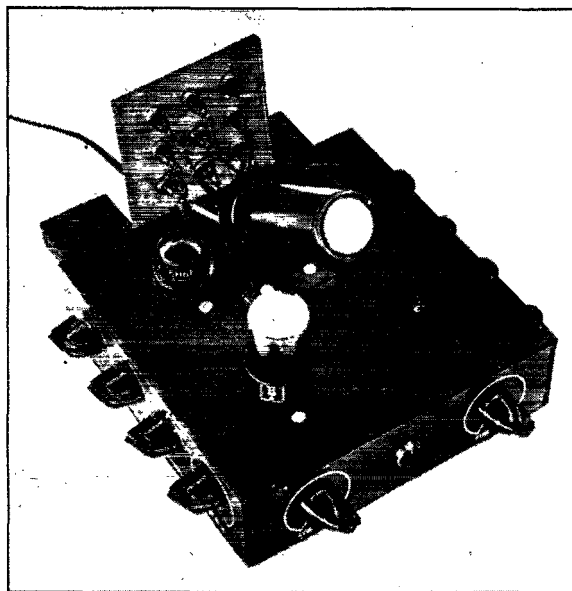

A simple oscilloscope using a 1-inch tube. The controls on the front, from left to right, are "SYNC AMPLITUDE," pilot light and "FINE FREQUENCY," and along the side, from back to front, are "FOCUS," "VERTICAL CENTERING," "SYNC-SWEEP" and "VERTICAL GAIN." Note the small neon tube, used for generating the sweep voltages, to the right of the 6SL7. A hood mounts over the 913 and the terminal panel at the rear of the chassis.

Fig. 1 — Wiring diagram of the simple 1-inch oscilloscope.

- C₁, C₂, C₃, C₄, C₅ — 8- μ fd. 250-volt electrolytic.**
C₆, C₇, C₈, C₉ — 0.1- μ fd. 600-volt paper.
C₁₀, C₁₁ — 25- μ fd. 25-volt electrolytic.
C₁₂ — 0.001- μ fd. mica.
C₁₃ — 100- μ fd. mica.
C₁₄ — 0.05- μ fd. 400-volt paper.
C₁₅ — 0.02- μ fd. 400-volt paper.
C₁₆ — 0.006- μ fd. mica.
C₁₇ — 0.002- μ fd. mica.
I₁ — 6.3-volt pilot lamp.
R₁ — 10,000 ohms.
R₂, R₂₃ — 0.2 megohms.
R₃, R₄ — 0.1 megohm.
R₅ — 0.25-megohm variable, "FOCUS" control.
R₆ — 50,000 ohms, variable, "INTENSITY" control.
R₇, R₈ — 0.5 megohms.
R₉, R₁₀, R₂₀ — 1.0-megohm variable "HORIZONTAL CENTERING," "VERTICAL CENTERING" and "VERTICAL GAIN" controls.
R₁₁, R₁₂, R₁₃ — 2.0 megohms.
R₁₄ — 50,000 ohms.
R₁₅ — 1.0 megohm.
R₁₆, R₁₇ — 0.25 megohm.
R₁₈, R₁₉ — 5000 ohms.
R₂₁ — 3-megohm variable. "HORIZONTAL GAIN" control.
R₂₂, R₂₄ — 3.0 megohms.
R₂₅ — 10.0 megohm variable. "FINE FREQUENCY" control.
R₂₆ — 0.1-megohm variable. "SYNC AMPLITUDE" control.
All fixed resistors are $\frac{1}{2}$ -watt carbon.
S₁ — S.p.s.t. snap switch mounted on R₆.
S₂ — Two-pole 5-position rotary, "SYNC-SWEEP."
S₃ — Single-pole 5-position rotary, "COARSE FREQUENCY."
T₁, T₂ — 6.3-volt, 1.0-ampere heater transformer.

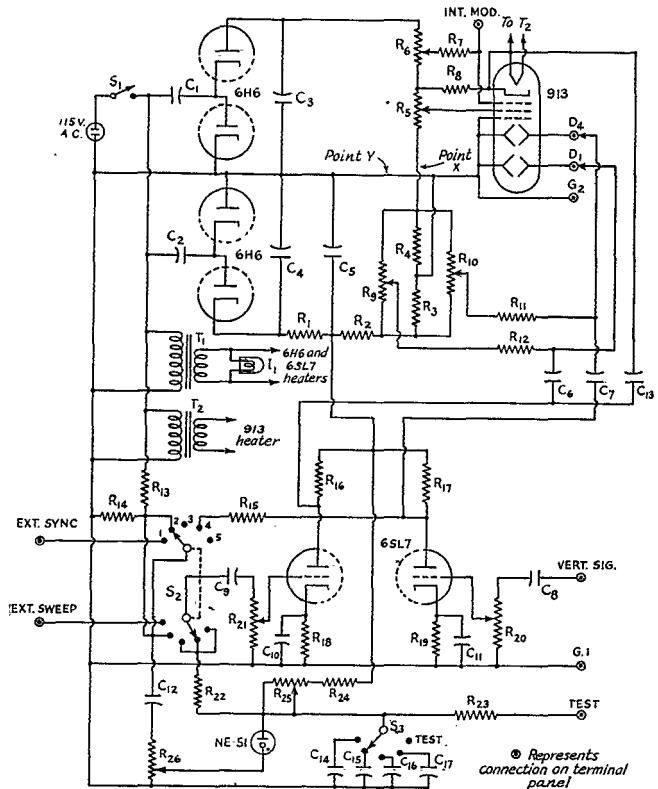

is variable between 12 and 700 cycles. Since only about 13 per cent of the condenser charge is used, the linearity of the sweep is fairly good. A synchronizing voltage can be coupled in through C_{12} and its amplitude adjusted by R_{26} . The "SYNC-SWEEP" switch, S_2 , allows five different conditions of sweep and synchronization, as follows: (1) external synchronization (2) line synchronization (3) internal synchronization (4) line (sine-wave) sweep and (5) external sweep.

The positive sawtooth from the generator becomes a negative sawtooth after amplification through the horizontal amplifier (one section of a 6SL7), and to make the trace sweep from left to right in the conventional fashion the cathode-ray tube must be turned so that the No. 1 pin is at the bottom, with pins No. 3 and No. 7 horizontal. Used in this manner a waveform will appear in the correct polarity when passed through the vertical amplifier but it will be inverted when applied directly to the vertical plates.

A positive blanking voltage is coupled through C_{18} to the cathode of the 913 and developed across

R_8 . When other than a negative sawtooth is used for the sweep, as when using Lissajou's figures for making frequency comparisons, it may be necessary to disconnect this blanking circuit by disconnecting one side of C_{13} . The grid of the 913 is brought out to a terminal marked "INT MOD," for use in experiments with intensity modulation.

Construction

The entire unit is built on a 7- by 7- by 2-inch chassis. The ten controls and the pilot light are mounted along the front and sides, and the two heater transformers are mounted on the back. The external connections are brought to nine tip jacks on a polystyrene panel which is also mounted on the back of the chassis (see Fig. 2). Mounting the jacks for connections at the back of the chassis keeps the leads clear of the controls.

The arrangement of the tubes on the chassis can be seen in the photographs. Wiring is conventional, except that leads in the sweep generator, amplifier grid circuits and all heaters should

About the Author

• Another new face in the amateur picture will be that of *E. M. McCormick*, who hopes soon to obtain his amateur license. Breaking into radio via a pair of 30s in a receiver (1935), McCormick took out his Radiotelephone first upon graduation from Kansas State Teachers' College in '41, and joined KOAM, Pittsburg, Kansas. After completing some graduate work, followed by a period as an electronics instructor, he joined the Army (1943) and is now a radar mechanic at March Field.

be shielded to minimize a.c. pickup. Too much pickup in the sweep circuit will cause it to synchronize with the line frequency and produce unstable sweeps at other frequencies. The outputs of the amplifiers are brought out in flexible leads terminated in pin tips which can be plugged into the proper jacks on the terminal panel, thus making it a simple matter to remove them when working directly into the 'scope deflection plates.

Since one side of the a.c. line is common to the d.c. voltages and chassis of the 'scope, it is necessary to have a means of determining when the chassis is connected to the grounded side of the line. The "TEST" terminal provides a means of checking this. With S_1 turned to the "OFF" position and S_3 set to "TEST," connect the "TEST" terminal to an actual ground or the common of the unit to be tested with the 'scope. If the neon tube glows, the a.c. plug should be reversed. Once the proper polarity for a given a.c. outlet is determined, a record or mark can be made for future use.

It is possible to operate this 'scope on the full 600-volt output of the quadrupling power supply by inserting R_2 at point X in Fig. 1 and disconnecting G_1 from G_2 at point Y. With the increased voltage the image will be brighter and will focus to a finer line. However, the two grounds (G_1 and G_2) will be at different d.c. potentials and the shell of the 913 will be "hot." Signals being amplified will use G_1 for ground and those being applied directly to the deflection plates will use G_2 . Considerable caution must be exercised to insure proper grounding and to avoid accidental electrical shock under these conditions. The other disadvantages of the higher voltage is that the deflection sensitivity of the 'scope is decreased about 40 per cent.

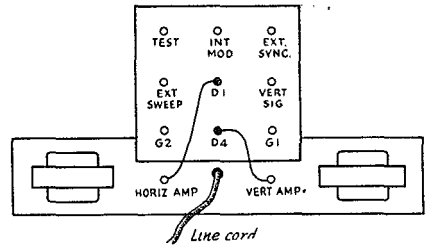
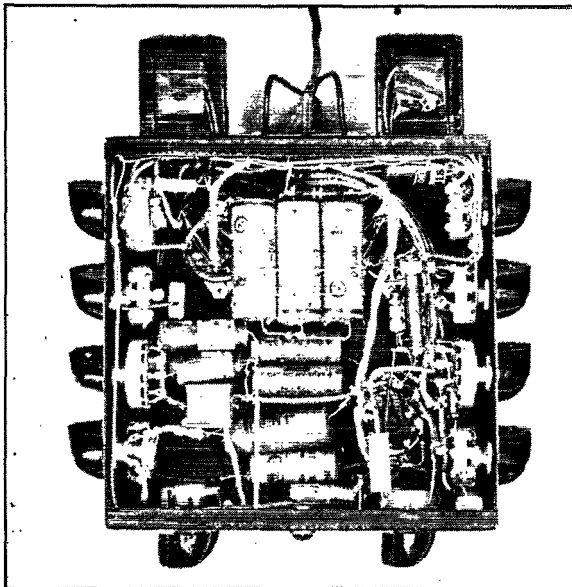

Fig. 2—A sketch of the back of the 'scope, showing the arrangement of terminals.

When operating on 300 volts, the direct sensitivity of the vertical plates is 125 volts/inch and 175 volts/inch for the horizontal. Working through the amplifiers at maximum gain, the vertical sensitivity is 0.9 volts/inch and 1.1 volts/inch for the horizontal. The a.c. power consumption of the unit is approximately 20 watts.



A view showing the arrangement of parts underneath the chassis. The controls along the left-hand side, from top to bottom, are "INTENSITY," "HORIZONTAL CENTERING," "COARSE FREQUENCY" and "HORIZONTAL GAIN."

Extended-Range Television Reception

In Three Parts—Part II

BY MARSHALL P. WILDER,* W2JLK

• The first part of this article covered the construction of the video, synchronizing, and sweep-generating circuits of a modern high-performance television receiver especially designed for weak-signal reception. In this second part the author discusses a simple method of video circuit design and describes the r.f. and i.f. sections of the receiver.

THE video circuits of the receiver already have been described in the preceding section,¹ but before going on to the r.f. and i.f. circuits it may be of interest to discuss the methods used in designing and aligning the video amplifiers in this set.

In general, video amplifiers employ constant-current devices, of which the pentode is an example. A generalized formula for the gain of a pentode when the load resistance is low compared to the plate resistance is the tube transconductance expressed in mhos multiplied by the load resistance in ohms. The transconductance of the 6AC7 is 0.009 mhos. Load resistor values of the order of 1000 to 4000 ohms cover those generally used when the pass band of modern television is amplified. The value of the load resistor should be as high as the total shunt capacitance, C_i —output capacitance plus input capacitance of the following stage plus stray capacitances—will allow. This capacitance, of the order of 30 $\mu\text{fd.}$ when a 6AC7 couples into a following 6AC7, must be measured since it determines the values of load resistance and peaking coil inductance when a certain pass band is required.

The method for measuring C_i from the plate of a video stage to ground employing an inductance of known value substituted for the load resistor of the stage in question will be the easiest for most amateurs to use. An inductance of approximately 40 $\mu\text{h.}$ can be made by winding 90 turns of No. 30 enamel wire close-spaced on a one-half inch form. Substitute for the load resistor in the plate of the following stage a non-inductive 100-ohm resistor. A vacuum-tube voltmeter, magic eye, or similar

device is connected from the plate of this stage to ground. A signal of such amplitude as not to overload the grid of the second tube or the indicating device is applied to the grid of the first tube. The frequency of the signal is then adjusted until resonance between the known inductance and C_i is shown by maximum reading on the indicating device. With frequency and inductance known a Type A Lightning Calculator or other LC slide rule will give the capacity, C_i .

Charts A and B, Fig. 8, may be used to design video amplifiers around the values most commonly encountered. For example, should C_i prove to be 26 $\mu\text{fd.}$ and a pass band of 4.5 Mc. be desired, chart A will indicate the proper value of load resistor as 1360 ohms. From chart B, with C_i equal to 26 $\mu\text{fd.}$ and a pass band of 4.5 Mc., the peaking coil size will be found to be 21.5 $\mu\text{h.}$ The value of C_1 is equal to 0.353 C_i , or 9.1 $\mu\text{fd.}$ A practical value for C_1 would be 7 $\mu\text{fd.}$, since the distributed capacitance across a single-layer coil of this inductance value is of the order of 2 $\mu\text{fd.}$ The gain of this stage is the tube transconductance in mhos $\times R_L$. For a 6AC7 the gain is $0.009 \times 1360 = 12.2$.

The method outlined above is the simplest and most practical form of high-frequency compensation. Other more complicated methods will allow use of a higher value of load resistance and in turn result in more gain per stage. A review of the literature will quickly familiarize one with the other methods and the reasons for employing them.²

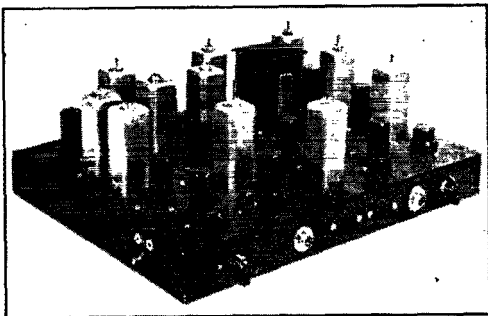

The r.f.-i.f. chassis, containing both picture and sound i.f. amplifiers. Locations of components is described in the text.

* Electronic Division, Remington Rand Inc., Middletown, Conn.

¹ Wilder, "Extended-Range Television Reception," Part I, QST, November, 1945.

² For example, Terman's "Radio Engineers' Handbook," McGraw-Hill Book Co.

Low-Frequency Compensation

When a video amplifier stage has been corrected for high-frequency response to allow a desired pass band the amplifier must also be corrected to give proper low-frequency operation. In the case of television amplifiers the amplitude response curve must be flat down to 20 cycles per second and should have useful response to as low as 2 cycles per second. This is readily accomplished by using a filter circuit in the plate of each video stage in such a way that as the frequency becomes lower the capacity C_f of the filter network (see diagram on chart C, Fig. 8) becomes less and less capable of by-passing R_f , so that

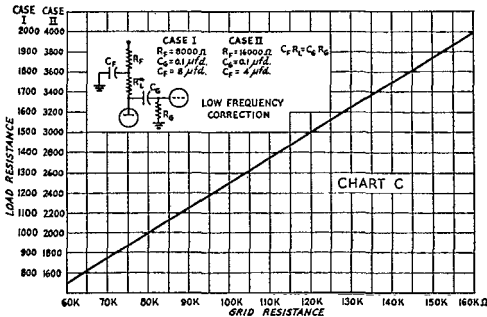
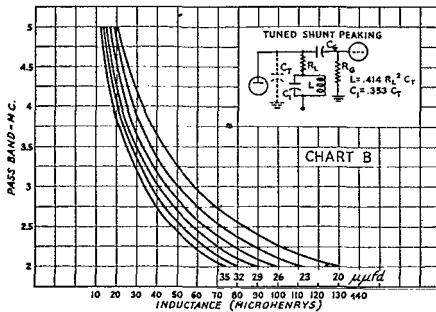
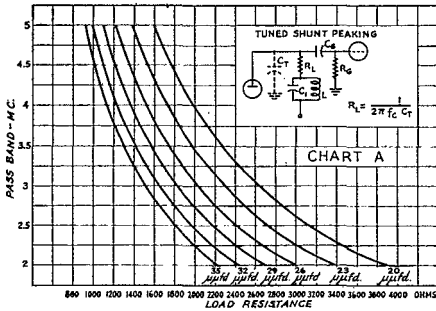
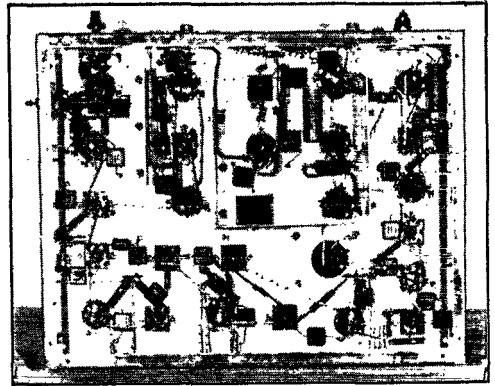

Fig. 8 — Video amplifier design charts. The method of using them is described in the text.



Below-chassis view of the r.f.-i.f. unit. Despite the number of stages, the wiring is clean and simple in layout.

effectively R_f becomes a part of R_L . This boosts the output of the amplifier stage at low frequencies. If the values are correctly chosen the loss at low frequencies in the network $C_f R_f$ will be compensated for in the low-boost network $C_f R_f R_L$. The time constant of $C_f R_f$ should be chosen to be approximately four times that of $R_L C_f$. A good value for C_f is $8 \mu\text{fd.}$, and for R_f , 8000 ohms. A useful value for C_c is $0.1 \mu\text{fd.}$ The value for R_g will be found by the formula $R_g C_c = C_f R_L$. The values must be right if perfect correction is to be effected — and it must not be assumed that the values stamped on the condensers or resistors are precisely as represented.

Design values for R_g will be found in chart C. For example, if the load resistor, R_L , is 1400 ohms, the coupling condenser, C_c , is $0.1 \mu\text{fd.}$, the plate decoupling filter, R_f , is 8000 ohms, and C_f is $8 \mu\text{fd.}$, then the correct grid leak is 112,000 ohms as read from the chart. If R_L lies between 2000 and 4000 ohms the plate decoupling filter, $C_f R_f$, should be $4 \mu\text{fd.}$ and $16,000 \text{ ohms.}$

It should be pointed out that if the cathode is not connected directly to ground it must be by-passed for all frequencies down to 20 c.p.s. This usually requires a condenser of $1000 \mu\text{fd.}$ Final adjustment for low-frequency response is best made by observing on a cathode-ray oscilloscope the tilt of the top of vertical blanking. Substitute a variable resistor of the order of $\frac{1}{2}$ megohm for the grid resistance and adjust until the top of vertical blanking is flat. Remove the variable resistor and substitute a fixed resistor of equal value. During this adjustment the 'scope probe should be on the grid being corrected.

It is not always possible to use this type of low-frequency correction. Triodes (with the exception of very high- μ triodes), diodes, or cathode followers are constant voltage devices and must be coupled to the following grid through a large capacitance, such as $1 \mu\text{fd.}$, and as large a value of grid leak as the tube will allow.

R.F.-I.F. Circuits

To be conventional, the description of a receiver should confine itself to the circuits and construction. But in this case the antenna is such an important part of the complete system that a few words about its dimensions are in order before going on with the receiver proper.

The rhombic antenna used is 60 feet on a side and has a major angle of 130° , a minor angle of 50° , and is 40 feet above the ground. One corner is supported by the house and the other three by wooden poles 50 feet high. The direction to the Empire State Building was quite accurately determined and the antenna designed and erected accordingly. The end of the rhombic pointing towards the signal source is terminated in a 600-ohm carbon resistor; as a precaution against the weather, a glass tube is slipped over the terminating resistor and the ends filled with sealing wax. A 600-ohm line approximately 90 feet long brings the signal to the side of the house where the r.f. amplifier is located. The spacers for the 600-ohm transmission line may be pieces of glass rod or other suitable insulators. An open transmission line was used because the losses with such a line proved to be much lower than with any of the coaxial or twisted-pair lines available.

The r.f. and i.f. circuits are shown in Fig. 9. The r.f. stage uses a 6AK5, one of the new miniature-type pentodes, with inductive coupling between the transmission line and the grid coil. The latter is adjusted to resonate with the tube and stray capacitances. Cathode-resistor bias is required with this type of tube, and a series dropping resistor of the proper value insures correct voltage on the screen. The plate voltage must not exceed 180 volts. Link coupling between the plate coil and the mixer grid coil via a 600-ohm open line 30 feet long affords a decided advantage in signal to noise ratio because a television receiver itself is a considerable source of interference. This interference results from the steep wave fronts of the sweep oscillators and from unavoidable corona discharge noise in the high-voltage power supply. Although all precautions were taken to minimize these sources of noise, such as ground bonding, corona shields at high-voltage points, and by-passing at various points in power supplies and in sweep circuits, a small amount of electrical disturbance remains, and all efforts to build up the signal should be at a point remote from the receiver proper. If the r.f. stage were located at the terminals of the rhombic further improvement might

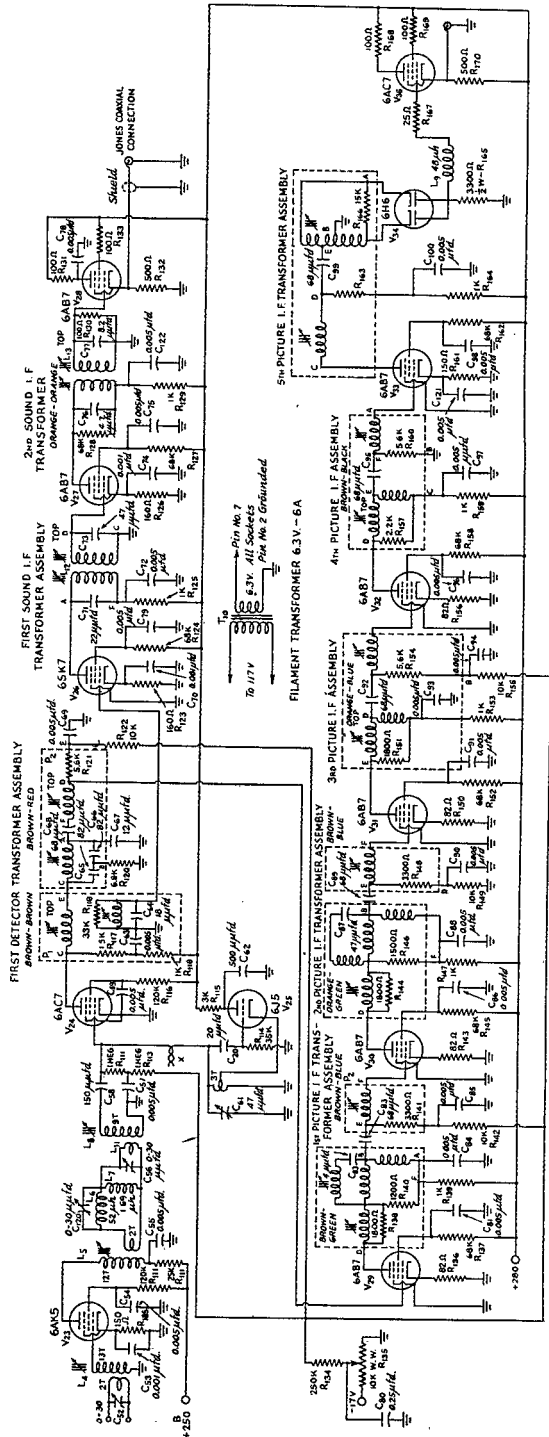

Fig. 9 — Circuit diagram of the r.f. and i.f. section of the receiver.

result, but this was not practical at the writer's location.

A high-pass filter was inserted as close as possible to the grid of the mixer in the link line. This filter was designed for infinite rejection below 10 Mc. and a rising characteristic leveling off at 40 Mc.² The filter (or wave trap) proved desirable in eliminating many signals from powerful transmitters in the 7- to 13-Mc. band, a form of interference which appears as a series of bars in the picture.

Oscillator injection into the grid of the 6AC7 mixer results in excellent conversion. A grounded-plate Hartley oscillator operates at 64 Mc. to beat with the a.m. picture signal at 51.25 Mc. to develop picture i.f. from 8.25 to 12.75 Mc. The same oscillator beats with the f.m. sound carrier at 55.75 Mc. to generate 8.25-Mc. sound i.f. with 75-ke. deviation. Proper oscillator injection will be indicated by -7 volts d.c. at the grid of the mixer. This voltage must be obtained by rectification at the mixer grid. The energy so rectified is stored by the mixer grid condenser and can be measured by an electronic voltmeter such as the Volt-Ohmist Jr. It is not necessary that this bias be exactly 7 volts but it should be between 5 and 10 volts, negative with respect to ground. Less injection voltage than the above minimum will result in the mixer's acting more as an r.f. amplifier (in the 8.25- to 12.75-Mc. band) than as an efficient converter.

The picture i.f. transformers were purchased as a kit from the RCA Manufacturing Co., Camden, N. J., and wired to operate with the tubes required by their design. The circuit of the i.f. amplifiers is essentially that of the TRK-120 RCA television receiver. Alignment of these amplifiers is straightforward and is greatly simplified

if a frequency-modulated signal generator is used. Such a generator either can be purchased or built of simple components as will be described in the next article of this series. The second detector is phased so that peak blacks are negative as taken out of the plates of the diode and fed into the grid of the cathode-follower output tube. A filter, L_9 , between the second detector and cathode follower removes any undesired carrier present, passing only the 0- to 4.5-Mc. picture signal. The video signal is then transmitted through a coaxial cable to the video amplifier in the chassis described in Part I.

The sound i.f. is amplified through two stages as shown in Fig. 9, and then fed into a cathode-output stage. From there, the signal goes by a coaxial cable to the auxiliary chassis shown in one of the photographs, where it is built up in a pentode, V_{36} , Fig. 10, to a level for effective limiting in V_{37} and V_{38} . The latter tube drives the diode discriminator which translates the frequency-modulated signals into audio frequency. The cascade limiter practically eliminates auto ignition noise, which otherwise would be extremely an-

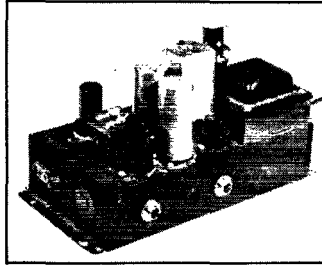
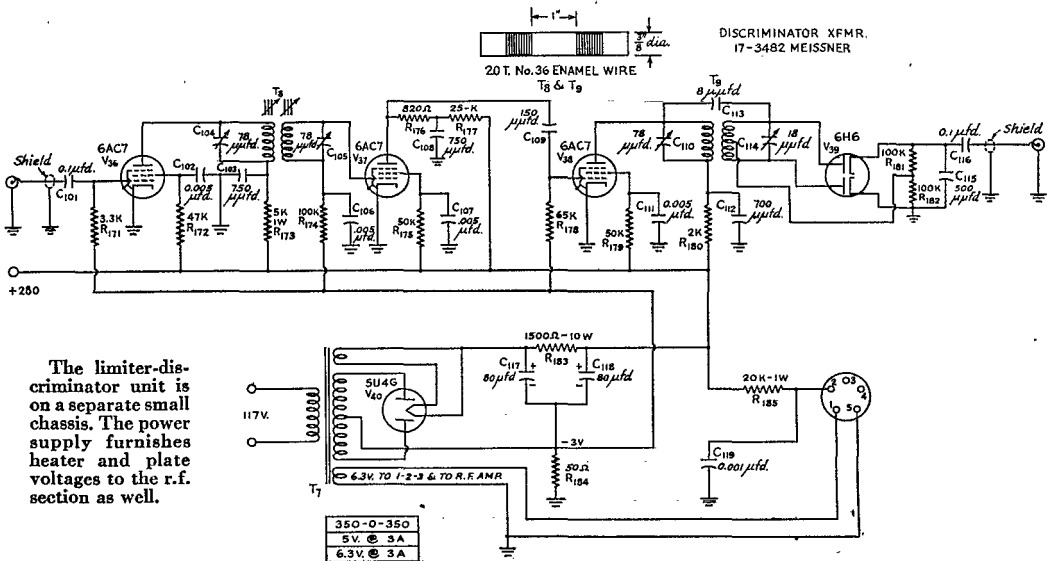

Fig. 10 — Final sound i.f. amplifier, limiters and discriminators.



The limiter-discriminator unit is on a separate small chassis. The power supply furnishes heater and plate voltages to the r.f. section as well.

noying since a six-lane highway passes a short distance from the front door of the house. A separate power supply for this auxiliary unit is included on the same chassis and also feeds power to the r.f. amplifier through a three-wire twisted cable.

Alignment of the sound i.f. amplifier is best achieved by using a test oscillator and output meter as in a.m. alignment procedure. Adjustment of the shape of the discriminator curve can best be made by observation on a cathode-ray oscilloscope when a frequency-modulated signal generator of the proper deviation is applied to the mixer grid.

R.F. Alignment

Experience with this receiver has shown the value of normalizing all currents and voltages of all tubes as specified in the tube handbooks. Do not *assume* that the heaters are operating at 6.3 volts, because there may be considerable drop in the heater wiring. If all voltages and currents are correct the receiver will be considerably easier to adjust.

Final alignment of the front end of the receiver in the r.f. and mixer stages is best done on the air. However, it will help considerably to make some preliminary adjustments on the bench. A 6J5 separate oscillator adjustable in frequency from 50 to 90 Mc. is a very useful tool to help in this alignment. The mixer grid coil and the plate and grid coils of the r.f. amplifier are tuned with brass slugs. A brass slug just outside the hot end of the coil will lower the inductance of the coil as it is drawn in by the adjusting screw, and the eddy currents flowing in the brass will effectively flatten and widen out the frequency response of the amplifier. The output is coupled in with approximately two turns at the ground end of the coil. Using an indicating device as in the video amplifier alignment procedure, put a 100-ohm noninductive resistor between B+ and the plate of the mixer. Adjust the test oscillator to 53.5 Mc., and then add or subtract turns from the mixer grid coil until resonance is indicated at 53.5 Mc. with the brass slug just coming in. The 64-Mc. oscillator coil should be close enough to the grid coil to develop the -5 to -10 volts re-

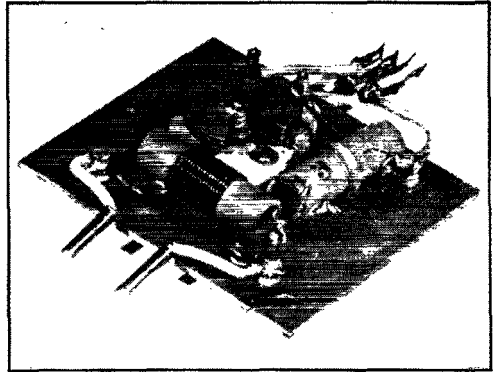

The high-pass filter for eliminating intermediate-frequency signals picked up by the r.f. transmission line.

quired on the mixer grid as outlined earlier in this article. Sometimes this is easier to achieve by soldering a small wire on a hot point on the oscillator coil and bringing it near another small wire soldered to the mixer grid. These two wires, if insulated, may be twisted together to form a small condenser, as shown at X in Fig. 9. It is wise to adjust the oscillator injection before adjusting for mixer grid resonance. During the adjustment of the mixer grid coil, the plate voltage must be disconnected from the oscillator so that excessive bias will not lower the mixer tube sensitivity below that of the indicating device. During the above adjustments the gain control must be set so that -2 volts bias is present on the mixer grid.

The alignment of the grid coil of the r.f. stage is accomplished in a similar manner. This adjustment is somewhat easier because the complication of the oscillator injection voltage is not present. After the grid circuit is aligned remove the 100-ohm test resistor and disconnect the grid coil at the grid and substitute a 10,000-ohm grid resistor. Inject through a capacitor of a few $\mu\text{fd.}$ approximately 1 to 2 volts from the test oscillator at 53.5 Mc. Trim the plate coil for resonance, as shown by maximum deflection of the indicating device when connected across the two-turn output coil. Remove the 10,000-ohm grid resistor and reconnect the grid coil. A strong indication at the resonant frequency of 53.5 Mc. will be observed with the test oscillator very loosely coupled. And once again resonance should occur with the brass slugs just entering the coils. When the oscillator is shut off the indicating device should show zero output. If it doesn't, the stage is probably unstable and better shielding and a recheck of voltages and currents is in order.

Constructional Details

The construction of the various units is shown in the photographs. The large chassis contains all the r.f. and i.f. stages except the r.f. amplifier, which is separately mounted in a metal box

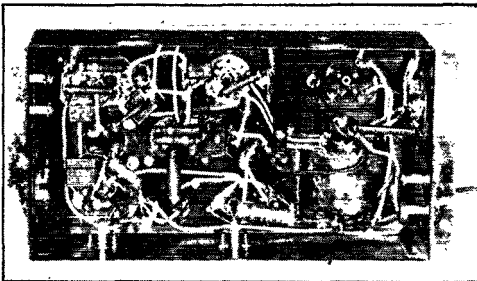

A bottom view of the limiter-discriminator unit.

affixed to the side of the house as previously mentioned. Looking at the top view of the main chassis, the r.f. input terminals and mixer tuning slug are on the left-hand edge near the front. On the front edge of the chassis, from left to right, are the oscillator trimmer condenser, C_{61} , the coaxial Jones connector for the f.m. cathode follower output, two power sockets, the coaxial connector for the video cathode follower output, and the gain control, R_{135} . Starting with the oscillator tube, V_{25} , at the lower left corner of the chassis and going toward the upper left, next in line is the mixer tube, V_{24} , then the mixer output transformer assembly, consisting of two units, P_1 and P_2 , and last V_{29} , the first picture i.f. amplifier.

In the second column the first tube is V_{27} , the second i.f. sound amplifier. Next is the first sound i.f. transformer assembly, then V_{26} , the first i.f. sound amplifier, followed by the second picture i.f. transformer assembly, P_1 and P_2 , and last, the second picture i.f. amplifier tube, V_{30} . In the third line, commencing with the second sound i.f. transformer, L_{13} , in the lower center of the chassis, is the sound i.f. cathode follower, V_{28} . The fourth line starts with the picture cathode follower, V_{35} . The next two sockets are not used, but were originally intended for the sound limiter and discriminator diode. The filament transformer, T_8 , follows, and last is the third picture i.f. amplifier, V_{31} . Along the right edge of the chassis in order are the picture second detector, V_{34} , the fifth picture i.f. transformer assembly, the

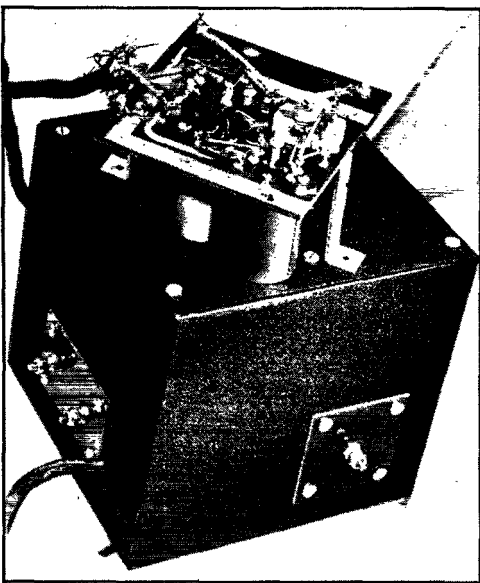

The r.f. amplifier removed from its housing. The box mounts on the side of the house so the amplifier can be placed as close as possible to the antenna terminals.

fifth picture i.f. amplifier V_{33} , the fourth picture i.f. transformer assembly, the fourth picture i.f. amplifier tube, V_{32} , and the third picture transformer assembly.

In the bottom view of this unit the socket for the oscillator tube, V_{25} , is directly underneath the oscillator trimmer condenser, C_{61} . Between the oscillator and the mixer tube, V_{24} , are the input tuning coils, L_{11} and L_7 , and the oscillator tank coil, L_{10} . In the first detector transformer assembly, P_1 and P_2 , the lead from P_1 terminal A goes to the right, feeding the grid of V_{26} , the f.m. sound i.f. Directly below P_1 and P_2 is V_{29} , the first picture i.f. amplifier. The rest of the picture i.f.'s follow around the lower edge and up the right-hand edge of the chassis. The low-pass filter, L_9 , can be seen leading over to the picture cathode follower, V_{35} . The transformer over V_{26} is the first sound i.f. transformer assembly; it feeds V_{27} , the second i.f. sound amplifier. The output of V_{27} goes to the right, feeding the second sound i.f. transformer. Its output goes down to the sound cathode follower, V_{28} , the output of which goes to the sound output terminal through a short length of coaxial cable.

The remainder of the sound channel is on a separate small chassis shown in another photograph. In this unit, the input terminal is on the front edge of the chassis at the left. V_{36} , the third sound i.f. amplifier, feeds T_8 , the third sound i.f. transformer directly behind it. V_{37} , the first limiter, feeds V_{38} , the second limiter, through an RC network, C_{109} , R_{178} . The output of V_{38} is fed to V_{39} , the discriminator diode, via T_9 . The output of V_{39} at audio frequencies is fed through C_{116} to the sound output terminal. Pre-emphasis is corrected by C_{115} . The d.c. power supply is conventional. In the bottom view, the socket at the upper left is for the input tube, V_{36} . Transformer T_8 is between V_{36} and V_{37} , with V_{38} to the right. Above V_{38} are the terminal of T_9 . The audio output terminals are directly above V_{39} .

In the photograph of the r.f. amplifier the bakelite "chassis" has been removed from the housing for the purpose of showing its construction. The tuning condenser, C_{30} , for the input circuit is plainly visible. All resistors and by-pass condensers are returned to ground as close to the socket as possible. The input and output coils are shielded from each other by shield cans above the chassis card. The input terminals from the feeders are on the left and right sides of the housing, the two output terminals being side by side. This unit is mounted on the house so that the output terminals are beneath.

The low-pass filter for eliminating i.f. interference is shown in another photograph. The input from the r.f. amplifier goes to the two terminals on the upper edge of the Formica board. L_6 ($52 \mu\text{h}$) is on the right edge of the board and C_{120} is to the left of L_6 . L_7 ($1.69 \mu\text{h}$) is on the lower

(Concluded on page 108)

HAPPENINGS OF THE MONTH



ELECTION RESULTS

With only three ARRL divisions coming down to actual balloting in the autumn elections, the result is two present directors returned to office and one new director elected.

In the Atlantic Division, Edward G. Raser, W3ZI, of Trenton, replaces Commander Walter Bradley Martin, W3QV, who has been the Atlantic's director since 1936 when the late Dr. Woodruff was elected president. The election was hotly contested, Mr. Raser winning by the small margin of 643 votes to Commander Martin's 601. Mr. Raser, who has served as assistant director of the division and as assistant SCM the last few years, is a communications engineer in the radio division of the New Jersey State Police. On the air since 1912, he is the secretary of the Delaware Valley Radio Assn. and of the Trenton Radio Association and editor of the former's "News."

In the Dakota Division the incumbent director, Tom E. Davis, W9VVA, won handily over his two opponents:

Mr. Davis	125 votes
Raymond H. Howe, W9EWN	21 "
Aaron E. Swanberg, W9BHY	92 "

In the Midwest Division the old-time director, Floyd E. Norwine, jr., W9EFC, won easily over Leslie B. Vennard, W9PJR, 303 votes to 135.

DEATH OF STEDMAN

Last month we reported that Director C. Raymond Stedman, W9CAA, of the Rocky Mountain Division, had been obliged by ill health to transfer his powers to the alternate director, Howard R. Markwell, W9TFP. It is now our unhappy duty to report Ray's passing, in Denver on November 26th, at the age of 39. He had been seriously ill for some months, critically so for some weeks.

He was a widely-known amateur with a flair for organization, continuously active in our circles since 1921, when he received his first amateur license. He was born in Denver in 1906, graduating from North High, at which time he entered the employ of the Mountain States Telephone & Telegraph Company, with whom he was associated until his death — being at that time a telegraph and teletypewriter circuit engineer. He practiced amateur radio throughout his school days, often operating with the lights out when he was supposed to be sleeping. In 1930 he was transferred to Helena, Mont., where he operated under the call W7ASQ until 1936, then returning to

Denver. He was a cofounder and past president of the Associated Amateur Radio Operators of Denver and has held most ARRL appointments, being the League director from the Rocky Mountain Division for the past five years, SCM for Colorado from 1925 to 1930, and the former Denver Emergency Coördinator.



He was also a skillful Morse operator. He leaves his wife, four children and his father, who is W9CAB. He will be missed not only by local amateurs but by hams all over the country, for W9CAA is a well-remembered call and amateur radio has lost a valuable friend in his passing.

The administration of the Rocky Mountain is now taken over by Mr. Markwell as acting director for the remainder of the Stedman term. He also is engaged in telephone and teletypewriter work with the Mountain States T&T.

REGISTRATION ELIMINATED

As a wartime safety measure, FCC required the registration of all transmitting apparatus. Its Order 101, in June of 1942, required the persons in possession of any transmitter belonging in a licensed amateur station to apply for a certificate of registration; and its Order 99 was similarly directed at persons in possession of unlicensed transmitters — except manufacturers and dealers, who submitted certain reports to FCC. These orders have served their purpose; the war is over. FCC on November 29th announced the cancellation of both 101 and 99. You no longer have to apply for a certificate of registration on your transmitter. If you have a certificate affixed to your transmitter, as you should, you may now take it off. If you never received your certificate, forget it. Registration, of course, is not licensing. No transmitter may be operated without an FCC license. And FCC Order 96, requiring the registration of diathermy equipment, is still in effect.

MORE OP LICENSES EXTENDED

Since Pearl Harbor FCC, by means of its Orders 115 and 115-A, has kept alive most amateur operator licenses that were valid on that date,

periodically extending them an additional year. Many of these licenses were thereby due to expire on December 7, 1945. Since the conditions which made the original orders necessary are continuing to exist during the present period of demobilization and readjustment, FCC on November 28th adopted its Order 115-B, which makes a further extension by ordering that:

Every amateur radio operator license which, either by its own terms or as extended by Orders Nos. 115 and 115-A, would expire during the period December 7, 1945, to December 7, 1946, is hereby extended for a period of one year from the date on which it would otherwise expire.

As before, the extension does not apply to a license suspended by FCC or voluntarily surrendered, nor to any licensee who hasn't complied with Order 75 (fingerprints and proof of citizenship).

Net result of the foregoing is that if you had an operator license at the time of Pearl Harbor or any time since, and nothing has happened to cancel it, it is automatically continued in effect at least until December 7, 1946, or until the further order of the Commission demanding a formal application for renewal. Unfortunately none of this applies to the lads who went into military service early and whose licenses expired before Pearl Harbor. However, there has never been any stoppage in the issuing of operator licenses, the exams are still being given, and a new ticket can be had within a few weeks of passing the test.

Throughout the war, conditions made it difficult for amateur and commercial licensees to make a showing of service or use of their licenses, which was a required condition for renewal; and so FCC by its Order 77 has waived this proof of use. The conditions continuing, the Commission on November 28th adopted its Order 77-E, directing:

That Sections 12.26 and 12.66 of the Rules Governing Amateur Radio Stations and Operators, and Section 13.28 of the Rules Governing Commercial Radio Operators, in so far as the required showing of service or use of license is concerned, be, and they are hereby, suspended until further order of the Commission, but in no event beyond June 30, 1946.

Long before that date, in fact in the very near future, mechanism for dealing with new station licenses and renewals and modifications will be fully operating.

1200-MC. BAND RELOCATED

On November 19th FCC announced several minor modifications of its plan of frequency allocations above 25 Mc., issued last May, one of which affects the amateur 1200-Mc. band. It has now decided that this band will be 1215-1295 Mc. Although not yet put at our disposal up to the moment of writing, it is expected that it will be very shortly. Our neighbors will remain as before: 960-1215 is for navigation aids, and 1295-1375 will be used in this country for television relay.

MILES JOINS F.C.C.

Comdr. Paul D. Miles, USNR, on November 15th became the head of a newly-created division in the FCC engineering department, known as the Frequency Service Division. An expert on allocations, he will supervise spectrum allocations for FCC and will probably be its representative on IRAC. He is admirably equipped for this work, having been for some years the chief of the Frequency Section of Naval Communications and the Navy's representative on IRAC, of which committee he was chairman during 1944. Within a few days of assuming his new duties he was off for Bermuda as one of FCC's representatives at the Anglo-American conference.

1946 will be a busy year in allocation work. FCC's postponed final proposals for the range below 25 Mc. are expected to be announced in February. About that time it is likely that a preliminary conference of major nations will occur to make plans for a world telecommunication conference. There are some indications that the latter conference will occur in Washington next summer, its decisions to take effect the first of 1947.

FURTHER GLOSSARY

Amateurs are apt to think of 3500 kc. as a pretty low frequency, as amateur frequencies go, and therefore to reserve the term "high frequency" for frequencies that are very much higher. Actually, there is an accepted international nomenclature for the various ranges of frequencies and it should be a matter of pride with amateurs to use the terms correctly.

Beginning at its low end, the spectrum is divided into very low, low and medium frequencies before it reaches the first range to contain an amateur band. The portions thereafter, in which we are interested, are as follows:

High frequencies are from 3 to 30 Mc. (wavelengths from 100 to 10 meters). Thus all of our DX bands, which we commonly refer to as "80, 40, 20 and 10," are high frequencies.

Very high frequencies run from 30 to 300 Mc. (wavelengths from 10 meters down to 1 meter) and thus include our bands at 5, 2½ and 1¼ meters.

Ultrahigh frequencies are from 300 to 3000 Mc. (100 to 10 cm.) and embrace our bands in the vicinity of 400, 1200 and 2400 Mc.

Super-high frequencies are from 3000 Mc. upward or, in terms of the presently-allocated portion of the spectrum, 3000 to 30,000 Mc. (10 cm. to 1 cm.) and include our bands in the neighborhood of 5, 10 and 20 kMc.

STATE GUARD W.E.R.S.

Remember that there were three kinds of WERS stations, one of them State Guard? And

(Concluded on page 114)

The Bright New World—of Sunspots

Wartime Research Uncovers Improved DX Prospects

BY COMMANDER E. H. CONKLIN,* USNR, W3JUX

• Far from being neglected during the war in the press of developing offensive and defensive electronic devices, research into ionosphere characteristics was considerably accelerated. The information collected not only explains some of the things that happened during prewar days but promises better long-distance communication, over a longer part of the sunspot cycle, than had previously been thought possible.

EACH of us who gets the old receiver down from the attic (lawd help the poor thing if it was in a humid basement) or gets delivery of a shiny new model becomes curious about the present status of radio conditions. Much is being said about radar, sonar, loran, and other electronic developments, but has anybody developed a better ionosphere while amateurs were closed down?

Offhand, one would say that conditions hardly can be improved by the scientists, any more than can the weather — though the newspapers did carry an item a few months ago about dispelling a fog along the California coast. But the scientists have done something for us — they have learned a lot more of world-wide conditions, about which we seem not to have been too wise before the war.

A considerable part of the prewar work on predicting radio conditions was based on measurements made by the National Bureau of Standards in Washington, and by Carnegie Institution stations in Peru (remember Harry Wells at OA4U?) and in Australia (and remember Lloyd Berkner at VK6MO?). The result was an assumption that conditions were much the same throughout the world, except for the normal differences with latitude.

During the war, however, a dozen or more new ionosphere stations have been established, some of them portable so that they could follow our advancing forces closely as they approached Japan. The result of the new observations from a larger number of locations was that geographical differences in conditions were quickly noticed and put to use.

One day last winter the writer called upon an old friend and neighbor from Evanston, Illinois — Lt. Col. Esterly Page who, more than 20 years

* Conklin Radio Co., 6800 Clarendon Road, Bethesda 14, Md.

ago, used to join in a local competition to see who could pile the most kilowatts into a few "fifty watters." Those were the days of pushing signals across the Atlantic and Pacific on 200 meters — one way — by just plain blasting, rather than by making use of the then little-known advantages of higher frequencies. Page's Army work at the time of the visit related to predictions of radio conditions. On the wall of his office in the Pentagon building was just one ionosphere measurement, taken in Hawaii at the bottom of the sunspot cycle in 1944. Instead of showing that frequencies only up to about 6 Mc. would be reflected back downward from the ionosphere, it showed vertical reflections up to 15 megacycles. That would be sufficient for consistent long-distance communication on frequencies almost up to the five-meter band!

Was this some peculiarity, such as the erratic sporadic-E layer that accounted for prewar summer short skip and 5-meter DX? No, not at all. The measurement itself showed that it was the good old DX contest stand-by, the F layer. Furthermore, if such conditions could be encountered in Hawaii during the poorest year of the sunspot cycle, what could happen about 1948? Why, possibly 5-meter work from California to Hawaii, or between islands in the Pacific.

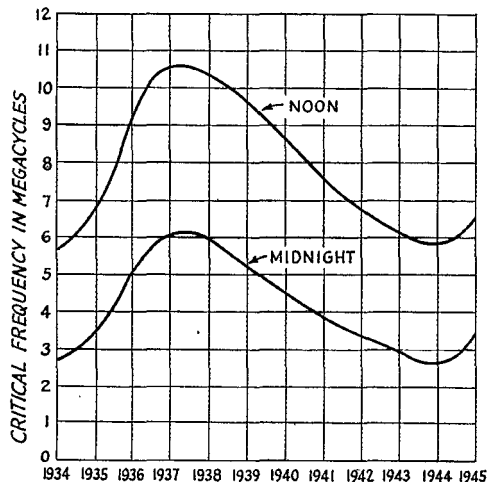

Fig. 1 — Yearly average critical frequencies of F_2 layer, ordinary ray, in megacycles, for noon and midnight as recorded at Washington, D. C. Data for 1945 include only the first ten months of the year.

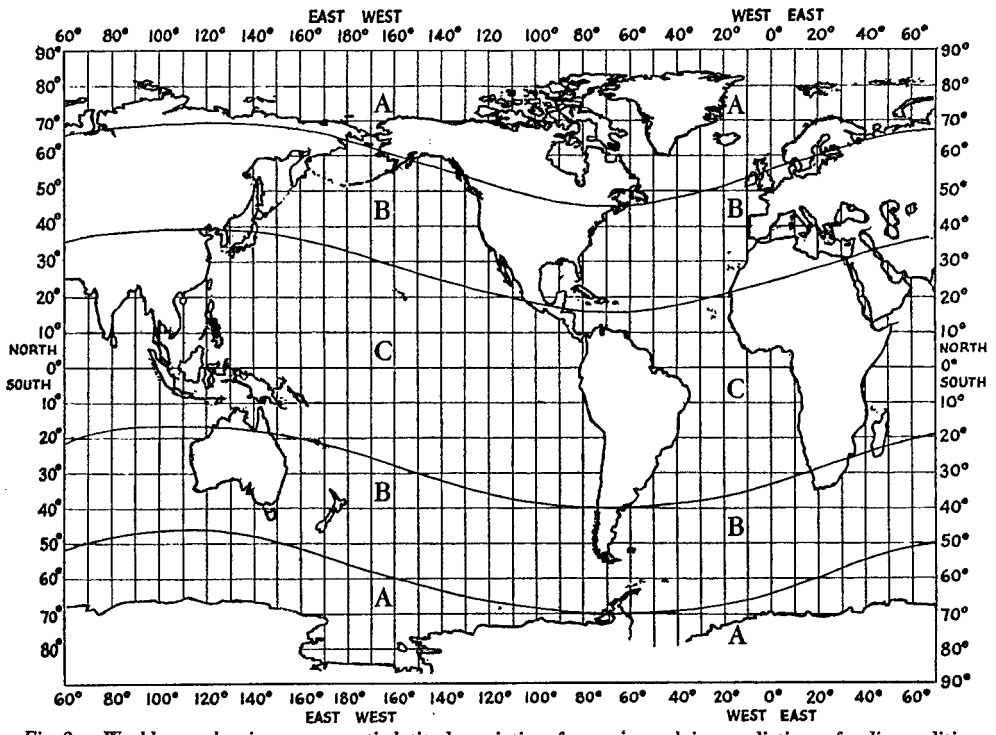

Fig. 2 — World map showing geomagnetic latitude variation, for use in applying predictions of radio conditions.

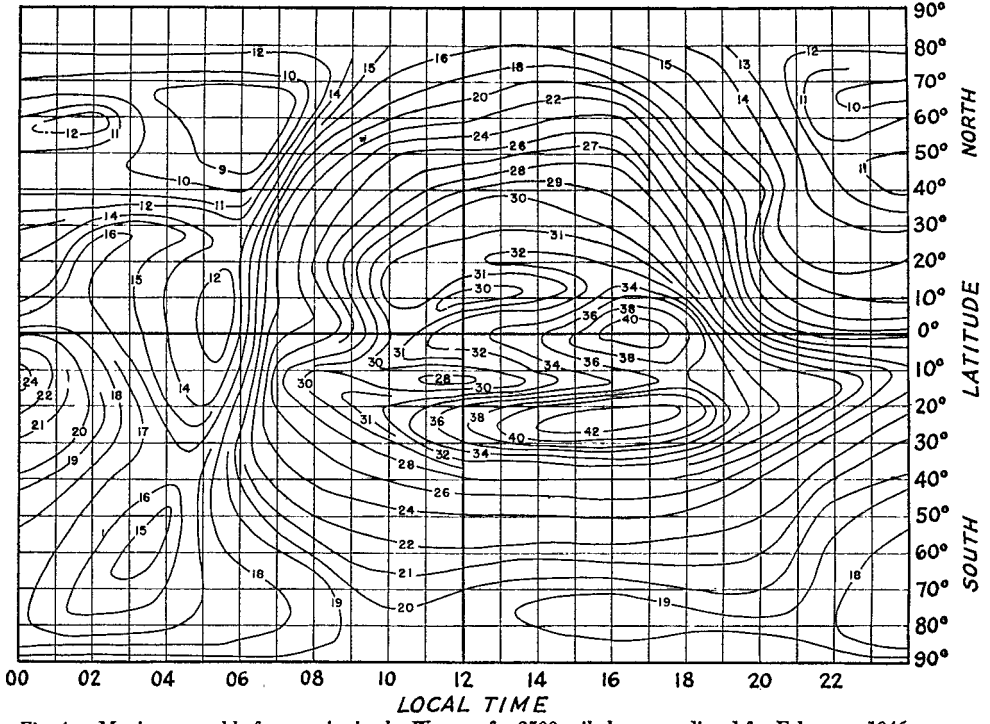

Fig. 4 — Maximum usable frequencies in the W zone, for 2500-mile hops, predicted for February, 1946.

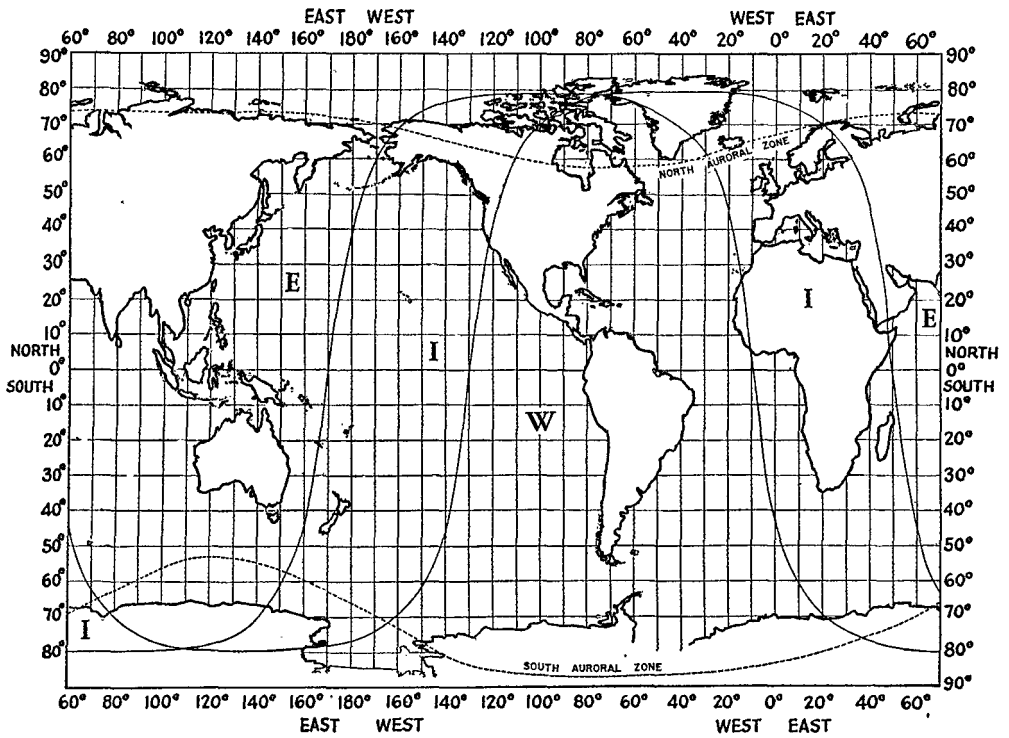

Fig. 3 — World map showing zones caused by variations in geomagnetic latitudes, covered by separate predictions.

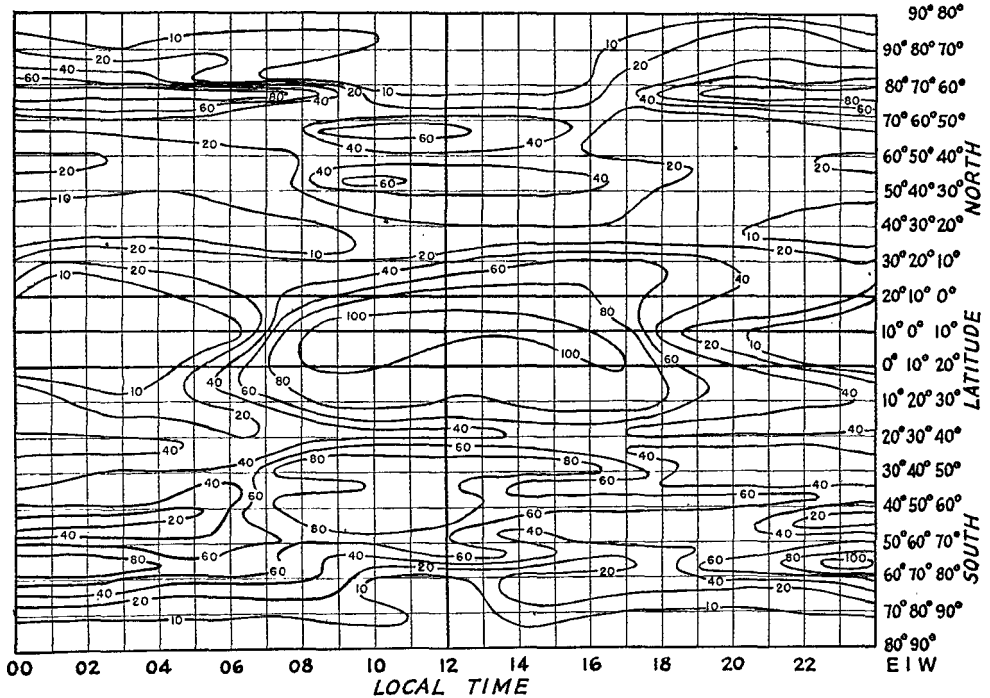

Fig. 5 — Percentage of time for occurrence of relatively intense sporadic-E reflections, predicted for February 1946.

Unexpected DX

The writer was very interested in this phenomenon and in the fact that conditions were found to be rather different in four parts of the surface of the earth. Just before the war, the probability of v.h.f. long-distance reception or communication was again brought to the attention of Navy personnel in a series of articles in a Navy technical bulletin, but there were always communicators who were astounded at some of the things that happened. In Pearl Harbor in September, 1943, Lieut. Tippey on the *USS Yorktown* said that during the Marcus raid he heard a station in Pearl Harbor on about 75 Mc. Many similar reports were received, some of which could be explained by two-hop transmissions by sporadic-E layer.

This was particularly true in the f.m. band around 30 to 35 Mc., which opened up day after day. In Borneo we listened to transmissions from Iwo Jima for a number of hours every afternoon on the *USS Phoenix*, and on the way up to Okinawa with the bombardment force, on the *USS West Virginia*, we were amused by complaints from Ulithi Atoll of our breaking up local harbor communications in this range. The transmitters and receivers on the ships usually were 25-watt Motorola and 2-watt Link sets of the police-car type.

The extent of 35-Mc. long-distance reception at the bottom of the sunspot cycle in the western Pacific is further illustrated by the following experiences. A ship in a sinking condition and without power for the high-frequency radio equipment had to transmit some kind of report and call for help. An f.m. equipment operating on wet batteries was used. A number of ships a thousand miles or so away received the message and took action to relay the request for assistance. Another time, an enemy raid was detected approaching a Pacific atoll. The report was put out on a local f.m. circuit on about 35 Mc., using the same frequency as another harbor circuit a great distance away. Ships in the second harbor received the warning, took it to be a local transmission, and went to "general quarters" to prepare their air defenses.

The writer's interest in the highest usable frequency just after the bottom of the cycle was pursued during the Okinawa invasion by spending a few hours each day checking up on the harmonics that could be heard. It was found that some of the long-distance radio circuits in the western Pacific, at 1200 to 4000 miles, were best handled in daylight on frequencies above 20 megacycles, making the proposed 21-Mc. band look mighty interesting. Frequencies from 20. to 26 Mc. opened up about an hour later than those around 14 Mc. and closed a little earlier, but they were good for about ten to sixteen hours a day in one direction or another. Japanese broadcast

station harmonics around 24 to 26 Mc. were perfectly good up to ten o'clock at night at Okinawa, and some signals from Navy transmitters at Guam held up just as long though, as expected, 4000-mile two-hop signals at the same frequency from Hawaii passed out several hours earlier.

So it is little wonder that Ken Bryan, K6MVV, used to put good ten-meter signals into Central America and the western U.S. when no other signals could be heard on the band! Ken has his new transmitter ready to demonstrate this phenomenon again. In a few years, when still higher frequencies should get through consistently, it will be a good bet that he will be able to connect with California on six meters in wintertime, if two-hop sporadic-E skip doesn't make it possible in summer before then.

Predicting Conditions

The present position in the long-term trend of radio conditions can be seen quickly from the curves in Fig. 1. The points on the curve are yearly averages of the critical frequencies for noon and midnight recorded at Washington, D.C. The point for 1945 includes only the first ten months of the year. It will be seen that present conditions are more than a year above the bottom of the cycle, which may be taken as early 1944, eleven years after the last minimum in 1933. Conditions now are comparable to those of 1935; they may be expected to reach a peak about the winter of 1947-48.

The wartime measurements of radio conditions have just recently been released from military security restrictions and can be disclosed. The world-wide measurements indicated that conditions change with latitude and longitude, but these positions are in respect to the *magnetic* poles of the earth. As a result, conditions in North and South America act as if the real latitude were up to 12 degrees farther north, as shown in Fig. 2. The earth's surface, therefore, can be divided into four zones containing areas that act as though they were farther north, farther south, or normal. These zones are shown in Fig. 3.

In applying the *F*-layer ionosphere information to communications in any direction from some point on the earth, a chart similar to Fig. 4, for the "W" zone — the Western Hemisphere — is used. These charts change with the season but they are available several months early and can be used to estimate the possibility of one of our bands opening up for consistent two-way communication in any desired direction from any place on the earth. A glance at this chart will explain why contest signals from some continents used to predominate at certain hours of the day. It will also show why the ten-meter band opened up this winter for fairly consistent work south,

(Concluded on page 104)

FOREIGN NOTES

BELGIUM

Although still forbidden even to possess a transmitter or transmitting parts, ON amateurs are confident of the eventual restoration of licenses and look forward to greatly increased activity in postwar years. *Reseau Belge* states government authorities have a high opinion of amateur work, particularly in view of the invaluable services rendered by Belgium amateurs to the nation's army in 1940 when they were grouped into a special unit for military communications assignments. In addition, many hams participated in later "resistance" movements during occupation years.

L. Richard, ON4UF, is temporarily serving as president of R.B. while ON4AA remains on military duty. "QSO", the society's official organ, is issued as often as conditions permit.

COLOMBIA

Renewing activities immediately after war's end, L.C.R.A. was instrumental in securing complete restoration of amateur frequencies and privileges for HK hams. The society now has well over one hundred members, with more expected.

Officers elected for the new term are: Dr. Fernando Carrizosa Valenzuela, president; H. McCormick, HK3HM, vice-president; Italo Amore, HK3IA, secretary; and Pedro E. Rey, HK3PR, treasurer.

CZECHOSLOVAKIA

A brief note from the Czech society, C.A.V., brings the welcome news that after six years of enemy occupation, OK amateurs are preparing to resume activities. There is yet no official word on government authorization.

FRANCE

R.E.F. believes that, as a result of its renewed contacts with French authorities, all prewar licensed amateurs will soon be reactivated. As a temporary measure, phone operation may not be permitted until the licensee has taken a written examination in voice work. The return of all prewar bands is expected.

"Radio-R.E.F." has obtained official sanction for publication quarterly, beginning in January.

MEXICO

All amateur bands existing before the war have been restored to XE amateurs, with the exception of certain specific frequencies still occupied by certain government services. Licenses are being renewed, but now requiring proof of ownership of equipment, technical ability and amateur status. According to Secretary Mariano Yustis C., XE1BX, L.M.R.E. is being made responsible to the government for continued progress in amateur technical and operating ability.

NETHERLANDS

We have pleasure in reporting the formation of a new Dutch society, *Vereeniging voor Experimenteel Radio Onderzoek in Nederland*, absorbing the former amateur groups in the Netherlands. The new headquarters may be addressed at Post-box 125, Hilversum, and its secretary is Ph. J. Huis, PA0AD. Application will be made for representation as the Dutch society of the Union. Best of luck, OMs!

NEWFOUNDLAND

On October 15, wartime restrictions were lifted

(Concluded on page 108)

Guests of Capt. William W. Orr, LSPH, at the post officers' club in St. John's during his tour of duty in Newfoundland (left to right): VO1L, VO1S, VO2O, Capt. Orr, VO1V, VO1H, VO1Y, and VO1M.



The "Little Gem II"

A Combination V.H.F. Wavemeter and Field Strength Indicator

BY BYRON GOODMAN,* WIJPE

SOME YEARS ago W1DF described a simple absorption-type wavemeter¹ that proved so handy around the local hamshacks for spotting r.f. at various frequencies that it quickly acquired the nickname of "The Little Gem." Recently we tried to extend its range down to the 2-meter band with unsatisfactory results, simply because it had not been intended to go that low and some of the leads were too long, and so a new one was built to take up where the old one left off. A few new ideas were added, and the result is a worthwhile gadget that it seems appropriate to call the "Little Gem II."

A war-time development that certainly seems destined to find many amateur applications is the Sylvania 1N34 Crystal Diode. This is a germanium crystal rectifier mounted in a package the size of a $\frac{1}{2}$ -watt carbon resistor, with pigtail leads at each end. Thus there is no more mounting problem than there is with a $\frac{1}{2}$ -watt resistor, except that the manufacturer recommends that the leads be held by long-nosed pliers during soldering, to prevent too much heat from getting

* Assistant Technical Editor.

¹ "A Sensitive Absorption Wavemeter," *QST*, July, 1941.

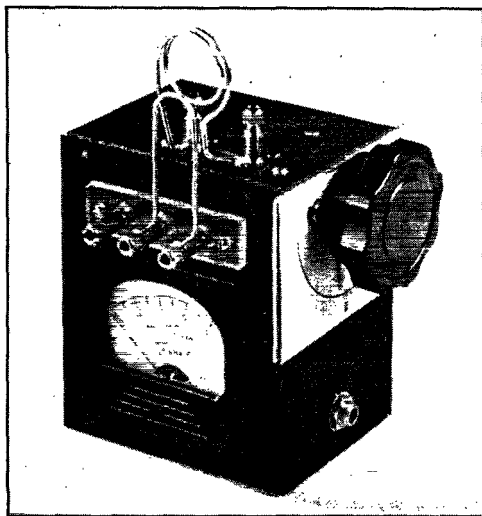

A combination wavemeter, field-strength indicator and 'phone quality monitor for the 144-Mc. band. The two-turn coil is part of the wavemeter portion, and the hairpin loop provides pick-up for the 1N34 crystal detector. For field-strength work, a short antenna is connected to the binding post at the left of the hairpin loop.

• One of the simplest yet most useful gadgets that can be built for the amateur station is an absorption-type wavemeter. If you increase its utility by combining with it the functions of non-selective field-strength indicator and 'phone quality monitor, you have something worth talking about. Here is a version designed primarily for the frequencies above 50 Mc., but the principles can be applied to any of our bands.

to the crystal element. However, slight care in soldering is not much of a price to pay for a rugged rectifier that has better efficiency than a 6H6 or even the 6AL5. If you are already arching one eyebrow at the mention of "crystal detector," it might be well to point out that this little crystal carries normal ratings of 22.5 ma. average current, 60 ma. peak current and 200 ma. maximum surge current! Surge current refers to transient values and peak current relates to the peak value of an applied a.c. signal. Actually, in the "Little Gem II," which uses the 1N34 with a 0-1 milliammeter, there is a better chance of burning out the meter than the crystal! The crystal is intended to replace vacuum diodes in video applications, where a high-efficiency diode is a necessity, but its small size makes it an excellent substitute for a diode in a compact receiver. It is a natural for our wavemeter job.

The Circuit

An absorption-type wavemeter consists of two parts, the tuned circuit and the indicating device. Since this wavemeter was intended for use between 50 and 250 Mc., the tuned circuit was given major consideration. As shown in Fig. 1, the tuning condenser is a split-stator affair of 25 μmfd . each section. It is mounted to give short leads to the coil, and the use of a split-stator condenser results in a low minimum capacity. The indication device includes a pick-up loop loosely coupled to the tuned circuit, the 1N34 crystal and a 0-1 milliammeter. The by-pass condenser, C_2 , furnishes a short r.f. return to the pick-up loop and avoids any resonances in this circuit within the frequency range of the wavemeter. For field-strength indication, an antenna is connected to one side of the pick-up loop and the wavemeter circuit, L_1C_1 , is detuned, resulting in a non-selective indicator. If at any time the frequency

is to be checked when the unit is used as an f.s. indicator, tuning the wavemeter through the transmitter frequency will result in a dip in the current indicated by the milliammeter. A 'phone jack, J_1 , in series with the meter, allows the gadget to be used for checking modulation quality or carrier hum by plugging in a pair of headphones.

Construction

The wavemeter is built in one of the familiar 3 by 4 by 5-inch metal cabinets. The tuning condenser, C_1 , is mounted under the top and the shaft comes out through a clearance hole in the side. An aluminum plate, $2\frac{5}{8}$ by $3\frac{7}{8}$ inches, is bolted on the side to back up the calibration scale. Flat-headed screws should be used at the bottom so that the paper of the scale will lie flat on the plate. A National FWG polystyrene terminal strip can be used to mount the two National FWA binding posts used for the coil, L_1 , although we used a plain strip of $\frac{1}{8}$ -inch polystyrene. The 'phone jack, J_1 , is mounted on the side of the case below the tuning knob, and a fancy handle from the local hardware store can be fastened to the other side of the case.

The meter is mounted on one of the removable sides of the case, and it should be located close to the bottom to allow space for the polystyrene strip that supports the FWA posts for the pick-up loop and antenna. These three posts could be mounted on a FWG strip and a pair of National XP6 buttons, but the polystyrene sheet was on hand and we preferred to mount the posts as shown in the photograph.

Wiring the unit is the essence of simplicity. Two wires dropped down from the two top binding posts to the stator connections of C_1 complete the wiring of the tuned circuit. A piece of No. 12

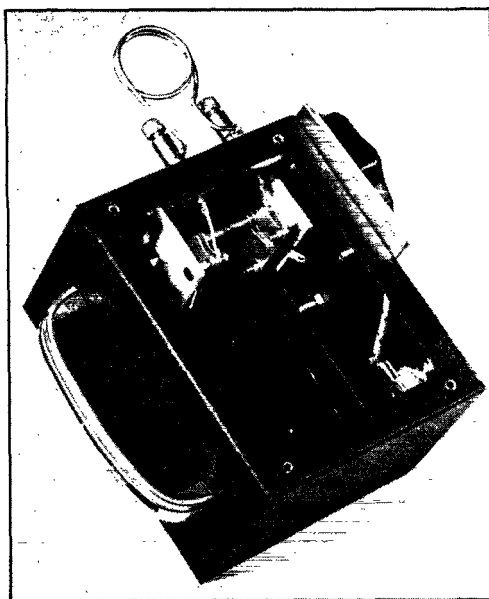

The leads from the coil binding posts to the tuning capacitor are short and direct.

wire is run from the meter up near the side binding posts and forms a tie point for the crystal and C_2 . Long flexible leads are run from the 'phone jack to the other meter terminal and to one side of the pick-up loop. A jumper from the antenna post to the pick-up loop post and the wiring is completed.

Calibration

The hard work comes in calibrating the unit, unless you are fortunate enough to have access to a v.h.f. signal generator with enough output to give an indication on the meter. Lacking the generator, the next best bet is a crystal-controlled transmitter from which one can pick off r.f. of known frequency.

It is probable, however, that the calibrating will be done with Lecher wires² in the majority of cases. With the Lecher wires, one will need a v.h.f. oscillator of a few watts, and this of course can be the regular 144-Mc. transmitter, or an oscillator capable of v.h.f. operation. If the meter is to be calibrated in the vicinity of 145 Mc., turn on the oscillator and attach a two-foot length of stiff wire to the antenna post of the wavemeter. With an oscillator capable of delivering 5 watts or so, a meter reading should be obtained several feet from the oscillator, with no antenna connected to the oscillator. The Lecher wires can then be very loosely coupled to the oscillator, and as the proper shorting points on the Lecher wires are found, a dip will be observed in the wavemeter current. Incidentally, this is the

² "A Lecher Wire System for U.H. Frequency Measurement," *QST*, October, 1941.

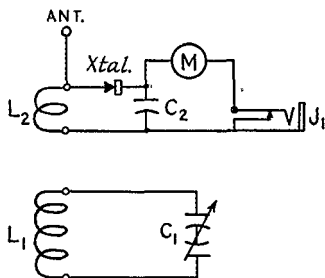
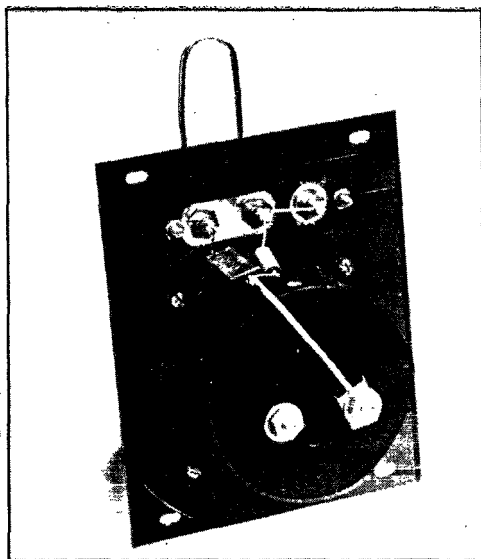

Fig. 1—Wiring diagram of the wavemeter and f.s. indicator.

- C_1 —25- μ fd. per section split-stator variable. (Cardwell ER-25-AD).
- C_2 —100- μ fd. small mica.
- J_1 —Closed-circuit telephone jack.
- M—0-1 milliammeter.
- L_1 —144 Mc.: 2 turns No. 12 wire, $1\frac{1}{8}$ -inch diam., spaced wire diameter.
- 220 Mc.: hairpin loop of No. 12, $1\frac{1}{4}$ -inch long, $\frac{3}{4}$ -inch spacing.
- L_2 —Hairpin loop of No. 12, $2\frac{1}{4}$ -inch long, $\frac{3}{4}$ -inch spacing.



A view of the back of the meter, showing the stiff supporting wire for the crystal and by-pass condenser.

most sensitive indication for Lecher wires we have ever seen, and it permits a high degree of accuracy in making the measurements. If now the tuning knob of the wavemeter is rotated, a sharp dip in wavemeter current will be found, and this point should be marked in pencil on the scale and the frequency, as calculated from the Lecher wire distance, should be noted for future calibration. As a double check on the calibration of the wavemeter, remove the antenna and tune the wavemeter for *maximum* meter reading. The two points should be identical, and if they are not it means the pick-up loop is coupled too closely to the tuned circuit of the wavemeter. You should be able to take this reading several feet from the transmitter.

The transmitter frequency should be varied until six or eight points between 130 and 170 Mc. have been obtained. If one is lucky, several of the frequencies will come out very close to integral numbers and will serve as starting points for the scale calibration. A pair of drafting dividers can be used to divide the spaces between these points, remembering that the divisions representing one- or two-megacycle intervals become greater as the frequency becomes lower, because of the nature of the tuning curve of a straight-line capacity condenser with no shunting capacity. It was found quite easy, however, to ink in a suitable calibration which checked within the accuracy with which the scale could be read. The important thing, of course, is to be able to spot one's frequency close to the band and after that to depend upon something more accurate. One possibility along these lines would be to have a

(Continued on page 104)

25 YEARS AGO THIS MONTH

THIS ARRL of ours is growing fast, the editor says in *QST* for January, 1921. "We are part of a new and wonderful American development — Citizen Radio." Traffic Manager Schnell reports great improvement in traffic conditions the past month, messages consistently going through to the West Coast via both the Southern and Central routes. Plans are all drawn for the testing of five transcontinental routes in mid-January, the stations selected along with their alternates, and instructions issued. We hope to make new records but success depends upon coöperation in eliminating QRM.

Although increasing attention is being given c.w., King Spark still reigns. The leading article is "Some Thoughts on Spark Operation," with pointers on design and adjustment. To obtain better practical constructional articles on this subject, *QST* announces a prize contest for manuscripts on "The Ideal Relay Spark Transmitter." James L. Autry, jr., 5ZX, offers practical pointers on "Tuning the Transmitter." Ernest Oke, of Peterboro, Ont., presents drawings of "A Rotary Gap of High Quenching Characteristics," having inner and outer members revolving in opposite directions.

Now that we are growing up, the editor calls on all hands to get down to the legal maximum wavelength of 200 meters. It is a sad fact that the average amateur tune today is right around 240 meters, and this will no longer do — the law must be obeyed. . . . 9XE is going to run another Washington's Birthday Relay. . . . A preliminary report shows that the second ARRL-BuStands fading test in October was more successful, and stations are being selected now for a third series to be run in January. . . . New England has its troubles. It is difficult to work from Springfield, Mass., to Worcester in the evening because of violent fading and terrific interference from the third and eighth districts — though the distance is only 60 miles and a 1 kw. transformer with two-step amplifier is being used in each test station. "We tried for ten nights consecutively to put a message through from Bridgeport, Conn., to Portland, Me., and while the message reached Portland over the long jumps, we were not successful in getting it past Springfield in short jumps. However, we have not given up, nor will we until it is finally accomplished." . . . Canadian calls being the same as ours, the Operating Department announces an ARRL regulation for identifying nationality, the distinction being in the intermediate used between the calls of the two stations. Traffic is

(Concluded on page 110)



HINTS AND KINKS FOR THE EXPERIMENTER



LINK COUPLED MODULATOR

MODULATION transformers are scarce and expensive; but speaker output transformers of the universal type are readily available, and at low prices. Many low-power transmitters use filter chokes in the Heising circuit; others use the split primary of a speaker output transformer for a modulation transformer. Both of these systems have the disadvantage of having to use a common power supply for both transmitter and modulator, and permit no adjustment for proper impedance match. Also, push-pull modulator tubes cannot be used. The following scheme is superior in both respects.

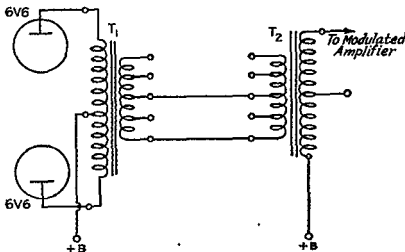

Fig. 2 — Universal-type output transformers connected back-to-back to obtain a wide range of impedances.

Use two universal speaker output transformers connected back-to-back, as shown in Fig. 2. By utilizing the voice coil taps, a wide range of impedances can be matched; step-up or step-down, single-ended or push-pull, Class A, AB, or B. Merely determine the impedance transformation ratio for the various voice-coil taps from the data sheet supplied with the transformers. Then, by using the ratios as a step-down from the modulator and as a step-up to the transmitter, a perfect match can be had. As an example: Push-pull Class AB 6V6s are to be used to modulate an 807 running at 400 volts and 60 m.a. The recommended load resistance for 6V6s, Class AB is 8000 ohms. The modulated amplifier represents a load of $400/.06$, or 6666 ohms. From the data sheet we find that secondary tap which will match 8000 ohms to, say, a 6 ohm voice coil. Then, all that has to be done is to find from the same data sheet a tap which will match approximately 6666 ohms to a 6-ohm voice coil, the two secondaries are linked together and the job is done with a

“link coupled” modulator at a fraction of the cost of a regular modulation transformer. — *Harry R. Hyder, W2LIW and Joseph Vitko, ex-W1BBA.*

— — —

V.H.F. MODULATOR WITH A2 AND A3

THE single tube modulator shown in Fig. 2 provides for both voice and tone modulation, with but a single tube. A neon bulb (with resistor removed) is used as a tone generator, for use on the v.h.f. bands, where m.c.w. operation is permitted.

The potentiometer, R_1 , serves as a pitch control. Some variation of R_4 and C_2 may also be necessary to get some neon bulbs to oscillate at the frequency desired. Insertion of phones in the monitor jack permits adjustment of the tone and provides a means of monitoring keying as well. — *Henry Morris, 423 So. Canyon Blvd., Monrovia, Calif.*

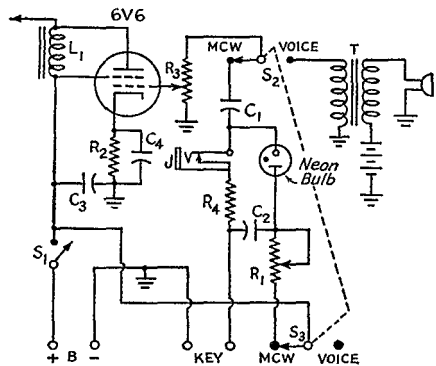

Fig. 2 — Single tube v.h.f. modulator for m.c.w. or voice.

- C_1, C_3 — 0.1- μ fd. 400-volt paper.
- C_2 — 5000 ohms.
- C_4 — 10- μ fd. 25-volt electrolytic.
- R_1 — 0.25-megohm potentiometer.
- R_2 — 500 ohms.
- R_3 — 0.5-megohm potentiometer.
- R_4 — 5000 ohms.
- L_1 — Modulation choke, 30 hy.
- T — Microphone transformer.
- N — Neon bulb (resistor removed).
- J — Monitor jack, closed-circuit type.
- S_1 — S.p.s.t. switch.
- S_2, S_3 — S.p.d.t. switch.



THE WORLD ABOVE 50 Mc.



CONDUCTED BY E. P. TILTON,* WHDQ

THE MAGIC date, November 15, 1945, meant many things to many people. To thousands of low-frequency men it meant the first glimpse of a portion of the radio-frequency spectrum which they had never used before — Ten, Five, or Two were better than nothing. To ten-meter men it was a field-day — who could guess what was in store on their band after four years of idleness; four years which included the passing of a sun-spot minimum? To a few five-meter regulars even 3:00 A.M. was none too early to start activity in their beloved stamping ground. To hundreds of occupants of the temporarily reactivated 112-Mc. band it meant pruning coils and inserting filament chokes, in order to get their gear working in the new 144-Mc. band. But to two amateurs, Rube Merchant, W2LGF, and Arthur Harrison, W6BMS, the high spot of F.C.C. Order 130 was that portion dealing with the frequencies between 5250 and 5650 Mc. Yes, that's Mc. — *megacycles!*

And so we have our first postwar "first" — at 7:46 P.M. on November 15th, W2LGF/2 and W6BMS/2 worked each other on 5280 and 5390 Mc., over a distance of approximately five miles, between two roof-tops in Garden City and Great Neck, L. I., respectively. Communication was on voice, and contact was maintained for more than two hours of continuous duplex operation.

This performance was repeated, for the benefit of several visiting members of the Headquarters staff, on November 24th. All of us were surprised at the simplicity of the gear, which was much more like ham radio than we had anticipated, and delighted with the quality and solidness of the signal. It hardly seemed possible that we were talking on a frequency many times higher than any of us had ever used before for communication.

Reflex Klystrons were used as frequency-modulated oscillators for transmitting, and as local oscillators, a.f.c. controlled, for receiving. Frequency modulation and control were both obtained by variation of the Klystron reflector voltage. Antennas (two at each station) were parabolas, thirty inches in diameter, with the Klystrons mounted on a short section of waveguide which opened toward the center of the "dish." Crystal mixers were used for receiving, and the i.f. was fed, by means of coaxial lines, to a standard f.m. receiver which had been modified

* V.H.F. Editor.

U.H.F. RECORDS

Two-way Work

- 56 Mc.: W1EYM-W6DNS, July 22, 1938 — 2500 miles.
- 112 Mc.: W2MPY/1-W1JFF, August 21, 1941 — 335 miles.
- 224 Mc.: W6IOJ/6-W6LFN/6, August 18, 1940 — 135 miles.
- 400 Mc.: W6IOJ/6-W6MYJ/6, September 14, 1941 — 60 miles.
- 5250 Mc.: W2LGF/2 — W6BMS/2, November 15, 1945 — 5 miles.
- W2LGF/2 — W7FOF/2, December 2, 1945 — 31 miles.

to include the a.f.c. circuit. The equipment was well within the capabilities of the more advanced amateur, and its builders, Merchant and Harrison, hope to see it duplicated, and improved upon, in the near future. A complete description of the setup, prepared by Merchant and Harrison in record time, appears elsewhere in this issue.

— . . . —

Operation has not been going on long enough to provide much information on the characteristics of our various new bands. Conditions on 28 Mc. have not been quite up to expectations, though the opening was probably late enough in the season to have passed the peak of conditions for that band. Activity on Five has been at a low ebb in most sections of the country, as might be expected, with Ten being released at the same time. No DX has been observed, at this writing, though it is expected during the middle of the winter season. Operators on Five are urged to get on and make every effort to promote activity — don't be satisfied with just looking over the band. Get on there and make some noise; use c.w., and use it often; arrange schedules with other stations and keep them — it is only by having plenty of signals on there every night that we will be able to make the best use of DX conditions when they do break.

On 144 Mc. the activity is building up toward the level of prewar activity on 112 Mc. Not much has been learned of the comparison between 112 and 144, and operators are asked to observe and report in this connection.

— . . . —

In prewar five-meter work it was noticed that sporadic-E DX usually followed on the heels

of a pronounced period of temperature-inversion bending. The October 21st session was no exception, though the sporadic E escaped the notice of the average amateur, as only 112 Mc. was available at that time. The f.m. band was wide open on October 22nd, according to W8UTR, who is located at Corozal, Canal Zone. He heard Boston, Chicago, Denver, and many other unidentified f.m. stations between 1:00 and 4:00 P.M., Canal Zone Time. Denver was heard on the following day. Signals were distorted and seemed to shift frequency at times, probably due to multipath reception or shifting in position of the reflecting layer.

Activity on 112 Mc. reached an unprecedented peak in the Hawaiian Islands, according to Lt. George Barnard, WINSS/K6, who had worked more than 35 stations before Nov. 15th. Several had expressed their interest in maintaining v.h.f. activity even after the reopening of the lower frequency bands. With all the fine locations in the Islands, and with that wonderful Hawaiian climate serving up nice temperature inversions as a regular diet, that shouldn't be too hard. The Island of Hawaii has two peaks, Mauna Loa and Mauna Kea, over 13,000 feet; Maui has Kolekole Peak, Haleakala Crater, an elevation of 10,000 feet, with a road to the top; and there are numerous spots over 2000 feet on Oahu which are readily accessible by car, where the other islands of the Hawaiian Group are line-of-sight, or nearly so.

Some idea of the degree of tropospheric bending existing in that area may be gained from the fact that the Kaneohe Bay tower, operating near the high edge of the 112-Mc. band, has been heard at Pearl Harbor and at Fort Shafter. You have to know Oahu topography to appreciate that — Kaneohe Bay, on the eastern side of Oahu, is separated from the Honolulu side of the Island by a continuous range of mountains, through which there is no path lower than 1200 feet. The two locations mentioned are close to sea level, on the Honolulu side.

Here is v.h.f. DX which breaks all records,

though it would be difficult to verify it. Listening at John Rodgers Airport, Honolulu, W5GSG heard airways communication from Christmas Island on 127 Mc., shortly before the end of the war. This is a distance of approximately 1000 miles!

The widespread temperature inversion which produced such a flurry of 112-Mc. DX on the night of October 21st, is now rather ancient history, but some observations have come in concerning it which have more than passing interest. Dana Griffin, W2AOE, visited W3BJR, Princeton, N. J., on that Sunday afternoon, running into a very interesting session on 112 Mc. as his first contact with amateur radio since 1941. During the afternoon several stations near Little Neck, L. I., were heard at W3BJR, and as darkness came on stations beyond the usual range were heard in all directions, culminating in a contact with W8MAP/1 at New London, Conn. W2AOE then returned to his home at Plainfield, N. J.; and though only an improvised indoor antenna and a 112-Mc. television receiver were available, stations from Philadelphia to New London were heard with good strength. From these observations, Griffin draws some interesting conclusions.

Many of the stations in what are normally considered to be poor locations for v.h.f. work were able to do just as well, or better, than stations more fortunately situated as to altitude. In fact, the high-altitude fellows were at a disadvantage, because their greater local coverage resulted in their experiencing much more QRM. It was also noticed that polarization was relatively unimportant in connection with reception of distant signals. Therefore, why not use a high-gain horizontal antenna for v.h.f. DX? This antenna could be mounted relatively low to the ground, to reduce local pickup, as height above ground would have little or no effect on signals which came in via inversion bending. In addition, the horizontal antenna would have the desirable effect of reducing the strength of the local signals, which would be vertically polarized.

(Concluded on page 116)

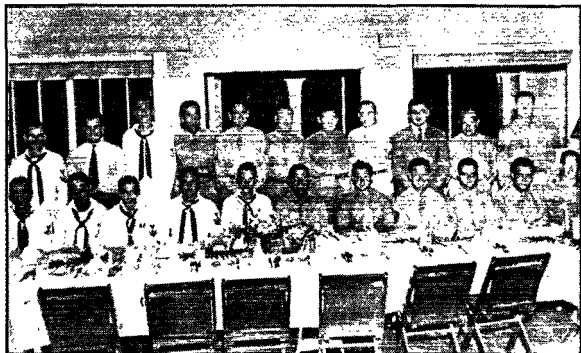

Mainland hams who attended the postwar hamfest at Honolulu, October 7, 1945. Standing, left to right: Henderson, RT1/C, W6TGA; Ohlemacher, Ens., W8VDM; Freng, RT3/C, W9JHO; Sampson, S/Sgt., W8QGE; Mallory, T/5, W1MEP; Kayhart, Lt., W2LFE; Schieferstein, Lt., W8UUX; Nininger, T/Sgt., W9UFQ; Zuckerman, W2LBF; Cole, S/Sgt., SWL; Sulfredge, T/4, W3FRH; Keefe, RT3/C, SWL; Dean, EM3/C, W9CEZ; Wenner, EM2/C, W3IVL; Hessler, RT1/C, SWL; Field, OPLO; Cartier, T/4, W9MUD; Rydinski, S/Sgt., W6RDR; Cook, T/Sgt., W1LTS; Marek, Lt., OPLO; Herrick, Lt., W7HOJ; Barnard, Lt., WINSS; (not pictured) Higginson, T/4, W9JND.

Loran—the Latest in Navigational Aids

Part II—Ground Station Equipment

BY ALEXANDER A. MCKENZIE, * WIBPI

PART I described in a general way the elements of a Loran system.¹ Up to now we have avoided details of the transmitting and receiving equipment and the method of presentation of the Loran signals. This section on the ground station (transmitting and timing) equipment will do little more than describe a series of "black boxes" and their interconnections. The relative complexity of the apparatus and wartime security considerations make a more detailed description undesirable. It is hoped that within a few months most of the Loran equipment information will be unclassified, with details available to the public. At this writing, however, this is the only Radiation Laboratory report on the subject in preparation for any publication.

Station Layout

First, let us consider once again what is required of a transmitting station. A review of Part I shows that apparently the whole duty of the Master transmitting station is to send out a continuous train of signal pulses. This is close to the truth. The duty of the Slave is to maintain synchronism, or keep the station delay at a constant, predetermined value at all times. The station delay is, by definition, the length of time which elapses between receipt of the Master signal at the Slave and the instant the Slave signal comes on the air. Let us assume that our station in the block diagram of Fig. 9 is a Slave station. Neglect

* Radiation Laboratory, Massachusetts Institute of Technology, Cambridge, Mass. This paper is based on work done for the Office of Scientific Research and Development under contract OEMar-262.

¹ Part I of this article appeared in *QST* for November, 1945.

the parts in dotted lines for the time being.

The remote signal receiving antenna is placed as far from the shock field of the transmitting antenna as the geometry of the site permits. It may be a Beverage wire, a relatively short vertical wire or a guyed pole. The Master signal is received by the antenna and passed through the receiving antenna coupling unit and low-impedance coaxial line to the attenuator (which in the non-attenuating state furnishes a small amount of amplification), thence to the receiver. The output of the receiver is fed to the timer (heart of the station) and presented as a pip on one viewing 'scope and as a pulse on another which is swept at a faster rate. The proper controls must be manipulated by the operator to arrange the transmitter keying circuits in such a way that the signal emitted from the transmitting antenna and picked up on the local signal antenna shall be delayed exactly the prescribed amount after the signal received from the remote station. Just before the timer sends out the keying signal to the transmitter, it sends out a blanking pulse to the attenuator which shuts off all signals received on the remote signal receiving antenna for longer than the duration of the transmitter's pulse signal. Since this local (Slave) signal is picked up on a very short local signal antenna which is connected to the receiver at a point beyond the attenuator, its amplitude must be controlled to a very small value. The receiver, then, is protected from the strong local signal by the attenuator. Its output is fed to the viewing scopes where the persistence of both the screen and the operator's vision allows a comparison between the Master signal and the local Slave signal.

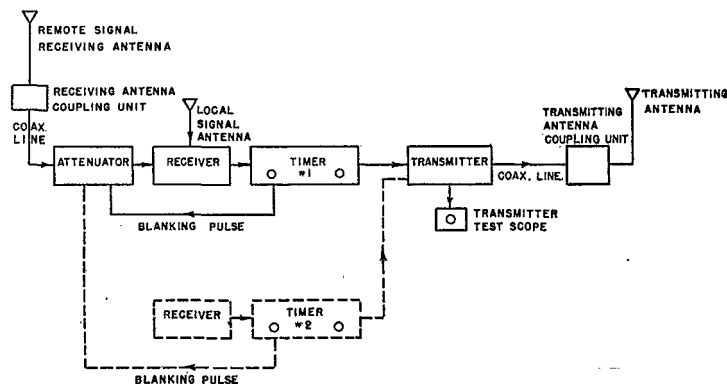

Fig. 9—Block diagram of a typical Slave station installation.

Energy from the transmitter passes through a coaxial line to the transmitting antenna coupling unit located at the base of the transmitting antenna, which might be an inverted L, vertical wire or tower of less than a quarter wavelength. Its location, including radial ground system, is as close as possible to the sea and as far as convenient from the receiving antenna.

The transmitter is provided with a combined test 'scope and frequency-checking device. If the station is a Slave at the center of a group of three, the transmitter must do double duty. The companion Master station signal is received, passed through the common attenuator and thence to the other receiver attached to Timer No. 2 (this interconnection and that to the local signal antenna have been omitted to avoid confusion). Timer No. 1 will synchronize with a Master station operating on a pulse rate of, say, $25\frac{1}{6}$ per second. Timer No. 2 will usually synchronize with a Master station operating at $25\frac{2}{6}$ pulses per second. Except for a brief moment every sixteen seconds when the two rates come into coincidence, the transmitter will be acting like two transmitters. There will be a cross-over of the blanking pulses, so that Timer No. 1 has its signal cut off by Timer No. 2 and vice versa, but this effect is not particularly troublesome because of its short duration.

Transmitters

Fig. 10 shows the transmitting equipment in greater detail. Either or both pulsers may be used, depending on whether the station is single or double type. It makes no difference to the transmitter whether it is used for Master or Slave operation.

The timer supplies a trigger pip to the input

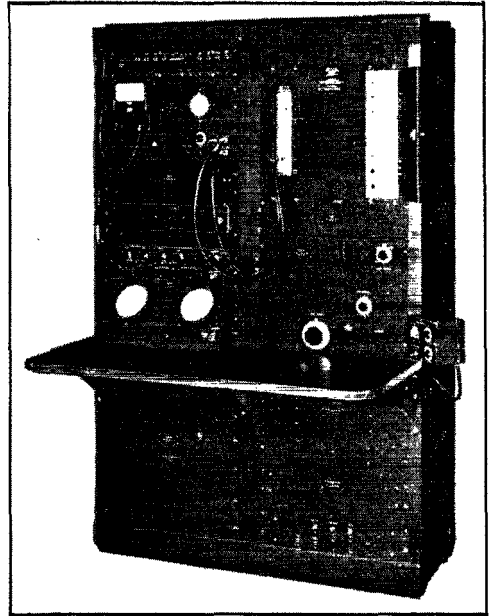

The pulses used in Loran transmissions must be timed to a fraction of a microsecond if the system is to give accurate bearings. This is a timer set-up. The primary frequency control is by a temperature-controlled quartz crystal.

transformer which steps up the voltage and feeds it to the grid of a pulse-forming gas tube. The gas tube circuits produce a keying pulse of definite shape and duration. This is amplified and passed on to the mixer, which in turn actuates the modulator. The modulator keys the oscillator by reducing the cathode voltage. Radio-frequency pulses pass through a low-impedance transmission line to a network which matches the line to the transmitting antenna. This antenna radiates radio-frequency pulses of a form and duration determined by the gas tube and r.f. circuits and occurring as frequently as the triggering pips from the timer.

The transmitter may be adjusted to operate at any frequency between 1700 and 2000 kc. The maximum peak output power of any transmitter under normal single-pulsed operating conditions is approximately 150 kw.; when double-pulsed, 85 kw., but is usually somewhat less. The average power might be of the order of 150 watts. The peak power is a function of average power and the duty cycle. The value of the duty cycle varies inversely with the recurrence interval (time between pulses) and directly with the pulse width. Stated algebraically, where *P* is peak power, *p* is average power, *L* is time between pulses (in microseconds) and *W* is width of each pulse (in microseconds):

$$P = p \frac{L}{W}$$

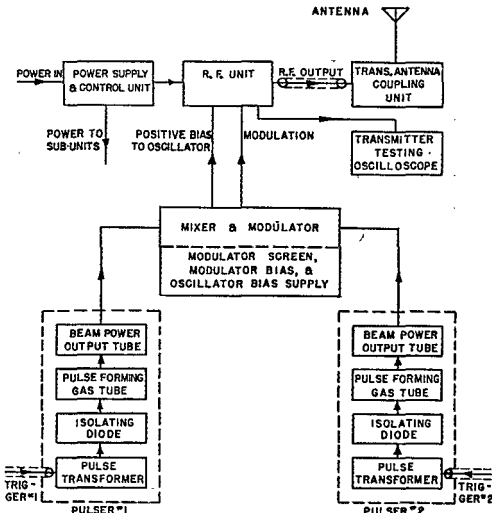
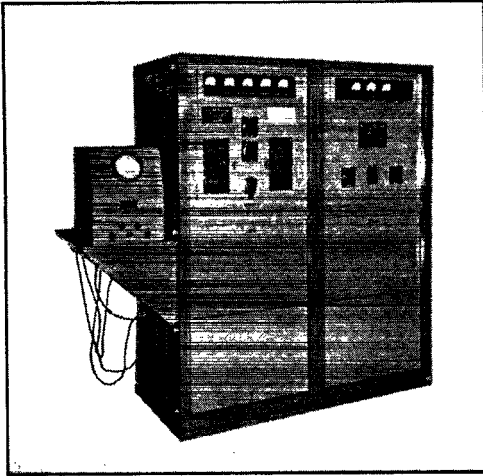

Fig. 10 — Block diagram of Loran transmitter.



Loran transmitting equipment has a peak power output of 150 kw., but because the transmissions are short pulses the average power is only about 150 watts. Present installations are keyed oscillators operating in the 1700-2000-kc. range.

Essentially, the transmitter is a self-excited oscillator, cathode-keyed. The amazing thing is that such a simple circuit can be used in such an exacting service. Crystal controlled m.o.p.a. transmitters have been built since the early, hectic days, but there are as yet none in routine operation in the field.

Timers

The timer is the very heart of the Loran system because it initiates the transmitter triggering pulses. If these pulses do not recur accurately and constantly, the signals are meaningless. The low-frequency quartz crystal which sets the pace must hold frequency sufficiently constant so that synchronism with another similarly inspired station can be held with a precision of one microsecond for at least three minutes at a time without adjustment. A watch with the same precision would be no more than one second wrong after running six years.

There are ten separate units which make up a complete timer. Fig. 11 shows the relations among the principal units, omitting such things as power supplies. The attenuator (shown in dashed lines) is a separate assembly, usually mounted in the wall of the shielded room which makes it possible to operate the timer in the same building with the transmitters.

The oscillator unit is equipped with a "phase shifter" which allows whole numbers or fractions of cycles to be added to or subtracted from the oscillator output manually. Manipulation of the phase shifter effectively advances or retards the position in time of the transmitted pulses relative to that of the received pulses. If there is a gradual

drift away from the desired position, it is then the duty of the Slave station to correct its crystal frequency so that it exactly matches that of the Master. Within certain operating limits, this correction may be automatically applied by the synchronizer. There is even a buzzer to warn the operator of trouble.

The "central" contains dividing circuits which reduce its crystal oscillator frequency to power-line frequencies. Assuming that 25 cycles per second is the output chosen from among the several available, we can call this output by its reciprocal or time-interval name and say that it is a 40,000-microsecond pulse. In a similar fashion, we can pick off and introduce into our viewing scopes as markers other outputs back down the line, calling these 10-, 100- and 1000-microsecond pulses. The intermediate outputs are also used to trigger delay circuits necessary for maintaining synchronization, as described below.

The twin 'scope presents this information. If we key our transmitter with 40,000-microsecond pulses and sweep the scopes so as to see one pip standing still, we will also see the received signal from the Master station as one pip standing still. All that remains to establish synchronization is to measure off a distance equal to 20,000 microseconds (for reasons to be shown later), measure off an additional bit for our station delay, say 1500 microseconds, and manipulate the phase shifter until our pip stands where a suitable ruler indicates 21,500. This is done with an electronic ruler after the 40,000-microsecond trace has been split into two 20,000-microsecond traces, one above the other as shown in Fig. 12(a). The graduations on the electronic ruler are the markers (10-, 100- and 1000-microsecond pulses) mentioned above. They are not shown in the figure. The reason for having measured off the initial 20,000-microsecond interval above now becomes apparent. It is one portion of the time elapsed between reception of the Master signal and the local (Slave) signal. From here on, however, we shall neglect the 20,000-microsecond portion of time at all scopes (mathematical proof to show that this is possible will not be furnished) and consider only the other portion.

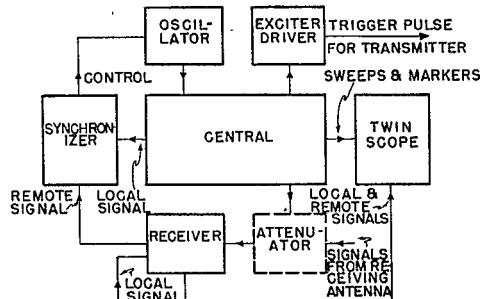

Fig. 11 — Loran timer, showing relations among units.

This constitutes the number of microseconds included between the extension of the upper trace pip to the lower trace and the pip on the lower trace. For instance, instead of thinking of the time between pips in Fig. 12(a) as 21,500 microseconds, we will call it 1500 microseconds. This 1500 microseconds is the Slave station delay which must be maintained at all times.

In order to set the delay exactly, movable pedestals generated with the help of variable delay circuits are imposed upon both traces. Portions of both pedestals can then be magnified by use of fast sweeps. The magnified graduations, or markers, allow the pedestals to be set apart within a fraction of a microsecond of the desired value. The signal pips are magnified at the same time and spread out as pulses. These are displayed on the fast scope. Then, when the traces are collapsed and appear as a single line, with two pulses close together, the phase shifter is moved until the pulses are exactly superimposed. Fig. 12(b) shows the relative positions of the pulses on

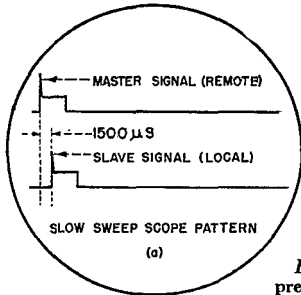
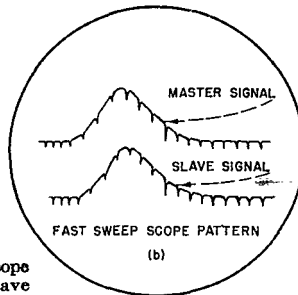

Fig. 12—Twin-scope presentation at a Slave station timer.



the fast scope (not superimposed) when synchronism is being maintained. The Master station sees a somewhat similar picture on its timer scopes, except that the relative positions are different. The positions depend upon the distance between the stations plus the station delay held at the Slave. The Master does not normally adjust its phase shifter. If the Master operator notices a discrepancy he may signal the Slave by "blinking" his pulse, making it appear to go off and on about once a second, until the Slave rectifies the error. The navigators' indicator, which is similar to the ground station timer in many ways, will be described in somewhat greater detail in Part III.

It has been mentioned that in order to prevent the local signal from paralyzing the receiver, thereby obscuring the weaker remote signal, an attenuator equipment is inserted between the receiving antenna and the receiver. It is customary to install the timer equipments in a room shielded with hardware

About the Author

• Recollections of the early days on what are now known as the v.h.f. bands always include the work of Alexander A. McKenzie, WIBPI. His operations from the top of Mount Washington made history during the period from '32 to '36 when WIBPI-WIFEX furnished many a station with their early 5- and 2½-meter DX contacts.

cloth. The first stage of the attenuator, enclosed in a metal box, is built into the wall of the shielded room and the other units are fastened close by. Fig. 13 shows the more significant portions and their relations to each other. The remote signal is amplified 6 to 10 db. when the two stages are in the amplifying state. Just before the local transmitter is triggered, however, the timer sends a

positive blanking pulse to the bias driver which inverts it and passes it along to the two stages as a strong negative bias pulse of a length determined principally by the timer. The local signal is then attenuated 126 to 134 db.; to such an extent that it must be re-introduced by other means to get sufficient amplitude for monitoring and comparing with the remote signal. Power for the shielded room must be brought in through a transformer equipped with a Faraday shield. Even the introduction of telephone lines without a shielded transformer will destroy the effect of the room.

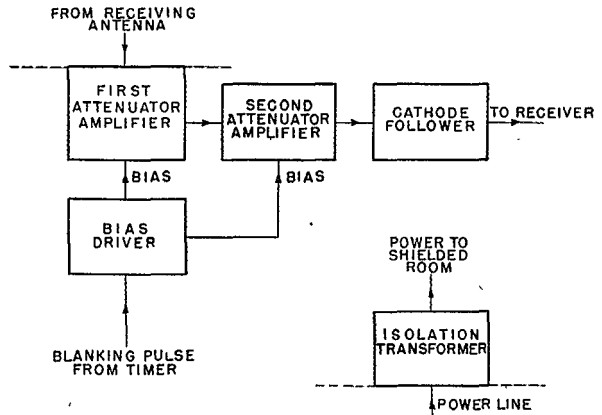

Fig. 13 — Block diagram of local signal attenuator.



How's DX?



How:

By way of introduction, this is a column that used to chronicle the doings of a particular breed of radio amateur. One of this species could be identified readily by his long ears, his nervousness whenever removed from his natural habitat — a smoke-filled ham shack lined with foreign QSL cards — and a friendliness toward only postmen, QSL Managers and hams who had worked more countries. Many of these fellows were good operators and had plenty savvy about radio, and they were able to do a mighty good job for their countries during the past five or six bad years. How did this species evolve? We really don't know, but a letter found among the effects of old Noxious Q. Nobands after he passed away may throw some light on the subject. The letter is reprinted in its entirety:

November 15, 1945

Dear Noxious,

Remember me? I'm one of the few things men chased back in 1940 that didn't wear nylons. I used to hang out next to high-powered locals and under automobile QRN. and even when I was weak and in bad shape the guys still found me. Some of these Joes went to great lengths to get the nod from me, but they always seemed to consider it worthwhile. These same Joes never forgot me, and they used to get together and talk about the old days with me even when they knew there was a big job to do before I could come back. The job is done and I'm back today and, mister, you're all through! I won't be seeing you!

DX

Apparently this is the doll our particular breed put the follow on, and she really had plenty of wolves after her. If she is back, they'll be back, and we'll be trailing close behind. Please let us know what you hear about her.

What:

We want to apologize for not having the place cleaned up a little better, but if you will just step into the shack perhaps Jeeves can find a little something for us to use for a toast to our old girl friend. "Make it the best, Jeeves — nothing is too good for an occasion like this." — — — — — Indications that she is back showed up the first day 28 Mc. was opened to us, with K4KD/K4 and W4IEN/K4 active and working. Since then other c.w. stations like G7FF, G7AA, G5DX, G7AL, EI5X, K4HLP, F3CIA, F8USA, D4USB, XE1CM, OK1FB, OQ5AE, P1X (Holland), CX1T (somewhere in Europe) and FP7A (?) have appeared and are working W's and VE's. The pickings on 'phone are no less fat, where the juicy ones are EA1D, AACS at Madrid airfield, SU1MW, W2NDJ/F, W7HLV/K7, W9LOG/VP4, LX1SI, G6BW, W6PUL/K6, W9GSG/K6, and old reliable K6M VV. OK, OK — so you've worked

them all and now have about fifteen countries and want to know where the DX is. Well, if you're so rugged that after four or five years of famine the above lists don't look like a feast, you do the column! — — — — — Undoubtedly by the time this reaches you there will be many more countries represented, but even if there are no additions it is well worth your while to get on ten and warm up the old fist and mike. Conditions are good and the band has the right sound to it.

DXCC:

The decision by the Communications Department to "wipe the slate clean" on the DXCC and start over again, announced last month, sounds to us like a lulu. It means that Johnny Newham starts in on the same footing as D. Xavier Oldtimer and still it takes nothing away from the pre-war man's accomplishments. The information on one's pre-war and post-war accomplishments can still be carried on a QSL card, but now Johnny will feel like he has a chance to knock Oldtimer's pins out from under him, a rather futile feeling if the old listing were retained. It gives the CD a chance to streamline and strengthen the DXCC rules, an obvious advantage to everyone. There will be some time before the rules can be completed and a new list of countries established, but in the meantime if you work everything you and your neighbor hear you know you won't be left out in the cold. Of the pre-war DX men we've

(Concluded on page 118)

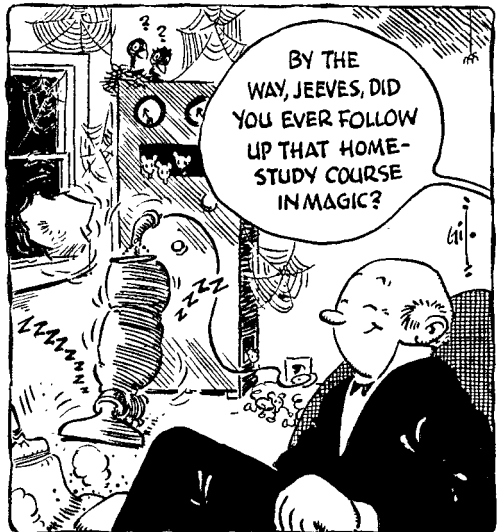

Listening in on the Stars

Doppler Whistles from Meteor Trails

BY OSWALD G. VILLARD, JR.,* W6QYT, EX-WIDMV

• While peaking up that communications receiver for reopening on the DX bands, why not take a little time out to make some observations on an interesting, but little known, phenomenon? Few hams know that meteors can be spotted without leaving the operating room.

MOST of us have done a little night star-gazing during our lives, for reasons of romance or profound astronomical speculation, and are consequently familiar with the shooting stars or meteors which flash silently overhead on summer nights like falling Fourth-of-July rockets.

Yet few are aware that it is possible to "hear" these visitors from outer space during the course of their brief plunge through the heavens, and even to estimate their speed without recourse to telescopes, photographic plates, or maps of the solar system.

How is this done, you ask? All that is required is a good short-wave receiver. For it turns out that falling meteors leave trails of ionized gas behind them which affect the propagation of short radio waves. These waves, in fact, are reflected from ionized meteor trails much as they are reflected from the regular layers of the ionosphere. Under certain conditions, when the regular layers are not heavily enough ionized to reflect short-wave signals from one point to another relatively close at hand, sporadic "sky-wave" transmission may still take place over this path because meteor trails are capable of reflecting signals when the regular layers are not. Since the meteor trails are relatively small in size when compared with the whole ionosphere, the amount of reflected energy is usually small and is not readily noticeable in everyday practice. However, when the short-wave listener knows how and where to look, the energy reflected by meteor trails easily can be recognized and identified.

Since a meteor trail is not static, but effectively moves across space with the same velocity as the meteor itself, the signal reflected by the front edge of the trail reaches the listener via a path whose length is rapidly varying. The effect is roughly the same as if the radio transmitter were located on the meteor itself. As a result, the speed of the

meteor's travel produces a "Doppler shift" in the frequency of the radio signal just as the motion of an approaching locomotive changes the apparent pitch of its whistle. Now if part of the signal from a fixed transmitter received at a given location consists of energy reflected from a moving meteor trail and part consists of energy reaching the receiver via a path of constant length, the difference in "pitch," or frequency, of the two components will produce a beat note which can be easily detected. The purpose of this article is to outline the conditions under which these Doppler beats can be heard in an ordinary short-wave receiver, and to describe their sound and other characteristics.

Identifying Meteor-Trail Reflections

To hear the Doppler beats which are the radio "sounds" made by meteors in the course of their brief plunges through our atmosphere, it is necessary to find and tune in a powerful short-wave broadcasting station operating on a frequency such that you are within its skip zone. The station should preferably be in the 11-, 15- or 18-megacycle band, and may be anywhere up to several hundred miles away, depending on ionosphere conditions. The main requirement is that you should not be receiving a direct, ionosphere-propagated ray — the signal must be very weak and fading, and may have a characteristic "hollow" sound.

Listen closely to this signal, and if your receiver has an "S" meter, keep an eye on the indicated strength. If conditions are right, you will notice from time to time irregular bursts of strength which may send the "S" meter up to fairly high values. These bursts will not last long — perhaps ten or twenty seconds — and the signal will soon fade down to the average low level. Some of the bursts may be quite weak, and may cause only a slight flick of the "S" meter.

At this point it should be noticed that during the first part of these bursts, especially the weaker ones, certain noises are audible on top of the received program. These sounds are short "whistles" super-imposed on the regular modulation. The pitch may be high or low — anything from a low grunt to a high "pweet." The whistles will last only two or three seconds, their duration being usually much less than that of the bursts of signal.

The whistles will, in general, vary in pitch. They may change from a high to a low tone — a sort of "pweecough" — or they may do the reverse. The pitch may even be constant. It will be unusual if any two whistles sound exactly alike.

* 61 Foster St., Cambridge 38, Mass.

On some occasions they and the burst may come thick and fast — two or three a minute; on others they may be less frequent. They are usually more noticeable during the early morning and early evening hours when long-distance transmission is best.

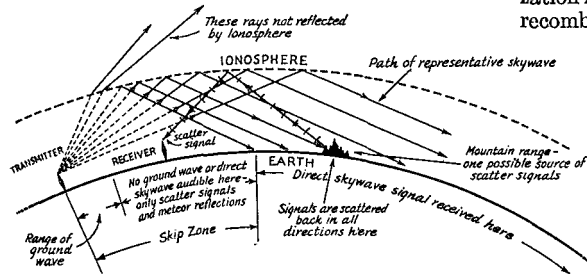

Fig. 1 — How signals are scattered back into the skip zone.

The whistles are the Doppler “sounds” of meteorites rushing into the earth’s ionosphere from the vast regions of outer space. The exact pitch heard is dependent on the speed of the meteor, the radio frequency, and the direction of the meteor’s track with respect to the transmitter and receiver.

Shooting Stars

That meteors have had an influence on conditions in the ionosphere, and hence on radio transmission, has been known for some time. There is some reason to believe that nighttime “E” region ionization is largely due to the many tens of thousands of small meteors which are intercepted by the earth’s upper atmosphere each day. J. A. Pierce has shown (see Bibliography 1) the connection between certain brief fades in normal radio transmission and the ionized trails caused by meteors. In the same paper he also demonstrated that energy reflected from meteor trails gives rise to brief bursts of signal received from transmitters within the skip zone. In a later paper (see Bibliography 2) he showed that the ionized regions caused by meteor trails could be detected and measured by means of regular ionosphere sounding equipment. Not long after that the chain of events was completed by two Indian scientists who first reported the Doppler “whistles” caused by reflections from the moving meteor trails themselves (see Bibliography 3).

Shooting stars, of course, are really small particles of matter from outer space which bombard the earth’s outer atmosphere at tremendous speeds. Collision of these objects with the molecules of gas comprising the atmosphere releases an

enormous amount of heat and quickly causes the particles to incandescence. The radiation thus given off causes intense ionization along the path followed by the meteor. This ionization rapidly diffuses outward after passage of the particles, thus at first increasing the area of the disturbance, but decreasing its intensity; eventually the ionization is dissipated, the positive and negative ions recombine, and the reflecting region disappears.

The weight of the matter composing the meteor is remarkably small in comparison with the dimensions of the ionized trail left behind after its passage. Considering ionization of an intensity sufficient to reflect a 10-megacycle signal, Pierce estimates that a meteor of average speed and weighing only one-quarter of a gram would be sufficient to ionize a cylinder of the earth’s upper atmosphere 1 kilometer in diameter and 100 kilometers long.

Why the Meteors Whistle

Let us consider a radio transmitter and receiver located far enough apart — say 30 to 60 miles — so that direct ground-wave transmission is negligible. The operating frequency is such that the receiver is within the skip zone. Under these conditions, the only energy from the transmitter detectable at the receiver which has been trans-

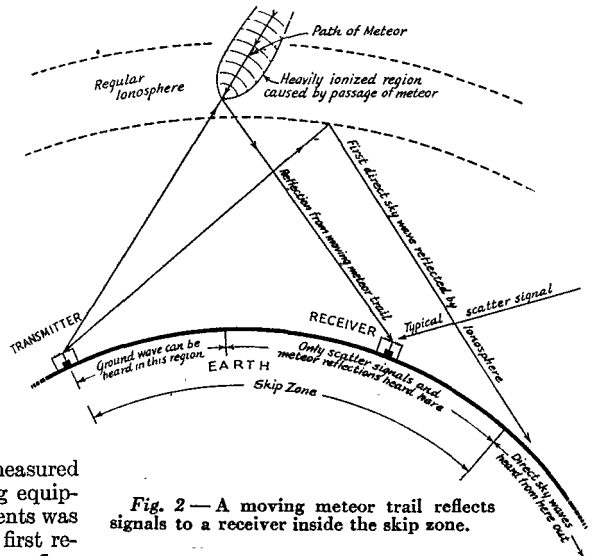
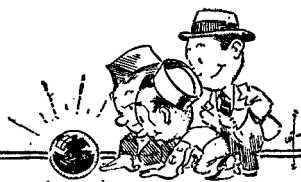

Fig. 2 — A moving meteor trail reflects signals to a receiver inside the skip zone.

mitted via the regular ionosphere layers will be a very weak signal scattered back to the receiver from irregularities on the earth’s surface or in the ionosphere at points outside the area which constitutes the skip zone (see Fig. 1). The paths traversed by these scatter signals are, of course,

(Continued on page 120)

THE CRYSTAL BALL



NOW THAT the gang is back on ten and five perhaps some of you crystal ball operators can disclose some new techniques for those bands.

This month's list of previews, contributed prior to that bright moment on the morning of Nov. 15th, includes excellent suggestions regarding our normal complement of bands. Furthermore, these layouts will make any shack more efficient and convenient. By coincidence, there are several GIs in the group of winners.

What kind of gear do you see in *your* crystal ball that would make two, five or ten meters more interesting and productive? Any ideas on rotatable antennas, "hot" receivers and other new devices that you are going to build up so you can make WAS on five, WAC on ten or that ninth state on two meters?

*Department Editor.

W8VGW DESCRIBES HIS CONTROL CIRCUITS

MY POST-WAR rig isn't going to be radically different from the gear we used to dream about. Although the manufacturers have been promising us wonderful and strange new gadgets, I have yet to run into anything startlingly different that could be adapted for ham use although I've been working in Army stations for two years, on stuff ranging in size from walkie-talkies to forty-kilowatt radioteletype transmitters. I have a few ideas from these commercial rigs, however, that I want to incorporate in my own station.

First of all, no more haywire! No more headaches such as when a rig develops a bug right in the middle of the Sweepstakes; or just when I'm about to work that 100th country. My rig is going to be built to commercial standards, and it will stay on the air when it's needed most. It'll be

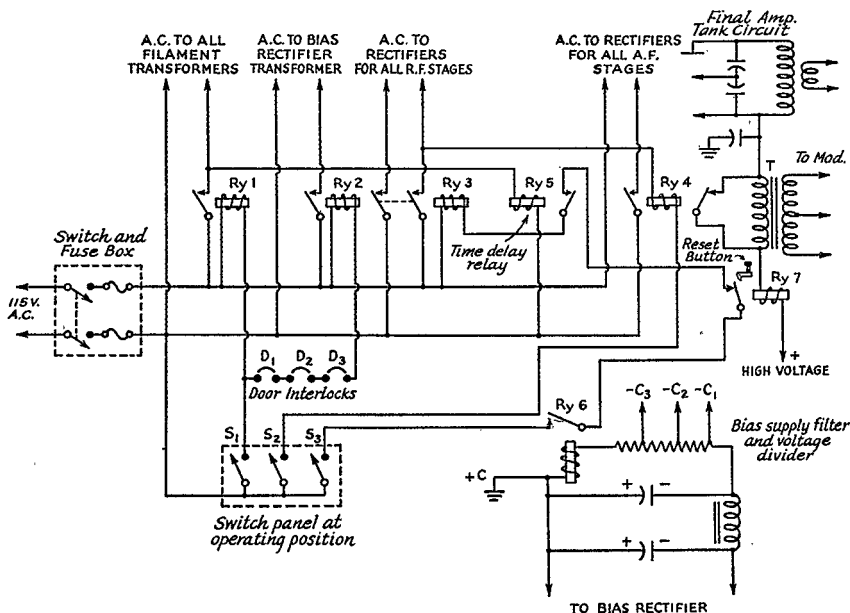

Fig. 1—Control circuit planned by W8VGW. Switches S_1 , S_2 and S_3 are located on the operating desk. S_1 is the main operational switch, S_2 is the "c.w."-phone switch and S_3 controls the high voltage circuit.

Ry1, Ry2, Ry3 — S.p.s.t. relay.
 Ry5 — D.p.s.t. relay.
 Ry4 — D.p.s.t. relay. One circuit open — one closed, on operate.

Ry5 — S.p.s.t. time-delay relay.
 Ry7 — S.p.s.t. overload relay.
 S_1 , S_2 , S_3 — S.p.s.t. switch.
 D_1 , D_2 , D_3 — Interlock switch.

completely enclosed in a metal cabinet. It will be ventilated, but the screens will be fine enough to keep out those bothersome bugs, the kind that fly. If some night, while dit-happy from too much DX and not enough sleep, I open the rear door to clean the relay contacts, a little interlock switch will remove all voltages, and the next night I'll still be alive to keep a sked with that VK4. If for some reason the plates of the final tubes should decide to blush a nice rosy red color, there will be an overload relay in the plate circuit to handle the situation and keep those precious bottles in their sockets, until the trouble can be located. If my bias rectifier should decide to call it quits, another relay will be right on the job to see that nothing blows up.

I can remember when I had to have three arms in order to switch from transmit to receive, and it took half a day to change the rig from c.w. to 'phone. Those days are gone forever. My new rig will have plenty of relays in the right places, so that all I'll need to run it are three little switches. These will be right on the desk within easy reach; one to turn on the filaments; another to switch on the high-voltage (and also to switch the antenna and disconnect the receiver); and a third one to change from c.w. to 'phone. There's no need to learn acrobatics just to run a ham station. Fig. 1 shows a circuit that should do the jobs previously mentioned, and be foolproof at that.

This circuit includes the following safety features:

1) High voltage cannot be applied to mercury-vapor rectifiers until the time-delay relay, Ry_5 , has operated. This relay starts its cycle as soon as filament voltage is applied, and operates 30 seconds later.

2) Should any doors be opened while the rig is in operation, one of the interlock switches will break the circuit to Ry_2 , removing the bias voltage. This causes Ry_6 to open, breaking the circuit to Ry_3 and removing plate voltages from the exciter and final units. Should the rig be in the 'phone position, Ry_3 normally will break the circuit for Ry_4 and remove plate voltage from the speech amplifier and modulator. As soon as the door is closed, voltage is again applied to all stages without waiting for the time-delay relay to recycle.

3) Plate voltage cannot be applied to the modulator unless Ry_3 is operated and there is plate voltage on the final amplifier.

4) With the transmitter on c.w., Ry_4 removes voltage from the speech and modulator units, and places a protective short across the secondary of the modulation transformer.

5) Plate voltage cannot be applied to any units unless the filament relay is operated and Ry_6 has gone through its 30-second cycle.

6) If the bias supply should fail, Ry_6 will open and break the circuit to the plate voltage relays (Ry_3 and Ry_4) thus removing all plate voltages before any damage occurs.

7) If, for any reason, the final plate current should become excessive, Ry_7 will operate and open, thus breaking the circuit to the high-voltage relays (Ry_4 and Ry_3) and removing plate voltages. Before plate voltage can again be applied, Ry_7 must be reset by operating the reset button.

An added refinement would be to connect relays for switching the antenna from receive to transmit, and for turning off plate voltage on the receiver. The antenna relay would normally connect the antenna to the receiver, and the receiver relay would normally be closed.

The circuit is designed for a rig which gets all filament voltages from separate transformers. It could be adapted to rigs which get some filament voltages from combined plate-filament transformers by putting relays in the B + returns of such plate-voltage rectifiers and connecting the windings to the output contacts of Ry_3 .

—S/Sgt. Elmer P. Orvis, W8VGW

CONVERSION EXCITER

I INTEND to use two oscillators in my v.f.o., one a stable crystal oscillator, the other a v.f.o. tuning the range of 500 to 1500 kc. The two oscillators will feed into a 6SA7 mixer. The sum frequency will be selected by a tank circuit and will drive a 6V6 to complete the unit. See Fig. 2.

By using crystals at 3 Mc., 6.5 Mc., 13.5 Mc., and 20.5 Mc. the complete range may be covered by a simple bandswitch. In order to cover the 28-Mc. band the 6V6 will double from 14 Mc.

JANUARY PRIZE WINNERS

• Contributors to the Crystal Ball Department are awarded monthly prizes consisting of a \$25 Victory Bond, first prize; \$10 in Victory Stamps, second prize and \$5 in Victory Stamps, third prize. One dollar in Victory Stamps is awarded the writer of each of the published letters not receiving a major prize.

The most interesting letters are selected by two members of the Headquarters staff, the conductor of the department and a "guest judge." This month's winners, chosen by John Huntoon, W1LVQ, Assistant Secretary, ARRL, and W2OEN, follow: S/Sgt. Elmer P. Orvis, W8VGW (first prize); CRT Bruce F. Brown, W7JBE (second prize); Cpl. H. W. Propsner, USMC (third prize); Pvt. Leigh Robartes, jr.; Lt. Lewis S. Norman, jr., W7GXR-W7CZG; C. L. Hardwick, OPLO; Harold S. Renne, ex-W8PTS; and Carl Shiffman.

The advantages of this arrangement? Constant bandspread, ease of calibration of the v.f.o. against broadcast signals, chirpless keying since the mixer tube may be keyed instead of the v.f.o., and very excellent frequency stability.

Concerning frequency stability, I expect not more than 200 cycles drift from a cold start. This drift will be constant for all bands except 28 Mc. where it will be doubled.

— Bruce F. Brown, CRT, W7JBE

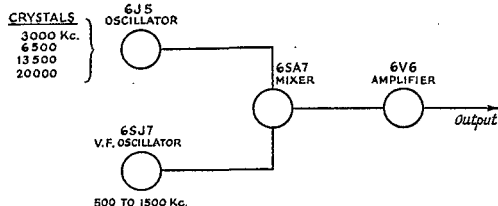

Fig. 2 — A functional diagram of W7JBE's proposed conversion exciter.

(W7JBE did not say where he is going to obtain the high-capacity variable required to give bandspread from 500 to 1500 kc. and still maintain the high-*C* oscillator necessary to provide suitable stability. — EDITOR.)

A MARINE HAS THE SITUATION WELL IN HAND

MUCH Naval communication has helped my ideas on postwar ham gear. Traffic rather than tuning "gizmos" will be my first consideration. A commercially-built receiver will fill the bill with a converter for the v.h.f. bands. A panoramic adapter is a "must"! Nothing will simplify the problem of changing frequency like that c.r. tube with the rippling c.w. sigs coming and going on that panoramic screen. I'll just pat the v.f.o. and swing my 500-watter to a reserved seat on 20 meters for my CQ. (Plenty power, eh? Sure — I'm out in the country and there will be Marines doing duty in old Shanghai again.)

A rotary beam? Yeah! Remote-controlled on top of the silo. We're going to have a "reefer" or a cold storage unit so the old ice house can be my new ham shack.

A continuous wire recorder will put out sweet-sounding CQs. An electronic bug with side tone and a keying relay with a dampener box (like those jobs they have on new relays to eliminate fuzzy dots, to eliminate chatter and bounce) will help a lot on c.w.

Voice? Certainly! Compression-modulated, push-pull 2A3s or triode-connected glass 6L6s with a compressor limiter.

A push-button crystal-controlled v.h.f. job in the car and some other devices for comfort and convenience in my ham shack will help.

Ambitious? Sure, but anything's possible. You should see the "hearing-aid" radio I use over here while I dream of fungus- and moisture-proofed

postwar rigs while my two-tube capacity-relay mouse trap keeps the rodents out of my chow and my QST's.

— Cpl. H. W. Propsner, USMC,
c/o FPO, San Francisco, Calif.

COMPACTNESS AND FLEXIBILITY

I PLAN to construct an entirely new "base of operations" when I settle down and I want to have everything as compact, clean-cut and interchangeable as possible. Rack and panel construction appeals to me both for my transmitter (and possibly a receiver or two) as well as for my test equipment. When I worked for RCA I had high- and low-voltage output jacks right on my bench. I intend to have a test panel which will include this feature, utilizing one of the tube-tester transformers with multiple secondaries and a rotary selector switch. An a.c. voltmeter will be available for ready use. This will provide a flexible, useful power source for experimental work.

My i.f. system will be built into the rack and will include provision for a dual power source (115 volts a.c. and 6 volts d.c.).

I plan on a 1600-kc. i.f. and as this presents quite a problem on the high frequencies I will include a fixed-tuned converter with 10-Mc. input and the normal 1600-kc. output, furnishing an adaptable arrangements for various v.h.f. and u.h.f. converters.

— Pvt. Leigh Robartes, jr.
Keesler Field, Miss.

SMALL BUT MIGHTY

W7GXR'S RIG must incorporate (integrally, in one cabinet, 21 × 19 × 14 inches), a 225-watt (input) phone-c.w. rig, with self-contained power supply, audio system and bandswitching on the major bands.

Perhaps you think that this rig is beyond the realm of construction. Fear not, for I have templates drawn up for my rig, which is in process of construction, and everything fits nicely. Every circuit is tried and proven. The r.f. section begins with my pet regenerative crystal oscillator, a lightly-loaded 6L6. Only one control is required for tuning and the cathode condenser needs only one setting. Any one of eight crystals is selectable by a switch, the ninth switch station opening the grid for input from an external v.f.o. The driver is an 807, capacity coupled to the 6L6; the tank coil inductance is changed by shorting out turns. The excess of driving power obtainable offsets the slight loss due to an inefficient tank circuit. The final is an 813. Three tank coils are used, one for 80 and 40, the second for 20 and 15, and the third for 10. The bandswitch shorts turns to obtain proper tank inductance.

The audio system? A 6SK7 feeds a 6N7 which feeds two push-pull 6C5s, driving Class AB₂ 6L6s. The only transformer is the modulation transformer. The 6L6s are Class B cathode-

follower coupled. The 813 is cathode-modulated. I have never used any other type of modulation, and the results have far exceeded my expectations. Two power supplies — one for the 813, 807, and the 6L6s in the audio, and one, well-regulated, for low voltage. (I like to keep the oscillator voltage independent of the p.a. supply.) I plan to run the 813 at 1500 volts, the 807 at about 600, the 6L6 audios at 350-450.

The rig fits nicely in the cabinet. The audio system is built up vertically on the left side of the cabinet, and uses about three inches of the horizontally-exposed frontage. The left end of the cabinet can be removed, exposing the "below-decks" wiring. The panel controls? Audio gain, crystal switch, oscillator tank coil switch, a Velvet Vernier for oscillator tuning, doubler band-switch, doubler tank, final bandswitch, final tank, filament switch, h.v. switch, oscillator switch, 'phone-c.w. switch, a.c. switch, and a meter switch plus a 'phone jack and a key jack.

Probably the niftiest rig y'ever heard, what?

— Lt. Lewis S. Norman, jr., W7GXR-W7CZG

OUTPUT AT 10-KC. INTERVALS FROM A ONE-CRYSTAL EXCITER

ONE device that is growing more distinct in my crystal ball is a crystal-controlled exciter, using only one crystal, yet having output on any one of the 10-kc. intervals throughout the bands.

Such a v.f.o. exciter could be a stable crystal controlling a 10-kc. multivibrator stage followed by successive selector stages at 10-kc. intervals, from 3.5 to 54 Mc. By suitable design, intervals of 20 or 40 kc. could be available above 54 Mc.

The major problem is not in the design of such a device but how to accomplish it, with a minimum of tubes and components, in a ham workshop! (Especially that 10- or 20-kc. selectivity — Editor.) Any ideas?

C. L. Hardwick, OPLO, Fort Wayne, Indiana

A POSTWAR SHOP AND SHACK LAYOUT

NONE of this junk-box haywire stuff for me after the war! My rig will be neat and professional-appearing, but it will definitely be home-made, so I can include various tricks and gadgets not included in store-bought equipment.

The major portion of my rig will be located in the attic and operated by remote control, including band-switching. In my "shack," which will be a small room on the main floor of my house, will be a small console with various controls for band-switching, changing frequency, and provisions for using either a mike or bug.

For the 10- and perhaps the 5-meter band, I will have a selsyn-driven, rotary beam antenna, with a dial to indicate the direction of transmission at all times. I will also have a large map on the wall in front of the console, with proper markings so that I can determine at all times the exact

region over which I am spraying the signal. Plate supply for the final stage will be continuously variable to provide smooth control over transmitter output. My "shop" will be located in the attic (which will be insulated!) and experiments in the higher frequency bands will be conducted from there.

Such a set-up will require lots of work and planning to put in operation, but will be well worth the effort.

— Harold S. Renne, ex-W8PTS

A UNIQUE GENERAL COVERAGE RECEIVER

I HAVE been planning my new receiver and have determined that it must have general coverage from 550 kc. to 450 Mc. as well as bandspread for the ham bands. In order to simplify the job I plan to build a common audio amplifier and power supply and to switch in either one of two r.f. sections, as shown in Fig. 3.

TO V.H.F. ANTENNAS

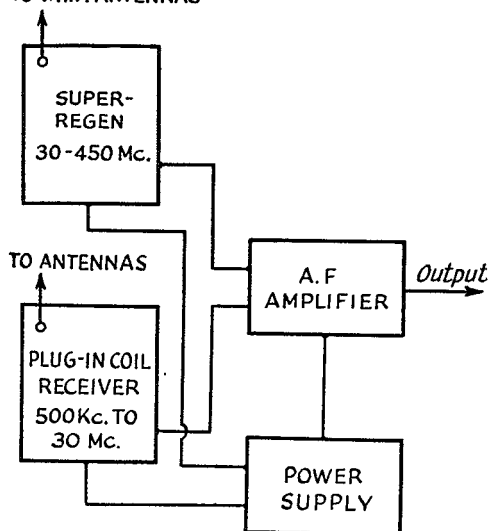

Fig. 3 — Block diagram of a proposed general coverage receiver layout. Plug-in coils will provide wide frequency coverage without complicated switching, and with high efficiency. This arrangement should prove interesting to beginners due to its flexibility and low cost through the dual use made of some components and to the "add-on" features.

An acorn superregenerative job will cover 30 to 450 Mc. with plug-in coils. Suitable antennas will be provided for the various bands.

The second r.f. section (also a plug-in coil arrangement) includes the range from 550 kc. to 30 Mc.

By careful placement of components and with adequate shielding, I can build the entire receiver on a 10 x 12 x 3 inch chassis.

— Carl Shiffman, 80 Hazleton St., Mattapan 26, Mass.

A Radio-Frequency Auto-Resonator

Automatic Remote Tuning for the Transmitter

BY PFC. JOHN F. CLEMENS,* W9ERN

HEREIN is proposed a method of remote control of an amplifier, the system requiring only one control wire. It may be applied to either a push-pull or single-ended stage and requires a minimum of equipment.

First of all, the amplifier must have gang-tuned plate and grid circuits if link coupling to the exciter stage is desired. This requirement is easily met by utilizing tuning condensers of the same plate shape in both plate and grid tank circuits. Since plate and grid impedances are of the same general magnitude and most tank circuits will be designed for a Q of about 12, tracking usually will be obtained with plate and grid tuning condensers of the same capacity.

Next, the tuning condensers must be actuated by a motor. A phonograph motor of the 1720 r.p.m. variety should serve the purpose well and provide adequate torque through a suitable speed-reduction unit. A satisfactory system should result using a 1720 r.p.m. motor with a $\frac{1}{4}$ -inch shaft driving a 3-inch dial-drive pulley which, in turn, drives a $\frac{1}{4}$ -inch shaft belted to a 3-inch pulley on the tuning-condenser shaft. This combination results in a speed-reduction ratio of 144 to 1 and produces a condenser-shaft speed of approximately 0.2 r.p.s.

*612 College Highway, Evansville, Ind.

While the idea of remote control of a transmitter is not new, the system described here is of more than ordinary interest because it requires only a single wire. It includes an ingenious scheme for automatic tuning of amplifier stages.

The "Wobbulator"

This same motor drives the "wobbulator" condenser which is the heart of the system. This condenser is in parallel with the main tuning condenser and consists of a cross-shaped rotor with crossarms about 3 inches long and $\frac{3}{4}$ inch wide. Only one rotor should be required and it might well be cut from thin sheet aluminum to reduce its inertia. The two stator plates are isosceles right triangles of aluminum of a size to fit approximately in the space between adjacent rotor arms. The condenser rotor is driven by an insulated shaft coupled directly to the motor shaft and therefore the condenser is turned at 1720 r.p.m. Because of the four-bladed rotor, it is apparent that the condenser capacity is varied from maximum to minimum four times per motor revolution, 6880 r.p.m., or 114 r.p.s. The capacitance of this "wobbulator" may be quite small

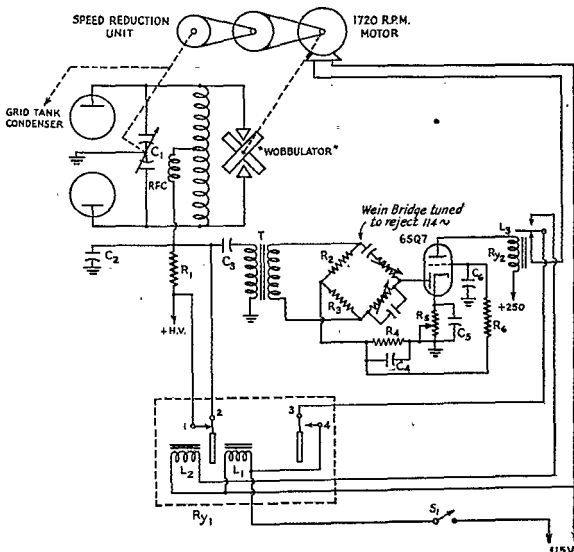

Fig. 1 — Circuit diagram of the automatic amplifier remote resonator.

- C₁ — Plate tank condenser.
- C₂ — 0.001 μ fd.
- C₃, C₄, C₅, C₆ — 0.1 μ fd.
- R₁ — 1000 ohms, approx.
- R₂, R₃ — 10,000 ohms.
- R₄, R₆ — 0.1 megohm.
- R₅ — 5000 ohms.
- T — Audio Transformer.
- Ry₁, Ry₂ — Relays (see text).

and a method of sliding the rotor on its insulating shaft should be provided to vary the spacing between the rotor and the two stator plates. Two or three micromicrofarads should be about the right variation in capacitance.

Principle of Operation

The diagram of Fig. 1 shows the complete system and the operation is explained as follows. When the push button, S_1 , which is located at the operating position, is depressed, L_1 of Ry_1 is energized opening the short circuit across R_1 . R_1 prevents off-resonance plate current from exceeding safe limits and provides a coupling impedance to be explained later. The motor also starts, since Ry_2 is normally in the "pull-in" position. The motor drives the main tuning condenser, C_1 , until the plate current begins to drop as resonance is approached. A typical graph of plate current vs. tank-condenser capacitance is shown in the drawing of Fig. 2.

Consider the instant that the tuning condenser is passing the region AB on the curve of Fig. 2. Since the tuning-condenser speed is very small compared to the "wobbulator" speed we can consider the plate current as fixed so far as variations caused by the main tuning condenser are concerned. The plate current now is modulated by the capacitance variations caused by the "wobbulator." Since the "wobbulator" varies at 114 c.p.s., a 114-c.p.s. variation occurs in I_b . This varying I_b causes a 114-c.p.s. voltage to appear across R_1 and this voltage is applied to the bandpass filter. But the bandpass filter is tuned to 228 c.p.s. and therefore blocks out the 114-c.p.s. note. Actually a simple RC Wein bridge or Hetrofil will suffice for the bandpass filter since all we need is discrimination against 114 c.p.s.

Since no voltage appears at the output of the bandpass filter the motor continues to run and turns the tuning condenser to the region of CD on the graph, or resonance.

Consider again that the tuning condenser stops in this region. The "wobbulator" still turns at 114 c.p.s. but now an important change has taken place in the plate-current variations. In passing from D to C , the I_b goes through a complete maximum-minimum cycle. This means that the I_b variations are now of twice the frequency of the "wobbulator" capacity variations and as a result a 228-c.p.s. note appears across R_1 . This note is passed by the bandpass filter and rectified by the diode section of the 6SQ7. The resulting d.c. is filtered and applied as negative bias to the grid of the triode section of the 6SQ7 causing its plate current to drop and Ry_2 to drop out. Thus Ry_2 stops the motor and energizes L_2 of Ry_1 . Ry_1

shorts R_1 , restoring full input to the amplifier. Since the motor has stopped, generation of the 228-c.p.s. signal ceases and Ry_2 will pull in again after the d.c. bias has bled off. But contacts 3 and 4 of Ry_1 have opened the motor circuit so that the motor cannot start again until the push-button S_1 is again depressed.

Complete 360-degree rotation of the tuning condenser is necessary and usually is the rule with transmitting tuning condensers. Inertia of the system should be kept as low as possible so that the motor will stop "dead" when power is removed. A magnetic brake may be incorporated if necessary. The final tank will be somewhat detuned depending upon the position of the "wobbulator" rotor when it stops, but this detuning should be negligible since the I_b variations caused by the "wobbulator" may be of the order of 1 per cent or so of the average plate current. A stage of amplification for the 228-c.p.s. signal before rectification will make possible extremely

small values of I_b variation. The system must not be made too sensitive since the distorted wave-shape of the I_b variation may contain a second harmonic component even in the AB region. The sensitivity control in the 6SQ7 cathode varies the no-signal bias.

Ry_1 is a locking relay which locks in either position and has separate actuating coils. It is a standard item manufactured by Potter and Brumfield Co. Ry_2 is a common garden-variety of sensitive relay with a 1000-ohm coil.

Since a connection to the 115-volt circuit will be necessary at the remote-amplifier position for filament heating, a single wire may be run from the push-button to the amplifier, utilizing the filament-supply connection as the other side of the remote-control circuit.

In operation the exciter is tuned to the desired frequency, the push-button momentarily depressed and the final plate voltage applied. The final amplifier resonates itself with the exciter and is ready for operation or another frequency shift.

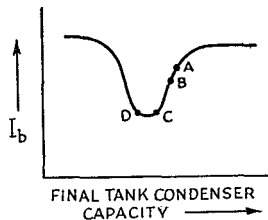

Fig. 2 — Graph of typical amplifier plate current as tank circuit is tuned through resonance.

Strays

Western Electric's portable Beachmaster announcing system generates a sound level of speech of 116 db. above standard reference level at a distance of 30 feet from the loudspeaker. When the microphone is talked into in a normal voice, the amplifier delivers 250 watts, the major portion of the energy being radiated in a 50-degree cone. Sounds as though it might get out a little better than we've been doing on two meters recently.



CORRESPONDENCE FROM MEMBERS

The Publishers of *QST* assume no responsibility for statements made herein by correspondents.

HAMS IN THE 20TH

Communications Section, Hqs. 20th Air Force, Guam Editor, *QST*:

The September issue of *QST* has just today come to my attention. It happens that recently I have given some thought to the subject of KBW's editorial on the newcomers, although when I first started thinking about it the emphasis was not on the newcomers, but on unorganized amateurs in general.

One of his questions was, "What are we going to do to get the radio-trained veterans of the armed forces into amateur radio?" There are two phases to this problem that may be successfully exploited. One centers around organizing these fellows while they are still in the service; the other is concerned with organizing them after they have become civilians again.

Late in September, when the 20-meter bootleggers got going, it occurred to several of us that we should immediately organize the amateurs of Guam for the benefit of all concerned. Exchange of information, unity and therefore strength of purpose, and emphasis upon good behavior and preparation for authorized operation and preventing bootlegging by pressure of amateur public opinion were some of the advantages to be realized. And they are being realized.

Through mimeographed notices and by announcements over the local Armed Forces Radio Station, WXXI, which has been extremely cooperative in broadcasting for us, we invited all those interested in amateur radio to meet in the Twentieth Air Force War Room. There have been several such meetings now, and they have served to get the ball rolling. It is evident from attendance at these meetings, running about 125 each, that there are on Guam at least 300 and possibly as many as 500 men, representing all the services, anxious to take an active part in amateur radio activities now while overseas.

The surprising thing to me is that about half of these fellows are newcomers to the amateur ranks, ranging from the greenest to those whose service training has prepared them to take the exam immediately. The green ones are generally those who have had an interest but not the opportunity to develop it. Some newcomers are practiced operators who need instruction in theory. We plan to accommodate them all.

Five chapters of the Twentieth Air Force Amateur Radio Association, sponsored by the Communications Section, are being formed on Guam by organizations related in a military fashion to the Twentieth Air Force. At least six other major groups are also organizing, and a few of these are expected to be chapters of the Association too. Our meetings are always open to everyone. All this is serving to prepare the old-timers and the neophytes alike for resumption of legitimate overseas amateur activities. Our headquarters chapter has acquired two quonset huts for operation rooms, shop, code practice room, library and administrative office, two 10 kw. power units for our own independent supply, 15- and 50-watt transmitters for crystal controlled operation on 2½ meters, receivers, automatic tape sending machines, and this is only the beginning. We shall present instruction in theory and code, and shall transmit on 2½ meters for code practice three times a day for an hour at a time.

What I have just described could be repeated in countless places overseas, by any ambitious hams who have ham interest at heart. With the let-down following hostilities, all agencies are anxious to cooperate to the fullest in promoting a project that provides recreation, maintenance of proficiency, instruction of newcomers, message service and voice contacts (eventually) between service men and their folks in the States. KBW, in speaking of the newcomers, says, "No,

there is no way we can reach any appreciable percentage of these men while they are still in the services." For Guam, anyway, this is not so. We are reaching them. And they can and should be reached in the same way at other places.

The editorial's proposals for organizing the fellows after separation from the service sound pretty good to me. I am sure there is a lot to be gained by the creation of attractive literature by ARRL for the use of clubs in contacting and interesting these people. Speaking for myself, I hope to be influential in rounding them up for whatever amateur club already exists in my locality of Alexandria, Virginia, and if there is no club then we shall form one just as we did here.

With the expanded amateur population an expansion of ARRL activities in the form of ARRL clubs is certainly in order and I am for it. There will be those who will accuse you of empire-building, but you cannot expect everyone to favor the idea. Such a club's direct official connection with ARRL headquarters would have psychological and real advantages for the individual member and it should be possible for ARRL to better serve the amateurs by having this closer connection with their "public opinion." These factors are particularly important in the transition period upon which we are entering now.

From my experience here on Guam I can say that if a call is sent out for those who are interested in amateur radio, there will be a gratifying number of responses from veterans eager to participate in amateur radio on an orderly, organized basis.

In closing let me make it clear that, although I am acting Chairman of the Twentieth Air Force Amateur Radio Association pending the election of officers in the very near future, the opinions expressed above are my own and not necessarily those of the Association.

— Major Melvin L. Jackson, W3AIM

LIBERATION

Hoten P.O.W. Camp, Munden, Manchuria Editor, *QST*:

Greetings to the gang from the Far East! I have been a "guest of the Emperor" for 3½ years, having been captured on Corregidor in May, 1942. I served in P.O.W. camps in Philippines, Korea, Japan and Manchuria. I hope to be home soon and to contact the gang on 10, 20, or 75. Also here are W6CVR, XZ2TM, W5HBX, W5EOJ, W7HQM and ex-W5AEX.

— Lt. Marion W. Taylor, USN, W9ALD

FAREWELL AND HAIL!

116 New Montgomery St., San Francisco, Calif. Editor, *QST*:

The first shall be last and the last shall be first, as the old saying goes. On December 7, 1941, I was in QSO with W5CEW of Shreveport, Louisiana, when I received word of the Jap attack. I passed the news on to CEW and cleared with the unusual signoff that we were both leaving the air. This contact was confirmed by QSL cards as our last contact before the recess.

This morning at 7:00 A.M. PST before leaving my home in Menlo Park, I fired up the rig and tuned on ten meters. W5CEW was calling CQ! I called him and we had a twenty-minute QSO. It was his first and my first ten meter contact after the reopening of the bands by the Federal Communications Commission. . . .

— Geoffrey Almy, W6TBK

HAMS IN OWI

c/o U. S. OWI, APO 290, New York, N. Y.

Editor, *QST*:

Considering myself sufficiently recovered from my recent strenuous activities, I thought you might like to hear about them.

I am employed by the OWI as an operator and technician, serving in the China Theater. In the midst of a very important mission, the Nips capitulated; I was therefore ordered to Chihkiang from my setup in Yuanling, to handle all press resulting from the preliminary surrender negotiations. These negotiations were attended by a large number of correspondents. The whole deal, setting up the BC-610 transmitter and the operating, was done by yours truly, *all alone*. I sent manually one day down there for twenty-one hours straight. From Chihkiang, I was ordered to Nanking for the final unconditional surrender. I finally managed to get transportation, practically occupying a C-46 with all the equipment I had along. We circled Chihkiang for a half hour getting altitude!

Arriving at Nanking four hours later, you can imagine my surprise when we landed and were surrounded by armed Japs. It seemed to be all right, though, because they immediately set to work unloading the ship, with gusto. The only thing that went wrong was my pet generator which they dropped from the C-46 while trying to get it on a truck. It weighs only seven hundred pounds! It wasn't damaged, fortunately. I finally got going in the Nanking Hotel, guarded by the few Chinese commandos who managed to get there for our protection. There were seventy thousand Japs in Nanking!

The big show is over now, but my fist is somewhat tired. I handled all the press and there was plenty. I have a drawerful of it as souvenirs all cleared to Chungking for retransmission Stateside and elsewhere.

I thought you might like to know about this because it was done by one ham, all alone. I don't care about the credit myself, but I think amateur radio should take credit for it. I received an Army commendation for the work at Chihkiang and another "possible" is in the offing for my work here, from theater headquarters. . . .

— David Sutherland, W2N1H

AP0 500, c/o Postmaster, San Francisco, Calif.

Editor, *QST*:

Enclosed you will find my Amateur War Service Record slip. I joined OWI in September, 1944, entering duty at San Francisco. After a six-weeks course conducted by OWI to teach methods used in the field, in the first week of December, 1944, I left San Francisco on the Liberty ship *Isaac Van Zandt* bound for the island of Leyte. However I never reached there as for military reasons the ship was diverted to Finchhaven, New Guinea, and her cargo discharged there. I went ashore with the 35 tons of radio equipment I was accompanying and in charge of. I spent the next two months in New Guinea awaiting the first available ship which would carry me on to Leyte. The war, however, moved on faster than I did, so by the time I was able to get transportation out of New Guinea my destination had been changed to Manila, which had just been liberated. I arrived in Manila on the *John Isaacson* after traveling sixteen days in convoy. Manila was a city of rubble and destruction with fighting still going on on the outskirts; it was common to hear artillery fire and bombing daily. This was in the latter part of March.

Around the last of April, Gerald Coleman, W8FRC, of Butler, Pennsylvania, and myself put the first KZFM transmitter on the air, a 50-watt type which remained in operation until September 10th when the present KZFM transmitter went on the air on a regular schedule. The transmitting site is at Polo, Bulacan Province, about seven miles north of Manila, and the temporary buildings are built on the blasted foundations of a former Manila b.c. station KZRM. The equipment here which I brought out with me from the States is the latest type of broadcast transmitter which uses two air-cooled 5-kw. tubes in the final in a high efficiency Doherty circuit. My operating personnel consists of three Filipino radio operators and two Filipino diesel en-

Our power is derived from a 50-kw. diesel plant with a 25-kw. gasoline plant as standby. Also occupying the same site and using the same 192-foot vertical radiator is AFRS radio station WVTM. We operate on a frequency of 710 kc. and WVTM on 1300. Incidentally, the first KZFM transmitter which we operated in Manila was the first American broadcast station in the area since the Jap occupation and the present KZFM is the only non-army broadcast station to be heard in the Islands at the present time. . . .

I have been a member of the League ever since I have been an amateur. I am anxiously awaiting the day when we can all get back on the air and renew our friendships of the past. Amateur radio has always been to me a bond of good fellowship as well as an educational pastime. Hoping to see you on the air soon — perhaps from here in the Philippines — I remain as ever an ardent amateur.

— John H. Thatcher, W7AAJ

REFUGE IN SM

Stockholm, Sweden

Editor, *QST*:

It was really long ago when I had my last QSOs with the W boys over there. And during this time quite a lot of things have happened under the Heavenside. Anyway, I think that I have the reasons to congratulate you for the victory of the democracies.

As you may already have discovered, I am a former Estonian ham, ES6E. I left Estonia in summer, 1942, and tried to get over to Sweden. Sorry enough I didn't succeed on my first trials and had to stay in Finland where I did some radio operating for our underground movement. But the Nazis did succeed and thanks to some guys I would like to meet in the dark I had to spend 5 months in a prison camp. In September, 1944, I came over to Sweden and have borne my title of political refugee already over a year.

I got a job at John Lagercrantz', SM5SV, who is the representative of Hammarlund, Hallierafters, National and a lot of others. I work as a radioengineer and have lot of fun with police f.m. sets. With me here in Sweden are ES3C, ES3D, ES6C, ES5E and maybe some more kids, whose calls I don't remember.

During the first occupation were deported to the east ES2C, ES7D, ES5F, ES4D, ES1E, ES8E, ES3F, ES4G and several others. ES8D has closed his eyes forever. We haven't had any contact with ES now and don't know what the other fellows are doing.

Please, if possible, QSP my vy best 73s to W2AVO, W2GRG, W1KQY, W9EMB, K4FCV and K7EVM. These are the ones I remember just now, as I am without my log-book and QSL cards. Yes, 73s to W8TBY, too — I met him here in Sweden. Well, this seems to be all for this time. Many thanks for your excellent *Handbook* and *QSTs*, which did help us in our work during the dark and hopeless days. My best wishes to you and every U. S. ham.

— Ulo Vilms, ex-ES6E

RADIATION RANGE

801 8th Ave., Fairbanks, Alaska

Editor, *QST*:

"It Seems to Me," that K.B.W. didn't give the whole truth in his inventory of effective bandwidths editorial. We still need more frequencies on 20 and 40 meters than on 80 meters to accommodate a given number of amateur "channels" due to the difference in radiation range between high and low frequencies.

The 80-meter band can accommodate many more amateurs for average conditions than can the same band width on 20 or 40 because an amateur on 80 meters can, most of the time, share his frequency with several other amateurs in remote parts of the country and not even be aware of the fact.

The FCC takes into consideration radiation range when assigning commercial frequencies, and on the broadcast band there are stations on the same frequency with no ill effects except in rare cases where the b.c. receiver is located in an exceptionally good locality for reception.

— Fred B. Tintinger, W7EGN/K7

WARSAW REPORT

Warsaw, Poland

Editor, *QST*:

Years of bad and dreadful war have passed, in which Poland was badly touched. During this war many of our OMs were killed. We are sending our first greetings from the ruins of Warsaw. After liquidating the revolution during the months of August and September, 1944, the Germans systematically burned street by street and only about 15% of the town is left. Most of our members have lost everything and have no place to live. We are starting now from the beginning. There is lack of everything. We have no radio literature, handbooks, catalogs, receivers, measuring apparatus.

The headquarters of the Polish P.Z.K. in Warsaw were completely destroyed during the 1939 distress. We have lost all our files, documents, etc., as well as all of our equipment which was gathered by us for years. Our private equipment was confiscated by the Germans. Several of our members were killed by execution by the Nazis. Detailed literature which is being prepared will pass into history.

The undersigned is the secretary of the Polish Radio Relay League and, SPIAF, Roman Kitzner, is member of the board of directors. We are planning to organize again the P.R.R.L. in Warsaw. We have contacted the remaining members of the P.Z.K. and will organize the first meeting.

Any help received from the American amateurs will be greatly thanked by the Polish amateurs. This can be arranged through the UNRRA. The undersigned are at present engaged in working for the Polish Radio and all correspondence can be forwarded as follows: c/o Polskie Radio, Wydział Techniczny, ul. Marszałkowska No. 56, Warsaw, Poland. Hoping to hear from you soon, we are sending our best greetings and regards to you and to all American amateurs from all remained Polish amateurs and remaining with 73.

— Roman Kitzner, SPIAF
— Mieczyslaw Kapczynski, SP3AE

POWER SQUADRONS

707 Sheridan Rd., Evanston, Ill.

Editor, *QST*:

In October *QST*, page 87, I found a familiar face and name, Lt. Clarence M. Cobb, USCGR, right in the middle of the radio sealing unit group photo. It might interest you to know that he is also in the U. S. Power Squadrans known as Past Commander Cobb, of Boston Power Squadron; perhaps you do, already.

When war hit, the squadrans, which are very much of the same sort as the ham organizations, jumped into training and reviewing with Naval reservists and newcomers. Where hams helped on the radio end, the squadrans pitched in on the boat handling and piloting and navigation. Maybe that, also, has come to your attention. Here are two national organizations, made up of men who liked their respective hobbies, which were more than hobbies, well enough to be versed technically. It certainly makes one feel good to know that in this country we do things like these.

Recently I wrote Walter Juettner, editor of the USPS "Ensign," asking him if he would discover if we had hams enough in the various local squadrans to bring out a good signalling course for them to use. We already have a course, but ops can teach it better, I feel. Do you know of the number of boating enthusiasts among the hams? It might be interesting for each organization to find out its opposite numbers.

— Temple Nieter, W9YLD

CQ DE SM??

Vasaplatsen 6, Gothenburg, Sweden

Editor, *QST*:

I am writing . . . wondering if you can give me the address of a young American amateur fitted with a transmitter capable for connection over the Atlantic. I am twenty years old and studying for the electronic engineer examination.

Here in Sweden the government took our transmitters at the beginning of the war but we have been promised that amateur radio will be free as before the war. Our radio regulations were almost exactly copied from your FCC regulations. The date when the "ban is off" is October, 1945. I am intending to build a transmitter with 50 watts output. It is almost impossible to get xtals here in Sweden, so I have to use an e.c. oscillator, driving a pair of 6L6GX, the tube of which is manufactured by Swedish factories.

— Hans Haglund

CAPTURED GEAR

APO 403, c/o Postmaster, N. Y.

Editor, *QST*:

I just wanted to let you know that in reading W5JSU's letter, "The Challenge Above 200 Mc." in the July *QST*, his comments are my sentiments also. And that T/Sgt. Russel McChee, W8RMU, and I have picked up some very good captured German equipment while we were in our travels. We hope to put some of it on the bands when we get on again. Some of the equipment came from radar and electronic devices, and some of it goes down to the 1000-Mc. bands. The tubes that they use are quite strange to ours, though we have been able to get most of them to operate and have sent some home.

I was wondering if someone can't write up a couple of articles describing some of these German sets and maybe doing some research with it. We have a large supply of all sorts of tubes and parts from a complete band switching and m.o.p.a. transmitter to a 1.5 kw. r.f. amp section. Well I guess we will have to wait till we can get back to our old shacks and start fooling around our findings so, 73 for now and CUL OMs.

— Sgt. R. R. Schellenbach, W6TKX

W4FYP/J

Tokyo, Japan

Editor, *QST*:

I'm now located in Tokyo living in true "fat-cat" style in one of Japan's best hotels — the Dai-iti in downtown Tokyo. The 68th AACG Gp. has its Hq. just across the street from the emperor's palace. Plenty of hams are up here: the 68th Gp. is commanded by a ham, Col. Guy H. Rockey, W3HZU. Maj. Ralph W. Kiser, W4FYP, Maj. Glenn D. Montgomery, ex-W6XEG, Maj. R. G. Martin, all hams, are members of Col. Rockey's staff. W/O Palmer at our AACG station WUQT at Atsugi airfield and M/Sgt. J. Wingle, W8OSL, are two old timers with us. We can practically have a hamfest in our own Hq. There are many more hams here in Japan and throughout the Pacific and all of them have done an excellent job for the AACG.

Our immediate problem is to set us up a ham station here in Tokyo. The Signal Section of GHQ does not have any information on the subject. We thought that when the FCC does let hams come back on the air the ARRL could put a little pressure on top-side Washington to let us have a station. Information on ham activities is very limited over here. It would be quite a thrill for us to talk to the states after all the time spent on the islands and I imagine the boys there would like to have some "Tokyo Victory" QSL cards. Mail is so bad that our *QST*'s are very old when we get them. . . .

My hotel is just across the street from Radio Tokyo and I went over and had a look around the other night. It is quite a fancy set-up with plenty of studios that look as nice as those in the States. They have a network of stations on regular broadcast frequencies and also several short-wave channels. Our Tokyo Armed Forces Radio Station is also located in the same building.

— Major Ralph W. Kiser W4FYP

(Error's note: Temporary "amateur" operation by members of the armed forces in foreign countries seems to be exclusively under the jurisdiction of the military theater commander or the communications officer on his staff.)



STRAYS



"A lot of traffic will drive an operator to desperate action," wrote W9KZD in a letter accompanying the photograph of his hand-made bug. This key, built in Burma by motor-pool friends of W9KZD incorporates a lot of otherwise useless bits of junk into a genuine "splatter-

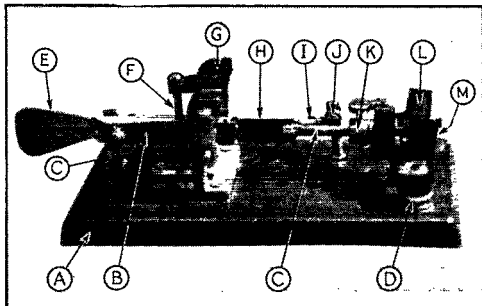

gun." The source of the material is as follows: *A* — Armor plate from Jap tank, *B* — Rocker arm from Jap hand key, *C* — Brass welding rod, *GI*, *D* — Binding post from Jap telephone switch-board, *E* — Piece of a Jap Zero's wing, *F* — Nail, *GI*, *G*₂ — Brass parachute buckle, *GI*, *H* — Spring from a Jap rifle ammunition clip, *I* — Piece of a C-Ration can, *GI*, *J* — Contacts from Jap relay, *K* — Bearing from Jap hand key, *L* — Piece of Jap bakelite coil form, *M* — Piece of Jap artillery shell. Coil springs, not shown, were made from strands of steel field telephone wire.

A new development in radio-telephony was demonstrated by the Federal Telecommunication Laboratories. The development, known as Pulse Time Modulation, produces a system whereby twenty-four or more conversations can be carried on the same radio frequency simultaneously without interference with each other.

The PTM demonstration was conducted from the I.T. and T. Building in New York, from which the PTM transmissions were beamed to a repeater station at Telegraph Hill, northwest of Red Bank, N. J. From there the signals were beamed to a second repeater station at the new Federal laboratories at Nutley, N. J., and thence back to the top floor of the building in New York. Federal engineers stated the circuit could be 8,000 miles long, or more, and still maintain the same quality of transmission. Repeater stations are required at intervals of approximately 30 miles along the 1300-Mc. circuit.

The PTM system "chops" the conversation up into small bits and fits them back together again at the point of reception. The pulses are so rapid

and the bits of conversation fitted so compactly in time intervals that when they are filtered at the receiving end and each conversation is re-integrated, the human ear is incapable of detecting the process. A faithful reproduction of each of the twenty-four speakers' voices is produced, each one being selected automatically for the receiving station individually called. The key to the filtering process is the Cyclophon tube, developed by the Federal Telecommunication Laboratories. The audible results which PTM presents to the ear are comparable with visual effects which the motion picture presents to the eye. Although the screen in a motion picture theater is completely dark much of the time that a film is being shown, the eye is not quick enough to detect the dark intervals. The effect of PTM on the ear is reported to be as flawless as the effect presented to the eye by the modern movie.

The National Association of Broadcasters announces that the Broadcast Engineering Conferences will be resumed, with the 1946 meeting to be held at Ohio State University in Columbus during the week of March 18th-23rd. This is a continuation of the annual conferences held from 1938 to 1942. The conferences will again be held annually, and the place of meeting will alternate between the campus of Ohio State University and that of the University of Illinois. Emphasis in the program for the forthcoming meeting will be placed on the impact of developments since 1942 on operating problems in broadcast engineering, including FM and television. Further information can be had from the director, Dr. W. L. Everitt, University of Illinois, Urbana, Ill.

Bill Dufendach of Kokomo, Ind., compiled these informative solutions to one phase of a ham's life:

- If she wants a date — meter.
- If she wants a call — receiver.
- If she wants an escort — conductor.
- If you think she's picking your pocket — detector.
- If she goes up in the air — condenser.
- If she is slow of apprehension — accelerator.
- If she wants chocolates — feeder.
- If she is a poor cook — discharger.
- If she eats too much — reducer.
- If she is wrong — rectifier.
- If she fumes and sputters — insulator.
- If she is narrow in her views — amplifier.
- If her way of thinking is not yours — corrector.
- If she wants to be a humorist — eliminator.
- If she wants a date — can you resistor?



OPERATING NEWS



F. E. HANDY, W1BDI, Communications Mgr.
E. L. BATTEY, W1UE, Asst. Comms. Mgr.

J. A. MOSKEY, W1JMY, Communications Asst.
LILLIAN M. SALTER, Communications Asst.

Happy New Year. 1945 proved a milestone in amateur radio. World War II moved to a swift climax; our frequencies were opened ahead of anything known at the end of World War I. The year ends on a rising tide of FCC orders and amateur operating on several bands. 1946 should prove a year that offers twelve full months of opportunity for amateurs. We look forward to (1) the opening of more amateur frequency bands to our normal uses, (2) ARRL operating announcements and activities, and (3) progress of the ARRL Emergency Corps¹ in its mission of setting up provisions for emergency radio service at many points. This promises to be the most important postwar amateur-organized activity. Is your station aligned with the Corps?

Get Acquainted with Your EC. If you know the Emergency Coördinator for your community or Section, ask him about the plans for offering an amateur radio emergency service to the area, projected tests and drills, his planning group, possible use of h.f. and v.h.f. stations, and the like. He should be able to tell you about progress on liaison with civic or other local officials, prospect of early amateur meetings, progress of amateur station and operator registrations in the ARRL Emergency Corps, and so on. Ask him for one of the new AEC application forms for indicating your facilities and interest in joining the Emergency Corps.

In the event that you do not know how to get in touch with the EC, drop a line to the SCM whose address you will note on page 8, this *QST*. If you know definitely that no EC has been appointed drop the SCM a line anyway, telling about your locality, its past and future likelihood of natural disaster or other contingency developing to require communications. Suggest names and radio facilities to help him (or his representative, the Section Emergency Coördinator) in recommending a man with judgment, time, and initiative, who will inspire the confidence of amateurs and community or other agencies served, alike, in organizing a strong successful local chapter of ARRL's Emergency Corps.

28 Mc., For DX, RCC, and Traffic. As the band most adaptable to several kinds of amateur interest of those presently opened for amateur occupancy by the FCC, the 28-29.7-Mc. band at

this writing is already on its way to a very full use by all classes of operating amateurs. The band is full of surprises. Contacts are surprisingly good. There's pleasure in them, whether for DX, rag-chewing or traffic handling. Results are predictable or the band may turn up the unexpected. See "How's DX," resumed elsewhere in this issue, for the detailed account of band doings to date, and the best suggested times for long distance use of the band for the weeks immediately in the future. The tremendous potentialities of a small rig, and low power, on this band, make it a "must" for every amateur. We'll see all of you there, sooner or later.

Temporarily 28 Mc. has to substitute for the lower frequency amateur bands, where we need night and day communicating ability for Section-wide and larger emergency-area coverage, and other uses. While not the optimum band for all purposes, choice of time-for-distance, and greater use of *relaying* to get messages back to stations within our skip zone that we cannot ourselves hear, will add measurably to what can be accomplished on special jobs.

Traffic Prospect. SCMs are to start listing summaries at the end of their station activities in *QST* of all ham traffic handled by stations of their Section. Even a single message sent or received through your station deserves a report of station activity to the SCM. He will be glad to have a report of your results, all station activity, and any traffic. Give him a postal card on the 16th, covering the preceding 30 days. This will give him your information for his news and aid the Section standing.

Uncle Sam has recognized the training and morale building possibilities of GI-amateur work in ETO (see editorial December *QST*) by setting up a limited licensing arrangement for GIs. This permits message communications, under certain limitations, between four-letter "X" stations in that one theater. Few X-stations have thus far been reported just subsequent to Thanksgiving but we hope to see more developments in this direction, even if time, frequency and power limits continue to apply. Remember the days of traffic skeds with KAs, K5s, NYs, etc.? The opportunity for training and morale-building traffic handling over amateur circuits is as attractive as ever it was. The shipping and mail delays, uncertainties and bottlenecks that frustrate the G.I., his unaccountably long separation from home,

¹ See "ARRL Emergency Corps Program," page 49, December '45 *QST*, for detailed plans, functions and operating diagram of this organization.

can all be broken by the G.I. ham himself and willing amateur traffic workers here at home. But it is up to the military to broaden G.I.-amateur authorizations and issue more of them to permit communication with continental U. S. A. and between theaters on satisfactory frequencies, if we are to more fully realize these possibilities. This is a top value job that amateur radio can and should be performing. Action by the military is required.

Speaking of traffic, W9EKK is believed to have sent the first traffic (Omaha to Lincoln, Nebraska) September 14th on 112 Mc. See Nebraska report, November *QST*. Here's a poser for operators who took part in or observed our amateur-radio reopening. Following our reactivation *what amateur stations were first to handle record traffic on the other amateur bands? On 144 Mc.? On 56 Mc.? On 28 Mc.?* Tell us about it, and let's see who was the first to use the bands these ways, just as a matter of editorial and historical interest. Oh, yes, who has a regular traffic sked on 28 Mc. or other bands? Tell us or your SCM about it. 'Tis Operating News.

About Reactivation of ARRL Appointments. All ARRL appointments except EC and Emergency Corps posts were suspended following Pearl Harbor. The CD looks forward to lifting the suspension of normal activities under these appointments, as soon as the return of more amateur frequencies, and reports via SCMs indicate sufficient readiness and interest to permit formal organization activities on a broad or national scale. The OBS appointees have already been restored to a normal status in order that they might transmit FCC and other information to amateurs. The function of ARRL Official Observers is to make helpful warning advices available to all amateurs. Data on their availability and equipment for currently used bands are being surveyed at this writing. It is expected that a selective restoration of the appointments of all OOs that can assist other hams by their operation, will be made at an early date.

ORS, OPS, RM, and PAM appointees. You are requested to drop a card to your SCM indicating the status of your stations. If not operating currently, please indicate when you will have completed rebuilding operations that may be in progress or when you expect to resume. If now active, indicate frequency used, days of operation and any other pertinent data. With the mid-January reports, Section Communications Managers are asked to indicate the number of ORS and OPS heard from in this manner. This is in effect a "roll call." The result will determine whether plans for a selective or a broad resumption of activities, or changes in the set-up for these appointees will be in order. How many ORS/OPS are at old home addresses? How many are operating now? How many awaiting the green

light from FCC on the lower-frequency amateur bands before starting amateur station operation?

Operating News Items. In the next few pages this department presents the currently available reports of national or general interest that concern amateur operating. Your assistance is requested in sending to *QST* information on operating events, activities, stories, briefs, oddities, etc., that may come to your attention in the course of your amateur operating. These may concern 'phone or c.w., high or low amateur frequency bands, DX, traffic or rag-chewing activity, fixed, portable or mobile operating, normal or emergency work, good or bad technique. Any and all articles pertinent to amateur radio operating will be welcomed and given consideration for appropriate use. There's plenty of action in progress in the amateur bands today. National highlights, exemplary operating, good procedure, public or private service performed by amateur radio, all can be discussed in these columns. Keep the operating news items rolling our way, please. We'll try to give you as well balanced a presentation of all that's doing as possible through 1946!

— F. E. H.

WIAW Operating Schedule

Bulletins

Official ARRL Bulletins containing latest FCC information relating to amateur operation and reactivation, and other bulletins on matters of general amateur interest are transmitted on regular schedules, as follows:

Frequencies: 3555, 7145, 14,280, 28,245 and 56,968 kc.

Times: 8:00, 9:00 and 10:00 p.m. EST, Monday through Friday.

Starting on the hour, simultaneous c.w. transmissions are made at 15 w.p.m. Telegraph transmission is followed by voice transmission on each of the above frequencies, except that 28,245-kc. transmissions are not made when the band is not open.

Radio Code Course

A University Extension course in radio code will start January 23rd under the auspices of the Massachusetts Department of Education. Classes are to be held in the Girl's Latin School at Boston Teachers College, from 7:15 to 9:15 p.m., Wednesdays and Fridays. Sylvester J. Connolly, W1MD, is instructor for the sixteen-session course, which is designed for those wishing to prepare for amateur operator license examinations, for Short Wave Listeners who wish to learn the code, and for those who already know the code but need a refresher. No previous knowledge of code is required. Basic instruction will be in code reception, although instruction in sending and proper operating procedures is included.

New Article Contest

In previous issues of *QST* we have invited contributions of "Ham Yarns" — stories of unusual happenings in ham operating. These were based on prewar contacts. Now that we are back on the air our interest is centered on what is taking place in present-day amateur radio. We are discontinuing the Ham Yarn type of article and instead inviting articles of general interest on postwar activities.

The best articles will be used in *QST*, one each month, and the writers may choose one of the useful prizes listed below. All articles should contain approximately 500 words.

There is an almost limitless variety of subjects. Perhaps you would like to write on Emergency Corps planning work and drills; 'Phone or c.w. operating procedures; working on radio club committees; organizing or running a radio club; the most interesting band (h.f., v.h.f., s.h.f., or what have you); code proficiency techniques; traffic work; DX activities; getting the most out of ham radio; or some other subject that rings the bell with you. Articles will be judged on originality and value to the whole ham fraternity.

Each month we will print the most interesting and valuable article. Please mark your contribution "for the CD Contest."

Prize winners may select a bound *Handbook*, *QST* binder and League Emblem, log books, or any other combination of ARRL supplies of equivalent value. Send as many entries as you wish. Try your luck!

Meet the SCMs

Much of the credit for the reappearance of Southern Texas in the Amateur Activities column belongs to J. B. Rives, W5JC, a well-liked fellow with a practical slant on things, who recently was elected to the SCM post for his section. Born in San Angelo, Texas on May 14, 1908, Mr. Rives completed his education at St. Mary's University, San Antonio. After a three-year interest in amateur radio he obtained his license in 1923 and was issued 5JC, now W5JC. Evidence of his ability as an operator is shown by the fact that he has won several DX Contest prizes and in 1935 walked off with first prize in the Radio Lab Contest. A real



high-power fan, 'phone and c.w., W5JC is well known for his DX to the Byrd Expeditions at the South Pole and to South American hams. Previous to his present occupation as associate course chairman of the radio code and communications division, San Antonio Aviation Cadet Center — Ground School, he was employed as monitoring officer of the Radio Intelligence Division, FCC; did radio sales work for Straus-Frank Company of San Antonio; and for a number of

years conducted his own radio service shop. Much commercial radio experience was gained by his work in the San Antonio Police Radio Department and at broadcast stations

KABC and KMAC. A past-president of the San Antonio Radio Club, he has been very active in the association's convention and hamfest activities. Some well-known ham stations have been built by him, the most notable being W5HDK, a deluxe prewar kw. outfit in San Antonio. W5JC now has a rotary beam on a telephone pole and separate ham shack underneath. Amateur radio is his only hobby; for recreation he indulges in bowling, fishing, and golf. Jim is doing a fine job as SCM and deserves all the cooperation the Southern Texas gang can give him.

PRESS SCHEDULES

The following list of press schedules has been compiled for code practice purposes. As these schedules are subject to change without our knowledge, we would appreciate knowing of any changes in the time or rate of speed of these transmissions or any additional stations transmitting code so that we may revise our list from time to time. The contents of these messages must not be divulged to anyone other than the addressee. PLEASE DO NOT USE THESE TRANSMISSIONS FOR ANYTHING BUT CODE PRACTICE.

Time (GMT)	Time (EST)	Call	Frequency (kc.)	Origin	Speed
0000	7:00 P.M.	WCX	7,850	New York	35
0000	7:00 P.M.	WDD/WHL	7,510/10,750	New York	35
0000	7:00 P.M.	WEV	7,730	New York	35
0000	7:00 P.M.	WQW2	5,270	New York	35
0030	7:30 P.M.	WBG3	7,340	New York	30
0030	7:30 P.M.	WBG7	7,620	New York	30
0030	7:30 P.M.	WCL/WBG7/WBG3	9,390/7,620/7,340	New York	30
0030	7:30 P.M.	WCX	7,850	New York	35
0030	7:30 P.M.	WJS	15,700	New York	35
0050	7:50 P.M.	WHI	7,955	New York	35
0100	8:00 P.M.	WDD	7,510	New York	30
0100	8:00 P.M.	WHL	10,750	New York	30
0100	9:00 P.M.	WCDA	7,830	New York	30
0200	9:00 P.M.	WCO	6,450	New York	13
0200	9:00 P.M.	WGEX	7,000	New York	30
0200	9:00 P.M.	WLWR	6,370	New York	30
0200	9:00 P.M.	WRUX	5,935	New York	30
0300	10:00 P.M.	WLWR	6,370	New York	30
0315	10:45 P.M.	WCD2	5,352	New York	35
0400	11:00 P.M.	KROX	9,890	San Francisco	30
0400	11:00 P.M.	WPJ	11,640	New York	30
0500	12:00 A.M.	WEE	6,920	New York	30
0500	12:00 A.M.	WHD	8,350	New York	16
0500	12:00 A.M.	WHI	7,955	New York	30
0900	4:00 A.M.	KFS	6,250	San Francisco	25
0900	4:00 A.M.	KMH	8,350	Los Angeles	16
0900	4:00 A.M.	KROX	9,890	San Francisco	30
0900	4:00 A.M.	KROZ	5,980	San Francisco	30
1200	7:00 A.M.	WCW2	15,852	New York	30
1200	7:00 A.M.	WCX	7,850	New York	35
1200	7:00 A.M.	WJS	15,700	New York	30
1200	7:00 A.M.	WLWR	12,967	New York	35
1215	7:15 A.M.	WHI/WPU	7,970	New York	25
1230	7:30 A.M.	WKO	15,970	New York	35
1400	9:00 A.M.	WCW2	15,852	New York	30
1400	9:00 A.M.	WHLA	17,910	New York	30
1430	9:30 A.M.	WCX	7,850	New York	35
1430	9:30 A.M.	WJS	15,700	New York	35
1440	9:40 A.M.	WCL	9,390	New York	25
1500	10:00 A.M.	WGEX	17,880	New York	30
1500	10:00 A.M.	WLWR	12,967	New York	30
1515	10:15 A.M.	KHF4	15,700	Los Angeles	35
1515	10:15 A.M.	KJE6	7,350	Los Angeles	35
1550	10:50 A.M.	WRM	18,560	New York	30
1615	11:15 A.M.	WCX	7,850	New York	35
1615	11:15 A.M.	WJS	15,700	New York	35
1700	12:00 P.M.	WJP	3,310	New York	35
1700	12:00 P.M.	WPK2	13,185	New York	30
1800	1:00 P.M.	WCX	7,850	New York	35
1800	1:00 P.M.	WJS	15,700	New York	35
1900	2:00 P.M.	WCX	7,850	New York	35
1900	2:00 P.M.	WJS	15,700	New York	35

2000	3:00 P.M.	KJE	15,850	Los Angeles	16
2000	3:00 P.M.	WRM	18,580	New York	30
2030	3:30 P.M.	WRK	15,910	New York	30
2045	3:45 P.M.	WLWR	12,967	New York	45
2100	4:00 P.M.	WCX	7,850	New York	35
2100	4:00 P.M.	WJS	15,700	New York	35
2115	4:15 P.M.	WJP	8,810	New York	25
2200	5:00 P.M.	WCA3/WHL	15,847/10,750	New York	30
2200	5:00 P.M.	WCL	9,390	New York	20
2200	5:00 P.M.	WCX	7,850	New York	35
2200	5:00 P.M.	WGEX	7,000	New York	30
2200	5:00 P.M.	WHL	10,750	New York	25
2200	5:00 P.M.	WJS	15,700	New York	35
2200	5:00 P.M.	WLWR	9,390	New York	30
2215	5:15 P.M.	KCI6	19,950	Los Angeles	30
2300	6:00 P.M.	KROX	17,880	San Francisco	30
2300	6:00 P.M.	KROZ	15,100	San Francisco	30
2330	6:30 P.M.	GAY	8,910	England	25
2330	6:30 P.M.	WCX/WJS	7,850/15,700	New York	35
2330	6:30 P.M.	WJP	8,810	New York	35
2330	6:30 P.M.	WJS	15,700	New York	35
2350	6:50 P.M.	WHL/WPU	7,955/14,635	New York	35

— . . . —

112-Mc. QSO Parties

The first Connecticut QSO Party since Pearl Harbor, and one of the first postwar QSO-fests of which we have heard, was held on 112 Mc., September 15 and 16, 1945. Approximately 132 stations participated! Two points were allowed for each contact and one point for each station heard, the sum being multiplied by the number of different towns worked. WIIND, operating portable at Prospect, Conn., made a score of 3885, based on 50 contacts, 5 heard, and 37 different towns. W1IJ, Madison, Conn., was second with 1650 points; W1MVH, New Haven, third; and W1BW, Branford; W1MRP, Westport; and W1ASO, Stratford, next in order. Many stations in New York, New Jersey, Massachusetts and Rhode Island took part, with all call areas except the 4th represented as portable first district participants. Connecticut SCM Fraser, W1KQY, was sponsor of the Party. It was a huge success!

In a successful attempt to stir up 112-Mc. activity, the San Antonio (Texas) Radio Club held a two-months contest on that band from September 15 to November 15, 1945. Those who participated had the time of their postwar lives chewing the rag each night. Those who could not participate because of having no rigs, chewed their fingernails to bits and started hurried projects to get something on the air for the next get-together. The club plans another QSO Party for after the holidays.

Among those entering the first SARC contest with a vengeance were W9WON, W9PEC, W3ESP, W5EHM, W5JLY, and W5BUV. Prizes were awarded to these contestants for such factors as lowest power, longest distance and most contacts.

Other SCMs and clubs looking for ways to pep up activity on the new 144-Mc. band will be interested in the above QSO Party results. It appears that hams still like to operate with some purpose, and the more stations we can get operating the more 144-Mc. fun there will be for all.

28 Mc.

Are you enjoying some of those nice 28-Mc. contacts that are so plentiful these days? It always was a freaky band, but when it is open, boy there is plenty to work! At this writing, with no bands of lower frequency yet available, 28 Mc. seems to be "all things to all men." The DX is starting to roll through again on both 'phone and c.w. The swings of some of the old DX-fists are sweet music to the ear. The band excels for rag-chewing, if you can beat OM Skip to the punch and get your dope across before he takes over!

We'll never forget that first postwar week end on 28 Mc.; it was the thrill of our first QSO all over again. Probably the greatest number of contacts on those first two days were between the fifth and fourth districts and W1-2-3. Man, how those 5s were knocking them off!! Did you notice the prevalence of stations in Dallas, Texas? Hi. Those Dallas boys really had things under control.

It's fun to shut off the transmitter once in a while and just listen to the band. That takes will power, but you soon know what's going on. There must have been plenty of frantic and hasty building when the announcement of the 28-Mc. opening arrived. Witness the number of lads testing their modulation . . . and the chirpy c.w. notes. But by and large signals were surprisingly good after a long shut-down and a sudden return to the air.

Yes, it's all things to all men. You can contact around the U. S. or go after foreign-DX when the band is open, and you can get in your local rag-chews when the band goes dead. We'd like to see more of that in the late evening, or at any time the band is dead. Just because you don't hear any signals, don't be discouraged. Try a CQ; maybe everybody is waiting for the other guy to call. Although we haven't heard any traffic being handled as yet, we imagine the traffic men will be plying their trade one of these days.

When conditions are right, 28 Mc. is a low-power man's paradise. Fellows with 25 watts or less can tear a terrific hole in the band when it's hot. So why not throw together a simple rig? We have heard a number of c.w. CQs labeled "fone or c.w.," but the beat oscillators must be rusty at some of the shacks. Before the war there were a good number of 'phone-c.w. contacts. It would be more interesting for all if the 'phone-c.w. habit were resumed. It may be our receiving antenna (yeah, we're one of the guys who hastily fastened a short hunk of wire to the receiver and threw the other end on the floor!), but we can't distinguish the voice on some of the weak 'phone carriers. When conditions are poor, more contacts would result if more of the gang would key their carriers. And we're not trying to make c.w. men out of 'phone men, or vice versa, either; we're just trying to be practical. See you on 28 Mc.!

Station Activities



ATLANTIC DIVISION

EASTERN PENNSYLVANIA — SCM, Jerry Mathis, W3BES — 3GRF is back from Tokyo, where he flew in with the first "Radio Tokyo," and says that some of the DX hounds were scouting around collecting J QSL cards. 3IU raised a K4 for his first postwar QSO on 10 meters. 3HFD has a kw. on 10-meter phone. 3AOJ is back on 10-meter c.w. 3AGV is racing K4KD for a 10-meter WAS. 3EVT, world famous DX man from Virginia, now is located in Landsdowne. 3EU is ready to go in League activities. 3IKW is home on leave. 3IRS is home from Valley Forge Hospital and is well on the road to recovery. The West Phila. Radio Assn. bought a receiver and will go on the medium frequencies as well as 2 meters. 3HRD reports that the new 2-meter band is working out better than 2½ meters. 3MW has signed up for the Army of Occupation in Germany. 3LN will fire up with an 833A at 1 kw. 3KT is teaching school again upon release from the Army. Will League members kindly submit recommendations for various appointments, particularly EC and OBS? Will prospective OOs please get their measuring equipment in gear and send in descriptions so that efficient Observers can be appointed? 737 Jerry.

MARYLAND-DELAWARE-DISTRICT OF COLUMBIA — SCM, Hermann E. Hobbs, W3CIZ — EKZ recently returned from Europe and is a civilian again. He writes that while he was overseas he met ON4UX. 1IIN/3 writes that thirty-one hams, inhabitants of the 2½-meter band from Baltimore and Washington, attended a hamfest at the Hotel Park Plaza in Baltimore on Nov. 9th. The meeting was arranged by 1IIN/3, CRB, and 9CSW/3. Another dinner meeting of the Baltimore Amateur Radio Society will be held in January. Contact 1IIN/3 for details. DKT was on 28 Mc. Nov. 15th with a new rotary beam. 1IIN/3 has a new 144-Mc. superhet and 144-Mc. transmitter. 9CSW/3 is rebuilding. FAM works Wilmington, Del. and Washington, D. C. on 2½ meters. EMQ has a new Abbott TR-4 revamped for 144 Mc. PV recently made an excursion to Western Pennsylvania with his 2½-meter mobile outfit and picked up twenty-five WERS hams among them 8BWP. The Washington Radio Club holds its code classes on Saturday nights and its meetings on the second and fourth Saturdays of each month. ZD passed through the District of Columbia on his way to Mexico. 73.

SOUTHERN NEW JERSEY — SCM, Ray Tomlinson, W3GCU — Asst. SCM, Ed G. Raser, W3ZI. Regional EC, ASQ; EC for Somerville and Somerset County, ABS; EC for Mt. Holly, Medford, Hainesport, and Pemberton, JNZ. ASQ reports that the WKPX network of WERS held its final test drill on Nov. 12th. This being the grand finale of the War Emergency Radio Service, the radio side and our entire personnel wish to thank the officials of the township, the Hamilton Twp. police organization and the entire personnel for the whole-hearted cooperation extended by them during the entire existence of the WKPX network. We remind OBS that it will be necessary for all appointees to submit as soon as possible a new schedule of frequencies. 8ISK, Toms River, has a forty-foot tower ready to erect. ITS has a Mims rotating mechanism for his 28-Mc. beam. CCO and IDY are pumping out r.f. on ten. AFH is lining up power equipment and shining up the beam, and ASQ is oiling up his steering-wheel rotator. DEA says he will look around on that band, too. GCU is gathering up the necessary digits to solder together a rock crusher for ten; Ray also is getting set to hike up a new antenna for 50-54 and 144. JNO fired up his 10-meter rig. Your SCM is looking for appointees for official broadcast work on 144, 28, and 56 Mc. Anyone interested in receiving official news first hand please contact this office, QTH in front of QST. GQX is grinding his 112-Mc. rig down for 144. ATF has reported back to

work for New Jersey Bell Telephone Co. after returning from the So. Pacific. DEA paid a visit to the western section of the country and acquired an XYL. ARN received his discharge from the Navy and has taken up residence in Franklin Park. GCU and FBC recently spent a very FB evening at the shack of GQX where everyone enjoyed themselves studying the "innards" of a newly-acquired Junior Volt-Ohmmist. ASQ has revamped his TR-4 for 144 Mc. AID has accepted a position as design engineer for Aeronautical Radio Mfg. Co., Mineola, L. I. EED, with the merchant marine, was last heard from in Hawaii. Jimmy Hassal is back in our ranks, having received his discharge from Uncle's Air Arm. GRW has stepped out of the merchant marine and is working for HW at Princeton Labs. HW has a brand-new Premax 40-foot vertical parked on his roof. We record with deep regret the passing of Maj. Hervy Scudder, of Trenton, who lost his life in a plane crash near Manila, P. I. He was a former student of ZI and one-time communications officer of the 119th Observation Squadron at Newark Airport. The Oct. meeting of the SJRA was held in club headquarters at 513 Cooper St., Camden; it was reported that some very interesting speakers have been lined up for future meetings. IAS and FTQ report a code class in progress with FB results, but more applicants are needed to carry on. FTX is at Millville Power House. BUF is building a kw. for 14 Mc. FDF is getting set to go on 28 Mc. AIR was last heard of in the Naval Labs at Washington, D. C. 73, Ray.

WESTERN PENNSYLVANIA — SCM, R. R. Rosenberg, W8NCJ — The need for Emergency Coördinators is very urgent at this time and it is suggested that former ECs write to the SCM for renewal of their appointments. The following EC appointments have been made or renewed recently: NDE, AOE, TOJ, and GU. GU is active on 2½ meters and has erected a quarter-wave ground-plane antenna for 28 Mc. OAJ and TGA have been discharged from the Signal Corps. IYQ from the Air Corps, and MWV from the Navy. TTD is teaching high school general science at Grandy, Mo. TTN has been released from a hospital in the Philippines. TVA returned to the States after several years in Brazil and is at Sheppard Field, Tex. OUH and VNE are awaiting discharges. UHO, now in England, is learning to run the mill. NUH writes that PDP is building up his rig. TWI has married a home town girl. HKU has moved to Bradford. AOE reports the following Mercer County amateurs active on 2½ meters: VI, OAJ, GRA, QCN, MWV, GEG, WDC, VUR, KY, VNL, 1KIU/8, AOE, and SFG. 1KIU/8 is reported to be working sensational DX on 2½ meters. KCV is stationed with the USSC in Honshu, Japan. UVD has his five-watter ready to go on the low frequency bands as soon as the go-ahead signal is given. The Mercer County Radio Assn. has twenty-six active members. The following officers have been elected: GEG, pres.; 1KIU/8, vice-pres.; VUR, secy.-treas. AOE, EC for Mercer County, reports that all members of the 2½-meter group in that locality have expressed willingness to continue in the emergency set-up and will be affiliated in an emergency net. The Radio Assn. of Erie's new club rooms in the City Hall Annex Building have been completely redecorated. The Assn. has assumed complete responsibility of the emergency communication set-up for Erie with EC GU in charge. Very 73. Ray.

CENTRAL DIVISION

INDIANA — SCM, Herbert S. Brier, W9EGQ — IIL is on Amchitka in the Aleutians, building a rig and a rhombic aimed at Indiana. EHT is back in Terre Haute. MBM has 700 watts on 28 Mc. EGV has an 807 on the band. DLI and RHL got on 112 Mc. a few days before the band was shifted. DHJ worked 8CVQ on 112 Mc. with 12 watts input. HDB heard, and was heard by the Milwaukee station on 112 Mc. PQL is building a new all-band transmitter. FDS built a 12-tube a.c./d.c. receiver. SNF is on the island of Kwajalein, and is radio operator on one of the main control circuits. TIY is in New Orleans with the FCC. ONZ and SVJ are home. WKN and KYQ have steel towers 60 feet high. EBB has 20 watts on the air in Washington, D. C. ANH reports a slight showing of life in the Terre Haute gang. DUT has his portable-mobile transmitter on 144 Mc. PBS is on the air with 350 watts. PUB is building a 100-

watt transmitter. UMK is home from the AAF resting. NLS will be home from Manila in time for Christmas. CWY is back after several years in Italy. CWO has a crystal-controlled v.h.f. transmitter. ABB is back with the Indiana State Police. 73. *Herb*.

KENTUCKY — SCM, Darrell A. Downard, W9ARU — CNE, BAZ, and GOM didn't lose any time getting on 28 Mc. ARU has the "Apartment House Blues." Marion E. Taylor is back from a Jap prison after more than four years internment. OEE, in the merchant marine, manages to make quarterly meetings at the ARTS. 5IEZ/9's basement takes on the appearance of a radio warehouse. Now that WERS doesn't keep the local gang busy they should have time to report to the SCM. This also applies to the gang in other parts of the State.

MICHIGAN — SCM, Harold C. Bird, W8DPE — 8UUV reports he has worked 42 stations so far, including 8UKS, of Lorain, O., who puts in a swell signal. UKS was worked with 4-element horizontal beam. 8WIK, Pontiac, is doing a fine job working the entire metropolitan area. 8UGR had his first contact on 'phone over a friend's portable-mobile rig. 8NVH, East Leroy, is home from the Navy and has his operator license. 9HSQ reports that the gang in U.P. is split up. 8PDB, using 130 watts and an SX-28A receiver, has made several Canadian contacts and has worked most districts in U.S.A. on 28 Mc. 8TNO is getting his exciter ready for 28 Mc. 8DIV had to rehash his modulator before he could resume activity. 8SNJ got going on 28 Mc, but had a bad condition in his speech which had to be cleared up. 8DYH has written some very fine dope for the APCO c.w. boys to follow. 8FX is busy getting out correspondence for the DARA. 8BIU is going strong as president of the DARA. 8MQG is working on public relations stuff with a very nice write-up for the papers. 8LSF and 8CSW are back in civvies. 8PUI is tied up with his police work. 8FQW is getting his rig together to get on 10 meters with $\frac{1}{2}$ kw. I would like to know how many are in favor having only one class of license. At this time you should give some thought as to power. Let's have activity reports from you fellows who are active on 28 Mc. It will not be long before your SCM will be snowed under with applications for PAM, ORS, RM, OBS, and other appointments. If you don't apply early you are going to be left out. Let's get going, gang, and show the rest of the country that this section is alive. Thanks for the fine cooperation during the emergency and the best of holidays to all. 73. *Hal*.

OHIO — SCM, Carl F. Wiehe, W8MFP — PZA reports an attendance of 140 at the November meeting of the CRA. GD is homeward-bound from the Pacific. BAH is home for good. 4HEQ and 4GXW visited Cleveland. LAG is back after a long absence. 3HOC attended the CRA November meeting. HC is attending meetings again. LEX has been elected to the CRA Board of Directors. Code instruction is being given and spot frequency stations are being set up at the ends of active bands. The Toledo Radio Club reports that SCC, a CPO, recently was discharged and is home again. WUF and TKS enjoyed the Detroit Amateur Radio Assn. Oct. 7th bamfest. NXX, TAR, WHA, RYX, and UFN have received their discharges and have returned home. RQL, JLR, ARF, RRZ, NGU, and JLQ have been heard on the air lately. DGU, EC for the Middletown area, reports resumption of ham activity. MSE is heard often. IBN has been discharged after two years in the Air Corps and is assistant superintendent of signals and alarms for Middletown. FVW is back in town in radio service work. STS is a sgt. in the Signal Service Dept. and is enjoying Kyoto. Congratulations to AIR on the arrival of a baby girl. PMJ is pounding brass on Mindanao. RHH succeeds CBI as EC for the Dayton area and is busily engaged in reorganizing the Emergency Corps there. The gang at Cincinnati is attempting to consolidate all prewar radio club, including QCEN and GCARA, into one large club. 73. *Carl*.

DAKOTA DIVISION

NORTH DAKOTA — SCM, Raymond V. Barnett, W9EVP — After renewing DX acquaintances on 28 Mc., we will reestablish our local emergency network on 144-148 Mc. SSW is putting his Stancor 10-P back on ten. GJJ has built up a superhet receiver covering all bands. He

will be on ten, as will EVP, who was fortunate in being able to borrow an SX-11 from ZRT. Capt. DAK, at Ft. Monmouth, writes that SEQ is a major in the Signal Corps on the West Coast. IRU, former 2nd Lt. in the Signal Corps, also is on the West Coast. JRU is with the Navy at Oakland. RJF, formerly of Jamestown, is with CAA in Minneapolis, and AZV is with CAA at Minot. PDN moved up to Fargo and is with Northwest Airlines. VUG, formerly of Bismarck, is an electrician at Puget Sound Navy Yard, Bremerton, Wash. He is the proud possessor of a 1st-class 'phone ticket and is looking for a broadcast station job. BLQ, of Zahl, and DYT and ILT, of Hanks, have been discharged from the services. GMY, of Williston, is on Okinawa. YYN is married and has a baby daughter. Ivar Nelson, ex-CLK, ex-NX, has returned to KFYR as chief engineer after two years' leave of absence during which he served Western Electric BuShips in the Pacific area. 73. *Ray*.

SOUTH DAKOTA — SCM, P. H. Schultz, W9QVY — AOZ is back after three years' Navy service as CRT and is enrolled in S. D. School of Mines. Sgt. WUU has been with a night fighter squadron in Hawaii but expects to be home at Alcester and on the air after Jan. 1st. Lt. DUC, USNR, is officer in charge of a combat aircraft service unit at Whidbey Island. He is looking for a schedule with the S. D. bunch. ZRA and YNW are back with Power City Radio in Sioux Falls. MRS and AXI are back in Sioux Falls. The grapevine has it that BJV and CJS, along with the Milbank gang, have their old 5-meter net in operation. How about some activity news? 73. *Phil*.

HUDSON DIVISION

NEW YORK CITY AND LONG ISLAND — SCM, Charles Ham, jr., W2KDC — After a very promising start on 112 Mc., the Long Island Emergency Net found that the shift to 144 created quite a problem. On November 19th, the first night of the new operation, QRM was noticeably absent. 2FI was outstanding on crystal control and acted as net control. Approximately 22 reported in. Drills will continue Mondays at 9 p.m. on 144 Mc., with ECs appointing a county control station each week or permanently. The present lower frequencies will be utilized for direct county control contacts when arrangements are made. Mobile and pack sets actually in use during the roll call are desired. A message was relayed from Jamaica to Southampton, and an answer received in fifty-seven minutes, relayed via six stations. MAF reportedly was on 1 microsecond recently. KDC picked the wrong band for the opening, as 56-60 was dead at that time. VR, at 1308 Sterling Place, Brooklyn, is a shut-in and would like some castoff 144-Mc. gear. K4DBE sends 73 from New York City, where he is taking a radio technician course. 3AIX/2, while mobile on the "Barbara Ann" on Long Island Sound, in contact with DRH talked overtime and ran the main battery down. ITN, just back from Pearl Harbor, has acquired an XYL, KKK, formerly of Jamaica, appears firmly settled in Teaneck, N. J. He is on 10 with 80 feet of RG 11/U feeding a doublet and was last heard working a K7. 9TWS/2, Westbury, saved KDC from grinding a lot of crystals by suggesting taking the 5th harmonic from a tri-tet circuit and doubling twice. It works fine, but a 6AG7 is the only tube to use for the oscillator. 2IUN is at Ranger and reportedly repairs radios in his "spare" time. 1NRV/2 asks if any hams live near him. LLV will be found at the other end right in your own building. KYJ, Richmond Hill, is machinist's mate in Brooklyn Navy Yard. GSC, of Far Rockaway, has been released from the Navy and is on 144 Mc. using a TR-4. 3GQR is in Astoria on terminal leave from Ft. Monmouth. The Sunrise Radio Club, SV, has temporary quarters at 126-06 146th St., South Ozone Park. They meet every Friday at 8 p.m. CJY wants a good receiver. ADW has delayed that famous mast-raising as he has to change elements to 144 dimensions. KOA plans a mobile rig on 144 Mc. NMP and NMZ also are active in Suffolk County. EBT is welcomed there and CKU and JWO are also on 144 Mc. DOG reports that extensive police, utility and other nets cover Suffolk, but he is active on the emergency net. He is looking for someone to replace him as EC. BVE, formerly of N.A.T., is back on 10 meters. DWG needed a micrometer to match his 10-meter antenna to RG 11/U. AMB schedules

K6a and W2s/K6 on Saturday P.M. on 4-element beam. IAG now is on 10 meters. KOK dusted off the beam on 10 and is very active. LKC has a new rig and beam on the air. There's much activity on North Shore. BKZ blew a power transformer. The N.Y.C. WERS operators had a luncheon on November 26th. CMU was high in the QSO Party on Nov. 11-12 with 2961 points. The Evening Session of the College of the City of New York has reorganized and meets Fridays at 9 P.M. in Room 130 Main.

MIDWEST DIVISION

IOWA — SCM, Leslie B. Vennard, W9PJR — UFL reports a club meeting to help all members to get acquainted and to understand the new rules and regulations. LDH is new EC in Keokuk. 51YN, of Dallas, Tex., has moved to Davenport. AQJ, back home from the Army, attended a meeting of fifty hams in Moline. RYT, AEP, and DIB visited AHP and admired his towers and sky wire. LAC, new president of the Burlington Radio Club, is very busy on 10 meters. CTQ is back from the Navy and has moved to Kansas City. QVA fell and broke his left arm, but will continue code classes. ALC, ESF, DVP, NLA, OMF, and WMP have been discharged and are back home. GWD, WNL, RZV, and PJR have been having real DX and fun on 112 Mc. but 146 Mc. is not so good. IXB is the only ham left in Hamburg. Please write for that EC or OBS appointment, fellows. 73. Les.

KANSAS — SCM, A. B. Unruh, W9AWP — VRZ and ESL are OBS. NLM will sign "7" after being a "9" since 1921. He is technical adviser, AAF B-29 program, and has moved from Wichita to Seattle. EJD has returned to Parsons from Oak Ridge, Tenn. TVU returned to Lakin from the Army and says 28 Mc. will please him more than 112 Mc. TVF, a s/sgt. in the Marines, writes from Japan, where he is quartered at "JMG." ALS built a 2½-meter receiver. SIL has returned home from the Navy. DJL, BCY, DMF, and JYZ had a 112-Mc. net. WARC was reorganized with ZKA, pres.; YVI, secy.; and ABJ, treas. The club is 100 per cent ARRL. AWP built a 2½-meter battery portable receiver and erected a 28-Mc. ves beam for the rig now under construction. Some Kansas 10-meter phones are: ICV, LOU, DJL, DMF, JYZ, QQT, and CVN. 73. Abie.

MISSOURI — SCM, Mrs. Letha A. Dangerfield, W9OUD — HIC is in the Philippines and had a letter from TCR, who recently married a Spar who can copy 25 w.p.m. KPM is in China and discovered 5KBB running the motion picture projector in his outfit. YCE and 8HTM are working together in Hawaii doing radio maintenance work. 6UTZ and wife, formerly HDK and TAB of Willard, stopped by to see OUD as they returned to California after visiting the old home. BMJ managed to get his old rig on 112 Mc. two days before the band was closed. BMS and OUD have a private communications line with an oscillator, bug, and speaker on the bench in the service shop and bug and speaker on the refrigerator in the kitchen. Fellows, please send in reports to your SCM each month so that we can have a good write-up for Missouri. 73.

NEBRASKA — SCM, Arthur R. Gaeth, W9FQB — KKQG-4, Council Bluffs, surprised the KHKN net by putting S9 signals into Omaha until Nov. 15th. Henry Peterson, ex-KHKN-43, has a Howard 435-A and is ready for the amateur exam. Paul Russum (LSPH), ex-KHKN-15, has an 809 rig ready. Cliff Allwine, ex-KHKN-23, has moved to Benson. Capt. HTE and Capt. BZV are home on furlough. Warrent Officer DYG relayed greetings from 4BYF and 4ECV to the SCM. Sgt. FQM is on Luzon Island. Pfc. LTL is stationed at AAF Overseas Replacement Depot in Greensboro, N. C. YUB, Louisville, Ky., is stationed in Omaha. MLB is looking for a new receiver and converting TR-4 to 144 Mc. EKK has HK24s 84 watts on 56 and 144 Mc., and a 1 kw. rig on 28 Mc. He reports that converter units for 10, 5, and 2½ meters are on the production line and that VUU now is a civilian. VIG visited UFD and is looking for a receiver. EUT reports that he has only a 40-meter rig and an SW-3, and that EW has left Western Electric at Lincoln and is going to Long Beach, Calif. JFJ has the gang curious about a new crystal oscillator circuit he discovered and has a T55 on 28 Mc. Col. ZGA/9, ex-4FWA, is stationed at Ft. Omaha and using a pair of 100THs, grid-modulated, 300

watts to an 8JK, that FSR helped to erect. EXZ is on 28 Mc. with a pair of 809s, 100 watts, TZ20s Class B, half-wave doublet, homemade 1937 ten-tube super. ROK is heard on 28 Mc. with an HK24 on c.w. and an indoor antenna. HGV is on 28 Mc. with a pair of T40s, RME-43, 3-element beam, and hooked W2, W4, W6, K6, and K7 on the 15th. FDG is building a 6L6 rig for 28 Mc. SHF reports SHH is due for discharge. 7GQO/9 is starting a radio school for the blind in the Omaha YMCA. RUH has competition on 28 Mc. from ignition QRM from his filling station. VHR had his transmitter stored away piece by piece, and now has a big wiring job to do. FQB has a little 7C5 crystal — 7C5 final on 28 Mc. UFD gave a talk on crystal experiments and donated a new crystal for a door prize at the last meeting of the Ak-Sar-Ben Radio Club. 8WJV was a visitor. 73 and Holiday Greetings. Art.

NEW ENGLAND DIVISION

CONNECTICUT — SCM, Edmund R. Fraser, W1KQY — GB News: Flight Officer Vincent Esposito (LSPH), S/Sgt. MEM, NRR, merchant marine, and Capt. NAM, Signal Corps, all discharged, met at "GB" recently. NAM is working for Tel. Co. in New Haven. ILG applied for membership. CSY is teaching music in Bridgeport. RT2C Jim Wilcox, USN, GB member, writes he is collecting parts for a rig and hopes to take his Class B license soon. Ex-SF, BPL, and George Dunbar (LSPH) were in New York buying radio parts. TD and KAT have bought new receivers. IGT, IND, FMV, MVH, TD, JQD, LVX, KQY, LZM, LTZ, and BW have converted their TR-4s à la DBM for 114 Mc. Our sympathies are extended to MVE on the death of his mother. WERS News: Hamden units were represented 100 per cent on the last test period. Twenty of the operators met at MSB's QTH, where a farewell party was held. Many of the WERS operators are attending code and theory classes conducted by IJ in the Hamden High School Tuesday and Thursday nights. Seven are attending the Wednesday night class conducted by KQY. Ex-BJ reports the Norwich WERS group ended operation Nov. 14th with three units and operators on the air. He and WJTR-5 expect to take the Class B exam in February. General News: At the hamfest held in American Legion Hall, Groton, Nov. 9th, 144 were in attendance. Speakers were HDQ and 2OEN/1 from ARRL, Comdr. J. B. Knight, and the comedy team of QV and DET. Among those present were: JAK, FMV, HRC, LZM, MFR, ALW, NEK, IJ, IND, JQK, LTZ, MEF, and KYW. Refreshments were served by CJA. CTI was paid a visit by CQF. Fred is building a rig for 80, 40, and 20 meters. AYY worked 2DFX, who was north of Schenectady, while operating from Mt. Everett, Mass. at an elevation of 2430 feet. CTC is working at Hatry & Young Radio Store in New Haven. LEI is out of the Army and working at the A. T. & T. Co. in West Haven. MJC, EUG, KAT, MEM, FMV, ILG, and JQD are on 28 Mc. working DX again. Ex-AKG is building a rig. KKS is aboard the SS *Mission Santa Ynez*, somewhere between the Canal Zone and T. H., and writes that he has been listening to the hams working DX. 73. Ed.

MAINE — SCM, G. C. Brown, W1AQL — Lt. (jg) Robert H. Mitchell writes from Italy that CEQ is a captain in CAC and has been on a tour of duty in Iceland, England, and Europe. QH is home after being released from the Navy. AKR is home from a long trip to Africa. CBV is on the air with an 807 and is putting out about 35 watts on 28,800 kc. BPX is working c.w. on 28 Mc. 6SVR is sweating out a discharge at Dow Field. AID received a letter from CWB, who has been flying the "hump" and now is stationed in Calcutta, India. What say, gang, why not send in some news? There must be a lot of the gang getting home from the four corners of the globe, so why not let us know about them? 73. "G. C."

EASTERN MASSACHUSETTS — SCM, Frank L. Baker, jr., W1ALP — We heard NBM say that he worked a ham in Spain on 10. A few stations heard here are: GOU, NIC, KQN, LZL, BB, LOV, NBI, HHU, IS, MME, LYL, ILL, CPB, LZW, and PI. EYY, MME and HX are civilians again. BY is working for the New Haven R.R. in the signal department. The Brockton Radio Club held a meeting which started with a supper. Officers are: LWI, pres.; MON,

vice-pres.; MQH, secy.; IZB, treas. ILL has a new baby girl. KCP is in China. 5JED is at Squantum Naval Base. 5GXS, who has been at M.I.T., has returned to Texas to become a civilian. CGM is a lt. comdr. in the Navy. The South Shore Amateur Radio Club held its regular meeting with the following present: AKY, JCX, LCK, LVR, ENN, IS, ALP, JXU, HXM, JXZ, JOB, MMU, KJD, KXN, FWS, CCL, DDO, MD, EUW, LFD, DPI, 5JED, the Mugford twins, R. Inglis, and Byers. JBY is home again. KBM writes from San Francisco that he is out of the Navy. AGR writes that the Norfolk County Radio Club meets on the 2nd and 4th Wednesdays of each month; HSB is president and AGR is secretary-treasurer. AGR, captain and assistant communications officer on the State staff of the State Guard, is traveling from the north of Maine to New York in his work. 2MXB, who was at Squantum, is back in the New York Fire Department. MIH is going to stay at his job in Hyannis. NKW spent some time in Norway, Me. recently. KB is EC for Haverhill. KBQ is working for Western Electric Co. KUA is opening up a service station. CCF is an engineer at W.E. HSS has returned to Camp Edwards and is re-enlisting. GEM is at Anisquam Light and will be on the air soon. NRZ is on in Gloucester and says that LON is on 2½.

WESTERN MASSACHUSETTS — SCM, William J. Barrett, W1JAH — DUZ has been assistant chief train dispatcher with the Army in France. John was married in France Sept. 27th. MIM/8 says LDV is now out of the Navy. MCF, a Jap prisoner since Wake, is home. FJK is touring Panama on a motorcycle. LXE is with the Army of Occupation in Japan. Dick Atwood reports for the Worcester gang, who are marking time during the transition from WERS to ham activity. In this connection, I have named BVR as Section Coördinator, to have charge of all Emergency Coördinators in the section. Where practicable, ECs will be named to cover the same community territory previously covered by WERS. 144 Mc. will be used in each individual community, with low frequency stations enlisted to work between communities and over greater distances. They will tie in with the section net. Nominations for Emergency Coördinators are in order, and recommendations should be sent direct to BVR, Percy C. Noble, 37 Broad St., Westfield. Under this set-up, each community has its own EC. BJS and Cutler Lamont are conducting classes each Friday night for members of the Springfield WERS group who want to get ham tickets. Ike has been using a Discone antenna on 112 Mc. and reports excellent results. How about getting those EC nominations in to BVR and some reports of activity to me by the 15th of each month? 73. Bill.

NEW HAMPSHIRE — SCM, Mrs. Dorothy W. Evans, W1FTJ — IJB is back in the States. APK is making official broadcasts nightly at 7 P.M. on 29.2 Mc. narrow-band f.m. 'phone until such time as the lower frequency bands are available. MOI had good luck on 2½ meters with a special beam antenna, not only working excellently to Nashua but into Massachusetts as well. MUW and MCB were active on 2½ meters. LSN, APK, and IP have been appointed OBS. APK, AXL, BFT, and EWF were heard on 28 Mc. the first day that the band was opened to us.

RHODE ISLAND — SCM, Clayton C. Gordon, W1HRC — The Associated Radio Amateurs of Southern New England, Inc., AQ, 54 Kelly Ave., E. Providence, was reorganized Nov. 9th and the following officers were elected: AKA, pres.; Bert Savage, vice-pres.; George Hunter, treas.; IQJ, secy. The Club meets every Friday evening. The Providence Radio Association has experienced a huge growth in size and activity since V-J Day. Attendance averages thirty-five per meeting. Special talks are given from time to time by members who have returned from the war, and several meetings have included the giving of door prizes. The 112 Mc. gang organized a hamfest at Oates Tavern on Nov. 3rd with prizes, including a most sought-after turkey, for hams and XYLS. It was well-attended by the local gang as well as visitors from Fall River, etc. The following day, the 112-Mc. band was choked with amateurs rehashing the time over again. Your SCM attended the hamfest at Groton, Conn., on Nov. 9th where he saw many of the Rhode Island gang, including BOS, CAB, DTZ, EOF, ex-GTN, IXT, JP, LYE, George Enos, and Harry Nicholson. Several of the Westerly gang were there.

NORTHWESTERN DIVISION

MONTANA — SCM, Rex Roberts, W7CPY — DXQ's father passed away Nov. 11th. DCZ is home again. HZJ is out of the WAC and again teaching. BMX, CC, and HEM are home from the services. HEM is building a rig. DSS is going to try 10-meter 'phone. Several are waiting for the 80-meter band to open so that the IBB Club can again function. The Butte Club held a successful Halloween party. CME has been discharged from the services. Several Butte hams are working on 2½ meters. The Butte Club is holding a contest for the greatest DX on this band. The Butte Club and the Anaconda gang held a joint meeting. CPY found a lot of "bugs" in the rig, which had been stored for the duration. EMF and CJN have worked 2½ miles on 112 Mc. 73. Ray.

OREGON — SCM, Carl Austin, W7GNJ — HAL, of Portland, reports that at least ten of the gang were on ten for the opening, and that HRV is said to have worked all districts. UHN has resumed publication again with an FB October issue. MQ reports that the Pendleton Radio Club has had some fine QSOs on 112 Mc. by BEE, HWY, ILA, and himself. Among those waiting or rebuilding are: KR, BDN, BKD, AQX, FPT, and AIP. GKX and BUS are awaiting discharge. IDJ, GLF, and QP have returned to Klamath Falls. K7DIS is back home after five and one-half years of radio work in Alaska. Early in 1940 AI went to Nome as operator and technician. He became SNC of the Alaska net, with a fine bunch who always got through, even if the use of three bands was necessary. After three and a half years at Nome, he was sent to the Aleutians, then was one of the first twenty men discharged. AI was the third 112 Mc. station on, with a QSO with CYT. K7ENU, AI's XYL, has been busy with the two small harmonics. It is rumored that FRO, of Ashland, bet FNM twenty bucks that amateurs would never get on the air again. GNJ claims a cut for prompting the bet. HHH hit 28 Mc. with her rig overhauled, screened, and even with interlocking switches. Returning Oregon hams, please report. Thanks. 73. Carl.

WASHINGTON — SCM, O. U. Tatro, W7FWD — KNFV held a farewell-to-WERS party at the home of Miriam Brown (LSPH), radio aide, with the operators of the following units present: KNFV-1, 3, 7, 13, 16, 17, and 18. Hams present were: DPU, IZG, DYD, JBH, UX, UYQ, IOQ, APR, CQA, ATN, IT, OTN, FWR, and FWD. The Tacoma Radio Club opened activity with a meeting in the Winthrop Hotel to listen to the 6 a.m. discourse on 2½-meter activity in Southern California. There were thirty-five present. The Yakima Amateur Radio Club elected the following: FCZ, pres.; IYB, vice-pres.; HRU, secy. AWX and HCE were elected to the Board of Directors. CMX, State EC, and the local CAA office staff turned out for the meeting. EPT and K7EUW/7 located on Green Mountain Nov. 11 with a TR-4, ½-wave vertical, extended double Zepp and a 4-element beam of the Yagi type, and made the following contacts on 2½ meters: CMX; GKY; AIU, Olympia; AEA, Tacoma; 3GQM/7; 9SSQ/7; 6RST/7, Bremerton; HOL; 9CAW/7; IVA; HS; BDW; 9SHW/7; GUI; 9PQW/7, Seattle; EOP, Angle Lake; JBH, Mt. Vernon; EHQ, Steilacoom. Anyone who heard EPT on that date and did not make contact, please advise G. T. Williams, P.O. 1729, Stn. A, Bremerton, Wash. AWX finds his mobile 112 Mc. antenna adjustment critical in transmission. ITR is ready to provide the air portion of any air-ground v.h.f. experiments. 4IHO/7 wants to get acquainted with the gang and is looking for usable parts. His QTH: F. F. Taylor, 208 Delafield, Richland, Wash. AEA, EC, reports: AEA, BTY, DSZ, DGW, EHQ, IMB, IVE, OS, and EVW are on 2½ meters; BTY uses 2½ waves in phase, DSZ a "J," EHQ six elements and IMB four elements. LD has been transferred to this area from Alaska. HMJ survived the blow at Okinawa and took time out from radio to help electricians restore wire service. ILC, now in Southeastern waters, plans on putting something together so he can contact home from his shore leaves. Capt. GMM has returned to the States. HUK is in Northern Italy. AIU, CMX, FWD, FWR, GKY, and HPJ are on 2 meters. 73. Tate.

(Continued on page 80)

Prevent TB

(Number one hundred forty-two of a series)



Merry Christmas

and

Happy New Year

from

National Company

which includes

- | | | | |
|------------------------------|-------|----------------------------|-------|
| C. L. Gagnebin | W1ATD | Barton Mitchener | W1GNV |
| T. P. Leonard | W1AUJ | Roger Semons | W1SD |
| James Ciarlone | W1BHW | John Weatherly | W9EQM |
| Ralph Dennis | W1CJ | Herman Bradley | W1BAQ |
| Calvin Hadlock | W1CTW | Harvey Poore | W1DKM |
| Seth Card | W1DRO | John Bartlett | W1EU |
| Don Hinds | W1FRZ | William Osborne | W1EXR |
| Robert Murray | W1FSN | Alfred Zerega | W1JMK |
| David Smith | W1HOH | Robert Williams | W1JOX |
| John Baxter | W1HRK | Clyde Tillotson | W5JVI |
| Vincent Messina | W1HRW | Victor Penney | W1MTS |
| Jack Ivers | W1HSV | Edmund Ogden, Jr. | W1MTO |
| Harold Gould | W1KWV | Norman Soper | W7IJZ |
| Richard Gentry | W1LEN | F. Lopez | W1KPB |
| S. W. Bateman | W1RX | L. Green | W1LML |
| Harry Harris | W8WVM | K. Nagle | W1JGD |
| George R. Ringland | W1EYZ | F. Nault | W1MKC |
| William S. Doyle | W1TV | A. McHenry | W1AII |
| Paul Silbert | W1AGE | Harry Gardner | W1EHT |

John Prusak (*Amateur License—No Call Letters*)

* For seven years it was our custom each year to buy National Tuberculosis Society Christmas Seals and have QST stick one on this page in each copy of the January issue. But this year, as in the past two years, it seems impractical to get girls to stick on 60,000 stamps. We are making our contribution in the same amount as if we had bought the Christmas Seals, and the printed reproduction above is a symbol of the stamp we wish were there.



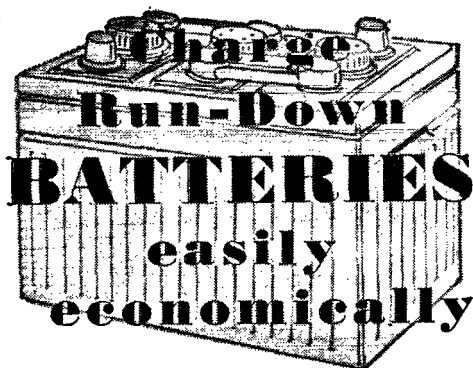

With a Mallory Portable Battery Charger it's a cinch to charge batteries in vehicles, laboratories or stations. Just plug the DC cord into the convenient dash receptacle and plug the AC cord into the nearest outlet—that's all there is to it!

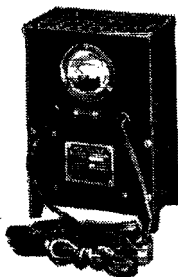

TYPE 107

The jumbo job for quicker charging. Initial charging rate: 10 amperes tapering to 7 amperes as the battery builds up. Size: 9½" high, 6¼" wide, 5¾" deep. Weight, only 11 pounds.

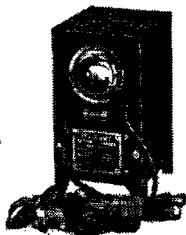

TYPE 5535 B

Mallory's medium-sized charger, Type 5535 B, has an initial charging rate of 6 amperes, tapering to 4 as the battery builds up. Size: 7½" high, 4¾" wide, 4¾" deep. Weight, only 7¼ pounds.

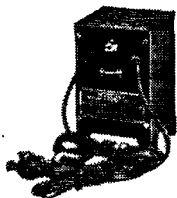

TYPE 3C

Mallory's Type 3C Battery Booster is the smallest of the family, with a charging rate of 4 amperes initial, tapering to 2 amperes. Size: 6" high, 3¾" wide, 3¾" deep. Weight: 4¼ pounds.

Mallory Battery Chargers are available from your authorized Mallory Distributor. See him for details about the complete Mallory line.

P. R. MALLORY & CO., Inc.
INDIANAPOLIS 6 INDIANA

P. R. MALLORY & CO. Inc.
MALLORY

(Continued from page 73)

PACIFIC DIVISION

SANTA CLARA VALLEY — SCM, Earl F. Sanderson, W6IUZ — RM: LLW. GOY is out of the Army and his new QTH is San Mateo. PEA is reconvertng to civilian life. Lt. Comdr. ASE, USNR, is stationed in Oakland. MZQ is in Missouri. QLO is on his way back from Pacific and soon will become a civilian. ZS is moving to a new QTH. MUC has joined the Eimac gang and his new QTH is Redwood City. Among those on ten during the opening days were: CHE, RRR, SC, JDC, GYO, and OKQ. That unexpected day found many of us in new QTHs dusting off chassis and condensers, deep in the heart of a rebuilding job. How about some dope on what you are doing and the DX you are working, fellows? 73. *Sandy.*

EAST BAY — SCM, Horace R. Greer, W6TI, — EC, QDE; EC v.h.f., FKQ; Asst. EC v.h.f., OJU; OO v.h.f., ZM. On Nov. 1st a reorganization meeting of the Oakland Radio Club was held in the Civilian Defense Control Room. The club expects to meet the first and third Thursdays of each month with a \$2.50 initiation fee and dues of 50 cents per month. Although the War Emergency Radio Service is through, most of the members plan on going into other emergency nets as they are organized. We must have a strong system around the bay for any necessity that may arise. GEA is building a new radio room in the basement. TI has a new radio room and is ready to go, using the same equipment with the exception of a new SX-28 receiver. CDA has moved his radio gear into a new radio room in his basement. DUB is rebuilding his old rig for the 10-meter band. ITH is using 500 watts input on 10-meter 'phone. The W6 QSL Bureau will reopen in January. Hundreds of cards have been in storage for the duration. The East Bay Section meetings will be resumed as soon as we get more bands back. Please get the news on your rigs so we may pass along the information. Have you any good ideas? If so, let's have them. In one week just before the 10-meter band opened I received one hundred telephone calls on what's new and what's cooking. ZM likes his new e.c.o. 73. "TI."

ROANOKE DIVISION

VIRGINIA — SCM, Walter G. Walker, W3AKN — The following stations have been copied by the SCM since the 10-meter band opened: MT, IAG, GGP, PK, BEK, HQT, EAI, of the Norfolk, Portsmouth, Newport News area. AJA is putting up a Johnson Q for 10 meters and re-vamping his transmitter with the Signal Shifter as a driver. AKN is building up a ten-meter rig. GSV advertised his radio equipment for sale or swap for an airplane. ICZ bought a home at Yorktown, Va. and will be on the air on 10 meters about January, 1946. IEX, Navy, has returned from the Southwest Pacific and is located temporarily in California. HTV Navy, is stationed at Newport News Shipyard awaiting completion of a new aircraft carrier. He is building a ten-meter transmitter. II has deserted the u.h.f. bands for 10 meters. The W6 stations have been heard working or calling him. Now that the lower frequency bands are being opened your SCM has hopes of receiving news for this column. Please let's hear from all of you. 73. *Walt.*

ROCKY MOUNTAIN DIVISION

COLORADO — SCM, H. F. Hekel, W9VGC — Your SCM reports with deep sorrow the death of our Rocky Mountain Division Director, C. Raymond Stedman, W9CAA, on Nov. 26th. EHC reports his wife should be ready for her ticket soon after Jan. 1, 1946. He also is looking forward to being a W5 instead of a WØ, as he expects to be with CAAUth. JRN is in Norfolk, Va., and has an XYL and as soon as junior gets here, which will be in the spring, Jim will start making plans for his discharge. ZEF is on 10 meters and he has a good-sized family started. No. 1 is a little girl eleven months old and she should have a brother sometime in the spring. UPT was transferred to Ft. Huachuca, Ariz., after three years at Douglas Army Air Field. TFP has taken over the duties of director. 3JIN/9, WYX, QYT, VGC, and JBI are ready to shoot on 2 Mc. and as soon as the tops of the mountains are cleared of snow and the roads are open several others will be ready to get back in the high country to try for DX records, we hope. BVZ spent the winter cruising up and down the east coast of China and expects to be back in Denver in February. 73. *HFH.*

UTAH-WYOMING — SCM, Victor Drabble, W6LLH — 6STB has returned from his RID job in the Hawaiian Islands and is attending B.Y.U. in Provo. He has built an

(Continued on page 84)

Which for You— SCREWDRIVER or SLIDE RULE?



Face the Facts:

**You Must Train Now to Step Ahead
of Competition Into a Good-Paying Job in Radio-Electronics**

— or be left behind because you lack the understanding of new electronic techniques

CREI home-study courses are for professional radiomen only and this CREI message is for those who are not afraid to face the facts! You are facing a completely new era in the radio-electronics world. The war-restricted curtains of secrecy have been pulled aside, revealing each day momentous, revolutionary applications of new radio-electronic principles and theories, and their complicated circuits, equipment, individual parts, etc.

No matter what your past radio-electronics *experience* has been, no matter what your training, *you must keep pace* with the new developments if you expect to get ahead in this *new* world of radio-electronics — or even maintain your present position in the field.

How much do you know about U.H.F. Circuits, Cavity Resonators, Wave Guides, Klystrons, Magnetrons and other tubes? All these revolve largely around U.H.F. applications. And here is where CREI training can

help you. In our proved home-study course, you learn not only *how* . . . but *why*!

Let CREI train you now to trade that "screwdriver" for a slide rule. Do something about increasing your technical ability and advance to the better-paying radio jobs that offer security and opportunity. The facts are in the free booklet. Send for it today.

WRITE FOR FREE 36-PAGE BOOKLET

If you have had professional or amateur radio experience and want to make more money—let us prove to you we have something you need to qualify for a better radio job. To help us intelligently answer your inquiry—please state briefly your background of experience, education and present position.



CAPITOL RADIO ENGINEERING INSTITUTE

HOME-STUDY COURSES IN PRACTICAL RADIO-ELECTRONICS
ENGINEERING FOR PROFESSIONAL SELF-IMPROVEMENT

Dept. Q-1, 3224—16th Street, N. W., Washington 10, D. C.

Contractors to U. S. Navy—U. S. Coast Guard—Canadian Broadcasting Corp.
Producers of Well-trained Technical Radiomen for Industry

MEMBER: NATIONAL COUNCIL OF TECHNICAL SCHOOLS

HQ-129-X
HAS ALL THIS
AT LOW COST!

Send card for technical details.

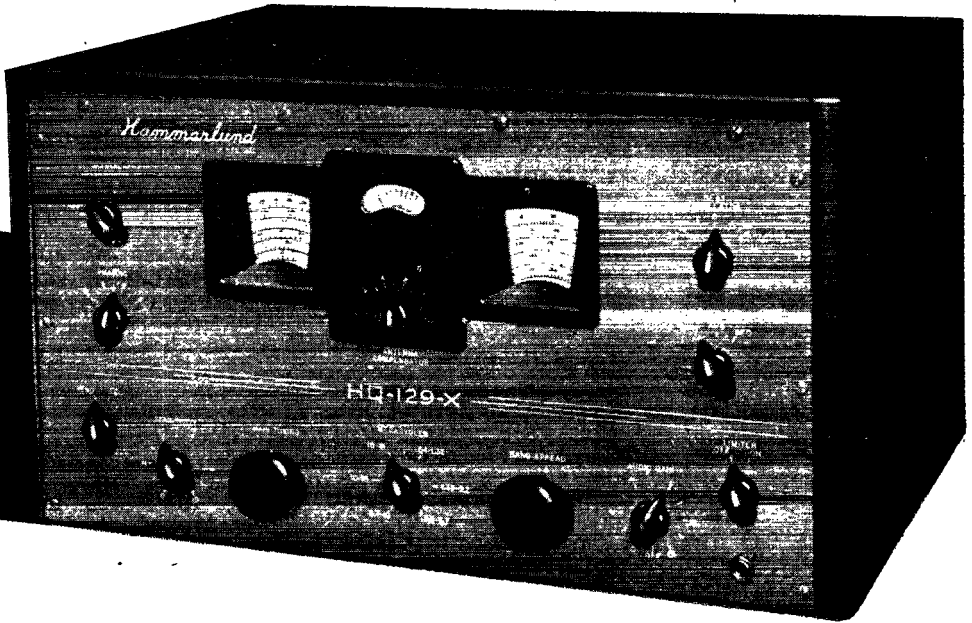

HAMMARLUND

THE HAMMARLUND MFG. CO., INC., 460 W. 34TH ST., NEW YORK 1, N. Y.
MANUFACTURERS OF PRECISION COMMUNICATIONS EQUIPMENT

Full range .54 to 31 M.C. accurately calibrated.

Band spread has four calibrated ham bands and one arbitrary scale.

Variable selectivity crystal filter (a Hammarlund patent) for phone as well as code reception

Low drift beat oscillator for receiving code and locating stations.

Antenna compensator to provide the maximum image rejection and high sensitivity.

Voltage regulation reduces effects of line voltage fluctuation.

Compensated oscillator reduces drift during warm up.

Automatic noise limiter. New series circuit reduces many types of interference.

Adjustable S-meter for reporting signal strength.

Earphone jack cuts out speaker when phones are used.

Send-Receive switch.

Three "IF" amplifier stages.

Two audio stages with improved tone quality and ample volume.

Eleven tubes including voltage regulator and rectifier.

Streamlined appearance finished in attractive two-tone gray.

Amateur net price \$129.00 less speaker. Subject to change without notice.

10" P. M. dynamic speaker in cabinet to match, \$10.50 net.

Dimensions overall, 13" deep, 19½" wide, 11" high, weight HQ-129-X receiver only — 52 lbs. net.



The Symbol of
**QUALITY, VALUE AND
 GUARANTEED PERFORMANCE**
 in Amplifier Kits . . . Transmitter Kits
 and Component Parts

THESE time-tested STANCOR Kits for Amateurs are designed for simplicity, efficiency and usefulness. Backed by the recognized and respected STANCOR guarantee against defects in material and workmanship, they render complete satisfaction.

Full data furnished on each unit . . . description, diagram, illustration . . . for proper assembly, wiring and operation. "Standardized" punched chassis simplifies set-up . . . accommodates variety of equipment without structural change. STANCOR units make possible maximum performance with minimum labor and expense. See your Jobber or write for full details.

STANCOR
 STANDARD TRANSFORMER CORPORATION
 1500 NORTH HALSTED ST. CHICAGO 22, ILLINOIS

IN TRANSFORMERS
STANCOR
 Give More

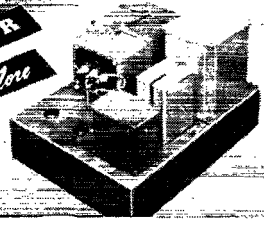

(Continued from page 80)

FB 10-meter 'phone rig; it is a 6L6-807 and is modulated by a 6SJ7-6J5 into a pair of 6V6s, power about 25 watts, 6QAA, Salt Lake City, reports FB success on the new 144-148-Mc. band. He works Provo hams and says 6MAV and 6STD can verify it. (He loads his gear in the trusty ol' auto and drives to Provo). 9PLH is teaching radio to the Bushnell Hospital patients at Brigham City. 6DLR is building his 144-148-Mc. gear in the glove compartment of his car. 9NFX is making numerous contacts on the 10-meter band. 4IHV/6NPU will be on the 10-meter band soon. K6VQP is out of khaki and is getting his gear together. The Ogden Amateur Operators' Club has drawn up a new constitution and by-laws. Membership of the club is growing since the opening of the bands. The Club recently spent an interesting evening at the airport watching the radio-sound experts at work. 6SYD is new OBS for North Utah. 73. Vic.

SOUTHEASTERN DIVISION

ALABAMA — SCM, Lawrence J. Smyth, W4GBV — DGS writes that BOU/-88BQ is back at Fort Belvoir with permanent duty for the fourth time during the war. EBZ is being moved from Kandy, Ceylon to Singapore. EOX and DGS have been on 2 1/4 meters with an HY75 with 35 watts input since the band was opened. DGS called a CQ the other night on 2 1/4 meters and who should come back but GPW. HUE and HPJ have a 2 1/4-meter rig, one in Washington. DLF is on 2 1/4 meters in Washington. GPW is out of the Navy, and has acquired an XYL. GPW is president of the Washington Radio Club and his XYL is secretary. DRZ, who was promoted to lt. comdr., is out of the Navy. EOX has been moved from the Bureau of Ships in Washington to the Navy Radio and Sound Lab at San Diego. CNY, formerly of WAPI in Birmingham, is working on merchant ship radar for Raytheon Co. DGS had over 100 W4 hams drop by for visits during the period of the war, including K. B. Warner, of ARRL. GWH, who now is a married man, is stationed at Norfolk. AUP is going strong on ten with 15 watts. 73. Larry.

EASTERN FLORIDA — SCM, Robert A. Murphy, W4IP — CEG reports from Luzon, P.I., and says 8UYC and 8VXH are with him. EEP has reenlisted in the Signal Corps for another three years and will be at Ft. Monmouth for awhile. IP jr. has changed from airplanes to seagoing vessels and is on the USAT *Simonds*, WXHR. The following have been selected for Official Broadcast Station appointments: BYF, ACZ, and PB. I would appreciate hearing from anyone interested in this or other appointments. We want to do all we can to build up a real Florida net, especially a hurricane net. Let me have comments from you fellows. HDB and AYW are getting together in Umatilla in 80-meter work and are tempted to go on 10 meters. BYF is changing over to 144 Mc. VV is very consistent on 10 meters along with FVV. ECV is in his glory on 10 meters. IP has some new QSL cards to send to fellows he worked on 112 Mc. and wants to hear from you. DZH is in Balboa for PAA. CNZ teaches flight operators in Miami for PAA. IEV is doing nicely on 10 meters since it opened up. Questions are coming in by the dozen and you can get answers by listening to broadcasts from W1AW on 3555, 7145, 14280, and 28245. Try it and see how well you can keep up with the news. Hope you fellows all have a very pleasant holiday season. Let me hear from you about your activities on the ham bands. 73. Merf.

WESTERN FLORIDA — SCM, Lt. Edward J. Collins, W4MS — BKQ lost a 35TG before the rig was on the air. DAO is having the RME-69 tuned up by UW. DXZ is building a new tower for the rotary beam and is on the market for a new receiver. EQR is considering a ground plane antenna for 28 Mc. and is moving his 112 Mc. gear to 144 Mc. QK is replacing some of his masonite panels with metal ones. UW is putting on low power and will have a big rig perking later. EZT is believed to be the first Pensacola station on 28 Mc. ECT is dusting things off. FJR has been copying 1AW. VR is getting his rig in shape. AXF has been prodding the OM to get her rig going on 28 Mc. JV has rented an FB location for nothing but radio. HJA is looking for a receiver for 28 Mc. FHQ and DXQ are awaiting the opening of 7 Mc. MS has the old rig in a new cabinet. BKQ is having trouble with an 807. We hear the 6s working AUP. UW and EZT are working on a b.c. station deal. ASV is back from the wars and working in Pensy. The filament transformer in MS's rig is a Thordarson and has been in use 24 years. ACB is scrambling around to get his gear perking.

(Continued on page 88)

PREVIEW!

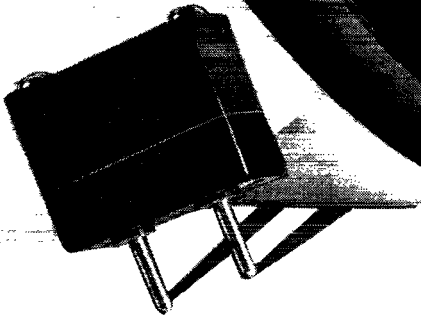

Be on the lookout for Type AX2 when it shows up on your distributor's counter. It's new and a worthy successor to the long line of quality crystals supplied by Bliley to the amateur fraternity over the past 15 years.

There's a huge background of creative experience and advanced engineering packed into this little unit. It represents

a long and intimate acquaintance with the needs of amateur radio, translated into the requirements of today.

Bliley crystal unit Type AX2 has been designed specifically for amateur frequencies in the 80—40—20 meter bands. Your Bliley distributor will have complete engineering and design data.

Bliley
CRYSTALS

**This new BLILEY crystal
type AX2, will be
available soon.**

Keep in touch with your BLILEY distributor.

BLILEY ELECTRIC COMPANY • UNION STATION BUILDING, ERIE, PENNSYLVANIA

NOW — a really high-powered RADIO ENGINEERING LIBRARY

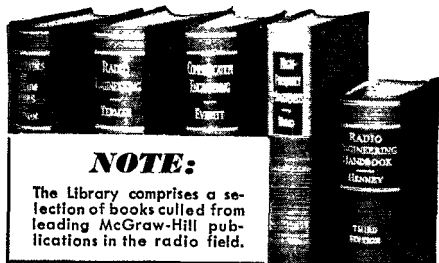

NOTE:

The library comprises a selection of books culled from leading McGraw-Hill publications in the radio field.

- ➔ especially selected by radio specialists of McGraw-Hill publications
- ➔ to give most complete, dependable coverage of facts needed by all whose fields are grounded on radio fundamentals
- ➔ available at a special price and terms

THESE books cover circuit phenomena, tube theory, networks, measurements, and other subjects—give specialized treatments of all fields of practical design and application. They are books of recognized position in the literature—books you will refer to and be referred to often. If you are a practical designer, researcher or engineer in any field based on radio, you want these books for the help they give in hundreds of problems throughout the whole field of radio engineering.

5 volumes, 3559 pages, 2558 illustrations

Eastman's **FUNDAMENTALS OF VACUUM TUBES**, 2nd edition
 Terman's **RADIO ENGINEERING**, 2nd edition
 Everitt's **COMMUNICATION ENGINEERING**, 2nd edition
 Hund's **HIGH FREQUENCY MEASUREMENTS**
 Henney's **RADIO ENGINEERING HANDBOOK**, 3rd edition

**10 DAYS' FREE EXAMINATION
 SPECIAL LOW PRICE EASY TERMS**

Special price under this offer less than books bought separately. Add these standard works to your library now; pay small monthly installments, while you use the books.

— SEND THIS EXAMINATION COUPON —

McGraw-Hill Book Co., 330 W. 42 Street, N. Y. 18

Send me Radio Engineering Library for 10 days' examination on approval. In 10 days I will send \$3.00 plus few cents postage, and \$3.00 monthly till \$24.00 is paid, or return books postpaid. (We pay postage on orders accompanied by remittance of first installment.)

Name.....
 Address.....
 City and State.....
 Position.....
 Company..... QST 1-46

(Continued from page 84)

Would appreciate hearing from all of you fellows about the 15th of each month. The gang is thinking about a real old-time Western Florida hamfest so let's hear from you where and when you want it. 8MJX, 7IQJ, and 9MEI are rarin' to get on ten. 73. *Eddie.*

SOUTHWESTERN DIVISION

LOS ANGELES — SCM, H. F. Wood, W6QVV — How about sending information on your activities and on nets formed? Some new OBS and EC appointments have been made but there are a number of spots not yet covered by ECs. If you are able to take on the job of organizing a net in your community, please get in touch with me. We believe that the work that was done in developing and training personnel for WERS work will be of great help in forming new set-ups and it is suggested that you keep your group intact, if possible. The Los Angeles City group is carrying on under this plan and Fred Stapp reports that Inglewood is doing the same. Equipment is being converted for use on the 144 Mc. band and is working out well. Stu Walmsley, secy. of the Inglewood Club, states that the club meets twice a month in Memorial Hall. The Valley Club meets each Friday. Large increases in membership of these clubs have been reported. The Glendale Club has been reactivated and meets the first and third Wednesday night of each month at Spar Heights Club House. Temporary officers are: MQA, pres.; MMF, secy.; and TUT, treas. EQM is serving well in getting the club under way again. Plans are being made for the next convention for the Southern area. New officers of the Inglewood Club are: QIR, pres.; MSO, vice-pres.; EKM, rec. secy.; RNN, corr. secy.; Harry Mintum, treas.; and QXB, sgt. at arms. Quite a gang have gathered in the El Monte area and those present at the first meeting, held at the home of 9CSB/6, were: 5JFM/6, ICS, VON, OQB, AAN, SYG, 8VHN/6, 9IKZ/SSU, UHO, and SCQ. ON has been appointed OBS for the San Dimas area. EQM has been appointed EC for the City of Los Angeles to head the radio communications division of the Citizens' Emergency Corps. KEI and GZZ have been appointed OBS for the Valley section and the Los Angeles area, respectively. AEL, SSU, UQL, QVV, and MFJ have their new rigs at the testing stage. A Happy and Prosperous New Year to all of you. Please get reports in so all can know what we are doing here in Southern California. CUL. *Ted.*

ARIZONA — SCM, Douglas Aitken, W6RWW — The 25 Club of the Tucson Short Wave Association, with OZM, RNB, SGF, TJH, TCQ, RMB, OWX, TXM, GS, JHF, 9DZA, and 8WEU in attendance, held a meeting recently and a good time was reported. Plans are under way to organize a State ham convention to be held about April of next year. MLL is in Tombstone taking chlorine treatments. UNN has been dabbling with 2½-meter stuff. Fellows, please drop a post card and let us know where you are and what's doing. 73. *Doug.*

SAN DIEGO — SCM, Ralph H. Culbertson, W6CHV — Asst. SCM, Gordon W. Brown, W6APG. QEZ has returned home with his new XYL. APG is operating on the new 2-meter band; he has his 10-meter mobile ready to go in the car. OLT is visiting in San Diego with his XYL. AIY, OZH and QEZ are operating on ten meters. PAX had the rig all set to go on the air but he now is in Los Angeles going to college and the rig is in La Jolla. APG, QEZ, DUP, and CHV have been copying WIAW on 7145 kc. The Palomar Radio Club held its first meeting at the home of Bill Gilmore, secy., La Jolla, with about eighteen of the old members present, including APG, QEZ, BKZ, BOS, CHV, DUP, MHL, NDD, TBI. Also present were several new amateurs who have applied for membership. It was decided that each member would give a short talk on his work during the war. An FB raffle was held with BKZ walking away with five or six prizes. Merry Christmas and Happy New Year to all the gang. *Ralph.*

WEST GULF DIVISION

NORTHERN TEXAS — SCM, Jack T. Moore, W5ALA — DLP has opened a radio shop in Dallas. CJJ is out of the Navy. 9FLG has moved to Dallas and is working for Guiberson Corp. ARV is home after a trip overseas. GCJ, home from the Navy, got on the bus the other night and met DZI — the last time they had seen each other was on Treasure Island in 1942. EQJ has opened a service shop in Dallas. AJG says beam antennas are the hot stuff on 112

(Continued on page 80)

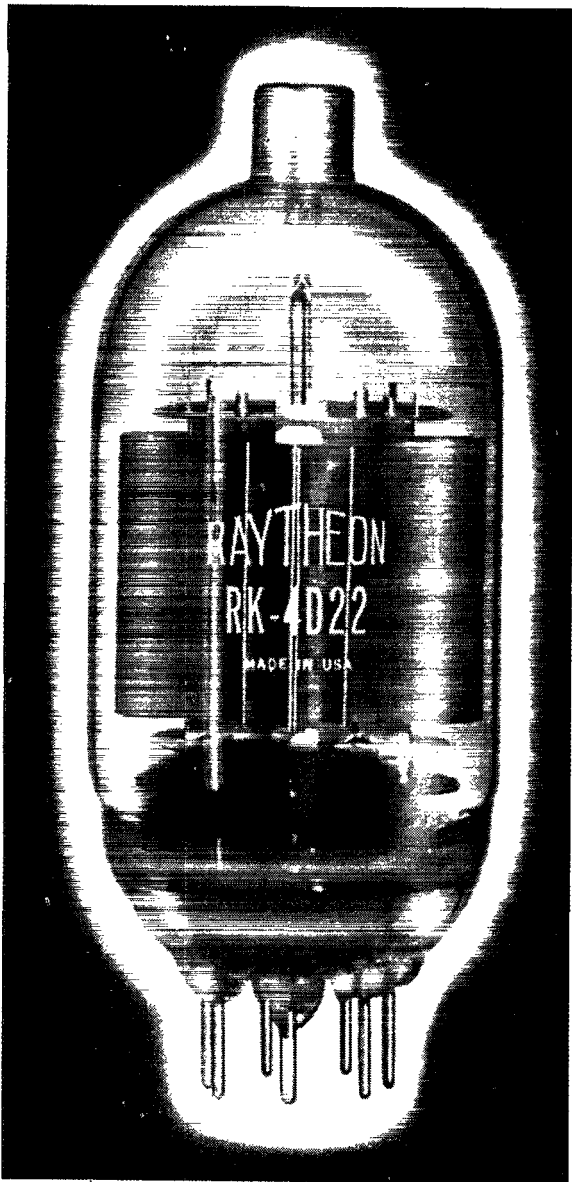

ACTUAL SIZE

New RAYTHEON BEAM AMPLIFIER

100 watts at 600 volts

Six Important Facts About RK-4D32 and RK-4D22

- ① Over 100 watt output at 600 plate volts.
- ② Low driving power requirements less than 1.25 watts required for full output.
- ③ High efficiency due to beam tetrode construction.
- ④ Full efficiency and no neutralization up to 60 megacycles.
- ⑤ Ruggedized construction for mobile and aircraft service.
- ⑥ 125 watts of undistorted audio output can readily be obtained from a pair.

Of special interest is Raytheon's newest cathode type beam amplifier. Capable of delivering 100 watts output with only 600 volts on the plate, this product of Raytheon research is of ruggedized construction designed particularly for ham use. It offers particular advantages for making a low powered, low cost, 100 watt band switch transmitter.

This new beam tetrode typifies Raytheon advanced engineering and precision manufacture. For any other tube application you may have, there is a Raytheon tube engineered to do that job, give you continuing satisfaction.

RATINGS

FILAMENT RATINGS

RK-4D32	6.3 volts at 3.75 amps.
RK-4D22	25.2 volts at .8 amps. or 12.6 volts at 1.6 amps.

MAXIMUM RATINGS CLASS C TELEGRAPHY

D.C. Plate Voltage	750 volts
D.C. Grid Voltage	-200 volts
D.C. Screen Voltage	350 volts
Plate Dissipation	50 watts
Screen Dissipation	12 watts



Excellence in Electronics

**POWER TUBE DIVISION
WALTHAM, MASSACHUSETTS**

COPYRIGHT 1948 RAYTHEON MANUFACTURING COMPANY

ANOTHER IMPORTANT

FROM MAGUIRE

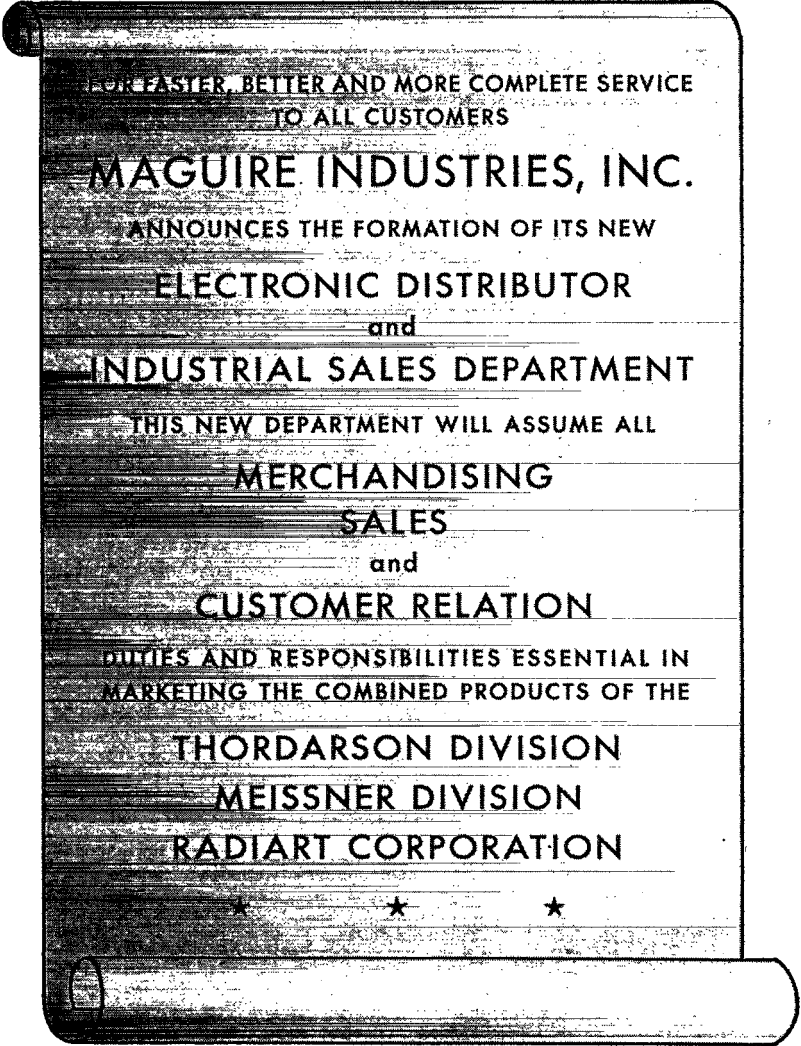

FOR FASTER, BETTER AND MORE COMPLETE SERVICE
TO ALL CUSTOMERS

MAGUIRE INDUSTRIES, INC.

ANNOUNCES THE FORMATION OF ITS NEW

ELECTRONIC DISTRIBUTOR

and

INDUSTRIAL SALES DEPARTMENT

THIS NEW DEPARTMENT WILL ASSUME ALL

MERCHANDISING

SALES

and

CUSTOMER RELATION

DUTIES AND RESPONSIBILITIES ESSENTIAL IN
MARKETING THE COMBINED PRODUCTS OF THE

THORDARSON DIVISION

MEISSNER DIVISION

RADIART CORPORATION

★ ★ ★

**ELECTRONIC DISTRIBUTOR AND
INDUSTRIAL SALES DEPARTMENT**

ANNOUNCEMENT

INDUSTRIES, INC.

**THESE SUPERIOR PRODUCTS NOW
AVAILABLE FROM A SINGLE SOURCE**

THORDARSON

TRANSFORMERS

Precision engineered and quality built transformers for all requirements...replacement, communications, sound amplifier, industrial, experimental and amateur.

TRU-FIDELITY AMPLIFIERS

In new, modern designs featuring advanced tone compensation, conservative ratings, ample ventilation, low hum level, multiple input channels and maximum flexibility of controls.

**Meissner**

COMPONENTS

Precision-built components including antenna, R. F. and oscillator coils; standard, plastic and Ferro-cart transformers; windings, coils, chokes and accessories.

SERVICE INSTRUMENTS

Meissner Analyst—operates by "signal tracing" method, fastest and most reliable—furnished complete. Signal Calibrator—a portable self-contained unit.

Radiart

VIBRATORS

Radiart Correct Replacement Vibrators are individually engineered to meet exactly the physical as well as the electrical requirements of each application.

RUST-PROOF AERIALS

A complete line of newly designed aerials to fit all cars; 3 and 4 section models—cowl, fender and under hood types . . . all made of finest materials.

SEE FOR YOURSELF!

See the outstanding products of the Electronic Divisions of Maguire Industries, Inc., at the Winter Meeting of the I. R. E. at the Hotel Astor, New York on January 23 to 26.

MAGUIRE INDUSTRIES, INC.

936 NORTH MICHIGAN AVENUE, CHICAGO 11, ILLINOIS

Books that tell you how



...and **WHY**
IN PLAIN, EASY-TO-
UNDERSTAND ENGLISH

1. Introduction to Practical Radio

By D. J. Tucker

Teaches all basic principles with the clarity and thoroughness needed for complete mastery of these essentials. Explains all the necessary mathematics at the points where it is used. Shows in hundreds of examples how to apply theory in the construction and operation of radio parts and circuits and in the solution of typical radio problems. Written by the chief engineer of WRR, KVP, KVPA, Dallas, and owner of the famous ham station W5VU. Large print. Many illustrations. \$3.00

2. Principles of Radio for Operators

By Ralph Atherton

Very clear, easy-to-understand explanations of the operating principles of every part of radio, with full material on antennas. Uses the effective instruction methods and materials developed for Navy Communications and Signal Corps training. Teaches all fundamentals of the construction, servicing and operation of radio equipment. Much practical reference data in appendix. Nearly 500 illustrations. \$3.75

3. An Introduction to Electronics

By R. G. Hudson

A simple but complete explanation of the underlying theory, with descriptions of the construction of the basic electronic devices and their uses in sound and picture reproduction, control apparatus, power and many other fields. Illus. \$3.00

FREE EXAMINATION COPIES

The Macmillan Company, 60 Fifth Ave., N. Y. 11
Please fill my order for the books checked by number below, with the understanding that my bill will be cancelled if I return them within 7 days.

1. 2. 3.

Signed

Address

A

(Continued from page 86)

Mc. COK advises the QRM on 23½ is really rugged. IJQ is rebuilding his rig to use a T55 in the final, and is putting up a new beam. He says the boys around Pampa are getting up a WAP (Worked All Pampa) certificate for 28-Mc. 'phone work, and advises that the Pampa Radio Club was active all during the war. Herman sends the following dope: IWQ is all set to get on the air; JAD, the only XYL with a ticket in Pampa, is ready with a Class A license; IZW, JAD's OM, is keeping caught up on his farm work so he will be ready to throw the switch; HVP has returned to a hospital in Chicago after a 30-day furlough; JHA has reworked the rig and is waiting in line; JZB, now in Phillips, has put fresh paint on the old beam; IYI is out of the Army and ready to go on 28-Mc. 'phone; ELO is putting his 28-Mc. 'phone transmitter in a rack. HMO, who is sweating out a discharge, sends the following news: ZZF is back servicing; HLS is flying B-29s but hopes to get out soon; AWP is working for T. & P.; HRA is out of the Navy; HVE pounded brass for the merchant marine but is home now. EHZ is doing experimental work in electronics, and has received a patent on a new type dial. Ross sends the following news: DUZ and IRB are ready to get on the air; GFN and IY are in the Navy; EVN is somewhere in the West Indies working for Pan-American; QA is snowed under with radio work; SP is making plans to get back on the air; DVQ is building a new house; HDG does service work when not busy as radio engineer for the City of Abilene; AAO keeps busy with his medical supply store; AUJ is in the wholesale automotive parts business; BKH is a Lt. comdr. in the Navy; Lt. Comdr. AUL saw heavy action in the West Pacific; BFI is with the Geophysics Dept. of Stanolind Oil & Gas Co. in Houston. NW will be back on the air soon. The SCM enjoyed a visit with the Kilocycle Radio Club of Ft. Worth, which meets on the second Thursday night of each month at the local YMCA. 73. Jack.

OKLAHOMA — SCM, Ed Oldfield, W5AYL — Quite a number of us now realize how much we need a little code practice. Receivers and transmitters are getting a brisk dusting and a quick overhaul. Antennas again are beginning to contaminate the symmetry of the landscape. Fever is mounting in the race to be ready "when and if." The OCARC is operating full swing and has welcomed a number of recently-returned veterans. HRT, who was in the Philippines at the beginning of the war and a prisoner of the Japs for three years, gave the club a very interesting account of happenings during that period. ARM, CVJ, and IFA gave a resumé of their stay and activities in the service of the country. The club constitution is being modified, and a lot of the fellows who did not keep their membership in ARRL in good standing now are getting behind to help push amateur radio to the top. New licensees are catching that contagious desire to "get going." OCARC will need a tremendous amount of cooperation in the coming year in preparation for the West Gulf Division Convention to be held next fall. AYL is extremely interested in hearing from all hams and clubs in the State. There's plenty of news, how about a little of it? Regards. Ed.

SOUTHERN TEXAS — SCM, James B. Rives, W5JC — FAR and CRI are on terminal leave from the Army Air Forces and have returned to San Antonio. EOS is teaching at Harlandale High School. GKI is in India. Capt. CNA has received his discharge after several years in the Pacific theater and is ready to get on the air in Austin. BKE is back and is assistant station manager for Braniff Airlines in San Antonio. NW has moved to Iraan. EHM won the 112-Mc. contest sponsored by the San Antonio Radio Club. ITU, KSB, and DCS are on 28 Mc. in Austin. JAK is active at Wink. KFP is instructor in E.E. at U. of Tex. 6TYF left Austin for overseas duty with the Navy. 9KFM is attending Tex. U. and is active on 28 Mc. CRT, back from the Navy, is located in San Antonio. 73. Jim.

CANADA

MARITIME DIVISION

MARITIME — SCM, A. M. Crowell, VE1DQ — 3AML reports that the reorganization meeting of the Moncton Amateur Radio Club was called by the past-president, 1CX, on Oct. 9th. There were approximately twenty members in attendance. A committee was appointed to bring in a slate of officers at the Nov. 13th meeting. The following officers were appointed: 1EL, pres.; 1LP, vice-pres.; 3AML, secy-treas. The following members were pres-

(Continued on page 92)



Favorite rectifier FOR HAM RIGS

Type GL-866-A/866

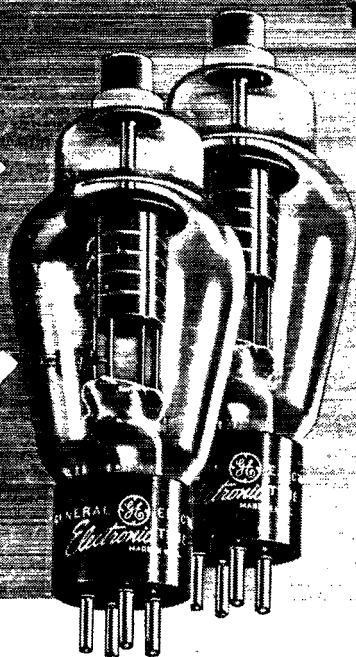

\$1.50

AMATEURS BUY PLENTY of these mercury-vapor rectifiers—and for a good reason. In dollar-value the GL-866-A/866 stands alone. A pair will deliver 3,180 volts at 0.5 ampere (full-wave rectified d-c)! Usually that's more than enough for your transmitter.

The GL-866-A/866 is sturdily built. Also, an edgewise-wound ribbon filament provides a large emission re-

serve, which contributes importantly to the tube's long life.

Check with your ham friends as to the all-around staunch performance of Type GL-866-A/866. Condensed ratings are given at the right. Your nearest G-E distributor will supply you with further information, or write direct to: *Electronics Department, General Electric Company, Schenectady 5, New York.*

CHARACTERISTICS of Type GL-866-A/866

Cathode type	filamentary
Cathode voltage	2.5 v
Cathode current	5 amp
Peak voltage drop, typical	15 v
Max anode voltage, peak inverse	10,000 v
Max anode current, instantaneous	1 amp
Max anode current, average	0.25 amp

ELECTRONIC TUBES OF ALL TYPES FOR THE RADIO AMATEUR

GENERAL ELECTRIC

161-E2-8880

AT LAST!!

A Complete, Practical Handbook of Present-day TELEVISION

Now, the tremendous opportunities in the field of television are brought within your reach—by means of this crystal-clear book. Written in plain English, concise and up to the minute, it makes television easy to understand. There is no mathematics to confuse you and make explanations difficult to follow. Hundreds of vivid illustrations bring every fact and point right before your eyes. You'll be amazed at how simple television can become with



TELEVISION SIMPLIFIED

by MILTON S. KIVER

Associate Instructor in radio, U.S. Army Air Forces. Formerly Instructor in radio, Illinois Institute of Technology.

This brand-new, authoritative handbook not only contains all the information you need for success in television, but covers the trouble shooting and repair of radio sets. Beginning with a clear, overall picture of the entire field, it breaks down the television receiver into its component parts and circuits. It analyzes them, step by step, showing how they are formed, the roles they play, and their operating characteristics.

BRIEF OUTLINE OF CONTENTS

The Television Field; Ultra-high Frequency Waves and the Television Antenna; Wide-band Tuning Circuits, Radio-frequency Am-

plifiers; The High-frequency Oscillator, Mixer and Intermediate-frequency Amplifiers; Diode Detectors and Automatic Volume-control Circuits; Video Amplifiers; Direct-current Reinsertion; Cathode-ray Tubes; Synchronizing Circuit Fundamentals; Deflecting Systems; Typical Television Receiver—Analysis and Alignment; Color Television; Frequency Modulation; Servicing Television Receivers; Glossary of Television Terms.

EXAMINE THIS BOOK FREE

Let this great book prepare you to take advantage of the brilliant opportunities television offers. Send for it NOW!

MAIL THIS COUPON

D. VAN NOSTRAND COMPANY, INC.
250 Fourth Avenue, New York 3, New York

Please send me "Television Simplified." Within 10 days I will either return the book or send you \$4.75, plus a few cents postage. (If you enclose check or money order for \$4.75 with this coupon we will pay the postage. Same return privilege, and refund is guaranteed.)

Name

Address

City

State

Q. S. T.—Jan. 46

(Continued from page 90)

ent: 1EV, 1GL, 1LP, 1JG, 1ND, 4BB, 4WE, 4ANO, 5DT, 1LD, 1MI, 1BE, 1FT, 5AHQ, 1MV, VO3Z, 1EL, 3AML, A. O. Cassidy, G. O. Leblanc, E. Pellerin, H. Surrette, B. Meal, F. Bourque, R. Bourque, B. Rayworth, and E. Koulinski. At the present time the club membership is thirty-six but it is expected that total club membership will reach forty-five by the next meeting. 1KS writes in about renewing his OPS, ORS, and OBS appointments and offers to take any other appointments or jobs. He also is interested in again becoming a member of the AEC. KJ, who sends the following items, is planning on 807s modulated by 811s. CW has a new rig full of 6L6s and 3Y5s. BD is building a rig with T125s in the final, modulated with TZ40s. AP, out of the Navy, has a shiny 813. AF, discharged from RCAF, is starting radio servicing business in Summerside. CO is building new rig. FR is working in New Brunswick.

ONTARIO DIVISION

ONTARIO — SCM, Donald R. Gunn, VE3EF — The following report was sent in by 3AZ: 3EF, our SCM, has retired to the Reserve RCAF after having attained the rank of wing commander and having been deputy director of signals communication for the RCAF. He is living in Oakville and has returned to the staff of the Ontario Hospital at New Toronto. These reports, which 3AZ undertook while 3EF was on active service, will henceforth be written by the SCM. Before closing this phase of amateur radio, however, your editor wishes to take this opportunity to thank all who were kind enough to send in news items from all parts of the world during the past six years. Without your assistance the VE3 column would not have been possible. All Canadian amateurs are happy to learn they can pursue their hobby once more and there is much activity these days getting receivers and transmitters to "perk" again. C U on the air soon.

QUEBEC DIVISION

QUEBEC — SCM, L. G. Morris, VE2CO — 2GK, 2FK, and 2OG were logged on Nov. 15th operating 28-Mc. 'phone. 2OG crashed the front page of that day's *Montreal Herald* with a feature picture of his big rack and panel job. Welcome home, 2CD and 2JT. These chaps, both RCAF officers, were POWS for several years, CD being captured in Java and JT in Singapore. 2AB has been appointed vice-president of the Provincial Transportation and Communications Board of Quebec. Two Montreal district associations are active — Le Cercle Canadien-Francais de la T.S.F. and the South Shore Amateur Radio Club. The Montreal Amateur Radio Club will be going again soon. Lt. Col. 2LE has been engaged for some months in the study of principles and applications of radar in storm detection at NDHQ, Ottawa. 1KG and 3ASX are instructors at the Montreal Technical School where they have formed a club made up of some forty-five students interested in becoming hams. Let's have news for this column, OMs. You can reach your SCM by calling Dexter 5511.

VANALTA DIVISION

ALBERTA — SCM, C. S. Jamieson, VE4GE — We are indebted to 4LQ for the report this month. The Edmonton boys are getting some much-needed code practice copying WIAW's official broadcasts. The NARC held a well-attended meeting in October. The CGM's circular letter came up for discussion and a suitable reply was framed. 4HM is very busy digging up parts of his rig, and has rebuilt his frequency meter. 4ATI, who was s/gt. with RCCS overseas, is back again and working for N.A.R. 4ATJ returned from overseas and was present at the October NARC meeting. We recently saw 4JL hauling quantities of antenna wire out of 4BW's joint. 4JP breezed into Edmonton for a short visit. He has his rig under renovation, his receiver in Calgary is being realigned, and he has built a basement ham shack. 4RU attended the meeting and renewed his *QST* subscription. Edmonton hams were given a demonstration of handie-talkie sets used by the U. S. Army. 4HJ, a confirmed c.w. man, was left speechless when his turn came to operate the gadgets! 4LQ erected two 40-foot sticks for antenna. 4XE, 4HM, and 5MJ gave a hand at the pole-raising. The gang retired to HM's shack to replace halyards on his masts and in the process managed to knock about a foot off the top of HM's chimney! 5MJ will be signing a VE4 call soon, and tells us 5SO is released from RCAF and is back

(Concluded on page 98)

ASTATIC PRODUCTS

*Have Always
Served the*

RADIO AMATEUR FIELD

D-104

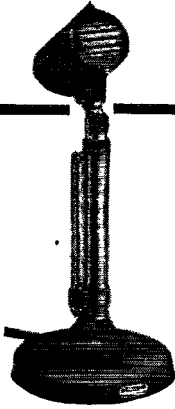

GDN
SERIES

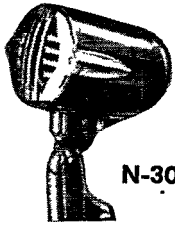

N-30

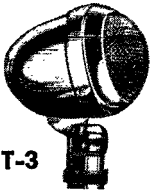

T-3



DN SERIES

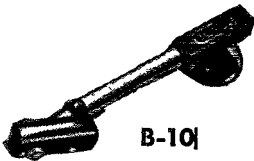

B-10

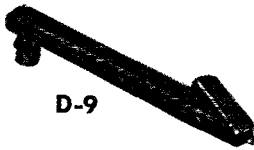

D-9

No relationship could be closer than that existing between veteran amateurs and The Astatic Corporation. Evidence of this relationship is found in the continued demand for Astatic Model D-104 Microphones, originated away back in 1933 and still, today, a favorite with many hams. With the gradual lifting of restrictions and a revival of amateur activities, Astatic looks forward to again serving this important field of radio. Microphones and Phonograph Pickups, long restricted to military use, are once more available, along with new and improved products being engineered and added from time to time to the Astatic line.

*Astatic Crystal Devices manufactured
under Brush Development Co. patents*

THE
Astatic
CORPORATION
CONNEAUT, OHIO
IN CANADA: CANADIAN ASTATIC LTD., TORONTO, ONTARIO

"You'll HEAR MORE
from Astatic"

3D23

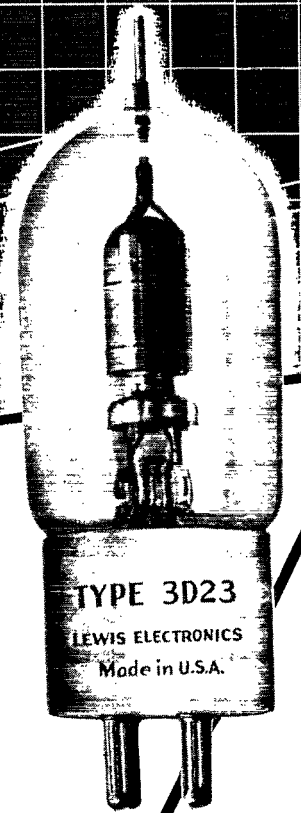
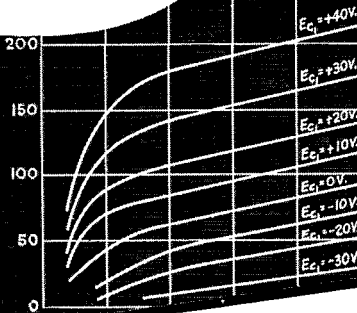

This is the Tube you hams have been seeking to install in your postwar transmitters

A remarkable new TETRODE for fixed or mobile operation

- Filament Voltage 6.3 AC or DC Volts
- Filament Current 3.0 Amperes
- Amplification Factor 65
- Mutual Conductance 2,750
- Plate Dissipation 35 Watts
- Medium 4 Pin Ceramic Base
- Maximum Power Output 130 Watts
- Approx. Driving Power 4.5 Watts

Inter-Electrode Capacities

- Input to Plate2 MMFD
- Input, 6.5 MMFD Output, 1.8 MMFD

Licensed under R. C. A. Patents

Catalog Sheet and Tubes Now Ready for Distribution

Lewis at Los Gatos

Manufacturers of all types of transmitting tubes — from 35 Watt West Coast type diodes to 35 kilowatt internal anode, multi-grid tubes. — A new member of the Aireon family.

Lewis Electronics, Los Gatos, Calif.

SUBSIDIARY OF **Aireon** MANUFACTURING CORPORATION

Aireon

Cinaudagraph Speaker

The Speaker of Tomorrow, TODAY

The Aireon Cinaudagraph Speaker is a product of deft engineering, vast experience, daily profound research and proved performance. It has an international reputation for tone, stamina and perfection. The plus features that you get in Aireon Cinaudagraph Speakers are inherent—born of the highest standards of inspection and use of the finest materials. You'll need these extra—these plus factors to help you do the better job you now require.

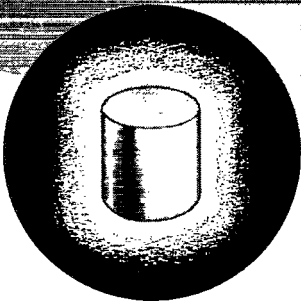
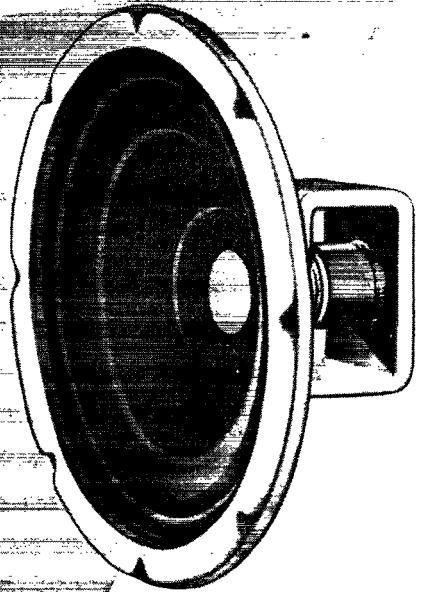

(ALNICO 5)

All P. M. Models of Aireon Cinaudagraph Speakers use Alnico 5, the miracle metal that gives you 4 times the performance without size or weight increase. No amateur set-up is complete without at least one—write for information, today.

Cinaudagraph Speakers, Inc.

Subsidiary of **Aireon** Manufacturing Corporation

3911 SOUTH MICHIGAN AVENUE, CHICAGO



HARVEY has it

... if it's ham equipment
... if it's possible to get

HARVEY has stocks of communications equipment, from complete transmitters and receivers right down to hard-to-get component parts. Some of these are the first postwar developments of leading American manufacturers with the very latest improvements and performance capabilities. Some are articles ordered by our Armed Forces in wartime (and manufactured to conform with their extremely rigid specifications) which are now available to you at great savings because of the sudden cessation of hostilities. Quantities are still limited, but as long as the supplies last, equipment and components will be delivered immediately.

Look over these values!



SIGNAL CORPS KEY . . . J-38

3/8" contact; shorting arm; beveled bakelite base; rugged construction. **SPECIAL, \$1.95**



D-B METER \$6.95

Westinghouse, 3 1/2" round case; -10 to +6db scale; 2.5V Zero level; 5V full scale; excellent output meter.

829 PUSH-PULL R-F POWER AMPLIFIER

Brand new; fully guaranteed; made by nationally known manufacturer.

SPECIAL \$4.95 Socket to match 829 **\$1.05**



In Stock!

THORDARSON C.H.T. MULTI-MATCH MODULATION TRANSFORMERS T-11M77

300 Watts capacity; 30 pounds of Thordarson's Premium Quality Line. **\$21.60**

WRITE, WIRE OR TELEPHONE HARVEY!

Telephone: LOnacre 3-1800

HARVEY RADIO COMPANY HARVEY

103 WEST 43rd ST., NEW YORK 18, N. Y.

(Continued from page 98)

at Vernon. 4BW took a plane trip down East to do some buying and promises plenty of new gear soon. He will make his postwar debut with a pair of 807s in final, in parallel. 4BV showed some home movies at the recent Cine Club meeting. 4ATH laments the fact that he has no antenna up yet. 4VJ, on the sick list, is showing genuine interest in W1AW's official broadcasts. 4ZI now has two jr. operators and two jr. YL operators! Notes from 4ZI: The SARC, of Lethbridge, has reorganized. 4EO's XYL still chalks up marksmanship records. 4ALI knocked over fifty new subscriptions to QST. 4PZ has been discharged from the RCAF and is back home. 4ARC moved to Champion to operate a general repair shop. 4ADY got a letter from 4GD advising him to be a good BCL and listen for news on the reactivation of ham radio! 4AEV reports that ham activity is booming in Calgary again. 4SW is ironing the bugs out of Norm's equipment. 4IN, an officer in the RCAF, was stationed in Calgary until recently. He now is at Clinton, Ont. on a special course and says he will not let the old "Haywire Net" down. 4AHZ and 4APA were ready to throw the switch on Nov. 15th. 4EY has the rig all set to go on ten meters. Cpl. 4ANS is stationed in Edmonton. 4EA is struggling with a new rig for 10-meter work. He has his receiver pretty well ironed out now. 73.

BRITISH COLUMBIA — SCM, C. O. I. Sawyer, VE6DD — The following news was sent in by 5DY: The Victoria Short Wave Club is again active and on Nov. 19th the following officers were elected: 5CH, pres.; 5HR, vice-pres.; 5DY, secy.; E. Lindley, treas.; 5GB, 5EC, 5AAZ, and 5IE, directors. Shortly after this meeting the executive committee got together to lay plans for resumption of the usual activities. These include classes for beginners in both code and theory, reconstruction and operation of the club station, 5EZ, and the completion of the club house. Plans were made for the raising of extra funds for this latter purpose. The annual meeting followed a dinner at the Strathcona Hotel, at which forty-one attended, including: 4FM, 4MN, 5AAZ, 5AAM, 5ABU, 5ACE, 5ADB, 5ADY, 5AEF, 5AFV, 5AGN, 5AHK, 5CH, 5DY, 5EC, 5GM, 5HR, 5IE, 5IL, 5OS, 5PO, 5PX, 5RX, 5TZ, ex-5CO and ex-5EE. A number of the Victoria gang are going to town on 28 Mc., including 5AAZ, 5CB, 5HR, and 5ZM, and the following are known to be planning to use that band: 5EC, 5CH, 5SW. 5OR, recently in the RAF in S.E. Asia, is believed to be en route home. 5SP, taken prisoner of war at Hong Kong, will be released from military hospital immediately. 5EP and 5QH are on the way home from their station in Australia with an Army Signals unit. New settlers in this section include 3AUU, 4KP, 4MN, 4FM, ex-4IC, 4BH, 4ASD, 4AGQ, 4ZC, and 4XY.

PRAIRIE DIVISION

MANITOBA — SCM, A. W. Morley, VE4AAW — First to report being back on is our great DX hound, 4RO. 4SO is struggling hard to get down to 10 meters. 4QG has been transferred to Regina. 4ABV is out of the RCAF, and we understand he is married. 4NM got married and ducked out of the Peg. Frank and the XYL have settled down in Montreal, where he is with TCA. 4FV, from Brandon, is in Winnipeg on business. "Unk" tells me he will make Montreal his headquarters but expects to come West several times a year. 4AJJ will soon be heard on 10 meters. The new radio station due to open soon in Winnipeg has 3AZP and 4AMC on the staff. 4JN is out of the RCAF and was in town recently. 4ABE is back at work after being discharged from the Navy. 4YM leaves for Flin Flon at the end of the month. Ham radio is back! 4AAW was in four bookstores looking for a copy of the latest *Handbook* but the answer was always, "Sorry, sold out." I expect a lot more news now that we are back on. How about you? Season's Greetings, gang. 73. Art.

Strays

Are you hearing a miscellaneous jumble of untunable signals in the 28-Mc. band? If so, look to your antenna change-over relay and clean up its contacts. Oxidized silver is probably acting as a rectifier.

CRYSTAL PRODUCTS, INC.
1519 McGee, Kansas City, Mo.

Send me.....Quartz Crystal Amateur Kits as advertised, Postpaid.
 Cash Enclosed. C. O. D.

NAME.....

ADDRESS.....

CITY.....STATE.....

USE THIS ORDER-BLANK TODAY

For Your Amateur X-Tal Kits!

COMPLETE ONLY
\$1⁰⁰
POSTPAID

**QUALITY
GUARANTEED**
by a Company
that has made
more than two
million crystals
for the Armed
Forces.



Each Kit Contains:

3 CRYSTAL BLANKS

These crystals are approximately 50 to 100 kc. below fundamental frequency of 7,000 kc., but can be ground to 7,000 kc. or over (with enclosed abrasive) to any desired frequency within the amateur band. The fundamental frequency can be doubled and redoubled to become operative at 14 mc. or 28 mc. or up.

2 HOLDERS

Complete with both regular electrodes and springs.

2 ADDITIONAL SETS of ELECTRODES

1 BAG ABRASIVE

for grinding crystals to desired frequency together with folder of instructions for most efficient method of grinding crystals.

Additional crystals, holders and electrodes may be secured.

Special Prices to Jobbers

Main Office:
KANSAS CITY, MO.

Crystal
PRODUCTS COMPANY

Canadian Distributors:
MEASUREMENT ENGINEERING
104 Lombard St.
Toronto 1, Canada



Vertical Antennas

Give Better Reception

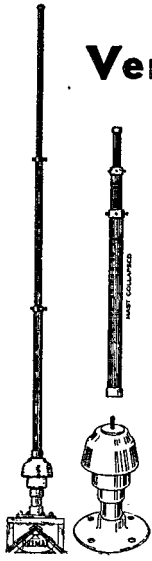

Premax Vertical Antennas are available in steel, monel, aluminum and stainless steel . . . the tested and tried designs that were so successful in the services of the army and navy. See your jobber . . . or write for complete information on the type of antenna you require.

Premax Products

Division Chisholm-Ryder Co., Inc.

4615 Highland Avenue

Niagara Falls, N. Y.

Read **AUDELS MECHANICS GUIDES** for profit

INVEST 15 MINUTES A DAY

Books on shelf: DIESELS, PLUMBING, WELDING, MACHINERY, BOILERS, AUTO SERVICE, ELECTRIC WORK, PAINTING, SHEET METAL, RADIO, WIRING, DIESELS, PLUMBING, WELDING, MACHINERY, BOILERS, AUTO SERVICE, ELECTRIC WORK, PAINTING, SHEET METAL, RADIO, WIRING, DIESELS, PLUMBING, WELDING, MACHINERY, BOILERS, AUTO SERVICE, ELECTRIC WORK, PAINTING, SHEET METAL, RADIO, WIRING.

Every Mechanic can Step Up his Skill with AUDELS GUIDES. Containing Practical Inside Information in a Handy Form. Covers facts and figures of your Trade. All illustrated and explained. Books sent to you for 7 Days Free Examination. Send No Money—Nothing to Pay Postman. Check and Mail Coupon Today.

MAIL ORDER

AUDEL, Publishers, 49 W. 23 St., New York 10, N.Y.

Mail for 7 days free trial books marked (X). I agree to mail \$1 in 7 days on each book ordered and \$1 a month until purchase price is paid. If I am not satisfied with guides, I will return them.

- | | | |
|---|--|---|
| <input type="checkbox"/> WELDERS \$1. | <input type="checkbox"/> AUTOMOBILE \$4. | <input type="checkbox"/> REFRIGERATION \$4. |
| <input type="checkbox"/> BLUEPRINT 2. | <input type="checkbox"/> RADIO 4. | <input type="checkbox"/> MATHEMATICS 2. |
| <input type="checkbox"/> MACHINIST 4. | <input type="checkbox"/> PLUMBERS 6. | <input type="checkbox"/> CARPENTERS 6. |
| <input type="checkbox"/> ELECTRICITY 4. | <input type="checkbox"/> SHEET METAL 1. | <input type="checkbox"/> DIESEL 2. |

Name _____

Address _____

Employed by _____ QST

It Seems to Us

(Continued from page 11)

bleeder resistors have opened up. The thing can be positively lethal. You're contemptuously familiar with it because you built it but the chances are that you've forgotten some of its connections and in any event you can't trust the condition of components after four years of idleness. Before the war we had lost some brilliant amateurs through electrocution and a considerable number had had horrible injuries. Most of us counted ourselves fortunate because we could remember by what narrow margins we had escaped similar fates. In 1939 *QST* formulated safety codes both for operation and for apparatus construction, and you may remember that we gave them much publicity at that time. You need to review them now like you never read anything before, because it may mean your life. Of several articles in 1939 issues the most important are in March and April, to which we particularly refer you. Your own actions as the operator of the equipment are the most important thing. You can take care of yourself if you will learn the ABCs of how to Always Be Careful. Some of the recommendations of the March, 1939, article are summarized in the box in this article. The most important one is the first one. You may remember our prewar slogan, "Switch to Safety." You do remember the old saw about the only good Indian. . . . Well, the only safe transmitter is a *dead* transmitter. There's no reason why you should ever trust any transmitter, even a new one, while you fiddle with its innards, changing coils or tuning up, protected from sudden death only by thin insulation and imagination. To entrust your life to a prewar transmitter is worse folly. Before you touch anything behind the panel, kill the whole rig. Yes, even the filaments, because if there's power anywhere on the set there's a good chance for trouble: something might fall on the key, or a relay become closed by the slamming of a distant door, or a component might choose that moment to break down, and where would you be? The only safe way is to pull the big switch — and then press the key a few times in case the bleeders have let go just then. Don't worry about tube life — yours is more important. Stay alive, OM; amateur radio needs you. Review those 1939 articles. Study your rig and develop your own precautionary practices. Make it a habit to Switch to Safety.

Strays

(Continued from page 25)

Two years ago I cut down ARRL's *Radio Fundamentals* to fit MCM Ring Book KO-11. In this way it lies flat and I can also use with it standard 6 x 9 1/2-inch sheets, plain, ruled and cross section. I also cut down part of the 1943 *Handbook* to the same size so that I have the references to the *Handbook* right with the same subject in the *Fundamentals*. — James Underhill



Out of the SMOKE—into your SET!

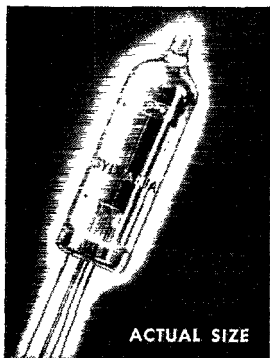

ACTUAL SIZE

Short leads within the tubes and outside the tubes mean FLAT response in the new high frequency bands you are now using.

THE research and skills that went into the development of the "super-small" vacuum tube, that became the heart of the famous proximity fuze radio transceiver, didn't stop there. Out of that experience has come a tube that will last hundreds of hours . . . a tube that makes possible rugged pocket radios . . . miniature walkie-talkie sets . . . one that will save you space and weight—in the shack, working portable and working mobile.

For full details write Sylvania Electric Products Inc., Emporium, Pa.

SYLVANIA ELECTRIC

Emporium, Pa.

MAKERS OF RADIO TUBES; CATHODE RAY TUBES; ELECTRONIC DEVICES; FLUORESCENT LAMPS, FIXTURES, WIRING DEVICES; ELECTRIC LIGHT BULBS

IN THE 144-148 Mc. Band . . .

USE THE

Coaxial Dipole

MODEL 105

FOR BEST RESULTS

Here's the vertically polarized antenna that gives you everything you need for convenience and efficiency in fixed and mobile installations.

- **LOAD MATCHING . . .** for 50 to 55 ohm solid-dielectric co-ax cables or bead-supported lines (also usable with 72 ohm lines)
- **CONTINUOUSLY ADJUSTABLE . . .** upper $\frac{1}{4}$ wavelength element slides in 4-jaw chuck; knurled nut locks whip at exact adjustment for best operation.
- **LOW LOSSES . . .** polyethelene insulation for minimum dielectric loss.
- **EASY INSTALLATION . . .** antenna base screws onto standard $\frac{3}{8}$ " pipe thread; junction box fits 49194 receptacle; bumper mount available.
- **DURABLE CONSTRUCTION . . .** tubes, pipes, and fittings are brass with chromium, rhodium, and silver plating to prevent corrosion and ensure high conductivity; spring-steel whip can flex repeatedly without damage.
- **LOW COST . . .** only \$12.50 net F.O.B.: Boston.

This remarkable new antenna is sold only thru the RADIO SHACK. Order today—immediate delivery.

Write for
FREE 108 PG.
CATALOG
on all ham gear

The **RADIO SHACK**
★ 167 WASHINGTON ST.. U.S.A. ★
BOSTON, MASS.. U.S.A. ★

RIGHT NOW you can get your



hallicrafters *Sky Champion*

S-20R **\$60⁰⁰** COMPLETE

With new bands continually opening up — and government restrictions on hams going by the board — you'll want one of these new Hallicrafters receivers. At a price within easy reach the Sky Champion embodies latest design features for efficiency and smooth reception, making every moment of its use a thrilling experience. Order today — immediate delivery.

also PROMPT DELIVERY on

NATIONAL • HAMMARLUND • ECHOPHONE

and the entire **HALLICRAFTERS** line

SPECIAL

Midget Variable Air Trimmers Popular APC style; screw-driver adjustment; ceramic insulation.

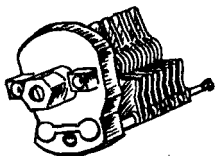

Mmfd.	Net each
10	19c
25	24c
35	29c
50	36c
75	44c
100	50c
140	59c

Please include 10c for packing and mailing.

Write for FREE 108 PG. CATALOG of all ham gear

The RADIO SHACK
 ★ 167 WASHINGTON ST. ★
 BOSTON, MASS., U.S.A. ★

NOW AMATEURS CAN USE THE HAR-CAM FM POLICE TRANSMITTER

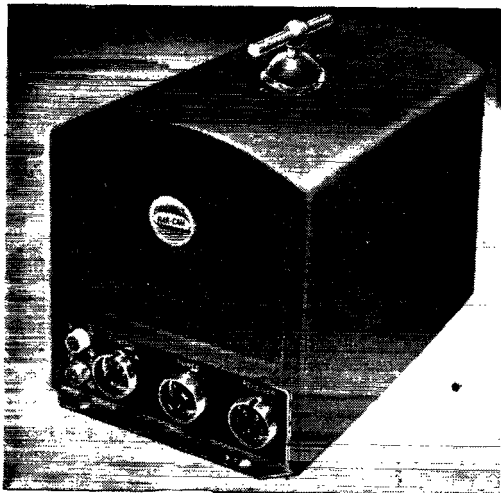

The F.C.C. announcement that the 28.95-29.7 megacycle band is available for amateur use with FM transmitters makes the HAR-CAM FM Police Transmitter the amateur's best bet. Now ready for shipment with AC or DC power supply.

For complete information write for Bulletin H-36 today.



HARVEY RADIO LABORATORIES, INC.

451 CONCORD AVENUE
CAMBRIDGE 38, MASSACHUSETTS

Christmas, 1944

(Continued from page 25)

my friend, Wilbur Kuure, W9YNY, and I debarked unsteadily down the ladder and made our way across an undulating swell to the Liberty ship *Chittenden*. There, we met Lt. Hal Franks, W5EGA, personally, for the first time. We all agreed that it was quite a small and bizarre world that December 25th.

Verbal reminiscences cluttered the air within W5EGA's exceedingly neat cabin for several hours. Shelves in his quarters were lined with excellent reading material including many late QST's. Compared to our situation aboard the *Belvis*, Kuure and I thought this a bit of heaven.

We were thoroughly acquainted by the time we appeared in the officers' mess. As the cuisine took shape before us and disappeared into our eager gullets, my army pal and I felt somewhat sorry for our less fortunate buddies on the home ship. But such is life. We had, in nautical terms, a "Little Roundhouse," consisting of a generous helping of everything on the menu. We swept our plates clean to Hal's amusement. I remember, most distinctly, the dessert of apple pie and ice cream.

Nightfall found Kuure and me "back to earth" on the *Belvis* after a most delightful Christmas Day. According to plan, we blinked a "goodnight and thank you" to W5EGA through the twilight. That was our last QSO of that series. Not long after that we weighed anchor and headed for our next stop on the long road back home. Our holiday was over, a new year had begun and there was still a war to be won.

Television Reception

(Continued from page 40)

edge. The output terminals extend from the lower edge of the board. These terminals have tube-base pins soldered to them to push into the input terminals of the tuner chassis.

This completes the description of the receiver. The third part of this article will discuss the results that have been obtained over the transmission path described in Part I. In order to present a comprehensive picture, the observations begun last summer will be continued through the winter and early spring so that the part played by atmospheric bending can be evaluated before the data are published. At that time, also, it is expected that information will be available on changing the r.f. circuits to the new channel allocation to become effective during the early part of 1946.

Strays

W6PCA suggests that Nov. 15, 1945 should be called VA-Day!

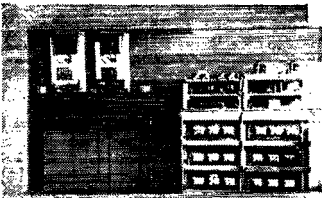

1915. World's first vacuum tube repeater, produced by Western Electric, made transcontinental telephone calls possible.



1919. Among the earliest P. A. amplifiers were these made by Western Electric and used at Victory Way Celebration in New York City after World War I.



1922. First amplifier used generally in commercial broadcasting. Many of these 8-type amplifiers are still in use.



1931. Negative feedback principle introduced by Western Electric in telephone amplifiers, since applied to broadcasting and public address equipment.



1931. Western Electric developed this first all AC amplifier unit which eliminated batteries, made equipment more compact.



1936. One of the twenty 1000-watt amplifiers used in the world's largest commercial public address system at Roosevelt Raceway on Long Island.



1937. 120-121 type Western Electric amplifiers for use in the finest audio systems for AM and FM transmission.

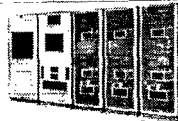

1942. New and improved battle announcing system amplifiers of the type that helped save the crippled carrier *Franklin*.

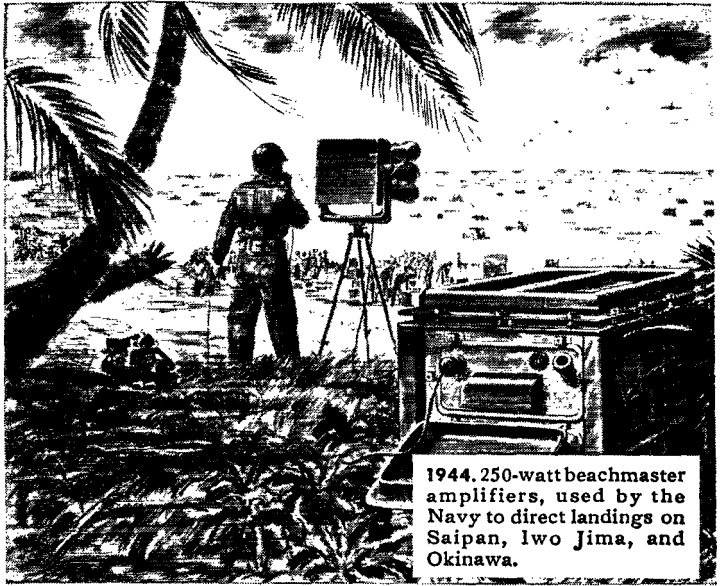

1944. 250-watt beachmaster amplifiers, used by the Navy to direct landings on Saipan, Iwo Jima, and Okinawa.

AMPLIFIER HISTORY... Made by *Western Electric*

For more than 30 years, Western Electric has made amplifier history. The skill and ability that time alone can bring, plus experience gained producing highly specialized sound equipment for war, mean continued leadership for Western Electric in the years ahead.

Buy Victory Bonds and hold them!



HUDSON AMERICAN

High Quality

TRANSFORMERS

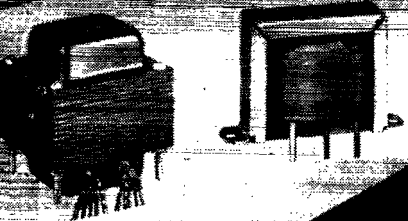

Our many years of experience in manufacturing and our intimate knowledge of Transformer requirements in the field, is your assurance that Hudson American Transformers and Reactors will give you the utmost in reliability and economy of operation.

Write for catalog 1045

HUDSON AMERICAN CORPORATION

A subsidiary of Reeves-Ely Laboratories, Inc.
25 W. 43rd STREET, NEW YORK 18, N.Y.



Sunspots

(Continued from page 46)

but for somewhat marginal east-west work in the northern U.S.

Finally, there is an unrelated bit of information given in Fig. 5. This shows the share of the time that sporadic-*E* "short skip" communication might happen at much higher frequencies such as on five and ten meters when the *F* layer is not good enough. It indicates that at the latitude of Washington, D. C., it is more likely to happen in the late morning than in the evening, during February, 1946. It also suggests that regular schedules in a southward direction, particularly during the eight hours centered on midday, and to Alaska, Greenland and Iceland during the night, are most likely to produce five-meter contacts outside of the U. S., during the month. This pattern changes monthly, so the chart will be of particular interest to those who enjoy "skip" in the v.h.f. bands. Another prediction gives the intensity of the sporadic-*E* reflections, but the picture is not much different from Fig. 5. For February, 1946, it simply indicates that in the hundred-percent latitudes and times shown in Fig. 5, half of the time sporadic-*E* reflections will support communications below 25 Mc., and the other half above. Weaker reflections are predicted where the percentage figure is lower.

If amateurs show an interest in making use of radio predictions, no doubt some means will be found to make the information available at least a month in advance of the date covered by the predictions.¹

¹ Discussions are now under way between Bustands and A.R.R.L.'s technical staff to determine the best method, in the light of new knowledge, of resuming the forecasts which were featured in prewar *QST*. — Editor.

NOW IN STOCK AT ALL LEADING RADIO DISTRIBUTORS

CODE PRACTICE

OSCILLATORS

WITH
ADJUSTABLE
RESONATOR

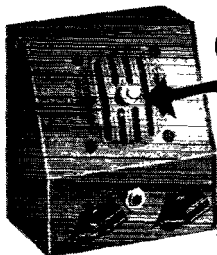

For Greater VOLUME
and Better TONE!

Adjustable Resonator (optional) increases volume five times. Tone frequency variable from 600 to 1500 cycles. Volume control from 0 to FULL ON. "PM" DYNAMIC speaker may be disconnected during operation. Up to 300 headphones may be used. Has phone jack for headphones. Optional built-in key. 110 V. AC or DC. Uses a 117N7G1 tube. Gray crackle finish.

MS 710PR • DeLuxe Master Oscillator with resonator and built-in key. Amateur net price...\$13.00

MS 710P • With built-in key but less resonator. Amateur net price...\$11.50

MS 710R • With resonator but less built-in key. Amateur net price...\$10.50

MS 710 • Less resonator and less built-in key. Amateur net price...\$9.00

Designed by
THE WORLD'S
CHAMPION
RADIO
TELEGRAPHER

TELEGRAPH

Apparatus Co.

412 SOUTH GREEN ST

CHICAGO 7, ILLINOIS

The Little Gem

(Continued from page 60)

second coil, across which is soldered a fixed condenser, which could be substituted for L_1 . With a 10- or 20- μ fd. fixed condenser across the coil one would obtain considerable bandspread and be able to spot himself within the 144-Mc. band with considerable accuracy.

In connection with the constancy of calibration when removing a self-supported coil such as is used here, we point out that two small eyelets were soldered to the leads of the coil where they go in the binding posts. These serve as stops and insure that the coil is always replaced in exactly the same position, and it was found that with care the coil could be removed and replaced without noticeably disturbing the calibration.

For field work where a short length of wire is not suitable for a pick-up antenna, a piece of brass rod that would just fit in the hole in the FWA binding post (0.01-inch diameter) was soldered into the end of a telescoping automobile antenna. The adjustable-length antenna can then be held in the binding post.

(Continued on page 108)

ORDER YOUR NEW Communications Receiver NOW from ALLIED *For Earliest Delivery*

Available on Time-Payments
Trade-ins Accepted

BE ONE OF THE FIRST to own and enjoy one of these celebrated receivers. All models cover amateur, short-wave, and broadcast bands. War-proved features... plus latest engineering developments. Allied is a leader in the distribution of communications receivers. Orders are filled in turn. Place your order now.

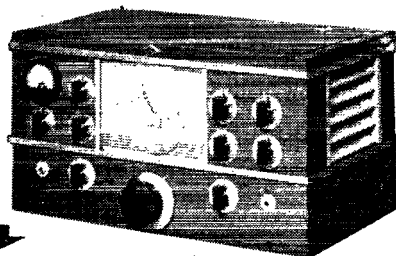

NATIONAL NC-2-40C

490 kc. to 30 Mc. range in 6 bands. Accurate single dial control. Temperature compensation. Automatic voltage stabilization. Adjustable series-valve-noise limiter. Flexible crystal filter. Phonograph or high level microphone pick-up jack. Net..... **\$225**
Speaker in matching cabinet, net..... **\$15.00**

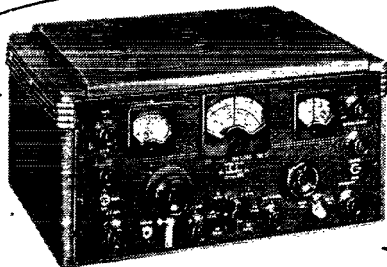

HALLICRAFTERS SX-28A

550 kc. to 42 Mc. continuous in 6 bands. Accurately calibrated tuning dial. Separate calibrated bandspread dial. Two r.f. stages. Lamb type 3 stage adjustable noise limiter. 6 position i.f. and crystal filter selectivity switch. Oscillator temperature compensated. Net..... **\$223**
PM23 Speaker, net..... **\$15.00**

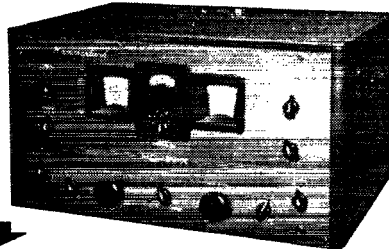

HAMMARLUND HQ-129X

Full range .54 to 31 Mc. accurately calibrated. 4 calibrated Ham bands and 1 arbitrary scale. Variable selectivity crystal filter. Low drift beat oscillator for code and locating stations. Antenna compensator. Voltage regulation. Compensated oscillator to reduce drift during warm-up. Automatic noise limiter. Net..... **\$129**
Speaker, net..... **\$10.50**

Other well-known receivers such as:

Hallicrafters SX-25	\$ 94.50
Hallicrafters S-20R	\$ 60.00
Hallicrafters S-39	\$110.00
Hallicrafters S-36A	\$415.00
PM23 Speaker	\$ 15.00
Echophone EC-1A	\$ 29.50

Net, F.O.B. Chicago
(All prices subject to possible change)

ALLIED RADIO

Everything in Radio & Electronics
833 W. Jackson Blvd. • Chicago, Ill.

ALLIED RADIO CORP., D. L. Warner W91BC
833 W. Jackson Blvd., Dept. 27-AA-6
Chicago 7, Illinois.

Date.....

- Please ship..... Model.....
- Enclosed \$..... Full Payment Part Payment
(Balance C.O.D.)
- Send literature on Receivers and Time Payment Plan.
- Send Allied Catalog of Radio Parts and Equipment.

Name.....

Address.....

City..... Zone..... State.....

HAM GEAR

at Newark Electric

This is our first crack at a column we think you will like. Because it is the first, we are devoting the entire page to it. And a good thing, too, considering the subject matter. Which will be ham gear, what goes into it by way of brains and parts, and sometimes about the people behind it.

Occasionally, we may inject general and specific thoughts on the ham world as they occur *and as we think they may be of interest to you*. Which means that you ought to stop in or drop us a card to tell us what you think of this new feature, to appear in *QST* each month. Please do.

As suggested above, the subject matter of this month's "Ham Gear" is a tough one to try to compact into even a full page. It takes Hallicrafters 34 pages of instruction manual to tell about the SX-28A — and no padding, either. (No pun intended.)

The reasons are fairly obvious, especially if you do some counting, as we have. It takes 29 different manufacturers, including Hallicrafters and other well known ham gear names, to produce and put together the 279 parts that go into this postwar version of the Super Skyrider — not counting the sheet metal or speaker. If you started out to build one yourself, and you had all the parts laid out on your bench — plus the test equipment and assembly tools — well, then you might as well go into business with us. It's obviously a lot of value.

Standard literature that we have available for the asking gives most of the important features of the SX-28A, and we'll be glad to send it to you. You'll see from it that not only will you have a splendid communications receiver but you'll also own the hottest b.c.l. job on the block when you own this. What we'd like to go into here, because we think you'd like us to, is some of the detail.

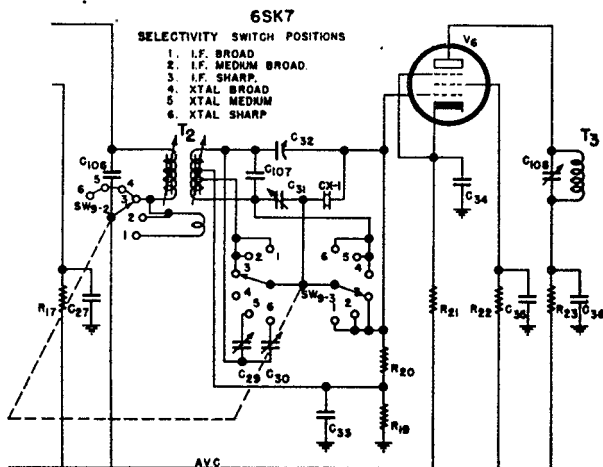

Let's just take the SX-28A crystal filter circuit, for a look at something really slick. That's what the diagram shows — and thanks to Bill Halligan (who, himself, would make an interesting column some time) for letting us reproduce it here.

The crystal filter and holder are wired directly into the receiver, instead of plugging in as before. This eliminates the socket capacity and losses. It also prevents polarity change which would occur if the crystal were improperly inserted in the circuit. The size of the crystal allows the BROAD CRYSTAL position to tune as broadly as possible. By using a specially designed polystyrene holder, the holder capacity has been reduced to a minimum. Meticulous engineering like this is characteristic of the whole job.

In positions 1, 2, 3 the crystal is short circuited. In position 4 the short across the crystal is opened and the iron core in the secondary of the transformer is adjusted for Broad Crystal Action and at this point is accurately tuned to the crystal frequency. Due to the close coupling of the secondary to the crystal, the sharply rising resonance curve of the crystal causes, in contrast, a sharply falling resonance curve in the secondary. The combined action of these two characteristics results in a relatively broad resonance curve for the CRYSTAL BROAD selectivity setting. In the MEDIUM CRYSTAL No. 5 position, C_{20} is adjusted for selectivity midway between the BROAD and CRYSTAL SHARP settings.

In position 6, or CRYSTAL SHARP, the trimmer C_{30} is adjusted for the sharpest, crystal action. Under this condition, the secondary is slightly detuned from the resonant crystal frequency, so that its resonance curve is not greatly affected by the crystal but still coupled tightly enough so that it can transfer energy to the crystal circuit. When this point is reached it is indicated by a rise in the output. Two such points of increased output will normally occur — one for each adjustment of the secondary on either side of the resonant frequency of the crystal.

There's more to tell — about single signal operation and selectivity — but where's the space? Drop us a line if you want more dope on the SX-28A, or the Hallicrafters or our catalog. And tell us how you like "HAM GEAR" as a column idea.

CHICAGO
Newark ELECTRIC Company

115-117 W. 45th St. NEW YORK 19 323 W. Madison St. CHICAGO 6

HAMS... here are all the things you've been waiting for in NEWARK's two big stores. Order from the store nearest you for fast service.

THIS MONTH'S FEATURES

The famous Newark bargain oil-filled, oil-impregnated

FILTER CONDENSERS

Fully guaranteed at rated voltages

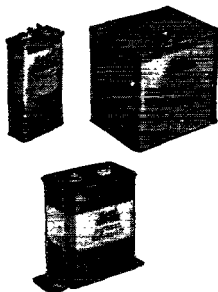

Capacity	Working Voltage	Height	Width	Depth	Wt.	Price
1 mfd.	1500 V. D.C.	2 3/8"	1 3/4"	1"	4 oz.	\$.79
1 1/2 mfd.	1500 V. D.C.	3 3/8"	4 1/4"	3 1/4"	3 lbs.	2.75
1 1/2 mfd.	1500 V. D.C.	5"	3 3/4"	1 1/2"	1 lb. 10 oz.	2.00
5 mfd.	1500 V. D.C.	4"	2 3/4"	1 1/4"	14 oz.	1.65
5 mfd.	2000 V. D.C.	4"	3 3/4"	1 1/4"	1 lb. 4 oz.	2.15
8 mfd.	2000 V. D.C.	4 1/2"	3 3/4"	2 1/2"	2 1/2 lbs.	2.75
.25 mfd.	2000 V. D.C.	3 3/4"	1 1/4"	1"	6 oz.	.69
Special Porcelain Insulators						
10 mfd.	3000 V. D.C.	4 1/2"	3 3/4"	3 1/4"	3 lbs. 8 oz.	4.75
15 mfd.	3000 V. D.C.	4 1/2"	4 1/2"	3 3/4"	5 lbs.	5.25
6 mfd.	3000 V. D.C.	6 1/2"	6 1/2"	3"	5 lbs. 6 oz.	3.25
with mounting feet, width includes mounting feet						
8 mfd.	3000 V. D.C.	7 3/4"	6 1/2"	3 3/4"	7 lbs. 4 oz.	3.95
2 mfd. & 4 mfd.	600 V. metal can	4 1/2"	2 1/2"	1 1/4"	14 oz.	.80

McELROY KEY

The Deluxe — Model CP 810 \$9.75

G.E. METERS

0-500 D.C. MA. 2" round Bakelite case..... \$3.50

ABBOTT TR-4

Compact, efficient 2 1/2 meter transmitter-receiver \$39.00

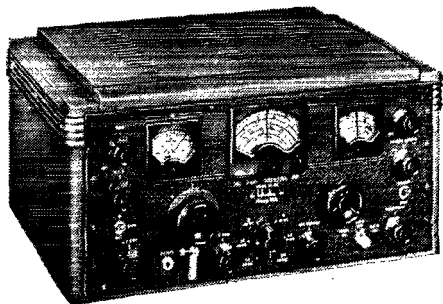

HALLICRAFTERS

SX-28A	Super Skyrider with crystal, less speaker.	\$223.00
S-20R	Sky Champion with built-in speaker.	60.00
S-22R	Skyrider Marine with built-in speaker.	74.50
SX-25	Super Defiant with crystal, less speaker.	94.50
S-39	Sky Ranger portable, AC/DC and battery	110.00
SX-36	FM/AM receiver.	415.00
S-37	V.H.F. FM/AM receiver.	591.75
PM-23	10" PM speaker in cabinet for use with SX-25, SX-28A.	15.00

THORDARSON TRANSFORMER

(POWER TRANSFORMERS AND CHOKES)

T-45556 or T-92R21	leads out of side, 778 V. C.T. at 200 MA. 115 V. 60 Cycle 6.3 V. C.T. at 5A. 5 V. at 30 amp. 9 lbs.	\$5.29
T-13C30	8H. 150 MA. 200 ohm 1600 V. Insulation 2 1/4 lbs.	1.41
T-4557 or T-74C29	leads out of side. 15H. 150 MA. 200 ohm 2000 V. Insulation 5 1/4 lbs.	2.82

HAMMARLUND

HQ-129X (with tubes)	\$129.00
ASP-210X	318.00
ASP-210SX	318.00

Available for rack mounting at same prices

NATIONAL

NC-2-40C and speaker..... \$240.00

RME

RME-45 and speaker..... \$166.00

Get Your Name on Our Mailing List

Be first to get announcements of merchandise available, special bargains, etc., etc. Send name and address on post card. State whether amateur, engineer, school, industrial or service man. Address orders and inquiries to Dept. Q, at NEWARK store nearest you. All Amateur XMTR Contest Blanks available at both stores.

ALL PRICES SUBJECT TO CHANGE WITHOUT NOTICE

NEW YORK
Newark ELECTRIC Company
CHICAGO

115-117 W. 45th St.
NEW YORK 19
BRYant 9-4735
(Adolph Gross)

"Dependable Service
Is the Foundation
of Our Business"

323 W. Madison St.
CHICAGO 6
DEARborn 0083
(Sam Poncher)



The Green Vitrohm Enamel used in the manufacture of all Ward Leonard Vitrohm Resistors and Rheostats is an exclusive development of Ward Leonard Laboratories — the result of more than 50 years of intensive research in resistor enamels.

Pick the Resistor with the Green Vitrohm Enamel and you pick the best. Now available at your Radio and Electronic Parts distributor.

Write for your free copy of our Radio and Electronic Resistor Catalog.

WARD LEONARD ELECTRIC CO.



Radio and Electronic Distributor Division

53 WEST JACKSON BLVD., CHICAGO, ILL.



RADIO

RADIO Technician and Radio Communications courses. Register now for new classes starting first Monday of each month. Day and Evening Classes.

AMERICAN RADIO INSTITUTE

101 West 63d St.

New York 23, N. Y.

Approved under GI Bill of Rights

IN A CLASS BY ITSELF! . . .

GENUINE
EASY-WORKING
"ORIGINAL"

VIBROPLEX

Reg. Trade Marks: Vibroplex, Lightning Bug, Bug

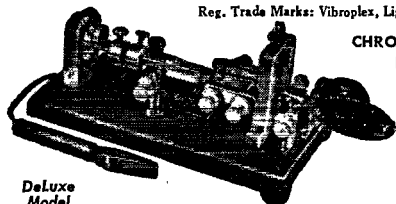

CHROMIUM
FINISHED
BASE

PATENTED
JEWEL
MOVEMENT

Deluxe
Model

America's finest radio key — the deluxe performer that sets new standards of sending excellence and operating ease. The jewels used in Delux Vibroplex keys are the same as those placed in the finest made watches and precision instruments, providing watch-like precision, feather-touch action, lifetime service and ease of operation unapproachable by any other key. Chromium finished base. Bright machined parts. Colorful red switch knob, finger and thumb piece. DIE CUT contacts and main spring. 3/16th contacts. Circuit closer, cord and wedge. Delux finish also available in "Lightning Bug" and "Blue Racer" models. Order NOW! Money order or registered mail. FREE catalog.

\$19.50



The "BUG" Trade Mark identifies the Genuine Vibroplex. Accept No Substitute

THE VIBROPLEX CO., Inc.

833 Broadway

New York 3, N. Y.

The Little Gem

(Continued from page 104)

For low-frequency field-strength work, it may become necessary to replace the hairpin loop by a coil of several turns, to build up the reactance in this circuit and increase the sensitivity of the instrument at the longer wavelengths. It will depend largely on the power available and the gain of the antenna being checked, so no fixed rules can be given.

A refinement that was left off this version of the "Little Gem" is the meter-shunting switch used to prevent meter burnout. If desired, a good place for it would be on the side of the case on which the handle is mounted. We left it off because we had no need for it at the present time, but if one is working with a multi-stage transmitter where several different frequencies are floating around it would be a useful addition to the instrument because it reduces the sensitivity.

Regardless of how simple or elaborate you make your version of the meter, we feel certain you will be pleasantly surprised at its sensitivity and more than pleased with its usefulness.

Foreign Notes

(Continued from page 47)

and all VO amateurs who had renewed their licenses each year were permitted to return to the air immediately. All amateur frequencies are available.

SWITZERLAND

U.S.K.A. reports that at war's end the Swiss government promptly reissued amateur licenses to prewar holders, opening the amateur bands at 56, 112 and 224 Mc., of which the last two are entirely new assignments. Then, on November 26th, all restrictions were lifted and amateurs permitted to work on all prewar frequencies! Throughout the period of emergency, Swiss hams were mobilized into a signal corps under command of HB9T.

The item in "Good News" of November QST prematurely reported HB opening of the 80-meter band; actually, this was a special temporary authorization for designated stations transmitting for a test in which many hams participated.

MISCELLANY

Ing. Sergio I. Clark, CM8CK, is Minister of Communications for the Cuban government. . . . According to TI2RA, hams in Nicaragua are planning to form a national amateur society. . . . An article in the "Nippon Times" reports the desire of J hams to revive their society and return to the air! . . . Many non-European national societies are concerned about the existence of broadcast stations in the old 40-meter band — a matter which, of course, cannot be remedied until the band is restored to amateur operation in the majority of countries.

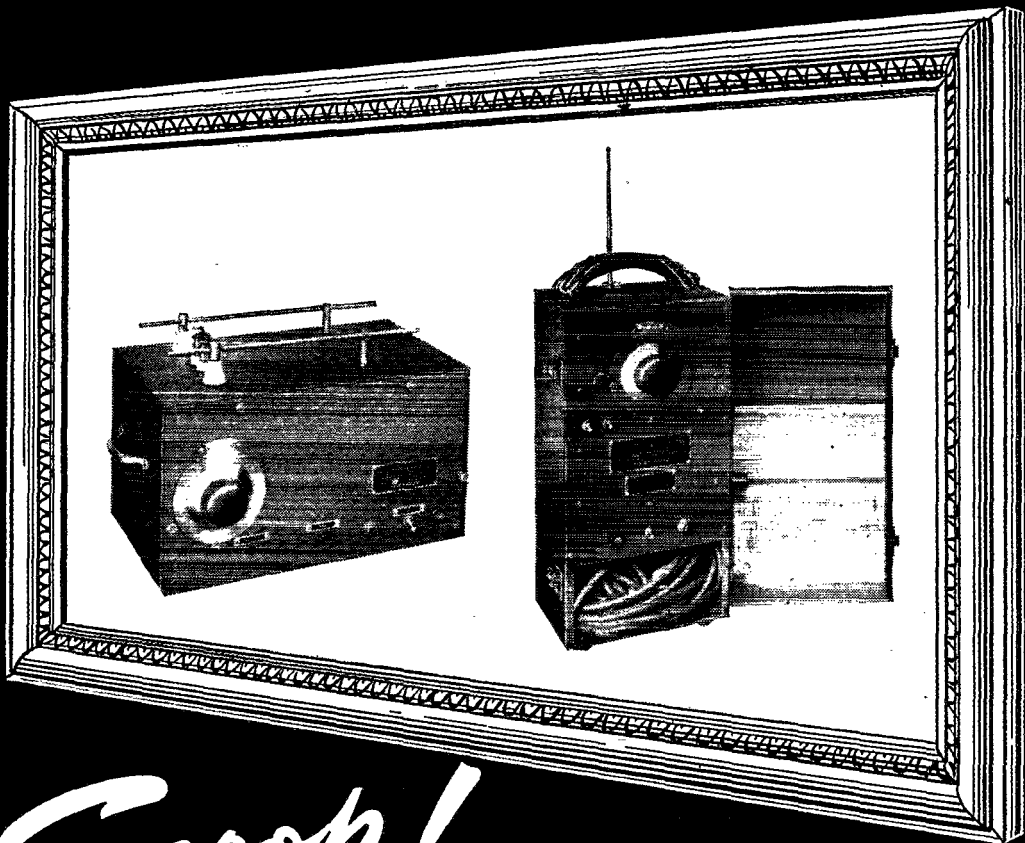

Scoop!

Left: Radio Modulator BC-423. High frequency signal generator operating from 195 to 205 mc., modulated at approximately 5000 cycles. Ruggedly built in steel case. Designed so that it can be re-adapted to many applications. Can be used as high frequency receiver, transceiver or frequency meter. Good for lab demonstrations requiring low power, ultra high frequency generator. Can be converted to $2\frac{1}{2}$ or $1\frac{1}{4}$ meter receiver.

Right: Frequency Meter BC-438. Ultra-high frequency signal generator operating from 195 to 205 mc. with crystal calibration. Aluminum chassis in steel case. Removable nickel plated 19" telescopic antenna. Use as high frequency receiver or transmitter. Can be converted to cover any frequency range. Takes dry batteries for portable use. Precision tuning control make it ideal for "on the nose" ECO transmitter control unit.

hallicrafters RADIO

THE HALLICRAFTERS CO., AGENT FOR RFC UNDER CONTRACT SIA-3-24
MANUFACTURERS OF RADIO AND ELECTRONIC EQUIPMENT

THESE VALUABLE ITEMS *Available Now*
or very soon. Write, wire or phone for further information • head phones • test equipment • component parts • marine transmitters and receivers • code practice equipment • sound detecting equipment • vehicular operation police and command sets • radio beacons and airborne landing equipment.

CLIP THIS COUPON NOW

RFC DEPARTMENT 409, HALLICRAFTERS
5025 West 65th Street • Chicago 38, Illinois
 Send further details on merchandise described above
 Send listings of other available items
Especially interested in _____
STATE _____
NAME _____
CITY _____ ZONE _____
ADDRESS _____

CLEAN ACCURATE HOLES



cut in radio chassis

Greenlee Punches make this tough job easy. No reaming, filing or tedious drilling. Tool has three parts: *punch* cuts through chassis, *die* supports metal to prevent distortion, *cap screw* is turned with wrench to cut holes. Sizes for holes $\frac{3}{4}$ " to $3\frac{1}{2}$ ". Ask your radio supply or electrical jobber or write for folder and prices. Greenlee Tool Co., 1869 Columbia Ave., Rockford, Illinois.

WRITE FOR FREE FOLDER



Adson RADIO CO.

Dept. Q -- 221 FULTON ST. N. Y. 7, N. Y.

EVERYTHING FOR AMATEURS AND SERVICEMEN
COMPLETE LINE OF ELECTRONIC EQUIPMENT



Founded in 1909

RADIO TELEPHONY RADIO TELEGRAPHY ANNOUNCING

Courses ranging in length from 3 to 9 months. Dormitory accommodations on campus for men and women students. Advanced students eligible for practical training at KPAC, 1 KW broadcast station owned and operated by Port Arthur College. New students accepted each month during year. If interested, write for details.

PORT ARTHUR COLLEGE PORT ARTHUR TEXAS

25 Years Ago

(Continued from page 80)

being interchanged with Canada but volunteers are needed for new trunklines to join with the Canadian routes.

A. L. Groves, reporting "Experiments with Single-Layer Coils," finds them not only superior to honeycombs at short waves but advantageous at long waves as well. It is his opinion that it is not so much the form of the winding of the new concentrated coils that makes them appear efficient as it is their freedom from switches and dead-end losses. John H. Miller reports "Some Interesting Receiving Equipment" in which leads to all the components are brought to a panel and connected by means of flexible leads and plug connectors. There is a loss of perhaps 15% but the set possesses extreme convenience for experimenting. C. W. Eliason, jr., finds "QRM and QRN Reduction" in receiving combinations involving two aerials. "The Possibilities of Loop Transmission" are reported by an unnamed author, giving us some conception of the values of received energy dealt with in this work. Huddy of 1II outlines a simple i.c.w. power supply for tube transmission making use of the invaluable Ford coil. Francis F. Hamilton, 9ZJ, director of the Central Division, gives his views on "The Sacredness of Amateur Radio" and points with pride at the record of the amateur in World War I. DeForest announces nightly news broadcasts from New York on 1650-meter radiophone.

Silent Keys

It is with deep regret that we record the passing of these amateurs:

W1MDL, RT 1/c Raymond A. Grenier, Rochester, N. H.

W6PZB, Lt. Marshall Lansing, Mesa, Calif.

W7AGP, Vance Prewitt, Astoria, Oregon.

ex-W8DXK, Col. Norman Lee Baldwin, USA Ret. (ex-5YH, ex-W2CXL).

W8PYS, Capt. Patrick Cavanagh, SC, Detroit, Mich.

W9EYB, Dana W. Heckart, USCG, Mission, S. Dak.

W9JNY, Lyle C. Burton, Buffalo, Kans.

VK3OW, F/O Gordon L. Templeton, RAAF, Coleraine, Victoria, Australia.

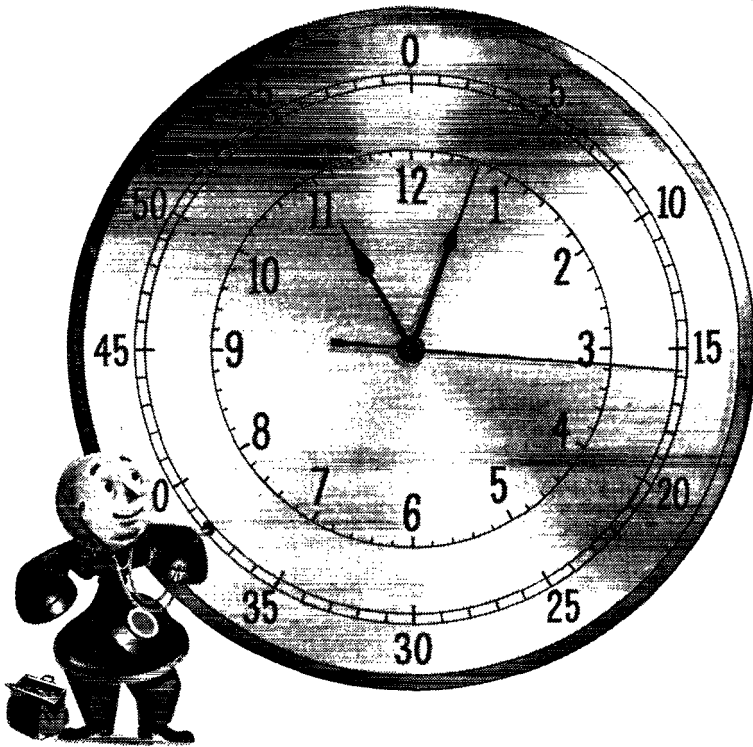

Clocks with tiny crystal hearts that beat 100,000 times a second

CRYSTAL HEARTS beat time in Bell Telephone Laboratories, and serve as standards in its electronics research. Four crystal clocks, without pendulums or escapements, throb their cycles without varying by as much as a second a year.

Precise time measurements may seem a far cry from Bell System telephone research, but time is a measure of frequency, and frequency is the foundation of modern communication, whether transmission is by land lines, cable, or radio.

These clocks are electronic devices developed by Bell Laboratories, and refined over years of research. Their energy is supplied through vacuum tubes, but the accurate timing, the controlling heart of

the clock, is provided by a quartz crystal plate about the size of a postage stamp.

These plates vibrate 100,000 times a second, but their contraction and expansion is less than a hundred-thousandth of an inch. They are in sealed boxes to avoid their variation in atmospheric pressure, and temperatures are controlled to a limit as small as a hundredth of a degree.

Bell Laboratories was one of the first to explore the possibilities of quartz in electrical communication, and its researches over many years enabled it to meet the need for precise crystals when war came. The same character of research is helping to bring ever better and more economical telephone service to the American people.



BELL TELEPHONE LABORATORIES *Exploring and inventing, devising and perfecting for continued improvements and economies in telephone service.*

V...—Again We Can Serve YOU...



CONCORD
RADIO CORPORATION
LAFAYETTE RADIO CORPORATION

An Old and Trusted Company

WITH A NEW NAME

WITH victory achieved the signal has flashed that will start amateur radio on the greatest boom in its history! And again leading the parade with *complete stocks of all standard lines of radio parts* — plus the equipment, resources and technical staff to help you with the new war-born developments — CONCORD RADIO is again ready to serve you with the same friendly, personal interest which

has made us the amateur's dependable source of radio parts and electronic equipment for 25 years. Here you have immediate access to vast stocks and to wide selections. Your every requirement, request and problem is handled by a staff of seasoned technical experts who KNOW amateur radio — many of them hams themselves. We invite you to avail yourself of CONCORD'S dependable service.

ALL STANDARD LINES

Hallcrafters • National • Hammarlund
 Receivers and Equipment

CONCORD is famous for carrying in stock for immediate shipment hundreds of nationally known lines of amateur radio parts and equipment. Below is a partial list:

Aerovox, Amphinol, Amherex, Amperite, Astatic, B & W, Bliley, Brush, Burgess, Cardwell, Centralab, Clarostat, Cornell-Dubilier, Dumont, Echobone, Eimac, General Electric, Hallcrafters, Hammarlund, Heintz & Kaufman, Hickock, IRC, Janette, Jensen, Johnson, Mallory, McElroy, Meissner, Millen, National, Ohmite, Pioneer, Presto, Racon, RCA, Readrite, Shure, Simpson, Solar, Sprague, Stancor, Supreme, Thordarson, Trimm, Triplett, Turner, UTC, Universal, Utah, Vibroplex, Weston, Warner.

Complete Catalog FREE

In addition to all standard brands of quality items, this Catalog and Buying Guide contains items not available at any price during the war, it offers many new post-war developments, it shows the last word in modern radio parts and electronic equipment. Many of the recent advances in the science of radio communication are included. You'll find this Catalog a priceless reference guide and a valuable addition to your library. Mail the coupon below for a copy. It's absolutely FREE.

TO OUR FRIENDS OVERSEAS: We are prepared and eager to resume the pleasant relations we enjoyed before the war. A complete and efficient export department is at your service.

Order Today for Shipment Tomorrow

CONCORD RADIO CORPORATION

LAFAYETTE RADIO CORPORATION

CHICAGO 7, ILL. ★

901 W. Jackson Blvd.

ATLANTA 3, GA.

265 Peachtree Street

CONCORD RADIO CORP., Dept. ST-16
 901 W. Jackson Blvd., Chicago 7, Ill.

Gentlemen: Send me at once a FREE copy of your latest Catalog and Buying Guide, listing standard lines of Radio Parts and Electronic Equipment.

Name.....

Address.....

City.....Zone.....State.....



Burlington

★ PANEL INSTRUMENTS

Guaranteed ACCURACY

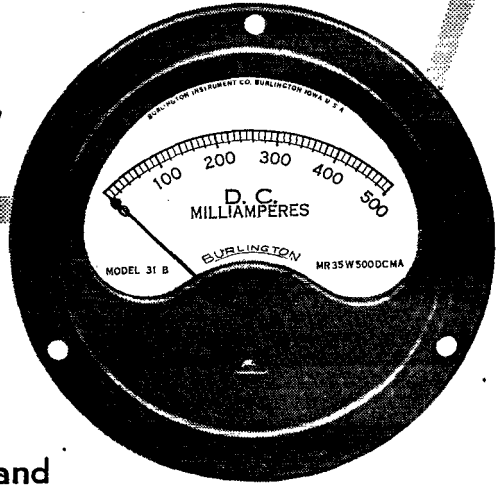

Due to design characteristics and close control of manufacturing processes, Burlington instruments embody the following advantages:

PERMANENCE OF CALIBRATION . . . All DC instruments employ Alnico magnets which are known to be more highly resistant to shock, heat, vibration, and stray fields than any other magnetic material.

FREEDOM FROM STICKING . . . Clearances for all moving parts are such that the results of entrance of small particles as encountered in field service are reduced to a minimum.

STABILITY OF OPERATION . . . All instruments are "NORMALIZED" after assembly to eliminate "zero shift" and other calibration errors due to ageing.

Exceptionally high torque to weight ratio of control springs to moving element insures minimum error under conditions of shock, vibration, and other rough usage.

Alignment of jewels and magnet core piece is such that the center lines of these parts coincide within plus or minus .002". The design of the brass movement frame and components is such that mechanical tolerances are reduced to a minimum in assembly. As a result, jewel and pivot wear is uniform which reduces "frictional torque" of the moving coil.

All series resistors and coils are heat treated and impregnated after wrapping to insure stability and long life.

All ranges AC & DC are available in 2½", 3½" and 4½" sizes, both square and round, flush mounting.

*Engineering service furnished for specialized applications.
No obligation. • Write today for further information.*

BURLINGTON INSTRUMENT CO.
800 Fourth Street • Burlington, Iowa

25 OSCILLATORS

• Each unit includes two separate Pierce oscillators and these have an auxiliary counter. Original application was for checking the difference between the frequencies of a standard crystal and one being produced. This unit includes power supply, one 0-1 mil meter for activity and another meter used as a counter meter. Original cost \$100.00 each.

• Can be easily modified for Ham transmitter driver for two frequencies. Sale price \$25.00 per set. 10 meter predimensioned crystals in FT243 holders \$2.75 each.

HATCHER & FISK, INC.
125 Kansas Avenue, Topeka, Kans.

COMMERCIAL RADIO INSTITUTE

A RADIO TRAINING CENTER FOR 24 YEARS

Resident Courses Only • Broadcast, Service, Aeronautical, Television, and Marine telegraphy classes now forming for mid-year term Feb. 1. Literature upon request. Veteran training.

Dept. B, 38 West Biddle Street, Baltimore 1, Maryland

Phone, Wire or Write

WHOLESALE
Radio-Electronic Parts
Tubes, Sets and
Equipment

R. G. SCELİ & CO.
317 Asylum St. Hartford, Conn.
Telephone 2-1144

BRANCH: 84 ELM ST., BRIDGEPORT, CONN.

Happenings of the Month

(Continued from page 48)

that the latter used some frequencies in our 3500 band? Although everything else in WERS has been washed out, FCC, by means of its Order 127-A on October 31st, extended the life of State Guard WERS until July 1st next, at the request of the War Department, to permit the continuation of training until the National Guard is reactivated. They use only the frequencies 3655 and 3825 kc., A-3 only, and not over 5 watts output.

KUDOS TO BUDLONG

Lt. Comdr. Arthur L. Budlong, assistant secretary of the League, recently on leave of absence from the Coast Guard to represent ARRL at the Rio conference, has been made an honorary member of LABRE, the Brazilian amateur society. The story is well told in the following letter from Colonel KrueI, LABRE's president, as translated by W1JLK:

LIGA DE AMADORES BRASILEIROS DE RADIO
EMISSAO

Rio, 23 October, 1945

Most Illustrious Sir
A. L. Budlong
38 LaSalle Road
West Hartford, Conn., U. S. A.

Cordial Greetings!

I take the greatest of pride in communicating to you the advice that the Deliberative Council of this body, considering the brilliant attainments of yourself in defense of the interests of amateur radio in connection with the Third Inter-American Conference on Radio Communications, resolved, as an exceptional tribute from Brazilian radio amateurs, to grant to you the title of Honorary Member of the Brazilian League of Transmitting Amateurs.

I congratulate myself, together with all Brazilian amateurs, on having the honor of including your name among those of our social group, and I seize this opportunity to present to you assurances of my highest consideration.

Attentively,

Riograndino KrueI, PY1AR
President

NOTICE TO MEMBERS DISCHARGED FROM THE MILITARY SERVICES

The requirement of continuous membership in the League for eligibility to ARRL offices has been waived for members serving in the uniform of the United States. See particulars on page 39 of *QST* for July last. Those desirous of taking advantage of this arrangement are asked to claim the right when renewing membership, stating the beginning and ending dates for their military service.

ARE YOU LICENSED?

• When joining the League or renewing your membership, it is important that you show whether you have an amateur license, either station or operator. Please state your call and/or the class of operator license held, that we may verify your classification.

Still your best choice for V-H-F

● Pre-war pioneers, the HY75, HY114B, and HY615 offered new conceptions of low-cost efficiency on the very high frequencies. Radio amateurs, who did so much to open up these frequencies, piled up innumerable long distance transmitting and receiving records with the tubes. The HY75 and HY615 powered wartime WERS nets of amateurs almost exclusively.

● A.R.R.L. and Radio handbooks have always been lavish in using the HY75, HY114B, and HY615 in equipment they described. The Abbott TR-4 transmitter-receiver contributed much to the fame of the HY75 and HY615. Maximum ratings up to 300 mc. (efficient circuit design permits even higher frequencies) spell continued popularity on the new "ham" bands.

● Popularity of this famous trio has not been confined to amateur circles. In all important war laboratories, the tubes were widely used. During many invasion thrusts in the Pacific, the HY75 and HY615 gave the Navy dependable intership communications. The HY75 design led to the Hytron 2C26A — r.f. pulse output tube of IFF (identification friend or foe), standard Army and Navy equipment for planes in combat areas. Developed from the HY615, the Hytron E1148 was in practically every British vehicular transmitter. The HY114B found its place in radar test equipment.

● Wherever real power output from small triodes is required on v-h-f, the HY75, HY114B, and HY615 still are your best choice. They fill a gap between "acorns" and miniatures which have limited power capabilities and larger triodes which cost much more. Brief data can give but a thumbnail sketch. You can best appreciate their superiority by putting the HY75, HY114B, and HY615 to work in your sockets.

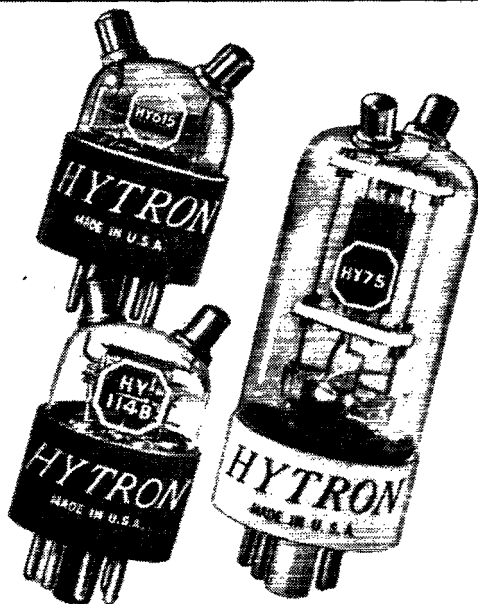

HYTRON V-H-F TRIODES

The HY75, HY114B, and HY615 are v-h-f triodes particularly suited as r.f. oscillator-amplifiers and as high sensitivity superregenerative detectors for fixed, mobile, or portable receivers, transmitters, transceivers, or transmitter-receivers. All three tubes feature short connection leads, low interelectrode capacitances, plate and grid connections to twin top caps, convenient octal bases, and a maximum operating frequency of 300 mc. for full plate input. Note in the HY75: low-loss lava insulation, rigidly supporting — for maximum resistance to shock and vibration — the graphite anode, vertical-bar grid, and instant-heating helically-coiled filament. The tiny HY114B and HY615 are capable respectively of 1.4 and 4 watts Class C output. The 1.4-volt filament of the HY114B makes it ideal for battery-operated portables.

CHARACTERISTIC	HY75	HY114B	HY615
Filament Potential (volts)	6.3	1.4	6.3
Filament Current (amps.)	2.6	0.155	0.175
Type of Filament	Thor.	Oxide	Cath.
Plate Potential (max. volts)	450	180	300
Plate Current (max. ma.)	80	12	20
Plate Dissipation (max. watts)	15	1.8	3.5
Grid-to-Plate Cap. (mmfd.)	3.8	1.3	1.6
Grid-to-Cathode Cap. (mmfd.)	1.6	1	1.4
Plate-to-Cathode Cap. (mmfd.)	0.6	1	1.2
Max. Operating Frequency (mc.)	300	300	300
Maximum Height (inches)	3 $\frac{1}{8}$	2 $\frac{1}{2}$	2 $\frac{3}{8}$
Maximum Diameter (inches)	1 $\frac{1}{8}$	1 $\frac{3}{8}$	1 $\frac{3}{8}$
Class C Power Output (watts)	21	1.4	4

OLDEST MANUFACTURER SPECIALIZING IN RADIO RECEIVING TUBES



HYTRON

RADIO AND ELECTRONICS CORP.



MAIN OFFICE: SALEM, MASSACHUSETTS

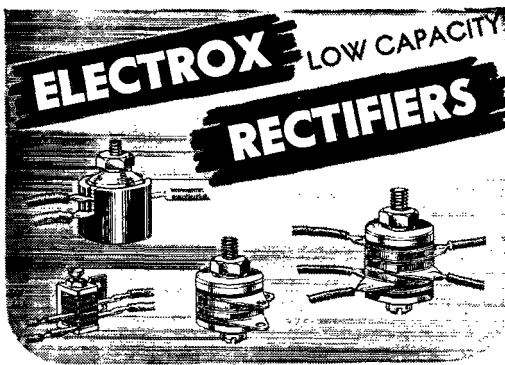

For dependable, trouble-free service in test sets, instruments, and similar electronic applications, use ElectroX Rectifiers, made by one of the oldest manufacturers of dry disk rectifiers. Finest quality, full and half wave low capacity copper oxide rectifier units; each unit inspected, tested, guaranteed right. Ask your parts supplier for ElectroX Rectifiers. If he cannot yet supply you, send us his name and ask for descriptive Bulletin 446.

ELECTROX DIVISION **SCHAUER MACHINE CO.**
2049 Reading Rd. Cincinnati 2, Ohio

► **TRANSMITTING TUBES** **RECTIFIERS**
CATHODE RAY TUBES

We have been appointed a sales agent by Defense Supply Corporation of Government surplus tubes and rectifiers. All are first grade Government tested and inspected tubes — not rejects.

The following types are immediately available:

826 (HF Triode)	Cathode Ray Tubes
VT 127A (HF Triode)	5AP1
304 TL	5BP4
872A M. V. Rectifier	3AP1

Many Other Types

Trade discounts to dealers on standard packages • Write for prices

LEWIS ELECTRONICS 16 Lyndon Avenue
Los Gatos, California

RECEIVING SENDING CODESPEED without strain

CHAMPIONS ENDORSE CANDLER WAY

Get skill, accuracy, speed with the highly endorsed Candler System. Learn to send and receive by telegraph or radio code. Government service and commerce need thousands of better trained operators. Air commerce, mail, freight, etc., demand expert, reliable operators. Good pay. Get the Candler System, the maker of champions. It teaches you the "knack" of sound sense, alertness, speedy sending and receiving without strain. Adventure — good pay. Learn at home or wherever you are. Rush name today for free book.

FREE! **CANDLER SYSTEM CO.**
Dept. 4-A, Box 928, Denver 1, Colorado, U.S.A.
and at 121 Kingsway, London, W.C. 2, England

Above 50 Mc.

(Continued from page 53)

Your conductor is inclined to favor this idea. We are having our first experience in working from a location where the normal working radius is less than 100 miles, our prewar location having been just about the ideal in v.h.f. spots. At our West Hartford QTH, which is the same hill where Ross Hull did his famous five-meter DX work back in 1934 and 1935, we are finding that our horizontal antenna occasionally pulls in signals from up Boston way, some 100 miles distant, slightly better than does the vertical. Though the difference is very slight, the reduction in strength of the vertically-polarized Hartford stations, which are all pure line-of-sight, is very helpful. The horizontal antenna, especially if it is a high-gain long-wire or parasitic array, is a very useful adjunct to any v.h.f. station. We do not feel however that there is any basis for recommending the abandonment of vertical polarization, as so many of our western friends would have us do. We are completely open-minded however — we've made many tests, and we plan many more — and we're willing to be shown. But don't try to sell us horizontal polarization on the strength of what happened when you changed over from a vertical dipole to a 4-element horizontal array!

New Record for 5250 Mc.!

• Not being satisfied with the 5-mile microwave work reported herewith, W2LGF decided to see what could be done at greater distances. Using the equipment described below, W2LGF/2 at Nassau, N. Y., worked W7FQF/2 at East Windham, N. Y., on December 2nd. The distance covered was 31 miles. Both rigs were operated from gas-engine generators. Low-powered 2-meter gear was taken along on the trip, but contact could not be made on that band!

Strays

Below are the amateur calls held by some of the New York ABC engineers.

- W2KJG — Pat Simpson
- W1ACQ — John O'Neill
- W2BUY — Bill Simpson
- W2HHK — Bert O'Leary
- W2LYC — Bill Teitz
- W2CHK — Gil McDonald
- W2OMT — Jim Cooke
- W2ESP — Maurice Kamke (WJZ)
- W2IP — Harold Campbell
- W2IGB — Bob Massell
- W1KZ — Al Bradley
- W2AMS — Henry Tregar (WJZ)
- W2AEB — Irv Grabo
- W2ZA/W3JA — George Milne

HARRISON HAS IT!

ALL STANDARD LINES

As one of the World's leading Amateur supply houses, we feel it our pleasant responsibility to maintain a most complete stock of all Receivers, Transmitters, accessories, parts, and associated equipment. We are factory authorized Distributors for the top quality manufacturers and we have been diligently restocking our warehouse with their newest, improved, post-war products.

Visit our stores, or send us your order for *everything* you need. We promise you fresh, clean material — quicker — at the lowest current prices — and, above all, our sincere desire to be of friendly, helpful service.

73, de Bill Harrison, W2AVA

HAMMARLUND SUPER-PRO

The dependable 200 series, improved, and constructed to Army specs! 18 tubes, noise limiter, electrical bandspread, variable IF selectivity, wide range audio. ASP-210-X... 540 Kc to 20 Mc ASP-210-SX... 1250 Kc to 40 Mc Either model, complete with power pack and speaker. **\$318**

HQ-129-X

The modern version of the well liked HQ-120. **\$129**

RME 45

COMPLETE **\$166**

NATIONAL

NC-2-40C **\$225**

HALLICRAFTERS

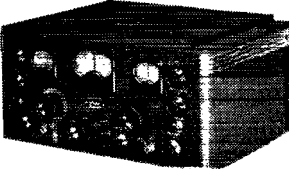

SX-28A
\$223

PM-23 Speaker
\$15

S-20R	Sky Champion	\$60.00
S-22R	Skyrider Marine	74.50
SX-25	Super Defiant	94.50
S-36A	FM/AM 27.3 to 143 Mc.	415.00
S-37	FM/AM 130 to 210 Mc.	591.75
S-39	Skyrider Portable	110.00
HT-9	100 Watt CW/Phone Xmitter	225.00
EC-1A	Echophone	29.50

SHUR 2-METER BEAM

Two element, fully adjustable 144 to 148 Mc. Light weight, durable. Complete with all fittings, 6-foot pole and all instructions. **\$5.59**

Single element dipole, complete as above. **\$3.97**

SHUR ANTENNA MOUNT

A most versatile mounting bracket and support for 1 1/2" dia. pole. Adjustable to rooftop, side or wall. Cast aluminum. **\$5.14**

DYNAMOTORS... for that mobile rig!

6 or 12 volts DC input. Output 500 volts DC at 160 ma continuous operation, 224 ma intermittent duty. Dependably made for military use. Ball bearings — high efficiency — internal hash filter for UHF — moisture proofed — fully shielded. 5" dia., 11" long, with mounting plate. Brand new, with spare set of brushes. **\$17.75**

A POST CARD will put your name on our mailing list to receive new catalogs, bulletins, additional HSS bargains, and details of how you may obtain, without cost, a copy of "Electronic Parts and Equipment," our new 800-page Buyers' Guide.

PLEASE SEND IT TODAY!

HARRISON SELECT SURPLUS

Certainly — Harrison has SURPLUS, too! A whole big department of it — *entirely separate* from our regular standard stocks. And it is **SELECT** surplus — our more than twenty years of experience comes in mighty handy now in combing the surplus field and screening out *only* those items that we know can be satisfactorily used for Ham and experimental work! This is your assurance of good, *usable*, guaranteed material at sensationally low prices — *top value* always!

Come in — browse — you are sure to buy many items.

SIGNAL CORPS CODE TRAINING SETS

Operates on 6, 12, 24, or 110 DC or 115, 230 AC Volts. Built-in speaker. Output to up to 100 headphones. Pitch (200 to 5000 cycles) and volume controls. Blinker light for visual. Excellent for code instruction groups, etc. New, with tubes, in portable carrying **\$23.75** case.

RAYTHEON TUBES

FB triodes for HF
RK-63 200 watt plate
Reg. net. **\$22.00**
HSS. **\$12.85**
RK-38 100 watt plate
Reg. net. **\$13.50**
HSS. **\$7.95**

GE RF METERS

0-4 Amp. Thermo-coupled. 2" round, flush bakelite case. **\$3.45**
Readrite 0-150 AC Volts. 2" round flush metal case. **\$2.10**

15 TUBE UHF RECEIVER

Signal Corps BC-406. Tuned to 205 Mc. Six acorn tube RF circuit, four IF stages. Can be adapted to 144 Mc receiver. 115 V. AC operation. Chassis 10 1/2" x 25 1/2", in metal case. Complete with tubes: 5-954, 1-955, 4-6SK7, 2-6SJ7, 2-6N7, 1-5T4. Parts alone are worth much more than our low HSS price. Used, but in tested working condition. **\$25**

OIL FILLED CONDENSERS

All new — perfect — high quality makes — guaranteed to be satisfactory for use in transmitters, amplifiers, etc., at full rated DC working voltage.

Compact, cylindrical metal case type. Conveniently mounts in 3/8" hole. 1 1/2" dia. x 4 1/2" high. 2 mfd. 1000 Volt

FOUR for **\$2.34** (Reg. price of one)

4 mfd. 600 Volt
THREE for **\$3.25**

Standard rectangular type with stand-off insulator terminals. 10 mfd., 600 Volt. 3 1/4" x 1 1/4" x 6" high overall. With mounting. List **\$10.80**. TWO for **\$2.47**.

.1 Mfd. 3000 Volt. List price **\$8.10**. HSS. TWO for **\$2.85**.

4 Mfd., 4000 Volt. List **\$48**. HSS. **\$11.75**

BATHTUB TYPE 600 VOLT

2 Mfd. 2" x 2" x 1" high. List **\$3.60**

FOUR for **\$2.12**

Single: .1 .15 .2
.25 .3 .5

Dual: .05 .1
.25 .5

ANY VALUE

59¢ each

KIT of one of each value

(Ten Condensers)

\$2.85

GE 5" OSCILLOSCOPE

Model CRO-5-S. Limited quantity.

\$167.50

HAM HEADQUARTERS

Since... 1925!



HARRISON RADIO CORPORATION

12 WEST BROADWAY • NEW YORK CITY 7

BARCLAY 7-9854

JAMAICA BRANCH — 172-31 Hillside Ave. — REPUBLIC 9-4102

Now! A Better Soldering Tool... THE KWIKHEAT

Has Built-in Thermostat Control!

THERMOSTATIC SOLDERING IRON



6 TIP STYLES

- #0—\$1.25
- #1—\$1.25
- #2—\$1.25
- #3—\$1.25
- #4—\$1.75
- #5—Melting Pot for tinning—\$1.25

HOT, READY FOR USE ONLY 90 SECONDS after plugging in! Kwikheat is the only soldering iron with a thermostat built into the tool itself!—maintaining the proper level of heat for most efficient, economical operation. **SAFE!**... Cannot overheat—**ECONOMICAL!**... Lasts longer—saves tips and requires less retinning. **POWERFUL!**—225 watts—yet exceptionally light weight (14 oz.). Well-balanced with cool protecting plastic handle. Modern streamlined design. Six interchangeable tip styles adapt one Kwikheat Iron to all your soldering jobs. You will be proud to own America's finest and most versatile soldering tool... from tip to plug Kwikheat is in a class by itself. Ask your dealer to demonstrate the quick-heating feature now!

*patented
Kwikheat Iron with choice of #0, #1, #2, or #3 tips \$11.00
Set of 5 tips, consisting of #0, #2, #3, #4, and #5 . \$6.00

Dept. PS-11, Kwikheat Division of
SOUND EQUIPMENT CORP., 3903 San Fernando Rd., Glendale, 4 Calif.

COMPLETE RADIO TRAINING!

Prepare now to accept a responsible position in Commercial Radio. New developments will demand technicians with thorough basic training, plus a knowledge of new techniques discovered during the war. Training open to high school graduates or those with high school equivalency. Courses 6 to 18 months duration in **RADIO AND ELECTRONICS**. Approved Veteran training in Radio. Write for Particulars.

VALPARAISO TECHNICAL INSTITUTE
Dept. TN Valparaiso, Ind.

AMATEUR GEAR HATRY & YOUNG

**EIGHT CONNECTICUT
AND MASSACHUSETTS
HAM STORES**

- | | | |
|----------------|----|------------|
| Hartford | C | Stamford |
| New Haven | O | New London |
| Bridgeport | N. | Waterbury |
| Boston — MASS. | | Lawrence |

How's DX?

(Continued from page 58)

mentioned the plan to, not a single one has anything but enthusiasm for the idea.

Predictions:

If you have read the magazines or newspapers at all during the past few years, you will realize that science has in store for us a brave new shiny plastic air-conditioned atomic world, in which we can sit back in our automatically-conforming plastic easy chairs and have most everything done for us by pushing a plastic button or interrupting a plastic beam of light. All this we are willing to accept but, horror of horrors, they plan to work our DX for us too! Well, almost. Seriously, the work of the Interservice Radio Propagation Laboratory of the Bureau of Standards during the past years has led to the ability to predict with considerable accuracy the times that various frequencies will be usable over practically any path in the world. These predictions, based on past experience and modifying factors like geography and the sun-spot cycle, work out well even for such seemingly erratic bands as 28-30 Mc. We hope to carry these predictions each month, as a service to *QST* readers, although we must confess there is considerable temptation to use them for our own selfish ends! The predictions in this issue are courtesy of Lt. Comdr. A. L. Budlong, USCGR, W1JFN, ARRL Asst. Secretary on leave of absence, who has access to the information and kindly whipped it into amateur-band shape.

The predictions tabulated below for the month of January, 1946 include only certain representative paths and of course indicate trends only. For example, in many cases it is stated that the maximum usable frequency does not come up to 28 Mc., but obviously there will be many opportunities for amateur communication over these paths, the chances being better as the m.u.f. approaches 28 Mc. In the not-too-distant future we hope to publish enough information to allow amateurs to work out the m.u.f.'s over any route they may be interested in, but for the time being we can only present a few representative paths. Where no maximum usable frequency is shown, it means the 28-Mc. band is open during the period shown — where a m.u.f. is shown and a single time, it indicates the time that m.u.f. is reached. Incidentally, these predictions indicate that 28 Mc. will not be quite as good during January as it was in November and December.

Path	Max. Usable Freq. (Mc.)	Time (GCT)
Washington — S. F.	27 Mc.	1800-2200
Washington — Rio		1800-2000
Washington — Paris	25.1	1500
Washington — Manila	20	2300
Washington — Sidney	23	2300
S. F. — Rio		1900-2300
S. F. — Paris	18.7	1600
S. F. — Manila	26.9	2400
S. F. — Sidney	24	2400
S. F. — San Juan, P. R.		1900-2100
N. Y. — San Juan, P. R.	26.4	1600

— W1JPE

"MUSTS"

FOR EVERY HAM'S BOOKSHELF

*"The All-Purpose Volume
On Radio"*

The Radio Amateur's Handbook

Text, data book, operating manual—it is all these and more. As a text it is probably more used in radio schools and colleges than any other single volume. As a practical constructional handbook, it stands in a class alone. As an operating manual, it provides information available from no comparable source.

The latest Edition of THE RADIO AMATEUR'S HANDBOOK is the largest ever published. It includes a comprehensive chapter dealing with War Emergency Radio Service plus other new material—all added without sacrificing the essential information in previous editions which made the HANDBOOK the world's most valuable and widely-used radio book. The theory and design sections cover every subject encountered in practical radio communication, sectionalized by topics with abundant cross-referencing and fully indexed.

\$1.50 Elsewhere

\$1.00 in Continental U.S.A.

\$2.00 Buckram Edition

A Course in Radio Fundamentals

By **GEORGE GRAMMER**

This book greatly smooths the way for the student of the technicalities of radio. It contains interesting study assignments, experiments and examination questions for either class or individual instruction. It describes in detail 40 experiments with simple apparatus giving a complete practical knowledge of radio theory and design. Price **50c**

The objective in preparing this course was to accent those principles most frequently applied in actual radio communication. "A Course in Radio Fundamentals" is a study guide, examination book and laboratory manual. Its text is based on the "Radio Amateur's Handbook." As a text,

Learning the Radiotelegraph Code

By **JOHN HUNTOON**

This booklet is designed to train students to handle code skillfully and with precision. Employing a novel system of code-learning based on the accepted method of sound conception, it is particularly excellent for the student who does not have the continuous help of an experienced operator or access to a code machine. It is similarly helpful home-study material for members of code classes. Adequate practice material is included for classwork as well as for home-study. There are also helpful data on high-speed operation, typewriter copy, general operating information—and an entire chapter on tone sources for code practice, including the description of a complete code instruction table with practice oscillator. Price **25c**

This booklet is designed to train students to handle code skillfully and with precision. Employing a novel system of code-learning based on the accepted method of sound conception, it is particularly excellent for the student who does not have the continuous help of an experienced op-

The A.R.R.L. Antenna Book

By **GEORGE GRAMMER** and **BYRON GOODMAN**

Feed systems and their adjustment. Construction of masts, lines and rotating mechanisms. The most comprehensive and reliable information ever published on the subject. Over 100 pages. Price **50c**

A comprehensive manual of antenna design and construction. Sixteen chapters, profusely illustrated. Both the theory and the practice of all types of antennas used by the amateur from simple doublets to multi-element rotaries, including long wires, rhomboids, vees, phased systems, u.h.f. systems, etc

AMERICAN RADIO RELAY LEAGUE, INC., West Hartford 7, Conn., U.S.A.

Are YOU ready to go on the air?

Get FIRST Delivery From Leo TRANSMITTER KITS

WRL transmitters at the price you want to pay... 15, 35, 70, 150 watts. Also units custom built to your specs.

RECEIVERS

Receivers of all manufacturers at OPA prices... ready for quick delivery.

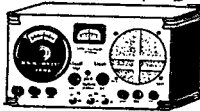

We invited inquiries for special equipment of all kinds.

EXCLUSIVE AT LEO'S

12 page V-J Radio Parts Flyer FREE
Giant Radio Reference Map. 15c
Handy Tube-Base Calculator. 25c

Immediate delivery on transmitting tubes and condensers, and "Everything for the Ham." Get yours FIRST from Leo.

Address Leo, W9GFQ, Dept. G-1
Council Bluffs, Iowa



Wholesale
RADIO LABORATORIES

EASY TO LEARN CODE

It is easy and pleasant to learn or increase speed the modern way — with an Instructograph Code Teacher. Excellent for the beginner or advanced student. A quick, practical and dependable method. Available tapes from beginner's alphabet to typical messages on all subjects. Speed range 5 to 40 W.P.M. Always ready, no QRM, beats having someone send to you.

ENDORSED BY THOUSANDS!

The Instructograph Code Teacher literally takes the place of an operator-instructor and enables anyone to learn and master code without further assistance. Thousands of successful operators have "acquired the code" with the Instructograph System. Write today for full particulars and convenient rental plans.



INSTRUCTOGRAPH COMPANY

4709 SHERIDAN ROAD, CHICAGO 40, ILLINOIS
Representing for Canada:
Radio College of Canada, 54 Bloor St. West, Toronto

110-VOLTS A.C. ANYWHERE! with Katolight Generators

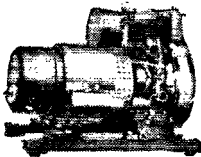

Furnish same kind of current as the highlines for operating radio receivers, transmitters and other standard A.C. appliances for continuous or standby service.

KATOLIGHT PLANTS are powered with Briggs & Stratton engines in sizes 500 watts through 2000 watts.

Ruggedly constructed, low operating cost. Manufacturers of A.C. Generators up to 100 K.W., also rotary converters, high frequency generators, motor-generator sets, special A.C. and D.C. motors.

KATO ENGINEERING CO., Box 750, Mankato, Minnesota

Listening to Stars

(Continued from page 60)

substantially constant in length, whatever their lengths may happen to be. The average strength of the scatter signals is also approximately constant, since the signals consist of components returned from many irregularities at different distances. These components may fade individually; however, since they are many in number the net effect is a somewhat wavy signal whose average strength is roughly constant.

At this point let us suppose that a meteorite arrives at the ionosphere oriented in such a direction that it is headed straight for both the transmitter and receiver. If the particle is a large one the ionization in its trail will be intense enough to reflect a radio signal of the frequency under consideration, even when that ionization has diffused over an area large enough to send back a considerable amount of energy from the transmitter to the receiver.

To the scatter signal at the receiver, then, is added a signal of varying path length reflected from the meteor trail. Each time this path length changes by one wavelength at the frequency of operation the phase of the two signals at the receiver will have changed through 360 degrees, and the amplitude of the resultant will have gone from complete addition to complete cancellation and back again, or through some equivalent change depending on their relative phases at the start of the cycle. So far as a receiver can tell, this change in the effective amplitude of the resultant signal is the same as a modulation on the original scatter signal.

An average speed for meteors during the course of their plunge is 40 kilometers per second, which is $40,000 \div 20$, or 2000 wavelengths per second at 20 meters. Because each half wavelength of meteor travel represents one full wavelength of path-length change for the reflected signal, a meteor moving at 2000 wavelengths per second will cause 4000 complete cancellations and additions per second of the two signal components at the receiver; in other words, the resultant signal will be modulated at 4000 cycles per second. This is the Doppler tone which is heard.

In actual practice, the pitch of the tone may vary all the way from a very low value to something of the order of 4000 cycles. It is known that meteors enter the earth's atmosphere (or more strictly speaking, ionosphere) along more or less random paths. If the path of the meteor is at right angles to a line drawn from the meteor to the transmitter and receiver, no tone can result because there is no change in the length of the path followed by the energy reflected from the meteor trail. However, if there is a component of velocity either toward or away from the transmitter and receiver, a tone will result. Consideration of the various geometrical possibilities will show that the tone can be either steady or varying in pitch, depending on the actual path of the meteor.

(Concluded on page 122)

MODEL 2405

Volt • Ohm • Milliammeter

25,000 OHMS PER VOLT D. C.

STANDARDS ARE SET BY



SPECIFICATIONS

NEW "SQUARE LINE" metal case, attractive tan "hammered" baked-on enamel, brown trim.

■ **PLUG-IN RECTIFIER**—replacement in case of overloading is as simple as changing radio tube.

■ **READABILITY**—the most readable of all Volt-Ohm-Milliammeter scales—5.6 inches long at top arc.

■ **RED•DOT LIFETIME GUARANTEE** on 6" instrument protects against defects in workmanship and material.

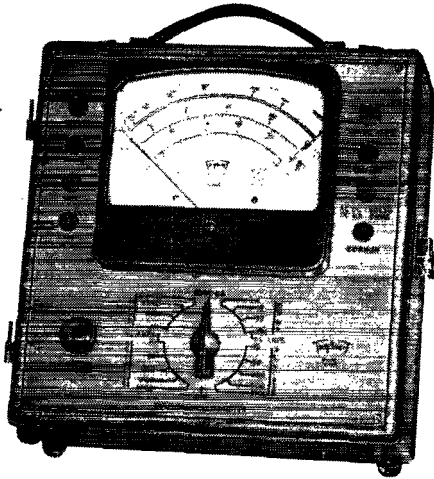

**NEW ENGINEERING • NEW DESIGN
NEW RANGES • 30 RANGES**

Voltage: 5 D.C. 0-10-50-250-500-1000 at 25000 ohms per volt.
5 A.C. 0-10-50-250-500-1000 at 1000 ohms per volt.
Current: 4 A.C. 0-5-1-5-10 amp. 6 D.C. 0-50 microamperes—
0-1-10-50-250 milliamperes—0-10 amperes.
4 Resistance 0-4000-40,000 ohms—4-40 megohms.
6 Decibel 10 to +15, +29, +43, +49, +55.
Output Condenser in series with A.C. volt ranges.

*Model 2400 is similar but has D.C. volts
Ranges at 5000 ohms per volt.
Write for complete description*

Triplet

ELECTRICAL INSTRUMENT CO.
BLUFFTON, OHIO

HAM

HEADQUARTERS FOR Equipment and Information

15 Years of Service

to HAMS throughout the U. S. and Canada.

Complete Line

of nationally famous Radio & Electronic Parts and Equipment.

Thousands of Items

in stock right now . . . comprising every well-known brand of Component Parts and Equipment.

FREE

WRITE TODAY for our current bulletins about extraordinary values in surplus Radio and Electronic Component Parts and Equipment.

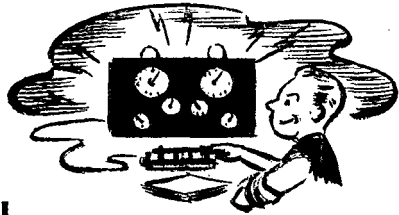

GET STARTED ON YOUR "DREAM SET" TODAY!

We have all the component parts and equipment and our HAM department, which is staffed by Engineers, will gladly help you with your problems. Write, phone, or visit us today.

Radio Product Sales Company

238 WEST 15TH STREET
LOS ANGELES 15, CALIFORNIA PRespect 7471

QST

YEARLY BINDERS



Are We Right?

You should have at least two of them—one for your complete 1945 file of copies, and one for each 1946 issue as published.

With each Binder is furnished a sheet of gold and black gummed labels for years 1926 through 1946. The proper one can be cut from the sheet and pasted in the space provided for it on the back of the binder.

Price **\$1.50** postpaid

Available only in United States and Possessions

THE AMERICAN RADIO RELAY LEAGUE
West Hartford, Conn.

122

(Continued from page 180)

The number of powerful short-wave broadcasters has greatly multiplied during the war and has made easier the job of selecting the proper conditions to "hear" the meteors. In Cambridge, Mass., the effect is particularly noticeable on stations in the New York City area broadcasting to Europe. Hearing the Doppler tones is greatly simplified if the receiver is equipped with a good a.v.c. circuit, which prevents overload during the bursts of signal caused by reflections from the meteor trails.

This method of detecting meteors is, in effect, a practical example of the principle of radar. Instead of microwaves, ordinary short waves are used, and instead of aircraft, meteor trails are detected. But the principle is much the same.

Knowing the pitch of the Doppler tone and the radio frequency used, one can calculate the component of the meteors' speed in the direction of the transmitter and receiver. However, since the exact path followed by the meteor is seldom known, its true speed cannot be measured in this way. But by listening over a long period of time and noting the pitch of the highest tone heard, a good estimate can be made of the speed at which meteors travel.

¹ J. A. Pierce, *Proc. I.R.E.*, Vol. 26, page 892 (1938) "Abnormal Ionization in the E Region of the Ionosphere."

² J. A. Pierce, *Physical Review*, Vol. 59, April (1941)

"A Note on Ionization by Meteors."

³ Chamanlal and Venkatamaran, *Electrotechnics* (Bangalore, India), Vol. 14, pp. 28-40, November (1941), "Whistling Meteors—A Doppler Effect Produced by Meteors Entering the Ionosphere."

Strays

A long awaited piece of much needed equipment has arrived if we are to believe the wording of an advertisement clipped from the *Washington Star* and forwarded by W9NDX/3. This startling "For Sale" announcement reads as follows:

"Transformer—GE; converting from 110-volt d.c. to 110-volt a.c.; power, 350 watts. Phone Columbia —."

Dwellers in d.c. areas, please note. Your problems are solved at last!

W9NDX recommends that W8CDX might be able to use such a device in connection with a further investigation of Bismark, his electronic dog.

WANTED

RADIO ENGINEERS for Design and Development of home radio receivers. Can use men with experience in design laboratories on communications and entertainment receiving sets.

Call or write Mr. Frank A. Hinners
Vice President in Charge of Engineering

Air King Products Co., Inc., 1523 63rd St., Brooklyn, N. Y.



Bob Henry is Delivering Receivers

I am delivering the following models:

National HRO Sr.....	\$197.70
National NC-240C complete with speaker.....	240.00
National One-Ten.....	56.10
Hammarlund HQ-129X complete with speaker..	139.50
Hammarlund Super Pro.....	330.00
Hallcrafters EC1A.....	29.50
Hallcrafters S20R.....	60.00
Hallcrafters S22R.....	74.50
Hallcrafters S39.....	110.00
Hallcrafters SX-25.....	94.50
Hallcrafters SX-28A.....	223.00
Hallcrafters S36A.....	415.00
Hallcrafters PM23 speaker.....	15.00
RME-45 complete with speaker.....	166.00

prices subject to change by factories

I specialize in the wholesaling of amateur receivers and transmitters. Demand for some models exceeds supply. If I can't make immediate delivery, you can reserve the model you want for preferred delivery. This assures you of earlier delivery with no obligation on your part. You can trade in your receiver. You can buy on 6% terms financed by me. I will help you get the best receiver or transmitter for your use and will see that you are satisfied. Mail, phone or wire your orders. Your inquiries invited.

W9ARA

BUTLER, MISSOURI

HENRY RADIO SHOPS

LOS ANGELES 25, CALIF.

"WORLD'S LARGEST DISTRIBUTOR OF SHORT WAVE RECEIVERS"



RCA INSTITUTES, INC.

Offer thorough training courses in all technical phases of

RADIO and TELEVISION

WEEKLY RATES

DAYS—EVENINGS

VETERANS: RCA Institutes is approved under G. I. Bill of Rights

For Free Catalog write Dept. ST-46

RCA INSTITUTES, INC.

A Radio Corporation of America Service
75 Varick Street, New York 13, N. Y.

RADIO COURSES

- RADIO OPERATING
- RADIO SERVICING
- CODE
- ELECTRONICS

• REFRIGERATION SERVICING

Personal Counselling Services for Veterans
Write for Latest Trade & Technical Catalog

Y. M. C. A. TRADE & TECHNICAL SCHOOLS
4 W. 64th Street New York City



65 models, sizes from 350 to 35,000 watts, A.C. types: 115 to 650 volts, 50, 60, 180 cycles, 1 or 3-phase; 400, 500 and 800 cycles, 1-phase. D.C. types: 6 to 4000 volts. A.C.-D.C. combination types available. Write for engineering assistance and literature. Model shown is from ATC lightweight series.

Over 250,000
Now in Service

D. W. ONAN & SONS

2632 Royalston Ave., Minneapolis 5

Minnesota

Electricity

FOR RADIO AND ELECTRONIC APPLICATIONS

Onan Electric Generating Plants supply electric service for electronics applications and general uses, mobile, or stationary. Driven by Onan-built, 4-cycle gasoline engines, they are of single-unit, compact design and sturdy construction.

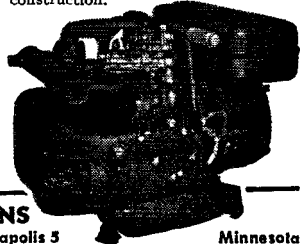

TRYLON BEAM ANTENNA SUPPORTS

Also Rhombic, Doublet, Flat Top, Vee, and Dipole Antenna Systems, Ladder Towers, etc.

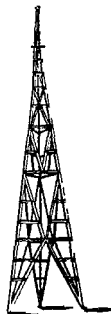

• Give your new rig full benefit of a modern, scientifically-designed antenna system! Trylon supports, available in types for every need, are inexpensive, easy to install—and permit quick, easy adjustment of antennas. All are packed in convenient knock-down form, complete with hardware, guys cut to desired lengths, and with full installation instructions. Trylon also offers a

complete line of AM, FM or Television antenna supports in bracket types for chimney, windowwall, roof or eave mounting; tripods, self-supporting and guyed ladder towers. Write for details. Give full data as to your requirements, for accurate recommendation by Trylon antenna engineering specialists.

TRYLON TOWER & ANTENNA DIVISION, Wind Turbine Company, WEST CHESTER, PENNA.

HAM-ADS

(1) Advertising shall pertain to radio and shall be of nature of interest to radio amateurs or experimenters in their pursuit of the art.

(2) No display of any character will be accepted, nor can any special typographical arrangement, such as all or part capital letters be used which would tend to make one advertisement stand out from the others.

(3) The Ham-Ad rate is 30c per word, except as noted in paragraph (6) below.

(4) Remittance in full must accompany copy. No cash or contract, discount or agency commission will be allowed.

(5) Closing date for Ham-Ads is the 25th of the second month preceding publication date.

(6) A special rate of 7c per word will apply to advertising which, in our judgment, is obviously non-commercial in nature and is placed and signed by a member of the American Radio Relay League. Thus, advertising of bona fide surplus equipment owned, used and for sale by an individual or apparatus offered for exchange or advertising inquiring for special equipment, if by a member of the American Radio Relay League takes the 7c rate. An attempt to deal in apparatus in quantity for profit, even if by an individual, is commercial and all advertising by him takes the 30c rate. Provisions of paragraphs (1), (2), (4) and (5), apply to all advertising in this column regardless of which rate may apply.

(7) Because error is more easily avoided, it is requested signature and address be printed plainly.

Having made no investigation of the advertisers in the classified columns, the publishers of QST are unable to vouch for their integrity or for the grade or character of the products or services advertised

QUARTZ — Direct importers from Brazil of best quality pure quartz suitable for making piezo-electric crystals. Diamond Drill Carbon Co., 719 World Bldg., New York City.

WHY not turn your unused equipment into ready cash which may be applied towards new and better equipment? Leo, W9GFG, offers you the best cash prices for communications receivers and test equipment. Write today for large illustrated catalog. Wholesale Radio Laboratories, 744 W. Broadway, Council Bluffs, Iowa.

CRYSTALS available — all types, including 100 kc., 465 kc. and 100 kc. Broadcast and Aircraft given prompt attention. Scientific Radio Products, Council Bluffs, Iowa.

CRYSTALS: complete units or blanks. All types. Your specifications and tolerances. One or one million. Refinishing and repairing of your present units. Rex Bassett, Incorporated, Ft. Lauderdale, Fla.

RADIO tests — Pre-examination tests for radio operators. Tests your knowledge before you appear for commercial radio operator license examinations. Avoids failures. Guides your preparation. Saves your time. Worth investigating at once. Also books for home study. Write for free circulars 5 Q. Nilson Radio School, 51 E. 42 St., New York 17, N. Y.

CRYSTAL frequency control units. All kinds, including 1000 kc. calibrating crystals. Also blanks. High quality. Low price. Prompt delivery. Standard Piezo Co., Box 164, Carlisle, Penna.

AMATEUR radio licenses. Complete code or theory preparation for passing amateur radio examinations. Home study and resident courses. American Radio Institute, 101 West 63rd Street, New York City.

WRITE, wire or phone: Bob Henry, W9ARA, Butler, Mo. 24 hour service: new and used receivers, transmitters, test equipment, radio parts of all kinds.

ALASKAN hams: Here is a source of supply closer to home. Stocking leading brands of ham gear, communication receivers, parts, accessories, engine generators. Save time and money. Robbie's Radio Supply, Alaskan jobbers. P.O. Box 1835, Anchorage, Alaska.

BILL Conkin, ex-W9BNX, now W3JUX, Bethesda, Maryland.

VHF tank circuits, all necessary parts, plain or silver plated. Details on request. W3AOC, Shaw, 3504 Baring, Phila., Penna.

GOVERNMENT surplus, steel tower, with insulated cable, base plate, \$1.10 per foot. Tower only, 75¢ per foot. Immediate shipment. Ace High Vertical Radiator Co., 207 Commerce Building, Sioux City, Iowa.

WIRE: coaxial connectors, Navy hand mikes. Catalog for stamp. Aldred, 2515 Boulevard, Jacksonville 6, Fla.

CAN my experience be of use in your business? Veteran, soon to be discharged, skilled in maintenance, modification of electronic, radio, radar, ground station, aircraft (h.f., v.h.f., u.h.f., v.h.f./i.f.) gear, test and laboratory apparatus. Three years practical training and experience with RAF and 3th AF, B.S.C. in ed. Age 26, married. Lt. John Wine, 0-481242, VAAF, Victorville, Calif.

ABBOTT MRT-3 transceivers, 2 1/4 meter. A.c. supply or Vibrapack. \$50 each complete. Three tube short-wave receiver, less power supply, \$25. 25 television lessons, \$25. Carl Stello, 925 Monroe St., N.E., Washington, D. C.

FM-Television radio course. New method. FM Engineers, Box 291, Dallas, Texas.

DYNAMOTORS, Pioneer, unused. Serial: 12-14VDC, 235VDC, 90Ma. vibration mount, filter, compact case. \$7.50. Les Dubin, W2AQN, 147 Elm Ave., Mount Vernon, N. Y.

FOR Sale: New 1 kw. crystal controlled transmitter for both c.w. and phone on 10, 20, 40, 80 meters. Built in standard Par-Metal cabinet with UTC-Stancor transformers, B & W coils, Johnson Cornell-Dubilier and Bud condensers. Ohmite resistors and Taylor tubes. Will sell for half of original cost. Immediate delivery. J. R. Mowery, P.O. Box No. 994, Lancaster, Penna.

HALLICRAFTERS SX-9, perfect condition, 5 bands. 545 to 42 Mc. C. Horn, 325 East 103rd St., New York 53, N. Y.

QSL's? QSL's? SWL's? Samples? Bliley Crystals. QST subscriptions. W8DED, Holland, Mich.

TRADE-Sell: New RCA 814 tube, never used. For dynamic microphone, Vibroplex, part on .22 revolver, or what? Also, new Radiotron Designer's Handbook, \$1.00. Hopkinson, 600 Basford Lane, Alexandria, Va.

SELL: Three 829-B tubes, unused. Make offer. W9JZU, Hoefle, 3105 Grand Ave., P.O. Box 22, Parsons, Kansas.

TRANSMITTERS: New 250-watt phone, 350 c.w., 5-foot rack, pair 813's in final, \$800. Audio Products Co., 2101 West Olive, Burbank, Calif.

QSL's: Tops in quality — Fritz, 1213 Briargate, Joliet, Ill.

RECEIVERS: SX-28A, \$223; 8X-25, \$94.50; RME-45, \$166.00; HQ-129X, \$129.00; NC-2-40C coming soon. Conklin Radio, Bethesda, Md.

SPECIAL buy: new transmitting tubes 815, \$3.25; 802, \$2.25; 829B, \$10; 828, \$9.25; 805, \$6.50; 813, \$12.50. Specials — new 5BP4 cathode ray and television 5" tube, \$10. New 4 µfd, 4000 v.d.c.; G-E Pyranols, \$9.75 each. J. A. Zebrowski, 32 West 12th St., Bayonne, N. J.

CALLBOOKS! Place your order for the Spring edition. Single copies, \$1.50; annual subscription, \$5. Radio Amateur Call Book, 608 South Dearborn Street, Chicago, Ill.

SELL: New 807s, 808s, 810s, 811s, 813s, 830Bs, 833A, Amperex ZB120s, 75-775 µuf split-stator, 7500 volt variable. Aerovox Hyvol and Dubilier Dykanol, 2 or 4 µfd, 2000 volt filters. Sangamo 5000 volt mica. List on request. Want HQ-120X, 2500 volt kilowatt plate transformer. Ed Schmeichel, W9YFV, 2116 West 35th St., Chicago 9, Ill.

GENEMOTORS, Eicor; 24 volt input, 525 volt output. Slightly used but in excellent condition. \$23.50 each. Filter condensers: oil filled, 4 µfd, 600 volt. Guaranteed. 75¢ each. Geophysical Service, Inc., 1914 North Harwood, Dallas 1, Texas.

CRYSTAL controlled exciter kit, HY75 output, 616 modulator, Husky a.c. power supply, coils for 112 and 144 Mc.; crystal for 144 Mc. band included. Complete parts and instructions, \$49.50 f.o.b. Wired and tested, \$13.00 extra. Needs 6 tubes, microphone, antenna to operate. Send for descriptive literature and bargain lists. Beta Products Co., 647 East 15th Street, Brooklyn 30.

SELL: 3 RCA 829B tubes. Unused. W9JZU, Hoefle, Box 22, Parsons, Kansas.

HERE's the tube you've been waiting for. High frequency operation, #829. For the purpose of building up our mailing list we'll send you this tube postpaid for only \$12.50. If you send your order right away we will also include, without charge, one porcelain coil form. Send your order to The Adams Company, 1210 Farnam St., Omaha 2, Nebraska.

FOR sale: RME-99 receivers, 450 watt transmitter, 5-band, complete. P.A. amplifiers, prices reasonable. C. H. Miller, 2221 Avenue D, Kearney, Nebraska.

CRYSTALS: Mounted 9 meg. low-drift for new 2-meter band, \$5.50. 7 meg. band, \$4.50. Marine, aircraft, police types available. Send specifications. Nebel Laboratory, 1104 Lincoln Place, Brooklyn 13, N. Y.

NATIONAL FB7A, 20-40-80, band-spread coils. Perfect condition: \$30. Henry Mohr, Macungie, Penna.

WANTED: One 850, two 860s, one 861 tube. Will pay cash or trade. Have government surplus radio transmitters. N. K. Stover, W3BBV, P.O. Box 722, York, Penna.

MAKE offer over \$25 for file QST, June 1919 to present. W8CEO.

NAVY transmitter and receiver, Model TAV-3. Portable and complete with generator A-1. Bargain at \$75, cash. Or will trade for good receiver. Fred Rudolph, Stryker, Ohio.

FOR sale or trade: pair T-55s and power transformer, T-6878, 600/600 v. a.c. at 200 Ma. Want: T-19P54 transformer, 0.100 Ma. Triplett meter, TZ40. W4DZO, Lowdermilk, Morgantown, N. C.

750-1000 watt phone and bug transmitter, 2 racks, 42" x 72" complete including Oscillograph, mikes, 2 receivers, 1 RME remote control, etc. Make reasonable offer. Estate Wm. W. Birney, W2LVE, 319 Parkville Ave., Brooklyn, N. Y.

WANTED: Thordarson T-11M78, T-15P21, T-15C39, T-15C48. State condition and price. Gerry Corrigan, W9BBB, 1102 State, Guthrie Center, Iowa.

WANTED: Used National 1-10 receiver. W3BWR, B. L. Norcross, 42 Laurel Ave., Linwood, N. J.

It won't be long now!



ECHOPHONE MODEL EC-1A

*A real communications receiver
at a sensationally low price*

Nearer and nearer to reality comes Hogarth's dream of a real communications receiver at a sensationally low price. Now available—or very soon—the 1946 Echophone, Model EC-1A, a 6-tube AC/DC communications receiver of outstanding value. With electrical bandspread throughout its frequency range of .55 to 30 megacycles, BFO for CW reception, and a new automatic noise limiter to suppress interference from automobile ignition, etc., the EC-1A provides genuine communications receiver performance in the lowest price range. Standard 115-volt AC or DC operation; also available for 200 to 250-volt operation.

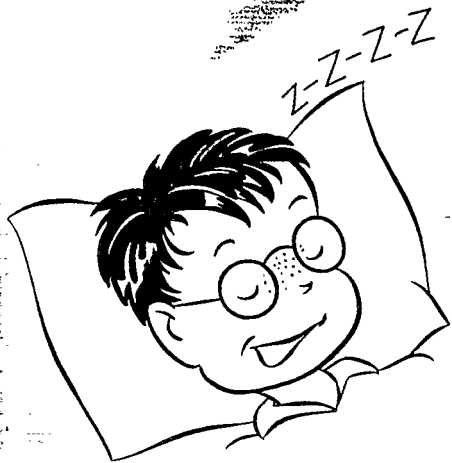

ECHOPHONE

ECHOPHONE DIVISION • THE HALLICRAFTERS CO. • 2611 INDIANA AVENUE • CHICAGO 16, U. S. A.

Designed for



Application

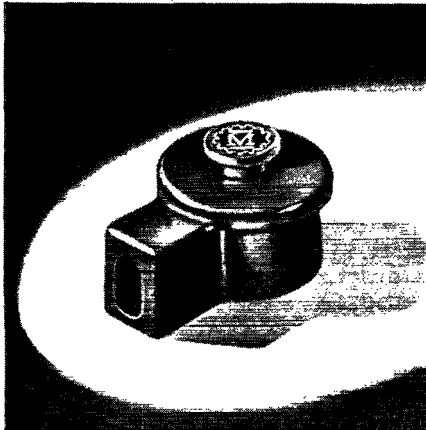

**THE NO. 36011
Snap-Lock Plate Cap**

For Mobile, Industrial and other applications where tighter than normal grip with multiple finger 360° low resistance contact is required, the new No. 36011, "Designed for Application" Plate Cap is now available. Contact self-locking when cap is pressed into position. Insulated snap button at top releases contact grip for easy removal without damage to tube. Molded black bakelite, to fit all tubes with 9/16" diameter contact ferrule.

**JAMES MILLEN
MFG. CO., INC.**

MAIN OFFICE AND FACTORY
**MALDEN
MASSACHUSETTS**



Index of Advertisers

	<i>Page</i>
Adson Radio Company.....	110
Aerton Company.....	94, 95
Air King Radio Company.....	122
Allied Radio Corporation.....	105
American Radio Institute.....	108
American Tel. & Tel. Co.....	111
Andrew Company, The.....	128
Astatic Corporation, The.....	93
Audel Publishers.....	98
Billey Electric Company.....	85
Burlington Instrument Company.....	113
Candler System Company.....	116
Capitol Radio Engineering Institute.....	81
Centralab.....	4
Collins Radio Company.....	9
Commercial Radio Institute.....	114
Concord Radio Corporation.....	112
Crystal Products Company.....	97
Echophone Radio Company.....	125
Eitel-McCullough, Inc.....	5
General Electric Company.....	91
Greenlee Tool Company.....	110
Hallcrafters Company, The.....	1, 2, 109
Hammarlund Co., Inc., The.....	82, 83
Harrison Radio Company.....	117
Harvey Radio Company.....	96
Harvey Radio Laboratories.....	102
Hatcher & Fisk.....	114
Hatry & Young.....	118
Henry Radio Shop.....	123
Hudson American Corporation.....	104
Hytron Elec. & Radio Corp.....	115
Instructograph Co., The.....	120
Kato Engineering Company.....	120
Lewis Electronics.....	116
Macmillan Co., The.....	90
Maguire Industries.....	88, 89
Mallory & Co., P. R.....	80
Marion Electric Instrument Co.....	8
McElroy Manufacturing Co.....	7
McGraw-Hill Book Co.....	86
Millen Mfg. Co., Inc., James.....	126
National Co., Inc.....	79, Cov. III
Newark Electric Co.....	106, 107
New York YMCA Schools.....	123
Onan & Sons, D. W.....	123
Port Arthur College.....	110
Premax Products Co.....	98
Radio Manufacturing Engineers.....	127
Radio Products Sales Co.....	121
Radio Shack Corp., The.....	100, 101
Raytheon Manufacturing Co.....	87
RCA Institutes, Inc.....	123
RCA Mfg. Co.....	Cov. IV
Scell & Co., R. G.....	114
Schauer Machine Company.....	116
Sound Equipment Corporation.....	118
Standard Transformer Corp.....	84
Sylvania Elec. Products Co.....	99
Telegraph Apparatus Company.....	104
Triplet Electrical Instrument Co., The.....	121
United Transformer Company.....	Cov. II
Valparaiso Technical Institute.....	118
Van Nostrand Co., Inc., The.....	92
Vibroplex Company, The.....	108
Ward Leonard Electric Co.....	108
Western Electric Company.....	103
Wholesale Radio Laboratories.....	120
Wind Turbine Company.....	123
Yaxley (P. R. Mallory & Co., Inc.).....	80

in TUNE with the TIMES!



This is an era of scientific progress. Radio performance which satisfied the amateur operator of 1941 is not going to satisfy him now—and it need not! RME is in tune with the times! While building new and better communications equipment for the exacting demands of war, RME has at the same time perfected even finer equipment for the amateur. Let's examine a few...



THE NEW

RME 45

1. The new RME-45 is so engineered that it delivers peak performance on ALL frequencies—from 550 to 33,000 KC
2. New in the radio field—and a most welcome addition—is the VHF-152 converter.
3. For the ham with wings, RME has carefully designed a practical, feather weight and highly efficient receiver transmitter.
4. And the DB-20 is now one of the most well-known units in existence.

With RME equipment, the amateur can be confident that he possesses the most carefully designed, painstakingly built, and most brilliant performing equipment modern science and pride in manufacture can produce.

THE RME
SPEAKER

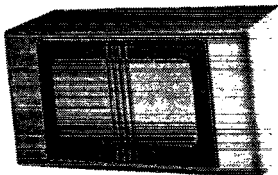

THE AT-12*
A RECEIVER-TRANSMITTER
FOR THE PRIVATE PILOT

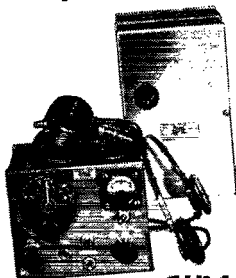

(Normal ten mile range)
Receiver Specifications:
180 to 420 KC—For
Range Station.
550 to 1500 KC—For
Broadcast Stations.
278 KC—For Tower Fre-
quency Position.
Power from small dry cells
for both units. Optional
equipment, 6 and 12 volt
input with external power
supply.*

THE VHF-152 CONVERTER*

For exceptional performance on
28 to 30 MC, 50 to 54 MC
and the new 144 to 148 MC
bands. With the VHF-152,
you can work these frequencies
through the double detection
method—with economy!*

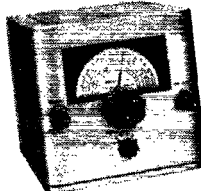

THE DB-20 PRESELECTOR

20 to 25 db gain achieved
throughout tuning range of
550 to 33,000 KC. Two highly
efficient RF stages provide
very high signal to noise ratio.

SINCE
1933

*Units now in preparation

LITERATURE ON REQUEST



RME

FINE COMMUNICATIONS EQUIPMENT

RADIO MFG. ENGINEERS, INC.

Peoria 6, Illinois U. S. A.

This new Folded Unipole Antenna for commercial use weighs only 15 pounds. Its "Slide Trombone" calibration eliminates old-fashioned pruning. Comparative tests show it out-performs other antennas at several times the price.

HIGH GAIN DIRECTIVE

ANTENNAS

for Amateur Use

In vital military and emergency communications all over the world, the name ANDREW means sound engineering plus skill and ingenuity in meeting specific antenna design problems.

NOW FOR AMATEURS

This engineering skill and know-how with commercial antennas is being applied to the production of ham antennas, including both vertically polarized directive arrays and horizontally polarized rotatable systems.

Andrew Co. pioneered in the development of HF antennas, coaxial transmission lines and accessories.

Andrew Co. specializes in the solution of antenna problems—in the designing, engineering and building of antenna equipment.

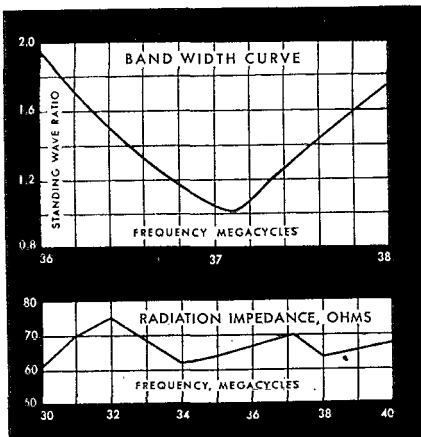

ANDREW CO.

363 EAST 75TH STREET
CHICAGO 19, ILLINOIS

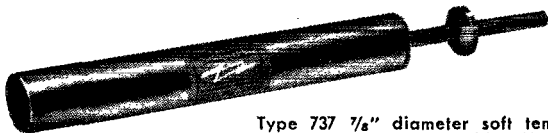

Type 737 7/8" diameter soft temper copper coaxial cable. Hundreds of miles of this Andrew cable are now in use with police and military transmitters.

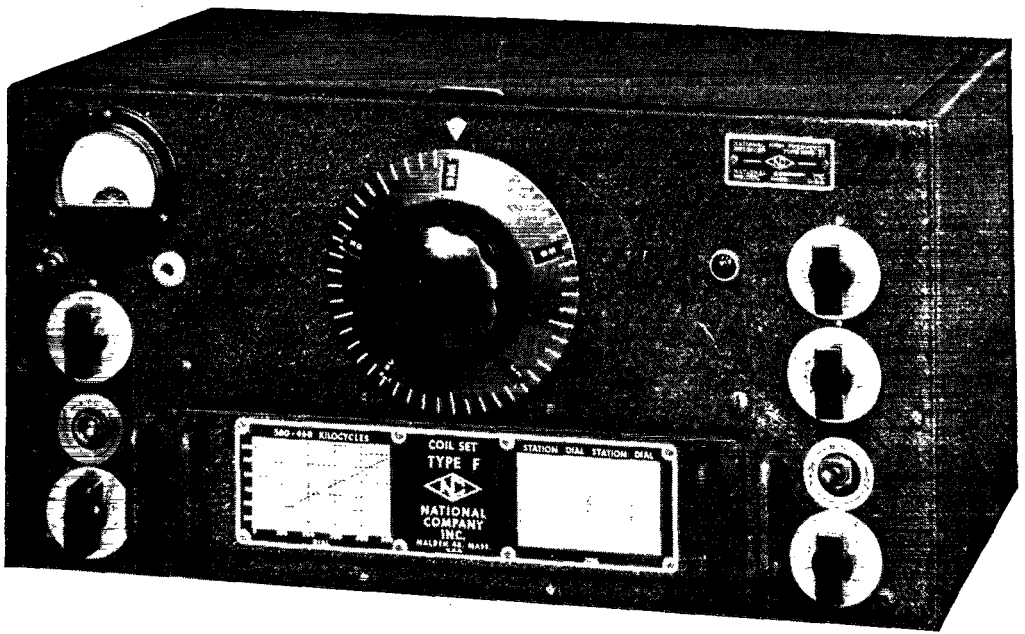

THE HRO-5TA

Your old friend, the HRO, has seen active service all over the world with the armed forces of the United States and our allies. Much has been learned, and the HRO has emerged from its trial by fire an even better receiver than the superb receiver you knew before the War.

The HRO-5TA (table model) and the HRO-5RA (rack mounting) are new receivers incorporating design improvements based on field reports from all over the world. They are superb performers of extreme reliability.

The new National catalogue lists the new HRO-5A receivers and their accessories. Ask your dealer for a copy.

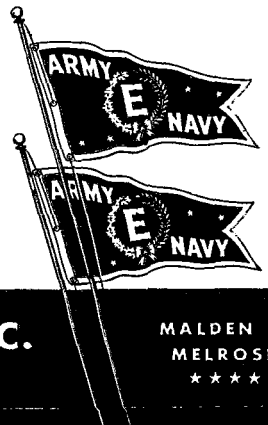

NATIONAL COMPANY, INC.

MALDEN, MASSACHUSETTS, U.S.A.

MALDEN
MELROSE

THE RCA 815 WILL GET YOU UPSTAIRS AT LESS COST

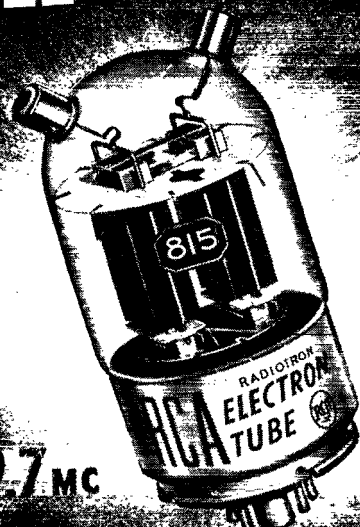

144-148 Mc

50-55

HANDLES 67 WATTS INPUT AT 144-148 Mc WITH 450-VOLT SUPPLY AND LESS THAN 0.5-WATT TUBE DRIVE

THE RCA-815 Push-Pull Beam Power Tube, originally developed for the amateur, was extensively employed in wartime mobile and aircraft transmitter designs because of its high power sensitivity, high efficiency, and low plate-voltage requirements.

Now the 815 is again ready to do service in the amateur high-frequency bands.

Priced at only \$4.50, it is the answer to a low-cost CW rig that can be operated from a simple power supply using receiver-type rectifier tubes, and can be driven to full output directly from a doubler stage.

Used as a plate-modulated r-f power amplifier, the 815 will deliver approximately 30

watts output at 144-148 Mc with only 360 volts on the plates and less than 0.5-watt tube drive!

The beam-power principle of the 815 accounts for its high efficiency and unusual economy on all bands from 2 to 20 meters. Good reason why you will want to use it.

See your local Amateur Tube Distributor.

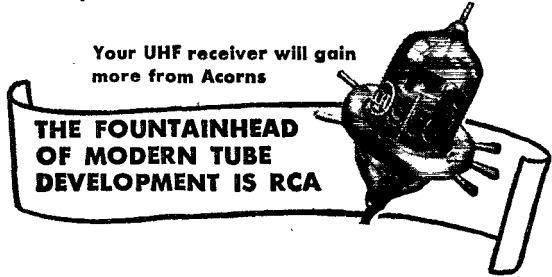

Your UHF receiver will gain more from Acorns

THE FOUNTAINHEAD OF MODERN TUBE DEVELOPMENT IS RCA



TUBE DIVISION

RADIO CORPORATION of AMERICA

HARRISON, N. J.