

QST

december, 1945
25 cents
35c in Canada

devoted entirely to

amateur radio

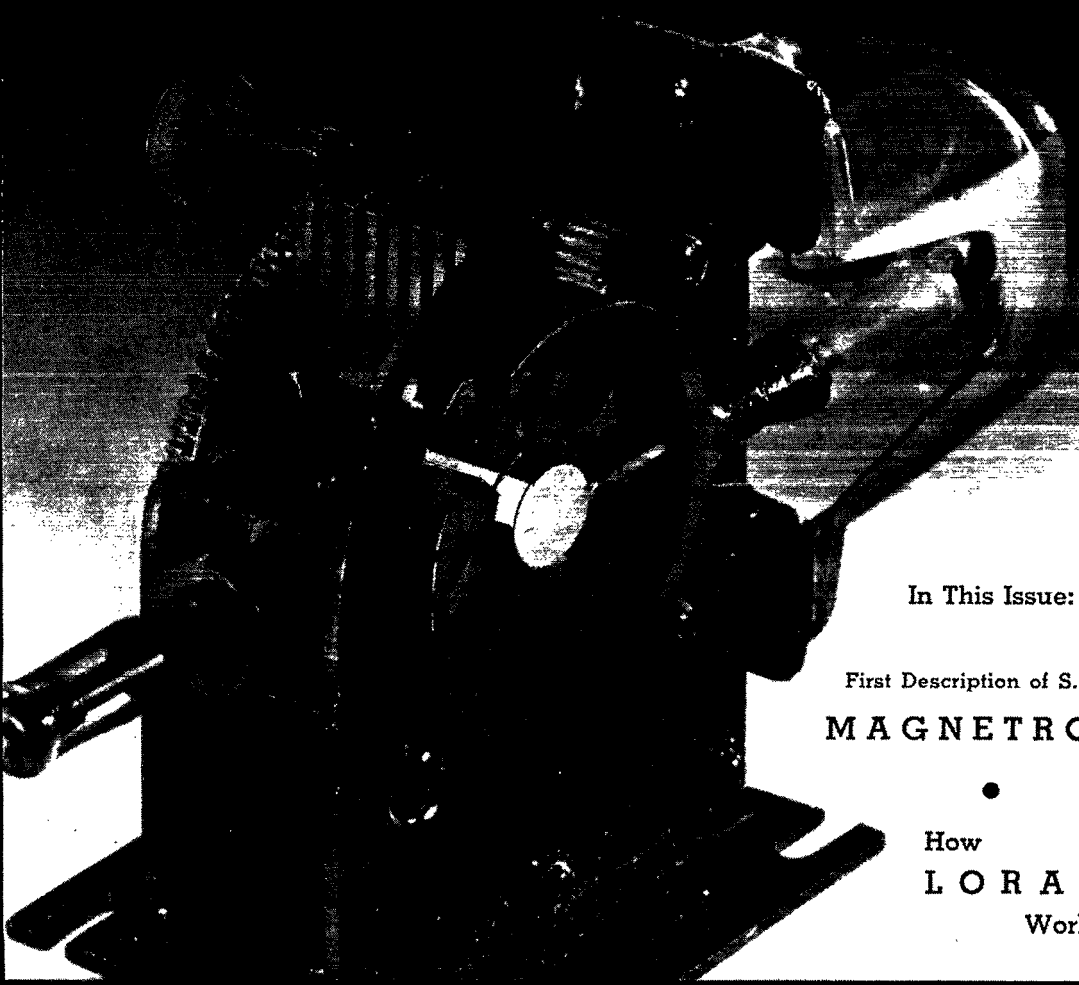

In This Issue:

First Description of S. H. F.
MAGNETRONS

How
LORAN
Works

for every transformer application



Miniature components to match the new "proximity fuse" miniature tubes. Output and input transformers, and reactors with dimensions $9/16" \times 3/4" \times 5/8"$.

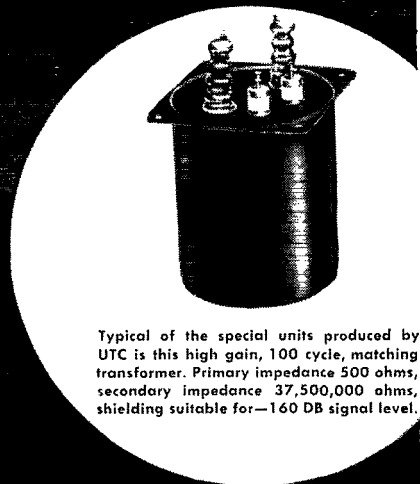

Typical of the special units produced by UTC is this high gain, 100 cycle, matching transformer. Primary impedance 500 ohms, secondary impedance 37,500,000 ohms, shielding suitable for—160 DB signal level.



UTC Special Series components cover the entire range of amateur and low priced PA requirements . . . attractively cased . . . economically priced.



UTC linear standard transformers are the ultimate in high fidelity design . . . frequency response guaranteed ± 1.5 DB 20 to 20,000 cycles . . . Low wave form distortion . . . Extremely low hum pickup.



United Transformer Corp.

150 VARICK STREET NEW YORK 13, N. Y.
 EXPORT DIVISION: 13 EAST 40th STREET, NEW YORK 16, N. Y., CABLES: "ARLAB"

NEW CHAPTER...

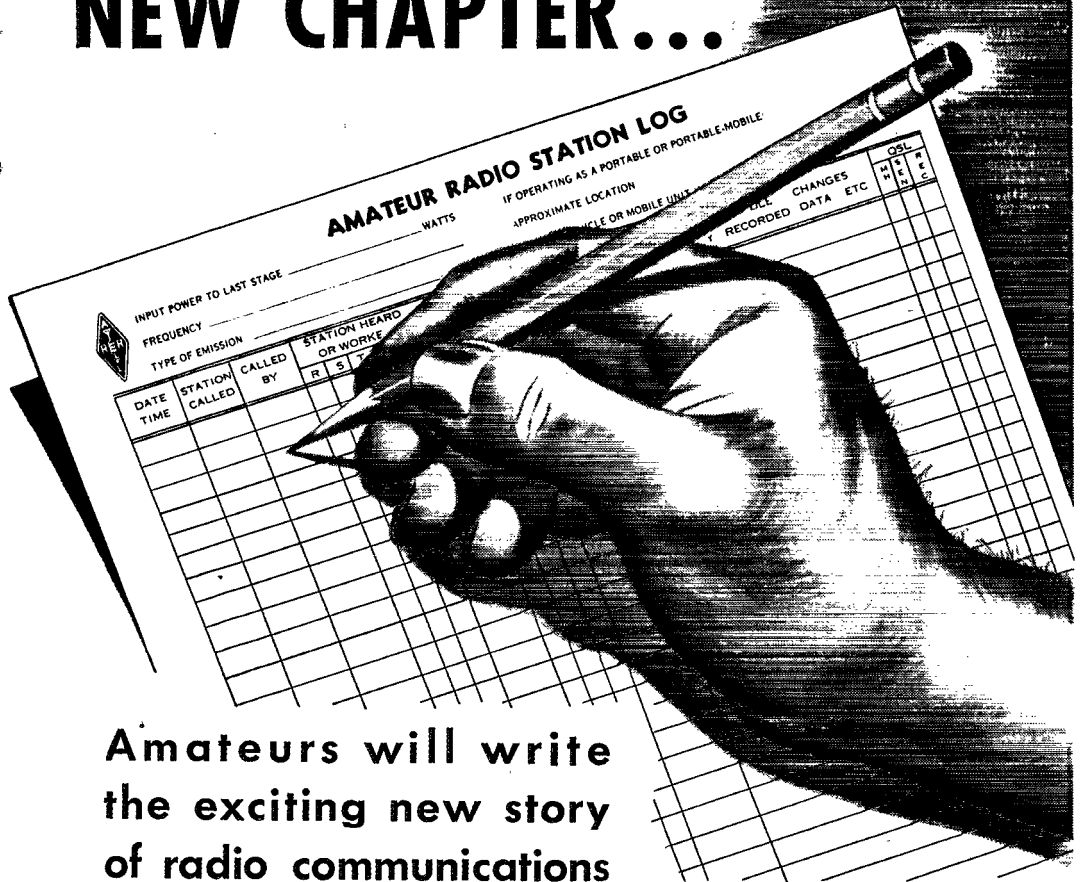

Amateurs will write the exciting new story of radio communications

The log books are opening up all over the world. Once again the fascinating data on stations heard or worked will be set down by amateur operators as they establish new records in radio communications. The reopened log books mark a new chapter in the development of radio.

Hallicrafters... as prime producers of amateur radio equipment... will play a prominent part in the new chapter. Hallicrafters high frequency transmitters and receivers will provide the instruments that will outline the future development of all radio science... especially in the VHF and UHF fields.

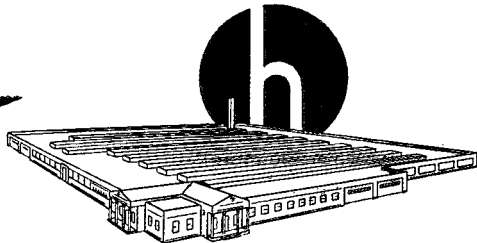

hallicrafters RADIO

COPYRIGHT 1945 THE HALLICRAFTERS CO.

THE HALLICRAFTERS CO. • MANUFACTURERS OF RADIO AND ELECTRONIC EQUIPMENT • CHICAGO 16, U.S.A.

home

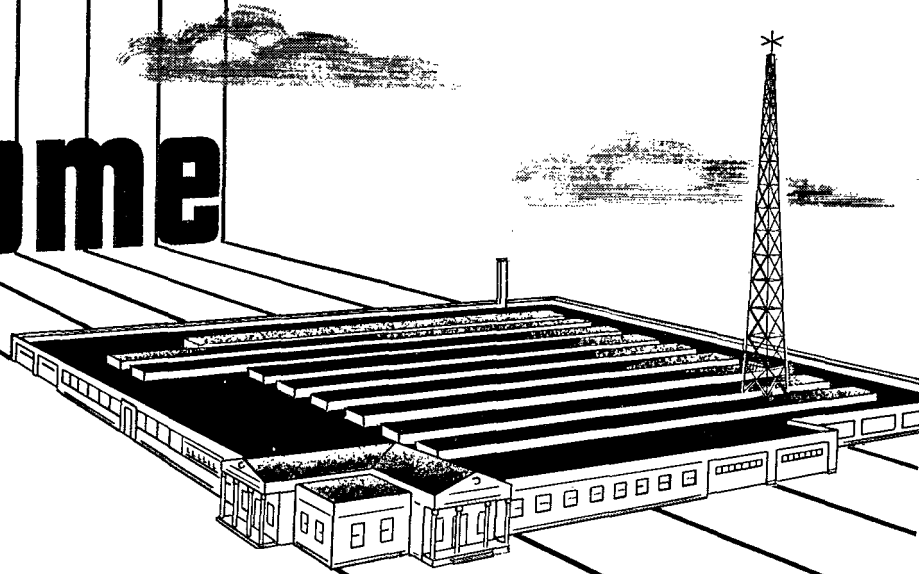

high frequency headquarters

Hallicrafters will shortly have a new home. Big, new headquarters for the further development of high frequency communications equipment are under construction in the heart of Chicago's great West Side industrial section.

Here, under the most advanced conditions, the science of radio will be brought to new heights of perfection by Hallicrafters engineers. In this \$600,000 modern plant, the finest of its kind, all operations will be combined under one roof. Straight flow production on one floor will assure constant economy and efficiency.

On this spot Hallicrafters engineers will apply their research techniques to the most extreme problems in FM, television, and high frequency development work. Here "the radio man's radio" will continue to be turned out with strict attention to the maintenance of custom built quality in each unit.



hallicrafters RADIO

THE HALLICTRAFTERS CO., MANUFACTURERS OF RADIO AND ELECTRONIC EQUIPMENT, CHICAGO 16, U.S.A.

COPYRIGHT 1945 THE HALLICTRAFTERS CO

DECEMBER 1945

VOLUME XXIX

NUMBER 12



STAFF

Editorial

KENNETH B. WARNER, W1EH
(Managing Secretary, ARRL)
Editor

GEORGE GRAMMER, W1DF
(Technical Director, ARRL)
Technical Editor

DONALD H. MIX, W1TS
BYRON GOODMAN, W1JPE
J. VENABLE FITZHUGH, W5VL
Assistant Technical Editors

A. DAVID MIDDLETON, W2OEN
Department Editor

EDWARD P. TILTON, W1HDQ
V.H.F. Editor

WALTER F. BRADLEY, W1FWH
Technical Information Service

Production

RALPH T. BEAUDIN, W1BAW
Superintendent

ELSIE C. HOCHMEISTER
Assistant

Advertising

F. CHEYNEY BEEKLEY, W1GA
Advertising Manager

Circulation

DAVID H. HOUGHTON
Circulation Manager

RALPH T. BEAUDIN, W1BAW
Assistant Circulation Manager



OFFICES

38 La Salle Road
West Hartford 7, Connecticut

Subscription rate in United States and Possessions, \$2.50 per year, postpaid; all other countries, \$3.00 per year, postpaid. Single copies, 25 cents. Foreign remittances should be by international postal or express money order or bank draft negotiable in the U. S. and for an equivalent amount in U. S. funds.

Entered as second-class matter May 29, 1918, at the post office at Hartford, Connecticut, under the Act of March 3, 1879. Acceptance for mailing at special rate of postage provided for in section 1103, Act of October 3, 1917, authorized September 9, 1922. Additional entry at Concord, N. H., authorized February 21, 1929, under the Act of February 25, 1925.

Copyright 1945 by the American Radio Relay League, Inc. Title registered at U. S. Patent Office.

QST

devoted entirely to

AMATEUR RADIO

PUBLISHED, MONTHLY, AS ITS OFFICIAL ORGAN, BY THE AMERICAN RADIO RELAY LEAGUE, INC., AT WEST HARTFORD, CONN., U. S. A.; OFFICIAL ORGAN OF THE INTERNATIONAL AMATEUR RADIO UNION



CONTENTS

It Seems to Us	11
Loran — the Latest in Navigational Aids — Part I. <i>Alexander A. McKenzie, W1BPI</i>	12
Centimeter-Wave Magnetrons <i>Henry F. Argento</i>	17
A Four-Band 125-Watt Transmitter <i>Byron Goodman, W1JPE</i>	22
300 Watts on 50 and 144 <i>E. P. Tilton, W1HDQ</i>	25
Simplified F.M. <i>Major J. C. Geist, SC, W3CPG</i>	29
Happenings of the Month	31
The Inter-American Radio Conference of Rio <i>Arthur L. Budlong, W1JFN</i>	33
Silent Keys	35
Utilizing the VR-Series Tubes <i>W. H. Anderson, VE3AAZ</i>	36
ESCTC Announces Course in Amateur Radio	37
Necessity is a Mudder . . . <i>Thomas J. Kelly, W4CNY/1</i>	38
"Gawp" "Sourdough"	40
WVW Schedules	41
An Inexpensive Transmitter Console <i>S. E. Garber, W3MGS</i>	42
Frequency Multiplication for the V.H.F. Bands <i>Harry A. Gardner, W1EHT</i>	45
ARRL Emergency Corps Program <i>F. E. Handy, W1BDI</i>	49
In QST 25 Years Ago This Month	51
Technical Topics	
Forms of Pulse Modulation	52
Waves and Wave Guides	53
Practical Applications of Simple Math <i>Edward M. Noll, W3WKX, ex-W3FQJ</i>	57
Foreign Notes	61
The World Above 50 Mc.	62
Correspondence from Members	64
The Crystal Ball	65
In the Services	66
Operating News	72
Amateur Activities	74
The Month in Canada	86
Ham-Ads	136
QST's Index to Advertisers	138
QST Index for 1945	141

REMEMBER THE NAME

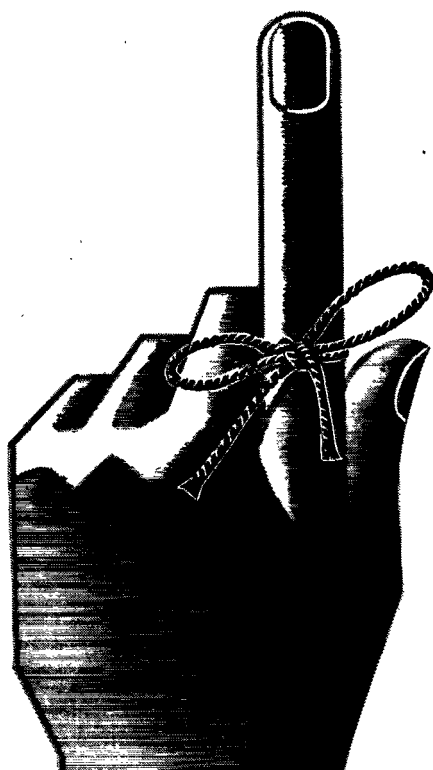

Remember the name ALSIMAG.

It represents the highest quality Steatite Ceramics for electrical and other technical uses.

Assembled in your design *you can forget the insulators.*

For they will give trouble-free, worry-free service from now on.

Whatever you are planning in the electronic or electrical field, we believe our specialized knowledge will be helpful.

Let's work together.

AMERICAN LAVA CORPORATION

CHATTANOOGA 5, TENNESSEE

43RD YEAR OF CERAMIC LEADERSHIP



ALCO has been awarded for the fifth time the Army-Navy "E" Award for continued excellence in quantity and quality of essential war production.

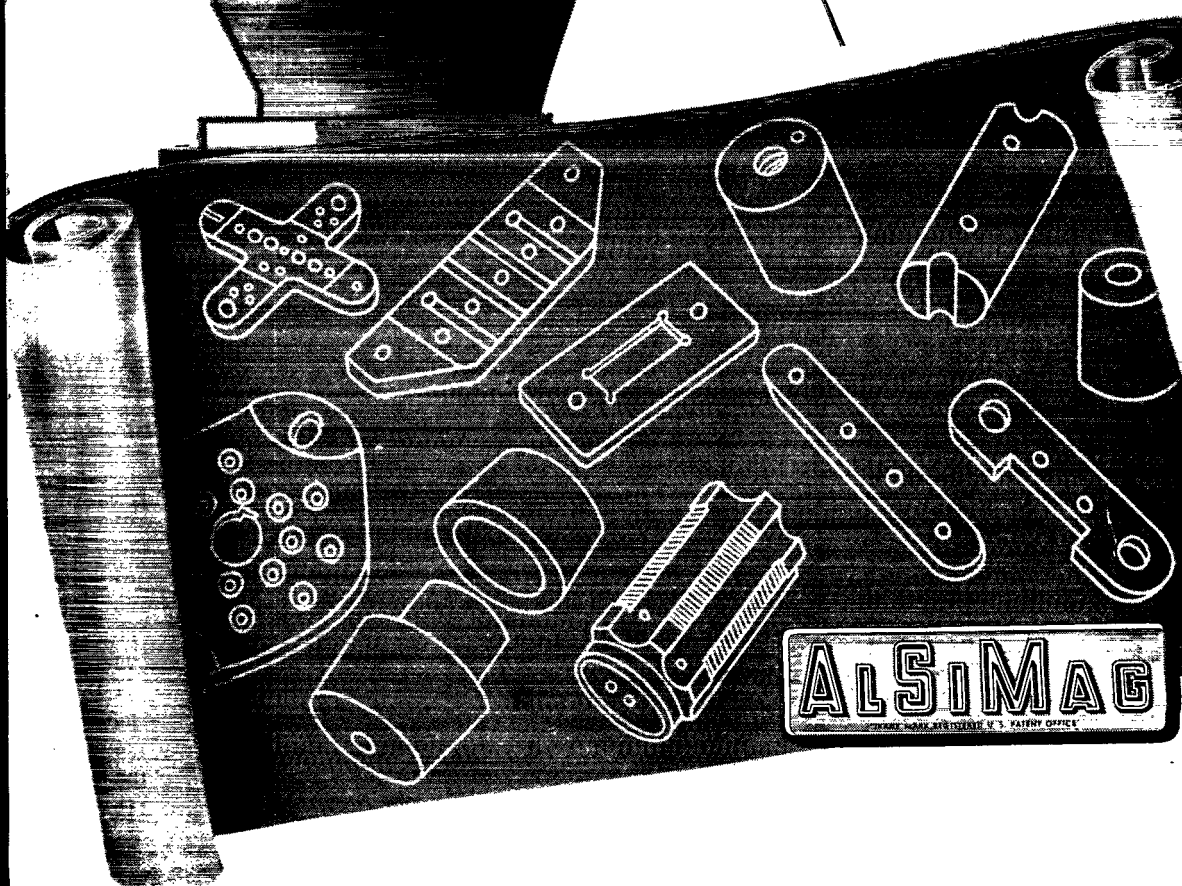

Tests Prove Eimac Vacuum Capacitors Far Superior in Operating Efficiency

Ability to handle high current at high frequencies is the true measure of the performance of a capacitor. A high peak voltage rating based on low frequency measurements does not tell the whole story.

The chart on this page shows the results of tests at 50 Mc. conducted on a standard Eimac VC50-32 Vacuum Capacitor and three other 50 mmfd. vacuum capacitors, designated on the chart by "A," "B" and "C." At just over 17 amps. (approximately 1525 peak volts across the capacitor) Unit "A" (rated at many times the applied voltage) became sufficiently heated to melt the solder on the end caps. Under this same test, the Eimac VC50-32 operates at less than 70°.

Eimac introduced the vacuum capacitor in 1938. It is interesting to note that the original Eimac capacitor design is still outperforming all comers. Such outstanding performance is typical of all Eimac products, which is one of the reasons why they are first choice of leading electronic engineers throughout the world.

Follow the leaders to

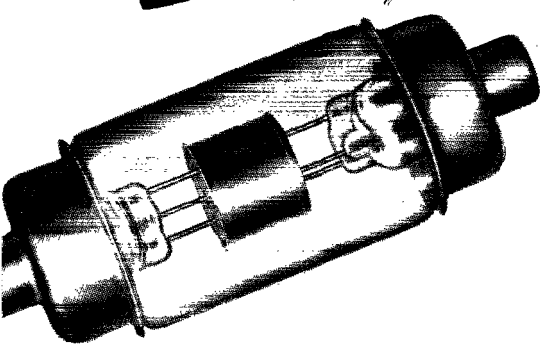

EIMAC VACUUM CAPACITOR TYPE VC50-32
General Characteristics

Mechanical:

Maximum Overall Dimensions	
Length	6.531 inches
Diameter	2.281 inches

Electrical:

Maximum Peak Voltage	32,000 volts
Maximum RMS Current	28 amps.

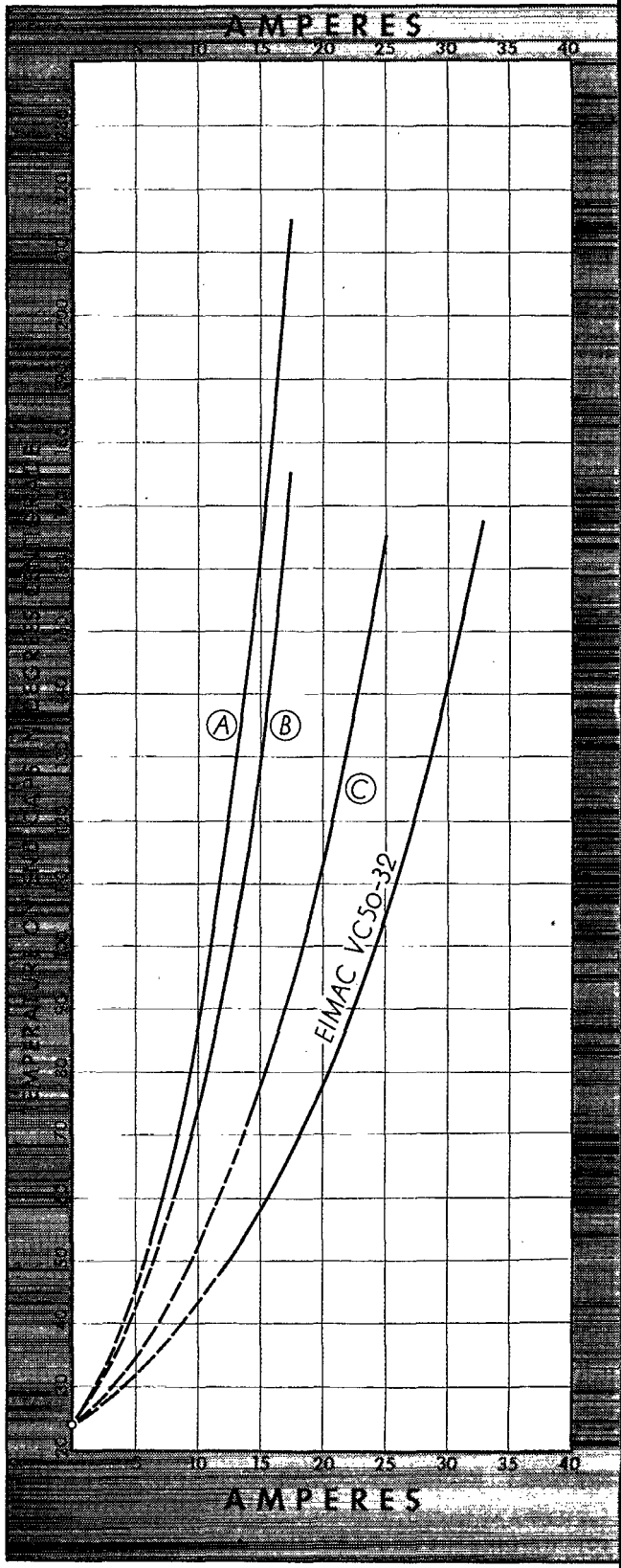



A background of *Performance*—over 50 years—is the *inside story* of the popularity that has brought leadership to *Thordarson* transformers. Performance over the years, after all, is the only true test of product quality.

Consumer acceptance will continue because *Thordarson* research and design engineers are never satisfied just keeping abreast of the times. These men are continually developing many transformer components which are instrumental in the production of new and better performing devices and equipment for the electronics industry.

This same pioneering spirit has been responsible for many new *Thordarson* transformer applications and developments during the war . . . all of which will be available shortly for civilian requirements.

Thordarson's well-tested methods of sales promotion and distribution will continue their joint task of making *Thordarson* Transformers, together with complete information on their applications and uses, available to everyone in the field.

Always think of Thordarson for top-notch transformers!

500 WEST HURON ST., CHICAGO, ILL.

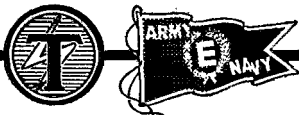

ORIGINATORS OF TRU-FIDELITY AMPLIFIERS

THORDARSON

ELECTRIC MANUFACTURING DIVISION

MAGUIRE INDUSTRIES, INCORPORATED



High power output, long life, feature these transmitting tube stalwarts!

- TYPE GL-892
Water-cooled . . . \$170
- TYPE GL-892-R
Forced-air-cooled . \$345

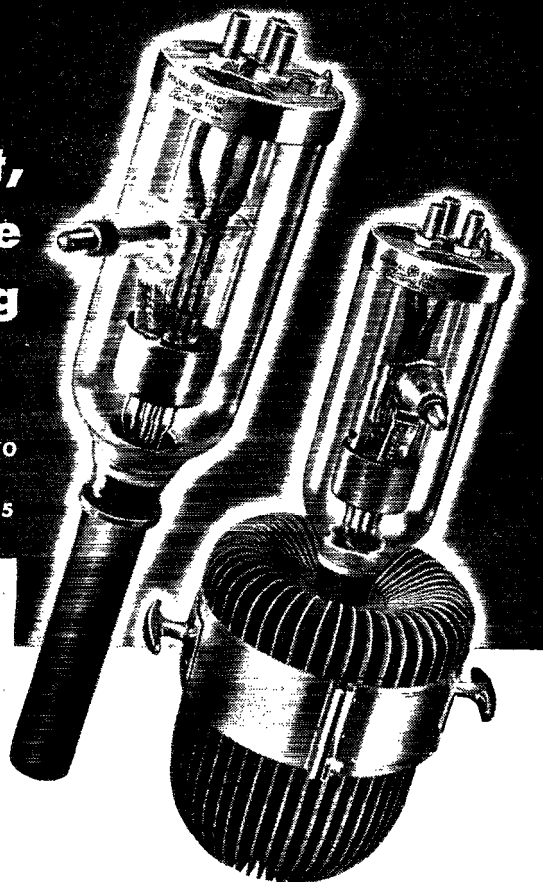

HERE is *proved* power, dependability, and long service life for the large AM transmitter owner or the manufacturer using electronic heating. General Electric Types GL-892 and GL-892-R have demonstrated their reliability in broadcasting and industrial sockets operating 24 hours a day, 7 days a week. With broad applications as high-power amplifiers, modulators, and oscillators, Types GL-892 and GL-892-R also are adaptable as to filament supply, their 2-unit filament permitting operation from 2-phase or single-phase a-c, as well as from d-c. For complete data to supplement the basic ratings at the right, see your nearest G-E Office or distributor, or write *Electronics Department, General Electric Company, Schenectady 5, New York.*

CHARACTERISTICS

Three-electrode high-vacuum power tubes for use as amplifiers and modulators in broadcasting and communications equipment—also oscillators in industrial electronic heating. Besides Types GL-892 and GL-892-R shown above, Types GL-891 and GL-891-R also are available at the same prices, and are similar in design characteristics except for the amplification factor, as given in the table.

Rating	GL-892	GL-892-R	GL-891	GL-891-R
Filament voltage	11 v	11v	11v	11 v
Filament current	60 amp	60 amp	60 amp	60 amp
Max plate voltage	15,000 v	12,500 v	12,000 v	10,000 v
Max plate current	2 amp	2 amp	2 amp	2 amp
Max plate input	30 kw	18 kw	18 kw	15 kw
Max plate dissipation	10 kw	4 kw	6 kw	4 kw
Amplification factor	50	50	8	8

Notes: (1) Filament voltage and current given above, are per unit of 2-unit filament. (2) Maximum frequency for all four tube types is 1.6 megacycles at max plate input; up to 20 megacycles at reduced ratings.

Come to
GENERAL ELECTRIC
with any special tube
problems. A staff of ex-
perienced G-E tube en-
gineers will work with
you closely to meet your
application or replace-
ment needs.

GENERAL ELECTRIC

161-D12-8650

TRANSMITTING, RECEIVING, INDUSTRIAL, SPECIAL PURPOSE TUBES
VACUUM SWITCHES AND CAPACITORS

Section Communications Managers of the A.R.R.L. Communications Department

Reports Invited. All amateurs, especially League members, are invited to report communications activities, training plans, code classes, theory-discussion groups each mid-month (16th of the month for the last 30 days) direct to the SCM, the administrative official of ARRL elected by members in each Section whose address is given below. Radio Club reports and Emergency Coordinator reports representing community organized work and plans and progress are especially desired by SCMs for inclusion in *QST*. **ARRL Field Organization appointments**, with the exception of the Emergency Coordinator and Official Broadcasting Station posts, are suspended for the present and no new appointments or cancellations, with the exception named, will be made.

ATLANTIC DIVISION				
Eastern Pennsylvania	W3BES	Jerry Mathis	623 Crescent Ave. 9701 Monroe St. Sliver Springs P. O. 623 E. Brown St. 4158 Ridge Road, West 927 East 23rd St.	Glenside Gardens Linden, Maryland Trenton 10 Spencerport Erie
Maryland-Delaware-District of Columbia	W3CIZ	Hermann E. Hobbs		
Southern New Jersey	W3CCU	Ray Tomlinson		
Western New York	W8UPH	Charles I. Otero		
Western Pennsylvania	W8NCJ	R. R. Rosenberg		
CENTRAL DIVISION				
Illinois	W9NUX	David E. Blake, II	4501 N. Malden St.	Chicago 40
Indiana	W9EGQ	Herbert S. Brier	385 Johnson St.	Gary
Kentucky	W9ARD	Darrell A. Downard	2077 Sherwood Ave.	Louisville 5
Michigan	W8DPE	Harold C. Bird	R.F.D. 2, Box 228	Pontiac 2
Ohio	W8MFP	Carl F. Wiehe	122 St. Albert St.	St. Bernard 17
Wisconsin	W9RH	Emil Felber, Jr.	1625 N. 18th St.	Milwaukee 5
DAKOTA DIVISION				
North Dakota	W9EVP	Raymond V. Barnett	406-17th St.	Bismarck
South Dakota	W9QVY	P. H. Schultz	118 N. Yankton Ave.	Pierre
Northern Minnesota	W9FUZ	Armond D. Brattland	Birchmont Drive	Bemidji
Southern Minnesota	W9YNQ	Millard L. Benker	608 N. Huron Ave.	Spring Valley
DELTA DIVISION				
Arkansas	W5GED	Ed Beck	2503 Bishop St.	Little Rock
Louisiana	W5DKR	Eugene H. Treadaway	P. O. Box 44	LaPlace
Mississippi	W5HAV	P. W. Clement	524 Santini St.	Biloxi
Tennessee	W4SP	James B. Witt	R.F.D. 6, Shady Dell Trail	Knoxville
HUDSON DIVISION				
Eastern New York	W2HZL	Ernest E. George	2044 Lexington Parkway	Schenectady 8
N. Y. C. & Long Island	W2KDC	Charles Ham, Jr.	151-06 84th Drive	Jamaica, L. I., 2
Northern New Jersey	W2CQD	Winford G. Beck	617 Spruce St.	Roselle
MIDWEST DIVISION				
Iowa	W9PFR	Leslie B. Vennard	2712 Washington St.	Burlington
Kansas	W9AWP	A. B. Urubier	14167 S. Seneca St.	Wichita 12
Missouri	W9OUD	Mrs. Letha A. Dangerfield	411 Moffett Ave.	Omaha 11
Nebraska	W9FQB	Arthur R. Gaeth	6105 N. 37 St.	
NEW ENGLAND DIVISION				
Connecticut	W1KQV	Edmund R. Fraser	48 Willow St.	West Haven 16
Maine	W1AQL	G. C. Brown	379 No. Main St.	Brewer
Eastern Massachusetts	W1ALP	Frank L. Baker, Jr.	91 Atlantic St.	North Quincy 71
Western Massachusetts	W1IAH	William J. Barrett	259 Columbia St.	Adams
New Hampshire	W1FTJ	Mrs. Dorothy W. Evans	P. O. Box 312	Concord
Rhode Island	W1HRC	Clayton C. Gordon	70 Columbia Ave., Gaspee	Plateau, Providence 5
Vermont	W1NLO	Burtis W. Dean	P. O. Box 81	Burlington
NORTHWESTERN DIVISION				
Alaska	K7GNN	James G. Sherry		Homer
Idaho	W7AVP	Don D. Oberbillig	P. O. Box 486	Boise
Montana	W7CPY	Rex Roberts	Box 1088	Glendive
Oregon	W7GNI	Carl Austin	1137 Federal	Bend
Washington	W7FWD	O. U. Tatro	513 N. Central	Olympia
PACIFIC DIVISION				
Hawaii	K6RLG	Howard S. Simpson	2068 Wells St.	Wailuku, Maui
Nevada	W6CW	N. Arthur Sowle	Box 2025	Reno
Santa Clara Valley	W6IUZ	Earl F. Sanderson	600 Acacia Ave.	San Bruno
East Bay	W6TT	Horace R. Greer	414 Fairmount Ave.	Oakland 11
San Francisco	W6RBO	William A. Ladley	200 Naylor St.	San Francisco 12
Sacramento Valley	W6MDI	Vincent N. Feldhausen	113 South Quincy St.	McClound
Philippines	KA1GR	George I. Rickard	Box 849	Manila
San Joaquin Valley*	W6BXB	Edward H. Noack	811 West Magnolia St.	Stockton
ROANOKE DIVISION				
North Carolina	W4CYB	W. J. Wortman	P. O. Box 566	Morganton
South Carolina	W4BOE/ANG	Ted Ferguson	3422 Rosewood Drive	Columbia 25
Virginia	W3AKN	Walter G. Walker	217-51 St.	Newport News
West Virginia	W8JRL	Kenneth M. Zinn	P. O. Box 132	Clarksburg
ROCKY MOUNTAIN DIVISION				
Colorado	W9VGC	H. F. Hekel	2743 Julian St.	Denver 11
Utah-Wyoming	W6LLH	Victor Drabble	1024 Oak St.	Ogden, Utah
SOUTHEASTERN DIVISION				
Alabama	W4CBV	Lawrence J. Smyth	808 Winona Ave.	Montgomery
Eastern Florida	W4UP	Robert B. Murphy	3302 S. W. Grapeland Blvd.	Miami 33
Western Florida	W4MS	L. Edward J. Collins	1409 N. 10th Ave.	Pensacola
Georgia	W4FDJ	Ernest L. Morgan	R.F.D. 2	Lyons
West Indies (Cuba) (Puerto Rico-Virgin Islands)	K4KD	Everett Mayer	P. O. Box 1061	San Juan 5, P. R.
SOUTHWESTERN DIVISION				
Los Angeles	W6QVV	H. F. Wood	429 So. Fairview	Burbank
Arizona	W6RWW	Douglas Aitken	341 S. Mt. Vernon Ave.	Prescott
San Diego	W6CHV	Ralph H. Culbertson	1712 Eads St.	La Jolla
WEST GULF DIVISION				
Northern Texas	W5ALA	Jack T. Moore	5712 Berkshire Lane	Dallas 9
Oklahoma	W5AYL	Ed Oldfield	2141 N. W. 35th St.	Oklahoma City 6
Southern Texas	W5JC	James B. Rives	1721 Kentucky Ave.	San Antonio 1
New Mexico	W5HJF	J. G. Hancock	110 S. E. Nevada St.	Portales
MARITIME DIVISION				
Maritime	VE1DQ	A. M. Crowell	69 Dublin St.	Halifax, N. S.
ONTARIO DIVISION				
Ontario	VE3EF	Wing Commander Donald R. Gunn	c/o Canadian Bank of Commerce	New Toronto, Ont.
QUEBEC DIVISION				
Quebec	VE2CO	Lieutenant L. G. Morris	4114 Hingston Ave.	Montreal 28, Que.
VANALTA DIVISION				
Alberta	VE4GE	C. S. Jamieson	581 W. Riverside Drive	Drumheller, Alta.
British Columbia	VE5DD	C. O. I. Sawyer	2634 West 31st Ave.	Vancouver
PRAIRIE DIVISION				
Manitoba	VE4AAW	A. W. Morley	26 Lennox St.	St. Vital
Saskatchewan	VE4SY	Arthur Chesworth	1084 Redland Ave.	Moose Jaw

*Officials appointed to act temporarily in the absence of a regular official.

new **VARIABLE** **CAPACITOR** **TECHNIQUE**

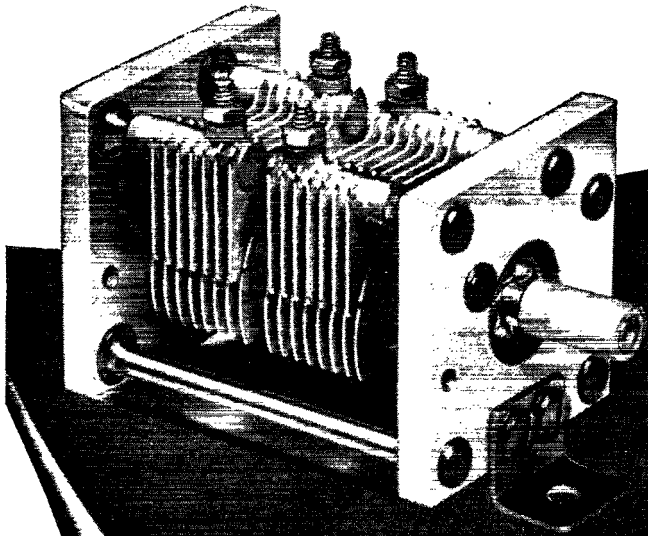

Send card for mechanical and electrical specifications.

Here's the answer to your UHF design problems. Noiseless operation — no rotor contacts — symmetrical layout. The new "VU" type variable capacitors can be used in conventional tuned circuits at frequencies as high as 500 megacycles. Write for folder with full technical data.



HAMMARLUND

THE HAMMARLUND MFG. CO., INC., 460 W. 34TH ST., NEW YORK 1, N.Y.
MANUFACTURERS OF PRECISION COMMUNICATIONS EQUIPMENT

THE AMERICAN RADIO RELAY LEAGUE, INC.,

is a noncommercial association of radio amateurs, bonded for the promotion of interest in amateur radio communication and experimentation, for the relaying of messages by radio, for the advancement of the radio art and of the public welfare, for the representation of the radio amateur in legislative matters, and for the maintenance of fraternalism and a high standard of conduct.

It is an incorporated association without capital stock, chartered under the laws of Connecticut. Its affairs are governed by a Board of Directors, elected every two years by the general membership. The officers are elected or appointed by the Directors. The League is noncommercial and no one commercially engaged in the manufacture, sale or rental of radio apparatus is eligible to membership on its board.

"Of, by and for the amateur," it numbers within its ranks practically every worth-while amateur in the nation and has a history of glorious achievement as the standard-bearer in amateur affairs.

Inquiries regarding membership are solicited. A bona fide interest in amateur radio is the only essential qualification; ownership of a transmitting station and knowledge of the code are not prerequisite, although full voting membership is granted only to licensed amateurs.

All general correspondence should be addressed to the Secretary at the administrative headquarters at West Hartford, Connecticut.



Past Presidents

HIRAM PERCY MAXIM, W1AW, 1914-1936
EUGENE C. WOODRUFF, W8CMP, 1936-1940

Officers

President.....GEORGE W. BAILEY, W1KH
Washington, D. C.
Vice-President.....CHARLES E. BLALACK, W6GG
Yuma, Arizona
Secretary.....KENNETH B. WARNER, W1EH
West Hartford, Connecticut
Communications Manager.....F. E. HANDY, W1BDJ
West Hartford, Connecticut
Treasurer.....DAVID H. HOUGHTON
West Hartford, Connecticut

General Counsel.....PAUL M. SEGAL
1026 Woodward Building, Washington 5, D. C.

Directors

President
GEORGE W. BAILEY.....W1KH
1530 P St., N.W., Washington 25, D. C.

Vice-President
CHARLES E. BLALACK.....W6GG
Box 108, Yuma, Ariz.

Canadian General Manager
ALEX REID.....VE2BE
240 Logan Ave., St. Lambert, P. Q.
Alternate: Leonard W. Mitchell.....VE3AZ
78 Raglan Ave., Toronto, Ont.

Atlantic Division
WALTER BRADLEY MARTIN.....W3QV
25 Arbutha Rd., Abington, Pa.
Alternate: Herbert M. Wallace.....W8BQ
P. O. Box 18, Drums, Pa.

Central Division
JOHN A. KIENER.....W8AVH
3462 Edison Rd., Cleveland Heights,
Cleveland 21, Ohio
Alternate: Earl S. Nelson.....W8DS
22551 Hadden Rd., Euclid 17, Ohio

Dakota Division
TOM E. DAVIS.....W9VVA
915 W. Becker Ave., Willmar, Minn.
Alternate: Aaron E. Swanberg.....W9BHY
1487 Breda St., St. Paul 4, Minn.

Delta Division
E. RAY ARLEDGE.....W5SI
P. O. Box 286, Pine Bluff, Ark.
Alternate: Samuel H. Dowell.....W5ERV
1057 Mildred St., Shreveport 15, La.

Hudson Division
ROBERT AKERIDGE KIRKMAN.....W2DSY
Werah Pl., R.F.D. No. 1, Box 61, Long Branch, N. J.
Alternate: George Rulfs, Jr.....W2CJY
38 Brookwood Drive, Manhasset, L. I., N. Y.

Midwest Division
FLOYD E. NORWINE, JR.....W9EFC
7405 Hlawatha Ave., Richmond Heights 17, Mo.
Alternate: C. A. Colvin.....W9VHR
% Omaha & Council Bluffs St. Railway Co.,
Omaha 2, Nebr.

New England Division
PERCY C. NOBLE.....W1BVR
37 Broad St., Westfield, Mass.
Alternate: Clayton C. Gordon.....W1HRC
70 Columbia Ave., Warwick, R. I.

Northwestern Division
KARL W. WEINGARTEN.....W7BG
3219 N. 24th St., Tacoma 7, Wash.
Alternate: R. Rex Roberts.....W7CPY
110 W. Brennan St., Glendive, Mont.

Pacific Division
J. L. McCARGAR.....W6EY
66 Hamilton Pl., Oakland 12, Calif.
Alternate: Elbert J. Amarantes.....W6FBW
1675 Dale Ave., San Jose, Calif.

Roanoke Division
H. L. CAVENESS.....W4DW
2607 Vanderbilt Ave., Raleigh, N. C.
Alternate: J. Frank Key.....W3ZA
Box 707, Buena Vista, Va.

Rocky Mountain Division
C. RAYMOND STEDMAN.....W9CAA
Address correspondence to the Acting Director:
HOWARD R. MARKWELL.....W9TFP
358 Monroe St., Denver 6, Colo.

Southeastern Division
WILLIAM C. SHELTON.....W4ASR
527 Revillo Blvd., Daytona Beach, Fla.
Alternate: William P. Sides.....W4AUP
Fleming Road, Montgomery, Ala.

Southwestern Division
JOHN E. BICKEL.....W6BKY
1834 E. Whittier Blvd., Whittier, Calif.
Alternate: Eldridge E. Wyatt, Jr.....W6ARW
P. O. Box 3597, Long Beach 3, Calif.

West Gulf Division
WAYLAND M. GROVES.....W5NW
c/o Humble Pipe Line Co., Iraan, Texas
Alternate: Jennings R. Puston.....W5AJ
P. O. Box 848, Curundu, Panama Canal Zone

"IT SEEMS TO US —"

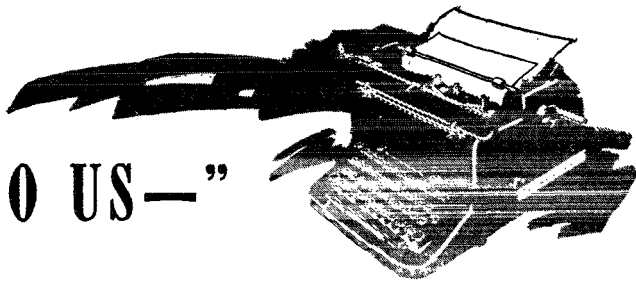

WERE OFF!

AS WE write it is not quite November 15th and so we can only speculate on how we fellows are going to find things after that magic date, and drool over how swell it's going to feel to be going again. But as we glance backward over our calendar it seems to us, by T.O.M.'s whiskers, that amateur radio has been doing pretty well for itself! It was just back in August that we were still dropping A-bombs on the Js. In three short months we are opened up on most of our frequencies above 28 Mc. We may work any DX that we can hook and we may operate portable on any band. Arrangements are almost ready to issue station licenses to those who don't now have them. The military services are working hard to clear our remaining bands and have already made a great deal of progress. W1AW is going again. Technical information is flowing out like mad. Our manufacturers and suppliers have tempting new arrays of stuff. Of course we're not really back "on" until we get "80, 40 and 20" but our point is that it's going to seem no time at all until things are like they were in the old days.

If we can judge by the notes in the QST's of twenty-six years ago, when we reopened after War I, we're not likely to make an astoundingly rapid return to the bands now open to us. Many of us, who have been too busy to overhaul leisurely, are going to have our equipment troubles: moisture in transmitters idle these many years, corroded connections, receivers out of alignment, halyards that have long since parted company with their pulleys, missing parts to replace. There'll be days and nights of hard work — and, we suspect, plenty of cussing — before our old rigs are perking again. But, boy it's worth it, when you think of the DX commercial harmonics you've been hearing on 10 and the grand extended ranges there have been on 5 recently. And of your old pals waiting to sked you. And of your chance to be the one to make the first QSO on a shiny new microband. Let's make the most of our new opportunities, fellows, and get going quickly.

But let us at the same time resolve to make a clean start in our operating habits and leave some of our prewar bad ones behind us. While we shall start out rather slowly, we must expect that our bands will soon become congested and we're going to need a new order of operating courtesies. Those of us first on the air

will set the pace for those who follow. Let's do it right. There are some things that definitely need our attention. Most of them boil down to the fact that we were rarely considerate enough of the other fellow. To get by, he had to do the same things. The result was our prewar madhouse of QRM, most of it unnecessary. Do you mind a few suggestions?:

1)- Make short calls, particularly when calling CQ. Short calls, repeated as necessary, are as effective as a longer call — either he hears you or he doesn't. And people detune a long CQ, because there's no sense in waiting all evening for you to sign and go over.

2) Use break-in and push-to-talk. Nothing so saves the air from needless cluttering-up. They are the hallmark of the efficient amateur.

3) Don't talk locally on a DX frequency. Shift to a v.h.f. The days are gone when we can afford to have local five-cornered gabfests messing up a longer-distance band all evening. If everybody does it, there'll be no DX for anybody. But it's quite all right on a local frequency; that's what little v.h.f.s are for.

4) Don't have just one power setting, your maximum. Be able to reduce power and to trim it to the minimum needed to sustain satisfactory communication. That will vary with conditions and the distance. FCC regulations require it. We should be ashamed to cause interference at a thousand miles when talking to another station only five hundred miles away.

5) Give honest signal reports, minus the flattery, and expect the same in return. Not only be satisfied with a candid report, demand it. What good can you possibly derive from a misleading report that caters only to your vanity? The way this Alfonso & Gaston show was going before the war, we were about to run out of S-numbers. Be honest in your comments, so the other fellow can really help himself from your information.

6) Don't be a show-off. Sure you can send faster than he can copy; everybody's rusty now. But you can't send *well* any faster than you can copy yourself, and you're rustier than you know, OM. Adjust your speed to the other fellow's. You only waste your time if he has to ask for repeats, and meanwhile you jam half the United States. A steady 18 will move more traffic than a flashy (and generally lousy) 27. Don't try to burn up a beginner; you were one

(Concluded on page 88)

Loran—the Latest in Navigational Aids

Part I—Fundamental Principles

BY ALEXANDER A. MCKENZIE,* WIBPI

TUCKED away in an "off campus" building, its personnel not encouraged to discuss their work with others in the super-secret Radiation Laboratory at Massachusetts Institute of Technology, there grew a project which was not radar. In December, 1941, preliminary tests proved that an extensive gridwork of radio energy corresponding to, but not identical with, latitude and longitude could be set up, available in fair weather or foul to anyone with the proper sort of receiver. In July, 1942, Laboratory field engineers began installing what was then called LRN transmitting equipment. Although the system and all its equip-

maker, the Hydrographic Office. Loran stations are also operated by the Royal Canadian Navy, the British Admiralty and the Royal Air Force. Later, when the Army found uses for special Loran gear, there was the same inspiring exhibition of coöperation between the armed forces and a strictly volunteer civilian organization.

There are many sides to the Loran picture, some of which can not yet be discussed. Much of the equipment now in successful operation was obsolete before it was installed, and some expedients were employed in the haste of war which will not be wholly in accord with peacetime concepts of commercial manufacture and operation.

In general, this article will try to deal with the overall Loran picture from an angle of interest to amateurs.

Elements of Loran

Consider a receiver capable of measuring very small time differences between the arrival of signals. If this receiver is placed midway between two transmitters which are keyed at the same instant, as in Fig. 1, it will measure no difference between the time of arrival of signals. In fact, if the receiver is moved anywhere along the perpendicular bisector of the line joining the two transmitters it will measure no time difference between pairs of instantaneously recurring signal impulses.

If the receiver is moved to point A of Fig. 2, a difference in time of arrival of the signals will be noted. Assuming the speed of propagation to be equal in every direction, the time delay measured by the receiver is directly proportional to the difference in distance traversed by the two

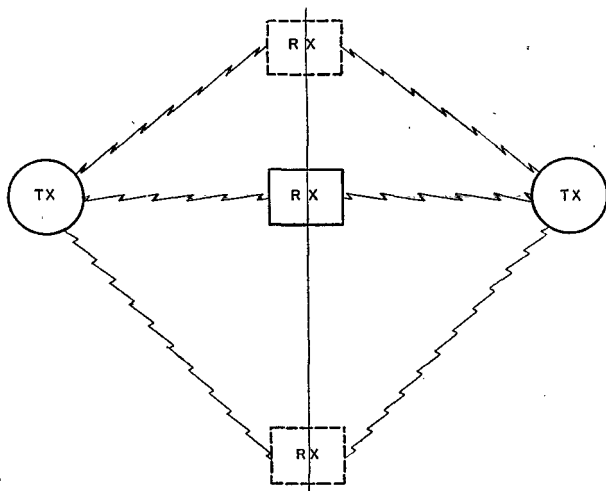

Fig. 1—A receiver located along the perpendicular bisector of a line joining the two transmitters sees no difference in the time of arrival of simultaneously keyed signals.

ment was carefully engineered, many aspects of the early installation depended upon the know-how and imagination which builds ham stations out of haywire. Indeed, many of the men responsible for both design and installation were hams.

By May, 1945, this system of *LONG RANGE* Navigation, LORAN, covered more than a quarter of the earth's surface, both land and sea. Thousands of Loran receiver-indicators had been manufactured and put into operation as standard equipment aboard ship and on planes. The task could not have been so brilliantly executed without close coöperation with the Navy through its operating agent, the Coast Guard, and its chart

*Radiation Laboratory, Massachusetts Institute of Technology, Cambridge, Mass. This paper is based on work done for the Office of Scientific Research and Development under contract OEMar-262.

In the excitement and glamor of wartime radar, other radio-electronic developments have been eclipsed—or kept even more secret. Among these is Loran, a long-range navigational aid that adds immeasurably to the safety of navigating the sea and air—a system which, in the long run, may prove to be one of the most useful inventions of the war.

In this, the first of three articles, the elements of Loran are discussed. The equipment and its use will be covered in subsequent installments.

sets of signals. At point B, the same time difference will be measured as at point A, thus leading to an ambiguity as to which side of the midpoint line the receiver is located. However, this ambiguity is resolved by the very practical trick of keying one transmitter, designated as the "Master," receiving the signal at the other transmitting location, waiting a definite time interval which we might call the "station delay," and then keying the second, or "Slave" transmitter. As shown in Fig. 3, points A and B equidistant from the midpoint may now be distinguished by the fact that the receiver measures a different time difference at each point. There will be a lesser difference or delay, measured between arrival of Master and Slave signals, at point A than at point B; this is because the Master signal is received later at A than at B, and the Slave signal is received sooner at A than at B, owing to the path lengths.

We have seen from Fig. 1 that in our simplified system the receiver may be moved anywhere along the perpendicular bisector of the base line joining the stations without changing the time difference reading (which in this case was zero). Identical time difference, or delay, readings will be found everywhere along the bisector of the base line of the practical Loran set-up in Fig. 3 (although here the time difference will not be zero).

If the receiver is continuously moved away from the base line at any point other than along the perpendicular bisector in such a way as to maintain a constant delay reading, it will be discovered that the receiver path describes a hyperbolic arc. As the receiver is started on its

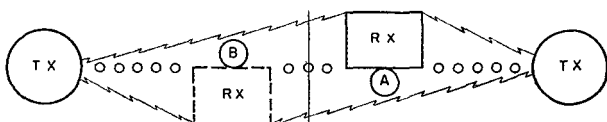
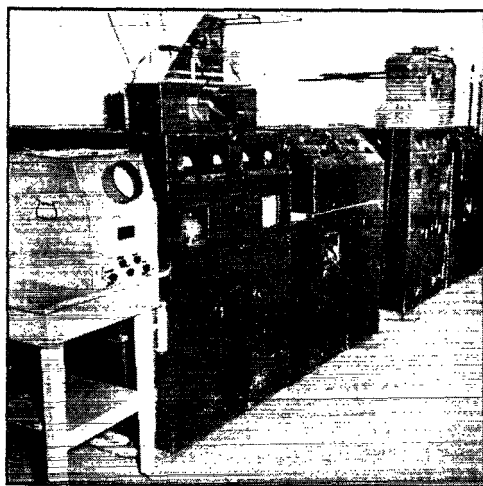

Fig. 2 — A receiver located at either A or B measures the same time difference in arrival of signals.

excursions from the base line at points nearer and nearer one or the other of the transmitting stations the lines curve more and more to enclose the proximate transmitter; see Fig. 4. The hyperbolic lines so generated are lines of constant time difference. Up to this point we have assumed a flat earth, but even on the real, spherical earth, these lines of constant time difference are very similar so that properly modified hyperbola-like lines may be drawn on charts or their values in terms of latitude and longitude tabulated. A pair of stations as shown in Fig. 4 would furnish to any receiver within range a finite series of lines of position (many more, of course, than we have shown).

This information alone would prove insufficient for most navigation, since the navigator of a ship



Official photograph, Royal Canadian Navy. The Loran transmitters at the Baccaro installation.

or a plane would wish to know not only in what "lane" he was traveling, but also at what point along the lane he happened to be at the moment. Fig. 5 shows the solution to this difficulty. Another pair of stations is arranged to give another set of lines of position which intersect the first set. The navigator's receiver then finds the two lines of position (such as J-6500 and K-5000) along which his ship is traveling at the moment. Their point of intersection tells him where he is at the time of the observation. In actual practice, only one transmitter is necessary for sending out both

Master signals. The navigator identifies pairs of signals, then, by a means other than a difference in their radio frequency. This last point is important in understanding how little of the limited radio spectrum is used up by the Loran system. It is probably apparent by this time, too, that the transmitters must be keyed very rapidly indeed to furnish

a useful, continuous service to navigators. Yes, they are pulsed. Since the velocity of propagation of radio waves is 186,000 statute miles a second, and therefore 0.186 miles per microsecond, all our thinking must be in terms of this small unit of time if we are to achieve any accuracy at all in the Loran system.

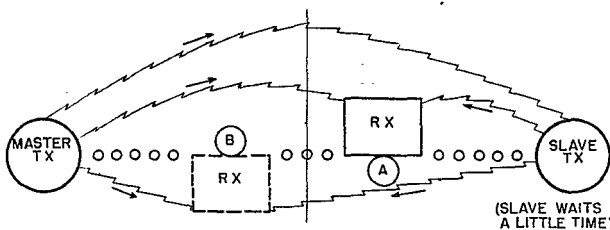

Fig. 3 — With a time delay between the Master and Slave transmissions, a receiver at A measures a smaller time difference between arrival of signals than does a receiver at B.

Frequency Considerations

Although we have referred to the fundamental concepts above as Loran, they would apply in general to other hyperbolic systems, notably the British Gee System, which has much in common with ours. One of the things which makes Loran successfully long range (and a thorn in the flesh of us amateurs) is its choice of radio frequency.

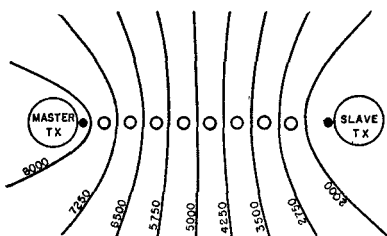

Fig. 4 — Hyperbolic lines of constant time difference with arbitrary numbers assigned.

The early development work was begun on a frequency near three megacycles which proved to be unsatisfactory for reasons outlined below. Operations were then shifted to a little above two megacycles. Although the frequency was satisfactory for Loran, the pulsed signal began ringing the telephone bells on Great Lakes ships at a great rate. Loran was then hastily moved into the recently vacated amateur 160-meter band which has proved excellent for the purpose.

The use of the present frequency (actually several bands of frequencies) has now proved to be mandatory for a number of reasons, principally the sky-wave characteristics. It should be noted, however, that a greater daytime range, particularly over land, would be obtained by going to a frequency very much lower than the broadcast band. An active experimental program has proceeded along these lines during the war, and should be continued by a governmental agency in the near future.

For the moment, let us consider only the over-water service of a Loran system operating at around 100 kilowatts peak power on approximately two megacycles. Previous knowledge suggests and experience confirms that useful ground-wave signals should be received at sea from a transmitter 700 nautical miles distant during the day and about 450 nautical miles at night. Over-land coverage is extremely limited. If we were talking about code reception we could count in a great many additional miles which would be added by virtue of the sky waves, but in a system which deals in units of microseconds, the additional time involved in a wave traveling from the transmitter up to the ionosphere and then bouncing back to the receiver, compared to the more direct ground wave, is considerable. See Fig. 6. A correction would have to be subtracted from each set of readings involving sky waves. The difficulty of determining the value of such a correction will be apparent to anyone who has communicated by means of the continuously varying sky waves. It so happens, however, that the fading experienced in communication is caused by layers which are such strong reflectors that they obscure the effects of another which is of the greatest usefulness in Loran. This is the "anomalous" or "nighttime" *E* layer. The "normal" *E* layer at a height of about 100 kilometers disappears at sundown as does the absorbing *D* layer at a height of about 75 kilometers, leaving the nighttime *E*, a tenuous, non-varying layer at about 95 kilometers. The relative steadiness of the nighttime *E* layer extends the range of Loran to double its daytime distance, or about 1400 nautical miles. This is because the additional time taken in propagation by means of the nighttime *E* layer can be determined and the average "skywave delays" plotted on charts or indicated in tables. It would be dangerous to use signals much beyond the 1400-mile limit since the strength of the "first hop" reflec-

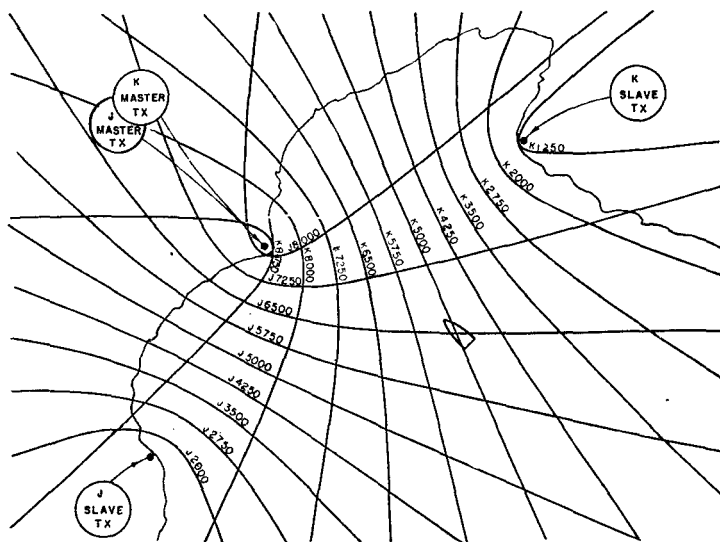
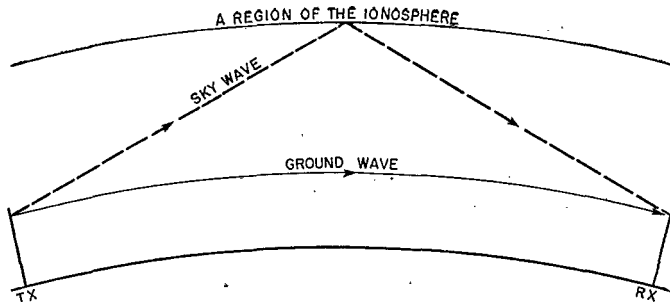

Fig. 5 — How two pairs of Loran transmitters furnish a fix for a ship.

Fig. 6—A longer time is required for the sky-reflected wave to reach the receiver than is taken by the ground wave, because of the longer path.



tion begins to fall off very rapidly and approximates that of the "second hop," the characteristics and identification of which are a more difficult matter. The whole business of sky wave reception has, of course, been over-simplified here.

It now becomes apparent why the 160-meter band has proved so valuable for Loran. Over water, the daytime signal from any given station might reach out to 700 miles, but would fall off at night to around 450 miles, owing to increase of atmospheric noise. However, at two megacycles the nighttime *E* sky wave provides a short skip and extends out to over 1400 miles without a gap between ground- and sky-wave regions. This is not true at a slightly higher frequency. Lower frequencies would work if available. It must be noted that there is a limitation against using the sky wave at less than 250 miles from the transmitter. It is also true that the useful coverage resulting from a pair of stations is less than the distance at which a single signal may be heard.

Since it is possible to match sky waves with receiving equipment, it is also possible to arrange the transmitting stations at such distances (about 1200 nautical miles apart) that they receive no ground wave signals from each other, but only sky waves. Thus "synchronization," or maintenance of constant station delay, can take place only at night. Despite the slight fluctuations in the nighttime *E* layer, the system has other advantages which have made it not only excellent for navigation but also for some types of bombing in the European phase of the war. This is known as "SS" (sky-wave synchronized) Loran.

Accuracy

A detailed discussion of the factors which limit the accuracy of Loran would not be of general interest. There are, however, a few criteria which will be apparent to most readers as soon as they are pointed out. Consider Fig. 4. It is clear that the greatest accuracy is obtained at the midpoint of the baseline joining the transmitters, since at that point an error of a microsecond involves less physical distance. As we move out on the perpendicular bisector the error increases because the lines begin to fan out and there is more distance between adjacent hyperbolic lines. The worst regions occur at either end of the extended base line. The error of a fix, Fig. 5, depends not only upon the errors of the hyperbolic lines of

position but also in their crossing angles. The closer to a 90-degree angle the lines make with each other, the less the error of the fix. The longer the base line between transmitters, the more hyperbolic lines of constant time difference there are and the less the divergence between adjacent lines comparable to those mentioned in connection with Fig. 4 above. It is, in fact, these last two conditions which let us tolerate the synchronizing errors caused by a fluctuating sky wave in the SS Loran system. SS transmitters are set up as nearly as possible at the corners of a quadrilateral whose diagonals are long compared to standard Loran base lines. The hyperbolic lines then cross at nearly right angles and there are many of them, nearly straight, in the area to be covered. See Fig. 7.

Pulsed Systems

We have shown that in order to make our system operate, we must key the transmitter very rapidly, or pulse it. In itself this does not seem to be a desirable state of affairs because we all know that a pulsed signal is a wide band signal, using up a lot of valuable frequencies. It has been mentioned, in connection with Fig. 5, that the navigator's means of identifying which pair of stations he is receiving is not accomplished by means of a different radio frequency for each pair. The pulse rate, the number of regularly spaced impulses in a given time interval, then, furnishes the identification. Provided we are able to transmit signals with small variations of pulse

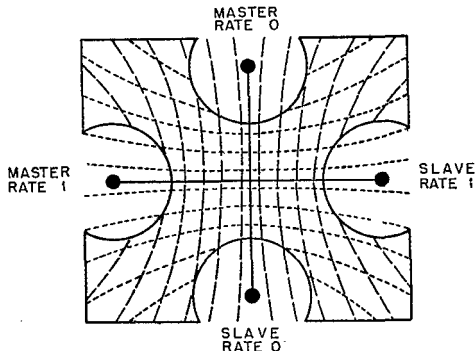

Fig. 7—Ideal layout for two pairs of SS Loran stations, showing good crossing angles and long base lines. The circles enclose "forbidden" areas of low accuracy.

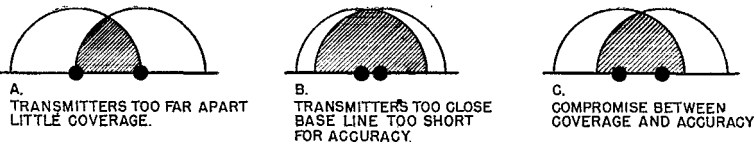
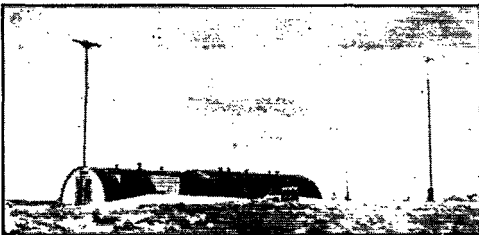

Fig. 8 — Effect of station placement on coverage available to navigators.

rate and build receivers to distinguish between the small variations, we have a fine way of getting something for nothing. For instance, we can fly a plane from San Juan to London by Loran navigation and never switch the receiver frequency once. The 18 transmitters required for this service occupy, of the total frequencies assigned for Loran, 100 kilocycles at 40 db down — all 18 of them, operating at once.

If the pulse rate is too fast there will be a limitation to the length of the base line. This is owing to a confusing multiplicity of signals appearing at the receiver scope when the base line is long compared to the time of arrival of successive pulses. The peak power of the transmitter will be somewhat less than with a lower pulse rate. If the pulse rate is too slow, there will be flicker in the images presented by the receiver scope, particularly when the signals have been greatly expanded by a fast sweep. The most favorable rate



Official photograph, Royal Canadian Navy.

From lonely outposts such as this, Loran beacons guide ships and planes on their courses regardless of weather. This is a Quonset-hut installation at Baccaro, Nova Scotia.

was decided upon as 25 pulses per second, although $33\frac{1}{2}$ has also been used with entire success. We refer to 25 pulses per second (or $33\frac{1}{2}$) as being the "basic" rate of a chain, or Rate 0. Rate 1 is $25\frac{1}{6}$ pulses per second. Rate 2 is $25\frac{2}{6}$ and so on. By maintaining these rates very exactly and by providing the receiving equipment with the necessary discrimination, the desired pair of signals is picked out and automatically identified. Although the other signals on the same radio frequency and within range are received, they appear to move across the receiver scope and do not interfere with reception of the desired signal. It is these beats between the adjacent rates which are heard when you tune to the dominant signals in our former 160-meter band.

Siting

For those who like to travel, the installation phase and siting of Loran stations was the adventurous aspect of the project. It is, in fact, another story for which there is no room in an outline account of the system. The Radiation Laboratory

was responsible for the proper siting and erection of five stations in the North Atlantic system. It also had two experimental stations which were initially used at the southern end. A lot of the fun of siting comes in the fact that there are no working formulas which automatically grind out the proper locations for the stations. Instead, we must take Nature as she is and make the best possible compromise between sites which are available and the ideal spot.

Siting of the stations must take into account all the factors discussed above and several more. Since we are considering an over-water system, it is apparent that the transmitters must be as close as possible to the shore. The attenuation caused by a five-mile stretch of land in the path between one of the experimental stations and the first permanent station was found to be more than 15 db. The primary consideration in the siting is to place the stations close enough together so that synchronization can be maintained. It's the old story, "You've got to hear 'em to work 'em." On one hand, the longest possible base line gives the greatest accuracy, for reasons described above; on the other, a long base line decreases the coverage from pairs of stations. The actual coverage is most often a compromise between these two factors and geographical considerations, as shown in Fig. 8. The first stations, erected by Radiation Laboratory, were placed as follows: Delaware, Long Island, southern and northern ends of Nova Scotia; east coast of Newfoundland, Labrador (a little north of Belle Isle), and the southern tip of Greenland.

(To be continued in a coming issue)

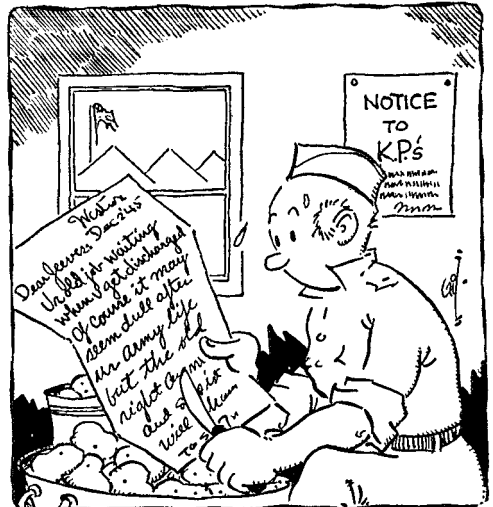

Centimeter-Wave Magnetrons

The Tubes That Made Microwave Radar Possible

BY HENRY F. ARGENTO*

ALTHOUGH radar has emerged from the war as a startling new discovery, its principles are not as new as they might appear to be at first hand. Radar was known and developed simultaneously in America, England, France and Germany during the early 1930s. Like every other electronic device, its development and improvement was predicated on the development and availability of tubes. The heart of any electronic device is a tube, whether it be a radio set, a radar, or an electronic counting device.

Very early radars were low-frequency devices which used enormous dual antennas and large, bulky transmitters and receivers. It was known at the time that radars capable of greater resolution and accuracy, as well as much smaller and lighter in weight, could be developed if tubes could be made available to generate power at the superhigh frequencies. Accordingly, the British Admiralty assigned the problem of developing a generator of microwaves to a research group at the University of Birmingham. The Birmingham group developed a practical form of cavity magnetron which, along with other developments, opened the possibility of obtaining satisfactory power output at extremely short wave lengths. In the latter part of 1940, a British technical mission headed by Sir Henry Tizard demonstrated the cavity magnetron to our American scientists.

In the fall of 1940, Raytheon assigned its best research and engineering talent and facilities to work with the Massachusetts Institute of Technology in the making of experimental microwave-type tubes. The art at that time was completely new — about as far advanced as radio was in the old spark-gap days of 1916. The theory of generation of microwaves was not understood, equipment for experimentation was not available, and methods of producing useful tubes were unknown.

As is now well known, radar operates on the principle of sending out extremely short bursts or pulses of high-frequency energy and measuring the time interval required for this small package

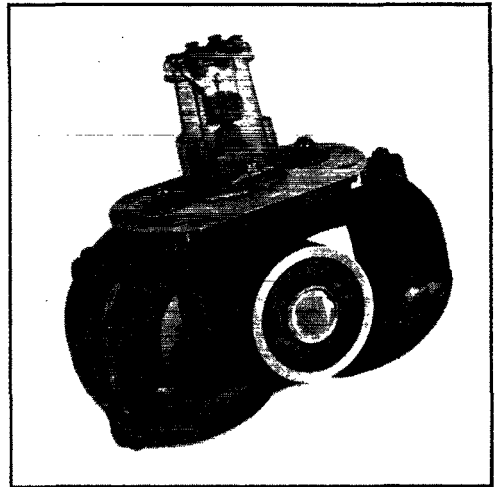

This type of package magnetron uses direct coupling from one of the magnetron cavities to a section of wave guide. The glass window on this section of guide acts as a matching transformer into the external wave guide.

The glass boot around the heater leads is cut away to provide for forced cooling of the heater leads and seal.

of energy to reach its objective and to be reflected back to its source. When the length of time required for the energy to travel back and forth is known, the distance to the object can be accurately ascertained. By concentrating the energy into a very narrow ray the beam can be used to scan different objects, and the orientation of the beam antenna system or "director" gives the direction. Thus the position as well as the distance of a given object can be accurately gauged.

The two basic requirements for the generator are that it be capable of producing an extremely large amount of r.f. energy for a short period of time, and that its frequency be as high as practicable so that the narrowest possible beam can be produced with a given size of reflector in the radiating system. It is further required that the generated frequency be quite stable. The magnetron is essentially a device which can be produced rapidly for intervals of the order of microseconds and which is capable of delivering hundreds, thousands and millions of watts of power at wave lengths in the centimeter range.

Magnetron Construction

To achieve such frequencies, conventional ideas of tuned circuits containing lumped inductance and capacitance had to be discarded. Even the shortest lead lengths are too long to allow satisfactory operation at these frequencies. For this reason the circuits are built directly into the

*Power Tube Division, Raytheon Manufacturing Co., Waltham, Mass.

Capable of almost unbelievably high outputs at tremendously high frequencies, the magnetron tube is the heart of high-performance radar equipment. This is the first published information on s.h.f. magnetrons, written by a member of an organization that had a leading part in the manufacture of both tubes and complete radar equipments.

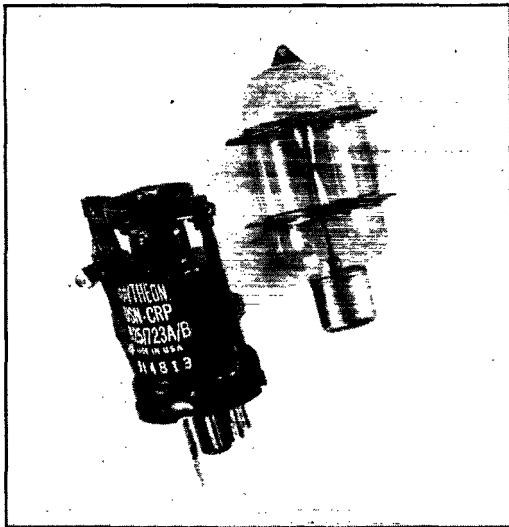

The metal tube is the 2K25, a receiver local oscillator of the reflex-klystron type that tunes from 8700 to 9550 Mc. The cavity is built in and is adjusted by the square nut on the side. Small variations of about 40 Mc. are obtained by changing the repeller voltage a small amount. What looks like an extension of one of the socket pins is a small length of coaxial line and antenna used for output coupling.

The glass tube is the 721A, a duplexing tube. Used in an external resonant cavity, it serves as an instantaneous switch to short the input of the receiver when the transmitter is on and hence protects the small crystal used as a mixer in the receiver. The cap on the side is for a "keep-alive" voltage which maintains some ions in the tube at all times and decreases the break-down time when the transmitter power is applied.

anode of the tube. Essentially, a magnetron is a thick-walled hollow cylinder of copper with a series of identical longitudinal "keyholes" in the wall around the inner diameter, the keyholes being cut so that the narrow slots open into the center hole. Each of the keyholes represents a transmitter circuit, with the hole itself making up the inductance and the slot providing the capacity. Conventional oscillators use just one tank circuit, but in order to obtain workable sizes of tubes the magnetron uses a series of multiple keyhole circuits all tuned to exactly the same frequency. In the center of the cylinder is placed an emitting cylinder, usually in the form of a nickel sleeve coated with active barium and strontium oxides which, upon being heated, produce a copious flow of electrons. Energy is removed from one of the cavities either by using a coupling loop or by having the cavity open into a wave-guide window.

In the operation of the magnetron a magnetic field is applied axially to the tube, causing the electrons to describe circular paths about the cathode when a high-voltage pulse is applied between anode and cathode. The electron motion can be looked upon as an air stream passing a slot, which, when the stream acquires the correct velocity, causes the cavity to resonate. The critical velocity of the electron stream is reached when one cavity represents a negative portion of

the output wave while the next cavity is positive. The problem of the growth of oscillations is too complex to be adequately covered by such a simple analogy, but space does not permit dealing with it more completely at the present time.

Building the Tubes

The manufacture of magnetrons is difficult, inasmuch as the tube requires a very high degree of vacuum, must be capable of delivering extremely high currents at high voltage, and requires the utmost in mechanical precision in a metal — oxygen-free copper — which is very difficult to machine. The original magnetrons were made by taking a solid cylinder of copper and drilling, machining, and broaching the desired configuration from the solid chunk. Approximately 100 man hours of expert machine work were required to accomplish this, and the results were not always too satisfactory because for full efficiency each of the cavity resonators has to be the identical counterpart of its neighbor. Moreover, after having been machined the tubes required hours of processing, aging and testing. Their production was slow and costly.

Foreseeing the need for large quantities of microwave equipment the Navy, in December of 1941, made funds available to Raytheon for the erection of a factory and the establishment of facilities for the production of microwave tubes. A building providing 120,000 feet of floor space was hurriedly erected. Equipment was designed, machines were ordered, and in May of 1942 Raytheon moved into this heavily guarded tube plant and produced the first magnetron in its new location. At the time these facilities were planned they were laid out for a maximum production of 100 magnetrons per day. No sooner had the plant begun operating than the demand for the tubes increased from the hundreds to the tens of thousands. Sufficient machine tool capacity did not appear to be available to meet this demand, and



The 2J38 is a "compact" lower-powered magnetron of the package type that was used extensively in aircraft radar. The output fitting is for coaxial line.

the magnetron loomed as the bottleneck item in the whole radar picture.

At this juncture Percy L. Spencer, WIGBE, the Raytheon Director of Research, developed a mass production system, known as the "lamination" method, that eliminated precision machine work and overnight expanded plant capacity from one hundred per day to over one thousand per day. In this method the desired anode configuration is stamped out of thin sheets of copper. Half of the copper punchings are discs having a diameter of about two inches, while the other half are stamped to a three-inch diameter. The two sizes are stacked alternately on precision jigs and then brazed together into one solid mass in an automatic conveyor furnace. In this way the entire magnetron body can be made without any precision machine work. Not only is the desired anode configuration achieved by this method, but the large laminations form the cooling radiator as well, making it an integral part of the tube body. This has the effect of providing much better cooling. To supplement the lamination method 20-foot diameter automatic exhaust machines were built, making it possible for one operator to do work formerly requiring fifteen in processing the tubes. All manufacturing was converted over to mass production techniques, with magnetrons being produced on a series of 120-foot production lines.

How well these methods worked is attested by the fact that magnetrons, the item which orig-

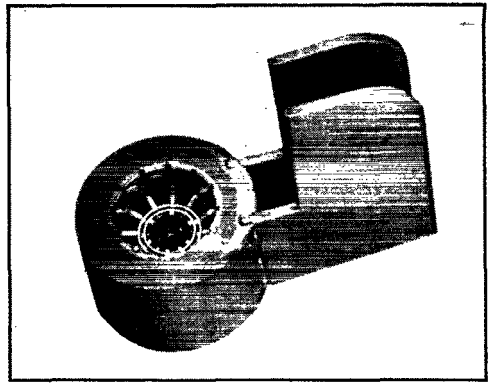

The insides of a 12-cavity 3-cm. magnetron shown actual size. The two rings inside the structure strap alternate cavities. The two fins are part of the cooling surfaces.

inally had been figured as a crucial bottleneck, never once held up the manufacture or shipment of a piece of radar equipment. Furthermore, these mass production methods were such that over half of all the magnetrons produced in the world flowed out of this one Raytheon plant.

Versatility Plus!

As the war progressed, different technical requirements dictated needs for different types of magnetrons. Special tubes were required to direct the guns of the big battle wagons, to search the skies for planes, to direct anti-aircraft searchlights, to track down fast flying buzz bombs, to make lightweight portable beacons, to direct precision bombing from the skies, and to land planes. The number and variety of tubes grew until there were fifty or sixty different types.

As usual, the first demand was for greater efficiency. Twenty per cent was about the best that could be obtained with the early tubes. By designing for better ratios of inductance to capacity and, principally, by discovering "strapping," tube efficiencies were increased to well over 50 per cent. As one of the photographs shows, the alternate solid sections between the cavities are electrically connected together. This forces alternate cavities to lock together to produce a single frequency, thus overcoming minor frequency differences between individual cavities.

The second requirement was for tunable magnetrons. At the rate new equipment was being designed, it looked as though there would have to be innumerable magnetron types if each one had to be a fixed-frequency device. To meet this need, several different types of tuning mechanisms were developed at Raytheon. The one that has probably had the widest use in the field is that employed in the 2J61A. In this tube a small capacity ring is mounted directly above the anode block opposite the ends of the cavities. By varying the distance between the ring and the anode body the capacity to each individual oscillator is readily changed. Varying the spacing between the ring and block imposed a rather serious problem, inasmuch as mechanical motion

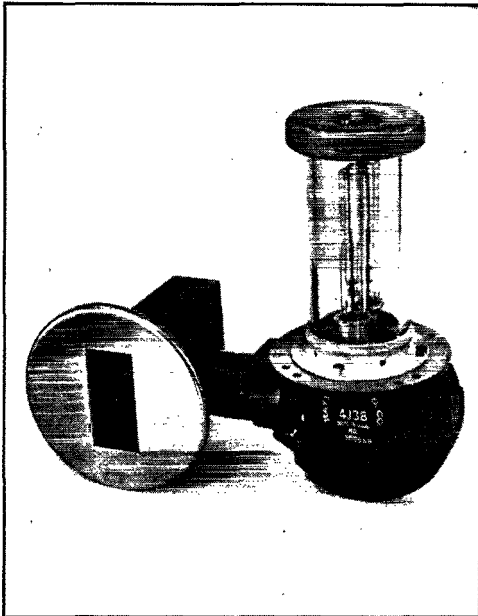

The 4J38 is a high-power "maggie" capable of a peak power output of 850 kilowatts at 3600 megacycles (8.3 centimeters). A pick-up loop in one of the anode cavities connects to a coaxial line which terminates in an antenna in the wave-guide section at the left. The ring at the top of the glass tube enclosing the cathode leads is a corona shield, required because of the high potential (30,000 volts) at which this tube operates. The over-all height is slightly over ten inches.

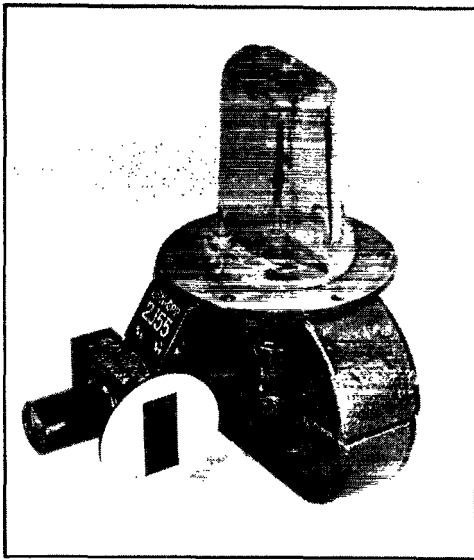

A "package-type" magnetron, in which the magnet is integral with the tube. The 2J55 operates at 9400 megacycles (3.2 centimeters). The over-all height of the tube is six inches.

had to be transmitted through a vacuum-tight body. It was solved by using a sterling silver diaphragm on one end of the anode and transmitting the motion to the capacity ring through this diaphragm.

In every piece of aircraft equipment weight and size are dominating factors. Magnetrons require a strong external magnetic field, usually produced by a separate permanent magnet weighing anywhere from 10 to 40 pounds. To overcome this weight difficulty, the newer "package type" tubes were designed. In these tubes the air gap is reduced to a minimum by inserting the magnet pole pieces directly into the tube and by making the external magnet actually a part of the tube. External-magnet tubes which previously had an over-all weight of 17 pounds were reduced in weight to 3½ pounds in the comparable package types—without sacrificing any efficiency or mechanical characteristics.

Characteristic of any new development, the cry soon was for more and more power. The early tubes were capable of delivering peak powers of 80 to 100 kilowatts. This was soon increased to 200-, 300-, 500-kw. peaks. However, even these powers did not satisfy the services. They demanded peak powers of at least one million watts. It can readily be understood what a difficult problem was presented inasmuch as cathodes for such tubes had to be able to deliver 100 amperes and the tubes had to be capable of operating at 30,000 volts. Oxide-coated cathodes able to meet these requirements were unknown. Intensive work and considerable ingenuity were required to develop tubes to meet these specifications.

These figures may sound fantastic to those whose experience with power tubes has been confined to ordinary operation where the output is continuous, particularly when the tube that

does the job, magnet and all, is no bigger than a 500-watt tube built for low frequencies. The explanation is the fact that with pulsing the tube is in the nonoperating condition a far greater part of the time than it is working; the "duty cycle" is such that the tube is "off" more than a thousand times longer than it is "on." But the capacity to produce the power must be there, nevertheless; the only "saving" is in the fact that the *average* power the anode must dissipate is not large.

Some Magnetron Types

It may be of interest to look at some of the characteristics of specific types which illustrate the various functions magnetrons were made to perform. One of the more common tubes is the type 2J61A, an eight-cavity tunable magnetron capable of delivering peak power of 100 kilowatts over a range of 3000 to 3100 megacycles when operated at 14 kilovolts. The magnetic field necessary for such operation is about 1700 gauss.

An example of a lightweight low-powered tube is the type 2J39. The 2J39 is an integral-magnet 10-centimeter oscillator weighing less than two pounds, and is capable of delivering nine kilowatts when pulsed at five kilovolts.

A tube which is fairly representative of the high-powered class of magnetrons is the type 4J31. This tube delivers one million watts when operated at thirty kilovolts and seventy amperes. Provided a sufficiently high antenna is used, enormous ranges can be scanned with a radar

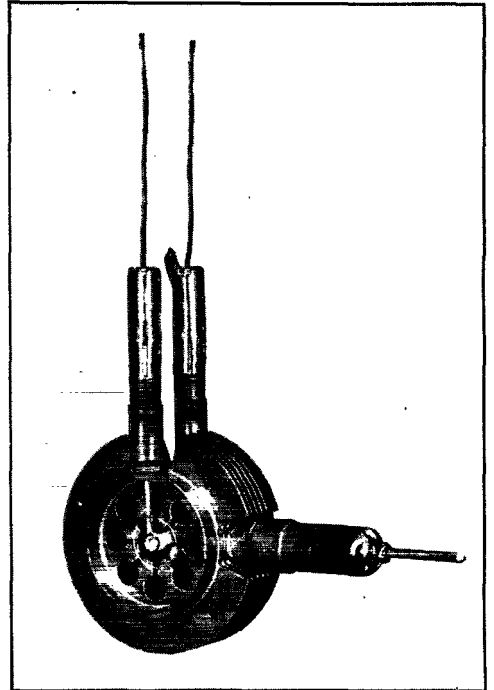

The real "works" of a 10-cm. magnetron, showing the eight cavities surrounding the cathode and the "strapping" of alternate cavities. The cathode is supported only by the heater leads coming in on either side of the cavities.

OUR COVER

In case you haven't guessed as much already — after reading this article — the gadget on the cover this month is a tunable magnetron, cut away to show the construction. A tuning range of approximately 100 megacycles at 3000 Mc. is obtained by means of the "vernier" gear drive.

built with such a high-powered tube.

The type 2J55 represents the ultimate today in the design of a three-centimeter magnetron. This tube, which operates at 9375 megacycles, is a package-type magnetron having an integral magnet. Its over-all weight, including magnet, is a bit over three pounds. At 12 kilovolts and 12 amperes, the 2J55 delivers 50 kilowatts of peak power.

The superhigh frequency radar required several types of special microwave tubes other than magnetrons. Of considerable interest are the velocity-modulated types, such as the 707 and the 2K28 at 10 centimeters, and the 2K25 at three centimeters. These tubes are used as local oscillators in superheterodyne receivers. Their operation is essentially the same as that of a common toy whistle. In a whistle a stream of air is blown past a resonating chamber, and if the air velocity is correct a sound whose pitch is determined by the volume of the resonator will be produced. In velocity-modulated oscillators, a stream of electrons is shot out of a gun through

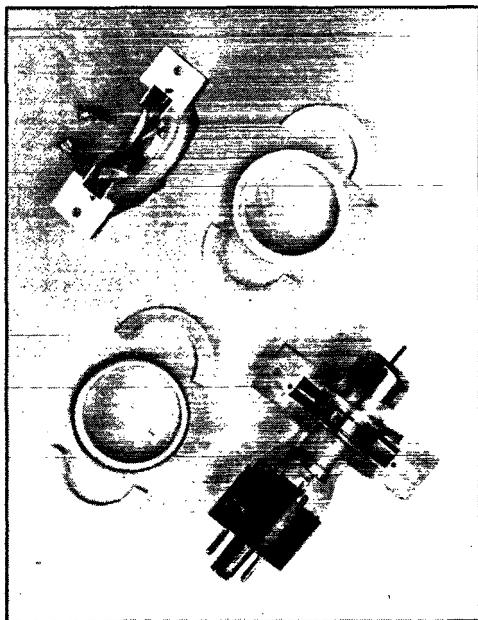

The local oscillator tube used in 3000-Mc. radar receivers, the 2K28 reflex klystron. The resonant cavity makes connection to the copper discs midway along the glass part of the tube. The other half of the disassembled cavity also is shown in this view.

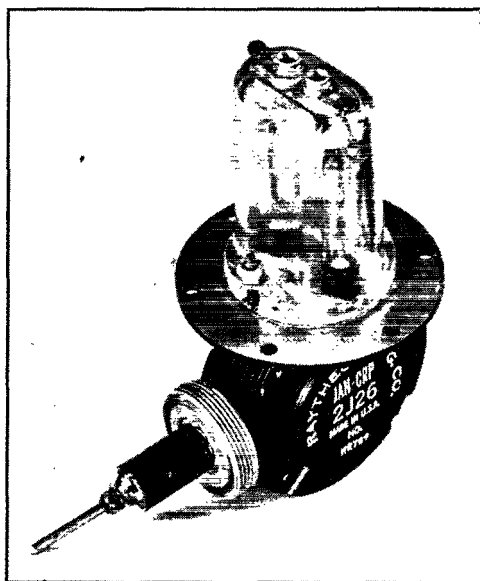

A 300-kilowatt magnetron, the 2J26. The output connection projects from the seal in the foreground. The pyrex bowl on top protects the cathode and heater leads and provides a mounting for the terminal jacks.

a small cavity resonator. By properly designing the cavity and by controlling the speed of the electron stream, oscillations are produced having a frequency determined by the constants of the resonator cavity. The 2K28, a common type of such tube, puts out an average power of 150 milliwatts at 10 centimeters with the resonator held at 300 volts. Such a tube readily can be frequency modulated, and it may be of considerable interest to the "ham" who wants to experiment with short-range directional communication at low power.

Wartime uses of microwaves have been almost wholly concerned with detection and direction applications.

However, the magnetron and other microwave tubes offer many other possibilities which up to now have not been explored. With peace, newer applications and uses will be discovered in ever-increasing volume.

ABOUT THE AUTHOR

Following the acquisition of a B.A. in physics at Harvard, H. F. Argento joined the Radio Frequency Laboratories at Boonton, N. J., for a year's research in circuits. The next thirteen years were spent at Raytheon, the first nine years involving circuit work, application theory, sales and tube engineering and production, and a year as head of the amateur division. Argento's past four years have been devoted to circuit application and sales engineering of Raytheon's microwave tubes.

A Four-Band 125-Watt Transmitter

Multi-Band Operation With the New 4D32 Tetrode

BY BYRON GOODMAN,* WIJPE

THE SIMPLE announcement that a new transmitting beam tetrode is available is not likely to arouse much interest, since tubes answering that general description are already quite common. If, however, the statement is qualified by saying that the tube carries full ratings to 60 Mc., has 50 watts plate dissipation and takes about one watt of drive, one is likely to perk up and ask for further information. This encouragement would bring forth the fact that the tube is the Raytheon RK-4D32 and that it is rated at 200 watts maximum input at 750 volts, an unusually low plate voltage for this power input. Typical operation allows 125 watts input at 600 plate volts. It might be mentioned that the tube was developed for aircraft work, where the need for higher power at low voltage is prevalent.

With the merits mentioned above, the tube looks like a good one for a medium-powered transmitter on the bands below 30 Mc. and possibly up to 50 Mc. The three-tube transmitter to be described uses the 4D32 in the output stage and goes readily to 30 Mc. Special 12.5-Mc. crystals — which we understand will soon be on the market — were not available at the time of writing for checking the performance on 50 Mc. The rig delivers 100 watts at 30 and 14 Mc. with only 600 volts on the plate and should certainly do no worse on the lower frequencies. Several other features are worthy of mention. For example, provision is included for keying either the oscillator or doubler stage — both 7C5 loktal beam tetrodes — a detail that provides break-in oscillator keying on 3.5 and 7 Mc., where it is most valuable,

and doubler keying on the higher frequencies where crystal-oscillator keying is more likely to produce a chirp. Crystal and meter switching allow easy QSY and tuning, and with only three tubes the number of coils for all-band operation is held to a minimum. For operation on 7, 14 and 28 Mc., 7-Mc. crystals are used, and 3.5-Mc. crystals are used for 3.5-, 7- and 14-Mc. work.

The Circuit

There are no circuit tricks, and the wiring diagram shown in Fig. 1 will be found to be quite conventional. The proper crystal is selected by S_1 in the grid circuit of the 7C5 Tri-tet oscillator, and oscillator keying is obtained by plugging in the key at J_1 . The 7C5 doubler is capacity coupled through C_6 to the oscillator and is keyed by plugging in at J_2 . It will be noted that both of these keying jacks are in the negative lead rather than in the cathode, since it was found that the doubler keying was slightly better this way, and negative-lead keying of crystal oscillators is recommended over cathode keying.¹

One problem in connection with a high-current low-voltage tube like the 4D32 is the size of the tank condenser in the plate circuit. If one is a conscientious designer and pays faithful attention to the optimum tank capacity as given in the Handbook, he finds that for optimum Q he would need 320 $\mu\text{fds.}$ tank capacity at 3.5 Mc. Even a condenser manufacturer might shy at this, so some other method was needed to allow a more normal size of tank capacitor and still avoid the harmonics likely to occur with a single-ended amplifier and a low-Q tank circuit. The solution is a simple one that is readily applicable to a single-ended screen-grid amplifier, and it consists of

* Assistant Technical Editor.

¹ Goodman, "Keying the Crystal Oscillator", *QST*, May, 1941.

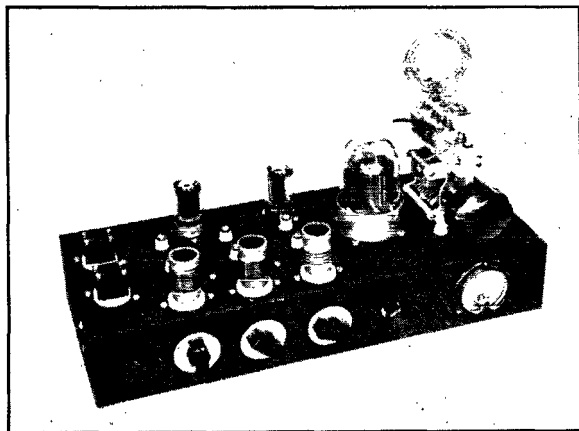

A 125-watt transmitter for 3.5 to 30 Mc. The left-hand bar knob switches crystals and the right-hand bar knob switches the meter to any grid or plate circuit. The small crystal holders, mounted two to an octal socket, are a new type.

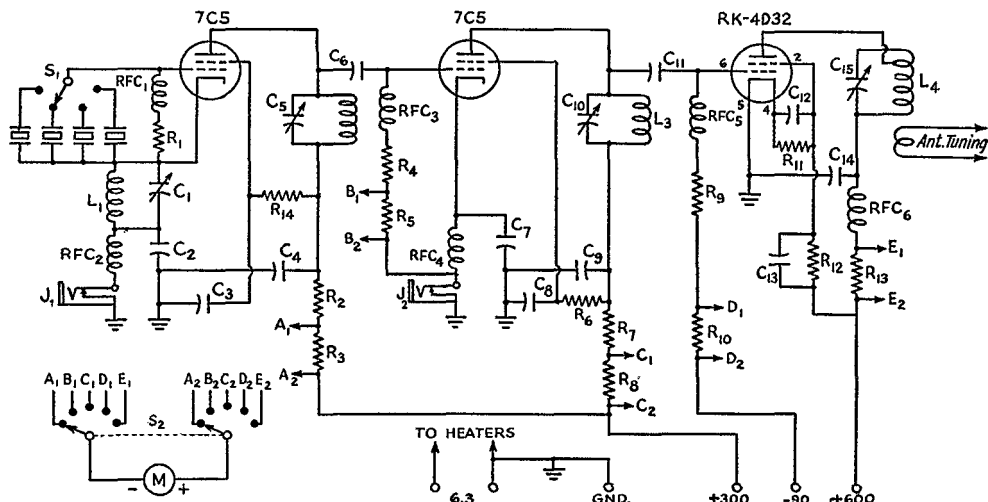

Fig. 1 — Wiring diagram of the 150-watt four-band transmitter.

- C₁ — 140- μ fd., receiving-type variable (Hammarlund MC-140-S).
- C₂, C₃, C₄ — 0.002- μ fd. mica.
- C₅, C₁₀ — 100- μ fd. receiving-type variable (Hammarlund MC-100-S).
- C₆, C₁₁ — 100- μ fd. mica.
- C₇, C₉ — 0.001- μ fd. mica.
- C₈ — 500- μ fd. mica.
- C₁₂, C₁₄ — 0.001- μ fd. 1200-volt mica.
- C₁₃ — 8- μ fd. 450-volt electrolytic.
- C₁₅ — 100- μ fd. 1500-volt variable (National TMK-100).
- J₁, J₂ — Closed circuit telephone jacks, midget type.
- M — 0-200 milliammeter.
- R₁ — 0.1 megohm, 1-watt composition.
- R₂ — 750 ohms, 1-watt composition.
- R₃, R₅, R₈, R₁₀ — 75 ohms, $\frac{1}{2}$ -watt composition.
- R₄ — 50,000 ohms, 1-watt composition.
- R₆ — 10,000 ohms, 1-watt composition.
- R₇ — 500 ohms, 1-watt composition.
- R₉ — 2500 ohms, 1-watt composition. See text.
- R₁₁ — 25,000 ohms, 10-watt wirewound.

- R₁₂ — 12,500 ohms, 20-watt wirewound (two 10-watt 25,000-ohm resistors in parallel).
- R₁₃ — Low resistance wound on $\frac{1}{2}$ -watt resistor. See text.
- R₁₄ — 25,000 ohms, 1-watt composition.
- RFC₁, RFC₂, RFC₃, RFC₄, RFC₅ — 2.5-mh. choke (Hammarlund CHX).
- RFC₆ — 2.5-mh. choke, 300 ma. (National R-300).
- S₁ — Single circuit 4-position ceramic rotary switch.
- S₂ — Two-circuit 5-position ceramic rotary switch.
- L₁ — For 7-Mc. crystal: 12 turns No. 20 enam. spaced to occupy 1 inch.
- L₂ — 7 Mc.: 18 turns No. 20 enam. spaced to occupy $1\frac{1}{4}$ inch.
14 Mc.: 10 turns No. 20 enam., spaced to occupy $\frac{3}{4}$ inch.
- L₃ — 7, 14 Mc.: same as L₂.
28 Mc.: 4 turns No. 20 enam., spaced to occupy $\frac{1}{2}$ inch.
- L₄ — 14 Mc.: 8 turns No. 14 wire 2-inch diam., 2 inches long. Plate tapped down two turns from plate end.
28 Mc.: 3 turns No. 12 wire, 2-inch diam., 1 inch long. Plate not tapped down.

tapping down the plate on the tank coil. The tube then looks into a circuit of higher Q, as has been described,² and the harmonics are reduced. For example tapping the plate halfway down on the coil has the effect of increasing the tank capacity by roughly four times. Thus a 100- μ fd. capacitor can be used at 3.5 Mc. and, by tapping down halfway, it will look like about 350 μ fd. when the coil resonates with 90 μ fd. in the circuit. At 7 Mc., 160 μ fd. is required, so a coil resonating with 90 μ fd. should be tapped down about 25 per cent of the way.

To permit simultaneous plate and screen modulation of the output stage without a special modulation transformer, the screen dropping resistor, R₁₂, is shunted by an 8- μ fd. electrolytic capacitor which by-passes the audio.

It will be noted that the meter is only a 0-200 milliammeter, and it would really shoot off scale when measuring the 4D32 plate current if R₁₃, the resistor across which this plate-current metering is done, were not of a carefully-adjusted

low value that exactly doubles the reading of the meter and makes it a 0-400 instrument.

No provision for antenna tuning is included because everyone has his pet method, and the output is simply taken off by link coupling to an antenna tuning unit.

Construction

As shown in the photographs, the transmitter is built on a chassis with no panel. However, the controls are laid out so that modification to rack-and-panel mounting would result in a reasonable control arrangement, although coil changing would be a bit awkward with the exciter-stage coils close to the panel. The coils were mounted in this position for two reasons — with no panel they are readily accessible from the front and it results in better wiring of the tank circuits. A usual way to arrange the exciter stages would be to mount the tuning capacitors on the front panel and the coils on a line along the center of the chassis, with the tubes at the rear. The leads from the coils to the tubes would then be, in effect, tapped down on the tank circuits, by the inductance of the leads from the capacitors to the coil

² Lampkin, "Improvement in Constant-Frequency Oscillators." *Proc. I.R.E.*, March, 1939.
Seiler, "A Low-C Electron Coupled Oscillator," *QST*, November, 1941.

sockets. This is, of course, a very fine point at low frequencies but it becomes increasingly important at 28 Mc. and above. The tuning capacitors are mounted on Millen 32102 steatite bushings.

The transmitter is built in a 7 by 17 by 3-inch chassis. Two octal sockets are used for mounting four crystal holders of the new type — soon to be on the market with standard amateur-band crystals — but the man with a collection of old-style holders could substitute any of the matching crystal sockets. A $2\frac{1}{2}$ -inch diameter shield can was cut to form a shield for the 4D32, and it comes up $1\frac{1}{4}$ inches or just above the bottom of the anode. The shield is fastened to the chassis with small self-tapping screws, to avoid interference with the tube socket which is spaced $\frac{1}{4}$ inch below the chassis by spacers swiped from an old variable condenser. Reference to the photograph of the bottom view of the transmitter will show a sheet copper ground plate which is cut out to clear the two 7C5 sockets and is bent upward to ground to the No. 5 pin of the 4D32 socket. Here again is a fine point that may not be necessary in low-frequency gear, but after seeing what happens to “lock-washer” grounds on chassis of this type that stood idle for “the duration”, we decided to eliminate the possibility of any aging of friction grounds. Further, the high conductivity of the copper results in low reactance returns between stages, a “must” in capacity-coupled high-frequency amplifiers. For the benefit of anyone who might be reluctant to engage in the mechanical work involved, we might mention that the thin copper used was worked with tin shears about as easily as a piece of cardboard might be. The two holes for the sockets were cut with the usual socket punches, clearance holes for the socket mounting screws were drilled, and the rest of the work was done with the shears. Wherever a ground lug was needed, a small tab was cut and bent up. Cleaning the copper with steel wool before starting the operations made soldering to the tabs a simple matter.

The final tank capacitor was mounted on three of the Millen bushings. The top plate on the capacitor was removed and replaced by a strap of aluminum which had been bent in the form of a “J”. One of the outside coil jacks passes through a hole in the bent-over end of the strap, and a

small $\frac{1}{2}$ by $\frac{3}{4}$ -inch cone insulator was used to support the “hot” end of the coil jack bar. The coils, which were standard B & W BEL types, were modified by adding a fifth plug to the empty center hole and shifting the link connection normally near the plate end of the coil to the plug that was added. The plug from which the link is removed is used for the plate tap.

The shunt resistor R_{12} is made by winding the necessary length of resistance wire on a $\frac{1}{2}$ -watt 75-ohm resistor. The resistance is adjusted to be equal to that of the meter, a simple matter if one has a low-range ohmmeter and not a difficult job if one hasn't. Simply pass some current through the meter and cut the shunting resistor value — by shortening the resistance wire — until placing the shunt across the meter halves the reading.

Adjustment

There is not much to say about adjustment because the subject has been covered so thoroughly in past issues of *QST* and the *Handbook*. The final tank coil, L_4 , is reworked as described above, and no effort should be made to squeeze the maximum inductance into this coil, particularly at the lower frequencies. Rather it should be adjusted to allow the use of sufficient capacity at C_{15} . This amounts to about 25 per cent mesh at 28 Mc., 50 per cent at 14 Mc. and 90 per cent at the two lower frequencies.

When working the output on the same frequency as the crystal, the 7C5 doubler and L_3 should be removed from their sockets and a jumper run between grid and plate contacts on the tube socket. The doubler tank condenser, C_{10} , should be set at minimum capacity. It is not recommended to run the doubler stage straight through because of the possibility of oscillation. The output of the crystal oscillator is more than enough to drive the 4D32.

The plate current of the crystal oscillator will run around 20 ma. and the doubler about 40 ma. Grid current to the doubler should be about 2 ma. and to the final at least 6 ma. under load.

A suitable key-click filter consists of an 8- or 10-henry choke and a 1- μ fd. condenser. A 50-watt modulator will handle the audio requirements if the 4D32 is run at 175 ma. and 550 volts. as recommended by the manufacturer.

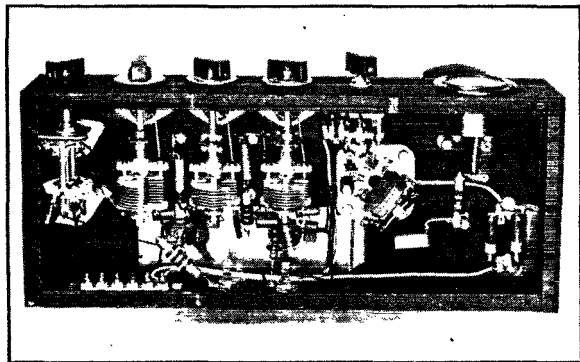

A bottom view of the transmitter, showing the copper ground strap and the arrangement of the various parts. The two jacks at the rear of the chassis are for keying circuits.

300 Watts on 50 and 144

A Driver-Amplifier for the new V.H.F. Bands

BY E. P. TILTON,* WIHDQ

This is a companion unit to the 50-Mc. a.m.-f.m. transmitter described by WIHDQ in November *QST*. It will work on the temporary 56-60-Mc. assignment as well as on the new six-meter band when the change-over comes.

THE NEW two-meter band is just as wide, in kilocycles, as the 56- and 112-Mc. bands, but the higher frequency brings greater instability in both transmitters and receivers. This increases the likelihood of serious interference in populous areas — and the danger of out-of-band operation is greater than ever. Thus, unfortunately, as the difficulty of obtaining stable operation increases, the need for it increases proportionately. Our experience on 112 Mc. has made us all only too familiar with the ease with which off-frequency operation can occur — if the antenna is coupled closely enough to an oscillator rig to give anything approaching maximum power transfer, a slight change in coupling can shift the transmitter frequency over the whole width of the band, and more. Our postwar operation in the 112-Mc. band has clearly demonstrated the need for something better than the modulated oscillator. If 144-148 is going to be anything more than a dumping ground for haywire and obsolete gear we should all do well to think twice before using a modulated oscillator for anything other than low-powered, portable, or emergency equipment.

Not so long ago the adaptation of the crystal-control idea to 144-Mc. design would have been considered well-nigh impossible, and we may as well accept the fact that incorporation of 144 Mc. in our "all-band" rigs is, even now, just about

* V.H.F. Editor.

¹ Tilton, "An A.M.-F.M. Transmitter for 50 Megacycles," *QST*, November, 1945.

out of the question. Even with the best low-C triodes, tank circuits shrink to the vanishing point before 144 Mc. is reached in any design which is at all suitable for use on the lower frequencies. In a way, then, the abandonment of harmonic relationship in our postwar frequency assignments above 28 Mc. is a blessing in disguise — it has freed us, once and for all, of the practice of making our v.h.f. gear merely an adjunct to our equipment for low-frequency operation.

It was with this idea in mind that the a.m./f.m. rig for 48-54 Mc., described in November *QST*,¹ was designed. The unit presented herewith is a companion piece. It is v.h.f. gear; there is probably nothing about it which is of value for other than its intended purpose, which is the generation of a powerful signal in the two- and six-meter bands — and in the five-meter band, so long as that old friend remains with us. It consists of a push-pull final stage which is driven directly from the exciter when the operating frequency is in the five- or six-meter bands, and a power tripler which drives the final for operating on two meters.

Getting Down to 144 Mc.

The 815 rig referred to above was designed before it was known that the 56-Mc. band was going to be made available to us on a temporary basis, but output on the 56-60 range can be obtained by making the 50- μ fd. section of C_{10} an adjustable padder. With this condenser set at minimum capacity the range of the v.f.o. will extend well above 14 Mc., for multiplying to 56 Mc. The crystal oscillator works very nicely with 14-Mc. crystals, and the sizes of the various coils and condensers are such that no change is necessary in any of these components to obtain output over the whole frequency range from 48 to 60 Mc., except perhaps a slight adjustment of the turn spacing in the 815 grid coil.

◆
Front view of the 300-watt driver-amplifier. The two large dials are the plate tuning controls. The small dial at the left adjusts the position of the output coupling link, the center dial is the grid tuning control for the final, and the third small dial is the tripler grid tuning control. Across the lower center are the filament switches and grid current meter jack.
◆

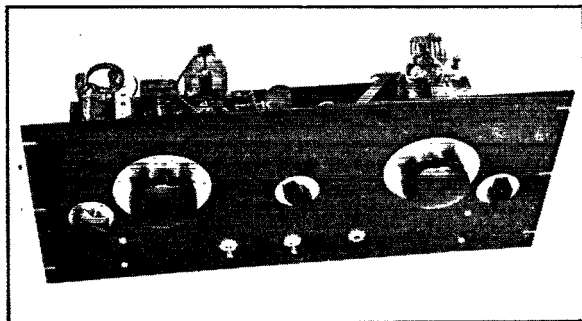

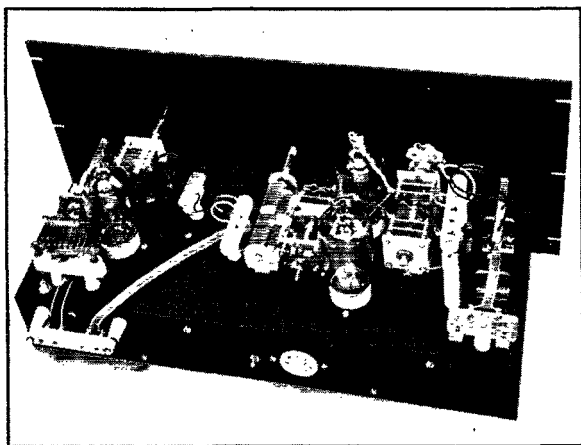

Rear view of the v.h.f. amplifier unit with 144-Mc. coils in place. All components are grouped for minimum lead length. Lucite rods are used for extension shafts on all tuning controls. Note the plug-in link between the tripler plate coil and the final grid circuit. Flexible links, for the final grid and output coupling circuits, are made of a new low-loss 300-ohm line (Amphenol 21-056).

The tripler stage can be any of several push-pull or single-ended combinations, a number of which were tried before the 35TG shown was selected. The simplest, and perhaps the best, solution if cost is no object is the use of an 829 as a push-pull tripler. It was found that about 50 watts could be obtained on 144 Mc. by this means, but the high cost of the 829 caused us to look for some other means of generating the necessary 144-Mc. drive. The 35TG was finally chosen because it permitted the use of one voltage source for both driver and final, and the fact that the same tube type is used in all three sockets simplifies the problem of maintaining a complete set of "spares."

As anyone who has worked with v.h.f. frequency multipliers knows, the secret of obtaining satisfactory output lies in providing adequate grid drive. More excitation is, in fact, required for the single-ended tripler than for the push-pull final. The 815 rig serves very nicely for both purposes — it will drive the tripler if operated close to maximum ratings, and it coasts along easily as a 50-Mc. buffer stage.

The Layout

That the arrangement of parts happened to work out to provide symmetrical front-panel controls is almost entirely coincidental. The thought in mind was to mount every component so as to eliminate stray capacity and inductance rather than to achieve pleasing appearance. As it developed, however, the arrangement worked out to give a neat appearance which matches up nicely with the exciter.

Looking at the front-panel view, the two large dials are the plate tuning controls for both stages. The small dial at the left controls the swinging link, the center dial is the grid tuning control for the final stage, and the one at the far right is the tripler grid tuning control. All parts are mounted well back from the panel, and lucite rods are used for extension shafts.

The rear view shows the general placement of parts. At the left, attached to the back of the 7 × 17 × 3-inch chassis, is the jack bar, con-

taining terminals A-A and C-C, into which the link from the exciter is plugged to furnish drive for either the tripler or final. The tripler grid coil, L_1 , is just above the link socket, with the plate condenser, C_5 , and coil, L_2 , for this stage between the tube and the front panel. The link between L_2 and L_4 is a plug-in affair, and its socket (which is a mechanical mounting only) is between the tripler plate and final grid condensers. Between the grid tuning condenser and the final tubes are the ganged neutralizing condensers. These are triple-spaced midget condensers, mounted back to back, with coupled shafts. The final tank condenser is mounted as closely as possible to the two tubes, at the right. The jack bar for the final plate coil and the homemade swinging link assembly are at the far right. All components are mounted as close together as possible without being so crowded that tubes cannot be removed from the sockets. So compact is the arrangement that several of the leads had to be soldered in place before the components were mounted on the chassis!

Some description of the way in which some of these parts are used is probably in order. We will begin with the method for changing bands. When the rig is to be used on 50 or 56 Mc., the switch S_1 is left open, so that the filament of the tripler will not light when S_2 is closed. The link from the exciter is plugged into terminals C-C in the jack bar, which is a Millen Type 40205 coil socket. The output of the exciter is thus connected to the link terminals on the final grid-coil socket, L_3 , which is a National Type XB-16. The plug-in link is left out of its socket, B-B, which is a Millen Type 33002 Crystal socket mounted on a small cone stand-off.

For operation on 144 Mc., switch S_1 is closed, lighting the filament of the tripler tube. The exciter link is inserted at terminal A-A on the link jack bar, coupling the exciter to the tripler grid coil, L_1 . The plug-in link which transfers the energy from L_2 to L_3 is inserted in its socket, and 144-Mc. coils are inserted in the sockets for L_3 and L_4 .

In order to eliminate the stray capacity and

inductance usually encountered in any plug-in base, the 144-Mc. coils for L_3 and L_4 are made to plug directly into their respective sockets. The grid coil, being of No. 12 wire, fits the socket contacts; the plate coil is fitted with pins removed from an old tube base or plug-in coil form. For the same reason, the plug-in link terminals on the L_3 coil socket are not used for 144 Mc. When conventional coil mountings and links were used, the 144-Mc. grid coil was little more than a loop of wire across the plug terminals, and the transfer of energy was inadequate to drive the final properly. Elimination of this useless capacity and inductance permitted the use of a fair-sized coil at this point, and the coupling efficiency was considerably improved.

The final-stage plate tank condenser has very low capacity. It was made from a Cardwell dual neutralizing condenser, which originally had an insulated flexible coupling between the two rotor sections. This was removed and a section of $\frac{1}{4}$ -inch brass rod, tapped for $\frac{9}{32}$ thread, was inserted in its place. A piece of $\frac{1}{8}$ -inch thick lucite was fitted to the bottom of the condenser assembly and this serves as a mounting base. The net result is a split-stator condenser which is ideally suited to our purposes. It has sufficiently wide spacing to eliminate the danger of flash-over, yet it is more compact than any ready-made unit we've seen — and its maximum capacity is only about 4 μfd . per section.

There is really no necessity for a plug-in coil at L_1 , inasmuch as it is never changed, but it was employed to permit the use of a standard commercial unit, for those who don't care to wind any more coils than necessary. Two turns were removed from one end, making it essentially an end-linked coil. The same type of coil (National AR-16, 10-C) assembly is used for the 56-Mc. coil for L_3 . One turn was removed from each end in this case, a center-linked assembly being needed at this point.

The use of these coils is evidence that residual capacity and inductance are far below normal in this layout — a conventional 10-meter coil is used, with only slight reduction in its normal inductance, for 5-meter operation. When this unit was first fired up the 112-Mc. band was still available, and a standard 5-meter coil served very nicely for 112-Mc. operation at L_3 !

Tuning Up

Meters should be provided for reading the tripler plate, final grid, and final plate currents. The jack which may be seen on the front panel is for insertion of a meter for measuring the tripler grid current, and is normally used only during initial tuning operations. The three meters mentioned above are mounted elsewhere in the writer's installation, so they do not appear on the unit. In the schematic diagram they are shown as M_1 , M_2 and M_3 .

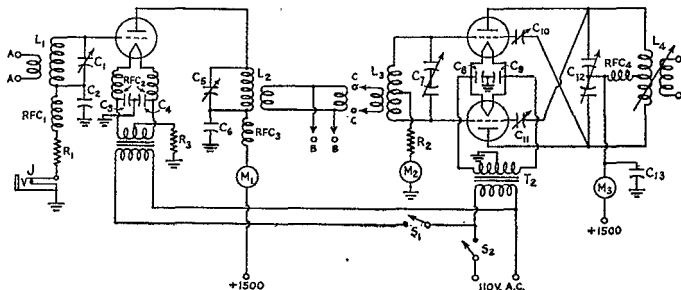

Fig. 1 — Schematic diagram of the 50-148-Mc., driver-amplifier using 35TGs.

- C_1, C_5 — 15- μfd . variable (Hammarlund HFA-15-E).
- C_2, C_3, C_4, C_6, C_9 — 0.001- μfd . mica.
- C_7, C_{12} — 0.0005- μfd . 5000-volt, mica.
- C_7 — 15- μfd . per section, split stator (Hammarlund HF-15-X).
- C_{10}, C_{11} — Neutralizing condensers (Cardwell Trim-air, 2-plates, triple spacing).
- C_{12} — 4- μfd . per section, split stator (Cardwell ED-4-DI). See text.
- R_1 — 50000 ohms, 10-watt.
- R_2 — 3000 ohms, 10-watt.
- R_3 — 250 ohms, 10-watt.
- RFC $_1$, RFC $_4$ — V.h.f. r.f. choke (Ohmite Z-1).
- RFC $_2$ — 10 turns No. 14 e., self-supporting, close wound on $\frac{3}{8}$ -inch diameter.
- RFC $_3$ — V.h.f. r.f. choke (Ohmite Z-O).
- M_1 — 0-150 ma.
- M_2 — 0-50 ma.
- M_3 — 0-300 ma.
- J — Closed circuit jack.
- T_1 — Filament transformer, 5 volts, 4 amperes.
- T_2 — Filament transformer, 5 volts, 8 amperes.

- S_1, S_2 — S.p.s.t. toggle switch.
- L_1 — 6 turns No. 18, $1\frac{1}{4}$ -inch diameter, 1 $\frac{3}{16}$ inches long, 3-turn end link (National AR-16, 10-C, with two turns removed from one end).
- L_2 — 2 turns No. 14 e., 1-inch diameter, spaced $\frac{1}{8}$ -inch. Link, L_2, L_3 — 2 turns No. 14 e., each end. Plug-in device is for mechanical mounting only.
- L_3 — 50-60 Mc. — Same as L_1 , but with one turn removed from each end of the original unit. 144 Mc. — 2 turns, No. 12 tinned, $\frac{3}{8}$ -inch diameter, spaced $\frac{1}{8}$ -inch. No plug-in base is used — coil leads plug directly into socket.
- L_4 — 50-60 Mc. — 3 turns each side of center, No. 12 tinned, 2-inch diameter. Adjust turns spacing so that low frequency end of range comes with tuning condenser at maximum capacity. Base is a Millen Type 40205 Midget plug.
- 144 Mc. — 1 turn each side of center, No. 12 tinned, spaced to fit holes in jack bar (Millen type 41205 Midget Socket). Pins for this coil may be removed from an old tube base or plug-in coil form.

The final stage should be tuned up on 50 or 56 Mc. first. The exciter link should be plugged into terminals *C-C* on the jack bar, and the five-meter coils inserted in L_3 and L_4 . With power on the exciter but no plate voltage on the final, rotate C_7 for maximum grid current. Set neutralizing condensers at maximum capacity, and rotate C_{12} . If the final-stage plate circuit is capable of being tuned to resonance there will be a pronounced dip in the grid current. The neutralizing condensers, C_{10} and C_{11} , should then be adjusted a small amount at a time until the dip in grid current disappears. Power may then be applied to the plate circuit. If everything is in order, the dip in plate current at resonance should bring the plate current down to less than 50 ma. It may be loaded up to nearly 300 ma., at a plate voltage of 1500 — an input 425 watts or more — before the plates of the 35TGs show more than their normal bright orange color. In other words, this rig works on 56 Mc. just about the way the average transmitter could be expected to perform on 14 Mc.!

Next, the operation of the tripler should be checked. With the exciter on 48 Mc. and the link inserted in the terminals *A-A*, adjust C_1 for maximum grid current. This should be around 20 ma. when no plate voltage is applied. For initial tests 750 volts is sufficient — the maximum voltage should not be used until everything is in order. Apply the plate voltage and tune C_5 for resonance, which should occur near minimum capacity. As this stage is being driven hard, harmonics will show up all along the line, hence the output frequency should be checked with Lecher wires or a reliable absorption-type wave meter.

When it has been determined that the output is actually the third harmonic, or 144 Mc., insert the plug-in link at *B-B* and the coils for 144 Mc. at L_3 and L_4 . Repeat the process of checking the final stage as outlined above for 56 Mc. Some change in the setting of the neutralizing condensers may be required for complete neutralization at 144 Mc. (the setting for this band is much more critical than for 50 or 56 Mc.), but the adjustment for 144 will usually be found to be satisfactory for the lower frequency as well.

Tests on 144 Mc. should be conducted at a lower voltage than is used for 50 or 56. Up to

2000 volts may be used at the lower frequency after everything is tuned up, but with the somewhat lower efficiency at 144 Mc., 1300 volts is the recommended maximum. Tuning operations should be conducted at not more than 1000 volts. A dummy load of some sort should be kept coupled to the final stage when high voltages are used, otherwise the high circuit losses at this frequency will cause sufficient tank circuit heating to melt soldered connections.

Do not be dismayed if the minimum dip in plate current at resonance is not impressive. Circuit losses keep this current high (about 100 ma. at 1000 volts) and the resonance dip is not a true indication of performance. Lamp loads, too, are unreliable at this frequency. The best indication of performance is the color of the tube plates. If the color does not indicate greater heat than is shown when 150 watts input is run with no excitation, then there is no cause to worry about harming the tubes.

In the initial tests on the air, which were made prior to the November 15th change-over, this rig was run at inputs up to 400 watts on 112-Mc. 'phone. Dummy load tests on 144 Mc. indicated a capability of 300 watts or more without excessive heating. Reports from a radius of 20 miles or so indicate that, though the signal from this rig is of terrific strength, it occupies less space in the band than would be taken up by a modulated-oscillator rig of but a small fraction of the power.

Possible Refinements

Most workers on 50 or 56 Mc. will want to be able to use c.w. occasionally. This may be taken care of by inserting a 45-volt battery between R_2 and ground. This will permit keying of a preceding stage.

The cathode-bias resistor, R_3 , can be increased in value to hold the plate current of the tripler to a reasonable value, in case it is desired to operate the final stage at full input at 144 Mc.

As greater excitation is available on the lower frequencies, it is desirable to make the grid resistor variable so the grid current can be held at the recommended value of 20 ma. per tube. This is done at W1HDQ by the use of a 3000-ohm, 50-watt potentiometer in series with R_2 .

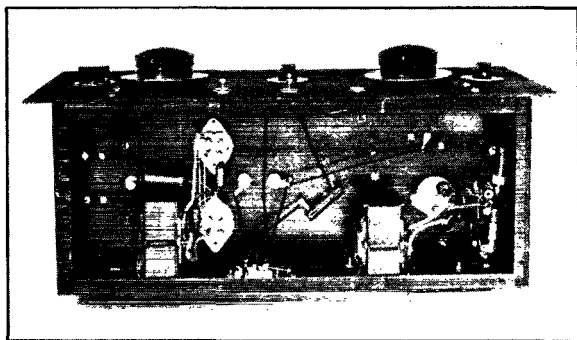

Under-chassis view of the 35TG driver-amplifier. Separate filament transformers are used for the two stages. The driver tube socket with its two filament r.f. chokes is at the right.

Simplified F.M.

An Easily-Applied System for A.M. or Narrow-Band F.M. Work

BY MAJOR J. C. GEIST,* SC, W3CPG

ONE of the main advantages of frequency modulation for ham work is the ability to modulate a transmitter of any input with negligible audio power. In spite of this seemingly great advantage, frequency modulation has not come into general amateur use. There has probably been some reluctance to change to f.m. beyond the normal inertia resulting from the somewhat complex modulation circuits and the number of r.f. multipliers required, along with the need for

put for fully amplitude-modulating the 832. A switch is provided so that either the 6J5 speech amplifier as a Heising modulator can be connected partially to amplitude-modulate the oscillator or the entire unit can be used as a 100-percent amplitude-modulator for the final amplifier.

Frequency Modulation

With the switch S_1 in the a.m. position, the modulator in a standard Class-B circuit is con-

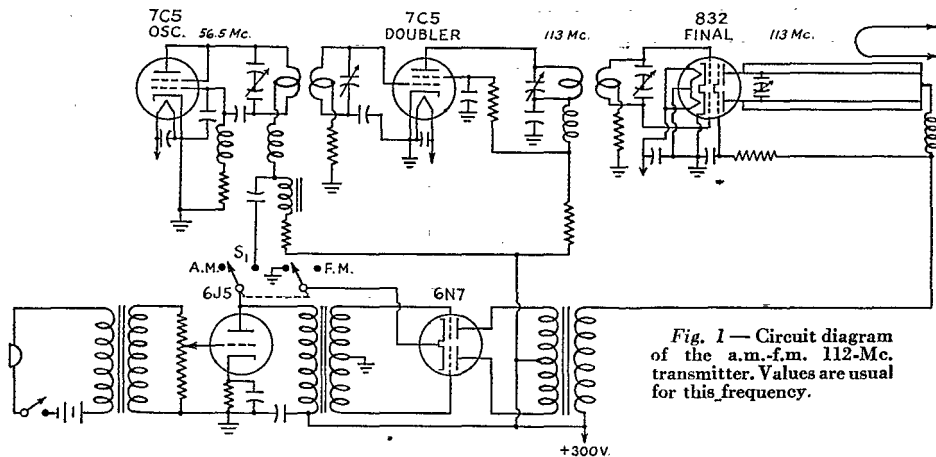

Fig. 1 — Circuit diagram of the a.m.-f.m. 112-Mc. transmitter. Values are usual for this frequency.

better receiving equipment to make use of the inherent advantages of this type of modulation.

The modulation method to be described in this article eliminates the need for complex circuits and numerous multipliers and yet maintains all of the advantages of f.m. In fact, this system is less complex than a.m. or the currently-used f.m. systems.

Circuit Arrangement

Fig. 1 shows the main features of a 2½-meter transmitter designed to be either plate modulated or frequency modulated. The transmitter starts out with a type 7C5 tube with plate and screen connected together operating as a self-excited ultraudion oscillator at 56.5 Mc. It is followed by a type 7C5 tube operating as an inductively-coupled Class-C doubler which drives a type 832 tube operating as a push-pull final Class-C amplifier at 113 Mc. The 832 is loaded to a total plate and screen input of approximately 20 watts.

The modulation unit consisting of a single-button carbon microphone, a type 6J5 speech amplifier, and a type 6N7 operating as a Class-B amplifier delivering approximately 10 watts out-

needed to the final amplifier. With the switch in the f.m. position the oscillator is amplitude-modulated at a low percentage. Amplitude modulation of the self-excited oscillator also causes frequency modulation since the frequency of a self-excited oscillator varies with changing plate voltage. Since the depth of modulation is kept low, the amplitude modulation is wiped out by the succeeding Class-C stages. The frequency modulation remains, and the frequency deviation is doubled by the succeeding 7C5. The resulting output from the transmitter is a virtually constant-amplitude frequency-modulated carrier.

After many of us have spent weeks and months in attempting to design an oscillator whose output frequency is constant with change in plate voltage, W3CPG comes along with the almost too obvious idea that f.m. can be accomplished by varying the plate voltage of a not-too-stable oscillator in accordance with speech through the medium of amplitude modulation. The system appears to be linear over a sufficient range to permit good-quality narrow-band f.m.

*212 Norwood Ave., Avon, N. J.

This method of obtaining frequency modulation will undoubtedly be considered poor engineering practice. The results obtained however seem to justify its use.

Linearity

Fig. 2 shows a curve of plate voltage versus frequency for the 7C5 oscillator. Points above 190 volts on this curve are not too reliable since the oscillator frequency drift at higher plate voltages was too rapid to permit making accurate readings. The curve shows that the characteristic is essentially linear from 130 volts up to the vicinity of 200 volts and possibly somewhat beyond. This variation results in a frequency change of 11.5 kc., or a deviation of about ± 6 kc. It is accompanied by a little over 20-per-cent amplitude modulation.

The transmitter at W3CPG/2 operates at a mean oscillator plate voltage of 180. A voltage change of ± 50 volts, corresponding to an amplitude modulation of 36 per cent, results in a frequency deviation of ± 8.5 kc. After the frequency doubler this deviation becomes ± 17 kc. The oscillator plate voltage actually was selected to be low enough to minimize frequency drift and still provide adequate excitation to the doubler. It seems to have been a happy choice from the frequency-modulation viewpoint, since approximately one watt of audio is giving good-quality f.m. with adequate deviation. It seems probable that the deviation could be extended by increasing the oscillator tank-circuit LC ratio, the amount to be obtained in practice being limited principally by the amount of C necessary to maintain satisfactory stability.

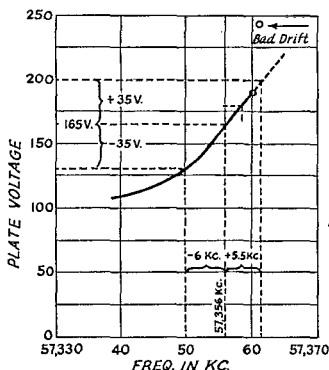

Fig. 2 — Plate voltage vs. frequency characteristic of a 7C5 self-excited oscillator under limited amplitude modulation.

Results

Tests have been run over a distance of about 7 miles using an a.m./f.m. superheterodyne receiver (Hallcrafters S-27) at the receiving location. Under exactly the same conditions, the transmitter modulation was switched instantaneously from a.m. to f.m. The a.m. transmissions were received best with the receiver in the a.m. position with a narrow-channel i.f. adjustment. The receiver gain control was set at 6 and the signal was

reported of good quality with sharp and clean modulation. No carrier drift was observed. On f.m., the signal was received best with the receiver in the f.m. position and the i.f. adjusted for broad-band reception. The quality of the signal was reported unchanged and the same audio output was obtained with the gain control at the same setting. No carrier drift was observed. With the receiver shifted to the a.m. position, practically no modulation was observable at the center of the carrier. When the i.f. selectivity was increased, the modulation was still intelligible but distortion increased and the audio output was lower.

The tests indicated that frequency modulation is accomplished with inconsequential amplitude modulation and that the frequency modulation provides communication equally as good in every respect as that resulting from amplitude modulation. It was proved practical to make use of all the advantages of frequency modulation without the necessity for critical adjustments of any kind. On the other hand, it was found that some f.m. occurs during amplitude-modulated operation. This is caused by inadequate voltage regulation of the common plate supply, since the output voltage varies slightly with the varying Class-B modulator load. The obvious corrective measure would be the use of a separate supply for the oscillator, or regulation of the oscillator voltage by means of VR tubes. A VR105 and a VR75 in series should provide nice stabilization for the 180 volts required.

The results obtained with this transmitter with f.m., along with the simplicity and low audio-power requirements of the modulation method used, indicate that the system is ideally suited for amateur work. The possibilities of adding a 100- to 200-watt final amplifier to the transmitter without the need for additional audio equipment is most inviting.

In designing any specific equipment using this method of modulation and the oscillator frequency are selected so that sufficient grid drive is available on modulation valleys, and so that the multipliers will increase the frequency deviation to the required amount at the desired output frequency.

The amount of frequency deviation realized probably depends upon the LC ratio in the oscillator tank circuit, among other factors. The transmitter constructed uses an oscillator capacitance of about $40 \mu\text{fd.}$ in each section and a coil of No. 10 wire consisting of $1\frac{3}{4}$ turns with a diameter of $1\frac{3}{4}$ inches. The oscillator is operated with a plate voltage of 180 and a plate current of 28 ma. Although no measuring apparatus was available, tests with a receiver indicated that the deviation realized was somewhat greater than normal a.m. sidebands, possibly between 10 and 15 kc. each side of the center frequency.

It is probably just a matter of time until f.m. is generally accepted for ham use, so it is felt that it might be well to keep in mind this simplified f.m. system when "that new rig" is being de-

(Concluded on page 90)

HAPPENINGS OF THE MONTH



SECOND REOPENING ORDER

HERE for your study is the text of FCC's Order No. 130 which on November 15th replaced our initial temporary one-band operation:

At a session of the Federal Communications Commission held at its offices in Washington, D. C., on the 9th day of November, 1945;

WHEREAS certain of the frequency bands allocated to the Amateur Radio Service in the Commission's Report of Allocations from 25,000 kilocycles to 30,000,000 kilocycles dated May 25, 1945, are now available for use by amateurs as authorized by this order; and

WHEREAS it is considered advisable that certain orders adopted by the Commission during the emergency, affecting the Amateur Radio Service, be cancelled, and that amateur station licenses be validated for a temporary period to permit the orderly processing of applications for new, renewed and modified licenses;

IT IS ORDERED THAT:

1) All amateur radio station licenses which were valid at any time during the period December 7, 1941 to September 15, 1942, and which have not heretofore been revoked are hereby VALIDATED for a six-month period commencing with the effective date of this order and ending May 15, 1946 (3 A.M., Eastern Standard Time).

2) (a) The following frequency bands are available for use for amateur station operation except in Central, Southern and Western Pacific Ocean areas, subject to the limitations and restrictions set forth herein.

- (1) 28.0 to 29.7 Mc., using type A1 emission.
- (2) 28.1 to 29.5 Mc., using type A3 emission.
- (3) 28.95 to 29.7 Mc., using special emission for frequency modulation (telephony).
- (4) 56.0 to 60.0 Mc., using types A1, A2, A3 and A4 emissions and, on frequencies 58.5 to 60.0 Mc., special emission for frequency modulation (telephony). This band is available for amateur operation until March 1, 1946 (3 A.M., Eastern Standard Time).
- (5) 144 to 148 Mc., using A1, A2, A3 and A4 emissions and special emissions for frequency modulation (telephony and telegraphy). The portion of this band between 146.5 to 148 Mc. shall not be used, however, by any amateur station located within 50 miles of Washington, D. C., or Seattle, Washington.
- (6) 2300 to 2450 Mc., 5250 to 5650 Mc., 10,000 to 10,500 Mc., and 21,000 to 22,000 Mc., using on these four bands, A1, A2, A3, A4 and A5 emissions and special emissions for frequency modulation (telephony and telegraphy).

(b) Upon the effective date of this order, no frequencies other than those assigned in this order shall be used for amateur operation.

3) The following orders of the Commission are hereby cancelled:

(a) Order No. 72, dated June 5, 1940, together with all amendments thereto, prohibiting amateur radio operators and amateur radio stations licensed by the Federal Communications Commission from exchanging communications with operators or radio stations of any foreign government or located in any foreign country.

(b) Order No. 73, dated June 7, 1940, together with all amendments thereto, prohibiting portable and portable-mobile radio station operation by licensed amateur operators and stations on frequencies below 56,000 kilocycles.

(c) Order No. 87, dated December 9, 1941, and Order No. 87A, dated January 9, 1942, prohibiting all amateur radio operation.

(d) Order No. 87B, dated September 15, 1942, suspending the issuance of renewed or modified amateur station licenses.

This order shall become effective the 15th day of November, 1945 (3 A.M., Eastern Standard Time).

BY THE COMMISSION:
T. J. Slowie
Secretary

HAWAIIAN RESTRICTIONS REMOVED

BECAUSE military clearance could not be completed in time, the FCC order quoted above did not apply to Hawaii and the island possessions in the Pacific. However, on November 14th, just before the effective date of the order, FCC was able to act, and by means of its Order 130-A it amended the quoted order so that K6 was able to go on the air with the rest of us. In Par. 2 (a), the words "except in Central, Southern and Western Pacific Ocean areas" are struck out. However, in the fifth item of frequencies, concerning the 144-148-Mc. band, Honolulu is added to the list of cities within 50 miles of which amateurs may not use the portion between 146.5 and 148 Mc. until further order.

NEW CALL AREAS

TO PERMIT the assignment of thousands of additional amateur station calls that do not exceed a total of five characters, FCC on October 24th approved a new system for postwar amateur calls. The old system involving nine call areas, identical with long-since-abandoned inspection districts and involving the splitting of some states, now gives way to a new plan embracing the ten call areas shown on our map — which is substantially as reported on page 20 of *QST* for September, which you may wish to see for further details. Puerto Rico and the Virgin Islands continue in the fourth call area, and Hawaii and the Pacific possessions in the sixth — except for the islands adjacent to Alaska which go along with the latter in W7 as previously.

One change of considerable significance has been made from the original ARRL recommendation reported in July *QST*: After the present W series is exhausted in any call area, a similar



series will be started using the prefix K instead of W. The matter of "shifting the digit" (to make such calls as WA9AA) will therefore not confront us until we have gone through two complete sets of calls. The use of K for this purpose will not destroy its identification value for outlying territories and possessions, since use on the mainland will involve 3-letter calls and a single-letter prefix (such as K1AAA), while outlying areas will have 2-letter calls and 2-letter prefixes, for example, KG6AA in Guam, KV4AA in the Virgin Islands.

The new system of course will be operative when FCC resumes the issuance of new licenses. We have no information yet as to when existing calls will be changed to accord with the new plan but shall report the details in *QST* as fast as they become available. In this connection FCC says:

It is fully appreciated that most of the amateurs who formerly held station licenses and who obtain new ones would prefer to be assigned their former call letters and, while the large number of amateur stations renders it imperative to assign calls systematically rather than on a request basis, nevertheless the Commission will continue its policy of assigning the same call to the station of the same amateur whenever appropriate. This principle has applied not only to renewed and modified licenses, but to new ones following a period of inactivity. It is proposed to continue this principle, so that if an amateur obtains a new license for his former location, it will ordinarily include assignment of the former call without change. It is also proposed to extend the principle to minimize any resulting changes so that most of these can be limited to a change in the numeral signifying call area. For example, a former call of the type W9AAA would be succeeded by one of the type W0AAA. It is expected that in a great majority of instances — more than 75 per cent — a former call can be assigned without any change.

Canada is also contemplating changes in call areas which would subdivide VE4 and VE5 to provide better recognition and to conform with the districts of the Department of Transport. The proposed new areas are as follows:

Manitoba.....	VE4
Saskatchewan.....	VE5
Alberta.....	VE6
British Columbia.....	VE7
Yukon & N.W.T.....	VE8

G.I. AMATEUR RADIO

MILITARY personnel of the British and United States Armed Forces in the European theater are now permitted to engage in amateur radio operation, to maintain and aid in training of radio operators, according to a memorandum of the Allied Force Headquarters dated 16 October. Applications are being entertained by the Office of the Chief Signal Officer, AFHQ, through signal

channels. The frequency band 7120-7210 kc. is assigned for this purpose, with an input to the final of 50 watts, A-1 only, amateur procedure, operating hours 0600 to 1800. The calls are four-letter X calls assigned by AFHQ, and X stations may communicate only with other X stations within the European theater. Plain-language messages in English may be handled, including those for third parties who are members of the British or U. S. Armed Forces. The memorandum concludes with the statement that "provided this experiment is successful within the theater, future operations may be extended to include other countries when amateur bands are opened therein" — which it is hoped includes U.S.A.!

We've received many G.I. inquiries as to whether the steps taken by FCC toward the re-opening of amateur radio here apply to licensed American amateurs in the military services overseas. They do not. FCC jurisdiction is confined to continental U.S.A., the territories, and the possessions excluding the Canal Zone — and naturally also excluding any possessions that are operating now under military government. The question of amateur operation in the military theaters is strictly a military matter.

BERMUDA CONFERENCE

THE long-expected Anglo-American conversations looking toward the next world telecommunications conference are now announced to begin in Bermuda on November 19th. In addition to delegations from the United States and the United Kingdom, many of the British dominions will be represented. U.S. preparatory meetings began in Washington in October. At the moment of writing it is uncertain whether frequency-allocation matters will be on the agenda or not, and our plans are, therefore, still uncertain.

ROCKY MOUNTAIN NOTES

ALTERNATE Director Howard R. Markwell, W9TFP, is now the Acting Director of the Rocky Mountain Division, as you will notice in the listing in the directory. We regret to report that Director C. Raymond Stedman, W9CAA, has been obliged, by the state of his health, to make a transfer of his powers to his alternate until further notice. All hands wish Ray a quick recovery.

ELECTION NOTICE

TO ALL Full Members of the American Radio Relay League residing in the Delta and Midwest Divisions:

You are hereby advised that no eligible candidates for alternate director of your respective divisions were nominated under the recent call. By-Law 21 provides that if no eligible nominee be named, the procedure of soliciting and nominating is to be repeated. Pursuant to that by-law, you are again solicited to name Full Members of your respective divisions as candidate for alter-

(Concluded on page 90)

ARE YOU LICENSED?

When joining the League or renewing your membership, it is important that you show whether you have an amateur license, either station or operator. Please state your call and/or the class of operator license held, that we may verify your classification.

The Inter-American Radio Conference of Rio

No Important Decisions Affecting Us—U. S. Amateur Proposals Adopted as Study Guide for World Conference

BY ARTHUR L. BUDLONG,* W1JFN

THE Third Inter-American Radio Conference was held at Rio de Janeiro beginning September 3, 1945, and was concluded with the formal signing of the documents on September 27th. It was attended by the largest group ever to attend one of these regional affairs (perhaps the location at Rio had something to do with it!) — more than 150 government representatives and 100 company and industry observers from a total of 22 of the American countries, Newfoundland, the Bahamas and the British colonies in the Caribbean area.

Aside from hitting an all-time high in the matter of general attendance, the conference, I am sure, hit a world high for amateur representation on official delegations. There were amateurs on the delegations of Argentina, Brasil, Bolivia, Chile, Colombia, Cuba, Ecuador, Paraguay and Peru; of these, three were presidents of their national amateur societies! But of this, and the wonderful Brazilian hospitality, amateur and otherwise, more later.

About the conference itself: It was the third of a series of American regional radio conferences, held within the framework of the Madrid Convention (which provides for such affairs) and subject to the general provisions of the international regulations and allocation table. The first two inter-American conferences were at Habana in 1938 (see report in *QST* for February, 1938) and at Santiago, Chile, in 1940 (see *QST* for April, 1940). The Rio conference was originally scheduled for 1943, but its calling was postponed by the war. As with the previous two conferences, the ARRL was represented both in the preparatory work and at the conference itself; in addition, in connection with my work in the Communications Division of the Coast Guard, at Washington, I had been a member of the Government group which formulated the United States proposals for Rio.

The principal objective at Rio was a rewrite of the Habana Convention, both to broaden its scope to embrace the general field of telecommunications (primarily in order that rate matters might be discussed) and to revise the organization of the Inter-American Radio Office (OIR), which had not worked out as hoped in its original form under the Habana Convention. This objective was realized, and there is now a new Rio Convention and a new set-up under it for an Inter-

American Telecommunications Office (OIT), but these do not directly involve amateur radio, so will not be treated here.

In addition, the conference adopted two Resolutions (one with respect to aviation communications and the other concerning freedom of information in radio communications), thirteen Recommendations (on a variety of subjects: high-frequency broadcasting, aviation, meteorology, monitoring stations, receiver coverage, time, press, rates and tariffs, etc.) and a Memorandum of suggestions for information and study. This Memorandum contains several items of interest to us, and these will be covered briefly.

The Memorandum came about primarily because the Rio group thought it inadvisable to revise the Santiago regulations, in view of the imminence of a world conference which would revise the basic regulations to which any inter-American regulations have to conform. Nevertheless, some of the subjects covered in these existing inter-American regulations were discussed, without formal agreements, and where it was found a unanimity of opinion prevailed, the matter was incorporated for future reference or study in the Memorandum. As its introduction states, "This record, which results from the exchange of views at this conference, therefore represents only a tentative common understanding on the subjects covered therein. It does not constitute formal action and commitment but rather expresses general harmony of thought among the representatives present."

Well, what subjects were taken up that involve amateur radio? There were two:

First was Santiago Recommendation No. XVIII, which was a three-part job involving (a) a recommendation to require prior amateur experience for radiotelephone operation in the 14-



First meeting of the technical subcommittee at Rio, Sept. 5th. Visible at the table, center, are Commodore E. M. Webster, USCG, U. S. representative on the committee, and, at his left, A. L. Budlong, ARRL's representative, who served as English "rapporteur" for the committee.

* Senior assistant secretary, ARRL, on leave of absence as Lieutenant Commander, USCGR, with duty in Communications Division, Coast Guard, Washington. In turn, Comdr. Budlong was given leave of absence from the Coast Guard to represent ARRL at the Rio conference. He expects to return to Hq. about the first of the year.

Mc. band throughout the Americas; (b) a recommendation that amateur stations be prohibited from being used for any type of broadcasting service, and (c) a recommendation that, prior to the Rio conference, the amateurs of the Americas seek to come to some agreement as to the subdivision of the bands for 'phone. The position of the United States on this, reflecting the request of the League, was that it would be desirable to retain the first two paragraphs, but that the third might be eliminated, since it obviously no longer applied. At Rio, the other countries went along with us. Remember, this doesn't mean (a) and (b) have been retained and (c) eliminated, but merely that the countries agree it is what they think should be done at the next inter-American conference.

The second item in the Memorandum of interest to us is an allocation table. The United States had taken to the Rio conference its current thinking with respect to proposed revision of the Cairo allocation table (*QST* has carried details during the past year), hoping that the other countries might find in our thinking some helpful ideas for them in drawing up their own proposals for the next world conference. During the course of the conference these world proposals were put before the other countries, it being pointed out that they did not represent the final U.S. point of view but only what we had done so far; nevertheless, we hoped they would be of interest. They were. In fact, what finally happened is that after various countries had added comments of their own to it, our U.S. table was included in the Memorandum as material which "is expected to be useful to the several governments in (their) continued study

. . . and also useful in the preparation of their proposals for the forthcoming world telecommunications conference."

This means that the current amateur allocation proposals of the United States have now been brought officially to the attention of all the other countries of the Americas. It also means that to the extent other countries hitched on comments to our amateur proposals, we have some idea of their current thinking on amateur radio. This comment is almost nil (an encouraging sign) and resolves itself into the following: With the exception of "proposals" for other services from a number of countries for the 1750-2050 kc. band, no adverse comment appears until the 200-Mc. region is reached; here, Canada thinks that our suggested 220-225 Mc. amateur band should be reserved for air-navigation devices "for the time being" and that the 420-450 Mc. band should be exclusively for air-navigation devices (the U.S. proposal is that the band be assigned jointly to amateur and air-navigational, to be exclusively amateur eventually).

So much for the actions of the conference as they affect us.

Generally speaking, it seems to me the signs for amateur radio are good. The comparative absence of comment on our allocation table bears out the impression I received from conversations with both amateur and nonamateur members of the various delegations: they know about the amateur in those countries, they are generally favorably disposed toward us. Our own U.S. delegation certainly left them in no doubt as to the attitude of the United States toward its amateurs; some very fine statements about us are a part of

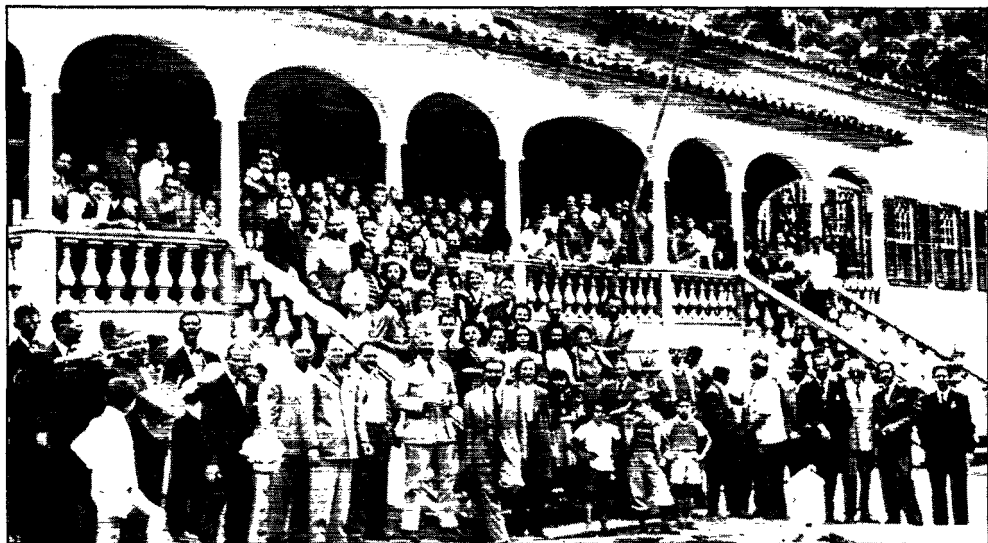

*The "barbecue" of the First Brazilian National Convention of Radio Amateurs, held by LABRE at Rio on September 2nd. In center, in uniform, Lt. Comdr. A. L. Budlong, WJFN, ARRL's representative at the Rio inter-American conference. To his right, J. V. Pareto Neto, PY1AX, of the LABRE council and managing director of Radio Internacional. Others present include PY1AR, Col. Riograndino Kruehl, president of LABRE; LU7BK, Oswaldo Rizzo Peuser, president of Radio Club of Argentina; PY1HL, the editor of QTC, LABRE's magazine; CE1AV; and Pys 1AD, 1AU, 1AX, 1BB, 1BG, 1BM, 1BNI, 1BV, 1BX, 1CC, 1CI, 1CL, 1GU, 1HF, 1HW, 1JV, 1LS, 1MR, 1OJ, 1OK, 1QY, 2UO, 4DM, 4HK, 6QH, 7LK.

the official record. This is an appropriate time to pay tribute to the splendid job our delegation members did for us whenever amateur matters came before the meetings. As always in the history of radio conferences, they are our staunch champions — an attitude which puts upon us the obligation of seeing to it that we merit that support.

The next inter-American conference will be held in Colombia, as soon as possible after the next world telecommunications conference.

It has been possible to recount with at least some feeling of adequacy the actual events of the conference; but when it comes to attempting an adequate description of the wonderful time I had with the other amateurs present, I feel licked in advance. For this was no conference at which a lone U.S. amateur representative missed the presence of others of his kind. Quite the contrary: there were amateurs all over the place! Not just peering in the windows, either — thirteen of them, from nine different countries, were members of their official government delegations (which was more than I was) and three of the thirteen were presidents of their national amateur societies (they had me there, too!). And a grand time we all had, talking ham radio, conferring together, and sampling the marvelous Brazilian amateur hospitality.

For we must start with the Brazilians. Perfect hosts, they left us all with recollections of a visit we can never forget. My own introduction was early; when I got off the plane at Rio, none other than Henry Smith (ex-CT2BK and CP1AA, now assistant managing director of Radio Internacional of Brasil) met me, on behalf of the company's managing director, Dr. J. V. Pareto Neto, PY1AX; both these gentlemen were responsible for innumerable courtesies which I subsequently enjoyed at their hands. They explained to me that the Brazilian amateurs were just concluding a week's convention of the Brazilian society, the *Liga de Amadores Brasileiros de Radio Emissoao* (LABRE), and on Sunday, September 2d, I attended the wind-up feature of that convention, a real Brazilian barbecue, where Col. Riograndino KrueI, PY1AR, president of the LABRE, presided as barbecue master.

This LABRE national convention was their first such event, but any U.S. amateur would have felt at home instantly, as I trust the photograph taken at the barbecue shows. Language differences didn't mean a thing; we were all friends at once, and to a U.S. amateur who hadn't been to a real amateur convention for more than three years it was not only nostalgic but pretty darned near overwhelming. And the chow! We stood up to tables set with an amazing array of silver and glassware, and groaning under tons of wines, fruits and vegetables; but the real feature of the meal was meat, brought to us from the barbecue pits on the long spits on which it had been cooked. You carved off what you wanted, and when you'd eaten that, they brought you more. In that one meal I made up for three years' meat rationing!

It was at this affair I first met Mr. Risso Peuser, LU7BK, president of the Radio Club of Argentina, Mr. Ramon T. Cartes, ZP5AC, president of the Radio Club of Paraguay, and Mr. Hugo Moreno, CP5EA, president of the Radio Club of Bolivia, all members of their national delegations to the conference. It was then I began to realize what amateur representation we had at the conference, and perhaps this is as good a time as any to list them:

Argentina: LU7BK	Oswaldo Risso Peuser, president of the Radio Club of Argentina.
Bolivia: CP5EA	Hugo Moreno, president of the Radio Club of Bolivia.
Brasil: CP5EB	Kenneth Schlicher (ex-W3ATN)
	J. V. Pareto Neto
	A. da Silva Lima
Chile: CE1AV	Capt. Alberto Stegmaier
	Capt. Marcelo Malbec
Colombia: HK3CK	Gustavo Figuero
Cuba: CO2WW	Amadeo Saenz de Calahorra
Ecuador: HC1JW	Victoriano Salvador
Paraguay: ZP5AC	Ramon T. Cartes, president of the Radio Club of Paraguay.
	Salvador Guanes
Peru: ZP6AB	Carlos Tudela, chairman of the Peruvian Delegation.
	OA4Z

I had many conversations with all these gentlemen. Most of us were guests at one time or another of the LABRE, and in turn threw the officers and directors of LABRE a testimonial dinner one night. Later, at a meeting with the officers of the LABRE at their splendid headquarters offices in Rio, remarks of each of us present were broadcast over the official LABRE headquarters station, after which we spent a long and enjoyable evening discussing amateur radio in the Americas, and planning what we were going to do about it in the coming years.

What we are going to do about it covered a wide range of subjects. On some of these we had differences of opinion, but on one we were all in agreement: One of these days we're going to have an all-American amateur convention at Rio.

Silent Keys

It is with deep regret that we record the passing of these amateurs:

W4QJ, Richard V. Nicely, Oteen, N. C.
W6ADD, T/5 Paul Caldwell, National City, Calif.

W8QWL, CRM Herbert Bartholomew, USNR, Dayton, Ohio

W9PJ, S. B. Mateske, LaCrosse, Wis.

W9QCO, James A. McEldowney, Springfield, Mo.

W9YAW, Cpl. Richard Frits, Arnolds Park, Iowa

G14OB, Sgt. Frank McBrinn, Belfast, N.I.

G12DDI, Sgt. Ian G. Campbell, RAFVR, Bangor, County Down, N.I.

Utilizing the VR-Series Tubes

Design Data for Voltage-Regulator Circuits

BY W. H. ANDERSON,* VE3AAZ

THERE is scarcely any circuit which is not beneficially affected by having a stabilized source of direct voltage. This is particularly true where quite modest amounts of power are involved, such as in receiver h.f. and b.f. oscillators, frequency meters and transmitter oscillators. Made to order for such applications are the OA3/VR75-30, OC3/VR105-30 and OD3/VR150-30 voltage-regulator tubes. While these tubes are intended to provide stabilized voltages of 75, 105 and 150 volts respectively, they are of such similar characteristics apart from voltage ratings that they may be used in whatever series combination will provide the desired voltage. For instance, a VR75 and a VR150 may be used in series when 225 volts is required, a VR75, VR105 and VR150 in series for 330 volts and several other combinations are possible.

Basic Regulator Circuit

Fig. 1 shows the basic voltage-regulator circuit. E_1 is the voltage from the power supply, E_o is the stabilized voltage, R_1 is the line resistor across which appears the voltage $E_1 - E_o$, and R_2 is the impedance of the load. Should a voltage divider be connected across E_o , the voltage across it will be maintained constant, but if a load of varying current is tapped down on the divider, the voltage applied to this load naturally will vary. In any event, the value of R_2 used in calculations should equal E_o divided by the total current flowing in the regulated circuit, whether it be through a resistor as shown or through some other load device or both.

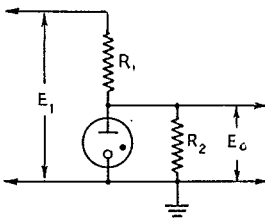

Fig. 1 — Typical simple voltage-regulator circuit for VR-type tubes.

Design Factors

The principal design factors in such circuits are the starting voltage of the VR tube together with its maximum and minimum current ratings. The starting voltage should be approximately 30-35 volts in excess of the normal voltage of the

tube; that is, the starting voltage of the VR150 is about 185 volts. The maximum current ratings of the tubes under consideration is 40 ma. While considerable latitude in current may be tolerated, 5 to 10 ma. generally is considered the safe lower limit, and about 30 ma. the maximum for long tube life.

Returning to Fig. 1, it is evident that R_1 and R_2 must be proportioned so that first, with the tubes non-operating (just before starting) the voltage across R_2 is a minimum of $E_o + N35$ volts, where N is the number of tubes in series, and second, the rated current of the VR tube

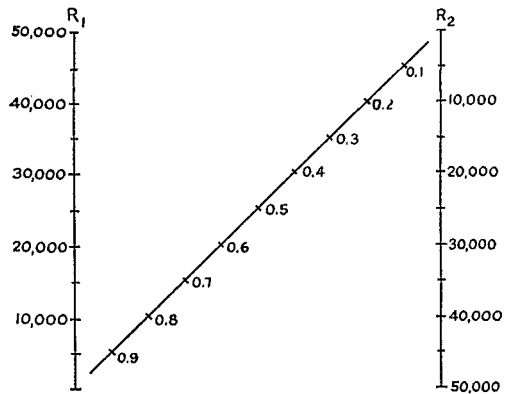

Fig. 2 — Graph showing the proportion of voltage across R_2 as a function of R_1 and R_2 (refer to Fig. 1).

plus E_o/R_2 must not cause the voltage drop across R_1 to exceed $E_1 - E_o$, and third, the minimum current through the VR tubes is maintained. These relationships may be expressed mathematically as follows:

$$\frac{R_2}{R_1 + R_2} > E_o + N35 \quad (1)$$

$$I_{tube} = \frac{E_1 - E_o}{R_1} - \frac{E_o}{R_2} \quad (2)$$

The starting-voltage condition often is readily satisfied in practice where the voltage is being supplied to a vacuum tube directly without voltage dividers, by the simple fact that when the power switch is turned on, the power supply heats up sooner than the rest of the set. Consequently, at the time when voltage is first applied to the regulator tube, R_2 is extremely large.

Paralleling Tubes

In cases where the circuit calls for more than 30 to 40 ma. through the tube, two or more tubes may be used in parallel. This should be avoided if

* *o/o* T. C. A., Moncton Airport, Moncton N. B., Canada.

possible, however, because of the danger of all tubes not beginning to conduct at the same instant, in which case the higher starting voltage will be removed from the unstarted tube, by the action of the started tube.

Graphical Calculations

Figs. 2 and 3 are nomographs to provide a ready solution of Equations (1) and (2). In Fig. 2, the values of R_1 and R_2 are aligned,

and the proportion $\frac{E_s}{E_1}$, where E_s is the

starting voltage, is found. This value then is entered in Fig. 3 and combined with the value of E_1 on the E scale to find the starting voltage. E_o (on the E scale) is applied to R_2 and the current, I , noted from the chart. Then $E_1 - E_o$ (again on the E scale) is applied to the value of R_1 . This current should be 10 to 35 ma. greater than the current previously determined, or 20 to 70 ma. for two tubes in parallel, and so forth. If either R_1 or R_2 is unknown, it will be necessary to use Fig. 3 to find the minimum proportion $\frac{E_s}{E_1}$, and then combine

this value with the known resistance in Fig. 2, following with a test for currents in Fig. 3.

Perhaps it should again be pointed

out that $E_o + N35$ is the *minimum allowable* starting voltage, although a higher voltage is in no way objectionable, providing the tube current checks normally.

If E_1 varies very widely, it is advisable to check both its upper and lower limits to assure that the various requirements will be met at all times.

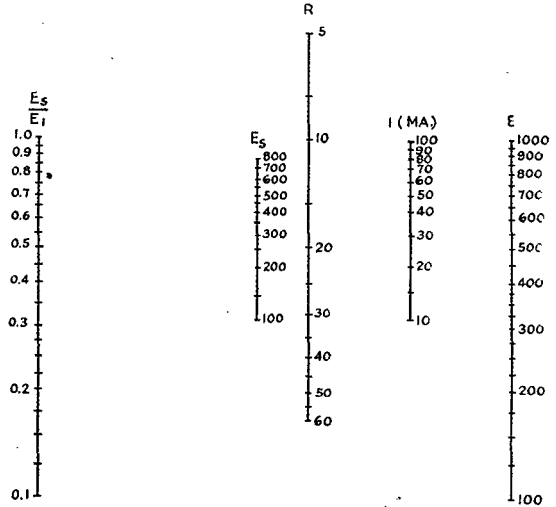

Fig. 3 — Nomograph for determining voltage and current relationships in a voltage-regulating circuit.

ESCTC ANNOUNCES COURSE IN AMATEUR RADIO

ACCORDING to information received from Lt. Col. George M. Simmons, SC, K7JDH and Executive Officer of the Eastern Signal Corps Training Center, a course in *amateur radio* will be offered at Fort Monmouth under the supervision of Headquarters, ESCS.

The announcement of the course stated "that a course leading to qualification for a Class B amateur radio operator's license will be given by the Fixed Station and Field Radio Sections of Officer's school to all interested students and military personnel of the ESCS."

This voluntary course will be conducted during off-duty hours on two days a week for 4½ weeks, a total of 22 class hours.

A prerequisite of at least 13-words-per-minute of clear text code speed (as is required by the FCC) has been established. Arrangements to teach the code are being made by the Field Radio Section. The FCC examination will be given to all students at the conclusion of the course in radio theory.

Classes are limited to a maximum of 30 students, each of whom must have attained the required 13 w.p.m. Questionnaires were circulated to all persons in the ESCS and the background and past experience of each man will be consid-

ered in the organization of classes.

The 1945 edition of the *ARRL Handbook* was designated as the official reference text for this course.

The subjects to be discussed and the time allotted them are as follows:

Subjects	Hours
Introduction.....	1
Electrical Fundamentals.....	2
Vacuum Tube Theory.....	1
Power Supplies and Rectification.....	2
R.f. Oscillators, Self-excited and crystal controlled.....	2
R.f. amplifiers.....	2
Keying methods.....	1
Radiotelephony Theory.....	2
Antenna Systems.....	2
International Laws and FCC Regulations.....	3
Review.....	2
Written Examination and Critique.....	2
Total.....	22

This is the first announcement of such a course and it is indeed gratifying to see this demonstration of the interest in amateur radio by the military.

We wish the men at ESCTC all the success such a venture deserves, and we sincerely hope that other military and naval installations will follow some similar plan.

— A. D. M.

Necessity Is a Mudder

or Ham without Points

BY THOMAS J. KELLY,* W4CNY/1

At the outbreak of the war we, like so many of the brethren, sold all of our ham junk to the Army or to one of the various training programs. Such reasoning, we reasoned, was a stroke of genius, since the halcyon days of radio were beginning and all of our precious stuff would be obsolete by VJ Day. Perhaps we were lulled into this line of thought by the wave of electronic sensationalism that has swept the country during the past few years.

If we are to believe all we hear, with or without a generous sprinkling of salt, any day now we will all be equipped with walkie-squawkies; and ships, trains, planes, etc., will be operated by absentee skippers who will be comfortably ensconced in suitable livery in Fifth Avenue establishments, ably carrying on their duties elsewhere by means of the modern genie, Electronics.

Since VJ Day a great many hams have been clothed in despair. Imagine their great disillusionment to find out that coil and condensers are still in use and that 6J5's and 76's still work! Alas and alack, we have been misled by unscrupulous people! Where are those cavities, klystrons, magnetrons, and microwaves we were told would obsolete every piece of radio gear in the world? In a frenzy, 40,000 hams tried to buy back their precious junk — but to no avail, for after four years of use by budding Marconis it might as well have been hit by an A-bomb.

Another step in our masterful reasoning was that on VJ Day military surplus equipment would be on the market in great quantity, and for a five-spot we could refill the shack and add that "drooled-over" scope to boot. This line proved to be as fallacious as the obsolescence angle. Surplus material is available in copious quantities provided you are willing to buy 8,632,199 8-31- $\frac{1}{2}$ anodized captive wing nuts in order to get a few odd-sized resistors. It is highly probable that by the time all surplus stocks are liquidated the ham cost will be only slightly less than the pre-war cost, and very few items will have a warranty.

Faced with all these troubles and taxes to boot, brother ham received another jolt. Deep in his Freudian subconscious he firmly believed the bands would not be reopened for at least one year after VJ Day, but in an unprecedented move the Commission announced restricted operation almost on VJ plus zero.

This was too much — no parts, no cavities, no surplus — the intangible thread unceremoniously snapped. The XYL's and OW's surreptitiously stole measurements for a tailored strait-jacket,

and the little muscle-bound men with the nets worked overtime.

Everywhere was heard the chant, "We must get on the air. We must get on the air." It is a fact that a goodly number did — with a vengeance.

An example of this extreme desperation is shown in the accompanying illustration. The builder of this monstrosity was several years ago a Southern gentleman of ordinary intelligence with a tendency toward rotundity. Later he and his were transported to Boston, self-styled Athens of America, where he began a vigorous campaign to narrow the broad "A."

This reverse-lend-lease Carpetbagger blew his top when the word was received. For days he couldn't eat, couldn't sleep, had coils before his eyes, and had dizzy spells. It was a clear case of the virus *ham fever* and the Southern Specific, *Peeruny*, wouldn't cure it. During a less delirious moment he was told by the XYL, quote, "The bleak cold wind blows out of the north and our children have no shoes — why not beg, borrow, buy, or embezzle enough to build a rig lest, alas, we perish?"

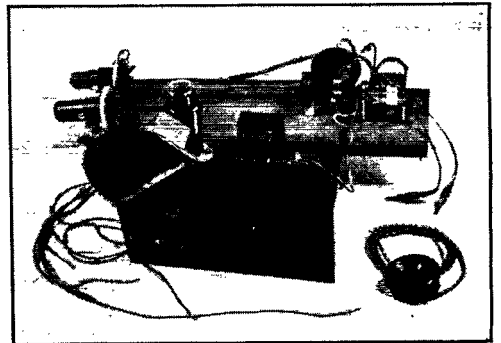

Front-panel view, exposing the "not-too-reflex baffle."

With this sage and dramatic statement the door was opened, and between the stacked creditors a light could be seen. Within a few hours parts were borrowed, bought, or swiped and a rig was born. Let it be added at this point that the builder has been restricted during the past few years by Navy specifications, and that the rig pictured herein should not be construed as a reflection of either the adequacy or inadequacy of Navy specifications, but instead should be viewed as a Daliesque means of self-expression.

Receiver

Further to prove the hackneyed and corny expression "to be involved in wireless, one does

*137 Virginia Road, Waltham, Mass.

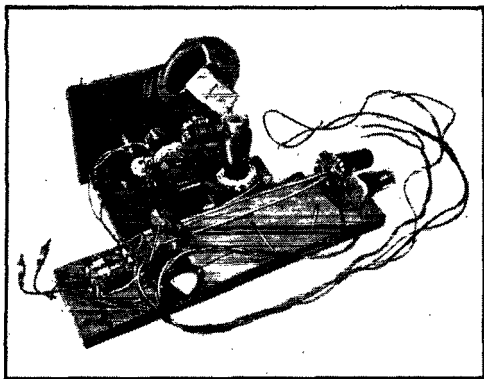

Rear view, including the high-dielectric-strength Southern pine matches. (The Lecher-wire support mechanism probably is more easily identified in this than in the front view.)

not necessarily have to be mentally unbalanced; however, albeit, it is a great asset," let us discuss the circuit and construction in detail. The receiver chassis is made of secondhand (or third-hand) plywood of no particular dimensions. The transmitter shelf is equally nondescript, having been rescued from the kindling box. To conserve space the transmitter is nailed to the receiver. In passing, mention should be made of the "not-too-reflex" speaker baffle. By sawing off the corner of the baffle on a 45-degree angle and drilling two holes in the panel, the quality of the 6-inch p.m. speaker is improved not a bit, and if the angle of cut is exactly 45 degrees, space is left to mount the speaker using two holes. Another innovation is the built-in Lecher-wires support assembly. This may be seen on the top of the panel, right side.

The receiver is rather conventional, consisting of a 6SN7GT superregenerative detector and a 6F6G audio. One unusual feature of the set was probably prompted by the government specification — 100% spare parts. Only half of the 6SN7 is being used, so that instead of replacing the tube, the second half may be quickly wired-in in the event of a failure. Some of the parts are the mortal remains of an f.m. tuner, some were borrowed from W5GNV, and the rest obtained through the last procurement category. The relatively large spacing between the tuning condenser and the wooden panel prevents any trouble from hand-capacity detuning effects, and at the same time provides space for the horizontally mounted 6SN7 detector. During the design, the need for a condenser shaft extension presented a problem; this was finally solved, however, by buying the heir an all-day sucker and appropriating the stick.

Transmitter

The transmitter is a conventional t.n.t. line oscillator of no particular merit. The line is made of a defunct hydraulic line and the tubes are again the ever-faithful 6SN7GTs. In previous pre-production models the transmitter employed a single 6SN7, but in an effort to raise the power

a second tube was added in a push-pull parallel connection. The added lead inductance and capacity shrunk the line length to a negative value, so the project was abandoned. To save time in reconversion, one triode in each tube was disconnected by clipping the jumper wires. The clipped jumper connections are still visible in the photograph.

Several conclusions were drawn during the design and construction of this transmitter. All and sundry are advised that a shunted a.c. voltmeter does not operate well as a d.c. milliammeter, since the indications are somewhat difficult to interpret. It is believed that a compass and coil galvanometer or d.c. meter would be more suited for this purpose. It is also believed that the advisability of using relays should be seriously considered, particularly if the relays have been used on shipboard for several years and were then dropped a few times.

Too much cannot be said regarding the length of resonant lines. Whatever value is suggested, add 100% and then prune only after the rig is working. A line excited by a single 6SN7 is approximately nine inches in length. When a single section in each of two 6SN7s is used instead, the line length becomes approximately 13 inches. If the lines are cut for a single tube and later two tubes are used, the shorting bar will usually locate about two inches past the end of the line, which will be fine for 140 Mc. after November 15th. In the described rig, the shorting bar is located on the exact end for a frequency slightly out of the band on the high side. By bending the rods to provide greater spacing it is possible to reach the center of the band.

Modulator and Power Supply

The power supply and modulator (not shown) are built on a metal chassis and are enclosed in a mahogany cabinet of Hepplewhite design. Normally these units are an integral part of a commercial broadcast receiver. The modulator stage contains a pair of 6V6s capable of delivering about 15 watts of well-distorted audio. The microphone (courtesy W5GNV) is a crystal headphone, the leads of which are terminated in nails of the same size as phone tips.

The cabinet for the modulator and power supply, ergo the b.c. receiver, normally supports the transmitter-receiver. Since a few nails and screws protrude through the bottom of the set, the XYL has added a touch of femininity by placing a copy of "Live Alone and Like It" between the two units.

External Cabling

Because the system must be dismantled quickly when friends call, the cabling is so arranged as to be quickly disconnected. A quick-disconnect point in the b.c. set is the tuning-eye socket. Filament and "B" connections to the rig are made by cramming the leads into the appropriate socket holes and locking them in place by wedging them with wooden kitchen matches (see photo). The

(Continued on page 94)

"Gawp"

The Polecat County Philosopher Gets Riled Up Listening on the 112-Mc. Band

BY "SOURDOUGH"

GAWSH all hemlock! This sure has been a spring and summer. First comes VE-Day and then VJ-Day and running through it has been the durnedest collection of ill-assorted weather as ever plagued a farmin' feller.

Wal — when things got squared up a piece Martha and me decided to go down to the city fer a spell. Idee was that Martha needed a change and wanted to see the stores now that there was something in 'em. O' course, the fact that Pine Notch is too far out for me to hear any 112-Mc. stuff had nothin' to do with it!

Some farmers say that city fellers is kinda looney sometimes. Never did think so myself, but I ain't so sure now. Dad burn it! I go around to a feller's shack. He's got a swell super, a fine location and a right good xtal-controlled transmitter. Man oh man! I ain't had such a thrill getting ready to go on the air since we wuz doing transatlantic tests back in the days when you young fellers wuz still an extry item on the laundry bill.

We send out a snappy CQ. When we goes over to "receive" my spirits go down like a dive bomber. Mush! Hogwash! Snarls, gargles, burps and squirms. The band sounded like a crowd of razorbacks had got into the feed trough. Why, 90 per cent of them fellers you could understand only when the super's i.f. was on "f.m. broad." Some



of 'em you couldn't understand even then — and I'm talking about "understanding," which has nothin' to do with quality except that the lousiest quality can still be understandable — and anyhow an old tube strapped as a diode with a simple tuned circuit makes a good fone monitor so there ain't no reason why a feller should hafta mess up the air just to ask what his quality is. You could hear 'em as had "rush boxes" complaining of the QRM and how "so-and-so covered 72 degrees on the dial." That weren't surprising. Some of them signals was washing about so's you could of heard 'em on 15,000 meters.

It weren't only the stinkeroo transmitters an' tha squealing receivers! There wuz also the guff they was *putting out* on the air. By cracky, I hope no BCL could hear 'em. Most all of it was the same bad old stuff that polluted the bands, pre-war, on the low frequencies. Coupla guys drooling away for hours, not to mention their wives, sisters, cousins, aunts, kids and their visiting half-brother from outta town, all of whom added their cute (?) little bits of humor and smart cracks to further poison an already infected ether. Perambulating polecats!

If a coupla guys wives wanta gawp about their husbands, their new clothes and what's for supper come Tuesday night — let 'em do it on the land-line. A 700-per cent overmodulated, inherently unstable oscillator is bad enough without using it for a party line. Fer at least on the party lines out our way we ain't too reluctant to cut in and tell 'em they've had their turn and to dry up — and you can't overmodulate a hand-crank fone!

All this here wuz happenin' at the time when only a few guys had got back on the air. What's it gonna be like when things really get going on 144? Only one thing fer it. The offending Joe with the wobbling mess of a xmtr has gotta be told — told nice, but definite, what the score is. If he's a right feller he'll be thankful and do somethin' about it. If he's just naturally careless he won't do nothin' at first but pretty soon he'll jest plain *have to*. Just before the war we wuz suffering from dew-eyed reporting on our signals. Feller would give out a "Q5R9" and then ask for repeats. Let's start right and tell 'em straight and no back-patting. Like most things, it all boils down to the old saw that either we watch things and get 'em sorted out or else we leave it to the other guy and 144 gets to sound like feeding time at the zoo.

Mind ye! T'warnt *all* like I sez afore. In the middle of these sloppy, sour, splashing signals there wuz some other fellers trying to check arrays with each other. They sure wuz patient and kept right on trying, right through the swill, to really do something useful on the band. Them fellers is the ones that count in ham radio.

Been reading through some 'way-back files of *QST*. There ain't such a lot that's new in the world. Things fellers tell me today as new and revolutionary more often than not were writ up ten, fifteen years ago in one form or 'nother.

I know one old-fashioned device that you fellers had better get ahold of. Cheap and easy to make and a means of keeping the RI from sending along them nasty little pieces of paper about being outside the band. The gadget I mean is the simple, foolproof (wal, pretty near!) absorption wavemeter.

WWV Schedules

STANDARD-FREQUENCY transmissions are made available as a public service by the National Bureau of Standards over its standard-frequency station, WWV, on the following schedules and frequencies:

2.5 Mc. — 7:00 P.M. to 9:00 A.M. EST (0000 to 1400 GMT).

5.0 Mc. — Continuously, day and night.

10.0 Mc. — Continuously, day and night.

15.0 Mc. — Continuously, day and night.

The 10- and 15-Mc. radio frequencies are modulated simultaneously at accurate audio frequencies of 440 and 4000 cycles. 5 Mc. carries both audio frequencies during the daytime but only 440 cycles from 7:00 P.M. to 7:00 A.M., EST, while 2.5 Mc. carries only the 440-cycle modulation. A 0.005-second pulse may be heard as a faint tick every second, except the 59th second of each minute. These pulses may be used for accurate time signals, and their one-second spacing provides an accurate time interval for physical measurements.

The audio frequencies are interrupted precisely on the hour and each five minutes thereafter, resuming after an interval of precisely one minute. This one-minute interval is provided to give the station announcement and to afford an interval for the checking of radio-frequency measurements free from the presence of the audio frequencies. The announcement is the station call (WWV) sent in code, except at the hour and half hour, when it is given by voice.

The accuracy of all the frequencies, radio and audio, as transmitted, is better than a part in 10,000,000. Transmission effects in the medium may result in slight fluctuations in the audio frequencies as received at a particular place; the average frequency received, however, is as accurate as that transmitted. The time interval marked by the pulse every second is accurate to 0.00001 second. The 1-minute, 4-minute and 5-minute intervals, synchronized with the second pulses and marked by the beginning and ending of the periods when the audio frequencies are off, are accurate to a part in 10,000,000. The beginnings of the periods when the audio frequencies are off are so synchronized with the basic time service of the U. S. Naval Observatory that they mark accurately the hour and the successive 5-minute periods.

Of the frequencies mentioned above, the lowest provides service to short distances and the highest to great distances. In general, reliable reception is possible at all times throughout the United States and the North Atlantic Ocean, and fair reception over most of the world.

Information on how to receive and utilize the service is given in the Bureau's Letter Circular, "Methods of Using Standard Frequencies Broadcast by Radio," obtainable on request. The Bureau welcomes reports of difficulties, methods of use, or special applications of the service. Correspondence should be addressed to the Director, National Bureau of Standards, Washington, D. C.

You take this here 21-Mc. band we might get. Tripling is as easy as doubling. For the same coil there ain't too much difference in condenser setting between 21 and 28 Mc. A quick check with the old reliable "click meter" and you know where you're at. Same idee but more so, in the new channels which ain't in harmonic relationship. We're gonna have some very techy services right close to our bands and we'd better light and stay in 'em. You wanna know which band you're on? Okay, shove an absorption wavemeter up near the final and you got an answer that's honest, a lot honeste than some of them "frequency checks" I heard them fellers on 112 Mc. giving out.

One bright thing happened when we wuz down to the city. Met up with a group of young fellers who had just got outta the service. They wuz all ops what had held down Army circuits and a nicer bunch of fine kids you couldn't find. Some folks got an idea that because a young Joe has been in the service and been overseas, that makes him a sorta real tough hombre what knows his own mind and is gonna have his own way.

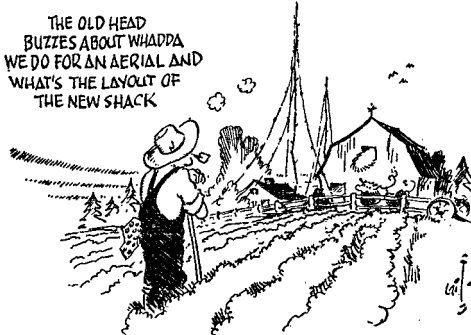

Malarky! These fellers (and a lot more like 'em I've met) wuz eager to be hams and spent all their time asking this old galoot questions. You old-line experienced hams are gonna find that these ex-GIs have a swell background of doing the right thing the right way. You've got the experience and it's up to you to help them GIs along. I don't mean in technical lines — they probably know more about 'em than you do. They want the story of how a ham works and the things he should ought and shouldn't oughta do on the air. By gurry, it took a lot of convincing to make these fellers see they could go on the air and say and do what they liked with their gear when they wanted to. They'll find it a keettle different from GI ideas but very FB. You old timers just kinda steer 'em real gentle like and they'll make as good or better hams than we wuz.

Keepin' an eye on farmin' is tough these here days. The old head buzzes about whadda we do for an aerial and what's to be the layout of the new shack. Aw shucks, you all been doing it too. Ain't it a wonderful feeling! Mebbe by the time the RFD gets this down to West Hartford you all will be getting back on the air. So here's DX and a swell rig to you. Good huntin'!

An Inexpensive Transmitter Console

Modern Design for the Amateur Station

BY S. E. GARBER,* W8MGS

Here is a transmitter cabinet that will furnish many ideas for that new post-war rig. It was built by W8MGS in four months of pre-war spare time, at a total cost of \$16.75, including metal, forming, spot welding, painting and plating.

IN DESIGNING the transmitter cabinet shown on these pages, our objective was a self-contained transmitter with a high degree of safety that would be readily accessible for adjustment or repair. It was to be of light-weight construction and, above all, pleasing in appearance. The usual amateur requirements of ease of construction and low cost were also important factors. After the normal pencil-scratching period, the final design was found to meet all of the above requirements so well that we thought others might like to follow the same principles.

A piece of 20-gauge cold-rolled steel 44 by 72 inches was laid out as shown in Fig. 1. Notches and cuts were made with a pair of tin snips, and the corners were bent on a local tinsmith's sheet metal brake. The round front corners were made by making a series of very slight bends within a predetermined area. It would be well to practice making the round corners on a piece of similar

metal before starting the corners of the cabinet. Channels, corner braces, top strips and top-corner gussets should also be cut and formed as shown.

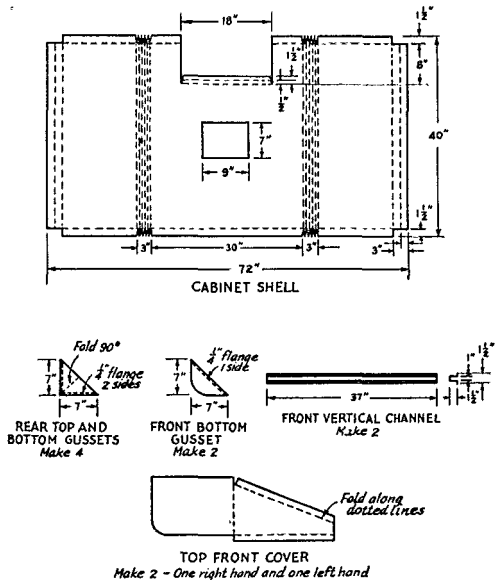
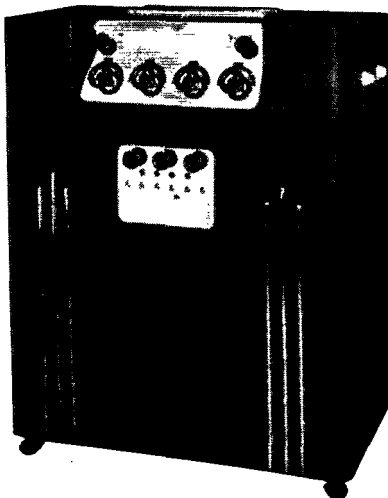

Fig. 1. — Details of the cabinet shell and reinforcing members. The material is 20 gauge cold-rolled steel.

All parts were spot welded together into one solid unit. First, however, in order to save the welder's time, all parts were riveted together with very small tinsmith rivets, in just enough places to maintain the correct shape of the cabinet. The weld spots were spaced approximately one to two inches, a procedure that gave a very rigid final product. All outside joints were filled with a 95-5 hard solder. This solder melts at 400° F. and, since the steel conducts away the heat fairly well, a husky soldering iron must be used. The acid flux was rinsed off with plenty of clean water to prevent subsequent corrosion. The excess solder from the corners and joints was removed with a file and then smoothed with steel wool and emery cloth, making the unit look as if it were only one piece of steel.

After the cabinet was completed, the lid was cut to fit and the opening was cut out. The lid fits flush within the space provided for it, and small 1/4-inch reinforcing channels were riveted and soldered on the underside to stiffen it. Hinges were riveted and soldered at the back-underneath side of the lid, and provision was made for bolting the hinges to the rear channel so that the lid could be removed at any time if it were necessary.



The homemade transmitter console at W8MGS rivals any commercial product in appearance and convenience. The meters, set behind a Lucite panel and using homemade scales, are indirectly lighted.

*3019 Wellington Drive, Dayton, Ohio.

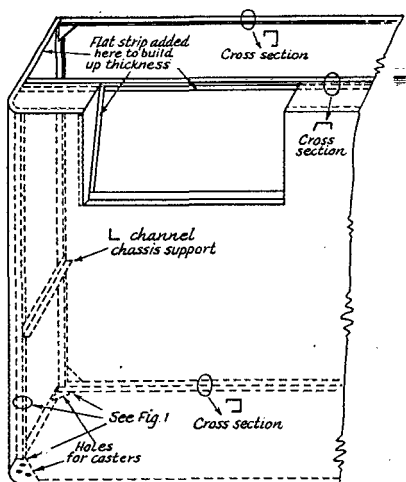

Fig. 2. — Assembly details of the transmitter console. The pieces are assembled with small rivets and then spot welded.

The cabinet was painted by a local instrument concern which had facilities for baking crackle finishes. However, if a crackle is not available or desirable, several coats of either grey or black brushed enamel would look very attractive.

To dress up the cabinet, a few strips of stainless steel trim were mounted on the front and an aluminum grille mounted on the lid. The grille was made from a sheet of aluminum cut into strips approximately $\frac{3}{4}$ -inch longer than the ventilating opening. Then slots were cut in the ends of the strips just long enough to permit the strips to fit in the opening. Spacers and long brass rods threaded on the ends were used to keep the polished and lacquered aluminum strips in place.

Tuning Panel

The meters on hand were of different sizes and models. To make them uniform in appearance they were removed from their cases and the scales removed. Two boxes were made of thick bakelite, one long enough for the four meters in the r.f. section and the other large enough for a modulator plate milliammeter and filament voltmeter. The meters were fastened to the bakelite back of

the case by tightening the terminal nuts. New scales were drawn on single strips of paper for each case, and these were mounted under the meter pointers and secured by the regular meter-scale screws. The front of the meter case was made of polystyrene (or Lucite) and fastened with screws to the front of the bakelite case (see Fig. 3). The meter scales are illuminated indirectly by pilot bulbs which are placed between the meters.

The tuning wheels and knobs connect to the tuning condensers, selector switches and other controls by flexible cables. The various lengths that were necessary were cut from automobile radio control cable. This can be done easily and backlash from loosened turns can be avoided if the cable is first tinned in the vicinity of the cut. Then a $\frac{1}{4}$ -inch copper tube about one inch long is slipped down over the point to be cut and the tube filled with solder. The tube is then cut in the center and serves as a short shaft. The final tank condenser was connected by two insulated universal joints because the angle between its shaft and the tuning wheel shaft was too sharp for flexible cable.

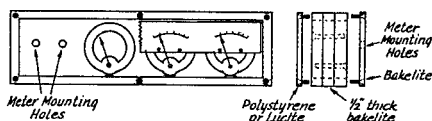

Fig. 3 — Assembly of the meter housing. The meter movements are mounted on holes in the rear bakelite plate, and a transparent cover is used over the bakelite meter housing.

For safety to the operator an interlock switch is used under the lid to cut off all power when the lid is raised, and a protective circuit with two overload relays and one master holding relay is used to protect the high-voltage power supply in case of an overload or accidental short circuit. Relays for antenna changeover and in the low-voltage-transformer secondary center taps are controlled by a single "send-receive" switch.

The Transmitter

The transmitter and power supply chassis were cut and formed from 18 gauge steel. Rivets were

A top view of the console, showing the lid and the construction of the grille.

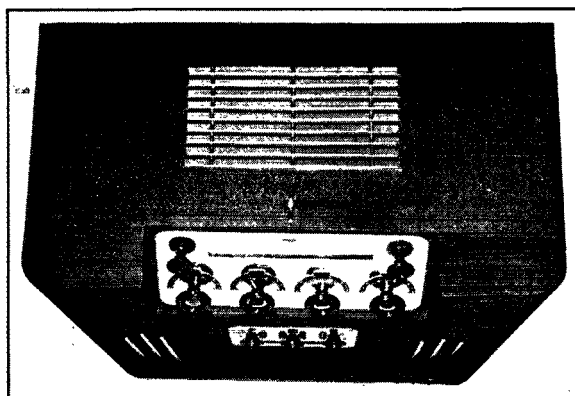

used to fasten the flanges in the corners and these joints were also filled with solder. The chassis were cadmium plated and then buffed to get a mirror finish. All three chassis are supported at the ends by small 3/4-inch angles which are bolted to the rear flanges and front vertical channels of the cabinet.

The transmitter consists of a pair of cathode-modulated HK-54s in the final driven by a RK49-807 combination. Excitation to the final amplifier is controlled by adjusting the 807 screen voltage, and the final amplifier bias is adjustable by switching to the proper tap on the grid-leak resistor. The excitation and bias controls are both available at the panel.

The middle chassis contains the speech amplifier, modulator and associated power supplies. The audio line-up is 6J7-6C5-6N7 transformer-coupled to a pair of 6L6's running Class AB₂. A 6H6 is used for volume compression, and a

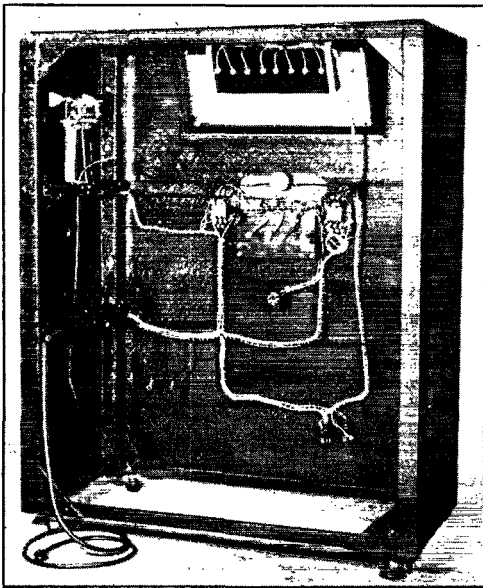

A rear view of the cabinet with the chassis removed, showing the antenna relay on the left-hand wall and the plug-in power cables.

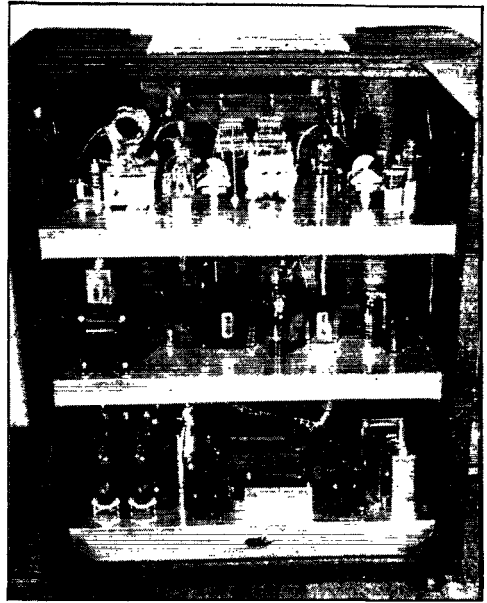

The three chassis of the complete transmitter are mounted on wall brackets along the side of the cabinet. Flexible cables pick up the tuning condensers and other controls on the transmitter chassis.

band-pass filter is included to attenuate the low and high frequencies and give a more useful voice-communications characteristic.

All wiring from meters, switches and relays is cabled and terminated at the chassis in 6-prong sockets and plugs. This permits removal of any chassis from the cabinet to the work bench and, by the use of an extension cable, still allows the removed unit to be energized and tested.

The rig was in operation over a year before the war, on 14-Mc. 'phone, and worked out very well. Because it does not have any heavy angle iron for a frame, it can be pushed around the shack on its 1 1/4-inch rubber casters without any trouble, and with all of the handling it has received (including an automobile trip to the amateur radio exhibit at a Hobby Fair) it shows no sign of strain or weakness in its construction.

Strays

The FCC has granted the University of Chicago (Cosmic Ray Laboratory) a license for a new experimental portable-mobile radio station, aboard a free balloon, within a 350-mile radius of Chicago. A two-watt transmitter will be installed on a free balloon which is to be sent aloft for the purpose of obtaining scientific information regarding the nature of penetrating radiations in the stratosphere. The small, light-weight transmitter will be frequency-modulated by impulses

produced as a result of the passage of high energy particles through a set of coincidence counter tubes in a cosmic ray telescope. The Cosmic Ray Laboratory believes that radio-equipped balloons would greatly facilitate investigations of cosmic rays, and proposes to develop radio sounding apparatus for the transmission of cosmic ray data from free balloons, thus eliminating the procedure of locating and recovering this apparatus after a balloon flight has been completed. Special authority is granted to operate the transmitter without the presence of a licensed operator at the transmitter.

Frequency Multiplication for the V.H.F. Bands

Tube Line-Ups for Stabilized Control at the New Amateur Frequencies

BY HARRY A. GARDNER,* W1EHT

Now that the war is over and we may expect to occupy the newly-assigned high-frequency bands in the not-too-distant future, the question of frequency multiplying from the low frequencies to these bands becomes a subject in which many amateurs will be interested. In considering building a new rig for these higher frequencies the choice of suitable tubes is a logical starting point for any discussion.

Tubes

If the multiplication starts at any of the lower frequencies, our old friend the 6L6 still is a natural for the first stages. This tube requires very little driving power and its output is rich in harmonics. It is easy to get good output from this

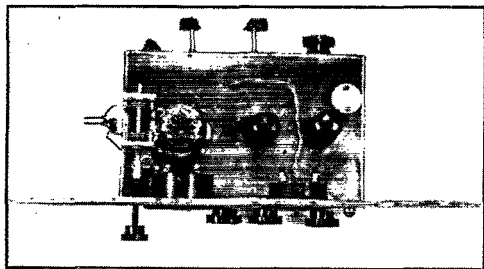

Top view of a 3-tube 112-Mc. crystal-controlled transmitter using a 6L6 as a 14-Mc. crystal oscillator in a Tri-tet circuit, another 6L6 as a quadrupler and an 832 as a push-pull output stage. The plate tank circuit is elevated to permit short leads to the plate terminals of the 832.

tube at harmonics as high as the fifth, which gives us a big start in the required frequency multiplication. The 6L6 will operate with fair efficiency up to the 112-Mc. region, but beyond this we must look to other tubes.

The 7C5 is an excellent tube up into the region of 150 Mc. and can be used as a multiplier with good results. However, since this is not a beam tube, it is not so easily driven, and the output is not so rich in harmonics. Therefore a high order of multiplication is not readily possible.

The 815 is a dual beam tube and while it would seem to be a good tube for higher-frequency work our experience has been that this tube will not stand overload of any kind, and it has not been found to be too satisfactory.

The 832, which is another dual beam tube, is an excellent one for work up to 300 Mc. and makes a

*25 Hillside Ave., Stoneham, Mass.

very fine push-pull multiplier. It is an easy matter to get good output at the fifth harmonic with this tube. While there are other tubes which might be satisfactory, for our money the 832 and its higher-power counterpart, the 829, are by far the best.

Push-Pull

If an attempt is made to go much above 150 Mc. a push-pull arrangement becomes almost a necessity because of the frequency-limiting effects of interelectrode capacitances. As the frequency is increased, the tube input and output capacitances become increasingly important. An HY75, for instance, can be used as a straight amplifier at 160 Mc. with conventional LC circuits if extreme care is used in the construction, but this is about the limit for this tube. In push-pull circuits, these capacitances are in series, which means that the total capacitance is halved. Using an 832 tube with the sections in push-pull, and a resonant-line tank circuit, we can easily get to 300 Mc. Push-pull circuits also are much easier to couple to when using resonant lines.

Push-pull circuits of course are limited to odd-harmonic multiplication, since even harmonics are cancelled in the plate circuit. This limits the choice of fundamental frequency considerably. However, this need not be a serious consideration, particularly since many amateurs contemplate the use of variable-frequency oscillators instead of crystal control.

When it comes to multiplying at higher frequencies, the 832 tube with a resonant-line plate circuit will work very well. With the grid circuit in push-pull and a 60-Mc. driver using a conventional coil-condenser arrangement, we can get three to five watts output at 300 Mc. by using a resonant-line plate circuit and quintupling.

Beyond 300 Mc. it is necessary to use some of

Since piezo crystals have definite practical limits as to thickness, frequency multipliers assume increasing importance as stabilized frequency control is extended into the v.h.f. and u.h.f. regions. In this article the author discusses some of his findings during four years of wartime work on multipliers and associated equipment. Some of this work has included systems with a total frequency multiplication of 18,000 times!

the newer tubes developed during the war, such as the disk-seal type, and to go to co-axial or cavity resonators. The amateur must become a good plumber to experiment in this region. This field undoubtedly will be the subject for a great many articles in the near future, and we shall not attempt to go into it at this time.

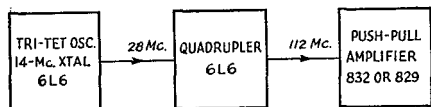

Fig. 1 — Block diagram showing suggested tube line-up for the 112-Mc. band.

Practical Tube Line-Ups

Having discussed some of the tubes available, let us look at some practical applications. Since the 112-Mc. band is ours for a short time only, we won't go into circuits but merely will suggest the line-up shown in Fig. 1.

Starting with a 14-Mc. crystal in a Tri-tet circuit, the oscillator output is at 28 Mc. This 28-Mc. output, if used to drive a 6L6 with the plate tuned to the fourth harmonic, will give a watt or

two at 112 Mc. This can be used to drive an 832 or an 829 as a push-pull amplifier which will put out a very respectable signal. The 829 will deliver an output of better than 60 watts while the 832 will produce about 20 watts at 112 Mc. Either tube requires very small driving power.

The 144-Mc. Band

Since the next band to be made available may be the 144-Mc. band, let us see how it can most easily be reached. A little arithmetic shows that $7.2 \times 20 = 144$. Since 7.2 Mc. is in one of the prewar bands, many crystals should be available. Again using a Tri-tet oscillator, the output circuit will be tuned to 14.4 Mc. A 6L6 as a doubler will bring us to 28.8 Mc. Using an 832 as a push-pull quintupler, at least a couple of watts output can be obtained at 144 Mc. If this is used to drive an 829 as a 144-Mc. push-pull amplifier the output can be boosted to at least 60 watts, which will cut a hole right through that modulated oscillator the other fellow is using. Another way of arriving at 144 Mc. is to use a 3.6-Mc. crystal and the second tube as a quadrupler instead of a doubler. A circuit using this line-up for either 80- or 40-meter crystals is shown in Fig. 2.

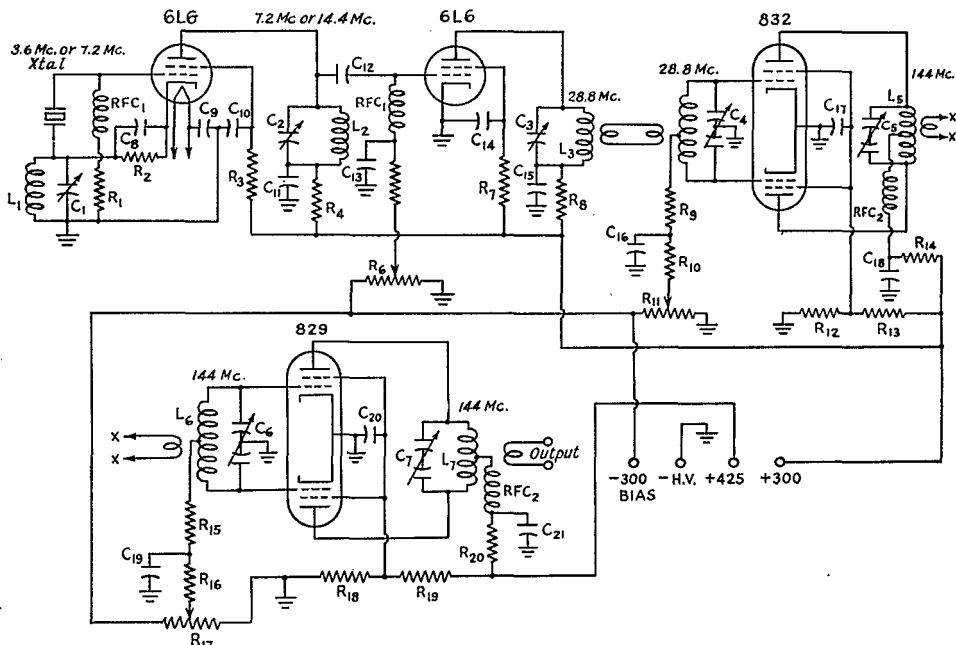

Fig. 2 — Circuit diagram of a 144-Mc. transmitter operating from a 3.6- or 7.2-Mc. crystal.

- C₁ — 100- μ fd. variable.
- C₂ — 50- μ fd. variable.
- C₃ — 25- μ fd. variable.
- C₄, C₅, C₆, C₇ — 15- μ fd. variable.
- C₈, C₉, C₁₀, C₁₁, C₁₃, C₁₄, C₁₅, C₁₆, C₁₇ — 0.001- μ fd.
- C₁₂ — 50- μ fd. mica.
- R₁ — 50,000 ohms.
- R₂ — 400 ohms.
- R₃, R₇ — 15,000 ohms.
- R₄, R₈ — 100 ohms.
- 6L6 grid resistor — 100 ohms.
- R₆, R₁₁, R₁₇ — 0.1-megohm wire-wound potentiometer.
- R₉, R₁₀, R₁₃, R₁₅, R₁₆, R₁₉ — 5000 ohms.
- R₁₂, R₁₈ — 20,000 ohms.

- R₁₄, R₂₀ — 50 ohms.
- RFC₁ — 2.5-mh. r.f. choke.
- RFC₂ — V.h.f. choke.
- L₁ — 14 turns No. 22 d.c.c., 1 inch diameter, 1 inch long for 3.5-Mc. crystals; 6 turns same dimensions for 7-Mc. crystals, polystyrene rod form.
- L₂ — 23 turns No. 20 d.c.c., 1 inch diameter, 1 inch long for 7 Mc.; 12 turns same dimensions for 14 Mc., polystyrene rod form.
- L₃, L₄ — 8 turns No. 12, 1 inch diameter, 1 inch long, self-supporting.
- L₅, L₆, L₇, L₈ — 4 turns No. 10 wire, $\frac{1}{8}$ inch diameter, $1\frac{1}{2}$ inches long, approx. (turns spaced to hit band).

50 Mc.

Now let us explore the possibilities of reaching the new 50-Mc. band. A suggested circuit with values is shown in Fig. 3. By using a crystal in the region of 3.5 to 3.6 Mc. we can get output in the region from 52.5 to 54 Mc. using a multiplying factor of 15. This necessitates a slight change in line-up. If a straight oscillator at 3.6 Mc. is used to drive a 6L6 as a tripler, and this in turn drives a 6L6 as a quintupler, sufficient output will be obtained to drive either an 832 or an 829 at 50 Mc.

variable-frequency oscillator which will tune over this range will serve equally well.

Checking Frequency

One of the prime requirements for building and adjusting equipment of this kind is a set of absorption frequency meters. Fortunately, small wavemeters for this purpose are available at a very reasonable cost, and they should be a part of every amateur's equipment if he is going to do any high-frequency building. The reason for this is that the relative spacing between harmonics

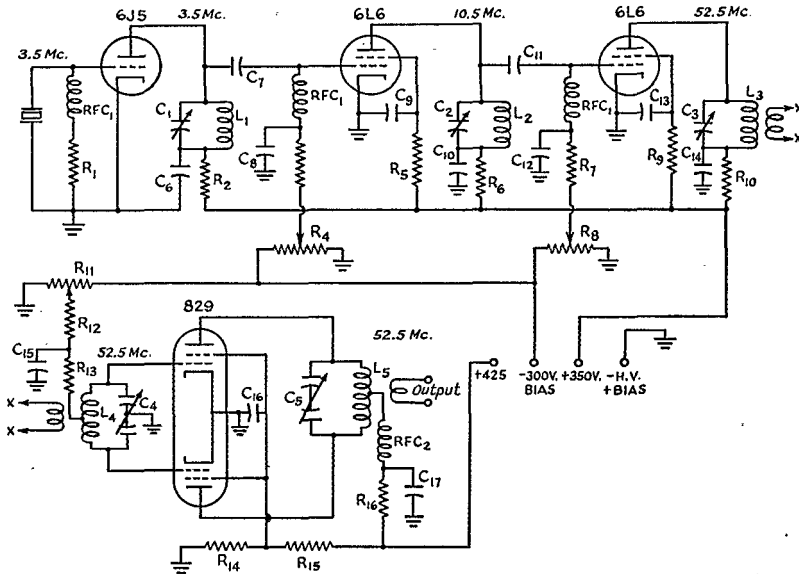

Fig. 3 — Circuit diagram of a 50-Mc. transmitter controlled by a 3.5-Mc. crystal.

- C₁ — 100- μ fd. variable.
- C₂ — 50- μ fd. variable.
- C₃, C₄, C₅ — 15- μ fd. variable.
- C₆, C₈, C₁₀, C₁₄ — 0.0082- μ fd. mica.
- C₇, C₁₁ — 100- μ fd. mica.
- C₉, C₁₂, C₁₃, C₁₅, C₁₆, C₁₇ — 0.001- μ fd. mica.
- R₁ — 50,000 ohms.
- R₂, R₆, R₇ — 100 ohms.
- 6L6 grid resistor — 100 ohms.
- R₄, R₈, R₁₁ — 0.1-megohm wire-wound potentiometer.

- R₅, R₉ — 15,000 ohms.
- R₁₀, R₁₆ — 50 ohms.
- R₁₂, R₁₃, R₁₅ — 5000 ohms.
- R₁₄ — 20,000 ohms.
- RFC₁ — 2.5-mh. r.f. choke.
- RFC₂ — V.h.f. choke.
- L₁ — 40 turns No. 24 d.s.c., 1 inch diameter, 1 inch long.
- L₂ — 17 turns No. 18, 1 inch diameter, 1 inch long.
- L₃, L₄, L₅ — 6 turns No. 10, 1 inch diameter, 1 inch long.

220 Mc.

It might be interesting to point out that it is an easy matter to have crystal control on the 220- to 225-Mc. band also. A few swipes at that crystal which is now at the high-frequency end of the 7-Mc. band will run it up to 7.4 Mc. From this frequency it is possible to get output at 222 Mc. using a total multiplication of 30. This can be obtained, as shown in the block diagram of Fig. 4, by using the crystal in a Tri-tet circuit whose output is tuned to 14.8 Mc. to drive a 6L6 as a tripler to 44.4 Mc. which, in turn may be used to drive an 832 as a quintupler to 222 Mc. A resonant-line plate circuit should be used at this frequency, of course. Either an 832 or an 829 can be used as an amplifier following the quintupler. By using an additional doubler, crystals from 3.67 to 3.75 Mc. may be used or, of course, a

becomes increasingly small; several may be included within the tuning range of a tank circuit making it necessary to exercise care in selection of the desired harmonic.

Another point of importance which many amateurs may overlook is that often a second multiplier stage will show output at undesired multiples of the oscillator frequency as well as at multiples of the preceding multiplier-output frequency. For example, in the circuit of the 144-Mc. transmitter using a 3.6-Mc. crystal, in Fig. 2, the 7.2-Mc. output of the Tri-tet oscillator is applied to the grid of a 6L6 as a quadrupler. A little experimenting with different plate coils in the quadrupler may show that it is possible to get output on a number of frequencies. For instance, if an attempt is made to double with this tube to 14.4 Mc., output will be obtained when the plate

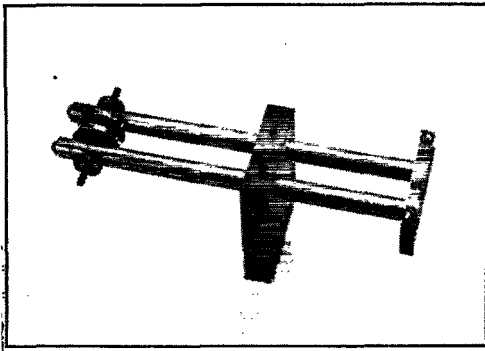

A resonant-line tank circuit for 160 to 300 Mc. designed to be used with an 832 or 829. The line is made from $\frac{3}{8}$ -inch brass stock. The silver plating is not necessary, but it makes the Q somewhat higher. The support is a block of polystyrene. The tuning condenser plates were made on a lathe from solid brass stock. The holes at the center are drilled and tapped to take a 6-32 flat-head machine screw the head of which is soldered to the plate. In use, a National flexible shaft coupling is fastened to one of the screws to provide a means of tuning from the front panel. The threads in the line elements should be a tight fit to prevent side play.

circuit is tuned to 10.8 Mc. as well as when tuned to 14.4 Mc. This output will not be appreciably less than that obtained on 14.4 Mc. If we continue to tune the plate circuit higher in frequency, we will find output at 18 Mc. and again at 21.6 Mc. and also at 25.2 Mc. It will be observed that these frequencies all are multiples of the crystal frequency. When an attempt is made to get output at the fourth or fifth harmonic, several of these "spurious" frequencies will show up within the tuning range of the usual tank circuit, and the output at any one of them will be sufficient to drive the grid of a beam tube in the following stage. This effect may or may not be desirable depending upon the output frequency required.

In either case it is obvious that it is possible to get some very interesting and possibly embarrassing results if absorption frequency meters are not available to identify the output frequency.

Decoupling

In most cases investigation has shown that signals at unwanted frequencies are caused by modulation occurring in power leads which have not been properly decoupled. An examination of the circuit diagrams of Figs. 2 and 3 will show that plate and grid decoupling is used in each stage. The proper ratio of resistance to capacitance for good decoupling is at least ten to one; that is, the value of the resistor should be at least ten times as great as the capacitive reactance of the by-pass condenser. This insures that only one tenth or less of the r.f. in the leads can possibly get into any other circuits, and this amount will not cause trouble.

Let us look at a practical example and see what

values of resistance and capacitance should be used. Since we are dealing with r.f., mica condensers should be used to cut down the leakage. A value of capacitance of $0.0082 \mu\text{fd.}$ is a stock size and reasonably small physically. The calculated reactance for 3.6 Mc. is

$$X_c = \frac{1}{2\pi f C} = \frac{1}{(2)(3.14)(3.6)(10^6)(0.0082)(10^{-6})} = 5.4 \text{ ohms}$$

Since the decoupling resistance should be ten times as great as the capacitive reactance, this means 54 ohms, and it should have a power rating of $\frac{1}{2}$ watt, assuming a plate current of 50 ma. The voltage drop across a decoupling resistor of this value obviously is negligible.

When we examine the formula for capacitive reactance, we observe that as the frequency increases, the reactance decreases in direct proportion, so that the same series of calculations for twice the frequency, or 7.2 Mc., shows that the required resistance is one half the proper value for 3.6 Mc., or 2.7 ohms. This means that the decoupling resistor now need be only 30 ohms. As we get into the higher frequencies we can decrease the size of the condenser and still use a very small value of resistance.

The 21-Mc. Band

In other cases, of course, decoupling may not be desirable, since the output obtained from the

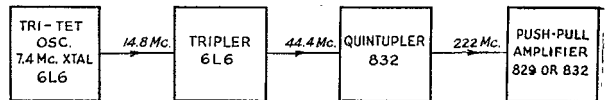
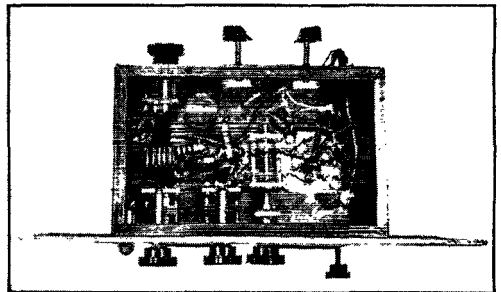

Fig. 4 — Block diagram of a 220-Mc. transmitter operating from a 7.4-Mc. crystal.

multipliers at each harmonic of the oscillator frequency may be useful. For the experimentally inclined, this opens up a very interesting discussion.

(Continued on page 96)



Bottom view of the 3-tube 112-Mc. transmitter. The tuning condensers from left to right are for the oscillator plate tank circuit, the quadrupler plate tank and the push-pull input to the 832. Mounting the latter under the chassis provides good isolation between this circuit and the plate circuit above. The variable in the upper left-hand corner is in the cathode circuit of the Tritet. The two "pots" at the rear are for adjusting bias to the optimum value.

ARRL Emergency Corps Program

BY F. E. HANDY,* WIBDI

*WERS Role Now Assumed by The Amateur Service — New AEC Plans —
Join — Recommend Coördinators — Participate*

EFFECTIVE November 15, FCC Order No. 127 rescinded all WERS licenses and regulations. This was a wartime service and World War II is over. The WERS substituted facilities for those normally made available by amateurs. It is now up to amateur radio to carry forward in its traditional role; amateur organization must henceforth supply emergency radio communication whenever and wherever needed.

The ARRL Emergency Corps, instituted before the war, and kept alive through the war to help WERS, must at once rebuild and reman its own organization to be ready to do the job. You will find that as an active amateur you will want to share in the pleasures and responsibilities of Emergency Corps operating.

At this time ARRL announces its plans for the reconstituted ARRL Emergency Corps. The new AEC program involves some changes. Additional supervision at Section levels has been arranged to insure, interesting, profitable, and regular activities and tests, to promote organization where none exists, and to insure coördination between communities. Sound prewar practices in the Emergency Corps will be retained. Changes in all cases are those indicated by war and prewar experience as likely to contribute to the success of the Emergency Corps in fulfilling our responsibilities in providing emergency communications for communities or special agencies.

Both mobile v.h.f. rigs, and fixed amateur stations on the lower and higher amateur-band frequencies will be required in the ARRL Emergency Corps. There will be a "full membership" and a "supporting" group. The segregation, however, will be based on active participation, not on the type station equipment as was the case before the war. A new registration, from scratch, of equipment, amateur operator experience, and previous WERS or AEC participation, etc., will be preliminary to issuance of one of the new pocket-size ARRL Emergency Corps membership cards, text for which is shown herewith.

Any amateur can join if qualified by FCC operator license, interest, and station. ARRL membership isn't required for the Corps though most amateurs are League members anyway, since this is not a direct SCM-appointment. The Corps used to feature periodic re-registrations. In the

future continued AEC membership will require annual approval or endorsement by the community AEC leader to insure continued membership. That endorsement will be based on activity and interest shown as well as on the continued availability of suitable licensed amateur equipment, all of which will be known to the Emergency Coördinator.

AMERICAN RADIO RELAY LEAGUE EMERGENCY CORPS

FOR PUBLIC SERVICE

This Certifies that John J. Doe

is a Full member of the ARRL Emergency Corps for one year from date below or endorsement on reverse side.

In the event of failure of regular communication facilities due to storms, floods, and similar disasters, this operator offers the use of his amateur radio station and services to his country and community.

He will cooperate closely in Emergency Corps activities, such as plans for rendering emergency communications service, and will participate as possible in appropriate preparedness drills and tests.

Dated Jan. 1, 1946

R. J. Clark
ARRL Emergency Coördinator

F. E. Handy
Comms. Mgr. A.R.R.L.

Provision for this endorsement is on the reverse of the new membership card. It should mean a great deal to the holder to be able to present a well-endorsed membership card showing consistent activity in the Emergency Corps. This identifies the holder with the Public Service responsibilities of the institution of amateur radio. It may be used as an introduction to amateur radio Emergency Corps groups in other cities, or taken as a token for recognition anywhere within our radio fraternity.

How to Help: Join the Emergency Corps if you can qualify. If you are in a position to operate or assist otherwise in local organization for supplying emergency radio communication do that. Follow the suggestions herein addressed to former AEC members, WERS operators, newly interested or prospective Emergency Corps members, or clubs, as appropriate, please.

Job Dimensions: Every one of nearly 300 WERS-licensed cities should continue to have provision for emergency communication, both as to plans, and *actual functioning organization*. The possibilities go beyond this coverage, however. The opportunity to be grasped by amateur radio is to make provision for emergency communication coverage for hundreds of *additional* communities and points, even beyond those that were in the wartime set-up.

The charts which accompany this announcement will help you to understand the administration and operation of the ARRL Emergency

* Communications Manager, ARRL.

¹ Station license requirement will be waived temporarily on initial AEC registrations where applicant received FCC operator license during the wartime suspension of amateur station licensing, at the discretion of the responsible Emergency Coördinator.

Corps. The Section Communications Manager (SCM) is the elected administrative ARRL official² who under the constitution and by-laws of the League appoints individual member-amateurs and amateur stations for specific activities in accordance with their qualifications, interest and ability to serve other amateurs or their communities. Section, community (and exceptionally, regional)³ Emergency Coördinators are appointed by the SCM.

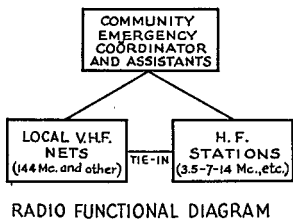
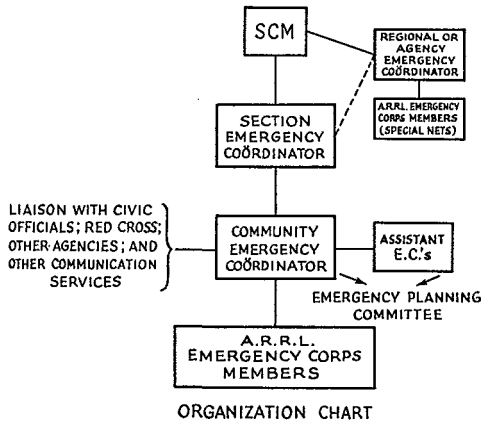

The Section Emergency Coördinator (new) is in charge of promotion of organization throughout the Section. He reports progress, advancement, and plans to the SCM, and acts as his executive in furthering provision for emergency amateur radio communications in every community likely to suffer in case of a natural disaster or other conceived emergency. He recommends ECs to the SCM, and determines the jurisdictional areas of ECs, etc., as required.

The Emergency Coördinator for a community heads local planning committees, operating groups and stations. The local direction and supervision of amateur station emergency organization is under his charge. He is responsible for contacting the agencies served, civic and other authorities, for liaison with other radio and wire services, for registrations of amateur operator and station facilities, designation of stations, disposition of operators, coöperation and coördination between the participating workers and stations, announcement of routine drills and special tests to insure continuing interest of the Emergency Corps members, and the highest efficiency in emergency net operation to meet every conceivable emergency need. He may appoint assistants.⁴ Monitoring of activities and certification of memberships in the

To old AEC members:

- 1) All old memberships and registrations are cancelled, effective on publication of this notice.
- 2) AEC work takes on increased significance. It will be a bigger activity in amateur radio, more important to communities.
- 3) Emphasis will be on local organizing and radio activity.
- 4) V.h.f. is now the accepted medium for local emergency communication. The 144-Mc. band is recommended for local nets. H.f. band stations will be recruited for long haul emergency requirements.
- 5) Drills and simulated emergency work are planned. Activity in these will be required to keep in the Full Membership group. The Supporting Division distinction in membership, formerly dependent on commercial or emergency power⁵ capabilities has been dropped. Distinction between full membership and supporting activity now will be made on ACTIVITY.
- 6) New membership cards will be issued. Annual endorsement by your Emergency Coördinator will be required to keep membership in effect.
- 7) Get in touch with your local coördinator or SCM to reestablish your membership.

To WERS Operators:

As fast as you can qualify as an amateur, you will be needed and welcome in Emergency Corps plans for your community. Contact your Section Communications Manager² who will refer you to the ARRL Coördinator for your locality. The ARRL Emergency Corps is the medium in which all hands together can organize and plan locally so the community is not let down in future emergencies. Your Coördinator will tell you how you can take part in local plans.

To Prospective AEC Members:

Here is an official activity in which you, as an amateur, will want to participate.

As soon as you have an operative station, on 144 Mc. or other amateur frequencies, aim to register in the ARRL Emergency Corps. Work closely with the Emergency Coördinator (wherever appointed) and the SCM.

To Radio Clubs:

Ask the local EC to talk to the club on community emergency communication plans. Ask him to bring registration blanks for your licensed members.

If no EC is available invite club attention to this announcement. Recommend an EC by writing direct to your SCM;² give him details of the local needs. Drop a line to ARRL for forms, to be made ready for the EC when appointed. If your community has never had organized amateur radio emergency service, why not? Discuss it and get behind organizing it.

² See list of SCMs and addresses, page 8, QST.

³ Regional Coördinators are appointed through SCMs when Hq. approval has been given to undertake special organization to cover a watershed, railway line or other area project of wide significance. Such appointments must be regarded as exceptional, and their functions outside the scope of this discussion.

⁴ These assistants include amateurs representative of different amateur bands, also voice and telegraph operation, who become members of the Emergency Coördinator's planning committee, to help in collaboration and organization of each community group.

⁵ Availability of emergency power will continue important. National field days with emergency power factor will continue.

Emergency Corps, for his area, are part of his responsibility. See ARRL publication *Operating an Amateur Radio Station* for a more detailed statement of functions.

It is the first priority program of every Section Manager, and Emergency Coördinator, to take those steps immediately necessary to insure the best radio communication facilities that our FCC reactivation orders will permit, for every one of the mentioned communities. The 2-meter band is already hot with station activity — ready to do an emergency communicating job in several hundred cities *when implemented by amateur organization and perfected through operating exercises.*

Summary: The ARRL Emergency Corps is the nationwide group of amateurs enlisted in the task of providing community emergency radio service. In each community the Emergency Corps consists of the Coördinator and all local radio amateurs who have registered their readiness to participate, joined AEC and actually employed their stations in regular drills, simulated emergency tests, etc. The new Corps has a clear mission. It will achieve its objectives by organization, self-training, actual operating tests, drills and interesting activities. *QST* will provide for free exchange of information on emergency organizing and operating. Your operating results will be in *QST's* station activities. Procedure will be standardized amateur procedure, plus such special phrases or code as may be adopted for brevity and limited security to meet your community need. You may have a part in working that out. Details will be available through your local EC. The actual operating plan for each community may differ in perspective depending on the distances to be covered, the agencies served, the traffic required to be handled. Meetings and discussions may lead to new friendships and development of the fraternal side of amateur radio too — but that is outside the scope of this article.

Field Days designed to further the general availability of emergency power supply and to test mobile equipment suited to disaster operation will offer special incentive to AEC members. Old-timers will remember these before the war. Such ARRL contests offer opportunities to test gear for DX beyond community limits. Some may be for AEC *only*.

Even before the war, ARRL Emergency Corps members participated successfully in scores of emergencies requiring exceptional establishment of communications by amateurs. Our Corps was first announced, and registrations in the AEC accepted, in September 1935. Get in on the new ARRL Emergency Corps from the start! It is dedicated to wholesome, constructive, interesting radio activity. It will benefit you. You want your operating skill to add to the stature of amateur radio, to achieve that satisfaction that comes from making your equipment and abilities play a part in the serious business of preparation for emergency that may face your community. You want to be active in radio work with a purpose. This is it! Join up, now.



QST for December, 1920, is the one that had our heading at the bottom of the cover and everybody thought the name of the magazine was *December*.

An article on "Self-Rectifying C.W. Sets" explains an entirely new idea in tube operation which has come to light in recent months — operation on alternating current without rectifiers and costly motor-generator sets. It may be i.e.w. with one-half the cycle at a musical frequency or, if another tube is added, both halves of the cycle may be used, improving the characteristics for heterodyne reception. . . . S. Kruse reports further on the ARRL-BS fading tests, in which 1260 curves of signal variation were analyzed. While frequently a signal varied simultaneously at even widely-separated receiving points, some traveling curves were found, appearing successively at various recording points. Inverse curves were infrequent and are considered chance variations. No connection was found between weather and transmission. It is believed that fading and swinging are caused by varying reflection and refraction of the waves. . . . K. E. Hassel, in "Induction Shooting," describes how to locate powerline QRN by means of a loop receiver in a car. . . . At last we have new tubes on the amateur market! RCA and E. T. Cunningham (Audiotron) announce a gaseous detector which they respectively call the U.V. 200 and C-300, at \$5; and a hard amplifier, U.V. 201 and C-301, at \$6.50. The A-P transmitting tube, by Moorhead, is offered at \$7.50, capacity about 12.5 watts, and any number may be used in parallel.

It has been some time since we had a trans-continental relay against time. To check our relay routes, a trancon test will be held on three nights in middle January. We shall try to lower our present record of an hour and twenty minutes for the round trip. We want the air absolutely quiet for these tests. . . . We're all set for a big convention of the Midwest Division in St. Louis in late December. . . . *Everyday Engineering Magazine* in a paid advertisement solicits entries in its trans-Atlantic sending tests to be held in February. . . . Bad weather pretty well washed out our attempt to report the election returns by amateur radio but in some cases we got information to the newspapers two hours ahead of the land wires. . . . It is reported that 2QR, operated by Harold and Hugh Robinson at Keyport, N. J., has been heard in Scotland on a radiophone of 100 watts input. We congratulate them, if true, but we are skeptical and Mr. Robinson seriously doubts the report, although he says it checks with his log. . . . The question of licensing amateurs in New Zealand is now before the House of Representatives and it seems almost certain that the necessary legislation will be

(Concluded on page 100)

• Technical Topics —

Forms of Pulse Modulation

WHETHER or not "pulse modulation" will be used in any of the u.h.f. amateur bands is a question that can only be answered by future developments. It will undoubtedly come up for discussions, however, and now is a good time to get acquainted with some of the definitions and concepts so that we can better understand the systems when they are described.

For an understanding of pulse-modulation methods, let us first define the terms used in pulse practice. A keyed oscillator sending a series of dots is a form of pulse transmitter. With the key "up," no power is applied to the oscillator and no r.f. energy is delivered. When the key is closed and then opened, a rectangular — with respect to time — pulse of power is applied to the oscillator and a rectangular pulse of r.f. is generated. If the key is closed and opened at regular intervals, the number of pulses per second is the *repetition rate* or *frequency*, measured in cycles per second. The time interval between two consecutive closures of the key is the *repetition time*. The length of time the key is held down for one pulse is the *pulse duration* or *pulse length* and is measured in microseconds (millionths of a second). The power, voltage or current that exists during the key-down condition is the *peak* or *instantaneous* value, while the *average* power, voltage or current is the value averaged over one cycle of key-up and key-down conditions. The ratio of key-down to repetition time is called the *duty cycle* and expresses the ratio of average to peak values of power, current and voltage. If the pulse shape is not truly rectangular — as is true in all practical cases — the shape of the pulse must be taken into account, but this is not important to the present discussion.

The above is of course quite straightforward and not unknown to any c.w. man who has watched his plate milliammeter while sending a string of dots. The rate at which they were sent corresponds to the repetition rate, the meter reading when the key was held down indicates the average current, and the value about which the meter needle hovered during keying represents the average current. If the dots were too light, the average reading was less than 50 per cent of the peak value, representing a duty cycle of less than 0.5, and if the average reading was more than half of the peak reading it represented longer dots than spaces and a duty cycle greater than 0.5.

Modulation of Pulses

Having defined the properties of pulses, it becomes a simple matter to demonstrate the various possible forms of modulation. Referring to Figs. 1, 2 and 3, we see that these types consist of (1) varying the pulse length while the repetition rate is held constant, (2) varying the repetition rate

while the pulse length is kept uniform and (3) varying the repetition rate while the duty cycle is unchanged. In Fig. 1, more average energy is transmitted when the pulse is lengthened, and the rate at which the pulse is made longer or shorter corresponds to the modulation frequency being transmitted. In Fig. 2, more average

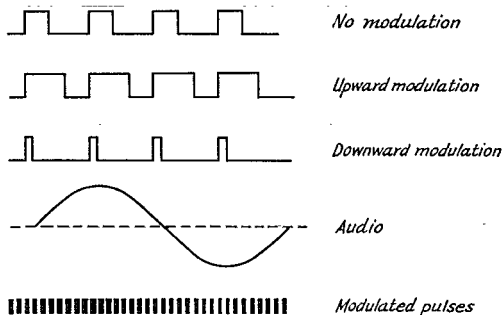

Fig. 1 — A representation of a pulse-modulated signal in which the repetition rate is held constant and the pulse length is changed in proportion to the modulation amplitude.

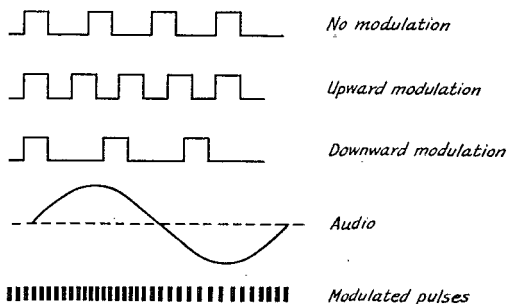

Fig. 2 — A pulse-modulation system using constant pulse length and varying the repetition rate in proportion to the modulation amplitude.

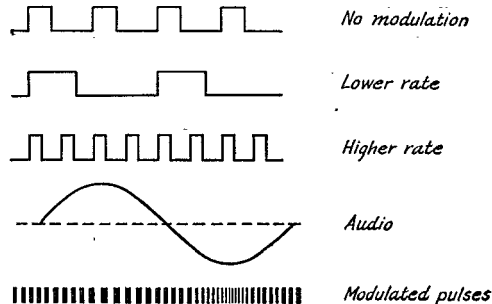

Fig. 3 — Maintaining the duty cycle constant results in a pulse-modulation system in which the repetition rate is proportional to the modulation amplitude, and the rate of change of repetition rate is proportional to the modulation frequency.

energy is obtained when the repetition rate is increased, and the rate at which the repetition rate is changed corresponds to the modulation frequency. These two types can be compared to an amplitude-modulated system, since modulation is accompanied by a change in average power level, and detection could be accomplished by a detector which gives an output proportional to the total amount of energy received over a period of time (integrating detector). A variation of Fig. 2 would consist of modulating the position in time of the pulse about the mean value. The deviation from the mean position would be proportional to the amplitude and the rate of change would be proportional to the modulation frequency. This corresponds to phase modulation in ordinary steady carrier communication and would require a detector sensitive to changes in pulse phase or repetition frequency. This variation would be used in systems where the duty cycle was low and a change in repetition rate would not effect an appreciable change in power level. Fig. 3 is similar to Fig. 2 except that the duty cycle is constant and therefore the power level does not change. Louder signals are obtained by greater excursions from the mean repetition rate, and the rate at which these excursions are made is proportional to the modulation frequency. This third system, therefore, is similar to f.m. and would require some form of detector responsive to changes in repetition frequency.

It should be remembered that the channel necessary for pulse communication is determined by the pulse length¹ and has no relation

to the modulation frequency. Pulse communication is thus essentially a broad-band affair, requiring receivers and transmitters capable of passing the sharp short pulses generally used.

Pulse modulation is not necessarily a method with inherent advantages, particularly for amateur work, but it is one method which permits the use of some tubes which cannot be modulated by ordinary methods. For example, the magnetron, hero of war-time microwave radar, cannot be used at high average inputs under steady carrier conditions because the plate current "runs away," but when the power is applied as pulses the tube is capable of delivering amazing peak power outputs. This makes it an excellent transmitter tube for any pulsed application but almost worthless for conventional amplitude or frequency modulation.

Further, pulse modulation gives no advantages in weak-signal reception, although there are some improvements in signal to noise ratios at high levels. From a DX standpoint it is not likely that pulse modulation will extend the operating range in the u.h.f. region unless the weak signal response can be improved. One possibility along this line is to use a device which can be made to integrate the pulsed signal and discriminate against the noise, such as a cathode ray oscilloscope and a photo-electric cell adjusted to respond to the signal but not to the noise reproduced between pulses.

— B. G.

¹ Hansen, "Band-Width Requirements for Pulse-Type Transmissions," *QST*, February, 1945.

Waves and Wave Guides

FURTHER consideration of wave diagrams of the type shown in Fig. 9 (repeated here from November *QST*) leads to additional information about propagation through hollow pipes. We have said that, in the case of the rectangular pipe under discussion, the cut-off frequency is that at which a half wavelength in space is equal to the distance between the side walls. No lower frequency than this can get into the guide, but all frequencies above the cut-off frequency will be transmitted. The distance between the top and bottom walls of the guide has been neglected intentionally, for the excellent reason that this distance does not matter. It will be remembered that the lines of electric force extend indefinitely in the up-and-down direction, in the type of wave shown in Figs. 5, 6 and 7, and no matter what the distance between the top and bottom walls the lines always meet these walls perpendicularly. This being the case, the lines of force can terminate at the top and bottom walls wherever the latter may be placed. The distance may be large or small, entirely without regard to the length of the wave being transmitted

This is a continuation of Technical Topics from November, 1945, *QST*.

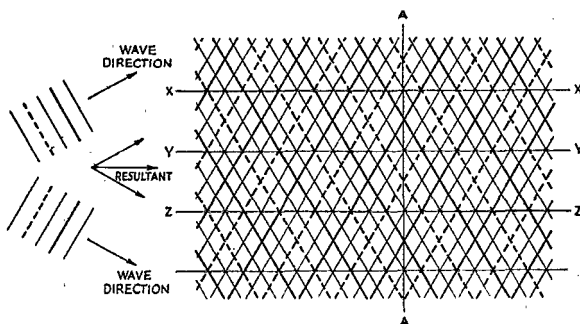

Fig. 9 — The fields of two traveling waves add at any point in space to give a resultant at that point having an amplitude and direction dependent upon the amplitudes and directions of the two component waves. This drawing represents a space distribution for a single instant of time. The two wave components, assumed to have equal amplitudes, are shown at the left, with the direction of propagation indicated. The resultant wave direction is shown by the small drawings between. Along lines such as XX, YY and ZZ the resultant amplitude always is zero, giving rise to standing waves in space.

Wave Velocity

The fact that the wave does not go straight down the guide as it would in free space but gets through by the process of bouncing back and forth between the side walls makes some revision of our ordinary notions of wave travel necessary. We are accustomed to thinking that waves move at a speed of 300,000,000 meters per second (in round figures) through air. Since the guide we have been talking about is filled with air, there is no reason to suppose that the waves will move through it at any greater or lesser speed. And that is true, when the actual path of the wave is considered. But that path is not the shortest route through the guide; it is a zigzag course that totals up to more length than that of the guide. Consequently the wave takes a longer time to get through the guide than it would take to cover the same linear distance in space. The more reflections there are in a given length of guide the longer it takes the wave to get through. And since there are more reflections when the actual wavelength approaches the cut-off wavelength, the longer waves will take more time than the shorter waves. This sums up to the fact that the velocity at which wave energy is propagated through a guide always is less than the velocity of waves in free space, and further that the velocity in the guide depends upon the relationship between the actual wavelength and the cut-off wavelength. A wave having a length just below the cut-off wavelength will take a relatively long time to go through, and one just at the cut-off wavelength never gets through at all because it is reflected at a 90-degree angle from the side walls and makes no progress down the guide.

The wave path is the hypotenuse of a right triangle having a base equal to the actual distance along the guide between successive points of reflection and having an altitude equal to the width of the guide. If the angle between the wave path and the side walls is known, it is a matter of simple trigonometry to figure out how much longer the wave path is than the linear distance through the guide, and from that to compute the time involved.

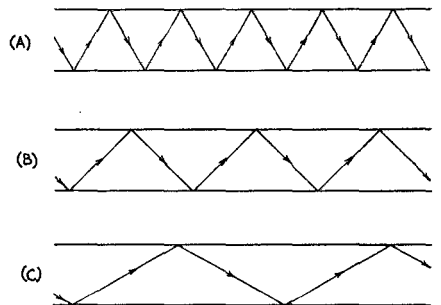

Fig. 11 — The three drawings in this figure correspond to the three in Fig. 10, and show the path taken by a component wave in traveling through the guide. The shorter the wavelength, the fewer reflections from the side walls in a given length of guide.

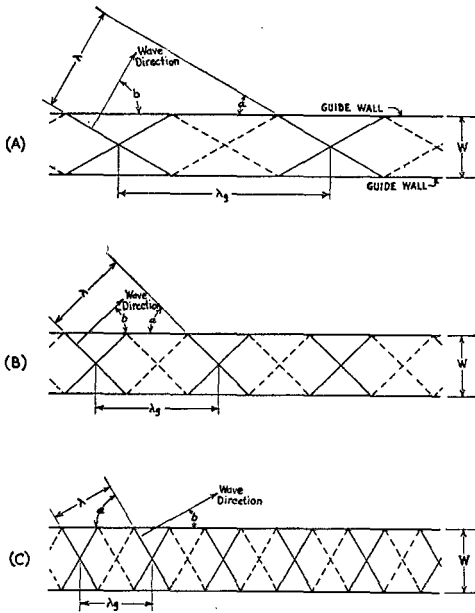

Fig. 10 — The smaller the wavelength in comparison with the cut-off wavelength of a guide, the smaller is the angle at which the wave strikes the side walls. In (A) the wavelength is close to the cut-off wavelength; in (B) a shorter wavelength is represented, and (C) shows the effect of making the wavelength still smaller. The width, W , of the guide is the same in all three cases. The wavelength in the guide, λ_g , always is greater than the free-space wavelength, but the ratio becomes smaller as the free-space wavelength, λ , is decreased.

through the guide. As usual, there are some practical considerations that enter into the question, but these are best considered a little later on.

A wave of length shorter than the cut-off wavelength (that is, a frequency higher than the cut-off frequency) will adjust itself to the guide by reflecting at the proper angle to result in zero electric field at the side walls. The required angle between the side wall and the wave direction becomes smaller as the length of the wave is made shorter in relation to the cut-off wavelength. Three cases are shown in Fig. 10, all for a guide of the same width but with successively shorter waves going through it. The angle b in each case is the angle at which the wave strikes the side walls and is reflected; that is, it is the angle between the *direction* in which the wave is traveling and the side wall. (It is *not* the angle between the *wave front* — wave fronts are represented by the alternate solid and dashed lines — and the wall. The latter angle is labeled "a" in the drawing.) As the wavelength becomes shorter the wave direction more nearly approaches the direction of the guide itself. In other words, there are fewer reflections from the side walls, in a given length of guide, when the length of the wave traveling through the guide is small in comparison with the cut-off wavelength. This is perhaps made a bit clearer by Fig. 11, in which is pictured not the wave itself, but rather the *path* followed by a particular part of the wave.

Wavelength and Attenuation

There is still another consequence of the zigzag motion of the wave through the guide. Along the component wave direction, the wavelength is the same as it is in free space. But along the guide direction, parallel to the walls, the story is different. If we define wavelength as the distance between two successive points at which the amplitude and direction of the field are identical — that is, between two successive points having the same phase — then the wavelength along the guide, labeled λ_g in Fig. 10, is greater than the actual wavelength. Furthermore, the wavelength in the guide is determined by the ratio of the actual wavelength to the cut-off wavelength, as shown by the relative lengths of λ (the actual wavelength) and λ_c in the three cases illustrated. The nearer the actual wavelength to the cut-off wavelength the greater the ratio between λ_g and λ . At cut-off, where the wave never gets through, the wavelength becomes infinitely large. The similarity between the behavior of λ_g and the time required for the wave to travel through the guide is apparent.

These facts are not just of academic interest. The required dimensions of a section of wave guide to resonate at a given frequency — comparable to a resonant section of transmission line — are determined by the fact that the wavelength is longer, for a given frequency, inside a wave guide than it is in free space. This difference in wavelength also is the reason why cavity resonators seem to have queer dimensions, to one accustomed to thinking in terms of free-space wavelength, and explains why cavities always apparently are too big for the waves they contain. Also, the fact that the waves travel more slowly through the guide than they do in free space has an important bearing on the energy losses in the guide. Since the conducting material in the guide is not perfect, the wave always suffers some energy loss at each reflection. The more reflections there are in a given length of guide the greater the total loss of energy; i.e., the greater is the attenuation. However, the amount of energy lost at each reflection also depends upon the resistance of the conductor, and since skin effect becomes greater as the frequency is increased, the proportional amount of energy lost per reflection increases with increasing frequency. Thus there are two factors operating in opposite directions, one tending to increase the losses at low frequencies or longer wavelengths, the other tending to increase the losses at higher frequencies or shorter wavelengths. The net result is that there is one frequency or wavelength at which the attenuation is least.

Group Velocity and Phase Velocity

One further observation can be made with respect to wavelength in guides. In free space, frequency, wavelength and velocity are related by the simple formula

$$f\lambda = c$$

where c is constant at 300,000,000 meters per

second. The same general relationship has to hold in a wave guide, since the equation is simply a definition of wavelength or frequency. But if the wavelength in the guide is longer for the same frequency, then the velocity in the guide has to be greater than in free space because the product of wavelength and frequency (the frequency is fixed) will give a larger number. In fact, the velocity in the guide increases in the same ratio that the wavelength increases. But we have already said that the wave travels more and more slowly through the guide when its length approaches the cut-off wavelength, and of course the wavelength in the guide becomes relatively greater under the same conditions. Thus there is an apparent contradiction — a contradiction, however, that disappears when the velocity in the guide is examined more closely.

It is fundamental in modern physics that nothing can move faster than light. If the velocity along the guide is greater than the free-space velocity, the guide velocity must be an *apparent* velocity rather than a real one if the fundamental law is not to be violated. This is actually the case; the *energy* in the wave travels at less speed in the guide than in free space, while the *phase* of the wave travels at higher speed. The velocity at which energy is propagated is called the "group velocity," while the rate at which phase changes along the guide is called "phase velocity." The group velocity is less than the velocity of light in the same ratio that the phase velocity exceeds the velocity of light.

The difference between group velocity and phase velocity is not hard to grasp. The idea can be demonstrated quite easily with a sheet of paper and a ruler (or any straightedge). Let the edge of the paper represent a boundary such as the wall of a wave guide and the ruler a wave front, its edge representing a line of constant phase in the same way that the solid and dashed lines of Fig. 10 represent such a line. Lay the ruler on the paper so that its edge is perpendicular to the edge of the paper. Then slide it along at a constant rate of speed, keeping its edge perpendicular to the direction of motion. The speed at which the ruler is moved corresponds to group velocity, and the speed at which its edge moves along the paper edge corresponds to phase velocity. In this case the group velocity and the phase velocity are the same, because the edge of the ruler moves along the edge of the paper at the same speed at which the ruler itself moves.

Now place the ruler at some angle less than 90 degrees with respect to the edge of the paper and again slide it along, still keeping the ruler edge perpendicular to the direction of motion. The edge of the ruler now moves along the edge of the paper faster than the ruler itself moves, and the smaller the angle between the ruler and the paper edge the greater the phase velocity becomes. For example, if the ruler and paper edge are very nearly parallel, the whole edge of the ruler moves over the edge of the paper almost instantaneously, even when the ruler itself is moved slowly. And when the two actually are parallel, the entire

length of the paper edge is crossed instantaneously by the ruler edge no matter how slowly the ruler is moved. This corresponds to infinite phase velocity.

Phase velocity simply measures the rapidity with which a line or plane of constant phase in the wave appears to pass an observing line, and it is entirely a matter of the direction in which the observation is made. It could be used in connection with waves in free space in directions other than the actual wave direction, although it might have no particularly useful application. In wave guides, where the guide direction is not the same as the reflected-wave direction, it is of more interest. However, it should always be kept in mind that the wave *energy* travels at *group* velocity; if we want to know how long it will take for a signal to get through a length of guide, for example, the time must be calculated on the basis of the group velocity. In a wave guide this is always less than the velocity of light because of the zig-zag path followed by the wave.

Types of Waves

In the first part of this discussion it was mentioned that an electromagnetic wave in space was ordinarily considered to be a plane wave: that is, one having the electric and magnetic field directions everywhere perpendicular or transverse to the direction of travel — the TEM wave. A little thought will show that a wave traveling through a guide cannot be of the TEM type — not, that is, when considered as a single wave traveling in the same direction as the guide.

Referring back to Fig. 9, the two component

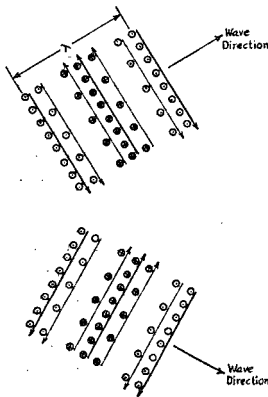

Fig. 12 — Another method of representing the two component waves of Fig. 9. Lines of electric force are represented by the small circles, the direction (perpendicularly into or out of the page) being indicated by dots or crosses. Relative field strength is indicated by the spacing of the circles. The associated lines of magnetic force are represented by the solid lines with arrowheads, with relative field strength indicated by the weights of the lines (still another method of portraying field properties!).

The lines representing the magnetic field actually should be drawn through the circles representing the electric field to indicate that the two groups of lines are intimately associated. However, this could not be done readily without making more confusion, so the magnetic lines are drawn alongside.

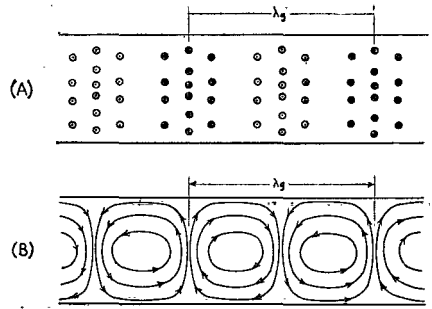

Fig. 13 — Instantaneous distribution of the electric field (A) and magnetic field (B) in a simple form of TE wave traveling through a rectangular guide. This is a view looking down on the wave, the side walls of the guide being represented by the horizontal lines. There is no component of the electric field directed along the guide (left to right) but the magnetic field does have such a component.

waves combine to form a resultant that propagates in the guide direction, this direction being midway between the two individual wave-component directions. We may redraw the two wave components as in Fig. 12, where we are looking down on the vertical lines of electric force. The circles with the inner dot represent lines directed out of the paper and those with the crosses represent lines directed into the paper. In a TEM wave the electric field is accompanied by a magnetic field whose direction is perpendicular to that of the electric lines and is transverse to the direction in which the wave is moving. The direction of the magnetic field is indicated by the arrows associated with the electric lines.

When the two waves are combined to form a resultant the electric fields simply add algebraically at every point because all the lines of electric force are either in the same direction or in exactly opposite directions; that is, as in Fig. 12, either into the paper or out of the paper. This addition results in the sidewise standing wave described previously, and also results in a lengthwise traveling wave directed through the guide and having a length greater than the wavelength in free space. The resulting distribution of the electric field at a given instant is shown in top view in Fig. 13-A.

Considering now the magnetic field, it is evident from Fig. 12 that the field directions in the two component waves cannot be added algebraically, because these directions depend entirely upon the directions in which the two waves are traveling. Vector addition is required. A detailed addition for every point in the field would be both complicated and tedious to try to describe, so it must suffice to say in a general way that because of the relative directions and intensities of the two fields at various points the resultant magnetic field turns out to have the configuration shown in Fig. 13-B. The variation in field intensity is indicated by the spacing between the lines, and the direction of the field by the lines and arrowheads. The magnetic field intensity does not vary

(Concluded on page 104)

Practical Applications of Simple Math

Powers of Ten for Radiomen

BY EDWARD M. NOLL,* W8WKX, EX-W3FQJ

POWERS of ten are one of the most convenient mechanics of algebra. They are very easy to manipulate and are particularly applicable to the type of calculations encountered by the practical radioman. Frequent use of powers of ten will speed calculations, reduce percentage of errors, and avoid unnecessary confusion and manipulation.

All of us studied powers of ten in detail if we went to high school and I'm sure even those who did not attend high school had a taste and understanding of it at some time. We are reluctant at times to apply our knowledge of math to the work we do because it requires a little practice. However, we shouldn't hesitate to lose a little time this week if we save double that amount of time next month, doing the same type of calculations with improved accuracy.

Derivation and Review

When any number is raised to a power it means the number is multiplied a certain number of times by itself. Thus,

$$\begin{aligned}10^1 &= 10 = 10 = \text{ten,} \\10^2 &= 10 \times 10 = 100 = \text{hundred,} \\10^3 &= 10 \times 10 \times 10 = 1000 = \text{thousand,} \\10^4 &= 10 \times 10 \times 10 \times 10 = 10,000 = \text{ten thousand,} \\10^5 &= 10 \times 10 \times 10 \times 10 \times 10 = 100,000 = \text{hundred thousand,} \\10^6 &= 10 \times 10 \times 10 \times 10 \times 10 \times 10 = 1,000,000 = \text{million.}\end{aligned}$$

Note that the power to which the number is raised (exponent) tells you how many tens are multiplied. For instance, 10^2 means two tens multiplied together; 10^3 is equivalent to three tens multiplied together, etc. Also it is possible to have powers of numbers other than ten, such as 2^3 which means $2 \times 2 \times 2 = 8$. Inasmuch as we are interested only in powers of ten for the moment, we will continue the explanation with tens.

In a similar manner, it is possible to have negative powers of ten. Thus,

$$\begin{aligned}10^{-1} &= 0.1 = 0.1 = \text{one tenth,} \\10^{-2} &= 0.1 \times 0.1 = 0.01 = \text{one hundredth,} \\10^{-3} &= 0.1 \times 0.1 \times 0.1 = 0.001 = \text{one thousandth,} \\10^{-4} &= 0.1 \times 0.1 \times 0.1 \times 0.1 = 0.0001 = \text{one ten thousandth,} \\10^{-5} &= 0.1 \times 0.1 \times 0.1 \times 0.1 \times 0.1 = 0.00001 = \text{one hundred thousandth,} \\10^{-6} &= 0.1 \times 0.1 \times 0.1 \times 0.1 \times 0.1 \times 0.1 = 0.000001 = \text{one millionth.}\end{aligned}$$

Here again the exponent indicates how many one tenths are multiplied together.

It is possible to make any number into a power of ten or to take any power of ten and convert it to a whole number using the above basic powers. For example,

$$\begin{aligned}100 &= 1 \times 100 = 1 \times 10^2 \text{ (usually written simply as } 10^2\text{)} \\200 &= 2 \times 100 = 2 \times 10^2 \\250 &= 2.5 \times 100 = 2.5 \times 10^2 \\2000 &= 20 \times 100 = 20 \times 10^2 \\255.7 &= 2.557 \times 100 = 2.557 \times 10^2 \\0.5 &= 0.005 \times 100 = 0.005 \times 10^3\end{aligned}$$

The rule which applies in this case is that in changing any number to a power of ten we count off from the decimal point toward the *left* the number of digits indicated by the exponent. In the above examples two were counted off, since it was desired to raise the number to a squared power of ten. The same quantities in terms of the third power of ten are:

$$\begin{aligned}100 &= 0.1 \times 1000 = 0.1 \times 10^3 \\200 &= 0.2 \times 1000 = 0.2 \times 10^3 \\250 &= 0.25 \times 1000 = 0.25 \times 10^3 \\2000 &= 2 \times 1000 = 2 \times 10^3 \\255.7 &= 0.2557 \times 1000 = 0.2557 \times 10^3 \\0.5 &= 0.0005 \times 1000 = 0.0005 \times 10^3\end{aligned}$$

Now it is possible to raise the same numbers to a negative power. The rule in this case is to count off from the decimal point toward the *right* the number of digits indicated by the exponent. The same numbers raised to the -3 power are:

$$\begin{aligned}100 &= 100,000 \times 10^{-3} \\200 &= 200,000 \times 10^{-3} \\250 &= 250,000 \times 10^{-3} \\2000 &= 2,000,000 \times 10^{-3} \\255.7 &= 255,700 \times 10^{-3} \\0.5 &= 500 \times 10^{-3}\end{aligned}$$

The next set of examples demonstrates how it is possible to take any one number and convert it to any power of ten. The number 321.123 is equal to the following powers of ten:

$$\begin{aligned}321.123 & \\32.1123 \times 10^2 & \\3.21123 \times 10^3 & \\0.321123 \times 10^4 & \\0.0321123 \times 10^5 & \\0.00321123 \times 10^6 & \\3211.23 \times 10^{-1} & \\32112.3 \times 10^{-2} & \\321123.0 \times 10^{-3} & \\3211230.0 \times 10^{-4} & \\32112300.0 \times 10^{-5} & \end{aligned}$$

* Box 94, Hatboro, Penna.
% Television Tech. Enterprises.

Likewise, any power of ten can be converted to another power of ten using the same count-off procedure, adding to or subtracting from the original exponent as the case may require. Thus, in converting 54.32×10^4 to the sixth power, we move two digits to the left or 0.5432×10^6 , and in converting to the second power we move two digits to the right or 5432×10^2 . The following examples demonstrate the conversion of a series of powers, all to the second power of ten.

$$\begin{aligned} 25 \times 10^6 &= 250,000 \times 10^2 \\ 2.5 \times 10^6 &= 25,000 \times 10^2 \\ 25 \times 10^3 &= 250 \times 10^2 \\ 2.5 \times 10^3 &= 25 \times 10^2 \\ 25 \times 10^{-3} &= 0.00025 \times 10^2 \\ 2.5 \times 10^{-3} &= 0.000025 \times 10^2 \end{aligned}$$

The next set of examples shows that a power of ten can be converted into many other powers of ten. The number 54.32×10^2 is equal to the following powers of ten:

$$\begin{aligned} 54.32 \times 10^2 \\ 5.432 \times 10^3 \\ 0.5432 \times 10^4 \\ 0.05432 \times 10^5 \\ 543.2 \\ 5432 \times 10^{-1} \\ 54,320 \times 10^{-2} \\ 543,200 \times 10^{-3} \end{aligned}$$

The radioman should be equally capable of converting any power of ten to a whole number. To do this the counting-off procedure is reversed. In converting an integral power to a whole number, the number of digits indicated by the exponent is counted off to the right from the decimal point; to convert a negative power, the number of digits indicated by the negative exponent is counted off to the left from the decimal point.

$$\begin{aligned} 1 \times 10^3 &= 1000 \\ 1 \times 10^{-3} &= 0.001 \\ 25 \times 10^3 &= 25,000 \\ 25 \times 10^{-3} &= 0.025 \\ 0.25 \times 10^3 &= 250 \\ 0.25 \times 10^{-3} &= 0.00025 \\ 364 \times 10^6 &= 364,000,000 \\ 364 \times 10^{-6} &= 0.000364 \\ 0.56 \times 10^{-4} &= 0.0056 \end{aligned}$$

Now let us take some typical components and convert their values to whole numbers, and then to powers of ten.

In resistor values, the basic unit is the ohm.
 0.5 megohm = 0.5×10^6 ohms = 500,000 ohms.
 10 megohms = 10×10^6 = 10,000,000 ohms.

The basic unit of capacitance is the farad.
 $5 \mu\text{fd.}$ = 5×10^{-6} farads = 0.000005 farad.
 $200 \mu\text{fd.}$ = 200×10^{-12} farads = 0.000000002 farad.

The basic unit of inductance is the henry.

$$\begin{aligned} 15 \text{ mh.} &= 15 \times 10^{-3} \text{ h.} = 0.015 \text{ h.} \\ 200 \mu\text{h.} &= 200 \times 10^{-6} \text{ h.} = 0.0002 \text{ h.} \end{aligned}$$

Manipulation

Powers of ten can be manipulated in the same

manner as whole numbers if the exponent rules are maintained. It is possible to add, subtract, multiply or divide them as well as to take powers and roots.

In the addition of powers-of-ten figures, the exponents must be the same; if they are not the same, one must be converted to the other:

$$\begin{aligned} (3 \times 10^3) + (0.5 \times 10^3) &= 3.5 \times 10^3 \\ (60 \times 10^4) + (3 \times 10^5) &= (6 \times 10^5) + (3 \times 10^5) \\ &= 9 \times 10^5 \\ (5 \times 10^{-1}) + (0.03 \times 10^2) &= (0.005 \times 10^2) \\ &+ (0.03 \times 10^2) = 0.035 \times 10^2 \end{aligned}$$

In the subtraction of powers-of-ten figures, the exponents must again be the same as in addition.

$$\begin{aligned} (3 \times 10^3) - (0.5 \times 10^3) &= 2.5 \times 10^3 \\ (60 \times 10^4) - (3 \times 10^5) &= (6 \times 10^5) \\ &- (3 \times 10^5) = 3 \times 10^5 \\ (0.03 \times 10^2) - (5 \times 10^{-1}) &= (0.03 \times 10^2) \\ &- (0.005 \times 10^2) = 0.025 \times 10^2 \end{aligned}$$

In the multiplication of powers of ten, the exponents are added algebraically.

$$\begin{aligned} (3 \times 10^3) (0.5 \times 10^3) &= (3 \times 0.5) (10^6) \\ &= 1.5 \times 10^6 \\ (60 \times 10^4) (3 \times 10^5) &= (60 \times 3) (10^9) \\ &= 180 \times 10^9 \\ (0.03 \times 10^2) (5 \times 10^{-1}) &= (0.03 \times 5) (10^2) \\ &= 0.15 \times 10^2 \end{aligned}$$

In the division of powers of ten, the exponents are subtracted algebraically (denominator from numerator), or transposed and added algebraically.

$$\begin{aligned} \frac{3 \times 10^3}{0.5 \times 10^3} &= 6. \\ \frac{60 \times 10^4}{3 \times 10^5} &= \frac{60 \times 10^{-1}}{3} = \frac{6}{3} = 2. \\ \frac{0.03 \times 10^2}{5 \times 10^{-1}} &= \frac{0.03 \times 10^3}{5} = \frac{30}{5} = 6. \end{aligned}$$

The sign of the exponent always is changed in moving from numerator to denominator or vice versa.

$$\begin{aligned} \frac{3 \times 10^3}{0.5 \times 10^3} &= \frac{3 \times 10^3 \times 10^{-3}}{0.5} = 6 \\ \frac{60 \times 10^4}{3 \times 10^5} &= \frac{60 \times 10^4 \times 10^{-5}}{3} = \frac{60 \times 10^{-1}}{3} \\ &= \frac{6}{3} = 2 \\ \frac{0.03 \times 10^2}{5 \times 10^{-1}} &= \frac{0.03 \times 10^2 \times 10}{5} = \frac{0.03 \times 10^3}{5} \\ &= \frac{30}{5} = 6 \end{aligned}$$

In raising the power of a powers-of-ten figure, the exponent is multiplied by the power to which the quantity is raised.

$$\begin{aligned} (3 \times 10^3)^3 &= 27 \times 10^9 \\ (5 \times 10^{-2})^3 &= 125 \times 10^{-6} \\ (3 \times 10^6)^2 &= 9 \times 10^{12} \end{aligned}$$

In taking roots, the exponent is divided by the root.

$$\sqrt[3]{27 \times 10^9} = 3 \times 10^3$$

$$\sqrt[3]{125 \times 10^{-6}} = 5 \times 10^{-2}$$

$$\sqrt[2]{9 \times 10^{12}} = 3 \times 10^6$$

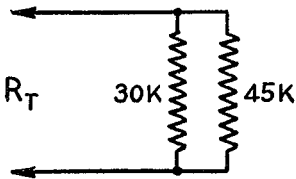

Fig. 1

Summary

The rules which must be observed and which should become second nature after a few weeks are:

1) To convert any number to any integral power of ten, locate the new decimal point by counting to the left from the old decimal point a number of digits equal to the numerical value of the exponent. To convert any number to any decimal power use the same procedure, only counting to the right from the decimal point.

2) To convert any powers-of-ten figure with a positive exponent to a whole number, locate the new decimal point by counting to the right from the old decimal point a number of digits equal to the numerical value of the exponent. To convert any powers-of-ten figure with a negative exponent use the same procedure, but counting to the left.

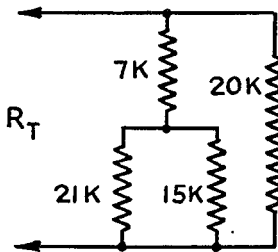

Fig. 2

3) In addition or subtraction of powers-of-ten figures, all figures must have the same exponents. If they do not, convert them all to the same.

4) In multiplication of powers-of-ten figures, the exponents are added algebraically.

5) In division of powers-of-ten figures, the exponents are subtracted (exponent of denominator subtracted from exponent of numerator) or the exponents are transposed, with change of sign, and added algebraically.

6) In taking powers-of-ten figures, the exponent is multiplied by the power.

7) In taking roots of powers-of-ten figures, the exponent is divided by the root.

In the following problem there are examples of numerous manipulations to demonstrate clearly the ease with which a complex problem can be worked out.

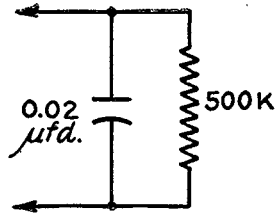

Fig. 3

$$\frac{(20 \times 10^6) - [(6 \times 10^2) + (0.3 \times 10^3)]^2}{\sqrt[2]{9 \times 10^{12}} (6 \times 10^{-3})}$$

$$\frac{(20 \times 10^6) - [(6 \times 10^2) + (3 \times 10^2)]^2}{(3 \times 10^6) (6 \times 10^{-3})} \quad (a)$$

(a) Equalizing exponents for addition.
(b) Removing the root

$$\frac{(20 \times 10^6) - (9 \times 10^2)^2}{18 \times 10^3} \quad (c)$$

(c) Addition
(d) Multiplication

$$\frac{(20 \times 10^6) - (81 \times 10^4)}{18 \times 10^3} \quad (e)$$

(e) Raising power.

$$\frac{(20 \times 10^6) - (0.81 \times 10^6)}{18 \times 10^3} \quad (f)$$

(f) Equalizing exponents for subtraction.

$$\frac{19.19 \times 10^6}{18 \times 10^3} \quad (g)$$

(g) Subtraction.

$$\frac{19.19 \times 10^6 \times 10^{-3}}{18} \quad (h)$$

(h) Transposition.

$$1.066 \times 10^3 \quad (i)$$

(i) Division completed.

$$1.066 \times 10^3 = 1066 \quad (j)$$

(j) Conversion to whole number — the answer.

That wasn't difficult at all and we kept our entire problem closely knit, not spread out over two pages and the back of a used envelope. Now let's do the same problem the hard way.

$$\frac{20,000,000 - (600 + 300)^2}{\sqrt[2]{9,000,000,000,000} (0.006)}$$

Sorry, OM, you do it that way, I've been converted to powers of ten.

Application

The succeeding problems demonstrate practical applications of powers of ten in electronic calculations.

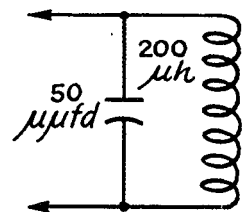

Fig. 4

1) Find the total resistance of the simple parallel combination of resistors in Fig. 1.

$$\begin{aligned}
 R_T &= \frac{30,000 \times 45,000}{30,000 + 45,000} \\
 &= \frac{3 \times 10^4 \times 4.5 \times 10^4}{7.5 \times 10^4} \\
 &= \frac{3 \times 4.5 \times 10^4}{7.5} = \frac{13.5 \times 10^4}{7.5} \\
 &= 1.8 \times 10^4 = 18,000 \text{ ohms.}
 \end{aligned}$$

2) Find total resistance of network in Fig. 2.

$$R = \frac{20,000 \left(7000 + \frac{21,000 \times 15,000}{21,000 + 15,000} \right)}{20,000 + 7000 + \frac{21,000 \times 15,000}{21,000 + 15,000}}$$

$$\begin{aligned}
 &= \frac{(2 \times 10^4) \left[(0.7 \times 10^4) + \frac{2.1 \times 10^4 \times 1.5 \times 10^4}{2.1 \times 10^4 + (1.5 \times 10^4)} \right]}{(2 \times 10^4) + (0.7 \times 10^4) + \left[\frac{2.1 \times 10^4 \times 1.5 \times 10^4}{(2.1 \times 10^4) + (1.5 \times 10^4)} \right]} \\
 &= \frac{(2 \times 10^4) \left[(0.7 \times 10^4) + \frac{2.1 \times 1.5 \times 10^4 \times 10^4}{3.6 \times 10^4} \right]}{(2 \times 10^4) + (0.7 \times 10^4) + \left(\frac{2.1 \times 1.5 \times 10^4 \times 10^4}{3.6 \times 10^4} \right)} \\
 &= \frac{(2 \times 10^4) [(0.7 \times 10^4) + (0.875 \times 10^4)]}{(2 \times 10^4) + (0.7 \times 10^4) + (0.875 \times 10^4)} \\
 &= \frac{(2 \times 10^4) (1.575 \times 10^4)}{3.575 \times 10^4} \\
 &= \frac{2 \times 1.575 \times 10^4}{3.575} \\
 &= 0.881 \times 10^4 = 8,810 \text{ ohms.}
 \end{aligned}$$

3) Find the time constant of the resistor-capacitor combination in Fig. 3.

$$\begin{aligned}
 t &= RC \\
 &= 0.5 \times 10^6 \times 0.02 \times 10^{-6} \\
 &= 0.01 \text{ seconds}
 \end{aligned}$$

4) Find impedance of same combination at 10 cycles.

$$\begin{aligned}
 Z &= \frac{(5 \times 10^5) \left(\frac{1}{6.28 \times 10 \times 0.02 \times 10^{-6}} \right)}{\sqrt{(5 \times 10^5)^2 + \left(\frac{1}{6.28 \times 10 \times 0.02 \times 10^{-6}} \right)^2}} \\
 &= \frac{(5 \times 10^5) \frac{10^6}{1.256}}{\sqrt{(25 \times 10^{10}) + \left(\frac{10^6}{1.256} \right)^2}}
 \end{aligned}$$

$$\begin{aligned}
 &= \frac{5 \times 10^{11}}{1.256} \\
 &= \frac{5 \times 10^{11}}{\sqrt{(25 \times 10^{10}) + \left(\frac{10 \times 10^5}{1.256} \right)^2}} \\
 &= \frac{5 \times 10^{11}}{1.256} \\
 &= \frac{5 \times 10^{11}}{\sqrt{(25 \times 10^{10}) + (63.4 \times 10^{10})}} \\
 &= \frac{5 \times 10^{11}}{1.256} \\
 &= \frac{5 \times 10^{11}}{\sqrt{88.4 \times 10^{10}}} \\
 &= \frac{5 \times 10^{11}}{1.256} \\
 &= \frac{5 \times 10^{11}}{9.4 \times 10^5} \\
 &= \left(\frac{5 \times 10^{11}}{1.256} \right) \left(\frac{1}{9.4 \times 10^5} \right) \\
 &= \frac{5 \times 10^6}{11.8} = 0.424 \times 10^6 = 424,000 \text{ ohms.}
 \end{aligned}$$

Note that in this type of calculation, while rather involved, the problem is held close-knit and there are no long strings of zeros and decimal points to add complications.

5) What is the resonant frequency of the resonant current of Fig. 4?

$$\begin{aligned}
 f &= \frac{1}{2\pi \sqrt{LC}} \\
 &= \frac{1}{6.28 \sqrt{200 \times 10^{-6} \times 50 \times 10^{-12}}} \\
 &= \frac{1}{6.28 \sqrt{10,000 \times 10^{-18}}} \\
 &= \frac{1}{6.28 \sqrt{10^4 \times 10^{-18}}} \\
 &= \frac{1}{6.28 \times 10^{-7}} \\
 &= \frac{10 \times 10^6}{6.28} = 1.592 \times 10^6 \text{ cycles} \\
 &= 1.592 \text{ megacycles.}
 \end{aligned}$$

FOREIGN NOTES

AUSTRALIA

VK-land may be on the air by the time you read this, since all amateur apparatus impounded by authorities at the outbreak of war is now being returned, and new regulations are being drafted. According to an Australian news broadcast, all restrictions are to be lifted by the end of November. New officers of W.I.A.'s federal headquarters, now located with the Victorian Division (P.O. Box 2611 W, G.P.O., Melbourne) are: R. Marriott, VK3SL, president; A. H. Clyne, VK3VX, secretary; and T. D. Hogan, VK3HX, treasurer.

BRAZIL

A November visit to ARRL Hq. by Luiz de Silva Oliveira, PY1IJ, new vice-president of L.A.B.R.E., brought the welcome news that PYs

have been opened on all prewar bands. Since Brazilian amateur licenses are issued for an "indefinite" period, there was no delay occasioned in relicensing. Other new officers of the society are: Col. Rigrandino Krueh, PY1AR, president; Pedro dos Santos Chermont, PY1AD, secretary; and Eduardo Fontenelle, PY1JA, treasurer.

CHINA

Over one hundred Chinese, twelve American and several British amateurs met in Chungking May 5th for the sixth annual convention of the China Amateur Radio League. Speaking over the nation-wide facilities of XUOA, Vice-president K. T. Chu praised the wartime record of Chinese amateurs, and expressed the hope that postwar

(Continued on page 104)

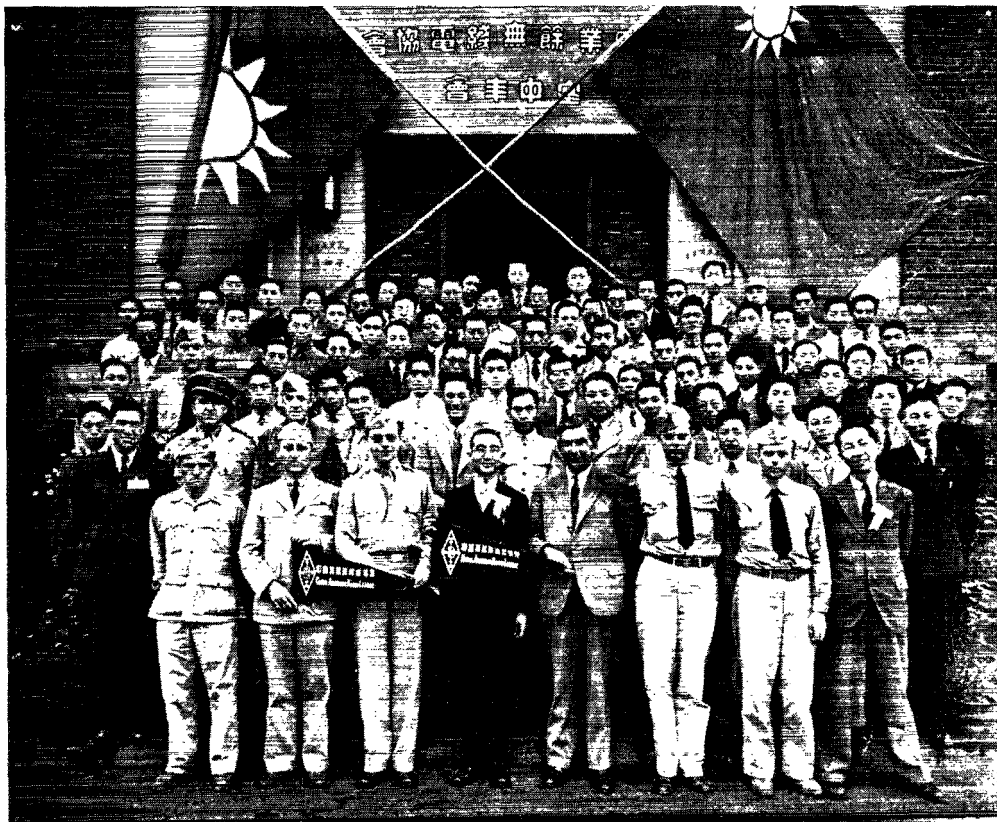

The China Amateur Radio League's sixth annual convention participants, gathered on the steps of the Central Broadcasting Building in Chungking. Only those holding C.A.R.L. banners were identified: (left to right) Lt. Irving L. Weston, USNR, W8IW; Capt. A. F. Timmons, USA; K. T. Chu, vice-president of the Chinese society; and Douglas Mellon of the Marconi Works, England. *QST's* thanks to W8IW and XU4SC, editor of the League's bulletin *CQ*, for this material.



THE WORLD ABOVE 50 Mc.

CONDUCTED BY E. P. TILTON,* W1HDQ

U.H.F. RECORDS

Two-way Work

- 56 Mc.: W1EYM-W6DNS, July 22, 1938 — 2500 miles.
- 112 Mc.: W2MPY/1-W1JFF, August 21, 1941 — 335 miles.
- 224 Mc.: W6IOJ/6-W6LFN/6, August 13, 1940 — 135 miles.
- 400 Mc.: W6IOJ/6-W6MYJ/6, September 14, 1941 — 60 miles.

WITH this issue we take up our prewar practice of listing, in box form, the existing DX records for each of our v.h.f. bands where activity has been reported. The records listed this time are, of course, prewar accomplishments. Records for these, or for corresponding new frequencies, and for the new v.h.f. and u.h.f. frequencies which were practically unknown before the war, will be listed as soon as reported.

The 335-mile record for 112 Mc., held jointly by W1JFF and W2MPY/1, may not be the final story of activity on that band, as exceptionally strong inversions during two periods in October resulted in some very long-haul work by numerous W1's, W2's, and W3's. No work of record-breaking caliber has been reported, but the fact that several W1's in the vicinity of Narragansett Bay are known to have worked down the Atlantic Coast as far as Wilmington, Delaware, indicates that a new record was at least a possibility. In any event, the details of work beyond 200 miles would be welcomed by this department.

While the maximum DX by means of temperature-inversion bending of v.h.f. signals usually occurs during the summer months, the late fall and winter period is also productive of some mighty interesting sessions as

* V.H.F. Editor.

well. Signals brought back to earth by an over-running layer of warm air can show up just as well in winter as in summer, and past experience has shown that, while the inversion periods may not occur so frequently in cold weather, signals are occasionally just as strong, and often the winter inversion is characterized by steadier signals than those of the warm-weather type.

The convection-type inversion,¹ so common along both seacoasts and in the area around the Great Lakes, is a warm-weather affair, and is well known only to v.h.f. workers who are fortunately situated adjacent to fairly large bodies of water; but inversions which characterize the approach of a storm can, and do, show up anywhere, and the resulting bending of v.h.f. waves produces DX of a very interesting sort. We most heartily recommend to anyone contemplating work on any v.h.f. or u.h.f. band a brief study of weather/radio correlation as a means of getting the most out of operation on our various new bands. The tie-in between weather and radio goes right on up through the spectrum, as anyone who had experience with radar during the war period well knows.

All this is mentioned at this time because a

¹ See "On the Very Highs," July, 1944, page 42.

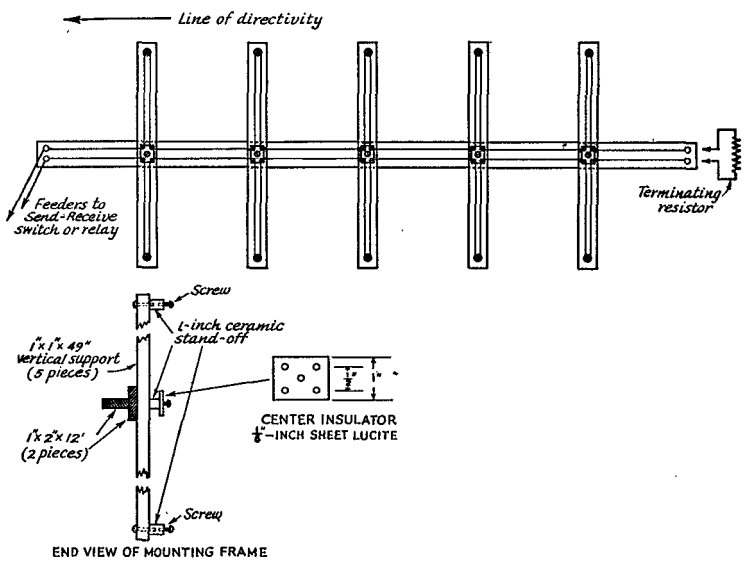

Fig. 1 — The experimental model of the Marconi-Franklin Series-phase Array. Any number of vertical sections may be used. The folded portions should be spaced as closely as possible — the 1/2-inch spacing shown is a convenient form. The array is unidirectional, toward the transmitter end.

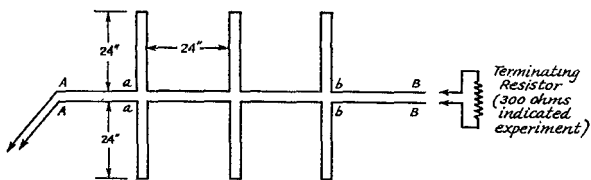

Fig. 2—Schematic representation of the Series-phase Array. Line sections Aa and Bb may be eliminated if desired.

great many new amateurs are appearing on the scene, and not a few old-timers are breaking into v.h.f. work while waiting for the low-frequency bands to be released. We hope that all v.h.f. newcomers will see that there is a great deal more to operation in this portion of the spectrum than merely shooting the breeze with a fellow across town, as a stop-gap until something better is available!

And winter is the aurora season. Does the eerie effect of the aurora borealis, which produced so many hectic sessions in prewar five-meter work, extend to the higher frequencies as well? We never were able to tell positively, on the basis of experience to date, but it seems reasonable that 112, and possibly 144 Mc., might show some response. We would all do well to watch conditions on these and other bands more carefully. Amateur experience on the frequencies above 28 Mc. played an important part in determining postwar frequency allocations—it is more important to observe and report than it appears on the surface.

Helpful Hints Department

To be good, an idea does not necessarily have to be new; in witness whereof we offer the following, turned in by two recent visitors to ARRL Headquarters.

A well-known foreign amateur, who insists on remaining anonymous, saw an antenna detailed in an old book² in the Headquarters technical library. It appealed to him for its possibilities as a low-frequency directive array, but as 112 Mc. was the only band available he decided to make a test model for that band. The method of construction used is shown in Fig. 1. Though the article mentioned described an array consisting only of the top half of the system shown in the accompanying sketches, the lower half, or image, was added as a logical development for v.h.f. use. The model was tested in the large open area in back of the home of WIEH.

The array was coupled to one of the "horseshoe oscillator" rigs having an output of a watt or two, and an afternoon was spent in walking circles around the array with a field-strength meter, while various methods of feeding and termination were tried. The use of a stub for matching was found to be unnecessary. A 400-ohm line could be attached at any point along the section Aa, Fig. 2, without appreciable variation in radiated power. Several

values of terminating resistance were tried at point B, with 300 ohms indicating the highest front-to-back ratio. Obviously, the line sections Aa and Bb are unnecessary. Their removal would reduce the length of the array by four feet.

While the initial tests were hurried and crude, they indicate that the array has a gain over a simple dipole of approximately 6 db, and its performance would seem to have some advantages over that of a parasitic array of similar gain. The front-to-back ratio, particularly when the terminating resistor was used, was extremely high; and radiation off the sides was negligible. The area of useful power across the front was quite broad, there being only a slight variation in radiated power indicated over an angle thirty degrees or so either side of the line of maximum directivity.

The results of these tests would seem to indicate that this type of array is worthy of further investigation by v.h.f. workers, as well as being of interest to the low-frequency DX men. Further checks are in order, but have been delayed by the pressure of reconversion at Headquarters. The array should be tried at greater heights above ground than were used in the tests described, and it should be subjected to a frequency characteristics comparison with a properly-adjusted parasitic array, the outstanding weakness of the latter for v.h.f. use being its narrow frequency response. If the Marconi-Franklin Array shows less critical response characteristics (and it would seem that it should) then it is definitely worth a try by anyone who wants something better than a simple dipole for v.h.f. work. Results of any tests on this type of array would be greatly appreciated.



Another recent visitor with an idea was William H. Faulkner, jr., W3BSY, whose 112-Mc. field-strength meter caught the eye of W2OEN, our Crystal-ball man, who plied W3BSY for details of its construction. The schematic diagram and constants are given in Fig. 3A. These are for 112

(Continued on page 108)

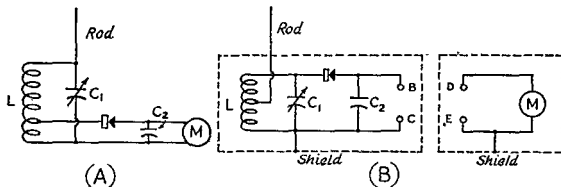

Fig. 3—Field-strength meters using crystal detectors.

The arrangement used by W3BSY is shown at A. L is 5 turns, $\frac{1}{2}$ -inch diameter, tapped $\frac{1}{4}$ -turn from the cold end. C₁ is a 2-plate midget variable. C₂ is 0.001 μ f. M is a 1-ma. meter. Coil size is for 112-Mc. band. For 144 Mc., reduce diameter to 3/8 inch.

In B, the meter is made removable, the points BC and DE being connected by means of a twisted pair. The meter is a 100-micro-ampere type. L is 2 turns, $\frac{1}{2}$ -inch diameter, center tapped. Use of 100 μ f. in C₁ permits 50 and 112 Mc. to be tuned with same coil.

² "Short-Wave Wireless Communication," Ladner and Stoner, John Wiley and Sons, Second Edition, 1934.



CORRESPONDENCE FROM MEMBERS

The Publishers of *QST* assume no responsibility for statements made herein by correspondents.

QST DE W1AW . . .

Aside from the capitulation of Germany and Japan, my biggest thrill in nearly four years was copying W1AW this evening at 8 p.m. — *W3HVD*. . . Many thanks to W1KH for his message and soon hope to be able to resume our activities — *VE4HM*. . . Glad to hear you on the air again; no more vitamins needed here now! — *W8UIC*. . . Nice note, frequency right on nose, no QRM — *W6ITH*. . . Last time I copied AW was the sorrowful day we gave up our frequencies and put our rigs in moth balls for the duration plus, but it was for a good cause we relinquished them — *W8RTN*. . . Sure was swell to copy the ole pater-station — *W9DXL*. . . Message of President Bailey was read at Milwaukee club meeting — *W9RH*. . . Am getting AW on 3555 kc. RST 599x nightly. Sure nice to hear a ham sig again. Thanks for all your efforts in our behalf — *W4MR*. . . Suggest higher speed for some schedules as 15 w.p.m. is tiresome to a majority of us — *W1NKKW*. . . Receiving AW here fine on 7145 kc., but no sigs on 14,280 kc. — *W6BKY*.

HIGHER EFFICIENCY?

Co. E, 2nd Bn., ASFPRD, Camp Beale, Calif.

Editor, *QST*:

Regarding 90 per cent r.f. amplifiers, how would it be to inject a little third harmonic in the grid circuit, too? That would lower the peak grid and subsequently the allowable plate minimum voltages. Do you think it's possible to squeeze out another drop?

— *Pot. Albert R. Orsinger, W5HUJ*

DOING A JOB IN SWPA

Luzon, P. I.

Editor, *QST*:

. . . You may rest assured that the hams are giving a good account of themselves out here in the Southwest Pacific Area. Practically all the key communications jobs are held by them, both officers and enlisted men. They formed the nucleus about which all these outfits were built. We can thank the League too for bringing these facts home to the people who should know them.

— *Capt. Henry Spilner, jr., W2NCY*

c/o FPO, San Francisco, Calif.

Editor, *QST*:

. . . My job has been 100 per cent radar maintenance throughout the entire period along with the extra duties of an instructor. I have repaired equipment almost totally damaged, in proverbial ham fashion, and have been commended by two admirals for what seemed to them a miracle in getting the gear to function, after it had been reported by so-called "experts" as totally disabled. I might add that baling wire was actually used.

— *L. J. Gilsdorf, CRT*

SHIP FREQUENCIES ON RECEIVERS

Spec. Engr. Detachment, Box 180
Santa Fe, New Mexico

Editor, *QST*:

In all the discussions of postwar amateur receivers I have never seen mentioned one particular idea that may have some merit. When we buy commercial jobs, why don't they have coverage of the ship-shore c.w. frequencies? If, in the interests of economy they can't add another coil combination, why not have one from 1000 kc. to 400 instead of 1600 to 550 kc. No one would miss the high frequency broadcast spectrum if they could have the ship calling frequencies at least.

— *Bob Hunter, W8KXS, ex-W9EKA*

MARCONI OR POPOV?

Box 233, Lewisburg, Ohio

Editor, *QST*:

In the July 8 issue of the *New York Times* column entitled "News of Stamp World," appears the following: ". . . 30-Kopecs, 60K, and 1-ruble stamps mark the fiftieth anniversary of the invention of radio by Popov."

This is the second time Russia has philatelically honored A. S. Popov, as on 7K and 14K items released in 1925 he is hailed as "Inventista de Radio" (Inventor of Radio).

I've always understood it was recognized the world over that Marconi was The Father (inventor) of Radio. Maybe I'm a little behind on worldly doings — but this is the first I've heard that a Russian was ever so recognized. Is there an explanation?

— *Carlyle Stockslager, W3TQT*

VALE LA7A!

(Editor's Note: The following letter was received by W8QLW and is published with his permission.)

Vestgrenså 5, Ulleval Hageby, Oslo, Norway

Dear OM:

On behalf of the friends of Arne Eikrem, LA7A, I should like to tell you about him as you will not meet him on the air any more. The bullets of the Gestapo got him whilst he was working at his concealed station in the woods north of Oslo on March 18th, 1945.

Before the war LA7A was one of the hardest-working amateurs, taking particular interest in portable work. During the war in Norway in 1940 he was in charge of a wireless station as a signal officer, but when the firing ceased he resumed work against the Nazis — underground.

His official occupation during the following years was that of carrying out repairs for a firm forced to work for the Germans, but all of his spare time he devoted to working for the liberation. As the Germans confiscated all private radio receivers and radio material — and of course all amateur transmitters — Eikrem managed to provide many hundreds with radio parts belonging to the Germans, help in repairing hidden radios, building receivers and even transmitters. His working day was very long as a result but in spite of this in 1942 he also took over the operation of a station which linked up the underground movement in Norway with London. The previous operator had been shot by the Gestapo but this did not deter Eikrem. Assisted by Miss Agnes Larsen, LA7A kept his station constantly on the air from the environs of Oslo and at the same time carried on with his own job.

The station had to be moved frequently as the Germans were at his heels with direction finders. During the winter of 1944 he had a very close escape as the Germans had cracked the code. Waiting for fresh supplies of radio material by air he had taken up the prearranged position in the woods. The Germans were also present. Eikrem was then assisted by an old schoolmate, Karl Nerdrum. They both managed to escape but the supplies were captured by the Germans.

This meant of course a break in the work, but new supplies and codes arrived in the course of two months and again the station went on the air. They handled a great deal of traffic. On March 18th the three companions, Eikrem, Miss Larsen and Nordrum, were again out in the woods. They had cleared off the traffic and were closing the station when a shot rang out. Nordrum fell fatally wounded, Eikrem and Miss Larsen managed to hide but were later captured as about twenty Gestapo men appeared. Eikrem was handcuffed. He knew his fate and that the chances of escaping were nil. He took a desperate leap which took him out of the reach of the nearest Gestapo men and sent him rolling down a hillock, but his enemies were too many and he was shot several times through the head. Miss Larsen was taken to the Gestapo headquarters and afterwards to a concentration camp, but she survived.

(Continued on page 114)

THE CRYSTAL BALL

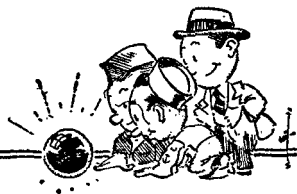

CONDUCTED BY A. DAVID MIDDLETON,* W2OEN

JUDGING from the letters received, many amateurs are putting in much time and doing a lot of skullwork to devise ways in which to avoid duplication of equipment, reduce installation space and costs and to provide the maximum operating convenience. How many of these plans will actually culminate in gear on the air is problematical, but if a feller would pick out the features that strike him as being most useful, and combine them with his own plans, he sure would have an honest-to-Betsy FB rig that would be a joy to operate and a delight to hear!

What'll you bet? Somewhere in the following crystal ball previews there are ideas that will eventually find a place in *your* shack!

THE LINE FORMS AT THE RIGHT!

HERE'S my idea of the ideal postwar rig. There isn't much about stability, efficiency or other r.f. considerations, but there are plenty of keys, lights and relays. I am a very lazy guy and anything I can do to make the pile easier to operate is a worthwhile improvement.

Know then, that at the time I plan to build this rig, I will have built, or will be in the process of building myself a splendid House, containing five studios, and a master control room which is the nerve center of the house. I plan to operate the ham rig from any of the five studios. The actual equipment, for the most part, is centrally located in the Equipment Room, adjoining Master Control.

Panoramic circuits figure prominently. In each control room there is an operating position. The transmitter panoramic shows at all times three or four short peaks marking the limits of the band, including 'phone regions, and the frequency of the transmitter is displayed by a higher peak in between, which moves back and forth as the transmitter frequency is changed. The band-switch, operated by a dial at the operating position,

selects the proper group of band-edge-limit frequencies for each band and displays them on the panoramic screen. The band-switch also sets the v.f.o. to give output on the desired band, adjusts the v.f.o. range to cover the band exactly, adjusts the panoramic circuit so that the whole band just fills the screen, and makes the necessary band-change adjustments in the power amplifier. The v.f.o. is of a type wherein a variable low-frequency oscillator beats with a crystal to produce a difference beat that exactly covers the band. The main v.f.o. tuning condenser is driven by a reversible motor, operated from two push keys at the operating position. The v.f.o. frequency may be put on the receiver panoramic by operating another push key in order to see where my frequency stands with respect to the other signals in the band. All this, of course, may be done without actually having the carrier on the air.

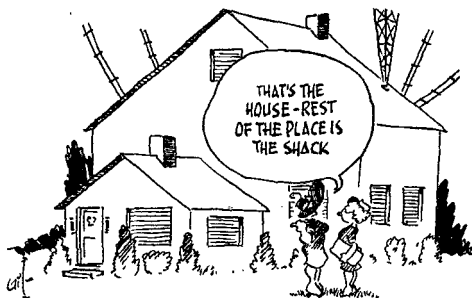

By operating another push key the v.f.o. frequency may be caused to change until it rests exactly on the frequency to which the receiver is tuned. This is accomplished by a side channel in the receiver using the same h.f. oscillator and terminated in a discriminator arrangement which is used to operate the v.f.o. motor in the proper direction until the frequency coincides with the receiver frequency.

*Department Editor.

(Continued on page 120)

DECEMBER PRIZE WINNERS

Contributors to the Crystal Ball Department are awarded monthly prizes consisting of a \$25 Victory Bond as first prize, \$10 in Victory Stamps as second prize, and \$5 in Victory Stamps as third prize. One dollar in Victory Stamps is awarded the writer of each additional published letter not receiving a major prize.

The most interesting letters are selected by two members of the Headquarters staff, the conductor of this department and a "guest judge." This month's winners, chosen by E. L. Batten, W1UE (Assistant Communications Manager), and W2OEN are: Sgt. Wm. A. Wildenhein, first prize; Edward B. McIntyre, W4FKV, second prize; Sgt. David A. Kemper, W2NTX, third prize; Pfc. Frank Huberman, W2JIL.



IN THE SERVICES

THE embryo of our In the Services column appeared under the heading, "WHAT THE LEAGUE IS DOING" in the January, 1941 issue of *QST*, as an appeal to hams to register service records with ARRL Headquarters.

Since then, the names of many thousands of hams have been added to the roster of amateurs who have aided so materially in the successful prosecution of the war. The value of the contribution made by these men is incalculable. The recording in our ITS files of their participation in the achievement of victory is a vital part of the history of amateur radio.

If you have not yet sent in your Amateur War Service Record, there is a convenient blank in October, 1945 *QST*.

ARMY—GENERAL

- ex-2DFK, Brown, T/Sgt., foreign duty
- 2GQI, Grayson, Lt., Harrisburg, Pa.
- 2LIR, Kreckman, Pvt., Ft. Bragg, N. C.
- 3GUE, Chamberlain, T/5, foreign duty
- 3IAG, Scherlis, Lt., Ft. Leavenworth, Kan.
- 3IWG, Adams, W/O, Camp Beale, Calif.
- 4GRT, Fariss, Lt., foreign duty
- 4RRR, Good, Pfc., address unknown
- 6LSS, Yasunaga, Pvt., foreign duty
- KOMCE, Suzuki, T/4, foreign duty
- 6MME, Scales, S/Sgt., foreign duty

- ex-K6NOF, Barr, Capt., foreign duty
 - 6OZE, Patrick, S/Sgt., foreign duty
 - 6RFI, Trindle, Lt., Santa Fe, N. M.
 - 6TKI, Stanis, Lt., foreign duty
 - 7EZC, Madsen, M/Sgt., Cheyenne, Wyo.
 - 7GBE, Harris, Lt., Indiantown Gap, Pa.
 - 7IKW, Scott, T/Sgt., foreign duty
 - 7IUM, Cherney, Pfc., San Francisco, Calif.
 - 8EBQ, Kraker, T/Sgt., foreign duty
 - 8JFM, Long, Capt., Maumee, Ohio
 - 8JLM, Cummings, Capt., foreign duty
 - 8MPH, Eiler, Lt., Ft. Bliss, Texas
 - 8ONV, Bucey, Pvt., Akron, Ohio
 - 8PUH, Klaproth, M/Sgt., Avalon, Calif.
 - 8PYK, Duncan, Pvt., foreign duty
 - 8REN, Benedict, Sgt., foreign duty
 - 8RSO, Genematas, Lt., Camp Swift, Texas
 - 8SSN, Hoynos, Lt., Edgewood Arsenal, Md.
 - 8SVX, Koski, T/4, foreign duty
 - 8VLI, Walchli, Pvt., Oak Ridge, Tenn.
 - 8UDJ, Mercer, Maj., Martinsburg, W. Va.
 - 8VRP, Grostick, Cpl., foreign duty
 - ex-8VUM, Vrobel, T/Sgt., Camp Chaffee, Ark.
 - 9BPH, Heabert, T/4, Altoona, Pa.
 - 9BLG, Taylor, S/Sgt., foreign duty
 - 9CZF, Mozley, Lt., Webster Groves, Mo.
 - 9DFV, Goff, Pvt., Camp Lee, Va.
 - 9DXF, Freer, Lt., Camp Wolters, Texas
 - 9FGS, Guy, Pvt., Toole, Utah
 - 9PGV, Nemirov, Pfc., foreign duty
 - 9GNE, Breiter, S/Sgt., Santa Fe, N. M.
 - 9K CZ, Gravitt, W/O, foreign duty
 - 9PLT, Key, Pfc., Santa Fe, N. M.
 - 9REN, Parks, Lt., foreign duty
 - 9UDB, Higginbottom, Capt., Ft. McPherson, Ga.
 - 9URR, Vieth, Pvt., Ft. Sheridan, Ill.
 - 9URP, Johnson, S/Sgt., Camp Stoneman, Calif.
 - 9VQF, Boggs, T/4, Washington, D. C.
 - ex-9VXE, Shimondle, Sgt., foreign duty
 - 9WHE, Smith, Pvt., Camp Patrick Henry, Va.
 - 9YBE, Campbell, Capt., foreign duty
 - 9YHR, Morris, S/Sgt., foreign duty
- Operator's license only:
 Adamsak, T/5, Camp Gruber, Okla.
 Carden, Sgt., Memphis, Tenn.
 Dawson, Sgt., foreign duty

- Dougherty, Sgt., foreign duty
- England, Pfc., foreign duty
- Foran, Pfc., foreign duty
- Geatane, Capt., Goldboro, N. C.
- Gaul, T/4, foreign duty
- Gray, Sgt., foreign duty
- Gray, Sgt., foreign duty
- Hanson, Pfc., foreign duty
- Jarnall, T/5, Camp Polk, La.
- Kittel, Pvt., foreign duty
- Klatt, Cpl., foreign duty
- Kohl, T/4, foreign duty
- Layman, Sgt., foreign duty
- McReynolds, Pfc., foreign duty
- Mens, Pfc., Denver, Colo.
- Nagaoka, Pfc., foreign duty
- Rowland, T/4, Cincinnati, Ohio
- Schmitt, Sgt., Camp Shelby, Miss.
- Sellers, Cpl., Pueblo, Colo.
- Stephenson, Lt., foreign duty
- Welch, T/4, Omaha, Nebr.

ARMY—AIR FORCES

- 1AIR, Stickney, Capt., Bridgewater, Mass.
- 1J7Q, Rosenthal, 2nd Lt., Grand Island, Nebr.
- 11GV, Cole, Lt., Robins Field, Ga.
- 1NOA, Rosa, Pvt., Keesler Field, Miss.
- 2COF, Laino, Pvt., Great Bend, Kan.
- 2LUV, Teasar, Capt., Whitestone, L. I., N. Y.
- 3AIM, Jackson, Maj., foreign duty
- ex-3BDW, Ferguson, Lt., Robins Field, Ga.
- 4FYF, Kiser, Maj., foreign duty
- 5DTP, Watson, Sgt., foreign duty
- 5GAA, Bouldin, Lt., Victoria, Texas
- 5ITN, Menefee, Cpl., foreign duty
- 5JQT, Rudolph, Lt. Col., Ellington Field, Texas
- 5KAI, Woods, Lt., foreign duty
- 5KFE, Rosa, Lt., foreign duty
- 5KQZ, Reed, Pvt., Lowry Field, Colo.
- 6JXP, Bates, Lt., Albany, Ga.
- 6LMS, Mace, Lt., Eglin Field, Fla.
- 6LPG, Arden, Lt., foreign duty
- 6MBA, Smith, 2nd Lt., foreign duty
- 6SNS, Roland, Sgt., foreign duty
- 6SXW, Paris, 2nd Lt., Las Animas, Colo.
- 6TWG, Connick, Lt., Fortuna, Calif.
- 6UPW, Nepple, Sgt., foreign duty
- 7FHE, Evans, Lt., Robins Field, Ga.
- 7GXR, Norman, Lt., Barksdale Field, La.
- 7ILE, Bundy, A/C, Sherman, Texas
- 7IQS, Bradford, Lt., Selman Field, La.
- 8KWX, Rempinski, Pvt., Detroit, Mich.
- ex-8KY, Haley, M/Sgt., Selfridge Field, Mich.
- 8MZU, Freeland, Pvt., foreign duty
- 8NCX, Dunkin, Maj., Dayton, Ohio
- ex-8NJQ, LaVier, Lt. Col., Scott Field, Ill.
- 8NQZ, Huff, Maj., Moultrie, Ga.
- 8OSL, Wingle, M/Sgt., foreign duty
- 8PQN, Darwish, Lt., Ft. Worth, Texas
- 8QXO, Pavluska, T/Sgt., Sioux Falls, S. D.
- 8RMB, Thies, Capt., Dayton, Ohio
- 8RWG, Lord, Cpl., Ft. Bragg, N. C.
- 8RXL, Plachetzki, Lt., foreign duty
- 8SFF, Pergosky, M/Sgt., Dalhart, Texas
- 8SGQ, Vester, Pvt., Pueblo, Colo.
- 8UAV, Connor, T/4, foreign duty
- 8USI, Friebersthauser, Cpl., March Field, Calif.
- 8VCT, Maekensie, Lt., Hondo, Texas
- 8WDZ, Green, Lt., Xenia, Ohio
- 8WLP, Lisy, Pvt., Keesler Field, Miss.
- 9BUN, Larson, M/Sgt., foreign duty
- ex-9FIV, Shearn, Capt., Englewood, Colo.
- 9JHE, Blevins, 2nd Lt., Covington, Ky.
- 9JVO, Conley, S/Sgt., Seattle, Wash.
- 9JWX, Kurz, Maj., Ft. Worth, Texas
- 9JXS, Mead, Cpl., Frederick, Okla.
- 9KHD, Jones, Maj., Beverly Hills, Calif.
- 9NWI, McGinnis, Maj., Midwest City, Okla.
- ex-9OG, Rollins, Lt., Chanute Field, Ill.
- 9OJX, Wexler, Lt., Robins Field, Ga.
- 9ONG, Barbour, Pvt., Memphis, Tenn.
- 9POO, Pettit, M/Sgt., foreign duty
- 9QUE, Herts, Capt., foreign duty
- 9RTJ, Jones, CWO, foreign duty



No more than "Serving at a Coast Guard Station in Florida" may be said of the duties of these hams; left to right: RM1c Milton A. Young, W8VCB; CRM Judson J. Reynolds, W1MWS; CRM Richard T. Lahey, W4EWS (ex-WIATO-WIEVC); CRM Walter C. Hamner, ex-K4DKS; RM1c Clarence R. Lantto, W9HQW.

98TF, Jurnecka, Lt., Madison, Wis.
 9TIV, Stodolka, Lt., Enid, Okla.
 9TQC, Peak, Sgt., Ephrata, Wash.
 9ULD, Bassette, Lt., Tuskegee, Ala.
 9UZY, Hyman, F/O, Midland, Texas
 9VQX, Kuehl, Maj., Orlando, Fla.
 ex-9VUL, West, Cpl., Hondo, Texas
 9WBV, Groncewski, F/O, Houston, Texas
 9WS, Sturgis, Maj., Highland Park, Ill.
 9YUM, Hoppe, Capt., foreign duty
 9YXX, Nichols, T/Sgt., Keeeler Field, Miss.
 9ZLX, McSherry, Cpl., foreign duty

Operator's license only:

Abeyer, T/Sgt., Chickasha, Okla.
 Alves, Pfc., Scott Field, Ill.
 Baker, Sgt., Alamogordo, N. M.
 Benn, Sgt., Madison, Wis.
 Braunig, Lt., Scott Field, Ill.
 Chan, M/Sgt., Truax Field, Wis.
 Dorf, Lt., Waycross, Ga.
 Duckworth, Pfc., Sheppard Field, Texas
 Elliott, S/Sgt., Key Field, Miss.
 Ewing, S/Sgt., foreign duty
 Gants, Cpl., Topeka, Kansas
 Hiehlin, Frederick, Okla.
 Humphrey, Sgt., Keeeler Field, Miss.
 Kiehm, Lt., Hollywood, Calif.
 Kwolek, S/Sgt., foreign duty
 Lloyd, Capt., Louisville, Ky.
 Martin, Sgt., Truax Field, Wis.
 Matthis, Sgt., Shreveport, La.
 McDowell, Sgt., Greensboro, N. C.
 Post, Cpl., Dallas, Texas
 Powis, Pfc., Hobbe, N. M.
 Reese, S/Sgt., foreign duty
 Runkle, Lt., foreign duty
 Smith, Capt., foreign duty
 Steinback, M/Sgt., Santa Ana, Calif.
 Svelnia, Sgt., Will Rogers Field, Okla.
 Toser, 2nd Lt., foreign duty
 Tretinik, Sgt., St. Louis, Mo.
 Wendt, T/Sgt., foreign duty
 Woore, Lt., Gulfport, Miss.

ARMY—SIGNAL CORPS

1ENB, Kukia, Capt., foreign duty.
 1IGD, Roberts, Lt., Reading, Mass.
 1IL, Nyatrom, Lt. Col., Springfield, Mass.
 ex-1JYD, Sneade, S/Sgt., foreign duty
 1KGQ, Johnson, Sgt., foreign duty
 1KHI, Parker, Maj., foreign duty
 1KIX, Staniewics, T/5, foreign duty
 1LHK, Eaton, T/4, address unknown
 2OKD, Gallonio, T/4, foreign duty
 ex-3CTH, Certaine, CWO, foreign duty
 3GPT, Zubrecky, W/O (jg), Philadelphia, Pa.
 5CPI, Harkins, 2nd Lt., Long Branch, N. J.
 5IGB, Rand, Sgt., foreign duty
 6IYU, McDonald, Lt., foreign duty
 6BFC, Hunter, Capt., foreign duty
 6DQH, Clark, T/3, New York, N. Y.
 ex-6FTO, Dietsch, Capt., foreign duty
 6IEW, Watson, 2nd Lt., Ft. Monmouth, N. J.
 6LGD, Cash, Lt., foreign duty
 ex-6LRE, Tibby, Capt., foreign duty
 6MXH, Bridge, T/Sgt., foreign duty
 6NPF, Ullman, Capt., Camp Adair, Oregon
 6OFZ, Richards, T/Sgt., foreign duty
 6RIS, Shelby, foreign duty
 6TJS, Salet, T/3, foreign duty
 6TMY, Larson, Lt., address unknown
 6TSS, Henderson, Pfc., foreign duty
 6TYN, Sanders, Capt., foreign duty
 6UBI, Skatzen, Pvt., Camp Crowder, Mo.
 6UBM, Baboon, foreign duty
 6ZG, Woolverton, Col., San Francisco, Calif.
 ex-KYCOI, Bucy, Capt., foreign duty
 7BMP, Dubbe, Sgt., foreign duty
 7PLF, Tucker, Sgt., foreign duty
 7GSI, Dickinson, Pfc., Pine Camp, N. Y.
 7VCO, Daniels, Cpl., Shelton, Wash.
 7VVO, Kennedy, T/3, foreign duty
 8EMU, Meredith, T/3, foreign duty
 8JMV, Parsons, Pvt., foreign duty
 8KBQ, Arcolotti, T/Sgt., foreign duty
 8KM, Long, T/Sgt., foreign duty
 8LNX, Skinner, T/5, Pine Camp, N. Y.
 8LZY, Tucker, Sgt., foreign duty
 8NOF, Hillier, Capt., Detroit, Mich.
 8PGE, Putnam, T/5, foreign duty
 8QAY, Wright, T/4, Camp Shelby, Miss.
 8RVJ, Bonanno, T/Sgt., Camp Crowder, Mo.
 8SIB, Harris, 2nd Lt., Chicago, Ill.
 8SKH, Hornik, Pvt., Camp Crowder, Mo.
 8UCF, Phillips, Pfc., foreign duty
 ex-8VHI, Lewandowski, CWO, foreign duty
 8VPK, Ketterer, Lt., foreign duty

8VUC, Payer, Pfc., Pine Camp, N. Y.
 9ACG, Schuchman, Sgt., Camp Crowder, Mo.
 9BXW, Cook, T/3, foreign duty
 9BZR, Flowers, foreign duty
 9DYG, Stora, W/O (jg), Atlanta, Ga.
 9EHW, Zieg, W/O (jg), foreign duty
 9FAQ, Kelley, T/5, foreign duty
 9FZD, Yount, Sgt., foreign duty
 9GAI, Catlin, Lt., foreign duty
 9GCI, Neumar, T/5, foreign duty
 9GQG, Farnsworth, T/5, foreign duty
 9HHI, Hughbanks, Cpl., Shelbyville, Ind.
 ex-9HRN, Light, T/3, foreign duty
 9JHM, Cartwright, T/4, foreign duty
 9MEL, Hart, Cpl., Ft. Brady, Mich.
 ex-9OBD, Foltz, Capt., Petaluma, Calif.
 9RCH, Frits, Pvt., Camp Crowder, Mo.
 9RVY, Ludden, Sgt., foreign duty
 9SBV, Bukacek, Maj., Camp Crowder, Mo.
 9SCM, Spalti, Lt., Omaha, Nebr.
 9SOF, Imier, Pvt., Gary, Ind.
 9SSI, Weiser, Pvt., Camp Crowder, Mo.
 9TFQ, Leopold, T/3, foreign duty
 9TGG, Guise, Pvt., foreign duty
 9UAL, Hall, T/5, foreign duty
 9UKQ, Andermann, Capt., Ft. Monmouth, N. J.
 9UXQ, Franklin, Sgt., foreign duty
 9VI, Waite, Lt. Col., Philadelphia, Pa.
 9YUB, Clapper, Lt. Col., Omaha, Nebr.

Operator's license only:

Aan, foreign duty
 Baxter, T/5, Hutohinson, Kansas
 Clark, Pfc., Robertson, Mo.
 Foye, Lt., Chicago, Ill.
 Franklin, foreign duty
 Gollin, foreign duty
 Graves, T/5, Lexington, Ky.
 Harris, Pfc., foreign duty
 Holobaugh, T/3, foreign duty
 Kanner, 2nd Lt., Philadelphia, Pa.
 Krebs, Lt., foreign duty
 Macklin, T/5, foreign duty
 Mellender, Cpl., Ft. Lewis, Wash.
 Miller, foreign duty
 O'Lone, S/Sgt., foreign duty
 Sutton, Pvt., Camp Crowder, Mo.
 Tary, T/4, Salem, Ohio
 Weber, T/5, foreign duty
 Wingert, Pfc., foreign duty

ARMY—AACS

3JUB, Mitchell, Sgt., foreign duty
 7GAL, Colby, S/Sgt., foreign duty
 9MET, Pollard, Lt., foreign duty
 9QCD, Harwood, Pvt., Crescent City, Ill.

Operator's license only:

Fenton, S/Sgt., Lomita, Calif.
 Hurrle, Cpl., foreign duty
 Reger, Lt., Manchester, N. H.

NAVY—GENERAL

1AGF, Bryant, EM3c, Newburyport, Mass.
 1BA, Mahler, Lt., Worcester, Mass.
 1DSB, LaFierre, foreign duty
 1HYD, Simpson, CSAD, North Providence, R. I.
 1HV, Morash, Comdr., Annapolis, Md.
 1IC, Gunning, S1c, Fall River, Mass.
 1IOK, Litwinowich, CRM, foreign duty
 1JBM, Deschene, RM3c, foreign duty
 1LXW, Hastings, Ens., foreign duty
 1MDC, Hood, RM3c, foreign duty
 1MRD, Simons, RM1c, Dorchester, Mass.
 1MVB, Darling, CRM, foreign duty
 1NWF, Willard, S1c, Great Lakes, Ill.
 1NYS, Nelson, S1c, Minneapolis, Minn.
 1NBS, Schira, foreign duty
 2BFC, Berler, CRE, foreign duty
 2BPA, Hopak, CRM, foreign duty
 2HPT, Murphy, CRM, Sonoma, Calif.
 2LHB, Dougherty, Ens., foreign duty
 2LLL, Muhl, M2c, foreign duty
 2NBI, Olthuis, Ens., Solomons, Md.
 2NOV, Sprague, Lt. (jg), Weston, Mass.
 2NVH, Scherer, Ens., foreign duty
 2OFB, Monego, CRM, Gloucester, N. J.
 2OKN, Belaaks, S1c, Brooklyn, N. Y.
 3CFV, Fischer, MAM2c, foreign duty
 3ESJ, Emott, Lt., Arlington, Va.
 3FNX, Copestake, CRM, foreign duty
 3GHA, McBrien, RM3c, foreign duty
 3HGG, Geiser, CRM, Pottstown, Pa.
 3IBT, Zubrecky, Lt., Silver Spring, Md.
 ex-3VP, Rose, Lt. Comdr., Washington, D. C.



This trio of hams on duty in the South Pacific area is constituted of two old timers and a newcomer to amateur radio. All three look forward with equal fervor to becoming civilians when Coast Guard duties will permit. Left to right: CRT John Jarnefield, W2KFC; CRT Merwin K. Beam, W1MQQ; RT1c Van R. Field, operator license only.

4ANK, Wood, Comdr., foreign duty
 4EFT, Bailey, Lt. (jg), Charleston, S. C.
 4ENI, Carter, CRM, foreign duty
 4EWV, Kirk, Lt., Annapolis, Md.
 4FBS, Keeler, RM1c, Tampa, Fla.
 4HUN, Harris, RM2c, foreign duty
 4HRH, Harris, RM, foreign duty
 4IBA, Reynolds, RM3c, foreign duty
 4IDP, Wilson, RM1c, foreign duty
 5GIL, Wright, Ens., Santa Fe, N. M.
 5JZU, Cooper, Ens., Norfolk, Va.
 6FGW, LeCompte, Lt., San Diego, Calif.
 6FJQ, Buck, Lt. Comdr., foreign duty
 6GOV, Doyle, Lt., San Diego, Calif.
 6HEK, Torohia, S2c, El Cerrito, Calif.
 ex-6MWI, Phillips, RM1c, foreign duty
 6NWM, Gross, CRM, foreign duty
 6OF, Lamoureux, CSP(Q), foreign duty
 6PNP, Trenary, RM1c, foreign duty
 6KRVF, Morgan, Lt. (jg), San Diego, Calif.
 6KSCB, Vigh, RE, foreign duty
 6SWP, Ryan, CRE, foreign duty
 6TGL, Letcher, S1c, Bremerton, Wash.
 6UPJ, Roberts, S1c, Brooklyn, N. Y.
 7DY, Dilley, Comdr., foreign duty
 7ENH, Grunewald, S1c, foreign duty
 7FFQ, Thode, RM1c, foreign duty
 7HB, Hutton, CRE, foreign duty
 7HJW, Hayes, Lt., Lewesworth, Wash.
 7OJK, Dunford, Lt. Comdr., Bremerton, Wash.

8AJU, Morgan, Lt., foreign duty
 ex-8CAY, Stalnaker, Lt. Comdr., foreign duty
 8GHM, Shields, RM2c, New Castle, Pa.
 8MBM, Weyerman, CRM, foreign duty
 8PTJ, Sturm, Lt., Huntington, W. Va.
 8QWW, Zolinas, S2c, Gulfport, Miss.
 8TMT, Kantor, RM2c, foreign duty
 8TRH, Syrontinski, RM1c, Bremerton, Wash.
 8TSL, Peters, RM1c, foreign duty
 8VRM, Hunter, S2c, St. Mary's College, Calif.
 8WMR, Myers, RM1c, foreign duty
 ex-9DSE, Raily, Lt. (jg), San Diego, Calif.
 9HNN, Mlescko, EM2c, foreign duty
 9ISH, Sather, CRM, foreign duty
 9JOD, Nichols, S1T3c, Camp Peary, Va.
 9JOW, Ammon, Ens., Washington, D. C.
 9KXP, Ives, RM2c, foreign duty
 9LIC, Britton, Lt., foreign duty
 9LSV, Granquist, Ship's Clerk, foreign duty
 9MFH, Warner, Lt. Comdr., Washington, D. C.
 9NIE, Anderson, RE, foreign duty
 9NLL, Kolar, MoMM3c, foreign duty
 9NNF, Waelterman, CWO, Hatboro, Pa.
 9PBG, Andrew, S2c, South Clinton, Ia.
 9RDR, Smith, RM1c, New Orleans, La.
 9SOC, Bass, S1c, Great Lakes, Ill.
 9TVX, Casteen, Midshipman, Kings Point, N. Y.
 9VVC, Williams, Lt. (jg), Greenfield, Ia.
 9WBC, Stewart, S1c, Charleston, S. C.
 9WVE, Cook, Great Lakes, Ill.
 9YAX, Fuller, RM2c, Inglewood, Calif.

Operator's license only:

Adams, S1c, Del Monte, Calif.

Basileco, A/S, Medford, Mass.
 Benjamin, RM1c, North Kansas City, Mo.
 Boutwell, S2c, San Diego, Calif.
 Carr, RM3c, Key West, Fla.
 Christensen, Ens., Daytona Beach, Fla.
 Coombs, RM3c, foreign duty
 Cox, A/S, Great Lakes, Ill.
 Crossley, Lt.(jg), Evanston, Ill.
 Earl, Lt., Norfolk, Va.
 Mausler, S1c, foreign duty
 Paul, S1c, Atlanta, Ga.
 Popkin, QM1c, Miami Beach, Fla.
 Rochelle, Sp(Q)3c, foreign duty
 Ruediaueli, San Francisco, Calif.
 Schroer, RM3c, foreign duty
 Smith, RM3c, foreign duty
 White, foreign duty
 Young, Ens., Dana Point, Calif.

NAVY—SPECIAL DUTY

1KNN, Chapman, CRT, San Diego, Calif.
 2OKO, Mendelson, RT3c, Newark, N. J.
 3HBC, Healey, RT2c, foreign duty
 4FDA, Graham, CRT, foreign duty
 4HIO, Willia, RT2c, Dearborn, Mich.
 5FZN, Martin, RT3c, foreign duty
 6BBK, LaFontaine, RT3c, Alameda, Calif.
 6QK, Bell, RT2c, Fremo, Calif.
 6UPO, Charnell, RT2c, foreign duty
 7DKE, Pierson, S1c, Gulfport, Miss.
 ex-7EDJ, Treasi, CRT, Bremerton, Wash.
 8JJA, Casto, RT1c, foreign duty
 8NIX, Grankowski, RT3c, Dearborn, Mich.
 8PEG, Rinehart, S1c, Great Lakes, Ill.
 8QOF, Beringer, S1c, Great Lakes, Ill.
 8TVE, Waite, RT1c, foreign duty
 9AUC, Pike, RT3c, New London, Conn.
 9BNJ, Kulpa, RT3c, Chicago, Ill.
 9DCN, Marohnic, CRT, Treasure Island, Calif.
 9IKW, Petraitis, RT3c, San Diego, Calif.
 9MAW, Hastie, RT1c, Kenosha, Wis.
 9QFV, Krug, RT2c, foreign duty
 9TLL, Sowden, RT Striker, foreign duty
 9VCC, Billburg, RT2c, Chicago, Ill.
 9WPT, Hammes, RT2c, Sabula, Ia.

Operator's license only:

Burns, S1c, San Diego, Calif.
 Coghlan, RT3c, foreign duty
 Tallman, RT1c, foreign duty

NAVY—AERONAUTICS

1MDS, Grant, ART2c, foreign duty
 2KZS, Jones, ARM3c, foreign duty
 2MVM, Lubok, ART1c, Hollis, N. Y.
 3ECT, Baird, ACRT, Corpus Christi, Texas
 3GAD, Quinn, Ens., Quonset Point, R. I.
 4FXF, Patton, ARM1c, foreign duty
 4HCO, Parks, S1c, Corpus Christi, Texas
 4HQB, Goode, Ens., Tallahassee, Fla.
 4ICM, Brodowski, ACRM, foreign duty
 5FHZ, Rhodes, ACRT, Memphis, Tenn.
 5FXN, Price, ART3c, Corpus Christi, Texas
 5HQK, LaFitte, ACRM, Berkeley, Calif.
 5IKA, Springer, ART1c, Corpus Christi, Texas
 6GHU, Harmon, ACRT, Bell, Calif.
 6IVI, Carr, Lt., Vero Beach, Fla.
 6LBP, Marshall, ACRT, Oakland, Calif.
 6RRF, Anderson, ACRT, San Diego, Calif.
 6SSO, Moore, AEM3c, foreign duty
 6UCJ, Schmidt, ARM2c, Alameda, Calif.
 8NCH, Rippel, Lt., Olathe, Kansas
 8RCW, Galicki, Ens., Banana River, Fla.
 8RJI, Neu, ACRT, San Diego, Calif.
 8UBN, Moore, ART1c, foreign duty
 9IRD, Groes, ART2c, foreign duty
 9JKO, Holloway, ART1c, Minneapolis, Minn.
 9NET, Murray, ART2c, Gulfport, Miss.
 9QQE, Krug, ACRT, Portland, Oregon
 9QUF, Smith, ACRT, foreign duty
 9ROX, Abbott, ARM2c, foreign duty
 9SIW, Krause, Lt., Ottumwa, Ia.
 9TYN, Deppe, A/C, St. Mary's College, Calif.
 9WUL, Morris, ART1c, Stuart, Fla.
 9YCN, Niessen, ACRT, foreign duty

Operator's license only:

Bishop, ARM3c, Patuxent River, Md.
 Botsford, ART2c, Norfolk, Va.
 Kerr, S1c, Corpus Christi, Texas
 Olsen, ART2c, Seattle, Wash.
 Rinn, ARM3c, Sanford, Fla.
 Rose, S2c, Memphis, Tenn.
 Schneider, S1c, Corpus Christi, Texas
 Stanley, ARM2c, Deland, Fla.
 Watters, ART3c, Corpus Christi, Texas

MARINE CORPS

4FHG, Webb, 2nd Lt., Cherry Point, N. C.

COAST GUARD

1LXO, Dorian, Lt., Washington, D. C.
 2CTV, Riche, RT3c, Groton, Conn.
 K4IGH, Sutphen, CRT, Charleston, S. C.
 6PSJ, Hayden, Cox. 3c, Hollywood, Calif.

MERCHANT MARINE AND MARITIME SERVICE

2JJB, Greens; 3IQK, Nebraska; 4GYR, Miller; 4HRM, Mashburn; 5UU, Fitzsimmons; 6AAM, Prochaska; 6JAU, Spicer; 6JXF, Pugh; 6NMM, Lopes; 7FLK, Hadley; 7IUB, McCurdy; 8SNA, Marshall; 9RCV, Endres; 9UWR, Breit, and ex-9UYX, Edmonson. Mitchell, Parker, Scale and Staples hold operator's license only.

CIVIL SERVICE

1LYA, Penney, radio mechanic, Gorham, N. H.
 1MKT, Gilbert, SC, engineer, Washington, D. C.
 1NQQ, Spencer, CAA, overseas communicator, LaGuardia Field, N. Y.
 2KOE, O'Malley, SC, radio engineer, Ft. Monmouth, N. J.
 2MZY, Wasserman, CAA, radio engineer, New York, N. Y.
 3AHO, Koval, SC, technician, Baltimore, Md.
 3IUD, Molloy, Navy Dept., radio electrician, Philadelphia, Pa.
 4DAN, Allen, Navy Dept., radio engineer, foreign duty
 4DRS, Rish, CAA, foreign duty
 4FFS, Leonard, Navy Dept., NRL, field engineer, Washington, D. C.
 5FFK, Whitcomb, NYA, foreman, Fredonia, Kan.
 6OAJ, Hedlund, Navy Dept., radio engineer, San Diego, Calif.
 7AAJ, Thatcher, OWI, engineer, foreign duty
 7BCS, Mowery, SC, Seattle, Wash.
 7EBZ, Stampalia, Dept. of Commerce, observer, Santa Maria, Calif.
 7JDL, Judson, NRL, Washington, D. C.
 8IBM, Garcia, AAF, foreman, foreign duty
 8JMO, Watts, NRL, radio engineering aide, Washington, D. C.
 ex-8MG, Urdike, AAF, radio engineer, Osborn, Ohio
 8PZP, Payne, Bureau of Aeronautics, Inspector, Akron, Ohio
 8VVS, Bohlander, NRL, Washington, D. C.
 ex-9DTY, Huyek, Navy Dept., Mare Island, Calif.
 ex-9JMG, Stanphill, SC, inspector, Tulsa, Okla.
 9LFF, Otto, CAA, technician, foreign duty
 9MIX, McFarland, Navy Dept., inspector, Aurora, Ill.
 9YMU, Fried, SC, superintendent, Omaha, Nebr.

Operator's license only:

Raffaele, AAF, instructor, Scott Field, Ill.

100 PER CENT WAR WORK—INDUSTRY

American Airlines, LaGuardia Field, N. Y.

ex-1BHA, Bertrand
 1CMR, Robitaille
 ex-1EKK, Asocks
 1HLJ, Hardy
 ex-2AQF, Tangen
 2EIC, Slack
 2HPJ, McKensie
 2ISV, Falk
 2LQA, Melville
 2MYW, Fahey
 2NFF, Fey
 3GHE, Cooney
 3JOY, Morphet
 ex-4EY, MacDowell
 4HTP, Lee
 5DJH, McNutt
 5FRN, Dore
 5GJE, McFarlen
 5IWP, Young
 5KOK, Gryst

ex-7GRH, Richmond
 K7EID, Riddell
 ex-8NJV, DeGasperi
 8NOK, Sebring
 8WHN, Severson
 9RBE, Sears
 9SNR, Norrid
 9VFC, Goukeneur
 9YPL, Klein

Operator's license only:

Hackaunda

Brush Development Co., Cleveland, Ohio

ex-2ERP, Bielecki
 8AIR, Schupp
 ex-8AUB, Hay
 8BM, Domizi
 ex-8BWB, Bernhardt
 8CTI, Summerville
 8EKE, Hensley
 8IRM, James
 8KFO, Sprosty
 8KHL, Link
 ex-8KOP, Arndt
 ex-8LLC, Denk
 8MXE, Jezek
 ex-8NP, Chambers
 8OBG, Blaha
 8OPX, Bamberg
 8PJV, Simone
 8PVY, Guarnieri
 8PZM, Mosonics
 8QCB, Gums
 8QPL, Haynes
 8RJE, Mace
 8SBB, Bamberg
 8SJM, Sestik
 8TAY, Bien
 8TTA, Foraha
 8UKS, Harris
 8ULL, Sawley
 8UWM, Matuszcyk
 8VUV, Marchant
 8JQY, Lane
 ex-9RMT, Miller
 ex-9UGL, Ragland

Collins Radio Co., Cedar Rapids, Iowa

6PRM, Boyd
 ex-8BNZ, Miller
 ex-8AYU, Lowder
 9CPE, Rieck
 9CVU, Boegel
 ex-9CXX, Collins
 9EIT, Everhart
 9GIM, Edmonds
 9JR, Webster
 9JTF, Lighthart
 9KRA, Johnson
 9LLE, Schmat
 9LRS, Cerny
 9MNA, Sperry
 9NKS, Icenbice
 9PEO, Bishop
 9PUN, Martin
 9ROW, Senti
 9RQN, Ennis
 9SEC, Lukehart
 9SPZ, Hubbard
 9SUG, Cerny
 9TTC, Bruene
 9UCM, Smith
 9YDL, Foster
 9ZXK, Gardner

Consolidated Aircraft

1IRL, Simpson, instructor, LaJolla, Calif.
 2BUB, Ramm, San Diego, Calif.
 2NXF, Young, ft. radio operator, San Lorenzo, Calif.
 5EVB, Sutherland, radio operator, Ft. Worth, Texas
 6FRY, Labby, radio inspector, San Diego, Calif.
 6SLO, Brown, foreman, Tucson, Arizona
 6SSU, Rodier, ft. radio officer, San Diego, Calif.
 7FRA, Harland, Tucson, Arizona
 7GXC, Potter, ft. radio officer, Berkeley, Calif.
 8URL, Gruver, ft. radio officer, San Diego, Calif.
 9AVQ, Clark, ft. radio operator, San Diego, Calif.
 9BVT, Mitchell, technician, Louisville, Ky.
 9DZA, Gilpin, engineer, Tucson, Arizona
 9IIB, Neiheisel, radio technician, Tucson, Arizona

9K0X, Chamberlain, technician, Louisville, Ky.
ex-9NW, Sutton, foreman, Downey, Calif.

Operator's license only:

Behrns, flt. radio operator, San Diego, Calif.
Hyatt, radio technician, New Orleans, La.

Farnsworth Telephone & Radio Corp.

1LBI, Allen, Stanford, Conn.
ex-6CET, Stagnaro, Ft. Wayne, Ind.
8ARW, Snyder, Greenville, Ohio
8DC, Beek, Pittsburgh, Pa.
8EOU, Wilson, Greenville, Ohio
8PYX, Willis, engineer, Marion, Ind.
8SAQ, Lindstrom
8TDN, Holzspfel, Greenville, Ohio
8VBU, Havens, Ft. Wayne, Ind.
9BKH, Bell, New Haven, Ind.
9DBJ, Leitchner, Ft. Wayne, Ind.
9DRS, Cole, Decatur, Ind.
9EEV, Wagner, Ft. Wayne, Ind.
9ETH, Meyer, Ft. Wayne, Ind.
9EZZ, McKay, Ft. Wayne, Ind.
9FBL, Edgbert, radio engineer, Marion, Ind.
9GBW, Ostman, resident manager, Washington, D. C.
9JLA, Curry, Ft. Wayne, Ind.
9JRC, Carl, Ft. Wayne, Ind.
9JKA, Mayle, project engineer, Ft. Wayne, Ind.
9LKI, Sanders, Ft. Wayne, Ind.
9KZB, Bigelow, Ft. Wayne, Ind.
9RMT, Hancock, Indianapolis, Ind.
9SWH, Clifton, Ft. Wayne, Ind.
9TNP, Beach, Ft. Wayne, Ind.
9VKG, Dutkiewicz, Ft. Wayne, Ind.
9WMD, Habig, Ft. Wayne, Ind.
9WRLE, Gust, Logansport, Ind.

Operator's license only:

Brown, troubleshooter, Marion, Ind.

Federal Telephone and Radio

1AEX, Austin, radio engineer, Dedham, Mass.
1BEF, Rich, Upper Montclair, N. J.
1MIG, Garber, Transmission Lab., New York, N. Y.
2ADK, Sundberg, engineer, New York, N. Y.
2AIF, Watzel, Transmission Lab., New York, N. Y.
2AQN, Dubin, engineer, Brooklyn, N. Y.
2ATK, Van Pelt, field engineer, Newark, N. J.
2BCC, Felsenheld, Transmission Lab., New York, N. Y.
2BED, Baasch, Transmission Lab., New York, N. Y.
2BKZ, Kolz, Transmission Lab., New York, N. Y.
2CGD, Clark, engineer, New York, N. Y.
2CNP, Padrosa, Test Dept.
ex-2COD, Fischer, Design Dept., New York, N. Y.
2CPD, Lewis, Engr. Dept., Montclair, N. J.
2CWE, Daubaras, engineer, New York, N. Y.
2DCE, Hoffman, estimator, Fairfield, N. J.
2DJY, Bortow, Transmission Lab., New York, N. Y.
2DIF, Thompson, Engr. Dept., Verona, N. J.
2EPI, Flynn, Transmission Lab., New York, N. Y.
ex-2FAC, Lengler, Transmission Lab., New York, N. Y.
2FAS, Kenyon, engineer, Williston, N. Y.
2FCQ, Clifford, engineer, New York, N. Y.
2FPL, Altess, wireman, Newark, N. J.
2FUV, Pochick, engineer, New York, N. Y.
2GAI, Carton, Test Dept., New York, N. Y.
2GIN, Shafer, Test Dept., New York, N. Y.
2HFE, Diven, Transmission Lab., New York, N. Y.
2HJA, Koleda, engineer, New York, N. Y.
2HMC, Oster, Engr. Dept., Montclair, N. J.
2HVM, Talamini, engineer, Newark, N. J.
2HXG, Newitt, engineer, New York, N. Y.
2IHX, Rudensee, Engr. Dept., Orange, N. J.
2IYW, Silver, Transmission Lab., New York, N. Y.
2IQV, Hart, engineer, Clifton, N. J.
2IRL, Detman, engineer, Brooklyn, N. Y.
2IVK, Moskowitz, Transmission Lab., New York, N. Y.
2IZP, Ellis, Engr. Dept., Summit, N. J.
2JAM, Walters, Transmission Lab., New York, N. Y.
2JN, Atwater, Engr. Dept., Montclair, N. J.
2JTW, Markowitz, Engr. Dept., Montclair, N. J.
2JVU, Frisch, engineer, New York, N. Y.

2KBQ, Nicholls, inspector, Newark, N. J.
2KEE, Gendler, Transmission Lab., New York, N. Y.
2KQV, Schreyer, engineer, New York, N. Y.
2KRR, Ala, tester, Newark, N. J.
2KSD, Sachs, Engr. Dept., Newark, N. J.
2KTB, Slade, radio technician, Newark, N. J.
2KUM, Johnson, Kearny, N. J.
2KVV, Friedman, Engr. Dept., New York, N. Y.
2MAA, Boroni, Design Dept., East Orange, N. J.
2MIK, Krause, Transmission Lab., New York, N. Y.
2MNZ, Storch, engineer, New York, N. Y.
2MO, Ports, Engr. Dept., Montclair, N. J.
2MOC, Rothstein, Engr. Dept., Bronx, N. Y.
2MRG, White, Test Dept.
2NB, Rommänder, Engr. Dept., West Caldwell, N. J.
2NFI, Knauer, Transmission Lab., New York, N. Y.
ex-2NJ, Tionaytis, Transmission Lab., New York, N. Y.
2NNG, Gordon, engineer, New York, N. Y.
2NPF, Nye, engineer, New York, N. Y.
2NSO, Johnson, Engr. Dept., Newark, N. J.
2NYN, Johnson, Engr. Dept., Mt. Arlington, N. J.
2OBO, Grieg, Transmission Lab., New York, N. Y.
2OCP, Crawford, Hasbrouck Heights, N. J.
2OCF, Hall, draftsman, Newark, N. J.
2OPT, Wilkowski, Test Dept., Newark, N. J.
ex-2PR, Sandberg, Transmission Lab., New York, N. Y.
3DYZ, Bedard, tester, Newark, N. J.
3IRY, Haynes, Transmission Lab., New York, N. Y.
3JUR, Breen, Engr. Dept.
6PAR, Arnold, engineer, Newark, N. J.
7HRL, Powell, engineer, Chicago, Ill.
ex-8BRJ, Wagner, Newark, N. J.
9KBL, Miles, radio engineer, New York, N. Y.

Operator's license only:
Boyle, Transmission Lab., New York, N. Y.
Gaines, lab. technician, New York, N. Y.

General Electric Co.
1ALR, L'ecuyer, Fitchburg, Mass.
1BWJ, Smith, general foreman, Lynn, Mass.
1COI, Nuttall, Erie, Pa.
1DRJ, Smith, line foreman, Salem, Mass.
1EJH, Martin, Bridgeport, Conn.
1EFC, Gibbs, radio engineer, Bridgeport, Conn.
ex-1FBS, Adams, Transmitter Dept., Schenectady, N. Y.
1GUA, Badger, Transmitter Dept., Schenectady, N. Y.
1HAX, Reiss, Bridgeport, Conn.
1HJP, Hewson, engineer, Schenectady, N. Y.
ex-2CKJ, Rew, Schenectady, N. Y.
2DAA, Mosseari, Schenectady, N. Y.
ex-2IWC, Tully
2KFN, Downey, radio engineer, Schenectady, N. Y.
2KXF, Earley, Schenectady, N. Y.
2MJT, Payne
2MRO, Reuther
2NAD, Ryan
2NAH, Ryan
2NBF, Gagne
2NTC, Staff
3HID, Davis
4DBE, Lawhon
5AE, Peine, Chicago, Ill.
ex-6CKP, Imler
6QWI, Gardiner
6SYR, Dick, San Francisco, Calif.
8AKS, Caster, Amsterdam, N. Y.
8BHS, Fisk, San Diego, Calif.
ex-8BXG, Pier, Union City, Pa.
8FBL, Kindl, Amsterdam, N. Y.
8FF, Baker, Broadalbin, N. Y.
8FPC, Sroka, Schenectady, N. Y.
8FWY, Coulthart, Syracuse, N. Y.
8GAS, Wells, Schenectady, N. Y.
8GAZ, Fischer, Broadalbin, N. Y.
8ITN, Evans, Schenectady, N. Y.
8KHT, Cary, Schenectady, N. Y.
8LWA, Thomas, Schenectady, N. Y.
ex-8MF, Coumont
8QVT, Douglass, Schenectady, N. Y.
8SBI, Eaton, engineer, Syracuse, N. Y.
8UFC, Chivers
8WBF, Zabawa, Schenectady, N. Y.

General Electronics, Greenwich, Conn.

1CTN, Ranhosky
1FSG, Bunblasky
1HIR, Hanack
1JON, Waldron
1NQP, Sale
ex-2ANQ, Crowe
2BIQ, Lefor
2CRQ, Wetherwax
2KFA, Lombardi
2LCA, Oberle
2LEM, Lemmo
3CHU, Jones
ex-4BEY, Arnold
5FRL, Beistle
7IV, Atherstone
ex-8CLW, Hollenbeck
ex-8CVC, Hood



Seven is a lucky number, but it took more than luck to enable these seven hams to keep WRW, the C.A.A. station located in San Juan, P. R., in operation. These men, who put their ham knowledge to work at WRW, are, left to right, kneeling: G. E. Meyer, K4HEB; C. A. Long, W5JAC; T. L. Lindsey, W4IHH (ex-W5). Standing: J. A. Brigman, W4IEN; Harold Cagle, W4DYX; E. W. Mayer, K4KD; W. C. Thomas, W4BZA.

General Radio, Cambridge, Mass.

1AEM, Gokey
ex-1AHO, Allen
ex-1AIB, Hodgdon
1AKC, Hobart
1AMB, Samour
1APV, Lundgren
1AS, Coleman
ex-1AUJ, Johnson
ex-1AYW, Litchfield
1AZF, Ausin
1BBJ, Stempel
ex-1BEL, Smiley
1BPF, Henuset
1BSX, Wentworth
ex-1BYX, Clapp
1CL, Richmond
ex-1CME, Kneeland
ex-1DDO, Ruplenas
1DFL, Packard
ex-1DK, Ireland
1ELV, Hawes
1FES, Surety
1HMK, Sorette
1IB, Bradshaw
ex-1IL, Lamson
1JK, Shaw
1KRJ, Pratt
1MMP, Lenihan
ex-1PZ, Ranlett
1QT, Wade
1WG, Hollis
ex-1WG, Burke
ex-2BKL, Burgess
ex-4EIR, Bibber
ex-5ZL, Clayton
ex-9AMM, Thiessen
ex-VE4FV, Sinclair

Harvey Radio Labs., Cambridge, Mass.
1ARF, Carpenter
ex-1GOT, Ajeman

IGEL, Johnson
IGKA, Getchell
IJJN, Jackson
IJHR, Vacca
IKYY, Blood
ILNQ, Vogel
INV, Hall

Operator's license only:

Cianciarulo
Hautaniemi

Haseltine Corp.

ex-1BQI, Davenport, field service engineer
KA1US, Arnold
2AFF, Trotta
2AGY, Stiepel
2BRO, Waller
ex-2DMA, Sturgell, field engineer
2EZE, Lowens
2GTL, Hansen
2HRC, Cunniff
2HSG, Mumma
2KQM, Fischman
2LJL, Sillman
2NET, Mitchell, field service engineer
2NNK, Oberlies
2OJO, Whitehouse
ex-3BMQ, Doughty, field service engineer
3BQN, Tyson
3COG, Seltzer, field service engineer
2DHR, Dunlap, field service engineer
3E1W, Farr, field service engineer
3GFB, Sheppard
ex-4MPV, DeLay, field engineer
5BGW, Sutton, field service engineer
5IQD, Todd, field service engineer
6ALR, Emm, field service engineer
6BQG, Slater
6FXT, Stubbe
ex-6MZP, Collins
ex-8AQB, Hay
8QA, Leist
ex-8TB, Gardiner
8TOY, Draper
8TW, Barnhart
8VII, Bowman
9BWW, Ore
ex-9CVM, Cox
ex-9ER, Mowrey
ex-9KD, Gray
9PCA, Helms
ex-9RBD, Kennicott
9TMU, Plaza
9ZJL, Stael

Operator's license only:

Carnes
Carter
Jerdid
Kleinman
Puzarelli
Schneider
Stewart
Wigutow

Lockheed Aircraft Corp.

6DHQ, Pascal
6HE, Wainwright
6JYO, Starbuck
6KWC, Gove
6PTI, Libby
6QKM, Wells
6TPD, McCallum
6UGS, Shott
6UKP, Browdy
8OUV, Dunmire
8RMO, Richey
9KWZ, Hallgren
9QWD, Carlisle
9RS, Braun
9VKI, Panissidi

Minneapolis-Honeywell

ex-2HQN, Mayer
3LZJ, Chudyk
4FBK, Strother
6HXB, Kidd
6TPY, Brown
7FTS, Ulowets
8CXX, Mihalick
8KOC, Nurches
8LAY, Boone
8PFO, Odell
ex-8QM, Peterson
8SYG, Russell
8YZB, Caspari
ex-8AJP, Upton
9AOJ, Prah

9AQJ, Fifer
ex-9AV, Raw
ex-9CDV, Palya
9CIX, Wilson
9DJH, Foster
9DZM, Dick
ex-9EAR, White
9EIE, Mullins
9ELH, Brsana
9FOZ, Tufford
9GHK, Porter
9GHO, Dahline
9GYH, Martinson
9HEX, Hatlestad
9HPS, Leonard
ex-9IHV, Onstad
9IKN, Miller
9IPO, Webb
9IPX, Nodler
9ITG, Beam
ex-9IUD, Smith
9JFH, Frary
9JZY, Titus
9KQO, Sorenson
9KVI, Wagner
ex-9LCN, Higginbotham
ex-9MEU, Sadilek
9NBW, Hage
9OBM, Hoch
9OGU, Johnson
9PPV, Vavra
9PTN, McNeill
9QIN, Clark
9QYX, Ebeltoft
9RHT, Booen
ex-9RJW, Cullerton
9RLM, Gable
9RXL, Pramann
9SIX, Gerrish
9TNT, Whempner
9UPK, Grantham
9WAB, Smith
9WBL, Henry
9YBM, Folsom
9ZDU, Coons
9ZNY, Feigal
9ZPB, Markusen
9ZXR, Smith

Operator's license only:

Fosse
Kunkel
Slaughter

M.I.T. Radiation Labs.

1AAW, Carpenter
1ACI, Gordon
ex-1AG, Pote
ex-1AME, Henkel
ex-1AOV, Hatchelder
1API, Costello
ex-1ASF, Sise
ex-1AUM, Briggs
ex-1AXZ, Ehrenfried
1BDS, Burgess
1BLQ, Speed
ex-1BOL, O'Leary
1BPI, McKensie
1BPR, Scully
1BQ, Janvrin
1BU, Howard
1BWJ, Parsons
1BXP, Parsons
1CBW, Farr
1CDY, Denger
ex-1CJM, Krainowek
1CKW, Ames
1COO, Bent
1DBD, Heath
1DDC, Brown
1DEY, Stone
1DOS, Lynch
1DPW, Jones
ex-1DQG, Boothroyd
1DSE, Gilbert
ex-1DSR, Goddard
1DVC, Edwards
1DVS, Mills
1DXK, Kinnear
1DXO, Abbott
ex-1EB, Pierie
1EHT, Gardner
ex-1EJT, Bunn
1EKT, Whitney
1EMJ, Arone
1ESP, Willett
ex-1EVL, Grass
1FSL, Miller
1FWK, Mae

1FYN, Tassinari
1FVY, Tassinari
1GFF, Ames
ex-1GGI, Rukas
1GJQ, James
1GKM, Davidson
1GLU, Moreau
1GND, Tracy
ex-1GSR, Allen
ex-1HLW, Mockapetris
1HME, Chaloff
1HOE, Wheeler
1HPV, Champigny
ex-1HQG, MacDonald
1HSM, Whitham
1HTG, Hagan
1HVN, Nichols
1HXK, Shulman
1HXT, Strom
1IDH, Niemiec
1IKZ, Greens
1ILL, Hall
1IPZ, Jubb
1IUP, Maloof
1IVU, Perkins
1JDO, Hilbrunner
1JEK, Currier
1JFR, Marfield
ex-1JGR, Halford
1JIR, Macnee
1JMY, Moskey
1JNW, Crosby
1JOV, Crooker
1JST, Carbary
ex-1JVJ, Stewart
1JVL, Lawrance
1JZZ, Luke
1KC, McKee
1KDH, Kurtaner
1KH, Bailey
1KMY, Sullivan
1KOD, Abajian
1KOF, Campbell
1KUD, Ceraaka
1KZD, Nicholas
1LAE, Perotti
1LAQ, Hewitt
1LCY, Fallows
1LJN, Nickerson
ex-1LIX, Ferrier
1LMF, Wilson
1LMQ, Thomas
1LNX, Bartro
1LRD, Sheridan
1LRH, Woodward
1LRM, Smith
1LUL, Fivelatis
1LVB, Elliott
1LVC, Gaggiardi
1MCS, Sliby
1MOR, Koury
1MQN, Cookson
1MTV, Goss
1MUW, Moskey
1MWO, Star
1MYE, Cushing
1MZS, Erskine
1NAD, Mansur
1NAX, Sherman
1NCZ, Nickes
1NFE, McCasland
1NDI, Mansur
1NIF, Westham
1NJI, Olivieri
1NKK, Cameron
1NOX, Rocco
1NPF, Rennie
1NPH, Manger
1NSJ, Friend
1PE, Berg
1SE, Holbrook
1TC, Kuper
ex-1TM, Spalding
ex-1UG, Derrah
1ZAC, Day
2ANZ, Stein
2AOP, Richardson
2BZB, Doersam
2FRD, Hammann
2INQ, Weiss
2LIX, Aldrich
2MPP, Gregory
2NFY, Gilbert
2AJB, Keener
2AMP, Butt
2AWH, Beers
2CND, Peck
2EVX, Sheppard
2FHD, Uphoff

3GFR, Chaconas
 3IWN, Scott
 3IWX, Jacob
 3JH, Kantor
 3JH, Duvall
 3RN, Vissers
 4AI, Eaton
 ex-4DUJ, Kline
 4DUK, Bell
 4EQE, Woodward
 4FTY, Powell
 4FRS, Faire
 4HRW, French
 4HA, Harvey
 5BUB, Pike
 ex-5DEQ, West
 5DQD, Little
 5GBB, Jacobi
 5GNR, Becker
 5GQW, Orpin
 5HGM, Cannavan
 5JAN, Hoefs
 5KIJ, Pourciau
 6CBK, Curran
 6CJ, Lindgren
 6DOB, Jones
 6IOY, Reed
 ex-6IOY, Reed
 ex-6IFF, Fenn
 6IVY, Lissauer
 6JBJ, Lents
 ex-6UG, Schwenden
 6JXW, Schneider
 6LCY, Cunningham
 6LJK, Blackburn
 ex-6LYZ, Beers
 6MNU, Hayes
 6MTQ, Hagler
 6MUY, Walters
 6NFM, West
 6NNZ, Herlin
 6OR, Johnson
 6OUA, Gardner
 6OUL, Proctor
 6PDP, Coleman
 KB&PQ, Jorgenson
 6PZU, Rieth
 6RIF, Young
 6RJS, Reinsch
 6SCU, Dixon
 6SNU, Newton
 6SVY, Kopp
 6SX, Jeffers
 6TIL, Gardner
 6TZJ, Hollingsworth
 6UTT, Minner
 ex-7AFN, James
 ex-7ALB, Brady
 7ASU, Mallach
 7ATU, Martin
 7BAC, Ward
 ex-7BJA, Herner
 7BMV, Griffiths
 7BNG, Sorvasg
 7BOG, Stanley
 K7BUB, Bennett
 ex-7CFB, Cook
 7CFX, Belleville
 7CPS, Barry
 7DPV, Lien
 7DTU, Niemann
 ex-7EBI, Josephson
 7FZH, Sechrist
 7GAM, Smith
 7GZD, Ilman
 7IGY, Sobczyk
 7LZ, Soper
 7VP, Johnson
 8DMW, Blossom
 8JIG, Krohn
 8DCH, Pound
 8NUX, Johnson
 8OTE, Young
 8RAN, Williams
 8RSE, Glos
 8SKV, Stoner
 8SL8, Horgau
 8TCI, Kamm
 9AGI, Suits
 9DIC, Eisenstein
 9ELQ, Sopotilov
 9FFY, Kerns
 9FPO, Mitchell
 9GOL, Moon
 9GSQ, Dewitt
 ex-9HRX, Kerr
 9HUC, Hopperle
 9IFM, Boyers
 9JZK, Reed

9LQZ, Hancock
 9LZM, Bissell
 9NGE, Foral
 ex-9NT, Chapman
 9NUF, Nibbe
 9NWB, Cowan
 9OFC, Brean
 9QZM, Roberts
 9SFZ, Murphy
 9SLT, Bentley
 9UEZ, Gamertfelder
 9VEP, Birchard
 9VFB, Logemann
 9VRB, Jarnots
 9WTR, Deerhake
 9YLD, Nieter
 9ZGF, Hartman

2JCG, Albrechtsen
 2MHW, Eidel
 2MJW, Gimler
 2OBE, Weismantel
 2EEQ, Snedeker
 5HQN, Kramer
 6BQ, Kiyomura
 6OWP, Bartlett
 8IQW, Harlan
 8IVQ, Yingling

Operator's license only:
Bruder

Radiation Lab., University of California

5LZX, Steldtmann
 6AOL, Park
 6DSZ, Clapp
 6DXB, Wiens
 6GN, Gilroy
 6IKQ, Caldera
 6KZN, Browne
 6LCT, Squires
 6LVD, Tucker
 6MGY, Wagner
 6MNG, Sessions
 6MUC, Clark
 6MUR, Johnson
 6MZS, Conover
 6NAQ, Waithmar
 6SQ, Morrison
 6SRR, Dexter
 6TFZ, Heerovich
 6TIA, Nickel
 6RMN, Parkin
 9QCF, Barrett

Radio Research Lab., Harvard University

1ADP, MacKetohnie
 1AHB, Turner
 1AHC, Grant
 1AYI, Boynton
 1AZZ, Norton
 1BFG, Powers
 1CCL, Hunt
 1DEG, Towle
 1DGC, Stephenson
 1EFF, Baldwin
 1EVE, Welch
 1EXU, Sullivan
 1FPR, Erickson
 1HRF, Gibson
 1IIP, Ayer
 1JPV, Cohn
 1JWG, Wilson
 1KFE, Eames
 1LNU, Cooke
 1MMY, Eggers
 1MBC, Oliphant
 1NVV, Plotts
 1TL, Brooks
 1UL, Preston
 1VV, Haskell
 2AER, Hollywood
 2HTV, Clark
 2IVI, Moran
 2KJX, King
 2UN, Roe
 5IVX, Fonopulos
 5KGY, Lohr
 5RK, Ross
 5TA, Collins
 6MRL, Reynolds
 6PKM, Robbiano
 6QHL, Manning
 6TZV, Crispell
 7CNV, Rhiger
 7DOX, Pearson
 7EWO, Barnard
 7EZZ, Yunker
 7FCA, Ellis
 7GRV, Bridgeford
 8JK, Kraus
 8KXH, Barnes
 8NUX, Johnson
 8PEF, Barrett
 8WAC, Davis
 9EGO, Frelch
 ex-9FMM, Harring
 ex-9JRV, Morehouse
 9KWE, Raburn
 9LGN, Dowell
 9QBE, Katsel
 9VKU, Duffy
 9WVG, Eldredge



Sgt. J. M. Dortch, W4DDF, early in his army career, tried to wrangle a transfer from Engineers to the Signal Corps in order to do radio work. That Johnny, now stationed in Kunming, China, was unsuccessful in getting his transfer, but was made communications chief and has been operating radio gear since that time, probably accounts for that happy smile.

Operator's license only:

Gronroos
 Jameson
 Lindgren
 Russell

Nasal Ordnance Plant, York, Pa.

2ATX, Dillmeier
 2BUV, Blatner
 3BDV, Shaffer
 3BIL, Turkington
 3FOV, McCrobie
 ex-3GA, Trout
 3GIH, Sechler
 3GZZ, Dorn
 3VH, Waeide
 3IQN, Thomas
 3JNT, Colson
 3JOH, Cullison
 8BQ, Wallace
 8CRJ, Smith
 8KJU, Spotts
 8OGM, Barkson
 8RFM, Shade
 8TTM, Calvert

Operadio, St. Charles, Ill.

4HYL, Hill
 9AUB, Kall
 9CUX, Horst
 9EXE, Engelschall
 9HMJ, Wagner
 9HQZ, MacDermaid
 9LBS, Hohberger
 9NAN, Chapman
 9TMI, Sullivan
 9YOM, Larson

Press Wireless

KA180, Stovall
 2ABS, Buff
 2AOA, Doscher
 2AZS, Bouteiller
 2DCO, DePasquale
 2DNW, Van Dyke
 2ELE, Fallo
 2FUB, Cohn
 2GPO, Asbury
 2HEU, Howard

OPERATING NEWS

F. E. HANDY, WIBDI, Communications Mgr.
E. L. BATTEY, WIUE, Asst. Comms. Mgr.

J. A. MOSKEY, WIJMY, Communications Asst.
LILLIAN M. SALTER, Communications Asst.

Postwar Operating Prospect. The enthusiasm with which all amateurs have greeted the return of W1AW to the air under temporary FCC authority has been evidenced in a flood of letters and cards. Thanks! The reports are welcomed. They give an idea of the coverage of the several transmitters. This is especially helpful as some of our antennas that became war casualties are undergoing rehabilitation.

W1AW has already carried the "hot" news concerning reactivation and FCC Official Orders concerning amateur station licensing, to date. It's a bright prospect. For all of us with that itchy yen for key or mike it is a prospect of gradually expanding amateur activity.

The Section Emergency Coördinator. News-of-the-month in amateur organization is that in view of the high importance of perfecting ARRL provisions for supplying the nation with emergency communication, Headquarters has asked every Section Communications Manager to appoint a *Section Emergency Coördinator*.

His responsibility includes the promotion of organization, advance planning, and practical provision of radio amateur facilities for supplying communication for the communities within the Section that are most likely to be faced with a natural disaster or other form of public emergency. The Section Emergency Coördinator will report monthly, through the SCM, on the status

and progress of all emergency communication plans for the ARRL Section for which he has responsibility. Community emergency planning and organization will continue to go forward under direction of an ARRL Emergency Coördinator appointed for the particular community. The Section Coördinator, however, will recommend any and all necessary measures to the SCM to insure an active program for each community or area that has had, or can be presumed to require, emergency radio communication, in the future.

ARRL Emergency Corps Invitation. You will want your station to be in the new ARRL Emergency Corps. Attention is invited to the announcement elsewhere in this issue which explains its function and tells how you can and should help.

Recommend an Emergency Coördinator to your SCM (address from page 6 *QST*) if your community has none. Place the support of your operating ability and station facilities, mobile or otherwise, behind the ARRL Emergency Corps by registering your facilities therein. Ask your Coördinator for a registration blank, or get your local club to drop a line to Hq. for such blanks.

All who participated in WERS are most cordially invited to continue activity, taking as prominent a part as possible in the reorganized local community radio activity. It only should be necessary for many to qualify for amateur operator licenses to meet the FCC requirements for operating an amateur station. Many forward-looking Radio Aides, WERS, have recently reported code classes in full swing to assist in qualifying members of their groups for ham tickets. Local radio clubs can do a world of good by sponsoring code class groups and assisting in every way possible in the whole program for conversion to the new Emergency Corps organization. WERS stalwarts are urged to write SCMs, and recommend one of their group who is a League member for Emergency Coördinator to carry on, where such an appointee is not already part of their organization.

Convert to 144 Mc. as quickly as possible. The new Emergency Corps will offer individual operators interesting activities, a chance to participate prominently in tests and simulated emergencies, a chance to demonstrate operating ability, and to become respected as a member of the group dedicated to giving radio communications service in emergency. The activities in each community will of course depend on the plans conceived by a planning group, dependent in turn on the anticipated emergency problems and re-



(Photograph by The Hartford Courant)

W1AW returns to the air! Communications Manager F. E. Handy, WIBDI, is here pictured at the ARRL Headquarters Station during the evening of October 31st when the first post-war transmission of information "to all radio amateurs" was made. It was a night of intense excitement at Hq. just as it must have been to the amateurs who tuned across 3.5, 7 or 14 Mc. and heard the long-familiar "QST de W1AW" ringing out once more!

quirements for that community. While the frequency ranges used by different groups may vary somewhat, it is expected that 144 Mc. will remain the important frequency for local emergency nets in most cases. The lower frequency (h. f.) equipped stations will be required for possible links to the outside and to provide operator reserves. The invitation to participate in the Corps is extended to every person in the U.S.A. and Canada with an amateur operator's license.

Come in with us to-day. See further announcement elsewhere in this *QST* and take steps at once to register in the AEC. One of those pocket Emergency Corps Member cards will be issued by the local Coördinator just as soon as he has the local authority, and your registration form.

Amateur Radio Procedure. A good many letters have been received on the subject of procedure, some for the adoption of military procedure for amateurs, more against. It may be timely for us to state that no action is being taken by ARRL to adopt military service procedure as such.

The amateur service has long followed its own procedure, this being formalized to the extent desired by and required by amateurs to effect standardization of calls, sign offs, request for fills, and insure intelligibility, speed and efficiency in amateur operation. Relay procedure, message form, word count, R-S-T, phonetics, break-in and emergency procedure are all discussed in the ARRL booklet, *Operating an Amateur Radio Station*. Also see the chapter on Radio Operating in the *Radio Amateur's Handbook*.

Let us add that on close examination all procedure is hybrid. Our present usages retain some borrowed elements from early Morse telegraph practice. They have some highly specialized elements peculiar to amateur needs. Many of the important sections conform to international procedures standardized and revised as found convenient at telecommunications conferences; some conform to military procedure usages at the present time. Under the proving ground conditions of wartime the services found it essential to get together on differences in their own procedures, and in turn to correlate differences in British and U.S.A. procedures. A "combined" military procedure was adopted after deliberation by the combined Chiefs of Staff. Agreements were reached on major points, and a common procedure, like a common language, helped in winning the war. Even so, each of six services represented in CCB committees retained some specialized procedure going beyond the common fundamentals, as required by its needs. The police, the airways, the railroads, the amateurs, etc., will always have peculiar requirements. While adhering to common elements to facilitate general understanding, and assist in training, it will continue to be necessary to standardize and adopt procedures to keep pace with special operating requirements and techniques.

This is not to say that there is not virtue and utility in certain elements of service procedure. But it would be sheer regimentation to make a

WIAW Operating Schedule: Transmissions of latest FCC information relating to amateur operation or reactivation are made as follows:

Frequencies — 3555, 7145 and 14280 kc.
Times — 8:00, 9:00 and 10:00 P.M.
E.S.T., Monday through Friday. Simultaneous c.w. transmissions. Each code transmission will be followed by voice transmission on each of the above frequencies in turn.

blanket adoption of military, or police, marine, or other special procedure en toto.

Those elements having superior utility in operation have in the past automatically "sold" their use to operators in the course of their pursuit of amateur radio. Operating habit is strong. Thus, whether we like it or not, there can hardly be less than a profound try-out of some of the more commonly used service procedures and abbreviations, when our thousands of G. I. amateur operators are back at their own keys and mikes. The good is bound to receive eventual adoption, the bad (that which may not best fit the operating needs) will be quickly discarded.

Your ARRL Communications Department does not believe that major changes in procedure should be adopted until the normal course of test-by-use and discussion within the amateur groups most concerned in a particular procedure has had full opportunity to bring out the strong and weak points. In every case also the need must be extensive and not confined to small groups within the amateur ranks, if the procedure for our amateur service is to be kept simple and universally useful, so as to command attention and use by all groups of amateurs. As amateurs, we intend to follow our own procedure. This procedure will necessarily be extended and improved from time to time. It will be that procedure developed in the field of amateur radio itself, by amateurs, for amateur operation.

— F. E. H.

ANNOUNCING!!

Plans for DX Century Club

It won't be long (we hope!) before it is possible to resume our DX contacts. Just what form the postwar DX picture will take no one can say, but we do know that as we get back our long-range bands, DX work will again take its place as one of the most fascinating of amateur activities.

There are sure to be many changes in the line-up of countries. There will be hams at innumerable spots we just dreamed of before. The prospects for interesting DX contacts are more intriguing than ever.

The fact is, it looks like we may have an almost new amateur radio so far as DX is concerned.

(Continued on page 130)

AMATEUR ACTIVITIES

ATLANTIC DIVISION

EASTERN PENNSYLVANIA — SCM, Jerry Mathis, W3BES — Amateur activities are proceeding apace. The York Road Radio Club has resumed formal meetings at its old stand in Elkins Park. The Beacon Radio Club amateurs are getting things set. 3GYV, 3KT, 3DPU, and 3FPW are out of the Army. The AEC is being reorganized and applications for EC are solicited. The Lower Merion and Haverford Townships WERS gangs had a joint meeting and farewell party attended by personnel from the Brookline Signal Corps station. Returned servicemen gave informal and entertaining talks on the activities of the Signal Service in the field. Will club secretaries please report activities of their club members each month? Applications for appointments are requested. 3JBC expects to be home for Christmas and his dad has his radio gear ready for him. 3I1N bought a new QTH. 3IXN will use a pair of 812s in his new final. 3HFD will use crystal control and f.m.-a.m. on the new 6-meter band with a pair of 35TGs in the final. 3CRO and 3DOU are planning super masts and antenna arrays. The gang has a field day every time the 2½-meter band opens and works W1s and W2s by the mile. Many old-time u.h.f. artists urge that we adopt universal horizontal polarization on the new 6-meter band. The lads using the QST ground plane antenna are getting out well. 3QV expects to go overseas again. 3DMQ was in the typhoon on Okinawa. 3JD is shipping out as radio operator again. The Lancaster Radio Club has reorganized and ran a Field Day meeting. 73, Jerry.

MARYLAND-DELAWARE-DISTRICT OF COLUMBIA — SCM, Hermann E. Hobbs, W3CIZ — EPD, chief radio officer on the SS *Edward G. Janeway*, c/o Postmaster, San Francisco, Calif., whose home address is Church St., Snow Hill, Worcester Co., Md., has returned from a voyage to Manila. While in Manila he met KALB and KAIAG, both of whom recently were released from a Jap concentration camp. They were working together in a radio shop in Manila. The WERS gang in Alexandria reports exceedingly poor results with short waves from Alexandria. JUD has returned to the old job. WN, of 920 Motter Ave., Frederick, Md., wishes to join the emergency gang. The following stations are on 2½ meters regularly: 9CSW/3, AIO, AUC, CRB, IFW, IBP, 4GMU/3, 1IIN/3, JE, 9CSW/3 has rebuilt and has 150 watts to an 829. 1IIN/3 blankets the area with his TR-4. DKT has rebuilt for operation on all bands when the ban is lifted.

SOUTHERN NEW JERSEY — SCM, Ray Tomlinson, W3GCU — Asst. SCM, Ed. G. Rasser, W3ZI; Regional EC, ASQ. Radio Aide ASQ reports that the Hamilton Twp. authorities have requested that the WKPX network of WERS be maintained in active operation until its discontinuance on Nov. 15th. Radio Aide ABS reports for Hillaboro Twp. that plans are being laid for the organization of an emergency set-up among the licensed amateurs in this locality to work with the police and fire companies in all municipalities. Bridgewater Twp., WJMN, is making plans along similar lines. UK is constructing a transmitter for use on the new 144-148-Mc. band. EED is at sea with the merchant marine, on the SS *Sea Hare*. GHK is in Zamboanga, Mindanao. Bill's QTH is: CWO William H. West, Co. A, 2nd Plat., 551st Sig. A.W. Bn., APO 717, c/o Postmaster, San Francisco, Calif. T/Sgt. IWF, who was transferred from the 85th to the 34th Division in July, is coming home to join the ranks of civilians. The DVRA membership committee reports good progress, with new members bringing the total to about 50, and more applications under processing. FBM dropped in on ZI recently; Ferd recently graduated from Radio Materiel School, and has been assigned to the West Coast. Ex-BSF passed the Class A exam recently. VE is permanently located at Fort Logan, Colo., where he has been assigned to the War Dept. Personnel Center. HKO is in the Philippines doing special communications work for the Signal Corps. Ex-EFE has left Western Air Lines in Alberta, Canada, and is back in Los Angeles where he intends to start in business for himself. BTX stopped in for a chat with ZI recently. GNU expects to appear for the radio-

telegraph exam in the near future. HAZ is in the Army with the Signal Detachment at Fort Jackson, S. C. RN, an old-time ship operator, has been working as civilian engineer for Radiation Labs. at M.I.T., Cambridge, Mass., and his assignment under secret communications project took him to England, Africa, Australia, Hawaii, and Alaska. HWO jr., stationed at a Signal Corps monitoring station somewhere in Hawaii, copies high speed circuits at 35 w.p.m. Lt. EOG/INQX is stationed with Det. 103rd, AACCS Sqdn., at Scott Field, Ill., as communications officer. Bill is anxious to hear from Sgt. BND. ITR is home sporting a brand-new discharge and intends to return to engineering school. IIN recently took upon himself a bride and expects to locate in Florida. GER, now 2MMN, will be commissioned as an officer in the USMS upon graduation from Officers' School, Trumbull, Conn. ISY has been transferred to RCA's high-powered transoceanic outlet at Rocky Point, L. I. ASQ is all set to "swing up" a new 112-Mc. antenna. GCU recently hung out a 112 Mc. "pusher rod." FTU has been heard on 112-Mc. c.w. AXU pumps out his 112 Mc. signals from a beam antenna. GQX expects to put a pair of HK-54s on 144 Mc. ITS is enjoying the superior operation of his new 112-Mc. converter. IDY is puncturing the ether with a pair of HK-24s on 112 Mc. 3UK packs a wallop down Trenton way. The Trenton boys are sure working out on 112. Some of the towns worked include Perth Amboy, Somerville, Bernardsville, Stratford, Highland Park, Philadelphia, Glenside, Neshanic Station, Feasterville, and Short Hills. IAS and FTQ, of the SJRA, plan to conduct code classes two nights weekly for the benefit of those who wish to brush up on their speed or improve their copying. Ex-AN/K4ENY/9AQE is now a full commander stationed at Naval Air Base, N. Y. PM2c HLY is stationed at Submarine Base, Navy 128, c/o Fleet Post Office, San Francisco, Calif. GCU and ASQ attended the September meeting of the SJRA with a view to obtaining recruits for Official Broadcasting Station and Emergency Coördinator appointments. Your SCM and your Regional Emergency Coördinator are desirous of obtaining applications for appointment as district emergency coördinators, to act as county coördinators responsible for local coördinators under their territories. Those interested please contact this office as soon as possible. There is a big job ahead for the public-spirited amateurs who are willing to help build up an efficient emergency organization. Applications for local coördinators also are needed.

WESTERN PENNSYLVANIA — SCM, R. R. Rosenberg, W8NCJ — Sgt. TVA has returned to the States, and is in Texas. TOJ reports that HKU has moved to Bradford. Warren now has the following active amateurs: BOZ, JSQ, RMM, VMW, TY, and TOJ. Lt. SHY writes from Okinawa, where he is operating a 300-watt transmitter carrying local armed forces radio broadcast programs. SHY has been in the Signal Corps for almost three years. According to word received from UVD, UHO is returning to this country from Europe. VNE is in Philadelphia awaiting assignment to a new aircraft carrier. TTN is in the Philippines on Mindanao Island. He was chief radio operator in the aircraft warning system, and saw service on Guadalcanal, Bougainville and Leyte. While on Bougainville he had the pleasure of meeting VK2AMP, 3FFN and 9EBG were in his outfit. UVD is erecting an 80-meter end-fed Zepp antenna. TTD tried his hand at raising cotton this summer. 3GJY is spending a well-earned vacation at Ambridge after his recent discharge from the Army. J. J. Blainer (LSPH), Springdale, another recently discharged veteran, holds a Class B ticket. NUH, RWJ, and WQ are employed at the same plant in Clarion. RWJ recently was released from the Army. VYU expects to resume studies at Carnegie Tech. in February. AOE and TOJ are new ECs; both are active on 2½ meters. Ed. Clark, ex-8BVK, one of Erie's pioneer radio amateurs, expects to be back in the active ranks soon. AAQ, employed by G. E. Co. at Erie for the past several years, recently became a member of RAE. At a recent RAE meeting, TXZ presented a very interesting technical talk and gave a demonstration on the cecilloscope. The Radio Assn. of Erie now meets in new club rooms, City Hall Annex Basement, 24 West 7th St., Erie.

CENTRAL DIVISION

ILLINOIS — SCM, David E. Blake, II, W9NUX — Many hams are building rigs for other bands and activity has reached a new high in Chicago. Transmitter hunts every other Sunday sure bring out the gang. Yours truly and 8TZO are playing checkers via 2½ meters and the old battle.

(Continued on page 76)



HAMS are settling down to the serious business of getting the rig ready to go on the air. As we write this, the go-ahead signal has not yet come, but there are no restrictions on planning.

There are some things we have wanted to say about degeneration, also called inverse feedback, and this seems like a good time to say them. Many good articles on inverse feedback have appeared, such as the one by Erhorn in *QST* for June 1943. We are not going to repeat all the standard dope, but there are a few pointers that may help when you are getting the rig ready.

It is often stated that one of the virtues of degeneration is that it "stabilizes the amplifier." This is correct, but do not misunderstand the word "stabilize." It means that the amplifier will have more nearly constant characteristics. For instance, the gain will be only slightly affected by line voltage shifts or a change of tubes. It does *not* mean that degeneration reduces oscillation, motorboating, flutter or other similar forms of instability. In fact, it makes them worse. Usually, it is necessary to wire a circuit with more care and provide better circuit isolation if degeneration is to be employed.

Phase shift can usually be ignored in audio amplifiers, but it is important when degeneration is used. Let's take a quick look at it.

As the names imply, the only difference between a degenerative amplifier and a regenerative amplifier (i.e. oscillator) is that the polarity of the feedback is reversed. In other words, the only difference between your stable amplifier and an oscillator is that the feedback is 180° out of phase. Anything that brings feedback into phase causes the amplifier to become an oscillator.

It is a characteristic of an amplifier that the phase always shifts when the gain is rising or falling. There is always a phase shift at each end of the range of each amplifier stage. There it is, and there is nothing that can be done about it.

The phase shift may amount to 90° for each resistance coupled stage, and to 180° for each transformer coupled stage. This phase shift is the maximum per stage and occurs only when the gain has dropped to zero at the end of the frequency range. If the gain is zero, there will be no trouble from oscillation due to phase shift, so here is a rule: *If feedback is limited to one transformer coupled stage, or to two resistance coupled stages, and if the feedback network itself contains only resistances, then you need expect no trouble from oscillation due to phase shift.*

If you want to apply feedback over more stages, the way to do it is this. Design all the stages *except one* with a wide frequency range, and make that one stage fall to zero gain before the other stages start to fall off. For instance, if the various stages of an amplifier are all flat from fifty cycles to ten thousand cycles, then there will be phase shift below fifty cycles and above ten thousand cycles. But if one stage cuts off at fifty cycles and at ten thousand cycles, then the amplifier will be "dead" at the frequencies at which it might otherwise oscillate. In other words, you have to design a wide range amplifier and then throw part of the range away.

Don't let these pointers scare you. Degeneration really works. If you avoid the two pitfalls mentioned above, you should have no trouble. The results are worth the effort if you want to turn a fine amplifier into a superb one.

WILLIAM A. READY



(Continued from page 74)

slip game is the rage once more. T/5 MZW, Hq. Co., 94 Sig. Bn., APO 887, c/o Postmaster, N.Y.C., writes from Paris, France. He heard from 1st Lt. WJS, who was chief of National Guard "ham" station. GJI is a B-29 pilot stationed in the Marianas. Pfc. PHB is on Leyte, P. I. MZ, who went skiing in the Tyrol Alps in July, sends his 73 to DXE and wants to know where NTV is. 1st Lt. GSP, 310th Ferrying Sqdn., APO 635, c/o Postmaster, N.Y.C., writes from England that he has made schedules with a few of the Gs and has joined the RSGB. He is planning a 500-watt rig with a rotary beam, and would like to hear from the Chicago Suburban Radio Assn. gang. YDV has a new jr. operator. 9FWU's operation has not hurt his jokes any. RP is back after being imprisoned in the Philippines. The Hamfesters are back at the Viking for their meetings. The Northwest Radio Club met twice a month all through the war. FCC, in Chicago, announces that exams for amateur licenses now are held on Friday. RLW has a new 4-element horizontal beam on 2½ and is ready for 10 meters to open up.

INDIANA — SCM, Herbert S. Brier, W9EGQ — ONB has been seeing Florida on his week-end leaves. AB spends his spare time listening for signals on 112 Mc. without success. CRZ and GOE are again civilians. WDV is a major, and has the Bronze Medal. PQL and HDB are working on 112-Mc. equipment. They hear many Chicago stations. DHJ is on 112. MEY took his Class A examination recently. IPU expects to get out of the Navy on points in five years. NVA says f.m. broadcasting is successful. He is still searching for information on wire recording. FDS is building a superhet receiver. EGV is mentally trimming trees; so his 80-meter antenna will be in the clear. His aim is 75-meter 'phone. UNS and HUV, 50 miles apart, have attempted to contact each other without success. QG has his transmitter and receiver dusted off waiting for 80 meters to open up. YMV is on the air in West Hartford. DIY is his guest for a week end. ZNC is on his way home. PUB expects to be out of the Navy in a few months. KYQ has his transmitter ready to go, 160 (?) to 40. IUM wants TTY's address. GQQ is in Central China, operating a 450-watt transmitter for the Army. HZY and RHL are building v.h.f. equipment. DUT has built a v.h.f. superhet. SNF is on Kwajalein Island. ABB is building a new transmitter with p.p. 35Ts in the final. MVZ put his portable-mobile in the car and visited several Chicago stations, following them in on their signals. MBM runs 55 watts to p.p. TW75s, modulated with 203As! JZA is pleased with results from his new rotary antenna. UYP is on his way back from Hindustan.

MICHIGAN — SCM, Harold C. Bird, W8DPE — The hamfest was held Oct. 7th in Pontiac, Mich., Community Market. Speakers were SSBY, radio inspector; Col. Dellenbaugh, Signal Corps, Capt. Judd, Signal Corps, and Richard Cotton, of the FCC, who demonstrated his 400-Mc. rig. The Ladies' Auxiliary of the DARA held a successful raffle and bazaar. Displays consisted of equipment of various makes used by the Signal Corps and included two types of Japanese sets. The public address system was furnished by WCAR, and Wayne Cooke, their chief engineer, made recordings of the speeches which now are club property. New officers of the Ladies' Auxiliary are: Mrs. Ray Devore, pres.; Mrs. Edward Gocha, vice-pres.; Mrs. Stella Steimack, treas.; and Mrs. Francis Higgins, secy. 8MV has been on furlough. 8LSF, on furlough, attended the hamfest. 8MGQ attended the meeting in civilian clothes. 8LU is picking up salvage parts for future use. 8COW visited LU while vacationing. 8AMS attended the hamfest. 8KNP is radio officer in Manila handling the transoceanic b.c. programs. Jim states that he never saw so many rhombic antennas in his life. 8NOH is back in Grand Rapids and is getting his rig together to get on the u.h.f. 8UHF has several unused RCA 829B tubes at a real bargain. If interested, contact your SCM. 8FWU is studying Phillips code and listening to long-wave stations. 9YKI is out of the Army and his address is Louis C. Sciez, 357 So. First Street, Ishpeming. 8LPQ sends the following: 8COW, QF, IHF, TRB, and UIG, from Saginaw, attended the hamfest. Lt. Col. SHAN has returned and expects to get on soon. 8QQS is on i.c.w. 8TIU is on with a crystal rig. 8ESA lost his father recently. 8FXM expects to get on soon. 8LNE gets on u.h.f. occasionally. T/Sgt. Jim Fetting is back from Europe and 8VJH appeared in the city still in uniform with a mobile rig. 8UIG is giving LPQ and IHF competition with mobile. 8IXJ, in Oahu, wants dope on amateur radio. 8BMH is operating a TR-4 on 113 Mc. in his Culver airplane. How about sending in a

report to your SCM? You have cooperated wonderfully in the past four years, now let's get going again.

OHIO — SCM, Carl F. Wiehe, W8MFP — CBI, of Dayton, reports: ENH visited Dayton recently before leaving for the Naval radio school at Del Monte, Calif. TOZ was in Dayton for a week's furlough from Sheppard Field, Tex. QID was in town for a few days leave but has returned to Washington. AGR has quit WERS activities because of the press of home and business duties. Dayton hams welcome the opening of the 2¼-meter band. The following calls have been logged: SDO, LJ, 3GJU/8, RHG, 9DCC/8, 7IYW/8, QWC, NSS, VMJ, DAL, WIH, ALZ, AGR, TDY, RHH, and IBQ. AZH has returned to Dayton from Denver. CBI has resigned as EC for the Dayton area. His successor will be RHH. PZA, of Cleveland, reports: XE1LM visited Cleveland and hopes to be the first ham in Mexico on 2¼ meters. CBI, former SCM, and MFP, present SCM, were recent visitors to Cleveland and conferred with Director AVH. They were quite enthusiastic about the excellent club room of the Cleveland Radio Club. The club meets the first Thursday of each month and the welcome sign is out to all. Visitors should call E. S. Nelson, DS. DBU is with the Veterans' Rehabilitation Program. TLZ spent a week at home before going back to her teaching duties. BAH was home on a brief leave from active duty in the Pacific. CRA is conducting code classes, with JNF as instructor. At the well-attended October meeting of the CRA the FBI ran off some of their films and answered questions. LEX was elected as a member of the Board of Directors. SBJ was home on furlough from the Pacific. SBR is back in civvies. TLQ, still in uniform, told of his activities while in France. UCY, our Navy nurse, and her brother were home on furlough. GD wrote from Okinawa. CTI is back home from Boston. QV, EBJ, AOK, CTI, PWY and PZA all took in the auto races and worked 112 Mc. to and from the track. VHY, of Washington C.H., who was active in the prewar Miami Valley Emergency Net, is back in civvies. PMJ is pounding brass in Zamboanga, Mindanao, P. I. His address is available from MFP. EQN, of Springfield, reports a lot of activity on 2¼ meters there. ACG reports from Portsmouth that WERS has been quite active during the past three years holding regular drills, which proved to be of inestimable value to Scioto County during the high water last March. TQS reports from Cincinnati that the Emergency Net Control Station (old WKHO-3) was moved to the new Red Cross headquarters and is ready for operation. During the latest transmitter hunt held in Cincinnati both the 112-Mc. and the 224-Mc. transmitters were found in a matter of minutes. First prize went to PNQ and second to VMA. The 2¼-meter hams are quite active and the round tables include some Dayton stations. VUV writes from Germany that he and another ham stumbled on a radio man's paradise when they uncovered a German communications depot. RSS is attending Columbia U. in N.Y.C.

WISCONSIN — SCM, Emil Felber, jr., W9RH — 6SIQ, attending the University at Madison, wishes to contact local hams. Look him up at 622 N. Henry, Madison. ZBY received his discharge recently and is going back to his old job at Signal Center Hq., 6th Service Command, Chicago. WWD, YPO, and QJG have returned home. QJG flew the "hump" route from India to China as pilot of a C-46. FPB expects to go with WWV, National Bureau of Standards. Sgt. Curtis Schultz is expected home from India. RT3c ROM is on the USS *Dayton* in the Pacific. Ed Thornley, S1c (RT) is marking time at the Navy Pier, Chicago. Ex-AFV expects to be discharged soon. M/Sgt. UPM, at Fort Monmouth, has been transferred to another outfit. HMO is at Camp Crowder, Mo., undergoing basic training. M/Sgt. ULE is at Sheppard Field, Tex. Pfc. Paul Ripple, who was in France, has been sent to Brussels, Belgium. Ens. PCN, USN, is on the aircraft carrier USS *Midway*. IZQ, DTK, and ANA are back in civvies. The Milwaukee Radio Amateurs Club held its first contest on the 112-Mc. band Oct. 7th and the winners, as announced by PYM, contest chairman, were first, GVL, using 30 watts input and having 21 contacts, who won an Eimac 35TG; second, GSP, using 8 watts input, who won a Leach antenna change-over relay; third, 8QK, using 55 watts input, who won a Hytron HY75 transmitting tube. Longest mobile contact was made by GPL. Winners were decided upon the basis of total points, two for each QSO and one for each airline mile. Highlight of the contest was QSP's installation of receiving and transmitting antennas and oscillator halfway up a 250-ft. tower.

(Continued on page 78)

The PROFESSIONAL Receiver



New **HQ-129-X** \$129 AMATEUR NET
LESS/SPEAKER

Price subject
to change
without notice.

There is a difference. The HQ-129-X receiver is designed purely from a professional point of view. The treatment of every detail is based on professional requirements. As soon as your dealer has the HQ-129-X in stock, go in and look it over and try it—you will see, hear and feel the difference.

WRITE TODAY FOR
TECHNICAL BOOKLET



HAMMARLUND

THE HAMMARLUND MFG. CO., INC., 460 W. 34TH ST., NEW YORK 1, N. Y.
MANUFACTURERS OF PRECISION COMMUNICATIONS EQUIPMENT

(Continued from page 76)

DAKOTA DIVISION

NORTH DAKOTA — SCM, Raymond V. Barnett, W9EVP — Burleigh and Morton County amateurs have launched a new project — The Cen-Dak Radio Club. Temporary officers are: GJJ, pres.; Bob Kyllingstad, vice-pres.; SSW, treas.; KZL, secy.; and CFU, activities manager. There were sixteen interested persons in attendance at an organizing meeting on Oct. 10th, including ZRT, of Mandan, newly-elected Alternate Director of the Dakota Division. The executive committee is working out details of our constitution and by-laws. Regular meetings will be held once a month and special meetings tentatively have been set for every other Wednesday night. GZD tells us that the Forx bunch are giving some heavy thought to getting the Forx Club going again. MYD is out of the Navy and attending the University. DM has been helping out at a local photo studio evenings while waiting for the bands to open. GZD is carrying nineteen credits at the University in addition to holding down a full-time job as operator at the University station, K1LO. ILLT, of Hanks, now back in "civvies," dropped off in Bismarck for a few hours' visit with SSW and EVP. He says WWL is just "waitang." HBR has moved from Rawson to Watford City.

SOUTH DAKOTA — SCM, P. H. Schultz, W9QVY — DJM has been discharged from the merchant marine and is starting a radio shop at Wagner. MBA, of Platte, is back at his old job with the b.c. station in Duluth, Minn. BJV is back in "civvies" after 4½ years with the 34th Division and plans to start up his radio shop at Watertown again. Drop Stan a line.

NORTHERN MINNESOTA — SCM, Armond D. Brattland, W9FUZ — BHY and PKO and his OW visited FUZ before the latter took off again for the Pacific. JNC happened in and quite a hamfest took place. OOK has been in Belgium, France, and recently was shipped to the Philippines. QIN, YLZ, and NBW, of Minneapolis, have mobile jobs on 2½. YEQ reports from Camp Crowder that HMH is stationed at the same camp after being transferred from Iceland. GWM is traveling around the globe as radio man on an ATC plane. DOP, who works for the telephone company at Little Falls, is getting the "bug" again. TAT is home on furlough and has a rig on 2½. JRI, USMCR, expects a release shortly. KRV is located with KWBW, Hutchinson, Kans. JNC and 4BQE/ANG, SCM of South Carolina, got a bunch of hams together at Columbia, S. C., and had a regular hamfest. Hams from the 1st, 4th, 5th, 6th, and 9th districts were present. NCS, USCGR, is teaching code at Atlantic City. 2EIH, director of the Metropolitan Airports Commission, is located in St. Paul, and wants to join the radio club. TOZ is one of the ardent 2½ boys and soon will put up a power pole for a mast. UVA was home on schedule and expects to be a civilian soon. DZM, in Anoka, puts in a fine signal to the Twin Cities. JIE gave a fine talk on bias supplies at the last St. Paul Radio Club meeting. BHY demonstrated his new electronic bug, while MTH spoke on the necessity of watching the band edges on 2½. ZWW writes from the Panama Zone of his activities with AACS and his travels. IPN gets on 2½ occasionally from the police station where he operates. URQ, RVS, and TAT are Twin City hams who are finding considerable enjoyment on 112 Mc. CRO, formerly of Redwood Falls, is located in Minneapolis with the Stark Radio Co., has a receiver built for 2½, and expects to have a transmitter going soon. 6BIP has been operating mobile around the Twin Cities. His XYL operates like an old-timer, c.w. or 'phone. For the information of the gang if you really want to get out on v.h.f. use i.o.w. UCA has been discharged from the services. GNR's future home will be in Des Moines. FUZ will be back at sea, perhaps when this report appears. RMLC ICQ, of Minneapolis, is overseas, and the information that he is an instructor in convoy school at San Pedro, in June QST, was incorrect. Please address reports to A. D. Brattland, 2802 So. Western, Los Angeles, Calif.

HUDSON DIVISION

NEW YORK CITY AND LONG ISLAND — SCM, Charles Ham, jr., W2KDC — Considerable interest is being shown in emergency operation. FI, GLC, KTU, RZ, CET, LKU, and NBQ have been acting control stations. Roll call is Monday at 9 p.m. and all are urged to listen and report. Tentative plans call for an NCS in each county with each NCS reporting to a master control. OBW, in Holbrook, is cooperating and DOG, in Riverhead, is EC for Suffolk,

CET is EC for Nassau, BKZ for Queens, JXH for Manhattan, LKP for Bronx, and OHE for Brooklyn. The latter three are expected to tie in with L. I. operations shortly. A QSO party was held recently and NBQ leads with 1200 points. Another is scheduled for November. CET acts as clearing agent. ADW is working on antennas with DOG reading the microvolts/meter. EBT, using low power, has been worked. JWO is on in Suffolk. HBO is back after four years in the Navy. George now is at 7120 Freshpond Rd., Ridgewood, and would like to hear from former members of the Tu-Boro Radio Club. BGO, N. Y. C. radio aide, is working on an emergency net tied to the N. Y. State Police System. All WERS equipment has been returned to owners except for a few unclaimed pieces. Owners or agents should contact BGO. The Sunrise Radio Club is looking for a shack. LKC has rotary in process for 10 and 20. EVZ is back from Germany and France. CTO is back from the Mediterranean area. DLT is back at his old job at LaGuardia Field. LFY is building a pretty 40-20-10 rig. LW designs b.c. receivers in Brooklyn. LKR finally finished that basement for the shack. BKZ is planning 100 watts on 115 and/or 144. OIE is all set for the lower frequencies. LFX is trying to repair a wafer-switch on an old communications receiver he picked up. LUY filed application for the Sunrise Radio Club. KPM has opened a radio repair depot. FUB has gone back to radio sales and service after several years with the Signal Corps in New Jersey. KDC was scared out of a week's DX in an explosion of the electrolytic capacitor during a N. Y. C.-Philadelphia 2½-meter contact.

NORTHERN NEW JERSEY — SCM, Winfield G. Beck, W2CQD — The Jersey Shore Amateur Radio Assn. has elected the following: Pres., FZY; vice-pres., LYI; treas., FC; secy., LMB. Nick Camenares writes from Tokyo and tells of hearing a bunch of fellows on 20 meters. The following portable-mobiles are on 2½: LI, HVK, NLY, IKS, IBL, GHO ABS, MEU, TR, 3AC, JN. MUP is building and rebuilding. 9BBD, at Eatontown, N. J., is running 300 watts on 2½. GHO is crystal controlled. CEJ is on 2½ with a good signal. MQS, in Staten Island, is putting out a consistently loud signal. LYP is having speech amplifier trouble.

MIDWEST DIVISION

KANSAS — SCM, Alvin B. Unruh, W9AWP — In September the KVRC, Topeka, held its first meeting since 1942, with ICV, elected president and WGM secretary. The WARC, Wichita, meeting, scheduled in Riverside for the purpose of reorganizing, was postponed because of the flood. PKD is back at WIBW, Topeka. VWU, discharged from the Air Corps, is a traffic cop and KGZC brasspounder. Other Topeka returnees are NVB from the Navy and UFA from the Army. FMR, WGM, and ICV are active on 2½ meters in Topeka. JZU, GFN, and EQD have returned to Parsons. IRE has received Navy discharge and now is in Parsons. 5HHF purchased a farm nine miles north of Parsons and prospects are good for another Kansas radio club. 5FFK, formerly of Seminole, is working for McKrae Telephone Co. in Fredonia and is eagerly awaiting reactivation of the lower frequencies. DJL, BCY, and AWP are making 2½-meter plans in Wichita. KFH has Navy discharge. FET has returned to KFBI, Wichita, after service overseas with OWI. BCZ is dispatcher at power and light company station in Wichita. DMF and BCY will remain with Boeing as engineers in the experimental laboratory. ICV and his YF spent a week end visiting friends in Wichita.

MISSOURI — SCM, Mrs. Letha A. Dangersfield, W9OUD — We regret to report the death of QCO, Springfield. GBJ is getting the rig in shape for operation when 40 and 20 are opened. GHD wrote from Amchotka and expects to come home after four years at Kiska. FIR/FOR has been to New York, Antwerp, and the Philippines with the merchant marine HIC left Texas and went to Manila, then to points unknown. BIU wrote from Chik-kiang, where the ATC was hauling Chinese troops. MOZ says the Weather Bureau is interested in an amateur set-up for WX reporting S/Sgt. FTD in New Caledonia, is located in radio maintenance and is learning a lot about receivers. KTK says DBD is at Scott Field with six other St. Louis hams. ZVJ, a pilot in the Marine Corps, has been on leave. MBE is radar 2c in the Navy out in the So. Pacific. EKG is back home. UAB was at Saipan, and now is roaming about the Pacific. ZVS has been trying to contact members of the Amateur Radio Relay League of St. Louis, of which he was president. 4HLN, ex-IGW, is home after several months in the So. Pacific as

(Continued on page 80)

..... Collins Autotune* receiver for civilian aircraft — 20 lbs. — ½ ATR

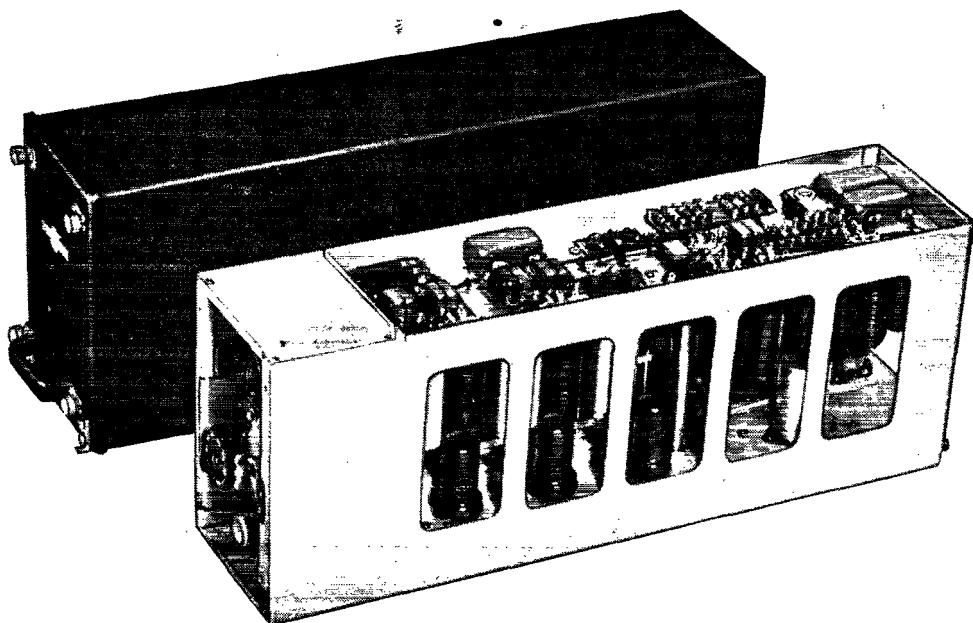

THE NEW 51K-1 crystal-controlled airborne receiver is an example of the advanced design, convenience and efficiency which Collins communication equipment offers for commercial transports and long-range executive planes.

It utilizes the rugged, dependable Collins Autotune system, which quick-shifts the tuning controls simultaneously and with extreme precision to any one of ten pre-selected frequencies at the turn of a tap switch. The frequency shift time is only two seconds maximum!

This quick, effortless re-tuning feature is a tremendous convenience—almost a *must*—in the case of planes which travel distances or use services for which frequency

shifts are necessary.

The 51K-1, completely enclosed in its case, weighs less than 20 pounds. It fits into a standard ½ ATR unit and can be stowed in any desirable place in the plane. It is completely operated by remote control from the pilot's position. The ten Autotune frequencies can be pre-set anywhere within the receiver's range—2.4 to 18 megacycles. The power source of the regular model is a 24 volt battery. A 12 volt model is optional.

From end to end the 51K-1 is a brilliant example of the high Collins standards of design, workmanship and performance. We urge you to investigate it fully before making receiver commitments.

*Trademark

COLLINS RADIO COMPANY, Cedar Rapids, Iowa
11 West 42nd Street, New York 18, N. Y.

In Canada, Collins equipment is sold
by Collins - Fisher, Ltd., Montreal

..... IN RADIO COMMUNICATIONS, IT'S...

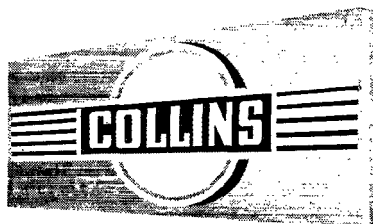

(Continued from page 78)

radio operator on a tanker. OUD and BMS are doing business at the radio shop in Joplin.

NEBRASKA — SCM, Arthur R. Gaeth, W9FQB — New ECs: MLB, EAT, HQQ, and YDC. New OBS: MLB, ROE, and EKK. Your SCM would appreciate applications for these appointments. K6TXV, ex-MUK, will attend RCA Institute in Chicago. Warrant Officer DYG is operating portable-mobile on 2½ meters at Camp Crowder. VKT had a near miss with lightning, with minor damage to the new SX-28. Cliff Allwine, KHKN-23, is doing a little sound work. Henry Petersen, KHKN-43, has his code speed up. IVW tells EXD that he is ready to go on the lower frequencies. QXR is active on 2½ and assisted FUV with new antenna. ZZG is active on 2½. EKK and company are producing 4-tube converters for 10, 5, and 2½ meters. Capt. BZV reports from Manila. Sgt. NYU, in Germany, mentions CCY, and is looking forward to uncrating his SX-25 and building a new rig with an HY51Z in final. Sgt. FQM writes from Luzon and inquires about license status. ACS was seen about town by UFD. Capt. Gray, of BNT, visited EKK, and purchased an 829 socket and associated parts for future activity. TYG visited RUH, and reports that he is on his way to a b.c. station in Kearney. ZPZ purchased an SX-23. RUH and FUV, each have picked up an RME-43. Sgt. QUA, now a civilian, is looking for a small rig. JCK joined CAP and is code instructor. UFD, working for Peterson in Council Bluffs, is experimenting with crystal oscillators. YMU has a 40-foot pole up and is working for Electric Fixture and Supply Co. QUQ now is a civilian. BQP, formerly of ETO, reports as a civilian and speaks of moving to the West Coast and trying for some marine operating. "Cellophane" (LSPH) is going to build a peanut whistle (portable) for her first rig. The Ak-Sar-Ben Radio Club added three new members and listened to an FB talk on radar and wave guide propagation by JHN.

NEW ENGLAND DIVISION

CONNECTICUT — SCM, Edmund R. Fraser, W1KQY — GB News: The following members have been discharged: Army: BSS, GMR, Dayton jr., Libertino, and Weinberger. Navy: DDX. Coast Guard: JHN. Merchant marine: Davidson. At the annual meeting held Oct. 12th the following were elected to office: LTZ, pres.; LZM, vice-pres.; ATH, secy.; JQK, treas.; IGT, LTB, and IND, directors. Visitors were CJA, NEK, QV, and Ronnie Griffin from New London. KPN, former club president, from Stratford, and ZT from Bridgeport. QV entertained the gang with several of his popular skits, and music was furnished by Milt Reeves and his accordian. There were 32 present. GB has held club meetings every Friday night since Pearl Harbor, and had thirty-seven members in the services with many others working out of town in vital defense industries. KQY received a letter and magazine from CX2AJ, who is anxiously awaiting the return of hams to the air. General news: KKS writes from Saipan that he met up with Steve Taber, GB member, at radio station WLXD. KKS is en route to Panama, traveling aboard the SS *Mission Santa Ynez*, as chief operator. APA is stationed at Camp Kilmer, N. J. Lt. Col. FOU, of Manchester, and 1st Lt. CTC, of Woodmont, have been returned to civilian life. KXB, of Torrington, is building a new shack. JAK is after a new Hammarlund Super-Pro. IJ, of Madison, is conducting a code and theory class at the Hamden High School two nights a week. KQY, while riding around the lake in East Hampton, spotted a mail box with FMP's call on it. CTI informs us that they have organized a 112-Mc. network in and about Norwalk. ZT has been appointed OBS. FJE, MSJ, and LVX have been building 112-Mc. equipment, designing it so it readily can be shifted to the new frequency assignment. BGT, GC, BW, LZM, and MVH are trying out new antenna systems. The first Connecticut QSO Party since P. H. was held on 112 Mc., Sept. 15th and 16th. Two points were allowed for each contact and one point for each station heard, the sum multiplied by the number of different towns contacted. Approximately 132 stations participated, with IND, who operated portable at Prospect, first with 50 worked, 5 heard and 37 different towns for a total of 3885 points. IJ, of Madison, was second with 1650 points. MVH, of New Haven, third, and BW, of Branford, MRP, of Westport, and ASO, of Stratford, next in order. Many stations in New York, New Jersey, Massachusetts, and Rhode Island participated, with all call areas except the 4th represented as portable first district participants. WERS News: West Haven units have been turned over to the Red Cross who in turn have placed them

in the hands of amateurs for future emergency work. New Haven and other towns of the New Haven warning district are doing likewise. Drills are being held on a reduced-attendance basis in Bridgeport, Norwalk, Waterbury, New London, and Norwich. Hitchcock, WKNQ-4; Tuttle and Weyand, of WKWG-65 and 70, respectively; and Sanichone and Mathews of WKAO-4 and 48, are busy mastering the 13 w.p.m. for ham license.

Traffic: W1CTI 1.

MAINE — SCM, G. C. Brown, W1AQL — CBV and UP are going to town on 2½ meters. MDK is living in Winn after spending some time working for Raytheon. MXT has an HY75 and is working KEZ, who has a pair of 76s. Both are on 114-Mc. INW is at Dow Field working in Aircraft Radio Maintenance. NUN is an operator at WL BZ, LEH, in Bangor, is working for the Radio Service Lab. 2KIF has been discharged from the Army. 2GW, a capt. in the Signal Corps, was a recent visitor to Maine. COM and MN have been released from the Navy. BOK was in town recently. ARK is back in the States from service overseas. GCB was in Boston recently for medical attention. Let's have some real up-to-the-minute news.

EASTERN MASSACHUSETTS — SCM, Frank L. Baker, jr., W1ALP — The Brockton Radio Club holds meetings on the 1st and 3rd Mondays of each month at the A.O.H. Hall, Ward St., opposite Brockton Depot. MEG writes that the Framingham Radio Club has started up and is planning a big hamfest. The Parkway Radio Assn. meets on the 2nd and 4th Thursdays of each month at Fidelia Club, West Roxbury. Officers are: IIM, pres.; JRN, vice-pres.; KTE, secy.-treas. The Mystic Valley Radio Club station, KAO, is on 2½. The South Shore Amateur Radio Club of Quincy meets on the 1st and 3rd Fridays at the Quincy YMCA. All of these clubs extend a welcome to any hams in these parts. Club secretaries, let me have the dope on the time and place of your club meetings and the calls of the officers. SS, new secretary of the M A K Radio Assn., writes that at the last meeting the club extended a vote of thanks to its outgoing officers, EU, pres., and CZV, secy., for their excellent coöperation and efforts. The new president is CB. SS is working at Mass. Radio. AHP, new president of the Fall River Amateur Radio Club, writes that the club has started up again. GDJ is vice-pres. and JYR, treas. The following attended the last meeting: IJC, IUL, DHX, IMA, JYR, MNM, JAB, GDJ, FGN, CRN, BUX, NNN, and AHP. LNR is a colonel. IBS is a lt. colonel. KVH is a lt. commander in the Navy. MEG says that 2½-meter activity up around Framingham way is running high and he made the first QSO with a DK-3 and LQI in Sherborn. MFZ, of Saugus, is in Navy radar. NPE is living in Taftville, Conn., and is looking for contacts on 2½. DID and EKT are working for Browning Lab in Winchester. 4IHA has gone to work in Michigan. MCS has gone back to Littleton, N. H. 8DMW is working for G. E. plastic plant in Pittsfield, Mass. BWJ is back at his old job. DPW is working at Raytheon. AME is with Watson Lab in Cambridge. LNX is working at Fore River in Quincy. HXE is now living in Stoneham and is on 2½. 4AJJ has gone back to Florida. 3IIL-1KNZ now is a civilian. IIQ is home and spending some time in Wolfboro, N. H. MZE is out of the Army. MTQ is in the Navy. MTV is at M.I.T. for a month. LWQ has been in Florida. EKG writes from Seattle, Wash., where he has been assigned to the Bremerton Navy Yard. MBG is going to build a mobile rig. 3GFR has gone to work with Allen B. Dumont Co. Pop Minot (LSPH), who used to be at M.I.T., is living in Boston. COX says the gang in Lowell on 2½ are: BPH, DBE, OQ, QM, MWM, MKX, NGJ, and LMT. The following are Official Broadcasting Stations: GAG, EHT, LZW, GDY, COX, LBY, ALP, BDM, MON, and MEG. FKV has gone to Florida. At the last meeting of the South Shore Amateur Radio Club, the following showed up: FKV, LJT, MQH, LWI, MON, LFD, LAT, IS, MMU, MD, CT, KDK, BNS, MPT, NVS, EXN, FVD, JXU, MMH, JXZ, EQJ, KJD, FWS, AKY, WK, CFP, CPB, BDM, MSK, PI, EUW, JOB, IHA, LZW, ALP, Carl Lindgren, 3IIL, 5JLO, K6RQO, and the Mugford twins. These hams are on 2½: AWX, JPM, JDO, RX, KAO, GWE, CRW, EU, KKR, WS, EYR, CBW, LBQ, HMH, BJE, LFD, AKN, ON, GZ, LSR, EL, LNX, MBC, GGP, JZD, FAX, AXA, JOY, GWK, WK, FVL, KWD, JAJ, NBC, JSM, LPB, AMK, HMA, IHF, AYG, FON, KID, NEW, BGU, DJZ, HXY, IOG, LOS, BPF, FQI, IDE, GRF, FMQ, DIA, LWJ, JYA, MXF, BIO, NBM, MTQ, LOV, EXR, MXX, DRO, HXE, MLS, ISK, NMX, EOG, JTF, NAK, 3JF, 5GN, 6QIL,

(Continued on page 88)

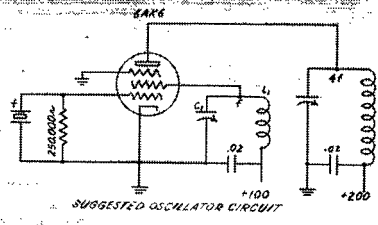
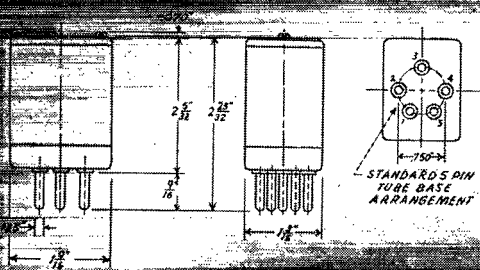

Announcing the **BLILEY**
Type ART crystal unit
for maximum VHF stability

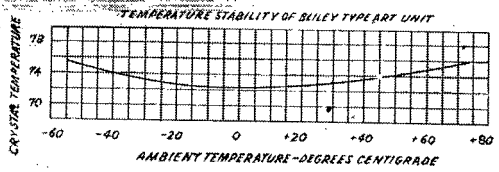
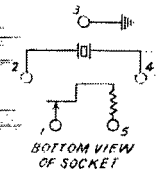

This new Type ART acid-etched*, crystal unit is another Bliley "first", designed for VHF services, such as police and railway communications, where frequency stability must be maintained over temperatures ranging from -55°C. to +75°C. With a built in heater operating on 6.3 V. at 1 amp. crystal temperature is held within $\pm 2^\circ\text{C}$. The unit will maintain an overall frequency tolerance of $\pm .005\%$ or better including variations due to the temperature change and tolerances required for crystal production. This rugged, compact, crystal assembly is available for any frequency between 3500kc. and 11,000kc.

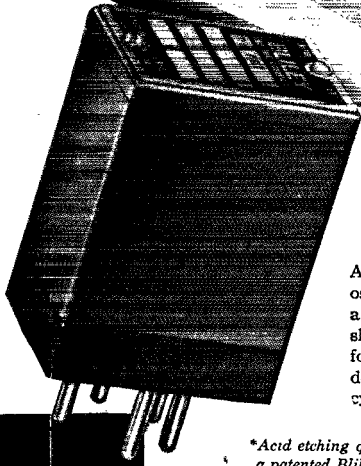

A schematic diagram of the oscillator circuit and tolerance to be maintained should accompany requests for quotations. See above design for efficient frequency multiplication.

*Acid etching quartz crystals to frequency is a patented Bliley process.



Radio Engineers —
 write for temporary
 Bulletin Q-26

(Continued from page 80)

20HG, 8BCY, 2OHT, 2BZB, 7FZV. NFZ is on with a pair of 7A4s with 6 watts. AVO and KEK have beams working well. KB is putting out an FB signal. LFS had an eight-way QSO in Hawaii on 2½. MQE, on Iwo Jima, is on 2½. LTR and ZCC are on the way home. AFF has gone to work for CBS. GQV and LB are on at Hampton, N. H. NEW has a new mike. NPN and MUO put out FB signals mobile. EHT has a crystal rig on. MYO and AWM are getting out well. NF is on and working them all. 9DYI is working around Boston for R.C.A. 9YMW, DYI, and MIH visited ALF. DVC is working in San Diego for M.I.T.

WESTERN MASSACHUSETTS — SCM, William J. Barrett, W1JAH — The Worcester WERS gang, WJBB, held a meeting Sept. 20th, at which the Worcester Emergency Radio System was organized. Officers are: AQM, pres.; ex-AAP, vice-pres.; Dick Atwood, secy.; IHI, treas. The station at Paxton will continue in operation as a relay station as soon as FCC issues a ham license. The Worcester gang have worked or logged the following 112-Mc. stations: BB, RBM, BCT, BJE, DBE, DEX, EHH, EOG, GDY, HPC, IHF, ILG, IOD, IXI, JVE, JWM, JYZ, KPZ, KWS, KZW, MBE, MUO, MXX, NBE, NDM, NOV, 3IUN, FNY and his XYL were recent guests of AZW. JHK has a new 829 p.p. RK-38 rig for 40 and an 829 p.p. 800 set-up for 10. BVR visited JAH recently and says he is waiting for a c.w. band to be released.

NEW HAMPSHIRE — SCM, Mrs. Dorothy W. Evans, W1FTJ — LVG is a civilian again. JCA reported en route to the West Coast and a Naval separation center. His QTH is 510 Congress Ave., Pacific Grove, Calif. BJF and his XYL recently visited JDF and MWI in Wayland, Mass. John still is working for Raytheon. GKE is busy in his motor repair business by day and walking the floor with his new YL Jr. operator at night! MMG reports from Tokyo Bay.

NORTHWESTERN DIVISION

IDAHO — SCM, Don D. Oberbillig, W7AVP — 2HGP was a Boise visitor while processing for Army discharge. Ex-3IOS, living at 1026 E. Terry St., would like to meet Pocatello hams. HPH, on 2½ meters, is busy with CAP. BMF has been discharged from the Navy. HFF and GXD hope that ham radio soon will be given the go sign. HOV dusted off the QSL cards and the rig. GXH hopes to be home from V-12 training. FOF is working on 2½ meters. DQX, formerly of Clarkston, Wash., visited in Boise. ZN is cleaning up the rig and looking the antenna set-up over. AHS has two nice new antenna poles ready for the skywire.

OREGON — SCM, Carl Austin, W7GNJ — Your SCM recently drove to Astoria and found EBQ working on receivers, radio compass and boat transmitters in the rear of KAST studio. BOO is engineer of the b.c. station and city police system. FKZ is manager of the b.c. station, and has a rig ending in p.p. T55s ready to go. FES is control room operator. HCY is in radio service work; his QTH is next door to the b.c. studio. EBQ has replaced his meters and will work 'phone as well as c.w. BDR and COU are back in Astoria from the So. Pacific. AYV, a Jap prisoner of war, is safe. AGP died in a Jap prison camp. IM is starting a radio service shop at Lakeview. IDJ is rushing around collecting his scattered ham gear. HCW is CRM, and was in the invasions of Iwo and Okinawa. ALU is itching to get home, and has a 7-21 Mc. rig planned, starting with v.f.o., ending in 813. Only three things are required to become a ham. (1) Get your license. (2) Join the ARRL. (3) Build the rig.

WASHINGTON — SCM, O. U. Tatro, W7FWD — The following new appointments have been made: CMX, State EC; EHQ, FLQ, JEA, JBH, and EKT, as OBS. Plenty of activity on 2½ meters is reported. AEA, of Tacoma, works Seattle. FWR, of Olympia, works EHQ, Stellacoom. HOL, of Seattle, made a recording of EHQ's transmission from Stellacoom. 7LSPH, of Mukilteo, hears Tacoma. The Spokane Radio Operators Club has been reorganized with EEN, pres.; ELN, vice-pres.; DSR, secy.-treas.; and GHD, asst. secy.-treas. The club meets every other Tuesday at 8 p.m. at 417 W. 2nd Ave. If interested in attending, contact Al Kern, GHD, 4907 N. Atlantic, Spokane 12, Wash. HCE, EC, reports that the YARC met Oct. 10th at the home of IYB to elect officers. ETX is getting ready for 10 meters. AWW, IYB, HRU, and CAM are ready with 2½. A 6V6MO and 815PA with line tuning is on the air at CAM. FCZ will use a separate exciter for each band in driving his 813 final. HW is constructing a rotary beam. The operators of KFNV held a get-together at the home of the radio aide, Miriam

Brown (LSPH), Nov. 13th, as a farewell to WERS for Snohomish County. GP, of Boeing was a recent visitor. HPJ, of the State Patrol, has built a 2½-meter receiver and is working on a transmitter. BT is on 2½. CMX, State EC, reports AWX cut a notch out of the porch for his rotary beam, AUI is working for the county and cleaning up old gear, and HW has electrical appliance and radio repair at Grand View. YS is watching for the opening day.

PACIFIC DIVISION

SANTA CLARA VALLEY — SCM, Earl F. Sanderson, W6IUZ — RM, 6LLW, PBV is stationed at midshipman school in Indiana. Lt. GFW has arrived home after being released from a Jap prison camp. The Santa Clara Amateur Radio Assn. held meetings recently to formulate plans for future activities and a new winter program. Your SCM would appreciate reports from club secretaries. The Oakland gang was host at a most successful hamfest recently, at which 268 were registered. There were interesting speakers, a demonstration of new transmitting type tetrodes, a hidden transmitter hunt, and a fine assortment of prizes. MUC is visiting the bay area after an absence of three years, during which he played an active part in the atom bomb program. Activity has picked up considerably on 112 Mc.

EAST BAY — SCM, Horace R. Greer, W6TI — EC, QDE; EC v.h.f., FKQ; Asst. EC v.h.f., OJU; OO v.h.f., ZM. Over 300 hams, XYLs, YLs, harmonics and friends were present at the hamfest sponsored by Oakland WERS on Oct. 14th. All districts were represented and the following were present: 1JRV, LXU, QP, 2CRJ, FUV, HVS, MMT, 3JCS, 4CPG, DLF, HVA, LA, TZ, 5FDR, 6AD, ADI, AEX, AED, AHG, AK, AKB, ALH, AQO, AVZ, AY, BDG, BET, BEZ, BF, BFZ, BGU, BGW, BHK, BIJ, BNB, BPV, BSB, BU, BWZ, CBD, CBF, CHE, CML, CRF, CTE, CVL, DDO, DDU, DJI, DUW, EE, EJA, ENM, ERS, ESH, EVQ, EY, FKQ, FVK, FW, FWO, GE, GES, GFW, GIZ, GLX, GPY, GZH, HB, HGM, HHM, HJE, HUB, ICP, IDY, IJA, IUZ, IWH, JQC, JSB, JSF, KGF, KIW, KNH, KQQ, KZN, LGW, LOZ, MFJ, MIO, MIX, MLD, MUC, NHB, NHU, NIG, NIO, NJJ, NNS, NO, NQJ, NRM, NTU, NVO, OCZ, OIB, OLL, OMC, OML, ONP, OV, OZA, OZC, PB, PCG, PEC, PI, PLV, PSY, PTD, PVU, PQQ, QBL, QDE, QEH, QFX, QJT, RCC, RCE, RFP, RJZ, RMM, RPY, RRR, RRR, RSS, RVY, RZC, RZS, SDX, SFT, SNY, SQ, SRR, SSN, SUK, SUZ, SYO, THO, TI, TNM, TQT, TSB, UDF, UFD, UGO, UHM, UKM, UMZ, VX, WB, ZM, 7DND, EVO, GLD, HEH, IFL, SVKZ, 9EWA, GQE, JRU, LMJ, QVZ, RSD, SAB, VLT, WBU, YCN. The committee, consisting of AD, AEX, AEE, MFZ, PB, QDE, SFT, SSN, ZM, and EE, did a swell job. SLX, ex-9BRZ, sends the following dope on the Eureka gang: QCA has a radio repair shop; PCQ is in the insurance business; NAO and SLX work for the phone company; DHE works in a lumber mill; IYN works in a bakery; 7AUP works in the weather office; SNTS is with FCC in Arcata.

SAN FRANCISCO — SCM, William A. Ladley, W6RBQ — Phone RA-8340. ECs DOT, KZP; OO u.h.f., NJW; Asst. SCM, GPB; OBS, FVK, NJW. 6NKE is stationed at Oahu. CIS and QGN are on the way home. ONP, u.h.f. enthusiast, has moved to Marin County. TBK, Menlo Pk., visited RBQ. BIP, visiting relatives in the East, worked RBQ as he passed through Placerville from Mt. Diablo. JWF writes from Sioux Falls Army Base. The Oakland gang gave an FB hamfest at Oakland. ZM visited State Guard Sig. Det. in San Francisco. HJP is back at Kwajalein. 6ZF is back in San Francisco. OKL is it. (jg) aboard SS *Kingsport Victory*. My term as SCM has expired and I hope my successor receives the same loyal support from section members that I have. May I suggest that you fellows get busy and make nominations so that the section will not be without an SCM. The rebirth of the San Francisco Radio Club has taken place and the club has held its first meeting. Here's a chance to give your support to one big club where all can plan for the future of amateur radio. The Marin Radio Club held its first postwar meeting at the Travelers Hotel in San Rafael on Oct. 4th. The following attended: WB, KNZ, SG, EY, OBK, GPB, RBQ, AOF, ZM, MRZ, PVC, FVK, HVX, TIJ, JTP, RAK. Allan Whitaker was toastmaster and Director McCargar addressed the meeting on League affairs. WB contacted PIV at Sacramento via 2½ meters for the first time. Clay spent many nights perfecting the proper beam receiver and transmitter for the occasion. RBQ made an Eastern trip. State Guard WERS is moving along with one hundred per cent attendance. EAR expects to be discharged from the

(Continued on page 84)

Microphones Engineered by

Electro-Voice

Answer Everyday Sound Problems



Maximum Intelligibility Under Extreme Noise

Hand-Held, close-talking single button carbon *DIFFERENTIAL microphone for all speech transmission in any noisy, windy, wet or extremely hot or cold locations. Cancels out background noise. Articulation is at least 97% under quiet conditions, and 88% under a 115 db noise field.

Model 205-S. List Price \$25
*Patent No. 2,330,010



Higher Articulation with Less Fatigue

Moving coil, hand-held Dynamic microphone for high fidelity speech transmission. Uniform response, free from peaks, in the useful frequencies gives higher articulation, provides more usable power level, and is less fatiguing to the listener. For outdoor or indoor use.

Model 600-D. Dynamic. List. \$27.50
Model 210-S. Carbon. List. \$17.50



Poly-Directional with Adjustable Polar Pattern

The versatile high fidelity Cardak is readily adjustable to reduce any combination of reflected sound. Cuts reverberation or random noise pick-up . . . minimizes acoustic feedback. For broadcasting, recording, public address, communications.

Model 725—Cardak I. List. . . . \$55
Model 730—Cardak II. List. . . . \$75



General-Purpose Dynamic for Voice and Music

Widely used because of its dependable all-around performance. Excellent frequency response for both indoor and outdoor speech and music pick-up. Rugged, small size, light weight. High output. Suitable for public address, dispatching, paging, recording and remote broadcast.

Model 630-C. List Price \$30



Velocity High Fidelity Bi-Directional Sound Pick-Up

Wide, flat frequency response, bi-directional polar pattern, high fidelity characteristics, wide-angle front pick-up, and pick-up range make it ideal for solo, orchestra, or chorus, for single speaker or groups. For indoor P.A., broadcasting, recording.

Model V-1-C. List Price \$30
Model V-2. List Price \$37.50
Model V-3. List Price \$50

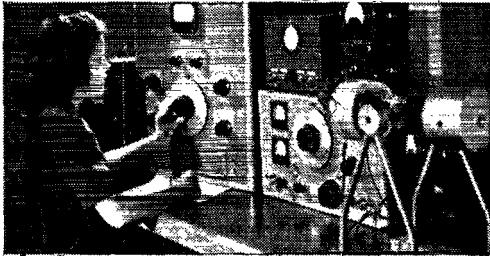

Corner of E-V "Lab"

One of our Quality-Control units used in testing close-talking microphones. Harmonic distortion, frequency response, positional response (for carbons) level, etc., are carefully analyzed. Calibration is effected by Bell Laboratory standards and our own reciprocity checks.



SEND FOR COMPLETE CATALOG

Gives valuable data on Electro-Voice Microphones for communications, public address, broadcasting and recording. Includes helpful Reference Level Conversion Chart.

Authorized Distributors Everywhere



No finer choice than

Electro-Voice

M I C R O P H O N E S

GUARANTEE

The E-V models shown here are guaranteed forever against defects in workmanship and material.

ELECTRO-VOICE, INC., 1239 South Bend Ave., South Bend 24, Indiana * Export Divisions: 13 East 40th St., New York 16, N. Y., U. S. A.—Cables: Arlab

(Continued from page 88)

Army shortly and will reside in Southern California. SAN JOAQUIN VALLEY — Acting SCM, Edward H. Noack, W6BXB — EEX is on 2½ meters in Modesto. Capt. DTJ has returned to KWG. PNM has returned to Stockton. OAV has been released from the Army and is living in San Diego. JIN is working for a local radio shop. The following hams are on 2½: Fresno: GCF, FTA, RSD, PDX, JCB, MUB, 2BWS, RKM, JPU. San Carlos: SF. Mobile jobs are: RSD, PDX, JCB, JPU. PDX, at Fence Meadow Lookout, worked FTA, MUB, and GCF in Fresno, and LEE, who was on Pine Ridge Lookout. JPU now is in "civvies." QOS is back from B-17 service and getting set for 2½. LOO is working at KMJ in Kerman. JHD is chief engineer at KFRE. NJQ is working in Oakland. PSQ, who came from India, is getting a discharge.

ROCKY MOUNTAIN DIVISION

COLORADO — SCM, H. F. Hekel, W9VGC — Ray Stedman, our Director, has been in the hospital since Oct. 15th. John Weber developed a misery in one of his feet and is in the Veterans' Hospital, Cheyenne, Wyoming. RT1c VIK made the front page on KMYR's newscast Oct. 11th. Russ was with the first troops to enter Tokyo as a member of Navy Mobile Communications, Unit 470, and is one of the head men operating Radio Tokyo. Bob Perske is now at sea as S1c (RM), USS *Bronz*, A.P.A. 236, C Div., c/o Fleet Post Office, San Francisco, Calif. EHC expects to be back in Colorado early in 1946. He and Mildred celebrated their ninth year of trying to prove that two can live cheaper than a lot of other people. FXQ has a very sick little girl. JB is the keeper of the bees (honey and otherwise). MCK, from Des Moines, Iowa, was in town working on 112 Mc. with a good signal. LYV, YFJ, OLL, and JKC have been sent home from the Army and Navy and LYV put a 300-watt rig on 112 Mc. OLL and YFJ started with a little less than 300 and the only bad luck reported was that YFJ had a 76 blow up. RHM is back in Walsenburg and would like to hear from KSE, Corp. 8VJY, of McKeesport, Pa., is at Peterson Field, Colorado Springs. On Oct. 4th the Radio Widows Club spent most of the evening recounting some of the high lights of 1945. Mrs. WYX was acting hostess. QDC is home from Africa and other points where life was not a bed of roses. SIE worked himself into a job as assistant supervisor of the Union Pacific RR.; his territory extends from Omaha to the West Coast. 73, by Heck.

UTAH-WYOMING — SCM, Victor Drabble, W6LLH — 6SID is back in the States and is at M.I.T. for a refresher course in radar. 6RMM, Army, has returned home from the African campaign. 6RAM, USN, is at Pearl Harbor. 6DTB is looking for a suitable place to build his 10-meter beam antenna. How about reports from the gang in Wyoming and Salt Lake City? 6UOM opened a radio shop in Ogden.

SOUTHEASTERN DIVISION

EASTERN FLORIDA — SCM, Robert B. Murphy, W4IP — According to FVW's log, over thirty stations in Miami are active. He and VV are the two most active hams on 2½. The following have been logged: HKJ, ECV, EBW, BYF, VV, IP, IEV, NB, AEW, HWG, CFC, HNL, AFF, FTJ, NK, K4FCL/4, 5BHU, 1LUR, 1NSH, 1MKO, 1DFY, 8VPP, 9DXM, 1NRT, 6RQJ, 5KJD, 9DYG, 9VHN, 1KVB, 1JMT, 9KBG, 1JIT, and 9TQK. 9TQK is working a 45-ft. antenna against 30- to 45-ft. heights in Miami. BYF has been appointed OBS. VV has raised his stick so he can work 9TQK better. FVW has his meals served him in between mail trips. BYF tells me that 9TQK is there with him and he says he has worked 1BRA in Delray Beach. Banana River has two hams experimenting with 2½ meters. I know of one CAA circuit on 145 Mc. working about nine miles, beamed, handling about 20 audio circuits on one r.f. frequency. HKJ, ex-2NJX, has gone north to N.Y.C. with A & O and is flying the northern route of ATC. AYW is planning an 80-meter Zepp in Umatilla and says 9LU is there with him. VP5EM writes from Kingston, Jamaica, B.W.I., that the hams there are looking forward to the day of opening the bands for many pleasant contacts with us. Sam Potter, from St. Augustine, now in the Philippines, writes that he is getting ready for a 10- or 20-meter contact with the good ole U.S.A. 2COI is in Miami and trying to get on the 2½-meter net. SRCW is an ensign at NAS, Banana River, and is one of the fellows trying to get on the air with someone on 2½. EYI writes from St. Pete. FXH is on AV in the Pacific. FZW was home on a 10-day leave. Casey Ingram has been discharged from the Coast Guard. ES has been in Washington, D. C.

Keep your ear tuned for the WIAW signal on 3555, 7145, and 14280.

WESTERN FLORIDA — SCM, Lt. Edward J. Collins, W4MS — 7EHB has gone to the West Coast. 6PNI has left for California. ASV was a visitor after a tour in the Navy. EQR has 60 watts running to T-20s on 112 Mc. and is Q5R9 in Pensy. BKQ has his 10-meter beam down and is rebuilding the framework. VR is rebuilding the big rig. CNK has been listening on 112 Mc. 8MJX has been experimenting on 112 Mc. DAO got a big kick out of EQR's 112-Mc. signals. QK has been gathering parts for a 112-Mc. rig. UW is ready to get on with 250 watts. 4MS was up "Nawth" and stayed with 3IOU. He went to 3GNA's and got a real demonstration of 112 Mc. 3BES's eight-stage crystal-controlled signal was worked and 60-mile signals were heard. GRF is getting ready to start the CAA Net. 7IQJ states that he is getting ready for 7 Mc. only. ECM has moved to the 5th district and was a visitor to Pensy. AXP is dusting off the 7-Mc. rig. ECT is about to bust out on 112 Mc. 4HJA wants to hear some 112-Mc. DX. COG was home on a short visit. A card was received from CJG on Iwo Jima. Floyd Grise (LSPH) is in Luzon. GGA has gone to college in Texas. GGN is captain in the Navy at Washington and holds the Navy Cross. EZT hopes to go into the b.c. game with UW. 5IVP and JV are parin' to get on. 9ZAR and 9LQV are stationed at Eglin Field and are about to get on 112 Mc. ACB, who is busy with his new Hallicrafter receiver, says Tally is about ready. 9MEI spends his Sundays flying a Cub. MS has a new QTH. AXF says the OM's disposition has improved now that he can work on the rig. FHQ has his rig ready for 7 Mc. DXZ is working on his Mims rotary unit. DXQ lives near EQR and is getting set. 4HQB has ordered parts for his rig. Ex-EK has been promoted to major. BJS has moved to Eastern Florida. Ex-BGA is in Miami.

GEORGIA — SCM, Ernest L. Morgan, W4FDJ — FJL, in Columbus, is readying the rig for the opening of the bands. GKI is in the So. Pacific. FGX enjoyed a furlough. BEK, on 112 Mc., wants contacts. CCJ has made twenty-five contacts in Washington on 112 Mc. since this band has been opened. FCW, en route to Manila via the Isthmus, was diverted to the States, paid a short visit to FDJ and now is in California for reassignment or termination. EEE has been appointed OBS; ERT has been appointed EC for Macon and Bibb County. My term as SCM has run out, and I urge that you select a successor.

SOUTHWESTERN DIVISION

ARIZONA — SCM, Douglas Aitken, W6RWW — KOL is out of the services. IYZ is reported to have an XYL. MLL says that three of his LSPHs are widely scattered — Quen in Japan, Rouzand in Ie Shiima, and Amado in France. TLY expects to get going with a bang when the bands open again. QWG is on a coastal run in Pacific waters. REJ is in the Philippine-Japan area. The Tucson Short Wave Association and the 25 Club certainly have run up an enviable record for training service men in code and theory. The Phoenix bunch have been having a good time with 2½ and IXC, QLZ, and FUU put on a demonstration on two-way car 2½ for the newly-formed radio group at North Union High. NGJ and NRP have been on the sick list. KMM is a civilian again. MAE has gone into the automotive repair business for himself. TKL has dusted off his 10-meter rig. OAS is putting an 814 in his final. Rumor has it that TOZ contemplates matrimony. Most of the gang should be getting from OZM the proposed set-up for an All-Arizona Radio Club.

SAN DIEGO — SCM, Ralph H. Culbertson, W6CHV — Asst. SCM, Gordon W. Brown, W6APG. BLZ reports that BAM is in the Signal Corps, telephone section, somewhere in Belgium. JQB, in Riverside, was at a power station in the High Sierras. AKC is out of the Navy. HBZ is working for the Thermador Transformer Co. in Los Angeles. JEZ is teaching radar at Corpus Christi, Tex., for the Navy. BXQ has been released from the USCG and is back at Laguna Beach. DLY has returned to his store in Los Angeles. BLZ has purchased a new home in La Jolla. FTT is back in San Diego as Raytheon engineer. KW is back home and has lots of time to teach the jr. operator the code. QEZ is reported to have a brand-new XYL. THM is with KFSD. HTJ reports that twenty-six hams, all working in radio and representing all W districts, met in a club house built by the Seabees on Iwo Jima shortly after V-J Day. They hold meetings every two weeks and work on 2½ meters and report a 1 kw. transmitter ready to operate on all available

(Continued on page 88)

NOW AVAILABLE

RAYTHEON

RK-65

You can now get immediate delivery on the famous Raytheon RK65 — an improved tetrode with 215 watts plate dissipation.

Easy to drive, this Raytheon tube offers longer life, greater mechanical strength and more dependable all-around performance.

Also ready for you are the following Raytheon tube types: RK20A, RK28A, RK48A, RK38, RK63.

See your local Raytheon outlet or write us for complete data.

RAYTHEON

MANUFACTURING COMPANY

Newton and Waltham, Massachusetts

COPYRIGHT 1945 RAYTHEON MANUFACTURING COMPANY

WORLD'S LARGEST MANUFACTURERS OF CAVITY
MAGNETRONS AND SUPER HIGH FREQUENCY TUBES

(Continued from page 84)

bands when opened. The Palomar Radio Club held its first meeting at the home of Bill Gilmore, the secretary. 2½ meters is going strong with the following stations noted: AIY, 80TC/8, RPJ, MKS, and 9IGO/8. Lt. PZB, of La Mesa, was killed in an airplane accident in the East.

WEST GULF DIVISION

NORTHERN TEXAS—SCM, Jack T. Moore, W5ALA—JBD is back in the control tower at Love Field. JCN is on the road for the Federal Telephone and Radio Corp. GKB has moved to Dallas. NW reports the purchase of a new SX-28A. ILJ hopes to get on the air with a KA call. JO sends the following Ft. Worth news: ATH is home after serving several years with Philco as a radar engineer; Speedy Maersch has returned to work for WBAF-KGKO; the Kilocycle Club was reactivated on Oct. 4th and the following officers were elected: Pres., FPY; vice-pres., BBH; secy., JO; treas., VQ; activities mgr., COK. The following Ft. Worth stations are active on 112 Mc.: BBH, FOA, GVZ, CHU, ATH, BYZ (using an HK-54), COK (who is installing a 50' tower in an effort to work Dallas), JO, and GWR. COK has been appointed OBS for Ft. Worth. JGY is a CAA air carrier radio inspector at Ft. Worth. AJG, working Ft. Worth on 112 Mc., reports that the following Dallas stations are active on 112 Mc.: JCN, IQT, HMH, 6JRK, DXR, ESC, BVM, JNK, JQY, IKL, TW, IXD, EZP, 9DXC, 8RBZ, 8MNE, 9QNC, 3ESP, 9PDX, 6MFO, and 4FPV. AQS has moved to the country. KLS is working in Dallas. GVL says that DID has his radio shop going full swing, while HGI is doing electrical work for the T.&P. Railroad. JIH has moved to Mineral Wells.

SOUTHERN TEXAS—SCM, James B. Rives, W5JC—Capt. EYB is back from Czechoslovakia and, at a recent SARC meeting, gave the boys an interesting account of his experiences. DTJ has completed a new 100-watt rig. EJT has been discharged from the Navy and is back in San Antonio. Sgt. D. K. Durham (LSPH), of Port Lavaca, is teaching code at Ft. McClellan, Ala. GLS shows technical movies at the Houston club meetings and IGJ and EIB give instructions in code and theory to those interested in obtaining a ham ticket. Activity on the 112-Mc. band in Houston and San Antonio is picking up since the clubs in both cities are sponsoring contests. KEE has received his discharge from the services, and has moved to San Antonio. EM3c IYJ is stationed at San Diego. FGT is RM1c at Pearl Harbor. JPC is in Guadalcanal. Capt. BUV is at SAACC. GYP is in the radio service business at Edinburg and is working on 112 Mc. JMP is with Western Electric and gave an interesting talk at the recent meeting of the San Antonio Radio Club. Lt. 3IVT, in the Navy, is stationed at Galveston as assistant electronics officer. EBT is back at WOI after serving as chief engineer for OWI in Washington. Maj. CBF is in Caserta, Italy. PT has moved from Dallas to San Antonio. The San Antonio Radio Club conducted a 2½-meter contest until Nov. 15th. JKC is on a Weather Boat in the Pacific.

NEW MEXICO—SCM, J. G. Hancock, W5HJF—Lt. Comdr. HWG is in Pearl Harbor, ENI is home after more than three years in the Army Medical Corps. Doc says his professional practice will prevent a great deal of ham activity.

The Month in Canada

MARITIME—VEI

From E. S. McLaughlin, VE1JH:

THE opening meeting of the Halifax Amateur Radio Club, for the 1945-46 season was held Oct. 19th with twenty-nine members, including the following, in attendance: VOIR, St. Johns, Newfoundland, 5TU, 4ALV, 4ANG, 3OF, 3PX, and 3ZC. 1EY has his discharge from the Navy and has returned to his radio repair business in P.E.I. INQ, of Hampton, N. B., has his discharge from military Headquarters Staff and is going to reside in Halifax permanently. 1EU, of the R.C. Signals, and 1HK, RCAF, have returned from overseas and were at the opening meeting of the club. 1LZ has been discharged from the RCAF and has returned to Dalhousie U. to continue his studies. The election of officers will be held and peacetime plans will be made at the November meeting of the HARC. During the past year we have had

hams from every province in Canada, and some from the U.S. and England drop in to our club meetings. It has been a pleasure to greet these visiting hams. 1JH has received a very interesting letter from 1FQ, who has been transferred from Signals to a concert party to bring entertainment to the troops in Germany and Holland. Brit traveled with this same concert party in Halifax before he joined the services and went overseas. Congratulations to 1DB, president of the HARC, and Mrs. Webb on the birth of a daughter on Oct. 25th.

ONTARIO—VE3

From L. W. Mitchell, VE3AZ:

MR. O. C. BOERTGER, secy.-treas. of the Kitchener Waterloo Radio Amateur Club, reports that since their last report in QST the club has held three meetings, one each in May, June, and September. The speaker at the May meeting was Mr. G. J. Irwin, chief engineer of Philco Corp. of Canada, whose talk entitled "New Horizons for the Radio Amateur" outlined the possibilities of ultra-high frequencies as applicable to amateur radio. The surprise of the evening was a draw for prizes which were donated by Standard Radio Products of Kitchener. Through the courtesy of the Panoramic Radio Corp. of New York, a booklet entitled "Panoramic Reception" was distributed to those in attendance. At the June meeting Mr. B. G. Graham, chief engineer of Spartan of Canada, spoke on cathode-ray tubes. He sketched the history of the development of the tube and outlined its operation and use. Standard Radio Products again donated a prize, a 10-hy. 400-ma. filter choke, which was won by Elroy Schiskoske. The September meeting proved to be the best attended meeting held to date, with thirty-two persons in attendance. These included five visitors from Guelph: 3HC, 3HR, and 1CK, now of the Botany Department, O.A.C. Prizes at this meeting were donated by Marsland Engineering Co. of Kitchener, and consisted of a desk microphone and stand and a 100-watt 5000-ohm adjustable resistor. The microphone and stand were won by Warren Doze and the resistor by 4AFN, now of Kitchener.

ALBERTA—VE4

From W. W. Butchart, VE4LQ:

GORDON ANDERSON, VE4ATS(?), who served with the RCCS and Imperial Ordinance Corps for the past six years, is resuming his duties with the Northern Alberta Railways, and will make Edmonton his headquarters again. During his years overseas Gordon gained much knowledge and experience with radar equipment, as well as radio, and it's our guess that his taste will run to rather elaborate gear in his new rig. 4YX, Edmonton, is up for discharge from the Navy. 4BW, Edmonton, genial owner of the Radio Supply Co. in Edmonton, has things well lined up for an early resumption of activity. He purchased an old garage and had it moved out to his home, where he promptly parked it in front of his XXL's favorite kitchen window, with the result that it had to be moved again. However, in its final location it is a thing of beauty in the eyes of its owner, and Ted has spent much time in fixing it up to meet his ham requirements. The antenna, tuned line, is already up. 4AH, Edmonton, is devoting quite a bit of thought to the make-up of his contemplated rig, and it wouldn't surprise us if he starts to throw a few parts together one of these days. 4EY, Edmonton, has been reading up on modulators, automatic modulation control, etc., and we can assume that "there's another good o.w. man gone wrong." The second meeting of the NARC was postponed because of trouble encountered in locating a suitable meeting place. As for activity at 4LQ, I've been busy on a systematic overhaul of my small equipment, including frequency meter, secondary standard, receiver, modulation monitor C.R. unit, etc., so that if and when we get word to go ahead, things will be in working order. We are very sorry to report that 4VJ, Edmonton, is not regaining his health as well as we had expected. 4XF, Edmonton, underwent a very serious operation recently, but we understand that things are progressing nicely for Pat. 4EA, Edmonton, is busy working on a receiver for ham work, and also is spending quite a bit of his spare time figuring out just what he will use to feed his sky-wire with once we get going again. 4LQ and 4ACQ have been working in the same Provincial Government Department for a year or two without knowing that the other chap was a ham until one day recently I, 4LQ, was wearing my call letters on a tie pin and Don spotted them. Among the hams seen at Radio Supply

(Continued on page 88)

**LOUD
SPEAKERS**

**BY
Jensen**

**WHERE
QUALITY
IS ESSENTIAL**

*Designers and
Manufacturers of
Fine
Acoustic Equipment*

**COMING
ATTRACTIONS**



Jensen
SPEAKERS WITH

ALNICO 5

5 MONOGRAPHS AVAILABLE

1. Loud Speaker Frequency-Response Measurements
2. Impedance Matching and Power Distribution.
3. Frequency Range in Music Reproduction.
4. The Effective Reproduction of Speech.
5. Horn Type Loud Speakers.

25c
Each

FREE to the Armed Forces, Colleges, Technical Schools, Libraries.

JENSEN RADIO MANUFACTURING COMPANY • 6611 SOUTH LARAMIE AVENUE, CHICAGO 38, ILLINOIS
IN CANADA—COPPER WIRE PRODUCTS, LTD., 137 RONCESVALLES AVENUE, TORONTO

P. R. MALLORY & CO. Inc.

MALLORY

BATTERY CHARGERS

AUTOMOTIVE and RADIO

The 3C Booster, ideal for boosting 3-cell lead-acid batteries in vehicles, laboratories or stations. Maximum charging rate: 4 amperes, tapering to 2. For more rapid charging of 6-volt batteries, Mallory offers Type 5535 B with 6-4 ampere rate, and Type 107 with 10-7 ampere rate.

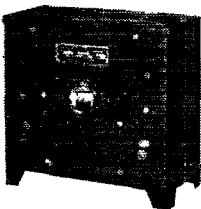

AIRCRAFT

Typical of the extensive Mallory line of aircraft battery chargers—Type 10-AC-24. Initial charging rate is 10 amperes, 6 amperes tapered when connected to standard 12-cell aircraft

storage battery. Mallory also makes filtered power supplies for testing and Rectostarters* for starting aircraft engines.

*Reg. U. S. Pat. Off.

ELECTRIC TRUCK

Mallory Automatic Battery Charger, Type 175 TC, is capable of charging 15 to 18 lead-acid cell heavy-duty electric truck batteries at an initial rate of 175 amperes, tapering to 150 amperes continuous. Will also charge 24 to 30 cell nickel-iron batteries of 500-750 ampere hour capacity within 7 hours. Other Mallory Industrial Truck Battery Chargers are also available.

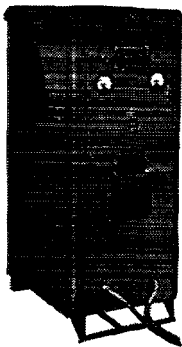

Units shown are part of the complete line of Mallory battery chargers and power supplies. For complete information, see your Authorized Mallory Distributor, or write direct to

P. R. MALLORY & CO., Inc.
INDIANAPOLIS 6 INDIANA



P. R. MALLORY & CO. Inc.

MALLORY

(Continued from page 86)

recently was Lt. Ken Smith, 4AOC(?), RCN. Upon his return to Ottawa, Ken hopes to be on the discharge list. 4AEV, Vulcan, Calgary, expects to be returned to civilian life soon. 4TF, Red Deer, has been discharged from the Army will take up the duties of district agriculturist in the Edmonton district. How about dropping me a line and passing along a few items of interest?

MANITOBA—VE4

From A. W. Morley, VE4AAW:

RO has completed a rig for 21 Mc. and has rigs about ready for 14 and 28. George is going after DX and is about ready to reestablish himself on the top of the Canadian heap. BQ is arranging for 500 watts 20 and 40 c.w. SO has everything lined up for 20 and 40. ACR is wrestling with e.c.o. WL has been busy rebuilding his rig to a pair 809s final. QV tells me he had a nice chat with 2BE while in Montreal recently and as a result came home and immediately put up antenna, as he did not want to be caught with his "jeans" down if and when the go ahead is given. Don also visited headquarters of the Michigan State Police where he met quite a few hams employed as engineers, operators, and dispatchers. PLEASE fellows how about a line once in a while.

It Seems To Us

(Continued from page 11)

yourself once. Instead, help him. And don't be ashamed to ask for QRS yourself when you need it. Why be ashamed? We can't all be speed merchants. And an honest request for QRS is much more understandable than to allege nonexistent QRM when you've just told a fellow he is QRK5. (Was he really Q5?)

7) Read up on how to adjust your bug key. Dots should be a third the length of dashes, not a thirtieth. Move that weight out!

8) Abbreviations belong to the field of c.w. In voice work, "say it with words." It's more understandable.

These things are just matters of common sense, OM — that and the old Golden Rule of doing as you'd be done by. And having a sense of responsibility, knowing that you're a representative of amateur radio in all the loud-speakers of the world and the pattern for the thousands of new amateurs who'll soon be joining us.

Good luck now, and happy hunting!

Asbury

Strays

From Leonard Doese, W9DJA, comes a timely warning. Says W9DJA, "I suggest that we test all condensers in our rigs before we return to the air. There must be thousands of leaky or otherwise defective by-pass, filter or blocking condensers still installed in long unused ham gear. Most of these prewar components are not hermetically-sealed and as they have had almost a four-year layoff, they may have gone bad. A test of these condensers now, may save much irritating time out when we get back on the air!"

The Tube* that "MADE" the 2nd Most Important Weapon of the War!



Actual Size

The second most important weapon of the war . . . "the detached brain for explosive projectiles" . . . credited by the Navy with battering down the attacks of Japanese suicide planes — turning back the German counter offensive at Ardennes — helping break the "buzz-bomb" attacks on Britain . . . was made possible through the development of the "micro-tube" by Sylvania.

This glass tube—less than an inch long and not much thicker than a pencil—was used to send out electro-magnetic waves, which, as the missile approached the target, bounced back and set off the fuze. Sylvania made 140,000,000 of them between 1941 and the end of the war!



**This tiny tube became the heart of the proximity or "VT" fuze—the complete radio transmitter capable of being fired from a gun! (Short leads within the tubes and outside the tubes mean FLAT response in the new and interesting high frequency bands you are now using.)*

SAVE WEIGHT—SAVE SPACE

- IN THE SHACK ● WORKING PORTABLE
- WORKING MOBILE

SYLVANIA ELECTRIC

Emporium, Pa.

MAKERS OF RADIO TUBES; CATHODE RAY TUBES; ELECTRONIC DEVICES; FLUORESCENT LAMPS; FIXTURES; WIRING DEVICES; ELECTRIC LIGHT BULBS

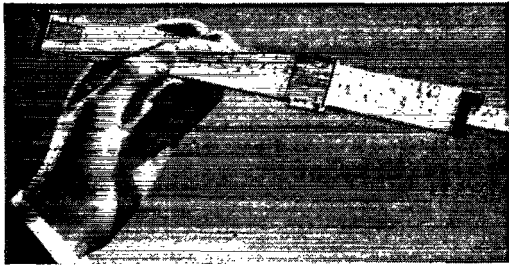

Can You Figure Out Your Own Future?

"Post-War is NOW!" Prepare now with a planned program of CREI technical training . . . get the jump on competition—get that better radio job you want—enjoy security!

What's ahead for you in the field of Radio Electronics? One thing is certain. Now that peace is here, Radio Electronics will surge forth as one of America's foremost industries, offering promising careers for radiomen with modern technical training.

NOW is the time to take the time to prepare yourself for the important, career jobs in radio-electronics engineering. You will find the knowledge gained from your CREI course useful almost from the beginning.

In our proved home-study course, you learn not only *how* . . . but *why!* Easy-to-read-and-understand lessons are provided you well in advance, and each student has his personal instructor who corrects, criticizes and offers suggestions on each lesson examination. This is the successful CREI method of training for which more than 10,000 professional radiomen have enrolled since 1927.

Your ability to solve tough problems on paper and then follow up with the necessary mechanical operation, is a true indication that you have the *confidence* born of *knowledge* . . . confidence in your ability to get and hold an important job with a secure, promising future. Investigate now the CREI home-study course best suited to your needs, and prepare for security and happiness in the New World of Electronics! *Write for all the facts today.*

● WRITE FOR FREE 36-PAGE BOOKLET

If you have had professional or amateur radio experience and want to make more money—let us prove to you we have something you need to qualify for a better radio job. To help us intelligently answer your inquiry—please state briefly your background of experience, education and present position.



Capitol Radio Engineering Institute

Home Study Courses in Practical Radio-Electronics Engineering for Professional Self-Improvement

Dept. Q-12, 3224 16th St. N. W., Washington 10, D. C.
Contractors to the U. S. Navy, U. S. Coast Guard and Canadian Broadcasting Corporation

Producers of Well-trained Technical Radiomen for Industry

MEMBER: NATIONAL COUNCIL OF TECHNICAL SCHOOLS

90

Simplified F.M.

(Continued from page 50)

signed. There is no reason why this system cannot be used on the lower-frequency bands where better receivers are already essential and should soon be generally available for both a.m. and f.m. reception.

Superregenerative Receivers on F.M.

In the course of operating the transmitter on the 2½-meter band it has been found, contrary to popular conception, that the superregenerative is a poor receiver of narrow-band frequency-modulated signals. The ability to realize audio from this transmitter seems to depend upon the characteristics of the individual receiver. Some show practically no audio when f.m. is used, while others do quite well. At first this was thought to be merely a matter of signal strength—the more signal the better f.m. results. However, this theory seems to be ruled out, since some receivers at high signal-level locations give very ineffective results. Perhaps it is a matter of *Q*, a high-*Q* circuit being too sharp to accept the f.m. which must be received all on one side of the resonance curve.

These results seem to invite further work toward a superregenerative receiver specifically designed for narrow-band f.m. Such a receiver would help overcome the other main objection to f.m. at present, i.e., the need for better receiving equipment, and would surely help to accelerate the general acceptance of f.m. on the higher-frequency bands.

Happenings

(Continued from page 58)

nate director thereof. See the original solicitation published on page 23 of August *QST*, page 21 of September *QST*, which remains in full effect except as to dates mentioned therein: Nominating petitions must now be filed at the headquarters office of the League in West Hartford, Conn., by noon EST of the 20th day of December, 1945. Voting will take place between January 1st and February 20, 1946, on ballots to be mailed from the headquarters office the first week of January. The new alternates will take office as quickly as the result of the elections can be determined after February 20, 1946, and will serve for the remainder of the 1946-1947 term. You are urged to take the initiative and file nominating petitions.

For the Board of Directors:

K. B. WARNER,
Secretary

October 1, 1945.

GLOSSARY

AN OLD-TIMER who has fallen behind in his reading during the war complains about some of the unintelligible abbreviations in *QST*. Perhaps we are taking too much for granted in these

(Concluded on page 84)

McElroy
Keeps building them better!

NEW!

McELROY Tape Pulling Head TPH-400

With an original arrangement that stops the re-wind when the tape pressure wheel is raised. Another novel arrangement admits the tape from any angle from the right which makes for smoother flow, prevents breakage, and permits the tape to come from any level on the receiving table. \$45.00.

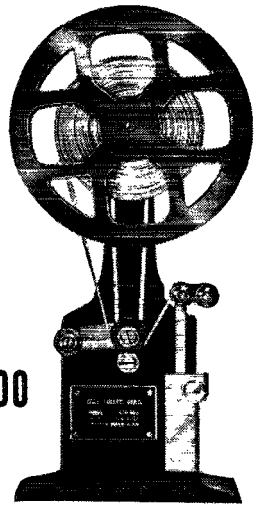

NEW!

McELROY Keying Head HED-400

Complete with built-in polarized relay. An ingenious McElroy design places the studs that pull the transmitting tape on the feed drum, not on the Star Wheel in the contact case. The absence of a Star Wheel opening in the contact case assures clean contacts and less headaches for you. \$240.00.

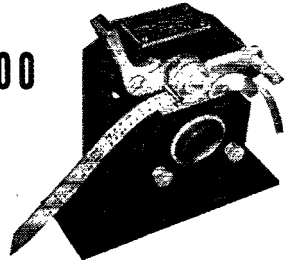

NEW!

McELROY Ink Recorder REC-400

Although smaller and lighter than previous models, it is capable of speeds up to 700 words per minute. The tape holder, which is part of the equipment, may be attached to either the right or back of the case. Operates from either AC or DC by snapping a toggle. \$195.00.

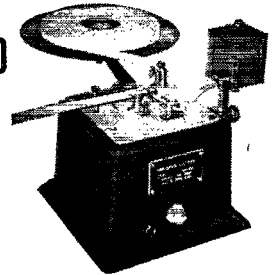

McElroy engineers never copy, never imitate. We create, design, build . . . we are never satisfied with mediocrity. And we deliver.



McElroy **MANUFACTURING CORPORATION**

32 BROOKLINE AVENUE

BOSTON, MASSACHUSETTS

Out of Two Laboratories

comes a **NEW** railroad communications



Rock
Island



SPERRY



● Sperry's Research Laboratory where Railroad Communications System was designed and developed

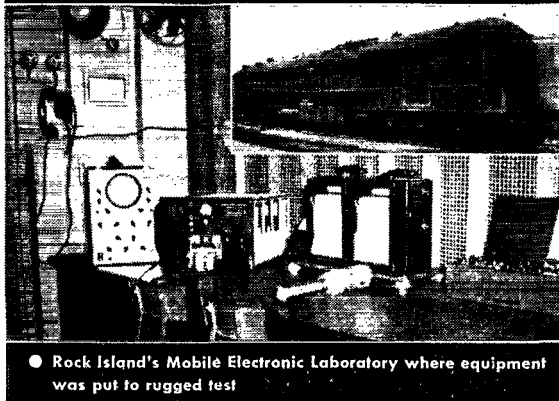

● Rock Island's Mobile Electronic Laboratory where equipment was put to rugged test

THE ENGINEERING STAFF of the Sperry Gyroscope Company, in collaboration with engineers of Rock Island Lines, has perfected a new *system* of railroad communications.

Designed especially for railroads by Sperry and tested extensively by Rock Island, this system offers to the railroad industry microwave applications, secret until now, which Sperry's vast engineering group developed during the war years in co-operation with the U.S. Navy. With the aid of Rock Island engineers working in their specially equipped Electronic Car, the Sperry system has been completely tested and proved.

Sperry's Railroad Communications System makes possible *for the first time* clear, audible signals through tunnels, deep gorges, and the usual terrain and atmospheric conditions encountered in

SPERRY GYROSCOPE COMPANY, INC.

Division of the Sperry Corporation

Leaders in the fields of . . . GYROSCOPICS • ELECTRONICS

system!

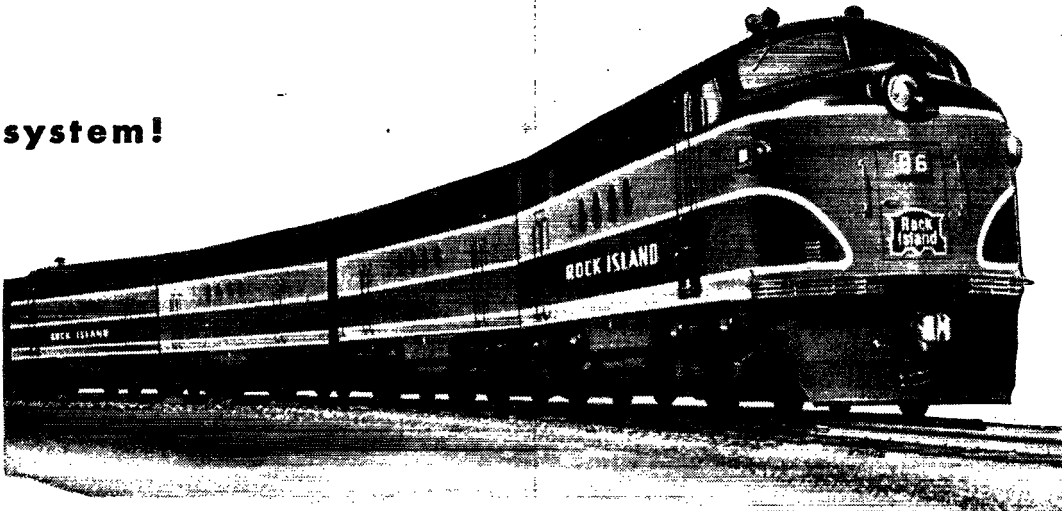

railroad service. No man-made or atmospheric disturbance interferes with vital business!

Automatic relay stations, employing heretofore-restricted radar components that can be substituted for overhead land lines in treacherous storm areas, will link way stations and headquarters, and provide a continuous en route connection between trains and wayside points. A specially designed antenna provides any required degree of directional control.

Rock Island Lines, whose "sole purpose is to provide the finest in transportation," is being equipped with a Sperry Railroad Communications System.

If you would like our help in planning a complete radio communications system to expedite the handling of your freight and passenger traffic, write our Industrial Department for further information.

**SPERRY RAILROAD
COMMUNICATIONS SYSTEM**

- **Microwave applications for the first time**
- **Designed especially for railroads**
- **Greater Range**
- **Increased Signal Strength**
- **FM Signal Audibility through any kind of interference**
- **Any degree of Directional Control**
- **Suitable for indoor and outdoor installations**
- **Available in both VHF and UHF**

GREAT NECK, N. Y. ★ LOS ANGELES • SAN FRANCISCO • SEATTLE • NEW ORLEANS • CLEVELAND • BROOKLYN • HONOLULU ★

RADAR • AUTOMATIC COMPUTATION • SERVO-MECHANISMS

Comparative Graph proves SHURE Super-Cardioid Microphone twice as unidirectional as Cardioid . . .

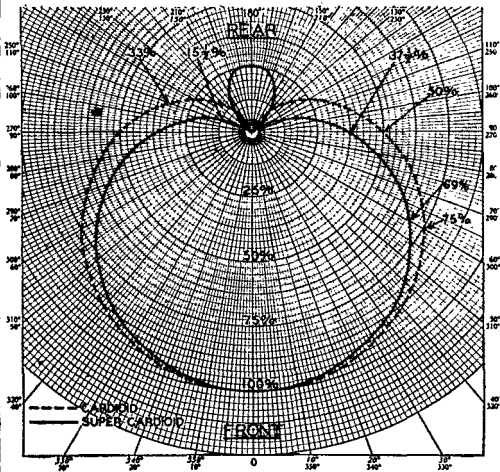

Here is the difference in pickup patterns between the Cardioid and the Shure Super-Cardioid Microphone. Maximum sensitivity (100%) is achieved by sound approaching the Microphone directly at the front. At 60° off the front axis, sensitivity of the Super-Cardioid is only slightly less than the sensitivity of the Cardioid (69% against 75%). The Super-Cardioid insures, therefore, a wide range pickup at the front. Beyond the 60° angle, the sensitivity of the Super-Cardioid decreases rapidly. At 90°, the sensitivity of the Cardioid is 50%; the sensitivity of the Super-Cardioid 37½%; 12½% less. For sounds approaching at a wide angle at the back (110° to 250°) the sensitivity of the Cardioid is 33%; the Super-Cardioid 15½% or 17½% less. It has been proved mathematically that the ratio of front to rear pickup of random sound energy is: *Cardioid 7:1; Super-Cardioid 14:1.*

This additional directional quality is important in critical acoustic work. The Shure Super-Cardioid, employing the exclusive "uniphase" principle, gives such performance in a single, compact rugged unit.



SHURE BROTHERS

Designers and Manufacturers of Microphones and Acoustic Devices

225 W. Huron St., Chicago 10, Illinois
Cable Address: SHUREMICRO

(Continued from page 80)

terms that are so familiar to us at Hq., so here-with a few definitions:

BWC — Board of War Communications, successor to the Defense Communications Board. A policy-forming organization, still possessing some wartime powers. Chairman of FCC is its chairman.

IRAC — Interdepartment Radio Advisory Committee, made up of Government agencies interested in radio. It exercises the powers of the President to assign frequencies to Government stations, as FCC does to civilian services. Commonly pronounced Irac. As coördinating agency for Government services, it is the agency which is determining the rate of return of amateur frequencies from military use.

LSPH — Licensed since Pearl Harbor. Refers to licensed amateur operators who have not yet been able to get a station license.

IARU — International Amateur Radio Union, a coöperative federation of national amateur societies, about three dozen in number. ARRL is the headquarters society.

IRPL — Interservice Radio Propagation Laboratory, the organization located at BuStans which correlates propagation data and issues predictions of frequency performance.

QST — General call preceding a message addressed to all amateurs and ARRL members. This is in effect "CQ ARRL." (Plug: Also the name of the best . . . But you know.)

Necessity Is a Mudder

(Continued from page 89)

ground connection is attached to the ground terminal and the modulator output connection is made by removing one of the modulator tubes, inserting a wire into the plate pin hole, and finally replacing the tube. The method of modulation is not mentioned in any current texts, but it may be safely stated that it is Heising modulation with an auto-transformer boost.

The antenna, which is a surprisingly normal-looking dipole located in the attic, is connected to the antenna changeover switch through a coaxial line, using alligator clips as the connecting medium. It should be stated, in refutation of evidence submitted by earlier investigators, that the steel clips do not overheat.

Operation

Prior to operation a few minor chores are required. The most important one is to convince the XYL that she should read a good book instead of listening to the b.c. set. Once this is accomplished the rest is pure gravy, and consists of bringing the transmission line down the attic steps and clipping it onto the rig. Next, the wires are crammed into the socket, with the matches following. Opening of one of the b.c. voice-coil leads and tripping the phono-radio switch completes the job.

Full automatic operation is not particularly

(Concluded on page 88)

NOW AVAILABLE

FOR ALL CIVILIAN USE...

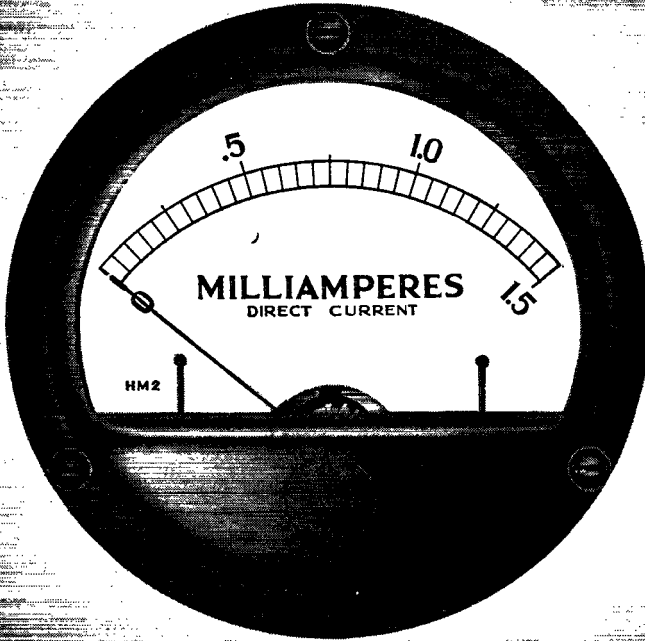

..... AT NO MORE COST THAN
STANDARD UNSEALED INSTRUMENTS

Marion Glass-to-Metal Truly Hermetically Sealed
1/2" and 3/4" Electrical Indicating Instruments

IMPROVED PRODUCT • APPEARANCE • PERFORMANCE • SALABILITY



MARION ELECTRICAL INSTRUMENT CO.
MANCHESTER, NEW HAMPSHIRE

EXPORT DIVISION • 458 BROADWAY • NEW YORK 13, N. Y., U. S. A. • CABLES, MORHANEX

CARDWELL CONDENSERS have grown up with "ham" radio . . .

Pioneer hams have long preferred and used them; new hams are still specifying "Cardwells for quality". In Catalog No. 46, you radio amateurs, both veteran and novice, will find, in addition to many new condensers, the tried and true friends of pre-war* days. Several of these are required components in such representative ham construction manuals as that issued by Taylor Tubes (to be reprinted soon by Taylor). Any Cardwell condensers listed in such manuals, or in the Catalog, can be obtained from your nearest Cardwell dealer. Delivery, if not on his shelves, in 30 days or better.

In the event that you have ideas for condenser types that Cardwell has failed to anticipate in the rapidly shifting field of electronic applications, we ask you to send them along to us. Your suggestions as to how Cardwell products can be made more useful to amateur radio and to industry, as well, are always welcome.

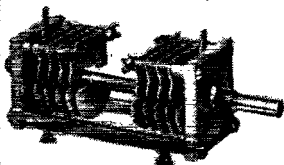

**Standard
Trim-Air Dual**
PL-6032
ER-50-AD

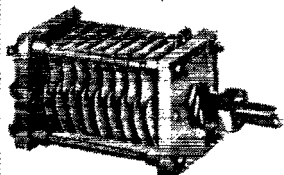

**Heavy Duty
Single Section
Trim-Air for
Portable-Mobile
Transmitters**
PL-6058
ET-30-ASP

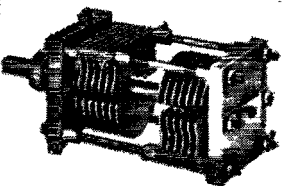

**Heavy Duty
Dual Section
Trim-Air for
Portable-Mobile
use**
PL-6057
ER-50-ADP

*Because of space limitations, it was virtually impossible to include in Catalog No. 46 every Cardwell condenser now in stock. If you had a favorite type that is not listed, ask your dealer to order it for you. Chances are it is still readily obtainable.

Cardwell Catalog No. 46, free, upon request



**THE ALLEN D. CARDWELL
MANUFACTURING CORP.**

Main Office: 81 Prospect St., Brooklyn 1, N. Y.
Factories: Plainville, Conn. — Brooklyn, N. Y.

(Continued from page 94)

desirable since it would complicate the external cabling, therefore the antenna changeover relay is manually operated. In most instances the receiver is operated for longer periods than the transmitter, so the relay was cleverly arranged to be in the "receive" position when it was in its normal unenergized condition. When it becomes time to transmit, the relay is held down alternately with the right thumb and index finger. This is a distinct advantage over other systems since it discourages long-winded transmissions. It was with this system that the famous saying, "L. S./M. F. T." originated. This mystic symbol is merely an abbreviation of "Let's shaddup, my finger's tired."

In spite of its innocuous appearance, the rig packs great potentialities. With its present location high atop Screwball Hill, station calls from all districts except W9 have been worked, and DX up to 45 miles has been recorded. (For years W4s have striven for a W9 squelcher and it is now believed that success is within reach.)

A number of hams in the Boston area are using 2½-meter superhet converters attached to f.m. converters as receivers. The quality report given during a contact with a ham using such a receiver was that the speech was not readable when tuned to the exact center of the carrier and that it was necessary to de-tune the converter to make the speech intelligible. Since an f.m. detector (discriminator) has zero response to amplitude modulation when the received signal is properly tuned in, it follows that the transmitter has either absolutely no frequency modulation — or a lot of it. Other quality reports received vary from "excellent" to "sounds like you are talking through a Kazoo, OM."

After three weeks' usage and 20 or 30 QSOs, not a single equipment failure has resulted. It is firmly believed this is due entirely to the high grade of Southern pine matches employed.

Frequency Multiplication for the V.H.F. Bands

(Continued from page 48)

sion and several possibilities. Suppose we leave out the decoupling networks. In the example previously given using a 3.5-Mc. crystal, output was obtained at 14 Mc. and also at 21 Mc. The latter lies in the proposed new band for amateur operation. Other examples might be cited where advantage of this phenomenon may be taken in arriving at a desired output frequency.

It is entirely practical to use an LC combination in which the condenser will tune to both of the above frequencies so that output could be obtained on either one at will without the need for coil switching or plug-in coils. An amplifier which would tune over this range also could be easily built.

By using variable-frequency oscillators of low frequency, it should be possible to get several spot frequencies in the higher-frequency bands with one setting of the oscillator dial, and the

(Continued on page 98)

SYNTHETICS FOR ELECTRONICS

SYNTHETICS FOR ELECTRONICS

A-N FITTINGS

The Line That Goes 'Round the World



CONNECTORS

ENCLOSURE LAMP RECEPTACLES

CONNECTORS

To know these popular Amphenol products better—write today for the new Condensed Catalog No. 72.

● Among other radio experts, "hams" now welcome the return of the Amphenol line from honorable service on far-flung battlefronts around the world. Amphenol components—greatly improved by wartime experience and augmented in number, style and type—are currently available for civilian applications. Simplifying buying, this wider selection of high-quality, tested items can be procured from one manufacturer.

AMERICAN PHENOLIC CORPORATION
In Canada • Amphenol Limited • Toronto

U. H. F. CABLES AND CONNECTORS • CONDUIT • CABLE ASSEMBLIES
CONNECTORS (A-N, U. H. F., BRITISH) • RADIO PARTS • PLASTICS FOR INDUSTRY

*Preferred
for
Performance*



TYPE BT AND BW RESISTORS

Over the period of the last two decades IRC Resistors have won a host of loyal friends—and daily are making new ones.

Engineered to highest quality standards these sturdy units can be depended upon for complete satisfaction in any rig.

Constant laboratory research, to improve both design and characteristics of IRC Resistors have made both the BT (Metallized filament type) and the BW (insulated wire wound) the most all-inclusive lines in the industry.

Nor did Uncle Sam overlook the quality features inherent in these composition type resistors when, during the war, he paid his respects by calling on IRC to furnish more than 60% of all the resistor requirements in this category.

For full information on Type BT and BW Resistors as well as other IRC products, request your free copy of Service Catalog No. 50 from your IRC Distributor or write direct to Dept. 18-L.

INTERNATIONAL RESISTANCE CO.

401 N. Broad Street, Philadelphia 8, Pa.
In Canada: International Resistance Co., Ltd., Toronto

*IRC makes more types of resistance units,
in more shapes, for more applications,
than any other manufacturer in the world.*

(Continued from page 98)

tuning range of the oscillator could be reduced considerably and still give complete coverage of the band being used. This would lead to a more accurate calibration of the oscillator dial.

Bias

Variable d.c. bias is shown in the circuit diagrams. While this may not be absolutely necessary, it is a very definite help. The amount of bias necessary depends upon the amount of excitation available to drive the stage, and this cannot be predetermined too accurately. Also, when a high order of multiplication is used, the output is very definitely a function of the bias applied, so that it is convenient to be able to adjust the bias for the best output for any given harmonic. In general, the higher the order of harmonic, the higher the bias necessary for maximum output. The potentiometers for adjusting the bias should be mounted at the rear of the chassis, since the adjustment need not be changed often.

Constructional Hints

This was not intended as a constructional article, but a few suggestions in conclusion might be in order. Coil forms for the lower-frequency stages may be made from 1-inch-diameter polystyrene rod. The rod should be threaded to take the wire. This job can be done on any lathe, or any machine shop will do the job at a very small cost. This will make a high-Q coil of rigid construction. Using these forms, it is suggested that a chassis with a depth of 3 inches or 4 inches be employed. One end of the form may be drilled and tapped so it can be mounted on the under side of the chassis by means of a machine screw through the chassis.

The sockets for 832 or 829 tubes should be sub-mounted on the chassis. This will bring the grid circuit below the chassis and the plate circuit above, providing shielding between these sections.

Coils for circuits operating at 50 Mc. and higher frequencies should be wound with No. 10 or No. 12 wire in self-supporting fashion. They should be mounted directly on the condenser soldering lugs.

Extremely short leads should be used throughout. At the higher frequencies, care should be taken with the placement of parts to insure that the leads are as short as is physically possible.

One thing which is often overlooked is that the leads of by-pass condensers for all single-ended circuits also should be short. Since these condensers form the r.f. return circuits, the inductance of the leads is a part of the tank circuit, and at the high frequencies this may become an important item. The length of the by-pass lead includes the chassis path from the point of grounding back to the cathode. Therefore, whenever possible, the by-pass condenser should be connected directly to the cathode and not to the chassis at some other point.

All decoupling networks should be placed at the point of connection to the r.f. circuit and not just somewhere in the leads, since coupling between leads can cause trouble.

(Concluded on page 108)

MORE POWER OUTPUT **BUT** LESS BATTERY DRAIN WITH HYTRON INSTANT-HEATING BEAM TETRODES

ZERO STAND-BY CURRENT Thoriated tungsten filaments of the Hytron 2E25, HY69, and HY1269 permit simultaneous application of all potentials. During stand-by, no precious filament current is drawn from the battery. Especially with the larger tube complements of FM transmitters, is conservation of battery power mandatory.

MORE OUTPUT—GREATER RANGE Only 4% of the current required for cathode types, is necessary to operate the instant-heating 2E25, HY69, and HY1269. (See table below.) Even in a mobile FM transmitter, 100 watts output is practicable. Imagine the advantages of such increased output in police, marine, or other mobile equipment.

SPARES PROBLEM SIMPLIFIED Using the 2E25, HY69, and HY1269, you take full advantage of the beam tetrode's versatility. The 2E25, for example, can power a whole transmitter—AF and RF—AM or FM. If more output is required, HY69's or HY1269's in push-pull still confine the spares complement to only two types.

ADVANTAGES OVER CATHODE TYPES Yes, the 2E25, HY69, and HY1269 cost more than cathode types. But they are worth it. Not only are they easier on the battery, and permit larger outputs, but they are designed, built, and tested for transmitting. Some advantages are: centering of filament potential at 6.0 volts, r.f. shielding to eliminate the necessity for neutralization, low-temperature insulation throughout, plate connection to top cap, and rugged construction.

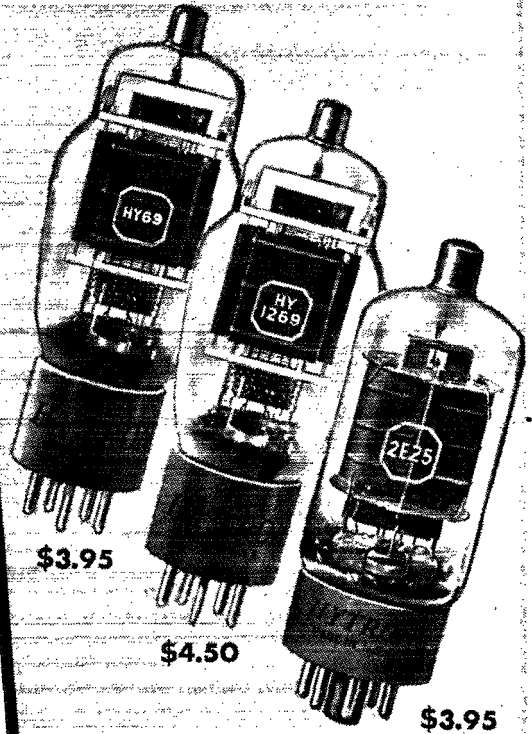

\$3.95

\$4.50

\$3.95

ABBREVIATED DATA HYTRON INSTANT-HEATING BEAM TETRODES

Characteristic	2E25	HY69	HY1269
Filament Potential (volts)	6.0	6.0	6/12
Filament Current (amps.)	0.8	1.6	3.2/1.6
Plate Potential (max. volts)	450	600	750
Plate Current (max. ma.)	75	100	120
Plate Dissipation (max. watts)	15	30	30
Grid-to-Plate Capacitance (mmfd.)	0.15	0.25	0.25
Maximum Seated Height (inches)	3 5/8	5 1/4	5 1/4
Maximum Diameter (inches)	1 7/16	2 1/16	2 1/16
Class C Power Output (watts)	24	42	63
Class C Driving Power (watts)	Less than one watt		

BATTERY DRAIN OF A CONVENTIONAL TRANSMITTER AND KAAR FM-50X EQUIPPED WITH HYTRON INSTANT-HEATING TUBES

AMPERE HOURS:	0	10	20	30	40	50	60	70
STANDBY DRAIN 24 HOUR PERIOD	0.0 AMP. HRS.—YET READY TO TALK INSTANTLY!							
AVERAGE TOTAL BATTERY DRAIN 24 HOUR PERIOD	56.8 AMPERE HOURS							
	2.2 AMPERE HOURS							

This chart, prepared by Kaar Engineering Co., is based on typical metropolitan police use of 140 radiotelephone-equipped cars operating three shifts in a city of 600,000 population. The 24-hour survey included 904 messages originated by cars and 932 messages acknowledged by cars. Transmissions averaged: 13 per car, 15 seconds in length, and 3 minutes 15 seconds transmitting time.



OLDEST MANUFACTURER SPECIALIZING IN RADIO RECEIVING TUBES

HYTRON

RADIO AND ELECTRONICS CORP.

MAIN OFFICE: SALEM, MASSACHUSETTS



VITROHM RESISTORS AND RHEOSTATS

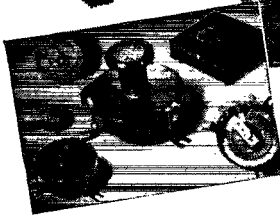

Ward Leonard Vitreous Enamelled Wire-Wound Resistors and Rheostats are now available at radio parts distributors.

Better than ever before, because they incorporate refinements and developments brought about through the war period. Write for your copy of the Radio and Electronic Resistor Catalog.

RESISTORS that withstand heat, moisture, vibration and other adverse conditions. Wide range of types, ratings, terminals and enclosures.

RHEOSTATS that include the widest range of sizes, types and current ratings from the tiny ring types for radio to huge power assemblies.

WARD LEONARD ELECTRIC CO.

Radio and Electronic Distributor Division
53 WEST JACKSON BLVD., CHICAGO, ILL.



COMPLETE RADIO TRAINING!

Prepare now to accept a responsible position in Commercial Radio. New developments will demand technicians with thorough basic training, plus a knowledge of new techniques discovered during the war. Training open to high school graduates or those with high school equivalency. Courses 6 to 18 months' duration in RADIO AND ELECTRONICS. Approved Veteran training in Radio. Write for Particulars.

VALPARAISO TECHNICAL INSTITUTE
Dept. TN Valparaiso, Ind.

In a Class By Itself!

GENUINE EASY-WORKING

Deluxe
Model

VIBROPLEX

Reg. Trade Marks: Vibroplex, Lightning Bug, Bug

CHROMIUM
FINISHED
BASE

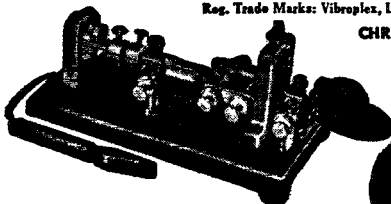

PATENTED
JEWEL
MOVEMENT
\$19.50



The "BUG" Trade Mark identifies the Genuine Vibroplex

Accept no substitute

America's finest radio key — the deluxe performer that sets new standards of sending excellence and operating ease. The jewels used in Deluxe Vibroplex keys are the same as those placed in the finest made watches and precision instruments, providing watch-like precision, feather-touch action, lifetime service and ease of operation unapproachable by any other key. Chromium finished base. Bright machined parts. Colorful red switch knob, finger and thumb piece. DIE CUT contacts and main spring, 3/16th contacts. Circuit closer, cord and wedge. Also available in "Lightning Bug" and "Blue Racer" models. Place your order now! Money order or registered mail. FREE Catalog.

THE VIBROPLEX CO., Inc.
833 Broadway New York 3, N. Y.

25 Years Ago

(Continued from page 51)

passed. . . . We have legislative troubles too. Danger confronts amateur radio in the Poin-dexter bill, which makes no proper provisions for us and reflects more of this imperialistic nonsense our military officers brought home from the European war. It is utterly un-American and we urge our members to write immediately to their senators to align their opposition.

In "Rotten Epistles," The Old Man arises in his might and swats back at this Young Squirt, as we felt sure he would. . . . Boyd Phelps of Minneapolis has been appointed manager of the Dakota Division, vice R. H. Pray. J. C. Cooper, jr., has been obliged to resign the management of the East Gulf Division because of pressure of affairs, and has been succeeded by E. H. Merritt. . . . Extensive investigation shows that someone on the East Coast has been falsely signing 7HH's call to mislead other amateurs. We would like to meet this fellow. If we can find out who he is we will drive him so far out of amateur radio that his call letters will be SOL.

B. F. Painter of Chattanooga reports experiments with a large Oudin coil, in which miniature ball lightning was produced. One ball struck his brother on the palm of a hand, giving him quite a jolt, and several days later he lost the skin from the palm. Another fire ball struck the boy in the forehead, giving him a bad headache. It was about 3/16-inch diameter, very white and sparkling and traveled fairly slowly, although a little too fast for him to dodge. Has anyone else seen anything like this?

Strays

The first postwar 112-Mc. contact from this station was with W3FYB at Greenbelt, Md. With our modulator unfinished we answered his CQ using pure c.w. When he came back, we found that by a lucky chance we had called a station located close enough to WWV so that 3FYB could read us by the audible beat between our carrier and the 115-Mc. harmonic from WWV! The only difficulty appeared when WWV sent the station identification in code.

— Henry L. Cox jr., W8UPS

Since the radio industry has adopted the practice of marking mica condensers by a color code, a chart giving the RMA standards for the Six Dot Color Code and the Three Dot Code as well as the Army and Navy standards has been a necessity to users of mica condensers. Cornell-Dubilier Electric Corporation has prepared a small card to fit into the pocket which incorporates all three of these standard color codes.

Copies of these useful color code cards may be obtained free by writing to Cornell-Dubilier Electric Corporation, New Bedford, Mass.

HAMS ... here are all the things you've been waiting for in NEWARK's two big stores. Order from the store nearest you for fast service.

THIS MONTH'S FEATURES

The famous Newark bargain oil-filled, oil-impregnated

FILTER CONDENSERS

Fully guaranteed at rated voltages

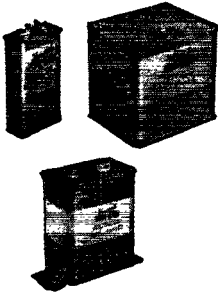

Capacity	Working Voltage	Height	Width	Depth	Wt.	Price
1 mfd.	1500 V. D.C.	2 3/8	1 3/8	1	4 oz.	\$.79
17 1/2 mfd.	1500 V. D.C.	3 3/8	4 7/8	3 1/2	3 lbs.	2.75
11 1/2 mfd.	1500 V. D.C.	5	3 3/4	1 1/2	1 lb. 10 oz.	2.00
5 mfd.	1500 V. D.C.	4	2 1/2	1 1/4	14 oz.	1.65
5 mfd.	2000 V. D.C.	4	3 3/4	1 1/4	1 lb. 4 oz.	2.15
8 mfd.	2000 V. D.C.	4 1/2	3 3/4	2 1/2	2 1/2 lbs.	2.75
.25 mfd.	2000 V. D.C.	3 3/4	1 3/4	1	6 oz.	.69
Special Porcelain Insulators						
10 mfd.	3000 V. D.C.	4 7/8	3 3/4	3 1/4	3 lbs. 8 oz.	4.75
15 mfd.	3000 V. D.C.	4 3/4	4 3/4	3 3/4	5 lbs.	5.25
6 mfd.	3000 V. D.C.	6 3/8	6 1/2	3	5 lbs. 6 oz.	3.25
with mounting feet, width includes mounting feet						
8 mfd.	3000 V. D.C.	7 3/8	6 1/2	3 3/4	7 lbs. 4 oz.	3.95
2 mfd. & 4 mfd.	600 V. metal can	4 7/8	2 1/2	1 1/4	14 oz.	.80

McELROY KEY

The Deluxe — Model CP 810 \$9.75

G.E. METERS

0-500 D.C. MA. 2" round Bakelite case..... \$3.50

0-8 RF ammeter, 2" round Bakelite case..... \$4.00

ABBOTT TR-4

Compact, efficient 2 1/2 meter transmitter-receiver \$39.00

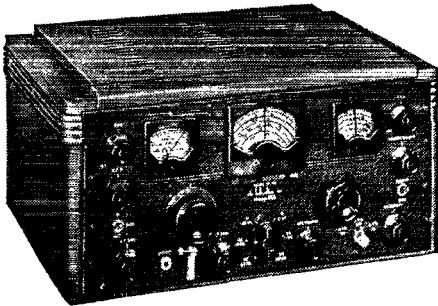

HALLICRAFTERS

SX-28A	Super Skyrider with crystal, less speaker.	\$223.00
S-20R	Sky Champion with built-in speaker....	60.00
S-22R	Skyrider Marine with built-in speaker...	74.50
SX-25	Super Defiant with crystal, less speaker...	94.50
S-39	Sky Ranger portable, AC/DC and battery	110.00
SX-36	FM/AM receiver.....	415.00
S-37	V.H.F. FM/AM receiver.....	591.75
PM-23	10" PM speaker in cabinet for use with SX-25, SX-28A.....	15.00

THORDARSON TRANSFORMER

(POWER TRANSFORMERS AND CHOKES)

T-45556 or T-92R21	leads out of side, 778 V. C.T. at 200 MA. 115 V. 60 Cycle 6.3 V. C.T. at 5A. 5 V. at 30 amp. 9 lbs.....	\$8.29
T-13C30	8H. 150 MA. 200 ohm 1600 V. Insulation 2 1/4 lbs.....	1.41
T-4557 or T-74C29	leads out of side. 15H. 150 MA. 200 ohm 2000 V. Insulation 5 1/4 lbs.....	2.82

HAMMARLUND

HQ-129X (with tubes).....	\$129.00
ASPC-210X.....	318.00
ASP-210SX.....	318.00

Available for rack mounting at same prices

NATIONAL

NC-2-40C and speaker..... \$240.00

RME

RME-45 and speaker..... \$166.00

Get Your Name on Our Mailing List

Be first to get announcements of merchandise available, special bargains, etc., etc. Send name and address on post card. State whether amateur, engineer, school, industrial or service man. Address orders and inquiries to Dept. G, at NEWARK store nearest you. All Amateur XMTR Contest Blanks available at both stores.

WESTERN ELECTRIC MICRO AMMETERS



Bakelite case fits 3 3/4" hole. Radium dial 150-0-150. Can be used with 0-200 micro and amp scale listed below. Excellent as a 5,000 ohm-per-volt meter or null, sound level and galvanometer indicator. Instructions included. No priority required..... \$7.50 0-200 paper scale for above..... .15

ALL PRICES SUBJECT TO CHANGE WITHOUT NOTICE

115-117 W. 45th St.
NEW YORK 19
BRyant 8-4735
(Adelphi Gross)

NEW YORK
Newark ELECTRIC Company
CHICAGO

"Service is the Foundation of our Business"

323 W. Madison St.
CHICAGO 6
DEArborn 0083
(Sam Poncher)

HARVEY

has the components you need
to build or remodel a ham rig

With the gradual lifting of restrictions on amateur radio, HARVEY resumes its place as unofficial ham headquarters. Here on our shelves are many of the necessities and luxuries you need to remodel or build your rig—at sensible, down-to-earth prices. Still with us are members of our staff, trained to give you sound technical advice. Yes, supplies are rapidly accumulating, and hams are busy at their rigs again—but not too busy, we hope, to stop in or write to HARVEY for components or equipment, or just to say hello.

The best buy of the month!

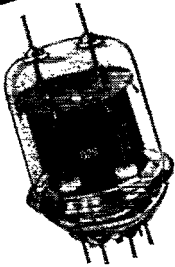

829 PUSH-PULL R-F BEAM POWER AMPLIFIER . . .

Made by nationally known manufacturer; **fully guaranteed; brand new**

SPECIAL \$4.95

Socket to match 829
Amateur Net **\$1.05**

R-F METERS — G.E. or Westinghouse; black face; 2½" case; ranges: 0—1 amps, 0—2 amps, 0—3 amps,
Amateur Net, **\$4.95**

**TR-4
In Stock!**

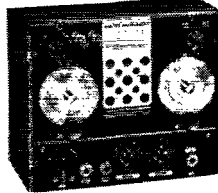

WESTINGHOUSE 3" MILLIAMMETER
Range: 0—1 mills; ideal for constructing volt-ohm-milliammeter. Amateur Net, **\$5.95**

REMEMBER, HARVEY DELIVERS
Telephone: LOngacre 3-1800

**HARVEY
RADIO COMPANY
HARVEY**

103 WEST 43rd ST., NEW YORK 18, N. Y.

(Continued from page 98)

The temporary model of the 112-Mc. transmitter described here and shown in the photographs is now in operation at W1EHT and is doing a really fine job. The other rigs will be on the air as soon as the bands are made available.

ABOUT THE AUTHOR

It took eleven years for Harry Gardner's interest in radio to expand to include an amateur license. W1EHT was obtained in 1932. A graduate EE from Northeastern University (1930) Gardner has been very active in New England club organizations and also is the Emergency Coordinator for Eastern Massachusetts. After twelve years with the Boston Edison Company, Gardner left there in 1942 to engage in essential research work at MIT's Radiation Laboratories. W1EHT has been an ORS, OBS, OPS and is an esteemed member of the RCC. He reports working all bands with special emphasis on "5 and 20."

Technical Topics

(Continued from page 56)

along any line drawn perpendicularly from top to bottom of the guide, since there is no variation of electric field intensity along such a line.

As Figs. 12 and 13 show, there is a component of magnetic force in the direction of propagation of the resultant wave. The wave is therefore not of the TEM type, since the TEM wave has no field component in the direction of propagation. However, in the particular wave shown there is no component of electric field in the direction of propagation through the guide. The wave is therefore transverse so far as this field is concerned, and therefore is known as a "transverse electric" or "TE" wave.

The wave we have been discussing is by no means the only type that can exist. It happens to be a simple one that lends itself readily to an explanation of the general principles involved in transmission of waves through hollow conductors. It is entirely possible, for example, for the magnetic field to be entirely transverse to the direction of propagation. In such a case, again considering the fact that the wave components travel at an angle to the direction through the guide, the resultant electric field must have a component in the direction of propagation. Such a wave is known as a "TM" wave. Thus there are three general types of waves, the TEM, the TE, and the TM. The last two have been known by other names ("H" and "E" respectively) but the standard designations are now TE and TM.

—G. G.

(To be continued in a coming issue)

Strays

A commercial operator was overheard by W8FU saying — "The only way I can see to figure out the output of that rig is by multiplying the plate volts by the antenna amps."

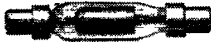

Y-PINENUT, 1-5 mmfd., 14000 Peak Volts, 10 Amps., Overall Length $3\frac{1}{4} \pm \frac{1}{16}$ " x $\frac{3}{8}$ "



X-PEANUT, 5-25 mmfd., 14000 Peak Volts, 20 Amps., Overall Length $3\frac{1}{4} \pm \frac{1}{16}$ " x $1\frac{1}{4}$ "



W-WALNUT, 6-50 mmfd., 20,000 Peak Volts, (Available up to 32,000 Peak Volts), 20 Amps. Overall Length $4\frac{1}{8} \pm \frac{1}{16}$ " x $2\frac{1}{4}$ "



VC 50, 6-50 mmfd., 20,000 Peak Volts, (Available up to 32,000 Peak Volts), 20 Amps. Overall Length $6\frac{1}{2}$ " x $2\frac{1}{8}$ "



VC 250, 50-250 mmfd., 20,000 Peak Volts, 60 Amps. Overall Length $6\frac{1}{2}$ " x $2\frac{1}{8}$ "

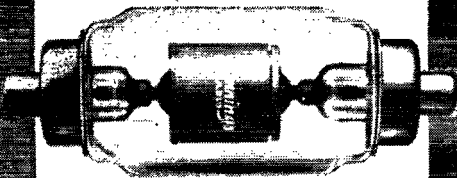

C-COCONUT, 50 mmfd., 50,000 Peak Volts, 60 Amps. Overall Length $8\frac{1}{2}$ " Long, 3" Diameter.

**NEW-HIGH VOLTAGE
VACUUM
CAPACITORS**

DEVELOPED DURING THE WAR for—

AMATEUR

**RADIO AND ELECTRONIC
POSTWAR EXPANSION...
NOW READY!**

Jennings
RADIO
VACUUM ELECTRONIC COMPONENTS

We welcome your inquiry and the opportunity to serve you and the Amateur Electronic field

WATCH JENNINGS FOR NEW DEVELOPMENTS IN THE FIELD OF SPECIALIZED VACUUM ELECTRONIC COMPONENTS

WRITE FOR BULLETIN QS

JENNINGS RADIO MANUFACTURING COMPANY • 1098 E. WILLIAM ST. • SAN JOSE 12, CALIFORNIA

Foreign Notes

(Continued from page 61)

plans would permit them to contribute more fully to future radio development. He predicted an increase in membership from the present figure of 1400 to 10,000 within a year, and announced C.A.R.L.'s intention of participating in future Union affairs.

CUBA

At the September meeting of officers, it was agreed to reorganize the short-wave section of R.C.C., with M. Aquiles Ortiz, CM2BG, chosen as president and James D. Bourne, CM2AZ, retained as secretary. It is believed Cuban authorities intend to reopen their amateurs only in accordance with release of similar frequencies to U. S. hams.

EIRE

Suspended for five years of war, I.R.T.S. is again active and has negotiated the return of all impounded gear which has been lying in government storage since September, 1939, with the proviso it be dismantled pending actual issuance of licenses. Society officials are in touch with government authorities seeking to reopen amateur bands as soon as possible, with special requests for the early use of 5 and 2½ meters.

FRANCE

Led by its new president, Robert Larcher, F8BU, the R.E.F. is reorganizing and hopes that amateur radio will soon be in full operation. Trouble has been experienced in attempts to secure return of confiscated apparatus, much of which was requisitioned for military use or destroyed in bombings, and the society is negotiating for the reimbursement of amateurs for such lost gear. No government action has yet been forthcoming on reopening amateur bands.

GREAT BRITAIN

R.S.G.B. expects that Gs will be opened up on other than DX bands shortly, probably by the time this is read, but word from authorities in middle October indicated that release of international ham frequencies is not probable for from four to six months, due to military needs. President Gardiner, G6GR, announces that "an agreement has been reached with other governments that operation on international amateur frequency bands will commence simultaneously."

NETHERLANDS

Looking toward a more unified organization and taking advantage of the six-year break in activities, amateurs of PA are planning a new and larger amateur radio society to be composed of members of several prewar groups. When accomplished, the new society will be proposed as the Dutch section of the Union, and N.V.I.R. will be absorbed into the larger organization.

All amateur groups were disbanded during occupation, by Nazi order. Little hope is held for

(Concluded on page 108)

From Design to Delivery PEERLESS

Does it Better!

A complete transformer service—from engineering design to correctly cased unit. Peerless transformers, windings, reactors, and fluorescent ballasts are available or can be produced in sizes and capacities to meet *your* needs. Write for new catalog.

**Prompt Delivery
If You Order Now!**

Choice territories open
for qualified
representatives

PEERLESS

ELECTRICAL PRODUCTS CO.

6920 McKinley Avenue
Los Angeles 1, California

HQ-129-X

NEW

*Better Audio
Quality*

*Improved
Stability*

*New
S-meter*

*Improved
Noise Limiter*

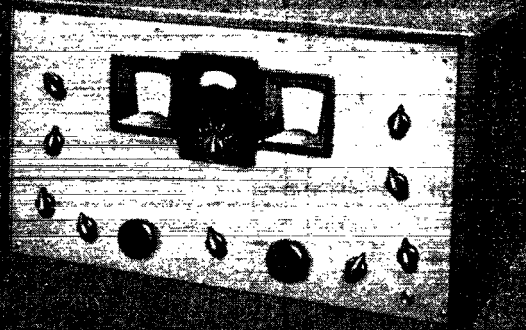

*Three I. F.
Stages*

*Accurate
Calibration*

*Easy
to Operate*

HARD TO GET? Yes and we are sorry too, but some last minute, essential war work had to be completed before we could really get into high gear on the new HQ-129-X.

Write for descriptive booklet on the HQ-129-X and technical data on other postwar products for amateurs, engineers and experimenters.

\$129.00

AMATEUR NET LESS SPEAKER

Price subject
to change
without notice



HAMMARLUND

THE HAMMARLUND MFG. CO., INC., 460 W. 34TH ST., NEW YORK 1, N. Y.
MANUFACTURERS OF PRECISION COMMUNICATIONS EQUIPMENT

THIS NEW MIGHTY MIDGET



No. 412

No. 482

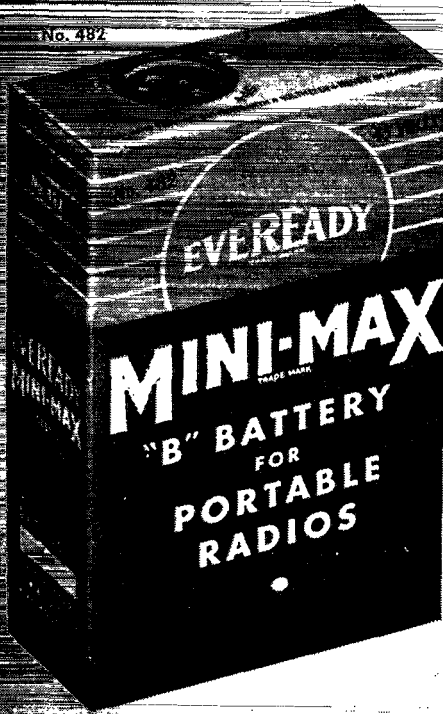

has changed the lives
of this whole family of
"MINI-MAX" BATTERIES

No. 467



No. 420



EVEN BEFORE PEARL HARBOR, battery construction principles developed by National Carbon Company were making possible new strides in portable radio and electronic equipment. Then came the war. The company was called upon to develop even more radical improvements in battery construction to meet the needs of light and extremely portable military communications of all types, and so the tiny 22½ volt "Eveready" "Mini-Max" "B" battery was born—a battery well under half the size of anything of comparable voltage—easy to carry as a match box!

This is what this new, improved battery construction means. It means a brand new line of portable radio equipment—equipment that will give the idea of the "personal radio" an entirely new meaning. It makes possible radio sets for individual use—sets so small that they can be slipped into the pocket of a vest, or carried in a woman's handbag. Portable radio business will not merely pick up where it left off December 7, 1941. It will be years ahead of itself.

Engineers and designers are already aware of the possibilities of this new battery. They are already at work on new radio and electronic devices which exploit its portability. And at this time may we invite all these creative men to avail themselves of our experience, our laboratories and to consult with our engineers. National Carbon Company, Inc. extends to you complete cooperation.

The words "Eveready" and "Mini-Max" are registered trade-marks of National Carbon Company, Inc.

Now that radio batteries are back again, National Carbon Company is offering an extremely useful new Portable Radio Battery Replacement Guide. Write for your copy today to our nearest Division Office listed below.

NATIONAL CARBON COMPANY, INC.
Unit of Union Carbide and Carbon Corporation



General Offices: New York, N. Y.

Division Sales Offices: Atlanta, Chicago, Dallas, Kansas City, New York, Pittsburgh, San Francisco.

We are Delivering RECEIVERS

HALLICRAFTERS
SUPER DEFIANT
SX-25

\$109.50
Complete

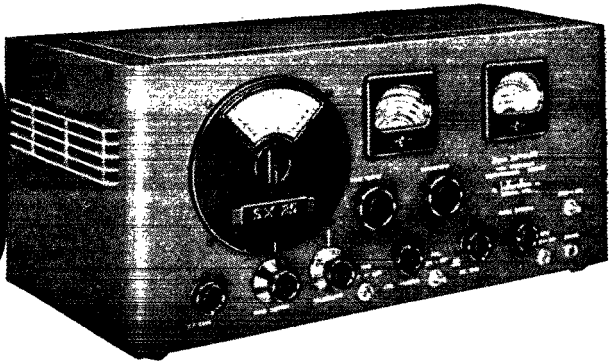

The hams who ordered early are *now* getting their communications receivers—just as fast as we can ship them out. Our stocks of popular sets are getting better all the time — prices are right (you may buy on easy, time payments if you wish) — shipments are prompt. Order one of these nationally known sets from the Radio Shack *today*.

ARE YOU REBUILDING?

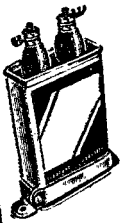

Here's a buy you shouldn't miss!
Xmtg condenser—2 mfd—1000
volts—oil impregnated—oil filled
—hermetically sealed—made by
famous manufacturer.
Regularly sold for \$3.96
Your cost—only 79c
Pls Incl. 10c Postage & Packing Chg.

UHF ACORN TUBES

Types—954-955-956-959
6 TUBES, \$2.95
same type, or assorted
Isolantite sockets for above—
88c each
Pls Incl. 10c Postage & Packing Chg.

HALLICRAFTERS

Model Number	Net Price
SX-28A Super Skyrider—Complete	\$238.00
S-20R Sky Champion—Complete	\$60.00
S-22R Skyrider Marine—Complete	\$74.50
S-39 Sky Ranger—Complete	\$110.00

NATIONAL

The famous HRO with 4 sets of general coverage coils, tubes, power supply, and spkr \$226.15
N-2-40Cabout \$225.00

HAMMARLUND

HQ-129X — Complete	\$129.00
ECHOPHONE	
EC-1A — Complete	\$29.50

A MERRY CHRISTMAS AND A HAPPY NEW YEAR FROM

Write for
FREE 108 PG. CATALOG
of all ham gear

The RADIO SHACK
★ 167 WASHINGTON ST. ★
BOSTON, MASS., U.S.A. ★



FOR
PORTABLE RADIOS

BURGESS BATTERIES

RECOGNIZED BY THEIR
STRIPES - REMEMBERED
BY THEIR SERVICE

CODE SENDING SPEED
RECEIVING

Have Skill, Accuracy

Be a "key" man. Learn how to send and receive messages in code by telegraph and radio. Commerce needs thousands of men. Expansion of air commerce and freight after war should create an even bigger peacetime demand for operators. The famous Candler System, maker of world's champions, teaches you the "knack" of sound sense and sound consciousness.

That is the secret of speedy sending and receiving. Good pay, adventure. Learn at home quickly.

FREE 52-PAGE BOOK explains extra course of training. Rush name for it today. It's absolutely free.

CANDLER SYSTEM CO.
Dept. 4-O, P. O. Box 928, Denver 1, Colo., U. S. A.
and at 121 Kingsway, London, W.C. 2, Eng.

(Continued from page 104)

the return of equipment originally impounded by Netherlands authorities and later confiscated by occupation forces.

NEW ZEALAND

Amateurs of ZL also have the problem of securing the return of gear removed by government police at the outbreak of war. N.Z.A.R.T. is moving for the reinstatement of amateur frequencies and finds the Post & Telegraph Department sympathetic and cooperative as always. Special request has been made for the early return of 80 and 5 meters.

POLAND

It is reported to us that the P.Z.K. headquarters in Warsaw was destroyed completely during the 1939 invasion, and all files, documents and equipment were lost. Personal amateur gear was confiscated by the enemy during occupation. It is not known whether P.Z.K. will live again, but indirect word indicates that some manner of amateur organization will evolve soon.

SOUTH AFRICA

As of July 1, S.A.R.R.L. was officially resumed, operating on an emergency basis until a general meeting can be arranged. A large number of members are still on active service. "QTC" was forced to cease publication through paper shortage, but plans early revival.

Above 50 Mc.

(Continued from page 68)

Mc. but the unit may be converted to 144 Mc. by changing the coil diameter from $\frac{1}{2}$ to $\frac{3}{8}$ inch.

Units of somewhat similar construction are in use at W2OEN and W1HDQ, except that 100 micro-ampere meters are used and the crystal-meter circuit is connected across the tuned circuit as shown in Fig. 3B. W2OEN made his meter a removable unit, which may be connected by any required length of twisted pair to the pickup section. The unit may then be set up at a distance from the array, leaving the meter in a convenient position for reading while making adjustments. The W1HDQ unit has a two-turn $\frac{1}{2}$ -inch coil, tuned with a 100- μ fd. variable condenser, by means of which 50 and 112 Mc. are picked up at opposite ends of the tuning range.

Fixed crystals of the type used for u.h.f. mixer service are excellent for this purpose. These small rectifier units, of the 1-N series, will be on the market soon at moderate cost. A field-strength meter of this type is fully as sensitive as most vacuum-tube types; it has the distinct advantage of requiring no turning on and off; and it is light in weight and compact in the bargain. Using a

(Concluded on page 110)



Switches

Shown above are a few of the many types of micro-switches, toggle switches, knife switches, rotary switches, band switches, etc., now available through the Hallicrafters Co., Chicago, agent for the Reconstruction Finance Corporation under contract SIA-3-24.

Other radio and electronic components such as resistors and condensers are also available in large quantities. Send the coupon for further details.

hallicrafters RADIO

THE HALLCRAFTERS CO., AGENT FOR RFC UNDER CONTRACT SIA-3-24
MANUFACTURERS OF RADIO AND ELECTRONIC EQUIPMENT

THESE VALUABLE ITEMS *Available Now* or very soon. Write, wire or phone for further information.

- head phones • test equipment • component parts
- marine transmitters and receivers • code practice equipment
- sound detecting equipment • vehicular operation police and command sets • radio beacons and airborne landing equipment.

CLIP THIS COUPON NOW

RFC DEPARTMENT 309, HALLCRAFTERS
5025 West 65th Street • Chicago 38, Illinois

Send further details and price on Switches and component parts

Send listings of other available items

Especially interested in.....

NAME.....

ADDRESS.....

CITY..... ZONE.....

STATE.....

THE RADIO AMATEUR'S LIBRARY

Many requests are received for the complete list of our publications.

The list follows:

<i>Title</i>	<i>Price</i>
<i>QST</i>	\$2.50 per year*
List of Stations.....	Discontinued
Map of Member Stations	Discontinued
Operating an Amateur Radio Station Free to members; to others 10¢	Discontinued
The Story of The A.R.R.L.	Discontinued
The Radio Amateur's Handbook	
a. Standard Edition.....	\$1.00**
b. Special Defense Edition..	\$1.00
The Log.....	35¢ each; 3 for \$1.00
How to Become a Radio Amateur	25¢
The Radio Amateur's License Manual.....	25¢
Hints & Kinks for the Radio Amateur.....	50¢
Lightning Calculators:	
a. Radio (Type A).....	\$1.00
b. Ohm's Law (Type B).....	\$1.00
Amateur Radio Map of the World.....	\$1.25
Two Hundred Meters and Down: The Story of Amateur Radio	Out of print
Building an Amateur Radio- telephone Transmitter	Out of print
A.R.R.L. Antenna Book.....	50¢
Emergency Communications Manual.....	10¢
The Minilog.....	25¢
Learning the Radiotelegraph Code.....	25¢
A Course in Radio Fundamentals	50¢

* In the United States and Possessions — other Countries \$3.00 per year.

** Postpaid in Continental U. S. A. — \$1.50, postpaid, elsewhere.

(No stamps, please)

●

**The American
Radio Relay League Inc.
West Hartford 7, Connecticut**

four-foot rod, the meter gives a half-scale indication at a distance of 100 feet away from the 3-element array at W1HDQ, with less than one watt of power in the antenna.

Activity reports were conspicuous by their absence during the month of October. Though occupation of 112 Mc. was apparently at an all-time high, it was of a temporary nature, and consequently most operators concluded that there was no point in reporting details.

From out in the Hawaiian Islands, Lt. Bud Barnard, W1NSS/K6, reports activity booming on 112 Mc., with K6's ESK UDM, W1's LTS MQO NSS, W2's LBF LFE OAG, W4FMW, W5JOF, W6's RHB RXV TAK, W7's HOJ IXK, WSCVJ, W9's BRC HJO JND and QVR going strong on the Island of Oahu. Rigs are largely HY-75's, though there are a couple of 829 rigs of somewhat higher power. A station is expected to be on at Hilo, Hawaii, which should be a good DX shot for the gang on Oahu — and not all impossible, from our own observations of the Hawaiian Islands.

Nearly all call areas are represented in Bremerton, Seattle, and Tacoma, Washington, according to W3GQM/7 of Bremerton. Apparently some nice temperature inversions develop in the territory around Puget Sound, for W3GQM reports that Tacoma stations, some 25 miles away, occasionally hit S9 peaks, though he is in the shadow of a 200-foot hill in that direction.

The trend to horizontal polarization continues in the Chicago area, W9PK having sold the idea to about a dozen stations. Jack reports a considerable improvement in coverage in each case. Most of the fellows are using the 4-element array described in Feb. 1942 *QST* on page 16. This Y-match arrangement is ideally suited to horizontal polarization, and would undoubtedly give better performance in that position than when mounted vertically. We doubt if this is a good comparison of the effectiveness of horizontal vs. vertical, however. The ideal vertical array has vertically-stacked elements; the parasitic array having several halfwave elements in line is definitely not vertical polarization in its most effective form. All the above is not said with the idea of taking sides in the polarization controversy — it merely emphasizes that there is more to horizontal-vertical comparisons than turning a vertical antenna over on its side.

There has been plenty doing in the Great Lakes area: W9DXX, operating from a tall building in Chicago's Loop District, has worked more than 100 different stations. The list worked by W9PK passed number 50 some time ago.

W4IP, Miami, Fla., reports that W1BRA/4 at Delray worked W4's FVW, VV, ECV, NB, BYF, and 1P, all of Miami, a distance of 45 miles, on the night of October 22. W9TQK/4 of Fort Lauderdale worked all these stations also.



Portrait of Randolph C. Walker by John Carlton

Engineers of Victory

NOW SERVE MEN AT PEACE

The creative engineering which armed our fighting men for Victory has no less a responsibility in the years of peace ahead. Now that the war is won, we have the job of making this a better world.

AIREON produced huge quantities of communications and radar equipment and other machinery for waging war. Its achievements were equal to its heavy responsibilities, and its workers established an outstanding record of performance.

AIREON enters peacetime production with a notable engineering organization, highly skilled personnel and great confidence in the future. We have developed many products which will contribute to better living, for the manufacture of which all 15 AIREON plants will continue in production.

In order to extend our usefulness we recently established an experimental laboratory in Greenwich. AIREON's creative engineering in radio communications, electronics, musonics and hydraulics will team with production proficiency in contributing devices for future service.

In peace, as in war, AIREON will stand for quality and performance.

Randolph C. Walker
PRESIDENT

Cinaudagraph Speakers

A SUBSIDIARY OF **Aireon**

3911 SOUTH MICHIGAN AVENUE, CHICAGO



This new Folded Unipole Antenna for commercial use weighs only 19 pounds. Its "Slide Trombone" calibration eliminates old-fashioned pruning. Comparative tests show it out-performs other antennas at several times the price.

HIGH GAIN DIRECTIVE

ANTENNAS

for Amateur Use

In vital military and emergency communications all over the world, the name ANDREW means sound engineering plus skill and ingenuity in meeting specific antenna design problems.

NOW FOR AMATEURS

This engineering skill and know-how with commercial antennas is being applied to the production of ham antennas, including both vertically polarized directive arrays and horizontally polarized rotatable systems.

Andrew Co. pioneered in the development of HF antennas, coaxial transmission lines and accessories.

Andrew Co. specializes in the solution of antenna problems—in the designing, engineering and building of antenna equipment.

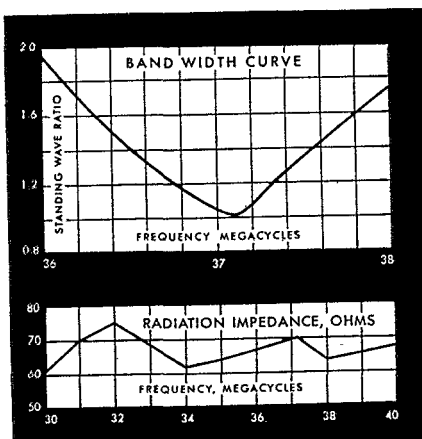

ANDREW CO.

363 EAST 75TH STREET
CHICAGO 19, ILLINOIS

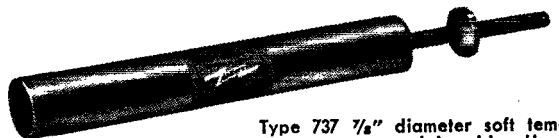

Type 737 7/8" diameter soft temper copper coaxial cable. Hundreds of miles of this Andrew cable are now in use with police and military transmitters.

TERMINAL IS YOUR BEST BET FOR BETTER BUYS!

HEADQUARTERS FOR AMATEUR EQUIPMENT

NOW . . . NEW RECEIVERS!

- HALLICRAFTERS**
 SX-28A, less speaker \$223.00
 SX-25, less speaker 94.50
 PM-23, speaker 15.00
 S-20R, Sky Champion 60.00
 S-39, Sky Traveler 110.00
 EC-1A Echophone 29.50

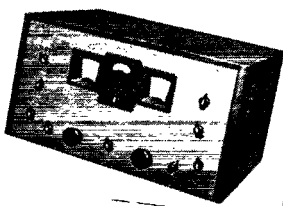

- NATIONAL**
 NC-240C, less speaker \$225.00
 HRO, less power supply and speaker 197.70
 HRO Power Supply 17.70
 HRO Speaker 10.95

- RADIO MFG. ENGINEERS**
 RME-45, complete \$166.00

- HAMMARLUND**
 HQ-129X, less speaker \$129.00
 SP-210X, less speaker . . . 318.00
 SC-10, speaker in cabinet . . 10.50
 Ask us for receiver catalogs!

VIBROPLEX "BUG" KEYS

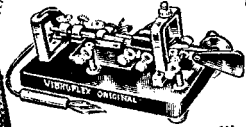

A Vibroplex "Bug" is the key to easier sending! Feather-touch action, free of tiring effort, adjustable to speed and personal touch.

- Vibroplex "Original" \$15.95
 Vibroplex "Lightning Bug" . . \$13.95
 Vibroplex "Zephyr" \$12.50

TRANSMITTING TUBES

All Types in Stock!

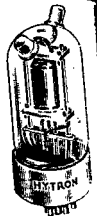

- RCA • RAYTHEON • AMPEREX
 NATIONAL UNION • TAYLOR
 EIMAC • ELECTRONIC ENTER.
 HEINTZ & KAUFMAN • HYTRON
 UNITED • GENERAL ELECTRIC

Ask us for catalogs and prices!

For That New Rig!

DUNCO Time—Delay RELAY

For use in preheating your 866's, etc. 30 second delay, coil voltage 120 volts A.C., 20 ampere contacts. This is one of the best relay buys we've had in a long time!

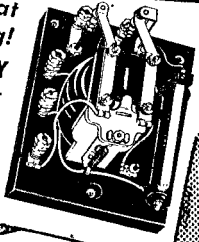

Net price . . . \$4.65

TEST EQUIPMENT

The model 101A shown here has the following ranges: 0/6/60/300/600/3000 volts D.C. (1000 ohms per volt); 0/12/120/600/1200 volts A.C.; 0/6/60/600 milliamperes D.C.; 0/200/2000/.2 meg/20 meg ohms

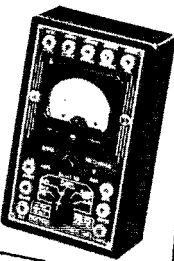

- Net price \$17.50
 Model 101B, same as above, except it has 4 1/2 meter Net price \$20.95

Terminal also carries a complete stock of RCA, Supreme, Superior, Hickok, Precision, Triplett and Weston instruments.

TRANSFORMERS

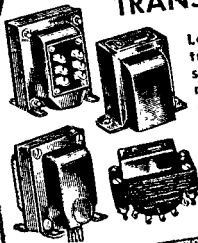

Let TERMINAL supply your transformers from its big stocks! Power, filament, modulation, audio, driver, chokes, etc.

- We handle:
 STANCOR • UTC • UTAH
 THORDARSON • KENYON

Ask us for transformer catalogs!

MICROPHONES



Terminal carries a complete stock of microphones for all requirements. We are authorized distributors for:

- ASTATIC • BRUSH • AMPERITE
 AMERICAN • SHURE • TURNER
 ELECTRO-VOICE • UNIVERSAL

Microphones for amateur, broadcast, public address and recording—write for catalogs!

RADIO BOOKS Complete Stock!

TERMINAL book department has just opened its new enlarged book department catering specially to radio engineers and amateurs. See us for latest, up-to-the-minute publications of:

- AMERICAN RADIO RELAY LEAGUE • McGRAW HILL PUBLISHING CO. • JOHN WILEY and SONS • D. VAN NOSTRAND CO., INC. • JOHN F. RIDER PUBLICATIONS • SUPREME PUBLICATIONS • GHIRARDI RADIO BOOKS

When ordering by mail please include 25% deposit!

TERMINAL RADIO CORP.

Home of Sound Radio Values

85 CORTLANDT STREET • NEW YORK 7, N. Y. • WOrth 2-4415

RACKS · CHASSIS · CABINETS

PAR-METAL

for
ELECTRONIC APPARATUS

ENGINEERS, CONTRACTORS: Send specifications for estimates, or request Catalogue No. 41

PAR-METAL PRODUCTS CORP.
32-62 49th ST., LONG ISLAND CITY, N. Y.
Export Dept.: 100 Varick St., New York, N. Y.

SOMETHING TO MAKE?

Development Engineer for well financed manufacturer is looking for radio, radio-electrical items to manufacture. Marketing service if desired. Write

Box 140 • QST

38 La Salle Rd.

West Hartford 7, Conn.

Carter THE PREFERRED POWER SUPPLY

Carter Dynamotors, Magnomotors, DC to AC Converters and Genomotors provide the finest rotary power for your mobile rig. Widely used and preferred by leading State and City Police Mobile Networks. Wide range of receiver and transmitter models, filter and starting relays available. Send today for the latest free bulletin.



CARTER . . . A well-known name in radio for over 20 years!



Correspondence from Members

(Continued from page 64)

This is the story of one ham serving his country. Fortunately, we have had many of his kind here in our country during these war years — others were perhaps more lucky than LA7A. The loss of Eikrem is a hard one and very difficult to overcome as we are so few and cannot afford to lose so energetic, helpful and unselfish a comrade.

I note that you are intending to reach out a helping hand to the amateurs abroad. This will certainly be very highly appreciated as the Germans laid hands on all radio gear available. In this connection I should like to mention something which is important — i.e., the lack of *QST* and the *Handbook* during the war years. Back numbers of *QST* and some of the more recent *Handbooks* would be of great interest. American currency will not be available for this purpose for a considerable time but we hope that perhaps this difficulty may be overcome as we are most anxious to get acquainted with developments in amateur radio during the past five years.

— O. Larsson, LA1V

AIDS FOR GLASS BLOWERS

338 Vanderbilt Hall, Boston 15, Mass.

Editor, *QST*:

. . . Regarding glass blowing, vacuum pumps and other elements of tube manufacture . . . one text that covers this subject rather fully is Strong's *Procedures in Experimental Physics* published by Prentice Hall, New York City.

C. N. Loewenstein's letter in the June, 1945, *QST* describing his experience in tube-making was interesting, but he gave no reference for the use of those not so well acquainted with the subject. With no exaggeration, the "art" of glass blowing is an extremely difficult one to master, but with adequate equipment and time anyone can succeed.

— Herbert L. Ley, jr.

845 Prospect Ave., Charleroi, Pa.

Editor, *QST*:

For the past three years I have been helping to blow radar bulbs, television bulbs for which are used by DuMont. My dad is a glass blower and I am his first helper. We have to make the bulbs to Army and Navy specifications and had a hard time at first, but when we got going we produced thousands of them.

If you want any further dope on how bulbs are blown I'll be glad to pass it along.

— John P. Souritch, W3RWA

MESSMAN MAKES RADIO SHACK

330 Vincent Blvd., Alliance, Ohio

Editor, *QST*:

You have done me a great service. About a year ago, when I was going to sea as a messman, I wrote to find out how I could get into the ship's radio shack. (I had been told that due to bad eyes, I could not be anything other than a messman.) After receiving a letter from Hq. I started the ball rolling.

After a while I went to Hoffman Island, and after the 20 weeks of school were over I had a second telegraph and second 'phone license. I had always been interested in amateur radio so I also went up to the local R.I. and came back with my ham ticket.

If it had not been for the ARRL, I might still be diving for pearls on one of the ships out on the deep blue but I can now watch some one else do that while I enjoy the comforts of the radio shack.

— Charles T. Unger

"PRELTO"

H.M.S. Ferret, c/o G.P.O., London, England

Editor, *QST*:

The May *QST* editorial wrote in defense of and for the retention of the term "ham."

We who have been in the game for a number of years understand the use of the name and use it occasionally in slang, although we more often simply refer to another ham as bloket

(Continued on page 110)

ORDER YOUR NEW Communications Receiver NOW from ALLIED *For Earliest Delivery*

**Available on Time-Payments
Trade-ins Accepted**

BE ONE OF THE FIRST to own and enjoy one of these celebrated receivers. All models cover amateur, short-wave, and broadcast bands. War-proved features... plus latest engineering developments. Allied is a leader in the distribution of communications receivers. Orders are filled in turn. Place your order now.

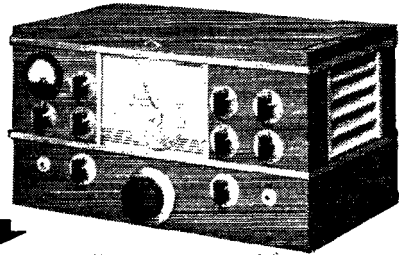

NATIONAL NC-2-40C

490 kc. to 30 Mc. range in 6 bands. Accurate single dial control. Temperature compensation. Automatic voltage stabilization. Adjustable series-valve-noise limiter. Flexible crystal filter. Phonograph or high level microphone pick-up jack. Net.....**\$225**
Speaker in matching cabinet, net.....\$15.00

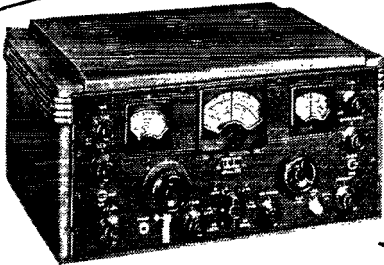

HALLCRAFTERS SX-28A

550 kc. to 42 Mc. continuous in 6 bands. Accurately calibrated tuning dial. Separate calibrated bandspread dial. Two r.f. stages. Lamb type 3 stage adjustable noise limiter. 6 position i.f. and crystal filter selectivity switch. Oscillator temperature compensated.
Net.....**\$223**
PM23 Speaker, net.....\$15.00

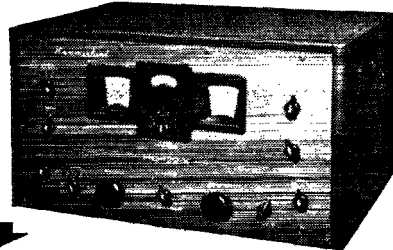

HAMMARLUND HQ-129X

Full range .54 to 31 Mc. accurately calibrated. 4 calibrated Ham bands and 1 arbitrary scale. Variable selectivity crystal filter. Low drift heat oscillator for code and locating stations. Antenna compensator. Voltage regulation. Compensated oscillator to reduce drift during warm-up. Automatic noise limiter.
Net.....**\$129**
Speaker, net.....\$10.50

Other well-known receivers such as:

Hallcrafters SX-25	\$ 94.50
Hallcrafters S-20R	\$ 60.00
Hallcrafters S-39	\$110.00
Hallcrafters S-36A	\$415.00
PM23 Speaker	\$ 15.00
Echophone EC-1A	\$ 29.50

Net, F.O.B. Chicago
(All prices subject to possible change)

ALLIED RADIO

Everything in Radio & Electronics
833 W. Jackson Blvd. • Chicago, Ill.

ALLIED RADIO CORP., L. M. Dezettel W9SFW
833 W. Jackson Blvd., Dept. 27-MM-5
Chicago 7, Illinois.

Date.....

Please ship..... Model.....

Enclosed \$..... Full Payment Part Payment
(Balance C.O.D.)

Send literature on Receivers and Time Payment Plan.

Send Allied Catalog of Radio Parts and Equipment.

Name.....

Address.....

City..... Zone..... State.....

Now!
A Better Soldering Tool...
THE KWIKHEAT
Has Built-in Thermostat Control!
THERMOSTATIC SOLDERING IRON



6 TIP STYLES

- #0—\$1.25
- #1—\$1.25
- #2—\$1.25
- #3—\$1.25
- #4—\$1.75
- #5—Melting Pot for tinning—\$1.25

HOT, READY FOR USE ONLY 90 SECONDS after plugging in! Kwikheat is the only soldering iron with a thermostat built into the tool itself—maintaining the proper level of heat for most efficient, economical operation. **SAFE!** ... Cannot overheat—**ECONOMICAL!** ... Lasts longer—saves tips and requires less retinning. **POWERFUL!**—225 watts—yet exceptionally light weight (14 oz.). Well-balanced with cool protecting plastic handle. Modern streamlined design. Six interchangeable tip styles adapt one Kwikheat Iron to all your soldering jobs. You will be proud to own America's finest and most versatile soldering tool... from tip to plug Kwikheat is in a class by itself. Ask your dealer to demonstrate the quick-heating feature now!

*patented
Kwikheat Iron with choice of #0, #1, #2, or #3 tips \$11.00
Set of 5 tips, consisting of #0, #2, #3, #4, and #5 . \$6.00



Dept. P5-11, Kwikheat Division of
SOUND EQUIPMENT CORP., 3903 San Fernando Rd., Glendale, 4 Calif.

COMMERCIAL RADIO INSTITUTE

A RADIO TRAINING CENTER FOR 24 YEARS

Resident Courses Only • Pre-Induction, Broadcast, Service Aeronautical Television, and Marine telegraphy classes now forming for mid-year term Feb. 1. Literature upon request. Veteran training.

Dept. B, 38 West Biddle Street, Baltimore 1, Maryland

AMATEUR GEAR HATRY & YOUNG

**EIGHT CONNECTICUT
AND MASSACHUSETTS
HAM STORES**

Hartford	C	Stamford
New Haven	O	New London
Bridgeport	N.	Waterbury
BOSTON—MASS.—LAWRENCE		

(Continued from page 114)

There can be little doubt that to the non-radio public even the term "amateur" implies some measure of ineptness or inability, whereas among private radio experimenters, we find men of diverse and sometimes very high technical ability.

Would it not be better when we wish to refer, either between ourselves or to the public, as a "private radio experimenter licensed to operate" to use a term which is not likely to have any uncomplimentary association. I suggest the initial letters of the above expression, PRELTO, would soon gain popularity. The word is easily pronounced, is not likely to be corrupted by different English dialects, and could be used internationally.

Further, the full expression is descriptive and in these days, with the intense use of initial letters in the Services, the abbreviation would not be entirely strange.

— Lt. W. B. Brown, R.N.V.R., G6QY

RECEPTION ON A CRYSTAL DETECTOR

Editor, QST:

I recently threw together a crystal receiver composed of an antenna series variable condenser and a condenser in parallel with a plug-in coil. By connecting my half-wave eighty-meter transmitting antenna and a ground to this receiver, I was surprised at its range and degree of selectivity. After the two local stations, which are within a mile of my location, went off the air, I could hear a dozen or so broadcast stations all over the eastern half of the country, and could separate them satisfactorily. Stations as far away as five hundred miles came in with good strength.

The biggest surprise of all came when I plugged in s.w. coils. With a 500- μ mf. tuning condenser across the coil, and by shifting coils, I first located the buzzing demon that is taking our 160-meter band. Next I heard several aircraft stations. As I tuned higher in frequency I heard a c.w. station thumping in so loud that I could read the clicks. Then — and this tops them all — I came to a group of short wave broadcast stations, "Big Ben" sounded, and there was the BBC rolling across the Atlantic into my crystal receiver! These stations were coming in around eight o'clock in the evening, and while the two local b.c. stations were on the air.

My location is average or even less. What could some of the boys do with half-wave 160-meter antennas at good locations?

— Leonard K. Yerger, jr., W3BTK

A "C.W. ONLY" LICENSE?

Somewhere At Sea

Editor, QST:

I have been thumbing through the February and March QSTs for the past five months, and have noticed a lot of letters pertaining to postwar QRM. It will undoubtedly be terrific, especially on the lower frequency bands.

How about a license equivalent to Class A, for c.w. operation in one or two of the bands? This ticket might require six months or one year operation on a Class B license, and a slightly higher code speed. The bands might be open to traffic handling and/or DX. This idea might be old stuff, but I haven't seen it printed before.

— W. E. Britton, LSPH

REPORT FROM PK

c/o Mrs. J. Sasse, Glintoeng No. 6, Malang, Java
Editor, QST:

I wish to make use of this very first opportunity to send our cordial greetings to our American ham friends and to express our gratitude for our final liberation after three and a half years of terrible oppression. As many of you will know from the articles in the newspapers the fate of the war prisoners and civil internees in the regions occupied by the Japs has been extremely hard. Our soldiers were deported to the jungles of Burma and Thailand and died there by the hundreds of tropical diseases and underfeeding. The civilians were put in concentration camps, the husbands separated from their wives, the children from their mothers. When dysentery broke out in the overcrowded camps, the Japs refused to supply medicine in sufficient quantities. Those among the PK amateurs who had served their country as

(Continued on page 120)

The Talk of Ham Radio!

Your Golden Opportunity to
WIN -- FREE
Your "Dream" Transmitter Plus
\$1125 in Victory Bonds

ALL AMATEUR TRANSMITTER CONTEST

Amateur Radio is on the threshold of a great era—its destiny is in the hands of those who have helped to bring about its present development.

So that Amateur Radio may be guided wisely to greater achievements, Taylor Tubes and the **All Amateur Transmitter Contest** sponsors listed below, want to get the best and latest

ideas of what Amateurs today want in the way of tubes and other components.

While everyone stands to benefit through this First Annual **All Amateur Transmitter Contest**—two contest winners will attain their "Dream Transmitter" completely built by Taylor Tubes, plus \$1125.00 in Victory Bonds.

Here Are the Highlights of the Contest

Entries must be postmarked on or before February 15, 1946—the official contest closing date. Transmitter design in either of two power classes may be entered. Class 1—input power to the final transmitter stage up to 250 watts. Class 2—input power to the final transmitter stage of from 251 to 1000 watts. Contestant must submit entry blank, full schematic diagram and front panel drawing, with sufficient data necessary to build his "Dream Transmitter." Each entry must be accompanied with a 150–250 word statement by the

contestant as to why he believes his transmitter design is outstanding and should win. The prize winning transmitter in each power class will be built by the engineering department of Taylor Tubes, Inc., and presented to the winning contestants as soon as practicable after all entries have been judged and the winning designs selected. The Victory Bond prizes in each power class will be presented to the winners immediately after the winning designs have been announced. See the official entry blank for complete particulars.

Participating Sponsors

Aerovox Corporation, New Bedford, Mass.; American Phenolic Corporation, Chicago, Ill.; Barker & Williamson, Upper Darby, Pa.; Bliley Electric Co., Erie, Pa.; Gothard Mfg. Co., Spring-

field, Ill.; International Resistance Co., Philadelphia, Pa.; E. F. Johnson Co., Waseka, Minn.; Solar Mfg. Corporation, New York, N. Y.; United Transformer Corporation, New York, N. Y.

Secure Your Entry Blank at Your Radio Parts Distributor
or Write Directly to Taylor Tubes, Inc.

Taylor HEAVY **CUSTOM BUILT** DUTY **Tubes**

TAYLOR TUBES INC., 2312-18 WABANSIA AVE., CHICAGO 47, ILL.



Burlington

★ PANEL INSTRUMENTS

Guaranteed ACCURACY

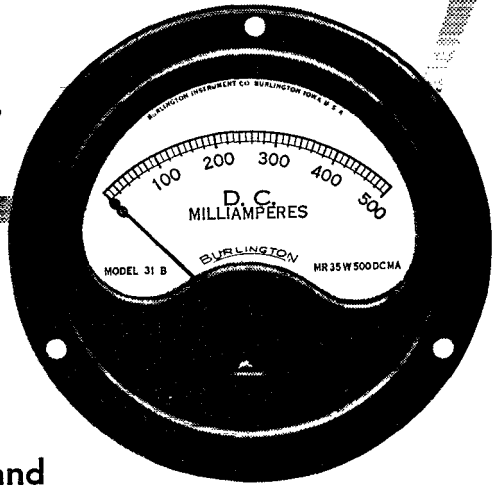

Due to design characteristics and close control of manufacturing processes, Burlington instruments embody the following advantages:

PERMANENCE OF CALIBRATION . . . All DC instruments employ Alnico magnets which are known to be more highly resistant to shock, heat, vibration, and stray fields than any other magnetic material.

FREEDOM FROM STICKING . . . Clearances for all moving parts are such that the results of entrance of small particles as encountered in field service are reduced to a minimum.

STABILITY OF OPERATION . . . All instruments are "NORMALIZED" after assembly to eliminate "zero shift" and other calibration errors due to ageing.

Exceptionally high torque to weight ratio of control springs to moving element insures minimum error under conditions of shock, vibration, and other rough usage.

Alignment of jewels and magnet core piece is such that the center lines of these parts coincide within plus or minus .002". The design of the brass movement frame and components is such that mechanical tolerances are reduced to a minimum in assembly. As a result, jewel and pivot wear is uniform which reduces "frictional torque" of the moving coil.

All series resistors and coils are heat treated and impregnated after wrapping to insure stability and long life.

All ranges AC & DC are available in 2½", 3½" and 4½" sizes, both square and round, flush mounting.

*Engineering service furnished for specialized applications.
No obligation. • Write today for further information.*

BURLINGTON INSTRUMENT CO.
800 Fourth Street • Burlington, Iowa

WE ARE PLEASED TO ANNOUNCE

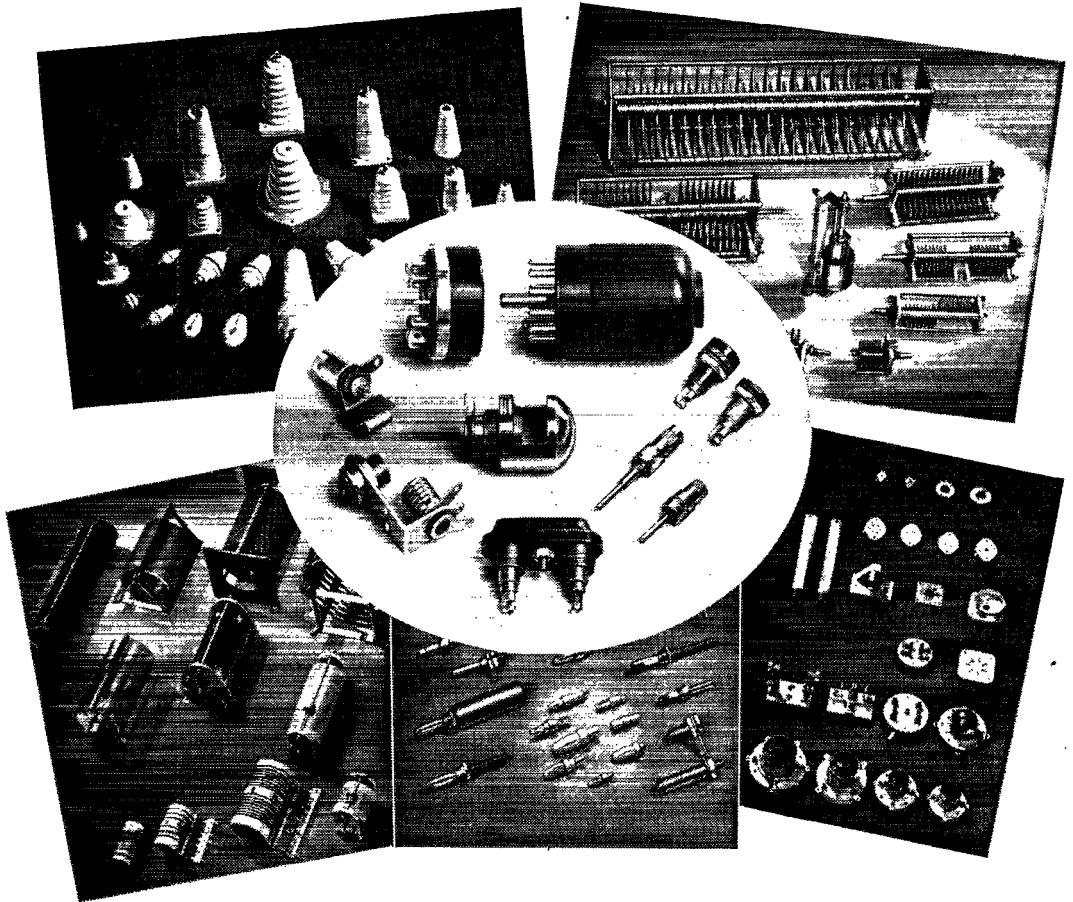

We are pleased to announce that the cable connectors, pilot light assemblies, tip plugs and tip jacks, former Mallory-Yaxley products, so highly regarded by the electronic industry for many years, will be manufactured and sold in the future solely by Johnson.

The wide acceptance and unquestioned quality of these products make them fitting additions to the Johnson line of plugs, jacks, inductors,

Johnson products are stocked by leading radio-electronic parts jobbers.

insulators, variable condensers and tube sockets.

All tools, inventory and manufacturing rights for these products have been acquired from P. R. Mallory & Company, Inc. Orders should specify the Mallory catalog numbers until these items can be incorporated in the Johnson catalog.

Write us, if you have a special problem involving any of these items.



JOHNSON

a famous name in Radio

Write for General Products Catalog 968-J

E. F. JOHNSON COMPANY • WASECA • MINNESOTA

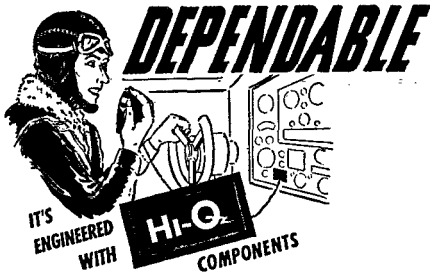

CERAMIC CAPACITORS

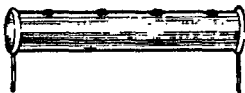

WIRE WOUND RESISTORS

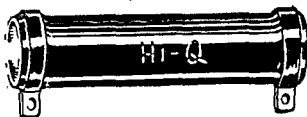

CHOKE COILS



ELECTRICAL REACTANCE CORPORATION
FRANKLINVILLE, N. Y.

IMMEDIATE SHIPMENT!

CATHODE RAY TUBES:

NEW 5BPI SYLVANIA or GE
LIST PRICE.....\$22.50
OUR PRICE..... 7.25*

CONDENSERS:

.01, .05, 0.5 MFD, 600 VOLT. METAL CLAD,
OIL FILLED PAPER BATHTUB TYPE C-D,
SOLAR, SPRAGUE, TOBE AND AEROVOX
PRICE 25¢ EACH AND UP

Write for complete list of relays, solenoids and other condensers from 50¢ up.

All the above material is Government Surplus. Every item new.

*Special prices on quantities

ELECTRONIC CONTROLS
INCORPORATED

44 Summer Avenue, Newark 4, New Jersey

(Continued from page 116)

officers of the A.R.P. were questioned by the Japanese gestapo called *kempetai* and now we know that a number of them were tortured to death. Of course all our radio equipment has been confiscated as was done with the furniture of our homes. Pianos, typewriters, cinecameras and ladies dresses were stolen and given to the natives who wondered what to do with them.

But now all this is over and we are looking forward to a new era of peace and freedom. The PK hams are eagerly awaiting the moment at which they can start their activity on the air and hear the voices of their American friends again. But, as I told you, they have lost all their gear, so they wish to buy new apparatus as soon as the circumstances will allow the shipment of same from the U. S. In the first place we want catalogs of transmitting parts, tubes, receivers, etc. and the manufacturers of these articles are kindly invited to send them. As many of the old addresses in the Call Book are void now, I would like to suggest that the catalogs are sent to me for further distribution.

Perhaps some U. S. hams with generous minds would be kind enough to look in their junk boxes for parts that they can spare and to send them to us for the benefit of those who cannot afford to buy new gear. We can use anything, also back copies of *QST* of the years 1941-1945 as this magazine has always been the source of our knowledge of radioamateurism from the very beginning. We had a few copies of *QST* in our camp and I can assure you that they have been read over several times from the first to the last letter.

— Jan J. Vanderkam, PK9KT

The Crystal Ball

(Continued from page 65)

The output of the v.f.o. is switched to the desired transmitter by relays operated from Master Control. The relay system is very similar to the switchbank relay system used by NBC, in New York, to cross-connect their studios to various facilities. It represents a very high degree of flexibility, speed, dependability and ease of operation. This same relay system gives the studio control over all necessary functions of the transmitter setup. The transmitter heaters are turned on automatically when it is set up to any studio, and a pair of push keys in the control room may be operated to turn the plates on and off. Crystal-filter monitoring circuits light colored tallies on the instrument panel when the carrier is actually on the air, when the transmitter is operating in a 'phone or c.w. region, or when the v.f.o. or fixed-frequency crystals are in the circuit.

The main transmitters, of which there are three, one for each frequency region, are in the order of 250-watts output each, and consist of about two stages operating from a set of grid-controlled rectifier supplies. A small "pot" on the control panel in the studio operates a phase-shifting device to control the output of the rectifiers, and the various supplies are adjusted so that at every setting of the pot the final plate voltage, grid bias and driver output are proper for optimum Class-C operation. The modulation, also, is applied to these three points to obtain practically linear modulation and reduce distortion to a negligible value as described by Lorber and others. Overall inverse feedback is also applied to further improve the characteristic. A dynamometer-type instrument in the control room indicates power input to the final stage and a remote-indicating

(Continued on page 122)

YOURS FREE

WITH ANY \$15 ORDER

This is frankly a very special thing for CUSTOMERS of Hatry and Young.

It is a fine transmitting tube, ideal for a dozen amateur purposes and uses, portable to permanent.

The purpose is to make it cost YOU, the H & Y customer, no extra penny. You can order \$15 worth of components from us and the tube will be sent free.

You can send \$9 for the tube and then later present your \$9 receipt on a purchase of \$15 or more and obtain \$9 worth of material for the receipt, having only to pay the \$6 to complete the \$15 transaction.

The quantity is limited... we will run out of tubes. When we do run out, the offer is off. We will be able to do no more and shall return your money OR act as YOU advise.

ORDER BY MAIL

Send check or money order to main office: Hatry & Young, 203 Ann St., Hartford, Conn.

OR GO INTO ONE OF HATRY & YOUNG'S 8 WHOLESALE BRANCHES

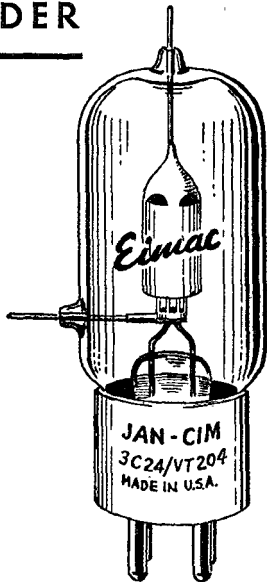

EIMAC 24G

DATA:

90 W. Class C
Plate Dis. 25W.
Mu 25
P. V. 2000 max.
P.Ma. 75
MAX. FREQ. 300 meg.
FIL. V. 6.3, 3a.

ISOLANTITE
BASE

REGULAR \$9 NET

HERE'S AN EXAMPLE OF
HOW THE DEAL WORKS

Suggestions: MOBILE RIG PARTS

One 7 x 9 x 2 CHASSIS.....	\$.75
One VIBRATOR POWER SUPPLY—MALLORY VP-554	12.30
One STANCOR CHOKE C-2303.....	1.11
Two 8mfd. FILTERS.....	.90
One 4-prong SOCKET.....	.24
TOTAL.....	\$15.30

EIMAC 24G

NO CHARGE

\$24.30 net for \$15.30

ANNOUNCING TWO NEW STORES

HATRY & YOUNG OF MASSACHUSETTS, INC.

42-44 CORNHILL • 639 ESSEX ST.
BOSTON • LAWRENCE

IN CONNECTICUT: 203 ANN ST., HARTFORD; 544 E. MAIN ST., BRIDGEPORT; 1172 CHAPEL ST., NEW HAVEN; 89 CHERRY ST., WATERBURY; 363 BANK ST., NEW LONDON; 525 MAIN ST., STAMFORD

HATRY & YOUNG • The ELECT in ELECTRONICS

VALUABLE FREE PRIZES for Amateurs.

Since, at this writing, there is only the 117 to 1155 megacycle band available for amateurs... See Crystalab's policy it is to give the amateur exactly what he wants... by making you, the amateur, the suggestions as to the type of crystal kit you desire, and awarding valuable prizes for the best suggestions.

We want your ideas

For an ideal crystal kit: the kind you need want to buy - in not more than 300 words. Write any form in any language - ideas will win. We'd like to know your wants as to FREQUENCY, BANDS, MODELS, KIT, SECONDARY STANDARDS, CRYSTAL APPLICATION SUGGESTIONS FOR NEW AMATEUR, INDUSTRIAL AND COMMUNICATIONS USES.

28 Prizes

- FIRST PRIZE: Crystalab Secondary Standard
- SECOND PRIZE: \$50 Victory Bond
- THIRD PRIZE: \$25 Victory Bond
- 25 \$5 PRIZES: (Awarded in crystals).

JUDGES

Raymond W. Woodward, PhD
General Research Laboratories
Underwood Corporation

Ernest B. Lewis,
Chief Crystallographer
Crystal Research Lab., Inc.

Russell G. Scott, Prominent Radio
Component Dealer

PROCESSED OCTOBER 1944

Contest closes Dec. 15, 1945. Time is short. Write us today!

★ CRYSTAL RESEARCH LABORATORIES ★

79 ALLYN STREET HARTFORD 3, CONN.



Electricity

FOR RADIO AND ELECTRONIC APPLICATIONS

Onan Electric Generating Plants supply electric service for electronics applications and general uses, mobile, or stationary. Driven by Onan-built, 4-cycle gasoline engines, they are of single-unit, compact design and sturdy construction.

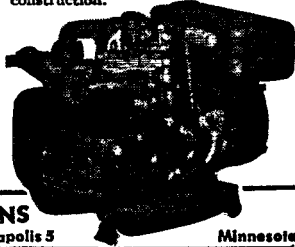

65 models, sizes from 350 to 35,000 watts. A.C. types: 115 to 650 volts, 50, 60, 180 cycles, 1 or 3-phase; 400 500 and 800 cycles, 1-phase. D.C. types: 6 to 4000 volts. A.C.-D.C. combination types available. Write for engineering assistance and literature. Model shown is from ATC lightweight series.

Over 250,000
Now In Service

D. W. ONAN & SONS

2631 Royalisten Ave., Minneapolis 3

Minnesota

▶ TRANSMITTING TUBES RECTIFIERS CATHODE RAY TUBES

We have been appointed a sales agent by Defense Supply Corporation of Government surplus tubes and rectifiers. All are first grade Government tested and inspected tubes—not rejects.

The following types are immediately available:

- | | |
|----------------------|-------------------|
| 826 (HF Triode) | Cathode Ray Tubes |
| VT 127A (HF Triode) | 8AP1 |
| 304 TL | 8BP4 |
| 872A M. V. Rectifier | 3AP1 |

Trade discounts to dealers on standard packages • Write for prices

LEWIS ELECTRONICS 16 Lyndon Avenue
Los Gatos, California

(Continued from page 180)

antenna ammeter calibrated in power output gives a constant check on the transmitter operating condition.

A further refinement is a relay in the receiver operating from the i.f. screen current, which may be switched into the circuit to put the carrier on the air as soon as the received carrier is switched off, and knock it off when the fellow I'm working comes back on. Obviously, both stations cannot use this feature at once.

Three receivers are located in the equipment room. All the controls are operated by selsyn transmitters in each control room by an assignment similar to the switchbank relay system. The selsyn transmitters are arranged on a panel in a layout similar to a receiver layout, and a group of keys and tallies are used to pick up any particular receiver, indicate which receiver I have or indicate that it is already in use elsewhere. Master Control has complete supervision over the receiver assignment circuit. The advantages of such a system are that the receiver control panel is identical in each studio, and identical no matter which type of receiver it is connected to, relieving the operator of the necessity of memorizing the layout of several different receivers, and reducing confusion. It also provides an economy in receivers, giving the equivalent of three receivers in five different locations, or a saving of twelve receivers.

The standard frequencies for the transmitter panoramic and for the periodic frequency check of the transmitter are derived from a primary frequency standard with a potential stability of much better than one part in 10^8 , or better than WWV. Such standards are commercially available (Western Electric D-151231).

This, then, is a brief idea of my postwar rig. If I have left anything out, I'm sure I will hear about it.

If any of you fellers are wondering, by now, if I am independently wealthy or have a rich old uncle, the answer is NO to both questions. *But, I can pay for the rig several times over by charging admission to see it.* Remember P. T. Barnum?

— Sgt. David A. Kemper, W2NTX

Note to the Editor: Please excuse the typewriter, as they don't allow us to have anything sharp in here.

REMOTE CONTROL METHODS AT W4FKV

Our postwar rig will have a simple control system by means of which it will be possible to select and tune the rig to as many as six bands from the operating position. This will be accomplished by using small reversible motors on the tuning capacitors and motors or magnetic "steppers" on the inductor switches and turrets. The final and driver stages with the modulator and associated power supplies may be located at any distance from the operating position and controlled by means of the control system and a 10-wire cable.

(Continued on page 184)

They'll Have Everything...



The best of all that's new in radio

Delco home radios will be in production soon . . . table models, consoles and portables . . . in FM and AM combinations and with standard broadcast bands. They'll provide the best of all that's new in radio . . . sets that set the pace in styling and performance . . . a line that covers the entire range of customer demand. For engineering vision and manufacturing precision . . . backed by long experience in producing Delco auto radios and Delco home radios . . . intensified by wartime accomplishments in building military radios and electronic equipment . . . look to Delco Radio!

ENGINEERING VISION—



MANUFACTURING PRECISION

They Finished Their Job—Let's Finish Ours
BUY VICTORY BONDS

DELCO RADIO  A UNITED MOTORS LINE

Delco Radio
DIVISION OF
GENERAL MOTORS

Wires and Cables
BIRNBACH
Since 1923

Quality PRODUCTS
Since 1923

A complete line of
WIRES, CABLES, HOOK-UP WIRES,
RADIO HARDWARE, SHIELDED
MICROPHONE CABLE and S. J. CABLE
Complete Stock at Your Dealer

BIRNBACH

BIRNBACH RADIO CO., Inc.
145 HUDSON ST. NEW YORK 13, N. Y.

Now—Solve your radio
and electrical problems
with these new books

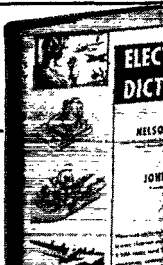

1. ELECTRONICS DICTIONARY

By NELSON M. COOKE, Lt. Com., USN, and JOHN MARKUS, Ed. *Electronics*. Up-to-date, precise definitions of nearly 6500 terms in radio, television, communications, and industrial electronics. 600 diagrams and sketches. 433 pages, \$5.00. *Just out.*

2. ELECTROMAGNETIC ENGINEERING

Vol. I, Fundamentals. By RONALD W. P. KING, Harvard Univ. Physical and mathematical essentials of electro-dynamics. 580 pages, \$6.00

3. PULSED LINEAR NETWORKS

By ERNEST FRANK, Sperry Gyroscope. A general method of analysis for solving network problems. Emphasis on voltage pulses. 266 pages, \$3.00

4. APPLIED MATHEMATICS

For Radio and Communication Engineers. By CARL E. SMITH, Research Engineer. From arithmetic to calculus, presented clearly and simply for home study. 336 pages, \$3.50

5. TRANSMISSION LINES, ANTENNAS, AND WAVE GUIDES

By RONALD W. P. KING, HARRY ROWE MIMNO, and ALEXANDER H. WING, Harvard Univ. Army pre-radar lectures, point of view of high frequency and electromagnetic theory. 347 pages, \$3.50

McGraw-Hill Book Co., 330 W. 42 St., N. Y. 18

Send me the books encircled below for 10 days' examination, on approval. In 10 days I will pay for books, plus few cents postage, or return books postpaid. (Postage paid on cash orders.)

1 2 3 4 5

Name.....

Address.....City and State.....

Company.....Position.....(QST 12-45)

(Continued from page 122)

Each stepper is a simple solenoid and plunger which moves the coil turret through 60° each time the solenoid is energized. A finger and ratchet arrangement move the turret and switch when the solenoid is energized, while a spring returns the plunger when the coil is de-energized. This solenoid will operate as fast as 20 times per second but we do not expect to operate faster than 2 or 3 times per second on the completed model.

The tuning motors are small motors such as were used on a.c./d.c. fans and appliances. These motors are series wound for a.c./d.c. operation and may be reversed by reversing the field or armature current. The direction of rotation of these motors is controlled by a single d.p.d.t. switch at the operating position which is marked "raise-lower." The proper motor is selected by a switch marked "tuning." This switch could be used to select as many as eleven different tuning motors but we only intend to use two at present, one for simultaneous control of the driver plate and amplifier plate tank capacitors, and one for tuning the grid circuit of the driver tube.

Various circuits are metered using one meter and another selector switch. The actual switch is in the transmitter and the arms connect to a local meter. Two leads carry the current to a remote (or operating position) meter; these two meters are in parallel and either switch will cause both of them to read simultaneously. The meter switch in the transmitter is rotated by means of a stepper which is controlled by the meter switch. This switch operates exactly as the band switch, except that the stepper moves the switch only 30° and there are, therefore, 12 positions in a complete revolution. This switch and stepper will not turn backwards but follow straight through continuously.

— Edward B. McIntyre, W4FKV

PROGRESSIVE CONSTRUCTION

IT SEEMS to me that many rigs are thrown together with little thought to future requirements. Extensive rebuilding is required and a lot of usable parts are consigned to the junkbox. Instead of starting with the thought, "What can I put on the air, with the bonds I have," I decided to lay down my ultimate requirements and then plan the rig so I could progressively build to reach that point with a minimum of lost time and money.

My chief mania is split between operating and tinkering with precision control. The rig must cover 3.5 to 54 Mc. in the main installation. The u.h.f. and v.h.f. spectrums would be separate.

So, here are my requirements:

- (1) 3.5-54-Mc. coverage.
- (2) Peak power, 500-600 watts, 'phone or c.w.
- (3) 50-w. standby rig for close-haul work.
- (4) Complete remote control from operating position.
- (5) Precision control of frequency, v.f.o. or crystal.

(Continued on page 128)

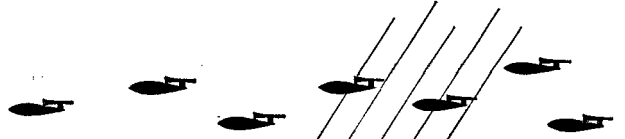
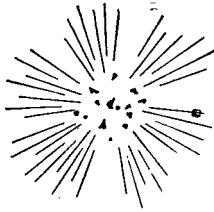

Target practice with Relays and Keys

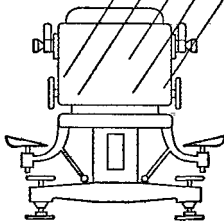
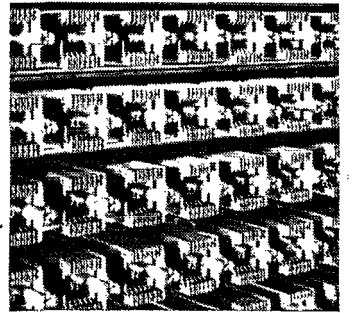

(Left to right) The operator punches the problem data on tape, which is fed into the computer. The solution emerges in the teletype receiver. Relays which figure out the problem look like your dial telephone system.

In designing the gun-control systems which shot down enemy planes, Army ballistic experts were faced by long hours of mathematical calculations.

So Bell Laboratories developed an electrical relay computer. It solved complicated problems more accurately and swiftly than 40 calculators working in shifts around the clock.

Resembling your dial telephone system, which seeks out and calls a telephone number, this brain-like machine selects and energizes electric circuits to correspond with the numbers fed in. Then it juggles the circuits through scores of combinations. It will even solve triangles and consult mathematical tables. The operator hands

it a series of problems with the tips of her fingers —next morning the correct answers are neatly typed. Ballistic experts used this calculator to compute the performance of experimental gun directors.

In battle action, Electrical Gun Directors are instantaneous. Such a director helped to make Antwerp available to our advancing troops by directing the guns which shot down more than 90% of the thousands of buzz bombs.

Every day, your Bell System telephone calls are speeded by calculators which use electric currents to do sums. Lessons learned are being applied to the extension of dialing over toll lines.



BELL TELEPHONE LABORATORIES EXPLORING AND INVENTING, DEVISING AND PERFECTING FOR CONTINUED IMPROVEMENTS AND ECONOMIES IN TELEPHONE SERVICE

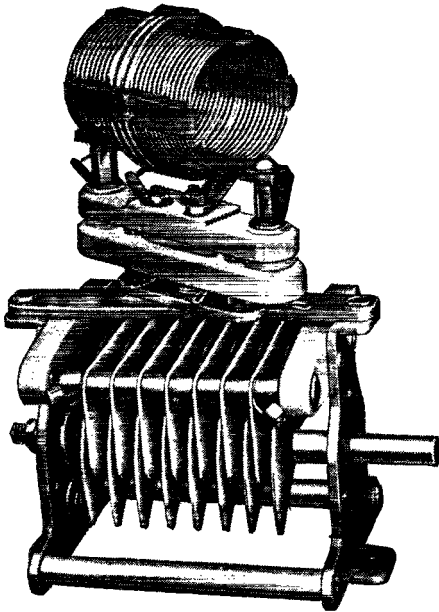

BACK AGAIN!

The TMK Condenser and AR-16 Coil Forms are back in "civvies," to help you make the new rig better. The AR-16 coils plug in a swivel mount on top of the TMK condenser, providing a compact efficient tuned circuit for exciters or low power transmitters.



NATIONAL COMPANY, INC.
MALDEN, MASS.

TURNER VT-73

DESK MICROPHONE

A Powerful, Precision Unit for Crisp, Clear Reports

VT-73 practically doubles your effective power at intelligible voice frequencies without over-modulation. Engineered especially for Quality Speech Recording, P.A., and Ham use with *rising curvature* of response between 500-4000 cycles. Has high capacity, moisture-proofed crystal with output of -52DB. Range 50-7000 cycles. Finished in rich black crinkle and chrome. Complete with ball swivel head, stand and 7 ft. cable.

A World-Wide Favorite with Prominent Hams

ASK YOUR DEALER OR WRITE

Complete Microphone Catalog
Write for Your Free Copy

TURNER

Pioneers in the communications field

Microphones

THE TURNER COMPANY
917 17th Street N. E.
CEDAR RAPIDS, IOWA

Crystals licensed under patents of the Brush Development Co.

V...—Again We Can Serve YOU...



**CONCORD
RADIO CORPORATION
LAFAYETTE RADIO CORPORATION**

An Old and Trusted Company
WITH A NEW NAME

WITH victory achieved the signal has flashed that will start amateur radio on the greatest boom in its history! And again leading the parade with *complete stocks of all standard lines of radio parts* — plus the equipment, resources and technical staff to help you with the new war-born developments — CONCORD RADIO is again ready to serve you with the same friendly, personal interest which

has made us the amateur's dependable source of radio parts and electronic equipment for 25 years. Here you have immediate access to vast stocks and to wide selections. Your every requirement, request and problem is handled by a staff of seasoned technical experts who KNOW amateur radio — many of them hams themselves. We invite you to avail yourself of CONCORD'S dependable service.

ALL STANDARD LINES

Hallcrafters • National • Hammarlund
Receivers and Equipment

CONCORD is famous for carrying in stock for immediate shipment hundreds of nationally known lines of amateur radio parts and equipment. Below is a partial list:

Aerovox, Amphphenol, Amperex, Amperite, Astatic, B & W, Biley, Brush, Burgess, Cardwell, Centralab, Clarostat, Cornell-Dubilier, Dumont, Echobbone, Eimac, General Electric, Hallicrafters, Hammarlund, Heintz & Kaufman, Hickock, IRC, Janette, Jensen, Johnson, Mallory, McElroy, Meissner, Millen, National, Ohmite, Pioneer, Presto, Raccon, RCA, Readrite, Shure, Simpson, Solar, Sprague, Stancor, Supreme, Thordarson, Trimm, Triplett, Turner, UTC, Universal, Utah, Vibroplex, Weston, Warner.

Complete Catalog FREE

In addition to all standard brands of quality items, this Catalog and Buying Guide contains items not available at any price during the war, it offers many new post-war developments, it shows the last word in modern radio parts and electronic equipment. Many of the recent advances in the science of radio communication are included. You'll find this Catalog a priceless reference guide and a valuable addition to your library. Mail the coupon below for a copy. It's absolutely FREE.

TO OUR FRIENDS OVERSEAS: We are prepared and eager to resume the pleasant relations we enjoyed before the war. A complete and efficient export department is at your service.

Order Today for Shipment Tomorrow

**CONCORD RADIO
CORPORATION**

LAFAYETTE RADIO CORPORATION

CHICAGO 7, ILL. ★ ATLANTA 3, GA.
901 W. Jackson Blvd. 265 Peachtree Street

CONCORD RADIO CORP., Dept. ST-125
901 W. Jackson Blvd., Chicago 7, Ill.

Gentlemen: Send me at once a FREE copy of your latest Catalog and Buying Guide, listing standard lines of Radio Parts and Electronic Equipment.

Name.....

Address.....

City.....Zone.....State.....

Are YOU ready to go on the air?

Get **FIRST Delivery From Leo's TRANSMITTER KITS** WRL transmitters at the price you want to pay...15, 35, 70, 150 watts. Also units custom built to your specs.

RECEIVERS

Receivers of all manufacturers at OPA prices... ready for quick delivery.

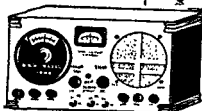

We invited inquiries for special equipment of all kinds.

EXCLUSIVE AT LEO'S

12 page V-J Radio Parts Flyer**FREE**
Giant Radio Reference Map 15c
Handy Tube-Base Calculator 25c

Immediate delivery on transmitting tubes and condensers, and "Everything for the Ham." Get yours **FIRST** from Leo.

Address **Leo, W9GFQ, Dept. QST-12**
Council Bluffs, Iowa



Wholesale RADIO LABORATORIES

RADIO

RADIO Technician and Radio Communications courses. Register now for new classes starting first Monday of each month. Day and Evening Classes.

AMERICAN RADIO INSTITUTE

101 West 63d St. New York 23, N. Y.

Approved under GI Bill of Rights

NEW 1945 ENLARGED EDITION OF THE PHILLIPS CODE

A thoroughly tested method of Steno-telegraphy arranged for use in wire and radio communication. It's definitely new, completely standard, strictly up-to-date. In addition to numerous changes and additions to previous editions, it contains:

- Radio Code Signals • International Morse • American Morse • Russian, Greek, Arabic, Turkish and Japanese Codes • World Time Chart • United States Time Chart • Commercial "Z" Code • Aeronautical "Q" Code • Miscellaneous Abbreviations used on international wire, submarine cable and radio telegraph circuits

This **NEW, ENLARGED** edition of **PHILLIPS CODE** is unquestionably an outstanding contribution to the advancement of wire and radio telegraphy. An invaluable aid to every trained and student operator. Price, \$1.50 postpaid.

LIBERAL DISCOUNT TO DEALERS

THE VIBROPLEX CO., Inc.

833 BROADWAY

NEW YORK 3, N. Y.

(Continued from page 124)

Next, I decided to group the equipment for maximum convenience. The operating position would carry the receivers, two exciters covering 3.5-28 and 7.0-54 Mc., speech amplifier, a good secondary frequency standard, panoramic receiver, CR modulation monitor and the necessary switching.

The drivers, p.a., modulators and bias and plate supplies would be located elsewhere on separate racks and remotely controlled. The antenna systems present a headache at my present location, but I hope to have a pair of 3.5-Mc. rhombics — one aimed to hit Europe, the other headed for the lower China area — and a 28-Mc. rotary beam, 3-element, plus a pair of Bendix autosyn motors and a navigator's radio compass indicator.

The exciters will be a pair of 802 oscillators, crystal and v.f.o., operating at fairly low plate voltage to reduce thermal drift, and voltage regulated. One will operate on 80 meters and include three 807s as doublers to 40, 20 and 10. The whole outfit will be gang-tuned. Unused tubes will be automatically cut off by blocking bias.

The other exciter will be the same except that the fundamental range will cover 40. Then the output fed to either a tripler to 21 Mc. or a series of doublers to 14, 28 and 54 Mc. The crystal oscillator in this case will be on 160 with several crystals to cover the emergency band — if such is the final answer to the FCC. If we do get back a portion of 160 for regular ham work, 160 will be the fundamental of the first e.c.o. exciter and the highest frequency will be the 14-Mc. band, the higher frequencies being covered by the second exciter. The speech amplifier will be transformer coupled. Included will be attenuating circuits to limit response to speech frequencies and reduce sideband width. A keying-monitor oscillator will be included.

The modulation indicator will be a 2-inch job, trapezoidal-pattern type which can be switched to either transmitter. The frequency meter will be the secondary standard described in the *Handbook*.

The switching panel will control plate and filament switching, transmitter selection and control, antenna selection and indication and all other functions necessary. It will also house mike and key jacks and overload relay reset switches.

Progressive construction proceeds as follows: I first get a 50-watt c.w. rig on the air. I buy a 36-inch relay rack and divide it into three sections, power supply, exciter, r.f. and antenna coupler. A heterodyne frequency meter is added and I'm on the air.

Next step, I add the audio and modulation system. I buy a second relay rack of the same type. I remove the exciter and substitute the modulator and its power supply where the exciter was. Then, in the new rack, I mount the receiver on the bottom, then a panel strip above the receiver to make up the 12-inch lower section, then the exciter and, on the top, the speech amplifier.

(Continued on page 130)



Bob Henry is Delivering Receivers

I am delivering the following models:

National HRO Sr.....	\$197.70
National NC-240C complete with speaker.....	240.00
National One-Ten.....	56.10
Hammarlund HQ-129X complete less speaker.....	129.00
Hammarlund Super Pro complete with speaker.....	318.00
Hallcrafters EC1A.....	29.50
Hallcrafters S20R.....	60.00
Hallcrafters S22R.....	74.50
Hallcrafters S39.....	110.00
Hallcrafters SX-25.....	94.50
Hallcrafters SX-28A.....	223.00
Hallcrafters S36A.....	415.00
Hallcrafters S37.....	591.75
Hallcrafters PM23 speaker.....	15.00
RME-45 complete with speaker.....	166.00

prices subject to change by factories

Demand for some models exceeds supply at present. If I can't make immediate delivery, you can reserve the model you want. This assures you of early delivery with no obligation on your part. You can trade in your receiver. You can buy on my convenient terms. Tell me your wishes. I will help you get the best receiver for your use and will see that you are satisfied. I have a large stock of amateur transmitters, tubes, crystals, parts, etc. Send to me for any apparatus in any catalog or advertisement at the lowest price shown. Mail, phone or wire your orders. Your inquiries welcomed.

Bob Henry W9ARA

BUTLER, MISSOURI

HENRY RADIO SHOPS

LOS ANGELES 25, CALIF.

"WORLD'S LARGEST DISTRIBUTOR OF SHORT WAVE RECEIVERS"

ANTENNAS

EST.



1906

For every radio purpose

BRACH ANTENNAS

since the beginning of radio broadcasting
have been pace-makers in their field

BRACH Antennas, tested and perfected to meet Army and Navy standards, have done their part for victory on land, on sea, and in the air.

And now, BRACH Puratone* Antennas will again resume their established leadership for Home and Auto Radios, Television, Marine, F.M. and other services.

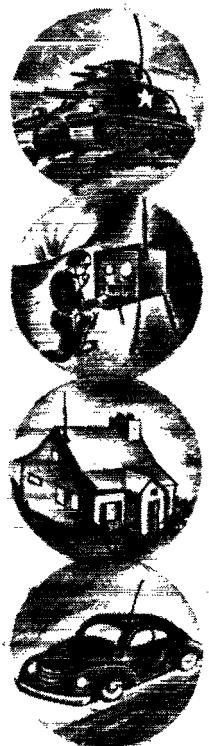

*Reg. Patent Trade Mark

L. S. BRACH MFG. CORP.

NEWARK 4, N. J.

For Experts BY EXPERTS...

that characterizes RADELL-built ham equipment . . . Right now, RADELL corporation is manufacturing communications equipment for the war effort . . . When that job is done and Victory secured, new items will be available—developed from experience gained in producing to meet stringent specifications and specialized applications... This equipment will be built by men who thoroughly know the ham field, who have retained their call letters through the years and who are willing to back their future by designing especially for the amateur who wants the best . . .

It will pay to watch for RADELL

RADELL CORPORATION

6323-27 Guilford Ave., Indianapolis 5, Ind.

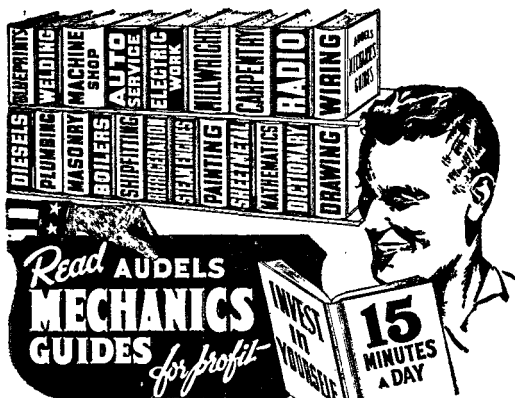

Every Mechanic can Step Up his Skill with AUDELS GUIDES. Containing Practical Inside Information in a Handy Form. Covers facts and figures of your Trade. All illustrated and explained. Books sent to you for 7 Days Free Examination. Send No Money—Nothing to Pay Postman. Check and Mail Coupon Today.

MAIL ORDER

AUDEL, Publishers, 49W. 23 St., New York 10. Mail for 7 days free trial books marked (X). I agree to mail \$1 in 7 days on each book ordered and \$1 a month until purchase price is paid. If I am not satisfied with guides, I will return them.

- | | | |
|---|--|---|
| <input type="checkbox"/> WELDERS \$1. | <input type="checkbox"/> AUTOMOBILE \$4. | <input type="checkbox"/> REFRIGERATION \$4. |
| <input type="checkbox"/> BLUEPRINT 2. | <input type="checkbox"/> RADIO 4. | <input type="checkbox"/> MATHEMATICS 2. |
| <input type="checkbox"/> MACHINIST 4. | <input type="checkbox"/> PLUMBERS 6. | <input type="checkbox"/> CARPENTERS 6. |
| <input type="checkbox"/> ELECTRICITY 4. | <input type="checkbox"/> SHEET METAL 1. | <input type="checkbox"/> DIESEL 2. |

Name _____

Address _____

Employed by _____ Q.S.T.

(Continued from page 128)

Next step is to add more auxiliaries. Another identical rack is bought. The panels are blank, but I add a piece at a time. First, the secondary frequency standard, the modulation monitor and then the second exciter.

Next comes a fourth identical rack. As circumstances permit, I add a v.h.f. receiver, a panoramic receiver and have one panel left to hold the completed switching system.

I then get a larger rack and install my power supply and the 500-watt r.f. section and the antenna coupler. Later I add the modulators. My setup is now complete. I have wasted no part except the heterodyne frequency meter which is no longer required. In all but the 500-watter, units are strictly interchangeable. Thus, if in operating, I find the location of units awkward I can rearrange them easily and only need to make a new connecting cable here or there.

— Sgt. William A. Wildenhein.

A ONE-TUBE TRANSMITTER FOR W2JIL

BEFORE Pearl Harbor I had, as a stand-by rig, one of those long-cherished dreams of amateur radio, a one-tube crystal-controlled 'phone and c.w. transmitter. It was an 813, plate-modulated, with about 100-watts output. On c.w. I keyed the screen and the power output was 150 watts. The crystal current was not excessive in either case.

For my new rig, I want a similar setup, except that I'd like about 500 watts. This type of rig is ideal for the city dweller lacking space.

— Pfc. Frank Huberman, W2JIL

Strays

Wm. B. Teitzel, W5DET, received the War Department's Meritorious Service Award "for extraordinary initiative over and above his regular duties as civilian instructor of aviation cadets in radio code and communications at the Enid Army Air Field."

Operating News

(Continued from page 78)

The DX Century Club, as we knew it, will be far out-dated. It must be reorganized to fit the new conditions.

Therefore, farewell to the old DX Century Club! We are going to wipe the slate clean and make a fresh start. Rules for a new DX Century Club are being formulated. They will be made as simple and straightforward as possible, with full benefit taken from lessons learned under the old rules. A new countries-list must be formulated. The old DX crowd will appreciate the magnitude of that task!

The new DX Century Club will have no connection with the old. Everyone will start on an

(Continued on page 132)

AMATEUR PICTURE BRIGHT

▶ Along with ARRL, The Astatic Corporation looks optimistically into the tomorrow of radio amateur activities, anticipating the enrollment of thousands of newcomers . . . young men with service-acquired radio training and amateur ambitions. The encouragement and coaching of these new "hams" will depend primarily upon veteran amateurs, long familiar with building their own rigs and maintaining the amateur code of ethics. The Astatic Corporation, through its jobbing outlets, will continue to serve the amateur field with dependable microphones, phonograph pickups and cartridges, long favorites with veteran hams.

You'll HEAR
MORE from
Astatic

THE **Astatic** CORPORATION
CONNEAUT, OHIO
BY CANADIAN: CANADIAN ASTATIC LTD., TORONTO, ONTARIO

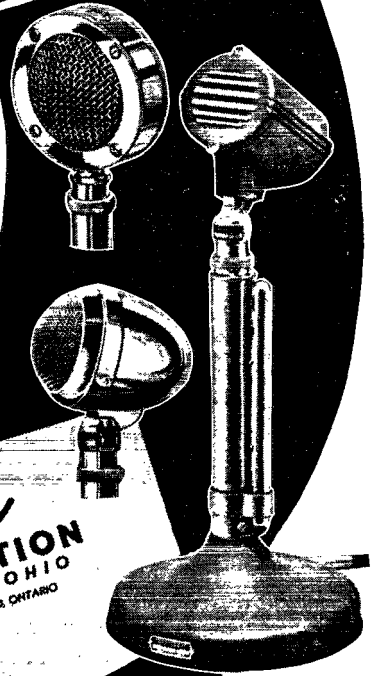

HAM HEADQUARTERS FOR Equipment and Information

15 Years of Service

to HAMS throughout the U. S. and Canada.

Complete Line

of nationally famous Radio & Electronic Parts and Equipment.

Thousands of Items

in stock right now . . . comprising every well-known brand of Component Parts and Equipment.

FREE

WRITE TODAY for our current bulletins about extraordinary values in surplus Radio and Electronic Component Parts and Equipment.

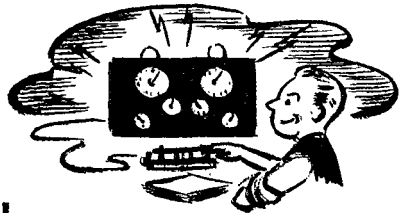

GET STARTED ON YOUR
"DREAM SET" TODAY!

We have all the component parts and equipment and our HAM department, which is staffed by Engineers, will gladly help you with your problems. Write, 'phone, or visit us today.

Radio Product Sales Company

238 WEST 15TH STREET
LOS ANGELES 15, CALIFORNIA

PRospect 7471

WAR SURPLUS SPECIAL

Super-size Plate and Bias Transformers

Practically all of your power transformer needs can be met with this transformer. Ideal for powering transmitters, modulators, P.A. amplifiers and high output amplifiers. Twin primaries for 110 or 220 volt 40-60 cycle input, with taps for high, normal and low line voltage.

This unit has five independent secondaries:

High Voltage.....850 Volts CT at 250 ma.
Bias Voltage.....280 Volts CT at 38 ma.

Rectifier filament winding for two 5Z3. Rectifier filament winding for one 6X5. Special winding delivers 36 volts at 4.9 amperes.

Very conservatively rated. Potted and housed in a black crackle-finished case 5 1/2" x 5 3/4" x 7". Net weight 23 1/2 lbs. This transformer is brand new and packed in original cartons.

Net price \$9.35 each f.o.b. Chicago.

Also on hand are heavy duty 10 henry and 10 milihenry potted choke transformers to match the above.

Net Price 10 henry choke \$3.05 each f.o.b. Chicago.

Net Price 10 milihenry choke \$1.67 each f.o.b. Chicago.

SEND IN YOUR ORDER TODAY

Guaranteed satisfactory or your money refunded

RALPH T. BRENGLE SALES CO.

549 W. Washington St., Chicago 6, Illinois

Adson
RADIO CO.
Dept. Q — 221 FULTON ST. N. Y. 7, N. Y.
EVERYTHING FOR AMATEURS AND SERVICEMEN
COMPLETE LINE OF ELECTRONIC EQUIPMENT



Founded in 1909

RADIO TELEPHONY RADIO TELEGRAPHY ANNOUNCING

Courses ranging in length from 3 to 9 months. Dormitory accommodations on campus for men and women students. Advanced students eligible for practical training at KPAC, 1 KW broadcast station owned and operated by Port Arthur College. New students accepted each month during year. If interested, write for details.

PORT ARTHUR COLLEGE PORT ARTHUR TEXAS

(Continued from page 130)

equal footing. Only contacts made after V-J Day will count. Confirmed contacts with 100 countries will remain the basic requirement for membership. Complete details will be announced later.

Members of the old DX Century Club and those amateurs who made Century Club listings are invited to continue to send any new cards, which confirm contacts made prior to December 8, 1941. There will be no new QST listings of the prewar Century Club. However, upon request from any of the members or any amateur who was listed in the 75-to-100 group, we will send a letter certifying the total number of confirmed-countries prior to the Pearl Harbor shut-down. Those desiring such certification are asked to drop us a postal card with current address. If you have received or do receive any additional confirmations covering prewar contacts, send them in for full credit, in accordance with the old rules.

Official rules for the new DX Century Club will be announced later. In the meantime, as bands are returned to amateur radio, start working all the DX you can and collect confirmations as of old. Be off to a good start when the rules are announced. Let's go!

ELECTION NOTICES

To all ARRL Members residing in the Sections listed below:

The list gives the Sections, closing date for receipt of nominating petitions for Section Manager, the name of the present incumbent and the date of expiration of his term of office. This notice supersedes previous notices.

In cases where no valid nominating petitions have been received from ARRL full members residing in the different Sections in response to our previous notices, the closing dates for receipt of nominating petitions are set ahead to the dates given herewith. In the absence of nominating petitions from full Members of a Section, the incumbent continues to hold his official position and carry on the work of the Section subject, of course, to the filing of proper nominating petitions and the holding of an election by ballot or as may be necessary. Petitions must be in West Hartford on or before noon on the dates specified.

Due to a resignation in the San Joaquin Valley Section, nominating petitions are hereby solicited for the office of Section Communications Manager in this Section, and the closing date for receipt of nominations at ARRL Headquarters is herewith specified as noon, Tuesday, January 15, 1946.

Section	Closing Date	Present SCM	Present Term of Office Ends
Md.-Del.-D. C.	Nov. 15, 1945	Hermann E. Hobbs	Dec. 1, 1945
Connecticut	Dec. 3, 1945	Edmund R. Fraser	Dec. 13, 1945
San Francisco	Dec. 3, 1945	William A. Ladley	Dec. 15, 1945
San Joaquin Valley	Jan. 15, 1946	Antone J. Silva (resigned)	
Sacramento Valley	Jan. 15, 1946	Vincent N. Feldhausen	June 15, 1941
Alaska	Jan. 15, 1946	James G. Sherry	June 14, 1942
Southern Minn.	Jan. 15, 1946	Millard L. Bender	Aug. 22, 1942
New Hampshire	Jan. 15, 1946	Mrs. D. W. Evans	Sept. 1, 1942
West Indies	Jan. 15, 1946	Mario de la Torre	Dec. 16, 1942
Idaho	Jan. 15, 1946	Don D. Oberbillig	April 15, 1944
South Dakota	Jan. 15, 1946	P. H. Schultz	May 18, 1944
Alabama	Jan. 15, 1946	Lawrence Smyth	May 22, 1944
Los Angeles	Jan. 15, 1946	H. F. Wood	July 1, 1944
Arkansas	Jan. 15, 1946	Edgar Beck	Aug. 17, 1944
Virginia	Jan. 15, 1946	Walter G. Walker	Oct. 15, 1944
Tennessee	Jan. 15, 1946	James B. Witt	Nov. 15, 1944
Georgia	Jan. 16, 1946	Ernest L. Morgan	Nov. 29, 1944
Kentucky	Jan. 15, 1946	Darrell A. Downard	Dec. 15, 1944
Mississippi	Jan. 15, 1946	P. W. Clement	April 1, 1945
Rhode Island	Jan. 15, 1946	Clayton C. Gordon	April 15, 1945
North Carolina	Jan. 15, 1946	J. Wortman	May 3, 1945
Northern Minn.	Jan. 15, 1946	Armond D. Bratland	June 15, 1945
Northern N. J.	Jan. 15, 1946	Winfield G. Beck	Sept. 23, 1945
West Virginia	Feb. 1, 1946	Kenneth M. Zinn	Feb. 15, 1946
Louisiana	Feb. 15, 1946	Eugene H. Treadaway	Feb. 25, 1946

(Continued on page 134)

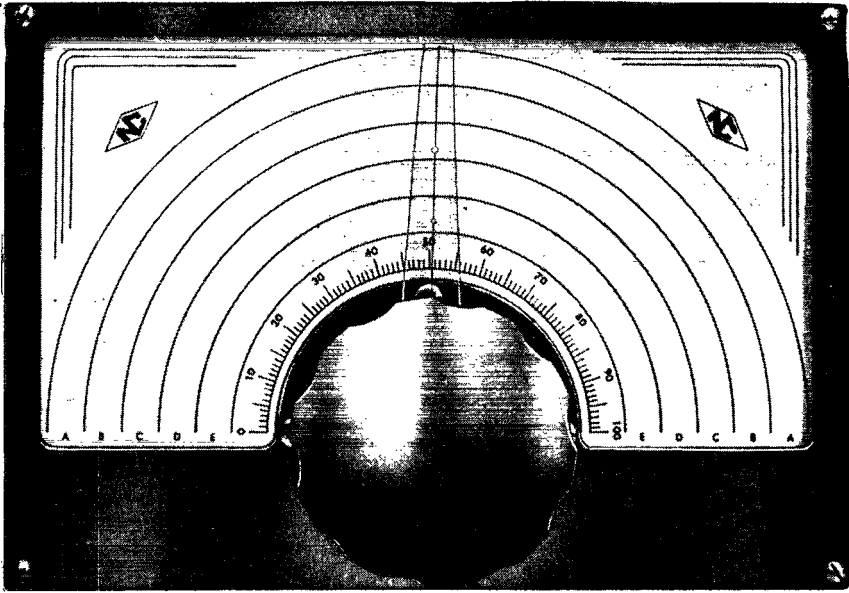

NATIONAL ACN DIAL *with Velvet Vernier Drive*

- Dial bezel acts as drilling template
- Blank scales for direct calibration

- Scale removable without dismantling mechanism
- Bezel can be drilled for switches or jacks

NATIONAL COMPANY, Inc.



MALDEN, MASS.

New R-F SIGNAL GENERATOR

by **B&W**

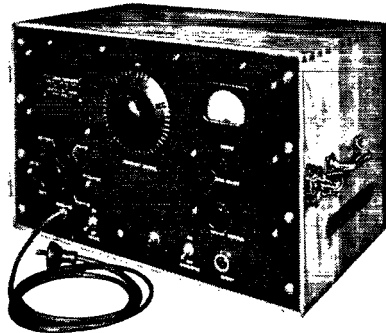

Here is a precision built, high level R-F Signal Generator covering the range from 400 KC to 60 MC in six steps. Modulation of 30% at 1000 CPS is optional by means of a panel switch. Output is three volts (RMS) at all frequencies and is read directly from a panel voltmeter. Output is through an output jack and coaxial cable (furnished) terminated in a 75 ohm resistive load. Calibration is accurate to better than $\frac{1}{2}$ of 1% and is read from a large individual calibrated chart, mounted in the lid of each cabinet.

For those who require a precision instrument of the finest design and workmanship, the B&W Type 101 Signal Generator will fully meet all requirements. Write for further details.

SPECIFICATIONS

Range— 400 KC.. 60 MC	Output voltage— 3.0 volts.
Bands— 400 KC..1000 KC	Output impedance matches 75 ohm load.
1000 KC..2500 KC	Modulation— 1000 CPS at 30%.
2500 KC.. 6 MC	Calibration accuracy— $\frac{1}{2}$ of 1%.
6 MC.. 13 MC	
13 MC.. 28 MC	
28 MC.. 60 MC	

BARKER & WILLIAMSON • 235 FAIRFIELD AVE., UPPER DARBY, PA.

T.A.C. ANNOUNCES THE NEW CODE PRACTICE OSCILLATOR WITH ADJUSTABLE RESONATOR

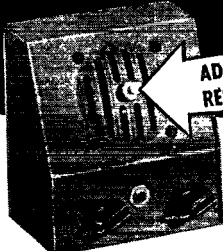

for Greater Volume
Better Tone
ADJUSTABLE
RESONATOR

- MS 716, less resonator and less built-in key. Amateur net price, \$9.00
- MS 716R, with resonator but less built-in key. Amateur net price, \$10.50
- MS 716P, with built-in key but less resonator. Amateur net price, \$11.50
- MS 716PR, DeLuxe Master Oscillator with resonator and built-in key. Amateur net price, \$13.00

Adjustable Resonator (optional) increases volume five times. Tone frequency variable from 600 to 1500 cycles. Volume control from 0 to FULL ON. "PM" DYNAMIC speaker may be disconnected during headphone operation. Up to 300 headphones may be used. Has phone jack for headphones. Optional built-in key. 110 V. AC or DC. Uses a 117N7GT tube. Gray crackle finish.

NOW IN STOCK AT ALL LEADING
RADIO DISTRIBUTORS

TELEGRAPH
Apparatus Co.

412 SOUTH GREEN ST.

CHICAGO 7, ILLINOIS



RCA INSTITUTES, INC.

Offer thorough training courses
in all technical phases of
RADIO and TELEVISION

WEEKLY RATES

DAYS - EVENINGS

VETERANS: RCA Institutes is approved
under G. I. Bill of Rights
For Free Catalog write Dept. ST-45

RCA INSTITUTES, INC.

A Radio Corporation of America Service
75 Varick Street, New York 13, N. Y.

Phone, Wire or Write

WHOLESALE

**Radio-Electronic Parts
Tubes, Sets and
Equipment**

R. G. SCELİ & CO.

317 Asylum St. Hartford, Conn.

Telephone 2-1144

BRANCH: 84 ELM ST., BRIDGEPORT, CONN.

(Continued from page 138)

1. You are hereby notified that an election for an ARRL Section Communications Manager for the next two-year term of office is about to be held in each of these Sections in accordance with the provisions of the By-Laws.
2. The elections will take place in the different Sections immediately after the closing date for receipt of nominating petitions as given opposite the different Sections. The Ballots mailed from Headquarters will list in alphabetical sequence the names of all eligible candidates nominated for the position by ARRL full members residing in the Sections concerned. Ballots will be mailed to full members as of the closing dates specified above, for receipt of nominating petitions.
3. Nominating petitions from the Sections named are hereby solicited. Five or more ARRL full members residing in any Section have the privilege of nominating any full member of the League as candidate for Section Manager. The following form for nomination is suggested:

(Place and date)

Communications Manager, ARRL
38 La Salle Road, West Hartford, Conn.
We, the undersigned full members of the ARRL residing in the Section of the Division hereby nominate, as candidate for Section Communications Manager for this Section for the next two-year term of office.

(Five or more signatures of ARRL full members are required.)

The candidates and five or more signers must be League full members in good standing at the time the petition will be thrown out as invalid. Each candidate must have been a licensed amateur operator for at least two years and similarly a full member of the League for at least one continuous year, immediately prior to his nomination or the petition will likewise be invalidated. The complete name, address, and station call of the candidate should be included. All such petitions must be filed at the headquarters office of the League in West Hartford, Conn., by noon of the closing date given for receipt of nominating petitions. There is no limit to the number of petitions that may be filed, but no member shall sign more than one.

4. Members are urged to take initiative immediately, filing petitions for the officials of each Section listed above. This is your opportunity to put the man of your choice in office to carry on the work of the organization in your Section.

— F. E. Handy, Communications Manager

ELECTION RESULTS

Valid petitions nominating a single candidate as Section Manager were filed in a number of Sections, as provided in our Constitution and By-Laws, electing the following officials, the term of office starting on the date given.

Western N. Y.	Charles I. Otero, WSUPH	Sept. 14, 1945
Hawaii	Howard S. Simpson, K6RLG	Sept. 14, 1945
Eastern Pa.	Ferry Mathis, W3EB	Sept. 28, 1945
Vermont	Burtis W. Dean, W1NLO	Oct. 15, 1945
New Mexico	Junius G. Hancock, W5HJF	Oct. 15, 1945



Then there was the studio engineer who committed suicide by cutting his throat at 78—outside in. — W8VPZ.

PROTECT YOUR HOME FROM
TUBERCULOSIS

BUY CHRISTMAS SEALS

LONG SCALE, WIDE RANGE VOLT-OHM-MILLIAMMETER

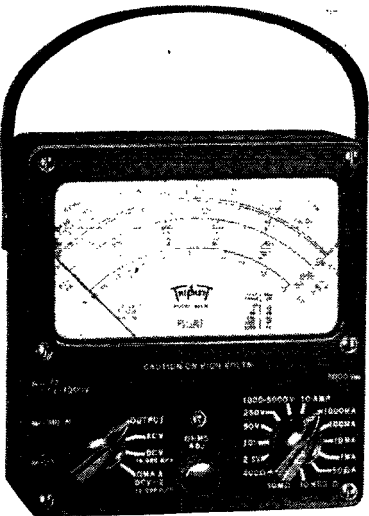

**DOUBLE SENSITIVITY
D.C. VOLT RANGES**
0-1.25-5-25-125-500-2500 Volts
at 20,000 ohms per volt for greater accuracy on Television and other high resistance D.C. circuits.

0-2.5-10-50-250-1000-5000 Volts,
at 10,000 ohms per volt.

A.C. VOLT RANGES
0-2.5-10-50-250-1000-5000 Volts,
at 10,000 ohms per volt.

OHM-MEGOHMS
0-400 ohms (60 ohms center scale)
0-50,000 ohms (300 ohms center scale)
0-10 megohms (60,000 ohms center scale)

**DIRECT READING OUTPUT LEVEL
DECIBEL RANGES**
-30 to +3, +15, +29, +43, +55, +69
DB

**TEMPERATURE COMPENSATED
CIRCUIT FOR ALL CURRENT
RANGES D.C. MICROAMPERES**
0-50 Microamperes, at 250 M.V.

D.C. MILLIAMPERES
0-1-10-100-1000 Milliamperes, at 250
M.V.

D.C. AMPERES
0-10 Amperes, at 250 M.V.

OUTPUT READINGS
Condenser in series with A.C. Volts for
output readings

ATTRACTIVE COMPACT CASE
Size: 2 1/4" x 5 1/4" x 6". A readily portable,
completely insulated, black,
molded case, with strap handle. A
suitable black, leather carrying case
(No. 629) also available, with strap
handle.

LONG 5" SCALE ARC
For greater reading accuracy on the
Triplet RED • DOT Lifetime, Guaranteed meter.

**SIMPLIFIED SWITCHING
CIRCUIT**
Greater ease in changing ranges.

Write for descriptive folder giving full
technical details

Precision first to last

Triplet

ELECTRICAL INSTRUMENT CO. BLUFFTON, OHIO



HERE'S THAT NEW
TRIPLET
625-N

Two-fisted solutions...

TO TRANSFORMER PROBLEMS BY N-Y-T SAMPLE DEPARTMENT!

There are two good reasons why N-Y-T facilities "crack" transformer, choke and filter design and production bottlenecks.

ONE: Extensive, modern, single-purpose manufacturing method, geared for economical production under rigid quality-control.

TWO: Experienced specialized-engineering linked to the accelerated tempo of new developments. Engineering capable of effecting economies in design and manufacture.

This is what we mean by "two-fisted" N-Y-T problem solutions—production that follows thru, even under labor and material shortages; engineering that lowers costs.

1. Specialized facilities
2. Experienced engineering

NEW YORK TRANSFORMER CO.

Orders require to Dept. S

26 WAVERLY PLACE
NEW YORK 3, N. Y.



HAM-ADS

(1) Advertising shall pertain to radio and shall be of nature of interest to radio amateurs or experimenters in their pursuit of the art.

(2) No display of any character will be accepted, nor can any special typographical arrangement, such as all or part capital letters be used which would tend to make one advertisement stand out from the others.

(3) The Ham-Ad rate is 30c per word, except as noted in paragraph (6) below.

(4) Remittance in full must accompany copy. No cash or contract discount or agency commission will be allowed.

(5) Closing date for Ham-Ads is the 25th of the second month preceding publication date.

(6) A special rate of 7c per word will apply to advertising which, in our judgment, is obviously non-commercial in nature and is placed and signed by a member of the American Radio Relay League. Thus, advertising of bona fide surplus equipment owned, used and for sale by an individual or apparatus offered for exchange or advertising inquiring for special equipment, if by a member of the American Radio Relay League takes the 7c rate. An attempt to deal in apparatus in quantity for profit, even if by an individual, is commercial and all advertising by him takes the 30c rate. Provisions of paragraphs (1), (2), (4) and (5), apply to all advertising in this column regardless of which rate may apply.

(7) Because error is more easily avoided, it is requested signature and address be printed plainly.

Having made no investigation of the advertisers in the classified columns, the publishers of QST are unable to vouch for their integrity or for the grade or character of the products or services advertised

QUARTZ — Direct importers from Brazil of best quality pure quartz suitable for making piezo-electric crystals. Diamond Drill Carbon Co., 719 World Bldg., New York City.

COMMERCIAL radio operators examination questions and answers. One dollar per element. G. C. Waller, W5ATV, 6540 Washington Blvd., Tulsa, Okla.

WHY not turn your unused equipment into ready cash which may be applied towards new and better equipment? Leo, W9GFQ, offers you the best cash prices for communications receivers and test equipment. Write today for large illustrated catalog. Wholesale Radio Laboratories, 744 W. Broadway, Council Bluffs, Iowa.

CRYSTALS available — all types, including 100 kc., 465 kc. and 100 kc. Broadcast and Aircraft given prompt attention. Scientific Radio Products, Council Bluffs, Iowa.

CRYSTALS: complete units or blanks. All types. Your specifications and tolerances. One or one million. Refinishing and repairing of your present units. Rex Bassett, Incorporated, Ft. Lauderdale, Fla.

RADIO TESTS — Pre-examination Tests for Radio Operators. Tests your knowledge before you appear for commercial radio operator license examinations. Avoids failures. Guides your preparation. Saves your time. Worth investigating at once. Also books for home study. Write for free circulars 5 Q. Nilson Radio School, 51 E. 42 St., New York 17, N. Y.

WHEN amateurs are on the air again there will be a complete line of James Knights Precision Crystals for every amateur activity. The James Knights Company, Sandwich, Ill.

AMATEUR radio licenses. Complete code or theory preparation for passing amateur radio examinations. Home study and resident courses. American Radio Institute, 101 West 63rd Street, New York City.

AMATEUR and radio servicemen's supplies. Albert Arnold, W5WX, 111 East 3th St., Amarillo, Texas.

WRITE, wire or phone: Bob Henry, W9ARA, Butler, Mo. 24 hour service: new and used receivers, transmitters, test equipment, radio parts of all kinds.

COMPLETE radio kits, \$10.95. Multimeter kits, surplus navy receiving, transmitting, test equipment, free details. Radio, 120 Cedar Street, New York 6, N. Y.

LOOK, fellows! Good stuff: 2 Thordarson C.H.T. #T-15 3C9, 500 ma., 5-25 h. chokes, New, \$13 each. One Stancor #A-3844, 300-watt modulation transformer, \$12. Three Johnson 70E45 var. condensers, 70 μ fd, 4500 volts. \$2.75 ea. W8LUA, 520 West 3rd St., Williamsport 28, Penna.

LOCATE accurately new ham bands with heterodyne frequency meter. Covers all bands through v.h.f.! Write W1JOY, Woodsum, Custom Electronics Laboratory, 9 Ellsworth Road, Nahant, Mass.

SELL: a number of new RCA 828 beam power transmitting tubes. \$9.75 each. Never used. B. H. Stevenson, W2BXA, 12 Mohawk Drive, Cranford, N. J.

FOR SALE: RME 69 receiver. George Kravitz, 7919 20th Avenue, Brooklyn 14, N. Y.

LARGE boxes full of aircraft, radio and electrical parts, \$4.75. Other bargains. Picart, 733-13 Street, San Diego, Calif.

GUARANTEED 813 tubes, \$10. Wise; 424 20th N.E., Cedar Rapids, Iowa.

FCC exams. Study guide with complete set of questions and answers for FCC restricted radiotelephone operator's permit. 50¢. Radio Services Company, 3056 South Abingdon St., Arlington, Va.

PHONE transmitter; enclosed rack; 6 meters; complete with tubes, crystal, microphone. New York City hams only. Phone Stillwell 4-2153, W2HQZ.

ALASKAN hams: Here is a source of supply closer to home. Stocking leading brands of ham gear, communication receivers, parts, accessories, engine generators. Save time and money. Robbie's Radio Supply, Alaskan Jobbers, P.O. Box 1835, Anchorage, Alaska.

QSL-SWL samples. Fritz, 1213 Briargate, Joliet, Illinois.

BILL Conklin, ex-W9BNX, now W3JUX, Bethesda, Maryland. **LOOK!** 4 μ fd 2000 volt DC G.E. Pyranol condensers, rectangular. Can guarantee A-1. \$3 each. Five for \$14.50, plus shipping. Dettman, W21RL, Glenwood Road, Brooklyn 12, N. Y.

FOR sale: 250 watt, four low-band rack and panel transmitter. Complete file all issues QST from 1916 to present, in binders. Write W3CA, Knollwood Road, Lee Hy Park, RFD 4, Roanoke, Va.

FOR Sale: Abbott TR-4 tubes, 6V vibrapack and cable; cost \$65; sell \$47. Harvey Radio Lab 300 v., 150 ma., a.c. power pack (may be used with TR-4); cost \$26, sell \$16. 6V, 300 v., 150 ma. dynamotor; cost \$35, sell \$19. Vibronlex original \$9. Abbott DK-3 tubes, a.c. power supply, \$14. Triplett 0-15 Ma. 2 inch, \$2.50. Percy C. Noble, W1BVR, 37 Broad St., Westfield, Mass.

WANT Model 18-C or 18-B Ferris signal generator. Not over \$300. Dunn, W6RAU, P.O. Box 413, Banning, Calif.

WANTED: Modulation transformer, Ken-O-Tap, No. 495 or Thordarson No. T11M 76. P. A. Johnson, 5453 Nebraska Ave., N.W., Washington, D. C.

CALIFORNIA kilowatt final, all new parts bought just before Pearl Harbor, some mounted, most still in original cartons. Thordarson power supply, 3000 volts, 500 mills. National, Johnson, Aerovox, Barker & Williamson. Write for detailed description. W5JNO.

SELLING ham gear: receivers, transmitters, parts, tubes, etc. Send stamp for list. LeRoy Green, Tupelo, Miss.

LABORATORY power supplies: 0-350 volts, d.c. 300 Ma. With tubes, \$75. Myron R. Smith & Co., 2400 Pleasant Ave., Minneapolis 4, Minn.

RECEIVERS: SX-28A, \$223.00, SX-25, \$94.50, RME-45, \$166.00. National prices soon. Conklin Radio, Bethesda 14, Md.

CRYSTALS: Prompt delivery of those Eidson fine crystals. Highest quality commercial units available throughout the 100-12500 k.c. range. Guaranteed to meet FCC specifications. Also repair and regrinding. Over ten years of satisfaction and fast service! We are as near as your telephone. "Eidson's", Temple, Texas. Phone 3901.

WANTED: FB7 coils, c.d. W3FLW, 3331 Sheffield Ave., Phila., Penna.

HICKOK, Model 202 VTVM in original carton, \$40. RCA 25-watt, p.m. trumpet speaker, cost \$89, for \$40. Kirkland, 20 Poole, Neptune, N. J.

QST, complete run, August 1933 to present. Good condition. Best offer. F.o.b. Walla Walla takes all. Ralph D. Gustin, Box 15, College Place, Washington.

WANTED: RME-99, Ken Moehl, W8PUF, Pittsfield Village, Ann Arbor, Mich.

HAMS! War surplus! What can you use cheap? Lectronic Research, Howell & Hegerman, Phila., Penna.

CRYSTAL microphones, Turner hearing aid type, ultra-sensitive, high output. Guaranteed, \$5. each prepaid. Radio Recording Labs, Box 14, Winthrop, Mass.

QST 1931-1944, in binders, \$50. Will not sell separate. Detroit hams! Equipment for sale. C. R. Funk, 220 Tennyson Avenue, Highland Park, Mich.

CRYSTAL frequency control units. All kinds, including 1000 k.c. calibrating crystals. Also blanks. High quality. Low price. Prompt delivery. Standard Piezo Co., Box 164, Carlisle, Penna.

SELL Transmitter 47 crystal oscillator. 46 before parallel 46's final; antenna coupler, 2 power supplies, tubes, crystal. J. Goodwin, South Deerfield, Mass.

QUARTZ crystal amateur kits using crystals made to Arky Signal Corps specifications, consisting of 3 crystal blanks (TC approximately 2 parts drit, operative 7000, 14000 and 28000 k.c.); 1 bag abrasive for grinding crystals to desired frequency, together with complete instructions; 2 holders complete with both regular electrodes and springs and 2 additional sets of electrodes. Complete kit only \$1.00, postpaid. Crystal Products Co. 1519 McGee, Kansas City, Mo.

It won't be long now!



ECHOPHONE MODEL EC-1A

*A real communications receiver
at a sensationally low price*

Nearer and nearer to reality comes Hogarth's dream of a real communications receiver at a sensationally low price. Now available—or very soon—the 1946 Echophone, Model EC-1A, a 6-tube AC/DC communications receiver of outstanding value. With electrical bandspread throughout its frequency range of .55 to 30 megacycles, BFO for CW reception, and a new automatic noise limiter to suppress interference from automobile ignition, etc., the EC-1A provides genuine communications receiver performance in the lowest price range. Standard 115-volt AC or DC operation; also available for 200 to 250-volt operation.

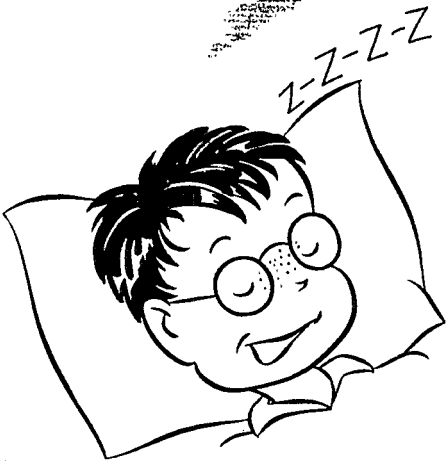

ECHOPHONE

ECHOPHONE DIVISION • THE HALLICRAFTERS CO. • 2611 INDIANA AVENUE • CHICAGO 16, U. S. A.

Designed for



Application

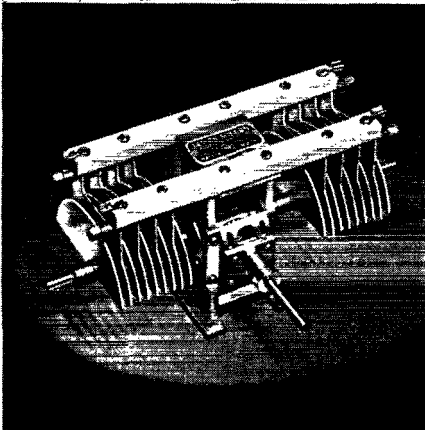

04000 Series

Transmitting Condensers

A new member of the "Designed for Application" series of transmitting variable air capacitors is the 04000 series with peak voltage ratings of 3000, 6000, and 9000 volts. Right angle drive, 1/1 ratio. Adjustable drive shaft angle for either vertical or sloping panels. Sturdy construction, thick, rounded, polished aluminum plates with 13/4" radius. Constant impedance, heavy current, multiple finger rotor contactor of new design. Available in all normal capacities.

**JAMES MILLEN
MFG. CO., INC.**

MAIN OFFICE AND FACTORY

**MALDEN
MASSACHUSETTS**



Index to Advertisers

Adson Radio Co.	132
Allied Radio Corporation	115
American Lava Corporation	4
American Phenolic Corporation	97
American Radio Institute	128
American Tel. & Tel. Co.	128
Andrew Co., The	112
Astatic Corporation, The	131
Audel Publishers, Theo.	130
Barker & Williamson	133
Birnbach Radio Co.	124
Billie Electric Co.	81
Brach Manufacturing Co.	129
Bregle Sales Co., The	132
Burgess Battery Co.	108
Burlington Instrument Co.	118
Candler System Co.	108
Capitol Radio Engineering Institute	90
Cardwell Mfg. Co., Allen D.	96
Carter Motor Co.	114
Cinaudagraph-Aireon Speakers	111
Collins Radio Co.	79
Commercial Radio Institute	116
Concord Radio Corporation	127
Crystal Research Laboratories	122
Delco Radio Co.	123
Echophone Radio Co.	137
Eitel-McCullough, Inc.	5
Electrical Reactance Corp.	120
Electro-Voice Corporation	83
Electronic Controls, Inc.	120
General Electric Company	7
Hallicrafters Co., The	1, 2, 109
Hammarlund Mfg. Co. Inc., The	9, 77, 105
Harvey Radio Co.	107
Hairy & Young	116
Henry Radio Shop	129
Hytron Radio & Elec. Corp.	99
International Resistance Co.	98
Jennings Radio Mfg. Co.	103
Jensen Radio Mfg. Co.	87
Johnson Co., E. F.	119
Lewis Electronics	122
Mallory & Co., Inc., P. R.	88
Marion Electrical Instrument Co.	95
McElroy Mfg. Co.	91
McGraw-Hill Book Co.	124
Millen Mfg. Co., Inc., James	138
National Carbon Co., Inc.	106
National Co.	75, 126, 133, Cov. III
Newark Electric Co.	101
New York Transformer Co.	135
Onan & Sons, D. W.	122
Par-Metal Products Co.	114
Peerless Electrical Prod. Co.	104
Port Arthur College	132
Radell Corp.	130
Radio Mfg. Engineers	139
Radio Prod. Sales Co.	131
Radio Shack Corp.	107
Raytheon Mfg. Co.	85
RCA Institutes	134
RCA Mfg. Co.	Cov. IV
Seell & Co., R. G.	134
Shure Brothers	94
Solar Capacitor Sales	140
Sound Equipment Corp.	116
Sperry Gyroscope Co.	92, 93
Sylvania Elec. Prod. Co.	89
Taylor Tubes Co.	117
Telegraph Apparatus Co.	134
Terminal Radio Co.	113
Thordarson Elec. Mfg. Co.	6
Triplett Elec. Instrument Co.	135
Turner Co., The	126
United Transformer Co.	Cov. II
Valparaiso Technical Institute	100
Vibroplex Co., The	100, 128
Ward Leonard Elec. Co.	100
Wholesale Radio Labs.	128
Yaxley (Mallory & Co., P. R.)	88

PEAK PERFORMANCE

on the "Highs"



with the new
RME 45

Features

Streamlined two-tone cabinet

Acoustically designed speaker housing

Relay rack mounting panel
Six bands, 550 to 33,000 KC

Automatic noise limiter
Relay control and break-in terminals

Signal level meter
Variable crystal filter

Bandspread—equivalent to 75 linear inches for every 180 degree sweep of main pointer

★
With the new RME 45 you'll have peak performance on the high as well as the low frequencies. There's no secret about how it was done—even though some of the experience has been gained while producing for the Armed Forces.

★
It was accomplished by the use of loctal tubes . . . shorter leads . . . reduced distributed capacity . . . temperature compensating padders . . . and a score of additional refinements—each making its individual contribution to increased efficiency.

★
The RME 45 combines careful workmanship with ease of operation, sound engineering and brilliant performance.

*Literature Describing the
RME 45 will be sent on request*



RME

FINE COMMUNICATIONS EQUIPMENT

RADIO MFG. ENGINEERS, INC.

Provia 6, Illinois U. S. A.

**you can't
put the squeeze
on SEALDTITE
CAPACITORS**



Just try it . . . Take a genuine "Sealdtite" capacitor and try to *squeeze* it. No results. You'll find it has no soft spots, which in ordinary tubulars provide room for moisture, the capacitor's worst enemy. Because the Solar capacitor has an internal winding of high quality paper and foil, skillfully *molded* into *solid* plastic.

No moisture can penetrate this protective case and its substantial construction permits rough handling, assures long and *reliable* service.

Use "Sealdtite" capacitors. Send for your copy of Catalog SC-1.
Any Climate—Any Atmosphere—
Any Service.



Ⓢ 7567



BAYONNE PLANT
WEST N.Y. PLANT



A TOTAL OF TEN ARMY-NAVY
EXCELLENCE AWARDS

SOLAR MANUFACTURING CORP.
285 MADISON AVENUE, NEW YORK CITY

Index to Volume XXIX—1945

ANTENNAS

Automatic Antenna Switching (Robinson).....	38, Apr.
Calculations for Antenna Orientation (Marquart).....	46, July
Coaxial Antenna for 112 Mc., A (Parker).....	40, June
Coupling Network for Working Several Bands on One Antenna (H & K).....	53, Jan.
Ground-Plane Antennas (Smith).....	28, Aug.
Matching the Antenna for Two-Band Operation (Marshall).....	23, Sept.
Plywood Antenna Masts.....	27, May
Ready Aim Fire (Marquart).....	43, Apr.
Rugged Pipe Mast, A (H & K).....	52, June
Series or Parallel Tuning Without Relays or Switches (H & K).....	53, June
Short-Wave Loop Antenna, A (H & K).....	55, Mar.
Transmit-Receive Antenna Switching Using Gas-Filled Tubes (H & K).....	52, Apr.
2½-meter Coaxial Antenna Made from Coast Guard Surplus (H & K).....	52, Jan.

ARRL Emergency Corps Program (Handy)....	49, Dec.
ARRL Affiliated Club Honor Roll.....	56, July; 67, Nov.
C.D. Staff Notes.....	66, Nov.
Challenge, A.....	65, Nov.
Election Notices and Results, SCMs.....	52, Feb.; 59, Apr.; 61, June; 61, Aug.; 88, Oct.; 73, Dec.
Ham Yarns.....	W9VOR, 59, Jan.; W9UCN, 51, Feb.; W8UMT, 63, Mar.; W2OEN, 62, June
Meet the SCMs.....	W6CW, 59, Jan.; W5ALA, 64, Mar.; W9FQB, 58, July
Military Radio Operating Procedures (Hertzberg).....	32, July
Now is the Time.....	57, Sept.
Planning for Emergency Communications.....	85, Oct.
Plans for DX Century Club.....	73, Dec.
Postwar Prospects.....	49, Feb.
Press Schedules.....	59, Apr.
Section Emergency Coordinators.....	72, Dec.
What is an SCM? (Austin).....	61, Aug.
W1AW Returns to the Air.....	73, Dec.
20-Year Club.....	64, Mar.; 57, Sept.

AUDIO-FREQUENCY EQUIPMENT AND DESIGN

Bass Boost (Grammer).....	35, July
Bass and Treble Boost Circuit (H & K).....	57, Aug.
Cathode Follower Circuits (Greenwood).....	11, June
Drive for Home-Recording Cutting Head (H & K).....	44, Feb.
Extended-Range Audio Oscillator, An (Leipert).....	24, Feb.
High Gain A.C.-D.C. Audio Amplifier, A (Rand).....	32, Jan.
Homemade Intercommunicating System, A (Hartnell).....	46, Jan.
How Microphones Work (Kahn).....	34, Sept.
Improved Driver Stages for Class A Amplifiers (Henry).....	45, Nov.
Inter-Com. Phono-Amp and Receiver Combination (H & K).....	53, June
Miniature Bass Reflex Cabinet (H & K).....	53, Sept.
Practical Applications of Simple Math (Noll) Part IX — Amplifier-Tube Operating Conditions in Relation to Circuit Values.....	42, Jan.
Part X — Determining Operating Points for Tetrodes and Pentodes..	40, Feb.
Push-Pull Class A Without Phase Inverter (H & K).....	52, May
Universal Output Transformers Used in Modulator (H & K).....	56, Mar.
Volume-Expander for Audio Amplifiers, A (Weidemann).....	19, Aug.

"THE CRYSTAL BALL"

Announcement.....	21, July
September, page 42	
Two-Stage Transmitter	
Modern Features for Postwar W3JOP	
Frequency Indications on a V.F.O.	
Ham Buys a Receiver in VJ-1, A	
Advanced Thoughts on Equipment Placement	
Simplified Low-Cost Transmitter, A	
Space-Saving Technique for Mobile Gear	
How's Your Crystal Ball Working, OM?	
October, page 74	
A Microwave System with Break-in Operation	
One-Unit Power Supply at W8AVH	
Aircraft Warning Tower for Ham Station	
Single-Dial Control and an Automatic Antenna	
November, page 51	
More of the Same, Only Better	
Built-in Convenience at W1HRG	
Introducing the "Peekmeter"	
Multi-Front-End Receiver with Dual I.F.	
Channels and Single Output Circuit	
Operating a Rig from the Darkroom	
One Ham's Ideal Receiver	
Lighthouses, Butterflies and Plumbing	
December, page 65	
Progressive Construction	
Remote Control Methods at W4FKV	
A One-Tube Transmitter for W2JIL	
The Line Forms at the Right	

COMMUNICATION, NON-RADIO

Carrier Current.....	50, Jan.
F.M. Receiver for Carrier-Current Communication, An (Guill, Jr.).....	46, Mar.
Home-Made Intercommunicating System, A (Hartnell).....	46, Jan.

COMMUNICATIONS DEPARTMENT

Amateur Radio Procedure.....	73, Dec.
ARRL Emergency Corps Invitation.....	72, Dec.

EDITORIALS

Above 25.....	9, Mar.
Disaster Relief — A Call to Organize.....	9, June
Inventory.....	9, Aug.
Ladies and Gentlemen — the Navy.....	11, Oct.
Newcomers, The.....	9, Sept.
On Being an Amateur.....	9, May
Phonetics.....	10, Mar.
Postwar Operation.....	9, Jan.
Reconversion Headaches.....	9, Nov.

Reopening.....	11, Oct.
Station Calls.....	9, Feb.
Them Thar Hambands.....	9, Feb.
Tropospheric DX.....	9, Apr.
Two More Hurdles.....	9, July
We Go To Work.....	10, Nov.
We're Off.....	11, Dec.
Year's End — and a New Year.....	10, Jan.

EMERGENCY AND RELIEF WORK

ARRL Emergency Corps Program (Handy)...	49, Dec.
Planning for Emergency Communications.....	85, Oct.
Radio Saves Life of Aleutian Outpost Commander (Granberg).....	42, Feb.
September Hurricane Finds Miami WERS Ready.....	66, Nov.
WERS on the Job in the Spring Floods.....	69, June
WERS Prepared.....	56, May
WKBS and the Syracuse Snow Storm.....	51, Feb.

FEATURES AND FICTION

"Bismarck" (Craft).....	29, Sept.
Building an RAAF B.C. Station (Turner).....	19, Feb.
Citizens Radiocommunication Service.....	45, Mar.
"Flummajimmery" ("Sourdough").....	44, May
Gawp ("Sourdough").....	40, Dec.
German Key, A.....	18, Jan.
"Ghost of Guam, The" — KB6GJX (Middletton).....	38, Mar.
Hamdom — W1IOB, W9MV, W2MUJ.....	53, Aug.
Ham Help for Ex-Service Men.....	60, Mar.
Hams Afloat (Nelson).....	42, Apr.
Hams in Combat	
Danger in the Early Morning (Tripp).....	41, Aug.
Hamming on the Road to Berlin (Welsh).....	50, May
His Last Strike (Hudson).....	36, June
In Burma with the AACs (Hanley, Jr., Shane, Chasan).....	48, July
Invasion Hams (Brawley).....	50, Apr.
Last Stand at Calais (G5NO).....	46, Sept.
Mine Sweeper, (Zimmerman).....	48, Mar.
Mobile with the 5th Armored Division (Meade).....	40, Nov.
Radio Saves Life of Aleutian Outpost Commander (Granberg).....	42, Feb.
See You in Tokyo (Coleman).....	44, Jan.
"Handbook" on Leyte, A (Read).....	22, Mar.
Hams in the F.B.I.S. (Read).....	34, Jan.
Hams on the Alaska Highway (Colvin).....	46, Apr.
Loran — the Latest in Navigational Aids (McKenzie).....	12, Dec.
Navy Communications and the Amateur (Redman).....	14, Oct.
Buships Ham Gallery.....	20, Oct.
Equipping the Fleet.....	23, Oct.
The Navy Afloat.....	52, Oct.
The Navy Ashore.....	16, Oct.
The Navy in Combat.....	60, Oct.
Necessity is a Mudder (Kelly).....	38, Dec.
QST Goes Voyaging on a USMS Training Ship (Middletton).....	13, Aug.
QST Looks at Television — 1944 (Read).....	11, Jan.
Radio Amateurs in Navy Radar (Lillie).....	24, Apr.
Radio Set SCR-506 — A Biography (Middletton).....	11, May
SARO Mid-Pacific Chapter.....	58, May
Signal Corps Radio Relay in North Africa (Perkins and Middletton).....	11, Sept.
This is Your Armed Forces Radio Station (Granberg).....	54, June
Those Singing Masts (Borgia).....	39, Sept.

FOREIGN NEWS

Amateurs Operating.....	60, Mar.
Bailey Addresses Chinese Amateurs.....	27, Aug.
British Notes.....	23, May
CARL — The Chinese Amateur Radio League.....	24, May
Foreign Notes.....	61, Dec.
Good News.....	14, Nov.
New Zealand Notes.....	22, Jan.
RSGE Notes.....	27, Aug.
Second London Hamfest.....	49, Jan.

HAPPENINGS OF THE MONTH

Allocations Below 25 Mc.....	27, Aug.
Allocation News.....	17, Apr.; 22, May; 19, June; 21, Sept.; 65, Oct.
Allocation Progress.....	33, Feb.
Bailey Elected Executive Secretary of I.R.E.....	18, Apr.
Bermuda Conference.....	32, Dec.
Board Meeting, 1945.....	23, May; 40, July; 19, June
Canadian Notes.....	34, Feb.; 23, May
Election Notices, Directors.....	23, Aug.; 21, Sept.; 42 Nov.; 32, Dec.
Election Results, Directors.....	33, Feb.; 18, Apr.; 42, Nov.
Engineers Wanted.....	18, Apr.
ESCTC Announces Course in Amateur Radio.....	37, Dec.
Examination Schedules, 1945.....	42, Nov.
Executive Committee Meeting.....	27, Aug.
FCC Takes the Ball.....	19, Jan.
G.I. Amateur Radio.....	32, Dec.
Glossary.....	90, Dec.
Gross to Berne.....	22, June
H.F. Lifeboat Radio.....	18, Apr.
Ignition Interference.....	82, Feb.
I.R.E. Winter Technical Meetings.....	22, Jan.; 17, Mar.
Maritime Radio Teachers Wanted.....	43, Nov.
Personnel Bureau Folds.....	66, Oct.
Personal Mentions — W3QV, W4XE, W3EEA, W9UZ.....	34, Feb.
Regulations Committes.....	39, July
Renewing Commercial Licenses.....	17, Apr.
Rocky Mountain Notes.....	32, Dec.
Staff Notes.....	20, Jan.; 43, Nov.; 65, Oct.
U.S.M.S. Ops Needed.....	21, June
Veteran's Band Proposed.....	20, Jan.
VWOA Celebrates 20th Birthday.....	19, Apr.
Warning to Carrier Current and Induction Field Experimenters.....	66, Oct.
Webster Chairmans I.R.A.C.....	21, June

KEYING

Better Electronic Keyer, A (Beecher).....	44, Aug.
Dual-Tone Keying Monitor (H & K).....	55, Mar.
Electronic Bug Movement (H & K).....	45, Feb.
German Key, A.....	18, Jan.
Plug for Your Bug Key, A (H & K).....	53, June
Source of Key Contact Material, A.....	56, Aug.
Versatile Electronic Key, A (Snyder).....	42, Mar.
Correction.....	82, May

MEASUREMENTS AND TEST EQUIPMENT

Battery-Powered One-Tube 450- and 1500-Kc. Signal Generator (H & K).....	52, May
Condenser-Checker and Output Meter, A (H & K).....	52, Sept.
Condenser-Checker Using a 6E5, A (H & K).....	52, May

Extended-Range Audio Oscillator, An (Leipert)	24, Feb.
Finding the 144-Mc. Band	15, Nov.
Forward-Reading "S" Meter, A (H & K)	54, Mar.
Increasing Vacuum-Tube Volt-Ohmmeter Sensitivity (Glenn)	35, Feb.
Multi-Purpose V.H.F. Equipment (H & K)	52, July
Simplified Method for Calculating L and C on the Slide Rule (H & K)	56, Mar.
Single-Gang Multipoint Switching for V.O.M.-V.T.V.M. (H & K)	53, Jan.
Some Handy Test Probes (H & K)	51, Jan.
Taming the Vacuum-Tube Voltmeter (Silver)	
Part I — New Method for Increasing Utility and Dependability	17, July
Part II — Construction of a Practical Instrument	34, Aug.
Vacuum-Tube Volt-Ohmmeter, A (H & K)	52, Apr.
Correction	10, July
WWV Schedules	76, Jan.; 70, Feb.; 90, Mar.; 82, Apr.; 41, Dec.

MICROWAVE TECHNIQUE

Band-Width Requirements for Pulse Type Transmitters (Hansen)	11, Feb.
Centimeter-Wave Magnetrons (Argento)	17, Dec.
Forms of Pulse Modulation	52, Dec.
Getting Acquainted with the "Lighthouse" Tube (Rand)	11, Nov.
Radar Techniques (DeSoto)	
Part I — Primer Principles	20, Apr.
Part II — Simple Analogies	46, May
Part III — Charges, Fields and Waves	44, June
Part IV — Boundaries	48, Aug.
Waves and Wave Guides	54, Nov.; 53, Dec.

MISCELLANEOUS

Attention — Inventors	44, Mar.
Automatic Relaying	23, Jan.
Blueprint Name Plates (H & K)	52, Sept.
Boston Radio Sealing Unit	87, Oct.
Captured Enemy Radio Equipment	18, Jan.; 43, Feb.; 32, June
Circulation Statement	38, May
Citizens Radiocommunication Service	45, Mar.
Code-Practice Oscillator Using No Transformer (H & K)	52, June
Equipment Nameplates from Hand-Drawn Negatives (H & K)	53, Apr.
Hyperbolic Functions (Minor)	30, June
Correction	10, July
Jig for Centering Holes in Shafts or Screws (H & K)	53, May
Missing in Action	78, May; 35, June
Microwave Relay Stations	22, June
New Source of Aluminum Stook, A (H & K)	53, May
Practical Applications of Simple Math (Noll)	42, Jan.; 40, Feb.; 57, Dec.
Radio Relay Links Planned	40, Aug.
Shield for Miniature Tubes	57, Aug.
Time Saving Idea for Coil Constructors, A (H & K)	53, May
Wire-Loop Forming Tool (H & K)	52, Sept.
World Wide Advertising via Radiophoto	92, Mar.

OBITUARY

Gold Stars:	
W7EDV, W8ULR	47, Jan.
W8MAD, W8UFO, W2KCD	41, Feb.
W7IZV, W8SPK	53, Mar.
W5IZP, W2MKW	49, Apr.

W6SPE, W3IKG, W1MLI	45, May
W7BHH, W7CYC	41, June
W3GXJ, W5EOO	16, July
W3GEF, W9RUJ	55, Aug.
W8HFW, W5CIQ, W1NKV	37, Sept.
Silent Keys	24, Jan.; 68, Feb.; 88, Mar.; 98, Apr.; 78, May; 35, June; 88, July; 94, Aug.; 28, Sept.; 120, Oct.; 122, Nov.; 35, Dec.

POWER SUPPLIES

Adapter for Octal-Base Rectifier Tubes (H & K)	56, Mar.
Auto Transformer for Filament Supply (H & K)	52, June
Full-Wave Transformerless Low-Voltage Supply, A (H & K)	52, July
New Type of Dry Cell	16, Apr.
Utilizing the VR-Series Tubes (Anderson)	36, Dec.

RECEIVING

Antenna Coupler for the Receiver (H & K)	52, June
Controlled Regeneration on RME-69 Receiver (H & K)	57, Aug.
Fox-Hole Radio (H & K)	53, Sept.
Graphical Solution of Bandspread Problems (Buccicone)	42, June
Homemade Radio-Range Receiver, A (Browdy)	17, Feb.
Improved Hetrofil Circuit (H & K)	53, July
Inter-Com, Phono-Amp and Receiver Combination, An (H & K)	53, June
Know Your Coupled Circuits (Espy)	76, Oct.
Midget Transmitter-Receiver, A (Clemens)	38, Jan.
Miniature Ham-Band C.W. Station, A (Gates)	25, Jan.
One-Tube Receiver (H & K)	56, Aug.
Panoramic Reception (Pollack)	18, Mar.
Substitute Discriminator Transformer, A (H & K)	52, Sept.
Using One Receiver to Check I.F. of Another (H & K)	45, Feb.
21-Tube All Purpose Receiver, A (Marshall)	31, Nov.

REGULATIONS AND LEGISLATION

Allocations Below 25 Mc.	27, Aug.
Amateur Examinations	21, Jan.
FCC Allocates 44-108 Megacycles	11, Aug.
FCC's Final Allocations Above 25 Mc.	11, July
FCC's Proposed Allocations Below 25 Mc.	15, July
FCC Report, The	14, Mar.
First Reopening Order	65, Oct.
Hawaiian Restrictions Removed	31, Dec.
Inter-American Radio Conference at Rio, The (Budlong)	33, Dec.
License Term Increased	43, Nov.
More on Postwar Station Calls	20, Sept.
New Call Areas	31, Dec.
Operator Licenses Extended	19, Jan.
Postwar Station Calls (Service)	24, July
Note on:	23, Aug.
Regulations Committee	39, July
Reopening	11, Oct.
Second Reopening Order	31, Dec.
Waiver of Proof of Use	33, Feb.

TRANSMITTING

Band-Width Requirements for Pulse-Type Transmissions (Hansen)	11, Feb.
Compact V.F.O. with Stable Output, A (Lynch and Goodwin)	34, Mar.
Crystal Control in the New Ham Bands (Holmbeck)	38, Nov.

Four-Band 125-Watt Transmitter, A (Goodman).....	22, Dec.
Graphical Solution of Bandsread Problems (Buccione).....	42, June
Inexpensive Transmitter Console, A (Garber).....	42, Dec.
Know Your Coupled Circuits (Espy).....	76, Oct.
Low-Frequency Aircraft Transmitter for CAP, A (Peterson).....	40, May
Midget Transmitter-Receiver, A (Clemens)....	38, Jan.
Miniature Ham-Band C.W. Station, A (Gates).....	25, Jan.
Polyphase Systems Applied to R.F. (Bickmore).....	11, Mar.
Additional Comments:.....	56, June
Notes on Electron-Coupled Oscillators (H & K).....	52, July
Search for V.F.O. Stability, A (Robinson).....	18, May
"Tom Thumb" (Palmer).....	48, Sept.
Using the New High Power Beam Tubes (Mix).....	67, Oct.
230 Watts from One 815 (Greenwood).....	26, Apr

TUBES

Adaptor for Octal-Base Rectifier Tubes (H & K).....	56, Mar.
Centimeter-Wave Magnetrons (Argento).....	17, Dec.
Curing Troubles with HY75 Tubes (H & K)....	55, Mar.
Getting Acquainted with the "Lighthouse" Tube (Rand).....	11, Nov.
New Transmitting Tube (4-125A).....	45, Apr.
New Tubes (6N4, 2C40, 3C22, 1B48, CK51OAX, 6AJ5, 2523N1, OA2, 4-25OA, 822S).....	46, Aug.
Shield for Miniature Tubes (H & K).....	57, Aug.
Using the New High Power Beam Tubes (Mix).....	67, Oct.
Utilizing the VR-Series Tubes (Anderson).....	36, Dec.

VERY-HIGH FREQUENCIES — APPARATUS

"Anti-Squealer" for Superregenerative Receivers, An (Rand).....	23, June
Crystal-Controlled Transmitter for the V.H.F.s, A (Brooks).....	25, May
Crystal Controlled 112-Mc. Mobile Transmitter, A (Waters).....	41, July
Dual-Input Receiver for WERS Local Controls, A (Craven).....	16, Jan.
Improved Handie-Talkie (H & K).....	56, Aug.
One-Tube F.M. Converter.....	22, May
One-Tube 112-Mc. Converter (H & K).....	52, May
Para-Talkie, The (Copland).....	34, Apr.
Transmitter-Receiver for CAP-WERS Work, A (Lathrop).....	24, Mar.
WERS Master-Controlled Transmitter, A (Rand).....	27, Feb.

VERY-HIGH FREQUENCIES — GENERAL

Automatic Relaying.....	23, Jan.
Choosing U.H.F. Sites (Rand).....	16, Sept.
Converting 112-Mc. Gear for 144 (Rand, Bradley).....	72, Oct.
Curing Trouble with HY75 Tubes (H & K)....	55, Mar.
Extended Range Television Reception (Wilder).....	18, Nov.
Finding the 144-Mc. Band.....	15, Nov.
Frequency Multiplication for the U.H.F. Bands (Gardner).....	45, Dec.
Multipurpose V.H.F. Equipment (H & K).....	52, July
On the Very Highs (Tilton)....70, Oct.; 59, Nov.; 62, Dec.	
Practical Design of Video Amplifiers (Henry) I, Apr.;.....	32, May
QST Looks at Television — 1944 (Read).....	11, Jan.
Simple Automatic Relaying System for WERS, A (McCoy).....	34, June
Simplified F.M. (Geist).....	29, Dec.
Transceiver Improvement (H & K).....	51, Jan.
Wide-Range Tank Circuits for V.H.F. and U.H.F. (Gable and Read).....	48, Apr
Transmission Requirements and Bell System Facilities for Video and Music.....	13, Feb.

WAR EMERGENCY RADIO SERVICE

FCC Announcements.....	57, Apr.; 59, June; 56, July; 27, Aug.
Hidden Transmitter Hunts for WERS.....	62, Mar.
Message from OCD in Washington, A.....	57, Jan.
Mutual Assistance Planned at New York City Meeting.....	57, May
Ohio CAP Field Day.....	61, Mar.
Radio Aides.....	56, July
Red Cross and WERS.....	27, Aug.
Red Cross Mobile Disaster Headquarters — WERS Equipped (Hendrix).....	14, Feb.
State Guard on 80.....	18, Apr.
WERS Expanded.....	19, June
WERS Standings.....	56, May
WERS Survey.....	60, Aug.
WERS of the Month	
Bethlehem, N. Y.....	62, Aug.
Burleigh County, N. D.....	58, Sept.
Mercer County, Pa.....	67, Nov.
Montclair, N. J.....	57, July
Pittsfield, Mass.....	60, June
San Mateo, Cal.....	58, Apr.

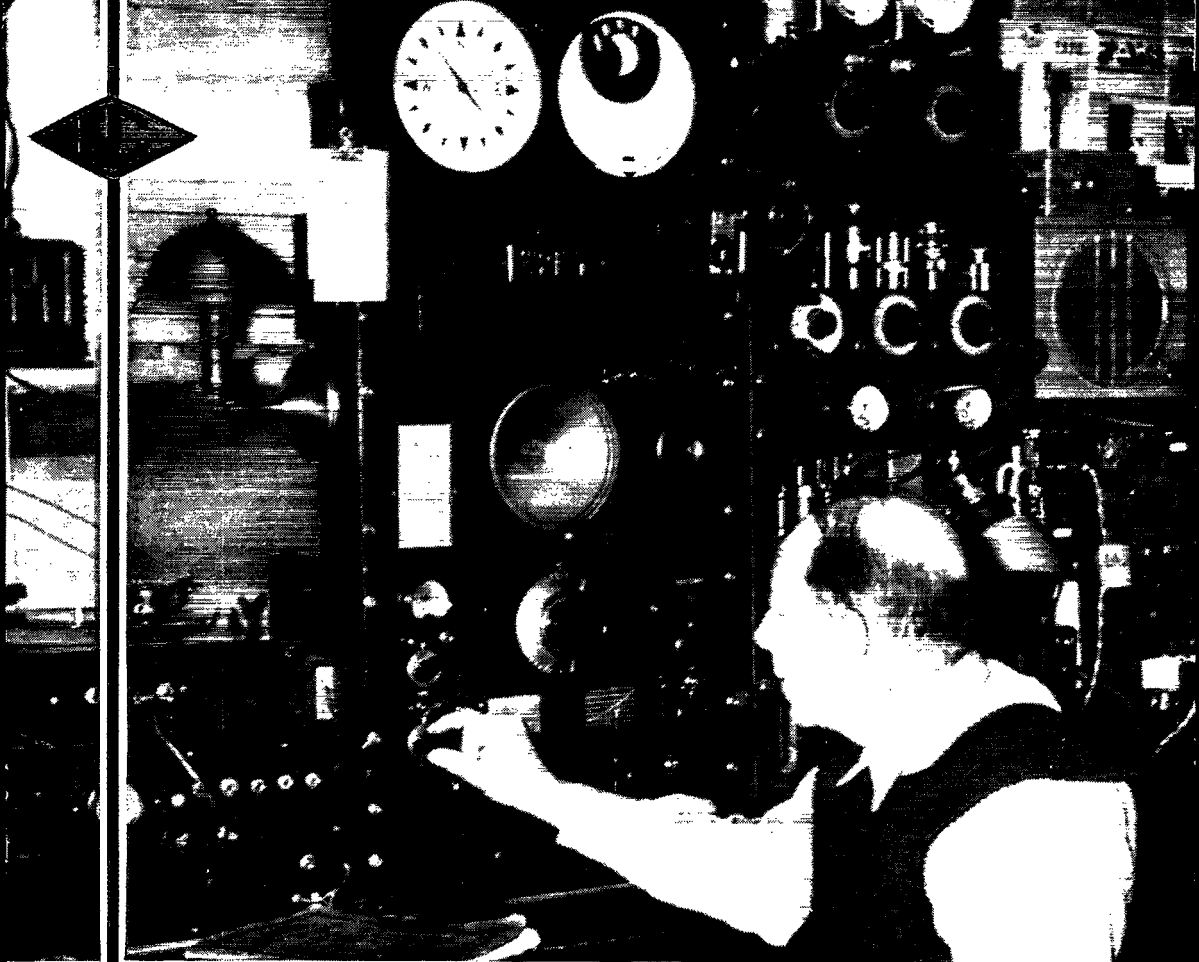

CAPTAIN HORACE L. HALL, U.S. Merchant Marine, retired, at his home in Springfield, L.I., N.Y., made daily recordings of transmissions from Australia, for more than four years, missing but four days. The apparently harmless news broadcasts kept the Australian Government in New York and Washington informed of every phase of the progress of the war, by a pre-arranged code.

The National HRO, used for this remarkable accomplishment is the first ever to have been shipped into the New York area and is over ten years old.

NATIONAL COMPANY INC., MALDEN, MASS.

RCA Tube Plant, Lancaster, Penna.
RCA manufactures power tubes,
as well as cathode-ray tubes, in
this modern plant.



Last year the production of
CATHODE-RAY TUBES

by the Tube Division of RCA
was approximately double that of
the next-largest manufacturer



THE FOUNTAINHEAD OF MODERN
TUBE DEVELOPMENT IS RCA



62-6196-36

RADIO CORPORATION OF AMERICA

TUBE DIVISION • HARRISON, N. J.